

UNIV. OF  
TORONTO  
LIBRARY

Digitized by the Internet Archive  
in 2008 with funding from  
Microsoft Corporation







P  
Technol  
B

# THE BUILDING NEWS

AND

ENGINEERING JOURNAL.

---

VOLUME ONE HUNDRED AND THIRTEEN.

*JULY TO DECEMBER, 1917.*

141364

29/11/18

---

Published for the STRAND NEWSPAPER CO., Ltd., by E. J. KIBBLEWHITE, Managing Director,

AT THE OFFICE OF THE "BUILDING NEWS,"

EFFINGHAM HOUSE, ARUNDEL STREET, STRAND, LONDON, W.C.

# INDEX TO VOL. CXIII.

[For Index to Illustrations see page V.]

**ABBAY:** church (Fort Augustus) 424; Do'rs of (Edinburgh) 397; Looock and Corsham church (Wiltshire) 364; M.P. for the 158; Westminster, propos'd war memorial chapel, 284 Academy, Royal, 177 Act: (Civil) Emergency, 319; Finance, 131; Workmen's Compensation, 141 Adams, L. out, H. F. R., the late, 357 Additions to the National Gallery, 29 Address, president's, R.I.B.A., 377 Addresses at the Thavos, re' estab., 401 Agricultural Association Bureau and drawing office, 105 Air-raid: and bombardment, national responsibility, 361; shelter against, 501; sump, reconstruction 167, 61 Aisle, south, Corsham church, Wilt., 364 Ailsborth, Victoria museum, 217 Alexander, Capt. G. L., the late, 214 Alhambra, new (Chesh.) 32, 36 Altar, Lady chapel and pendants, All Saints' church, Gt-Oxford, 393 America, Architectural Institute of, 18 American Institute of Electrical Engineers, 55 Amersham, Bucks., Woodland Court, 42 Ancient Scottish bridges, 497 Anglo-Catholicism, revived, 79 Annual report, Local Government Board, 101 Apparatus repairs, simple, 104 Application, tenancy, 128 Apprentices, enlisted, 210 Apprenticeship in the building trades, 37 Archaeological: Association, Bristol and Gloucestershire, 78 (British) 78, society (Cambridg.) 78 (Hampstead S. Home) and 477; Norfolk, 118 (Society) 108 Architect: and his bill of costs, 48; London County Council (Mr. W. E. Riley, F.R.I.B.A.) 81 Architects' and ass'tants' women, 442; list of daily, 78; British Royal Institute of, 377, 476; Cape Institute of, 155; charges, 173; fees, 78, 261, 492, 500; Government, and, 459; licensing of, 223; Manchester society reorganised, 281; slackers, 499; society of (London) 18; war committee, 421, 487; women, and the A., 157, 201 Architectural: as occupation, 124, 457 (Edinburgh) 41, 42, 175, 237 (meeting) 163 (new premises) 41, 225, 237 (of Ireland) 289, 157 (pictures at) 204 (school of architecture) 204; Craftsman Society, Glasgow, 497; Institute of America, 506; League of New York, 282; profession, ethics of the, 414; report, Government of India, annual, 112; Society, Nottingham and Derby, 257, 290, 176 Architecture: and the future, 303; degradation of, 169; initiative, lacking, 19, 49; school of, Architectural Association, 201; university of London School of, 180 Armour in churches, 52 Artistic, National gallery of, 43; Christian modernism and, 129; College of, Edinburgh, 159, 295; competition, Carnegie, 38; gallery, Hulme, sculpture, 184; on the hire system, 293; popularity, 202; school of, Newcastle-Tyne, 237; to be ignored in reconstruction, 142 282; to name for photographers, 42 Artillery: batt., 293, 221; wood from autumn leaves, 462 Artistic: Bibles, 19 Art and Ind. Exhib. Exhibition, 513; medals, Club, Burlington, fine design of, 46; of deceased, 190; of 1917, 123 Art: and architecture, from dusts of, 96 Art: and craft, 179; natural, 179 A photograph, 19 Association: Architectural, 124, 437 (Edinburgh) 179 (meeting) 124, 437 (New York) 11, 202 (of Ireland) 380 (picture at) 201 (school of

architecture) 201; British Archaeological, 78; London of Master Decorators' 437; Antiquaries and E-tate Agents' Institute, report, 39 Autumn leaves: artificial wood from, 162 Avonshire, Donslet, Comb Pine church, 162 **BADEN-BADEN**, new buildings for the World, 197 Bachmann court, St.owell Park, Cran-croft, 17 Baltic Exchange, 298 Banks: of England, National Provincial (Lancto.) 184; of Liverpool, new premises at Darham, 177 Bar's fault of concrete, 318 Bernardino's statue of Lincoln, 279 Barrington court, Som. set, 44 Barrow: housing conditions at, 219, 221 Basme-toke, All Saints' church, 278 Bath, 122 Beauty, eight of, 282 Bedstead: painted (David Garrick's) 49; State, a famous, 319 Bed: sugar refineries, 318 Beetle, wood-boring, 342 Belfast cathedral, 221 Benevolent: Fund, Survivors' Institu-tion, 538; Institution, builders', 55, 80 Benn-U. v. Sprague, 17 Berwickshire Naturalists' Club, 298 Birkenshaw, house, wanted at, 298 Birmingham: housing and town plan-nings, 258; munition factory, outcrop and entrance building, 495; new school, 58; roads, widening of, 322 Bishop Hoekley, memorial to, 359 Bight of beauty, 222 Board: Fuel Research, 79; Metropoli-tan Water, 438, 441; of Education, housing of, 1 Board of Trade Journal, 480 Bolton, Lancashire, and Cheshire miners' hall, 237 Bonds, bonus, 202 Bradford-on-Avon, bridge chapel, 462 Brewer, Mr. A., the late, 179 Bribery and corruption, 142 Bricks of cement, clay, and shale, burned under new process, 516 Brick, Mr. P. E., 282 Bridge: chapel, Bradford-on-Avon, 462; Charing Cross railway, 22; Sus-sexian, famous, 298 Bridges, Scottish, ancient, 467 Brine and salt, deteriorating action of, on reinforced concrete, 511 Bristol and Gloucestershire Archaeo-logical Society, 78 British: Archaeological Association, 78; Architects, Royal Institute of, 377; Art, National Gallery of, 43; Arts, Royal Society of, 323; comit-tee (exportation to Holland) 40 (insti-tute) 43 Bronze-plated iron, pre-Roman, 518 Build, how the Chinese, 64 Builder: charged with stealing two principal, 238; the village, 428 Builders' and workmen's dwellings, 175; benevolent institution, 58, 95 Building: a concrete house in three days, 423; by laws, Local Govern-ment Board on, 340; chapel, Mony-bull railway, 18; contracts, 142; Cunard, Liverpool, two interiors, 277; dear, and its remedies, 242; Han-Compton distret, 179; home, 1, 121, 153, 351, 398; illegal, 164; in Canada, 258; insurance office, Kew, 477; Lon-don County Council, new, 162; ma-terial, 159 (after the war) 379; pri-vate, 1; restrictions, 99; roof of an electric-light, 288; societies, 95; tallest, in the world, 250; trade, 19 (apprenticeship in the) 97; trades employers, National Federation of, 92 Buildings, concrete, noise in rein-forced, 37 Bureau: Agricultural Association and drawing office, 438; of standards, 219 Burial of a river, 340

Burlington Fine Arts Club, drawings of deceased masters, and decorative furniture at the, 460 Burn, houses that will not, 177 Burning of St. Mary's, Whitechirk, 339 Burst pipes, 43 Bushell, Rev. W. D., the late, 199 Business names, registration of, 161 By-laws, local, 221; model, 331, 401 **CAIRO** cathedral, 99 Camberwell borough council libraries, 12 Calme, Mr. R. A., the late, 98 Camera, 379 Campaign, Chicago's "build as usual," 62 Canada: mineral production of, 298; Royal Architectural Institute of, 397; building in, 358 Canal control, 158 Cant, 341 Cap: Institute of Architects, 158 Capital and labour, 81 Carline, rebuilding, 198 Cardiff fire hazard, All Saints' church, Carnegie art competition, 33 Castle Lynton, Hythe, Kent, 277 Catalogue of the Walker art gallery, 358 Cathedral: B-fest, 221; Cairo, 99; Cork (St. Fin Barre's), 299; Liver-pool, 258; St. Paul's, 179; Washing-ton (founder's tomb), 36 Cathedral, last of linen, in, 358 Cement: British, exportation of, to Holland, 401; clay and shale bricks of, burned under new pro-cess, 516; green, lettering on, 54; industry (Briti-h) 45 (Danish) 238 (Japan) 99; Manufacturers, Ltd., Associated Portland, 278; Portland, 21, 43 (manufacture in) 24; rein-forced, 19 Chamber, council, Edinburgh, new heraldic frieze, 362 Chancel organ, and stalls screens, St. Mark's church, South Audley St., W., 337 Chapel tunnel, 399, 450 Chapel, Lady, All Saints' church, Gt-Oxford, 392; memorial, West-minster, 330, 344, 379, 598; morn-ing, at Windermere, 259 Charges, architects' 17, 58 Charing Cross railway bridge, 22 Chester, production of lighting, 92 Chevrons for war service, 321 Chicago, "build as usual" campaign, 62 Chimney, old, 159 China-clay, 358 Chinese city, model, how they build, 64 Chiswick, new almshouses, 56 Christian modernism and art, 129 Church: Basingstoke (All Saints) 278; Boringdon, 362; Cambridge, 190; Comb Pine, Axminster, 462; Corsham, Wiltshire (south aisle) 364; Dun-fleming (St. Margaret's) 243; East-Bathampton (St. Peter) 421; Edg-haston (St. German) 578; Ersmore (road screen, Christ church) 277; Fort Augustus (Abbey) 424; Goring (All Saints, lady chapel and roof) 369; Harrogate (St. Wil-fred's) 177; India (Wesleyan, Madak) 402; Ireland (Celtic Romanesque) 96; Jerusalem (church of the Holy Sepulchre) 407, 478; Liverpool (St. Nicholas) 179; London (St. Dunstons) 293; Norbury (St. Stephen's, road-screen) 417; Oxford (restoration of St. Nicholas) 293; St. Paul's, wood-work (new) 119; Southsea (St. Paul's, war memorial, pious) 177; theatre near, 379; Thonford Heath (St. Luke's) 217; woodwork, English, 50 Churches: annour in, 82; City, 379; for munition workers, 42 Cinema exhibitions, 59 Churches: 278; garden, Rulind; King's College, Cambridge, 495; model Chinese, 278 Civil Engineers, Institution of, 302, 398 Clark, Mr. H. C., F.R.I.B.A., P.P.S.I., the late, 44

Cleopatra's needle, 259 Clergy, dilapidations, and the, 479 Clock-tower memorial (Rangoon) 158 Clogged sewer pipes, 138 Club: naturalists', Berwickshire, 298; players', addresses at the, 40 Coal: converted iron dust and ashes, 99; distribution of, 62 Coldebarrow manor, East Grinstead, 297 Colledge: imperial, of science and technology, main entrance of, 363; of arts, Edinburgh, 139, 298; royal technical, Glasgow, 189, 319 Colonial and English gardens, 164 Colour schemes, curative, 425 Column, fire and load tests, 215 Comedy of the courts of law, 421 Commandeering hotels, 1, 99, 355 Commercial timber and English forestry, 163 Comb Pine church, Axminster, 462 Committee: Architects' Registration 281; architects' war, 421, 438; health, 297; housing London County Council, 39, 301; national war sav-ings, 402 Company, Gas, Light and Coke, 98 Concession, air-raid sufferers, 61 Competition: for modern houses, 516; national housing, R.I.B.A., 502 Competitions: Belfast (Sir C. Lanyon memorial) 78; Carnegie arts, 29; Cork (St. Paul's), 278; cottages for industrial classes, 364; designs for workmen's houses 438, 459; Tuesday (Norway) 444; Monte-Vides (school buildings) 178; "Oxen Jones" prizes, 444; war memento for relatives of the fallen, 219 (memorial) 138 (plaque) 178 Computor National d'Escompte de Paris, King William Street, E.C., 437, 444 Concrete: 379; barges built of, 518; consistency, measuring, 157; con-struction, 62; house, building in, 189, 429; plain and reinforced, consisting of mix upon, 119; reinforced, buildings, noise in, 37 (decomposition of salt and brine on), 315 (set slab design) 295, 297 (tablets about) 117 (X-ray examina-tion of) 198; road construction, 61; surfaces, painting exterior, 57 Construction, building trade employers, 81 Construction: concrete, 62 (road, 61) scaffolding, safety in, 475 Consumption, insurance, 141 Contracts: building, 144; prime cost sums in, 476 Control: canal, 158; timber, 159, 179, 219, 298, 321, 477 Co-operative: societies and trade unions, 201 Cork cathedral of St. Fin Barre, 299 Corrosion of iron in Ferro-concrete, 467 Corruption: in library and, 144 Corsham church, Wiltshire, 364 Cossins, Mr. J. A., the late, 462 Costs, bill of architects', 438 Cottage, Somersdale, 57 Cottages, country, 458; workmen's, competitive designs for, 459 Council: chamber, Edinburgh, new heraldic frieze, 362; Keighley town, 319; London county, 79, 407 (housing committee) 39, 301; Manchester, 214 workmen's national housing, 42, 141, 183 Country cottages, 458 County and municipal engineers, 3 Court: Barrington, Somerset, 441; Summerhill, Stourbridge, 397 Courts: Emergency Act, 319; of law, comedy of the, 421 Covenant landlord's, 479; lessor's, 401 Cranbourne Towers, Dorset, 388 Cross of S. Kentigern, 497 Crossing, King Minster, looking north, 441 Crow, Private A. A., the late, 400 Cunard building, Liverpool, 277 Curative colour-schemes, 422

David Garrick's painted bedroom.  
Dayson, W. Rupert, the late, 66.  
Dawn, mascot, 39.  
"Dead hand," 362.  
Decorative painting.  
Death of Earl Grey, 189.  
Death-rate of Shoreditch, high, 201.  
Deepening of our sea harbours, 40.  
Defence of the Beard Reclamation, 411 (Lodge Commission).  
Dezas, M. Hilarie, 279.  
Degradation of architecture, 469.  
Design: flat slab, reinforced concrete, 297, 298; for workmen's houses, 438; in dress, Miss May Morris on, 357; new materials and methods in influencing, 178; selection for technical institute, Oakenfates, Salop, 277.  
Deteriorating action of salt and brine on reinforced concrete, 515.  
Diagonal streets, 305.  
Dilatations, clay's, 479.  
Dimensions in feet and inches, when to, 57.  
Dining hall designed for country house, Tudor style, 77.  
Disabled soldiers, industrial village for, 340.  
Distribution of road, 82.  
Dredging, ferro-concrete, 238.  
Dunington hall, 462.  
Dorset, Cranbourne towers, 388.  
Downing Street, 438 (Mrs. Lloyd George).  
Drake monument, Malsbury church, 388.  
Draper, Mr. A. T., the late, 179.  
Driver, exhibition, 45; office and agricultural association, 48.  
Drawings of the deceased masters and decorative furniture at the Burlington fine arts club, 460.  
Dress, design in, Miss May Morris on, 357.  
Drew, Mr. H. P., the late, 59.  
Drier, patent drying without, 117.  
Dry rot, 57.  
Dublin, old Houses of Parliament, 202, 217; rebuilding, 195.  
Duke, Mr. E. L. P., the late, 98.  
Dust or ash, coal, converted from, 46, 378.  
Duty: architect's breach of, 58; of estate, 121.  
Dwellings, for the working classes:  
101; workmen's builders and, 178.

**EAST:** Blattinghorn, church of St. Peter, 421; Grinstead, Coldharbour manor, 371.  
Edgoston (St. German's) church, 278.  
Edinburgh: Architectural association, 460; college of art, 159; council chamber, new heraldic frieze, 363; gold court, 458; Holmwood avenue, 397; royal college of art, 477; editor's page, Sunday, 467, 469, 472.  
Education, Board of, housing of, 1.  
El Guadalupe, Spain, 284.  
Electric lamp, Oram, 341; station building, roof of, 398.  
Electrical engineers, American institute of, 58.  
Elizabethan residence, famous in Somersetshire, 359.  
Employers and workmen, 21; building trades, National Federation of, 58.  
Employment: exchanges, 181, 497; workmen and, 59, 420.  
Engraving, new methods, 179.  
Enchanted window, 199.  
Engineer, borough, Southend on Sea, 458.  
Engineers: Civil, Institution of, 302, 358; county and municipal, 37; electrical, American Institute of, 58.  
English and colonial gardens, 164; cemetery (Rome) 179; church woodwork, A. D. 1350-50; forestry, commercial timber and, 163.  
Enlisted apprentices, 219.  
Entrance: building and caution, 100; factory, Birmingham, 465; Victoria and Albert museum, sculptured panels in the, 1, 7, 57, 117, 337; portal and vestibule, house in S.W., S.W., 344; to municipal building, 278; to hall, 292.  
Epona, Christ church, roof record, 277.  
Epton, Mrs., 98.  
Ethical Institute, 121.  
Ethics of the architectural profession, 461.  
Evidence, expert, 78, 98.  
Exchange, employment, 181, 497.  
Exchanges, labour, 122; Royal, Manchester, 257.  
Exeter, St. Nicholas' priory, 257.  
Exhibitions: Arts and Industries, Manchester, 279; of architecture, 458; horticultural (Port Sunlight) 189; war, 497; Imperial, in modern ventilation, 408; modern loan, at the Grosvenor, 407; military, 401.  
Explosion, at Silvertown, repairing houses, 21.

Exportation of British cement to Holland, 40.  
Exterior concrete surfaces, painting, 57.  
**FACTORY**, munition, Birmingham, entrance building, and canteen, 495; damages for a, 518.  
Famous horses, St. Mark's, Venice, 477.  
Fees, architects', 78, 261, 462, 500.  
Feet and inches, when to dimension, 57.  
Ferro-concrete: floating dock, 238; iron in, corrosion of, 497; vessels, 179.  
Finance Act, 121.  
Fire: brigade headquarters, Cardiff, 96; column and load tests, 218.  
Fires, wood, 294.  
Fixing memorials and tablets, 442.  
Flask house, Hampstead, 392.  
Flat slab design, reinforced cement, 263.  
Flats in course of erection, Park Lane, 401.  
Flut, Thos. T. Foden the late, 18.  
Floods, 121.  
Floor slab, reinforcement, 53.  
Folkstone, Hockley Sole manor, 444.  
Footings, timber without, 519.  
Forestry: 88, 142; English and commercial timber, 163.  
Forests of Russia, 238.  
Forum, looking towards the Colosseum, 207.  
Fountain's tomb, Washington cathedral, 36.  
France, reconstructing villages in, 47.  
Frieze, new heraldic, council chamber, Edinburgh, 363.  
Fuel: artificial, 203, 221; research, 79, 99.  
Furnish, of: decorative and drawings of deceased masters at the Burlington Fine Arts Club, 460.  
Future: architecture and the, 302; residential college, Bristol, 340.

**GAS** hill-dwellings, 137.  
Gallery: Grafton, exhibition at, 458; Grosvenor, Modern Loan Exhibition at, 461; Hulton art sculpture gallery, 181; National Gardens, 209, 39; (to British art), 483; Walker's art catalogue, 358.  
Garden: city (net profits on first), 407; Ralph, King's College, Cambridge, 495.  
Gardens, English and Colonial, 164.  
Garratt, Mr. Edward, 288; semi-circular, profit on, 457; Light and Co. Company, 98; making wood in, 219.  
Gascon, Capt. Charles, the late, 218.  
Gates, Ian, 86; Phillip Norton Somersetshire, 338.  
German profiteers, 477.  
Glasgow, Architectural Craftsmen Society, 258, 457; Royal Technical College, 199, 331; warehouse, West Nile Street, 364.  
Gloucestershire, Notgrove Manor, 184.  
Gold medal, Harben, 319.  
Government: architectural, 159; and technical journals, 237; of India, annual architectural report, 442.  
Gordon, Mr. Henry, the late, 137.  
Graft, varnish, 362.  
Grafton Gallery, exhibition at, 458.  
Great Chalfield and South Wraycliff manor-houses, Wilts, 417.  
Green: Abour House, Holborn Vauxhall, 137; cement, lettering on, 344.  
Grey, Earl, death of, 199.  
Grinshaw, Mr. J., the late, 18.  
Grosvenor Gallery, modern art exhibition at, the, 461.  
Growing, wheat, 159.  
Gully emptier, steam motor vacuum, 258.  
Gypsum roofs, reinforced, 392.

**HALL:** dining, for country house, Tudor style, 77; Dunington, 402; Lancashire and Cheshire mine's (Bolshevik), new, Hildesheim House, Surrey, 357; Westminster, 138; staircase and entrance, 437.  
Ham Commission district, building record, 479.  
Hampstead, Substone and Arboreal Societies, 144.  
Handle sub-contracts, how to, 177.  
Handley, Sapper B. D., the late, 329.  
Hauling-streets to get good results, 37.  
Harnden Gold Medal, 319.  
Harlow, sea, deepening of, our sea, 460.  
Harragote, new house near, 362; 81.  
Williford's church, 77.  
Haultain, death of, 463.  
Heat, materials withstanding, 124.  
Heat-insulating value of pumice materials, 324.  
Hedges, Lieut.-Col. J. R., 99.  
Memorial, the late Bishop, 567.  
Romy, R.A., the late Mr. Napier, 278.

Heraldic frieze, council chamber, Edinburgh, 363.  
High School, Tulsa Hill, 362.  
Hill Crest, Tottenham, Harles, 157.  
Hippocampus, 157.  
Hire system, art on, 323.  
Hockley Sole Manor, near Folkestone, 444.  
Holly, Sec.-Lieut. W., the late, 199.  
Holy Trinity, Tamworth, 357.  
Holroyd Abbey, Edinburgh, 397.  
Horned ram memorial, 399.  
Horses, famous, St. Mark's, Venice, 477.  
Hossey, Mr. G. C., the late, 23.  
Horticultural Society, Royal, Wisley, 407.  
Hospitals: slacks, Palace Green, Kensington, 344; South African, 302; Richmond, Surrey, 392; Hotel, Chicago, 59.  
Hotels, conducting one of, 169, 358.  
Houghton, Mr. W., the late, 179.  
House: building, 121, 138, 241, 308; construction, tips for, 91; concrete, building in three days, 423; country, dining hall for, Tudor style, 77; Flask, Hampstead, 392; St. James's, S.W., entrance and vestibule, 344; near Harrogate, new, 247; of Winley, 164; shortage, 401, 152, 48; smallest, 200.  
Wakeman's (Ripon), 219.  
Housebuilders, National Federation of, 298.  
House: betting, but higher rents, 439; design for, 169; 458; for the working class, 319, 459, 457; Manor, Great Chalfield and South Wraycliff, Wilts, 417; modern construction, 202, 217; repair of, effects of Silvertown explosion, 21; scarcity of, 199, 279, 281; small and legislation, 417; that will not burn, 177; warred, 164; Birkenhead, 209; workmen's, scarcity of, 79.  
Housing: 219, 222, 279, 474; accommodation of Sunderland 277; after the war, 413; and town planning, 169; 269; 277; Board of Education, 1; Committee, 535; Surveyors' Institution, 321; Committee report, London County Council, 29; 169; conditions (Barrow), 219; Council, Workmen's National, 42, 141, 158; of the Industrial population, 209, 209; of the working class, 19, 83; policy, national, 218; problem, 398; questions, 38, 42, 238; scheme, 58, 141, 349; (S. National), 169; F. the late, 77.  
Hut, new Y.M.C.A. offices, 178.  
Hythe, boat, Lympne Castle, 277.

**ILLEGAL** building, 164.  
Imperial: college of science and technology, South Kensington, main entrance, 392; exhibition, 497.  
Import of timber, 79.  
Improvement of the Thames estuary, 340.  
Increase of rent, 119.  
Indian Government of annual architectural report of, 442; Wesleyan church at Madak, 362.  
Industrial: population of Scotland, housing of, 209; reconstruction, 450; revolution, coming, 407; of the textile, 119, 142; village for disabled soldiers, 340, 420.  
Industries, new, 158.  
Industry: British cement, 458; cement, Danish, 388 (in Japan) 99; peace and, 442; saw-milling, 259; slate quarry, 179.  
January, Manchester, 122.  
Initiative: lacking in architecture, 496.  
Institute: architectural of America, 516; auctioneer and estate agents, 39; British architects' (Royal) 377; Cap. of architects, 154; (chemical engineers) (American) 58; of British architects, royal, 179; royal architectural (Canada) 397; technical, Oakenfates, Salop, 277.  
Institution: builders' benevolent, 58; civil engineers', 35; 398; 497; surveyors', 328; 338 (housing committee) 328 (incorporated benevolent fund), 358.  
Insurance: company proposed office for, 257; of carpenters and, 141; office, Kew, 417.  
Interiors, two, in the new Cunard building, Liverpool, 277.  
Ireland: architectural association of, 289, 427; Royal University of, 476; new church in (Celtic Romanesque) 96.  
Iron: bronze-plated, pre-Roman, 518; in ferro-concrete, corrosion of, 497.

**JACOB**, Col. Sir Samuel Swinton K.C.I.E., C.V.O., the late, 462.  
Japan, cement industry, 99.  
Jerusalem, church of the Holy Sepulchre, 437.  
John Tann's, Ltd., 484, 487.

"Journal, Board of Trade," 439.  
Journal, technical, Government and, 110, 237.  
Julian Gullot, the late, 322.

**KEIGHLEY** town council, 319.  
Kelvin, St. legend of, 417.  
Kensington, hospital for shell shock, 344.  
Kemp, Lympe castle, near Hythe, 277.  
Kerrison, Mr. G., 259.  
King Edward VII school of art, New Castle-on-Tyne, 237.  
King's college, Cambridge, 401.  
King's college, hospital, 350.  
**LABORATORIES**, new, royal horticultural society, Wisley, 402.  
Labour: capital, 21; exchange, 122; general rate of, 258.  
Lady chapel, altar, and pinnacles, All Saints' church, Greatford, 363.  
Lamp, Oram, 341; electric, 307.  
Lancashire and Cheshire miners' hall, Bolton, 237.  
Land: laws, 361; reform, 411; taxes, 417.  
Landscape, 157.  
Law: architects' registration, 181; case concerning sewage overflow, 496; courts of, comedy of, 421; real property, and conveying, 2; uncertainty of, 219.  
Laws, land, 361.  
Lead: and Minister of Munitions, 219; white, regulations concerning, 422.  
League of Nations, New York, 382.  
Leaves, national safety, 362.  
Leaves, autumn, artificial wood from, 462.  
Lectures, public, three, 298.  
Legend of St. Kent, 417.  
Legislation, small houses and, 417.  
Lessee's covenant, 401.  
Lettering on green cement, 344.  
Levelling, 202.  
Licensing of architects, 22.  
Lighting, production of, 82.  
Line, unslaked, 99.  
Lincoln, Bernard's statue of, 379, 330.  
Linton, 341; 381; 382; the late, 857.  
Littler, Sec.-Lieut. Tom, the late, 79.  
Liverpool: bank of, new premises at, Durham, 137; cathedral, 258; Church of England, two (interior) 277.  
Load, tests and column, fire, 218.  
Local: by-laws, 221; Government Board, annual report, 164; taxation, 419.  
Locke, the late, Private W. W., 278.  
Lodge, Murray, Newmarket, 117.  
London: County Council, 79, 497 (architectural building, new, 162 (housing committee) 69; master printers (houses) 358; master printers, 477.  
Lymington castle, near Hythe, Kent, 277.

**MACHINERY**, prohibiting importing of, 179.  
Machines, Arts and Industries exhibition, 497.  
Magnaesia in Portland cement, 524.  
Manchester: council, 21; industry, 122; royal exchange, 257; society of architects, 460; traffic congestion, 701, 241.  
Manor: Coldharbour, East Grinstead, 437; Hockley Sole, near Folkestone, 444; houses, Great Chalfield and South Wraycliff, Wilts, 417; Notgrove, Gloucestershire, 184.  
Manufacturers, Ltd., associated Port Land cement, 278.  
Master, Mr. F. L., the late, 25.  
Massey day, 38.  
Master: Tower bridge, 459; decorators, London association of, 437.  
Masters, deceased, drawings of, and decorative furniture at the Burlington Fine Arts Club, 460.  
Materials: building, 159; influencing design, 178; refractory, 258; supplies of, 301.  
Mathew, Sec.-Lieut. Volney, the late, 180.  
Matthews, Capt. J. B., the late, 140.  
Measurement, timber, 184, 218.  
Mechanical: 398; 438 (home) 29; trades, St. Paul's, Southsea) 177 (Scottish national) 479 (Scottish sculptor) 457 (Smithfield) 487; window frame, 487.  
Memorials and tablet, 436, 441.  
Metropolitan water board, 493, 441.

Military hospital, South African, Richmond, Surrey, 202  
 Minerals, production of, Canada, 295  
 Miners' hall, Lamma-hire and Cheshire, Bolton, 257  
 Mining, London, 19  
 Ministry of health, 197; of reconstruction, 107  
 Mix, concrete, upon the strength of plain and reinforced concrete, and the effects of grading of sands, 119  
 Mixtures, paving, 120  
 Models, by hand, 281, 401, Chinese city, 238; modern houses, competition for, 216; modernism and art, Christian, 137  
 Monte Video, new school buildings, 174  
 Monument: 79; Drake, Musbury church, 358  
 Money, see Lieut. W. E., the late, 359  
 Morning chapel, Wandersme, 259  
 Morris, Miss May, on design in dress, 282  
 Motor vacuum gully emitter, steam, 224  
 Municipal and county engineers, 3; buildings, Panchal, Madeira, entrance to, 257; water-galley, 60  
 Municipal: factory, canteen and entrance building, 495; workers, churches for, 420  
 Murray Lodge, Newmarket, 117  
 Musbury church, Drake, monument, 358  
 Museum: Aldershot (the Victoria) 217; Victoria and Albert, sculpture at the main entrance, 17, 57, 117; war, 1, 59

**NATIONAL:** building trade employers' conference, 85; Federation of house builders, 299; gallery, 60; conditions to 39 (of British art) 42 (Scottish); housing, competition, R.I.B.A. council, workmen's, 42, 141, 155 (scheme); 48; responsibility for air-raid damage, 361; safety, league of, 362; service, 281; university of Ireland, 476; war museum, 1, 59 (savings committee) 402  
 Natural asphalt, 282  
 Naturalists' club, Berkshire, 298  
 Needle, Cloptons's, 259  
 New York, architectural League of, 282  
 Newcastle-on-Tyne, corporation, 319; King Edward VII. school of art, 237  
 Newmarket, Murray Lodge, 117  
 Nigs for house construction, 60  
 Noise: deadening, 39; in reinforced concrete buildings, 37  
 Norbury, St. Stephen's church, road across, 417  
 Norfolk and Norwich archaeological society, 118  
 Norwich: builder charged with stealing two pine pals, 358; city engineer summoned for an air-raid, 470  
 Notes, parliamentary, 139, 155, 430, 357, 870, 299  
 Notices, local authorities', 357  
 Nottingham and Derby architectural society, 237, 420, 476

**OAKEGATES,** Salop, clerical design for Technical Institute, 277  
**OBITUARY:** Adams, Lieut. H. F. H., 287; Alexander, Capt. George Luard, 218; Arncliffe, Capt. J. B., 3; Bagnall, Edward, 225; Barclay, Mr. David, F.R.I.B.A., 64; Barfield, H. E., 137; Bradburn, Mr. G., 60; Bradshaw, Lieut. H. H., 119; Bremner, Mr. A., 179; Brain, Capt. A. G., 312; Brown, Mr. J., 393; Buckley, Mr. J.; Caine, Mr. R. A., 282; Clark, Mr. H., F.R.I.B.A., 114; Collins, Mr. J. A., 422; Crow, Private A. A., 100; Davison, W. Rupert, 292; Davy, Capt. H. R., 124; Deans, M. Hildre, 279; Dewick, Rev. E. L., 405; Dodd, See Lieut. E. J., 78; Draper, Mr. A. J., 179; Drew, Mr. P. H., 59; Dukes, Mr. A. H., 99; Ely, Mr. W. 257; Flint, Mr. Thomas Foden, 18; Fuller, Mr. Henry, 285; Garratt, Mr. Edward, 294; Gascoigne, Capt. Charles, 218; Geraldson, Mr. T. A., F.R.I.B.A., 157; Gibbs, Mrs. A. M., 159; Grimshaw, Mr. James, 18; Handley, Sephor, B. W., 399; Holley, Lieut. Col. R. H., 99; Honey, R. A., Sephor, 78; Hild, F. S. A., Mr. William, 109; How, G. Gerald C., F.R.I.B.A., 72; Houldston, Mr. W., 179; Howarth, Private, 47; Howden, Sephor, 78; Huxford, Mr. T. J., 124; Huxford, M. S. A., 107; Kettle, See Lieut. Tom, 79; Lester, Private W. W., 155; Martin, Miss, 14; Martin, Mr. W., 55; Mather, See Lieut. M., 150; Matthews, Capt. J. B., 440;

Moorey, See Lieut. W. C., 509; Olley, Mr. O. J. R., 359; Parkes, Mr. S., 270; Parkins, Lieut. J. H., 39; Paul, Capt. W. E., 137; Potter, Mr. Thomas, 238; Pullford, Mr. George C., 90; Rodin, Auguste, 417; Ryde, See Lieut. J. T., 444; Scott, Lieut. L., 359; Shanks, Capt. J. A. G., 319; Shoppee, Mr. C. H., 262; Stobley, Mr. W. D., 119; Stokes, Mr. R., 278; Symon, Dr. W. H., 179; Thompson, Mr. Clannor, 89; Toole, Mr. Kevin, 159; Trevarthen, J., 417; Trenchard, Henry, 119; J., Walker, Mr. G. Bickerton, J. P., 442; Westlake, J. Stephen, B.A., 117; Wheatley, See Lieut. J. H. L., 213; White, Mr. H. H., 122; Willis, Mr. Ambrose, 468; Wing, See Lieut. E. W., 237; Wright, See Lieut. C. L., 218  
 Official drawing and agricultural association, 488; insurance, Kent, 417; proposed, for an insurance company, 257; War, stipidity of, 301. (8 days of the) 312  
 Okehampton, 19; memorial, 14  
 Organ, stalls, and channel screens, St. Mark's Church, South Andley Street, 357  
 Organ, 19; 19; 162  
 Oram electric lamp, 311  
 Otway, 8. 8. 8. reading room, 414  
 Overgrowing, 238  
 Overflow, sewage, law case concerning, 499  
 Ownership, municipal, 341  
 Oxford, St. Nicholas Priory Church, restoration of, 4, 281

**PAINT:** dry, without driers, 117  
 Painted bedstead (David Garrick's), 99  
 Painters in Water colours, Royal Society of, 352  
 Painting, walls, 104; exterior concrete surfaces, 57  
 Panels, sculptured, archway, main entrance, Victoria and Albert Museum, 37, 57  
 Paper, sorted, 57, 500  
 Parnis, Comptoir National D'Exposés, King William Street, London, 457, 444  
 Parisian parlours, 417  
 Park Lane, flats in course of erection, 402  
 Park, Lieut. House of, old, and Parliament Square, Dublin, 292, 217  
 Parliamentary notes, 159, 158, 339, 357, 356, 399, 414  
 Patent, invention of, 257  
 Paul, Capt. D. E., the late, 137  
 Paving mixture, 169  
 Payment for submitting tenders, 22  
 Peace, industry, 412  
 Pearson, John Longborough (contemporary), 35  
 Perfect building, the, 140, 135  
 Photographers, 47; of ironwork, 412  
 Photographic Society, Royal, 19  
 Photography, London Salon of, 2  
 Physical welfare, 138  
 Pictures, architectural, at the A.A., 204  
 Pip-bulking, 219  
 Pipes, 240  
 Pipes, bars, 42; clogged sewer, 183  
 Planning, housing and town, Birmingham, 238  
 Plantation and nurseries, women in, 441  
 Playgoers' Club, address at the, 101  
 Popularising art, 362  
 Pundchester Terrace, No. 35, 177  
 Portland cement, 210, 439 (magnesia) 101, 321  
 Portrait Painters, Royal Society of, 245  
 Porter, the late Mr. Thomas, 338  
 Premises, new, Architectural Association, 41, 225, 237  
 President of the R.I.B.A., 351, 377  
 Prevention of tuberculosis, 208  
 Prime cost sum of contracts, 476  
 Priory, church, St. Nicholas, Oxford, restoration of, 244; St. Nicholas, Exeter, 277  
 Problem housing, 197 (Hobdell) 298; small dwelling and H. solution, 2, 17, 23, 116, 122, 57, 62, 77, 83, 56, 105, 111, 127, 137, 142, 177, 182, 184, 222, 239  
 Production of lighting, Chester, 83  
 Profession, architectural, ethics of, 197  
 Profit of the best garden city, 407; on raw economies, 157  
 Profiters, German, 477  
 Property, effect of the war on real estate, 104, 107, and conveyancing, 2, seized for war use, 439  
 Provision of timber, 39  
 Public lectures, three, 297  
 Purley, Wallington, 217

**QUARRY** industry, scale, 179  
 Question, housing, 35, 2, 398  
 Ralls, air, and bombardment, national responsibility for, 803  
 Railway bridge, Charing Cross, 22

Rainfall, 138  
 Rangoon, memorial clock tower, 138  
 Reading room, 8. 8. 8. Otway, 114  
 Realm: Defence of the, 411 (dossier construction) 39  
 Reconstruction: 199; Dublin, 199  
 Reconstruction: industrial, 427; to be ignored in 282; Ministry of, 101; Villages in France, 477  
 Reform, 199  
 Registration: law, architect's, 181; of business names, 101  
 Regulations, white lead, 422  
 Reformed: cement, 19; concrete (buildings, noise in), 87; deterioration of action of salt and brine on, 315 (consistency of mix upon the strength of) 423 and 118 (data about) 263, 297 (some wrinkles design) 117 (X-rays examination of) 128; gypsum roofs, 507  
 Reformation, Poor-Law, 83  
 Reforms, straight-brig, 77  
 Rent, increase of, 119  
 Rents: 5% higher, but better houses, 426  
 Re-organisation: Committee, Architects', 281  
 Repairs, simple apparatus, 101  
 Republics of Salonika, 219  
 Report, annual, of the Local Government Board, 161  
 Reserds: Lady chapel and altar, All Saints, Church, Gosford, 262; Yoxall, Burton-on-Trent, 262  
 Reservoirs, Washlaw Park, 497  
 Residential College, Bristol, future, 410  
 Responsibility, national, for damage by air-raids, 361  
 Restoration of St. Nicholas Priory church, Oxford, 281  
 Restriction, 284  
 REVIEWS: A plea for wider use of Artists and Craftsmen, 321; Art of Englishmen, 480; Bulletins des Archives de la République, 302; Charing Cross to Baghdad, 262; Church Ornaments and their Civil Antecedents, 222; Cobing Tables, 459; Domestic Architecture, 370; Elements of Graphic Statics, 379; Floor Slab Reinforcement, 362; History of the Abbey of St. Albans, 362; Naval Architecture, 79; Notes on the Manufacture of Earthenware, 79; Practical Structural Design, 359; Protective Clothing for Women and Girl Workers, 494; Revolution of the House in War-time, 338; Smoke Abatement, 110; Strength of Structural Elements, 479; Terms of Industrial Peace, 342; The Gum Tree 26; The Small Garden, 79; The Use of Mean Sea Level as Datum for Elevation, 53; Transactions of the Birmingham Archaeological Society, 592; Where the Great City Stands, 438  
 Revelation, coming into, 237  
 Revivition, coming into, 276, 281  
 R.I.B.A. national housing competition, 502  
 Ridge Green House, Surrey, new, 161, 33  
 Ripon, Wakeman's house, 219  
 River, burial of a, 340  
 Road: construction, concrete, 61; improvement, 222; materials, transport of, 216  
 Roads, widening, Birmingham, 322  
 Rodin, Auguste, the late, 417  
 Roof and spire, Bristol church, Epson, 277; St. Stephen's church, Norbury, 117  
 Roof of an electric station building, 477  
 Roofing materials, heat-insulating value of, 324  
 Rugs, gypsum, reinforced, 501  
 R. H. G. 477  
 Royal Academy, 477; Architectural Institute of Canada, 397; Exchange, Manchester, 257; Institute of British Architects, 577, 476; Photographic Society, 477; Royal Britain, 19, 254; Society of British Arts, 323; Society of Portrait Painters, 282; Technical College (Glasgow), 159; 124  
 Rusby garden city, King's College, Cambridge, 495  
 Russia, forests of, 239  
 Ryde, J. Pitsoam, 219  
 Ryde, the late, 44

**SAFE,** John Tann, Ltd., 477  
 Safety in scaffolding construction, 147; League of National, 352  
 Saint: Luke's (Plumpton) Hostel, 217; Margaret's (Dunelm), 348; Martin's High School (Tulse Hill), 262; Paul's Cathedral, 179 (church, southern) 177; Peter's (East Blatchington), 421; Will's (Biarrotze), 477  
 Salon of Photography, London, 278  
 Salonika, re-planning of, 219  
 Salt and brine, deteriorating action of, on reinforced concrete, 315  
 Sand, asphaltic, 19  
 Sanks: grading of, and consistency of mix upon the strength of plain and reinforced concrete, 118

Saw-milling industry, 250  
 Scaffolding construction, safety in, 147  
 Scarcity of houses, 199, 281  
 Schemes: housing, 121, 151, 349 (Barrow) 219, 241 (National) 420 (R.I.B.A.) 19  
 School: Architecture, King Edward of London, 159; Art, University of Vill., Newcastle-on-Tyne, 237; St. Martin's, High (Tulse Hill), 60  
 Westminster: war memorial, 39  
 Schools, Birmingham (new), 58  
 Science and Technology, Imperial College, South Kensington, main entrance of, 399  
 Scotland-on-Tyne, new church at, 119; bridges, ancient, 477  
 2837; houses, memorial, 439  
 Screen, road (Christ Church, Epson) 277, (St. Stephen's Church, Norbury) 417  
 Seaside College, organ and stand, St. Martin's, South Andley Street, W. 337  
 Sculptor, Scottish, on war memorials, 437  
 Sculpture: Gallery, Hulme Art Gallery, 184; to main entrance, Victoria and Albert Museum, 17, 57, 117  
 Septic tank, new form of, 36  
 Service: national, 251; war, chevrons for, 321  
 Sewage overflow, law case concerning, 499  
 Sewer-pipes, clogged, 183  
 Shale, cut cement and clay, bricks burned under new process, 516  
 Shanks, Capt. J. A. G., the late, 314  
 Shakespeare, monument to, 59  
 Shin-shock, hospital for Kensington, 314  
 Shelter against air-raids, 501; open-air, 302  
 Shells, 138  
 Shoppee, Mr. C. H., the late, 362  
 Shorehedge, high death-rate, 101  
 Shortage of houses, 191, 128, 408, 359  
 Siner, 560  
 Sinks: explosion at, repairing houses affected by, 21  
 Slab design, reinforced concrete, 61  
 "Slab, 257  
 Slab, stone architects are" 499  
 Slate quarry industry, 179  
 Small dwelling, problem of, 2, 17, 23, 36, 43, 67, 62, 77, 83, 96, 102, 117, 122, 137, 142, 162, 177, 182, 184, 222, 237; houses, legislation, 411  
 Smallest house in London, 477  
 Smithfield war memorial, 437  
 "Snail-shell" stair, 21  
 Societies: building, 25, co-operative and trade unions, 201  
 Socio-architects (London), 18  
 Socio-architects (Bristol and Gloucestershire Archaeological, 75; British Arts (Royal), 323; Cambridge, Socio-architects, 75; Glasgow Architectural, 477; Hampstead Seborne, 457; Horticultural, Royal, laboratories for, 462; 397; Socio-architectical, 118; Nottingham, 477; Architectural, 237, 420, 473; Painters in Water-colours (Royal), 342; Photographic (Royal), 19, 254; Portrait Painters (Royal), 282; Somerset Archaeological, 98  
 Soldiers, disabled, industrial utility of, 167, 340, 407  
 Somerset Archaeological Society, 75  
 Somersetshire: cottage in, 57  
 George Inn, Norton St. Phillip, 335  
 South African, Military Hospital, Richmond, Surrey, 202  
 South Kensington, Victoria and Albert Museum, main entrance, 17, 57, 117, 357  
 South-east-on-Tyne, terrazzo engineer of, 458  
 Southsea, St. Paul's, war memorial 477, 460, 407  
 Spain, El Guadalquivir, 254  
 Specification, 322  
 Staples, Luceok Abbey and Corsham Church, 118, 364  
 Stair, "snail-shell," 24  
 Staircase, hall, and entrance, 437  
 Standards, Bureau of, 210  
 Streets, bread, a famous, 318  
 Statue, Burnard's, of Lincoln, 279, 339  
 Steam motor vacuum gully emitter, 419  
 Stokes, the late Mr. Ralph, 275  
 Stowell Park, Cirencester, Badminton Court 17  
 Straight-bow, reinforcement, 77  
 Streets, diagonal, 555  
 Stucco, handling to get good results, 37  
 Stupidity of War Office, 301  
 Sub-contract, how to handle, 177  
 Submitting tenders, payment for, 22  
 Sugar refining, best, Stokebridge, 397  
 Sums in contracts, prime cost, 476  
 "Sunday at Home," editor's page, 132  
 Sutherland, housing accommodation at, 417  
 Supplies of materials, 501

Surfaces, concrete, painting exterior, 57  
Surrey: Ridge Green House, new hall, 337; South African Military Hospital, Richmond, 362  
Surveyors' Institute, 258, 383, 458 (Resolving Committee) 321 (Incorporated Beneficent Fund) 338  
Suspension bridge, famous, 298  
Swadeston, Edith Cavell memorial window, 38  
Symons, Dr. W. H., 179  
System, lire, art on the, 323

**TABLES** and memorials, fixing, 441  
T.A.S. society, new form of, 36  
Tate gallery trustees, 139  
Taunton, National Provincial Bank of England, 154  
Taxation, local, 342

Taxes, 261  
Technical: Architectural Craftsmen Society (Glasgow) 258; College, Glasgow, 1st, inst. design, design for new (Luganates, Salp., 277; journals, and the Government, 237; schools, 259

Technology: Imperial College of Science and main entrance of, 363  
Tendency application, 138  
Tenders, payment for submitting, 22  
Tests, load, and column fire, 218  
Thames: estuary, improvement scheme, 340; Valley district surveyors' association, 338  
Theatre: near church, 119; without flights, 319  
"Thames," 343  
Thernton Heath, St. Luke's church, 217

Timber: commercial, and English forestry, 163; control, 159, 170, 216, 298, 321; import of, 79, 259; measurement of, 151, 218; mining, 16; provision of, 39  
Tomb founder's (Washington cathedral), 36  
Tombstones, Herts., "Hill Crest," 137  
Tower Bridge, master, 439

Towa hall, new, St. Pancras, 279  
Trade: building, 10 (apprenticeship in the, 97 (employment exchanges and 310; of to-morrow, 107; unions and co-operative societies, 201  
Traffic, congestion of, 161 (Manchester) 91, 94  
Transfer, cost of land, 201  
Transport: mechanical, growth of, 219; of road materials, 219  
Tres, 198  
Truarden, John Marshall, the late, 117  
Triptych, memorial, 119  
Tuberculosis: prevention of, 238; treatment of, 238

Tulor style, dining hall, for country house, 77  
Tuke Hill, St. Martin's high school, 192  
Tunnel, Channel, 399, 480

**UNIVERSITY** of London school of architecture, 189  
Unrest, industrial, 119, 144  
Unlaked time, 99

**VACUUM** motor gully-cum-pit, steam, 258  
Valuation, 151  
Vapstone, Mr. W., the late, 399  
"Varnish graft," 361  
Vanguard, Henry, the late, 119  
Ventilation, recent experiments in, 403  
Vessels, ferro-concrete, 179  
Vestibule and entrance, house in St. James's, S.W. 24

Vicar's memorial, Oldhampton, 4  
Victoria: and Albert museum, sculptured panel, arch-vault, main entrance, 17, 57, 117, 397; museum, Aldershot, 217  
Village builder, the, 422  
Villages: industrial, for disabled soldiers, 319, 429; reconstruction of, French, 47

**WAGES**, workmen's, 79  
Walker art gallery, catalogue of, 259  
Wall, painting a, 104  
Wallington, Purley, 217  
Walshaw Dean reservoirs, 497  
War: committee, architects', 421, 428; damage, 213; effect of, on property, 247; exhibition, 377; housing after the, 443; memo for relatives of the fallen, 219; memorial (Aberdeen) 138 (Chapel, Westminster Abbey, proposed) 284, 339, 344, 379, 398 (Chatham) 158 (home) 39 (Jersey) 31, 32 (London) 177 (Scottish national) 179 (Scottish society) 190, 437 (South-Island) 467 (Westminster school) 39; museum, 1 (national) 59; office (stupidity) 391 (ways of) 342; saving: committee, national, 402; service, chevrons for, 321; use, property seized for, 439; your, 457  
Warehouse, West Nile Street, Glasgow, 364  
Washington cathedral, founder's tomb, 36

Water board, metropolitan, 198, 441  
Water-colours, painters in, royal society of, 342  
Waterworks, Bad-n-Baden, new buildings for, the, 397  
Westlake, John Stephen, B.A., the late, 117  
Westminster: alms, proposed war memorial chapel, 284, 329, 344, 379, 398; hall, 128, 242; school war memorial, 29  
Wheat-growing, 159  
Whately, Sec. Lieut. J. H. L., the late, 218  
"Whereas" more, 137  
Whitaker, burn of St. Mary's, 339

Wiltshire: bridge chapel, Bradford-on-Avon, 462; Great Chalfeld and South Brexhall manor houses, 417; Lacock abbey stables and Corsham church, 364

Wiltshire: bridge chapel, Bradford-on-Avon, 462; Great Chalfeld and South Brexhall manor houses, 417; Lacock abbey stables and Corsham church, 364

Wiltshire: bridge chapel, Bradford-on-Avon, 462; Great Chalfeld and South Brexhall manor houses, 417; Lacock abbey stables and Corsham church, 364

Wiltshire: bridge chapel, Bradford-on-Avon, 462; Great Chalfeld and South Brexhall manor houses, 417; Lacock abbey stables and Corsham church, 364

Window: enchanted 193; memorial (Edith Cavell) 38  
Windows, gas-filled, 357  
Windsor house of, 61, old, 539  
Wishy, new laboratories, tropical horticultural society, 462  
Women: architects, and the A.A., 120-121; and their art, 104; in: nurseries and plantation, 41  
Wood: artificial, from autumn leaves, 402; boring beetle, 342; fir s., 204; iron, 204  
Woodlands, Capt. Amherst, Bucks., 257  
Woodwork: English church, A.D. 1250-1300, 501

Woodworking, some wrinkles in, 243  
Workers, churches for, 110, 210  
Working-class: dwellings for the, 101; houses for the, 219, 298, 357; housing of the, 19, 83  
Workmen: and employment exchanges, 59, 429; employers and, 21; compensation act, 141; cut-throats, competitive designs for, 49; dwellings (builders and) 178 (design for) 48; houses, security of, 79  
Workmen's national housing council, 12, 141, 183; wages, 79  
Wray, Sec. Lieut. E. W., the late, 257  
Wright, Sec. Lieut. C. L., the late, 218  
Wrinkles: about reinforced concrete, 117; in woodworking, 243.

**X-RAY** examination of reinforced concrete, 198  
Yacht, 319  
Y.M.C.A. officers' hut, new, 178  
York: minister, crossing, looking north, 444; new house near Harrogate, 502  
Yoxall, Burton-on-Trent, rebates, 57

**ZINC** pipes, flushed through clogged sewer pipes, 183

INDEX TO ILLUSTRATIONS.

**ABBAY**: Holyrood, Edinburgh, 397; Stables, Lacock and Corsham church, 364; Westminster, proposed war memorial chapel, 284  
Airdrie, shelter, a.s.z.net, 500  
Aisle, south, Corsham Church, Wilt., 394  
All Saints' church, Cresford, Wrexham, Lady chapel, altar and ambo, 363  
Almshouses, Chislewick, 36  
Arentham, Bucks, Woodland Court, 257

Apparatus repairs, simple, 194  
Archievolt, main entrance, sculptured panels over Victoria and Albert Museum, 17, 57  
Art: class, outdoor, 363; gallery, Hulse (sculpture and china halls), 184; school of King Edward VII, Newcastle-on-Tyne, 237  
Aminster, Dorset, Comb-Pyne church, 462

**BADEN**-Baden, new buildings for the water-works, 297  
Badminton Court, Stowell Park, Cirencester, 17  
Bank: National Provincial of England (Taunton), 181; of Liverpool, Durham, 177  
Bath ward, military hospital, Richmond, Surrey, 302  
Billiard and billiard rooms, Summerhill Court, Stourbridge, 397  
Birmingham, munition factory (entrance building and canteen), 495  
Bible chapel, Bradford-on-Avon, Wilt., 462  
Building, Canard, Liverpool, two interiors, 277  
Buildings, new municipal, Finchal, Madeira, 257

**CANTEEN** and entrance, munition factory, Birmingham, 495  
Cardiff fire brigade headquarters, 96  
Castle, Lymne, near Hythe, Kent, 27  
Cathedral, Washington, founder's tomb, 26  
Chamber, council, Edinburgh, new headle frieze, 363  
Chancel, organ and stalls, screens, St. Mark's church, South Audley Street, W., 357  
Chapel: Bradford-on-Avon, Wilt., 462; war memorial, Westminster abbey, proposed, 284  
Chislewick, new almshouses, 36  
Church: Bradford, Epsom (new road screen) 277

Church: Comb-Pyne, Aminster, Dorset, 462; Corsham, Wiltshire, 364; Enfield (St. Stephen's) 141; Epsom (Christ church) 277; Gressford (All Saints) 363; Harrogate (St. Wilfred's) 77; Ireland (Celtic Romanesque) 96; Jerusalem (church of the Holy Sepulchre) 477; Medak (Wesleyan) 462; Musbury (Drake monument) 338; Neaden (St. Catherine) 134; Newbury (St. Stephen's, road screen) 37; Oxford (St. Nicholas priory church) 254; South Audley street, W. (St. Mark's, memorial screen) 357; Thornton (St. Mary) 217; woodwork, English, 502; City, garden, Knisp, King's college, Cambridge, 495; class, art, outdoor, 363; Coldharbour manor, East Grinstead, 397; college of science and technology, south Kensington, main entrance of, 363; Colosseum, the Forum, looking towards, 144; Comptoir National D'Escompte De Paris, King William street, E.C., 437, 444  
Concrete houses, 424  
Corsham church and Lacock abbey stables, 364  
Cottage, 60, Somers-street, 57  
Court, badminton, Stowall park, Cirencester, 17  
Cranbourne towers, Dorset, 338  
Crossing, Yorkminster, looking north, 444  
Cunard buildings, Liverpool, two interiors, 277

**DAY** room and general view, S.S.W. of South African Military Hospital, Durban, 397  
Dining-hall for country house, Tudor style, 77  
Dorset, Cranbourne towers, 338  
Drake monument, Musbury church, 338  
Dublin, Houses of Parliament, old, and Parliament square, 217  
Durban, Bank of Liverpool, 177  
Dwelling: perfect, the, 195; small, problem of, and its solution, 17, 36, 77, 96, 117, 137, 144, 177, 181, 237

**EAST** Grinstead, Sussex, Coldharbour manor, 397  
Edinburgh: council chamber, new heraldic frieze, 363; Holyrood abbey, 397  
El Guedalquivir, Spain, 284  
Elevation, St. Martin's High School, Tulse Hill, 592

English church woodwork, A.D. 1250-1300, 502  
Entrance and staircase hall, 437; building, munition factory, Birmingham, 495; main and 8-bed hall, Military Hospital, Richmond, Surrey, 302; of the Imperial College of Science and Technology, South Kensington, 363; shell-stock hospital, Kensington, 344; to municipal building, Finchal, 237; Victoria and Albert Museum, South Kensington, panels over main, 17, 57, 117, 357  
Epsom, Christ church, new road screen, 277  
Exchange, Royal, Manchester, 257  
Exeter, St. Nicholas priory, 257

**FACTORY**, munition, Birmingham (entrance building and canteen), 495  
Fire brigade, headquarters, Cardiff, 96  
Flats, Park lane, facing Marble Arch, 462  
Fletcher, Mr. Henry, M.A., F.R.S.A., 124  
Forum, looking towards the Colosseum, 144  
Founder's tomb, Washington cathedral, 302  
Frieze, new heraldic, council chamber, Edinburgh, 363

**GALLERY**, sculpture, and china hall, Hulse, 184  
Garden city, Knisp, for King's college, Cambridge, 495  
Gardow, warehouses for Messrs. John Menzies and Co., Ltd., 364  
Gleacestershire, Nodgrove manor, 184  
Great Chalfeld and Wroxall manor houses, Wilt., 417  
Green Arbour house, Holborn Viaduct, 137  
Gresford, Wrexham, All Saints' church, lady chapel, altar and tower, 463, 593

Hall: dining, for country houses in France, 179; Lancashire and Cheshire miners' (Bolton), 237; new, Ridge Green house, Surrey, 337; 81; bridge and entrance, 437; 81; new, new house, near, 502; St. Wilfrid's church, 77  
Headquarters, Cardiff fire brigade, 96  
Headle frieze, new, council chamber, Edinburgh, 363

Holyrood abbey, Edinburgh, 397  
Horse, 319  
Houses: in the Fields, 502  
Hillcrest, 77; Totteridge, Herts., 137  
Hockley Sole manor, near Edekstone, 444  
Holyrood abbey, Edinburgh, 397  
Horticultural society, laboratories for, 462  
Hospital: shell-stock, Palace green, Kensington, 344; South African military, Richmond, Surrey, 393  
House: concrete, 424; country, dining hall for, 77; street, James, Holborn Vardnet, 127; in St. James's, S.W., entrance and vestibule, 244; new, Harrogate, Yorks, 502; Ridge Green, Surrey, dining hall, 357  
Houses: manor, Great Chalfeld and Wroxall, Wilt., 417; of Parliament, old, and Parliament Square, Dublin, 217  
Hulse art gallery, sculpture, and china hall, 184  
Hythe, Lymne castle, 277

High school for girls, Tulse Hill, St. Martin's-in-the-Fields, 502  
Hillcrest, 77; Totteridge, Herts., 137  
Hockley Sole manor, near Edekstone, 444  
Holyrood abbey, Edinburgh, 397  
Horticultural society, laboratories for, 462  
Hospital: shell-stock, Palace green, Kensington, 344; South African military, Richmond, Surrey, 393  
House: concrete, 424; country, dining hall for, 77; street, James, Holborn Vardnet, 127; in St. James's, S.W., entrance and vestibule, 244; new, Harrogate, Yorks, 502; Ridge Green, Surrey, dining hall, 357  
Houses: manor, Great Chalfeld and Wroxall, Wilt., 417; of Parliament, old, and Parliament Square, Dublin, 217  
Hulse art gallery, sculpture, and china hall, 184  
Hythe, Lymne castle, 277

**IMPERIAL** college of science and technology, main entrance of, 363  
India: new church at Medak, 462  
Inn, the George, Norton Street, Phillip (Somersetshire) 338  
Ink-factory, technical design for, Dukerates, Salp., 277  
Insurance: company, proposed branch office, 257; office, Kew, Surrey, 417  
Ireland, new church (Celtic Romanesque) 96

**JERUSALEM**, church of the Holy Sepulchre, 437

Kensington, Palace green shell-stock hospital for, 344  
Kent, Lymne castle, near Hythe, 277  
King's college, Cambridge, Knisp garden city, 495

**LABORATORIES**, Wisley, for the Royal Horticultural Society, 462  
Lacock abbey stables, and Corsham church, Wiltshire, 364  
Lacock and Cheshire miners' hall Harrogate, 237  
Liverpool: bank of Durham, 77; Canard building, two interiors in, 277  
Lymne castle, Hythe, Kent, 277

**LABORATORIES**, Wisley, for the Royal Horticultural Society, 462  
Lacock abbey stables, and Corsham church, Wiltshire, 364  
Lacock and Cheshire miners' hall Harrogate, 237  
Liverpool: bank of Durham, 77; Canard building, two interiors in, 277  
Lymne castle, Hythe, Kent, 277

**LABORATORIES**, Wisley, for the Royal Horticultural Society, 462  
Lacock abbey stables, and Corsham church, Wiltshire, 364  
Lacock and Cheshire miners' hall Harrogate, 237  
Liverpool: bank of Durham, 77; Canard building, two interiors in, 277  
Lymne castle, Hythe, Kent, 277

**LABORATORIES**, Wisley, for the Royal Horticultural Society, 462  
Lacock abbey stables, and Corsham church, Wiltshire, 364  
Lacock and Cheshire miners' hall Harrogate, 237  
Liverpool: bank of Durham, 77; Canard building, two interiors in, 277  
Lymne castle, Hythe, Kent, 277

**LABORATORIES**, Wisley, for the Royal Horticultural Society, 462  
Lacock abbey stables, and Corsham church, Wiltshire, 364  
Lacock and Cheshire miners' hall Harrogate, 237  
Liverpool: bank of Durham, 77; Canard building, two interiors in, 277  
Lymne castle, Hythe, Kent, 277

**MANCHESTER:** royal exchange, 257  
 Manor; Goldinour, East Grassfield, 397; Hoesley Sole, near Folkestone, 414; houses, Great Chalfield and Wraxall, Wilts., 417; Notgrove, Gloucestershire, 184  
 Memorial: chapel, proposed war, Westminster abbey, 284; to the late Lord Strathcona, 337  
 Military hospital, Richmond, Surrey, 302  
 Mincers' hall (Holton) 237  
 Minister, York, view of crossing, looking north, 444  
 Monument, the Drake, Musbury church, 338  
 Municipal buildings, Fanchal, Madeira, entrance to, 237  
 Munition factory, Birmingham (entrance-buildings) 495  
 Museum, Victoria and Albert, South Kensington, main entrance, 17, 57, 117, 337  
 Murray lodge, Newmarket, 117  
 Musbury church, the Drake monument, 338

**NATIONAL** provincial bank of England, Taunton, 184  
 Neasden, St. Catherine's church, 144  
 New church in Ireland (Celtic Romanesque) 91; premises, architectural association, Bedford square, 237  
 Newcastle-on-Tyne, King Edward VII. school of art, 257  
 Newmarket, Murray lodge, 117  
 Norbury, road screen, St. Stephen's church, 417  
 Norton, St. Philip, Somersetshire, the George Inn, 338  
 Notgrove manor, Gloucestershire, 184

**OAKENGATES.** Salop, design for technical institute, 277  
 Office: for an insurance company, proposed, 237; insurance, Kew, Surrey, 417  
 Open-air shelter, military hospital, Richmond, Surrey, 302  
 Operating theatre, South African military hospital, Richmond, Surrey, 302  
 Organ, stalls, and chancel screens, St. Mark's, South Audley street, W., 337  
 "Otway," s.s., reading-room, 444  
 Outdoor art class, 363

**PANELS,** sculptured, in the archivolt, main entrance, Victoria and Albert museum, South Kensington, 17, 57, 117  
 Paris, Comptoir National D'Escompte, King William street, London, 437, 444  
 Parisian parlour, 417  
 Park lanc. flats in course of erection, 402  
 Parliament, old houses of, and Parliament square, Dublin, 217  
 Perfect dwelling, the, 495  
 Plans: architectural association, new premises, 234; Comptoir National D'Escompte de Paris, King William street, E.C. 437, 444; craft museum, King's college, Cambridge, 495; dwelling, problem of the small, 17, 36, 77, 96, 117, 137, 144, 177, 184; El Guadalupal, Spain, 284; "Ellercrest" (Totteridge) 137; hospital for shell-shock, Palace green, Kensington, 311; insurance office (Kew), 417; school of art, King Edward VII., Newcastle-on-Tyne, 257; South African military hospital, Richmond, Surrey, 302; St. Martin's high school, Tulse Hill, 502; technical institute, Oakengates, Salop, 277; Wallingford, Purley, 217; war memorial chapel, proposed, Westminster abbey, 284; warehouse, for Messrs. John Menzies and Co., Ltd., Glasgow, 364  
 Porchester terrace, No. 35, additions and alterations, 177  
 Premises, new architectural association, Bedford square, 237  
 Priory church (St. Nicholas) restoration, 284; St. Nicholas, Exeter, 257  
 Problem of the small dwelling, 17, 36, 77, 96, 117, 137, 144, 177, 184, 237  
 Purley, "Wallingford," 217

**RAIDS,** air, shelter against, 500  
 Reading-room, S.S. "Otway," 444  
 Reinforcement, straight-bar, without bends, 77  
 Repairs, apparatus, simple, 164  
 Revivals: war memorial (St. Paul's, Southsea), 177; Yoxall, Burton-on-Trent, 57  
 Ridge Green House, Surrey, new hall, 337  
 Road screen: Christ church, Epsom, 277; St. Stephen's church, Norbury, 417  
 Room: day, and general view, S.S.W. of military hospital, Richmond, Surrey, 302; morning and hilliard, Summerhill Court, Stourbridge, 397  
 Royal Exchange, Manchester, 257  
 Ruslip garden city, for King's college, Cambridge, 495

**SAINT:** Catherine's church (Newcastle) 144; James's, S.W., house in, 341; Luke's (Thornton Heath) 217; Mark's, South Audley Street, W. (memorial to the late Lord Strathcona), 337; Stephen's church (Lambeth), 144; Stephen's (Norbury) (road screen), 417; Wilfrid's church (Harrogate), 77  
 Salop, Oakengates, selected design for Technical Institute, 277  
 School: High, for Girls (Tulse Hill), St. Martin's-in-the-Fields, 502; of art, King Edward VII., Newcastle-sculptured panels in archivolt, main Newcastle-on-Tyne, 337  
 Science and Technology, Imperial College of, entrance of, 303  
 Screen: new road, Christ church, Epsom, 277; road, St. Stephen's church, Norbury, S.W., 417  
 Sculpture and china hall, Hulme Art Gallery, 184  
 Sculptured panels in archivolt, main entrance, Victoria and Albert Museum, South Kensington, 17, 57, 117, 337  
 Sections: Comptoir National D'Escompte de Paris, King William Street, E.C., 444; Holyrood Abbey, Edinburgh, 397; Technical Institute, Oakengates, Salop, 277  
 Septic tank, new form of, 36  
 Shell-shock, hospital for, Palace Green, Kensington, 311  
 Shelter: against air-raids, 500; open-air, military hospital, Richmond, Surrey, 302  
 Small dwelling, problem of, 17, 36, 77, 96, 117, 137, 144, 177, 184, 237  
 Somersetshire: cottage in, 57; George Inn, Norton St. Philip, 338  
 South African Military Hospital, Richmond, Surrey, 302  
 South Kensington Imperial College of Science and Technology, main entrance, 303  
 Spain, El Guadalupal, 284  
 Staircase, hall, and entrance, 437  
 Stourbridge, Summerhill Court, 397  
 Stowell Park, near Cirencester, new hall, station, 17  
 Straight-bar reinforcement without bends, 77  
 Summerhill Court, Stourbridge, 397

Surrey: Ridge Green House (new hall) 337; South African Military Hospital, Richmond, 302  
**TANK,** septic, new form of, 36  
 Taunton, National Provincial Bank of England, 184  
 Technical Institute, Oakengates, Salop, 277  
 Technology, Imperial College of Science, main entrance to, 303  
 Theatre, operating, South African Military Hospital, Richmond, Surrey, 302  
 Thornton Heath (St. Luke's church) 217  
 Town founder's, Washington cathedral, 36  
 Tudor, bridge, Hill-Crest, 137  
 Tudor style, dining-hall designed in, 77  
 Tulse Hill, High School for Girls, St. Martin's-in-the-Fields, 502  
**VICTORIA** and Albert Museum, sculptured panels over main entrance, 17, 57, 117, 337  
**WALLINGFORD** (Purley) 217  
 War: memorial chapel, Westminster abbey, proposed, 284; rerodis (St. Paul's, Southsea) 177  
 Ward, bath, South African Military Hospital, Surrey, 302  
 Warehouses for John Menzies and Co., Ltd., Glasgow, 364  
 Washington cathedral, the founder's tomb, 36  
 Waterworks, new buildings for the, Baden-Baden, 397  
 Wesleyan church, Medal, India, 462  
 Westminster abbey, proposed war memorial chapel, 284  
 Wiltshire: bridge chapel, Bradford-on-Avon, 432; Corsham church, 77  
 Wisley: new laboratories for the Royal Horticultural Society, 462  
 Woodland Court, Amersham, Bucks, 257  
 Woodwork, English church, A.D. 1250-1550, 502  
 Woodworking, some wrinkles in, 244  
 Wraxall manor houses, Great Chalfield and, 417  
**YORK:** Harrogate, new house near, looking north, 444  
 Yoxall, Burton-on-Trent, new rerodis, 57



# THE BUILDING NEWS

## AND ENGINEERING JOURNAL.

### CONTENTS.

**Effingham House.**

Currente Calamo .. .. . 1  
 The Problem of the Small Dwelling and Its Solution.—VII. .. .. . 2  
 Municipal and County Engineers—Their Organisation and Administration .. .. . 3  
 Legal Intelligence .. .. . 4  
 Statutes and Memorials .. .. . 4  
 Our Illustrations .. .. . 17  
 Correspondence .. .. . 17  
 Architects' Charges and the Institute Scale .. 17  
 Professional and Trade Societies .. .. . 18

1 Building Intelligence .. .. . 18  
 Our Office Table .. .. . 19  
 Clips .. .. . 19  
 To Correspondents .. .. . 20  
 Tenders .. .. . 20  
 List of Tenders Open .. .. . 20  
 Trade Notes .. .. . 20  
 Latest Prices .. .. . viii.

**Strand, W.C.2.**

Kensington, S.W. Mr. Alfred Drury, R.A., Sculptor, Sir Aston Webb, R.A., Architect.  
 New Bathminton Court, Stowell Park, Gloucestershire, for the Earl of Eldon, D.L.  
 Exterior view from the carriage court and interior showing gallery front and staircase, Mr. Sydney Tatekell, F.R.I.B.A., Architect.  
 The Problem of the Small Dwelling and Its solution, Seventh and eighth stages. Two sheets of plans, Nos. 12 and 13, by Mr. Robert Thomson, Architect.

### OUR ILLUSTRATIONS.

The Sculptured Panels in the Archivolt to the main entrance, Victoria and Albert Museum, South

## Currente Calamo.

The Minister of Munitions is to be questioned in the House of Commons as to whether sanction has been given by his Department to prolonged private building operations now being carried on in Westminster, whether he is aware that entirely new work is being begun by the destruction of a building erected within a few years, and recently in the occupation of the London County Council, and whether the expenditure of labour on such work will be prevented during the continuance of the war. It would really be useful if Dr. Addison, in the course of his reply, could indicate on what principle certain building operations in the capital have been allowed to proceed while others, seemingly as useful, have peremptorily been stopped.

Lord Crewe, as chairman of the London County Council, described last week as a "sleeping beauty" the partly-finished County Hall, on the Thames at Westminster Bridge, now being put to temporary use as the home of the National Welfare and Economy Exhibition. If a modicum of the money and labour expended on erecting wooden shanties in the Embankment gardens and the London parks and ineffectively adapting luxurious hotels to office purposes had been used to complete the County Hall, the Government long ago would have had at their command admirable and extensive clerical accommodation. As it is material is deteriorating and money is being needlessly and extravagantly spent otherwise at the bidding of people who seem as often at cross purposes as the muddlers in Mesopotamia.

We fear little will be got by way of a reply from Mr. Lloyd George's satellite, The Premier's ideas about finance are really so extraordinary! Dealing in his speech at Dundee on Saturday last with the bread difficulty, he told his hearers that to control the price of bread if necessary the Government will "resort to the Exchequer in order to bring it within the compass of the bulk of the people." That is to say, to square the profiteers the taxpayer will have to make good the difference between their prices and a reasonable charge to the consumer! Now, housework is only a less vital necessity than bread. Moreover, there is no substitute for it, and

the shortage of houses at the moment is more imminent than that of flour. But with regard to house building, Mr. Lloyd George is as obstinate as when he first stopped it in 1909-10. He said:—"We have practically stopped housebuilding. Now, there is no man in this country who thinks that housebuilding is a bad thing in itself. I have heard of many associations for all kinds of impossible purposes, but I never heard of an association to stop housebuilding. Therefore, I take it that here is something that everybody agrees is in itself a beneficial object. We have had to stop it. Why? It takes too much labour. It takes material which is essential for war purposes. It takes transport which you can't possibly spare; and if you permit housebuilding it interferes with the prosecution of the war. Therefore, to stop it is an essential war measure. I apply the same principle to every restriction which is introduced. Take horseracing; there are people, I believe, who disapprove of horseracing. I neither approve nor disapprove. I have absolutely no views on the subject, but the question whether it is good or bad in itself has nothing to do with the action of the Government. It is entirely a question of the extent to which you can permit it without interfering with the war work and war activity of the country. Anything beyond that is irritating and mischievous. Anything short of that is not adequate to the needs of the case. The one test is—Is it necessary as a war measure?" Builders, therefore, apparently, with any money left had better go on the turf especially in Ireland! They have loyally submitted to war restrictions. All they have asked as yet is that the exceptional taxation laid on them five years before war broke out should be removed, and that if Government has any money to spare presently it shall be lent to them on fair terms to make up for the lack of capital he has, scavenged from their doors not given as a dole as he proposes to deal out war bread.

We are glad to note that at the luncheon given last Thursday to the Lord Mayor and Sheriffs and Sir Alfred Mond, the First Commissioner of Works, presided over by Mr. Banister Fletcher, F.R.I.B.A., chairman of the Library Committee of the City Corporation, Sir Alfred Mond worthily sketched the pur-

pose and proper scope of the proposed War Museum, which some people, probably with axes of their own to grind, want to relegate to the Tower of London! As Sir Alfred Mond truly remarked, there is a tendency, which he deplored, for memorials to be side-tracked in order to supplement the funds of institutions which were created in times of peace or for purposes of public utility, which ought to be carried out regardless of memorial schemes. It is hoped to build a dignified building, with representations of the great men who had taken a great part in the great enterprise; a great Hall of Honour, representing the achievements of British regiments, of the men from the Overseas Dominions, of his Majesty's ships, and of the Allied Forces. It was an elaborate scheme which would require a considerable amount of money to carry out. The site of the building ought to be in some fine central position, easily accessible to citizens and visitors. It would be most unfortunate to place such a building on a side track because there happened to be a cheap site available, and it would be impossible to house the Museum in some building which had been erected for an entirely different purpose. Sir Alfred appealed to the City of London for its support in the creation of a worthy Museum. The Lord Mayor, promising his support to the scheme, remarked that he presumed Sir Alfred would like the Museum to be in the City of London.

A circular sent us by the Board of Education indicates that the space taken up by the staff transferred to the Victoria and Albert Museum is not quite half of the total space of that Museum. The main entrance to the Department will be the door in Exhibition Road, hitherto used as the western entrance to the Museum. The great central door in Cromwell Road will remain as the Museum entrance. The President, Parliamentary Secretary, Permanent Secretary, Permanent Secretary of the Welsh Department, and the Chief Medical Officer will continue to occupy rooms in Whitehall. The medical branch of the Board is already at Cleveland House, St. James's Square. With these exceptions the whole of the administrative staff will be housed in the Museum. The Board of Education (General) will continue to

use its telegraphic address, which is "Aristides, South Kens., London." The examination section calls itself "Rhoadames, South Kens., London," and the medical department "Medication." The last is not a bad portmanteau word, and will probably be oftener remembered than the other two!

So many things have gone, or are going, down in the earthquake of this world-wide war, that one wonders whether even our Land Laws will survive this shock, as they have others. Our law of Real Property, or Conveyancing, is still mainly based on the Feudal system and the ancient theories that this produced. The whole structure needs overhauling and rebuilding from the bottom. In its application to our lives of to-day it constantly works hardship and injustice. Take the recent small case of "Chester v. Cater" as a specimen of the muddle of the law and the varying views of the judges. It was a little thing of itself, beginning in a county court with an action about a yew-tree, but it is full of lessons for those who learn. The plaintiff had become yearly tenant to the defendant of a farm he owned, which adjoined other land belonging to him. At the time of the letting a yew-tree was growing on the boundary of the defendant's land overhanging the land let to plaintiff; though not so low that it could be reached by animals on the farm let to the plaintiff. But the yew-tree went on growing until it was within their reach. A mare in foal belonging to the plaintiff ate of the foliage, and so was poisoned. Then he, as tenant, sued the defendant for its value as damages. The county court judge treated the tenancy as in contract, and as the defendant had given no warranty to cut the tree judgment was given for him. On plaintiff's appeal to the High Court the two judges were quite opposed in their views of the law. Coleridge, J., held that as, if the parties had been adjoining owners, the defendant would have been liable, so it should be in the case of adjoining landlord and tenant. Indeed, this would seem to be stronger, for the landlord gets his rent, and so should be under a duty to protect his tenant from his poisonous overhanging trees. But Rowlatt, J., was quite as certain the other way; holding that the plaintiff, as tenant, saw the tree and took the risk, so he had no claim, as it was only a contract, and there was no warranty. Thus the county court judgment for defendant stands good; and two rules of law go on side by side on the same land.

Mr. J. Harrison, Queen Street, Darfield, has been appointed sanitary inspector and surveyor to the Darfield Urban District Council.

A Civil List pension of £80 per annum has been granted to Mrs. Arthur Hughes, in consideration of the merit as a painter of her late husband, Mr. Arthur Hughes, and of her inadequate means of support.

At Odley Police Court last Friday, the parchment of the Royal Humane Society was formally handed over to Mr. Thomas Deane, a partner in the firm of Isaac Deane and Sons, builders and contractors, Ilkley. On April 29 Mr. Deane rescued a five-year-old boy from the River Wharfe near Ilkley Bridge, and by the persistent use of artificial respiration was successful in saving the boy's life.

## THE PROBLEM OF THE SMALL DWELLING AND ITS SOLUTION.

VII.

By ROBERT THOMSON,  
WITH ILLUSTRATIONS.

I much regret having referred in last week's issue to the optical disabilities of the politicians responsible for the adoption and issue of the reports on housing therein referred to without having, at the same time, submitted the evidence upon which alone such reference was justifiable. This omission I now make good, and since the members of the Departmental Committee on the equipment of small holdings have themselves already provided the necessary evidence in their report to the President of the Board of Agriculture and Fisheries, this evidence will be best given in the official version, which is as follows:

Sir—The Committee that you appointed on February 27, 1912, to inquire and report as to the nature and character of the buildings which should be provided for use in connection with small agricultural holdings in England and Wales, beg to submit the following report:—

1. By the terms of our reference we were required to undertake a two-fold task, which embraced, in the first place, an investigation of the requirements of small holding tenants and of the possibilities of economy in making provision for those requirements, and, in the second place, the preparation of a series of plans and specifications in the light of the information obtained.

2. To this end we have held seventeen meetings of which five were for the purpose of hearing evidence. In addition to the meetings of the full Committee, sub-committees met on five occasions.

It is only necessary for the architect to glance through the Committee's voluminous and exceedingly weighty report—the avoidpious of my copy being exactly one pound eleven ounces—to at once see that it was physically impossible for the Committee to have even inspired this report. By reading the last paragraph in their report the whole position is made clear. This paragraph is as follows:—

"166. Finally, we wish to place on record our thanks to our secretary, Mr. C. W. Sabin, for the untiring zeal which he has displayed in obtaining information for us, and particularly for the mastery way in which he has tabulated that information and made it readily available for our use."

It is safe to state that no ordinary business man acting for himself or any professional man acting on behalf of others would have been so grossly neglectful of his duties as to have accepted such a palpable absurdity. It is only the glass-eyed variety of custodian of the people's welfare who can so grossly neglect his duties with absolute impunity. Unfortunately, the politicians by issuing the Committee's plans as models for the guidance of local authorities and others have given them an appearance of value which they certainly do not intrinsically possess.

The examples given on the two accompanying Sheets XII, and XIII, show plans each of which on one of these sheets has its counterpart on the other, and the three sets of figures underneath each pair of plans bring the number represented up to the grand total of eighteen.

To the casual observer glancing over the two sheets the corresponding pairs would probably strike him as being almost exactly alike, but in making such an assumption he would be very far wrong indeed.

The two sheets are given side by side to enable the earnest student to realise in a very practical way the effect of the structural developments which were described in considerable detail in last week's issue.

As a matter of fact, instead of being even approximately equal to those on Sheet XII, the plans on Sheet XIII, mark one of the great strides which carry the

single-flatted type of dwelling far beyond the realm in which direct comparison with the existing two-flatted official type of dwelling would be either possible or useful, and I will require to again direct the attention of the "experts" who "advise" the Government to study their own declaration in regard to planning which appears in paragraph 19 of the Advisory Committee's report. I will again quote that paragraph, and this time will give it complete. As very often happens, the sting in this quotation is in its tail—mark the last ten words of it beginning with "Careful planning."

When the accommodation to be provided has been settled, it is clear that there is a definite limit to the degree of economy to be secured by the careful planning and arrangement of that accommodation. This limit is determined by the fact that the quantity of material necessary to provide a given amount of house-room cannot be reduced below a definite amount. Careful planning enables the minimum to be approached very closely.

By going to the bottom of the pile of plans which have already appeared in the present series the reader will see how far the Committee's own offspring, in regard to which the quotation just given was written, has already been snowed under.

I should here explain that although the examples given to-day are incomparably ahead of anything which the two-flatted type of cottage can give, the effect of "careful planning" is, even with the advantages offered by the plans on Sheet XIII, not yet nearly one-half exhausted.

It is a dangerous thing for either inexperienced amateurs or amateur experts—to either of which appellations the Committee themselves can determine that to which they belong—to dogmatise in regard to the planning of the small dwelling which, to my thinking, is by far the most complex of all subjects which any architect could have been called upon to face.

The Committee's assumptions of perfection in regard to their own plans which their paragraph on "planning" implies must, I feel sure, have done immense harm by overawing many young architects who would not unnaturally feel it presumptuous on their part to question the capacity of such a high, or to be strictly correct highly placed, authority, more particularly as the Government, by the adoption and issue of these plans as models, had given them an endorsement which, to say the least, is misleading.

The malign influence of those inexperienced committees is, however, not confined to the young and inexperienced but is widespread and far-reaching. The case of Mid-Lanark is one of many examples of this which might be cited.

Mr. William Ross Young, town planning engineer, Middle Ward of Lanarkshire, in a paper read at the forty-second annual congress of the Incorporated Sanitary Association of Scotland, states:—

"The first matter local authorities will have to consider is the minimum size and standard of construction they are to adopt, and in this connection it may be stated that the Mid-Lanark District Committee have closely followed the recommendations of the various advisory and departmental committees which have reported on the matter."

The examples given on Sheet XII, mark the completion of the series of elementary groups. One of the characteristic features common to all the plans of these groups is that they are all on the one and the same dead level in regard to their ceiling height, which has in every case been assumed at 8 ft. While this arrangement has the advantage that it enables the reader to make direct comparisons either between any two apartments or between any two or

more dwellings having roofs of similar area, and thus preserves the simplicity of these elementary groups, on the other hand it has the drawback that it does not deal justly with the single-flatted type of dwelling in comparing it on a dead level with the two-flatted type. In this connection I have to point out that the plans of the single-flatted type of cottage, when built in groups of semi-detached fours, give ceilings 10 ft. 3 ins. high with substantially less walling than the official two-flatted type of corresponding roofed area require to give ceilings of only 8 ft. high. This fact will be clearly brought out when the question of the two-flatted terrace type of dwelling comes to be dealt with, since this type is already accepted as being the most economical of all existing types of cottages to construct and maintain.

In the meantime, however, it will not do to entirely ignore the Government's model plans shown on Sheet II., and I propose, therefore, to now give some figures which illustrate in a forceful way the economical character of the single as against the double-flatted type of cottage dwelling. A comparison with the official six-apartment plan, Fig. 17, as the basis would show the single-flatted dwelling off to the greatest advantage; but as my desire is that the official plans be shown in, for them, the best possible light, the Advisory Committee's plan No. 6, shown in Fig. 14, Sheet II., will be taken as the basis. This plan, when standardised with a 4 ft. 1/2 in. passageway, measures for the group of four dwellings 86 ft. 5 1/2 in. by 22 ft. 3 1/2 in., and when the small break in front is added its total roofed area works out at 1,972 square feet, thus giving 986 square feet as the area of each pair.

The walling is as follows:—

Front and back wall	.....86.5 1/2 × 2 =	172 11
End walls	.....22.8 1/2 × 2 =	45 5
Party walls	.....20.10 1/2 × 3 =	60 7 1/2

Lineal feet	.....	250 11 1/2
Taking the height as on Fig. 16 at	.....	22 6

Gives a superficial area of sq. ft. .... 6,921 6 1/2

Adding thereto—

(a) the walling at one side of passage way, 20.10 1/2 × 13.9 = sq. ft.	.....	287 0
(b) the gables on the three party walls (22.8 1/2 × 6.7 ÷ 2) × 3 =	.....	224 2

Giving a total superficial walling area of sq. ft. .... 6,932 8

The corresponding figures for plan 986, Fig. 58, Sheet IX., are:—

Front and back wall	.....80.3 × 2 =	160 6
End walls	.....22.2 1/2 × 2 =	44 5
Party wall	.....20 × 2 =	40 0
Extra for wings	.....8' 0" × 2 =	17 0

Lineal feet	.....	242 5 1/2
Height as on Fig. 16	.....	22 6

Gives a superficial area of square feet ..5,555 3 1/2

Adding thereto the gable on the party wall .....22 1/2 × 6.5 ÷ 2 = sq. ft. 72

Giving a total of superficial ft. .... 5,627 3 1/2

From which falls to be deducted for the reduced height of wings an average of .....2' 0" × 34' 0" × 2 = 136

Giving a total superficial walling area of 5,491 3 1/2

The difference between the walling of the four dwellings of the official plan, Fig. 14, and that of the single-flatted group of four thus works out at 1,341 square feet in favour of the latter.

The surplus of 1,341 square feet can be utilised in either of two ways. In the first place, it would in some districts be required to give the necessary thickness of outer walling in the lower story, and it is, therefore, in the present instance so applied. In the second place, it could be utilised to increase the ceiling height from 8 ft. to 10 ft. 3 in. by employing my patented method of construction, which

was explained in last week's issue. The effect of employing this 1,341 square feet of surplus brickwork walling for the first-named purpose is seen in plan Fig. 69, while the advantages of utilising it for the last-named is brought out by the figures appended to plan 986, Fig. 75.

The result of adding 4 ft. 6 in. to the height of the four dwellings erected to plan, Fig. 75, would be as follows:—

Back and front walls	.....80' 8" × 2 =	161 4
End walls	.....22.1 × 2 =	44 2
Party wall	.....20 5	
Extra for wings	.....8' 6" × 2' 0" =	17 0

Lineal feet	.....	242 11
Height to give 10' 3" ceilings	.....	27 0

Gives a superficial area of square feet 6,558 9

Adding thereto the gable of party wall .....22.1 × 6.5 ÷ 2 = 71 0

6,629 9

Deducting the saving effected by wings 136 0

Gives a total superficial area of sq. feet 6,493 9

The extra brickwork required to increase the thickness of the walling of the main building in plan, Fig. 69, is almost exactly equal to that required to add 4 ft. 6 in. to the height of the four dwellings built to plan, Fig. 75. The result of these two operations is, however, very widely different. The effect of increasing the thickness of the walling is very clearly seen by comparing the figures showing the house-room on the plans shown by Figs. 69 and 58 respectively. The loss of house-room amounts to 297 cubic feet, which, at the officially based rate of 15d. per cubic foot, represents a loss of £18 11s.

With plan, Fig. 75, the result is very different indeed, the effect of the structural developments being to show a gain of 3,534 cubic feet in each of the four dwellings as compared with the average for each of the four in the official model plan, Fig. 14, on Sheet I.

This gain of 3,534 cubic feet, when priced at the officially based rate of 15d. per cubic foot shows an advantage in house-room alone equivalent in value to £220 17s. per dwelling. In addition thereto, and without taking into account any of the savings which it effects in foundations and in other directions, it gives a structure which is fire-resisting and is very much more substantial and which ought to be vastly more durable than any of the counterparts of this plan shown in Figs. 14, 24, 57, 58, and 69, and the tale is not yet half-told.

One of the effects of increasing the height of ceiling is to increase the air space in the parents' bedroom of this plan, 986, Fig. 95, to 2,160 cubic feet, which is equal to the combined air spaces both of the Committee's parlour and their "desirable" parents' bedroom, which are to be seen together in the dwelling shown in the plan, Fig. 57.

As the great increase in the air space of this apartment would enable it to be used as a bedroom by night and as a parlour by day, it is obviously necessary that there be some means of marking the important advantages which this difference secures over the plans in which the ceiling is too low to provide the necessary air space for these two purposes.

In order, therefore, to provide for this differentiation I have added the second set of figures shown in all the plans on Sheet XIII.

(To be continued).

Captain John Basil Armitage, Cheshire Regiment, is reported killed on May 17 by a stray shell. He was the eldest son of Mr. W. Armitage, of Altrincham. Captain Armitage was an architect before joining the Colours. He leaves a widow and three children.

MUNICIPAL AND COUNTY ENGINEERS — THEIR ORGANISATION AND ADMINISTRATION.

By P. H. PALMER, M.I.C.E.

Last Thursday Mr. P. H. Palmer, M.Inst.C.E., borough surveyor and water engineer, Hastings, was installed as President of the Institution of Municipal and County Engineers, in succession to Mr. J. S. Brodie, M.Inst.C.E., of Blackpool. Subsequently there were discussions on papers entitled "Public Abattoirs," by Mr. H. A. Brown, engineer and surveyor to the Urban District Council, Weston-super-Mare, and "Extraordinary Traffic and Excessive Weights on Highways," by Mr. H. T. Wakelam, M.Inst.C.E., county engineer, Middlesex.

There is no doubt, said Mr. Palmer in his presidential address, that after the war there will be great changes in life and general business methods, which will in a great measure apply to and affect the work and lives of the younger generation of engineers and surveyors. It is, therefore, necessary that the engineer and surveyor should not only be well up in his own particular work, but he should be trained to organise and be a good business man. The work of an engineer and surveyor to a large town or district requires careful organisation; and it is, therefore, necessary to have a homogeneous scheme, in which all the various departments will work together smoothly in order to make a success. We are living in times which call for great administrative ability—a demand which is not easily met. The question of administration goes hand in hand with that of organisation, for unless there is proper organisation there cannot be proper administration. There should be a single mind in control from which all plans and authority should start; there should be delegated authority in conformity with the branches of organisation; the recognition of subdivisions of authority, loyally carried out; the determination of a general scheme for its attainment, and the exercise of constant and frequent inspection. The necessity of areas of discretion is consequent upon the fact that unforeseen conditions and circumstances incident to the work in hand are constantly arising in the various branches of work, and must be dealt with, without avoidable reference to the administrative head.

The methods of carrying out the various parts of an ordinary task should be left as far as possible in the hands of the head of the department concerned. Superior officers should be left to control as many details as they can safely accomplish, but any undue interference with the responsibility assigned to subordinates is calculated to upset the general effectiveness of the system employed. With subordinates they should be fully alive to the fact and realise that they are being held responsible for results, and that they are free to get the best results out of the particular branch under their control; this should give them an interest in their work, and engender loyalty to their chief, factors which go a long way towards the successful working of all administrations. Administration must be governed by rules and regulations which are both important and unavoidable, but they should be of such a nature as not to hamper the freedom of the subordinate too closely. The duty of inspection, which is a most important one in all matters of administration, should not be carried out with any idea of being antagonistic to fellow-officials or workmen, but should be exercised more in the nature of finding out efficiency and methods, and introducing improvements, rather than constantly on the look-out for wrong-doing.

HOUSING PROBLEMS.

The housing of the people will have to be taken in hand with a bold and unstinting resolve; very large sums of money will be required for the purpose, and steps should be taken to induce the Local Government Board to give to local authorities some simple and expedient means of launching prelimi-

\*From the Presidential Address at the Hastings meeting of the Institution of Municipal and County Engineers on June 27.

nary "town-planning schemes." With the present machinery and formalities it takes three years and upwards to get a scheme through and into working order. Great care would, of course, be necessary in dealing with any preliminary scheme, so that complications did not arise in the carrying out of the complete scheme. The idea of standardising cottages and buildings in connection with town planning schemes has been largely advocated, but I hope this idea will not be overdone, as one can imagine nothing much more monotonous than a number of buildings of the same plan and elevation; and it is, perhaps, advisable that in all large schemes an architect of repute should be associated with the engineer and surveyor in its development, in order that true artistic taste may be incorporated—an attribute too too often found developed in the engineer to any marked extent. It is absolutely essential, in carrying out the proper spirit of town planning, that everything connected with the scheme should be of a permanent and lasting nature, otherwise that which was intended to be a thing of beauty and joy would only eventually become tawdry, dilapidated and commonplace.

Municipalities should bear in mind that in town planning, as in most other municipal enterprises, to do a thing on the cheap is always much more costly in the long run than doing the thing well at first; the latter method gives satisfaction as soon as it is done, and the original cost is not borne in mind very long, but the constant repair and upkeep of a thing badly done is a reminder to the authority and a source of worry to the engineer. There is now, and has been for some time past, a great and a growing tendency to convert large houses into flats; in the South of England there is a great demand for them, brought about largely by the domestic servant problem and the tendency of people to get rid of the expense, anxiety and trouble of a house. There is great difficulty in dealing with their conversion under the ordinary by-laws, as in most cases there is little or no structural alteration to the premises. These conversions, so long as they generally comply with sanitary conditions, ought not to be seriously opposed or objected to by local authorities; flats are, generally speaking, much to be preferred to the ordinary tenement house containing a number of lodgers. From a rating point of view, it is better to have one or two flats let than a whole building empty, and not bringing in rates, if existing as one house.

#### THE HIGHWAYS.

Much literature has been written and a great deal of discussion has taken place during the last ten years as to the improvement of highways. There is no doubt that a most remarkable improvement in the condition of road surfaces generally throughout the country has taken place. Before the war, in some districts in the South of England they appeared almost perfect; but many of these roads have been badly cut up by the heavy traction engine and military motor traffic. Much of the improvement in road surfaces has been brought about by the use of tar and tar compounds; and there are few road authorities in the kingdom which have not organised their road-making so as to embrace the surface treatment of their roads. There are many articles on the market for the treatment of road surfaces; but I find that dissolved tar (No. 2 grade), if applied in a proper manner and under suitable climatic conditions, gives extremely good results, especially where the road traffic is not particularly heavy.

Road construction is, after all, more or less a matter of money; some county councils are able to spend such sums on making and resurfacing the roads in their districts as are out of the question in the case of small boroughs and districts of small rateable value; and in the case of old boroughs most of the roads in the first instance have been constructed either entirely without or with very indifferent foundations; old gas and water mains exist, and the roads are frequently broken up for repairs to these mains. These causes have to be taken into account

in the cost of upkeep, and operate against the making and maintenance of good road surfaces. In the South Coast towns road metal has been almost unobtainable for the last two years; railway companies refuse to carry it except in small quantities, and for long periods have refused carriage altogether; so that in the case of older towns road repairs have been much neglected; and had it not been for the general use of tar spraying, the roads must have gone to pieces. No doubt, after the war is over, very large quantities of materials will be required, and large sums will have to be expended in putting roads all over the country into a satisfactory state of repair; the greater difficulty will be, however, for local authorities to find the money without material increase of rates.

#### REINFORCED CONCRETE.

I should like to refer to the subject of design and construction of reinforced concrete structures: it is a matter which I have tried to study and master for the last four or five years, but I have come to the conclusion that this subject is one which is of such a special nature that the design and calculation of the strains of such structures, except those of a simple character, should be left to men who are making and have made the subject their special study. The calculations involved in ascertaining the stresses and strains in a large and complicated structure require the application of higher mathematics to a degree that the general body of municipal engineers are not capable of giving; but I certainly am of opinion that they should be in the position of following those calculations through, after they have been made by the expert, but even this requires a very sound knowledge of mathematics. The carrying of such designs into execution should only be entrusted to firms of repute and who have had experience in such constructions. One hears a deal of successfully completed structures, but not often of the many which are failures through either faulty calculations or construction, or due to both. One has heard of the obstacles placed in the way of municipal engineers by the Local Government Board in the early days of reinforced concrete, and I think they were quite justified in their action.

#### MECHANICAL TRAINING.

It is highly desirable, if it can be obtained, that the engineer should have some mechanical training. He is called upon frequently to carry out schemes where mechanical power of one kind or another is used, and he should know something of the design and construction of the plant to be installed. Most municipal engineers have control of mechanical plants and machines, and to be in a position to know what is wrong and how it should be put right, is a distinct asset to the municipality and a control over those actually in charge of such plants. I have found this knowledge of enormous benefit to myself; it has saved the Hastings Corporation money and enabled me to carry out work by administration which I could not have done without.

#### MORE RESPONSIBILITY FOR SURVEYORS.

The Prime Minister's recent speech, after resolutions passed at the Labour Party's Conference, dealing with labour after the war, might well apply to all local government officers. I cannot think that the term Labour Party should be simply applied to those who work with their hands; as the use of automatic machinery becomes more general, it will be necessary for "labour" to work more with their heads; and of all the classes of local government and educational officers, the municipal engineer and surveyor surely has more responsibility thrown upon him than any other. He is responsible for the spending of large sums of money, and for the success or failure of various schemes; and to a large extent for the healthiness of the town or district. One only need refer to the recent success achieved in the House of Commons by the National Union of Teachers to see what can be done by organisation, and diligent and steady working, to achieve an object in view; and although teachers have been recognised apparently as a national asset, they have not certainly any ground for

priority of claim over local government officers on grounds of "national importance."

#### RECOGNITION FOR LOCAL GOVERNMENT OFFICERS.

The country has depended upon Local Government officers very largely in the war; and the response made by municipal engineers and their staffs to the call of national duty, as well as the work being done by those whose age prevents them from field service, deserves recognition in some tangible form at the hands of the Government; and superannuation, and some form of security of tenure, is surely not too much for the Government to pay for all the work that Local Government officers have done for the war. In conclusion, I would like to say that what teachers and other professional workers can do, municipal engineers and surveyors can do, if they will throw their whole energies into proper and efficient organisation, and be prepared to combine into one body, and make the sacrifice of time and the necessary expense to make it effective.

#### LEGAL INTELLIGENCE.

Damages, £275, awarded against the Gas Light and Coke Company for accident sustained when viewing a house. In this case, tried last Wednesday, before Mr. Justice Shearman and a common law jury, the plaintiff, Mrs. Kinber, recovered £275 damages for negligence against the defendants, whose workmen failed to warn her of a hole made by them on the top of a landing in a house in which they were carrying out repairs. Mr. Justice Shearman said that the owners in pursuance of his contract with the lessee of the premises, had instructed the builder to employ the defendants to make alterations in the premises. The lessee put the house into a house-agent's hands, who gave the plaintiff an order to view. The lessee had a right to use the premises and to give permission to other persons to come into them. The defendants' servants, who were making repairs on the premises, let the plaintiff in when she knocked, and allowed her to walk up the stairs without warning. They had taken up a board on the landing, and had left a hole there, as they were entitled to do in making their repairs. The landing was ill-lighted. The jury had found that the defendants were not negligent in failing to protect the hole, but that they were negligent in failing to warn the plaintiff. The facts in this case were unusual, but general principles covered the case. The defendants were under a duty towards anyone who was entitled to be on the premises, and the plaintiff was therefore entitled to judgment. A stay of execution was granted.

#### STATUES AND MEMORIALS.

VICARS OF OKEHAMPTON.—LIST FROM 1267.—An interesting historic addition to All Saints' venerable parish church, at Okehampton, in the form of a tablet bearing the names of the vicars from early times, has just been placed on the wall of the north aisle. A former vicar, the Rev. Stanley R. Carden, who is now at St. Marcellus, is responsible for the work being carried out, having collected the funds. The oak tablet is of the 15th Century style of Gothic art, and measuring 4ft. 6in. by 2ft. 8in. The carved foliage and tracery panel are well executed, and harmonise pleasantly with the immediate surroundings. The tablet bears the record of forty names, dating from 1267, but does not include the name of the present vicar, the Rev. R. H. Welham, M.A. The memorial was designed and executed by Messrs. Harry Hens and Sons, sculptors, Exeter, who also were responsible for the pulpit, reredos, and clergy and choir stalls in the church. The present Okehampton parish church, was dedicated by Bishop Grosseteste in 1251, a day after the dedication of the Chagford parish church.

A novel method for illuminating swimming baths—and so reducing the danger, which is ever present, of bathers at the deep-water end of the bath who may have happened on accident lying at the bottom unobserved, and so losing their lives—has been installed at Seattle, Washington. Large specially designed water-proof automobile headlights are installed at intervals of 10 ft., and are, it is said, very effective.



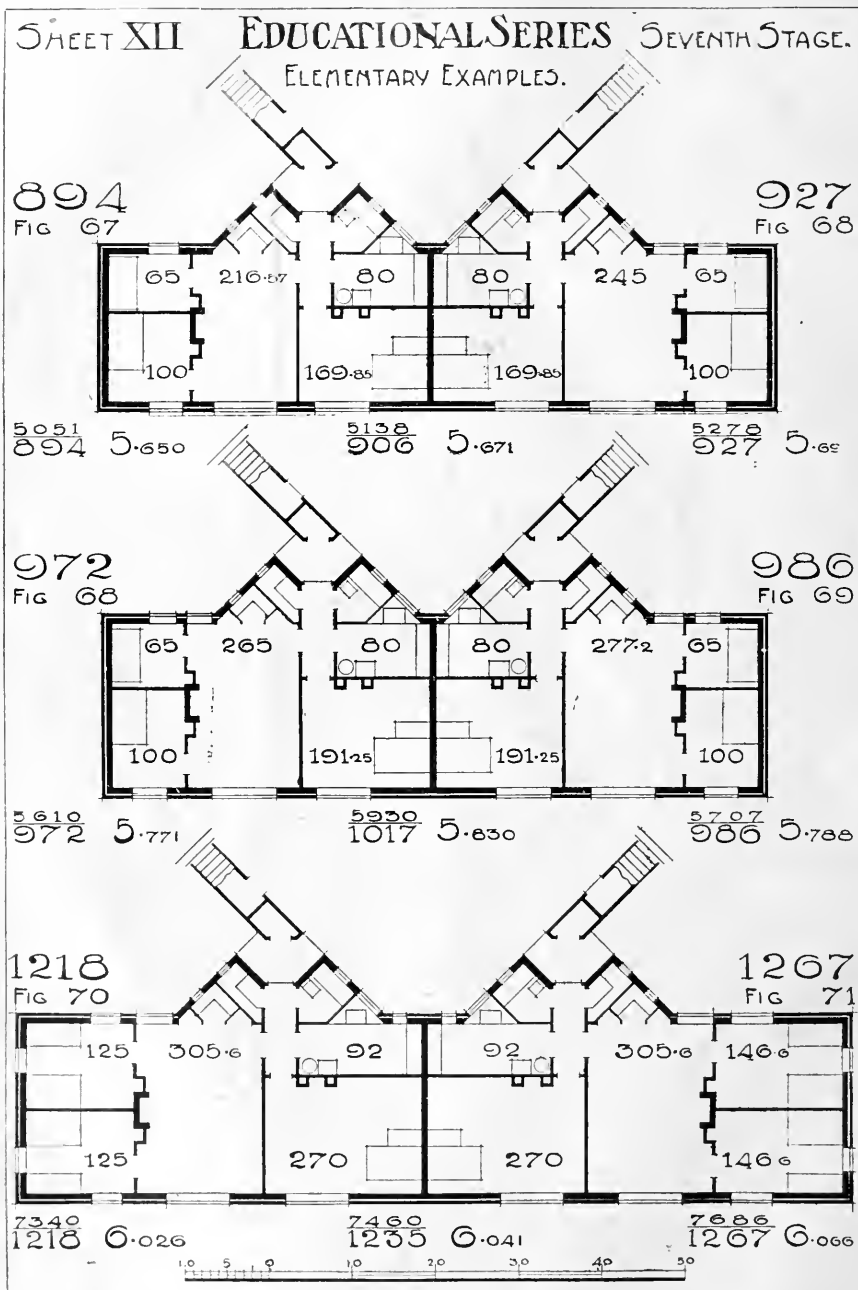





*(Cyril Blin, Photos.)*

STOWELL PARK, GLOUCESTERSHIRE, BADMINTON COURT: FOR THE EARL OF ELDON, D.L.  
MR. SYDNEY TATCHELL, F.R.I.B.A., Architect.



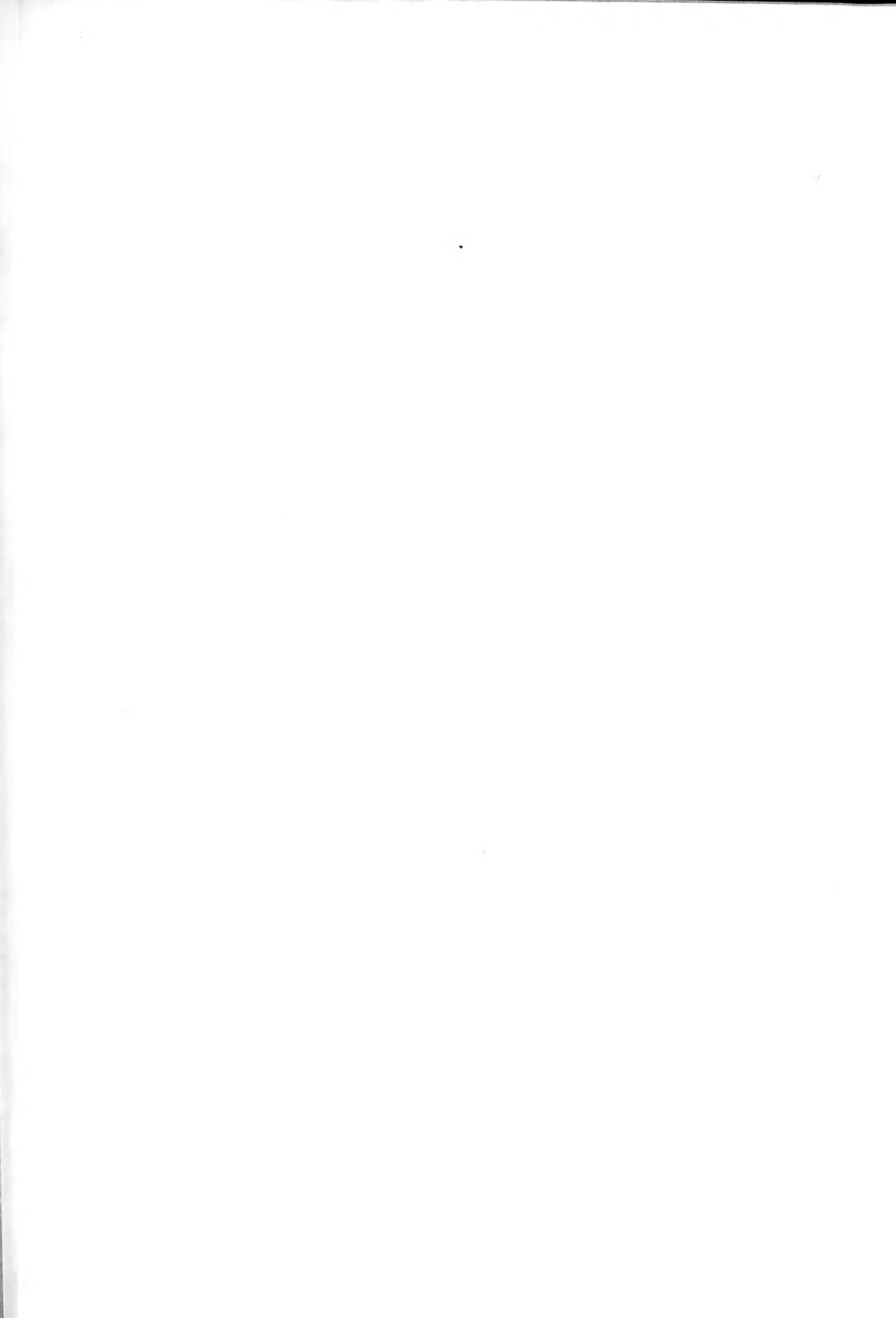





THE SCULPTURED PANELS IN THE ARCHIVOLT OF THE MAIN ENTRANCE, VICTORIA AND ALBERT MUSEUM,  
SOUTH KENSINGTON, S.W.

Mr. ALFRED DAWKIN, R.A., Sculptor. Sir ASTON WEBB, R.A., Architect.





*Carl Elze, Photo.*

STOWELL PARK, GLOUCESTERSHIRE, BADMINTON COURT GALLERY  
FOR THE EARL OF ELDON, D.L.—MR. SYDNEY TATCHELL, F.R.I.B.A., Architect.



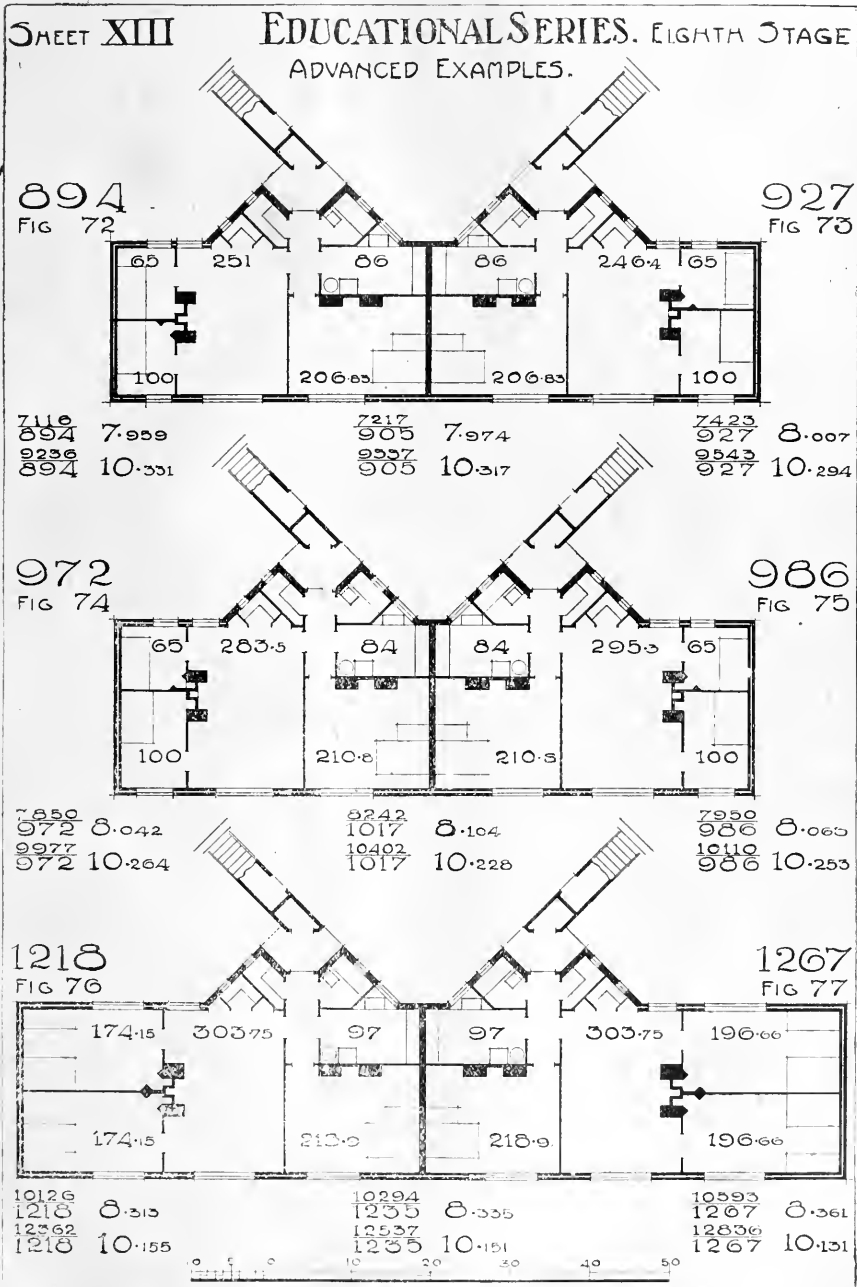

SECTION : TYPICAL EXAMPLES.—By Mr. ROBERT THOMSON, Architect.





## Our Illustrations.

SCULPTURED PANELS IN THE ARCHIVOLT OVER THE MAIN ENTRANCE, VICTORIA AND ALBERT MUSEUM, SOUTH KENSINGTON, S.W.

In our last issue double and single-page illustrations were given from the fine set of photographs in the present exhibition of the Royal Academy. To-day we conclude this series of panels to the archivolt spanning the principal portal of Sir Aston Webb's great memorial and national museum at Brompton. Mr. Alfred Drury, R.A., designed, modelled, and sculptured these admirable symbolic figures, which are set out in nine panels, and running through them reads the following inscription:—"The excellence of every art must consist in the complete accomplishment of its purpose." Having given the first five, we now include the remaining four set out on the accompanying double-page sheet. The attributes of art thus represented are as follows:—"Observation," "Ideality," "Thought," and "Purpose." The statues connected with this same entrance referred to in our letterpress last week will be published at an early date.

NEW BADMINTON COURT, STOWELL PARK, NEAR CIRENCESTER.

Some views of the recently added South Terrace at Stowell Park, Gloucestershire, appeared in THE BUILDING NEWS on May 3 last, when descriptive particulars about the work were given. All the alterations and additions lately carried out in connection with this mansion by the Right Hon. the Earl of Eldon, D.L., were designed by Mr. Sydney Tatchell, F.R.I.B.A., of Queen Anne's Gate, Westminster. The house was erected about thirty years ago from the plans of the late John Belcher, R.A. The Badminton Court, to-day illustrated, forms part of the new work. The exterior photograph exhibits this building flanking the carriage court. The interior shows the gallery front and staircase placed at the end of this spacious and handsome hall. Mr. E. W. Gossett is the resident clerk of the works who superintended generally all these undertakings, which were executed by the workmen belonging to Lord Eldon's property near Cirencester. The stone, too, was quarried on the estate. Messrs. William Pearce, Limited, of Birmingham, made the gun-metal casements and supplied the lead quarry glazings. The stone and wood-carving was done by the late Mr. Henry Frith, of Gloucester. The sanitation, heating, and plumbing work, under the supervision of Mr. G. Willis-Vollaire, M.Inst.C.E., one of the engineers of the London Sanitary Protection Association, was executed by Messrs. Darbin and Katesmark, of London. We have another photograph from Stowell Park lent us by Mr. Tatchell, the architect, which will be published in due course. It illustrates the winter garden standing at the end of the south terrace hereinbefore mentioned.

THE PROBLEM OF THE SMALL DWELLING AND ITS SOLUTION.

Among our illustrations to-day is given a further pair of pages of "elementary" and "advanced" examples in association with Mr. Robert Thomson's patented plan of staircases and porch arrangements combined with larders, etc. His descriptive and suggestive article upon these proposals appears on page 2. This series started on May 23, and will be found continued in our issues for May 30, June 6, 13, 20, and 27, each set of schemes showing variety and detail developments on the same lines. The present sheets are numbered 12 and 13—the seventh and eighth stages of his thesis.

A memorial tablet, including a medalion portrait of the late Sir William Ramsay, K.C.B., F.R.S., is to be erected in the University of Glasgow, of which he was a graduate and teacher. The University Court has arranged that the memorial, which is designed by Sir John J. Burnet, shall be placed in a conspicuous position at the entrance to the Bute Hall.

## Correspondence.

BENNETT v. SPRAGUE.

To the Editor of the BUILDING NEWS.

Sir,—On reading Mr. William Woodward's letter in the "Building News" of June 27, 1917, on the evidence he gave before Mr. Pollock, the Official Referee, in the above case, I am somewhat surprised to note a number of statements which appear therein, and as I was engaged by Mr. Bennett to conduct this case as his professional adviser, I think it is only right that I should be allowed to reply to some of these comments, and to be able to do this more clearly I do so by way of answers to each of the statements in his letter which I object to. The claim certainly was a heavy one, being for about £1,800 in fees, and was very much beyond the value of the services rendered. The learned Referee awarded to Mr. Sprague less than one-third of this amount, he to pay all costs, and the drawings to be handed over to Mr. Bennett for his use.

1. (Mr. William Woodward) will confine myself to the scheme which was finally approved.

Reply: It was proved in evidence that no scheme was approved, and, as a matter of fact, two sets of tracings showing the contemplated building have been laid before the Coventry city surveyor, the first of which was returned, as it neither satisfied the requirements of the authorities nor the requirements of the client. The second scheme submitted had one section and one elevation only. The drawings are not approved or even laid before the Licensing authorities.

2. I gave evidence on behalf of the architect (Mr. Sprague), and I was supported by two other architects.

Reply: It is my opinion that architect members of the Institute who give evidence for architects who are not members of the Institute are not entitled to rely upon, or use the Institute scale, which, although it is sometimes taken as being the usual custom, appears to be used by outside architects only when it suits their purpose.

3. "In this case tenders were not produced and a specification was not written."

Reply: This statement is an admission that Mr. Sprague was not entitled to be paid by commission, but was only entitled to claim for the value of the work he had done. The drawings were shown to be tentative only or preliminary sketches, and were not in any sense of the term working drawings. Mr. Woodward refers to ten carefully inked-in drawings; these drawings were in tracings on linen, from which sun copies had been taken; what he calls working drawings are now in pencil. He also states that the plans were figured up. As I have a copy of the plans before me whilst I write, I can state without fear of contradiction that there is not a single dimension on the drawings, except widths of corridors, and no lines of dimensions used by quantity surveyors are visible thereon.

4. "A section, not quite completed, showing the stairs, and an outlined plan showing the drainage system, completed the set."

Reply: These drawings are only partly completed in pencil, and were not traced and submitted to the local authorities with the other ten drawings.

5. "I said that after deducting a sum of 100 guineas for the specification, the architect was fully entitled to the 2½ per cent."

Reply: Why not 300 or 500 guineas? It is evident to me that until the whole of the drawings and specifications are complete the scheme is not sufficiently illustrated to be used as an attached document to a contract form.

6. "I stated in Court that the usual practice is to await the acceptance of a tender before the above-mentioned details are supplied."

Reply: I do hope that this is not Mr. Woodward's practice or that of any member of the Institute. If the constructional steelwork and other engineering details are not furnished by the architect from his own knowledge, it is certainly his duty to obtain

the necessary assistance to enable him to do so before a contract is signed.

7. "I stated that the detail plan of the drains was not necessary."

Reply: Surely Mr. Woodward cannot mean this, as if the levels of the drains are not fixed so as to meet the outfalls it may be necessary to raise the whole building out of the ground and incur extras.

8. "I also pointed to the fact that the words 'general and detailed drawings' were not included in Clause 5 as in Clause 1."

Reply: This is certainly an omission which ought to have the attention of the Practice Committee of the Institute, and only shows the general imperfection of the drafting of the schedule.

9. "We know that the schedule is under revision by the Institute."

Reply: I have to say that, as a member of the Institute, I do not know that the schedule is under revision, but I do know that at one time, some years ago, as quoted in "Spsons," that 1½ per cent. is published as being the value of sketch or preliminary drawings, and not 2½ per cent.

10. "I do not intend to urge that my view of Clause 5 is the right one."

Reply: May I express a hope that Mr. Woodward will assist the Institute in defining what Clauses 1 and 5 really mean?

I am pleased to know from Mr. Woodward's letter that he agrees with Mr. Pollock's decision—viz., that this case could only be decided on a quantum meruit basis, and that he did not rely upon and believe that the drawings were not the working drawings, but that they were preliminary or sketch drawings, and that the values put upon them by Mr. Bennett's witnesses were generous.

Mr. Woodward has omitted to mention in his letter one important point arising in this case, and that is the custody of drawings, which in this case were not working drawings, but preliminary drawings, which are usually submitted in competitions, so that whatever sum an employer pays, the drawings become his property, and he has a right to use them.

The importance of this case and the points raised in it are so vital to architects generally that I have a full and detailed report of the case will be obtained for and considered by the Practice Committee of the Institute, and that they will give a considered opinion, and if they would like to examine the drawings when handed over to Mr. Bennett, I feel sure that he will agree to give them every facility for doing so.

Yours faithfully,

J. COLTON NICHOL,  
King's Court, 117, Colmore Row, Birmingham.

ARCHITECTS' CHARGES AND TITLES INSTITUTE SCALE.

Sir,—I am in no sense connected with the case of which you give a report in the current number of the BUILDING NEWS, and there is no need for me to attempt any emphasis upon what you have said in your editorial note about the importance of members of the R.I.B.A. being substantially in agreement as to the meaning of so fundamental a clause as No. 5 in the authorised scale of professional charges quoted by Mr. William Woodward in his letter on page 550 of your Journal of Wednesday last. There remains, however, something more to be said about the omission of the specification in this particular case of Bennett v. Sprague, as that circumstance involves questions of fact and not mere matters of opinion, upon which people are so apt to differ. The defendant, Mr. Sprague, set up the claim of 2½ per cent., but he had not written his specification, and that militated materially against, even if it did not entirely vitiate, his chance of success under this Clause 5, upon which both parties relied. The Official Referee, Mr. Pollock, rightly insisted that the specific requirements of that clause must be strictly complied with. Mr. Woodward tells us that in his evidence he proposed the substantial deduction of a lump sum of £100 as a set-off in consequence of the non-preparation of the specification, but surely this showed a misapprehension of

the point by failing to grasp the salient fact that, however ample and admirable Mr. Sprague's drawings may have been in so far as they went, they could not, under the circumstances, have gone far enough to conform with Clause 5, because no building work of such a character as a theatre can be sufficiently investigated and digested by the designer, however expert he may be, till the project has been brought seriatim into review by the process of going carefully through the provisions trade by trade and item by item as only happens, at this stage of the business, during the process of writing the specification. Such a document is not so much a matter of so many folios of a descriptive sort or letterpress writing valued at so much a page. All kinds of questions arise necessarily in the mind of the architect as he proceeds to describe his intentions to enable others to realise what he means; and should he foolishly, as some do, hand over the specification to his quantity surveyor to prepare, this same sort of analysis takes place, even in such a vicarious scrutiny. Anyway, till the specification is completed, many details must be left obscure and undetermined, needing more amplification and description on the general drawings or involving marginal sketches to the specification. These latter additions are not nowadays often added to the specification itself, because lithography has given place to the typewriter. In any event, however, bills of quantities and reliable tenders from builders, based thereon, are only possible after the specification has been produced; and even if clause No. 5 does not intend, as Mr. Woodward urges with good reason, that full half-inch scale details shall have been prepared for the 2½ per cent., he had to admit that Mr. Sprague only supplied in this instance one elevation and one incomplete section. In a theatre the stairways and approaches are usually very compact, and intricate contrivances economising space and complicating construction, so that such parts of the structure specially require many sections to make their involved arrangements clear and obvious. As to a half-inch detail of the façade or any other important portion of the building, most architects, for their own satisfaction and information, might be expected to prepare a half-inch detail at this earlier stage of the matter; but the structural ironwork and specialists' provisions would, in fact, only be undertaken when the clients had decided to go on and get in tenders, based, of course, upon the agreed-to scheme, as already prepared by the architect. Unfortunately, this case was complicated by financial and personal relationships between the parties bringing in many matters having nothing to do with architects' fees.—I am, etc., A PAST MEMBER OF THE INSTITUTE COUNCIL.

#### PROFESSIONAL AND TRADE SOCIETIES.

**THE SOCIETY OF ARCHITECTS.**—An ordinary meeting of the Society of Architects was held at 28, Bedford Square, London, W.C., on Thursday, April 12, 1917, at 6 p.m. The ballot was taken for the following candidates for membership, and was declared to be unanimously in their favour:—Clark, Henry Stanley, 66, Bronesbury Villas, Kilburn, N.W.; Johnson, Thomas Foster, 4, Brankesome Road, Norwich; Keefe, Richard Cyril, 11, Fleet Street, Dublin; Le Gros, Walter, Briar Cottage, Holland Avenue, Chaux, Roser, Walter, 8, Gelli Crescent, Risca, Mon. The following applicants have been found by the Council to be eligible for candidature, and their nominations were announced at the ordinary meeting on June 7, 1917. Communications in respect of the candidates must reach the Secretary for the information of the Council before July 12, 1917, after which date their names will go forward for election by ballot of the members at the next ordinary meeting. For membership:—Jackson, Gordon, Walford Seaton (Captain), Gordon Highlanders, Talbot Hill, Bournemouth; Jarvis, William Herbert, 35, Pier Road, Eritch, Keston, Leic.; Knapp, Laurip, Fed. Malay States; Marshall, James Ernest, The Laurels, Cross Lane, Grappenhall, Cheshire; Poynter, Ambrose, F.R.I.B.A. (Lieut. R.N.V.R.), 8, Grafton Street, Old

Bond Street, W. Herbert Edmondson (member) of Wakefield, notification of whose death some months ago has only lately been received, was entitled to Mr. Arnold S. Nicholson, M.S.A., of that city, and subsequently commenced practice there, and during the last twenty years carried out many buildings of a commercial and domestic character. The late Mr. Edmondson joined the Society in 1896, and was 46 years of age.—News of the death in action last October of Frederick Cross King, of Belfast, a Second Lieutenant in the Machine Gun Section, has just been received, from which it appears that while waiting the signal to advance a high-explosive shell hit one of the gun emplacements, wiping out the whole team. The late Mr. King was entitled to Messrs. Watt and Tulloch, F.R.I.B.A., and commenced practice in 1908 in partnership with his brother, Mr. G. G. King, at present on active service with the Royal Fusiliers. The late member joined the Society in 1914, and was 33 years of age.—Dinshaw Dorabji Mistry, of Bombay, who died on December 3, 1916, at the age of 82, received his early professional training under the late Major-General Waddington, C.B., Chief Engineer to the Government of Bombay, and the late John Campbell, F.R.I.B.A., M.S.A. He joined the Society in 1889, and on relinquishing his practice after forty years' work he was placed on the list of retired members in 1911.—William Stanley Dean (member), of Bournemouth, died on January 24, 1917, after a long illness, at the age of 38. He was entitled to Mr. G. A. Bligh Livesay, F.R.I.B.A., of Bournemouth, who served in the present war as a lieutenant in the South Wales Borderers, and is believed to have been drowned on active service. The late Mr. Dean's practice was chiefly in domestic work, and some of his designs were exhibited in the Architectural Section of the Royal Academy in 1900. He joined the Society in 1911.—Richard Cecil Davies, of Chester, who died on May 17, was one of Chester's most prominent citizens. He became a member of the City Council in 1893, and was elected Sheriff in 1901, appointed an Alderman in 1906, and elected Mayor in 1908. He was a member of the most important committees, and was chairman of the Electricity Committee. His activities were not confined to Chester, and he was at one time chairman of the Hoole District Council. The late Major Davies was an old member of the Volunteer Force. Serving first in the Earl of Chester's Rifles, he afterwards joined the Yeomanry, and subsequently received a commission in the Flintshire (Buckley) Engineers, in which he rose to the rank of major. He had the long service medal, and had well earned his retirement; but on the outbreak of war he volunteered for active service, and was gazetted a captain in the R.E. (Regular Forces), and made a D.O.R.E. for Chester. By his death Freemasonry in the province loses one of its most prominent figures. The late Mr. Davies's family have been connected with the architectural profession in Chester since about the year 1815. Alderman Davies became a partner with his father, Mr. John Henry Davies, and on the latter's death became head of the firm, consisting of his brothers, Mr. Fred Davies and Mr. Horace Davies. The late Mr. R. Cecil Davies had been a member for the last ten years of the Council of the Society of Architects. He, in connection with his firm, carried on the work for the Chester Union and extensive alterations and rearrangements for the Wirral Union, Holywell Union, and the Hawarden Union. He and Mr. H. Beswick were joint architects for the City and County Unionist Club premises in Newgate Street.—Thomas Ivor Moore, Assistant Director of Barrack Construction, was among the victims of the air raid on London on June 13. He was 58 years of age, and had been a member of the Society since 1904. He was a Justice of the Peace for Surrey, and was Chairman of the Governors of the Secondary School, a member of the Cottage Hospital Committee, and had identified himself closely with the social and public life of Woking, where he resided.

Tenders to the Lambeth Borough Council for wood-block paving vary from £21 to £29 per thousand, as compared with a pre-war price of 23.

## Building Intelligence.

**BIRMINGHAM.**—At a meeting of the Birmingham Education Committee the report of the special sub-committee appointed to consider the programme of building work to be considered after the war was discussed. The total estimated expenditure is put at £318,371, made up as follows:—First period, £210,271; second period, £90,100; third period, £39,000; and fourth period, £29,000. In the first period the estimated expenditure on elementary schools, either in the shape of new buildings, enlargements, or extended facilities, amounts to £574,649; on higher education, £23,750; on technical instruction, £92,500; on special schools, £17,452; and on hygiene, £1,920. The largest expenditure contemplated in this period is on technical education, and is made up of £78,340 on the Suffolk Street extension, alterations to existing buildings, £1,800; and furniture and fittings, £12,560. On higher education it is proposed to spend £21,500 on a new school to meet the requirements of Erdington, Ward End, and Saltley, and £2,250 on improvements to the Waverley Road and George Dixon schools. As regards elementary school accommodation, small schools for congested areas near the centre of the city are suggested in Bath Row, Garrison Lane, and Peel Street, at a total cost of £24,625. Another proposed school in Nansen Road, Saltley, is estimated to cost £19,775. In the second period the most important suggestion is that of a new secondary school at King's Heath, to cost £30,000. Special schools are also proposed to be erected at Greet and Small Heath, involving an expenditure of £10,100. A new school is contemplated for erection in the third period, the proposed site being York Road, Hall Green, and the cost £15,000. In this period, also, an expenditure of £1,000 odd is proposed on domestic centres, while in the last period new elementary schools in Oxhill Road, Handsworth, and Willow Avenue are projected, at a cost of £29,000.

**MONTHULL COLONY.**—A further extension of the buildings available for the use of the inmates at Monthull Colony has been made by the provision of a new chapel, which was formally opened and dedicated last Saturday. The keynote of the new building is its simplicity, a restrained Gothic design having been employed. The cost of the building, which will accommodate 500 persons, will be about £2,720. The ceremony was performed with a golden key, a gift of Mr. A. Whitwell, the architect, of Messrs. C. Whitwell and Son, of 3, Newhall Street, Birmingham.

The death is announced of Mr. James Grimshaw, outdoor superintendent of the Paving, Sewering, and Highways Department of the Manchester Corporation.

The Rochdale Health Committee have received a report from their Maternity Centres Sub-Committee stating that they had appointed representatives to look out for suitable places for a children's hospital as part of the child-welfare scheme. It is understood that the health committee will again go into the question of the utilization of the Springfield premises for this purpose.

With employment at home and fears abroad, remarks the *Tablet* in its review of architecture at the Royal Academy, the architectural world is not more happy than its fellow microcosms. "Let it go to the Royal Academy and think itself to be an Italian prince of the sixteenth century, strolling through his gallery of paintings, fresh from the easels of the painters of his day. It might be the anodyne of an hour." It might; but some of those sixteenth century "anodynes" were fatal!

The death has occurred, at his residence, at Bournemouth, of Mr. Thomas Foden Flint, surveyor and valuer, who, until his retirement in 1911, had for about fifty years led an active professional life in Birmingham. He was engaged in various important surveying schemes in connection with the development of the city many years ago, and was also connected with the negotiations between property-owners and the Great Western Railway at the time the Great Western Arcade was built over the railway tunnel between Snow Hill and Moor Street. Mr. Flint was eighty years of age.

## Our Office Table.

Mr. Edwin Seward, a Cardiff architect, after some years of study has patented a substitute for mining timber, which is being placed on the market. The props are on exhibit at the entrance to the Cardiff Exchange, and the chief points about them are that they are simple in construction, are indestructible, and do not deteriorate in water or damp. The chief component materials are to be found adjacent to collieries, viz., colliery cinders, stone and crushed clinker, which, when washed, manipulated, combined and duly strengthened, results in a prop the finished weight of which is light enough to allow of efficient handling by one timberman. They are said to be cheaper than timber, and represent in construction the vascular tissues of timber, and are produced in lengths and girths of any reasonable standardised dimensions for special seams or situations. They can be produced ready notched to any angle, rebated or bevelled at ends according to the requirements of colliery managers.

Since the first explorer descended the Athabaska River, upwards of 150 years ago, the existence in the northern part of the Province of Alberta of deposits of asphaltic sand has been recognised. This material consists of approximately 15 per cent. of high-grade bitumen and 85 per cent. of silicious sand. They represent the largest known deposits of solid asphaltic material; the deposits are as yet totally undeveloped; at the present time every ton of asphalt used in Canada is imported from foreign countries. The areal extent of the deposits is probably not less than one thousand square miles, and the average thickness is upwards of 100 ft. Recently the Mines Branch of the Canadian Department of Mines has undertaken an investigation not only of the deposits themselves, but also of methods best adapted to the commercial treatment of the crude bituminous sand. The results of this work suggest the use of the bituminous sand in a more or less crude form in the surfacing of streets and highways; to separate the asphalt or bitumen from the crude material in order to derive a more or less pure product; or to destructively distil the crude bituminous sand for the purpose of obtaining crude petroleum therefrom. Considering the absence of developed petroleum fields in Canada, such distillation could be undertaken under exceptionally favourable conditions. A study of possible separation and distillation methods is being made at the Mellon Institute of Industrial Research in Pittsburgh. Though details are not yet available, a process for economically effecting the separation has been developed. The area of bituminous sand is under Government reserve. There is reason to believe, however, that within a reasonable time this reserve will be removed and provision made whereby private individuals or companies may acquire areas for development.

The first annual concert of the Regimental Association of the Artists Rifles' O.T.C. was held last Wednesday at the training camp of the 2nd Battalion in Gidea Park. Colonel W. Shirley, C.O., stated that the Regimental Association was now twelve months old. It had nearly 4,000 members, which was a good start, but there were still many old Artists who did not quite realise the help that members could give if they would. The headquarters of the Association was at 17, Cravea Street, and there men from the hospitals could always meet. The Artists Rifles, since the outbreak of war, had supplied 6,000 officers to the Army, and had won six V.C.'s, fifteen D.S.O.'s, and eighty-five D.C.M.'s. Sir Ernest Birch explained that the objects of the Association could not be so much in evidence now, but the organisation would be fully needed for the work to be done on the conclusion of the war. Branches of the Association are now being formed at Durban, British Columbia, Toronto, Calcutta, and Manila. As an employment agency it is confidently expected that it will do much to direct the steps of discharged artists towards the portions of the Empire where their services will be most needed. There are 10,000

ex-members of the regiment, nearly all professional men.

The Burgh Surveyor of Dalkeith has prepared a report regarding the housing of the working classes in Dalkeith. The report states that there is a dearth of houses in the town, and consequently there are evidences of overcrowding, and that the class of house most urgently required is cottages of four apartments, with ground attached. Probably 200 would be required, and it is suggested that as a first instalment a scheme of fifty houses might be considered. It has been arranged that the Council will discuss the whole question when the number of occupants of the houses reported on is ascertained.

An exhibition of prints is being held at the gallery of the Royal Photographic Society, 35, Russell Square. The changing aspects of London always interest those who cherish memories of the City, many of which will be revived by such works as Mr. J. Keane's "Rainy Evening in the Strand," the two representations of Leicester Square at night, by Mr. R. H. Lawton and Mr. H. W. Fincham, and Mr. Gideon Clark's "November Sunset, Westminster." No less welcome will be other pictures of English life, ranging from Mr. E. W. Taylor's "Playmates," a group of children in a sunny cottage garden to Mr. C. C. Weston's "Riverside Tea Garden." More impressive are the reminders of how in the face of peril our Navy holds the sea. Mr. F. J. Mortimer's expeditions of the threatening force of the waves, our watching cruisers, and the dangers of modern piracy have already won appreciation, which will be appropriately extended by "The Vigil" and "The Trail of the Hums." The exhibition continues until July 21.

Reinforced cement is now being used with success in America for the construction of burial vaults and caskets of the most durable sort. Each casket is reinforced with sets of rods, that intersect at frequent intervals, and with strong wire mesh. The cement used is thoroughly treated with water-proofing. The cover, like the rest of the receptacle, is able to withstand great weight. It fits into a V-shaped groove that extends around the rim of the vault. Before it is put in place for the last time the groove is filled with liquid cement, so that when the casket is closed it is hermetically sealed. In each cover is a plate-glass panel, over which a small cement lid is sealed. The vaults, the tops of which are more rounded, are made in much the same manner as the caskets.

The scheme which has been formulated, with the sanction of the National Service Department, for the organisation of the building trade, with a view to the enrolment of volunteers for substitution for men of military age engaged on Government work, was explained to a large meeting of employers and employed in the Birmingham Town Hall, on Sunday. The chair was occupied by Sir Hallowell Rogers, who pointed out the necessity for providing substitutes in order to release men of military age, and the scheme which was now proposed was to be carried out by a joint committee of employers and employed. He understood the representatives of the trade who met in London undertook this work because they wished to do it through their own organisation, and not through the agency of the Labour Exchanges. Mr. Ernest J. Brown, of the London Federation, remarked that the National Service scheme had had a lot of cold water thrown upon it. The scheme had even been called a failure. Up to a certain point it was; but, as a matter of fact, the supply of munitions in the past was a failure up to a certain point. So far as the building trade was concerned, employers and employed had joined hands in order to see the matter through. He firmly believed this co-operation would lead to better relations between the operatives and employers after the war. Mr. J. Parsonage, operatives' secretary of the Central Joint Committee for National Service, urged that the scheme proposed was in the interests of the operatives. The conditions

were good, and had only been obtained after a hard fight. There was a strong element of suspicion against the scheme. (Hear, hear.) That, he admitted, had been fully justified, not on account of this scheme, but in view of the action of the Government, and the way they had dealt with the trade unions, playing one off against another. He believed that if, when agreements had been made, it had been pointed out that they were subject to the exigencies of the military situation, there would not have been so much unrest as had prevailed and was now prevailing. Mr. William Moffat moved a resolution pledging the meeting to do its utmost loyally to co-operate in the administration of the scheme with a view to bringing it to a successful issue. Councillor H. Simpson seconded the resolution, which was carried, with two dissenters.

### CHIPS.

A Copenhagen telegram says that M. Zahrtmann, the well-known painter, is dead. A proposal is about to carry out extensions at Huller's College, Hull, at a cost of about £10,000.

The will has been proved at £1,015 of Second-Lieutenant A. D. Aitken, R.E., architect, who was killed last August in Egypt.

Mr. A. E. White, formerly of Kingston-on-Hull, for twenty-eight years city engineer of Hull, left net personally £13,277, gross £13,423.

The Right Hon. W. Hayes Fisher, M.P., has been appointed President of the Local Government Board, and Mr. Stephen Walsh, M.P., Parliamentary Secretary thereto.

The Dalmeir and West of Scotland Estates Company have been granted permission by the Clydebank Dean of Guild Court to build twenty-nine tenements of houses on the south side of Dumbarton Road, Dalmeir.

The works included in the contract of Morrison and Mason, Limited, for the construction of the river wall extension at the new London County Council Hall site have been completed, and the certificate of completion has been issued.

The death is announced of Mrs. K. S. Macquoid in her ninety-fourth year, the English woman novelist, who was of the well-known black-and-white artist, the late Mr. Thomas Macquoid, R.I., and mother of Mr. Percy Macquoid, R.I.

The Westminster City Council are relaying the worn-out paving in Eceleston Street and Chester Square in Val de Travers asphalt, because the wood paving had become, as is the case with a considerable number of metropolitan thoroughfares, dangerous to traffic.

Many Salopians will learn with regret of the death of Lieutenant H. Maulkinston, of the Lincolnshire Regiment, who was wounded on April 25, and died in a London hospital on the 14th ult. Lieutenant Maulkinston, who was a pupil in the county surveyor's office at Shrewsbury, was buried at Mablethorpe, where he was surveyor before he went to the war.

Two photographers on the staff of a London paper were summoned at Folkestone recently for taking photographs of injured in hospital after the air raid without permission. They were bound over. Lady Watkin, it is stated in the *British Journal of Photography*, was fined 20s. for being in possession of a camera without a permit. A special constable saw her taking a photograph of houses smashed by the bombs.

On June 17, at All Saints' Church, Winterton, the crucifix, which has been given by the Sunday-school teachers and children in memory of the men from this parish fallen in the war, was dedicated. It is the work of the firm, Bowman and Sons, Stanford. The figure is of fumed oak, with gilt halo, and the trefoil extensions of the cross are beautifully carved. It has been placed in an ancient niche in the east wall of the north transept. The architect was Mr. W. H. Wood, of Newcastle.

Application was made to the West Bromwich magistrates last week by the owners of two houses for an order to recover possession of the houses in order to make extensions to them. Mr. J. Clark said the trouble was that the tenants could not get other houses, and appeared to be "between the devil and the deep sea." It was stated by one of the tenants that he had tried to get a house at Oldbury, but was told there were 500 on the waiting list there. Mr. P. Wood (presiding magistrate) said this was a case of destroying houses at a time when they were badly needed. A short time ago it was reported that twelve people lived in a two-roomed house. The cases were adjourned for a month.



# THE BUILDING NEWS

## AND ENGINEERING JOURNAL.

**Effingham House.**

**CONTENTS.**

**Strand, W.C.2.**

Corrente Calamo .. .. . 21  
 The Problem of the Small Dwelling and Its Solution.—VIII. .. .. . 23  
 A "Snail-Shell" Stair .. .. . 24  
 Building Societies .. .. . 25  
 Obituary .. .. . 25  
 Our Illustrations .. .. . 26  
 A New Form of Septic Tank .. .. . 36  
 Dry Rot: Its Causes and Prevention .. .. . 37  
 Handling Stucco to Get Good Results .. .. . 37  
 Noise in Reinforced Concrete Buildings .. .. . 37

Building Intelligence .. .. . 38  
 Statutes and Memorials .. .. . 38  
 Correspondence .. .. . 38  
 Competitions .. .. . 38  
 Our Office Table .. .. . 38  
 Chips .. .. . 40  
 To Correspondents .. .. . 40  
 To Arms! .. .. . 40  
 Tenders .. .. . vii.  
 List of Tenders Open .. .. . viii.  
 Latest Prices .. .. . viii.

**OUR ILLUSTRATIONS.**  
 Tomb of the late Bishop Henry Bates Satterlee, Founder of the Cathedral, to be erected in Bethlehem Chapel, Washington Cathedral, Mr. W. D. Caroe, M.A.Cantab., F.S.A., F.R.I.B.A., Architect.  
 New Almshouses, Burlington Lane, Chiswick, to be built by the Parochial Charities' Trustees. Perspective view, plan, and detail of entrance gates. Mr. Maurice B. Adams, F.R.I.B.A., Architect.  
 The Problem of the Small Dwelling and Its Solution. Advanced examples. Sheets Nos. XIV. and XV. Mr. Robert Thomson, Architect.

### Corrente Calamo.

The "Whitley Committee," as it is called, which is a Sub-Committee of the Government Reconstruction Committee, has issued an interim report dealing with the problem entrusted to it of devising means for securing a permanent improvement in the relations between employers and workmen. We have not space to reproduce it, but its main purpose is the establishment of joint standing councils of workmen and employers in the various districts and industries to discuss "industrial questions apart from and prior to any differences with regard to them that may have begun to cause friction." Frankly, we think the work of any such councils will end in talk. It has been sufficiently obvious lately that in some of the great industries the workmen who have struck have totally disregarded the wishes of their own trade unions. The truth is that increasing numbers of workmen think and say that their unions have become more and more the comfortable sleeping-places of officials on their pilgrimage to the paradise of political place and profit. The Syndicalist has come along, as we predicted ten years since he would do, and there is no mistake about his ideals and the attraction they have for numbers of workmen. He is, in fact, the Sinn Feiner of industrial unrest. His purpose is the destruction of the capitalist system, and the substitution for it of an Industrial Republic. While the war lasts he will possibly make little headway, but by-and-by, when employers can no longer afford to pay war bonuses out of excess profits, and workmen will find it difficult to obtain constant employment at any wages at all, all the recommendations of Trade Councils will avail little. It is of little use reviling the Syndicalist as some do. He may, as some suggest, be only an agitator, determined to go one better than the trade unionist, with an eye to the loaves and fishes; or he may be the herald of a new epoch when we shall all have to turn workmen or starve. But if trouble comes meanwhile, his adherents will not be found in the joint trade councils, but quite elsewhere and very inconveniently. We did nothing but talk about Home

Rule for half a century, and at last when we gave it, postponed its operation, and now the Sinn Feiners have started a new propaganda altogether. We are not pessimists; but we incline to doubt whether district trade councils will be let talk a tittle of the time, and at the moment we doubt whether any member of this Government knows what should be done.

In the House of Commons last week Lord H. Cavendish invited the First Commissioner of Works to explain why his Department, in carrying into effect the repairs to the houses affected by the explosion in the East of London, had renewed floors over foundations of wet mud instead of concrete; and, seeing that this action on the part of his Department was calculated not only to endanger the health of the inhabitants, but to involve a waste of public money, would he say what action he now proposed to take.—Sir A. Mond, in reply, said the object of the work undertaken by the Department on behalf of the Ministry of Munitions was the most rapid possible reinstatement of the damaged property, and that object was undoubtedly achieved. He had made inquiries as to the possibility of compelling owners to contribute to the expense of affecting certain desirable alterations to their property, but the powers were limited, and it was not the duty of his Department to reconstruct or alter the character of private property at the public expense; concrete underfloors were therefore not put in in those houses where they did not exist before. As regards the last part of the question, Sir A. Mond denied the assumption that any action on the part of his Department had endangered the health of the occupants of the houses or had involved any waste of public money. He had personally visited the property on several occasions, and to his knowledge this property had been very materially improved in many respects.—Mr. W. Thorne asked if the borough surveyor of West Ham had had this under supervision.—Sir A. Mond said that the local authorities were fully conversant with what was being done all through. Probably; but, as elsewhere, the Government disregard Acts of Parliament which are obligatory on local authorities and private owners and builders when it starts building itself!

Whether the Government or the L.C.C. is responsible seems a matter of dispute. Councillor Grisley, one of the Canning Town representatives on the West Ham Borough Council, told a *Star* man last week that though it was possible that some improvements might be effected in the way of design in the new dwellings to be erected, the partly-demolished houses were being repaired on the old lines—that is to say, they are being patched up on their old mud foundations, and being restored to what they were before the explosion. So far no plans for the new houses had come before the West Ham Borough Council, and when such plans did come the Labour group, at all events, would insist upon an improved scheme of planning. "The whole trouble," said Mr. Grisley, "lies with the L.C.C. and their system of draining the island area of Silvertown. Up to about ten or twelve years ago the West Ham Corporation kept the area dry by pumping, but now the pumping station has been discarded, and the drying of the foundations depends upon the efficiency of the drainage system installed by the L.C.C. at North Woolwich. This system has been far from satisfactory in recent years, and we have often had to complain about it to the London County Council." One employed on the reconstruction work states that the floors of the cottages are being repaired and relaid over liquid mud. Plaster and other debris from the explosion has been thrown into the mud, but no attempt made to concrete floors or put damp courses in the walls. The total estimated cost of the reinstatement appears large, but that seems an inseparable accompaniment of Government building.

Manchester is getting on. The City Council only stultified itself by one vote—35 to 34—last Wednesday when after discussion Sir Charles Behren's resolution—"That in view of the fact that the Council on March 1, 1916, deferred the consideration of the following motion, viz.: 'That all existing resolutions of this Council which prevent or postpone action in connection with the Royal Infirmary old site be, and the same are hereby rescinded, and that the Special Committee be authorised to resume consideration of and to present a report upon the subject,' until the Traffic Congestion Special Com-



mittee have presented their report, which the Council desired should be in their hands within three months of that date, and of the fact that such report is not yet in the hands of the Council, though a period of over fifteen months has since elapsed, the Council be recommended to take the motion referred to into consideration without waiting for the report of the Traffic Congestion Special Committee—was rejected by a majority of one. The way had been cleared by some very pertinent remarks by Councillor Todd, the chairman of the Art Gallery Committee, who expressed regret that it had been necessary to close the exhibition of the Blair pictures for a time. While on this subject he desired to emphasise his regret and that of his colleagues that owing to the inaction of the Corporation with regard to the provision of a suitable gallery on the Piccadilly site only a small portion of the pictures collected by the late Mr. James Gresham had come into the committee's possession. "We have lost," Mr. Todd went on, "I regret to say, the best part of that collection. I hold in my hand a catalogue of 400 pictures which are to be sold by the trustees at Christie's, and those pictures certainly would have come to us if we had provided suitable rooms for them. In 1907 the Council asked for plans for an art gallery and library. Many plans were sent in, and in 1911 one was selected. The Council approved the plan and paid the fee in respect of it." The ultimate fiasco is familiar to all readers. Once again an effort is to be made to waste the site as a tramway centre—perhaps at the next Council meeting, and urgent action is imperative on all who are anxious that Manchester should not disgrace itself.

The Committee of the House of Lords, after all, has done better than the House itself in the matter of the Charing Cross Railway Bridge. The scheme came before the Committee on the 3rd inst., when, the London County Council's opposition having been withdrawn on certain modifications of the original proposal, the Bill was opposed only by the Royal Institute of British Architects and the London Society. Evidence was given by Mr. Tempest, chief engineer to the South-Eastern Management Committee, who, in cross-examination by Mr. H. Lloyd, K.C., for the opposition, said the company had abandoned the powers already obtained for the widening of the bridge, but not for the widening of Charing Cross Station. The widening of the station and attendant street improvements would cost about £700,000. The strengthening of the bridge as now proposed would cost £167,000. Sir Francis Dent, general manager of the South Eastern Railway Company, said if the present scheme was assented to the company would not raise any objection to a larger improvement because they had spent the £167,000. Mr. Lloyd said he believed it would be agreed that the bridge was an eyesore. He was not in a position to ask their lordships to throw out the Bill. He asked, however, that protection should be given by which there would be

no obstacle in the future to the placing of Charing Cross Station on the other side of the river and the building of a handsome road approach to it. He asked that Parliament should hold the hand of the company for two years, so that, if thought proper, this site might be used as a war memorial. Sir Aston Webb opposed the Bill, and said if the bridge was at the bottom of the river he should not be sorry. Lord Plymouth, president of the London Society, expressed the opinion that if the present Bill were passed there would be danger of indefinitely delaying a great public improvement. Lord Ribblesdale and Mr. John Burns also opposed the Bill in its present form. The latter remarked that when the Channel Tunnel was constructed—as he now believed it inevitably would be—the traffic on the reorganised South-Eastern Railway would probably be doubled or trebled. Charing Cross Station and bridge would then be miserably inadequate. The Chairman (Lord Kintore) said the Committee would allow the Bill to proceed upon the promoters giving the undertaking that no expenditure with relation to Charing Cross Station other than that required for the strengthening and repairing of the bridge should be incurred by the company. The Committee had also decided that in the event of any public improvement being authorised involving the removal of the existing station and bridge within fifteen years the railway company should not be reimbursed for their expenditure on the strengthening of the bridge. The Committee also required that the company should not begin the construction of the works above water until the expiration of three years from the passing of this Act unless the Board of Trade, in the public interest, should require the work to proceed earlier. We rather hope the effect of the last stipulation will be that the work above water at any rate will never be done at all. Anyhow, we have three years in which to work hard to get rid of the eyesore.

It is more than a possibility of the near future that here and in America builders of repute will ask to be paid for submitting tenders, and it is almost certain that building owners will save money thereby. Mr. W. H. Nelson, of Moline, Ill., who recently read a paper on the subject before a convention of the American National Association of Builders' Exchanges, told his hearers that last year \$2,000,000,000 was spent in erecting buildings in the United States. It cost the contractors of the country \$80,000,000 to furnish competition. A large portion of this waste is not only lost to the contractors, but is an economic waste, which the consumer pays. The public is the loser because of present methods. The ultimate consumer pays the bill. He will welcome any change in methods that will save him an unnecessary expense, lower the cost of building work, and better the character of work. He will save if he has to pay for tenders. He will see to it that architects and engineers make careful and conservative estimates, so as to avoid paying for competition twice or three times. It would help the real archi-

tect; it would make each owner pay for just the competition he received and not compel him to pay for competition received by others.

Mr. Nelson went on to explain the system on which he would base charges on tenders. He claimed that there are three main factors governing the relations between client and contractor: 1. Quantity and quality of materials; 2. Character of labour and personal service; 3. Price to be paid for both. The first factor—quantity and quality of materials—can be determined and definitely set forth in the form of plans and specifications, upon which the bidder can base his price. The second—labour and personal service to be rendered by the bidder or expected by the buyer—varies as much as human nature varies, and cannot be so definitely or exactly set forth. The price—or third factor—can be based definitely upon the materials, but must necessarily vary upon the personal service, depending upon the value placed upon it by either the bidder or the buyer. How much the contractor shall charge for tendering is his business. But in order to standardise and make a start Mr. Nelson suggested a method. It is recognised that the cost of figuring is in proportion to the size of the job. That is the first factor. In fact, the percentage of cost of figuring reduces almost in exact proportion as the size of the job increases. The only mathematical way to arrive at it correctly is to work it out by taking the square root of the amount of the contract. Now, if any factor or number is chosen to multiply this square root number by it will be found that the percentage of charge will be reduced automatically as the size of the job increases. Builders can set these factors themselves. The electrical contractors can use 30 per cent. of the square root; the plumbing contractors 20 per cent., etc. They can establish one definite factor for each branch for universal use throughout the country. Why not? Architects of repute will not compete unless they are paid to do so; and, one way or another builders of repute are paid—or pay themselves. Why not recognise the fact and leave the client who objects to the scalpers?

The Legislature of the State of Idaho has passed an Act "to provide for the licensing of architects and regulate the practice of architecture." The State Board of Examiners is to consist of five members, one a member of the architectural or engineering departments of the State University, and four architects who have been in regular practice for five years. The term of office is four years, two of the first appointments to expire in two years to secure a two-year alternation. Vacancies, as well as regular appointments, are made by the Governor. The examination fee is \$20, and is retained whether the candidate passes or not. The licence fee is \$20, and each practising member of a firm must have a separate licence. The salary of the secretary-treasurer is \$500, this and other expenses to be paid from the Board's receipts. Those with school diplomas and three years in practice, who have licences



induced by the exhaust action of the bedroom flues to flow inward by way of the duct already referred to, which delivers it into the chamber around the heating stove, by which it is warmed and from which it passes into the living-room, whence it flows over the partition into the bedrooms, descends therein, and, entering the exhaust flues at the floor level, is by them discharged at the chimney top, which is carried several feet above the ridge of the roof, so that it may be clear of any of those disturbing influences which roofs invariably cause when the chimney top is within their range of action. The withdrawal of the air at the floor level provides for the most efficient conservation of the heat. With the free inlet and outlet and the sootless exhaust flues which this system of heat-actuated ventilation provides, it is obvious that neither the volume nor the velocity of the air flow in these flues can be affected either by soot in them, since there is none, or by the sizes of the apartments through which the air is withdrawn, and that, consequently, the smaller the bedrooms are the more frequent must be the renewal of their air contents. This works in the right direction. For example, in a dwelling erected to plan, Fig. 93, which shows bedrooms of the largest size which it is desirable to construct, with an air flow velocity of only 2½ feet per second in the exhaust flues the air contents of these two apartments would be renewed between five and six times an hour; and in dwellings in which these two bedrooms have air contents equal in volume to those in the smallest size of dwelling officially called for, and which shows these bedrooms of the smallest size it is desirable to construct, the renewal of their air contents would be effected between nine and ten times an hour.

As the average velocity of air flow in these exhaust flues when the air supply is warmed is well over 3 ft. per second, and as the air contents of the living-room in plan Fig. 93 would, with its chimney assisting to only a very moderate extent, be renewed between three and four times an hour, with an outflow velocity of only 2½ ft. per second in the bedroom flues, there is thus ample flue capacity to provide an even more frequent change of air, and the regulation of its rate of flow is easy. While any considerable increase in the rate of flow just named might tend to cause discomfort in the living-room, the same difficulty does not arise in the case of the bedrooms, since in these the more rapid the renewal of their air contents the more invigorating is their atmosphere; and this, of course, gives the very atmosphere which is required for the prevention of consumption and the alleviation of consumptives.

As to the purity of the air supply thus made available there can be no question, since the living-room is unoccupied at night, when the bedrooms are in use. This arrangement has the further advantage that it enables the occupants of the bedrooms to benefit by the warmth of the living-room flue, a boon which should be highly appreciated by those who have hitherto been compelled to retire to rest in the icy atmosphere of an upstairs bedroom.

It is important to note that by this system of ventilation the air flow is so arranged that the deleterious gases given off by the combustion of illuminants are prevented from either contaminating or tending to overheat the air supply of the occupants of the living-room, and that as there is no artificial light needed in the living-room when the bedrooms are occu-

ped, the occupants of the dwelling are thus protected from the evil effects of the products of combustion given off by the illuminants.

With the invigorating atmosphere which this heat-actuated system of ventilation can provide, not only would all risk of danger, both from overheating and overcrowding, be eliminated, but the occupants of even the smallest of the health-promoting class of dwelling would be ensured that ample supply of fresh air which is essential to the building up of that vigorous disease-resisting constitution by which alone consumption and other diseases can be most effectively prevented.

Since the area of the opening between each of the bedrooms and the living-room does not require to be any greater than that of the exhaust flue of the bedroom to which it belongs, and as this area is preferably secured by a slot extending along the whole length of the partition, its width need never be more than 1½ in., and it cannot therefore in any way prejudice either the privacy or the quietness of any of the apartments.

The adoption of this inspiration of common sense not only provides the occupants of the two smaller bedrooms with an air body the volume of which is about four times as great as that in the two corresponding bedrooms when these are built to the Committee's desirable standard, but by enabling the sizes of the bedrooms, so far as their air supply is concerned, to be advantageously reduced in size it enables the much needed increase in the size of the living-room and of the parents' bedroom to be effected without detriment to the occupants of the two smaller bedrooms and without increasing the roofed area or the cost of the dwelling beyond that of the Committee's "desirable" size of dwelling.

In order to bring out as clearly as possible the principal characteristic features of the habitable apartments and the many important advantages which they offer, a suggested arrangement of the principal pieces of furniture is shown in plan, Fig. 93. In the living-room, which is a handsome apartment measuring 20 ft. 3 in. by 15 ft., the furniture shown against the wall opposite the fireplace comprises a side table, sideboard, music cabinet and piano, and in front of the back window a box ottoman. The dining-table, which is shown of a size to comfortably seat a family of eight, is placed at the end of the apartment nearest to the kitchen and convenient to the pantry, thus ensuring the least possible labour to the housewife. The writing-table shown in front of the principal window is sufficiently distant therefrom to allow of chairs being comfortably used between it and the window. The piece of furniture shown in the front corner opposite the piano might be either a cabinet or grandfather clock.

The two cupboards adjoining the chimney breast would always be useful. Attention is directed to the large, clear space in front of the fireplace. This space would be sufficient to accommodate the largest of families in a cosy circle in front of the fire. The lighting of the apartment by windows in opposite ends would ensure a bright, cheerful living-room, and the fireplace being arranged in one of the long sides of the room is thus in the best possible position for the distribution of heat. As a nursery for the upbringing of young children this apartment would be perfect.

In the kitchen the hinged tables referred to in a previous article are shown dotted one on each side of the sink.

Mothers who have had experience in the bringing up of a large family agree

that all children up to five or six years of age ought to be under the direct care of their parents by night, and the principal bedroom has been made of sufficient size and is so arranged as to meet this requirement. Its rectangular floor area clear of the bedroom furniture is greater than that of the official parlour. It is therefore sufficient to accommodate the usual parlour furniture, and its air space is equal to that of the air spaces of both the parlour and the "desirable" standard size of parents' bedroom in the official type of dwelling. The advantages which a roomy bedroom such as this offers are many and at times great. In the event of illness an extra bed for the sick child could be fitted up; or, in the event of either of the parents being laid up, the spacious character of the apartment would enable them to have the company of some of the family without entailing discomfort for want of either floor or air space. As I am preparing a set of plans dealing with the parlour question, the parents' bedroom will again come under review, together with the two bedrooms for children, when this plan appears, probably in next week's issue.

(To be continued.)

#### A "SNAIL-SHELL" STAIR.

"The only spiral concrete staircase of its kind in the world" has just been placed in the tower of the South-East Museum in Los Angeles. Similar stairways exist elsewhere, as in the tower of St. Paul's and the tower of the Cathedral in the City of Mexico, but they were built before the age of concrete. When viewed from above, its resemblance to the shell of a snail at once gave it a name. Says Frank Reed, of that city, writing in the *Engineering Record*:

"It is, for its purpose here, an improvement over Sir Christopher Wren's masterpiece—the spiral stairway ascending the interior wall in the tower of St. Paul's Cathedral, London. The South-East Museum helical staircase is built inside a well in the centre of the tower, thus not only preserving for shelves or mounted objects the entire interior wall-space of the tower, but also supplying on its own exterior wall additional space which may be employed for museum purposes. . . . The tower containing the stairway is seven stories in height, with three mezzanine balconies in the three upper stories, giving the equivalent of ten stories.

"The tower is 35 ft. square, and is supported by twelve columns and external walls 8 in. thick, reinforced with steel. It rests on a solid concrete slab or raft 3 ft. 6 in. thick. The total height is 125 ft., and the weight is 1,000 tons. The construction was carried on continuously, a story being poured at a time. The staircase well is 9 ft. 2 in. in external diameter and is supported by four corner columns with 8-in. walls between them, with light and ventilation openings at each story. The stair is known as a caracol, on account of the likeness to a snail-shell presented by a vertical view, as shown in one of the photographs. "With one exception it is the only helical staircase in America having a hollow centre, the other one being an ancient stone staircase in the tower of the Cathedral in the City of Mexico. The stairway contains 160 steps with 7½-in. rise each, and was built around a galvanised iron form in the shape of a pipe, while wooden forms were placed for the stairs. Material was placed at a special rock-crushing and sand plant located about one mile from the building, in a dry river bed."

In addition to the housing schemes already mentioned, the Dublin City Council have agreed upon the erection of eighty-eight cottages in the Bowne Street area, at an estimated cost of £22,075. Petitions for provisional orders in respect of other proposed schemes have been submitted to the Local Government Board.



BUILDING SOCIETIES.

The Report of the Chief Registrar of Building Societies for the year 1915, just issued, states that the advances on mortgage made by building societies in 1915 were 2½ millions sterling, or 25 per cent. below the advances in 1914, and 28.4 per cent. below those in 1913. For the purpose of estimating the effect of the war, comparison between 1915 and 1913 figures is more useful than comparison between 1915 and 1914 figures, and taking the former it is found that the diminution in new business has been evenly distributed in the various countries. Only one district—Manchester—showed successive increases for the years 1914 and 1915.

Dealing with the total mortgages held by twenty-three large societies it is remarked that the balance outstanding on mortgage is about £260,000 less than that in 1914, but that in spite of this decrease the position of the societies is still an improvement on the position in 1913, an exceptionally favourable year for building societies as a whole. In the remaining societies, the effect of the year's working does not give so unfavourable a comparison with the large societies as has been exhibited for a few years past. The percentage decreases in mortgage balances shown on page xv. show, however, that the smaller societies are affected during times like the present to a greater extent than the large.

On the whole the membership of building societies has remained stationary during the period which the report covers, although fluctuations have occurred in certain districts. The Northern and North Midland Districts of England and Leinster, are the only districts to show increases. The membership of London societies has decreased by 2,600, but there is an increase in the average membership of societies in the United Kingdom.

The receipts for the United Kingdom decreased by £1,060,000. Ireland, however, exhibiting an increase.

The management expenses per £100 of the balance outstanding upon mortgage securities show very little variation from those of the previous year. The assets exhibit generally a reduction of about half a million sterling on the total. The balance outstanding on mortgage securities fell by about £1,200,000 during the year, but other assets rose by about £700,000, which indicates continuity of the policy adopted in the earlier stages of the war of maintaining an adequate amount of easily liquidated assets, invested sometimes in War Loan stock, to meet any demands for withdrawal of deposits and shares. The reduction mentioned in total assets naturally followed the decreases which appear in amounts due to shareholders, depositors, and other creditors. Under the headings just mentioned there is a total reduction of £660,000, of which £560,000 is to be attributed to depositors and other creditors. There is a substantial increase in the net balance of profit and reserve.

It is the subject of comment that alterations found to have been required in balance-sheets beyond the mere rectification of clerical errors should have been demanded by the office when it is remembered that the accounts had to be certified by a person publicly carrying on the business of an accountant. Some of the alterations required were such as to affect materially the position of the society as disclosed in the balance-sheet. In two cases, liabilities were found to have been omitted altogether, and considerable reductions in balance-sheet totals were due to the elimination of prospective interest, which, although required by Statute, had not been effected.

A few societies were found to be making advances on the security of members' shares, and they have been required to discontinue the practice, as it is not authorised under the Building Societies Acts.

There have been a number of cases where the borrowing powers indicated under the Acts have been exceeded. The excess in one society was over £7,000, and in another, where the excess was over £3,000, the auditor had given a full certificate.

In the preface to the report for 1914 there appeared a table showing the position dis-

closed by the last returns of all societies before the outbreak of war, and that exhibited in the returns made on any date during the year ending December 31, 1914. The table was necessarily incomplete, as the figures for the year ending July 31, 1915, were not available, but it is now possible to give the figures for July 31, 1915, and December 31, 1915, and the extended table is accordingly inserted below. In order to facilitate comparison, the figures subsequent to July 31, 1914, have been expressed in terms of those at that date to the nearest one-thousandth, the additional comparative figures being given in italics beneath the actual figures—

Summary of Societies making Returns to any Date during the Year ending—	Members.	Receipts.		Advances	
		£	£	£	£
(1) December 31, 1912.	608,757	22,355,256	8,438,256	45,085,262	16,075,746
(2) December 31, 1913.	612,000	23,391,679	9,322,470	45,810,262	16,075,746
(3) July 31, 1914.	625,100	23,824,811	9,423,501	46,645,681	16,210,862
(4) December 31, 1914.	628,885	23,234,355	8,874,618	47,164,980	16,093,649
(5) July 31, 1915.	628,485	22,524,019	8,358,456	47,402,221	16,048,625
(6) December 31, 1915.	633,877	22,172,902	6,623,184	47,067,646	15,531,990

Two building societies were added to the Register in 1915, one being terminating and the other permanent; and sixty-two were removed from the Register. The number added is the lowest on record. Of the sixty-two societies removed from the Register, twenty-one furnished notices of termination of dissolution, sixteen furnished notices of termination of winding-up, and in eight cases the registry was cancelled. Of the remaining societies, two were amalgamated with other societies, and two transferred their engagements to other societies.

Twenty instruments of dissolution, three notices of commencement of dissolution, and one notice of commencement of windings-up were registered, also ten complete alterations of rules, fifty-six partial alterations of rules, one change of name and fifty changes of address.

The societies removed from the Register included one society which had been in existence for over sixty years, one for more than forty years, sixteen for more than thirty years, twenty-three for more than twenty years, thirteen for more than ten years, (and eight of which were less than ten years old. Five had not been in existence for several years, but their registry was not formally cancelled until 1915.

The oldest society removed from the Register was the Langport and Mid-Somerset Benefit Building Society, Reg. No. 124, Somerset, established 1849, and incorporated 1875. The winding-up of this society under the supervision of the Court commenced in 1911, but a receiver had been previously appointed on behalf of debenture holders. The assets did not realize sufficient to pay the debenture holders in full, consequently no assets came into the liquidators' hands for realisation. It is understood that the debenture holders received about 12s. in the £. The last annual account and statement of the society prior to the appointment of the receiver showed £19,608 outstanding on mortgage securities, of which £12,810 was represented by properties in possession. The other assets amounted to £1,158, and there was a balance deficient of £2,914.

Mr. P. T. Lovejoy, formerly assistant in the engineer's department of the Walthamstow Urban District Council, has been killed in action.

There has just been placed in Holywell Parish Church a stone effigy of a priest, which was found when the church was rebuilt in 1769. Pennant, who records the discovery, states the effigy is that of Thomas, second son of Thomas ap Dafydd, abbot of Bangor, and who was vicar of Holywell. The figure is headless, his hands are clasped in sacerdotal robes, and in the clasped hands is a chalice. The date of the figure is probably 1450-80.

OBITUARY.

The death occurred last Saturday, after a prolonged illness, at his residence, Awoy Cottage, Abbey Road, Harborne, of Mr. Frederick William Martin, a well-known architect in Birmingham. He was the eldest son of the late Mr. William Martin, of the firm of Messrs. Martin and Chamberlain, and was educated at Rugby and London University. His father's firm in Colmore Row were responsible for many years for the designs for the elementary schools erected by the old School Board. On the death of Mr. Chamberlain, Mr. F. W. Martin and his brother, Mr.

Liabilities.		Assets.		
Holders of shares.	Depositors and other creditors.	Net balance of fund upon profit and reserve.	Balance mortgage securities.	Other Assets.
45,085,262	16,075,746	5,810,783	60,891,410	4,080,381
45,810,262	16,075,746	5,810,783	61,923,316	4,168,893
46,645,681	16,210,862	5,863,622	61,801,501	4,918,664
47,164,980	16,093,649	5,940,770	61,980,326	5,219,075
47,402,221	16,048,625	5,977,181	61,859,209	5,668,818
47,067,646	15,531,990	4,101,100	60,770,033	5,930,311

Herbert Martin, were taken into partnership by their father, and the work of designing the Board schools was continued by them until the School Board was abolished and its functions transferred to the City Council. Mr. Martin was the designer of many of the principal business premises in the city, and also, among other public buildings, of the Holywood Asylum, the new Children's Hospital in Ladywood Road, and the Women's Hospital at Sparkhill. He was a member of the Royal Institute of British Architects, and prior to his illness a very active member of the Birmingham Architectural Association. Mr. Martin was fifty-seven years of age. He married the eldest daughter of the late Rev. Dr. Crosskey, who survives him with five children, one of the sons being on service in France. The funeral will take place to-day at the Crematorium, Perry Barr.

The death took place at Crowborough on Monday week of Gerald Callcott Horsley, F.R.I.B.A., of 23, Bedford Gardens, Kensington. The youngest son of the late John Callcott Horsley, R.A., he was 54 years of age, and was educated at Kensington School, and afterwards was articled pupil to Mr. Norman Shaw, R.A. He became a student of the Royal Academy, and was the Owen Jones travelling student of the Royal Institute of British Architects (1887, 1888). He was a past president of the Architectural Association. In 1895 he married Susan, daughter of the late Mr. Peter Black, Glasgow. He was fourth in the order of voting at the recent election of the members of Council of the R.I.B.A. Among his principal works may be mentioned—The Links, Hythe; Bramham Court, (Entrance Court), Suffolk; St. Paul's School for Girls, Brook Green, Hammersmith; No. 10, Bishopsgate Street, E.C.4, new premises for the London County and Westminster Bank, W. Felling; a scheme for the enlargement of All Saints', Hanley; "Coverwood," Surrey; New Berodes, St. Peter's, Hammersmith; St. Chad's, Longdon, Leek; "Framwood," Stoke Poges; Bramridge Forest, Balcombe, Sussex; Additions to Balcombe Place (Music Gallery), Sussex; Painted Decoration St. Swithun's Church, Bournemouth; and New Stables, Whitly Hall, Yorks.

At the meeting of the Bristol Sanitary Commission last week the Health Committee's resolution on the utilisation of the Kingsland Road and Oxford Road sites at St. Philip's, was submitted. The Health Committee now declared that the site was unsuitable for houses, and asked the Sanitary Committee to report to the Council in favour of the ground being left unutilised as an open space. An amendment to adjourn the vote for six months was defeated, and the committee decided by a large majority in favour of erecting dwellings on part of the ground.

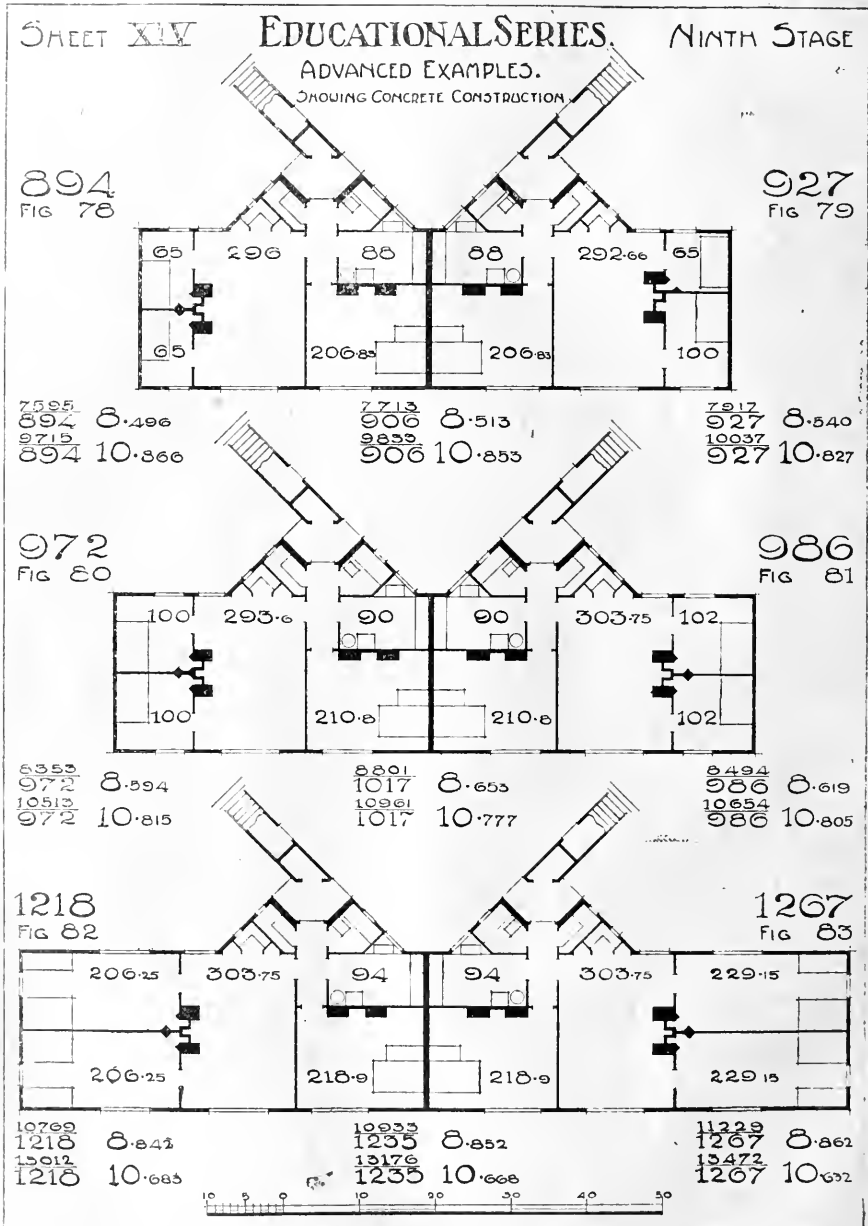

THE PROBLEM OF THE SMALL DWELLING AND ITS SOLUTION.

By Mr. ROBERT THOMSON, Architect.



THE BUILDING NEWS, JULY 11, 1917.

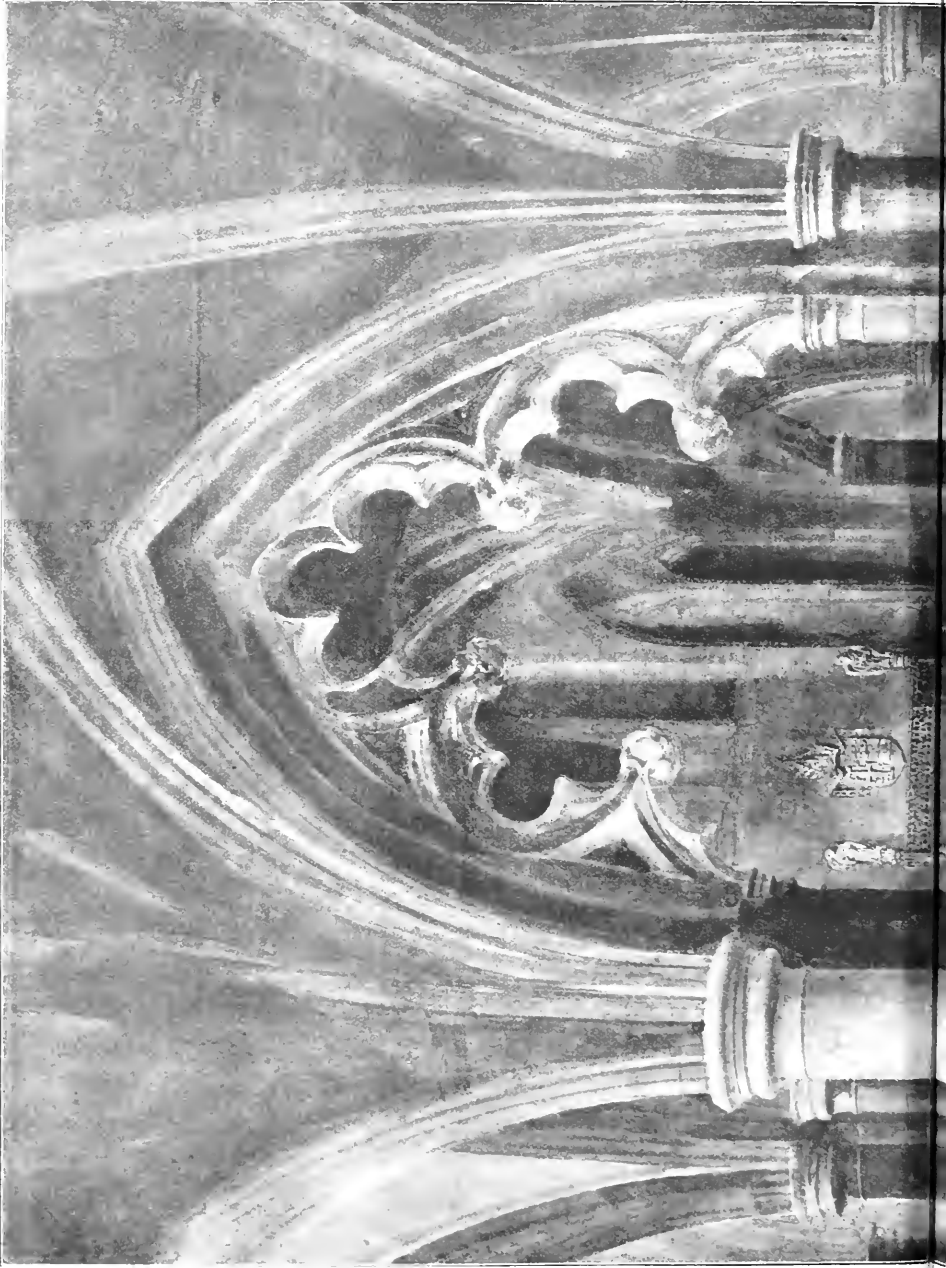

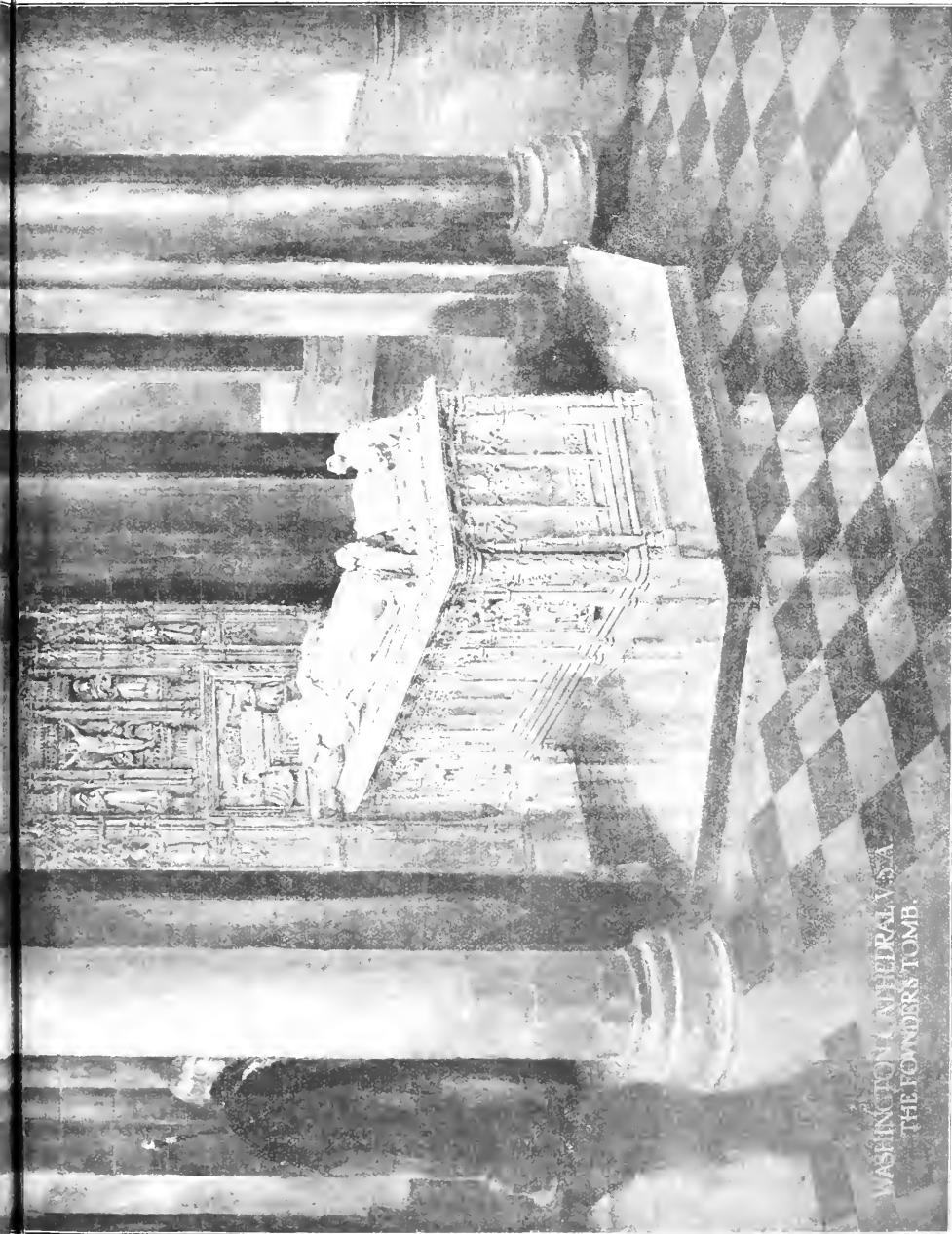

WASHINGTON CATHEDRAL, U.S.A.  
THE FOUNDERS' TOMB.

THE FOUNDERS' TOMB, WASHINGTON CATHEDRAL.  
Mr. W. D. Crago, M.A., Cantab., F.S.A., F.R.I.B.A., Architect.



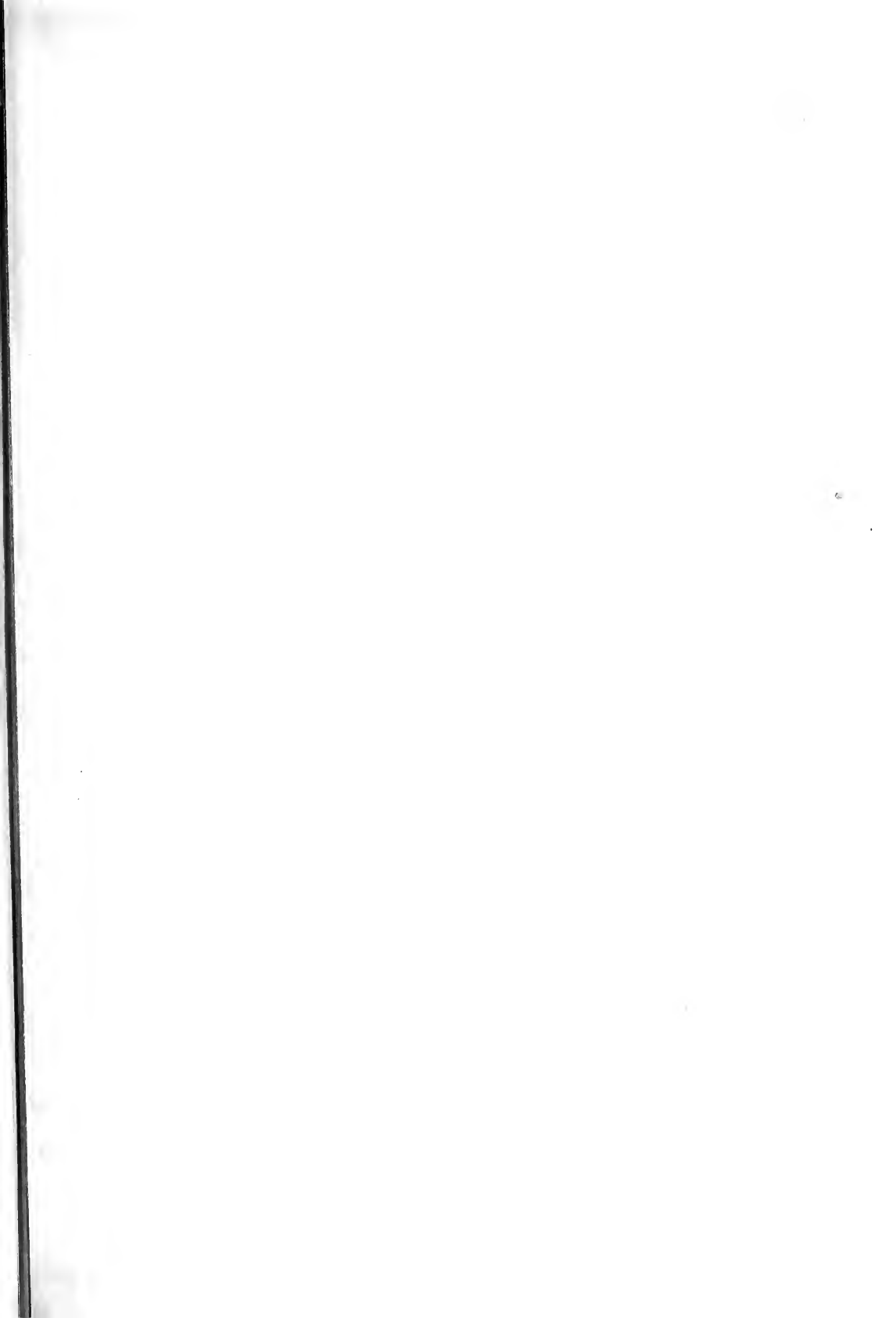



MORICE B ADAMS ARCHT K OBE 1917

ALMSHOUSES FOR THE CHISWICK PAROCHIAL TRUSTEES TO BE BUILT

SKETCH DESIGN  
ENTRANCE GATES

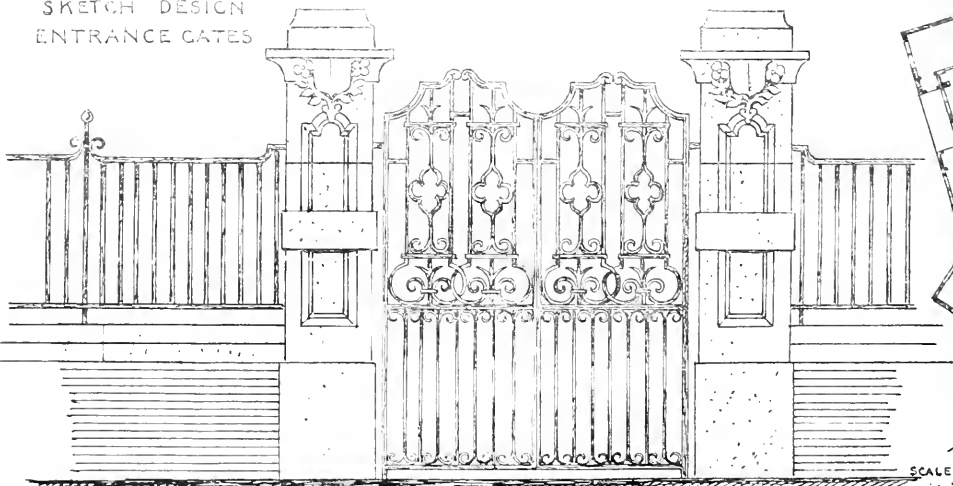

NEW ALMSHOUSES, BURLINGTON LANE, CHISWICK, TO BE BUILT BY THE



JULY 11, 1917.



SHIRE 1917

BURLINGTON-LANE ON THE SITE ALLOCATED BY THE DUKE OF DEVONS

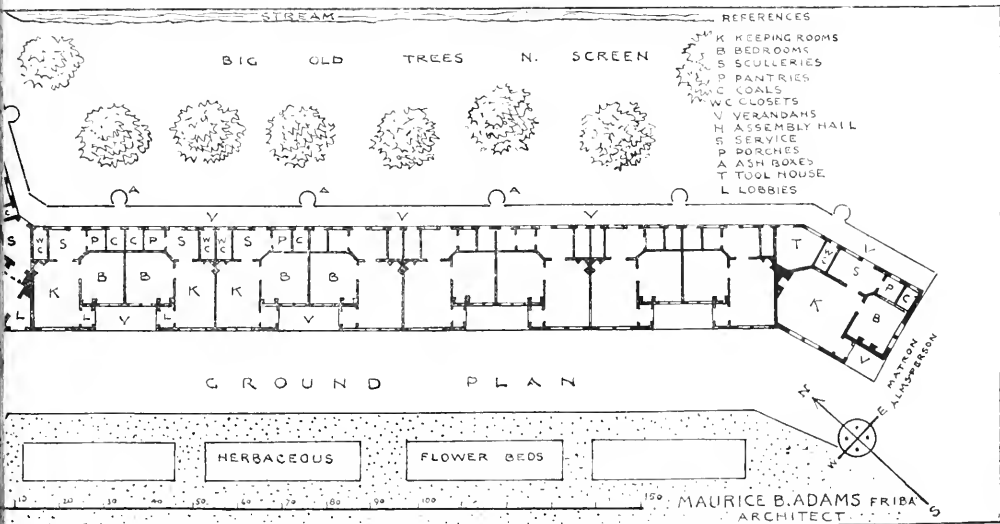

PAROCHIAL CHARITIES TRUSTEES.—Mr. MAURICE B. ADAMS, F.R.I.B.A., Architect.





## Our Illustrations.

### WASHINGTON CATHEDRAL: THE FOUNDER'S TOMB IN THE BETHELHEM CHAPEL.

The design illustrated by this double-page plate shows the tomb of the late Bishop Henry Yates Satterlee, founder of the Cathedral at Washington. The position is at the back of the high altar, and the monument will be constructed of alabaster, the flooring being in Tennessee marble. Mr. W. D. Caroe, M.A. (Cantab), F.S.A., F.R.I.B.A., is the architect of this memorial. The Cathedral was built from the designs of Mr. G. F. Bodley, R.A., joint architect with Mr. H. Vaughan, of Boston. This cathedral was fully illustrated in the *Building News* by perspective views and a long description (August 2); plan and elevations and sections appeared on August 9 and 16, 1907. The present drawing of the Founder's Tomb is now on view at the Royal Academy Exhibition.

### NEW ALMSHOUSES, BURLINGTON LANE, CHISWICK, FOR THE PAROCHIAL CHARITIES TRUSTEES.

The trustees have had these houses in contemplation for several years, but till lately a site was not available. The triangular plot now allocated by the Duke of Devonshire is admirably adapted for the purpose, but its actual boundary lines are very irregular in shape. The lower or extreme point of its pear-like contour practically faces the south by west, and has the vista of a new road running towards the river. At the wide upper end of the land there are some big old trees shielding the property from the north-east winds. To ensure suitable sunny homes this row of almshouses obviously had to be placed as here shown, parallel to the stream behind, but in order to produce a symmetrical forecourt within the lines of so unequally balanced a parcel of ground a semicircular lawn was adopted in front of the cottages. Their aspect obtains the maximum amount of sunshine, and at the ends, right and left, the plan is marked by an inclination in order to present a frontage on both east and west in relative alignment with the lay-out of the adjacent roads on the Duke of Devonshire's property. The new secondary school for Chiswick has lately been erected close to this site. The accommodation provided for each inmate of the almshouses is identical, and is clearly shown by the plan, which illustrates also the position of the little social hall put towards Burlington Lane. This fits in between the two sets of tenements, all of which are self-contained and on one floor. Sitting-out verandahs and screened porches occur in the front, and a working covered way extends along the whole length of the block at the rear. The main approach will be in Burlington Lane, which bounds the grounds of Chiswick House. The war has hindered the starting of these houses, but it is hoped in the not distant future to make a start with the work. Mr. Maurice B. Adams, F.R.I.B.A., is the architect.

### THE PROBLEM OF THE SMALL DWELLING AND ITS SOLUTION.

Sheets XIV. and XV. are given to-day showing the schemes elaborated to a further stage by Mr. Robert Thomson, architect, and described in another article on this subject. The back numbers of the *Building News* which contain this series of plans and particulars are dated May 23 and 30, June 6, 13, 20, and 27, July 4. Others will follow till the articles are completed.

The Hford Urban District Council have instructed their surveyor (Mr. H. Shaw) to prepare plans for an outfall sewer to the River Thames. The cost, it is estimated, will be £53,000.

An altar rail has been completed for the new church at Ashford, Wicklow, for the Rev. Pierce O'Donnell, P.P. It is in white marble with onyx shafts, and fitted with handsome wrought iron and brass castes. The work has been executed by Mr. Cullen, sculptor, from the design of Mr. P. J. Morden, M.S.A., architect, 5, Trinity Street, Dublin.

### A NEW FORM OF SEPTIC TANK.

The drawings show an inexpensive septic tank built on accepted principles for a family of from two to six persons. The cross-section of the tank shows it as if cut down through the centre across the direction of the flow. The tank is constructed by sinking in the ground on a concrete bottom two lengths of 24-in. vitrified tile pipe. All joints must be made water-tight. Through the tank are

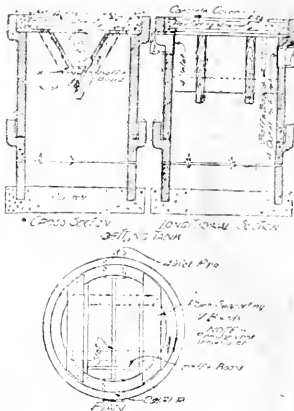

FIG. 1.—Plan and sections of septic tank made from tile pipe.

placed boards in the shape of a V, the bottom left open to form a slot, one board projecting enough at the bottom to prevent gases from the bottom of the tank from rising through the slot. The V-boards are shown at "A." The inflowing sewage enters the tank through the inlet pipe and flows through between the V-boards and out at the outlet pipe on the opposite side of the tank. On its way the solids settle out through the slot in the V-boards and remain in the bottom of the tank. The sediment in the bottom ferments and gases rise from it, carrying with them small particles of partly-rotted sediment. These rising particles strike the outside of the V-boards and are deflected outward, being unable to mix with the inflowing sewage. The gases escape through the vents in the cover of the tank and the particles of sewage, freed from the gas bubbles, again sink and are further digested in the bottom of the tank. The liquids which flow through the tank between the V-boards, being freed from the solids, flow out at the outlet and to the filter. A baffle board placed near the outlet pipe projects several inches below the water-level, and prevents any solid matter from flowing out with the effluent.

### A REINFORCED CONCRETE COVER.

In constructing the tank care must be taken not to have the inlet and outlet pipes project too far into the tank, as this will cause difficulty in inserting the V-boards. The V-boards are supported by 2 x 2 inch pieces, as shown in the drawings. These are fastened to two planks fitted across the top of the 24-in. pipe inside the bell. Between these permanent planks temporary planks can be laid to act as a form in constructing the concrete cover. Vent holes must be left in the cover as indicated on the cross-section. These may be formed by pieces of tin or short lengths of one or two-inch pipe. These are necessary to permit the escape of the gases generated by the decomposition of the solids. Iron rings should be fastened in the top of the cover to facilitate removing it should it ever become necessary. In pouring the concrete cover, tarpaper should be carefully fitted around the inside of the bell to prevent the concrete from sticking to the vitrified tile pipe. All permanent wood used should be cypress, since this will not rot and will last indefinitely, whereas any other kind of wood would have to be renewed every few years.

The concrete cover should be reinforced top and bottom, as shown, with chicken wire or fence wire. The openings for the inlet and outlet pipes can be cut with a sharp steel point. It is customary when cutting the pipe to fill the pipe completely with sand, in order to prevent its cracking while being cut.

### THE FILTER.

While the proper construction of a septic or settling tank is of importance, the construction of the filter is of as great, if not of greater, importance than that of the tank, for while the tank removes the visible impurities there still remain to be neutralised the noxious elements which are not visible, but whose effect is of as great consequence. The filter shown in the drawing is made of one length of 24-in. tile pipe. This need not have a concrete bottom unless it is near enough to a cellar wall to make it damp, or it is desired to lead the effluent directly to a stream. If the bottom of the filter is composed of the natural ground a good deal of the effluent will seep away and be disposed of in this manner. For the same reason the underdrain should be laid with open joints, in order to permit the effluent to enter the ground on its way through the pipes. If the pipe line is long enough the effluent may entirely soak away before reaching the outlet, provided that the grade is not too steep. The main consideration in constructing the filter is the size of the grains used. Over the pipes should be spread a 2-in. layer of broken stone or gravel about 1 in. in size. On top of this spread a layer of 1/2-in. stone about an inch or so deep. The remaining volume of the filter should be filled with clean, sharp gravel or screenings not more than 1/2 in. nor much less than 1/4 in. in size. It has been found by experiment that this size produces the best effluent, being fine enough for the development of the bacterial jelly, and not so fine as to unnecessarily retard the flow through it. If possible it is best to use broken stone in preference to round graded gravel, since the rough surfaces present a better breeding ground for the bacteria. The object of the coarser stone in the bottom is to prevent the finer particles from sitting into the pipes. The bacteria which act in the filter cannot live without air. Therefore, an opening must be left in the cover to permit access of air, or the action of the filter will not be successful.

### NO SYPHON CHAMBERS NECESSARY.

It has been customary in almost all installations to have syphon chambers which permit the tank effluent to be discharged upon the surface of the filter at intervals, the intervening time being necessary for the air to work into the filter to supply the bacteria. An a filter which handles the drain-

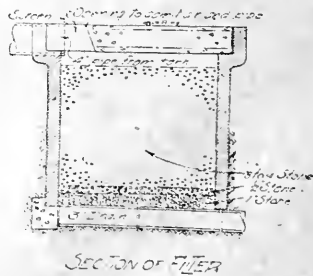

FIG. 2.—Construction of filter.

age from one house this is not necessary, since there is never a constant flow, and the filter receives a charge of clarified sewage only when some of the house fixtures are in use, such as the bath-room tank or the emptying of a dishpan into the sink. These discharges occur at intervals as a rule, and allow time enough in between for the astringing of the filters.

Septic tanks built on this principle may never have to be cleaned out, since the stor-

age capacity is sufficient to contain the sludge accumulations of several years. The longer the matter remains in the tank the greater is its reduction in volume. If, however, it should be found advisable to remove the sludge at any time it can be pumped from the bottom of the tank with an ordinary hand-pump and allowed to run out on the ground, where it will dry out without any offensive odour and assume the appearance and character of finely powdered garden mould. Tanks should never be entirely cleaned out, as this removes the colony of bacteria, and the action of the tank will be interrupted until a new colony becomes established.—C. E. Anderson, in the *National Builder*.

#### DRY ROT: ITS CAUSES AND PREVENTION.\*

By E. J. GOODACRE, A.M. Inst. C.E. (Assoc. Mem.), Assistant Borough Surveyor, Shrewsbury.

The prevalence of dry rot in this country is caused by the growth of fungi, which are responsible for the rotting and eventual destruction of structural timbers in buildings, etc. Dry rot fungi are of domestic growth, and are not found in living trees, but the disease may possibly originate when the trees fall in the forest. There are known at present to be three different species of fungus. The cause of dry rot is directly attributable to infection—chiefly by direct contact—accompanied by conditions favourable to the germination of the spore. The conditions required for fertility are moisture and moderate temperature. The rate of decay is dependent upon the relative humidity—the ratio of the amount of moisture to saturation point at a given temperature (10 to 20 deg. Cent.). No doubt the prevalence of dry rot in this country is due to this fact. Moisture is, therefore, essential to the activity of dry rot fungi in a greater or lesser degree according to the species; but it must be noticed that the degree is fairly constant to the respective fungi. Authorities differ as to whether these fungi can be grown in water. Temperature affects the fungi, and dry rot progresses much faster in summer than in winter in an ordinary building which is heated and thus has its air made relatively dry during the winter months. In examining a building affected by dry rot, the fungi should be carefully and minutely examined with a view to identifying the species. The extent of the rotting can generally be estimated approximately by boring test holes in the timber at frequent intervals. If the material is badly rotted, the borings brought out will be in the form of brown powder. Hammering on the timber with a hammer is another method frequently adopted, a dull sound denoting probable rotting internally. The presence of dry rot fungi can often be detected by the familiar unpleasant odour. The first obvious preventive measure is to guard against contact with infected wood, including spores. Fungi should be deprived of the conditions favourable to growth. The timber should be thoroughly dry and well-seasoned; in fact, it would be well to have all timber, such as floor joists, etc., desiccated or "stoved" to a temperature of 50-60 deg. Cent. The seasoning is rendered more important nowadays owing to the amount of timber felled before maturity. The timber should be protected from wet during building operations, and afterwards protected by adequate ventilation and suitable methods of construction. Floor joists—especially the ground floor joists—should be creosoted; all vegetable earth should be removed from under floors. The building site should be covered with at least 4 ins. of cement concrete, asphalted on the upper surface, or 4 ins. of tarmacadam would be a very effective substitute. The ventilation underneath floors should be carefully designed. Care should be taken that no shavings are left under the floors by the carpenters, as this practice is frequently the origin of dry rot. In cases where boards or wood

blocks are fixed directly on the concrete, they should be bedded on some bitumastic compound; the concrete and the screeding also must be thoroughly dry. On no account should wooden pegs driven in the ground be used as concrete screeds. Special attention should be given to dampcourses, and the more extensive use of vertical dampcourses would be a step in the right direction. No timber should be painted which is immaturely seasoned or rot dry. Infected wood should be oiled to keep down the spores, and carefully removed and burned, and not deposited in a builder's yard. The carpenters' tools, especially the saw used on the work, should be sterilised. The adjoining woodwork should be carefully tested, and removed if there is the least sign of the fungi. The brickwork or stonework should be sterilised by a blast flame, and the woodwork should be dried—not by a gas jet, which forms moisture as a product of combustion—and treated with a wash of dilute formalin, which is a safe and most effective antiseptic, although it must be noticed that through evaporation this treatment is purely temporary. Carbolic acid is also a valuable antiseptic for this purpose. Hot lime-wash is very useful for a mild attack, and, in fact, most antiseptics are more or less effective.

#### HANDLING STUCCO TO GET GOOD RESULTS.

At a meeting of the American Concrete Institute, Mr. J. B. Orr presented a paper on "Artistic Stucco," in which the history and development of this material were outlined, with indications of the proper manner of applying it. The specifications recommended by Mr. Orr follow:—

**Preparation of Surface.**—The entire surface is examined and all loose form scale removed from the surface, i.e., the scale is caused by cement adhering to forms from previous pours. (When the form is not entirely filled in one day's operations, a film of cement adheres to the form in places and sets when the pour is made. This film invariably forms a scale surface on the face of the concrete when the forms are removed.) The entire surface is gone over with a hand pick or an axe to roughen the surface; if brick, rake out joints. This is for the purpose of forming key for stucco. The surface to be brushed clean and thoroughly soaked, ready for application of stucco.

**Proportions: Straightening Coat.**—The proportions of this coat shall consist of 4 parts of Portland cement of approved brand to 12 parts of sand and 2 parts of hydrated lime. The above material to be thoroughly mixed dry, then tempered with water, to which has been added 3 parts of concentrated waterproofing paste to every 25 parts of water.

**Finish Coat.**—The proportions of this coat shall consist of 5 parts of Portland cement to 12 parts of sand and 15 per cent. of hydrated lime. (If white colour is desired, use Medina white cement and local white sand.) The above materials to be well mixed dry, then tempered with water, to which has been added one part of the waterproofing paste to every 18 parts of water.

**Application of Stucco: Straightening Coat.**—Care has to be taken that the surface is thoroughly saturated with water to insure perfect blend, then apply straightening coat. Bring the surface to a true and straight condition, using a traversing rod. (No darby float to be used on first coat.) Then scratch the surface with a wire or nail scratch. (This gives an under cut and insures good bond.)

**Application of Finish Coat for Smooth Surface.**—If stipple, use same process, only stipple before set. If rough cast, dash the finish material with a broom. Thoroughly saturate the first coat surface with water until it presents a glaze appearance; when this glaze disappears, which will be in a few minutes, apply the finish mortar, which should not be too soft, and bring the surface to a true condition with darby float. When the mortar will permit, go over the surface with hand float, bringing to a true finish free of cat-faces or voids; the entire surface to be gone over with burlap or hand float and patted to take out float marks. No joints to

be allowed in the work where they can be seen. The entire surface to present a uniform appearance in colour and texture. Mortar should be applied as quickly as possible and at all times protected from the sun.

**Protection.**—Special care should be taken to avoid too rapid drying; if in the direct rays of the sun, the mortar should be protected with burlap or wet canvas, and when sufficiently resistive, should be sprinkled with water for at least six days.

**Stucco on Metal Lath.**—If stucco on metal lath, specify three-coat work with good fibre in first and second coats, waterproof in second and third coats.

**Forming Moulding.**—Cores for moulding should be formed of concrete by concrete contractor, allowing about one inch for finish. All moulding to be run and finished with hand float to give same texture as rest of surface and to help bind the surface. When a condition arises where a heavy coat of mortar is necessary, a key for the mortar should be formed by driving galvanized nails into the core.

#### NOISE IN REINFORCED CONCRETE BUILDINGS.

A well known firm in the North of England having appealed for help to overcome the noise in one of its reinforced concrete buildings caused by the mechanical vibration of its machinery, has received the following hints from contributors to the *English Mechanic*. The nuisance is not of infrequent occurrence, and one or other of the means suggested for overcoming it may be found of service.

The iron rods or expanded metal in the walls make these very fine conductors of sound. Your shafts are no doubt carried on the walls by brackets bolted through them, and as you are using level wheels, the noise is communicated directly to the walls. The wheels, if well made and properly pitched, should be inaudible. An old belief among millwrights was that hornbeam ran smoother and quieter than apple, but I was never able to distinguish any difference between them. If you have padded under the machines, it can only be the shafting that is at fault, so pad the brackets on the walls and put felt washers under the bolts. If you are using bevels with iron-to-iron teeth, even cut teeth, you must drop them if you want silence. Another method would be to eliminate the shafting and gearing as far as possible and drive each machine with a steam-engine, direct-coupled, as they are slow running. Unless there is a rumble in the machines, this should eliminate all noise.

David J. Smith.

If I might hazard a suggestion, it is to abolish the bevel gearing, if possible, as it is usually noisy, the noise being transmitted via shaft, etc., to walls. A belt-drive can be substituted by putting a pulley on each shaft and a pair of jockey pulleys to form a corner for the belt to go round, so as to be in the plane of each pulley. As it is a cross-belt that is needed, the pulleys must be at unequal distances, so that the crossing does not come on the jockeys. Try it on a small model first to get correct position of jockey pulleys. F. A.

Unless the machinery can be effectually isolated everywhere from walls, etc., the "padding" will be unavailing. There must be no holding-down bolts, wall-boxes, or brackets, or piping, and no metal or wood guards or other incidentals making contacts which could transmit sonorous vibration from any part of machines, shafting, or gearing to the fabric. This condition seems impossible of fulfilment; and, even if it were satisfied, vibration would be communicated through the air. But a promising expedient—of an antithetical sort—presents itself. Let us, for once, leave the source of trouble severely alone, and make the space inhabited by the clerical workers sound-resisting. Close every crevice communicating with the other rooms; give ventilation by channels or openings debouching remotely from any noisy space or window opening out of such. Lino floor, ceiling, walls, columns, etc., and doors on both sides with sound-absorbent material, such as cowhair felt, which—when a satisfactory thickness has been found by trial—

\* Read at the Hastings meeting of the Institution of Municipal and County Engineers.

may be protected by linoleum for the floor, and cloth, or canvas, or Willesden paper for the rest. If a portion only of the story may suffice, let the partition be double, and packed with slag wool or pitchpine sawdust. Presumably stairs are external; if not, the necessary treatment will suggest itself. Probably the walls, even if somewhat rough in places, could be successfully hung with ordinary wallpaper if well pressed and rubbed on, and to that the felt would be attachable by glue—it is desirable that it should cling closely everywhere to the walls. Wood fillets may be added where necessary.

Diapason.

I got over this difficulty in one case by substituting a half-crossed belt. If a counter-shaft could be placed far enough above or below one of the other shafts, it would do away with the noise by not having the gearing.

E. C. B.

## Building Intelligence.

MIDDLESBROUGH.—Mr. S. E. Burgess, borough engineer, Middlesbrough, has prepared three alternative schemes for a clinic for the treatment of venereal diseases. These schemes, which are located in various parts of the town, are under consideration by the Town Council and the North Riding County Council. It is proposed that the populous urban districts in the environments of Middlesbrough, and which are in the area of the North Riding County Council, shall join with Middlesbrough in the working of an approved scheme. The estimate for the various schemes, each embodying the same accommodation, is approximately £56,000 each. The plans have also been sent to the Local Government Board for their opinion as to which of the schemes should be put into operation.

### STATUES AND MEMORIALS.

SWADSESTON.—The dedication took place on Sunday week of a stained-glass memorial window to Edith Cavell, placed in the parish church at Swadeston, where she was born and spent her girlhood. Her father, the late Rev. Frederick Cavell, was for forty-six years vicar of the parish, and built the present vicarage. The window is placed in the east end of the church, immediately above the altar. It was designed and executed by the firm of Herbert Bryans, of London. In the centre is a figure of the Saviour on the Cross, with the inscription, "Greater love hath no man than this, that he lay down his life for his friends." This central piece is flanked by the Virgin and St. John, beneath which are the words, "He was wounded for our transgressions. He was bruised for our iniquities." Two smaller side lights contain figures of Joan of Arc holding a cross, and Florence Nightingale with a lamp in her hand. The inscriptions are, "Be thou faithful unto death" and "He will give thee a crown of life." In the top lights appears a representation of the Annunciation, and below the central figure of the Crucifixion is the figure of Edith Cavell in nurse's attire, kneeling in devotion, and having beside her an open hymn-book showing the words "Abide with Me," the title of her favourite hymn. The remainder of the window contains figures of the Apostles and other saints. An alabaster tablet, the work of Mr. Gough, of London, is fixed to the wall on one side of the window, sets forth the purpose of the memorial.

William Clark, foreman plasterer, of South Elmhall, was fined 10s. at Barnsley last Wednesday for failing to exhibit the official form of male employees.

The number of students enrolled in the evening classes of the London County Council up to the end of June has decreased by 197 per cent., and this reduction is due to the operation of the Military Service Acts and war conditions generally. The same causes have operated to a less extent in the case of the day classes (less than whole-time classes), where the reduction is only 54 per cent. The figures given do not include the attendance of students in munition classes at Shoreham Technical Institute and the School of Building.

## Correspondence.

### ARCHITECTS' CHARGES AND THE INSTITUTE SCALE.

To the Editor of the BUILDING NEWS.

Sir,—The two letters which appeared in last week's BUILDING NEWS show the interest which is being taken in this important matter; and I will, as briefly as possible, reply to some of the observations made as regards my own views on the subject.

It must be borne in mind that professional practice must be considered with some regard to the times of the day. In my youthful days it was the practice to complete the whole of the working drawings—eighth scale, half-inch scale; and full-size details of every part of the work—all inked-in and coloured; and the detailed specification written; before builders, etc., were invited to tender. Now the building has to be completed and occupied in about half the time taken up with the preliminary work also mentioned.

It also frequently happens, nowadays, that on the receipt of the tenders the job has to be cut down, and all the preliminary work altered accordingly—in fact, much of it becomes quite useless.

Mr. Nicol states that "no scheme was approved." My instructions were that the war, and the war only, stopped the execution of the work; and that I believe to be the fact.

Mr. Nicol objects to members of the Institute adopting the Institute scale on behalf of architects who are not members of the Institute. I shall continue to give evidence on behalf of any architect, member or no member, whose client tries to get out of paying what are fair and reasonable charges.

Mr. Nicol states that "the drawings were shown to be tentative only or preliminary sketches, and were not in any sense of the term working drawings," and his further remarks convince me that either we were giving evidence on different sets of drawings, or that I had become, temporarily, blind and silly.

Mr. Nicol will, I know, forgive me for suggesting that he is importing some humour into this case by the remark that the necessity of supplying a detail plan of the drains, before the tender is accepted, is proved by the risk that "if the levels of the drains are not fixed so as to meet the outfalls it may be necessary to raise the whole building out of the ground and incur extras." I have been thinking of the Piccadilly Hotel and what a devil of a job I should have had to raise it out of the ground if the levels of the drains had not been fixed, to meet the outfall, before I accepted a tender.

"A Past Member of the Institute Council" devotes the greater part of his letter to the absolute necessity of the detailed specification being written before the tenders are received. No doubt architects differ much in their practice as regards this; and I can only say what my custom is, good, bad, or indifferent. I write the outline only of the work required under the different trades, and this I hand to my quantity surveyor, who knows my style of work. He comes to me on any question necessary, and I at once supply him with the useful detail, including the beds of the stone. Nothing further is done re the specification until the tender is accepted.

In other respects I do not differ materially from the views expressed by "A Past Member of the Institute Council."

I am sorry, Sir, that to reply, in detail, to all the points raised in the letters above referred to, would involve the writing of an essay; besides, there are one or two other remarks in Mr. Nicol's letter which invoke my tendency to risibility which I must, or you would, suppress.—I have the honour to be, Sir, your obedient servant.

WM. WOODWARD.

13, Southampton Street, Strand.

July 6, 1917.

### COMPETITIONS.

CARNEGIE ART COMPETITION.—It is proposed, as part of the scheme of the Carnegie United Kingdom Trust for the publication of certain selected musical compositions, to adopt a specially designed border to the title page of the works. In order to secure a design of a distinctive character and of high artistic merit, a first prize of £50 and a second prize of £25 are to be offered by the Trust. The design will consist of an ornamental border elaborated at the corners, but sufficiently narrow at the sides and top to allow adequate space for the title of the work and its composer, etc. The design will be printed in one colour only. Full particulars and specifications of the competition will be supplied to intending competitors on application to the Secretary, Carnegie United Kingdom Trust, Dunfermline.

## Our Office Table.

Last Thursday was the centenary of the birth of John Loughborough Pearson, one of the most successful church architects of the Victorian era. Such churches as those of St. Michael, West Croydon; St. John, Red Lion Square; and St. Stephen, Bournemouth, apart from the completed building of Truro Cathedral and the North Front of Westminster Abbey (which was not entirely his work), sufficiently testify to his great ability, and his single-minded devotion to his art. Limiting his energies to one phase—French Gothic—while some of his contemporaries were seeking by eclectic combinations to create a new style which failed to respond to their efforts, Pearson more nearly approached the ideal of the church architect of mediæval times than any we have known.

It is announced that "in consequence of vigorous and persistent attacks in some of the so-called 'religious papers' Mascot Day has been abandoned," and the committee formed to carry out its objects dissolved. We are glad to hear it. The "religious papers" were not alone in their criticism. We have said before, and we say again, that the stupid but very dangerous attempts to revive occultism in its various forms are discreditably to high and low alike and dangerous in the extreme to people of unbalanced minds.

Questions affecting housing, particularly from the point of view of property owners, were discussed last Wednesday at a conference of builders, owners, and others interested in heritable property in Scotland, held in the Merchants' Hall, Glasgow. Ex-Bailie William Forrest, Edinburgh, presided. Discussing the principles of taxation, Dr. Ebenezer Duncan, Glasgow, declared that the present system of rating was unjust and inequitable. The housing question could never be solved until taxation on rentals was abolished. Resolutions were adopted calling for the repeal or complete amendment of the provisions of Part I. of the Finance Act, 1910, expressing the opinion that in any permanent scheme, supported by public funds, provision should be made to ensure the continuance of the supply of housing accommodation by private effort; and advocating the removal of assessment for rates and taxes on heritable property.

Mr. E. Sidney Hartland, President of the Bristol and Gloucestershire Archaeological Society, devoted his annual address (published in Vol. xxxix. of the society's Transactions) to a discussion of the legend of St. Kenelm, the boy saint, whose shrine at the ancient Abbey of Winchcombe is a beautiful little dale at the foot of the Cotswold Hills, was a famous place of pilgrimage until the Reformation. To-day not one stone upon another of this great religious building remains. The abbey was founded about the end of the first decade of the ninth century by Kenulf, king of the Mercians, and father of the saint, whose remains were probably interred there.

"The Elements of Graphic Statics," by Ernest Sprague, A.M.I.C.E. (London: Scott, Greenwood and Son, 8, Broadway, E.C. 4s.), is a useful text-book of its subject. Mr. Sprague insists, rightly, as we think, that



the graphical treatment of engineering problems is often less laborious and more lucid than mathematical analysis; and, given reasonable care in draughtsmanship, it ensures accuracy. The beginner who will work through the book will find this the case, and that he will be able far more intelligently and profitably to continue his studies than without it.

The following recent additions have been placed on view in Room 1 of the National Gallery:—"The Sacrifice of Isaac," by G. B. Piazzetta. Presented by Mr. Robert C. Witt, F.S.A., a Trustee of the Gallery, through the National Art-Collections Fund. "A Cathedral Interior, 1638," by Bartholomew Van Bassen. Presented by Mr. Frederick A. White, through the National Art-Collections Fund. "A Flowerpiece," by Jan Van Huysum. Bequeathed by the late Dr. W. D. Wilkes.

A meeting of old members of Westminster School, held last Thursday evening at the school, decided to raise a Westminster School War Memorial Fund as a permanent memorial to the Westminsters who have given their lives for their country. Sir Walter Phillimore remarked that it was not intended to erect so costly a memorial as that in Broad Sanctuary, for in addition to recognising the services of those who had sacrificed their lives, it was proposed in the scheme which would be submitted that provision should be made for their children hereafter. Up to last month 1,137 Westminsters had served with the forces, of whom 112 had fallen.

At the last meeting of the London County Council, discussing the Housing Committee's report estimated expenditure on capital and on rate and revenue accounts for 1917-18 at £101,810, and estimated income as £229,806, with a surplus of £9,472, Mr. J. D. Gilbert said he was disappointed that more progress had not been made with the Tabard Street scheme; old property had been allowed to remain a public eyesore and a disgrace to the Council, and had been relet in an insanitary condition. The block of buildings erected was one of the ugliest he had ever seen, and being flush with the street it was impossible to have the window open. On the vote for clearance of insanitary areas and for the purpose of dealing with the Brady Street property, Sir E. Smith moved an instruction to the committee to consider and report upon the advisability of the presentation of a supplementary estimate of 25,000. Mr. Leon seconded the proposal, and after discussion it was agreed to. The estimates of the committee were agreed to.

The Committee set up by the Prime Minister during the period last year when he was Secretary of State for War to consider the question of placing a memorial in the home of every victim of the war has nearly approached the end of its labours. The design for the memorial is to be open to public competition, and when the results of this are obtained the Committee will be in a position to make a final selection, which, it may be hoped, will be simple though symbolical, and dignified by its plain statement for all time of the fact that from the home to which it has been presented by the nation went forth one who died in the cause of country and of freedom.

The report of the Defence of the Realm Losses Commission, on the application of the Duchess of Albany, dated February 20, 1917, for payment out of public funds of the sum of £9,179 for loss sustained by the requisition of standing timber on parts of Esher Common by the Home-grown Timber Committee, has been presented. The applicant is Lady of the Manor of Esher, and her claim to payment in respect of the timber in question is derived from the settlement of the Claremont Estate. This was purchased by her late Majesty Queen Victoria. It was her private property, and it was settled by her Majesty on the late Duke of Albany on his marriage. Under that settlement, dated October 19, 1832, the present applicant is tenant for life in possession, and her son, the present Duke of Saxe-Coburg-Gotha (the entail having been

barred) is entitled to the remainder in fee-simple. The standing timber is admittedly part of the inheritance. The Duke of Saxe-Coburg-Gotha, the remainderman in fee, is an alien enemy. He is not a party to the application, neither are the trustees. Although it is taking a somewhat generous view of the direct loss which the applicant will suffer, the Commission think it is not unreasonable to award to the applicant the one-fourth of the value of the timber which would have gone to the tenant for life. Payment is therefore to be made out of public funds to the applicant of a sum of £2,294 15s., in full satisfaction and discharge of all claims by the applicant other than those in respect of reinstatement of actual damage done on the premises by the cutting and removal of the trees, which we reserve until the end of the military occupation. Very "generous," we think, as apparently eventually the money will go to an alien enemy.

The basement of one of Chicago's new hotels is occupied as a dining room, which is really a restaurant and theatre combined. Tables accommodating 1,200 diners are arranged in a balcony and on seven semi-circular terraces that rise one above the other in front of a stage. Between the terraces and the stage is a skating rink, the ice for which is kept in condition by a special refrigerating system. Though this dining room measures 100 ft. by 100 ft., the ceiling is so made that there are no pillars to obstruct the view, save close to the sides. The calling of guests is done silently, the names of persons wanted being shown on a large screen with the aid of a telatograph. A \$30,000 pipe organ is situated at the back of the stage.

To deaden the noise from passing trucks rumbling over a concrete floor, a factory has successfully used a heavy tar paper pasted to the floor by paint. The method of application, as described by David Fliegelman, in the *Contract Record*, is as follows: The floor or aisle to be protected is first given one coating of gray cement paint. On the following day when the paint is thoroughly dry, a second coat is applied. At the same time one side of a five-ply tar paper is painted; and when both paper and floor are still wet, the paper is carefully laid, wet side down, on the floor and rolled with either a roller or wide-tired truck until all signs of air-pockets beneath the paper disappear. The surface seems to improve with age, and very effectively reduces noise at a low cost.

Some interesting practical suggestions are embodied in the report drawn up by Messrs. Sydney A. Kelly, C. F. Elias, J. T. Jones, and W. F. Beavan, the Auctioneers and Estate Agents' Institute, in response to an invitation issued by the Liverpool Corporation for evidence bearing on the proposed revision of the regulations affecting building and estate development within the city. The report, which has just been approved by the local branch of the institute, is in two sections. Messrs. Kelly and Elias, reviewing general aims and development, recommend that all revision should be in the direction of a greater degree of air space about houses, and especially at the rear of houses; the encouragement, where possible, of spaces with trees, grass, etc.; the practical solution of the allotment question; a serious attempt to decrease the cost of housing by a sympathetic consideration of the revision of the regulations governing the mode of laying out and construction of streets and passages. They also suggest that the line and tracks of all main and arterial roads should be defined; that factory areas should be zoned; that landowners, developers and builders should, with certainty, know beforehand what is required of them; that matters in dispute, if any, should be referred to a special local tribunal as arbitrators; that all regulations governing the land and buildings should be codified in one volume, with an illustrated supplement, and that this should be printed and sold at a reasonable price at the town clerk's office. Existing conditions in relation to building by-laws have been considered by Messrs. Jones and Beavan, who express the opinion that the administrative by-laws, as

now existing, are necessary for the working of a city such as Liverpool; that in practice they have not been found unreasonable, and, having regard to the trend of legislation, no abrogation can be expected. They suggest, however, that the Health Committee should have greater powers to deal with careless and dirty tenants.

In a circular addressed to local authorities the Local Government Board state that their attention has been drawn by the Controller of Timber Supplies to the grave difficulties which now obtain in regard to the provision of timber to meet the enormous present and prospective demands for purposes of national importance, and to the urgency of reducing to a minimum the consumption of timber for all but the most essential needs. It is strongly urged that the use of timber for road works should be confined to the sole purpose of repairs, that the re-laying of all wood paving should be deferred for the present, and that where work for the improvement of road surfaces cannot possibly be postponed, the local authorities should adopt some alternative method, such as surfacing with asphalt or other bituminous material, or taking up a section of sound wood paving, which could be replaced with sets, and using the blocks thus set free for repairing worn out places. Very good advice as far as it goes—especially if results lead all concerned to give up wood paving altogether and stick to asphalt.

The Controller of Timber Supplies announces that two Orders have been made by the Army Council under the Defence of the Realm Regulations. The Standing Timber (United Kingdom) Order, 1917, provides that sales of standing timber are prohibited without the licence of the Controller, which must be applied for by the purchaser in the prescribed form with full particulars. The Order has no application to sales of real property, and no licence is required for purchases by a single buyer not exceeding £300 in value for three months. It is further announced that the Order is designed to prevent the purchase of standing timber with a view to holding for higher prices without felling and conversion. There is no intention of restricting the sale and purchase for felling and conversion within a reasonable time by persons having available the necessary plant and resources for the purpose. With regard to auctions, no objection would be raised to these being held subject to a permit afterwards being obtained by the proposed buyer. It would appear preferable, however, that sale by tender should be substituted when possible.

The Home-grown Timber Prices (Great Britain) Order, 1917, fixes maximum prices for timber of the ordinary qualities, leaving other descriptions to be sold at proportionate prices in accordance with the usual trade customs. It is hoped that any cases where the absence of a maximum price for special grades results in excessive prices will be promptly brought to the notice of the Controller of Timber Supplies, Caxton House, Westminster, S.W. 1.

The death in action is notified of Lieut. Joseph Henry Parkin, R.E., of Riddings, Sheffield, only son of the late Mr. J. H. Parkin and Mrs. Parkin. Deceased was an architect and surveyor by profession, serving his articles with Mr. G. W. Bird, of Ripley. At the time of enlisting he was engaged as a Government surveyor at Grimsby. He was married only in May last.

Mr. Arthur Ritchie Upjohn has been elected on the Court of the Glaziers' Company. Since the commencement of the year nine new members have taken up their lives, including Mr. C. F. Fenton, who can trace back his forefathers in connection with the company to May, 1758. The company has subscribed ten guineas to the French Red Cross Society.

Mr. John Brown, of 95, Elswick Road, Newcastle, who died at his residence on Tuesday week in his 73rd year, was a painter and decorator, and for many years was manager of the firm of Messrs. J. Richardson and Co., of Dean Street. He was a member of the National Association of Master House Painters and Decorators of England and Wales, and rose to the position of President, his year of office being marked by a gathering of the tradesmen one end of the country to the other. The deceased had no mean skill as an artist, as had his father before him.

CHIPS.

Mr. M. Martin has been appointed senior assistant county surveyor of Galway during the absence of Mr. George Lee on road service in France.

St. John's Church, Hull, having been sold to provide a site for an art gallery, the bodies interred in or under the church are being removed to the local cemeteries for burial.

The 800th anniversary of the building of Peterborough Cathedral was celebrated on Friday, St. Peter's Day. The actual date of the commencement of the building was March 12, 1118.

Mr. H. J. Watson, of St. Helens, Cocker-mouth agent for Lord Leconfield's Cumberland and Yorkshire estates, was elected last Friday President of the Land Agents' Society for the ensuing year.

The exhibition of metallic art will be opened to the public at the Liverpool Museums to-day at 3 p.m. The Royal exhibits included in the exhibition are of great interest, and include a selection of present-day orders and decorations.

A marble statue of the late John Cannon O'Mahony has been erected at the Parish Church of Cloughduv, Crookstown, Co. Cork. It is the work of Mr. M. J. McNamara, of the Cork School of Art, whose model was accepted in competition with other Irish artists.

Captain H. C. Brierley, Manchester Regiment, who was killed in action on June 23, was, prior to the war, a senior assistant in the City Surveyor's Department, Town Hall, Manchester. He was a Fellow of the Surveyors' Institution, and Institution Prizeman in 1900.

Captain Anstey, the military representative at the House of Commons Tribunal last Tuesday, said that he had received instructions not to press for C. 3, B. 3, and C. 2 men unless they were mechanics, tradesmen, or clerks. The Army was very short of mechanics, and every available mechanic was being used.

Mr. Robert O'Brien Furlong, C.B., of Cavendish Road, Bournemouth, has died at the age of seventy-four. Called to the Irish Bar in 1867, he served as secretary to the Royal Sanitary Commission, Dublin, as standing counsel to the General Post Office in Ireland in 1879-80, and as Solicitor for Inland Revenue in Ireland and Special Commissioner for Income Tax from 1888 till 1907, being made a C.B. in 1901. He was a magistrate for Hampshire.

A public meeting was held last Monday evening at the People's Hall, Latimer Road, Hammersmith, to take action with reference to the flooding of houses in the St. Ann's Road district after recent heavy rains. Councillor G. P. Murfitt (Hammersmith) presided, and after the Chairman (Captain Isidore Salmoza, L.C.C.) and Mr. F. R. Anderton, L.C.C., had addressed the meeting the following resolution was unanimously adopted, on the motion of Councillor Neale, Kensington, seconded by Councillor C. Moore (Hammersmith): "That this meeting of ratepayers and property owners resident in the boroughs of Kensington and Hammersmith draw the attention of the London County Council to the serious flooding which took place on June 15, 16, and 22, caused by the inadequate drainage in the locality, in consequence of which there has been serious personal loss of property and danger to public health, and it requests that the London County Council take immediate steps to prepare plans and start the work at the earliest opportunity."

TO CORRESPONDENTS.

We do not hold ourselves responsible for the opinions of our correspondents. All communications should be drawn up as briefly as possible, as there are many claimants upon the space allotted to correspondents.

It is particularly requested that all drawings and all communications respecting illustrations or literary matter, books for review, etc., should be addressed to the Editor of the BUILDING NEWS, Effingham House, 1, Arundel Street, Strand, W.C.2, and not to members of the staff by name. Delay is not infrequently otherwise caused. All drawings and other communications are sent at contributors' risks, and the Editor will not undertake to pay for, or be liable for, the return of drawings or photographs.

When favouring us with drawings or photographs, architects are asked kindly to state how long the building has been erected. It does neither them nor us much good to illustrate buildings which have been some time executed, except under special circumstances.

\*Drawings of selected competition designs, important public and private buildings, details of old and new work, and good sketches are always welcome, and for such no charge is made for insertion. Of more commonplace subjects, small churches, chapels, houses, etc.—we have usually far more sent than we can insert, but are glad to do so when space permits, on mutually advantageous terms, which may be ascertained on application.

Telegrams: "Timeserv, Estrand, London." Telephone: Gerrard 1201.

TERMS OF SUBSCRIPTION.

Twenty-six shillings per annum (post free) to any part of the United Kingdom; thirteen shillings for six months; for the United States, £1 10s. (or \$19.50); to India, £1 10s. To any of the Australasian Colonies, or New Zealand, to the Cape, the West Indies, or Natal, £1 10s.

\*Our Direct Subscription Agents for Australia are Messrs. E. T. Kibblewhite and Co., Printers and Publishers, 19, York Chambers, 105, Liverpool Street, Sydney, New South Wales; for Japan, The Maruzen Co., Ltd., 24-26, Nishinashi Terai Sanchoe, Tokyo; who will receive Subscriptions at £1 10s. per annum on our account. Copies of the paper will be sent by us direct to the subscribers' address.

\*\*The special rate to Canada is £1 10s. = \$7.30, for 12 months, and 16s. = \$3.65c. six months. Our Direct Subscription Agents for Canada are Messrs. Sells, Ltd., 302, Shaftesbury Buildings, McGill Street, Montreal, who will receive Subscriptions, £1 10s. per annum, on our account.

Cheques and Post Office Orders to be made payable to THE STRAUS NEWS-PAPER COMPANY, LIMITED, and crossed London County and Westminster Bank.

NOTICE.

Bound Copies of Vol. CX. are now ready, and should be ordered early (price 12s. each, by post 12s. 10d.), as only a limited number are done up. A few bound volumes of Vols. XXXIX., XL., XLI., XLII., XLIII., XLIV., XLV., XLVI., XLVII., XLVIII., XLIX., L., LXXI., LXXII., LXXIII., LXXIV., LXXV., LXXVI., LXXVII., LXXVIII., LXXIX., LXXX., LXXXI., LXXXII., LXXXIII., LXXXIV., LXXXV., LXXXVI., LXXXVII., LXXXVIII., LXXXIX., XC., XCVI., XCVII., XCVIII., XCIX., C., CII., CIII., CIV., CV., CVI., CVII., CVIII., and CIX., may still be obtained at the same price; all the other bound volumes are out of print.

BACK ISSUES.

Most of the back issues are to be had single. All back issues over one month old will be charged 6d. each, postage 1d. Subscribers requiring back numbers should order at once, as they soon run out of print.

Handsome Cloth Cases for binding the BUILDING NEWS, price 2s., post free 2s. 5d., can be obtained from any Newscaster, or from the Publisher, Effingham House, 1, Arundel Street, Strand, W.C.2

ADVERTISEMENT CHARGES.

The charge for Competition and Contract Advertisements, Public Companies, and all official advertisements is 1s. per line of Eight Words, the first line counting as two, the minimum charge being 6s. for four lines.

The charge for Auctions, Land Sales, and Miscellaneous and Trade Advertisements (except Situation Advertisements) is 6d. per line of Eight Words (the first line counting as two), the minimum charge being 4s. 6d. for 50 words. Special terms for series of six insertions or more can be ascertained on application to the Publisher.

SITUATIONS VACANT.

The charge for advertisements for "Situations Vacant" is Two Shillings and Sixpence for Twenty-four Words, and Sixpence for every Eight Words after. All Situation Advertisements must be prepaid.

SITUATIONS WANTED AND PARTNERSHIPS.

The charge for advertisements for "Situations Wanted" and "Partnerships" is One Shilling for Twenty-four Words, and Sixpence for every Eight Words after.

All Situation and Partnership Advertisements must be prepaid.

RECEIVED.—D. and Co.—and Co.—R. H. B.—C. J. P. and Co.—G. and Co.—A. S. A. Co., Ltd.—V., Ltd.—R., Ltd.—W. P. and Co.—W. W. and Son—C. and S.—J. D. and Son—Z. P. M.—D. J. S. and Co., Ltd.—C. and C.—G. I. and Son—E. T. B., Ltd.—P. B. and J.—J. P. and Son.

M.—Yes. T. R. W.—Please send. J. H. H.—No space to spare. VENDOR.—Our opinion is against you.

TO ARMS!

COUNTY OF LONDON ENGINEERS VOLUNTEERS (Field Companies).

Headquarters, Balderton Street, Oxford Street, W. Orders for the week. By Lieut.-Col. C. D. Clay, V.D., Commanding.

OFFICER FOR THE WEEK.—Platoon Comdr. A. Gerard.

NEXT FOR DUTY.—No. 3 Company.

APPOINTMENT.—Dr. Hugh Gibson to be Medical Officer.

PROMOTIONS.—Acting-Corporals Gillespy and Salisbury to be Corporals.

MONDAY, JULY 16.—Technical Instruction for No. 3 Company, Right Half Company, Regency Street, Drill, No. 3 Company, Left Half Company, Signalling Class, Recruits' Drill, 6.30.

TUESDAY, JULY 17.—Lecture, 6.30. Physical Drill and Bayonet Fighting, 7.30.

WEDNESDAY, JULY 18.—Drill No. 1 Company, Left Half Company.

THURSDAY, JULY 19.—Drill, No. 2 Company, Left Half Company. Ambulance Class, 6.30. Signalling Class.

FRIDAY, JULY 20.—Technical Instruction for No. 3 Company, Left Half Company, at Regency Street, Drill, No. 3 Company, Right Half Company, Recruits' Drill, 6.30.

SATURDAY, JULY 21.—N.C.O.'s Parade, 2.0. Map Reading.

SUNDAY, JULY 22.—Parade will be at Esler for Engineering Instruction.

ARMLETS.—Members are warned that armllets must be worn at all plain clothes parades.

MUSKETY.—For all companies. See Notice at Headquarters.

NOTE.—Unless otherwise indicated all drills will take place at Headquarters.

MACLEOD YEARSLEY, Coy. Comdr. and Adjutant.

Advertisement for FREDK. BRABY & CO. LTD. TANK MAKERS LONDON. GALVANIZED CISTERNS AND TANKS. GLASGOW, FALKIRK, BELFAST, & DUBLIN. Includes an illustration of a large tank and contact information.



# THE BUILDING NEWS

## AND ENGINEERING JOURNAL.

Edinburgh House,

### CONTENTS.

Strand, W.C.2.

Currente Calamo .. .. .	41	Legal Intelligence .. .. .	58
The Problem of the Small Dwelling and Its Solution.—IX. .. .. .	43	Our Office Table .. .. .	58
Obituary .. .. .	44	Chips .. .. .	50
Our Illustrations .. .. .	57	List of Tenders Open .. .. .	59
When to Dimension in Feet and Inches, and When in Inches Alone. . . . .	57	Tenders .. .. .	60
Correspondence .. .. .	58	To Correspondents .. .. .	60
Professional and Trade Societies .. .. .	68		
Building Intelligence .. .. .	68		

Albert Museum, Principal Façade, South Kensington, S.W. Mr. Alfred Drury, R.A., Sculptor. Sir Aston Webb, R.A., Architect.
New Reredos, Voxall, Burton-on-Trent. Mr. Cecil G. Hare, Architect.
A Cottage to be erected in Somersetshire. Mr. Philip Tilden, Architect.
The Problem of the Small Dwelling and Its Solution. Sheets XVI. and XVII. By Mr. Robert Thomson, Architect.

### OUR ILLUSTRATIONS.

Statues of Queen Victoria, St. George and St. Michael to the main entrance Victoria and

## Currente Calamo.

Yesterday afternoon a general meeting was held, convened by the president, Mr. Henry M. Fletcher, M.A., to afford the members of the Architectural Association an opportunity of inspecting the new premises to which it has removed from Great Smith Street, Westminster, to 34 and 35, Bedford Square. The Bedford Estate offered terms which were considered very favourable, and certainly the situation will be found easy of access and convenient to the majority of the members. The two houses thus acquired for forty years will have to be considerably altered, but these changes cannot, of course, be made till after the war. Preliminary plans have been prepared by Mr. Robert Atkinson, F.R.I.B.A., the Head Master of the Association Architectural Schools, and furnish an admirable solution of the problem presented. Mr. Atkinson does away, of course, with the staircase of No. 34, and throws the intervening space occupied by the approach and stairs into one building so as to combine the rear rooms on the several floors. The rear premises present a frontage to Morwell Street, and there, on the site of an existing outbuilding, the new studios will be extended. The paved yard, with a side connecting gallery or corridor facing south, will separate the studios from the main premises, and yet connect them as a whole. The studios will have an additional approach from Morwell Street. The basement floor at this yard level will have the caretaker's rooms towards the front, and at the rear, where there are two big segmental bay windows, will be situated the students' common room, overlooking the paved court before mentioned and facing the recreation room in the outbuilding below the new big studios. Here, also, will be located the cloakrooms and lavatory provisions for the men. No. 34 will supply the front entrance hall, as already described, for the whole of the premises, and on the ground floor will be placed the council chamber and general inquiry or public office. Behind will come the library, lit by the pair of bays mentioned before, and over the library, on the first floor, will be the general meeting room, with the president's chair and platform between the two

big windows. The members' tearoom and a second room for members, side by side, will overlook Bedford Square enclosure on the front, and will afford the amenities characteristic of a first-class club; indeed, it is hoped that members may find their new home convenient for mid-day lunches and for afternoon teas.

The Ladies' Studio will be over the general meeting room on the second floor, with the head and other masters' rooms on the same level in front. Here a room for slides, of which the Association has a very large collection, will be situate, and a waiting-room for those wishing to interview the masters. The "art and life room" will be at the back over the Ladies' Studio, and the remainder of the top floor will be storerooms. The studios will be three storeys high, one over the other, in the rear new building previously spoken of. These will be amply lighted, and the top studio will have skylights also. A separate staircase is provided in this building, and an escape staircase will probably have to be contrived from the general meeting room leading on to the "east gallery" flat roof, so as to connect the staircases in the two buildings back and front. The accommodation provided in these plans for ladies is due to the contemplated admission of women students, and for this purpose the meeting was called yesterday to alter the By-law No. 14, which provided that only members of the Architectural Association could become students in the schools. We are very glad that now Parliament has recognised the full citizenship of women, and other schools of architecture have admitted them as members, that the Council of the Architectural Association has realised that it is more consonant with its traditions to join the lead in this as in other architectural matters rather than be dragged reluctantly by and by in the wake of an irresistible movement. We had to go to press before the meeting had decided this question, but have no doubt that the alteration of the by-law was carried.

The opportunity was afforded by the meeting to show the students' drawings exhibited in this building as representing the work of the third-year class during the past year in the day school. The evening

school has, of course, been closed owing to the war. Eighteen students have attended during the annual term now ending. We have examined the exhibits and can testify to much good work having been accomplished, taking into account the restricted number and choice of students available. We cannot attempt to place the designs in any order of merit; the subjects are varied and their treatment is very diverse. Mr. Eric Knight seems perhaps the most fully represented, and his essays in design are uniformly more or less meritorious. He sends the Entrance to a Greek and Roman Archaeological Museum, a Garden Piazza, a Row of Almshouses of the Northamptonshire type of masonry, with low millioned windows, a Screen Wall in a French manner, an heroic Monument for a Park, and we must praise his electric public lighting Standard of lofty proportions and capable style of treatment. Mr. Antonio H. Basto shows an octagonal Chapel connected with a Classical cathedral in an Italian mode. It has a coffered domed ceiling with green marble detached columns, and a pedimented altar tomb on one side. The metal screen of good character is placed in the entry. The circular Garden Pavilion contains a Fountain, and is placed on a terrace with stepped approach. The statues on the parapet newel scrolls to the stairs are much too small and inconsequential. This student sends some creditable working details of construction. Mr. Arye Chandhuri shows work hanging next the last-named with carefully worked out schemes for the chapel and colonnaded garden pavilion. Mr. Wenning, a Dutch student, has devoted much care to his work, and the garden above, with an Italian casino effect, is sketched-in very forcibly in water-colour, and not so glaringly hot as Mr. Basto's yellow trees and muddy sky sketch for the same subject. Mr. E. C. Gentry shows an Entrance to a Courtyard, the bay of a Palace Façade, a French Staircase, and a Pavilion. His row of five Cottages has a tiled upper story fit for a pretty site. The Retaining Wall and Steps to a formal garden by Mr. C. E. Cat is accompanied by his garden terraced Pergola and a pleasing set of Cottages. Other similar plans are shown by Mr. C. M. Master, Mr. G. R. Galsworthy, Mr. P. R. Udvaldia, and Mr. W. E. de Souza.

It is not always easy to know whether or not you have sold, or bought, or leased a bit of land or a house. The parties may have done their little best and agreed to terms which, in any business view, would be binding. But if one side craves off and the law and the lawyers come in, then anything may happen. The recent case of "Chaproniere v. Lambert" is a good example of the "law's uncertainty." At an interview plaintiff agreed to take a lease of a farm from defendant, who himself wrote down the terms, which were that it was to be for three, seven, or fourteen years at £90 a year, payable quarterly, some fixtures to be taken over. This paper was not signed. The plaintiff gave defendant a cheque for £25—i.e., £22 10s. first quarter's rent and £2 10s. on account of fixtures, and defendant handed him a signed receipt for the £25 as rent. Plaintiff never took possession; defendant refused to complete, so plaintiff brought this action for specific performance, and the question was whether a binding contract to grant the lease had been made. The defence was based on the Statute of Frauds, that tricky old Act of the reign of Charles II, and the cases with which every word of it has been encrusted during the centuries. There must be a note in writing signed by the party to be charged. Well, the note of the terms written by defendant, coupled with his signed receipt, made, when taken together, such a note and signature in the eye of any business man. But the law said that as these two papers were not connected by written reference, they could not be read as one, and thus there was no binding contract under that famous old statute. This decision of Mr. Justice Eve has now been confirmed on appeal by three Lord Justices with much learning, if little light, and the plaintiff loses the farm and the costs. It seems a queer result, for the parties clearly meant to make their bargain. No doubt the law was rightly laid down. But the case seems to show once more that no one should touch our land laws without first going to the lawyers, who will otherwise get in, if only at the end.

The Workmen's National Housing Council, founded in 1898 to induce municipal authorities to provide good and healthy houses for the people, and to protect and promote the interests of working-class tenants, will hold an important housing conference at Blackpool on Saturday, September 1, prior to the Trades Union Congress week. The morning—10 a.m. to 12.30 p.m.—will be devoted to the consideration of the most suitable type and minimum of accommodation required for working-class dwellings. Lantern illustrations will be exhibited, showing blocks and tenements—Bourville, Well Hall, Watford, Mid-Lanark, and Garden Suburb types—and the plans of the Government's Advisory and Departmental Committee for Rural and Urban Housing; and the health-promoting dwelling. The afternoon 2 to 5 p.m.—it is suggested, shall be given to the discussion of "State Loans Free of Interest for Housing Schemes," "Land Values in Relation to Housing," "The Rating of Empty

Dwelling-houses" and "The Abolition of Rates and House Duty on Dwelling-houses" and "The Problem of the Prices of Building Materials in Relation to 'Combinés' and 'Rings' of Manufacturers and Merchants." Resolutions on the above or other phases of the housing problem before August 1 are invited, but in view of the short time available for the consideration of resolutions it is desirable that the final draft of resolutions for the agenda shall be left to the decision of the Executive. The Council on June 12 had a conference with Lord Rhondda, President of the Local Government Board, on various matters, and if before September 1 decisions are arrived at by the Government that do not meet with the agreement of the Council it will be necessary to allow time for the Government's attitude to be considered at Blackpool. All inquiries should be addressed to the Secretary, Mr. J. Silas Whybrow, 41, Cowcross Street, London, E.C.

Mr. Mervyn Macartney has a sensible letter in the *Guardian* on the Housing question. He points out that the man who understands machinery is of superior mental calibre to the old farm-hand. He will expect higher wages and better housing, and can afford in consequence a higher rent for his cottage. That the labourer is worthy of his hire is a true saying. The Reconstruction Committee advocate more cottages being built, and this subject has had the fullest attention of the Town Planning and Rural Housing Council, which lately interviewed Lord Rhondda on this matter. As a Government official he, of course, refused to commit himself, while expressing the most edifying sentiments on the subject. "In my opinion," says Mr. Macartney, and certainly in ours, "the deputation presented a poor case. They asked for money on a large scale for what seems to be an unnecessary piece of extravagance—£150,000 for fifteen sets of plans. No wonder the Scottish members who accompanied Lord Rhondda lifted up their hands in horror. Half a dozen well-thought-out plans drawn to a large scale would meet all the requirements of the working classes in this country. The plans could be clothed in a great variety of different materials—brick, stone, tiles, rough-cast, plaster, wood, and cement. As to the farm-buildings, there is no aesthetic objection to the use of galvanised iron. It is because we have divorced this extremely useful material from its proper purpose that we have made its employment a byword."

Last Wednesday the Carnegie Trust offered the Camberwell Borough Council a grant of £4,089 to wipe out the existing debt on the council's libraries, stipulating for the appointment of a chief librarian, whose first duty should be to reorganise the library system of the borough, the reimposition of the full 1d. library rate, the reopening of two libraries at present closed, a drastic review of the present stock of books, and an annual expenditure of at least £400 during the

next ten years on additional books. The Trust also suggested that the Art Gallery and its maintenance might be taken over by the London County Council. There was some niggling criticism at the council meeting, but the council finally adopted the recommendation of the Library Committee that the offer should be accepted. Camberwell seems hardly to have acted up to its responsibilities in the past with regard to its art gallery or its libraries, and we trust the recommended transfer of the former to the L.C.C. may mature, and that the libraries may be better administered and well overhauled.

Mr. C. R. Eastman, of the American Museum of Natural History, has an interesting letter in *Nature* on "The Hippocampus in Ancient Art." Reproductions of early figures of the common Mediterranean species of Hippocampus have been published by Prof. Raymond Osburn in the *Zoological Bulletin* for March, 1915, and also by Mr. Eastman in the annual report of the Smithsonian Institution for the same year. It is remarked in the latter of these articles that no mention is found in Aristotle of this striking form of fish-life, and the term "Hippocampus" was used by the poets of classical antiquity as the name of a sea monster, half-horse and half-fish, on which sea divinities rode. Nevertheless, the design of the seahorse occurs not infrequently in the plastic arts of Hellenistic civilisation, both in Greece and in Italy. The seahorse is figured occasionally also among the island gems, as stated by Furtwangler, who figures one of them (*Antike Gemmen*, Vol. I., Pl. V.). Figures of animals, including fishes, represented in ancient Grecian vase paintings have been made the subject of special study by a young French artist, Morin-Jean, and a compatriot of his, P. H. Bousnac, has written interesting articles on fish designs inscribed in ancient Egyptian monuments. Only one instance is known where the Hippocampus is depicted in ancient works of art from the Nile Valley. The design referred to forms part of a decorative painting in the interior of a mummy-case dating from the Twenty-sixth Dynasty (700-500 B.C.), now preserved in the City Museum of Gloucester. A brief description of it is given in Vol. II, of the "Historical Studies" published by the British School of Archaeology in Egypt, accompanied by a photograph of the original. Certain of the details are thus indicated:—"The greater part of the Hippocampus is outlined in black on the white ground of the coffin; the ears, the eyes, the nostrils, and the mane [i.e., conventionalised dorsal fin] are indicated in black; round the jaw is a wide black band edged with yellow; the muzzle is yellow with black dots; the wide horizontal stripes on the neck are alternately blue and red edged with black. . . . The date of the coffin accords well with the period of the archaic Athenian pediments."

It is a constant observation that during a sudden cold snap hot-water pipes burst, while the cold water usually freezes up.

tight without rupture of the pipes carrying it. A French experimenter has recently looked into the cause of this. He finds that the hot water invariably falls to several degrees below zero Centigrade before beginning to solidify, and that the ice then formed is perfectly solid and transparent. Ordinary cold water, on the other hand, begins to congeal as soon as the "freezing point" is reached; this ice is filled with air bubbles, and presents a soft and mushy appearance. The explanation is that the air and other impurities in ordinary water furnish nuclei of crystallisation. Ice formation thus begins sooner and proceeds more slowly than if these were absent; and the ice formed is more mobile, so that pressures are not so severe. Hot water, however, is to a large extent free of gas particles, which have passed off during the process of heating, so this effect is not observed. Freezing does not take place gradually, but all at once, with somewhat of an explosive effect; and there is no cushion of gas bubbles to take up the shock. That this explanation is correct is indicated by the fact that when a current of air is forced through the hot water just before freezing, it behaves in every detail just like cold.

The representatives of the leading Royal and other important art institutions throughout the country on Saturday last memorialised the Treasury calling attention to the dissatisfaction of the general body of artists with the composition of the new board appointed to manage the affairs of the National Gallery of British Art (Tate Gallery). In view of the importance of the decisions of this body to the future welfare of British art, the memorialists regard with the gravest misgiving the absence of members directly and adequately representing the artists of this country. So does everyone else whose opinion is of the slightest value, and we cannot but think that this laudable co-operation of the artistic organisations of the country will receive the attention that it merits. The signatories are:—Edward J. Poynter, President, Royal Academy; Frank Brangwyn, President, Royal Society of British Artists; Frank Short, R.A., President, Royal Society of Painter-Etchers and Engravers; Thos. Brock, K.C.B., R.A., President, Royal Society of British Sculptors; Dermot O'Brien, President, Royal Hibernian Academy; Cuthbert Grundy, President, Royal Cambrian Academy; T. C. Gotch, President, Royal British Colonial Society of Artists; Lota Bowen, President, Society of Women Artists; J. J. Shannon, President, Royal Society of Portrait Painters; Davit Murray, R.A., President, Royal Institute of Painters in Water Colours; Alfred Parsons, R.A., President, Royal Society of Painters in Water Colours; E. A. Walton, R.S.A., President, Royal Scottish Society of Painters in Water Colours; J. Coutts Michie, Vice-President, Aberdeen Artists' Society; Robert Home, President, Society of Scottish Artists; Alfred Drury, President, Society of Artists, Birmingham; E. Rimsault Dibdin, President, Museums Association;

Frank Walton, President, Royal Institute of Oil Painters; Janet Stancomb-Wills, President, Royal West of England Academy; Nellie M. Hepburn Edmunds, Vice-President, Royal Society of Miniature Painters; A. S. Hartrick, Acting President, Senefelder Club; S. Melton Fisher, Chairman, Pastel Society; L. Kemp-Welch, President, Society of Animal Painters; and Michael Simons, President, Royal Glasgow Institute of Fine Arts.

THE PROBLEM OF THE SMALL DWELLING AND ITS SOLUTION.—IX.

By ROBERT THOMSON.  
(WITH ILLUSTRATIONS.)

Before proceeding to discuss the parlour question it will be useful to take a look at the Government's model plans of their parlour type of dwelling. These plans, which are shown in Fig. 27 of the departmental report and in Figs. 11 and 21 of the Advisory Committee's reports, are respectively given in standardised form in Figs. 17, Sheet II., and Figs. 50 and 51, Sheet VIII., of the present educational series. Of the Departmental Committee's plan, Fig. 17, nothing further need be added to what has already been said regarding it in my previous articles, not that there is nothing further to say about it, but simply because it is so crudely planned that criticism would be wasted upon it. It is the only four-in-a-group plan of the parlour type of cottage put forward by the Government's advisers, and the only examples of the "parlour" dwelling which the Advisory Committee give are both of the semi-detached type.

Regarding the latter of these, shown in Fig. 50, the report states that "the main building of each house is but a few inches larger than the living-room type of house shown in Design 6"—see Fig. 14, Sheet II., for this plan—"and no larger than Design 5." As their Design 5 is merely their Design 6 without a passage-way and with earth instead of water-closets (the dimensions of the main building of each, except for the passage-way and a trifling difference in the size of the break in front, being exactly alike), I cannot follow the Committee's reasoning; and their offhand statement that "the parlour type of house is therefore secured at the extra cost of the projecting scullery and coal shed" does not help to elucidate the mystery.

The following accurately stated data regarding these plans should therefore be more helpful to the reader than the Committee's loosely worded remarks. The total roofed area of their pair of cottages to plan Fig. 50 is 1,216 sq. ft., and the area of the "main building" of the pair is 914.5 sq. ft.; and the total roofed area of their "First Prize" pair, given in Fig. 51, is 1,208 sq. ft., while that of a pair of their live-apartment cottages, shown in plan Fig. 14, Sheet II., is 986 sq. ft., and that of the plan of their Design 5, when provided with a passage-way to bring it into line with their Design 6, works out at 1,044 sq. ft.—This plan will appear in a later issue.

Even these figures do not help to an understanding of the Committee's point of view, and if the reader will turn to my elementary plan, Fig. 28, Sheet V., he will there find a perfectly equipped six-apartment parlour type of cottage meeting every official requirement as to sizes of apartments, and its total roofed area for

wing and main building is only 905 sq. ft., while the amount of brick work required in its construction would be very much less than that required by any of the Committee's parlour plans. The Committee do not appear to have grasped the fact that the two wings which they dismiss so airily have an area of 301.5 sq. ft., and that this represents almost one-third that of the 914 sq. ft. area of their main building. Neither do they seem to be aware of the other well-established fact, that a simple roof, such as that provided for in the plans of my health-promoting class of dwelling, would cost very much less for the four dwellings which it covers than the six roofs which would be required to cover four dwellings of the Committee's parlour type.

The amount of material which would have to be cut to waste in their design of roofing would be discreditably great in any case, but when done by "experts" who unblushingly state that "it is essential to sacrifice space to secure economy," the responsibility becomes worse than discreditably. If the committee study plan Fig. 99 on Sheet XVI herewith, they will see that it gives 10,132 cubic feet of house-room as against 4,933 cubic feet given by their Design 11 as standardised in plan Fig. 50, showing a difference of 5,194 cubic feet in favour of plan Fig. 99; and when this is priced at the officially-based rate of 15 pence per cubic foot, it brings out the fact that to build to the official plan would deprive the occupants of the dwelling of house room worth £324 12s. 10d., since the official plan would take more brickwork to build the semi-detached pair than would be required to build a pair of the semi-detached floors to plan Fig. 99. Perhaps they might want to know what could be done with a roofed area similar to that of the main building of their pair? If so, all they have to do is to turn to either plan 95 or plan 96, also on Sheet XVI., and a very simple calculation will at once enlighten them.

By the way, are the committee satisfied that the two smoke flues from the scullery can be got into the wall of the main building as they appear in the design? In practice there would, I fear, have to be some "head scratching" done by the builder before things came right. The multiplicity of down pipes, with their inevitable drain connections, and the extra cost which these involve, would have been more usefully employed in providing a chimney to ventilate their favourite flueless bedroom. Perhaps these points may be made clear in some future report! That there is to be another report by Mr. Sabin I gather from the concluding paragraph of the Advisory Committee's report, which is as follows:—"99. In conclusion, we desire to place on record our warm appreciation of the services rendered by our secretary. It is due in large measure to his skill in organisation, and to his unflinching devotion to his arduous duties, that we are now able, in the publication of the present report, to bring the first part of our labour to an end." The report just referred to in that paragraph, the language of which sounds very familiar, is dated August 24, 1914. It is now the latter half of July, 1917, and the country never was in such dire need of a clear lead in regard to housing matters than it is at the present moment. Surely, therefore, it is high time for the committee to bring another part of their arduous labour to an end by at once publishing the second report, the appearance of which they so clearly foreshadow in the concluding sentence of their first report.

I have a recollection of having read

somewhere a statement emanating from the conference of great experts who met during Easter week at Oxford, to the effect that they, the committee, had good reason to believe that the Government would accept their scheme as outlined in great detail in their agenda. From the similarity to a former competition of the conditions of competition suggested at Oxford is it possible that any member of the Government's Advisory Committee is in any way associated with the great experts who, while they may be every one of them perfect in the designing of cities, have never yet managed either individually or collectively to make even a passably decent plan of a small dwelling? Why do not the members of the Association who propose to take the Government under their care themselves prepare the necessary plans and retain for their own Association the £150,000 which they recommend the nation to waste on another fatuous competition scheme? If they are capable of guiding they ought to be capable of providing the plans also. Look at the standardised plan, shown in Fig. 51, of the parlour cottage which obtained the first prize in the competition engineered by some members of the Advisory Committee, and see the molehill produced from the mountain of 1,436 plans submitted. That competition was, of course, foredoomed to failure by those who projected it when they set forth the sizes of apartments prepared by the members of the committee, who sacrificed space to secure economy. Take their first prize plan. The E.C. is certainly very convenient to the scullery door. The committee appear, however, to have some misgiving as to this, because they state:—

"As an alternative to the position shown the E.C. and coal-place could be transposed." But they evidently failed to notice that those requiring to use the E.C. in its transposed position would have to almost crawl into it on their hands and knees, since the eave of the roof is only about 4 ft. 6 in. high. The arrangement of the joists in the cross section of this design is such as to suggest doubt as to the stability of the structure, particularly as the roof collar would not provide a cross tie of any very great value in resisting the outward thrust of the spar legs. There are many other points which might be severely animadverted upon, such, for example, as the lowness of the ceiling on the ground floor, the steepness of the stair, the difficulty of placing the bed in the bedrooms, etc., etc.

I very much regret that it has not been possible to put something more worthy of criticism before the reader. The responsibility for this, however, lies with the advisers of the Government, not with me. Having reviewed the best that the Government Committees have themselves been able to give in the way of parlour cottages, it will be interesting to see what the material required to construct dwellings to their designs would be capable of giving in the way of house-room when competently employed in constructing dwellings in which the size of every one of the six apartments is in exact accordance with the committee's own officially standardised requirements, as set forth in paragraph 35 of their second report.

The four sets of plans on the accompanying Sheet XVII, have been prepared to enable me to deal in a simple yet exact way with the question (1) of the parlour, (2) of semi-detached fours versus the terrace type of house, and (3) of back lane and through-passage-way. Plans Figs. 102 and 102a show respectively the ground and upper floors of one of the middle houses in a

terrace of the two-flatted type of parlour dwelling belonging to the second stage group of plans shown on Sheet III. of the present series. In each of the four plans on Sheet XVII, the entrance lobby is shown 4 feet 6 inches wide. Plan Fig. 103 also exactly meets the official requirements as to sizes of apartments, but it has this very important advantage, that each pair of dwellings has a roofed area which is 244 square feet less than that of a pair of dwellings built to plans 102 and 102a. Although plan Fig. 103 would give dwellings which would be much more economical to construct, and more comfortable and convenient to live in than those which plans Figs. 102 and 102a would give, they would not and could not be made to give a dwelling of the health-promoting class. Plan Fig. 104 shows what can be done to meet the vital requirements of the occupants in an economical way. In each of the apartments in each of the four plans on this sheet both the floor areas and the air capacities of the apartment are clearly marked. From these figures it will be seen (1) that the floor area of the living room in plan Fig. 104 is greater than that of both the parlour and the living room in plans Figs. 102 and 103; (2) that its air contents are more than three times those of the parlour, and more than twice those of the living room in the other two plans; (3) that the actual air contents of the two smaller bedrooms are greater than those of the two corresponding apartments in either of the other two plans; (4) that the air contents of the parents' bedroom are greater than the combined air contents of both the parlour and the parents' bedroom in plans Figs. 102, 102a, and 103; and (5) that the air space available in the kitchen is nearly twice as great as that in the kitchens of the other two plans. In addition to the air space in the two smaller bedrooms of plan 104 there has to be taken into account the great volume of air body which is made immediately available for the use of the occupants of these apartments by the method of coupling up which was fully explained in last week's issue.

As I find it difficult to visualise the greatly increased volume of the air body which would be made available for the use of the occupants of a dwelling constructed to plan Fig. 104, it occurred to me that there would be others in like case, and for my own and their assistance the leviathan plans seen in Figs. 105 and 106 have been devised. In these big dwellings the office accommodation in the wing is exactly similar in size to that of plan Fig. 104, and each of the apartments is exactly dimensioned to show what their size would require to be in a dwelling constructed with ceilings eight feet high, so as to provide an air body equivalent in volume to that which would be available for the use of the occupants of the corresponding apartments in the best-parlour type of dwelling built to plan Fig. 104. This arrangement enables comparisons to be very clearly shown between plans 105 and 105, which are identical in arrangement, and to my thinking conclusively proves that it is impossible to economically meet the vital requirements of the people by any existing type of dwelling. With my next week's article there will appear another group of four plans in which the contrasts are proved by carrying them to the *reductio ad absurdum*. In the interval the interested reader might turn his attention to the preparation of the plan of a two-flatted six-apartment terrace dwelling having apartments each of the exact size and shape of those shown in plan Fig. 105.

Provided the committee appointed by the experts who met in conference at Oxford last Easter could take sufficient time from their self-appointed task of splitting into prizes the £150,000 which they have already asked the Government to allocate for their quite unnecessarily complex competition scheme, they would find that the preparation of a set of plans of terrace houses such as those just suggested, for each county, would provide for them some useful data to guide them in the carrying out of their arduous labour.

It must be pointed out that, although the dwellings shown in Figs. 105 and 106 could give dwellings of such ample areas, they could never give the simple but effective system of ventilation obtainable by the arrangement of the apartments shown in Fig. 104, and that, therefore, notwithstanding the larger sizes of their apartments, they could never give the economical actively health-promoting class of dwelling shown in Fig. 104, and which, although only about one-half the roofed area, would cost only about one-third as much as the leviathan on account of the difference in the methods of construction employed, and because of the heavier scantling of the timbers required in the larger building.

The discussion of the parlour and other questions will, I find, be better postponed until next week's article, since they are much too important to be dealt with at the tail end of this week's.

Erratum.—For the word "flue" in the fourteenth line from the bottom of the first column on page 24 of last week's issue read "fire."

(To be continued.)

#### OBITUARY.

We regret to record the death, on the 12th inst., from heart failure, following pneumonia and over-work, at his residence, 66, Inverness Terrace, W. 2, of Mr. Howard Chatfield Clarke, F.R.I.B.A., P.P.S.I., in his fifty-seventh year. Mr. Clarke, who was the son of the well-known architect, Mr. Thomas Chatfield Clarke, had of late been busily engaged in surveys and valuations as honorary adviser to the Ministry of Munitions. He was elected a Fellow of the R.I.B.A. in 1906. The funeral service was held on Monday last at Essex Church, The Mall, Kensington, the interment afterwards being at Highgate Cemetery. Mr. Clarke, who carried on practice at 102, Bishopsgate, E.C., had a varied and extensive clientele, and many of his works have been illustrated and many volumes. Among them will be found the following, with the dates of their appearance appended:—77-78, Gracechurch Street, and Devonshire Square, August 8, 1899; Gresham's School, Holt, Norfolk, August 15, 1902; Indemnity Mutual Marine Insurance offices, Old Broad Street, E.C., December 18, 1903; Shell House, 104 and 105, Bishopsgate Street, E.C., October 29, 1909; Cordwainers' Hall, Cannon Street, E.C., February 25, 1910; and offices for the Leathersellers' Company, Bishopsgate, E.C., July 31, 1914. Some other buildings he designed were:—176, Tottenham Court Road; 15, Devonshire Square, E.C.; and 5 and 7, Old Queen Street, Westminster, S.W.

Second-Lieutenant Evelyn Llewellyn Husler Jones, Welsh Fusiliers, of Fishwick, Newton Abbot, who was killed in action on March 26, an Associate of the Institute of Civil Engineers, and a barrister, has left £23,395.

At the last meeting of the London County Council, Harold Frederick Ponton, (1st class assistant), architect's department, private, The Royal Fusiliers (City of London Regiment), was reported killed in action.

A war shrine made of oak, with a large cross of beaten copperwork in the centre, provided by the contribution of residents at Hampton Court, has been placed on the outer wall of the Palace entrance near the Trophy Gates. It bears the names of fifty-four men who have fallen in the war.



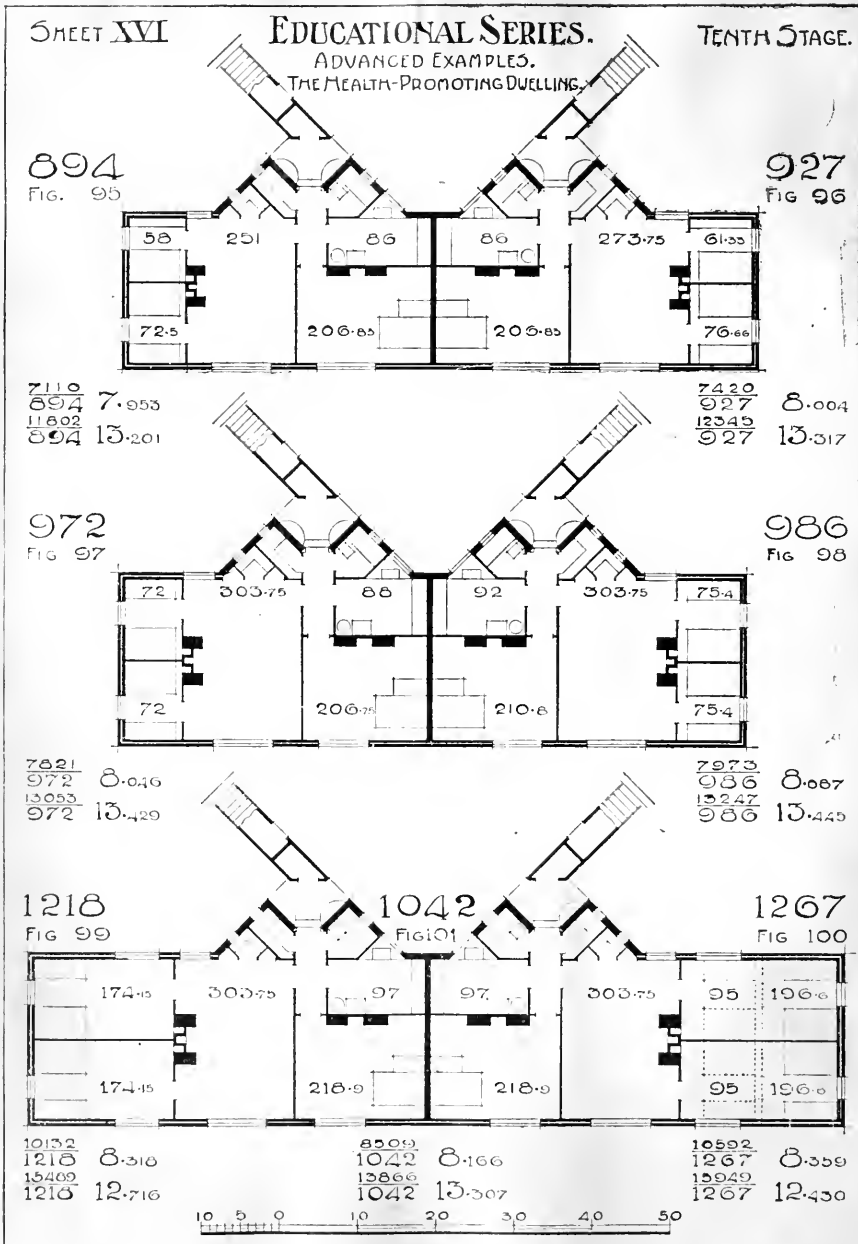

THE PROBLEM OF THE SMALL DWELLING AND ITS SOLUTION.  
 By Mr. ROBERT THOMSON, Architect.





THE BUILDING NEWS, JULY 18, 1917.



A COTTAGE TO BE ERECTED IN SOMERSETSHIRE.—Mr. PHILIP TRUPES, Architect.



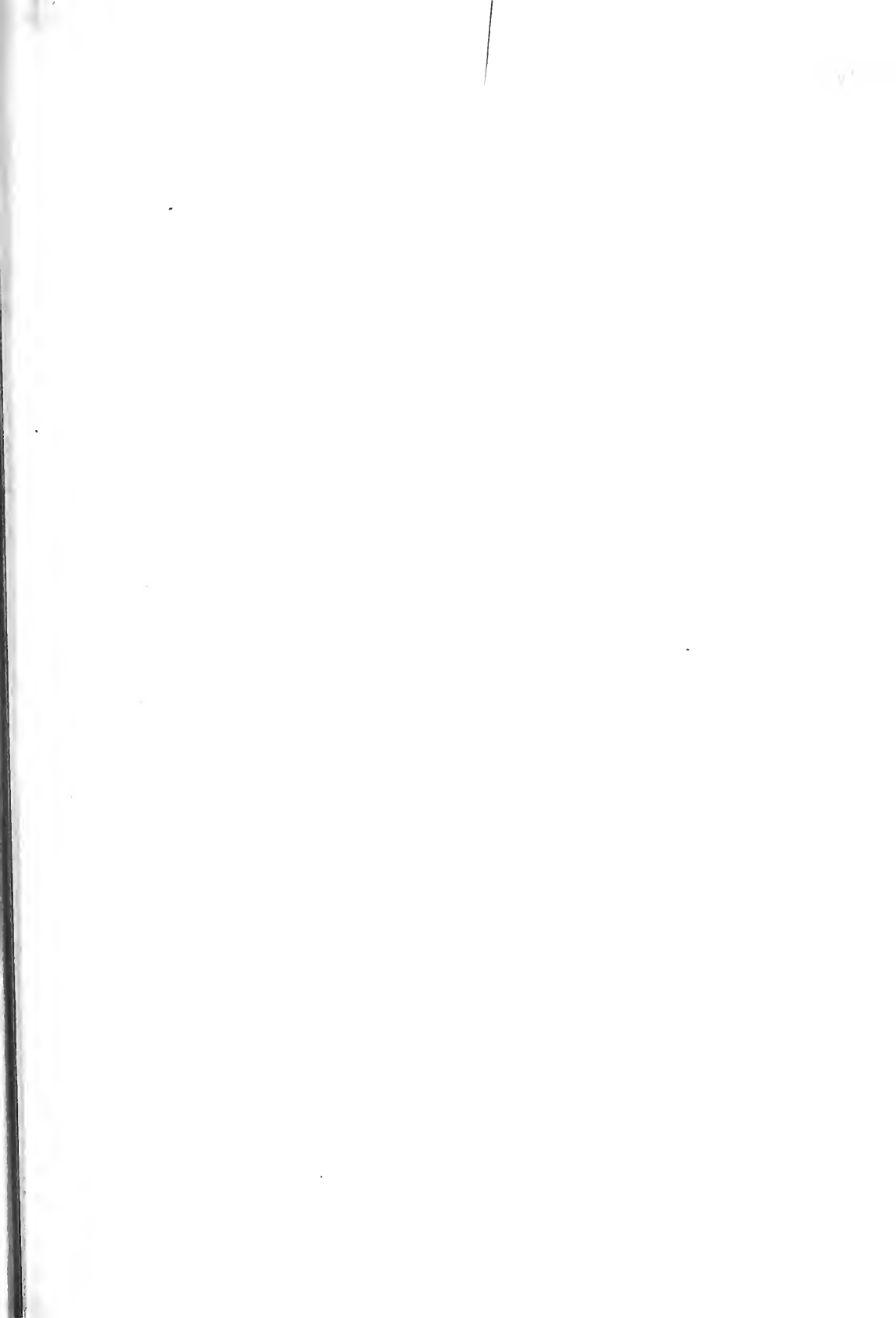

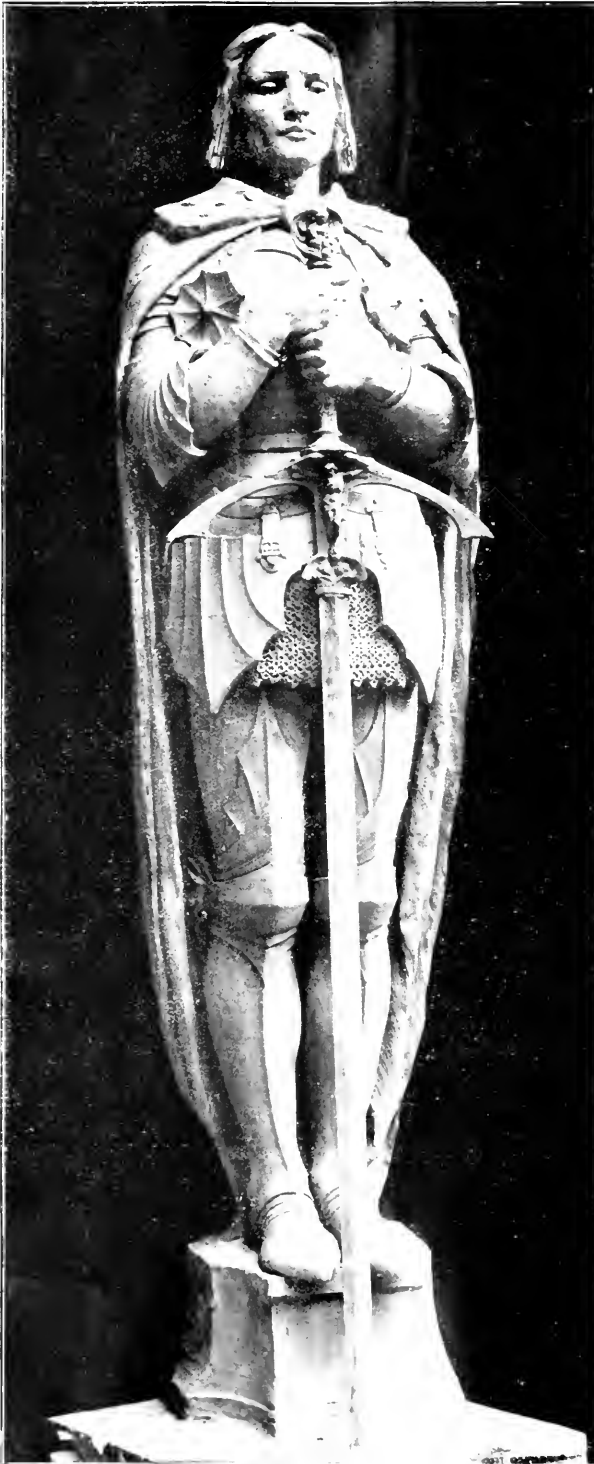

SCULPTURE TO THE MAIN ENTRANCE, VICTORIA AND ALBERT MUSEUM, LONDON.  
 MR. ALFRED DRURY, R.A., SCULPTOR.

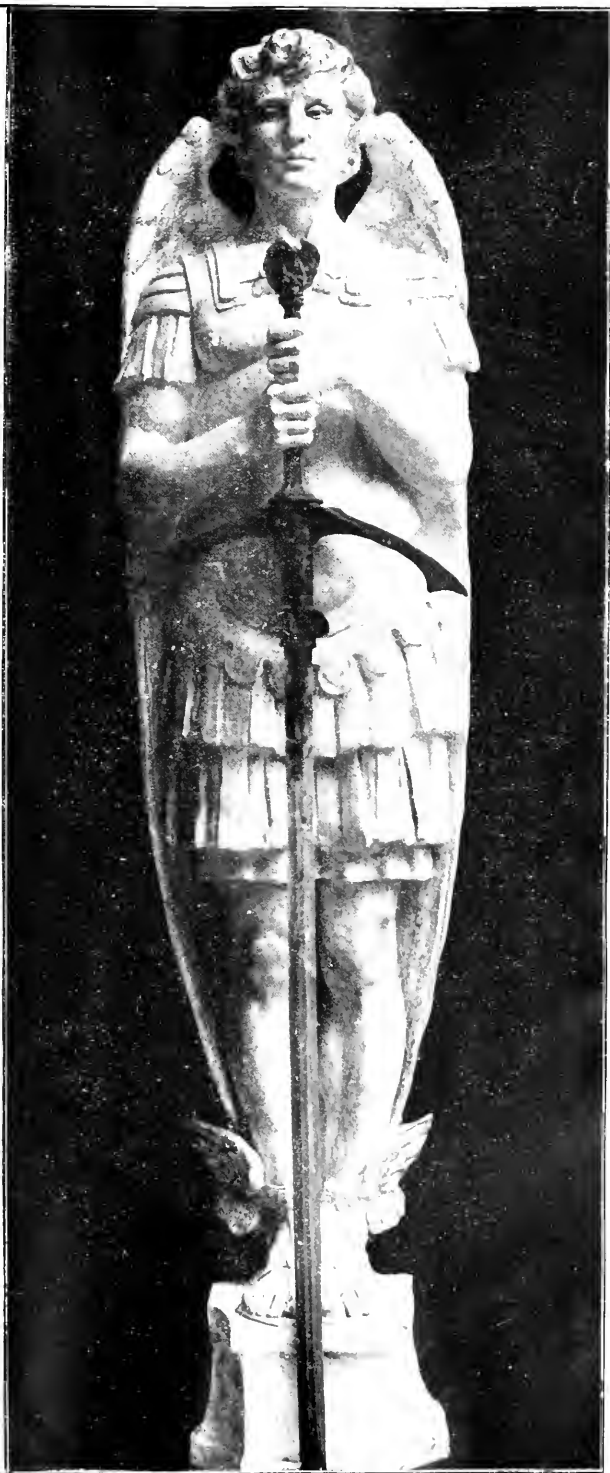
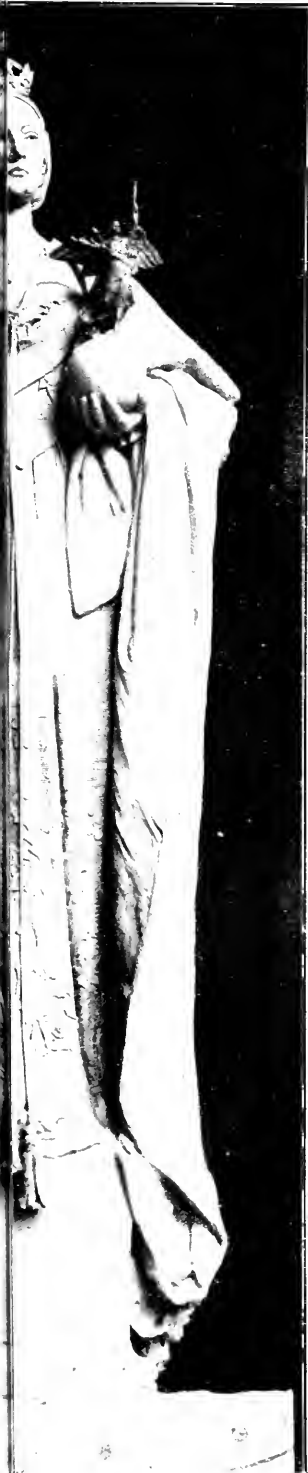

VICTORIA. ST. MORITZ.  
MUSEUM, PRINCIPAL FACADE, SOUTH KENSINGTON, S.W.  
SIR ASTON WELLS, R.A., Architect.



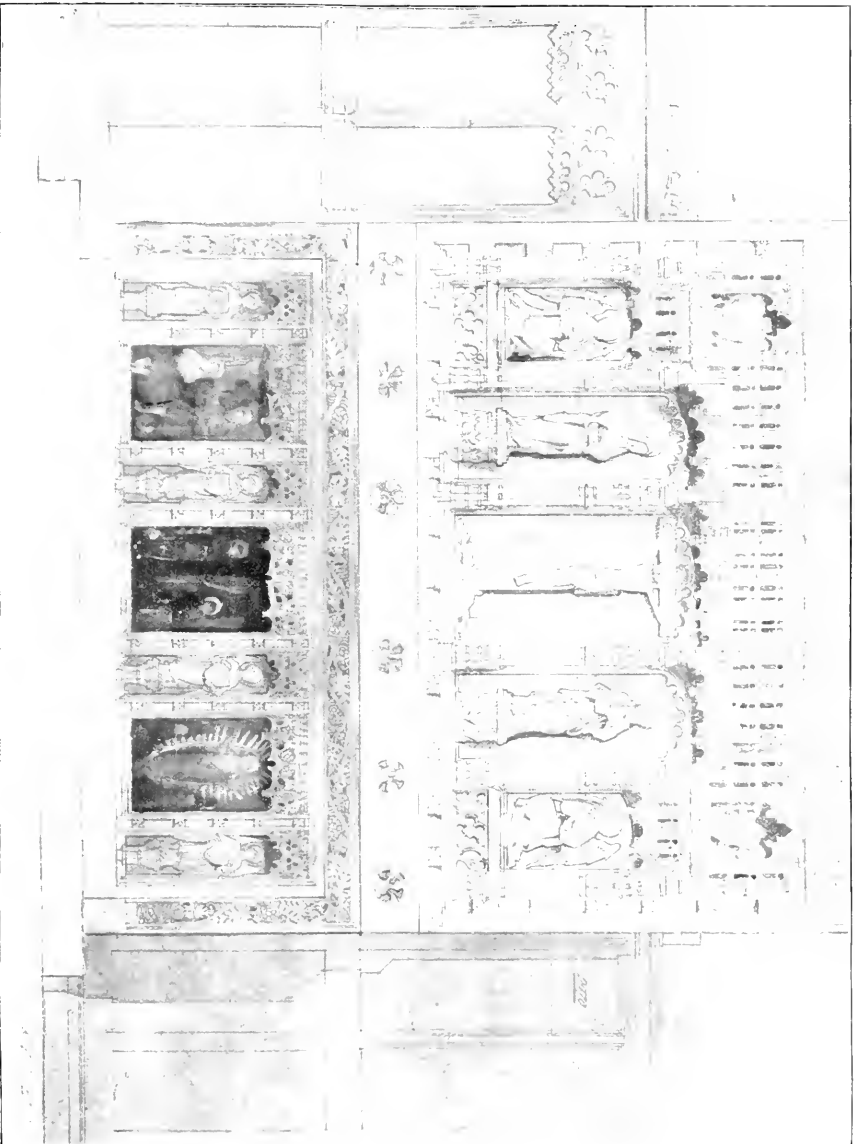

NEW REBEDOS, YONALL, BURTON-ON-TRENT.—MR. CECIL G. HARE, Architect.



SHEET XVIII

EDUCATIONAL SERIES  
SOME CONTRASTS

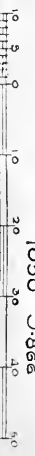
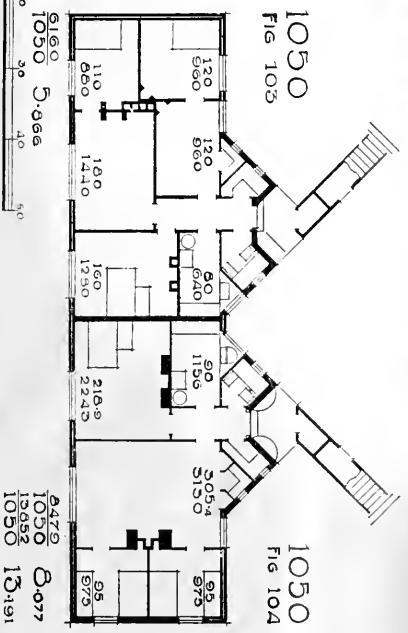
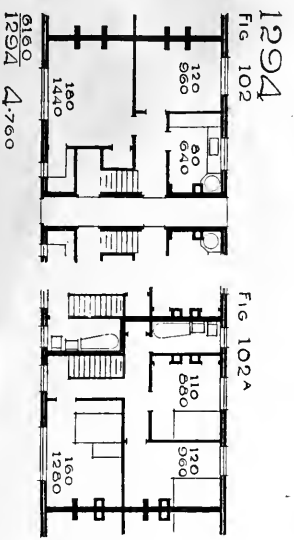
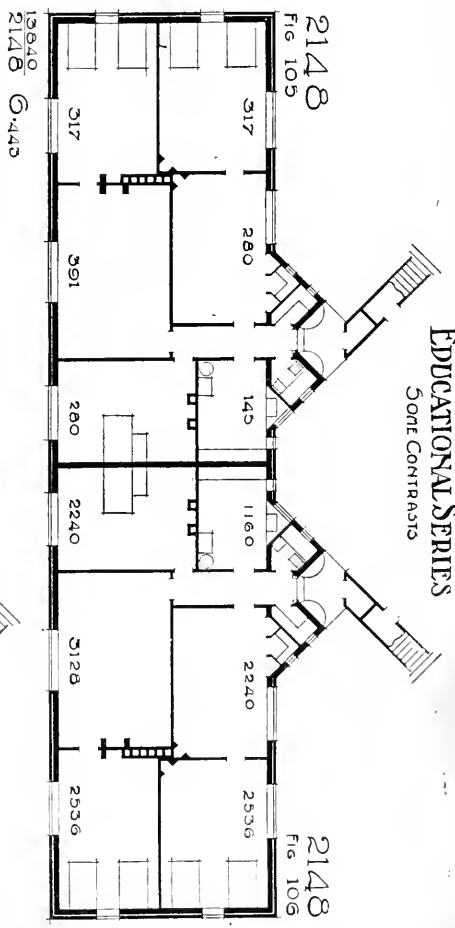

THE PROBLEM OF THE SMALL DWELLING AND ITS SOLUTION.—By Mr. ROBERT THOMSON, Architect.





## Our Illustrations.

SCULPTURE TO THE MAIN ENTRANCE, VICTORIA AND ALBERT MUSEUM, PRINCIPAL FACADE, SOUTH KENSINGTON.

The archivolts emblematic of the attributes of the fine arts introduced over the portal of this great building were illustrated in our issues of June 27 and July 4, by reproductions from a set of fine photographs shown this season in the Royal Academy Exhibition by the sculptor, Mr. Alfred Drury, R.A. Continuing the same, we to-day have chosen the statue of Queen Victoria, representing her Majesty at about the age of forty. The companion figure of the Prince Consort will be given soon, and the same period of his life has been depicted by the artist. The side figures given are of St. George and St. Michael. Sir Aston Webb, R.A., is the architect. In the previous numbers mentioned a few descriptive particulars were published. These statues are in Portland stone. Another similar sheet of illustrations, completing the series, will appear at an early date.

NEW REREDOS, YOXALL, BURTON-ON-TRENT.

This reredos is of white alabaster, and consists of five recessed and richly-canopied niches, the central subject being the Crucifixion, with kneeling angels in prayer on either side. The shields above the angels bear emblems of the Blessed Sacrament, the Chalice and the Pelican. The altar is of carved oak with painted panels, divided by small niches holding carved angels with shields. The central subject here is our Lord in Glory, with the Annunciation on the one side and the Baptism on the other. The panels were painted by Mr. F. A. Jackson, and the remainder of the work was carried out by Mr. Bridgman, of Lichfield, the architect being Mr. Cecil G. Hare, of 11, Gray's Inn Square, W.C. The drawing here reproduced is now on view at the Royal Academy.

A COTTAGE TO BE ERECTED IN SOMERSETSHIRE.

This cottage, which is to be erected as soon as it is possible to do so, is not essentially a working man's cottage, but being destined for a gentleman and his wife who do their own work, it appeared that a somewhat more architectural treatment was necessary than is usual. The walls are to be of Ham Hill stone and the roof of thatch. A barrel ceiling of Hyrib, cement-plastered, will form the inside of the roof, also affording a fire-proof building. The woodwork is oak, touched with colour and gilt, and the fire-places are to be of stone, also the staircase in the projecting bay. The architect, Mr. Philip Tilden, hopes to employ his own workmen in building it.

THE PROBLEM OF THE SMALL DWELLING AND ITS SOLUTION.

Among our illustrations this week we reproduce Mr. Robert Thomson's two sheets of plans in this series marked XVI, and XVII. The article given herewith explains the proposals. The previous examples and descriptions will be found in the BUILDING NEWS for May 23 and 30, June 6, 13, 20, and 27, July 4 and 11.

On the spot where St. Augustine is said to have preached—the summit of Chatham Hill, Kent—a new church, dedicated to St. Augustine, has been erected, and last Wednesday the Rev. Cyril Reinold was instituted and inducted the first vicar.

An excellent situation for a hospital just opposite Golden's Hill Park, looking out over Haverstock Heath, has been commandeered by the War Office as a site for the Allies Hospital Benevolent Society. There is room for the erection of hospital huts to hold 1,000 men. Funds are urgently needed for the installation of the hospital. Donations can be sent to the Hon. Treasurer, Sir George Wyatt Truscott, at the office of the Society, 135-7, New Bond Street, W.1.

## PAINTING EXTERIOR CONCRETE SURFACES.

The life of cement is the alkali content; remove this alkali and the cement becomes worthless. It is the alkali that renders it difficult to get a satisfactory paint coat over a cement surface. Neutralise the alkali with an acid and the cement is weakened, the surface is soft. This was one of the earliest methods taken for treating cement surfaces, using diluted muriatic acid. This cleaned the surface and removed the alkali therefrom, but it at the same time converted the free lime into calcium chloride, injuring the surface, and making it liable to crumble. Sulphuric acid also had been tried, with the same result of course. Moreover, enough acid remained, after washing off, to affect the painting, and it, too, was badly injured.

If a cement surface is allowed to stand to the weather for a year or more the weather will neutralise the alkali, and the cement will have become dry—an important consideration. This method is far better than the acid application, but one should not figure on having a cemented surface or stucco house, or other structure painted at once upon completion.

### ZINC SULPHATE TREATMENT.

The McNicholl process seems to be the best treatment yet devised for coating a fresh-cemented surface. It consists of zinc sulphate 5 pounds to the gallon of soft water. The zinc sulphate forms a chemical compound that prevents the alkali from attacking the paint coating afterwards applied. This process is also good for interior walls, over Keene's or Portland cement. When it is dry apply a coat of either pure raw linseed oil or an oil paint, thinned out with benzine. Some use a common varnish size, instead of paint or oil, it being cheaper, but the oil or paint is better.

Another formula calls for equal parts of water and zinc sulphate, which is applied on the dry cemented surface, using a stiff bristle brush. This coating will have become hard in three or four days, the zinc sulphate having changed the caustic lime of the cement into calcium sulphate or gypsum, and zinc oxide has been deposited in the pores of the cement. When oil paint is subsequently applied it becomes incorporated with the zinc coating and forms a lasting coating. Zinc sulphate has no known injurious effect on concrete or cement surfaces; consequently there is no disintegrating chemical change set up. The process has proved a decided success.

Another treatment for the cement surface is to apply a solution of 10 pounds of carbonate of ammonia to 45 gallons of water. This forms insoluble calcium carbonate on the surface of the cement, and a large amount of ammonia is liberated, leaving a good surface for paint. This does not injure the cement, but where mortar containing lime is used in doing stucco work it is better to use two weak solutions of this wash than one strong one.

### CORRECT METHOD OF PAINTING.

The following is a correct method for painting on cement:—

The priming coat: One hundred pounds white lead, in oil; 4 gallons pure boiled oil, and 1 gallon turpentine; or in place of boiled oil use 9 gallons pure raw oil and 3 half-pints of japan.

Second coat: One hundred pounds white lead in oil; one-third boiled oil and two-thirds raw oil, and 1 pint japan drier, or 4 gallons raw oil, and the japan.

Third and last coat: One hundred pounds white lead in oil; one-third gallon boiled oil and two-thirds raw oil, or 3½ gallons raw oil, 1 pint turpentine, and same of japan.

Red lead is a good pigment for painting over cement, using 35 pounds dry lead oxide to a gallon of boiled oil, and 1 quart of turpentine. Red lead makes a more elastic paint than white lead, and seals up the pores better, but the red is not desirable under light paints.

Another method for painting over the zinc sulphate treatment consists in using a paint thinned only with turpentine, with a little varnish to serve as a binder. The second coat is the same. The third coat should be thinned with a mixture of three parts boiled oil and one part pure turpentine. The next and last coat should be thinned with tur-

pentine only, with a little varnish for a binder. This would give a flat or lustreless surface, desirable in some instances.

In painting over cement it is thought by some experts that considerably more turpentine should be used than in any ordinary painting, and use very little japan driers. As to oil, the boiled is thought to be preferable to raw. In the priming, the paint should be thin, using turpentine and no oil, although each succeeding coat may have a little more oil than the one before it. It is also important that each coat be given ample time for drying before the next coat is applied.

### SUITABLE PIGMENTS.

As to the pigments that may be safely used in painting over cement or concrete surfaces we have the following: For buff, use yellow ochre. For light yellow, use zinc chromate or zinc yellow. For red, use iron oxide, ultramarine, or vermilion. For blue, use ultramarine; the sulphate ultramarine by preference. For green, use ultramarine green, or oxide of chromium green. For white, use zinc white; the oxide or sulphide (lithopone). For black, use mineral black, black oxide of manganese, black oxide of iron. For gray, use both graphite and lithopone, or lithopone and mineral black.—*The Cement World.*

## WHEN TO DIMENSION IN FEET AND INCHES, AND WHEN IN INCHES ALONE.

In a communication published in the May journal of the Boston Society of Civil Engineers, Mr. Sturgis H. Thorndike, of Fay, Spofford and Thorndike, consulting engineers, Boston, Mass., calls attention to the difficulty of making a standard rule which will determine when dimensions should be stated in feet and inches and when in inches only. In the hope of bringing out further discussion, Mr. Thorndike offered the following suggestions:—

For use in engineering structures, the English system of measures provides two units of lengths—the inch and the foot. The suggestion is that these be regarded as serving two distinctly different functions. The first unit is adapted to stating the width and thickness of any material or member which is constant in cross-section, but may have any convenient length; that is, the inch is the convenient unit in which to state size as distinct from length or distance. For instance, Americans habitually use the term 30-in. Bethlehem girder beam, 42-in. steel plate, 16-in. brick wall, 30-in. vitrified clay pipe, 36 in. by 50 in. egg-shaped sewer, 36-in. cast-iron water pipe, 12 in. by 16 in. yellow pine slab, 28-in. stone coping, 16-in. reinforced concrete slab, etc. Americans seem naturally to use the inch alone in these cases until the dimension exceeds 5 or 10 feet. On the other hand, they do not speak of a 720-in. roadway. I therefore believe that—perhaps subconsciously—we are using the inch as distinct from the foot and its subdivisions as the convenient unit in which to state the size of most materials and members.

The convenient unit for length or distance seems to be almost always the foot. This unit may be divided decimally, but such division is outside the scope of this present discussion. If it is to be divided into inches, and especially if a number of lengths or distances may sooner or later need to be added together, the greatest convenience seems to be attained when the inch is regarded strictly as a subdivision of the foot, not as a different unit, and consequently when we state a length as 1 ft. 7 in. not as 19 in.

This recognition of the existence of two units, one adapted for one purpose and one for another, may clear up much of the confusion and solve most of the difficulties, including the dimensioning of plates. It sometimes results in stating the same dimensions in two different ways on the same plan, according to the purpose desired. For instance, the size of an I-beam may be 15 inches, but the distance from a plate on the bottom of it to a plate on the top of it will be 1 ft. 3 in. Whether this is an advantage or not is open to question. To me it seems an advantage, as emphasizing the difference in use between the two units.

There will still remain a wide field for the exercise of discretion. The limit of size to be

stated in inches seems to be a matter of judgment and convenience rather than rule. We speak of a 120-in. wheel base on an automobile, but of a 10-ft. sewer. There will also be differences of opinion on the distinction between size and distance; one engineer will mark his concrete culverts 23 in. by 32 in. for convenience in figuring stresses; another will mark it by 2 ft. 4 in. by 2 ft. 8 in., classing it as a mass of concrete.

## Correspondence.

### THE BUILDERS' BENEVOLENT INSTITUTION.

To the Editor of the BUILDING NEWS.  
Sir.—This institution is the only one of its kind in the country for aged and unfortunate master builders and their widows.

It was established in 1847, and since then has granted pensions to many hundreds of deserving cases. It has been presided over from time to time by the most prominent members of the building trade of London, and its funds are most carefully distributed after the closest investigation of each individual claim. It is needless for me to state that this charity, in common with many others, has suffered very materially in consequence of the present war through the many urgent calls made upon the public. It is with the greatest difficulty that the necessary funds are procurable in order to continue the payment of pensions already granted, notwithstanding the fact that advantage has been taken of the existence of the State old age pension. At present there are fifty-six pensioners (male and female), to whom more has been paid during each of the last few years than the total amount received as subscriptions and donations. To meet the deficiency stock has had to be sold out.

The building trade has contributed very largely in men and money in conducting the war, and I sincerely trust that you will be good enough to consent to aid us in the direction above stated.—I am, Sir, your obedient servant.

W. J. REDDHAM, Secretary.

Per Corner House, Kingsway, W.C.

### PROFESSIONAL AND TRADE SOCIETIES.

THE NATIONAL FEDERATION OF BUILDING TRADES EMPLOYERS OF GREAT BRITAIN AND IRELAND.—The half-yearly general meeting of this federation will be held at the Midland Adelphi Hotel, Lime Street, Liverpool, on Wednesday, July 25, 1917, at 10.30 in the forenoon. The Lord Mayor of Liverpool will open the meeting by extending a welcome to the members attending the meeting. The business includes the consideration of a form of sub-contract submitted for approval, the report of Housing Committee, a proposal for a Builders' National Industrial Parliament, interim report of a sub-committee of the Reconstruction Committee re joint standing industrial councils, Courts (Emergency Powers) Bill, inter-relations of building trade employers, and any other recommendations from the Executive Council. The proceedings include, on July 24, at 7.30 p.m., reception by the President of the North-Western Federation of members of the general meeting and their ladies. On Wednesday, July 25, 1917, at the Midland Adelphi Hotel, Liverpool, 1.30 p.m., luncheon to the delegates and their ladies; at 4 p.m., visit to St. George's Hall. On Thursday, July 26, at 10.30 a.m., visit to Liverpool Cathedral at the invitation of the contractors, Messrs. Morrison and Sons, Wavertree, Liverpool; at 1 p.m., luncheon to delegates and their ladies, followed by a visit to Port Sunlight and Messrs. Lever Bros., Ltd., Warrington.

### TRADE NOTES.

It is the latest patent "Air-Pump" ventilators, supplied by Messrs. Robert Boyle and Sons, Ventilating Engineers, 64, Holborn Viaduct, London, have been employed at the Mountain Works, North Omsby, Middlesex.

## Building Intelligence.

BIRMINGHAM.—The new schools for the parish of St. Thomas, which have been erected opposite the church in Granville Street and near to Bath Row, were opened last Wednesday. The schools were originally built in 1831. Later, the infants' department building was taken down and rebuilt, and the whole remodelled, at a cost of £1,912. The schools were enlarged again in 1892 and 1894 at a cost of £2,479. In 1907 new buildings were put up in Chequers' Walk, at a cost of £2,900. The present scheme provides for a three-department school, with accommodation for 400 infants, 322 juniors, and 700 mixed scholars, total 1,522. The new extension is of ferro-concrete, and is fireproof as well as bomb-proof. The building has a lofty elevation. Over the entrance is a large apartment, to be used for assembling the children and for meetings. Supported on pillars over the playground are ten class-rooms, each for forty children, and above are two open-air playgrounds for the use of the girls. The total cost of the new extension is about £11,500. The architects are Messrs. Harrison and Cox, Colmore Row, Birmingham.

### LEGAL INTELLIGENCE.

ARCHITECT SUED FOR ALLEGED BREACH OF DUTY.—SUTTON and HARWORTH v. STEPHENS.—On July 9 an action was commenced, before Mr. Pollock in the Official Receiver's Court, which is likely to last some weeks, by Sir Richard Vincent, Bart., of 1, Bolton Square, Piccadilly, and Mr. Simon Harworth, of Curzon Street, Mayfair, against Mr. Stephens, an architect, of 49, Hans Road, London, for damages for alleged breach of duty as architect and quantity surveyor in connection with the building of a new hotel in Piccadilly, to be known as the Park Lane Hotel. Sir R. V. Sutton sued as the owner and Mr. Harworth as the intending lessee of the site. The plaintiffs by their statement of claim asserted that the defendant negligently advised them, for the purpose of preparing the site, to obtain tenders for a small section of the excavation, underpinning and other work necessary, and not for the whole work as one job; that he advised the plaintiffs to accept, and accepted for them, a tender for the first section made by Holliday and Greenwood, Limited, on an estimate of prices reduced by a sum equal to 20% per cent. on the aggregate of the items for work and materials in such estimate without making any reserve, and afterwards employed them on further estimates containing prices and rates in excess of those for the first section. It was also alleged that the defendant negligently supervised the works executed by Holliday and Greenwood, also the construction of the steel work and the kind to suit large and unsuitably advised plaintiffs that certain buildings belonging to Sir John Cottrell would not be interfered with by the erection of the hotel. It was further alleged that the quantities prepared by the defendant were untrustworthy. The plaintiffs said that in consequence of the alleged negligence of the defendant they had had to pay large sums to Holliday and Greenwood, Limited, and also to Sir John Cottrell, and they were not able to sue defendant's drawings, bills of quantities and specifications. The defendant denied that his duties covered all the things alleged by the plaintiffs; he denied all the allegations of negligence; and denied acting in any matters without authority, or that he failed to exercise reasonable care and skill in the preparation of quantities, and said that his employment had been wrongfully terminated in July, 1915, for which he counterclaimed damages.

The Birmingham Housing Committee last Friday reported a shortage of from ten to twenty thousand houses, and it has been officially estimated that at least 50,000 houses in the old parts of the city will have to be replaced. It was stated the committee would be necessary to build at least 5,000 houses a year immediately after the war, and this would entail an annual expenditure of a million and a quarter. It was suggested that private enterprise should be invited to submit proposals as to what they could accomplish, leaving the corporation to provide the balance,

## Our Office Table.

Sir Andrew Agnew, who presided at a meeting of the Royal Scottish Arboricultural Society in Glasgow on Wednesday, advocated an independent Department of Forestry for the United Kingdom, with branches in England, Scotland, and Ireland. He said it was impossible for forestry to develop if it got only snippets of time from the President of the Board of Agriculture. Forestry should be kept as free as possible from politics. A resolution approving of these views was carried on the motion of Sir Hugh Shaw-Stewart. Mr. Paton (Kilmarnock) was declared that in the nurseries there were already millions of forest trees available for planting, and the Government should plant immediately, seeing that the country was being denuded of trees. Sir Charles Bine Renshaw denied that British railways looked askance at home-grown timber. That was an entire delusion. The only difficulty, he said, was the small quantities in which the timber was offered. Mr. Charles Carlow, of the Fife Coal Company, remarked that there was an immense field for pit-wood and oak if they could be grown in Scotland.

"There are, we are glad to say," reports the Scottish Land Court in their statement for 1916, "some estates on which the practice of renting the tenants on their own improvements did not prevail: for example, the estates of his Grace the late Duke of Fife. But we have found as a general rule this practice did prevail to a greater or less extent. In some cases we found that after change of ownership rents were doubled, and in one case quadrupled, and that this rise was almost entirely created on improvements made by the tenants." During the year fair rents were fixed for 139 holdings. The rate of reduction was 22 per cent.

The June "Proceedings" of the American Institute of Electrical Engineers contains a most interesting and excellently illustrated paper on the illumination of the Panama-Pacific International Exposition. In it the author, who was Chief of Illumination for the Panama-Pacific International Exposition in San Francisco, describes the system of lighting adopted for the Exposition, which was generally conceded to have initiated a new era in the art of illumination. From a narrow engineering point of view the lighting would have been regarded as inefficient, but the object striven for was to suppress high intrinsic brilliancy, while bringing out the architectural beauties of the Exposition structures in the most effective manner, bathed in a harmony of colour. Many beautiful effects were obtained by the various installations which are described, and one of the most original features was the successful effort to preserve the curvature and detail in relief by the use of lights of different strengths and colours thrown from different or opposite directions upon the same object.

Mrs. Lloyd George, who presided last week at the National Economy Exhibition, remarked: "When we went to 11 Downing Street, nine years ago, we found a big scullery there, with not a window, not a gleam of light, nor ventilation of any kind. It took me some little time before I could persuade the Board of Works to build me a nice little scullery. I did not rest till I got it. Now there is a nice little complete scullery, with a glass roof, and a window which opens out into the garden. Perhaps you would not believe me if I told you that when Mr. Asquith came to 10, Downing Street, nine years ago there was not a single bathroom in the place. That is enough about Downing Street—I think it has improved a little since we have been there." Evidently Mrs. L. G. won't "wait and see," while the Board of Works higgles about baths or sculleries! More power to her elbow!

The Estates Committee of the Sheffield City Council have submitted a scheme for the erection at High Winchbank of 224 houses, and at Crookes, on the Walkley Hall estate, of 200 houses; also the proposal of a private builder to erect 117 others. The committee point out that in future the corporation

should step in where private enterprise fails to provide working-class houses, but that the corporation should take in hand a building programme for, say, five years, building 800 houses per year, roughly a third of the estimated requirement, thus leaving plenty of opportunity for private enterprise. The suggestion of 800 per year is put as the minimum, but if building is not taken up by private enterprise the corporation will perforce have to build more extensively.

The cordial reception given to Mr. Richard Bagot's proposal that after the war the British Empire should present to the Italian nation a monument to Shakespeare for erection in Rome has led to the formation in London of a central committee to organise the movement. No public appeal for funds will be issued during the war, but it is hoped that any persons, societies, colleges, or other public or private bodies desirous of eventually associating themselves with the object in view will promise their support. It is also hoped that the various Shakespeare reading societies in the country will assist in the formation of sub-committees. Mr. Richard Bagot is at present acting as hon. secretary to the committee, and any communications addressed to him at the Athenaeum, Pall Mall, will be duly acknowledged.

The Building Trades Central Advisory Committee (Operatives), which advises and assists the Ministry of Labour on matters affecting workmen in connection with the Employment Exchanges, held their fifth meeting last Wednesday. Mr. C. F. Rey (Director of the Employment Department) presiding. The committee were informed that an arrangement had been made whereby workpeople sent through Employment Exchanges to work of national importance should travel at specially reduced rates. They also considered the scheme of apprenticeship in the building trade, which has been recommended by a conference (convened by the London Central Advisory Committee for Juvenile Employment) of representatives of the Institute of Builders and of the London Building Trades Unions.

The committee of the National War Museum are anxious to make, as far as possible, a complete history of the war in photograph. Such a record should be of permanent historic value and European importance. Efforts to obtain similar national collections are now being made by all the other belligerents. We wish, therefore, to make a strong appeal to all friends and relations of officers now serving, or who have at any time served; with H.M. Forces during this present war for free gifts of bromide photographs. Such photographs should be unmounted and printed on bromide paper—this in order to facilitate docketing and to secure their permanence. If the donors will write on the backs of the photographs they contribute such details as will form a minute concise biography, with dates of promotion, distinctions, etc., they will very materially assist the committee. All photographs received will be duly acknowledged, and we feel that our appeal has only to be generally known to meet with an adequate and cordial response.

In the Truro (Cornwall) rural district, during a recent discussion of that council on the need of more houses, one of the members stated that "a man must be a good Christian to let a house to a large family."

Captain Ernest William Frost Hammond, M.C., H.A.C., younger son of Mrs. J. A. Hammond, of 5, Dollis Road, Finchley, and of the late Alfred Hammond, of 25, Bedford Row, was reported "missing, believed killed," on May 3 has now been reported "killed." Captain Hammond, who was twenty-seven years old, was a member of the Surveyors Institute.

The scarcity of houses in Carmarthen is illustrated by a string of removals which took place recently. A house rented at £50 per year became vacant by the death of the tenant, and says a correspondent of the *Western Mail*, people from a slightly smaller house moved in. Another tenant went into the second house, and altogether twelve removals followed one another. Finally a tenement at 18, 10d. per week became vacant as the result of the £50 house being available.

CHIPS.

A memorial to the late Dean Pigou, in the form of a sculptured recumbent effigy, was unveiled in Bristol Cathedral on Monday by Mrs. Pigou, the late Dean's widow.

The London County and Westminster Bank (interim dividend is 9 per cent. for the half-year ending June 30, less income-tax, payable on August 1—same as a year ago.

The Master of the Plasterers' Company (Mr. Frederic Hudson) and the Upper Warden (Mr. P. L. Mot) have been re-elected. Mr. William Albert Stearns has been elected the Renter Warden.

The work of the Session 1916-17 in the School of Architecture, at University College, was brought to a close on July 5. Architecture certificates have been awarded to Miss Faith Brooke and Mr. C. H. Basto.

At a vestry meeting in a city parish a resolution was passed last week expressing detestation of the wanton destruction during the air raid of the east window of the parish church, one of the most beautiful examples in London.

Mr. Arthur Ventris, Assistant City Engineer of Westminster, and Superintendent of the City Council Highways Department—although his retirement should take effect in November—has agreed to continue his duties for another year.

To prevent hot lead from sticking to the pot or the tools heated in it, good solution is a mixture made up of powdered charcoal, 1 quart; salt, 1 pint; yellow prussiate of potash, 1 gill; and cyanide of potassium a lump the size of a walnut. This may be coated over the parts to which the lead sticks.

The tablet which is to be erected on Chawton cottage, near Alton, Hampshire, to-day, the centenary of the death of Jane Austen, is of oak, simple in design, and bears the following inscription: "Jane Austen lived here from 1809 to 1817; and hence all her works were sent into the world. Her admirers in this country and in America have united to erect this tablet."

The Provost of Oriel opened last week the Illinois Institute, a small ancient building now converted into a village institute. Inside the building, in the small entrance hall, are hung views of Oxford lent by the painter, Mr. Walter Tyrwhitt. On the walls of the reading room are hung a list of the sons of the village who are fighting for their country and of the heroic dead.

Mr. Francis Burdett Ward, Wisbech, architect and surveyor, sued Mrs. E. A. Hall, Walton Highway, wife of John Hall, farmer, for £15 15s. last week in the county court, for services rendered as architect. Judgment was entered for the plaintiff on £310, the total cost of the building of a house, which came to £15 15s. 9d., £15 10s. for the commission and 8s. 9d. for an advertisement.

The Montreal Builders' Exchange have been in communication with the Canadian Society of Civil Engineers and the Province of Quebec Association of Architects on the subjects of civic tenders being opened in the presence of the parties tendering and of the expediency of separating the heating and plumbing contracts from those of general contracts. The Builders' Exchange have asked for the co-operation of other bodies.

Camberwell Borough Council last Wednesday appointed two additional women sanitary inspectors at a commencing salary of £125 per annum, rising by annual increments of £10 to a maximum of £175. The successful applicants were Mrs. Ethel May Barr, house visitor under the Bernondsey Heath Borough Council, and Miss Frances O'Riordan, sanitary inspector and health visitor under the Deptford Borough Council.

On Saturday week the death of Mr. James Thomas Buckley, of 6, Lower Bealey, Rochdale, occurred. Mr. Buckley, who was sixty-nine years of age, and latterly had not been well, had a small allotment, and had finished attending to it when he suddenly fell backwards and died almost immediately. For nearly forty years Mr. Buckley had carried on business as a plumber, first in Regent Street, and for a number of years in Eastgate Street, Rochdale.

The Secretary of the War Office again directs the attention of quarry owners, managers, or other persons engaged upon the quarrying or output of road materials in quarries, slag dumps, or slag works, to the notification in the "London Gazette" of June 26, 1917, whereby they must furnish full details of their output and labour to the Secretary, War Office, Central Committee, 55, Cromwell Road, London, S.W.7, on forms to be obtained from him.

LIST OF TENDERS OPEN.

ENGINEERING.

July 23.—The Directors of the Clayton Amalgam Co., Ltd., Manchester, are prepared to receive tenders for the works included in the Railways Contract No. 3. The works comprise the reinforced concrete girders and decking and the brickwork parapets, etc., for the viaducts.—The Secretary, The Clayton Amalgam Co., Ltd., Manchester.

July 31.—Installation of Heating Apparatus for hot water system.—Mr. Hewett, 80, St. Alban's Road, Dartford.

Aug. 31.—Sealed tenders, endorsed "Tender for Contract No. 923," will be received at the Town Clerk's Office, Municipal Offices, Johannesburg, not later than 12 noon on August 31, for refrigerating plant at Market Buildings, Newtown, Johannesburg. Drawings and documents can be viewed free on application to the Council's agents in London, Messrs. E. W. Carling and Co., St. Dunstan's Buildings, St. Dunstan's Hill, London, E.C., but a deposit of £1 1s. is required for copies.

PAINTING.

July 19.—Sundry decorative works and repairs at the Inman's Markets Road.—For the Kensington Board of Guardians.—W. K. Stephens, Clerk, Guardians' Offices, Marlborough Road, Kensington, W.

July 21.—Painting at Falsgrave Gardens and caretaker's house (exterior) and at Gladstone Road Boys' School (interior), Scarborough.—For the Town Council.—Harry W. Smith, Borough Engineer and Surveyor, Town Clerk's Office, Scarborough.

July 24.—Painting externally the whole of the corrugated iron buildings forming the isolation hospital at Upney Lane.—For the Barking Union District Council.—A. Pratt, Acting Clerk, Public Offices, Barking.

July 25.—Painting work required at various parks, recreation grounds, and cemeteries.—For the Leeds Corporation Parks Committee.—Town Clerk, Great George Street, Leeds.

ROADS AND STREETS.

July 23.—Construction of a new entrance road to Wessex Gardens School, Golders Green, N.W.4 (from the termination of Wessex Gardens, Golders Green, to the school in Wessex Gardens).—For the Hendon Education Committee.—James Anderson, Secretary to the Hendon Education Committee, Council Offices, Hendon.

July 24.—Supply of the following (for one year, ending September 30, 1918): Road sweepers, brooms, oil, etc.; horse hire; tools; and Portland cement.—For the Rochester Corporation.—Apsley Kennette, Town Clerk, Guildhall, Rochester.

SANITARY.

July 27.—Laying certain sewers, etc., in the town of Rathfriland.—For the Newry No. 1 Rural District Council.—W. R. Bell, Clerk of the Council, Rural District Council Offices, Corkinew, Newry.

TIMBER.

July 23.—Supplying about 1,300 cubic feet of Irish oak timber, in the round log of large size, to selection, free from shakes, large knots, or other imperfections, and which has been felled in the winter.—For the Belfast Harbour Commissioners.—D. J. Owen, Secretary, Harbour Office, Belfast.

To commemorate the establishment at Barton-on-Sea, Hampshire, in 1914 of a convalescent depot for Indian troops who fought in Europe, an obelisk of unpolished Hampshire granite, subscribed for by members of the staff, has been erected.

An important project is under consideration for the establishment in Manchester of an orthopedic hospital and a hospital for limbless soldiers. Land suitable for a hospital site has been viewed; there is vacant land behind the Royal Infirmary, and a house at Rusholme has also been visited.

A stained-glass window placed above the altar in the Lady Chapel at St. Mellitus Church, Hanover, in memory of Owen Hart, the Boy Scout who lost his life in attempting to rescue two persons from drowning in the Brent at Greenford last August, was dedicated last Thursday.

A composition for colouring doorsteps, gateposts, stonework, etc., patented by J. Dargue, 59, Currock Road, Carlisle, consists of slaked lime and a colouring medium, such as red oxide, yellow ochre, lampblack, etc. The mixture is vented into a paste with water and moulded into blocks. (Gne, size, alum, etc., may be added. According to the provisional specification, cement may be used as an ingredient.)

The death, on June 25, at No. 3, Bingham Road, Addiscombe, near Croydon, is announced of Mr. Harry Phelps Drew, late of No. 35, King Street, Covent Garden, W.C. Mr. Drew was a surveyor, aged sixty years. Mr. Drew was the architect of business premises in Keon Street and Drury Lane, W.C.; factory at Wolverton, Bucks., for Messrs. McCormac and Co.; a large ice-factory in Battersea; and ice-works for Messrs. Carlo Gatti.

# OGILVIE & CO.

Mildmay Avenue, ISLINGTON, N.  
EXPERTS in HIGH-CLASS JOINERY,  
ALTERATIONS & DECORATIONS.

Telephone DALSTON 1968.  
Many years connected with the late firm of W. H. LASCHELL & CO., of Bunhill Row.  
ESTIMATES FREE.

FOR **Olivers' Seasoned Hardwoods,**  
APPLY TO—  
**WM. OLIVER & SONS, Ltd.,**  
120, Bunhill Row, London, E.C.

### TENDERS.

\* Correspondents would in all cases oblige by giving the addresses of the parties tendering, at any rate, of the accepted tender: it adds to the value of the information.

- ABERKENF.—For the repair of seven cottages at Alma Terrace, Aberkenfig, for the Earl of Dunraven Lodge of Oddfellows, Bridgend:—
  - J. Davies, Riverside Mills, Maesteg, near Bridgend, .. £130 0 0
  - H. Thomas, Meadow Street, Aberkenfig .. 120 0 0
  - W. T. Howell, Quarella Road, Bridgend .. 110 0 0
- ASHBY-DE-LA-ZOUCH.—For repairs to the steam roller, for the urban district council:—
  - Warren Bros., Newhall (accepted) £32 10 6
- AYLESBURY.—For rebuilding a boundary wall and erecting buttresses at the Blechley Road council school, for the Bucks County Education Committee:—
  - J. Edwards and Co., 423 15s. (recommended for acceptance).
- BARGOD.—For laying a sewer in John Street, Bargod, for the Gelligaer Urban District Council:—
  - W. Jenkins (accepted) .. £51 18 6
- BIRMINGHAM.—For laying clinker-masphalte over an area of approximately 12,000 yards, for the corporation:—
  - Highways Construction, Ltd., Finsbury Court, London, E.C. (accepted)
- BROADWAY.—For repairs to cottages at Broadway, for the Evesham Rural District Council:—
  - J. Knox, Evesham .. £27 15 0
  - Stewart and Co., Broadway .. 23 10 0
- CHILMSFORD.—For painting parts of the interior and exterior of 106 working-class dwellings in Rainford Lane, for the town council:—
  - H. Potter .. £299 0 0
  - F. J. French .. 282 17 6
  - T. J. Bailey .. 240 8 3
  - F. G. Bratchell, Hornchurch .. 199 16 8
  - W. E. Wisley (accepted) .. 196 0 0
- DISS.—For repairs to the infectious diseases hospital, for the urban district council:—
  - C. Markwell, £22 10s. (accepted).
- EGREMTON.—Building walls at Digney, for the district council:—
  - James Smith (accepted).

- GOSPORT.—For the renovation of various schools, for the Gosport and Alverstoke Education Committee:—
  - Accepted tenders:—Alverstoke School, C. M. Dash, 456; Leasland Boys' School, J. Vaux, £33 15s.; St. Mary's R.C. School, W. T. Sawkins, £28 18s. 6d.; children's homes, T. E. Gibbons, £28 15s.
- GRIMSBY.—For extensions to the isolation hospital at Immingham, and the painting of the whole of the roofs, sides and external woodwork of existing building and new blocks, for the Grimsby Rural District Council:—
  - M. Holmes and Co., Ltd., Grimsby £319 10 0
  - A. Waddingham, Harborough .. 290 6 0
- HEADINGLEY.—For labour required in connection with the reconstruction of the tramways in Victoria Road, Headingley, for the Leeds Corporation:—
  - Accepted tenders:—(Section 1) J. Speight, tramway work £308 2s. 6d., highway work £277 18s. 4d.; (2) B. Speight and Sons, tramway work £398 15s., highway work £277 18s. 4d.
- HULL.—For the construction of foundations for a cooling tower at the electricity works, for the corporation:—
  - C. Greenwood (accepted) .. £2,195 11 6
- MOIRA.—For the concrete pillars and work in connection with the erection of the new canal foot-bridge at Moira, for the Ashby Wolds Urban District Council:—
  - Low and Sons, Burton (accepted).
- MORFETH.—For the rebuilding of the Castle Wood R. Hall (accepted) .. £66 5 6
- PALGRAVE.—For the construction of a cesspool in connection with the Palgrave sewer, for the Hartismere Rural District Council:—
  - W. G. Buck, Wortham .. £49 17 6
- PORTH.—For interior and exterior painting in accordance with specification, at the Cymmer Colliery Workmen's Library, Porth:—
  - S. A. Keehan, 40, Trehaod Road, Trehaod (accepted) .. £79 10 6
- PORTSMOUTH.—For the extension of the concrete sea wall along the Esplanade, east of South Parade Pier, for the corporation:—
  - Frank J. Privett .. £697 0 0
  - E. and A. Springins .. 665 0 0
  - G. F. Smith and Co. .. 595 0 0
  - J. Tanner .. 575 0 0
  - G. J. Davis and Sons .. 553 0 0
  - Frank J. Corke\* .. 539 0 0
- SHEFFIELD.—For painting work at Moorhead lavatory and Fitzalan Square lavatories, for the corporation:—
  - Accepted tenders:—J. Pittrell and Sons, Ltd., £20; Simpson and Melling, £141.
- SWALLOWSTON (SHEFFIELD).—For white-washing, colouring, etc., at the Swallowston Hospital, for the South Kotherham, Handsworth and Kiveton Park Joint District Isolation Hospital Committee:—
  - Simpson and Melling, Attercliffe Common, Sheffield .. £68 0 0
  - E. Hudson, Ecclesall Road, Sheffield .. 40 0 0
  - Harrison Bros., Rotherham .. 37 5 0
- ULVERSTON.—For painting and colouring the inside of the fish market, for the urban district council:—
  - J. G. Spencer (accepted).

- WIVELSCOMBE.—For the outside painting of the Wivelscombe school, for the county education committee:—
  - F. G. Hewlett (accepted) .. £21 10 0
- WOLSTANTON.—Works at Knutton Lane Bridge, for the urban district council:—
  - W. Bullock, 419a (recommended for acceptance).
- WOLVERHAMPTON.—For the construction of a new boiler-house wing, including overhead coal bunkers, foundations and skeleton structure for the boilers, economisers, etc., for the electricity committee:—
  - Melville, Dundas and Whitson, £3,806 0 0 (Recommended for acceptance).
- WORKING.—For carrying out improvements to the heating apparatus at the Worthing High School for Girls, for the West Sussex Education Committee:—
  - J. Smith and Son, Brighton .. £250 0 0 (Accepted)

### TO CORRESPONDENTS.

We do not hold ourselves responsible for the opinions of our correspondents. All communications should be drawn up as briefly as possible, as there are many claimants upon the space allotted to correspondents.

It is particularly requested that all drawings and all communications respecting illustrations of literary matter, books for review, etc., should be addressed to the Editor of the BUILDING NEWS, Emfingham House, 1, Arundel Street, Strand, W.C.2, and not to members of the staff by name. Delay is not infrequently otherwise caused; all drawings and other communications are sent at contributors' risks, and the Editor will not undertake to pay for, or be liable for, unsought contributions.

When favouring us with drawings or photographs, architects are asked kindly to state how long the building has been erected. It does neither them nor us much good to illustrate buildings which have been some time executed, except under special circumstances.

### NOTICE.

Bound Copies of Vol. CXII. will be ready shortly, and should be ordered early (price 12s. each, by post 12s. 6d.), as only a limited number are done up. A few bound volumes of Vols. XXXIX., XLI., XLVI., XLIX., LIII., LXL, LXII., LXIV., LXV., LXVI., LXVII., LXVIII., LXIX., LXXI., LXXII., LXXIII., LXXIV., LXXV., LXXVII., LXXVIII., LXXIX., LXXX., LXXXI., LXXXII., LXXXIII., LXXXIV., LXXXV., LXXXVI., LXXXVII., LXXXVIII., LXXXIX., XC., XCI., XCII., XCIII., XCIV., XCV., XCVI., XCVII., XCVIII., XCIX., C., C.I., C.II., C.III., C.IV., C.V., C.VI., C.VII., C.VIII., C.IX., C.X., and C.XI. may still be obtained at the same price; all other bound volumes are out of print.

RECEIVED.—C. P. and Co.—J. B.—A. J. B.—B. Bros. and Son—G. and Co.—J. O. and Son, Ltd.—P. C. B. and Co.—L. and N.—C. S. I. Co.—L. B. and Son, Ltd.—M. T. and Son—M. H. B. Association—F. J. H.—W. H. S. and Son.

A. G.—Yes.  
TRINOMIAL.—Thanks, no.

MANUFACTURER.—The original patent expired long since, 2. Yes.  
G.—No son; but there was a brother, who, we think, died some years after.

# COULTER & CO.

BANK FOOT  
FOUNDRY,

BATLEY, YORKS

Write for  
**NEW CIRCULAR**  
giving Particulars of Advantages  
and new Patented Improve-  
ments.

REVISED PRICES.

MAKERS OF PATENT  
STONE-SCABBLING MACHINES.

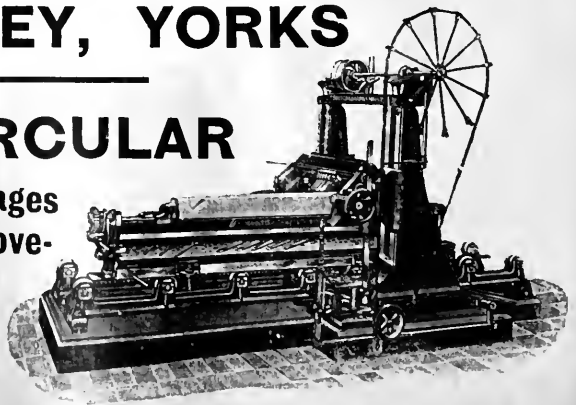

# THE BUILDING NEWS

## AND ENGINEERING JOURNAL.

**Effingham House,**

Currente Calamo .. .. .	61
The Problem of the Small Dwelling and its Solution .. .. .	62
The Architectural Association Meeting at Bedford Square .. .. .	63
How the Chinese Build .. .. .	64
Obituary .. .. .	64
Our Illustrations .. .. .	67
Straight-bar Reinforcement without Bends .. .. .	77
Correspondence .. .. .	78

**CONTENTS.**

Professional and Trade Societies .. .. .	78
Legal Intelligence .. .. .	78
Our Office Table .. .. .	79
Competitions .. .. .	79
Clubs .. .. .	79
Trade Notes .. .. .	79
Tenders .. .. .	80
List of Tenders Open .. .. .	80
Latest Prices .. .. .	viii.
To Correspondents .. .. .	ix.

**Strand, W.C.2.**

**OUR ILLUSTRATIONS.**

A New Dining Hall for a Country House, designed in the Tudor style by Lieut. Murray Adams-Acton, Architect.  
 St. Wilfrid's Church, Harrogate. The aisles and nave in course of building. Mr. Temple Moore, F.R.I.B.A., Architect.  
 The Problem of the Small Dwelling and its Solution. Sheets XVIII. and XIX. More contrasts and health promoting homes in three sizes. By Mr. Robert Thomson, Architect.

### Currente Calamo.

Mr. Lloyd George seems to have discovered at last that it is the duty of the Government to compensate all sufferers from air-raids or bombardment. We hope his scheme will not be such a failure as the warning signals so far. Already the State has received as premiums under its insurance scheme far more than it is ever likely to be called on to pay out for reinstatements, not one penny of which, we suppose, is ever likely to be returned to the insurers, even if general compensation is now to be vouchsafed. Whatever the scheme for the future is to be, it should embrace property, person, and furniture, of course with proper and usual precautions to detect and prevent fraudulent claims. Whatever the sufferer's position is, he is entitled to be compensated for the damage and injury the State is, as yet, unable to prevent. This has been made clear enough by the Committee on War Damage, which represents 712 local authorities, and whose deputation to the Premier was headed by the Lord Mayor of London. We hope Mr. Lloyd George will move quickly. People generally are pardonably sore about this matter, and some are saying, doubtless untruly, that till the West End is raided, and havoc has been wrought there to the same extent as in the City and the East End, the Government will not take action.

In view of the increasing interest shown in the subject of concrete road construction, the Roads Improvement Association recently instructed Mr. H. Percy Boulnois, M.Inst.C.E., to prepare for them a report upon the present position and possible future of concrete roads in this country. This report (which has now been completed, and is being issued by the Association in pamphlet form) reviews at the outset the work which has been carried out in the United States and Canada, and the remarkable fact is given that "during the year 1914 alone it was estimated that no less than 17,000,000 square yards of concrete roads were constructed in America, and that at the present time there must be at least 50,000,000 square yards of such roads in the United States." The manner in which

American engineers deal with the construction of a road is set forth in much detail, and examples given of the proper methods of mixing and laying the concrete, in addition to a description of the materials to be used. Mr. Boulnois then gives particulars of the various concrete roads that have been constructed in this country, from which it would appear that, comparatively speaking, but slight progress has been made, and the roads limited to only a few districts, the city of Chester and Dunfermline in Scotland being two of the principal ones. He says that, with proper organisation, a good concrete road can be constructed at a cost of about 5s. per square yard, and that the cost of maintenance of such a road would be very trifling; but it is evident that in order to secure success, much more care should be exercised in its construction than has hitherto been the case in some instances. Mr. Boulnois said very little as to the benefits of reinforcement, but has no doubt that reinforcement, properly applied, has revolutionised concrete construction, and where very heavy weights are to be carried by a road, or where there is found an unstable sub-base, it might be found desirable to insert some form of reinforcement, but each case must be considered on its merits. We should rather say it has been found desirable, remembering what has been done at Chester and elsewhere under competent direction and with a really good system.

"The House of Windsor" as the designation of the British Royal Family is a welcome and authoritative substitution for the alleged surnames Gueph d'Este, Wettin, and Saxe-Coburg and Gotha, quite apart from the delight of all of us at having got rid of any nominal connection of our Royal House with Germany. In addition, the new name perpetuates historic associations, going back for more than eight centuries. Windsor appears to have been a Royal residence before the coming of the Norman, and even in the time of the Heptarchy a stronghold existed there. The mound on which the Round Tower of Windsor Castle now stands formed the chief part of that ancient work. Before the Conquest there was a Royal hunting lodge here. Edward the Confessor granted the manor to the abbey of Westminster; while Harold,

before he assumed the Crown, had a castle in the adjoining parish of Clewer. William the Conqueror replaced Harold's primitive wooden enclosure by a stone wall, and in the course of centuries there grew the stately palace we now know. Henry I., who resided much at Windsor, married his second Queen in the chapel there. Additions to the castle were made by Henry II., and the first complete Round Tower was built by Henry III. about 1272. John was at Windsor after the granting of Magna Charta. Edward III. was born in the castle, and in 1334 he reconstructed the Round Tower in order to receive the Knights of his newly-established Order of St. George or the Garter. Edward selected Harold's Mound as the site of his tower because of a legend that on the summit King Arthur used to sit surrounded by the Knights of his Round Table. It was at Windsor that the Black Prince married "the fair maid of Kent," a lady who had already been twice married and had four children. David Bruce and James Stuart, Kings of Scotland, were prisoners at Windsor. Henry VI. was born at the castle in 1421, and Edward IV., who built St. George's Chapel, was buried there. As a Royal mausoleum the Chapel of St. George ranks next to Westminster. It was completed by Henry VII., who built the so-called "Tomb House," part of which dates, however, from the time of Henry III., who built it in honour of Edward the Confessor. Henry VIII. and Charles I. were buried in St. George's, Windsor; many Royal marriages have taken place there, and Wolsey's Chapel contains a cenotaph to the Prince Consort and the tombs of Prince Leopold, Duke of Albany, and the Duke of Clarence. Queen Elizabeth loved Windsor and built some chambers, which still remain on the north side of the upper ward. It has indeed been for centuries the chief residence of the English Sovereigns. The State apartments were built by Wren in the time of Charles II.; William III. came to Windsor in the winter of 1688 on his famous journey from Torbay to London; Queen Anne used to hunt in the park in a chaise; and George III. made it his principal residence. He added considerably to the Queen's House, but under George IV. the castle was transformed by Wyattville. George IV. died at the castle in 1830, his successor, Wil-



ham IV. in 1838, and the Prince Consort in 1861, all three in the same room.

America is not going to repeat Mr. Lloyd George's colossal blunder. Chicago, with characteristic energy, has started a "Build as Usual" campaign. A preliminary meeting has been held, participated in by the Building Constructors Employers' Association, the Illinois Chapter of the American Institute of Architects and the Illinois State Society of Architects. Committees have been appointed whose duties will be to make a thorough inquiry into the present building conditions and to formulate reports for consideration. Federal authorities have emphasised that the Government desires all projected building operations to proceed without interruption. Mr. Howard E. Coffin, a member of one of the advisory committees of the Council of National Defence, has said:—"Unemployed and closed factories, brought about by fitful and ill-advised campaigns for public and private economy, will prove a veritable foundation of quicksand for the serious work we have in hand. It is evident to every thinking man that our industries on the farm, in the shipyards, in the mines, in the factories, must be more prolific and more efficient. We need prosperity in war-time more than when we are at peace. Business depressions always are bad and doubly so when we have a fight on our hands." Men who are best informed as to the economic conditions now prevailing share Mr. Coffin's opinion. There should be no cessation of activity in any of the phases of building unless it can be shown that they interfere with the Government's plans for the progress of the war. Action such as has been taken by the Illinois architects and builders will foster a feeling of confidence and safety. It would have done so here if our own organisations had long ago united to ward off the staggering blow dealt to the second great group of industries in the realm.

Simple concrete construction suitable for dwelling-houses and other buildings has been devised and is being largely used in America to secure a minimum cost of forms and rapidity of construction. It involves a combination of pre-moulded concrete sectional columns connected by sectional wall forms. The columns are made of comparatively short hollow blocks having pairs of shoulders projecting from their opposite ends. These are laid up rapidly in successive courses to the required height of the wall forms. They are keyed, clamped, or braced to correct line, and the vertical interior space is filled with monolithic concrete containing the required vertical reinforcement rods. As soon as this concrete hardens, solid strong columns are provided and the panels of wall forms can be placed on each side between a pair of columns and drawn up tightly against the column by ordinary transverse bolts. After the form is concreted the lower portions of the panels can be removed and put on above in the usual way, thus providing rapid and simple construction for the walls. With competent superintendence the method might well be more frequently adopted here.

#### THE PROBLEM OF THE SMALL DWELLING AND ITS SOLUTION.—X.

By ROBERT THOMSON.

[WITH ILLUSTRATIONS.]

Although authorities have been for long agreed that the smallest size of cottage which should be built for use as a family dwelling ought to contain three bedrooms, it has never hitherto been found possible, with the limited amount of money available, to provide these bedrooms and give a living-room as well. The minimum number of habitable apartments in the small dwelling is thus inexorably and almost automatically fixed for us at four, and the minimum total number of apartments, when the kitchen is included, at five. But beyond all doubt five apartments are essential in the labourer's cottage, and no more are required by the best-paid artisan, or even by the great majority of tradesmen.

As the wage-earners embrace probably about nine-tenths of the population, not only of this, but of every other country which has reached a similar stage in its progress towards civilisation, five may therefore be regarded as the standard number of apartments which ought to be provided in what may be described as the international type of dwelling for the peoples of the world—in short, the small dwelling.

Although the number of apartments in such dwellings is apparently fixed arbitrarily at five, and although one of these apartments would provide a sitting-room free from the kitchen taint, there would undoubtedly remain a strong desire for another apartment, not so much for use as a sitting-room, but for the purpose of displaying, free from the destructive energies of the children in the living-room, those small family gods which every good housewife treasures. The housewife's desire for this little amenity in the dwelling, which is wholly laudable, is, fortunately, one which ought to, and can easily, be gratified.

If the reader will turn to sheets II., III., and VIII. he will see examples in which this sensible requirement is entirely disregarded. He will also be able to note that the provision of a parlour means a very substantial addition to the size, and, consequently also to the cost, of the two-flatted type of dwelling.

Taking, for example, plan Fig. 20, which is the only one of the two-flatted type arranged four in a block which exactly meets the official requirements as to the sizes of its apartments, it will be found that each pair of six-apartment parlour dwellings provided for in this block require a roofed area 246 square feet greater than that of the corresponding pair of dwellings shown in plan Fig. 19, in which the sizes of each of the five apartments are all in exact accordance with the "desirable" standard set forth in Column 2 of the table in Paragraph 35 of the committee's report. As the official sizes of the habitable apartments in plan Fig. 19 are all very seriously inadequate, and as investigation shows that to sufficiently increase the sizes would be to entail a burden beyond that which would be justifiable, the provision of a parlour in a two-flatted type of dwelling is economically out of the question. Although it is thus economically impossible to give a parlour in a dwelling of the official type, there is no difficulty whatever in the way of providing all that is required in a dwelling of the single-flatted type. When house-room and economy are both so essential in the dwelling, why leave the space in the parents' bedroom unutilised by day, and that in the parlour

neglected by night? This neglect to fully utilise the space in the parents' bedroom appears to me to be inexcusable, more particularly since it is essential that the size of this apartment in order to be such as to provide an air body equal in volume to the combined volumes which the officially standardised bedroom and parlour would provide, more especially since the bedroom is of sufficient size adequately to serve for the upbringing of young children, is easily capable of efficiently serving for parlour as well.

On reference to plan Fig. 93, Sheet XV., it will be seen that the parents' bedroom is so planned that the relative arrangement of its doorway, fireplace, and window, and the disposition of the bedroom furniture are such that, without detracting from either its usefulness or healthfulness as a bedroom, it can be utilised also as a parlour, and that for this purpose it would lose nothing either in comfort or convenience from the presence of the bedroom furniture. For example, by making this one apartment alternately serve for these two purposes, it would in the first place avoid the extra cost which the addition of a separate parlour would entail. In the second place, the occupants would benefit by having at their disposal an air body of a volume considerably more than twice that of the official size of parlour in the six-apartment type of dwelling; in the third place, it would as a bedroom provide its occupants with an air body not very far short of twice the volume of that in the "desirable" official size of bedroom; and, in the fourth place, it would keep the work of the housewife much below that required in a six-apartment dwelling. By this arrangement a parlour would be brought within the reach of vast numbers of people who could never otherwise hope to possess one. In order that it may be possible to appreciate the advantages which the two apartments, the bed-parlour and the living-room, offer, it is necessary to bear in mind (1) that in the official basis plan from which this plan has been developed there is no parlour, (2) that its kitchen is the only living-room, and (3) that the parents' bedroom is relatively very small. The parlour, when it is the sixth apartment in the dwelling, imposes extra labour on the housewife. In the health-promoting dwelling, on the other hand, by the separation of the living-room from the kitchen and by utilising the large bedroom for the usual parlour purposes, the occupants would obtain the equivalent of five exclusively habitable apartments, whereas in a dwelling of similar roofed area constructed to the official model plan, the only exclusively habitable apartments would be the three small bedrooms.

Turning now to the series of plans arranged on sheet XVIII., it will be seen that Fig. 107 shows a mid-terrace dwelling, each pair of which has a roofed area of 1,294 square feet, and that plans Figs. 108 and 109 show four-in-a-block dwellings, the roofed area of each pair of which is also 1,294 square feet. Since the terrace type of dwelling has heretofore been unquestioningly accepted as being the most economical form in which dwellings can be provided, it is therefore now possible to submit the new class of dwelling to the most severe test to which it can be put by comparing it with a mid-terrace dwelling. I am glad to have the opportunity of making this comparison because it enables me to prove the truth of my statement that the single-flatted type of cottage dwelling, when built in semi-detached rows, gives ceilings 10 ft. 3 in. high with less walling than the official

two-flatted type of cottage of corresponding roofed area requires to give ceilings of only 8 ft. high. The figures relating to the plans which prove this are as follows:—  
 Four mid-terrace dwellings to plan Fig. 107, sheet XVIII., when standardised with 4 ft. 1½ in. passageway, measure 98 ft. 3 in. from centre to centre of party walls, and are 26 ft. 4 in. wide, so that the total roofed area of the four dwellings works out at 2,587 sq. ft. 3in., thus giving 1,294 sq. ft. as the area of each pair. The walling of four of these dwellings is as under:—

Front and back walls.....	98' 3" × 2 =	196 6
Party walls.....	24' 6" × 4 =	98 0
<hr/>		
Lineal feet.....		294 6
Taking the height as on Fig. 10 at.....		22 6
<hr/>		
Gives a superficial area of sq. ft.....		6,626 3
Adding thereto—		
(a) The walling at one side of each of two passageways 24' 6" × 13' 9" × 2 = sq. ft.		673 9
(b) The gables on each of the four party walls (26' 4" × 7" ÷ 2) × 4 = sq. ft.		399 4
<hr/>		
Giving a total superficial walling area of sq. ft.		7,699 4

The corresponding figures for four dwellings to plan Fig. 109 are:—

Front and back walls....	96' 6" × 2 =	191 0
End walls.....	25' 0" × 2 =	50 0
Party wall.....		24 3
Extra for wings.....	8' 6" × 2 =	17 0
<hr/>		
Lineal feet.....		282 3
Height to give 10' 3" ceilings.....		27 0
<hr/>		
Gives a superficial area of sq. ft.....		7,621 0
Adding thereto the gable of party wall 25' 0" × 7' 3" ÷ 2 =.....		91 0
<hr/>		
Deducting the saving effected by two wings.....		7,712 0
<hr/>		
Gives a total superficial area of sq. feet.		7,576 0

In addition to the balance in favour of plan Fig. 109 shown by these figures, there falls to be added other substantial economies effected in the amount of foundations by the new method of construction employed; but there is no need to go into these in detail since the balance is already sufficiently in favour of the health-promoting dwelling.

The establishment of the fact that the new class of dwellings gives ceilings 10 ft. 3 in. high with less walling than the two-flatted type requires to give ceilings only 8 ft. high is not by any means the most important feature brought out by these plans. If the reader will turn to the figures appended to plans Figs. 107 and 108 he will there see the amazing extent of the superiority which the new class of dwelling offers in the way of house room. But even the figures of £329 and £235 there shown do not adequately represent the actual superiority of plan Fig. 109 over the other two since no monetary value has been put upon the system of ventilation with which it is equipped.

Since the vital importance of the advantages which an efficient system of ventilation would provide in a small dwelling can hardly be overrated, it is desirable that some idea of the effect of its employment should be given in an easily understandable form, and it is therefore for this, among other purposes, that the plan shown in Figs. 110 and 111 have been prepared. The following brief descriptions of each of the series of plans on sheet XVIII. should be helpful.

Fig. 107, which forms the basis of the series, shows the plan of a mid-terrace two-flatted type of dwelling in which the size of each of the six apartments is in exact accordance with that called for in Column 111 of the table given in Para-

graph 35 of the Advisory Committee's report. Fig. 108 shows the plan of a single-flatted six-apartment parlour type of dwelling, the roofed area of each pair of which would be exactly the same as that of a pair built to plan Fig. 107. Fig. 109 shows the plan of a dwelling of the actively health-promoting class, the roofed area of a pair of which would be also exactly similar to that of a pair built to plan Fig. 107. Fig. 110 shows the plan of a dwelling in which the size of every one of its six apartments is such that with the officially standardised 8 ft. ceiling height the occupants would have at their disposal an air body equivalent in volume to that which would be available for use of the occupants of the health-promoting dwelling constructed to plan Fig. 109; but although equivalent in volume it is important to note that before the air space in each of these two plans could be of approximately equal value the dwelling erected to plan Fig. 110 would require to be equipped with a system of ventilation which would ensure the renewal of the entire air contents of each of its six apartments three times every hour. With such a system in operation this plan would offer health-promoting accommodation for the number of adult occupants stated in each of the apartments of plan Fig. 111.

Even with such a system, however, it would still be behind the dwelling erected to plan Fig. 109, since the latter combines a system of heating the incoming air with its system of ventilation. Because of this and of the fact that the living-room in plan 109 has the advantage of utilising two exhaust flues, the ventilating capacity of this apartment would be so much higher than that of the corresponding apartment in the dwelling erected to plan 110 that it would be enabled to provide by day for as many occupants as it would at night, whereas the larger plan provides for only seven occupants by day, as against ten by night. The plan of this huge dwelling shows in graphic form, and exactly to scale, the size which a dwelling of the type shown in Fig. 108 would require to be before it could offer to its occupants the same volume of air body as that which would be provided for in a dwelling built to plan Fig. 109. The monstrous size of building which the two flatted type of dwelling shown in plan Fig. 107 would entail in order to give its occupants an air body equivalent in volume to that which plan Fig. 109 provides, would be fearful to contemplate.

It should be noted that plans Figs. 110 and 111 require only three chimney heads for four six-apartment dwellings, and that although there are only the three chimney heads, yet every one of the six apartments in each of the four dwellings in the group has a chimney flue. This arrangement is in marked contrast to that shown in a set of plans now lying before me. These plans show a block of four cottage dwellings, three of which consist of five and the fourth of six apartments. The community to which these dwellings belong is said to be from the architectural standpoint "Without equal in the whole world." Notwithstanding this unique distinction, it is interesting to note that although this block of four super-perfect dwellings has five chimney-heads, some of which are very costly, each of these dwellings has a bedroom which is without a chimney-flue or other adequate means of ventilation. With so many proved advantages in favour of the new class of dwelling, which are brought out in the comparisons on Sheet XVIII., there need be no doubt remaining in the mind of anyone as to its having provided sufficient evidence to dispose of both the question of

back-lane and through passageway for good and all. To go into these questions in further detail would be to waste both space and time. The evidence against both is too overwhelming to need elaboration.

It should be further noted that the width of entrance lobby in plans Figs. 108, 109, 110, and 111 is 5 ft., but that of plan Fig. 107 has been kept at 4 ft. 6 ins., as in plan Fig. 102, Sheet XVII., and that the walling of plan Fig. 108 has been increased to 15½ ins. in order to utilise the surplus brick material which would have been saved had its walling been kept at the 11 in. thickness as in plan Fig. 107. Had the walls of both of these plans been kept alike, plan Fig. 103 would have had about 400 cubic ft. more house room to its credit, so that the disparity in this respect between it and plan Fig. 107, when the difference in house-room is priced at 15d. per cubic foot, would have been £119 6s. 5d. instead of £94 6s. 5d., as shown.

The remarks in reference to the plans on Sheet XIX. will be better held over until next week, when the complementary sheet of plans showing how to remedy the defects of the imperfect plans in this week's issue will be dealt with.

(To be continued.)

THE ARCHITECTURAL ASSOCIATION MEETING AT BEDFORD SQUARE.

The first general meeting held in the A.A. new premises in Bedford Square (as announced in our last issue) was well attended, a representative gathering of many of the older members of the association being present, and Mr. Henry M. Fletcher, M.A., presided. The plans for the intended extensions and adaptation of the buildings, by Mr. Robert Atkinson, were on view.

The President explained that the accommodation furnished by No. 35 would amply suffice for the needs of the association during the continuance of the war, but at an early date a doorway would be opened out leading into the adjoining house (No. 34), where the library of the association would be situated. The ground floor apartments are well adapted for readers' temporary needs and purposes of the library. The out-building in the yard of No. 35, next Morwell Street, is to serve as the men's studio meanwhile, and the social needs of the members are to be provided for in the rooms which will not at present be required for the current business of the architectural classes. The council chamber and general office are to be in the front of the ground floor, leaving the rooms as they are at present, the decorations, general conditions of the premises, heating, and electric lighting being suitably good and sufficient.

Sir Aston Webb congratulated the council and members generally on the favourable opportunity which had enabled the association to secure so admirable a pair of Bedford Square houses in every way appropriate, with the prospect of providing precisely the kind of premises they wanted in an ideal central position. Although they were all delighted when the move was made from Great Marlborough Street to the Royal Architectural Museum in Taiton Street, owing to the war it had been found impracticable to keep on with their depleted income, and consequently a change became inevitable; so the premises were, by consent of all concerned, sold, temporary accommodation being utilised in Great Smith Street, adjoining the rear of their Westminster quarters. These chambers were too contracted and unequal to the work of the association, and though business had been carried on for the past eighteen months under trying circumstances, with no small success, it was quite evident that when work is resumed on the return of members from the front it would be impossible to go on at Westminster. Indeed, as the president had explained, their lease in Great Smith Street would expire at the end of this year. Sir Aston Webb paid a warm tribute to the president personally for the energy he had individually devoted to the

carrying out of the business of the acquisition of the Bedford Square property, and Mr. Henry Fletcher, in his reply, acknowledged the consideration and co-operation which the association had from the first received from the surveyor of the Bedford estate, Mr. Fitzroy Doll, who had been a member of their body since 1869. Several members spoke in approval of the premises which had been secured.

The president, according to notice, proposed from the chair the resolution set down on the agenda paper as to by-law No. 14, viz.: "That the words 'all students in the schools must be members of the Architectural Association' be deleted." The object of this change was to allow women to join the school classes.

Sir Aston Webb seconded, though he remarked in doing so that for various reasons he doubted whether women could ever hope successfully to practise as architects. Not a few men who entered the schools and served their articles realised subsequently that they were more fitted for other callings. At the same time, it became more and more clear that an art education could not be perfect without some real acquaintance with architecture, such as their school and the schools of the Royal Academy furnished. Two or three ladies at the Academy Architectural School had lately much distinguished themselves in this way, and one had so well succeeded that the male students were left far behind.

Mr. Geo. H. Fellowes Pryme advocated that women should be allowed to become members of the Association, but the president pointed out that such a measure would involve an alteration in the constitution of the society, and in the absence of the bulk of their members it did not seem desirable to attempt such a change; in fact, for the present their duty primarily consisted in "carrying on," or, at most, preparing quarters in which to be able to proceed when those at the war returned and peace had been declared. The motion on the notice paper, at any rate, did not contemplate more than a change in a particular by-law, which a special general meeting was qualified to pass.

Mr. C. H. Brodie directed attention to the necessity of qualifying the wording of the resolution; otherwise it might be understood that male students need not be members of the association.

Mr. E. Guy Dawber thereupon moved an amendment, which made it perfectly clear by introducing words to the effect that all male students must be members of the association.

Mr. Henry Lovegrove seconded this, and Mr. Maurice B. Adams, supporting the need of strict exactitude, instanced an occurrence in the Westminster School of Art, when held at the Royal Architectural Museum, which led to serious trouble because a woman who had secured a free studentship for only one subject, claimed a right to attend all the classes. This being refused, she threatened to shoot the curator, Mr. Ford. This led to a case before the magistrate, and special protection for the officials had to be provided to prevent this threat being carried out.

Sir Aston Webb having accepted the amendment, it was agreed to in conjunction with the provision to allow women to become students in the Association schools, the voting being unanimous.

Tea was provided by the council, and those present were able to survey the building and inspect the students' drawings, which we described last week at some length.

A meeting of Wykehamites (Winchester School) at Lovell's Inn Hall, London, have decided to establish a memorial to scholars fallen in the war. A committee's recommendations included the foundation of scholarships for the sons of officers, the provision of a great hall, and the erection of cloisters.

At to-morrow night's meeting of the Society of Architects, at 26, Bedford Square, London, W.C.1., a second paper will be read on "Controlled Fuels," by Mr. R. Colburn Lovell, A.R.I.B.A., M.S.A. Analyses will be shown of several artificial fuels, together with the analyses of their component parts. Fuels from cinders and coal dust will be made by simple processes at the meeting.

## HOW THE CHINESE BUILD.

The Chinese architect does not build on the level—at least, he doesn't imagine his critic standing on the ground to judge his efforts. He plans in such a way that his houses—for he thinks in groups rather than in individual structures—will present something symmetrical and harmonious to any one viewing them from a hill or a pagoda. By the same token the Chinese artist takes his stand on an elevation so that he can get into his canvas more of the landscape than one can see from the ground. The fact that no pagoda or hill may be at hand from which to see the architect's triumph does not trouble him says Mr. Luther Anderson in "Asia" (New York), the journal of the Asiatic Association, "for he expects all those who really care anything about art to have enough imagination to picture in their minds the general harmony of his design, even though they can see only a part of it at a time." Contrasted with the Western notion, the difference is really fundamental:

"When we think of architecture we usually have individual buildings in mind. We speak of the Cathedral at Cologne, St. Peter's at Rome, the National Capitol at Washington, and the Woolworth building as noble examples of Occidental architecture, and justly so; but it is to be noticed that we are always thinking of only one building at a time, and not a group of buildings. Now, the Chinese idea of an architectural triumph is not that of a single building rising in beautiful lines to a great height, but a large number of buildings and *patios* symmetrically arranged and covering a great deal of ground. Individualism has always appealed strongly to Western nations, and this ideal seems to be expressed in our architecture. In the Orient, on the contrary, the family has always been more important than the individual. It is, therefore, quite natural and in keeping that the group idea should find expression in Chinese architecture.

"Because the beauty of Chinese architecture owes so much to the symmetrical arrangement of the various buildings composing a given group, it is difficult to do justice to Chinese buildings by means of photographs. The camera will at best take in only one or two buildings, and these will, by course, hide the rest. In order to show by means of a photograph the real beauty of a Chinese temple or palace, one would have to take a picture from an aeroplane. Even then one would fail to do it justice unless one could obtain it in colours."

The Chinese developed a type of architecture which differed from all others, not only in arrangement, points out Mr. Anderson, but in form. Isolated from the rest of the world, they of course borrowed little or nothing from other nations, and hence have "no exotic characteristics":

"The Chinese house exhibits certain features which can be traced back to the tents of the barbarian ancestors of the Chinese who wandered in from the West. The roof, though made of heavy beams, rafters, and tiles, still retains to some extent the shape of a tent. The process of construction reminds one of the raising of a tent, the pillars and the roof being erected first and the walls filled in afterward. The roof does not rest on the walls, but on pillars corresponding to the poles of a tent. The roof hangs in graceful lines, and is caught up at the corners like looped canvas. It seems to have been draped rather than built. The sweeping lines are exactly those which canvas would take if hung over the supporting beams. A Chinese building owes a great deal of its beauty to these graceful roof-lines. And in accordance with the theory that one cannot have too much of a good thing, the Chinese often ornament their buildings with several roofs, one above the other, as in the pagoda types.

"Internally as well as externally the Chinese house reminds one of a tent. There is no ceiling to hide the surface of the sloping roof and its rafters. Instead of a wooden floor there is only a layer of bricks paving the cold earth, with mats and rugs covering this flooring. The various buildings composing a house are arranged so as to face a courtyard, much as one would pitch tents around a campfire.

"The beams and rafters supporting the roofs of the more pretentious houses are decorated with curious designs and miniature landscape paintings in pleasing colours. When the Chinese gentleman reclines on his couch he has something to look at, something around which to weave his dreams.

Here and there in the tracery of the eaves and *svastikas* are scenes from the ancient legends, poetry, and history of his country. These pictures are so delicately interwoven and harmonised with the design that they do not obtrude themselves or irritate the eye, but rather, when one is not looking for them, sink into the design and become a part of the whole colourful decorative scheme. Perhaps the ancient Chinese thus decorated the interior of their tents with embroidered draperies, and when their abodes became more permanent they still required interior decorations which would satisfy the eye and stimulate the imagination."

One respect in which modern art may owe much to the Chinese is the use of strong colour. In this is seen a striking feature of Chinese architecture:

"The boldness with which the Chinese employ bright colours is justified by their excellent good taste. They comprehend better the harmonious combination of bright colours than any other people, and are therefore able to produce effects at, once startling and pleasing.

"The walls of a Chinese house are constructed of brick, wood being used for pillars, beams, rafters, window-frames, and doors. As a rule, only the woodwork is painted, but in the more pretentious buildings, such as palaces and temples, the exterior brickwork is covered with a coating of plaster, which is painted a deep red. The roofs of temples, palaces, and pagodas are usually covered with tiles glazed in beautiful colours. The Temple of Heaven in Peking owes much of its beauty to the roof.

"The most wonderful thing about a Chinese house is the spirit of peace which seems to pervade it. The courtyards, enclosed by houses which are in turn surrounded by high walls, have an air of security and seclusion which is not to be found in our Western homes. Into these peaceful courtyards, the noise of the busy world does not penetrate. The triple doors seem to shut out the storms of the world and its troubles.

"In the more pretentious houses some of the courtyards are transformed into miniature landscape gardens. There are miniature mountains, precipices, lotus-ponds, bridges, grottos, and rustic nooks. The irregular rocks are so well fitted together and built up against the sides of the house that they seem to have been placed there by Nature long before the houses were erected. The proportions are so carefully worked out that everything seems to be larger than it really is. And the arrangement is so irregular that Nature is simulated to perfection. There is usually a little open pagoda built to command the best view of the garden, where its owner may sit in solemn contemplation of the man-made beauty surrounding him."

## OBITUARY.

Mr. David Barclay, F.R.I.B.A., a well-known architect in Glasgow, died on the 15th instant. A member of the firm of H. and B. Barclay, 245, St. Vincent Street, he was a native of the city. With his brother he was the architect of the municipal buildings of Greenock, and also of the Glasgow Academy buildings. He was also an architect of the Royal Technical College in George Street, his plans for which were selected in competition. He was a Fellow of the Royal Institute of British Architects, Past President of the Glasgow Institute of Architects, a governor of the Glasgow School of Art, a Vice-President of the Glasgow Art Club, and a member of the Royal Glasgow Institute of the Fine Arts. Mr. Barclay, who was over seventy years of age, was a member of the Incorporation of Masons, of which he was Deacon in 1901.

The Barrow-in-Furness Corporation have passed plans for a cinema in Abbey Road to accommodate 800 persons. The plans have been prepared by Mr. A. Winstanley, of St. Ann's.



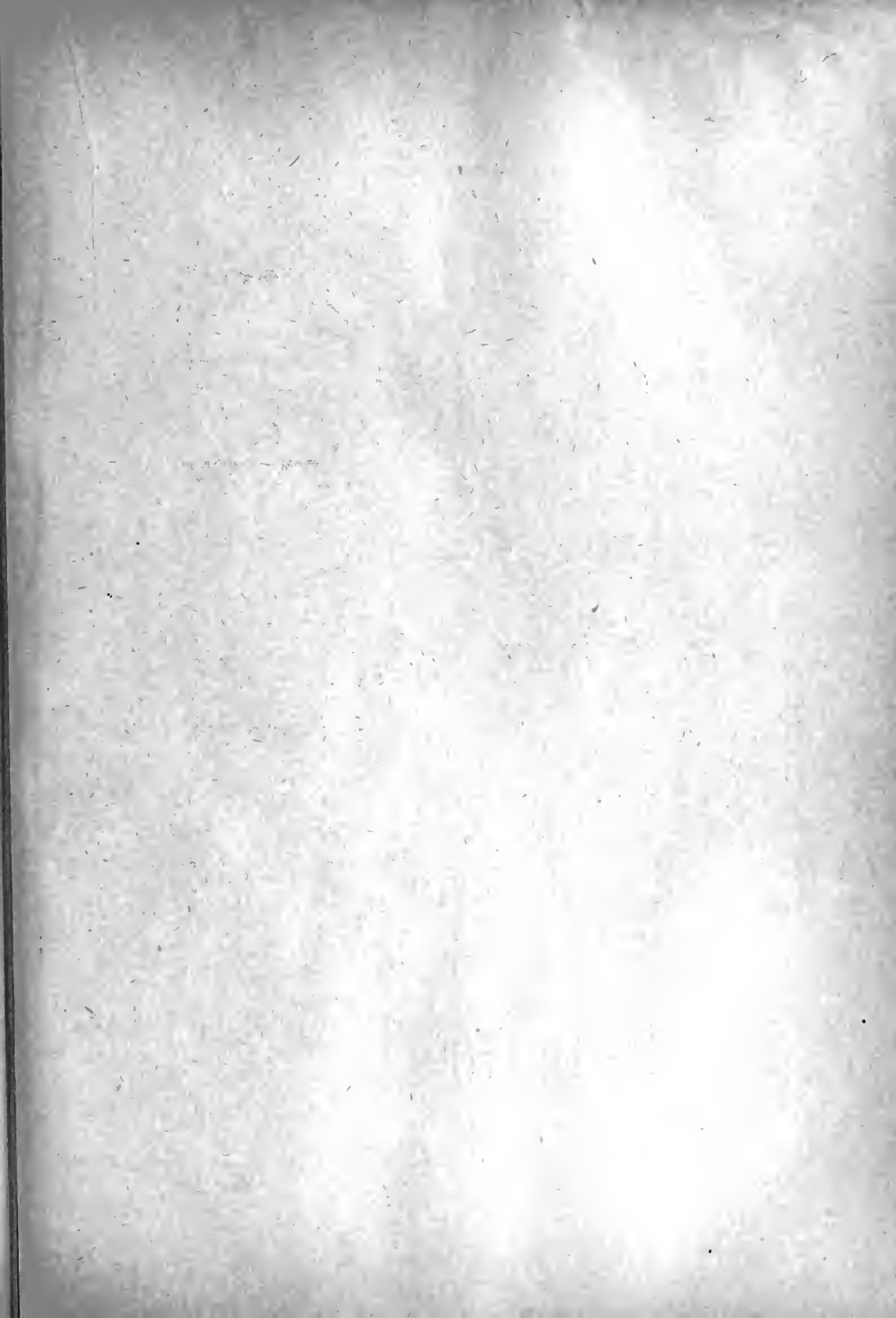

SHEET XVIII

EDUCATIONAL SERIES.  
MORE CONTRASTS.

REDUCTIO AD  
ABSURDUM.

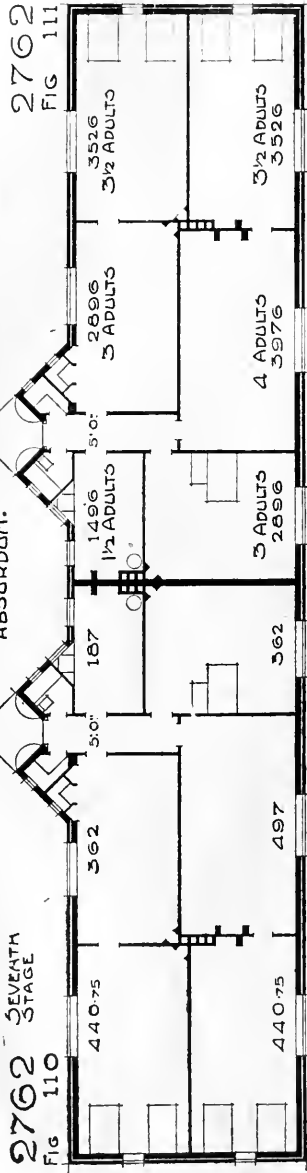

1894  
2762 6.627

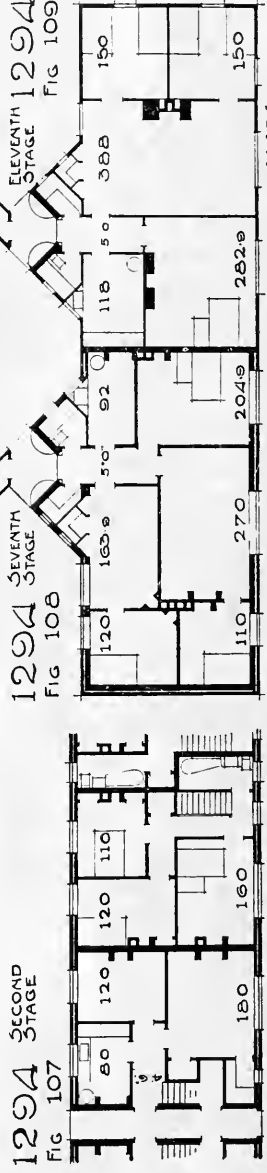

9160  
1294 4.760  
INFERIOR TO PLAN FIG 109 BY  
52.74 C.F. AT 15 PENCE PER C.F. - £329.12.10.

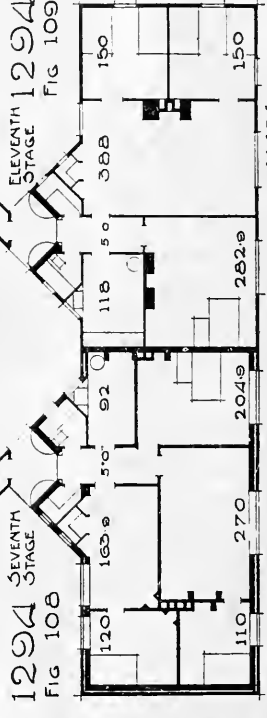

7669 5.527  
1294  
INFERIOR TO PLAN FIG 109 BY  
57.65 C.F. AT 15 PENCE PER C.F. - £335.0.5.

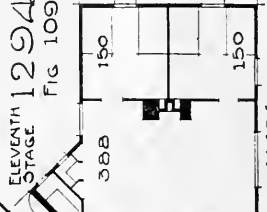

11434  
1294 8.836  
15310  
1294 14.149

THE PROBLEM OF THE SMALL DWELLING AND ITS SOLUTION.—By Mr. ROBERT THOMSON, Architect.





*F. J. Woodcock, Ph. ca.*

NORTH AISLE, ST. WILFRID'S CHURCH, HARROGATE, IN COURSE OF ERECTION.  
MR. TEMPLE MOORE, F.R.I.B.A., ARCHITECT.



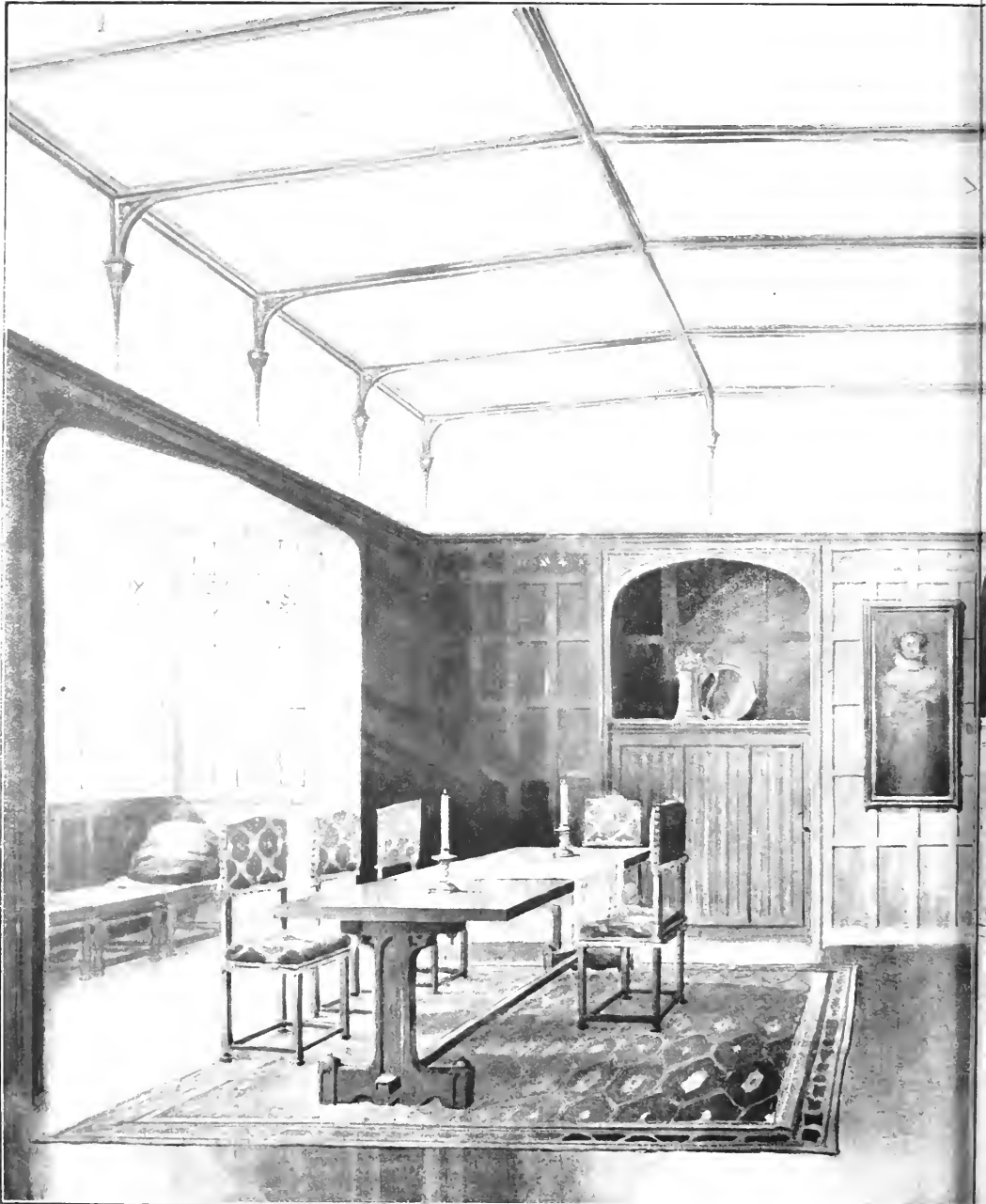

A NEW DINING HALL FOR A COUNTRY HOUSE, DESIGN

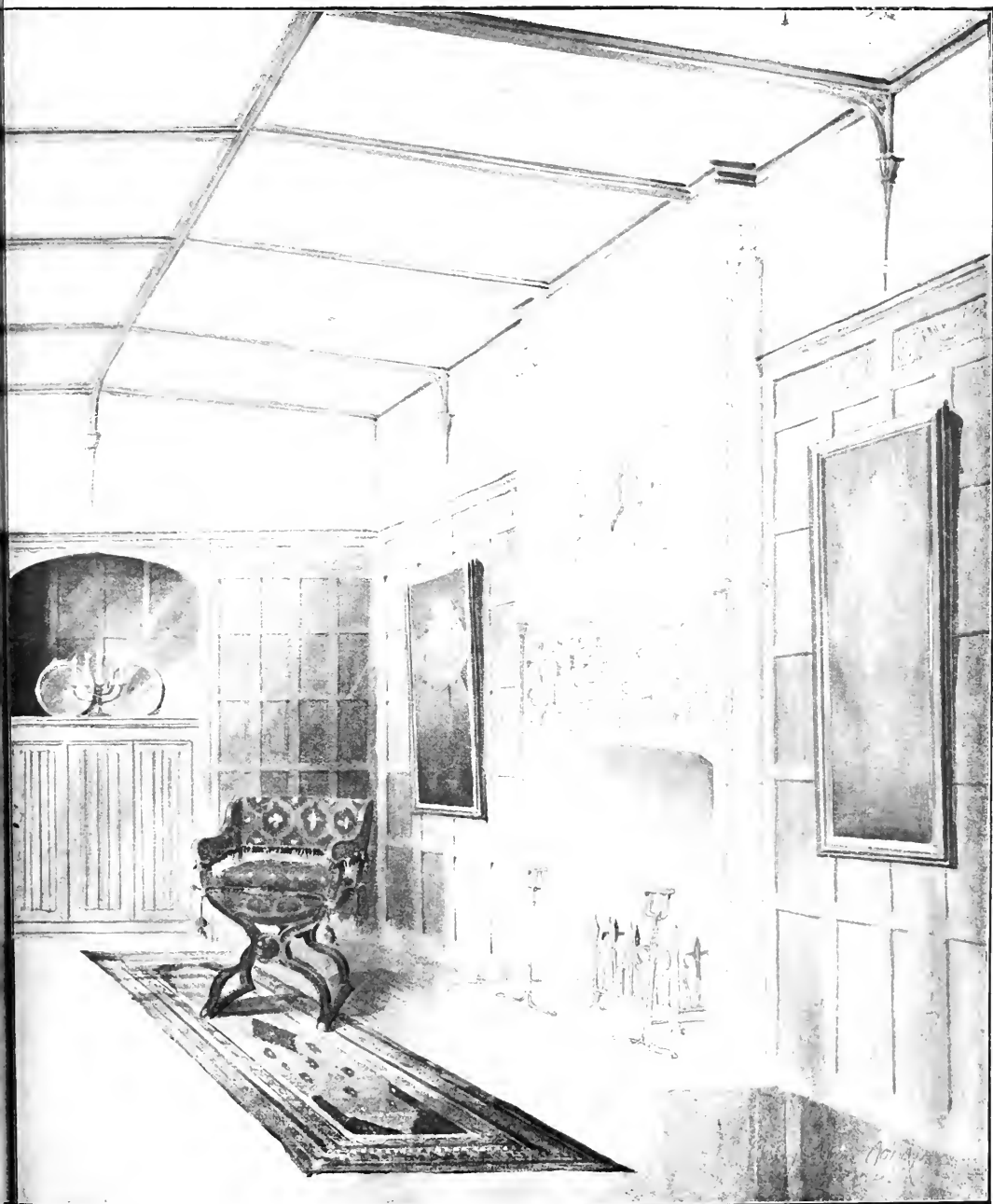

IN THE TUDOR STYLE.—Lieut. MURRAY ADAMS-ACTON, Architect.

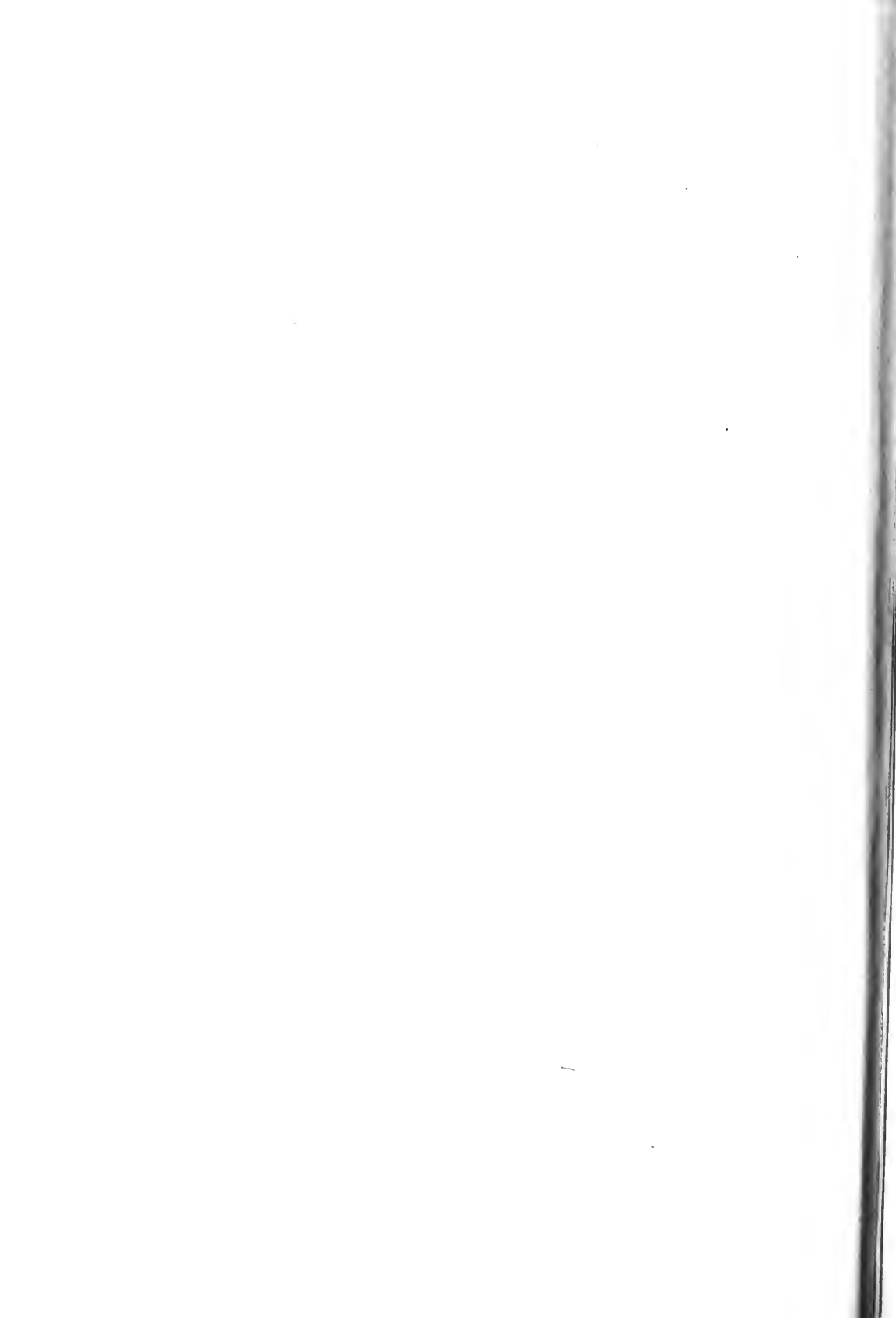





*T. J. Hanstcock, Photo.*

SOUTH AISLE, ST. WILFRID'S CHURCH, HARROGATE, IN COURSE OF ERECTION.  
Mr. TEMPLE MOORE, F.R.I.B.A., Architect.

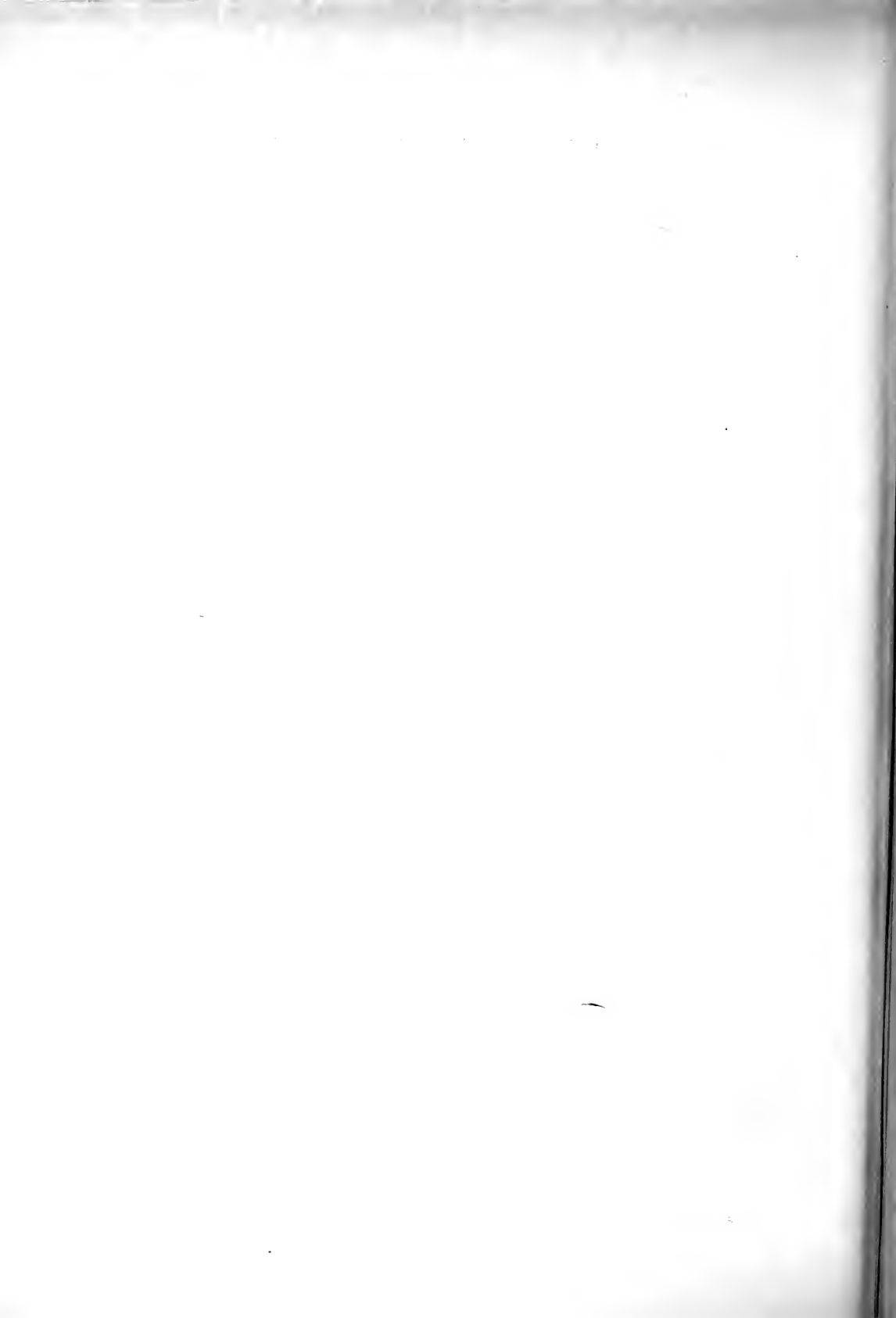

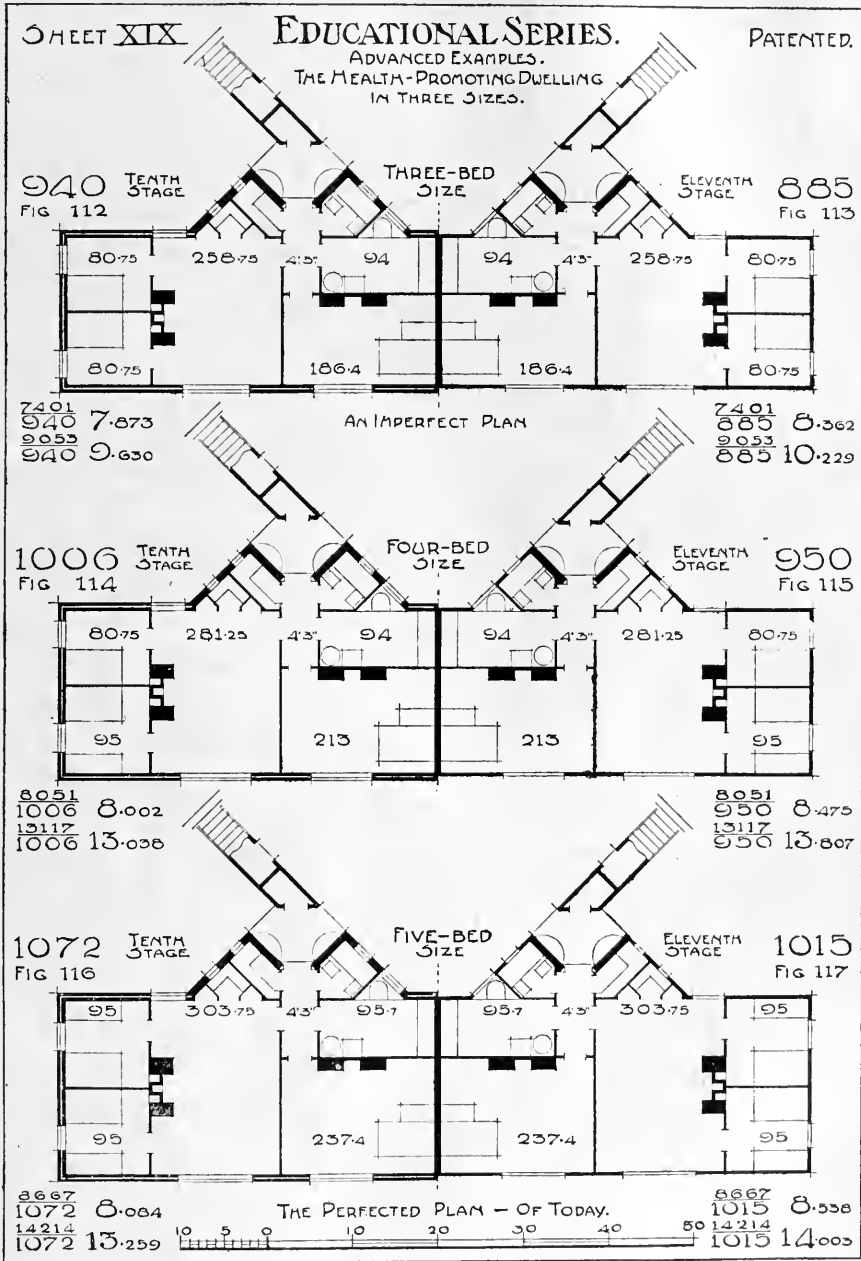

THE PROBLEM OF THE SMALL DWELLING AND ITS SOLUTION.  
 By Mr. ROBERT THOMSON, Architect.

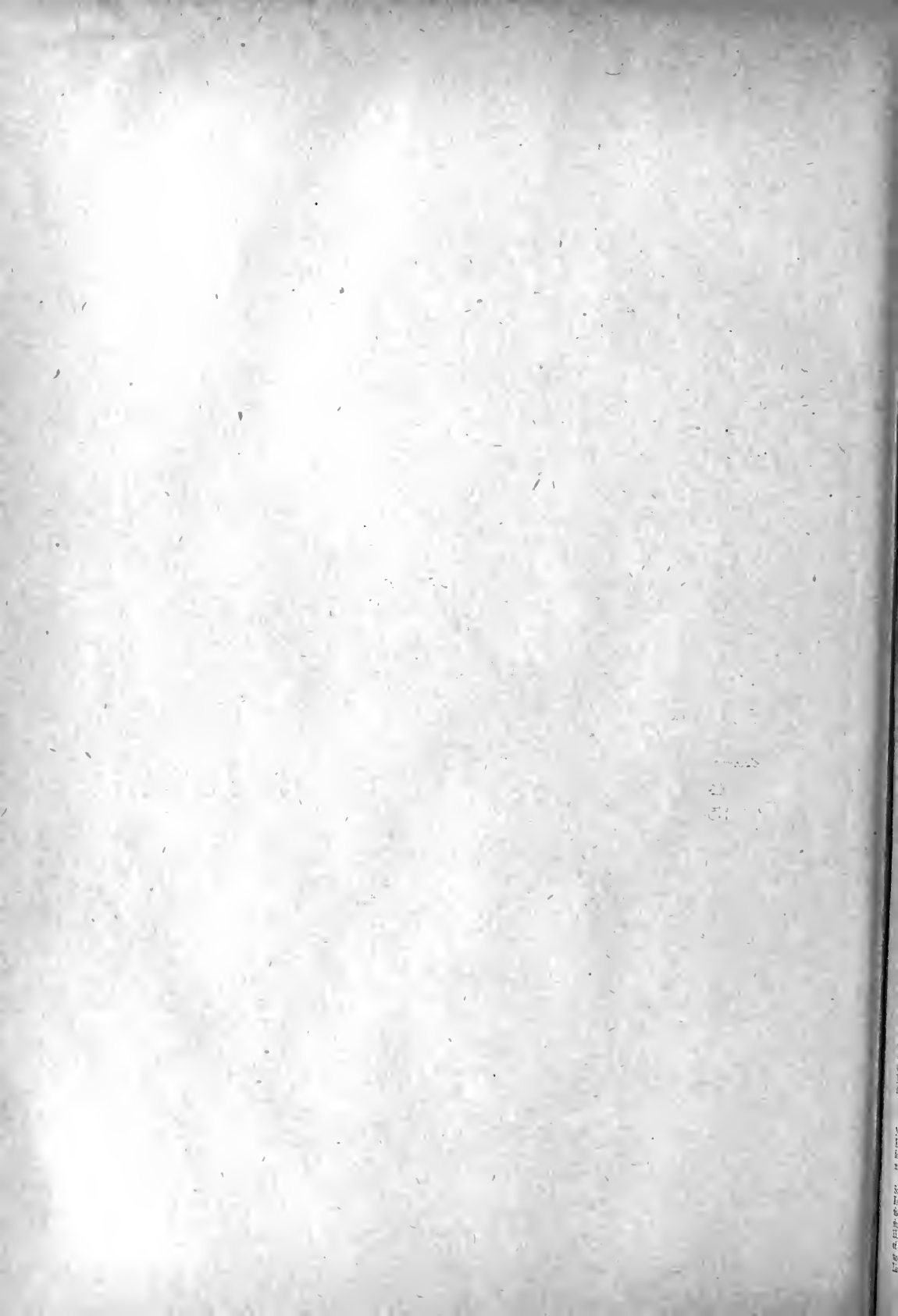

# Our Illustrations.

## A NEW DINING HALL FOR A COUNTRY HOUSE DESIGNED IN THE TUDOR STYLE.

The intention in arranging this house has been to carry out the work on historic lines in a definite way, trusting largely to precedent. Lieut. Murray Adams-Acton has, however, introduced a personal influence and given the hall an individual character. The room needs little by way of description. The buffets are recessed and linen panels to the keyboards below are nearly flush with the wainscoting of the walls. The cambered plaster ceiling, with central bosses in the compartments give a sense of height in contrast to the long low millioned stone fireplace window to the left of the view. The fireplace with the armorial bearings carved on the chimney breast, is reminiscent of the Tudor period and in keeping with the rest of the work. The result is comfortable and homelike, avoiding stylistic verisimilitudes.

## ST. WILFRID'S CHURCH, HARROGATE.

We illustrated the choir of this fine new church in Yorkshire in the BUILDING NEWS for May 30th last, from a photograph on view at the Royal Academy this season. There are three other pictures shown in the

## STRAIGHT-BAR REINFORCEMENT WITHOUT BENDS.

In a number of reinforced concrete flat-slab buildings being erected a rather new type of floor is being employed, distinguished by a reinforcement of short, straight bars, without bends. To provide for the negative moments at column heads, separate mats of unbent rods, placed near the top of the slab, are used, instead of the usual bent steel. The main slab steel is thus in short lengths from column to column, obviating the need of long bars. One of the flat slab buildings in which the straight-bar system of reinforcement is being used is the factory for the T. Eaton Company, on Alice Street, Toronto, of which a description of the construction of the plant appeared in the *Contract Record* of June 15. The reinforcement details of this building are outlined in this article, and will serve to indicate the general principles adopted in straight-bar work and the advantages applying to this system.

The reinforcing arrangement herein described applies to the typical floor, which is a 7½-in. flat slab. The average panel measures 20 ft. square. The columns are circular and provided with capitals and drop-heads 5 ins. deep and 8 ft. square. The columns of the first eight storeys are steel-cored with heavy Bethlehem shapes. The upper four storeys have reinforced concrete

crete blocks and steel chairs ensure the correct location of both the mat and main panel steel.

The diagrams herewith graphically show the lay-out of the steel for both exterior and interior panels. In the Eaton building all of the slab steel is composed of ½-in. square twisted rods. For the interior panels the rectangular bands comprise thirteen bars 15 ft. long, spaced at 9-in. centres. Each band is supported on three ¾-in. square twisted rods 10 ft. long, held by chairs 1 in. from the form work. These rods are at right angles to the band rods. A 1-in. concrete fireproofing is thus provided below the steel. The rods comprising the rectangular band are staggered so that alternate bars extend 6 ins. over the column capital. The diagonal bands are composed of nine rods 21 ft. long, spaced at 10 ins. centres. These are wired together and supported on chairs. The rods are staggered in the same way as those of the rectangular band, so as to bring alternate rods 6 ins. beyond the column capital.

For exterior panels the rectangular bands have fifteen bars, with 8½-in. spacing, while the diagonal bands have ten bars, with a 9-in. spacing. The straight wall bands of exterior panels consist of seven bars, 15 ft. 9 ins. long, spaced 8½ ins. apart. The three support rods carrying the rectangular bands act both as spacing and support bars, and

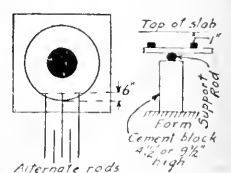
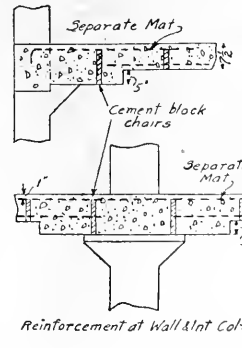
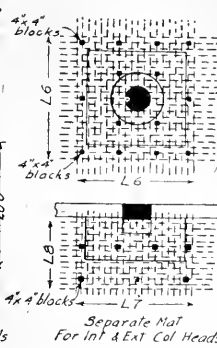
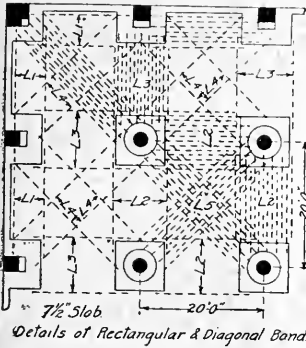

LIST	NO.	ARRANG.	SIZE	LENGTH OF BARS
L1	15	1/2\"/>		

Details of flat slab reinforcement featuring short bars without bends

same frame by Mr. Temple Moore, F.R.I.B.A., Architect. The accompanying pair of photographs belong to this same series. An unusual interest is given to these pictures by their showing the work in progress, the church at the time being in an advanced stage of construction. A description on May 30 briefly furnished some particulars of the undertaking, consequently there is nothing to add to-day. The fourth photograph will appear so soon as can be managed. It represents the east end of the sanctuary.

## THE PROBLEM OF THE SMALL DWELLING AND ITS SOLUTION.

Continuing this series of articles by Mr. Robert Thomson, we give to-day sheets xviii. and xix. showing plans which furnish contrasts and the reductio ad absurdum as well as health-promoting arrangements for tenements in three sizes. The accompanying article gives descriptions of these variations. Reference can be made to previous issues of the BUILDING NEWS of the following dates, May 23 and 30, June 6, 13, 20, and 27, July 4, 11 and 18.

A sum of £21,000 is put down for the National War Museum in the Supplementary Estimates, of which £16,000 is a grant in aid for the purchase of exhibits, books, pictures, medals, photographs, posters, models, etc.

Mr. and Mrs. Howarth, of 15, Parliament Street, Bolton (formerly of 55, Mills Street, Fritchold, Rochdale), have been informed that their son, Private F. Howarth, of the Yorkshire Regiment, was killed in action on June 13. Private Howarth, who was thirty-one years of age, was a moulder. He served his apprenticeship with Messrs. T. Robinson and Sons, Limited, Rochdale.

columns without cores. The presence of the cores does not impose any material readjustment of the slab reinforcement. Slabs which are designed for extra heavy loading do not differ in the essential lay-out of the reinforcement from the arrangement outlined below for the typical floor. The only departure from the standard practice in this case is in regard to the number and spacing of the bars.

### SEPARATE MAT AT COLUMN HEADS.

The general bar lay-out consists of diagonal and rectangular bands in the lower part of the slab to take the main slab stresses. These bars extend from column to column without protruding beyond the limits of one panel. For the reinforcement of the slab against the negative moment over the column a separate mat or cross frame of bars is located over the column-head near the top of the slab. This mat comprises straight bars in two directions, and has no connection with the bottom slab steel. The top mat is supported on small concrete blocks, which provide rigid supports for maintaining the mat steel in proper position and at the right level. The lower steel is held on steel chairs. The bars in both the bottom and top of the slab overlap sufficiently on each side at the line of inflection, as established by uniform loading, to provide a zone for the travel of the line of inflection, which is reinforced at both top and bottom of the slab.

This general scheme thus secures four-way reinforcement for the main panel and two-way reinforcement for the column-head. All bending of bars is eliminated, and short bars, not exceeding, in this case, 21 ft. for diagonal bottom bars, are made possible. The placing of steel is greatly simplified, and the con-

to take the temperature and shrinkage stresses.

### ARRANGEMENT OF SEPARATE MAT.

The mats which take the negative moment at the column-heads have bars in two directions. There are twenty rods, 15 ft. long each way, tied together at 6 in. spaces. They are carried at the proper level by four support rods of ¾-in. round steel 10 ft. long, which rest on concrete blocks 4 by 4 ins. in section. These blocks are 4½ ins. or 9½ ins. deep, according as they are placed in the main slab or in the drop-head. The location of the mat is such as to give a 1 in. of concrete on top of the steel for fireproofing. This brings the top of the mat 6½ ins. above the bottom of the slab, and leaves about 5 ins. between the mat and bottom steel.

Around the exterior columns, which are square and provided with brackets and drop-heads, a half-mat is employed. The longitudinal rods number thirteen, and are 15 ft. long. The transverse rods, twenty in number, are 7 ft. long, and have 3 in. right-angle hooks to bond into the wall lintels. The rods are spaced at 6 ins. In this case two support rods of ¾ in. round steel 10 ft. long are used, with cement block supports.

### HOW THE STEEL IS PUT IN PLACE.

The steel is laid as follows: First, the rectangular bands are placed by laying the spacing bars in their proper position on the slab form-work and then running the band-bars, with their proper staggering and spacing, and wiring the whole together. The diagonal bars are then properly staggered and spaced and wired together into a rigid mat. The steel chairs which support both the rectangular and diagonal bands at the

proper distance from the bottom of the slab are not placed till their pouring is about to proceed, so as to prevent injury to the reinforcement from rough usage.

In placing the mats, the concrete support blocks are first placed in position and the four support rods set on them. The bars comprising the mat are then placed at their required spacing, and are wired together rigidly. Where columns have steel cores, as is the case in the first eight stories, the four centre bars of the mat in each direction are bent to pass around the core.

#### SHORT RODS MAKE STEEL EASY TO PLACE.

A number of advantages of the system which has been outlined are claimed. All long bars are eliminated. In this case, for 20-ft. square panels, the longest bar which occurs, a diagonal bottom bar is only 21 ft. long. Where bars do not exceed this length they are more readily obtained from stock and more easily handled. Owing to the separate mat arrangement, there is no bending—an item that helps to reduce the cost of placing steel and makes it simpler to set in place. If desired—and it is advisable to do so on large jobs—the bands and mats can be assembled on the ground and hoisted to the building in units and placed by unskilled labour, ready for pouring. This would reduce the time of placing steel after the form-work is completed. The short lengths do away with the awkwardness of handling long bars, which require a large number of men to handle them, and possibly disturb inserts, pipe-sleeves, etc., and interfere with workmen. The steel can be handled as fast as the carpenters can put up forms, since each panel is completed in itself. Moreover, the bars can be assembled and left on the decking until the floor is ready for pouring. Then the chairs and blocks can be set with the assurance that the location of the steel is correct. This prevents damage by workmen.

#### COLUMN REINFORCING.

The reinforced concrete columns of the Eaton building are reinforced with both longitudinal and spiral steel. Nine round rods,  $\frac{1}{2}$  in. diameter and 17 ft. long, form the longitudinal reinforcing, and are tied to the spirals, which have a 2-in. spacing. The spirals and longitudinal rods are built up and erected in units and tied to dowels from the column of the storey below. In the cored columns there are four longitudinal rods, tied with  $\frac{1}{2}$ -in. round steel at 12-in. centres.

The beams and lintels have both trussed and straight rods, carried in stirrup frames. The stirrup frames have four 5/16-in. longitudinal rods, with 5/16-in. stirrups hooked for support on the form-work. The frames run the whole length of the beam or lintel, from column to column. The main rods are spaced and supported by saddles, fastened to the stirrups. Both the trussed and straight bars overlap 5 ft. beyond the columns.

The reinforced concrete stairs have ten  $\frac{3}{8}$ -in. square twisted rods 14 ft. long, spaced at 6-in. centres, tied with  $\frac{3}{8}$ -in. rods at 18-in. centres. The main rods fasten at their lower ends to 3-ft. dowels, extending from the floor or landing slab. In the upper end the rods are hooked, being provided with 6-in. 100-degree hooks. When the stair abuts at its upper end into the landing a 5-ft. dowel, bent at the centre at 45 degrees, is placed.

#### STEEL IN FOUNDATION PIEDESTALS.

The foundation piers of the Eaton building are 4 ft. square, spreading into mattresses 16 ft. square and 4 ft. deep. The spread mattresses are reinforced with four layers of mats of rods running in four directions. The "w" two mats of rods, running longitudinally, are transversely respectively, comprise six 1-in. rods 14 ft. long. The top two mats running diagonally have 1-in. rods, the four rods in one mat being 18 ft., and the eight rods of the other mat being 15 ft. 3 ins. long. The method of constructing the foundation mattress is to pour about 9 ins. of concrete, set one mat, pour another 9 ins. of concrete, set the second mat, and so on.

On an average there were eighty-five tons of reinforcement steel to each floor, this including slab, column, stair, and beam and lintel reinforcement. The interior mats weigh 502 lbs., while the exterior mats weigh 316 lbs.—*The Contract Record.*

## Correspondence.

### EXPERT EVIDENCE PER SE.

To the Editor of the BUILDING NEWS.

Sir,—The case of Bennett v. Sprague before Mr. Pollock is not after all so important as has been implied, but it is clear that it brings us once more up against the real difficulty of securing effective and reliable witnesses in building disputes.

Only the other day at the Annual Meeting of the Royal Institute of British Architects, Sir Aston Webb stated that he had personally "always declined to give evidence." I have been told by men of unquestioned status that they refuse chiefly because they could not compete in open court with other practitioners who are more than careful in handling facts when in the witness-box.

I much regretted to observe the manifest discrepancies in the letters sent you for publication about matters of fact in the case of Bennett v. Sprague, as I have personally had some experience of the almost insuperable task in securing the kind of witnesses I wanted for this very reason. Errors in practice happen now and again in all professions and hard swearing goes a long way of course in commercial cases. It will not trespass upon your space with examples of evidence tendered by architects and surveyors of good standing.

Permit me to illustrate my point by alluding to what occurred in a very different kind of dispute in the High Court when I happened to serve on the jury. The case was one of warranty as to the soundness of a pair of carriage horses which subsequently were found to be suffering from spavin and the purchaser refused to keep the horses. Several veterinary surgeons were called on behalf of the vendor and they testified that spavin was harmless, some maintained that spavin was no detriment, indeed almost the reverse. Mr. Justice Manisty, who tried the cases pertinently observed to one surgeon expert "I suppose you want the jury to believe that spavin is an improvement on nature!" This was in the old courts next Westminster Hall in the seventies, before the new courts in the Strand were completed and opened for business.—I am your obedient servant.

A SENIOR FELLOW OF THE R.I.B.A.  
July, 1917.

### PROFESSIONAL AND TRADE SOCIETIES.

BRISTOL AND GLOUCESTERSHIRE ARCHEOLOGICAL SOCIETY.—The annual meeting of the Bristol and Gloucestershire Archeological Society was held at Gloucester last Wednesday, the President (Mr. E. Sidney Hartland, LL.D., F.S.A.) in the chair. The report of the Council stated that the number of members was 461, as compared with 510 a year ago. Twenty-six members had died, nineteen had resigned, and the names of seventeen others had been removed in consequence of their subscriptions having lapsed. Seventeen members had been elected during the year. There were now six hon. members and Institutions, seventy-nine life members, and 376 subscribing members. The Council recommended for election and re-election the following members of Council and officers:—As President, Mr. E. Sidney Hartland, LL.D., F.S.A.; President of Council, Mr. F. A. Hyett; Vice-Presidents (re-election), the Lord Mayor of Bristol and the Mayor of Gloucester, when members of the Society, Mr. John E. Pritchard, F.S.A., Mr. A. E. Hudd, F.S.A., Rev. C. S. Taylor, F.S.A., Mr. H. W. Bruton, Canon Bartlett, F.S.A., Mr. H. W. Carric, Archdeacon Sinclair, Mr. Christopher Bewley, Professor Oman, F.S.A.; (election), Canon Bazeley, Colonel Russell J. Kerr, and Mr. W. St. Clair Baddeley. The following members of Council retired, and were eligible for re-election:—Mr. F. Were, Mr. F. J. Cullis, Mr. A. C. Fryer, Mr. Leonard Barnard, Mr. J. L. Osborn, and Colonel Noel. The following were, in addition, nominated for election:—For Bristol, Mr. Cecil Powell; Gloucester, Mr. F. W. Waller; Stroud, Rev. W. B. Atherton; Tewkesbury, Mr. A. E. Hurry; Thornbury, Mr. H. Jenner-Fust; and Chel-

tenham, Mr. Crooke and Mr. F. B. de Saumarez. Hon. Editor, Mr. E. Sidney Hartland; Hon. Treasurer, Mr. F. Hannam-Clark; Hon. Secretary for Bristol, Mr. L. J. U. Way, F.S.A.; Hon. General Secretary, Mr. Roland Austin.—Upon the proposition of Colonel Jeune, seconded by Mr. Bretherton, the recommendations of the Council were adopted.—Referring to Mr. Hurry's resignation, the President paid a warm tribute to the valuable services he had rendered as Hon. General Secretary for six years, and, on behalf of the Council, asked his acceptance of bound copies of the Society's "Transactions."—Mr. Hurry suitably acknowledged the gift and the references made to his services.—The President afterwards delivered an interesting address on "The Ethnologist in Archaeology."

BRITISH ARCHEOLOGICAL ASSOCIATION.—The congress of the British Archeological Association at Brighton concluded, on Saturday last, with visits to the Norman churches of Old and New Shoreham and to Chichester, where the cathedral, St. Mary's Hospital, and the church of St. Olave, dating back to Roman times, were inspected. In conducting the members over the Norman church of Old Shoreham, Mr. Mainwaring Johnston took occasion to point out that the famous zig-zag window in the flat Norman buttress of the south transept is misdescribed as a feature of the original structure. It is, he said, a later embellishment, copied from one of the similar windows in the tower buttresses of Clymping Church.

THE CAMBRIAN ARCHEOLOGICAL SOCIETY.—Dr. Boyd Dawkins, presiding at Shrewsbury, last Friday, at the annual meetings of the Cambrian Archeological Society, said the war was making things critical for the society. They were drifting away from their work of dealing with the antiquities of Wales, and heroic effort must be made with the new Welsh life showing every where. He thought Wales would do as well in archeology as in politics. Canon Fisher was appointed joint editor; Colonel Morgan, Swansea, was elected chairman of council; and Mr. Lenfer Thomas treasurer.

### LEGAL INTELLIGENCE.

ARCHITECT'S CLAIM FOR FEES.—At Birmingham Assizes last week Mr. Justice Shearman, sitting without a jury, heard an action brought by William de Laey Aherne, architect, Waterloo Street, Birmingham, against the James Cycle Co., Sparkbrook, to recover £120 fees alleged to be due.—It was stated on behalf of the plaintiff that in the autumn of last year he was instructed by Mr. Arter, the managing director of the company, to prepare plans for a canteen, and agreed to do the work for a fee of 10 guineas and 2s per cent. on the total cost of the building put up, which was expected to be £3,500. In all, plaintiff prepared five plans, visiting several munition works and inspecting the canteens there. Eventually the work was given to another architect.—Mr. A. McEwan, A.R.I.B.A., vice-president of the Birmingham Architectural Association, gave evidence that the plaintiff's charges were quite reasonable. Comparing the plaintiff's final plan with that from which the building was eventually put up, he said they were "clearly identical."—For the defence, Mr. J. B. B. Arter, managing director of the company, said plaintiff's offer was to supply drawings, specifications, and quantities for 10 guineas and 2s per cent. on the cost if the work was proceeded with. When these terms were put to Mr. Aherne in the course of correspondence, he objected to the inclusion of the specifications and quantities, and as he did not reply accepting, witness, thinking there was an end of the matter, instructed another architect, who prepared fresh plans. Mr. H. P. King, chief assistant to Mr. Wizley, architect, gave evidence of preparing the plans from which the building was put up without any reference to the plans previously submitted by the plaintiff.—His Lordship found that the contract did not include specifications and quantities, and that the plaintiff was prevented from going on with what he had undertaken to do. In addition to the 10 guineas to which Mr. Aherne was obviously entitled, he awarded 40 guineas damages, and gave judgment for plaintiff for 50 guineas. His Lordship added that it was a proper case for bringing in the High Court, and he certified for High Court costs.

## Our Office Table.

Various questions of a technical character having recently arisen relating to the supply of gas, the Fuel Research Board have undertaken, at the request of the Board of Trade and other Government departments concerned, to conduct an investigation and to advise them as to the most suitable composition and quality of gas and the minimum pressure at which it should be generally supplied, having regard to the desirability of economy in the use of coal, the adequate recovery of by-products, and the purposes for which coal is now used.

"Naval Architecture," Part I, by J. E. Steele, B.Sc. (London, Cambridge University Press, 5s. net), covers just what is required by the student in his first year's course in practical shipbuilding, theoretical naval architecture, and ship drawings. The volume is principally concerned with the type followed in connection with ordinary merchant vessels, and the principles which underlie all ship construction. The text is lucid, and the illustrations clear and well chosen.

The Court of Appeal have dismissed the appeal of the Sheffield Corporation in respect of an award of £560 against the corporation for personal injuries sustained by the plaintiff coming in contact with one of the iron spikes fencing a tree, the sight of one eye being practically destroyed. The contention of the corporation was that the guards were admittedly safe in normal circumstances, and that there was no further degree of care imposed upon them by reason of the Lighting Order, under which the town was placed in a state of darkness. The Lord Chief Justice held that whether or not the corporation had exercised reasonable care was a matter for the jury to decide, and Lord Justice Scrutton concurred.

The Dumbarton Town Council, the *Glasgow Herald* states, have been presented with rather a novel point on procedure arising out of the scarcity of workmen's houses in town. A proprietor in Levenhaugh Street, whose property, it is estimated, can be repaired and made habitable for £50, closed it up rather than spend the money, and the local trades council requested the town council to make a request to the Ministry of Munitions that the houses should be reopened for letting purposes. The town council took up the attitude that they had no power in the matter, but Councillor Ward has forced them to take action, and they are now to support the trades council's application to the extent of writing the Ministry of Munitions, stating that the matter has been before them. The position of the landlord is that he positively refuses to do anything.

At the last meeting of the London County Council, there was considerable discussion on the recommendation of the Improvements Committee, to the effect that no opposition be offered to the insertion in the South Eastern and London, Chatham and Dover Railways Bill of a clause providing that the company shall not execute any works other than the works authorised by the Bill for the purpose of enlarging or improving Church Cross Station. Sir Edward Smith asked whether the Council was to lose the right to the strip of land, valued at £106,000, which the railway company had agreed to give up for the widening of the Strand. Mr. Ward replied that as the company had lost the right to widen the station the Council naturally lost the *quid pro quo*. Mr. A. T. Taylor moved a rider to the effect that the railway company be informed that the Council held to the assurance given before the House of Commons Committee that the arrangement whereby the strip of land required for the widening of the Strand should be surrendered to the Council, should not be prejudiced by the Bill now before Parliament. This was accepted, and the recommendation approved.

At last Thursday's meeting of the Common Council Mr. J. G. Howell asked the chairman of the City Lands Committee on whose authority the Monument had been reopened, and whether any precautions were being taken to prevent visitors from taking snapshots? Mr. J. R. Pakenham replied that the Monument

had been reopened to the public by direction of the City Lands Committee. Some time ago an application was made for permission to utilise the summit of the Monument for the taking of a panoramic picture, and the committee had to refuse. The applicant then approached the Government, with the result that the committee were informed that the Government no longer wished the Monument to be closed, and that it could be reopened forthwith. After that an air raid occurred, and the committee, on their own account, approached the Government, which, however, still said it had no objection. As for snapshots, he did not think that much harm would be done in that way.

The Controller of Timber Supplies announces that the following relaxations of the restrictions on the import of timber from North America have been arranged:—Neutral Sallies.—Timber may be imported from Canada and the United States of America under the usual procedure as regards import licences. Deck Loads.—A general licence has been granted by the Department of Import Restrictions for the importation of timber as deck cargo from Canada and the United States of America. In this case it will not be necessary for importers to apply for licences. The orders which limit the prices of imported softwood to those current during the last week of January, 1917, will not apply to timber imported from Canada and the United States after July 19, 1917. Timber so imported may be sold by the importers at its cost price, delivered to store, plus 10 per cent., provided that the price so calculated does not exceed by more than a third the price current during the last week of January, 1917, for softwood of similar quality and description in the same locality. It may be sold by persons other than the importers at prices which are in accord with the foregoing proviso.

Mr. Gilbert Telper, of Hatch End, Pinner, writing to the *Guardian*, is grateful, "as one of the rank and file of the artisan class," for other changes in London churches in the direction of "revivified Anglo-Catholicism," for "a noticeable change in the architecture of the building, the Italian Romanesque style, with its basilican east end coming into favour. In buildings of this kind the choir and organ are placed at the west end, the altar-space being reserved for the sacred ministers and numerous acolytes, etc.; side-chapels and shrines are placed in various parts of the building, orientation not always being observed."

"Notes on the Manufacture of Earthenware," by E. A. Sandeman (London: Crosby Lockwood and Son, 7s. 6d. net), a very useful book, has been out of print some years, and the publishers have issued a second impression. There is not much literature of use to the practical potter, who will find the manual lucid and trustworthy; and architects and builders who depend so largely on the potter for numerous appliances will find their knowledge of his specialities in their line refreshed by its perusal.

Mr. Walter Addington Willis, who was appointed arbitrator to determine the difference which arose between the Birmingham Building Trades Employers' Association and the Birmingham and District Allied Building Trades Unions has made his award as follows:—(1) That the rates of wages of the workmen concerned shall be increased 1d. an hour, as from and including July 23, 1917, and until the expiration of the three months immediately following the declaration of peace. The award shall be limited in its operations to employment on or in connection with munition work as defined in the Munitions of War Acts, 1915 and 1916. The award raises the wages of skilled workers to 1s. 1½d. per hour, and of labourers to 10½d. per hour. The total increase obtained by the operatives since the outbreak of war is 2½d. per hour, equal to about 10s. per week.

The officers of the Tylers' and Bricklayers' Company elected for the ensuing year are as follows:—Master, Col. Stanley George Bird, M.V.O.; Upper Warden, Mr. Homer John Brogdon Moorland; Renter-Warden, Mr. William Estone.

## COMPETITIONS.

**BELFAST.**—The drawings in connection with the Sir Chas. Lanyon Memorial Competition, which is open annually to students of the School of Art, Belfast, were adjudicated on the 5th inst., by the chairman of the Technical Instruction Committee of the Belfast Corporation and Mr. W. J. Gilliland. In the senior competition the first prize was awarded to Mr. Benjamin Cowser and second prize to Mr. John McAleery. In the junior competition the competitors' work was so equal in quality that the prize was divided between Mr. Malachy Bradshaw and Mr. Hamilton. In the senior competition on condition of the award of the first prize is that the successful competitor shall submit further measured drawings of an historic building, dating back to the seventeenth century, before he receives the second instalment of his prize money. Mr. R. Wilson, last year's winner, submitted this year drawings of Greyabbey, which were so satisfactory that he was given the second portion of the prize. The Fitzpatrick prize for class work was won by Mr. Albert Baker.

## CHIPS.

The East Stow R.D.C. have requested the clerk to make inquiries for suitable sites for the erection of workmen's dwellings. Mr. A. L. Hunt, architect, of Bury St. Edmunds, has been asked to submit plans.

In memory of Jack Cornwall, V.C., a brass tablet placed in the Walton Road School, Manor Park, by the scholars and staff, has been unveiled by Lady Jellicoe. The Jutland Battle here was a former pupil of the school.

As a memorial to the late Mr. Harry Orbell, who was chief organiser for the Dock, Wharf, Riverside and General Workers' Union, Mr. Ben Tillett, the general secretary of the union, on July 19 unveiled a red granite headstone over the grave in the Tower Hamlets Cemetery, Bow, E.

The death is announced of Mr. William Maggs, builder and contractor, of Lodway, Easton-in-Gordano. He was well known and much respected in the neighbourhood of the Somerset side of the Avon, and was entrusted with much of the new building around Pill, Lodway and St. George.

The Home Secretary has informed Mr. Vincent Kennedy that a war shrine has been maliciously destroyed at Ramsgate, apparently by some religious fanatic who called himself in an anonymous letter "The War Shrine Protest Committee." The police are endeavouring to trace the offender. We hope he will be lynched.

Second-Lieutenant Tom Littler, R.F.C., the only child of Mr. and Mrs. John Littler, of Simla, Beixhara, was killed in an aerial action on July 3, aged 19. He was educated at Paignton College, and after some experience at the engineering works of the Great Western Railway Company, Swindon, joined the Artists Rifles O.T.C. in November, 1916, and transferred to the R.F.C. as cadet last March. He obtained his commission on April 12 and his "wings" on May 16.

The Controller of Timber Supplies announces that as a result of representations made on behalf of retail timber merchants by a deputation of the Retail Timber Trade Section of the Timber Trades Federation, the concession granted in May last, whereby sales of imported soft timber not exceeding 20s. in value might be made without obtaining a permit from the Controller of Timber Supplies, will now be extended, and that such sales up to £5 in value may until further notice be made without permit.

The collection of Masonic portraits formed by the late A. M. Broadley and sold at Messrs. Hodgson's on June 15 last for £370 to Mr. Dring, of Quaritch's, has now found a permanent home in the library of Grand Lodge. The collection is, in effect, a "grand register" or extra-illustrated copy of Anderson's "Freemasonry in the Eighteenth Century," revised by John Northcote, 1734, extended to five volumes imperial folio by the addition of over 500 mezzotint and other portraits, views, autograph letters, drawings, broadsides and caricatures, arranged by Mr. Broadley.

## TRADE NOTES.

Boyle's Latest Patent "Air-Pump" Ventilators, supplied by Messrs. Robert Boyle and Son, ventilating engineers, 64, Holloway Viaduct, London, have been employed at the Moor Park Hospital, Preston.



**FOR**  
**Olivers'**  
**Seasoned**  
**Hardwoods,**  
**WM. OLIVER & SONS, Ltd.,**  
**120, Bunhill Row, London, E.C.**

**TENDERS.**

\*. Correspondents would in all cases oblige by giving the addresses of the parties tendering—at any rate, of the accepted tender: it adds to the value of the information.

**REPAIRS.**—Extension of Electricity Works, for the Corporation.

W. Moss and Son, Ltd., Loughborough (accepted) . . . £5,521 0 0

**BLACKHILL COLLEGE (DURHAM).**—For builder work in connection with proposed alterations at Blackhill Colliery boys' temporary school for the Durham County Education Committee.—

F. W. Goodyear, Durham . . . £620 0 0  
 \* Recommended for acceptance.

**CITY OF LONDON.**—For twenty double pole electric switches at the Metropolitan Cattle Market Public Slaughterhouses, for the City of London. Recommended for acceptance.—

The Kartrett Engineering Co. . . £195 0 0

**LONDON, E.C.**—For supply of turbo-alternator plant at Whiston Street, for the Shoreditch Electricity Committee.—

Ateliers de Construction Gerlikon (Swiss) . . . £31,815 0 0

Brush Electrical Engineering Co., Ltd. . . 39,250 0 0

Howden and Co., Ltd. . . 27,193 0 0

Fraser and Chalmers, Ltd. . . 26,728 0 0

Hitro (alternative) . . . 26,436 0 0

Williams and Robinson, Ltd. . . 26,600 0 0

British Westinghouse Co. Ltd.\* . . 26,538 0 0

British Thomson-Houston Co. Ltd. . . 26,518 0 0

Farsons and Co., Ltd. . . 25,990 0 0  
 \* Recommended for acceptance.

**LONDON, W.**—For supply of 10,000 crocussed wood blocks, for the Marylebone Borough Council.—

Burt, Boulton and Haywood, per 1,000 (accepted) . . . £17 0 6

**LONDON, W.**—For works at Nos. 5 and 6, Scrubbs Lane (electricity sub-station), for the Hammersmith Borough Council.—

G. W. Clarke . . . £63 5 0

W. Chapman and Son . . . 39 10 6

Lyle, Ltd. . . 39 17 6

Chudley Bros., 56, Shepherd's Bush Road . . . 33 19 3  
 \* Recommended for acceptance.

**SALFORD.**—For painting schools, for the Salford Education Department.—

Accepted tenders.—T. and A. B. Cain, 24, Cardiff Street, Higher Broughton, £33 8s.; P. Cameron, 500, Liverpool Street, Seadley, 46 10s.; D. Dawson, 60, Hampson Street, Salford, £14 8s.; J. Evans, 58, Great Clowes, Lower Broughton, £24 2s.; Horsfield and Son, 177, Chetham Hill Road, 4 9s.; D. Lea, 45, Plymouth Avenue, Chorlton-on-Medlock, 436 0s. 6d.; Plevin and Son, 227, Liverpool Street, Seadley, £29 10s.; W. Walton, 14, Frederick Road, Pendleton, £268 13s. 0d.

**TOTTENHAM.**—For resetting a Lancashire boiler at their sewage outfall works for the Tottenham and Wood Street Joint Drainage Committee. Major W. H. Prescott, R.E., Engineer of the Committee, Town Hall, Tottenham, N.—

Timmis and Co. . . £231 0 0

Joseph Fox and Sons . . . 225 0 0

Thomas Warrington . . . 265 0 0

W. J. Maddison . . . 235 0 0

Reading Boiler Setting Co. . . 217 10 0

Smith Bros. (Burdley), Ltd. . . 290 0 0

W. Simms, 129, Broad Street, Ratcliffe, E.\* . . 190 10 0  
 \* Accepted.

**WEST HAM.**—For (1) repairs to lantern lights on roof of Education Offices; (2) Providing tidal valves, etc., in yard of offices for the West Ham Education Committee.—

G. and E. Hosking—(1) £35 10s.; (2) £70. Accepted.

**WOODFORD.**—For painting and repairs, for the Urban District Council.

Accepted tenders.—Wallace and Wallace, painting exterior joint work at the Council's offices, £33; A. Stokes, repairs to fence at the Council offices, 4s. 10s.



**CHIPS.**

All firms requiring basils for the manufacture of munition workers' or silica brick-makers' gloves are requested to communicate with the Director of Army Contracts, 5d, Imperial House, Tothill Street, London, S.W.1.

Mark Leon, described as a company promoter, was fined £100 by Mr. Justice Lawrence at the Central Criminal Court for giving a £1 currency note as an inducement to show favour to a clerk in the Contracts Department at the War Office, who immediately reported the matter to the authorities.

The estate of Grange, Burntisland, Fifeshire, has been sold for £14,600. Included in the sale was the large freestone quarry known as the Grange Quarry, also Whinstone Quarry. The rent, apart from the quarries, is £502, and the public burdens, on an average of five years, about £120. The upset price was £12,000.

The death took place on July 19, in his sixty-third year, of Mr. George Bradbury, 'Kindere', Bromborough, auditor and surveyor and for many years diocesan surveyor to the diocese of Liverpool. Mr. Bradbury was responsible for many designs of church buildings and structural alterations and improvements of existing fabrics.

At the Old Bailey, London, last Thursday, Louis Prechner (34), managing director of the Warrington Manufacturing and Supply Company, which had held contracts with the Royal Army Clothing Factory, Pimlico, since December, 1915, was fined £500 and ordered to be detained until the money was paid for corruptly offering and giving gifts to Mr. Wakeford, an assistant to the chief inspection officer at the depot.

Wandsworth Borough Council reports that the Victoria Cross has been awarded to Corporal Edward Foster, the Mayor's Battalion, East Surrey Regiment. From the age of fourteen until the age of twenty-three he was in the service of the council at the Tooting destructor, and was then transferred to the council's contractors for the removal of house refuse, in which employment he continued until June, 1915, when he enlisted.

A scheme has been adopted for the erection of a memorial to the old boys of Oundle School who have fallen in the war. The Grocers' Company, who are the founders and governors of the school, propose to erect a permanent chapel in place of the present tin structure. The suggestion was made that the memorial should take the form of a sanctuary and choir to be built at the east end of the chapel, and this work has been undertaken by the parents of the boys attending Oundle School, the cost being estimated at between £15,000 and £20,000.

**LIST OF TENDERS OPEN.**

**ENGINEERING.**

**July 27.**—Supply and fixing of a new sectional boiler and additional radiators at the Highgate Council School, North Hill, Highgate.—For the Hornsey Education Committee.—A. W. Allen, Secretary for Education, 206, Stapleton Hill Road, Stroud Green, N.4.

**July 31.**—Installation of Heating Apparatus for St. Alban's Church and Vestry, Dartford, on the hot water system.—Mr Hewett, 89, St. Alban's Road, Dartford.

**Aug. 31.**—Sealed tenders, endorsed "Tender for Contract No. 925," will be received at the Town Clerk's Office, Municipal Offices, Johannesburg, not later than 12 noon on August 31, for refrigerating plant at Market Buildings, Newtown, Johannesburg. Drawings and documents can be viewed free on application to the Council's agents in London, Messrs. E. W. Carling and Co., St. Dunstan's Buildings, St. Dunstan's Hill, London, E.C., but a deposit of £1 1s. is required for copies.

**LIGHTING.**

**August 4.**—For lighting the streets and roads of the urban district, in accordance with the conditions of contract (Three Years)—For the Ballyclare (Ireland) Urban District Council.—E. Hill, Town Clerk.

**PAINTING.**

**July 27.**—Painting, etc., interior of the Bentley Working Men's Club and Institute.—H. Townend, Secretary, Working Men's Club and Institute, Prospect View, Millgate, Bentley (Doncaster).

**ROADS AND STREETS.**

**August 7.**—Urgent repairs: To lay and steam roll about 3,270 yards super of ballast 4 in. thick; to lay and roll 4,720 yards super of cinders 3 in. thick, and other attendant works.—For the Beaconsfield Urban District Council.—H. G. Hogarth, Clerk, the Old Bank House, London End, Beaconsfield.

**August 7.**—Construction of an accommodation road about a quarter of a mile long at Dromantine, situated about midway between Gorrageville and Pointpass Stations.—For the Great Northern Railway Company (Ireland)—T. Morrison, Secretary, Amiens Street Station, Dublin.

**SANITARY.**

**July 27.**—Laying certain sewers, etc., in the town of Rathfriland.—For the Newry No. 1 Rural District Council.—W. R. Bell, Clerk of the Council, Rural District Council Offices, Workhouse, Newry.

**July 30.**—Supplying and laying about 350 yards of 12 in. stoneware pipes, with 9 in. and 4 in. branch drains, manholes, catchpits and other works appertaining thereto.—For the Bridgwater Rural District Council.—T. M. Reed, Clerk, Bridgwater District Council Offices, Northcote, Bridgewater.

It is proposed to erect a parish hall, with a Calvary outside, for St. Mellitus' Church, Hanwell, in memory of those who have fallen in the war.

**For GLASS SHELVES & TABLE TOPS**

Apply to  
**JAMES CLARK & SON, Ltd.**  
 RAILWAY ARCHES, BLACKFRIARS RD., LONDON, S.E.  
 GLASS POLISHERS, DRILLERS, BEVELLERS.

**BRABY'S**  
**AUTOMATIC**  
**FLUSHING TANKS**

SIMPLE. RELIABLE.

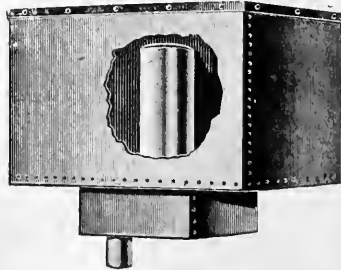

**Fredk. BRABY & CO., Ltd.**

352 to 364, EUSTON ROAD, LONDON, N.W.



# THE BUILDING NEWS

## AND ENGINEERING JOURNAL.

**Effingham House.**

Corrente Calamo .. .. .	81
The Problem of the Small Dwelling and Its Solution—XL .. .. .	83
National Building Trade Employers' Conference .. .. .	85
Builders' Benevolent Institution .. .. .	85
Our Illustrations .. .. .	96
Coal Concreted from Dusts or Ashes .. .. .	96
Apprenticeship in the Building Trades .. .. .	97
Professional and Trade Societies .. .. .	98
Obituary .. .. .	98

### CONTENTS.

Correspondence .. .. .	98
Legal Intelligence .. .. .	98
Building Intelligence .. .. .	96
Our Office Table .. .. .	99
Trade Notes .. .. .	99
Tenders .. .. .	100
To Correspondents .. .. .	100
List of Tenders Open .. .. .	vii.
Chips .. .. .	vii.
Latest Prices .. .. .	viii.

**Strand, W.C.2.**

### OUR ILLUSTRATIONS.

Carlisle Fire Brigade Headquarters. View of Westgate Street front, with plan. Major E. Vincent Harris, F.R.I.B.A., Architect.	
A New Church in Ireland based on the style of the Celtic Romanesque. View, plan and longitudinal section. Mr. Arthur Hill, B.E., M.R.I.A., F.R.I.B.A., Architect.	
The Problem of the Small Dwelling and Its Solution, with sheets XX, and XXI, by Mr. Robert Thomson, Architect.	

## Corrente Calamo.

Mr. Hayes Fisher, the President of the Local Government Board, in a statement to local councils, says that when the war is over it will be necessary to rely far more than in the past on local authorities to provide the houses required, with their roads, water, and drainage accompaniments; and that he is authorised by the Cabinet to say that the Government recognises that it will be necessary to afford substantial assistance from the public funds to local authorities prepared to carry through at the conclusion of the war a programme of housing for the working classes which is approved by the Local Government Board. Mr. Fisher adds that he is fully conscious that it is not likely that the complete solution of the housing problem can fully ever be accomplished except with the co-operation of private enterprise, including public utility companies, and that "it may be advisable" to afford them assistance "in one or other" of the directions which are now under the consideration of a conference sitting at the Local Government Board. We do not know who have been invited to that conference, and we regard the last half-promise to private enterprise with little satisfaction. If more mistakes either as regards planning, reasonableness of cost, and suitability of site are not to be made of the sort we have been pointing out in detail during the last ten weeks, money will be wasted on houses which will not be a real solution of the problem of the small dwelling, and the taxpayer will be saddled with the cost of houses which might have been better built by private enterprise, financed by the State with a minimum of cost and of better design and construction.

In the building trades, as in most businesses, it is very usual to engage travellers to sell goods on terms of commission only. Some letter or memorandum is generally written out between the parties, and all goes well until a dispute arises, and the matter goes before a court of law, where anything may happen. A really instructive example of this occurred in the recent case of "Levy v. Goldhill and Co.," where

the plaintiff had been engaged by the defendants to obtain orders for them in their trade of hardware, etc. In May, 1915, defendants wrote plaintiff agreeing to pay him "half profits on receipt of orders (provided that the customer is good). . . . Same applies to repeats on any accounts introduced by you." That was all that the writing said; no time stated, nor any salary, and nothing about notice. Within a year defendants terminated the agreement, and plaintiff now claimed damages for wrongful dismissal, for breach of agreement on account of repeat orders received since he left, and payment of his commission thereon. This vague little written note made a pretty legal puzzle, but Mr. Justice Petersen dealt with it fully and faithfully. There could be no claim for wrongful dismissal without notice, as there was no contract of service. The defendants had merely arranged with the plaintiff to act as their agent in introducing customers. But no definite period had been agreed upon, so that either party could end the agency when he chose. Thus the question of notice never came in at all. The only leg upon which plaintiff could stand was as to repeat orders from his own customers. The Judge now held, upon the cases, that he could still claim commission on any such orders coming to defendants, although after his agency was ended. Therefore the plaintiff had judgment for damages for breach of the agreement, which damages would be the value of the possibility of future repeat orders being sent to defendants by customers of plaintiff's introduction and as to which there would be an inquiry in chambers.

Mr. W. E. Riley, F.R.I.B.A., the architect of the London County Council and superintending architect of metropolitan buildings, will attain the age of 65 years on October 12, 1917, when, in accordance with standing order No. 342 (a), he will retire, unless the Council resolves that his retirement will cause inconvenience to the public service. The General Purposes Committee think that his services should be retained by the Council for a period of twelve months in view of the present state of affairs and the undoubted inconvenience of his retiring at the present juncture. Mr. Riley has expressed his willingness to continue to serve for that period. They recommend: "That as the retirement of

Mr. W. E. Riley, the architect of the Council and superintending architect of metropolitan buildings, would cause inconvenience to the public service, his services be retained until October 12, 1918." Every reader will be very glad that Mr. Riley has consented to remain. At the present juncture no successor could fill his place with equal public benefit; and whenever he retires it will be difficult to replace him by one of equal experience and with a record like his of unbroken success, especially in matters such as housing and others, or as regards the tact and courtesy which have during his long service been so heartily appreciated by his professional brethren.

Mr. A. D. Jenkins, the Liverpool city surveyor, gave a very helpful "weekly talk" last Thursday to the members of the Liverpool Rotary Club on "Capital and Labour." Admitting that the subject was a thorny one, he submitted that there was a necessity for placing it on a firmer basis if this country was to maintain its trade supremacy. With equity and reasonableness on all sides, he thought trade disputes could be settled, and fairly settled, without resort to such drastic steps. Two great organisations should be set up representing both sets, to one of which every person in every town should belong. Whatever the business or trade, every wage or salary earner should belong to the society with which his trade or business was associated. Each of these societies should appoint representatives to sit on committees to be formed for districts, and each district would appoint representatives to sit on one controlling committee for the whole of the country. A similar organisation should be formed to represent capital. If all differences which could not be settled locally were sent to the district committees, and, in case of failure, then on to the central committees, he thought, considering that the latter body would comprise some of the best brains in the country, a settlement would always be arrived at. However, in case of failure, then arbitration should be resorted to, and the award should carry all the powers of the Government behind it. That is what we have advocated for years past, and without it no organisations or committees will be worth twopenny. It has

recently been stated that we are losing probably five hundred million pounds' worth of things annually, which otherwise, by the hearty co-operation of employer and employed, could be produced.

Assuming that the organisations to which he had referred were in working order, they would, said Mr. Jenkins, then have a registering agency for the whole of capital and labour in the country, and if returns were made by the individual wage or salary earner, corroborated by similar returns from the employer, it would be possible for the correct record to be kept of the wage or salary earned by every individual. Having this, the capital value of every person could be estimated on an equitable scale according to and based upon the individual earnings. Then, he submitted, they would have arrived at the capital value of labour engaged in the work of the nation. It must then be determined what was a fair and reasonable remuneration to pay labour for its daily work, and capital for its use by way of interest or dividend. A certain sum would have to be allowed for reserves and other contingencies, and the surplus, after paying all expenses, would be profits, which the co-operation of capital, brains, and labour had realised. It might be asked why he included every class of labourer to participate in these surplus profits. He did so because he submitted that every scavenger or clerk working for a municipal authority, every school teacher, every clerk working for a private employer, every man driving a taxicab, and every woman cleaning an office or school building, was as much a part of the machinery contributing to the country's success as the capitalist who happened to be in a position to supply unlimited cash, or the artisan who earned his £4 or £5 per week. They were all absolutely necessary, and should participate in the profits made in the country in the same ratio as they contributed their labour or skill in helping to make these profits, and that ratio could only have as a basis their wage or salary-earning capital value assessed on an equitable basis comparable with cash value.

Two very important meetings have been convened by the Government during the last week or two, one dealing with the distribution of coal, and the other with the question of the people's bread supply. Both these meetings were held exclusively for the information of the Press, and the avowed intention of the conveners of both meetings was to enlist the sympathy of the Press and to secure the widest possible publicity for the Government schemes. While it is satisfactory to find that the Government is fully alive to the urgent importance of a Press campaign, it is not equally satisfactory to note that the value of the trade newspapers of the country as a great publicity agent is not yet so fully realised as it should be. It is true that a start seems to have been made in this direction on a limited scale, but so far

there is no indication that the Government appreciates its own opportunities of getting in touch with the classes who are most closely concerned. At first sight it may seem that it is hardly the duty of those who are responsible for the conduct of trade newspapers to teach the Government Publicity Department its own business, but the fact does not seem to be appreciated that, after all, the workers are the people who are making the money which the nation needs, and are willing to invest it. The Coal Distribution scheme has been given a small show in a section of the trade Press, and one would like to feel that this is a first step in the right direction. But there is no reason why other schemes should not be given equal publicity in the columns of newspapers that are read regularly by all classes of workers, skilled and unskilled. The Exchequer Bonds, for instance, would find scores of willing buyers if they were properly advertised in papers that are read by all the varied workers in the laundries of the country—foremen, engineers, ironers, men and women of all ages and of very various types, all making good wages and quite ready to assist the country and themselves by making small investments. At present the Government, or whoever is responsible for the distribution of its advertisements, seem unaware of this.

Dr. J. Charles Cox, LL.D., F.S.A., has an interesting paper on "Armour in Churches" in last Saturday's *Tablet*. There are, as he points out, many fanciful ideas about the origin of the practice of lodging the weapons of actual combat within the sacred buildings which, whatever his religious opinions may be, no candid reader will deny were real centres and faithful reflections of the common life of the people, when Archbishops were seldom found in the ranks of the pacifists, but, when occasion needed, on stricken fields of battle, as prompt to don sword and buckler for the defence of their flocks as to minister the last consolations to the brave dying. Dr. Cox's list of armour still to be seen, not merely in the great churches, such as St. Mary Redcliffe, Bristol, or St. Mary's, Warwick, or in Westminster Abbey, but in the ordinary ancient parish churches is a very useful one. From the days of Edward II, every parish was bound to fully equip a soldier or soldiers for foreign service. This parish armour seems to have been almost invariably kept within the church, both in town and country. In Elizabethan days, when the number of soldiers required from each parish as archers or billmen was notified with exact precision, it came about that the room over the porch, which was then but little wanted for its original purpose as a sacristy, or chamber for a church-watcher, was often turned into a well-stocked parish armoury, as at Chelmsford, Repton, and the shamefully dispersed one at Baldock, Herts. Hence it has come about that remains of inferior parish armour have been actually re-suspended as armour pertaining to a person of distinction, as was the case at Woodbridge,

Suffolk. Dr. Cox has noticed pieces of corselets, targets, and brigandines in the chests of two Essex and one Suffolk and Devon churches; whilst in West Somerset he was just in time to save a would-be antiquarian incumbent from fixing over the tomb of a manorial lord the morion or open helmet provided in Elizabethan days for the parish soldier!

Chester, thanks to the skill and enterprise of her electrical engineer, Mr. J. E. Britton, has done so much to save fuel and labour in the production of her lighting, that we take it for granted there will be no bones made by the Treasury about the trifling grant of £200 asked for under the Development Fund Act of 1909 to extend the generation of electricity for the use of the farming and rural industries along the banks of the Dee. With a fall of 2 ft. or 3 ft. of water and tides to contend against the hydro-electric power plant which was brought into use some three and a-half years ago has amply justified its installation. Last year alone more than two million Board of Trade units of electricity were obtained by the Chester plant at an inclusive cost of less than 4d. per unit, and altogether some six million units have been generated at a cost of .087d. per unit for wages, repairs, maintenance, rent, rates, and taxes. This plant, with the aid of batteries for the peak load, now practically supplies one half of the current consumed in Chester. It is now proposed to utilise about forty miles of the river. On this length there is a fall of 170 ft., and assuming that it is possible to produce by water power 10,000,000 Board of Trade units per annum at a cost of 4d. per unit and obtain an average selling price of 2d. per unit, the balance of income over expenditure capitalised at 15 per cent. would provide for a capital expenditure of £400,000, which is much more than is likely to be needed for the erection of weirs and some ten or twelve turbine plants. It is calculated that enough energy would be available from power now running to waste for the use of 2,000 farms, and would result in a saving of 20,000 tons of coal per annum. Surely this should encourage many other towns to follow suit, in view of the stern present necessity for saving coal and oil now lavished on the wasteful production of dear gas, and the monopoly of our means of transit!

The July booklet of the British Reinforced Concrete Engineering Company, Limited, of 1, Dickinson Street, Manchester, is mainly devoted to a practical exposition of the paramount claims of floor-slab reinforcement, a matter too often neglected by designers, even when actuated by the best intentions. Weakness in floor slabs is very difficult to remedy, but very easy to prevent. In reinforced concrete work prevention is most easily secured by using only the best materials available, clean water, clean aggregate, and good cement for the concrete, and reinforcement in as few pieces as possible to obtain correct fixing with the least amount of supervision necessary and to lessen the risk of displacement after fixing. Steel wire is better than steel

rods, because it has a much greater strength and a very much higher elastic limit, and the elastic limit is the real measure of safety. The ordinary commercial manufacture of drawn-steel wire has a breaking strength at least 25 per cent. greater than that of rolled-steel rods and an elastic limit 100 per cent. greater, and it is actually safer construction to use drawn-steel wire reinforcement stressed up to 25,000 lbs. per square inch than to use rolled-steel rods stressed up to 16,000 lbs. per square inch. Provided the steel wire is used in such a form that it is correctly spaced there is no comparison between the two materials, and it should always be used for floor slabs in preference to rods. We may add that this is made certain if the British Reinforced Concrete Company's system is adopted.

THE PROBLEM OF THE SMALL DWELLING AND ITS SOLUTION.

XI.  
By ROBERT THOMSON.  
[WITH ILLUSTRATIONS.]

In previous articles I have purposely refrained from dealing with the all-important question of ventilation, but it is one of the greatest importance.

I will quote somewhat freely from Dr. Macfie's work, "Air and Health," one of the volumes of the New Medical Library, because Dr. Macfie's writings proclaim him to be thoroughly conversant with the work of real scientists as well as with the very grave dangers which are imposed on the people by the scandalously defective character of their dwellings. In Chapter XIII. of "Air and Health," Dr. Macfie writes:—"Vital thing though ventilation be, it is seldom or never satisfactorily practised. Both natural and artificial ventilation are hampered by fears of draughts; and anxious experiments are made to discover exactly how many feet of air may be permitted to move per second and how much cubic space is necessary to allow change of air without draught. Fear of perfilation, which is the best form of ventilation, renders perfect ventilation quite impossible, and makes the state of the air in many private houses and public places a disgrace to civilisation. Look at this picture."

"Take, for instance, the case of a room, say about 12 ft. 6 ins. square and 9 ft. in height, in an ordinary terrace house, as tenanted by the artisan and labouring classes. Here we have a cubic capacity, allowing for deductions for furniture, large projections, as chimney breasts, etc., and space occupied by the bodies of persons, about sufficient—according to the standard laid down by Dr. Parkes—for one adult, provided the ventilation is perfect and the air of the room changed three times per hour. But what are the actual conditions prevailing in numbers of such rooms? Doors, windows, and blinds all closed or drawn, and no provision whatever for ventilation. Often there may be five or six occupants in the room which, as we have already seen, is only sufficient for one adult, even with perfect ventilation; the air strikes one on entering as being manifestly impure and much too hot for health or comfort; it is oversaturated with moisture, highly charged with organic matter from the breaths and bodies of the occupants, and the carbonic acid derived from the breath and combustion of lights is found to be much in excess of the prescribed limit of permissible impurity."

"That," states Dr. Macfie, "is by no means an exaggerated description. Not

only is such vitiation common, but it is often complicated and aggravated by fusty smells from old wallpapers and by evil smells from malodorous courtyards."

The foregoing description of the sitting-room, which is quoted from William H. Maxwell's treatise on "Ventilation, Heating, and Lighting," is of special interest in the present series of articles, because the air capacity of the apartment described is almost identical with that of the largest size of living room in the Government's model type of cottage dwellings, and it might have been written with these and the living room in the dwellings forming the community at Well Hall which is "without equal in the whole world."

Having glanced at the state of matters as they, to our discredit, at present exist, let us now look at what our scientists say ought to be. Dr. Parkes, in his standard work on hygiene, makes this statement:—"A certain amount of fresh air has to pass through a given space in a fixed time in order to maintain a certain degree of purity; the amount has been fixed at 5,000 cubic feet for each adult healthy male in an hour. Before considering the appliances for moving this air we must consider what would be the minimum size of the air space for each healthy male adult through which the fresh air has to pass."

After giving details of Pettenkofer's experiments in changing the air by mechanical means, etc., he states that "A change equal to four or three times an hour is, I believe, generally all that can be borne under the conditions of warming in this country, and if this be correct, from 750 to 1,000 cubic feet should be the minimum allowance of initial air space."

Huxley, in his "Elementary Physiology," states that in bedrooms "at least 800 cubic feet of well-ventilated space" is essential for each adult.

Willoughby, in his "Hygiene," states:—"The air of a room should be completely changed three or four times per hour—i.e., every twenty or fifteen minutes. A greater rate of movement cannot be borne if the air be cold, but may be scarcely perceived if it be warmed before admission. With a change every fifteen minutes, two persons would require, for comfort, a room, say, 10 by 15 ft. and 10 ft. high."

Notter and Firth state that:—"A change equal to three times an hour is all that can be borne under the conditions of warming in this country, or that is practically attainable with natural ventilation, and, if this be correct, from 1,000 to 1,200 cubic feet should be the minimum allowance for the initial air-space."

Dr. Whitelegge confirms this estimate, and says:—"It is found experimentally that with ordinary appliances, and under the average atmospheric conditions of the climate of England, the air of a room cannot be changed more than about three times an hour without causing inconvenient draughts."

Dr. Macfie writes:—"If these statements are correct, how can we expect to ventilate such a room as that described by Maxwell? Suppose there are only two gas jets; yet, even so there are less than 100 cubic feet per head, and in order to keep the air reasonably pure it would have to be changed ten to thirty times an hour. How are we to change it ten to thirty times an hour without causing a draught?"

That vitally important question is completely answered by the effective system of ventilation which is provided for in the health-promoting class of dwelling with which the present series of articles has been dealing.

Plan Fig. 109, Sheet XIX., the capacity of which is shown by plan Fig. 111,

although its roofed area is no greater than that of a mid-terrace six-apartment dwelling with apartments in exact accordance with official requirements, would give a dwelling much too large for even the largest of ordinary families.

In the perfected plan of my health-promoting class of dwelling the requirements of the great sanitarians are fully met, and my plan Figs. 116 and 117 would provide dwellings which would be ideally perfect in regard to both air-space and ventilation for families considerably larger than the average number in this country.

The efficiency of ventilation is usually ascertained by estimating the amount of carbon dioxide in the air of the apartment ventilated. Dr. Macfie writes:—"Now, the first question is, What percentage of carbon dioxide must be considered to indicate undue vitiation—what is the limit of permissible impurity?" "So far nine volumes in 10,000 is the only legal limit yet fixed, and this applies only in the case of the artificially humidified air of cotton cloth weaving sheds. At first sight it might be thought that the carbon dioxide percentage could be kept most easily low by providing plenty of air-space, and plenty of air, therefore, to dilute impurities, and legislative attempts have been made to ensure pure air by enforcing the provision of so much cubic space per head."

The requirements of the Local Government Board and other authorities, in regard to ventilation, fix the minimum allowance of air space per occupant as follows:—In common lodging-houses occupied at night only, 300 cubic feet; ditto, day and night, 400 cubic feet; ditto seamen, 400 cubic feet; ditto, in Belgium, 469 cubic ft.; ditto in New York, 600 cubic feet. The minimum allowance of sleeping space in common lodging-houses in London was raised by the L.C.C. regulations to 350 cubic feet. Dr. Macfie, commenting on this, states:—

"A little consideration, however, will show that such regulation of space is by itself of little value. Unless there be movement of air, space alone is futile. However large the space may be, the air will become impure unless fresh air circulates through it, and, however small the space, the air may be kept pure by sufficient circulation. It is the circulation of air, and not the space, that matters. Where the Local Government Board prescribes 300 or 400 cubic feet of space per head in lodging-houses they ought also to prescribe that the air should be changed ten or twenty times an hour—a prescription, however, under ordinary circumstances quite impracticable."

"How to pass 3,000 cubic feet of air per hour through 300 or 400 cubic feet of space in a poor man's room is a problem still to be solved. Three hundred or 400 cubic feet air-space in a common lodging-house may mean anything in the way of impure air. As things are at present matters are most unsatisfactory, for 300 or 400 cubic feet of space per head is not enough."

In paragraph 36 of their report, the Advisory Committee on Rural Cottages, "As a result of further investigation and particularly of further medical evidence," recommend that the minimum allowance of air-space in the bedrooms of five-apartment dwellings be fixed at 400 cubic feet per adult.

In addition to ranging the nation's wage-earners with the occupants of common lodging-houses, the Committee not only make no provision for ventilation, but actually propose to prevent it by sub-

mitting as models plans in which there is a bedroom without any chimney flue or other adequate means of ventilation.

Figs. 126 and 127, Sheet XXI., show respectively the plan of the Advisory Committee's design No. 8, which they state provides one of the most convenient and economical of cottages, and the plan of their design No. 5, both in standardised form, and each provided with a passage-way 4 ft. 1½ in. wide. On the same sheet Figs. 124 and 125 show plans of dwellings of the health-promoting class arranged as semi-detached towns, the roofed area of Fig. 124 corresponding with that of Fig. 127, and of Fig. 125 with that of Fig. 126, thereby enabling the reader to make direct comparisons between the corresponding pairs, one of which gives two-flatted dwellings, the other single-flatted ones. It also enables him to judge of the Committee's conception of what constitutes convenience and economy in a dwelling.

As to convenience. The fact that absolutely no cupboard or storage accommodation whatever is provided for in the Committee's "most convenient of cottages" would at once and alone damn the Government's model plans in the eyes of all good housewives.

As to economy. The facts in regard to this are not difficult to arrive at. Let the reader turn to the figures appended to the plans, the relative economy of which it is desired to test, and by simple subtraction ascertain the difference in the volume of habitable house-room which each of the selected plans would respectively provide.

Taking, for example, blocks of four dwellings, the one erected to the Committee's champion standardised plan, Fig. 126, the other to the smaller perfected plan of the health-promoting dwelling, Fig. 123, Sheet XX.: the latter block would give 32,584 cubic feet, and the former 16,636 cubic feet, showing a difference of 15,948 cubic feet, which, when priced at the officially based rate of 15d. per cubic foot, works out at £996 15s., against the most convenient and economical block of dwellings which the Government's model plan would provide.

As to the quality of the accommodation which these two plans would respectively provide little further need be said than that the disparity would be so great that it would be farcical to make detailed comparisons.

The Committee themselves draw attention to the objectionable arrangement of the stairs in the two centre houses of their design No. 8, and recommend using, with the two end houses from this design, the two centre houses from their design No. 5. This combination gives their design 8a, which, to judge from the number of alternative elevations they have provided for it, they appear to regard with something like veneration.

One of the objects in preparing Sheet XXI. was to enable attention to be drawn to the objectionable appearance which these outposts of civilisation, the c.e.s., have when arranged on three sides of the dwellings, as in the official plan, and to offer the suggestion that they might be housed together with the fuel stores underneath the stairs, where they would certainly not be seen from the front roadway.

Now that Sheet XX. is available it is possible to deal with the differences between the plans on it and those on its complementary Sheet XIX. The six plans on each of these sheets vary as to size internally in one direction only. All those on Sheet XIX. have the same internal length of frontage, the variation in size being in their width from front to back, while those on Sheet XX. are, on the other hand, all of the same internal width, their varia-

tions in size being all in the direction of their length.

Of the six, plans Figs. 112 and 113 were purposely made imperfect in order that it might be possible to more easily show and emphasise the advantages obtainable by the elimination of the imperfections. These imperfections—they can hardly be called defects—consist mainly in (1) the inadequate size of the principal bedroom, (2) the size and shape of the living-room, and (3) the shape of the smaller bedrooms.

As to the principal bedroom, it is, from the health point of view, more important that this apartment be of sufficient size to enable it to efficiently serve for the two purposes of parlour and bedroom, than that it be made smaller in order that the space gained should be thrown into the two bedrooms for children, since such extra space would not in the slightest degree increase the healthfulness of these apartments. The fault lies in the internal width of the dwelling, which is insufficient to allow of the various apartments being properly proportioned.

The advantages obtainable by carefully adjusting the dimensions to meet requirements in the most economical form are shown on plans Figs. 118 and 119. In these plans the parents' bedroom would provide air contents equal in volume to the air spaces of the official parlour and the "desirable" size of parents' bedroom in combination. The living-room is larger and better proportioned than in plans Figs. 112 and 113, while the children's bedrooms, although smaller in area, are so much better proportioned as to enable an additional bed to be used in one of them. The reduction in the size of these apartments does not impair their healthiness, because the effect of the reduction is to correspondingly increase the rapidity of the air-flow through them.

There is an error in the figures appended to plan Fig. 118. This error was also purposely introduced to enable me to emphasise the advantages which the ratios offer in the way of detecting discrepancies. The ratios appended to plans Figs. 112 and 113 are correct and the plans wrong, but in the case of Fig. 118 the plans are correct. A glance at the other ratios on the sheet at once suggests an irregularity in those of Fig. 118. The roofed area of this plan, instead of being 948 as shown ought to be 927 and the ratios  $\frac{7387}{927} = 7.968$  and  $\frac{12417}{927} = 13.394$  respectively. With these corrected figures it will be seen that plan Fig. 118, as well as plan Fig. 119 is slightly smaller than plans Figs. 112 and 113.

These plans Figs. 118 and 119 show the smallest size of the bed-parlour type of the health-promoting class of dwelling which it is desirable to construct. The only advantages to be gained by increasing the size of the two bedrooms for children would be those of convenience. Adding 3 ft. to the length of each dwelling would enable the occupants to obtain the advantages of the hanging wardrobe arrangement shown in the furnished plan on Sheet XV.; but in the case of dwellings in which "economy is so essential that space must be sacrificed to secure it" plans Figs. 118 and 119 should be adhered to.

If the reader will turn to Fig. 12, Sheet II., he will there find that this plan, which the Committee state "is a variation on No. 8 (see plan Fig. 126 herewith), adapted to a village or semi-urban situation where a drainage system exists," is of exactly the same roofed area as plan Fig. 118, and comparisons between the two should be made.

It is important to note that the addi-

tional house-room which the plans Figs. 120 to 123 inclusive would give over that shown in plans Figs. 118 and 119 would be obtained at a relatively small extra cost, because the only additions to the structure would be in the horizontal members and in the back and front wall and the longitudinal partition. It is clear, therefore, that of the plans on this sheet, which are all of the four-bed size, while the smallest would give the cheapest dwelling, the largest would give the most economical one—that is, of those of the four-bed size.

For the perfected plan of the health-promoting dwelling the reader must turn to Figs. 116 and 117, sheet XIX. The size and shape of the various apartments and the size of the office accommodation in this plan leave, in my opinion, nothing to be desired except that three inches be added to the width of the lobby, so as to bring it into line with that on plan Figs. 122 and 123. With that slight adjustment everything is just right, nothing being either too large or too small. To give a larger dwelling would, of course, involve extra cost, and any increase in size is not necessary.

The cost of this dwelling over that which plan Figs. 122 and 123 would provide would be relatively moderate in amount. Since the difference between the plan Figs. 120 and 121 and that shown in Figs. 122 and 123 is so small that anyone who can afford to pay for the former can almost equally well afford to pay the small additional cost for the latter, and as plan Figs. 114 and 115 is inferior to and larger than plan Figs. 120, 121, and plan Figs. 112 and 113 is imperfect, the total number of plans of the bed-parlour type of the health-promoting class of dwelling shown on these two sheets is thus reduced to three standard sizes—(1) the smallest, Figs. 118, 119; (2) the medium, Figs. 122, 123; and (3) the largest, Figs. 116, 117.

In addition to these three plans, there might be a fourth which would bear the same relationship to plan Figs. 116, 117, that plan Figs. 118, 119 does to plan Figs. 122, 123. This fourth plan, which would, like plan Figs. 116, 117, be of the five-bed size, would have roofed areas of 990 and 936 respectively, according to the type of walling employed. In comparison with the other three standard plans, it would thus provide for housing the largest number of occupants at the most economical rate per head.

With such very small bedrooms as the Government's model plans provide serious difficulties arise whenever the sex composition of a family even of only moderate size does not exactly conform to the accommodation provided—which it rarely does. The result of this is that, although the size of the family may be no larger than that for which the meagre accommodation in the dwelling was designed, one of the bedrooms has to be dangerously overcrowded in accommodating it.

Another danger and difficulty is that none of the official types of dwellings have their smaller bedrooms so arranged that they are capable of comfortably accommodating two beds, the result being that the occupants of the apartment may be huddled together, so that there is unhealthy overcrowding of the one bed. In the five-bed type of the health-promoting class of dwelling this difficulty would rarely arise.

As it is the custom among workers for many of them to supplement their earnings by keeping boarders or by letting off accommodation to lodgers, the two extra beds which the five-bed size of dwelling provides would prove a boon not only to

the people who rent such houses, but also to the boarders, who would find a home in them.

In existing types of dwellings thousands of young people who have to live in lodgings are to-day compelled to pay high prices for the share of a bed in a tiny, imperfectly ventilated bedroom and the partial use of a small stuffy kitchen, in which they have not only to take their meals, but also such rest and recreation as its cramped accommodation allows.

In the health-promoting class of dwelling, on the other hand, these same young persons would, at relatively less cost, be able to enjoy the use of a living room of ample, indeed spacious, dimensions, with considerably more cheerful and home-like surroundings, and the exclusive use of a bed in a perfectly ventilated bedroom, while the housewife would at the same time be able to attend to their needs with less expenditure of energy than is at present the case.

In many rural areas the wife of the agricultural labourer by letting off the surplus bed accommodation might easily earn from summer boarders alone more than sufficient to enable her husband to pay an economic rent for the five-bed size of cottage. The health-promoting dwelling would thus not only help the labourer and his family but would, as compared with existing types, reduce the number of houses required, and thus enable the benefits of improved housing to be more widely and more quickly distributed, and thereby more speedily relieve the prevailing congestion. It would also act as a strong magnet—firstly, to keep people on the land, and secondly to attract many who although anxious to go are now repelled by the lack of decent housework and the sordid conditions of village life.

(To be continued).

### NATIONAL BUILDING TRADE EMPLOYERS' CONFERENCE.

As a preliminary to the summer meetings of the National Federation of Building Trade Employers of Great Britain and Ireland, which opened in Liverpool on July 25, a reception was held at the Adelphi Hotel on the evening of July 24. The guests, consisting of the officers, council, delegates, and their ladies, were received by Mr. Thomas Foster (Barnley), president of the North-Western Federation, and Mrs. Foster, and by Councillor James Storr, J.P. (Stalybridge), president of the National Federation, and Mrs. Storr. An enjoyable musical programme was submitted.

#### FIRST DAY'S PROCEEDINGS.

On July 25, Councillor James Storr, J.P., of Stalybridge, presiding, the proceedings opened with an official welcome by the Lord Mayor, who referred to the fact that the federation emanated from Liverpool. The building trades, he said, had probably been more hardly hit than almost any other trade by the war. It was certain, however, that as soon as the war was over the building trade would be one of the first trades required for the work of reconstruction.

Mr. T. Foster (Barnley), president of the North-Western Federation, in proposing a vote of thanks to the Lord Mayor, referred to the scheme which the Federation had in hand for promoting better relations between employers and workers.

#### THE SHORTAGE IN HOUSES.

The Housing Committee of the federation submitted a report which gave rise to some discussion. The committee had considered the progressive decline in the building industry during the last two decades, both as regards housing and other building works, and particularly with regard to the question of sound and satisfactory investment in both directions. They recommended—(1) the repeal of the Finance Act, 1909-10 (Part 1), to reinstate confidence in building as an investment which had been seriously impaired; (2)

that the present system of rates for local and national expenditure be abolished, and the substitution thereof of the principle that all expenditure of a national character (but made through local authorities) be placed on national Budget to be met by income-tax, and all local expenditure for purely local purposes be similarly met by a local income-tax to be levied on all persons enjoying such amenities whose income was above the present tax basis; (3) an alternative proposal for the reorganisation of the rating authorities, with one authority to make valuations; (4) that the provision of cheaper land for building operations be made easier, and every encouragement be given for needed development; (5) that Government subsidies to meet increased costs of labour and materials should be granted to responsible persons, or loans issued at lower rates on security of properties in order to encourage building by private enterprise; (6) that public authorities should let work by contract and not by direct labour; (7) that building by-laws be overhauled, with a view to their being made less costly to the execution of housing work; and (8) that the construction of roads in connection with housing schemes be reconsidered.

Mr. Moffat (Birmingham) moved a resolution accepting the report of the Housing Committee, and providing for a committee to investigate the effect of the present system of rating on building operations, including its application to houses under £50 a year, and to suggest methods for remedying the present shortage of houses. In the housing question the building trade, he said, was faced with one of the biggest problems of its history.

Mr. Davidson (Leeds) seconded the motion, on the understanding that the federation was not committed to the policy laid down in the report of the Housing Committee. He was not in agreement with the committee's views regarding the incidence of local taxation.

Mr. Smetniurst (Oldham) emphasised the urgency of the housing question, which, he said, ought not to be complicated by bringing in the question of rates and taxes, which was bound to raise difficulties. He proposed as an amendment that two separate committees should be appointed—one to deal with the incidence of rating generally and the other to deal with the housing question.

Mr. S. Easton (Newcastle) seconded the amendment. He attributed the shortage of houses, firstly, to the operations of the Finance Act, and, secondly, to the excessive building carried out a few years ago.

Mr. Scape pleaded strongly for decentralisation by the formation of building boards throughout the country, those boards to be under the supervision of the Government.

Mr. Foster (Barnley) thought higher wages for the working classes was the real remedy for bad housing.

The resolution, as amended by Mr. Smetniurst's proposal for two separate committees, was agreed to.

#### TO REMEDY INDUSTRIAL INEQUITY.

The delegates next gave consideration to a scheme for the establishment of a builders' national industrial parliament, representative of trade unions and employers' associations, "to promote the continuous and progressive improvement of the building industry, to realise its organic unity as a great national service, and to advance the well-being and status of all connected with it."

Mr. Smetniurst, reviewing the causes of industrial unrest, held that the employers were largely responsible because of the attitude which they had adopted of resistance to the demands of their workpeople. As against this attitude the workers had pursued a policy of limited output—a most demoralising system, but one that could be defended from the trade union point of view. In the future there must be co-operation instead of conflict between the two sides, and the human relation must be brought more into the activities of business life than formerly. Such a condition of things could, he believed, be brought about through the medium of the national industrial parliament which the federation hoped to bring into being. He proposed the adoption of the scheme.

Mr. Dove (London), in seconding, claimed that this was the first well-considered scheme to be brought forward for bringing all those

concerned in the building trades into line for their mutual benefit.

The scheme was unanimously approved.

A report by the secretary of the federation (Mr. A. G. White) on inter-relations of building trades employers, designed to avoid causes of friction and overlapping on trade matters, was approved.

#### EXCESS PROFITS DUTY.

The Executive Committee brought forward a resolution protesting against profiteering, and calling on the Government to repress practices of this kind.

Mr. Bertram Moss (Liverpool and Warrington Master Builders' Association), speaking in support of the resolution, declared that nothing had proved more disastrous to the working classes than the excess profits duty. He suggested the abolition of excess profit-duty where the business affected was concerned with household commodities, and that the profits of such businesses should be limited to pre-war standard. At present the working classes were being made to pay the excess profits tax.

The resolution was carried. A further resolution, which was agreed to, called for the removal by the Government of the provisions of the Finance Act, 1910, which had contributed largely to the present house shortage, and appealed for Government encouragement to private enterprise and co-operative endeavour in the matter of house building.

#### VISITS.

The delegates last Thursday morning paid a visit to the new cathedral, and were shown over the building by the contractor, Mr. Morrison, and his staff. In the afternoon they crossed the river to Port Sunlight, and inspected the village and the Soap Works.

At a luncheon in the Adelphi Hotel, Mr. H. McLaughlin (Dublin) proposed "The National Federation." He said the work of the federation had been an inspiration to the Dublin Association, which had made very rapid progress since it joined the federation. It was the duty of local associations to unite among themselves more fully than hitherto, and then to co-ordinate themselves under the National Federation.

The President (Councillor James Storr) replied. They were hopeful, he said, that when the war was over the building trade would enjoy a period of prosperity. They must not, however, expect to retain the whole proceeds of that prosperity for themselves.

As a federation they were now getting into closer touch with the trade unions of the country, and so long as the workers were prepared to act on the lines already laid down on their behalf, they (the employers) must not begrudge them a fair return for their labours. The Trade Conciliation Board, of which he was the president, had been the means of creating a better spirit between employers and employed than had hitherto obtained in the trade. He hoped that spirit of conciliation would further extend. (Hear, hear.)

The Liverpool Master Builders' Association was proposed by the President of the North-Western Federation (Mr. Thomas Foster), and acknowledged by Mr. Charles Tomkinson (senior past president). Mr. Wilcox (Wolverhampton) gave "The North-Western Federation," which was responded to by Mr. Foster.

### BUILDERS' BENEVOLENT INSTITUTION

On the occasion of the seventeenth annual meeting of the Builders' Benevolent Institution held at Pop Corner House, Kingsway, on Monday, the Committee expressed gratitude to Major George R. Holland, R.A., for again accepting the presidency.

The report stated that only by the exercise of the most scrupulous care had it been possible to continue to pay the pensions already granted.

During the past year two men had died and one had had his pension terminated. One woman had been added to the pensioners' list.

A legacy of £1,000 (free of duty) had been received from the late Mr. Charles Cox.

On the motion of Mr. Frank May, seconded by Mr. H. S. Foster, the report was adopted.

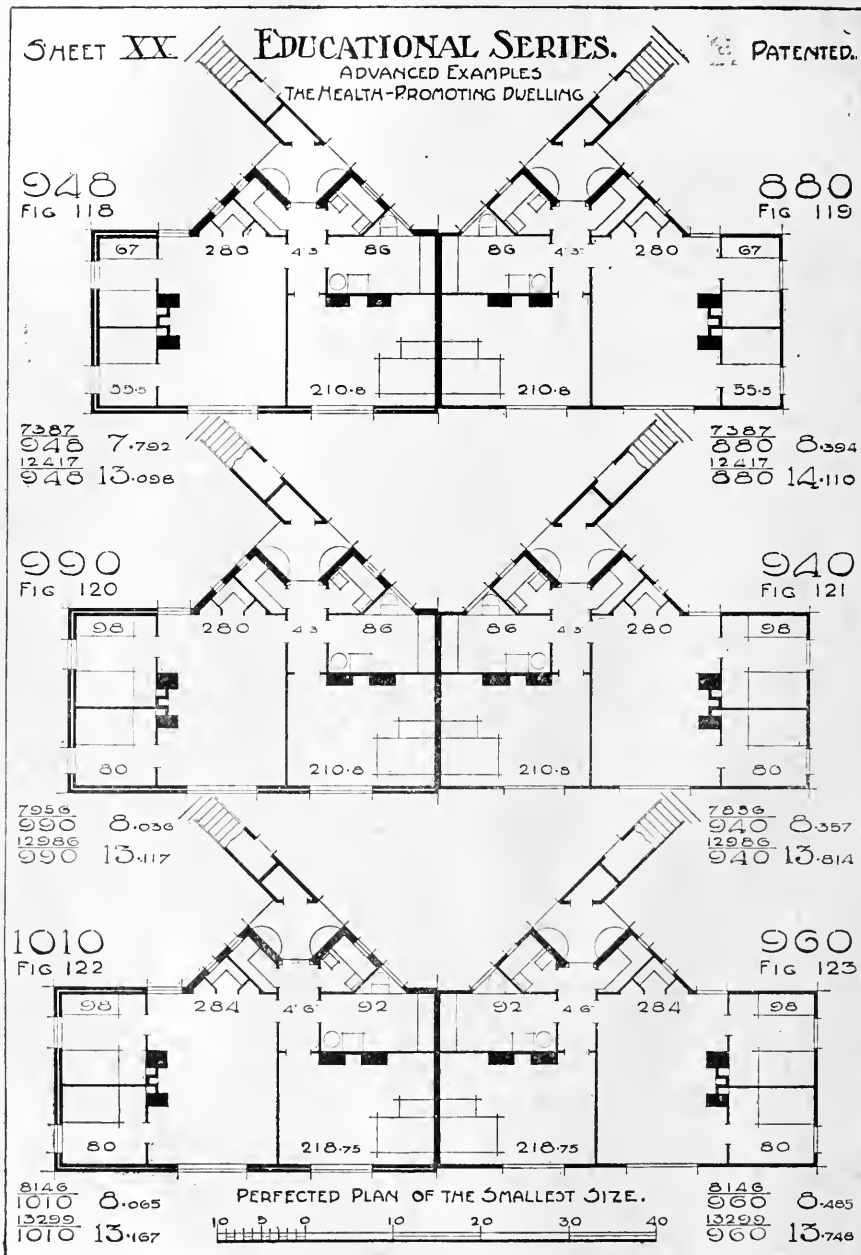

THE PROBLEM OF THE SMALL DWELLING AND ITS SOLUTION.

By Mr. ROBERT THOMSON, Architect.





THE BUILDING NEWS, AUGUST 1, 1917.

# A CHURCH In the Style of the IRISH ROMANESQUE

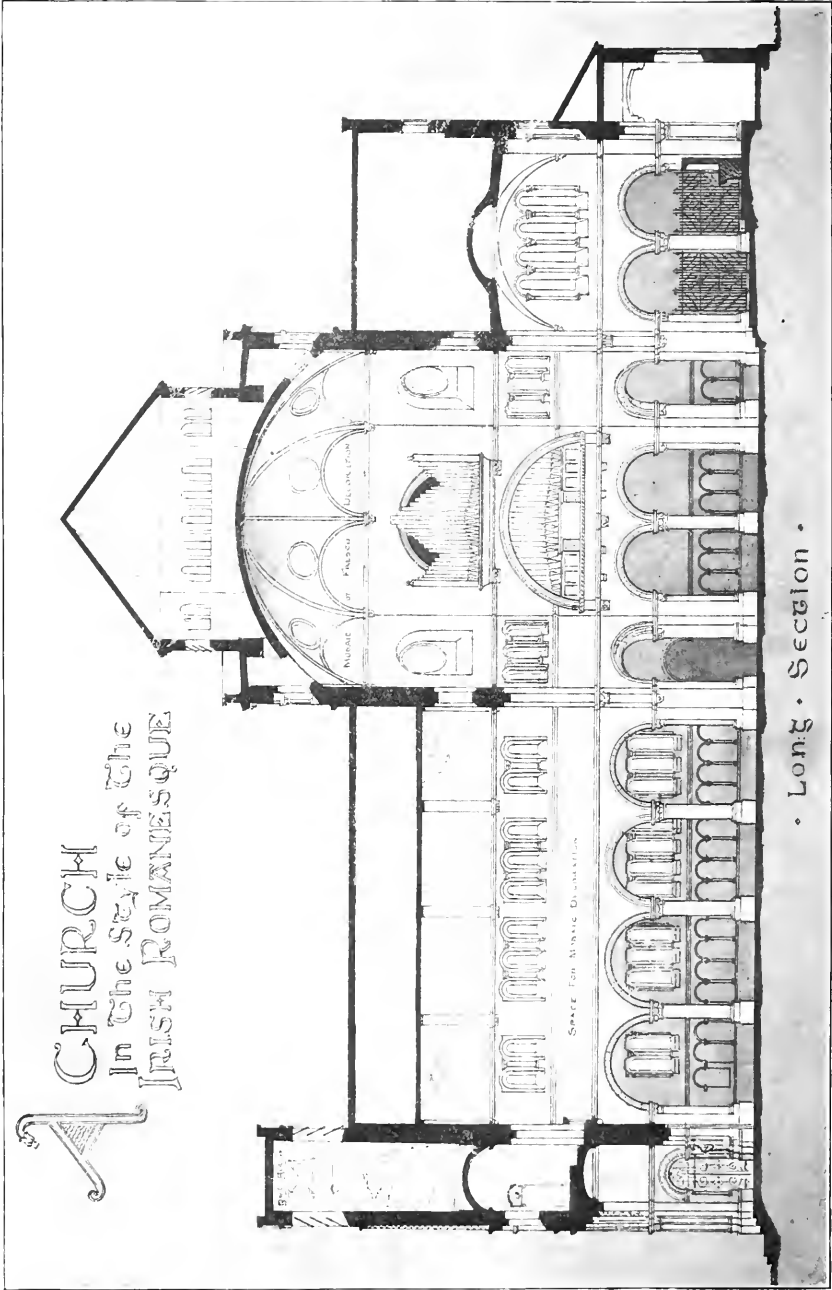

• Long Section •

ROYAL HIBERNIAN ACADEMY EXHIBITION, DUBLIN, 1917.





THE BUILDING NEWS, AUGUST 1, 1917.

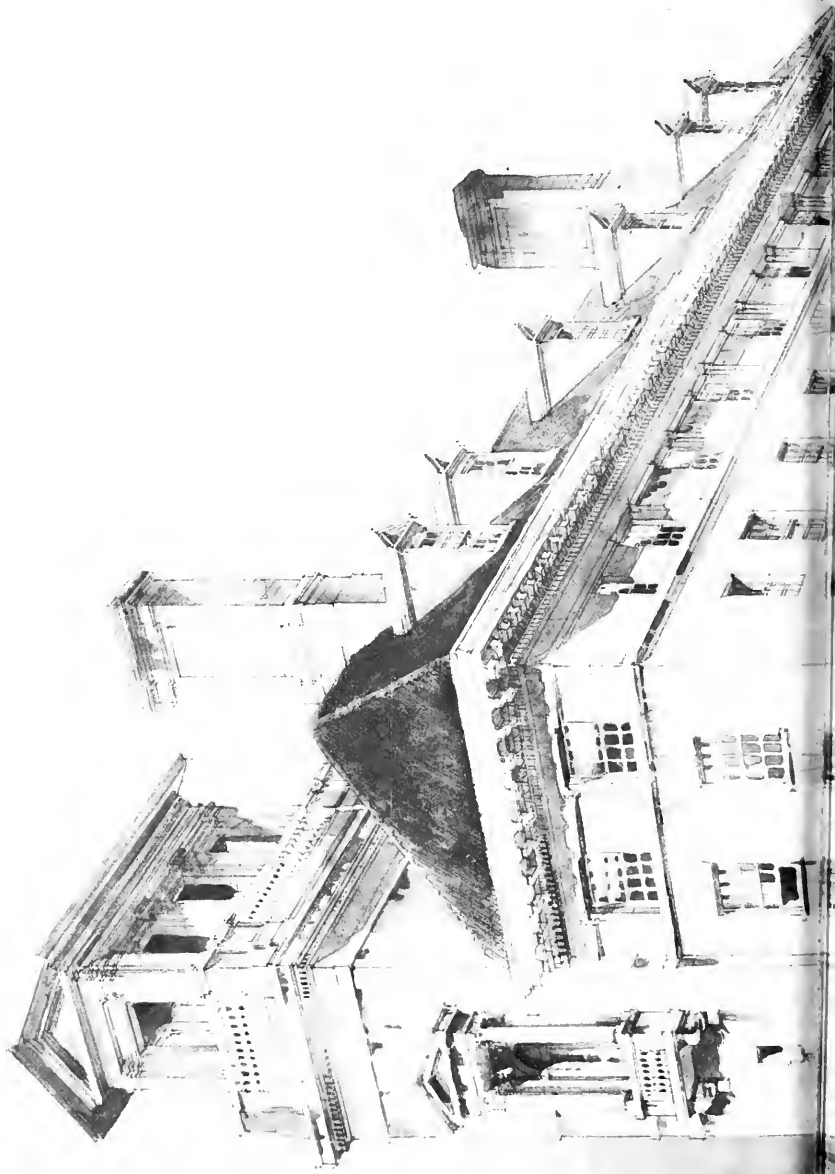

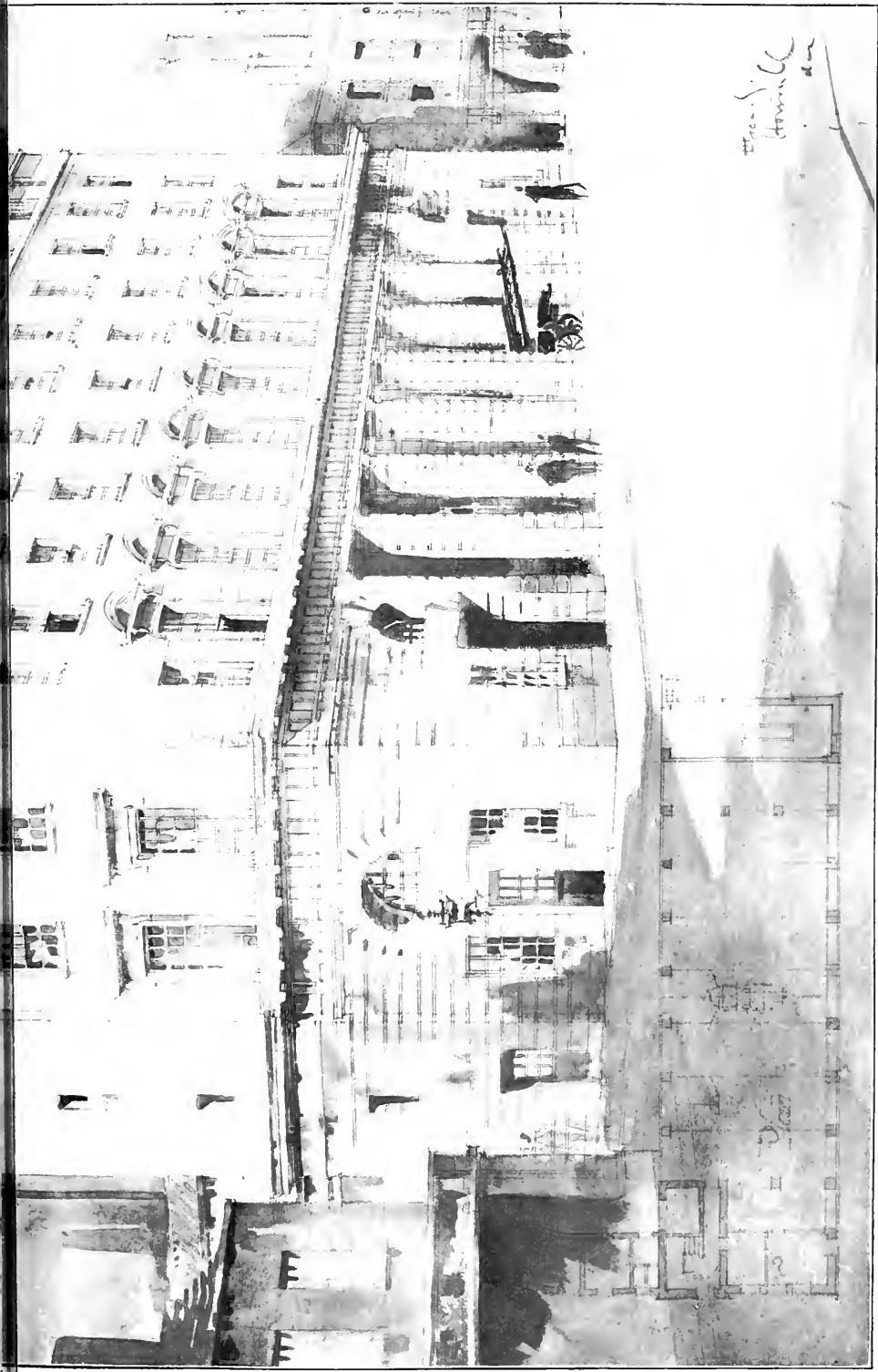

CARDIFF FIRE BRIGADE HEADQUARTERS, WESTGATE STREET FRONT.—Major E. VISCENT HARRIS, F.R.I.B.A., Architect.



THE BUILDING NEWS, AUGUST 1, 1917.

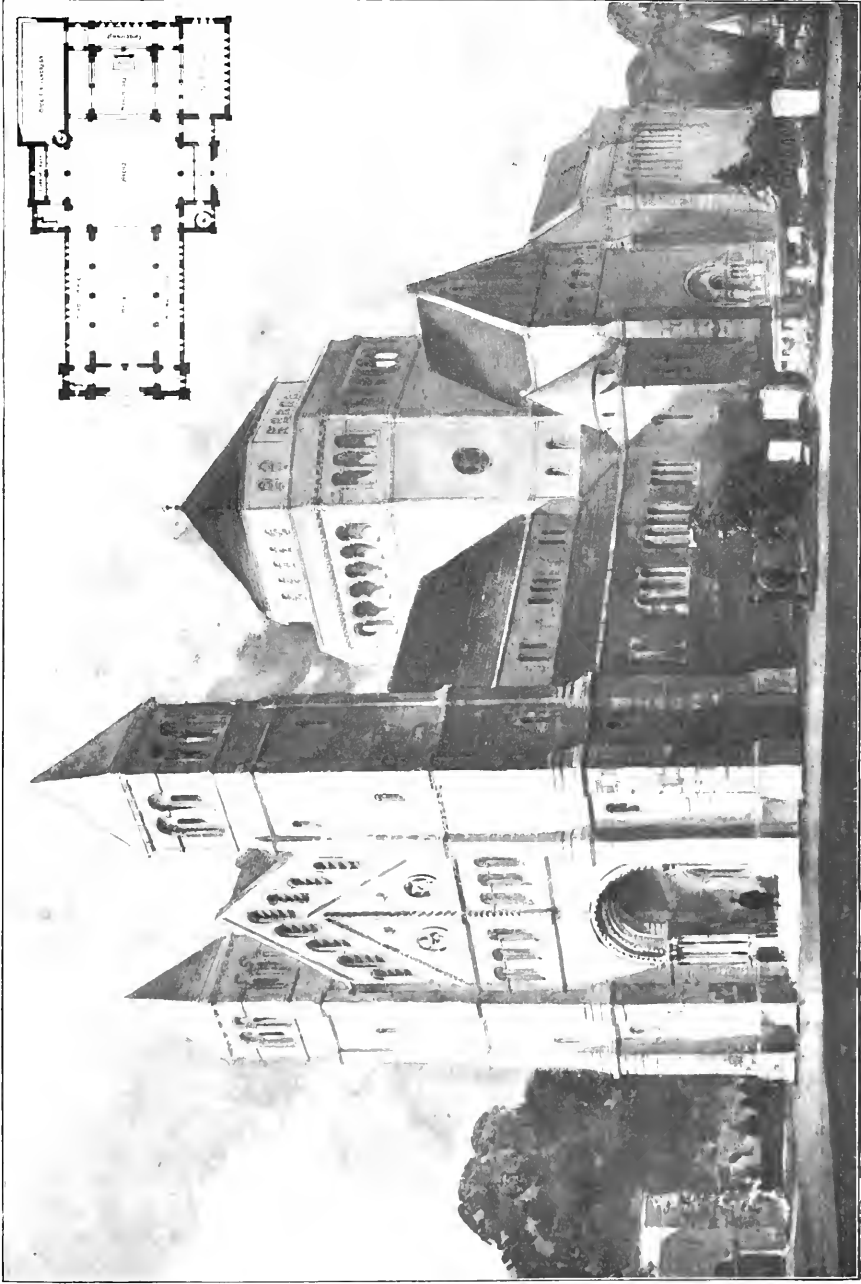

A NEW CHURCH IN IRELAND BASED ON THE STYLE OF THE CELTIC ROMANESQUE.  
Mr. Arthur Hill, B.E., F.R.I.B.A., M.R.I.A., Architect.



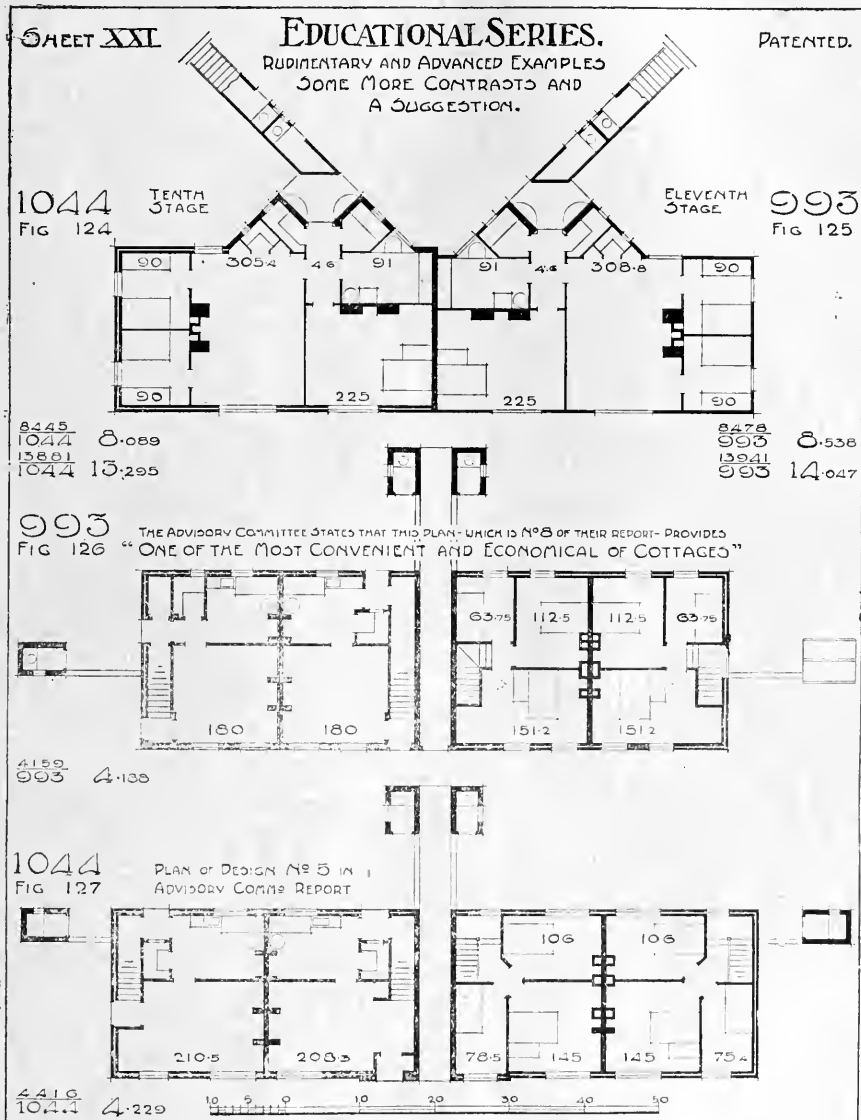

THE PROBLEM OF THE SMALL DWELLING AND ITS SOLUTION.  
 By Mr. ROBERT THOMSON, Architect.

# Our Illustrations.

## CARDIFF FIRE BRIGADE HEAD-QUARTERS.

The main front of this borough fire station is situate in Westgate Street, the return elevation facing Quay Street, Cardiff. The main feature of the plan consists in the facility of access and allowances for immediate service. Provision is made for up-to-date motor engines, and eight machines are accommodated. The superintendent's office is placed on the ground floor, as well as the call office and space for boiler-house. A recreation room for the firemen is furnished at the street level. The battery-room, also an instrument-room, form part of the equipment. Twenty sets of men's quarters are arranged for the staff on the upstairs floors. Sliding drop poles lead from each level to the machine-room, and the latest appliances in use in America have been adopted by the Cardiff authorities. The scheme has been worked out by the architect, Major E. Vincent Harris, F.R.I.B.A., of New Square, Lincoln's Inn, W.C. Portland stone was used for the masonry. The station occupies the site of an old river bed, which circumstance necessitated very deep foundations, considerable difficulty being experienced in erecting the buildings in consequence. The work has lately been finished. We published the competition drawings as submitted by Messrs. E. Vincent Harris and Thomas A. Moodie on January 24, 1915, when they were awarded the first premium. At the same time the plans and elevations of the second prize design were given by Messrs. Ivor Jones and Percy Thomas, architects, of Cardiff. Naturally the war caused much delay in the execution of the premises, and this building therefore has only been recently furnished and fully occupied.

## A NEW CHURCH IN IRELAND BASED ON THE STYLE OF THE CELTIC ROMANESQUE.

The illustrations given are reproduced from drawings exhibited this year at the Royal Hibernian Academy in Dublin. The design, so well adapted to contemporary needs, is founded on the Celtic Romanesque of the Twelfth Century, in so far as the ornamental detail is concerned, but, of course, as regards planning no precedent exists in Ireland for a large cruciform church with a central octagonal space, because the little churches of that age were only intended as sanctuaries served by ecclesiastics in convents or employed in ministering to relatively small communities and not for large congregations common to more modern times. Mr. Arthur Hill, R.E., M.R.I.A., F.R.I.B.A., of Cork, is the architect. The plan and section explain how the somewhat unusual dimensions of the auditorium for many worshippers have been worked out with dignity and proportion skilfully set out with the entablature lantern over the crossing. This is arched and vaulted above. The organ is a conspicuous feature in the planning of the transepts.

## THE PROBLEM OF THE SMALL DWELLING AND ITS SOLUTION.

This series of articles, with plans, will be found in the following issues of the BUILDING NEWS—viz., May 25 and 30, June 6, 13, 20, and 27, July 4, 11, 18, and 25. Mr. Robert Thomson is the author of these suggestive schemes, adopting the patented methods of approach to tenements of various sizes. The accompanying plans occupy sheets XX. and XXI.

Mr. Chambers Thompson, for many years a member of the Council Urban District Council, died on the 29th ult. He had been in hospital for some time, and recently it became necessary to amputate one of his legs.

Mr. Thomas Chickbank Pulford, late of 77, Cornhill Street, died a few days ago in his 82nd year. Deceased was the inventor of a kind of bar printer. He was a nephew of George Chickbank and of Thomas Croswick, R.A., and was himself an artist of no mean repute.

## COAL CONCRETED FROM DUSTS OR ASHES.\*

(Second Paper.)

By R. GOULICERS LOVELL, A.R.I.B.A., M.S.A.

The Coal Controller, in describing the basis of his scheme for coal transport, has said that the first main principle is: "That consumption of coal should take place as near the producing point as possible."

If a fuel can be concreted from any waste of calorific value in the localities where they exist, it is clear that we shall be assisting the country by the reduction of coal transport and by the utilisation of waste. The transport thus saved would be available for our Allies, and the waste thus utilised would be to the advantage of ourselves.

We hope to prove that this is possible. I am permitted by the President of the Society of Architects to comply with the suggestions made at the last meeting: That the process of manufacture should be demonstrated and that the analyses of the

a special sugar-waste solution and again dried. The fine aggregate is taken from the coal-cellar dust, only that which passes 4-in. mesh being used. These two bases should be intimately mixed with the matrix or binder. For this purpose I employ an old butter churn, cake-mixer, or other suitable utensil, falling which the whole mixture can be well shaken or mixed together by hand.

Up to this point A process and B process are exactly the same. Process A is employed wherever the sun has much value, or where heating-chambers are available. The mixed aggregates and binder have in some cases a small quantity of creosote oil added, placed into moulds, and allowed to concrete, the time, of course, varying with the amount of heat available. The fuel, when cold, is emptied out of the moulds, broken up, and is hardened by exposure to the atmosphere.

With Process B, the small quantity of creosote oil, if used, is placed in a boiler or an iron saucapan, the mixture of bases and matrix is added and placed upon a fire

TABULATED ANALYSES.

Name.	No.	Volatile Matter.	Coke.	Ash.	Fixed Carbon.	B.T.U.'s of Bases.	B.T.U.'s of Component Parts.	Percentage of Resultant Fuel.	B.T.U.'s of Resultant Fuel.
Anthracite Dust.....	64 An.B.	13.26	84.92	12.16	72.76	—	12,775	91.38	12,570
" " Bases	73 An.C.	5.78	91.77	6.42	85.35	13,660	12,027	99.02	11,870
" " Bases	"	13.57	84.38	21.52	62.86	—	—	—	—
" " Bases	"	6.45	91.63	6.20	85.43	13,650	—	—	—
Anthracite and Peat.....	68 An.P.B.	23.82	74.04	20.76	53.28	—	8,272	92.80	8,150
" " Bases	69 An.P.C.	19.51	75.59	22.98	52.41	7,650	8,280	96.55	8,170
" " Bases	"	17.41	76.71	15.31	61.40	7,830	—	—	—
Ashes and Peat.....	66 A.P.B.	21.16	77.10	51.42	25.68	—	6,786	98.22	6,690
" " Bases	74 A.P.C.	12.41	85.32	56.18	29.14	5,340	6,520	98.25	6,435
" " Bases	"	30.23	67.20	42.38	21.82	—	—	—	—
" " Bases	"	16.29	81.21	48.78	32.43	6,360	—	—	—
Ashes and Coal Dust.....	62 A.L.B.	15.44	83.95	27.57	56.38	—	9,041	98.05	8,910
" " Bases	63 A.L.C.	5.17	92.78	35.96	56.82	8,890	8,094	97.14	7,980
" " Bases	"	16.86	82.73	38.64	43.49	—	—	—	—
" " Bases	"	5.15	92.15	56.20	56.55	8,870	—	—	—
Kent Coal Dust.....	59 S.B.	29.32	69.54	21.30	48.24	—	11,422	98.35	11,250
" " Bases	60 S.C.	25.22	73.41	20.20	53.21	11,870	10,375	98.58	10,230
" " Bases	"	39.83	67.53	24.86	42.57	—	—	—	—
" " Bases	"	25.22	73.41	20.20	53.21	11,870	—	—	—
Kent Coal Dust and Washings.....	60 S.B.	18.26	86.96	59.14	21.82	—	5,669	98.62	5,580
" " Bases	61 S.C.	11.52	87.64	65.68	21.96	4,440	4,400	93.33	4,980
" " Bases	"	19.98	79.15	57.72	21.53	—	—	—	—
" " Bases	"	11.62	87.49	64.90	22.59	4,460	—	—	—
London Coke.....	57 L.B.	21.40	77.69	23.96	53.73	—	11,261	96.10	11,110
" " Bases	58 L.C.	8.20	89.95	17.94	72.01	11,620	10,107	98.86	9,980
" " Bases	"	15.43	83.10	39.29	52.61	—	—	—	—
" " Bases	"	8.12	89.99	17.88	72.11	11,640	—	—	—

NOTE.—The percentage of Raw Material in the Resultant Fuel should be observed.

component parts and the resultant fuel should be shown.

My colleague, Mr. C. M. Hughes, and I are anxious to explain all that we can, and to submit the results of our work to the same criticism as before. We do not claim that our process increases the total thermal value of the aggregates, but we do say that there are many so-called waste materials which may be converted by this simple process into a fuel valuable for many purposes. By its means a British thermal unit costs less than that obtained by means of Nature's coal. This is the point that must appeal most strongly to the commercial mind.

As explained last month, there are three methods of making the fuel, which may be called A, B and C. These three methods will be demonstrated, simple domestic utensils being employed. It will thus be possible for manufacturers to judge the class of plant which exists all over the country, and which can be used for immediately putting into operation the manufacture of this fuel for use during the winter months.

A and B may be termed dry processes. In this case we take as aggregates Ashes and Coal-dust. The familiar cinder-sifter first plays its part by sifting the fine dust which is of little or no value. The coarse aggregate is therefore composed of all between 1/2 and 3/4 mesh. This is dried, if you like, in the domestic frying-pan; it is then sprinkled with

and stirred until a temperature of about 120°F. is obtained, when the whole is emptied into any mould, such as an old pan or bath. In a short time it is cold, and is emptied out, broken up, and allowed to harden.

Process C is a wet process in which there is no need to dry the aggregates. They are mixed as before, but with a different matrix mixture; the creosote oil, if used, is added and well mixed, the whole is then moistened with the solution until a consistency of mortar or concrete is obtained. It is then emptied into shallow moulds, or between sheathing boards, and dried by exposure, but with protection from the wet.

In all three processes the character of the matrices varies with the character of the aggregates, and the different aggregates have to be treated in different methods. It is usually found that in most cases the smoke of the resultant fuel can be diminished by an increase of the remaining ashes; in the case of furnace fuels the clinking can be diminished. As will have been observed, this method of concreting fuel dispenses with any kind of pressure beyond a slight tamping into the moulds.

Capable men are required to control the manufacture in order to standardise, as far as possible, the qualities of the various fuels.

Process A is more particularly suited to



those climates favoured with a succession of sunshine, or it is equally well suited to those industrial concerns having ovens or heating chambers where the moulds and their contents could remain for twenty minutes or half an hour. For low-grade cokes, coals, or bar ashes Process A is the best method.

Process B is suited for any form of rotary asphalt plant, either fixed or movable. I understand that many road construction firms have plenty of these portable heaters, which are possibly unemployed owing to the war. These could be taken to any dumps of coal slack, coke dust, or cinders, and very quickly transform them into a good fuel. Even after the war it is conceivable that these portable machines could be better employed in this manner than in road making. Our researches have proved that a certain blending of calcareous and carbonaceous matters go to form a hard road mastic which may be termed malleable. Road engineers will understand the full significance of this, and I shall probably have more to say on this subject later on.

For all materials high in carbon but low in volatile matter Process B is the best method.

Process C is the cottager's process of producing coal in his own back yard. Of course, it would be better for a community to send its ashes and dusts to a central depot and there have it done under proper supervision, but there is nothing to prevent an isolated individual or firm from utilising their waste materials by this process. The ordinary form of concrete-mixer could be taken to any dumps of waste material in the same way as the ordinary asphalt-mixer can be employed as before described.

For high-grade cokes, high-grade bituminous coals, or a mixture of the latter with ashes, peat, sawdust, etc., Process C is the best method.

Having demonstrated by simple appliances the different processes of manufacture, I have now to submit a tabulated statement of the analyses of seven different types of fuel made under the three processes, together with the calorific values of their component parts. The services of the West Ham testing laboratory have been employed in this connection, and the thermal values have all been determined by the Mahler-bomb calorimeter. (See table.)

In addition to the above sample the following are also shown:—

Messrs. Selfridge's bar-ash and coal dust.  
Coventry coal slack.  
Newcastle coke dust.  
Shoreham pan-ash coke and sawdust.  
Killamey sawdust.  
St. Helens coal slack.  
Portland Cement Co.'s bar-ash and coal dust.

Hadley coke dust.  
Carlton Hotel bar-ash and coal dust.  
Western Mail coal slack.

It will be observed that these examples extend from peat to anthracite. Samples of materials from which they have been produced and the samples of the resultant fuel are shown in each case; they will light from the sticks, incandescence, and flare. This is, perhaps, more remarkable in the case of anthracite dust. There are many collieries where fine coals are produced to-day in abnormal quantities, due to unusual friability, as, for instance, the Kent coal shown in the tabulated statement. I understand the percentage of slack is over 70 per cent. of the total output. It is here demonstrated that by our process fuel can be economically made equal in value to the large coal worked in the same seams. By utilising this mine to its full extent the Coal Controller's problem of transport in Kent and Sussex would be very much diminished.

We are now awakening to the enormous waste that has been taking place in this country in the consumption of coal, the valuable chemical by-products of which have been lost beyond recovery. Mr. Madden, the gas engineer of Cardiff, has stated in an address: "The system we employ to burn this valuable gift of Nature will be accounted to us as a barbarism by future generations when the coal supply of the

world is running low in the cellars of the earth."

The conservation of our wonderful coal-fields is a duty imposed upon us. Our industrial supremacy in the past had been founded greatly upon our riches in this respect; therefore, in the present time of stress it behoves us to adopt every effort to extract every benefit we can from every coal mine in the country. Professor Franke, in his recent book, has stated that the production in one year in Great Britain was 250 million tons of bituminous coal; the waste slack utilised only produced in briquettes 1½ million tons. In Germany, during the same period, the production was 183 million tons of bituminous and brown coals; the slack utilised produced in briquettes and pressed blocks 1½ million tons.

The briquetting method of utilising coal slack requires a pressure of 200-1,500 atmospheres, costly machinery and plant are constructed, and the slack has to be transported to the briquetting factories. The concreting process, on the contrary, enables the simple machinery and plant to be taken to the dumps of slack, thus saving at least one lot of handling and transportation. The concreted fuel is manufactured in situ. Further, it is submitted a better fuel is produced—one which lights from the sticks, incandescences and flares. The rough, fractured surfaces not only help in the ignition, but having more the appearance of Nature's coal they help in stimulating the confidence of the purchaser.

It is even suggested that on board ship the bar-ashes from the furnaces and the coal dust from the bunkers can be easily concreted into a fuel with a calorific value of about 11,000 B.T.U.'s.

The dumping of inferior grades of coal or other materials cannot strictly be regarded as waste up to the present, because never before has it been demonstrated that these materials can be employed usefully. Now that this process has been given every publicity, to leave these materials lying as rubbish when every effort is being strained to develop the resources of the country would be willful waste.

It may appear rank heresy to the medical officer of health, but I appeal to the Local Government Board to order the closing down of the refuse destructors in many localities. The house refuse could quite well be collected in two different receptacles. The vegetable refuse during the war could be dumped, deodorised and afterwards used as a fertilising agent; the cinders and ashes, as before explained, could be made into a decent fuel.

In my own town of Eastbourne a few months back great dumps of cinders existed which produce a concreted fuel of 7-8,000 B.T.U.'s. These are now being consumed, together with quantities of Welsh coal, in order to destroy the summer vegetable refuse. The transportation of this coal can be avoided, and the vegetable refuse after the war can be used to help improve the land. It is true that a certain amount of power is gained by destructor furnaces, but the amount of fuel required for this alone is nothing compared to the great consumption of cinders and coal required to destroy the house refuse.

It is said that one of the wonderful ways to win the war is to help to save England's coal. Every individual can assist. It is shocking to walk through the City of London early any morning and to see outside almost every door buckets of ashes awaiting their removal to the destructor. Officialdom is, of course, very busy and overworked just now; lack of staff and increase of work easily accounts for that.

It is individual efforts that have built up the British race. We drive best on a minimum Government control. Spontaneous efforts of all classes are to-day accounting more for our march to victory than the efforts of the best bureaucratic organisation in the world. The V.A.D.'s, the canteen workers, the munition workers, the allotment workers, the Women's Land Army, and, above all, our glorious Volunteer Army will bring us an assured victory. Therefore, we appeal to the individual to take part in a further effort to help to win the war—by reducing the

transport of coal and by the utilisation of waste.

I shall fall out with nobody; the Colliery Proprietor will have at his disposal a process of reconstructing coal cheaper than any method at present in vogue; the Industrial User will have available a fuel which can be made in a form that can be stored in the minimum of space and without danger of spontaneous combustion; and the Householder will be able to clear his cellar to the last particle of dust and his grate to the last particle of cinders, and so produce his own home-made coal.

The town refuse yard, the gas works, the brick and tile works, and others have thousands of tons of potential coal scattered up and down the land. The individual and the firm can help the country and themselves by tackling this question now, and so have plenty of decent fuel ready on the spots which are now only heaps of Dusts and Ashes.

#### APPRENTICESHIP IN THE BUILDING TRADES.

A new scheme of apprenticeship in the building trades has been adopted unanimously at a conference convened by the London (Central) Advisory Committee for Juvenile Employment between representatives of the Institute of Builders and of the building trades organisations.

The object is to regularise the method of entry into the trade and to provide proper means of training. All apprentices are to be bound, and the length of indenture is for five or six years, but, if a boy has satisfactorily completed a two years' course at a day technical school where instruction is given on the lines of the Brixton School of Building and has obtained a certificate of proficiency from the principal, the period so spent is to count as part of the apprenticeship, and the apprentices will start at the third year's rate of wages. Where no premium is paid the wages are to range from 6s. 6d. a week in the first year to 34s. 6d. in the sixth year.

The training is to be of two kinds: In the workshop and on jobs. The employer shall undertake that every opportunity shall be given the boy to learn the trade to which he is apprenticed. In the continuation school, all apprentices who have not obtained a certificate from a day technical school shall be bound, during the first two years of apprenticeship, to attend such during the employer's time, for one whole day or two half-days every week (or a minimum of six school hours), as may be found most convenient to the employer, without deduction from wages, and shall further be bound to attend evening school for two evenings each week while the schools are open; school attendances to be certified from time to time. All apprentices during the third and fourth year of their apprenticeship shall be bound to attend technical classes for two evenings each week while the schools are open. All apprentices shall be encouraged to qualify for the Institute's medals and awards.

Overtime by apprentices shall not be worked during the first three years of the apprenticeship and subsequently shall be discouraged; but if worked at the employer's request, the apprentice shall be paid such proportional additional wages as apply to the workmen.

In general, premiums shall not be required; but nothing in this scheme shall prevent a private agreement between an employer and a parent or guardian or any body or association acting on behalf of such parent or guardian providing an agreed sum of money as a premium to the employer for the facilities provided for learning the trade chosen. Should statutory powers be given to education authorities permitting under proper conditions and control some of the scholarship rewards, bursaries, or maintenance grants now obtaining being utilised for instruction in employers' works, such rewards or grants should form an Apprenticeship Fund for payment to the employer of a suitable premium where premiums are desirable and necessary.

There shall be formed a committee consisting of representatives of the building industry, education authority, and the London (Central)

Advisory Committee for Juvenile Employment of the Ministry of Labour. The Committee shall be called the "Building Trades Apprenticeship Committee." This Committee shall (1) itself or through one of its members be a party to the indenture; (2) approve the form of the indenture and see that the indenture carries out the agreed apprenticeship scheme; (3) subject to the approval of the local education authority, either itself or through a sub-committee visit the schools attended by apprentices and advise on the instruction given; (4) have power to vary the terms of the apprenticeship scheme and take such steps and make such regulations as may be thought desirable in the interests of the scheme; but before any decision is put into force it shall be open to either a majority of the employers or a majority of the workmen present to ask that the question be referred to their respective Associations for consideration, and no action shall be taken until the reply of the Association has been received; (5) appoint persons to serve on the Local Selection Sub-Committee and Appeal Sub-Committee.

Provision for the appointment of Local Selection Sub-Committees and an Appeal Sub-Committee are included in the scheme.

### PROFESSIONAL AND TRADE SOCIETIES.

SOMERSET ARCHAEOLOGICAL SOCIETY.—The Somerset Archaeological and Natural History Society held its sixty-ninth annual meeting at the Castle Museum, Taunton, last week, when the Dean of Wells (Dr. Armitage Robinson) was re-elected president for the ensuing year. The report of the council, which was adopted, described the work of the society, and stated that the total membership was now 902, as against 883 in the previous year. The council had recently taken steps to form a committee, whose objects were to advise any persons intending to restore, alter, or add to an ancient building, to encourage the care and preservation of ancient buildings suffering from neglect, and to report to the society upon any proposed restoration of ancient buildings which threatened to destroy their archaeological value. Sixty-three new members were elected, and the officers of the society were reappointed.

### OBITUARY.

It is with regret that we record the death of Mr. R. Adolphus Came, which took place at his residence at Woodhall Spa on Thursday, July 19, after a brief illness. Deceased, who was seventy-two years of age, was an architect, and carried out a large amount of work, especially in Woodhall Spa. He designed most of the chief houses in the town, and was also responsible for the design of the Royal Hotel, with its winter gardens. He went to reside in the Spa when there were very few houses erected, and it was to his enterprise that the Spa owes its beauty of design, its prettily arranged streets, and the abundance of trees which line all the roads and streets. He spent a large sum of money in developing the Spa, and had the satisfaction of discovering a second mineral water spring. For many years he served on the local urban council, and was responsible for much good work, particularly in adding to the beauty of the place and for providing for the comfort of visitors. The funeral took place at Woodhall Spa on Monday week amid general signs of regret.

Mr. Samuel Salmon, of Clevedon, Reigate, Surrey, and of Finsbury Pavement House, who died on December 27, in his eighty-eighth year, left £194,717.

At St. John's Church, Moston, on Sunday week, Mr. J. L. Paton, High Master of the Manchester Grammar School, unveiled a tablet erected in the chancel to the memory of Lieutenant Norman Victor Holden, 6th Lancashire Fielders, who died of wounds received in the Dardanelles on June 4, 1915. Lieutenant Holden was a son of the Rev. W. Holden, rector of St. John's, Moston.

## Correspondence.

### EXPERT EVIDENCE PER SE.

To the Editor of THE BUILDING NEWS.

Sir,—Architects scarcely need be surprised when expert evidence fails to be appreciated at its true value in building cases tried in public Courts of Justice. The following incident occurred not very long ago in the King's Bench, though it was not reported in the papers. The action cited came within my own professional experience, and it certainly supplies an extraordinary example of obtuseness, not only on behalf of the counsel engaged on both sides, but also of the judge as well as the jury. The particular subject to which I allude had nothing whatever to do with the issue of the case in so far as I was concerned, and consequently I could not intervene, it being no business of mine. What happened, however, enabled me to realise how entirely deficient in common well-educated people ordinarily are about the simplest matter of technical art. During two consecutive days several hours were devoted to discussing the detail here mentioned. Its relative importance was very small, but three "expert witnesses" were called, who swore that an enlarged and coloured photograph (exhibited in court) was "a genuine high-class portrait painted in oils from the life." Evidence was deduced to show that the lady represented in this undamaged picture had given several sittings to the artist who painted this portrait. The complainant said he had paid her handsomely for these sittings, besides providing for hotel expenses, but he could not state her name or furnish her last known address. Neither was he able to produce the lady or the artist whom he described as "a foreign painter," whose place of abode was uncertain. Obviously the origin of this so-called "painting" was more than doubtful. The complainant, a photographer by trade, informed the Court that he had this portrait got up for exhibition in his shop to show customers what he could do in that direction. All this evidence, surely, ought, in the absence of the artist, to have suggested to someone engaged on the trial the need of a more exact definition, and particularly so because the expert witnesses had endeavoured to justify the high price set upon the picture by giving a manifestly incorrect description of it. Much stress, too, was laid upon the merit of the portrait as a work of art, and the serious view taken as to that resulted in much valuable time being wasted arguing about it. A tyro in art might almost at a glance have told the difference between a genuine oil painting and such a coloured photograph. Nevertheless, no one hinted this discrepancy as possible, and nobody asked the "experts" a direct question on that crucial point. No one knew! "Brisons la!" To me this was very remarkable. Quite apart from this picture incident, the complainant failed; worse than that, the trial forebode beyond a doubt an ultimate charge of arson. Before the end of the case, anticipating this result, he committed suicide. I may add the jury were ignorant of this tragedy prior to their verdict.—I am, Sir, your obedient servant.

### AN EXPERT WITNESS.

London, July 26, 1917.

At Sudbury Town Hall the mayor referred to the fact that Captain Tait (the borough surveyor) had received honourable mention in General Murray's despatches, and congratulated him, in the name of the council, on this distinction.

Second-Lieutenant Ernest John Dodd, R.F.A., killed on July 17, was the only son of the late J. H. Dodd and Mrs. Dodd, of East Common, Harpenden. After leaving St. Alban's School he was articulated to a firm of architects and surveyors, and was elected a Professional Associate of the Surveyors' Institution. Before the war he was on the staff of the Valuation Department, Island Revenue. He joined the Artists' Rifles in September, 1914, and was gazetted to the R.F.A. in June, 1915.

### LEGAL INTELLIGENCE.

**GAS LIGHT AND COKE COMPANY FAILS TO PREVENT THE BOROUGH COUNCIL OF HACKNEY FROM GRANTING FAVOURABLE TERMS TO POWER CONSUMERS.**—On Wednesday last, in the Chancery Division, Mr. Justice Astbury decided a case of great importance to municipal authorities and companies supplying electric power and light, as well as to consumers within their areas. The plaintiffs, the Gas Light and Coke Company, complained that the Borough Council of Hackney, as the authority under the Electric Lighting Order of 1895, were giving more favourable terms to power consumers in respect of their lighting than to consumers of light only, and an injunction was asked to restrain the council from making this differentiation, which the company said was a breach of Sections 19 and 20 of the Electric Lighting Act of 1882. Under the scale of charges issued by the council in 1914, the power consumer was allowed to use 20 per cent. of the energy supplied for lighting; the result being, as the company contended, that consumers for power were supplied with energy for light at a lower rate than consumers for light only. His Lordship, giving judgment, said in practice the council had not allowed the user of the 20 per cent. for purposes other than the lighting of a factory or workshop taking the power supply, nor had they threatened or intended to do so, nor had they ever had anybody applying for such a case. Parliament had sanctioned power companies competing with light companies in various districts, on the terms that one-fifth of the supply taken by the power-user might be used for light, this being on the footing that factory and workshop lighting did not, as a rule, amount to or exceed one-fifth of the amount taken. In his opinion there was no breach of the provisions of the 1882 Act, and the action failed, and must be dismissed, with costs. Mr. Justice Astbury said the importance of this case extended far beyond the Borough of Hackney, and he asked for an extension of the usual time for appealing. His Lordship assented.

**VERDICT FOR ARCHITECTURAL DECORATORS UPHOLD.—Savage and Co. v. Harvey** (before Lords Justices Pickford and Scrutton). This was an appeal by the defendant, Albert Robert Harvey, of 8, Waterloo Place, and Fitzroy House, Mill Hill, against a verdict entered for the plaintiffs, Messrs. Savage and Co., architectural decorators, of Albemarle Street, at the trial before the Lord Chief Justice and a Special Jury. The action was to recover upon a contract for decorative work done and goods supplied to the defendant's house at Mill Hill, at a cost of upwards of £12,000. The plaintiffs alleged that the defendant had induced them to give him credit by falsely representing to them that he was a man of great wealth and held the position of financial adviser to the Cabinet. The jury found for the plaintiffs and assessed the damages at £5,250. In giving judgment, Lord Justice Pickford said that as a defence to the action the defendant pleaded that the goods were on grounds on which he said he was not liable, as to which there was in fact a conflict of evidence between the plaintiffs and the defendant. The jury, after having heard and seen both parties give their evidence, came to the conclusion that they believed the plaintiffs and did not believe the defendant. In that state of the evidence the defendant asked for judgment or a new trial. But the Court would not go into the evidence for the purpose of ascertaining whether they would or would not have come to the same conclusion as the jury had come to. This Court were satisfied that there was evidence upon which the jury could come to their verdict. It was not suggested that it was a case in which the verdict was so unreasonable that it was a nervous verdict, and on that ground ought to be set aside. There was no reason at all for interfering with the verdict, and the appeal failed. Lord Justice Scrutton concurred, and the appeal was accordingly dismissed, with costs.

For the vacant appointment of Surveyor to the Sheerness Urban District Council, the following have been selected to interview the Council, the salary offered being £300 to £400 per annum: Messrs. J. Singleton Green, M.I.M.E., M.I.M., and C.E., M.R.S.T.; A.W.E., and Surveyor of H. Kingsley, H. Crabb, F.S.J., A.M.I.C.E., A.R.I.B.A., A.M.I.M.E., M.I.M., and C.E., M.I.W.E., aged forty-two, Borough and Water Engineer, Pembroke Dock; Harry Clegg, A.M.Inst.C.E., M.I.M. and C.E., aged forty-five, Engineer and Surveyor, Felixstowe.

## Building Intelligence.

**CAIRO CATHEDRAL.**—The project for building a cathedral in Cairo in memory of Lord Cromer, Lord Kitchener, and all the men of the Imperial Forces who died in Egypt, Gallipoli, and Palestine, has been furthered by a gift of land for the site. The Sultan of Egypt has granted about eight acres of land in one of the chief centres of Cairo. The site is known as the Ismailia Palace, though the palace itself was pulled down some years ago, and is probably the finest in Cairo. When the fullest allowance of space for the cathedral has been made, it is hoped that the group of buildings to occupy the site will include premises for the new British school, which already is as great a success as it was a necessity. The services of Messrs. G. and A. Gilbert Scott, the former being the architect of Liverpool Cathedral, have been secured. Actual building will not commence until after the war.

**EDGBASTON.**—Since the war broke out church-building has been almost stationary, and the new church of St. Germain, Edgbaston, is probably the only one in the country begun and completed during the progress of the war. It is, too, a noteworthy coincidence that it is named after a famous French soldier-bishop—a designation which will always be a definite reminder of our association with the gallant French nation in the present world-struggle. The site for the church (at the junction of Portland Road and City Road), which covers an acre and a half, was given by the Gillett Trustees a long time ago, on condition that "a church be dedicated by June, 1917." A commencement was made by cutting the first turf in March, 1915; the foundation-stone was laid in July of the same year; and the consecration will take place in September next. On Sunday week, after a stirring appeal by the Rector of Birmingham, in the old church, on behalf of the Equipment Fund, the large congregation walked to the new church, where, on behalf of the builders (Messrs. Collins and Godfrey, Tewkesbury). Mr. Frankus presented the keys to Dr. Rosslyn Bruce, the energetic chairman of the Building Committee, who handed them to Mr. Ernest Hill, the senior warden. As indicating the pleasant association of the builders, the architect, and the Vicar of St. Augustine's during the progress of the work, Mr. Frankus asked Dr. Bruce's acceptance of a handsomely-engraved and inscribed gold key. The new church, in which all the seats will be free, was designed by Mr. Edwin F. Reynolds, licentiate R.I.B.A., and accommodation will be provided for about 670 worshippers. The building has cost about £8,400, all of which has been subscribed. This, however, is exclusive of a further large sum (about £1,000) required towards the equipment—namely, altar, pulpit, chairs, organ, choir seats, etc.

A bust of the Rev. Dr. Cobb, rector of St. Ethelburga's, Bishopsgate, is to be executed by Mr. Allan Wyon in bronze for presentation to Dr. and Mrs. Cobb by the congregation. The idea is that on the death of the survivor the bust shall become the property of the church.

A fine mosaic of the early sixth century Christian Church has been discovered in Palestine north-west of Beersheba, under works recently occupied by the Turks. It bears a Graeco-Syriac inscription referring in superlative terms to a Saint George whose bones were found beneath the mosaic. The latter has been somewhat injured by Turkish trench digging, but is, nevertheless, a fine specimen. It is for the present stored at a dépôt in Cairo.

Mr. Edgar L. P. Duke, builder and contractor, of Plymouth, who has died at the Royal Naval Hospital, Plymouth, was a brother of the Right Hon. H. E. Duke, K.C., M.P., Chief Secretary for Ireland and member for Exeter. Since the outbreak of war, Mr. Duke had been engaged on Government service. Deceased was fifty-nine years of age, and leaves a widow and six children. One son is on national service and two others are in the Army.

## Our Office Table.

To overcome the sanitary and economic handicaps of nipa as material for house construction, the Director of Health of the Philippine Islands and his associates have designed a model house for the islands to be constructed out of a new fireproof material invented by the Philippine Health Service. This is composed of cement, sand, and nipa, or the husks of rice, reinforced by bamboo. For what is known as a first-class mixture the ingredients are one part each of cement, sand, and nipa. This material is formed into shingles for the roof and slabs for the sides. The shingles weigh from 850 to 1,000 grammes each. Efforts have been made for some time to devise material which could be used in the construction of houses that would be cheap enough to be within reach of the poor, and at the same time less combustible than those of nipa, the building material of the poor in the islands. The annual losses by fire resulting from the excessive inflammability of nipa have been a great burden on the people. This new composition, in the judgment of the chief of the fire department of Manila, gives the model house better fire-resisting qualities.

Mr. Fred J. Hayes, chairman of the Finance Committee, Lancashire Divisional Council, writes from 55, Peter Street, Manchester.—Owing to the restriction of building by the Ministry of Munitions and the great difficulty in obtaining materials, the Y.M.C.A. are finding it almost impossible to proceed with some of their schemes for work in military camps and other centres. The need in some quarters are very urgent, and we are most anxious to meet it. One way of meeting the difficulty would be if we could have of any disused churches or chapels, institutes, or clubs built of portable materials, such as timber, corrugated iron, or asbestos sheeting, which might be presented to us as a gift, or, if this is impossible, offered to us at a reasonable figure. We could then arrange for these to be taken down and re-erected in some centre where they would be of great value for our work among the troops, munition workers, and others.

At the sixth ordinary general meeting of the British Portland Cement Manufacturers, Limited, a profit on the year ending April 30, 1917, of £125,945 0s. 7d., making, with a balance of £73,154 1s. 1d. brought forward from the previous year, a total of £199,099 1s. 8d. The interim dividends on the preference shares paid and declared for the past year absorbed £70,800, and a dividend on the ordinary shares at the rate of 4 per cent. per annum is to be paid, absorbing £55,304 17s. 7d., which leaves a balance of £72,994 1s. 1d. The adverse conditions affecting the cement trade which were alluded to in the last report have been intensified throughout the past year. In these circumstances the directors are glad to be in a position to report that the profits for the period are only less than in the previous year by £2,547.

The *Gun Tree*, a new Melbourne monthly, commences with a Foreword by the Governor-General, Sir Ronald Munro Ferguson, who does not directly accuse the Government of neglect. In an opening dialogue it is shown that forestry, or the lack of it, affects the weekly bills of every householder in the community. Two interesting articles appear on "Forests and Rainfall" and "Pines and Eucalypts," by W. Russell Grimwade. Much information from other pens, including "Victorian Forests," by A. D. Hardy, F.L.S., is given in the sixteen pages contained in the issue, and the publication should do much to educate public opinion on this subject of vital importance to all. Not only architects, but every adult, is asked to become a member of "The Australian Forest League," and to send in their names with 2s. 6d. (a year's subscription) to the Editor, Forest League Office, 57, Swanston Street, Melbourne.

One of the greatest forces produced by chemical action is that which is generated by

the swelling of quicklime, or unslaked lime, when it is brought into contact with water. The lime, when wet, swells with a force that is well-nigh irresistible. Not long ago on a big American job it was necessary to tear down a number of stone pillars 20 ft. high and 12 ft. square in a factory. Dynamite was impracticable because of near-by machinery. So holes were drilled in the pillars and filled with quicklime, upon which water was poured. The mouths of the holes were closed by tamping. In twenty minutes, as the lime swelled, the great pillars split and broke in all directions.

Last year the Victoria and Albert Museum was fortunate enough to obtain the painted bedstead, with its original Indian cotton hangings, which was made between 1770-1775 for David Garrick's villa at Hampton. The bedstead was presented by Mr. H. E. Trevor, a descendant of David Garrick's brother George, and now, through the generosity of this gentleman, with the co-operation of some admirers of David Garrick, the museum has secured the rest of the contemporary furniture which was made for the Hampton bedroom. These consist of three wardrobes, a corner cupboard, a basin-stand, a dressing-glass, and five chairs. With the exception of the dressing-glass, all the furniture is decorated in green and yellow in the same manner as the bedstead, some pieces having designs of Chinese figures and landscapes. The dressing-glass is supported by snakes in carved and gilt wood, and is decorated in a style designed to suggest the Redden china. Apart from its historic interest, the furniture presents an attractive scheme of decoration which should be useful to modern artists and decorators. It is at present exhibited in Room 57 of the Woodwork Galleries of the museum.

In Japan the cement industry is reported as particularly flourishing, the output having increased, according to the *London and China Telegraph*, from 3,741,000 barrels in 1913 to 3,943,000 barrels in 1915, and a still greater output in 1916, while exports have increased from practically none five years ago to 668,000 barrels in 1915 and a still larger export in 1916. Japan's sales have been particularly heavy in the South Seas, and a considerable trade has been built up in India, the trade in the South Seas being almost entirely at the expense of Hong Kong and the German trade. Japanese newspapers predict an output of nearly 12,000,000 barrels within two years. The Hong-Kong industry is in better shape than it has been, although the business is more restricted. Cement from the United States, it is predicted, will have no part in the trade so long as present freight rates obtain.

### TRADE NOTES.

Boyle's latest patent "Air-Pump" Ventilators, supplied by Messrs. Robert Boyle and Son, ventilating engineers, 64, Holborn Viaduct, London, have been employed at the Bump-hope Colliery, Pelton Level and Craighad.

At a meeting of the Bradford City Council yesterday, the Street Improvement Committee recommended the adoption of a scheme, approved by the Local Government Board, for providing workmen's dwellings to replace labouring-class dwellings at Victoria Road, Eccleshill. These municipal dwellings are to take the place of buildings already pulled down or intended to be pulled down.

The Norham Brick Co., of Peterborough, failed in their claim before the War Losses Committee for compensation for the military occupancy of their premises since June, 1916. It was admitted that since March that year the company had not manufactured any bricks. The Chairman of the Commission remarked that building operations being so restricted by the war, bricks were not required!

Lieut.-Colonel John Ralph Hedley, D.S.O., Border Regiment, who died suddenly from heart failure on Sunday, July 15, while on active service, was the third son of the late John Hedley, of Wooler Cottage, Wauchope, formerly of Wooler, Northumberland. He was recognised in Northumberland as an authority on the valuation of property and estates, and in 1910 was appointed to superintend the land valuation of South-East-Yorkshire.

# OGILVIE & CO.

Telephone DALSTON 1288.

Many years connected with the late firm of W. H. LANSHELL & CO., of Bunhill Row.

### Mildmay Avenue, ISLINGTON, N.

EXPERTS in HIGH-CLASS JOINERY.

### ALTERATIONS & DECORATIONS.

ESTIMATES FREE.

## FOR Oliver's' Seasoned Hardwoods,

WM. OLIVER & SONS, Ltd.,  
120, Bunhill Row, London, E.C.

### TENDERS.

\*.\* Correspondents would in all cases oblige by giving the addresses of the parties tendering—at any rate, of the accepted tender: it adds to the value of the information.

**ALDERSHOT.**—For work required at Carzate House, Aldershot, for the urban district council.—  
Accepted tenders:—Decorative work, E. J. Clinton, Union Street, Aldershot, £87 15s.; electric lighting, etc., installation, Birch and Vertue, The Arcade, Aldershot, £22 15s.

**BOSTON.**—For repairing Clough Bridge at Kirton Helms, for the Court of Sewers, E. Bett, Kirton, Lincolnshire, Surveyor of Sewers.—  
Emery and Co., 3, Holte Road, Aston, Birmingham, £235 0 0  
Lancelly and Sons, Kirton, Boston (accepted) .. .. . 199 0 0

**BOURNE (Lincs.).**—For making a dam across the drain, for the North Fen Drainage Trustees.—  
T. H. Hinson (accepted) .. .. . £900 0 0

**DORCHESTER.**—For lime-washing and repairing at the Dorchester Church of England schools during the summer holidays.—  
G. Roberts and Son, Durgate Street, Dorchester .. .. . £21 3 0  
L. Voss, Princes Street, Dorchester (accepted) .. .. . 18 2 0

**GREENWICH.**—For the removal, in wooden barges, of ashes from Greenwich generating station for periods of six or twelve months from August 1, 1917, for the London County Council.—  
W. H. Penfold, Lewisham, 48, 6d., for six months and 4s. 6d. for twelve months, per cubic yard; A. Penfold, Deptford, 38, 8d. and 3s. 6d.; H. A. Cumis, Southwark, 2s. 2d. and 2s. 2d.; H. Covington and Sons, Ltd., Battersea, 2s. 1d. for six months; C. H. Norris, Ltd., Erith, 2s. for twelve months; W. R. Cumis, Ltd., St. Dunstan's Hill, E.C. 18, 11d. for twelve months; C. Murrells Executors, Blackfriars Bridge, E.C. 1s. 1d. and 1s. 11d.; Cory Lighterage, Ltd., Mark Lane, E.C. 1s. 6d. for twelve months.

Accepted  
**HYLIFE.**—For the construction of a ferro-concrete roof for the Gas Committee. Mr. W. B. McLusky, engineer.—  
Smith Bros. (Burnley), Ltd., Turf Moor, Burnley.

**HORSHAM.**—For work on the roof trusses of Denno Road schools, for the managers of the Horsham Council Schools.—  
Rowland Bros. (accepted) .. .. . £20 0 0

**LONDON, W.C.**—For sewer works, for the Westminster City Council.—  
J. A. Ewart, Ltd., 21, Old Queen Street, Westminster, £2,507 2s. 2d. (recommended for acceptance). (Also tendered)—Bovis, Ltd., H. Boyer, J. Ford, D. R. Pater-son, Ltd., and J. Mowlem and Co.)

**LONDON.**—For painting and repairing works at Buckingham Palace Road, Great Smith Street, and Marl-hill Street baths, for the Westminster City Council.—  
J. R. Sims, 60, Horseferry Road, S.W.1 .. .. . £282 0 0  
Recommended for acceptance.

**LONDON, W.**—For decorative works and repairs at the infirmary, Marlborough Road, for the Kensington Board of Guardians. Mr. E. Flint, 80, Coleman Street, E.C.2, architect.—  
E. W. Holland and Co. .. .. . £740 0 0  
J. Roberts and Co., Ltd. .. .. . 485 0 0  
T. W. Heath, Ltd. .. .. . 427 10 0  
J. Whitaker and Son, 175, Earl's Court Road, S.W. .. .. . 414 12 6

**LITON.**—For laying new surface-water sewer from the premises of the Vauxhall Motors, Ltd., for the Luton Town Council.—  
A. J. Powdrill (accepted) .. .. . £175 0 0

**NEWPORT (MON.).**—For alterations and additions to fuel condenser, for the Electricity Committee.—  
E. Green and Son (accepted) .. .. . £741 0 0

**NORTHWICH.**—For erection of shed for the night-school, for the urban district council.—  
E. W. Bastock (accepted) .. .. . £39 3 6

**PATSHAM.**—For erection of memorial at the Indian cemetery on the Downs near Brighton, for the Brighton General Purposes Committee.—  
W. Kirkpatrick, Ltd. .. .. . £2,473 0 0  
(Recommended for acceptance.)

**WALSAL.**—For painting, etc., of various schools in the borough, for the Walsall Education Committee. Mr. J. H. Taylor, borough surveyor.—  
G. Stevenson, 80, Wolverhampton Street, Walsall .. .. . £163 10 0  
W. Harding and Son, Bridge Walsall .. .. . 54 10 0  
F. Fryer, 707, High Street, Blythe, Walsall .. .. . 28 5 0

**WALTHAMSTOW.**—For carrying out alterations and improvements to the low-pressure heating apparatus of the three-floor block Chapel End Schools, for the Education Committee. H. Prosser, M.S.A., architect to the committee.—  
Palooskar and Sons .. .. . £97 0 0  
Boyd and Co. .. .. . 93 0 0  
F. Davies .. .. . 55 0 0  
Watkin and Son (accepted) .. .. . 53 11 0

**WALTHAMSTOW.**—For providing and installing an electrically-driven pump to the heating apparatus of the three-floor block William Morris School, for the Walthamstow Education Committee. H. Prosser, M.S.A., architect to the committee.—  
Watkin and Son (accepted) .. .. . 95 0 0

**WALTHAMSTOW.**—For cutting out the old cast-iron mains and providing new small-bore steel tubing for the "Reck" heating apparatus at Selwyn Avenue Junior School, for the Walthamstow Education Committee. H. Prosser, M.S.A., architect to the committee.—  
Boyd and Co. (accepted) .. .. . £70 0 0

**WOLWICH.**—For the supply of a new float bridge for Woolwich ferry, for the London County Council.—  
Archibald D. Dawney and Sons, Ltd., Battersea .. .. . £205 0 0  
H. Young and Co., Ltd., Vauxhall Cross .. .. . 205 0 0  
Joseph Westwood and Co., Ltd., Millwall .. .. . 203 10 0  
Drew-Bear, Perks and Co., Ltd., Battersea .. .. . 187 10 0  
Accepted.

Accepted.

Accepted.

Accepted.

Accepted.

Accepted.

Accepted.

Accepted.

Accepted.

Accepted.

Accepted.

Accepted.

Accepted.

Accepted.

Accepted.

Accepted.

Accepted.

Accepted.

Accepted.

Accepted.

### TO CORRESPONDENTS.

We do not hold ourselves responsible for the opinions of our correspondents. All communications should be drawn up as briefly as possible, as there are many claimants upon the space allotted to correspondents.

It is particularly requested that all drawings and all communications respecting illustrations or literary matter, books for review, etc., should be addressed to the Editor of the BUILDING NEWS, Elgin House, 1, Arundel Street, Strand, W.C.2, and not to members of the staff by name. Delay is not infrequently otherwise caused. All drawings and other communications are sent at contributors' risks, and the Editor will not undertake to pay for, or be liable for, unsought contributions.

When favouring us with drawings or photographs, architects are asked kindly to state how long the building has been erected. It is desirable that there be some time executed, except under special circumstances.

\*.\* Drawings of selected competition designs, important public and private buildings, details of old and new work, and good sketches are always welcome, and for such no charge is made for insertion. Of more commonplace subjects, small churches, chapels, houses, etc.—we have usually far more sent than we can insert, but are glad to do so when space may be ascertained on application.

Telegram: "Timeserver, Estrand, Londo."  
Telephone: Gerrard 1201.

### TERMS OF SUBSCRIPTION.

Twenty-six shillings per annum (post free) to any part of the United Kingdom; thirteen shillings for six months; for the United States, £1 10s. (or 87 80c. gold). To France or Belgium, £1 10s. (or 87 francs). To India, £1 10s. To any of the Australian Colonies, or New Zealand, to the Cape, the West Indies, or Natal, £1 10s.

\*.\* Our Direct Subscription Agents for Australia are Messrs. E. T. Kibblewhite and Co., Printers and Publishers, 19, York Chambers, 105, Liverpool Street, Sydney, New South Wales; for Japan, The Maruzen Co., Ltd., 11-16, Nionhashi Tori Sanchoe, Tokyo; who will receive Subscriptions at £1 10s. per annum on our account. Copies of the paper will be sent by us direct to the subscribers' address.

### NOTICE.

Bound Copies of Vol. CXII. will be ready shortly, and should be ordered early (price 12s. each, by post 12s. 10d.), as only a limited number are done up. A few bound volumes of Vols. XXXIX., XL., XLV., XLVI., XLVII., XLVIII., XLIX., L., LXXI., LXXII., LXXIII., LXXIV., LXXV., LXXVI., LXXVII., LXXVIII., LXXIX., LXXX., LXXXI., LXXXII., LXXXIII., LXXXIV., LXXXV., LXXXVI., LXXXVII., LXXXVIII., LXXXIX., XC., XCI., XCII., XCIII., XCIV., XCV., XCVI., XCVII., XCVIII., C., C.I., C.II., C.III., C.IV., C.V., C.VI., C.VII., C.VIII., C.IX., CX., and CXI. may still be obtained at the same price; all other bound volumes are out of print.

RECEIVED.—Q. M. C.—J. C. S.—J. S. and Son—H. and G.—C. and B.—M. and Co., Ltd.—C. H. P., Ltd.—F. H. and Co.—W. and W.—E. C. and C. Co., Ltd.—G. R. Co., Ltd.—M. C.

L. C. P.—Yes.  
MAJOR T.—Please send.  
FRIDRUM.—Sorry; much too long.

P. M.—Good line drawings are always preferred. A. A.—Your objections seem to us ridiculous. The same nonsense was talked when women took up medicine, and we have never known a single instance that would justify your last remark.

## WANTED FOR MUNITIONS.

# OLD LEAD

## FRY'S METAL FOUNDRY,

25-30, Holland Street,  
Blackfriars,  
LONDON, S.E. 1

Hargreaves Street,  
Red Bank,  
MANCHESTER.

HOP 4720 (two lines),  
"Frymetals, Friars, London."

CITY 2026.  
"Frymetals, Manchester"

The Ministry of Munitions has recently taken over the

## Control of Lead

fixing the maximum price which may be paid for Old Lead

viz.: 26/- per cwt.

We are able to offer you this maximum price at your Works. Carriage to be paid by us. Sacks and special Munition labels will be forwarded to you if desired.

Terms—Prompt Net Cash.

# THE BUILDING NEWS

## AND ENGINEERING JOURNAL.

**Effingham House.**

Currente Calamo .. .. .	101
The Problem of the Small Dwelling and its Solution .. .. .	102
Painting a Wall .. .. .	104
Simple Apparatus Repairs Defective Concrete Columns .. .. .	104
Our Illustrations .. .. .	117
Some Wrinkles About Reinforced Concrete .. .. .	117
Paint Drying Without Drier .. .. .	117
The Effects of Grading of Sands and Consistency of Mix Upon the Strength of Plain and Reinforced Concrete .. .. .	118

**CONTENTS.**

Legal Intelligence .. .. .	118
Professional and Trade Societies .. .. .	118
Building Intelligence .. .. .	119
Obituary .. .. .	119
Our Office Table .. .. .	119
Trade Notes .. .. .	119
To Correspondents .. .. .	120
To Arms! .. .. .	120
Tenders .. .. .	120
List of Tenders Open .. .. .	120
Latest Prices .. .. .	viii.

**Strand, W.C.2.**

**OUR ILLUSTRATIONS.**

Sculpture at the main entrance Victoria and Albert Museum, South Kensington. The Prince Consort, "Aspiration" and "Knowledge." Mr. Alfred Drury, R.C.A., sculptor. Sir Aston Webb, R.A., architect.
Murray Lodge, Newmarket. The Dining-room and the Hall. Mr. Andrew N. Proctor, F.R.I.B.A., architect.
The Problem of the Small Dwelling and its Solution. Sheets xvii. and xviii. Mr. Robert Thomson, architect.

### Currente Calamo.

The President of the Local Government Board has appointed a committee to consider the question of building construction in connection with the provision of dwellings for the working classes in England and Wales and to report on methods of securing economy and despatch in the provision of such dwellings. The committee consists of Sir J. Tudor Walters, M.P. (chairman), Sir Charles Allom, Mr. F. Baines, Mr. James Boyton, M.P., Mr. W. Fairley, M.I.C.E., Mr. G. Marlow Reed, Mr. J. Walker Smith, A.M.I.C.E., Mr. J. Squires, Mr. Raymond Unwin, F.R.I.B.A., and Sir Aston Webb. Mr. E. Leonard, of the Local Government Board, has been appointed secretary of the committee. We trust "economy and despatch" includes economy of plan. The past efforts of similar committees, as we have been showing during the last eleven weeks, have signally failed to do that, and the Government itself, as we have also shown, has spent money wastefully on dwellings which in our opinion badly serve their purpose. All will be glad that the new committee is to have the invaluable aid of Sir Aston Webb, and we are glad to see the name of Mr. James Boyton, M.P., included. His long and practical experience will be most useful, especially as regards suitability of sites and their real value.

The report of the Organised Committee to consider the shortage of houses, its causes and remedies, and to formulate proposals to lay before the Government calculated to assist in solving the question of the housing of the people on the conclusion of war, is just published, price one shilling, and can be had of the secretary, Mr. Norman McKellen, A.S.A.A., York Chambers, 27, Brazennose Street, Manchester. It should be studied by all who really have this matter at heart. The principle upon which the committee approaches the housing question is that the most efficient and practical means of solving the problem is to encourage the investment of private capital in house property, thus providing a market which will justify the housebuilder in resuming his business after the war. The committee is con-

firmed in this belief by the announcement by the President of the Local Government Board that the "complete solution of the housing problem is not likely to be accomplished without the co-operation of private enterprise." The committee is widely representative of all interests in land and housing, and is entirely independent of any political organisation. It comprises representatives of associations of builders, architects, surveyors, estate agents, land and property owners, and others experienced in the production of houses for the working classes, and the report outlines the views of business men upon this important question. The report is a level-headed one, and perfectly unbiassed. The committee is not hostile to public schemes where necessary; but it emphasises the fact that, as we have again and again urged, there is no need or excuse for public authorities to embark on uneconomic schemes when private enterprise is ready and able and willing to do the work better if only allowed. In the past, moreover, the public authorities have done little but talk, while private enterprise has worked. The number of houses built in forty large areas by private enterprise from 1900 to 1916 was 354,643, or 98.13 per cent. of the whole. The public authorities have built 6,653; of the public authorities, one local authority has built 2,246, and eighteen have built none at all. That private enterprise would have continued to supply the demand is evident from the fact that from 1900 to 1906 32.40% per annum were built by private enterprise, from 1907 to 1910, 23.697 per annum, and from 1911 to 1914 only 13.750 per annum. There was no general scarcity of houses in 1910. Then came the Lloyd George Finance Acts of 1909-10, and to-day we are confronted by a house famine. Is this likely to be met by public authorities? The articles we have been publishing for the last twelve weeks show that it is ridiculous to expect it in the face of the bad and expensive planning set forth as a model. In several instances we are glad to know those articles have already stimulated private enterprise, and as soon as builders are allowed to build they will bear fruit in the erection of really economical houses, both as regards cost and fitness, and will prove the real solution to the problem of the small dwelling.

The House of Commons has made itself supremely and characteristically ridiculous over the Bill establishing the Ministry of Reconstruction. The measure is unpopular, and its purposes vague. The House should, therefore, have either accepted the Bill or firmly told the Government that it would not have it. Instead of that, the House first of all indicated its dislike to the Bill, and then when the Government intimated that it was determined to press it, reluctantly acquiesced; but any graciousness in the acquiescence was entirely spoilt by the fact that a few obstructionists were allowed to keep the discussion going until three o'clock last Friday morning. The Government did not come out of the business badly. The Whips had not got their men on the spot, and if Mr. Gulland and Mr. Rea had not whipped up reluctant Liberals to vote, the Government would have been defeated by their own friends. Mr. King and Mr. Pringle executed their usual antics during the small hours, but amendments were made on Friday, and the Bill passed through report and third reading in a few minutes. Dr. Addison is assured of his position—and his salary, but what the new department is going to cost and what it is going to do is still as incomprehensible as ever.

It is a pity when parsons preach about the housing question that they should let their zeal outrun their knowledge! The Rev. F. L. Wiseman, in a sermon at the Albert Hall, Nottingham, is reported to have said that the abnormally high death-rate of Shore-ditch is "attributable to the speculative builder." This is a remarkable instance of loose thinking and hasty generalisation, and we are glad Mr. Wiseman has been told so by Mr. Norman McKellen, the secretary of the Nottingham branch of the National Federation of House Builders, in a very pertinent letter to the *Nottingham Guardian*. Of course there are unhealthy dwellings in Shore-ditch, and the housing conditions there are responsible for the abnormally high death-rate. But no one has seen any houses of recent erection that are unhealthy to the point of raising the death-rate of a district. Modern by-laws will not permit it, and the unhealthy dwellings of Shore-ditch are old. They were probably built sixty or seventy years ago,



and we may be sure that when they were built they were reckoned to be good, convenient property with all the latest modern improvements. The old builder, now long since dead and gone, never contemplated that the Rev. Mr. Wiseman would hold him up to public execration and charge him with being the cause of the abnormally high death-rate in the far distant 20th century. The speculative builder of to-day is as anxious as any other manufacturer to produce creditable goods, but he is limited by the ability of tenants to pay rent. Notwithstanding this, he builds good houses, and is compelled to do so or he cannot sell them. He improves upon the houses of his competitors, and there are houses built during the past generation in Nottingham by speculative builders that are healthy and convenient beyond the wildest dreams of the social reformer of a century ago. It is manifestly unfair for the abnormally high death-rates of the country to be laid at the door of the speculative builder, and for the really responsible people to be absolved of all blame. If they did their obvious duty they would see that the supply of modern houses was kept up on economic lines, and thus clear away the areas which cause the high death-rates. All this is cogently pointed out by Mr. McKellen, and we hope Mr. Wiseman by now is a wiser man.

"The Trade of To-morrow," by Ernest J. Benn (London, Jarrold and Sons, 2s. 6d.), should be read by all who have perused his "Trade as a Science," and by the thousands besides who are growing nervous lest all the talk about "Reconstruction" after the war should simply saddle us with a tribe of still less successful and still more irresponsible administrators of the round-men in the square hole type, who are just now lordling it over us with all the energy of the newly fledged official. If by the time our grandchildren are ready to occupy our places in industry we are to hand over any industry at all worth pursuing, something more than the writing of platitudes and the chatter of enthusiasts will be necessary. It is certainly time for some of us to begin to make it plain to these people who are at present enjoying their brief spell of authority with high salaries and comfortable quarters that, when peace is once made, the country will not stand a continuation of anything in the nature of the numerous permits, controls, exemptions, licences, prohibitions, and badges to which it has submitted since 1914. Most of our new "Ministers" will have to retire when the war is over, or we know what will happen. Mr. Benn really makes our flesh creep when he suggests that the Prime Minister may appoint a "Minister of Building."

Fifty leading architects and builders are to send experts immediately offer their services. An organisation has to be improvised within a few weeks. The Charity Commissioners, the Governor of the Isle of Man, the King's Proctor, the Duchy of Lancaster and the Local Conservancy Board kindly lend their services if some of their clerical officials, and we trust that the new office may live up to all the high traditions of red tape the Steward and Clerk of Balmoates of the County Palatine established as "Establishment" Officer. They should then proceed to appoint a thou-

sand clerks and messengers a thousand is always the minimum. When they have exhausted the applicants with influence the public swarms in. There is no examination, no test of qualification. With this motley crew the Minister of Building manages somehow to accomplish the task for which he was appointed. The work costs five times as much as it is worth, hardship and injustice are scattered broadcast, blunders innumerable are made—but we are at war, and this sort of thing is the best we can do. As soon as the rush of work connected with the building regulations is over, the army of officials in the Hotel Royal begin to think of the future. The quarters are pleasant, the pay is good, the work unexciting, and the taste of power delicious. So a Reconstruction Committee is set up to prepare great schemes for the future. But when the war is over the fifty leading experts, who are mostly giving their services, will hasten back to their own affairs, and the brains and push and energy of the Ministry will be gone. This, of course, does not worry the professional official, in the least; he will be glad to see the back of these hustling persons, so that he can establish himself and his minions behind a permanent parapet of forms and jackets, minutes and memoranda, imposts and precedents, all, of course, in triplicate.

"Let us reconstruct," as Mr. Benn says, "by all means. Indeed, if we are to live, we must reconstruct, but at all costs the fatal blunder must be avoided of construction upon the flimsy foundation of improvised war-time makeshifts. All these hurriedly conceived and badly constituted Ministries, Controllershops, and Directorates must be swept clean away, and if good is to be done a new start made upon surer and more solid foundations." How, he sets himself to show, and we think, with success.

#### THE PROBLEM OF THE SMALL DWELLING AND ITS SOLUTION.

XII.

By ROBERT THOMSON.  
[With Illustrations.]

Now that the plans on the accompanying sheets XXI. and XXII. are available for reference, it is possible profitably to resume consideration of the all-important subject, ventilation. In last week's article the vital requirements of the occupants of dwellings were considered from the scientific points of view. This week the practical application of these requirements in regard to the dwelling itself will be dealt with. Among the broad facts brought out last week were: (1) That ventilation, which has heretofore been entirely neglected in the planning of cottage dwellings, is a vitally essential factor in the solution of the housing problem.

(2) That each adult occupant of an apartment, or his equivalent, whether in mansion or in cottage requires the delivery of a continuous supply of pure fresh air, aggregating 3,000 cubic feet per hour. (3) That with an unwarmed air supply the contained air body in the apartment cannot, without creating unpleasant draughts, be renewed much oftener than about three times an hour. (4) That in order to simultaneously meet these requirements there must, therefore, be immediately available within the dwelling for each adult occupant or his equivalent a contained air body of 1,000 cubic feet. (5) That with a system of heating capable of adequately warming the incoming air supply the limitation referred to in item 2 does not apply.

With cottage dwellings of any of the many types already in use the provision of apartments having 1,000 cubic feet of air space for each adult occupant or his equivalent would require, when built in

blocks of four, a roofed area of between 4,000 and 5,000 square feet. Even when arranged in flats with the patented wing which ensures the greatest possible economy in office accommodation, the size of the building would be prohibitively large, as may be seen at a glance on referring to plan Figs. 105 and 106 on sheet XVII. of the present Educational series. It is obvious, therefore, that anything like reasonably adequate provision in the way of house-room is impossible of attainment with any type of cottage dwelling at present in use. In case it may be suggested that the size of the apartments could be reduced if their air contents were more frequently renewed, it may be well to point out that, as already stated, not only does the necessity for comfort impose a limit to the frequency with which the air is renewed, but that the capacity of the ordinary chimney flue also imposes a limit, and that this latter is the first reached limitation when the apartment is designed to accommodate more than one adult occupant.

If the reader has not already in mind the statements which appeared in the earlier articles of this series regarding the defects of existing types of dwellings and the inefficiency of ordinary chimney flues as a means of ventilation, he should at this stage refer to these and also to the statements showing that there is only one possible relative arrangement of chimney breasts, fireplaces, chimneys, and exhaust flues, in a five-apartment dwelling in which the maximum degree of efficiency, comfort, convenience, and economy is required. As an example showing what can be economically accomplished in the way of providing adequate house-room and efficient ventilation in a cottage dwelling, let us carefully analyse the capabilities of the perfected plan of the actively-health-promoting class of dwelling shown in Figs. 116 and 117 on sheet XIX.

Beginning with the parents' bedroom, which may be meantime considered as first in order of importance, since it is in it that the younger of our future citizens spend most of the first few years of life, it will be seen that it has a floor area of 237.4 square feet. This means that its contained air body is 2,433 cubic feet gross, and that therefore with a change of air three times every hour would mean that 7,299 cubic feet of air would pass through it in that time. Allowing 3,000 cubic feet for each of the parents, there would remain 1,299 cubic feet available for the infants. As no ordinary smoke flue is of itself able continuously to maintain the required rate of outflow, because of the accumulation of soot in it, an independent exhaust flue is provided in addition to the smoke flue; and as this exhaust flue runs, throughout its entire length, alongside the smoke flue from the kitchen fire it can thus be kept in good condition. With this duplicate arrangement of flues and a properly arranged fresh air inlet the occupants of this bedroom would enjoy the benefits of an ideally perfect supply of fresh air.

Turning now to the living-room, it will be found that its floor area is 303.75 square feet, and that this, with its 10 ft. 3 in. ceiling height, provides an air body of 3,114 cubic feet.

The reader who wishes to carefully follow my remarks would do well before proceeding further to peruse the article describing my patented three-flue heat-actuated system of ventilation, unless he already has its arrangement well in mind.

In this living-room the restrictions in regard to the frequency of the renewal of its air contents do not apply, because it is

provided with a system of heating as well as a system of ventilation, so that whenever the temperature conditions require it the air supply can be adequately warmed before it is passed into the apartment. Because of this there would be no discomfort imposed upon the occupants by renewing its air contents five to six times an hour. With a 9-in. smoke flue from the living-room, a 14-in. by 9-in. exhaust flue from each bedroom, and a rate of flow of 3 ft. per second in the latter, 18,900 cubic feet of air would be passed through the living-room every hour, without taking into account the smoke flue, which would more than make good the loss due to wall friction in bedroom flues.

As the air flow in this apartment is, as has been already explained in previous articles, so arranged that it carries away the products of combustion from the illuminants without these being allowed to contaminate the air supply of the occupants, the living-room in the health-promoting class of dwelling built to the perfected plan, Figs. 116 and 117, would therefore meet in an ideally perfect way the requirements of six adult occupants.

Although mentioned last, the two bedrooms intended for the children of from six to seven years of age upwards are not the least important. The total volume of the air body which is immediately available for use by their occupants at any moment is 5,060 cubic feet. As has just been shown, the total outflow of air by their two exhaust flues would, with a rate of outflow in these flues of only 3 ft. per second, be 18,900 cubic feet per hour; therefore this would be passed through these apartments an air supply sufficient to provide six adult occupants with fully 3,000 cubic feet of air each. This rate of outflow would mean the renewal of the air contents of each of these bedrooms nearly ten times an hour. But even with this rate of outflow there need be no discomfort for the occupants, since in these apartments the slotted arrangement of the air inlet, by spreading the inflowing air in a wide wave, prevents the impingement of draughts on the occupants, the air body passing fairly uniformly downward.

With the equivalent of six adult occupants in the living-room and the parents taking advantage of their bedroom as a parlour, there would thus be provision for eight adult occupants, and the day accommodation would thus provide for the same number of occupants as the bedrooms would by night. As a family equivalent in number to eight adults would be an unusually large one, it is clear that the rate of outflow through the smaller bedrooms could in the case of families of average size be, without detriment, stopped down to suit requirements.

Considering the rate of air-flow through the two smaller bedrooms, it should be helpful to here quote Dr. Macfie, who in "Air and Health" states: "Stagnant air, however pure, is unnatural air, and any ventilation that means still air is bad ventilation. The imperceptible ventilation which is the ideal of sanitarians is a delusion and a fraud. Health requires perceptibly moving currents of air. The skin is man's broadest surface of contact with the external world, and it is not made sensitive to heat, and cold, and touch without good reason. To protect the skin from wind and cold and variations in temperature is to institute a wholly unnatural environment. Wind to the skin, variation in heat and cold, are natural stimuli of the constitution, and the natural man has a nervous system and a vascular sys-

tem that react to these and require these." "All the writers on ventilation assume that ventilation which causes any perceptible motion of cold air is not permissible. But why? Simply because the unnatural habits of so-called civilised peoples render them unduly sensitive to draughts; and because, through erroneous reasoning, cold air and draughts are considered dangerous. It is always easy to make a scapegoat of a draught, and the worse the ventilation the more certainly will a draught be discoverable. Even in a railway carriage, with every window and ventilator shut, there will be draughts pouring down the cold window-panes, and the heat of the carriage will compel thin streams of cold air to pour in through the crevices."

"Is there no sound foundation at all, then, for the almost universal fear of draughts and chills? Are draughts never dangerous? Yes, there is a certain amount of danger in the small draughts which are the result of precautions against fresh air. The danger is twofold: *In the first place*, the inmates of a badly ventilated room are living in a moist, hot atmosphere, and therefore all their skins are probably moist and warm with dilated blood-vessels. Now, when a small draught impinges upon a small fraction of such skin it naturally (like any stream of cold air injected into warmer air) abstracts from that part of the skin a large amount of heat. Under natural conditions wind blows all over the body, and the vascular system meets cold air by reducing the supply of blood to the skin and by producing more heat. But what is the nervous system to do when it receives contradictory messages from the skin—when the skin as a whole says that the air is moist and hot, and when the skin on which the draught is blowing says that the air is cold? Naturally and inevitably, the needs of the small area whereon the draught is blowing are ignored, and heat continues to be abstracted from it, with the result sometimes that chemical changes causing rheumatism are produced. The body is not intended for such fractional heating and cooling, and the blood supply to the skin cannot be arranged to suit such unnatural requirements.

"*In the second place*, small draughts are concentrated currents of air, and thus are especially likely to raise dust and germs; and ill-ventilated rooms and buildings are also especially likely to contain pathogenic germs.

"The man who protects his skin with too many shirts or too many double windows is living an unhealthy and unnatural life that will probably end in disaster. It is largely the sea breezes and the mountain breezes that make residence by the sea and in mountain districts so stimulating."

Dr. Macfie having had, of course, to take the dwellings of the people as he found them, states:—

"The ordinary house, especially the ordinary house of the poor, will never be adequately ventilated until people learn to open their windows *widely*, and understand that fresh, cold wind never gives anyone 'cold'; but, on the contrary, prevents 'cold.' It is not the engine-drivers and stokers of trains that catch 'colds'—it is the passengers in the stuffy carriages. Cold air no more causes a 'cold' than it causes scarlet fever; and all pulmonary troubles are less common where there is free ventilation.

"A 'cold' is a germ disease, and though the germ of common 'cold' is unknown, yet there is no doubt that it flourishes best in dark, ill-ventilated places. When a house is free from dust,

when it is washed out daily with sunlight and air, its inmates will be almost free from 'colds.'"

Within the dwelling "The solution of the whole dust problem, so far as solution can be found, is ventilation, sunlight, and cleanliness."

While Dr. Macfie advocates wide-open windows, it is important to note that he at the same time states that "For five months in the year open windows in England do mean considerable discomfort; but habit and a little extra food and clothing will do much to render the cold tolerable." It is probable that if he had known of the evolution of the health-promoting dwelling at the time of writing, the good doctor would have agreed that most people would prefer to have a dwelling in which during the winter half of the year they could get their full supply of pure, fresh air without laying the interior of their dwelling open to all the vagaries of the storm as they would have to do when the wide-open window is depended upon for ventilation.

Let me here point out that each of the plans on the accompanying Sheet XXII. would cost no more than its corresponding basis plan, which will be found on one or other of Sheets II. and III., when both are similarly equipped, fitted and finished, and that even the smallest of them would adequately meet every health requirement sufficient for a family larger than the average. These plans, therefore, prove that there is no economic difficulty in the way of giving the people actively health promoting dwellings in which they could live and rear their families under ideally perfect health conditions, instead of forcing them to live in dwellings in which they would have neither sufficient floor room, air space, nor ventilation.

In view of the foregoing facts, I feel impelled to repeat the statement that in England and Wales alone 250,000 lives are sacrificed every year, and that the health and strength of another 250,000 doomed ones are continuously being gradually sapped mainly because of the lack of adequate air-space and efficient ventilation in their dwellings. Besides these figures there are the large numbers of both of these classes of victims in Scotland and Ireland to be taken into account. But England, even with Wales, Ireland, Scotland, and the Isles, contains less than one-thirtieth of the world's population, and there are countries in which the sacrifice of life is relatively quite as great as in this country. It was by keeping constantly in mind this awful picture of preventable waste of life and suffering that I have been enabled to evolve the hitherto unknown actively health-promoting class of cottage dwelling, and to thereby provide the key by which alone the housing problem can be economically solved, and by its solution bring to an end the appalling sacrifice of life which the existing defectively planned dwellings in this and other countries entail.

I noticed in the public Press last Thursday that Dr. Saleeby has savagely and, I think, unfairly attacked the insurance companies, accusing them of profiting by disease. In my opinion, if the insurance companies would look into the housing question they would easily find ample evidence which would not only effectively turn the tables against the Doctor, but would enable them to join in a movement designed to secure the healthy housing of the people, the realisation of which would result in enormous benefit to themselves by effecting an enormous improvement in the health of the nation.

In this connection let me give an article which, under the heading "Baby Week Hysteria," appeared in the Press the week before last:—

"Dr. Haslip, speaking yesterday at the resumed sitting of the British Medical Association, said during the recent 'Baby Week' a fit of hysteria came over a large number of people. 'The President of the Local Government Board has stated plainly,' he added, 'that the question of infant mortality is greatly bound up with that of housing. It is a disgrace to the profession that they have not the pluck to say one word in their Ministry of Health scheme about the housing question, which lies at the very foundation of the health of the community.'"

Across plans Figs. 132 and 133, and also some earlier ones, there will be seen dotted lines. The object of these lines is to enable me to draw attention to the fact that the apartments within the dotted lines, each with its floor area of 95 square feet, would give a more actively health-promoting apartment than would the larger apartments, of which the portions dotted off are less than half. The reason is that with my patented method of ventilation in operation the air takes the short circuit, leaving that at the far end around the beds comparatively undisturbed. This has been well brought out in the extensive series of experiments and tests which I found it necessary to conduct in order to ascertain the best proportions and arrangements of the details of the ventilation system.

The plans on Sheet XXIII, are the equivalent of the mid-terrace houses, the figures for which will be found appended to each of the three plans on Sheet III.

Attention is directed to plans Figs. 133 and 139. In the former the width of the dwelling is just right, and would enable the building to be reduced in size and cost and its health-promoting properties increased by cutting off the portion beyond the dotted line.

In the latter plan, on the other hand, the living room and parents' bedroom are unnecessarily, and therefore wastefully, large. The bedroom, with its 300 square feet of floor area, is thus equal in extent to the total combined floor areas of the parlour and living-room in the Government's model plans, and its air contents about a fourth greater than the total of the two official ones in combination.

(To be continued.)

#### PAINTING A WALL.

The scarcity, badness, and dearth of wall papers, combined with the growing popularity of flat wall paints, are leading to many walls being painted which, in other times, would have been papered. The following hints from the *Carter Times* will be appreciated by those undertaking such work for the first time, and possibly even by the skilled painter.

One of the first essentials in producing a finely-finished flat-coated wall (says the writer) is that the light be good. It will not always be possible to have the light right, but when a choice can be made, do the job when the sun is out and in the forenoon, especially ceilings, which are almost the most difficult to handle from the view point of brushing. Even in the best of daylight one's eyes must be sharp and attention concentrated upon the task.

All paint mixed to dry flat is short in spread a few seconds after it has been laid on the wall. It sets quickly, so all spreading must be done immediately. Mix your material fairly thin and flow it on as you would enamel or varnish. Just as much thin paint ought to be laid on the surface as will "stay put," showing no runs or sacs.

Thin paint flows together better than thick, and that is what wipes out brush marks, laps, and joints.

Let us go through each step in the process of painting a wall, assuming, for the purpose of illustration, that the person using the brush doesn't know a thing about it. Then details for the brush action needed for best results can be clearly stated in proper order.

Have the pot half full of paint. Work the brush (a 4-in. or 4½-in. flat wall brush) well into the paint, and wipe out as dry as possible on the edge of the pot. Then dip the brush into the paint about 1 in., only, slap it on the inside of the pot to remove the surplus paint, and you are ready to coat in the wall.

Begin at brushing at the upper right hand corner, next the picture mould. An up and down stroke is much better than side strokes, and the up stroke will lay more paint than the down stroke. A lighter stroke is possible coming up, but the down stroke is also necessary. Don't ride the brush by bearing down too hard. It will cause the paint to leak over the ferrule. Start painting the first stretch about 1 ft. wide, and brush it down the same distance. One dip of the brush will carry just about enough paint to cover that amount of surface as it should be. Coat this first area in quickly and roughly, seeing only that all the surface is covered; then with light strokes of the bristle ends lay the surface off smoothly; dip the brush again as before, brush the stretch down roughly 1 ft. more and lay off with light brush strokes. Permit the light strokes only to run up over the joint.

Repeat this method of coating in one small area at a time downward until the skirting is reached, and this 1 ft. wide stretch finished, taking care to lay off and join up each section smoothly with the one before it. Never go back beyond the last area coated to pick up joints, laps, streaks, or brush marks. The paint has set. To put the brush into it lifts the sticky coat clear off the surface, leaving a bare spot. Don't try to spread this paint even a little more or the pigment will pile up on top of itself. Knowing this you can see the necessity of finishing each small area while the paint is wet and before you leave it. Flat coats flow together, level up, and wipe out brush marks only if let alone. Brushed too long, or after it has set, the flowing is disturbed, to the disfigurement of the surface. Don't play with the paint, and don't worry it. Put it where you want it, lay off smoothly, and let strictly alone, then it will take care of itself. A flat paint is flat because it leaves an excess of pigment on the surface. Brushing brings the oil to the surface and makes it glossy. Brush as little as possible.

Start the second stretch at the top of the wall 1 ft. wide, and bring down one foot at a time. Since the first paint spread was at the top of the first stretch, that portion has set most. So the second stretch had best be started at the top. Joining this second stretch to the first should be done in the same way as the 1 ft. areas are joined.

In laying off the paint, especially when joining small areas and the stretches together with a light touch of the brush, every stroke should be in a slightly semi-circular manner up and down. Straight strokes are taboo for smoothing and finishing.

Coming to a window opening, it is necessary to coat in the space above and below at the same time. That is, lay on one small area at the top and then one at the bottom. See-saw back and forth that way to keep both edges wet until you get by the window and can again carry the stretches up and down from picture mould to base board.

Should an edge set up on an unusually long ceiling before you get back to join up the next stretch, sort of wiggle stroke of the brush will help make a good joint. Lay the wet paint on next to the partly set stretch. With a light semi-circular stroke lay it over the joint a little, and then press the brush down fairly hard, nearly flat on its side over the joint. Pull and wiggle it at the same time, making wavy brush marks in the paint. Lay off again with light

strokes to smooth up. Do not take quite so wide a stretch next time across.

A word about brushes spattering and leaking. The best brush you can buy is an excellent investment for this work. Long, flexible bristles set in rubber, well trimmed and shaped, make a fine tool. Use it carefully on odd jobs for a while to break it in, but first spread the bristles and drop a table-spoonful or two of water in on the wood plug to swell it, not the bristles, if it is not a rubber-set brush. Never soak a new brush in water; it makes the bristles soft and flabby. A used brush always does better work than a new one. To stand a good brush upright with its weight on the bristles will ruin its shape, making it unfit for cutting clean, sharp edges. Hang it on a hook in an oil-bath well up on the bristles or wash it out clean and lay flat in a not too dry place.

Some brushes leak and most painters spatter. A leaking brush is not to be understood, even by its maker; the best of them do it. Of two first-class brushes made identically alike by the same people, one will leak and the other will not.

But the spattering painter can be understood. And if he will not correct the error of his ways, he should at least feel the necessity of working with a wiping cloth in one hand to remove paint spatters and the material run on to the woodwork where it is not wanted. The cutting of ragged edges, leaving the window glass and floors dotted with paint spatters, leaves a bad impression. By this means painters have educated fussy owners to consider them a messy lot and an inconvenience not to be courted when it can be avoided.

#### SIMPLE APPARATUS REPAIRS DEFECTIVE CONCRETE COLUMNS.

Too dry a concrete, not puddled enough, was the cause of peeling and disintegration at the bottom of columns. These columns, 15 ft. high and 20 in. square, were reinforced with eight 1½-in. rods bound with spiral reinforcement. A satisfactory repair was made in the following manner, which is described by J. D. Evans in *Engineering News-Record*:—

The concrete was cut off level, and a wood form placed around the bottom of the column—the top board leaning out so as to form a hopper—and a piece of ½-in. pipe was put in at the high point of the cut, extending from the centre of the column out through the

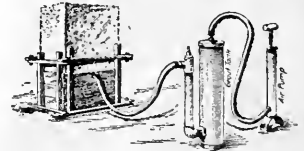

Voids in repaired portion of column filled with grout forced in by tire pump.

form. A fine gravel concrete was put into the hopper, thoroughly rammed, and allowed to set for about two weeks. The forms were removed, and the patched part was trimmed to conform with the rest of the column.

The voids in the repaired portion of the column were then filled with pure cement grout forced in through the pipe by a compressed-air apparatus made from a piece of 5-in. water spout, the top being sealed and having a valve from an automobile tire set in the centre, as shown in the drawing. The bottom was sealed also. From near the base a smaller pipe extended to about the top of the tank. After the grout had been poured in, this was connected by an air-tight line to the pipe cast in the column. By the use of an automobile-tire pump, the grout was forced into the voids. After pumping for some little time, water could be seen seeping out on the sides of the columns, showing that the scheme was working out satisfactorily. Several buckets of grout were forced into a few columns, and undoubtedly filled all voids due to the shrinkage of the concrete.





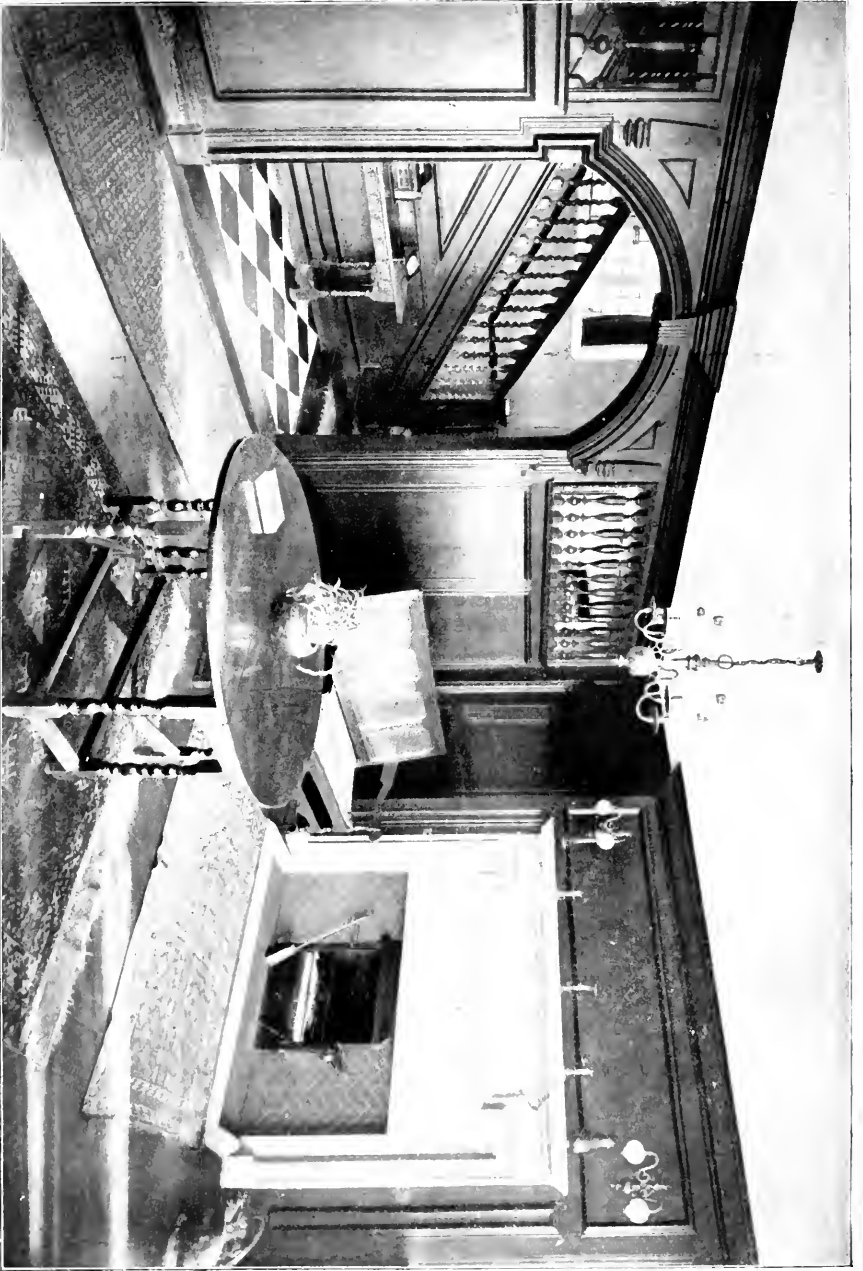

*Photo by J. B. P. Co.*  
MURRAY LODGE, NEWMARKET: THE HALL. MR. ANDREW N. BRESNICK, ELLI. A. ARCHITECT.





THE QUEEN

SCULPTURE AT THE MAIN ENTRANCE, VICTORIA AND ALBERT MUSEUM

THE PRINCE ALBERT

MR. ALFRED DRURY, R.A., Sculptor



...CDSORT.  
RT MUSEUM, PRINCIPAL FACADE, SOUTH KENSINGTON, S.W.  
F. ASTON WELLS, R.A., Architect



THE BUILDING NEWS, AUGUST 8, 1917.

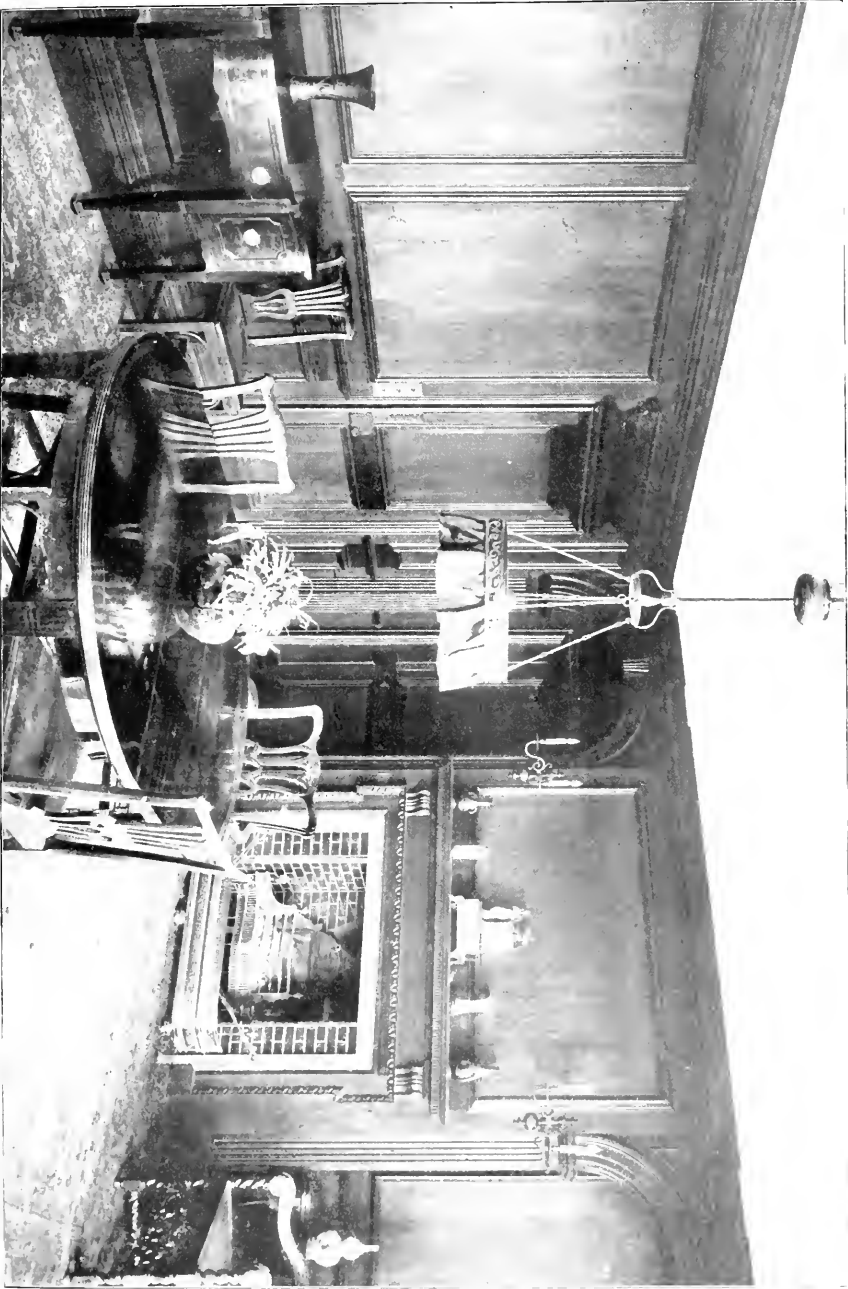

THE DINING ROOM.





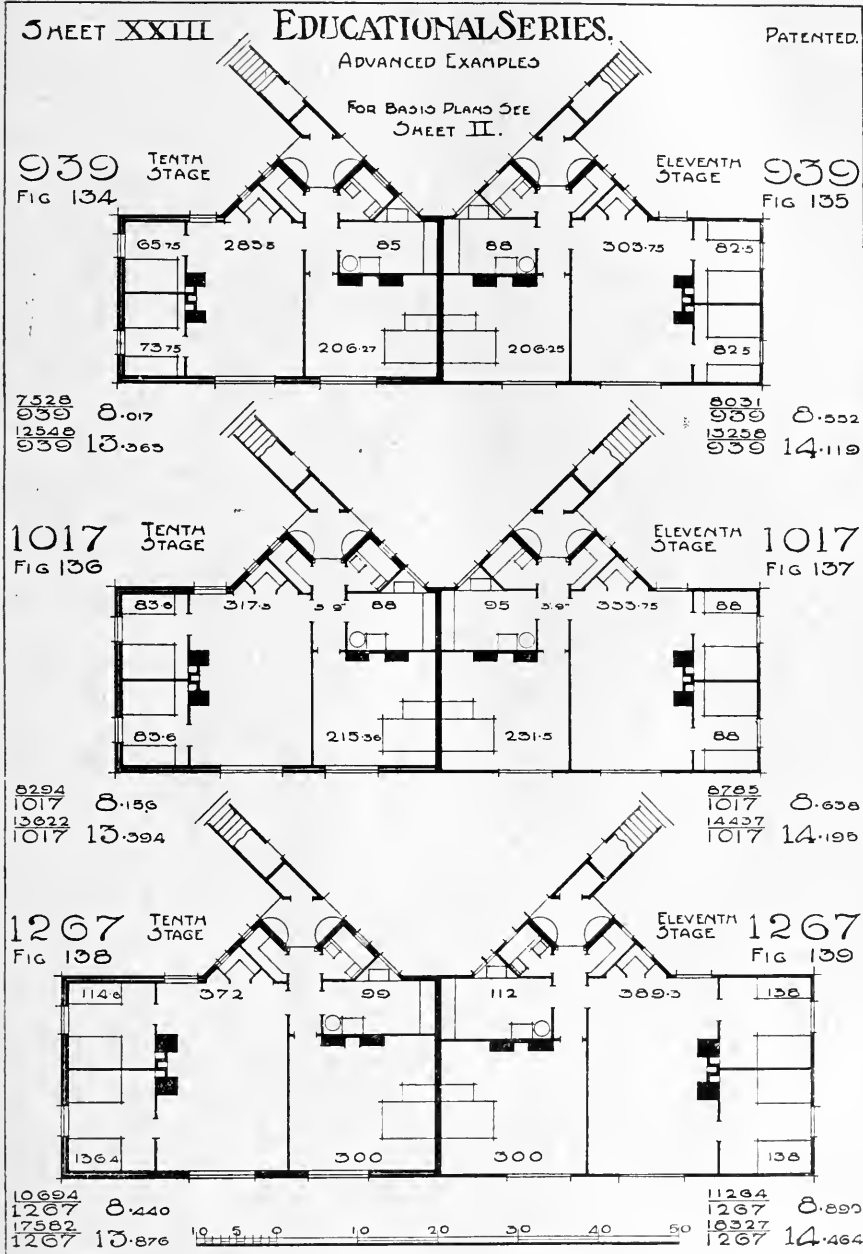

THE PROBLEM OF THE SMALL DWELLING AND ITS SOLUTION.  
 By Mr. ROBERT THOMSON, Architect.

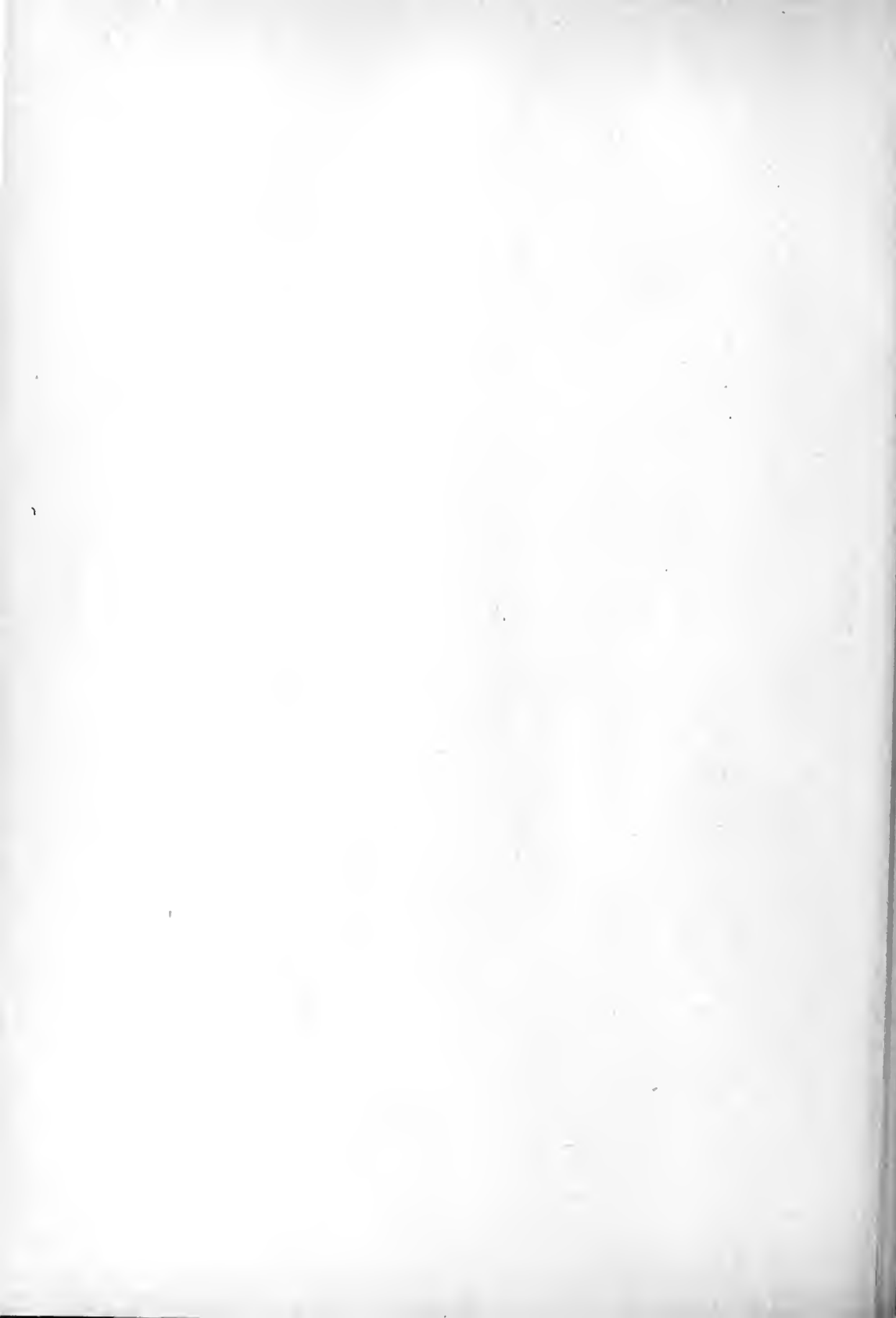

## Our Illustrations.

### SCULPTURE AT THE MAIN ENTRANCE, VICTORIA AND ALBERT MUSEUM, SOUTH KENSINGTON.

The archivolts panels illustrated from the photographs exhibited this summer at the Royal Academy by Mr. Alfred Drury, R.A., were illustrated in *THE BUILDING NEWS* June 27 and July 4. The first group of statues, with Queen Victoria in the centre, appeared in our issue for July 18. To-day we complete this series of illustrations by a further double-page plate giving the Prince Consort at the age of forty, and statues of "Inspiration" and "Knowledge." The whole of this sculpture is the work of the same artist, Mr. Alfred Murray, R.A. Sir Aston Webb, R.A., is the architect. There is nothing to add to the previous brief descriptions given, in the main, on June 27.

### MURRAY LODGE, NEWMARKET: THE HALL AND DINING-ROOM.

These two photographs represent the simple treatment of the interior of Murray Lodge at Newmarket, built some few years ago for Mr. D. Malcolm Scott. Both the hall and dining-room are apartments about 23 ft. long, with ceilings about 9 ft., 6 ins. from the floor. A pleasing effect has been obtained by panelling the whole wall surface in wainscot oak. Messrs. Parnell, of Bugby, were the general contractors, and the same firm carried out the whole of the joinery in an excellent manner. Mr. Andrew N. Prentice, F.R.I.B.A., of Hastings House, Norfolk Street, Strand, is the architect.

### THE PROBLEM OF THE SMALL DWELLING AND ITS SOLUTION.

These plans and articles have continued week by week in *THE BUILDING NEWS*, commencing with May 23, with descriptions by Mr. Robert Thomas. The dates for reference are May 30, June 6, 13, 20, and 27, July 4, 11, 18, and 25, and August 1. The present sheets are numbered XXII. and XXIII.

### SOME WRINKLES ABOUT REINFORCED CONCRETE.

#### BONDING STRENGTH OF PAINTED RODS.

Tests of painted rods for bonding strength with concrete have been made by the Boston Transit Commission of Boston, Mass. The paints were first given weathering tests and tests for action when in contact with alkali water, acid water, and sea water. The results of these tests were very varied, some of the paints failing badly to pass the weathering tests and the alkali water test, both of which tests should be passed by any paint used by the Commission.

For the bonding test, plain round 3/4-in. steel rods were carefully cleaned and cut in 24-in. lengths. After being painted with the requisite coats of paint and allowed to dry for a proper time, the rods were embedded for 11 inches of their length on the long axis of concrete cylinders, which were 12 inches long by 6 inches in diameter. The concrete was proportioned by volume 1 part of cement to 2 parts of sand to 3 parts of broken stone (sized 3/4-in. to 1 1/2-in.). The rods were allowed to set in the concrete blocks, undisturbed for two months. Three rods of each series were then pulled out of the concrete in a testing machine at the Massachusetts Institute of Technology, under the direction of Professor H. W. Hayward, and the bonding strength of the painted rod with the concrete measured. Some plain, unpainted rods had been buried in cylinders and the bonding strength of the painted rods was found to be much less than for these. The best bonding strength of any of the painted rods was only about one-fifth that of the plain rods. The second best bonding was only about one-sixth that of the plain rods. The other paints gave bonding strengths between 2 per cent. and 10 per cent. of the plain rods.

#### KEEPING REINFORCING BARS IN POSITION.

The holding of reinforcing bars in proper position while concrete is being placed is a matter which merits the utmost attention.

The labours of the best designer and detailer can be set at naught by the carelessness of those in charge of the construction of reinforced concrete structures, while placing steel and concrete.

A designer spends many days designing and detailing a complicated structure, the strength of which can be greatly impaired by comparatively slight displacement of the reinforcement at critical sections. Much time is spent in designing and detailing the reinforcement for a structure, and the all-important matter of getting and keeping the bars in correct position is disposed of by a single note, such as the following: "All reinforcement to be bent and placed as shown on plans and to be securely fastened or tied to prevent displacement during pouring of concrete and to insure proper position of reinforcement in the finished structure." It is left to the discretion of the construction foreman to devise a means of keeping the bars in position, and as a result the strength of the structure may depend on whether the foreman thoroughly understands his business or not.

This is neither good practice nor economy. The method and means of supporting reinforced bars should be clearly indicated on the plans, since they are as important details as the location of bends of bars and stirrups. It is just as important to show the supporting bars, supporting blocks and clips, and the spacing bars, as it is to show the main reinforcement in detail. Before the structure can be built it is necessary for someone to devise a means for keeping bars in position during construction, and, as a general rule, a good designer is more capable of handling these details to good advantage than anyone else.

#### GLUE Moulds FOR CONCRETE.

Multiples of small concrete ornamental members like ballusters, handrails, etc., have been advantageously cast in moulds made of ordinary glue. The wooden pattern is nailed to a board and enclosed with shallow sides, making an open box higher than the pattern, which is filled with melted glue covering the pattern to a depth of about an inch. After the glue is set it is turned bottom side up and the bottom and pattern removed, leaving a mould which is painted with white lead followed with shellac to prevent the absorption of moisture.

The mould is good for a large number of castings, and can be cut up, melted, and used over again with a loss of about 18 per cent. It is very tough and rubbery, and should be cut with a knife into about 1 1/2-in. cubes, which will melt in three or four hours.

#### PAINT DRYING WITHOUT DRIER.

From the *Railway Review* of Chicago, we learn that a notable innovation has been introduced on the Pennsylvania Railroad in the method of painting their passenger coaches; it has worked successfully for over four years and may now be taken as established on the railway. A large oven is used which takes in a complete carriage and the process of painting is, briefly, as follows:—

The car is first painted complete, both inside and outside with priming coat, run into the oven and kept there for three hours under a temperature of about 250° F. It is then removed, putty is applied to fill up all depressions and the surface glazed, after which a number of surface coatings are applied dependent on the nature of the surface of the steel of which the coach is built. Sometimes a single coat suffices, sometimes as many as four coats have to be applied to give the necessary body. After the application of each coat it is baked. The surface of the coach is next rubbed smooth with emery cloth and oil till it is quite smooth and flat. The various colours, as required, are then applied in two coats, each coat being subjected also to baking. The striping, lettering, etc., is then added and the surface is given two or three coats of high grade baking finishing varnish which complete the process, but on the inside some of

the gloss of the varnish is removed by rubbing.

The oven, which is 90ft. 3 ins. in length, is heated by means of steam coils, there being a control which regulates the flow of steam to the coils and thus gives any desired temperature. It is lined with a 1/2 in. steel shell insulated with magnesia lagging 3 ins. thick; and behind the lining is a jacket of galvanised iron. The doors are insulated with the same kind of lagging which is held in position by steel plates on the outer and inner sides. There are ventilators on the sides for the admission of air and also four roof ventilators for the volatile elements of the paints. This system of oven baking is particularly suited to steel coaches which expand and contract under temperature effects twice as much as wooden coaches, so that naturally the paint on them is more liable to crack.

Artificial driers dry in from one to two days' time, but they continue to act in a slight degree for a long time after, making paint or varnish slowly more hard and brittle and so more liable to crack or disintegrate under expansion and contraction. Careful experiments were first made by the chemical and physical testing departments of the Pennsylvania Railway together with the master painters which showed that by baking each coat of paint or varnish the use of artificial driers could be largely or entirely eliminated; that once the heated air has dried therein no further change occurs in their condition. Hundreds of such tests were made on small panels, then in 1913 a full sized oven was got ready which has been in continuous service ever since. A car painted by means of it has been in continuous service for 34 months and remains quite good; it is to run so for another three or four months and then is to be returned to have the colour touched up only where abraded, then varnished by the baking process and returned to service. Two additional ovens are now being provided, and it is probable more will follow. The following advantages are claimed for the system:—

- (1) The durability of the various coatings is doubled.
- (2) The inside appearance of the coach continues as good as new for a very long time and there is no cracking of the varnish.
- (3) The outside of the coach is not embedded with black dirt and soot and consequently remains bright and clean for a long time.
- (4) The time for keeping a coach in the shop for painting is reduced from 16 to 5 days.
- (5) The number of coaches in the shop at any one time is not over one half the number under the old system.

The death is announced, on July 29, of John Stephen Westlake, B.A., son of Mr. N. H. J. Westlake.

The death is announced, accidentally killed at Colchester Station on July 30, of John Marshall, only son of C. J. Trevarthen, late of the Bank of England and the Artists Rifles, aged twenty-nine years.

Mr. Rayner Starr, aged 82, of Fitzjohns Avenue, Hampstead, formerly a partner in Debenham, Starr, and Sons, Limited, auctioneers, King Street, Covent Garden, has left £25 to the Auctioneers' Benevolent Fund, and a total of £73,453.

At an inquest at Liverpool on July 31 on the bodies of Arthur Carter, surveyor of the Liverpool District Council, and Robert Forshaw, labourer, whose bodies were found in a sewer, the jury found that death was due to asphyxiation, expressing the opinion that the gas came from a certain factory. The evidence showed that Carter put on a respirator, but Forshaw would not. Workmen, it was stated, never used them because they were in the way.

The Orange Street Church, Leicester Square, built by the Huguenots in 1688, and together with Sir Isaac Newton's house, demolished in 1913, has been replaced by a new building, which was opened a few days ago. For the first hundred years the church was held by the Huguenots; then came the Anglican period, in the course of which Toplady, author of "Rock of Ages" served as minister. During the last 15 years the church has been in the hands of the Congregationalists.

### THE EFFECTS OF GRADING OF SANDS AND CONSISTENCY OF MIX UPON THE STRENGTH OF PLAIN AND REINFORCED CONCRETE.

An interesting paper was read by Mr. L. N. Edwards, supervising engineer of bridges for the city of Toronto, at the recent convention of the American Society for Testing Materials, held in Atlantic City, June 26 to 29, on "The Effects of Grading of Sands and Consistency of Mix upon the Strength of Plain and Reinforced Concrete." The paper presented the results of three series of tests made by the Department of Works of the city of Toronto, under the direct supervision of Mr. Edwards. These tests were undertaken with the object of securing information relating to (1) the influence of the grading of sand; (2) the effect of the consistency of mix upon the strength and physical characteristics of the concrete properties; and (3) the effect of varying the time of mix. The author drew the following conclusions:—

#### COMMON PRACTICES UNRELIABLE.

1. The commonly practised "visual examination" test of sand aggregate for concrete is generally unreliable, since it gives at best only a superficial knowledge of the cleanliness of a given sand.

2. The generally accepted practice of proportioning a concrete mix by volume, as, for example, 1 part cement, 2 parts sand, and 4 parts broken stone, is impracticable and unscientific, since it does not take into account the adaptability of the grading of a given sand to the production of a dense, strong, and reliable concrete. Proportioning by volume, as commonly used, gives no guarantee of the production of a concrete having a desired strength, hardness, or other physical properties.

3. The strength, toughness, and durability of the concrete to be secured from the use of a given sand can be determined only by an actual test of that sand in a properly prepared concrete.

4. In field operations incident to spading, slicing, or otherwise compacting the concrete, the movement of the water content of the mass is intensified whenever the sand aggregate contains insufficient fine material to hold the cement in suspension by the formation of an adequate amount of sandy paste. The free movement of the water tends to produce an improper distribution of the cement.

#### AMOUNT OF WATER.

5. The use of a quantity of water sufficient to produce a concrete, the mortar component of which is of a saturated, sticky, semi-plastic consistency, is for most practical purposes required in order to facilitate economical and efficient placing. This quantity of water is ample for the development of the proper functions of the cement. An increase in the quantity of water used results in a proportional decrease in the strength of the concrete. This decrease is in no sense a function of the proportions of the mix.

6. The excess water in an over-saturated concrete necessarily occupies space and thereby links-up the mass. By reason of its high surface tension, it forms water globules which, although somewhat affected by the weight of the concrete, are, nevertheless, distributed throughout the mortar component, and are accumulated underneath the particles of the sand and stone aggregates and the reinforcing steel. By evaporation, this excess water ultimately disappears, leaving a considerable volume of water voids and cavities which constitute an extremely important factor in the strength and reliability of the concrete.

#### BOND BETWEEN CONCRETE AND REINFORCING.

7. The usual failure of reinforced concrete depends upon the intensity of the bond existing between the concrete and the steel reinforcement. Concrete containing an excess of water not only develops less surface contact with the steel on account of the resulting increase in the volume of water voids and cavities, but, in addition, the excessive moisture provided by the water tends to accumulate around the reinforcement, thus contributing materially to a decrease in strength. This condition becomes further aggravated by reason of the tendency of the latter to become less resistant with age.

8. For the various grades of concrete, the minimum ultimate strengths assumed in the modern practice of plain and reinforced concrete design are not assured by the commonly specified requirements for sand and stone aggregates, and by the present lack of uniformity and of efficiency in field methods and operations.

9. The results obtained show no definite relation between the compressive strengths of 1:3 mortar cubes and the compressive strengths of the concrete produced from the same sands.

In the course of the paper the author took occasion to submit the following specifications for a cement to be used for general concrete purposes.

Sand shall be of hard, preferably silicious, material, clean, rough free from dust, soft particles, vegetable loam or other deleterious matter. It shall consist of particles graded from coarse to fine, of sizes that will pass, when dry, a sieve having 4 meshes per linear inch. The grading of particles shall otherwise conform to the following:—

Not more than 80 per cent. shall pass a sieve having 10 meshes per linear inch, not more than 55 per cent. shall pass a sieve having 20 meshes per linear inch, not more than 15 per cent. shall pass a sieve having 50 meshes per linear inch, and not more than 5 per cent. shall pass a sieve having 100 meshes per linear inch. Upon the 10, 20, and 50-mesh sieves an allowable variation of 5 per cent. will be permitted.

Sand, when combined with a normal Portland cement and 1-in. broken granite, limestone or trap of good quality in the proportions 10 lb. of cement, 21 lb. of dry sand, and 35 lb. of dry broken stone, thoroughly mixed with 4½ lb. of water for not less than 1 minute, and moulded into cylinders 6 in. in diameter by 12 in. long, shall develop a compressive strength of 1,300 lb. per sq. in. when tested at the age of 7 days and a strength of 2,200 lb. per sq. in. at the age of 30 days. Strength shall be determined from an average of five cylinders tested at each age. The cylinder shall be removed from the form 24 hours after moulding, and shall be stored in a moist closet or in damp sand until tested.

Sand failing to develop the above strengths may, at the option of the engineer, be accepted for use, provided that the proportion of cement be increased by an amount sufficient to fulfil the strength test requirements.

### LEGAL INTELLIGENCE.

**CONVICTION AGAINST ROSYTH CONTRACTORS QUASHED.**—Lord Hunter has issued judgment in the appeal by a London firm of contractors at present erecting houses at Rosyth for the Scottish National Housing Co., Limited, who, in June last, were fined at a General Munitions Tribunal in Edinburgh £10 in respect of each of five workmen whom they had taken into their employment without clearance certificates. These men had been in the employment of a company at their brickworks at Rosyth, and it was at the instance of the company that the complaint was taken, as the men had left without notice. The London firm appealed to Lord Hunter, as Judge of appeals, maintaining that the contractors had no title to make the complaint, and that on the fact as established no offence had been committed by the complainers. Lord Hunter has sustained the appeal, quashed the conviction, and found the respondents liable in expenses, modified to 5 guineas. In the course of his note, Lord Hunter said the complainers were engaged in making bricks of a special quality for the Admiralty, but they were neither fire bricks, nor silica bricks, and they also had a contract for the supply of pug clay to the Methil Docks. The complainers maintained that their establishment was of a class dealt with by the Order of July 1, 1916, which extended the provisions of the Munitions Acts as to the prohibition of the employment of persons who had left munition work to "any establishment engaged in the construction, alteration, repair or maintenance of docks and works in estuaries." He did not see how it could be maintained that an establishment where materials were manufactured for use in construction or repair was therefore necessarily an establishment for construction and repair. No one could say that a brickworks supplying a contractor with bricks for the erection of a build-

ing was constructing the building, although without the material the construction work could not proceed. The contracts of the complainers were not in any sense to construct, alter, repair, or maintain any works, but to supply materials. In defining munitions work, the Act of 1916, Section 9 (1) (a) included the terms to the manufacture "of the materials of any class specified in an Order made for the purpose by the Minister of Munitions, required for, or for use in . . . the manufacture or repair of arms, ammunition . . . and . . . other articles . . . intended or adapted for use in war." This showed the distinction which the Legislature drew between the manufacture of articles themselves and the materials used in such manufacture. In dealing with the construction, alteration, or repair of works of construction and buildings for naval or military purposes in Section 9 (1) (b), no provision similar to that in 9 (1) (a) was made for the extension of munitions work to the manufacture of materials used in such construction.

**LONDON BUILDING ACT.**—The Tribunal of Appeal, consisting of Mr. Arthur A. Hudson, K.C. (chairman), Mr. John Slater (architect), and Mr. Howard Martin (surveyor), sat at the Surveyors' Institution last Wednesday to hear an appeal in reference to connecting the Clifton Hotel with 46, Welbeck Street, Cavendish Square, W. The action was entirely a friendly one, and the District Surveyor had helped the appellants in every way. It was intended to utilise 46, Welbeck Street, which had lately been acquired by the owners of the hotel, as a sort of drawing-room and lounge in which light refreshments could be served. Objection was taken by the existing Surveyor, who insisted that all the existing staircases should be fireproof, and also that the lobbies and landings of 46, Welbeck Street, the added house, must be of fire-resisting material.—The Chairman said the tribunal agreed that Section 68 should be a positive enactment that a public building should be constructed of fire-resisting materials, and that he had no jurisdiction to review the District Surveyor's decision in that respect. Obviously the section was a very important one, and went to the root of questions affecting the safety of the public. Once they had converted one building into a public building by joining it with another, the only person to see that it was made fireproof was the District Surveyor. There was a right of appeal to the District Surveyor exceeded the requirements of Section 68.—The appeal was dismissed with costs, although the tribunal considered the suggestion made by Mr. Slater to clear away the cellars in the basement and make a corridor with a glass roof over would solve the difficulty.—Mr. Asbridge said there would be no objection to the glass roof so long as the front was open.

### PROFESSIONAL AND TRADE SOCIETIES.

**NORFOLK AND NORWICH ARCHEOLOGICAL SOCIETY.**—A summer excursion of the Norfolk and Norwich Archeological Society took place on Monday week in the Waveney Valley, extending into several parishes of Suffolk, and exploring a border region which the society had not previously covered since 1861. The Guildhall and fine church of Beccles were first visited, and then Kross Hall, Barsbam Church (where the Rev. Allan Coates furnished explanations of a bit of flint in the Decorated age). It has a round western tower containing five bells, one of which dates from about 1550. The churchancel screen is Jacobean, and so also are the pulpit and font. Mettingham Castle, built by Sir John de Norwich, who died in 1361, is now only represented by a gatehouse and some ivy-clad masonry in ruins. Sir John de Norwich, the builder of the castle, obtained permission to castellate as a reward for his services in the French wars. He was the son of Sir Walter de Norwich, of a family who are believed to be descended from the Bigods, Earls of Norfolk. During the eighteenth century a Mr. Safford pulled down an old farmhouse, which occupied the interior of the fortification, and built the present mansion. Some visits were paid to places of interest in Bungay, mainly remarkable for their ruinous condition. It was there that Hugh Bigod, who was chiefly responsible for the accession of King Stephen and later took sides with Matilda, sustained a famous siege that in the end resulted in his surrender. Ditchingham Church, dedi-

ated to St. Mary, is built of flint and stone in the Perpendicular style. A brass to Philip Bosard, Margaret his wife, and their nine children, dated 1490, appears in the chancel. Roger Bosard, 1566, is commemorated by a brass in the nave. By the kind invitation of Mr. William Carr, the members took afternoon tea at Ditchingham Hall. Later on they called at Kirstead Hall, a delightful old house, characteristic of the style of its period—1614, according to a date appearing over the main doorway; and finally they called at Forningland Church.

## Building Intelligence.

**SCOTSWOOD-ON-TYNE.**—The new church of St. Margaret, Scotswood, was consecrated on Saturday week. The building is situated at the junction of Denton Road and Armstrong Road, and has been designed in the style of architecture which prevailed at the end of the fourteenth century and with tracered windows. The roof is covered with red rosemary tiles, and the outer doors and the spirelet are of oak. The floors of the chancel and the baptistry are laid with mosaic. The total length of the church, internally, is about 120 ft., and there is accommodation provided for 550 people. It has been erected at a cost of about £6,500. The work has been carried through by the Rev. G. C. Harris, B.A., who has been in charge of Scotswood for the last five years. Among the gifts to the church may be mentioned the oak reredos and frontals, the carved oak pulpit, the brass lectern, the carved stone font, and the silver chalice. It is hoped that the east window will be filled with stained glass after the war.

### OBITUARY.

Henry Vaughan, the well-known American architect, died at his home in Boston on June 30. He was seventy-two years old. Our contemporary the *American Architect* says:—"He was an influence rather than a personality to the younger men, and a personality which was felt indirectly rather than by the actual work which he accomplished. A man who was of very retiring disposition, modest to the last degree about his own achievements, mingling but rarely with his fellow architects, never accepting a commission unless he could personally attend to every detail thereof, his whole life wrapped up in the art of his profession, endowed with a sense of fitness which is reflected in every line of his finished product, a man who exerted a surprising influence in an almost absolutely unseen manner. We knew Mr. Vaughan as typifying the best and purest expression of English Gothic architecture which this country has seen. He was never at fault for artistic expression, never in doubt as to what was the right thing to do, and absolutely refused to do anything but what his architectural conscience told him was right. The fundamental principles of good architecture were so thoroughly understood by Mr. Vaughan that with his intense devotional spirit, his buildings could not fail to have a high value, and he worked on up to the very month of his death without any diminution of this earnest spirit."

Lieutenant Henry Herbert Bradshaw, of the Royal Engineers, who was an assistant to Mr. S. S. Platt, the borough surveyor, and lived at 153, Ashfield Road, Rochdale, was killed on July 22. While leading his men a shell burst, and Lieutenant Bradshaw was so severely wounded that he died soon afterwards. Deceased, who was thirty-three years of age, enlisted in May, 1916, as a sapper in the Engineers. Later he was recommended for a commission, and underwent training at Newark. Lieutenant Bradshaw got his commission in February of this year and went to France in May. Lieutenant Bradshaw was an associate member of the Institution of Civil Engineers, and a Professional Associate of the Surveyors' Institution. Deceased had a very kindly disposition, and he had made many friends since going to Rochdale. He was married to September, 1915.

We regret to announce the death on Saturday last of Mr. C. W. Stephens, the senior

partner of the firm of Messrs. Stephens & Alunt, of 49, Hans Road, S.W., the architects of the new block of premises, Regent Street, forming part of the scheme prepared by the Office of Woods and Forests on behalf of the Crown, the double-page sheet of details of which, reproduced from the working drawings of Mr. Henry Tanner, jun., we gave in our issue of January 26, 1916. They were also the architects of the large hotel in Piccadilly, overlooking the Park, which is at present in a half-built condition. The firm also built Harrods' Stores and a series of flats and other important structures in Chelsea and the South-west district of London.

## Our Office Table.

The Local Government Board have issued the following statement. The Courts (Emergency Powers) Act, 1917, which has recently received the Royal Assent, has made amendments in the Increase of Rent and Mortgage Interest (War Restrictions) Act, 1915, which are of interest to tenants of houses to which the latter Act applies. By virtue of the new Act a tenant can recover from the landlord any amount paid by him in excess of the standard rent fixed by the Act of 1915 and irrecoverable under that Act, at any time within six months from the payment, or from July 10, 1917, if the excess was paid before that date, and he may without prejudice to any other method of recovery deduct it from rent payable during such six months. Cases have been mentioned in which landlords or their agents have entered up as arrears in rent books sums which by the Act of 1915 were declared to be irrecoverable. Under the new Act any person who after July 10, 1917, makes an entry in a rent book for similar document showing or purporting to show any tenant as being in arrear in respect of any sum which by virtue of the Act of 1915 is irrecoverable, and any landlord who does not on the request of the tenant delete any such entry made before that date, is liable on summary conviction to a fine of £10.

A useful treatise on "Smoke Abatement," by H. Hamilton, A.R.San.I., etc. (Manchester: Sherratt and Hughes, 36, Cross Street., 5s. net.), is mainly devoted to the nuisance as perpetrated by mechanical furnaces, but there is much other practical information given in a plain, straightforward fashion by the author, who is a qualified smoke inspector and has evidently had experience of the pigheadedness of workmen, the parsimony of employers, and the tolerant indifference of local authorities, which are responsible for the neglect of the perfectly practicable publicitary means by which the waste of coal and the pollution of the atmosphere might be in a very great measure avoided. It always has been so since the days of Queen Elizabeth, in spite of committees and commissions almost as numerous as the members and controllers of the present Government. Just now, in London, there seems a tacit tolerance of all breaches of the smoke prosecution laws, and we regret Mr. Hamilton's excellent advice is likely to fall on stony ground as far as the metropolis is concerned. To some of our sleepy borough councils, and to all local authorities and officials we advise especially the purchase and study of his book.

A supplementary report to the Report of the Commissioners appointed to inquire into the cause of the industrial unrest of the North-west area of England, which includes Lancashire, deals especially with the conditions at Barrow. The general propositions as to industrial unrest are much the same as in the remainder of the area, but the geographical isolation of the town sets up special problems. Chief of these is the housing question. Barrow has had a large influx of new population, and the housing question has thereby been greatly aggravated. For three years the population had been constantly increasing, and there was no evidence that the Government or the municipality had taken any practical steps to deal with a problem that had become a crying

scandal. On the other hand, the Vickers Company had tackled the question, and by the end of 1915 had had erected 520 modern cottage houses.

The Rev. J. Willis writes from the Vicarage, Defford, to the *Guardian*:—"There is in the little half-timbered church of Besford, near Worcester, an ancient memorial triptych. It was placed there in the last quarter of the sixteenth century. The historian Hallanger, writing about the year 1620, described it in the following manner:—"There is in the wall of this chappell the monument of a chylde within leaves of wayncott which, opened, show the tombe. The leaves being opened, there appeareth highest of all our Saviour on the Raynbow sitting in judgment, and underneath the resurrection of the dead. Beneath a chylde praying, and lowest of all a chylde layde out for buriall. On the right hand Tyme with his sythe, on the left Death with his dart. Under Tyme a chylde presentinge a flower. Under Death a chylde blowing a bubbell." The whole is now difficult to discern, yet parts may be clearly seen. Have any readers knowledge of anything similar? We should like to be able to make a fair copy of it."

At a meeting of the London County Council last Tuesday an application was made for a music and dancing licence for a theatre proposed to be built on a site in Golden Square and Warwick Street, W., adjoining the Church of the Assumption. Father Brown, of the Presbytery, Golden Square, the trustees of the Church of the Assumption, Warwick Street, and the Catholic Federation had raised an objection to the proposals, on the ground that the erection and licensing for public music and dancing of a place of entertainment would inevitably cause grave scandal, annoyance, nuisance, and inconvenience to the congregation of the Church of the Assumption. The architect for the theatre stated that, although the building would be provided with a sliding roof, he was of the opinion that no sound from the theatre would be audible in the church, and that any disturbance of the church services would be impossible. He admitted, however, that the stage door would be situated within a few yards of the Presbytery door; but he contended that no nuisance would be caused thereby to the residents. The Council resolved itself into committee to discuss the details of the proposal. On the resumption of the sitting it was decided to reject the application for a licence. Consequently, the theatre will not be erected on the site submitted.

The Department of Technology of the City and Guilds of London Institute, Exhibition Road, London, S.W.7, have issued their programme for the session 1917-18. It is published, at the price of 9d. net., by John Murray, Albemarle Street, S.W.1. It covers over 80 technological subjects in which examinations are held. The book contains over 400 pages of regulations for the registration, conduct, and inspection of classes and examination of candidates, and for the award of teachers' certificate in manual training and in the subjects dealt with.

### TRADE NOTES.

Boyle's latest patent "Air-pump" ventilators, supplied by Messrs. Robert Boyle and Son, Ventilating Engineers, 64, Holborn Viaduct, London, have been employed at the National Filling Factory, Pembury.

Builders and others with saw-benches lying idle should note an advertisement in our columns for pieces sawn to size for Government work. We understand that the firm, which is Government controlled, has more work than it can handle, and its delivery is urgent.

The County Surveyor of Northampton (Mr. C. S. Morris) has obtained a gang of ten German prisoners to work on the roads. If the experiment proves successful, another gang is to be engaged. They cannot be worse than the "conscientious objectors," which Mr. F. J. Wood tried on the East-Sussex county roads.

**TO CORRESPONDENTS.**

We do not hold ourselves responsible for the opinions of our correspondents. All communications should be drawn up as briefly as possible, as there are many claimants upon the space allotted to correspondents.

It is particularly requested that all drawings and all communications respecting illustrations or literary matter, books for review, etc., should be addressed to the Editor of the BUILDING NEWS, Effingham House, 1, Abchurch Lane, Strand, W.C.2, and not to members of the staff by name. Delay is not infrequently otherwise caused. All drawings and other communications are sent at contributors' risks, and the Editor will not undertake to pay for, or be liable for, unsought contributions.

When favouring us with drawings or photographs, architects are asked kindly to state how long the building has been erected. It does neither them nor us any good to illustrate buildings which have been some time executed, except under special circumstances.

\*Drawings of selected competition designs, important public and private buildings, details of old and new work, and good sketches are always welcome, and for such no charge is made for insertion. Of more commonplace subjects, small churches, chapels, houses, etc.—we have usually far more sent than we can insert, but are glad to do so when space permits, on mutually advantageous terms, which may be ascertained on application.

RECEIVED.—V. L. Ltd., R. F. W. and Son—W. and D. S. A. Co., Ltd.—B. of S.—V. de T. A. Co., Ltd.—P. T. and Co., Ltd.—C. C. P. and Co., W. C. Co., Ltd.—H. O. B. R. and Son—G. P. Co., Ltd.—M. G. and Co.—E. and R., Ltd., T. Ltd.

F. G. H. Ves. R. J. H. Ltd.—Please send. J. M.—Many thanks. We wish more good line drawings reached us. When as well done they made far better architectural illustrations than the usual detailed drawings and photographs of more recent years. D. T. M.—We should use "Poilite" in preference to the other material you name; and "Devolite" for the flooring.

**TO ARMS!**

COUNTY OF LONDON VOLUNTEER ENGINEERS (Field Companies).

Headquarters: Balderton Street, Oxford Street, W. Orders for the week. By Lt.-Col. C. B. Clay, V.D., Commanding.

OFFICER FOR THE WEEK.—Plat. Comdr. P. Bowden. NEXT FOR DUTY.—Plat. Comdr. W. J. A. Watkins.

MONDAY, AUGUST 13.—Technical instruction (see article) for No. 3 Co.; Right-half Co. at Regency Street. Drill, No. 3 Co., Left-half Co. Signalling Class. Recruits' drill, 6.30.

TUESDAY, AUGUST 14.—Lecture, 6.30. Physical Drill and Bayonet Fighting, 7.30.

WEDNESDAY, AUGUST 15.—Drill and Elementary Bridge Construction, No. 1 Co., Right-half Co. Amphibious Class.

THURSDAY, AUGUST 16.—Drill and Elementary Bridge Construction, No. 2 Co., Right-half Co. Amphibious Class.

FRIDAY, AUGUST 17.—Technical instruction (see article) for No. 3 Co., Left-half Co. at Regency Street. Drill, No. 3 Co., Right-half Co. Signalling Class. Recruits' drill, 6.30.

MISKETEERY.—All X.C.O.s and men who have signed the "A" and "B" agreements are required to attend during this month in order to enable the Corps to obtain the Capitulation Grant. Preference will be given to these men in firing.

ARMLETS.—The new-issue Armllets can now be obtained at Headquarters, and every enrolled man must obtain one without delay, and all old (red) Armllets must be returned to the Orderly Room.

NOPE.—Unless otherwise indicated, all drills will take place at Headquarters. By order, MACLEOD YEARSELEY, Adjutant.

August 11, 1917.

**FOR Oliver's Seasoned Hardwoods,**

APPLY TO—**WM. OLIVER & SONS, Ltd.,**  
120, Boshill Row, London, E.C.

**TENDERS.**

\*Correspondents would in all cases oblige by giving the names of the parties tendering—at any rate, of the accepted tender; it adds to the value of the information.

ASHTON-IN-MAKERFIELD.—For renovating schools, for the elementary education authority. Accepted tenders: Uniland Moor school, D. B. Ashurst and Co., £12 10s.; Ashton Emmanuel school, N. Turton, £29 10s.; Ashton R.C. school, R. Pennington, £13 7s.; Downall Green R.C. school, R. Garner, £16; Park Edge R.C. school, R. Garner, £29 10s.; St. Thomas's mixed school, R. Garner, £29 10s. A. accepted.

BLKEMHALL COLLEGE.—For alterations and improvements to the Blackhall temporary council school premises, for the Durham County Council.—F. W. Teasdale, Durham, builder's .. £620 0 0  
W. Wilson and Co., South Shields, electric light .. .. 34 0 0  
J. Garrick, Durham, lat. payor .. 64 12 0

CHESTER.—For erection of a small-pox hospital, for the Chester Urban District Council.—Humphreys, Knightsbridge, £2,688 (accepted). The building to be of reinforced brickwork.

EBER.—For work at the Sanatorium, for the urban district council.—Ling and Sons .. .. £137 0 0  
Ling and Sons .. .. 124 15 0  
D. C. Bowyer (accepted) .. .. 81 10 0

HEBBY.—For repairs to boilers, etc., at certain schools, for the Education Committee.—Enley and Sons, Ltd., repairs to boiler at Quay school £11 10s., taking down and repairing boiler at R.C. school £9 10s. (accepted).

HENGER.—For reinstating portion of the damaged part of the County Intermediate School for Girls, Hengoed, for the governing body of the Gelliogier County School for Girls, Hengoed. Mr. D. Pugh Jones, F.S.I., County Hall, Cardiff, County Architects.—H. Jones, 34, Ilton Road, Cardiff £1,209 17 0

HOVE.—For outside work at the Connaught Road (Higher-grade) School, and inside painting and other works at the Aldington National School, for the borough council.—A. W. Lacey, Goldstone Villas, Hove (accepted) .. .. £129 15 0

KINGSTON-ON-THAMES.—For ferro-concrete sheet piling of 28-ft. run for the repair of the lower walk of the Queen's Promenade for the corporation.—Holloway Bros. (London), Ltd., £2,000 0 0  
Wallis and Sons, Ltd. .. .. 1,827 0 0  
J. Garrett and Son\* .. .. 1,274 0 0  
\* Recommended for acceptance.

LEEDS.—For painting, etc., at Potternewton Park and Chapel Allerton Recreation Ground (Contract No. 3,068), for the corporation.—Pitts and Payne, 181, Woodhouse Lane, Leeds (accepted) .. .. £94 14 0

LONDON.—For painting and repairing works at Buckingham Palace Road, Great Smith Street and Marshall Street Baths, for the Westminster City Council.—J. R. Sims, 60, Horseferry Road, S.W. 1 .. .. £282 0 0  
(Recommended for acceptance.)

MADSTONE.—For drainage work at 117 to 127, Kingsley Road, Maidstone, for the Town Council.—Martin and Newham .. .. £111 14 4  
Crutenden and Son .. .. 110 13 0  
N. Smith .. .. 106 3 0  
K. Pearce and Sons .. .. 95 0 0  
R. C. Barney and Sons (accepted) .. 94 12 6

NEWPORT (I.W.A.).—For setting back and rebuilding wall of Messrs. W. B. Mew, Langton and Co.'s store abutting on bridge over the Lakely stream at Little London, for the Newport Town Council.—H. and F. Lamy (accepted) .. .. £68 0 0

NEWTON ABBOT.—For the erection of a coal and coke store at the joint isolation hospital. Mr. Samuel Segar, Architect, Newton Abbot.—F. J. Zealley and Son .. .. £214 0 0  
Frank Parker .. .. 194 0 6  
Hugh Mills and Son .. .. 173 0 0  
All of Newton Abbot.

ROMSEY.—For repairs to town hall, for the town council.—Goulding and Son (accepted) .. £24 8 4

SHALTERS BRIDGE.—For repairs to Shalters Bridge, for the Durham County Council.—Scott Bros., Aycliffe (accepted).

SOUTHAMPTON.—For alterations and additions to the laundry of the poor-law institution, St. Mary Street, Southampton, for the Guardians.—W. Jones, Eccleston-square, Cobbett Road, Bitterne Park, Southampton .. .. £895 0 0  
H. Stevens and Co., Millbank Works, Millbank Street .. .. 868 0 0  
H. Cawte, 30, Church Street, Southampton .. .. 830 0 0  
Jenkins and Sons, Ltd., 148, Above Bar Street .. .. 829 0 0  
J. J. Udall and Co., 36, Carlton Place, Southampton (accepted) 794 0 0

WIMBORNE.—Exterior work at the urban district council's offices.—Wallace and Wallace (accepted) .. £63 0 0

**LIST OF TENDERS OPEN.**

**BUILDINGS.**

August 10.—Repair of roofs of nice houses in Howard Street and Upper Queen Street, Belfast.—E. M. Stewart, 50, Upper Arthur Street, Belfast.  
August 16.—Repairs and painting at the isolation hospital, Lee Mill, near Ivybridge, Devon.—For the Plympton St. Mary Rural District Council.—The Chairman, Rural District Council, Underwood House, Plympton.  
August 27.—Erection of a bathroom, etc., and plastering, etc., certain wards at Eastville Institution, and painting, etc., in the cottage homes at Bowdland, in accordance with specifications.—For the Bristol Board of Guardians.—J. J. Simpson, Clerk, St. Peter's Hospital, Bristol.

**ENGINEERING.**

August 13.—Providing and installing a low-pressure heating apparatus to portions of the Guildhall, Lichfield.—For the City Council.—H. Russell, Town Clerk, Lichfield.  
Aug. 31.—Sealed tenders, endorsed "Tender for Contract No. 923," will be received at the Town Clerk's Office, Municipal Offices, Johannesburg, not later than 12 noon on August 31, for refrigerating plant at Market Buildings, Newtown, Johannesburg. Drawings and documents can be viewed free on application to the Council's agents in London, Messrs. E. W. Carling and Co. St. Dunstan's Buildings, St. Dunstan's Hill, London, E.C.5, but a deposit of £1 is required for copies.

**PAINTING.**

August 9.—Externally painting, etc., 37 houses on the housing estate, Woodside, Croydon.—For the Town Council.—J. M. Newham, Town Clerk, Town Hall, Croydon.

**SANITARY.**

August 14.—Emptying ashpits, etc., in portions of the parish of Norton, Sheffield.—For the Norton Rural District Council.—F. Wolstenholme, Acting Clerk, "The Edge," Sheffield.  
August 20.—Scavenging the works of Fulmer.—For the Fulmer Parish Council.—Clerk of Parish Council, Fulmer.

**GALVANIZED CORRUGATED ROOFING SHEETS.**

**BEST QUALITY.**

Perfectly and thickly coated with zinc, insuring real durability.

PROMPT DELIVERY can be given, to any ordinary



**GOOD STOCKS**

kept at our London Works in all the usual lengths and gauges.

whether straight sheets or curved radius.

**FREDK. BRABY & CO., LTD.,** 352 to 364, EUSTON ROAD, N.W.1, **LONDON.** IDA WORKS, DEPTFORD, S.E.8.



# THE BUILDING NEWS

## AND ENGINEERING JOURNAL.

**Effingham House,**

**CONTENTS.**

**Strand, W.C.2.**

Currente Calamo .. .. . 121  
 The Problem of the Small Dwelling and Its Solution.—XIII. .. .. . 122  
 The Architectural Association .. .. . 124  
 How Materials Withstand Heat .. .. . 124  
 Our Illustrations .. .. . 137  
 Building Intelligence .. .. . 137  
 Gas-Filled Windows .. .. . 137  
 Obituary .. .. . 137

More "Whereas"! .. .. . 137  
 Competitions .. .. . 138  
 Statutes and Memorials .. .. . 138  
 Our Office Table .. .. . 138  
 Parliamentary Notes .. .. . 139  
 To Correspondents .. .. . 139  
 Tenders .. .. . 140  
 List of Tenders Open .. .. . 140  
 Latest Prices .. .. . viii.

**OUR ILLUSTRATIONS.**

Hillcrest, Totterdse, Herts. View of garden front and detail photograph of terrace and bays, with two plans of the house. Messrs. H. V. Ashley and F. Winton Newman, F.F.R.I.B.A., Architects.  
 Green Arbour House, Holborn Viaduct Station, E.C. Mr. Arthur F. Fisher, F.R.I.B.A. (Messrs. Yetts, Sturdy, and Fisher), Architect.  
 The Problem of the Small Dwelling and Its Solution. Sheets XXIV. and XXV., by Mr. Robert Thomson, Architect.

### Currente Calamo.

The latest Report of the Land Union is a valuable summary of the facts showing that it will be impossible to restore the attractiveness of land development and the building of houses by private enterprise unless the three land value duties (Increment Value Duty, Undeveloped Land Duty and Reversion Duty) and the system of valuation under Part I. of the Finance (1909-10) Act, 1910, are repealed. Far from small owners not being affected, there have appeared numerous cases of houses of small value having been sold in which it was clear that there was no rise in the value of the site, but nevertheless Increment Value Duty was claimed. Finally the Lumsden judgment established this, that under the Act whenever a house was sold (or leased for more than fourteen years) although the value of the site had not increased one penny since April 30, 1909, and even if the vendor lost on the transaction, yet under the definitions of the Act and the calculations thereby authorised increment might be revealed and duty on money paid for compensation for goodwill of a business or on trade fixtures. As it is, whenever a man sells a house or shop for more than what, in the opinion of the Commissioners of Inland Revenue, is its value, the tax may be claimed, and unless the owner or lessor is willing to appeal to a referee at the risk of having to pay costs, he must submit to the claim.

So far from promoting the building of houses and the development of land, the Finance (1909-10) Act, 1910, has had precisely the opposite effect, and, in the opinion of those connected with the building industry and those who formerly financed it, Part I. of the Act is responsible for the present serious shortage of houses. It has compelled builders and developers to submit to irritating interrogatories and formalities, also to artificial and uncertain claims which it is impossible to estimate, and thereby created a distaste for the industry and a sense of insecurity that has stopped the flow of capital requisite for the purpose. The taxes have engendered in those who had invested their money (particularly in the case of the working men and small tradesmen who

were accustomed to invest their savings in small house property and building plots) a feeling that they were being unfairly treated. Land and buildings, like all other forms of property, were subject to Estate Duty on death and to Income Tax, and, in addition, were subject to rates, so that in no sense could it be said that land was a privileged form of property. Moreover, until the introduction of the Finance (1909-10) Act, 1910, the public had been particularly encouraged to invest in this form of security, thus special statutes, such as the Building Society Acts, had been passed to facilitate the investment in land and buildings, and the Chancery Courts always treated mortgages of land as a premier security for trust moneys, and large portions of the funds of many charities, universities, colleges, insurance societies, friendly societies and trade unions are invested in real property or leaseholds. Necessarily, therefore, the attack on these investments has aggravated the depreciation of land and led many mortgagees to call in their mortgages or require additional security.

The valuation, with or without modification, could not be fairly used as a basis for rating, for assessing to Estate Duty, or compulsory purchase of land; in particular that the attempts of the Commissioners to arrive at the value of undivided shares of the freehold, or of leasehold or other derivative interests in land, by calculations and the aid of tables of percentages and other statistics is a total failure if it is intended by such means to arrive at the market value of such undivided shares and derivative interests, and the determination of Increment Value by a series of deductions from a price realised on the sale of land and buildings in no way indicates or corresponds to any variation of the market value of the site. After allowing all claims of supporters of the Valuation Department that (through its activities in checking valuations of executors and other accounting parties and its valuation of property passing by deeds of gift) additional Estate Duty and Stamp Duty have been secured, and throwing in all receipts for the Land Value Duties under the Finance (1909-10) Act—the aggregate falls far short of the

salaries of the officials and general expenses of the Department. Finally, so far from producing revenue, it has in this respect not only been an utter failure, but by depreciating the market value of a great national asset must tend to cause a loss to the Exchequer in Estate Duty and other duties on transactions in land.

Water is very often a serious difficulty with which contractors have to deal when building upon new and unknown land. For there may be some little subterranean spring which will rise and give great trouble later on, or some tiny stream, hardly noticed in the dry season, may swell to a torrent with heavy rains. Then questions of legal liability crop up, and these are as costly as they are complicated. The recent case of "Greenock Corporation v. Caledonian Railway Co." was a big business, but the decision of the House of Lords is, in principle, applicable to all similar disputes, be they large or little. The corporation had built an artificial lake or pond in a public park, which looked very pretty as part of the landscape; but they had done this by damming up the channel of a natural stream which flowed through the site of the park into the town of Greenock and thence into the sea. All went well during an ordinary rainfall, but on the morning of August 5, 1912, there was an abnormal storm of rain, and as the water could not get away by the stream that Nature had provided it flooded the railway station, causing much damage, for which the company now claimed against the corporation. Their real defence was that they could not be held responsible for this unprecedented storm of rain, which, they pleaded, in terms of Scotch law, was a *damnum fatale*, or fated, or predestined injury; and which English lawyers describe as an "act of God." The court held the corporation liable, and the House of Lords, by five judges, has now confirmed this ruling. It was there laid down that it is the duty of anyone who interferes with the course of a stream to see that the works which he substitutes for the channel provided by Nature are adequate to carry off the water brought down even by an extraordinary rainfall, and he is liable in damage for any resulting deficiency. They decided

that such damage is not the result of fate or of the "act of God," but of the obstruction of a natural watercourse and subsequent heavy rain. The man who alters Nature's plans as to water is bound to provide against the ordinary operations of Nature, though not against her miracles. In other words, the acts of man must all be exhausted before the law will consent to put down a catastrophe to the "act of God."

Some sort of an effort by the Manchester City Council to deal with the old infirmary site seems likely at last. The Traffic Congestion Committee finished the investigation last Wednesday of the matter on which they have been busy for months, and have agreed on their report, which will be submitted to the council in September. The idea of converting the site of the old infirmary in Piccadilly into a network of tram lines has been abandoned. The committee do, however, propose that a portion of the site should be used as a tramway terminal. At the same time they acknowledge that it is the duty of the Old Infirmary Site Committee to prepare and submit to the city council a scheme for dealing with the site. It may be that to meet the wishes of the Site Committee, as well as of the Tramways Committee, Parker Street will have to be widened on the Mosley Street side. The committee say that if this is done the site may be used for a building architecturally worthy of such an important position, with an open space and ornamental grounds in front of such building. A solution would thus be found for a problem which has been before the council for years. As to the cost of the proposed changes, no estimate is given by the committee, but it is stated that it cannot be less than a million and a half pounds. That, at any rate, is less than the three million scheme which the council rejected long ago. It remains to be seen whether it will at last do something to rescue the finest site in the city from its prostitution to weeds and rubbish during the last decade, and disregard the cross issues and vested interests that have combined to make the civic authorities the butt of every visitor.

Mr. John Hodge is reported to be hatching another new plan for the Labour Exchanges—"Employment" Exchanges, we beg pardon! Mr. Hodge's period as Minister of Labour has hardly been marked so far by any startling success, and it is little likely that he or anyone else can remodel the Labour Exchanges so as to make them a really useful factor in employment. A circular recently published by a number of Labour leaders nominally in defence of the National Service department revealed very plainly the low estimation in which the Labour Exchanges are held in labour circles, and they have long been laughed at by employers. It is said that the first step is to be the setting up of an Advisory Committee for each exchange, in the hope that by this means the exchanges will be brought into some definite and useful

relation with employers and employed. It is much more likely to be another abortive addition to the numerous committees of one sort or another which are the favourite shunting grounds of the present powers that be for problems they have neither the desire nor the ability to solve.

We regret very much to note that Mr. Basil E. Peto, M.P. for the Devises Division since 1910, has announced that he will not be a candidate for Parliament after the war. Like most other honest men, he regrets that he does not see a determination on the part of the present Government to approach the great problems of the near future with a clear but national policy that would afford a key to their solution; and that under these circumstances he has felt it his duty to inform the chief Whip that his support of the Government must be conditional in the future. Mr. Peto, who was born in 1862, is a partner in the well-known firm of Peto Bros., building contractors, and his activities at home and abroad have been many. He has done nine years of strenuous work in Parliament, and finds "results negligible." They are not so appreciated by his many friends, who know well that solid work in sensible and practical directions is little likely to-day to win the recognition or co-operation of our present bureaucracy.

Time and again we have insisted on the costly common shortsightedness of housing reformers and local authorities who refuse to put a properly fitted bath in a worker's dwelling, and waste the ratepayers' money on public baths run by a big staff and very partially available by those who need baths. The *Housing Journal* gives an instance in point supplied by the experience of the South Shields Corporation. The increase of expenditure for the washhouses department in 1917 as compared with 1914 is £203, and the increase of receipts compared with the same period is £24. The average amount paid by 16,996 users in 1914 was 5½d., and the cost to the baths 10d. The average amount paid by 13,523 users of the washhouses in 1917 is 7½d., and the cost to the baths 1s. 4d. For every customer using the washhouses during the past year ending February it has cost the corporation 1s. 4d. to produce 7½d.; during the same period of 1914 it cost 10d. to produce 5½d. Take into consideration the original cost of constructing the baths, and it will be recognised that public baths are a charge on the rates, and private baths in the people's homes a saving of the rates to a larger degree than that represented by the maintenance of public baths. We may add that much water would be saved into the bargain.

We regret to record the death of Mr. Herbert H. Wigley, partner in the firm of Messrs. Geo. Wigley and Sons, auctioneers, land agents and surveyors, of Winslow, Bucks, who was killed in action on July 31. Mr. Wigley became a Fellow of the Surveyors' Institution in 1907, and was also elected a Fellow of the Auctioneers' and Estate Agents' Institute in 1911.

## THE PROBLEM OF THE SMALL DWELLING AND ITS SOLUTION.

XIII.

By ROBERT THOMSON.

[WITH ILLUSTRATIONS.]

Having been for a long time anxiously on the outlook for plans showing the most perfect examples of cottage dwellings in this country, this much-desired information, strange to say, came to hand by way of America, where it was given in an article which appeared in the *Journal of the American Institute of Architects*, issued in April last. In this article, which has for its title, "The Remarkable Application of Town-planning Principles to the War-time Necessities of England," the Secretary of the International Garden Cities and Town Planning Association states:—

"The most remarkable of all the additions to the housing resources of the country is, without a doubt, the Well Hall Estate, which was built by the Government for the accommodation of munition workers at Woolwich. Some sixteen hundred houses have been built there on virgin soil, and the result is a community which I can confidently say is, from the architectural standpoint, without equal in the whole world. Formerly I would have given the palm to Margaretenhohe, near Essen, while the Hampstead Garden Suburb ran that closely; but the Well Hall Estate is undoubtedly first."

By thus awarding the palm to these Well Hall dwellings, and at the same time relegating the dwellings of the German suburb of Margaretenhohe to second place, and those of the Hampstead Garden Suburb to third place, the Secretary of the International Garden Cities has inferentially given the authors of the plans of the dwellings in the two last-named and also those of other garden city specialists a nasty knock, because for any dwelling to be put into a lower category as regards the quality of its planning than that actually occupied by the crudely planned Well Hall houses is a disgrace indeed, as anyone who cares to critically examine the plans of these houses can easily see for himself.

To me this American article is welcome, because it not only provides proof of the truth of my remarks regarding the inefficient planning of dwellings which appeared in the earlier articles of the present series, but it places on permanent record the statement that these Well Hall houses represent the highest standard to which the planning of cottage dwellings had up to that date attained not only in this, but in any other country throughout "the whole world."

I may as well confess that the plans of those Well Hall houses had already been utilised by me as the "awful examples" in preparing the descriptions of the dwellings of existing types herein before given. The Well Hall Estate referred to has an area of ninety-six acres, sixty-six of which lie on the east, and thirty on the west, side of the road leading from Woolwich to Eltham. The total number of dwellings erected thereon is 1,298 showing a density of 13.5 houses to the acre. The dwellings are of four classes, containing four, five, six, and seven, apartments, respectively. Class I, embracing the last, and Class IV, the first named. With the exception of the 212 four-apartment flats constituting Class IV, which are built in two-story tenements, the whole of the 1,086 remaining are two-flatted cottages.

The total cost of the 1,298 dwellings erected at Well Hall has been officially



dated at £806,660, and the average cost, therefore, works out at £621 9s. 3d. per dwelling.

The secretary of the International Garden Cities states in his article that "The expense on the Well Hall Estate was colossal, so much so that there is a fear that the extravagance may deter others from copying the example," but he need have no fear on this score as no competent architect would ever for an instant, think of using the plans of these primitive dwellings as examples worth copying.

The cost of houseroom in the habitable apartments and kitchens of the Well Hall dwellings works out at over thirty-four pence per cubic foot, and therefore compares very badly with the figure of nineteen pence, which is the average cost per cubic foot of houseroom in the cottages erected at the same time by the County Council of the Middle Ward of Lanarkshire, while the figure of fifteen pence per cubic foot, which has been used throughout in the present educational series, is insignificant in comparison.

Upon learning of the veneration with which the Well Hall dwellings are regarded in garden city circles and in those other circles "wherever garden cities and town-planning are talked about," I at once decided that it was essential to give further examples of these super-perfect dwellings and forthwith prepared the two Sheets XXIV. and XXV. accompanying this article.

If the reader will lay Sheet VIII. alongside these two sheets he will at once recognise the strong family resemblance which the Well Hall plans on the two latter bear to those of the General Collection shown on the former, which are all characteristic examples "of the work of the garden city specialist."

Since the volume of houseroom provided has a direct and powerful influence upon the health of the many successive generations who may occupy any dwelling, and as the vital requirements of the occupants do not vary with any change in their social status, it is clearly imperative that every dwelling be so designed as to ensure such a supply of pure fresh air as will impose no drawbacks upon its occupants.

One of the main objects, if not actually the main object of building houses, ought, therefore, to be to provide adequate houseroom for their occupants.

As the amount of houseroom which is provided by one type of dwelling in comparison with that provided in others, which are similarly equipped, fitted and finished, is dependent on the skill shown in the planning, and it may be also in the method of construction employed, the vital importance of efficient planning and construction is at once established. When it is shown that it is possible for the same money to give dwellings which almost double the amount of houseroom, and at the same time render available practically treble the volume of the air supply obtainable with the garden city types of dwellings built at Well Hall and elsewhere, the question as to the relative values of any two or more dwellings becomes one not of artistic opinion, but, being based upon simple arithmetical calculations, is one of solid practical fact. It would be exceedingly helpful, therefore, if the secretary of the International Garden Cities would prepare and publish calculations showing the value of the houseroom which has been sacrificed in the Well Hall Community by their lack of efficient planning.

As these Well Hall dwellings, besides having all the defects of the Departmental and Advisory Committee's plans

which have been issued by the Government as models, have some others which are peculiar to themselves, it may be well to run over a few of their shortcomings. A glance at the published plans shows that the dwellings are all of the combined kitchen-living-room type, that their apartments are all very small, that the living-room opens directly out of the scullery, and that each of the five apartment dwellings, which constitute about one-half of the total erected, has one of the committee's favourite flueless bedrooms. It will also be seen that many of the apartments are mutilated and distorted, that the larder in many cases cannot be reached from the scullery except by passing through the living-room, and that there is no provision whatever either for washing or drying clothes.

The arrangement of the bath and w.c. in these dwellings provides not only an interesting study, but also furnishes a guide to the classification of the dwellings. Although within the metropolitan area of the London County Council, the w.c.s of the houses constituting Classes II. and III., which embrace about two-thirds of the total number forming the community, are entered from the outside, and the great majority of them cannot be reached except in full view of the occupants of the range of dwellings behind, while their bath is in every case in the scullery.

In the houses constituting Class II., which mean for their occupants a step up in the social scale, there is a real bathroom, and the occupants do not require to go outside for the w.c., this being provided in the bath-room; while the Class I. houses, which provide for those who care to pay the extra rent an opportunity of mounting another rung in the social ladder, have their bath and w.c. in separate apartments.

Turning to the Well Hall plans on Sheet XXIV., it will be further seen that the occupants of two of the dwellings, in order to reach their entrance doorway, have to approach directly in front of the window of the living-room of the adjoining dwelling, an arrangement which must be disliked by the occupants of both. In the left-hand dwelling of the group the position of the doorway giving access from the entrance lobby to the living-room could not have been worse placed for the comfort of the occupants.

The stairs in every case are steep and contain winders, while those in the three five-apartment dwellings are very narrow, measuring only 2 ft. 9 ins. in the rough, and those in the second and fourth cottages, being lit by skylights which are about 16 ft. above the bedroom floor level, are thus of the type which the Advisory Committee so justly condemn. The position of the housewife when at the sink in the left-hand house, pinioned between the draught from the scullery door on the one side and the gas cooker on the other, must be most uncomfortable.

On approaching this block one wonders what can have been the cost of the scaffolding required in the erection of the two isolated chimney heads, each of which rises about 16 ft. above the eave of the roof. It must have been very great. It was certainly unjustifiable.

Passing to Sheet XV., Figs. 146-7-8 and 9 show plans of the 212 flats. These all give dwellings of a very undesirable type. In some cases two, and in others four, families use the same entrance, two of the latter using the same stair. These dwellings have no entrance lobby, each being entered directly from the common passage-way or staircase, and as the regular daily cleansing of passage-ways,

stairs, and staircases which are in common use by two or more families is usually the source of much ill-feeling between the families concerned, the occupants of such dwellings have in this alone a very distinct grievance.

While the Well Hall plans on Sheets XXIV. and XXV. show what their authors have been able to give in the way of houseroom, floor space, comfort, convenience, and economy with the materials employed, the plans of the health-promoting class of dwelling at the top of each of these sheets show what the same materials are capable of giving when efficiently utilised.

Plan Fig. 144, besides giving a dwelling which is perfectly equipped with office and other accommodation and conveniences, provides five instead of only four apartments, as in the Well Hall flatted dwellings shown in the plans Figs. 146-7-8 and 9 below, and the floor area and air contents of every one of the apartments in plan Fig. 144 are in exact accordance with official requirements.

With the efficient three-flue heat-actuated system of ventilation which the health-promoting class of dwellings provide, in operation it is possible to reduce the floor area of the two smaller bedrooms without the least detriment to the health of their occupants, and to thereby correspondingly increase the size of the living-room, as shown in plan Fig. 145, and by increasing the ceiling height to 10 ft. 3 ins., for which there is ample building material, the relatively enormous increase in the houseroom shown by the figures is obtained.

The two plans of cottages at the top of Sheets XXIV. and XXV. prove that there is no longer any need to give people the imperfectly planned dwellings shown in the garden city type of dwellings.

Since, in my opinion, there is more bad planning to the acre in the garden-city type of suburbs than in any other similar area elsewhere, it is interesting to find that the secretary of the International Garden Cities himself admits their unsatisfactory character. Referring to the planning of the garden-city dwellings of a few years ago he says:—

"We had the street-door opening into the large, and often draughty, living-room, with the open stairs to the bedrooms going out at another corner, while very little provision was made elsewhere for cooking or other domestic duties. The bedrooms were none of them square, and headroom was a minor consideration, so that getting into and out of bed became sometimes a matter of delicate strategy."

Proceeding, he states: "I am far from regretting that these things were done. They were probably necessary, and were almost inevitable. But it was overdue, and it was expensive, as many cottage companies and owners have found to their cost when they have come to make alterations necessary to secure tenants after the first rush of popularity had subsided. After a dozen years of constant experiment, a type seems to be evolving which does more nearly meet the case."

That is quite a frank confession, which amply warrants all I have written in previous articles.

It is a pity, however, that Mr. Secretary is "far from regretting that these things were done." Except for very bad planning they were neither inevitable nor necessary.

It would have been more to the point if he had expressed his extreme regret for those companies and owners who, accepting the garden-city specialists at their own valuation, employed and paid them

for services which they clearly did not efficiently perform.

As to the type of dwelling which he says seems to be evolving, I have been unable to find any trace of it. It is certainly not to be found among the collection of plans which he himself published in the spring of the present year, nor yet among the Well Hall dwellings, the quality of the planning of which, although "without equal in the whole world," is quite indistinguishable from that of the Committee's model plans issued by the Government.

The sublime mistake of the garden-city specialists is that they always look behind and pat themselves on the back when comparing any trifling advance they may have made by getting rid of a defect which should never have existed.

If instead of looking backward they would look ahead sufficiently far to realise the enormous possibilities which have hitherto been neglected in the planning of dwellings, my efforts for the education of the "expert" may not have been vain.

(To be continued.)

#### THE ARCHITECTURAL ASSOCIATION.

By the courtesy of the Architectural Association, we are enabled to give the



MR. HENRY M. FLETCHER, M.A., F.R.I.B.A.,  
President of the Architectural Association.

portrait of its new President, Mr. Henry M. Fletcher, F.R.I.B.A., whose year of office, if likely to be a strenuous one, will, we are confident, be marked by conspicuous success.

Mr. Henry M. Fletcher, M.A., F.R.I.B.A., was born in London in 1870, and educated at Marlborough and Trinity College, Cambridge. After three years as a pupil of Mr. Morryn Macartney, he travelled in Italy and Greece during most of the year 1896, and started practice in 1897.

His work has been mainly domestic, and has been rather among country than town houses. We may instance houses at Kenilworth, Cambridge, Tilford, Crowthorne, Cookham Down, and the New House, Airle Gardens; a Nurses' Home at Ipswich and a Tuberculosis Dispensary at Stepney; and alterations and reconstructions of old build-

ings at Cadhay House, Devon; Up Cerne Manor, Dorset; Awardley Hall, Lincolnshire; Graceland Manor, Leicester; North Perrott Manor, Somerset, and Trinity College, Cambridge.

At the present time Mr. Fletcher is serving on the London Ambulance Column for the transport of wounded at stations and hospitals, and is an original member and sub-commandant of the London 43rd Voluntary Aid Detachment, so well known to our readers as the A.A. Detachment, which was formed by the Association as one of its war activities. He is also a member of several of the committees appointed to look after the interests of architects during and after the war, and has been specially interested in the question of new premises for the A.A.

We remind all readers, especially those who are preparing to enrol themselves presently in the ranks of our calling, that the Architectural Association, which is the recognised educational body for the architectural profession, and which enjoys the patronage of His Majesty the King, has acquired the leases of two houses in Bedford Square, where its educational work will in future be carried on. Since its formation in 1837 the Association's educational activities have grown continuously, and its school of architecture has become world-famous and attracts students from all countries, particularly in the British Empire. It is now opening its

#### HOLLOW MATERIALS WITHSTAND HEAT.

One of the subjects discussed at the recent convention of the American Society for Testing Materials was that of the heat-insulating properties of materials used in fire-resistant construction. A paper was presented by Mr. W. A. Hull giving results of experiments. The materials included in the investigation were:—(1) Clays that are used in the manufacture of hollow tile fireproofing; (2) concretes, including two proportions of a number of aggregates; (3) gypsums, including specimens from three manufacturers prepared from mixtures differing in kinds of filler and in ratio of plaster to water; (4) one specimen of lime mortar; (5) one specimen of a new material. In most cases three specimens of each material or mixture were tested.

The results of the various tests were described and a number of interesting illustrations produced, and the author reaches the following conclusions:—

#### CONCLUSIONS.

The tests as a whole indicate that there is not a very great difference among concretes from the aggregates commonly used, in respect to the protection that would be afforded to steel reinforcement embedded in concrete near the surface, assuming that the concrete protection did not come off and expose the reinforcement. It would not be wise to draw conclusions on that point from this work. As to protection of steel members, the insulating properties of the denser clays are indicated to be inferior to the more porous clays and to the concretes. It is to be noted in this connection that this work deals exclusively with solid materials, and it is not attempted to draw comparisons between hollow blocks or tile of one material and a solid mass of another. The more porous clays compared fairly well with the concretes. It should be stated that the porosity of the more-porous clay specimens was undoubtedly due in part to lighter burning in the kiln.

Gravel concretes gave particularly unfavourable indications. While the ground covered in this work alone is by far too narrow to permit of drawing hard and fast conclusions, the indications are consistent with the results of other investigations. There is strong evidence that some gravels, at any rate, are distinctly inferior for concrete for fire-resistive construction. Cinder concretes are apparently to be viewed with suspicion, especially if the cinders contain much combustible material, which is apt to be the case with cinders from bituminous coal. No anthracite cinders were included in this investigation.

Gypsums made good heat-retarding records, but were very soft and weak after test. There was a favourable showing made by the denser, as compared with the more porous mixtures, which is consistent with theoretical considerations.

A movement is on foot among the tenancy of the Arderne (Cheshire) estate to provide a memorial at Tarporley to the late Earl of Haddington, their landlord for many years. It is proposed to place a portrait of the Earl in the Tarporley Hunt Clubroom, and also to present a new organ case to Tarporley church.

The first meeting of the departmental committee appointed by the Government to inquire into and consider the question of providing houses on a great scale for the working classes after the war was held at the Local Government Board offices last Thursday. The proceedings were conducted in private, but the business was of a purely formal nature.

Acting-Major Alan Robert Constantino Jenks, M.C., born in 1891, at the outbreak of war had just completed his student career as a civil engineer, having taken a science degree with first-class honours at London University. He fell to a sniper on a reconnaissance which he insisted on making before our front lines on the afternoon of July 31. He was the only child of Edward Jenks, Principal of the Law Society, and the late Annie (Dorham) Jenks, and married, last October, Stella Bishopp, second daughter of the late Rev. E. A. Duckett, of Taunton.

schools to women students, as there will probably be many who, under present-day conditions, will desire to adopt architecture as a profession. All students, however, should wherever possible choose the A.A. schools as their place of education. They have no equal elsewhere, and are superior in every way to every other similar school, college or technical institute.

At St. George's Church, Royal Naval Barracks, Chatham, last week, the Chaplain of the Fleet dedicated memorials to officers and men of H.M.S. "Russell" and "Swiftsure." To the memory of the "Russell" there is a window in the south clerestory, and to the "Swiftsure" two windows in the north wall of the Lady Chapel.



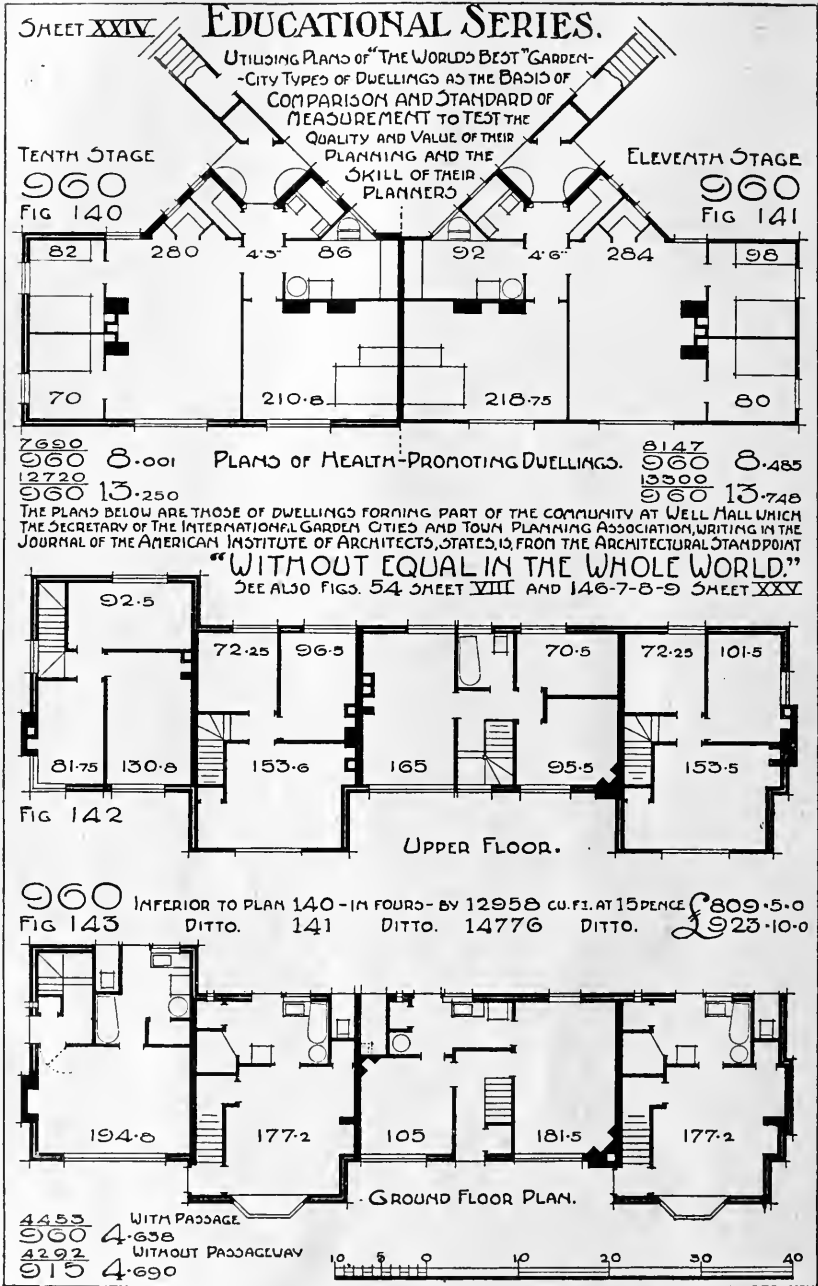

THE PROBLEM OF THE SMALL DWELLING AND ITS SOLUTION.

By Mr. ROBERT THOMSON, Architect.

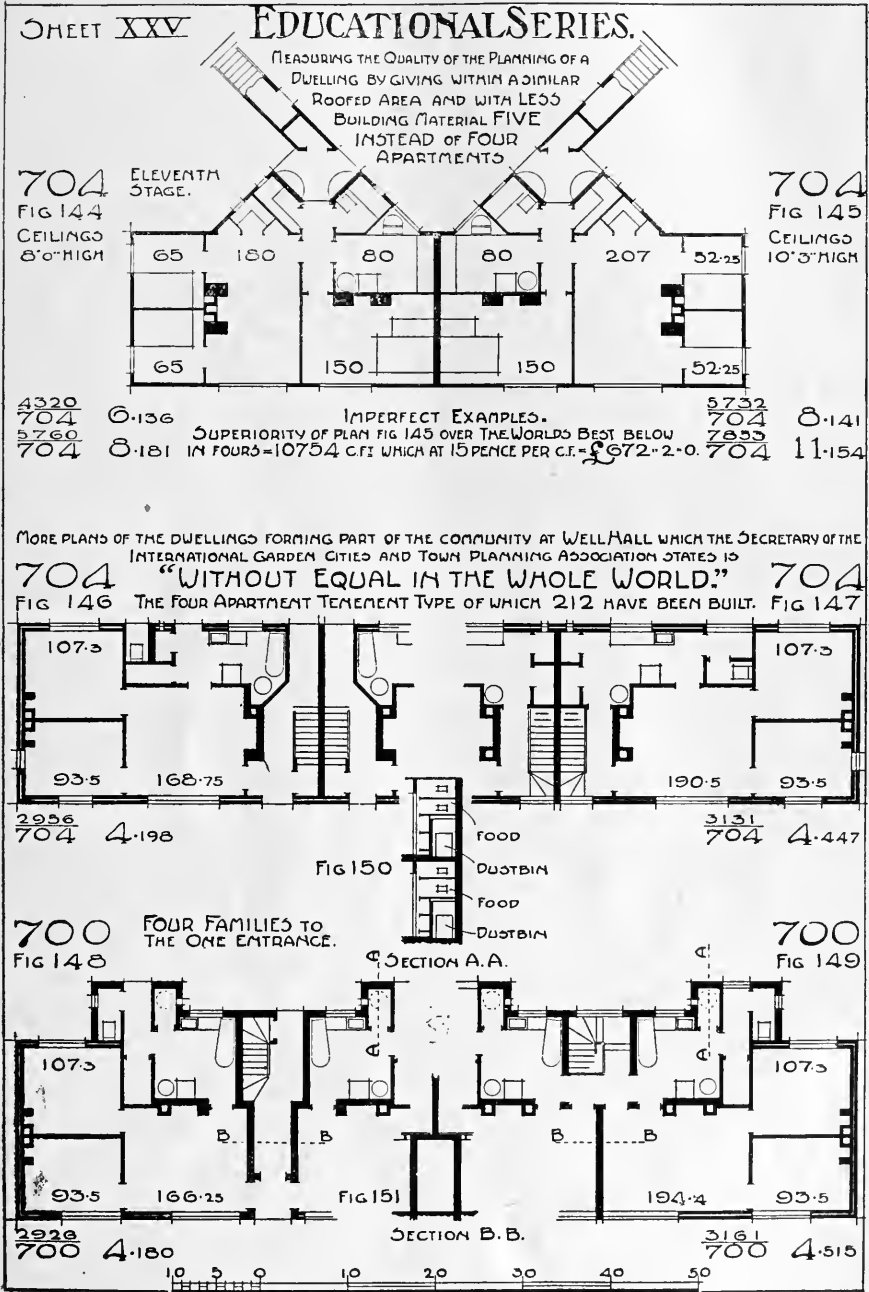

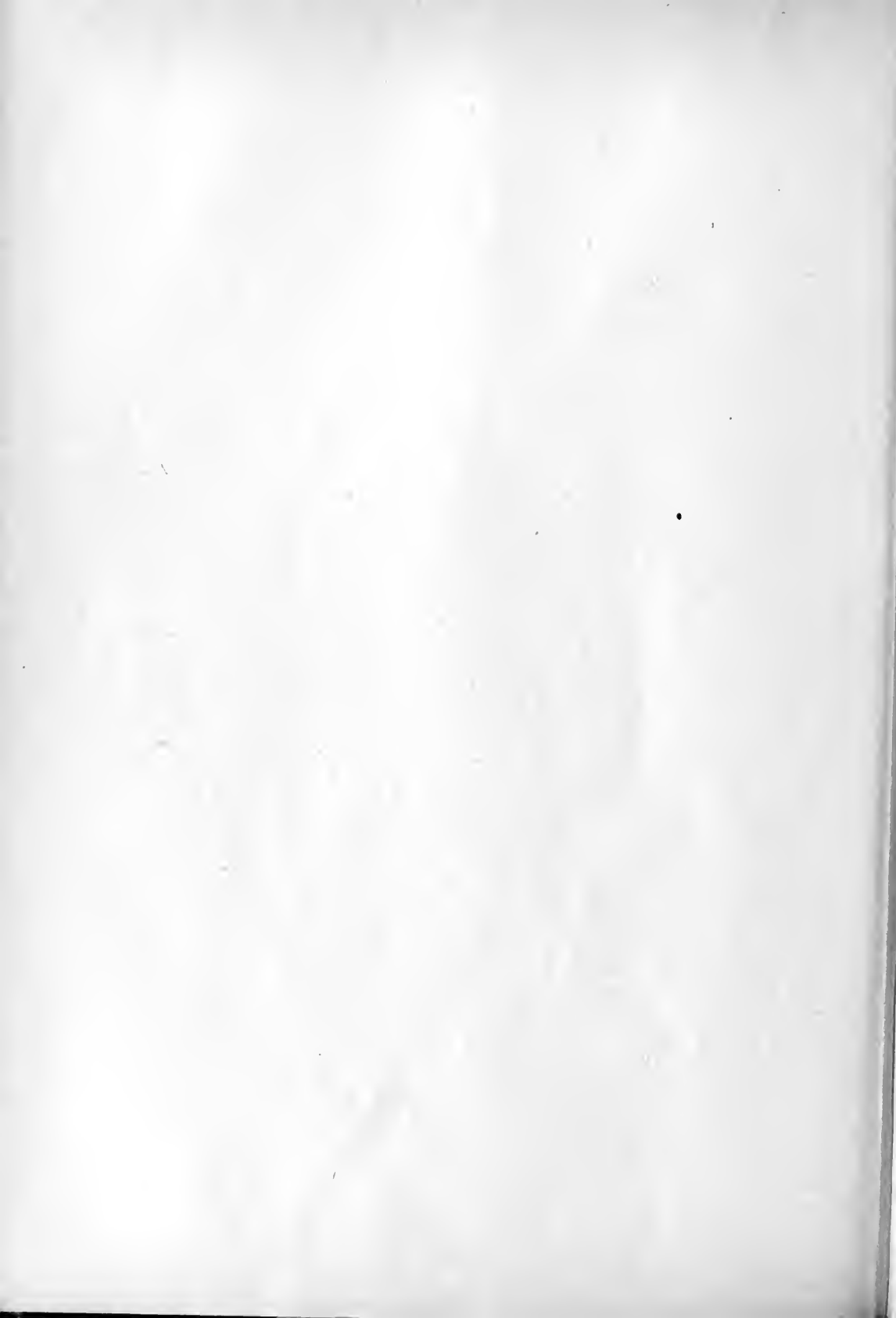





NEW HOUSE AT TOTTERIDGE, HERTS : GARDEN FRONT.  
Messrs. H. V. ASHLEY and F. WINTON NEWMAN, F.F.R.I.B.A., Architects.





HILL CREST TOTTERIDGE:

Mess<sup>rs</sup> ASHLEY & WINTON NEWMAN ARCHITECTS

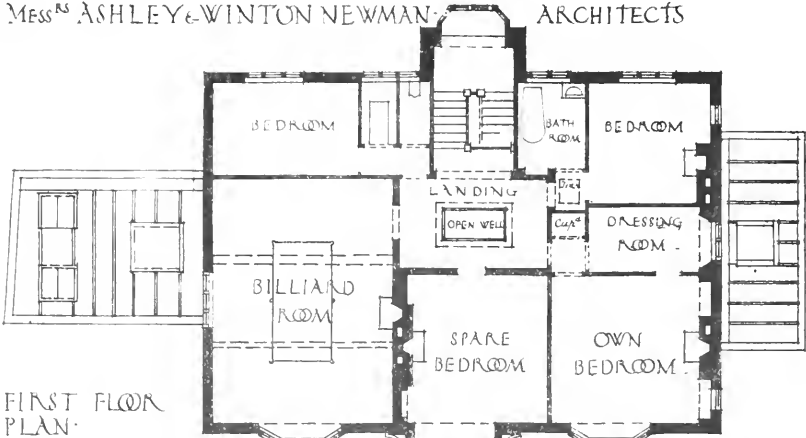

GROUND FLOOR PLAN

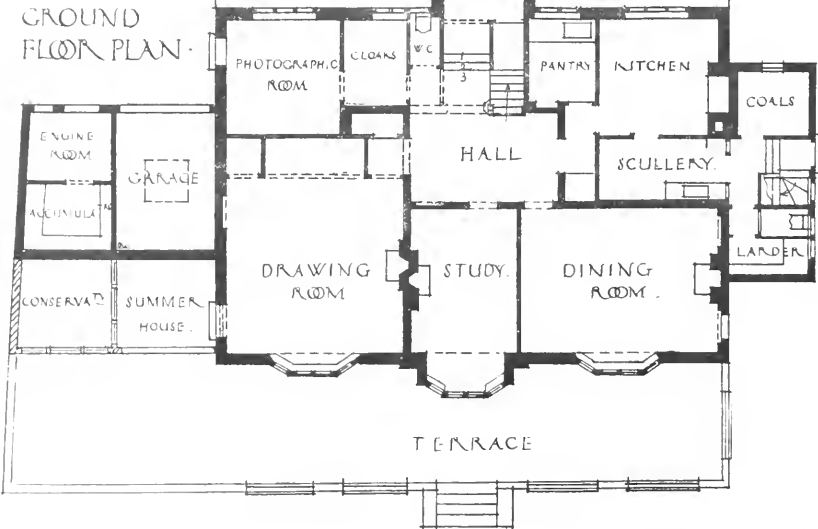



GREEN ARBOUR HOUSE, HOLBORN VIADUCT STATION, E.C.  
MR. ARTHUR F. USHER, F.R.I.B.A. (MESSRS. YETTS, STURDY AND USHER), ARCHITECT.





NEW HOUSE, TOTTERIDGE, HERTS: TERRACE AND BAYS.  
Messrs. H. V. ASHLEY and F. WINTON NEWMAN, F.F.R.I.B.A., Architects.



## Our Illustrations.

### "HILL-CREST," TOTTERIDGE, KENT.

We give two views of this house, which has been built in Totteridge Lane, the site being part of the garden of the adjoining house belonging to the building owner, who desired to vacate the larger residence for a smaller one. The original building is an early example of the late Norman Shaw's work, and it was desired to erect a new house on a smaller scale in keeping with the bigger one. The back of this new dwelling faces due south, commanding extensive views, consequently that aspect was chosen for the principal rooms. Owing to the fall of the ground a wide terrace suggested itself, and this furnishes a pleasing and natural setting to the house as well as its garden. The accommodation is clearly shown by the pair of plans here given with the photographs. The builders were Messrs. C. Miskin and Son, of St. Albans. The architects were Messrs. H. V. Ashley and Winton Newman, F.R.I.B.A., of 14, Gray's Inn Square, W.C.

### GREEN ARBOUR HOUSE, HOLBORN VIADUCT STATION, LONDON.

This building occupies a site at the Holborn end of Old Bailey. The major part of the ground floor, together with a portion of the basement and first floors, are used by the parcels department of a railway company. The upper floors were arranged for commercial purposes, to be subdivided as might be necessary. The condition of unobstructed space on the ground floor necessitated the building being steel framed. The floors, roofs, and flats are of concrete and "expanded metal." The elevations to Old Bailey and Green Arbour Court are faced with Portland stone. The front roof is covered with Westmoreland slates, the dormers being in copper. Messrs. Hammond Champneys, Waygood Otis, Ltd., and Messrs. A. and P. Stevens supplied the lifts; Messrs. Rust and Co., the tiling; Messrs. Hayward supplied the pavement lights; and Frederick Bray and Co. the copper work to the roof. The Val de Travers and the Metropolitan Asphalt Co. executed the asphaltic work. Messrs. Ford and Walton, Ltd., were the general contractors, and Mr. J. Davis acted as clerk of works. The building was designed by Mr. Arthur F. Usher, F.R.I.B.A., of Messrs. Yetts, Sturdy, and Usher, 45, Finsbury Pavement, E.C.

### THE PROBLEM OF THE SMALL DWELLING AND ITS SOLUTION.

This pair of pages of plans, made by Mr. Robert Thomson, are numbered XXIV, and XXV. The series commenced on May 30, and continued as follows: June 6, 13, 20, and 27; July 4, 11, 18, and 25; August 1 and 8. On each occasion the designs shown were accompanied by an article and descriptions in our pages.

## Building Intelligence.

WAR SEAL MANXIONS, FULHAM.—On Thursday last Mr. Hayes Fisher, M.P., President of the Local Government Board, laid the corner stone of the first block of buildings in course of erection at Fulham for homes of men disabled in the war, provided by the War Seal Foundation Fund. The buildings, on a site presented by Mr. Oswald Stoll, near Walham Green Railway Station, will contain 72 sets of rooms, in which a disabled man with members of his family will have the use of a living-room, two bedrooms, kitchen, and domestic arrangements, specially designed by the architects, Messrs. Joseph and Smithem, of 83, Queen Street, E.C., for the requirements of an invalid. Wide doorways will allow the passage of a wheeled chair from bedroom to lobby, an open balcony, and a lift, and a covered way will admit to the administrative block, where curative or ameliorative treatment will be freely provided. The inclusive rent will be 6s. 6d. weekly. The buildings were illustrated and fully described in our issue of May 21, 1916.

### GAS-FILLED WINDOWS.

The most familiar form of gas-filled window is the double sash, common in parts of the country where the winters are cold. The resistant power of these is usually ascribed to the layer of air between the two sets of glass panes, but Mr. Halbert P. Gillette tells us in *Engineering and Contracting* (Chicago) that it is chiefly due to the film of air condensed on the surface of the glass. He has experimented with various other gases, and concludes that a double pane filled with carbon dioxide, the familiar gas used to charge soda-water, is the best. This gas has only half the conductivity of air, and with a window "filled" with it the heat loss would be one-third of that with a single window in still air, and one-fifth in a wind. The editor of the paper just named believes that the "gas-filled" window is a good companion in efficiency to the "gas-filled" electric lamp, and that we shall hear more of it. Mr. Gillette calculates that when the temperature is 20 degrees greater within a glass pane than without it, 19.3 degrees of the drop is due to the two adherent air-films, and only 0.2 degree to the glass itself. He says:—

"We now see how very important a factor is the resistance of the equivalent air-film in problems of this character. The thickness of the equivalent air-film decreases rapidly when the air is mechanically agitated, as when a wind is blowing. For this reason a strong wind blowing against a window-pane almost doubles the heat lost by conduction. Hence, also, double windows or double glazing is so effective in reducing heat losses. In a double window there are four air-films instead of two, and a strong wind can reduce the thickness of only one of the four. . . ."

"Obviously, a triple-pane window would be more effective than a double-pane window, but ordinarily the cost of triple-pane windows would be prohibitive. Accordingly I have designed a double-pane window in which the space between the two panes is filled with a gas of low conductivity, like carbon dioxide, the panes being hermetically sealed, preferably by welding of the glass at the edges. . . ."

Carbon dioxide has about half the conductivity of air, hence my design of gas-filled windows will offer nearly 50 per cent. more resistance to heat conduction when no wind is blowing, and 70 per cent. more when a strong wind is blowing, than is offered by the ordinary double-pane window. Remembering that even an ordinary double-pane window offers almost three times as great a resistance to heat conduction as a single-pane window when wind is blowing, it will be seen that my design of gas-filled window offers five times as great resistance as single-pane window. In short, the heat losses from buildings, which occur mostly through window-panes, can be greatly reduced at relatively slight expense. Other gas than carbon dioxide may prove even better. . . ."

"The practical applications of the film theory of conduction are so numerous and important that it is certain that many radical changes in the design of engineering structures and machines will occur within the next few years as a result of this theory. . . ."

"To the experimenter a splendid opportunity presents itself to extend our knowledge of heat transfer and to co-ordinate the data into formulas readily applicable. Prior to the advent of the film theory, heat-conduction data were chaotically confusing. These will soon be reduced to order as a result of better understanding of this theory. Already the writer has co-ordinated many data hitherto contradictory. . . ."

Mr. A. W. Ward, borough surveyor of Shrewsbury, has had his salary increased from £400 to £450 a year.

William Ward, seventy-four, house decorator, of Hollydale Road, Peckham, was fined £20 at Lambeth Police Court, last week, on a charge of loitering for the purpose of betting.

An anonymous Harrogate resident has offered to build at his own expense a handsome Church of England chapel for the new cemetery on the east side of Harrogate, provided that a suitable site is obtained for the building.

### OBITUARY.

The death occurred at his residence, at Durham, on Saturday last, of Mr. Thomas Henry Graden, A.R.I.B.A., who has carried on an extensive practice as an architect in Durham for thirty years. The third son of the late Mr. and Mrs. Geo. Graden, of Durham, he was born sixty-two years ago. He served his articles as an architect with the late Mr. C. Hodgson Fowler, and was assistant with several firms in the North. He went to South Africa some thirty years ago, and returning to Durham, began business on his own account. Among the buildings which he designed was the present Durham Miners' Hall at Hed Hills, Durham, which we illustrated in our issues of April 17 and 24, 1914; the Congregational Church and School, Whitley Bay, given by us in that of February 22, 1907; and St. Thomas' Secondary School for Girls, Red Hills, Durham, which appeared in that of November 30, 1906. His wife died some ten years ago. There was no family. The funeral is to take place to-day at St. Cuthbert's Church, Durham.

We regret to announce the death of Captain W. Edgar Paul (Royal Scots Fusiliers), which took place at the front on the 31st ult. Captain Paul was the second son of the late Mr. Charles Paul and of Mrs. Paul, of 56, Pembroke Road, and husband of Mrs. Paul, of 16, Duchess Road, Clifton. He was educated at Clifton College. On leaving school, in 1891, he became an architect and surveyor, served on the staff of the Corporation, and afterwards held charge of the estate property of the Bristol Brewery Company, but more recently carried on a private practice in Baldwin Street, Bristol. Shortly after the outbreak of war he helped in the formation of the Bristol University O.T.C., but was offered and accepted a commission as captain in the Royal Scots Fusiliers. He was sent first to France, and then to Salonika, where he was on duty for eighteen months, but last winter was invalided home. On recovery he again went to the front, and on July 31 was killed in action.

### MORE "WHEREAS"!

The following ORDER of the Minister of Munitions revoking the Orders of the 9th day of May, 1917, and the 14th day of June, 1917, as to road stone quarries has been issued.

"WHEREAS by an Order dated the 9th day of May, 1917, the Minister of Munitions ordered that from and after the date thereof until further notice Regulation 96G of the Defence of the Realm Regulations should be applied to all road stone quarries throughout the United Kingdom of Great Britain and Ireland, AND WHEREAS by an Order dated the 14th day of June, 1917, the Minister of Munitions ordered that notwithstanding the said Order of the 9th day of May, 1917, Regulation 96G should not be applied to any road stone quarry outside England and Wales or to any road stone quarry wherever situated producing only gravel and flint used as road stone, and further ordered that the application of Regulation 96G should be postponed until the 15th day of July, 1917, AND WHEREAS the Minister of Munitions is desirous of revoking the said Orders of the 9th day of May, 1917, and the 14th day of June, 1917, with a view to an Order being made by the Army Council in place thereof, NOW the Minister of Munitions in exercise of the powers conferred upon him by Regulation 96G and every other power enabling him in that behalf hereby as from the date hereof revokes the said Orders of the 9th day of May, 1917, and the 14th day of June, 1917, and hereby gives notice that the same are so revoked. (End of Serial No. C. 4729)."

The death is announced, on August 8, at 54, Cornwall Gardens, South Kensington, of Herbert Evelyn, beloved eldest son of Sir Herbert H. Bartlett, Bart., and Lady Bartlett, aged forty-two.

Motor-cars—or rather parts of the chassis thereof—in reinforced concrete are possibilities of the near future, according to the Motor correspondent of the *Westminster Gazette*, in that journal of the 7th instant.

### COMPETITIONS.

**WAR MEMORIAL FOR NEXT-OF-KIN.**—The Government are offering prizes, amounting in all to not less than £500 (in proportions to be subsequently decided), for a limited number of the most successful models for a small memorial plaque in bronze, to be given to the next-of-kin of those members of his Majesty's naval and military forces who have fallen in the war. The plaque must have an area of as nearly as possible 16 square inches. It may be a circle of 42 ins. in diameter, or a square of 42 ins., or a rectangle of 5 ins. by 35 ins., and it is to be produced by casting from a model, which should be finished with precision. All designs submitted must be actual models in relief in wax or plaster of the size indicated. No models on a larger scale will be considered, and no competitor may submit more than two models. The design should comprehend a subject and a brief inscription. It is suggested that some symbolical figure subject should be chosen, but the following inscription has been decided upon, and this must form part of the design:—

"HE DIED FOR FREEDOM AND HONOUR."

Since the surname of the person commemorated and the initials of his Christian names are to be engraved on the plaque, the design should be arranged so as to leave space for the name. In the case of a rectangular design this space should be left at the base. If the design is circular a margin surrounding, or partially surrounding, it should be left free. Competitors are reminded that the design should be essentially simple and easily intelligible. All the competitors must be British-born subjects. Each model should be packed in a small box and delivered to the Director, National Gallery, Trafalgar Square, W.C.2, not later than November 1. The model must not be signed, but should be marked on the back with a motto or pseudonym, which should also be written on a sealed envelope containing the competitor's name and address. Models to which prizes are awarded shall be the sole property of the Government, who will arrange for the appearance of the artist's signature or initials on the finished plaque. Copies of the instructions may be obtained on application in writing to the Secretary, War Office, or to the Secretary, Admiralty.

### STATUES AND MEMORIALS.

**ABERDEEN.**—At their last meeting the finance committee of the town council considered the remit from the council with reference to the proposed memorial to soldiers and sailors who have fallen in the war. Plans by Dr. Marshall Mackenzie were submitted showing the front elevation to Schoolhill and the elevation of the interior of the proposed memorial. The proposal before the committee is that a memorial be erected fronting Union Terrace at the corner of Blackfriars Street, the memorial to be circular in form, and the walls to be panelled and surmounted by a dome. On the panels it is proposed to inscribe the names of soldiers and sailors who have lost their lives in the war, these to be arranged regimentally. The memorial will be entered from Schoolhill by an imposing front. The court and balcony will enter into the art gallery. It is not known how much the memorial will cost, but it is expected that the town council will make a gift of the site, which will perhaps amount to a saving of £5,000.

**CHATHAM.**—The church decoration committee, having decided to commemorate the officers and men of the Chatham Port Division who have fallen in the war, propose the erection of an oak reared, a screen with two wings, behind the high altar. The design, approved by the Admiralty, has been prepared by Mr. W. D. Carge, F.R.I.B.A., architect to the Ecclesiastical Commissioners, who has drawn up a scheme which embraces the patron saints of the Allied Powers, together with the coats of arms of Britain's colonies. The material will be dark oak, the figures being thrown into relief by gilding, while the coats of arms will be coloured.

**New Zealand Expeditionary Force.**—Missing since June 7, 1917, Grosley H. Wood, 21,136, France. Information gratefully received by Mrs. Norman Shaw, 6, Ellerdale Road, Hampstead, N.W.

### Our Office Table.

The President and Council of the Royal Academy have appointed Mr. Arthur T. Bolton, F.S.A., F.R.I.B.A., Soane Medalist, (1893) and Institute Medallist (Essays), 1895, to be Curator of Sir John Soane's Museum, 13, Lincoln's Inn Fields, W.C. The late Curator, Mr. Walter L. Spiers, died on May 23.

Shingles sufficient to cover two small panels were fireproofed by the Forest Products Laboratory of the Forest Service and sent to Seattle for fire tests to be conducted by the West Coast Lumbermen's Association. Shingles for one panel were painted with two coats of zinc borate paint, and the other shingles were given a zinc borate injection. Samples of these shingles tested in the inflammability apparatus at the laboratory indicate that the treatment and coating are effective.

An attack has been delivered on the wood worm which has damaged the timbering of Westminster Hall throughout centuries. The name of this creature, according to Mr. Frank Baines, architect to the Office of Works, is *xyestobium tessellatum*, and it does all its destructive work while in the larval stage. As a beetle it is harmless—as a grub—well, I could bury you waistdeep in some of the holes it has made in the oak work of the Hall. It lives only in oak. I am convinced that it has been going on for more than 400 years. Some of the patching done a hundred years ago has been attacked. All other methods of exterminating *xyestobium tessellatum* having failed, Mr. Baines called in the assistance of Professor H. Maxwell Lefroy, of the Imperial College of Science and Technology, South Kensington, and he invented a spray, which is constituted thus:—

50 per cent. tetrachloroethane, 6 per cent. cedarwood oil, 2 per cent. solvent soap, 2 per cent. paraffin wax, and 40 per cent. trichlorethylene. The first is a perfect insecticide, and is so dangerous that those who handle it must use gas masks. The cedarwood oil protects the wood against future attacks, and the scent impregnates the timber and keeps the beetle away. The soap holds the oil and renders the wood non-inflammable, and the paraffin wax prevents chemical action. The trichlorethylene is a solvent and diluent—and is itself a feeble insecticide. The roof has been sprayed with this several times, and Mr. Baines is confident that the plague will be effectively stayed. This drastic treatment is a last measure of protection, and science can suggest nothing further at present.

If the scheme of the Boundaries Commissioners for Westminster goes through, there will be in future an M.P. for the Abbey. At present Westminster has three members, and the Commissioners propose to cut them down to two, the constituencies to be named Abbey and Hyde Park. The member for the Abbey will represent an imposing historical tradition. There was, it is said, a member for the City of Westminster before there was a member for the City of London. The member for the Abbey will represent the illustrious English dead as well as the toiling population of riverside Westminster, and the constituents that will trouble him least, and in many cases, if not all, inspire him most, will be the crowd of stone stamens who address imaginary meetings in the nave and transepts.

A gentleman in search of a house is both amused and resentful at the long string of questions he is called upon to answer on a printed form of "tenancy application." There are upwards of a dozen specific interrogations plus a number of stipulations. Some of the questions are of a very intimate description. The gentleman suggests two or three others which the drafter of the "form" has omitted. For example, he thinks that the would-be agent or landlord should ask for the birth and marriage certificate of applicants and particulars of the number of times they have been vaccinated.

One stipulation made is that the house will not be let to "any person of military age."

The Carnegie United Kingdom Trustees, who have considered carefully the reports prepared for them and now in course of publication with regard to the physical welfare of mothers and children, will be prepared to consider favourably the cost of the acquisition or erection of a suitable building in London for the housing of a Central Bureau or Institute of a national character, to serve as a co-ordinating agency for all the various local and other organisations connected with infant and maternal welfare in England and Wales, and of a similar central Institution for Scotland. The purpose of the proposed Central Institutes would be to assist the various voluntary and statutory bodies engaged in the subject in England and Scotland respectively; it would not supersede them or encroach upon their proper spheres of local interest.

At the monthly meeting of the Waltham-on-Dearne Urban Council, the acuteness of the situation created by lack of housing in the district was referred to by Mr. William Hallatt, who suggested that an attempt should be made to mobilise the local authorities in the Dearne Valley area in the direction of securing joint representation to the Local Government Board for assistance to enable the local authorities to deal with the problem Mr. Hallatt mentioned that in Wath alone 500 or 600 houses were wanted immediately, and the lack of them was seriously retarding the industrial development of that district. Mr. Marshall Robson said it was hopeless to attempt to gain the ear of the Government in the face of the claims of cities like Sheffield, Birmingham, and Leeds, unless the urban and rural authorities of the area co-operated. There was not an empty house in the district, and yet there were a number of establishments, each with a thousand or more men away fighting, employing as many men to-day as they did before the war. In every such instance there was a clear case for 250 new houses. He calculated that they were expecting back into that district 8,000 to 10,000 men, all married or marriageable. It was decided to summon a conference of the following local authorities:—The urban councils of Mexborough, Swinton, Waltham-on-Dearne, Thurnscoe, Wombwell, Darfield, and Hoyland Nether, and the rural councils of Rotherham and Doncaster.

Burton-on-Trent is bidding for new industries. Few, if any, towns in the kingdom offer such excellent advantages as Burton, which possesses every facility for the cheap production and convenient distribution of manufactured goods. There are no slums; nearly all the workmen's cottages are modern, with big gardens, and the health records are unrivalled, thus ensuring healthful and pleasant environment for the worker. Gas and electricity are supplied by the corporation. The gas works having within recent years been reconstructed and brought thoroughly up to date, the charges for domestic and industrial service compare favourably with those of other towns. Electric lighting in factories is charged for at the power rate, and electric motors are let out on hire at nominal rentals. Gas engines can also be obtained on the hire-purchase system. Mr. R. S. Ramsden, manager of the gas undertaking, especially emphasises the advantages available in the way of cheap gas. The price for motive power or other manufacturing purposes is from 1s. 7d. to 2s. 1d. per 1,000 cubic feet.

The annual statement of the work of the Thames Conservancy Board mentions that although the rainfall in 1916 was not the highest recorded, the total natural flow of about 875,000 million gallons was the maximum for any year since the records were begun in 1885. Of 435 men in the Conservators' service at the outbreak of the war over 300 had been called to the Colours and their places, for the most part, occupied by women. Through the locks 9,798 barges conveyed 267,696 tons of merchandise. The passage of launches through the locks numbered 54,655 and lock tolls were paid in respect of fifty-seven houseboats and 103,000



skirts, punts, etc. The income of the board last year was £53,974 and the expenditure £43,840.

At the concluding sitting last Saturday evening of the Conference of Modern Churchmen, organised at Cambridge by the Churchmen's Union, Professor Percy Gardner, delivered an address on "Christian Modernism and Art." He said the question whether Modernist views of religion involved a particular attitude towards art should be considered. He dealt with only one kind of art—the plastic and graphic, which, he said, probably had its origin in magic. Opposed to it were mysticism and Puritanism. Early Christianity set out with a prejudice against art as naturally pagan, and many Christian schools had regarded it as idolatrous or worldly. Mysticism led to symbolic art, which was indifferent to beauty. How far he asked, could painting be Christianised? Landscape painting was essentially religious, but not always Christian. Wordsworth, however, looked on landscape in a Christian way. Landscape painting had been transformed by science and historical painting by the critical study of history. Modernists would welcome the progress produced in painting by science and historical study. They also appreciated Greek sweetness and light, which was parallel to a high morality. Modern schools of realism, by the rejection of beauty, became foul and degraded. Referring to the use of painting and sculpture in churches, Professor Gardner said they might either have stained-glass windows or fresco paintings on the walls. He thought the latter had many advantages over the former when there were good wall spaces. In either way it was possible to give series of representations from the whole history of Christianity, and so teach people Church history, regarding which they were usually very ignorant.

A circular (with accompanying schedules) dealing with the subject was sent out last Friday from the Edinburgh offices to the clerks of all the local authorities of Scotland by the Local Government Board for Scotland. Realising that private enterprise, which prior to the war was responsible for practically all house building, will be unable to grapple successfully and speedily with this arduous task, the Board have come to the conclusion that for the years immediately following the war it will be necessary to rely far more than in the past upon local authorities to provide the houses required, together with the necessary roads and streets, and services of water, drainage, and lighting. The Board are now authorised to say that the Government recognises that it will be necessary to afford substantial financial assistance from public funds to local authorities who are prepared to carry through, without delay at the conclusion of the war, a programme of housing for the working classes approved by the Local Government Board. The circular adds that it is not possible at this stage to indicate either the form which this assistance will take or the extent of it, but it may be taken that it will be available for a limited period only. If, therefore, the local authority are of opinion that there is a housing need in their area, and desire to share in the financial assistance referred to, they are asked to fill in a schedule and return it to the Board not later than October 15 next. In conclusion, the circular states:—"It is in the knowledge of the Board that the report of the Royal Commission on Housing in Scotland, which will shortly be before the Government, deals with housing for the working classes, including the provision of houses by private enterprise, either in the form of public utility societies or otherwise. Accordingly, at this stage the Board refrain from making any suggestion on this aspect of the question, although they fully realise its great importance."

Mr. Hall Caine last Saturday afternoon, opening the twenty-third horticultural exhibition at Port Sunlight, and dealing with the housing of people, said he thought Port Sunlight was a great contribution towards the solution of one of the most difficult problems of modern life. You could not house people in kennels and treat them as

dogs without the certainty that they would acquire the vices of dogs. The recognition of this was the first source from which the improvement of housing in towns and cities sprang, and Liverpool, he believed, was the pioneer among the great towns in this movement. Even London came long after Liverpool, and was only now beginning to tackle it seriously. When Lord Leverhulme pitched his camp at Port Sunlight thirty years ago he brought with him the great idea that a master's best capital was not in his money but in his men, and also brought with him another idea—that beauty and utility could go together. The result was Port Sunlight, a little town which had apparently solved the difficult problem of humanising the lives of workmen in the midst of the most vigorous industrial activities. This was a great achievement, and the man who made it was ensured of an enviable immortality. No man, however, did any work of public usefulness by himself alone. Everything that had been worth doing had been done by the members of a community working together.

PARLIAMENTARY NOTES.

HOUSING IN SCOTLAND.—On the vote of £47,058 for the salaries and expenses of the Local Government Board of Scotland, the Solicitor-General for Scotland (Mr. Morrison) said the Royal Commission on Housing in Scotland, appointed five years ago, would issue their report in the course of the present month. The report would deal with the problem from a national standpoint, including rural as well as urban housing, and present a scheme for financing operations by means of contributions both from the local authorities and the State. Meantime, with a view to dealing immediately with the question of housing accommodation in Scotland after the war, the Cabinet had come to the decision that it was necessary to afford substantial financial assistance from the public funds to local authorities which were prepared to provide houses for the working classes after the war. The Local Government Board of Scotland had just issued a circular to the local authorities asking for information as to the need of houses in their districts, and hoped to have the replies by October 13. The vote was agreed to.

TATE GALLERY TRUSTEES.—Mr. Rowlands (L., Dartford) asked the Prime Minister whether an eminent artist declined to join the newly-formed Board of Trustees of the Tate Gallery, owing to dissatisfaction with the constitution of the board; whether there were any artists on the board; and whether the Government proposed to do anything to meet the objections raised by the memorialists on behalf of a number of art institutions.—Mr. Bonar Law (Chancellor of the Exchequer) said the answer to the first two parts of the question was in the affirmative. As regarded the third part, the Government would bear in mind the representations contained in the memorial.

TRADE NOTE.

Our New Zealand readers will be interested in the following extract from a recent letter received from the well-known firm of builders' merchants, Messrs. McLeod and Gardner, Ltd., Hastings, N.Z.:—"One of our builders used powder to waterproof cement on a damp section of a rough-cast wall. A day or two afterwards, really before the work had time to set, there was very heavy rain for two or three days, when the district suffered from very heavy floods, and upon examination of the work afterwards, it was discovered that the new waterproofed cementwork was quite dry, whereas the damp had soaked right through the old non-waterproofed work. The result is that the owner is now having all his walls puddled."

A churchyard cross has been erected at St. Erth, Cornwall, by Mrs. Helen Carter to the memory of her husband, Major H. A. Carter, V.C. and other heroes of the parish who have fallen in the war. The memorial of Portland of Dean stone, is about 25 ft. high. The shaft stands upon two bases, the lower one 12 ft. square, and the one it carries 7 ft. 6 ins. square. The column carries a cross, the eastern side with the figure of the Virgin and the Child, and the western that of the crucified Lord. At the summit of the Virgin Mary and St. John, with the "Alpha and Omega" below.

TO CORRESPONDENTS.

We do not hold ourselves responsible for the opinions of our correspondents. All communications should be drawn up as briefly as possible, as there are many claimants upon the space allotted to correspondents.

It is particularly requested that all drawings and all communications respecting illustrations or literary matter, books for review, etc., should be addressed to the Editor of the BUILDING NEWS, Effingham House, 1, Arundel Street, Strand, W.C.2, and not to members of the staff by name. Delay is not infrequently otherwise caused. All drawings and other communications are sent at contributors' risks, and the Editor will not undertake to pay for, or be liable for, unsought contributions.

When favouring us with drawings or photographs, architects are asked to state how long the building has been erected. It does neither then nor is much good to illustrate buildings which have been some time executed, except under special circumstances.

\*"Drawings of selected competition designs, important public and private buildings, details of old and new work, and good sketches are always welcome, and for such no charge is made for insertion. Where more commodious, all drawings and other chapels, houses, etc.—we have usually far more sent than we can insert, but are glad to do so when space permits, on mutually advantageous terms, which may be ascertained on application."

Telephone: Gerrard 1291.

Telegrams: "Timeserver, Estrand, London."

TERMS OF SUBSCRIPTION.

Twenty-six shillings per annum (post free) to any part of the United Kingdom; thirteen shillings for six months; for the United States, £1 10s. (or \$7 20c. gold). To France or Belgium, £1 10s. (or 42*l.*). To India, £1 10s. To any of the Australian Colonies, or New Zealand, to the Cape, the West Indies, or Natal, £1 10s.

\*"Our Direct Subscription Agents for Australia are Messrs. E. T. Kibblewhite and Co., Printers and Publishers, 19, York Chambers, 105, Liverpool Street, Sydney, New South Wales; for Japan, The Maruzen Co., Ltd., 11-16, Nishinomiya, Nakano, Tokyo; who will receive subscriptions at £1 10s. per annum on our account. Copies of the paper will be sent by us direct to the subscribers' address."

BACK ISSUES.

Most of the back issues are to be had singly. All back issues over one month old will be charged 6*d.* each, postage included. Subscribers requiring back numbers should order at once, as they soon run out of print.

SITUATIONS WANTED AND PARTNERSHIPS.

The charge for advertisements for "Situations Wanted" and "Partnerships" is One Shilling for twenty-four words, and Sixpence for every Eight Words after.

All Situation and Partnership Advertisements must be prepaid.

RECEIVED.—R. I. C. and Co., Ltd.—G. A.—B. O. Co., Ltd.—R. T. A.—W. S. and Son—H.—D. F. W.—B. and D.—J. M. and Son—W. O. and Son—W. A. S. and Son—J. D. and Son—V. L.—T. B. B., Ltd.—E. McE. and Co., Ltd.—A. W. F. D.—Yes.

A. J. S.—Thanks. No.  
B. S.—We know nothing of the firm. See our "Directory" pages for leading people in that line.

R. E.—Thanks. We always prefer line drawings where possible. Picture perspectives are not of much use to architects.

Mr. D. Roberts, borough surveyor of Lewes, has been voted a war bonus of £25 per annum. Mr. Charles W. Thompson, Bank Chambers, Rochester, architect and surveyor, designed the model abattoir on Rochester Common for Messrs. Payne and Co., which was opened by the Mayor last week.

The death is announced, on August 5, at Lappworth, Rowlands Road, Worthing, of Mrs. Annie Maria Gribble, widow of Charles Risdon Gribble, architect, formerly of Barnstaple and London, aged 79.

Lord and Lady Faringdon of Glenmalur have given a stained-glass window to Monzie Parish Church, near Crieff. It has four lights, with flamboyant tracery extending to the arch at the top. The scheme is the well-known one of the Evangelists, emanating from Sir Edward Burne-Jones, R.A.

Mr. Henry Barlow Webb, of Holmhead, Holdbury, St. Mary, near Dorking, who died on June 3, aged eighty-three, left estate of the gross value of £246,406, of which £220,952 is net personally. Probate of his will has been granted to his widow, Sir Aston Webb, C.B., R.A., and others. The testator left his residuary estate in trust for his daughters and their issue, whom he valued at £10,000, to the male descendants of his cousin, Sir Aston Webb, and the balance among other relatives.

**OGILVIE & CO.**

Telephone DALSTON 1586.

Many years connected with the late firm of W. H. LANCEFIELD &amp; CO., of Bunnhill Row.

**Mildmay Avenue, ISLINGTON, N.**  
**EXPERTS in HIGH-CLASS JOINERY.****ALTERATIONS & DECORATIONS.****ESTIMATES FREE.**

FOR

**Olivers' Seasoned Hardwoods,**

APPLY TO—

**WM. OLIVER & SONS, Ltd.,****120, Bunnhill Row, London, E.C.****TENDERS.**

\* \* \* Correspondents would in all cases oblige by giving the addresses of the parties tendering—at any rate, of the accepted tender: it adds to the value of the information.

**BIRMGHAM.**—For the supplying and laying of 350 yards, or thereabouts, of 12 in. stoneware pipes, with 3 in. and 4 in. branch drains, manholes, catchpots and other works appertaining thereto, for the Bodwater Rural District Council. Mr. W. Horace Cousins, Engineer.—  
Gransille, Ed., Westhay, near Bodwater .. .. £307 10 0  
Accepted. (Surveyor's estimate, £307.**BURLEY.**—For cleaning and painting four wards of the male infirmary, for the Guardians.—  
Hartland Bros., Wolverhampton Street, Dudley, £25 (accepted).**HOBDEN (DERHAM).**—For painting miners' hall and caretaker's house, for the Trustees of the Horden Lodge, Durham Miners' Association:—  
Burden, J., Ltd., West Hartlepool £143 12 6  
Robson, J., and Son, 6, Victoria Buildings, High Street West, Sunderland\* .. .. 142 10 0  
\*Accepted.**LONDON, N.E.**—For cleaning and painting at the Eastern Hospital, for the Metropolitan Asylums Board:—  
Pekrill, H., 24, Cannon Road, Woodstock .. .. £375 0 0  
Payne Bros., Leavesden, Watford .. .. 243 0 0  
Kazak, E., Heathfield House, Berkhamstead Road, Belford .. .. 218 0 0  
Kent .. .. 218 0 0  
Edgar, H. J., 3, Craven Terrace, Lancaster Gate, W. .. .. 205 0 0  
Irms, A. H., 7, Devonshire Square, Bishopsgate, E.C. .. .. 197 0 0  
Vigor, A., Ltd., 10, Coleman Street, E.C. .. .. 187 0 0  
Acting Engineer-in-charge, rec'd estimate, £195.  
\*Recommended for acceptance.**MILLOW.**—For cleansing reservoir at the water-works, for the urban district council:—  
Crowley, J., .. .. £160 0 0  
Sherman, P., .. .. 149 10 0  
Bassett, P. J. (accepted) .. .. 79 0 0**NORTHWICH.**—Erection of shed, for the urban district council:—  
Bostock, C. W., £29 3s. 6d. (accepted).**OXFORD.**—For painting and decorating the Cowley Poor-Law schools, for the guardians:—  
Wyatt and Son .. .. £150 0 0  
Gray, W. M., .. .. 133 0 0  
Lombard, Ltd., .. .. 87 0 0  
Green, E., and Son\* .. .. 81 0 0  
\*Accepted.**ROCHFORD.**—For repairing well in the laundry drying room, for the Romford Board of Guardians:—  
Walter, G. J., Barking-side (accepted), £125 10s.**WIGAN.**—For the glazing, with patent glazing, of a portion of the roof of the market hall, for the corporation. Mr. A. T. Goswami, borough engineer.—  
Penruyok Patent Glazing Co., Ltd., Glasgow, £176 (accepted).**WIGAN.**—For improving the heating arrangements in the council chamber at the borough courts, for the corporation. Mr. A. T. Goswami, borough engineer:—  
Furnwood and Glover, 165, Ormskirk Road, Wigan, £80 10s. (accepted).**WIGTON MAGNA (LEICS.).**—For taking up existing sewer of about 120 lineal yards and replacing same in cast-iron pipes (provided by the council); also a new manhole, etc., in Cross Street. Wigton Magna, for the Wigton Magna Urban District Council:—  
Emery and Co., Aston .. .. £385 0 0  
Palmer, A. E., Leicesters\* .. .. 377 18 0  
\*Accepted.**WINCHESTER.**—For alterations and repairs to the child welfare centre, No. 4, The Square, for the city council:—  
Wise and Lansell, £195 (accepted).**WINCHESTER.**—For alterations at Messrs. Colson's brewery, for the city council:—  
Hunt, J., £1,710 (accepted).**LIST OF TENDERS OPEN.****BUILDINGS.****August 17.**—Erection in reinforced concrete work of boiler-house, engine-room, and switch-house at the new electricity works, Balmatlock Bridge, Glasgow.—For the Corporation.—Lindsay, Town Clerk, City Chambers, Glasgow.**August 23.**—Work required in extension of an existing cart shed to form a garage for motor wagons at their Bradford Road Station (Manchester).—For the Gas Committee.—Chairman, Gas Committee, Gas Offices, Town Hall, Manchester.**August 24.**—Certain alterations at the union workhouse, Holywell; and the dismantling and disconnecting of present boilers and connections and their re-erection in the proposed new buildings.—For the Guardians.—P. H. Roberts, Clerk, Union Offices, Holywell.**August 27.**—Erection of a bathroom, etc., and plastering, etc., certain wards at Eastville Institution, and painting, etc., in the cottage homes at Downend, in accordance with specifications.—For the Bristol Board of Guardians.—J. J. Simpson, Clerk, St. Peter's Hospital, Bristol.**ENGINEERING.****August 24.**—Installation of a hot-water supply at the Eccles New Road Institution in place of the existing hot-water plant.—For the Guardians of Salford Union.—E. H. Inckley, Clerk, Poor-Law Offices, Eccles New Road, Salford.**Aug. 31.**—Sealed tenders, endorsed "Tender for Contract No. 923," will be received at the Town Clerk's Office, Municipal Offices, Johannesburg, not later than 12 noon on August 31, for refrigerating plant at Market Buildings, Newtown, Johannesburg. Drawings and documents can be viewed free on application to the Council's agents in London, Messrs. E. W. Carling and Co., St. Dunstan's Buildings, St. Dunstan's Hill, London, E.C., but a deposit of £1 ls. is required for copies.**September 12.**—The Corporation of Boodle invite designs and tenders from specialist firms for erection and completion of an overhead coal bunker in the present boiler-house; the coal bunker to be constructed in reinforced concrete, and to hold at least 400 tons of coal.—J. S. Tunnity, Town Clerk, Town Hall, Boodle.**March 30.**—The Acting British Consul at Santiago reports that a decree has been issued calling for tenders for the improvement of the port of Antofagasta (Chile). By the terms of this decree the amount to be expended on this work must not exceed £1,700,000. Details may be obtained from the Port Commission Offices in San-

tiago, and copies are expected to be received shortly at the offices of the Chilean Legation in London, 22, Grosvenor Square, W.1. Tenders will be received up to 3 p.m. on March 30 by the Minister of Finance, Santiago.

**FURNITURE.****August 20.**—The Commissioners of H.M. Works invite tenders (from manufacturers only) for the supply of tables (pedestal, writing, etc.), for six or twelve months from September 1.—The Secretary, H.M. Office of Works, Storey's Gate, London, S.W.1.**PAINTING.****August 18.**—Cleaning and painting the public street nameplates, boundary signs, and mile plates in the Hulme (Manchester) division of the central district.—For the Paving, Sewering and Highways Committee.—Secretary's Office, Paving, etc., Department, Town Hall, Manchester.**ROADS AND STREETS.****August 25.**—Construction of a stone-paved foot-path in Rectory Lane and Bishops Hall Lane, Chelmsford.—For the Town Council.—G. J. Martin, Town Clerk, Municipal Offices, Chelmsford.**SANITARY.****August 20.**—Scavenging the parish of Fulmer.—For the Fulmer Parish Council.—Clerk of Fulmer Parish Council, Fulmer.**August 24.**—Laying 990 yards of 6-in. stoneware sewers, 263 yards of cast-iron sewers, the construction of manholes and lamp-holes on connection therewith; and the construction of settling tanks, bacterial filters, and siphon chambers and laying out irrigation land for treatment of sewage at Pains Hill, Linsfield.—For the Goudstone Rural District Council.—C. Phillips, Clerk, Council Offices, New Oxford.

Mr. S. Skidmore, the surveyor for the northern division of Shropshire, has resigned after twenty-four years' service.

St. Joseph's Church, Cwmaman, was opened on the 2nd inst. It has been erected at a cost of £4,200, of which sum more than one-half has been subscribed.

It is proposed to provide a morning chapel at Ealing Parish Church as a memorial to the late Rev. Dr. W. E. Oliver, who was Vicar of Ealing for over thirty years.

A sub-committee appointed to inquire into the hospital accommodation at Retford has decided that the existing building is out of date. It is recommended that a new one be built on the North Road, and the owner of the site, Major Donnan, has offered to give it.

An exhibition of etchings by Andrew Geddes (1783-1844) has been arranged in Room 132 of Victoria and Albert Museum. It comprises ninety-nine proofs of thirty-three different subjects, several states of each subject being exhibited to show how the plate developed under the artist's hand.

Mr. H. R. Crabb, borough and water engineer of Pembroke Dock, has been appointed surveyor to the Sheerness Urban District Council. The Sheerness Council have decided to retain the services of Mr. T. E. Berry, the late surveyor, as consulting engineer in regard to the sea defences and drainage.

Mr. S. S. Platt, M.Inst.C.E., has served forty-seven years as borough surveyor, Rochdale, and his good spirits are not seconded by as good health as his many friends could wish. He has carried out many difficult schemes for the corporation, and all hope he may continue to serve well beyond his jubilee year.

**WANTED FOR MUNITIONS.****OLD LEAD****FRY'S METAL FOUNDRY,**25-30, Holland Street,  
Blackfriars,**LONDON, S.E. 1**HOP 4720 (two lines).  
"Frymetals, Friars, London."Hargreaves Street,  
Red Bank,**MANCHESTER.**CITY 2026.  
"Frymetals, Manchester."The Ministry of Munitions  
has recently taken over the**Control of Lead**fixing the maximum price which  
may be paid for Old Leadviz.: **26/-** per cwt.We are able to offer you this  
maximum price at your Works,  
Carriage to be paid by us. Sacks  
and special Munition labels will be  
forwarded to you if desired.**Terms:—Prompt Net Cash.**

# THE BUILDING NEWS

## AND ENGINEERING JOURNAL.

**Effingham House.**

Currente Calamo .. .. .	141
The Problem of the Small Dwelling and Its Solution.—XIV. .. .. .	142
Our Illustrations .. .. .	144
Obituary .. .. .	144
Women Architects and the A.A. .. .. .	157
Measuring Concrete Consistency .. .. .	157
Building Intelligence .. .. .	158
Parliamentary Notes .. .. .	158
Correspondence .. .. .	158

**CONTENTS.**

Statues and Memorials .. .. .	158
Professional and Trade Societies .. .. .	158
Our Office Table .. .. .	159
Trade Notes .. .. .	159
To Correspondents .. .. .	159
Chips .. .. .	159
Tenders .. .. .	160
List of Tenders Open .. .. .	160
To Arus! .. .. .	160
Latest Prices .. .. .	viii.

**Strand, W.C.2.**

*OUR ILLUSTRATIONS.*

The Forum looking towards the Colosseum and the Colonnade of the Forum, Temple of Victor and Pollux, Rome. Drawings finished on the spot by Mr. Fred Richards, A.R.E., A.R.C.A.  
 Exterior of St. Stephen's Church, Bush Hill Park, Enfield, and interior of St. Catherine's Church, Nrasden, N.W. Mr. J. S. Alder, F.R.I.B.A., Architect.  
 The Problem of the Small Dwelling and Its Solution, Sheets XXVI. and XXVII. by Mr. Robert Thomson, Architect.

### Currente Calamo.

The Workmen's National Housing Council (41, Cowcross Street, London, E.C.1) will hold an important housing conference in Congregational Schoolroom, Victoria Street, Blackpool, on Saturday, September 1, 1917, at 10 a.m. prompt. The chairman, Mr. John Hill, J.P., supported by the Parliamentary Committee of the Trades Union Congress and Mr. Stephen Walsh, Parliamentary Secretary of the Local Government Board, will be present. The first business of the morning will consist of a consideration of the most suitable type and minimum of accommodation required for working-class dwellings. Lantern illustrations will be exhibited of block buildings—Bournville, Garden Suburb, Watford, Mid-Lanark, Westhoughton, and Well Hall houses—the plans of the Government's Advisory and Departmental Committees for Rural and Urban Housing, and the health-promoting dwelling which we have been illustrating during the last twelve weeks. After the discussion the following resolutions will be considered:—

1. Private Enterprise and National Assistance.  
 "That this conference re-affirms the decision of the Birmingham (1916) Conference in emphatically protesting against the suggestion of the Government to assist private persons and limited liability companies with public money to enable them to build houses that will be let at rentals based on the ordinary laws of supply and demand."
2. Loans Free of Interest.  
 "That this conference, having in view the urgent necessity for the erection of working-class dwellings, is of opinion that in order to erect sanitary cottage housing to let at rents within the reach of the workers, the Government be called upon to grant loans of money, interest free, to public authorities."
3. Government Control of Building Materials.  
 "In view of the enormous increase in the cost of building materials (largely due to the existence of combines and rings) and the consequent increase in the cost of building construction which will be imposed on local authorities attempting to secure the proper housing of the people, this conference demands that steps be taken by the Government to control the materials necessary, and, by fixing maximum prices, protect the community against the danger of housing reform schemes being used to provide opportunities for the exploiters at present controlling the building material market."
4. Land Values and Housing.  
 "In view of the great and growing need for more houses in town and country, this conference declares its belief that the first step towards solving the problem is making unused building sites available and cheap,

and by removing the 'hostile tariff' on the building industry in the form of rates on houses; and, further, is of opinion that land can be cheapened and building stimulated by taxing and rating land values and unrented houses, and urges the Government to take immediate steps to make use of the land valuation for that purpose."

5. Deputation to the Government.  
 "That it be an instruction to the Executive to ask the Prime Minister, or other Ministers that may represent the Government, to receive a deputation, consisting of two persons from each of the bodies responsible for the resolution adopted, with two representatives of Labour Housing Association."

Any amendments to the resolutions must be received at 41, Cowcross Street, E.C., by Mr. J. Silas Whybrew, the secretary, by Monday, August 27. In order to provide opportunity for as many speakers as possible it will be suggested that movers of resolutions be allowed ten minutes; all subsequent speakers five minutes each. We hope architects and others interested in the housing question will attend the conference and contribute their quota to the discussion of this the most pressing matter—next to the war—of our time.

The reply of Mr. Hayes Fisher, the President of the Local Government Board, last week to the deputation from the London Insurance Committee denouncing the scandalously unsatisfactory treatment of London consumptives—"insured" under Mr. Lloyd-George's much-vaunted Act was a gratifying revelation that one Minister, at any rate, is alive to the real cause of the evil. Mr. Hayes Fisher said he believed that in some cases money spent on treatment was largely wasted, owing to the unsatisfactory housing conditions to which consumptives returned. We have said so for years, and that bad housing is more responsible for the making of consumptives than any other contributing cause. Mr. Kingsley Wood, the chairman of the Committee, said that sanatorium benefit in London was a miserable failure, and many insured persons were not getting the benefit for which they compulsorily paid. Owing to the lack of funds, instead of 932 beds being provided at one time, as formerly, there were now only 400 beds available. A melancholy feature was the waiting list of over 300 persons. There was a deficiency in the Committee's funds of £6,000 in 1915, and they were still without adequate funds. Two-thirds of the consumptive persons in

London applied too late. He urged better financial treatment and the great need of "after-treatment," and welcomed Mr. Hayes Fisher's housing scheme, as disgraceful housing conditions were the root cause of tuberculosis. The worst of it is, as we have been pointing out week by week for the past three months, the plans of houses recommended by the Departmental Committees are in many vital particulars little better than those they are intended to supersede!

The Workmen's Compensation (War Addition) Act, 1917, which comes into force on September 1, will add 25 per cent. to the weekly payments allowed under the Act of 1906 in all claims on and after that date. This increase of a quarter upon these payments is based entirely upon the great rise in the prices of food, etc. The insurance offices dealing with this class of business have met the matter by agreeing to charge an extra premium of 10 per cent. as from September 1. With regard to new claims on and after this date, that is easily adjusted, and the offices have also agreed not to increase the rates for insuring domestic servants. But the Act goes further and is really retrospective, for it makes the increase of 25 per cent. apply also to all the thousands of existing payments now being made by employers or their insurers. This provision raises several nice points. For contracts have been made and policies issued on the basis of the former weekly payments and the old premiums, which fact places both employers and insurers in an awkward position. Undoubtedly the liability to pay the quarter added to the compensation payments falls directly upon the employers, who will only be legally insured for the original sums upon which premiums were calculated. It is, however, seen to be clearly a case for compromise between the parties. The Accident Insurance Offices at their recent meeting took the view that in small businesses no additional charge should be made, but that where, in large factories, there were many workmen receiving weekly payments, which will now be so much increased, the employers should be asked to agree to the increased premiums, which must henceforth be reckoned with being dated back to the time when the weekly benefits first began to be paid.

Doubtless some such businesslike solution of the difficulty will be generally accepted. Perhaps, after the war, the whole matter of workmen's compensation may be put upon a better basis in a scheme of direct State insurance, which will save the present waste of energy in the way of litigation and other things.

The August "News-Sheet" of the Bribery and Secret Commission League contains a number of cases of bribery and corruption—several very flagrant ones, including some in which it was sought to influence Government officials. Is it any wonder that it is so when the sale of honours is unflinchingly defended by members of the Legislature? The "News-Sheet" has some very pertinent remarks on this matter, and we should be very glad to see a prosecution instituted on the lines the *Times* recently suggested, which it quotes:—"Unquestionably, so far as the Sovereign is concerned, honours are bestowed solely by reason of the presumed merit of the recipient, of which merit the nomination of the proposed recipient by the Minister is to the Sovereign the sole and sufficient evidence. It follows that if in the course of this process any 'gift or consideration as an inducement or reward . . . for showing favour . . . to the proposed recipient, moved either to the Minister or his agents (e.g., the party Whips), there can be no doubt that a prosecution of the parties concerned would lie under the Prevention of Corruption Act, 1906; and would probably succeed. . . . One day a recipient of his Sovereign's favour who had been 'fleeced' by party politicians were bold enough to invoke, by means of proceedings under the above Act, the scrutiny of His Majesty's judges of such a transaction, the system would *ipso facto* disappear. If he at the same time, by the institution of civil proceedings, recovered, as he could do, the moneys unlawfully obtained from him, and devoted them to the funds of a hospital or other charity, public opinion would with acclamation ratify the display of the Sovereign's favour in his particular case." An admirable suggestion, but we fear hardly likely to be adopted!

At the annual meeting of the Royal English Arboricultural Society last Wednesday at Whilgh, near Tunbridge Wells, a very pertinent statement of the past and present position of forestry in England and Wales was issued for publication, which we regret want of space to-day compels us to postpone till next week. We suppose war, and the blundering regulation of timber by the Government, has convinced most of us that the past neglect of British timber production and dependency on supplies from abroad is mainly responsible for the present deplorable and disastrous shortage, and we dread that worse may follow if the State takes to "regulating" matters in the same stricken fashion in which it has made things worse as regards food and coal. It is therefore most urgently our duty to strengthen by all means the hands of all who are endeavouring to make our

slap-dash rulers understand what is really wanted, and that its attainment is impossible without their co-operation. Unfortunately, timber, like confidence, is a thing of slow growth, and time must elapse before we can once again supply our needs from our own plantations. But in the meantime much can be done to reduce railway rates, to make rings of buyers illegal, and the freeing of forestry from the legislative anachronisms and anomalies which impede its cultivation. To these ends the manifesto of the Royal English Arboricultural Society practically and informatively contributes.

The first "Memorandum" of the Federation of British Industries (39, St. James's Street, S.W.) has reached us. It embodies the recommendations in reply to a request from the Ministry of Labour for proposals for dealing with "industrial unrest" on the lines of the "Whitley Report," which can now be obtained for a penny from H.M. Stationery Office through any bookseller. We have said before that the suggestions in that Report are, in our opinion, worth very little, "vague and uncertain," as the Federation Memorandum very truly describes them. The Federation takes our view, repeatedly expressed, which is the view of all honest people, viz., "that if no strike or lock-out could take place until the question had been submitted to final arbitration by a truly national council of employers and employed there would be good grounds for hoping that the time for reflection afforded and the pressure of popular opinion would ensure the loyal adoption of the award." If it did not, then strikes and lock-outs before arbitration should be made heavily penal in purse and person.

The question of compensation for extras arises in most building contracts, and, in view of the fact that no architect can foresee exactly what extras may be needed any more than he can tell what whims the owner will desire to satisfy, controversies must often be settled by the architect. Contractor William Jackson, of New York, according to the *American Architect*, agreed to build a house for Henry Donald which should not cost over \$10,000, and at the time stated to Donald that the extras would not be over \$200 by reason of changing the building material from unit brick to hollow tile. Jackson stated that hollow tile cost a very little bit more than unit brick, yet when the house was finished Jackson presented a bill for extras in the amount of \$2,005, which Donald refused to pay. Thereupon Jackson sued Donald to recover for the extras, and in the trial of the case claimed that when he made the statement that the change from unit brick to hollow tile would only be a question of a couple of hundred dollars he made the statement in ignorance of what the cost would be. Among other things, the New York Supreme Court said: "He (meaning Jackson) is then in a culpable position of having induced the owner to substitute the hollow tile upon representation that he personally did not know to be true and

charging a price that cannot be brought within the scope of the representation." Jackson should recover only such sum as he told Donald would be the amount of the extras. (Jackson v. Donald. 163 N. Y. S., 201.)

## THE PROBLEM OF THE SMALL DWELLING AND ITS SOLUTION.

XIV.

By ROBERT THOMSON.

[WITH ILLUSTRATIONS.]

The four plans on Sheet XXVI., one of the two which accompany this article, constitute a series which embraces many other plans already dealt with throughout the various successive stages covered by the present main series of which they form part. Plan Fig. 152, for example, which is the first in order of the series of four on Sheet XXVI., has as its basis the plan of design No. XXVI. in the Departmental and of design No. 9 in the Advisory Committee's reports, the equivalent of both of which will be found in standardised form in Fig. 12, Sheet II., of the present series. It is also of exactly the same roofed area as my plan Fig. 19 on Sheet III., which shows the committee's "desirable" requirements set forth in the two-flatted type of dwelling in the second stage of development.

Since the committee state that the plan of their design No. 9 "is a variation on No. 8, adapted to a village or semi-urban situation where a drainage system exists," and as their No. 8 forms an element in their plan No. 8a, the other element of which is their plan No. 5, and as they state their No. 6 is merely "a modification of No. 5, adapted to a site in a village or urban area where there is a drainage system and water is laid on, and where ready access from the road to the back-doors of the centre houses is important," the whole of their four-in-a-block type of houses, except their No. 7, which they themselves say is undesirable, and their No. 10, which, being three-flatted, is absurd, are thus represented. It is further worthy of note that, apart from the two plans just referred to, the committee's basis plan No. 9 is the smallest of their four-in-a-block type, of the economy of which, they say, there can be no doubt, and as plan Fig. 152 represents four mid-terrace houses, which all are agreed is the most economical form in which housing has hitherto been built, and as these again have the official model plan No. 9 as their basis, we at last reach bedrock on which the foundation is laid for considering the successive developments shown in each of the three other plans on Sheet XXVI. Furthermore, as these two plans Figs. 12 and 19 have their counterpart in each of the successive stages up to and including the eleventh stage, they are thus probably the most important representative examples of the present series.

With that lengthy and explanatory statement as an introduction, the interested reader will easily realise the importance of the wide application which, through these basis plans, is thus given to the plans Figs. 153-4-5 and 6. Plans Figs. 153 and 154 show the equivalent of plan Fig. 152 at the tenth and eleventh stages respectively, while the leviathan plans shown in Figs. 155 and 156 represent in graphic form the equivalents which, as compared with plan Fig. 152, plans Figs. 153 and 154 respectively provide in the way of air supply by means of their three-flue heat-actuated system of ventilation. In order therefore that it may be possible to realise in a tangible form the possibilities which health-promoting dwellings erected to plans Figs. 153 and 154 would

offer in the way of preventing disease, it is only necessary to directly contrast plans Figs. 155 and 156 with the Committee's type of dwelling which plan Fig. 152 would give. In studying the contrast between them it must be borne in mind that even if dwellings were built to plans Figs. 155 and 156 they would require to provide a change of their air contents three times every hour. When the further fact is realised that one of the bedrooms in each of the dwellings built to the official model plan Fig. 152 would be without a chimney or other means of ventilation, it will then be fairly easy to understand how very far it falls short of meeting even the absurdly inadequate requirements in the way of air supply called for by the Committee themselves.

In order that all dwellings of the health-promoting class may be in every respect perfect instruments in combating disease, it is essential that the flooring in each apartment have a seamless surface which is impervious to moisture. Heavy linoleum of the A1 quality, such as Florentine or Tileum, if properly laid on a concrete surface would meet requirements as to impermeability, but some have the misfortune to be cold to the touch. A surfacing composed of magnesite and asbestos would, because of the insulating properties of the asbestos, give a covering which would be more comfortable to the touch, and would at the same time admirably meet requirements as to seamless and impermeability. This type of surfacing is already available in Bell's Asbestos Company's "Decolite" composition flooring, but as to whether the cost of this material can compete with that of the quality of linoleum already referred to I cannot say. If it can, it is in every way an ideal material.

With wooden floors, such as are usually employed in existing types of dwellings, and constructed as shown in section in Fig. 13, Sheet II., the dust gathers in the joints between the flooring boards, and this dust is, by the vibration of the floor, riddled through the joints, and in the course of years forms little ridges on the bottoming below, where it provides a congenial breeding place for vermin and other noxious insects. I have personally for many years made a point of investigating this evil wherever and whenever opportunity offered, and therefore speak with a special knowledge of this subject, hence my strong advocacy of the seamless floor. Another serious drawback of the wooden floor is its absorbency. The consequence of this is, that those housewives who have a passion for cleanliness and take a delight in scrubbing their floor, are actually doing harm in another way, because, while getting rid of dirt, the water which the flooring boards absorb and that which runs into the joints continues to be given off for hours in the form of moisture, the result being that the children whose nursery floor it may be have to suffer.

As the plans on the two Sheets XXVI. and XXVII. are specially suited to illustrate my remarks in regard to the dwelling as a means of preventing consumption, I give the following quotations, which show the opinions held in regard to sanatoria by the medical men named. Again quoting "Air and Health," Dr. Macfie, writing in regard to sanatoria, states:—"They are a very costly weapon of warfare against disease, and it is probable that the money spent on sanatoria might have been more profitably spent in improving the housing of the poor." He also quotes Macormac as follows:—"We spend so much of our short life in bedrooms that with a pure bedroom atmosphere, pure and fresh, in fine, as is the outer atmosphere itself—for here nothing

less will suffice—there would, as I affirm and maintain, and with all my convictions believe, be no tubercle and consequently no scrofula, no consumption whatever."

The following quotations appear in the August issue of the *Housing Journal*, and as they have a direct bearing upon the subject with which the two sheets of plans accompanying this article have been arranged to illustrate, they come in very appropriately at this stage:—"Dr. Dickenson, of Newcastle, at a conference in December, 1915, said:—"One is bound to confess that sanatorium treatment of the phthisical poor has not come up to expectation, and practically never results in the cure of open tuberculosis." Dr. Hemborough, M.O.H. for Northumberland, considered that sanatorium patients would derive little permanent benefit from the treatment so long as they had to return to the bad home conditions under which so many of them lived. Dr. Taylor, M.O.H., Chester-le-Street, said it was useless to treat a man in a sanatorium, where he lived under ideal conditions, and then discharge him to an ill-ventilated, insanitary home. Dr. Renny, M.O.H. for Sunderland, considered that ill-ventilated and closely crowded dwellings were the great factor in the spread of infection, the poorer sanatorium patients almost invariably declined after returning home. In a recent report, Dr. Guy, the tuberculosis officer for Edinburgh, said: "The housing question is one of the vital points in dealing with the problem of tuberculosis. Hitherto we have heard a great deal about sanatoria, etc., and too little about these houses. The disease should be attacked there, and my opinion inclines to the belief that if all the money which is at present being poured out on sanatoria had been spent on an improvement of housing conditions, the result would certainly not have been less satisfactory." My own opinion is that every cottage dwelling can and therefore ought to be as perfectly health promoting as any sanatorium. Only a very little reflection is required to show that as a building there is nothing except perhaps the advantage of its location which a sanatorium has to offer that a competently planned cottage dwelling cannot give. The same workmen can, with the same tools and materials, build either the one or the other as they may be directed, and even any drawbacks under which the cottage may labour in regard to its site can generally be largely counteracted by its planning and the method of disposing it upon the site.

If the reader turns to Sheet XXVII. accompanying this article, he will see three plans, all of which will give dwellings which would be as perfectly health-promoting as any sanatorium. These plans are so arranged relatively to each other that the dwellings built to them are enabled to have in each of their four sides windows which provide an unobstructed outlook on all four fronts. This method of grouping the buildings on the site offers several important advantages. Among these one is that the angular disposition automatically utilises the slightest atmospheric currents to promote circulation, thereby preventing stagnation of air about the dwelling. Another, that the windows are further removed from the noise and dust of the street. A third, that with windows on all four sides of the building the occupants are enabled to take full advantage of all sunshine that may be available. A fourth, that the angular disposition of the buildings offers an easy means of counteracting drawbacks which a roadway lying in the wrong direction often

imposes. A fifth, that what would be only a strip of ground between the building line and the street becomes quite a respectable patch. A sixth, that it enables cottages built in pairs to require no greater length of street frontage than would cottages of similar size built four in a block. A seventh, that from the moment the occupants pass in at their garden gate they are independent of their neighbours—an advantage which is equally enjoyed when health-promoting dwellings are built four in a block.

In addition to the ordinary bedroom accommodation, there is the open-air sleeping accommodation which the entrance porch provides in every dwelling of the health-promoting class. This porch thus provides for the domiciliary treatment of consumptives, and local authorities would find it much cheaper to provide such dwellings for such occupants and their families than to maintain such patients in a sanatorium, and this local authorities would find it much cheaper to utilise for the domiciliary treatment of consumptives.

Attention has already been directed to the great advantages which the larger sizes of the health-promoting class of dwellings offer in the way of providing for boarders or lodgers, who always form a fair percentage among the working-classes. In addition to these occupants, the health-promoting dwelling, if built in sufficient numbers, would provide admirable accommodation for the boarding-out of those children who are forced by circumstances into the unhomelike shelter of those institutions which are so destructive of individuality, particularly in the case of their younger occupants. With such dwellings the comfort and brightness which might be brought into the lives of many old-age pensioners, by being adopted as lodgers, would be mutually beneficial to the other occupants of the dwelling. The old people could in many ways lighten the burden of the housewife by performing many little services, not the least of which would be that of taking charge of the children during the occasional absence of the mother, who might like to go marketing or want to visit friends.

As houses are at present built, many people who might want to have a lonely parent with them are precluded for lack of room for a spare bed. The abolition of institutional life for the young and the aged, which could be so easily effected by the health-promoting class of dwelling, would of itself alone be of incalculable benefit, not only to the individuals directly concerned, but also to the nation at large it would prove to be an unmixt blessing.

There is in medical circles at the present time a movement having for its object the creation of a Ministry of Health; but it has not yet been made clear what such a Ministry could do in regard to the housing question, which an eminent medical man in a letter to me says "is the crux of any healthy nation." No doubt the creation of another Ministry would be gratifying to those who are promoting the movement, but for The People themselves, who are alone directly concerned, the best and, indeed, the only really effective Minister of Health would unquestionably be an actively health-promoting dwelling, and to give this no Minister of Health is needed. In fact, without such a dwelling even the most magnificently housed Ministry of Health would be relatively powerless to prevent disease. The creation of a Ministry of Health before the nation is healthily housed would be like employing the tail to wag the dog. Even a Ministry of Housing designed to enable the dog to wag its own tail could do nothing practical in the way of providing



plans of dwellings, and without these efficient housing reform is impossible.

I was much interested in reading in the current issue of the *Housing Journal* the report of the deputation from the Workmen's National Housing Council, who on June 12 last laid their views upon housing before Lord Rhondda at the offices of the Local Government Board. As these have a direct bearing on the present series of articles, the following quotations will, I am sure, be of interest. Mr. Whybrow, the secretary of the Workmen's National Housing Council, who introduced the deputation, said:—"In the first instance we expected that the final recommendations of the committees which have been set up by Government Departments would have provided a standard which your Board could have adopted when making recommendations on housing to local authorities. Speaking generally from a layman's point of view, the whole of the plans of the Departmental and Advisory Committees' reports comprise rooms which are small and ill-ventilated. All of them have a third bedroom, with no fireplace, and with no methods of ventilation. It is suggested that an air brick would provide ventilation if inserted in the outer wall; that obviously is quite useless. We find that these model plans have been adopted at Well Hall, Rosyth, and other places. The fact that the committees have suggested the scullery as a suitable place for a bath has been responsible for the Well Hall and Mid-Lanark housing scheme having baths in the scullery. We are quite convinced that if the Government allows these models to be adopted and copied it will perpetuate all the evils which it should be the desire to abolish. We do insist that no houses should have less than three bedrooms. At Well Hall and Rosyth a considerable number of houses have been built with only two bedrooms, and it is distinctly undesirable. It is aggravating the difficulty of family life; it is responsible for growing children having to leave home to go to lodgings to avoid overcrowding. I emphasise the fact that these houses are small. We are not architects, but we know that it is possible to provide decent, healthy homes at approximately the same amount of money necessary to build the ordinary type of house. We insist that every workman's dwelling should have a separate bathroom, have adequate accommodation, and hot and cold water provided, so that the housewife can have all the advantages and every necessary facility to enable her to perform the many duties she is at present compelled to undertake. We earnestly hope you will realise that the recommendation of the Government's Advisory Committees are hopelessly wide of the mark, and that you will give consideration to plans that will meet the requirements of the workers of the country. I have taken the liberty of bringing along a plan that does provide these requirements, and I will leave it with you. If you do ask your architects to express an opinion and they criticise it, I hope we shall have an opportunity to answer their criticisms."

Dr. Ethel Bonham said: "I represent an association composed almost entirely of practical housekeepers—women who know where the shoe pinches. I am also a medical practitioner, and have studied the housing problem for thirty years." With all the emphasis she could bring upon it, she believed that bad housing conditions were responsible for four-fifths of the child mortality.

Mr. L. Bramley said: "In the National Health Insurance Act special provision is made for building sanatoria. Public

money would be quite as well spent—in fact, much better spent—in the prevention rather than on the effects of bad housing."

Lord Rhondda, in the course of his reply, said: "I am not in the Cabinet. I cannot tell you what the attitude of the Government will be on this point or that. This Department fully realise the great importance of the housing question. You have all shown that this question of housing is really at the root of the problem of death, and if we are to have a healthy nation it can only be secured by having happy homes under healthy conditions. I am much obliged for your coming here and placing your views before the Department. The housing question and the question of health, which are intertwined, is the greatest problem we have to deal with in this Department. I am sanguine that before I leave it I shall have put it in good shape for my successor."

If the reader will turn to Sheet XV. of the present series, he will see in Fig. 93 a plan somewhat similar to that left with Lord Rhondda. So far no intimation of any criticism having been made regarding the plan left with Lord Rhondda has yet been received.

(To be continued.)

## Our Illustrations.

### THE FORUM LOOKING TOWARDS THE COLOSSEUM AND THE COLONNADE OF THE RUINED TEMPLE OF CASTOR AND POLLUX, ROME.

These two pencil drawings graphically explain their relation one to the other in accordance with the precise purpose of the artist. Mr. Fred Richards, A.R.E., A.R.C.A., who kindly lent us the pair of studies as finished on the spot. The bird's-eye sketch of the Forum furnishes from the standpoint of its altitude almost a complete plan of the ruins near the little Temple of Romulus, son of Maxentius. Its position is marked by the quaint little circular ruin by the Via Sacra, and the Gateway of Jesu Maria is seen to the left. Directly in front is the church of St. Francesco Romana set hard by the Basilica of Constantine. This church was founded by Leo IV, and by Nicholas I, in the 9th century. The tall belfry figuring to the rear is one of the best preserved examples of its kind, belonging to the 13th century. It stands close to the Sala Capitolare of the adjoining convent, long tenanted by Olivetan Monks. This group of buildings, as shown, partly obscure the Colosseum. The arch of Titus, spanning the Summa Sacra Via, appears in the far distance beyond the Colonnade of the Temple of Castor and Pollux, standing to the right in the middle distance of the picture.

The detail drawing given of this splendid specimen of the Corinthian order affords some idea of the grandeur of the proportions adopted in this work of restoration carried out during the age of Augustus, A.D. 6, by Tiberius. The tall basement is principally formed of concrete, with some large blocks of tufa remaining on the east side. It is surmounted by three noble columns supporting a fragment of the architrave, all belonging to the rebuilding by Tiberius. The shafts are almost perfect and they measure 4 ft. 9 ins. in diameter and are 47 ft. 6 ins. high. Mr. Richards has drawn the detail of this entablature and cornice entirely freehand without a straight edge or ruler, using a three B pencil. Such an accomplishment of delineation is worth the attention of architectural draughtsmen. The quality given to the representation of the decayed masonry affords an almost technical idea of its present condition in masonry. The background includes the old Capitol, behind which is seen the top of the new Victor Emanuel Monument in this picture, to the right of which is the domed church of St. Maria

Liberatrice. These studies were made for Messrs. A. and C. Black's "Sketch book in Rome" issued some little while since to a smaller scale than the reproductions given to-day.

### ST. STEPHEN'S CHURCH, BUSH HILL PARK, ENFIELD.

We give a west view of the exterior of this church, recently completed by the erection of the two western bays. It consists of a nave 84 ft. long and 27 ft. wide; aisles of same length and 12 ft. wide; chancel 41 ft. long and 24 ft. wide; lady chapel of same length and 15 ft. wide; organ aisle, and clergy and choir vestries, with folding screen between, to admit of use as one large room for parish meetings, etc. There are, in addition, a recessed baptistry at west end of nave, and a tower porch at west end of south aisle, and two other entrance porches. The nave and chancel are of lofty proportions, with traceried clerestory windows, and opened timbered and panelled roof of arched form; and there are handsome arcades, with stone pillars and richly moulded arches, dividing the nave and chancel from the aisles and lady chapel. Large traceried windows are features at east and west ends of the church. At present only the lower stage of the tower has been built, up to the height of clerestory window-sills; but, when completed, the tower and spire, rising to a height of 170 ft., will be an important feature, and a landmark for many miles round. The general style of the church is Decorated Gothic. The stone dressings inside are of Bath stone, outside of Weldon stone, and the walls throughout, inside and out, are faced with Caenstone free stone, roughly chiselled. The roofs are covered with rough red hand-made tiles, floors laid with marble mosaic, or with wood blocks under the seats, which are of oak. The accommodation provided is for 750 persons. The architect is Mr. J. S. Alder, F.R.I.B.A., of 1, Arundel Street, Strand, W.C., and the builders Messrs. John Bentley & Sons, of Waltham Abbey.

### INTERIOR OF ST. CATHERINE'S CHURCH, NEASDEN, N.W., ALSO EXTERIOR WITH PLAN.

We gave a cross view of the chancel of the last-named church in our issue for January 17 last, with some particulars of the building. To-day we give a more general photograph of the interior looking east into the sanctuary. An external view of the church, showing one tower at the west end, together with a plan of the building, appeared in our issue of March 21 this year. Mr. J. S. Alder, F.R.I.B.A., is the architect.

### THE PROBLEM OF THE SMALL DWELLING AND ITS SOLUTION

These two sheets are figured XXVI. and XXVII. The series began on May 23 and has continued week by week with articles by Mr. Robert Thomson, architect, on the following dates, June 6, 15, 20, and 27; July 4, 11, 18 and 25; August 1, 8, and 15.

### OBITUARY.

We regret to have to record the death of Mr. Jean Martin, late of the Paint Department in the Paris Agency of the well-known firm of Messrs. Lewis Berger and Sons, Ltd., of Homerton, E.9. He fell on the battlefield, wounded by shrapnel, on May 3, and died the following day. He was mobilised in the 1st Regiment de March d'Afrique. His loss is keenly felt by his chief, Mr. Paul Coulon, and by all his colleagues, and our sincere sympathy goes out to his relatives.

Benjamin George Wilmer, of Frinton-on-Sea, Essex, and of 14, Bury Street, St. Mary Axe, E.C., ironfounder and iron and marble merchant (net personality £21,657) has left £46,492.

A marriage will shortly take place very quietly between Harry Rigg, P.W.D., India, elder son of the late Mr. Henry Rigg, late consulting engineer to the Government of India, and Gwendolen, third daughter of Major-General Owen Jones, C.B., late R.E., of Bryn Tegid, Bala, North Wales.



SHEET XXVI

**EDUCATIONAL SERIES.**

RUDIMENTARY AND ADVANCED EXAMPLES  
ARRANGED TO ILLUSTRATE THE REMARKS ON VENTILATION.

2080  
FIG. 156

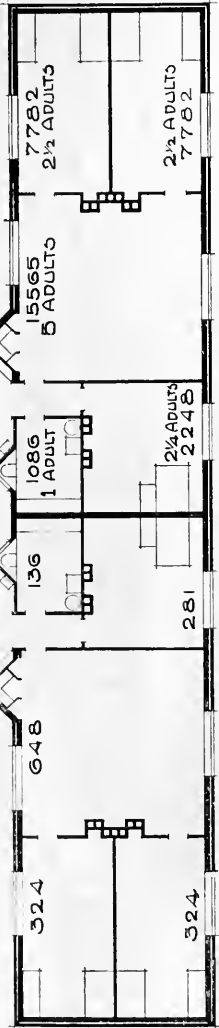

PLAN FIGS 155-6 SHOWS TO SCALE THE SIZES OF APARTMENTS WHICH WITH CEILINGS 8 FEET HIGH AND THE RENEVAL OF THEIR AIR CONTENTS THREE TIMES AN HOUR WOULD BE FEASIBLE TO BUILD TO PROVIDE AN AIR SUPPLY EQUAL IN VOLUME TO THAT WHICH THE ACTIVELY HEALTH-PROMOTING DWELLINGS BUILT TO PLANS FIGS 153-4 WOULD EASILY GIVE.

**EXAMPLE OF RUDIMENTARY PLANNING.**

075 MID-TERRACE HOUSES TO PLAN FIG 12 SHEET II. FOR BASIS FIG 152 PLAN SEE DESIGN No 9 OF ADVISORY COMMITTEES REPORT.

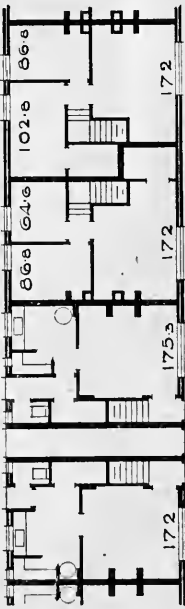

4133 THE HABITABLE AND KITCHEN HOUSEHOLD IN FOUR DWELLINGS TO THIS PLAN WOULD SHOW A SHORTAGE AS COMPARED WITH THAT OF FOUR BUILT TO PLAN FIG 152 = 14754 c.f. WHICH AT 15 PENCE PER C.F. = 2210.00  
Ditto.....154-16640.....

072  
FIG. 153  
TERRACE-OTTAGE

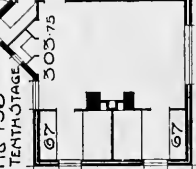

THE ACTIVELY HEALTH PROMOTING CLASS OF COTTAGE DWELLING.

072  
FIG. 154  
ELEVANTERRAGE



8393  
072  
SEE PLAN FIG 93 SHEET XXV FOR SHORTEST ARRANGEMENT OF FURNITURE IN THE TWO PLANS ABOVE. 072 14048

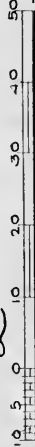



SHEET XXVII

**EDUCATIONAL SERIES.**

ADVANCED EXAMPLES.  
THE COTTAGE SANATORIUM.

PATENTED.

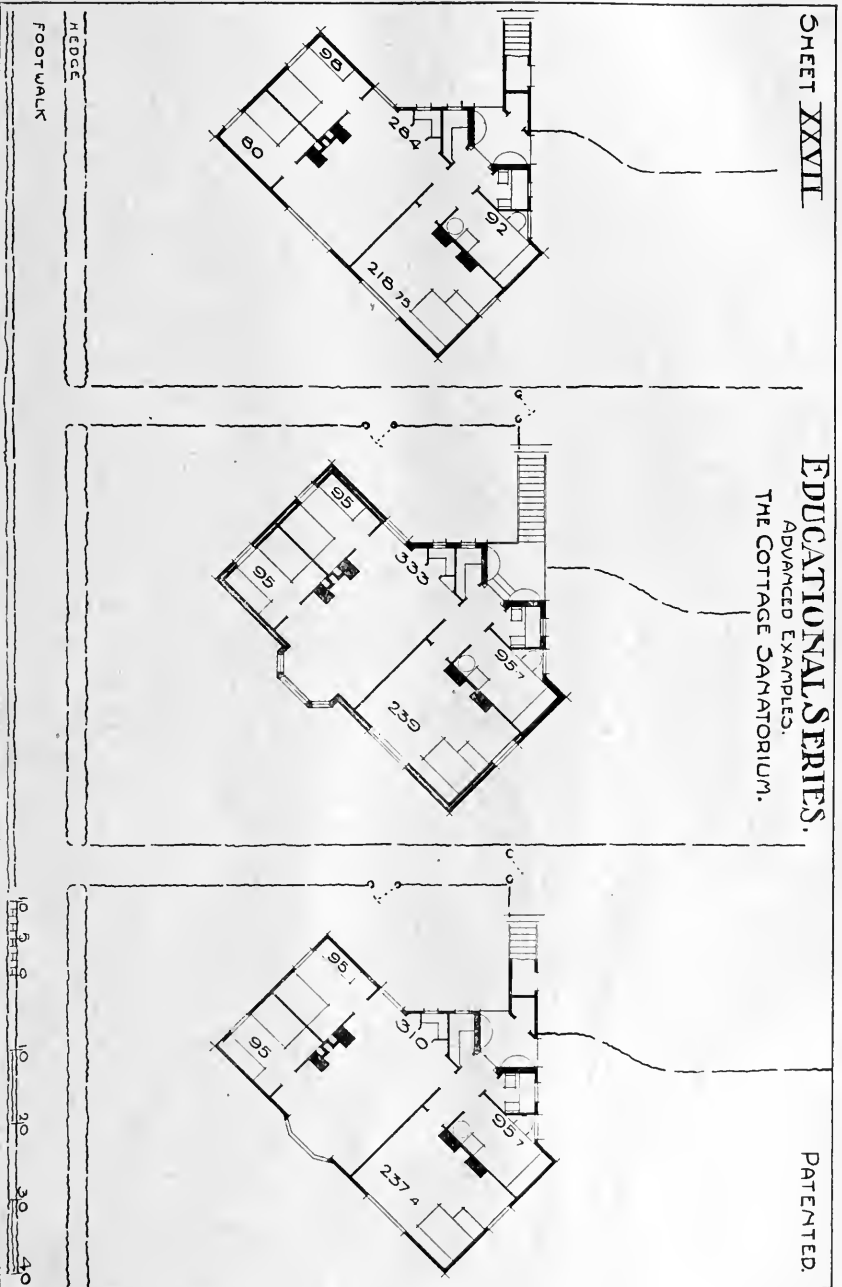

THE PROBLEM OF THE SMALL DWELLING AND ITS SOLUTION.—By Mr. ROBERT THOMSON, Architect.

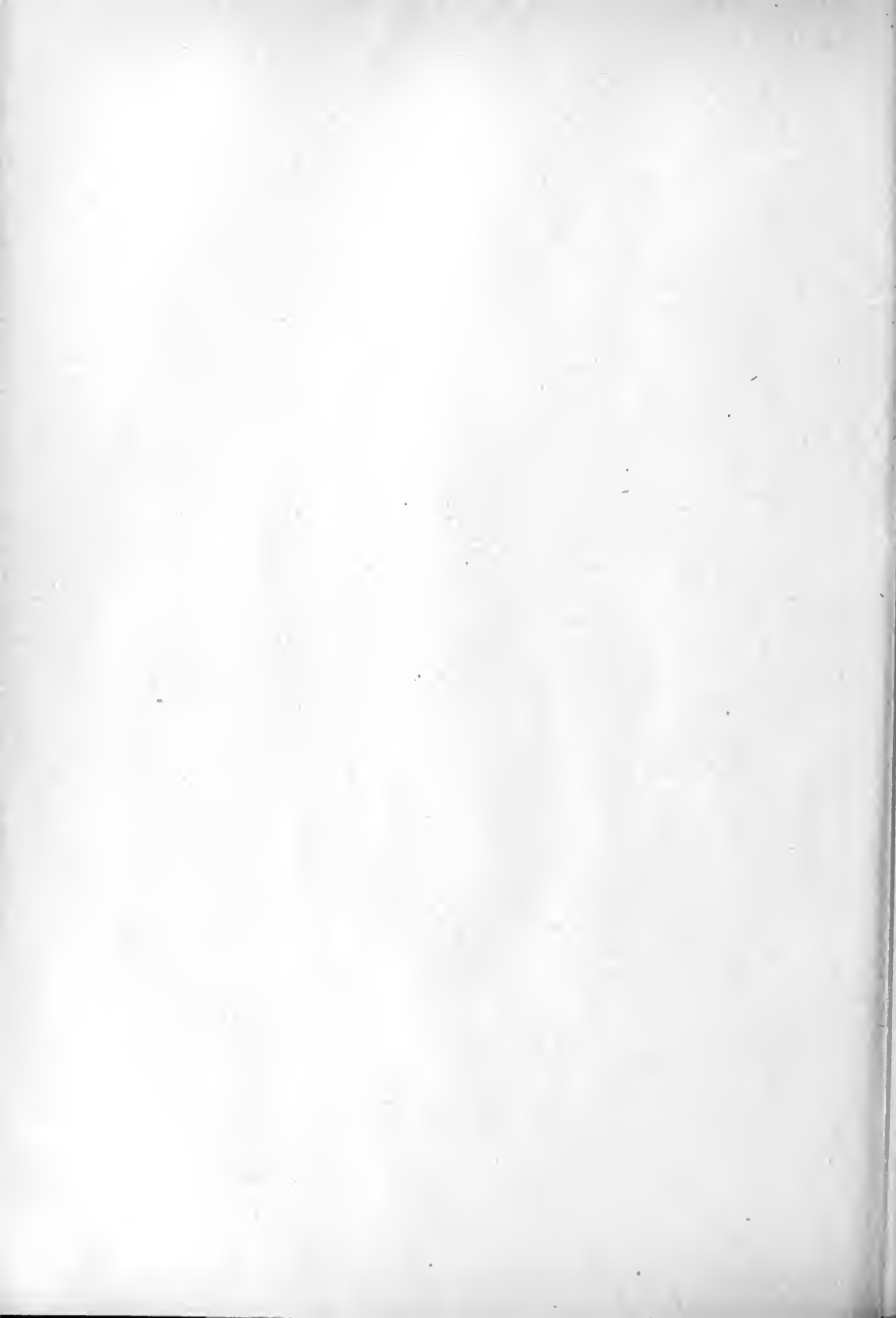



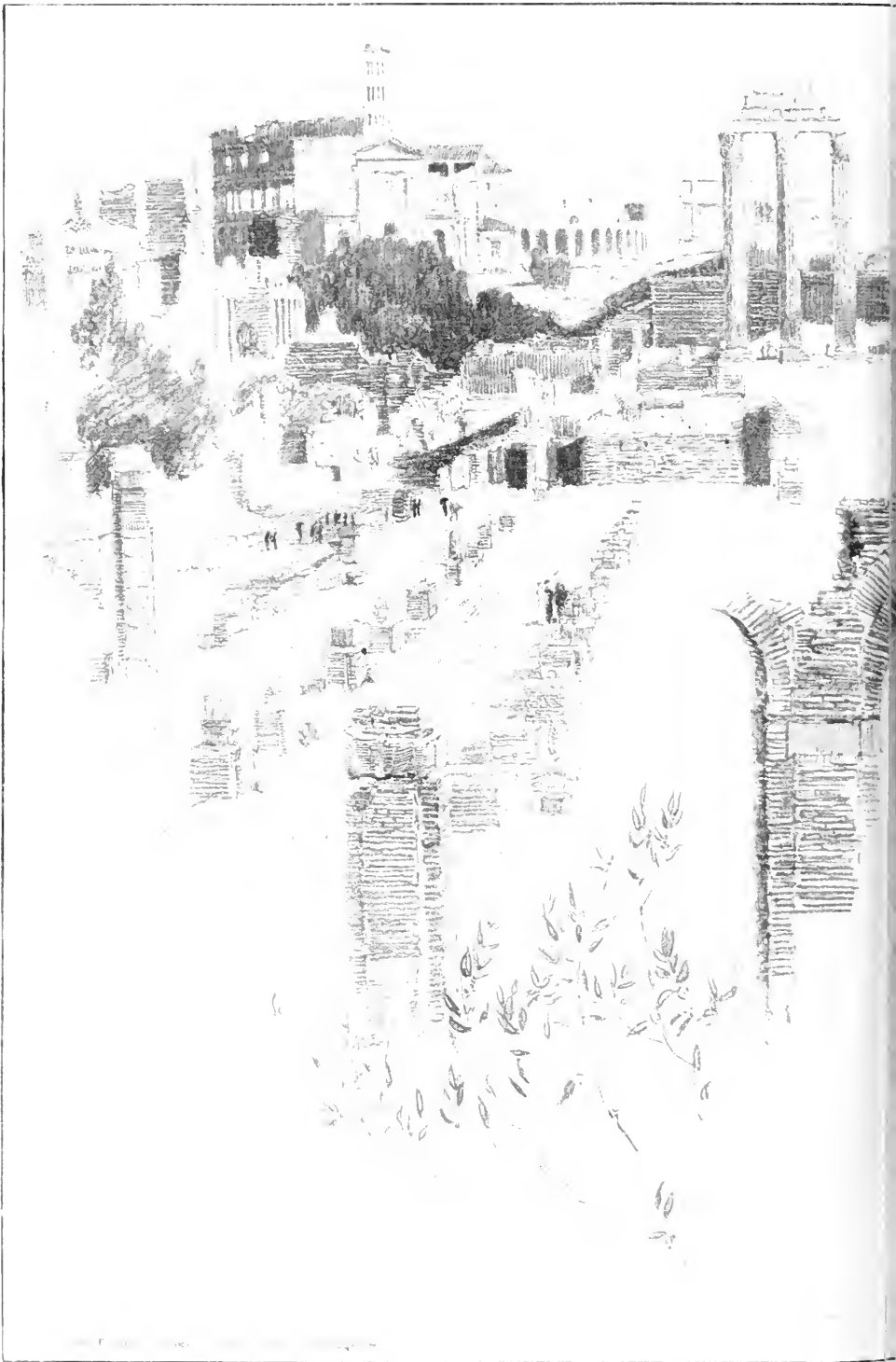

THE FORUM LOOKING TOWARDS THE COLOSSEUM AND THE O  
From Pencil Drawings by M

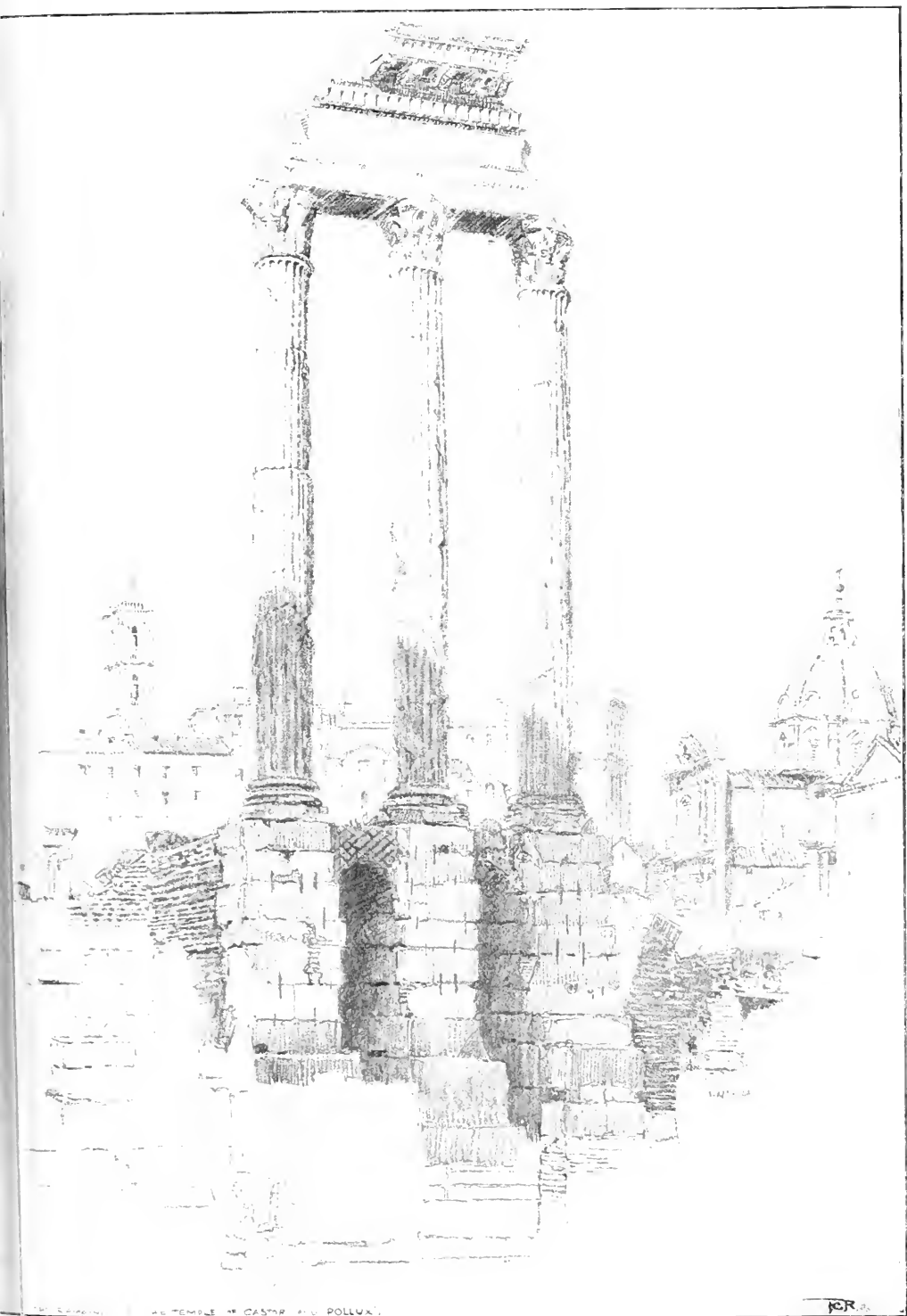

ONADE OF THE RUINED TEMPLE OF CASTOR AND POLLUX, ROME.  
ED RICHARDS, A.R.E., A.R.C.A.

JCR.





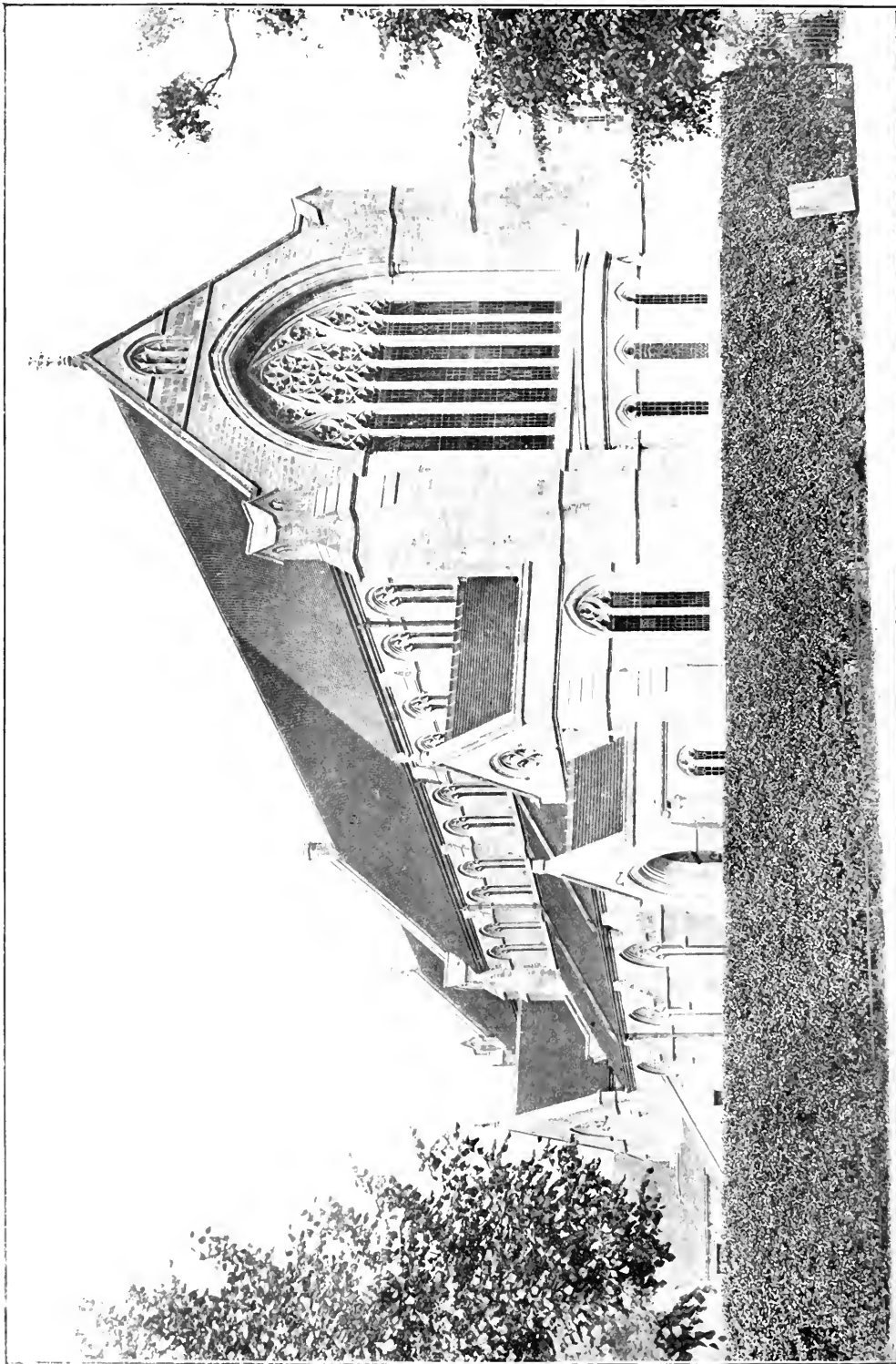



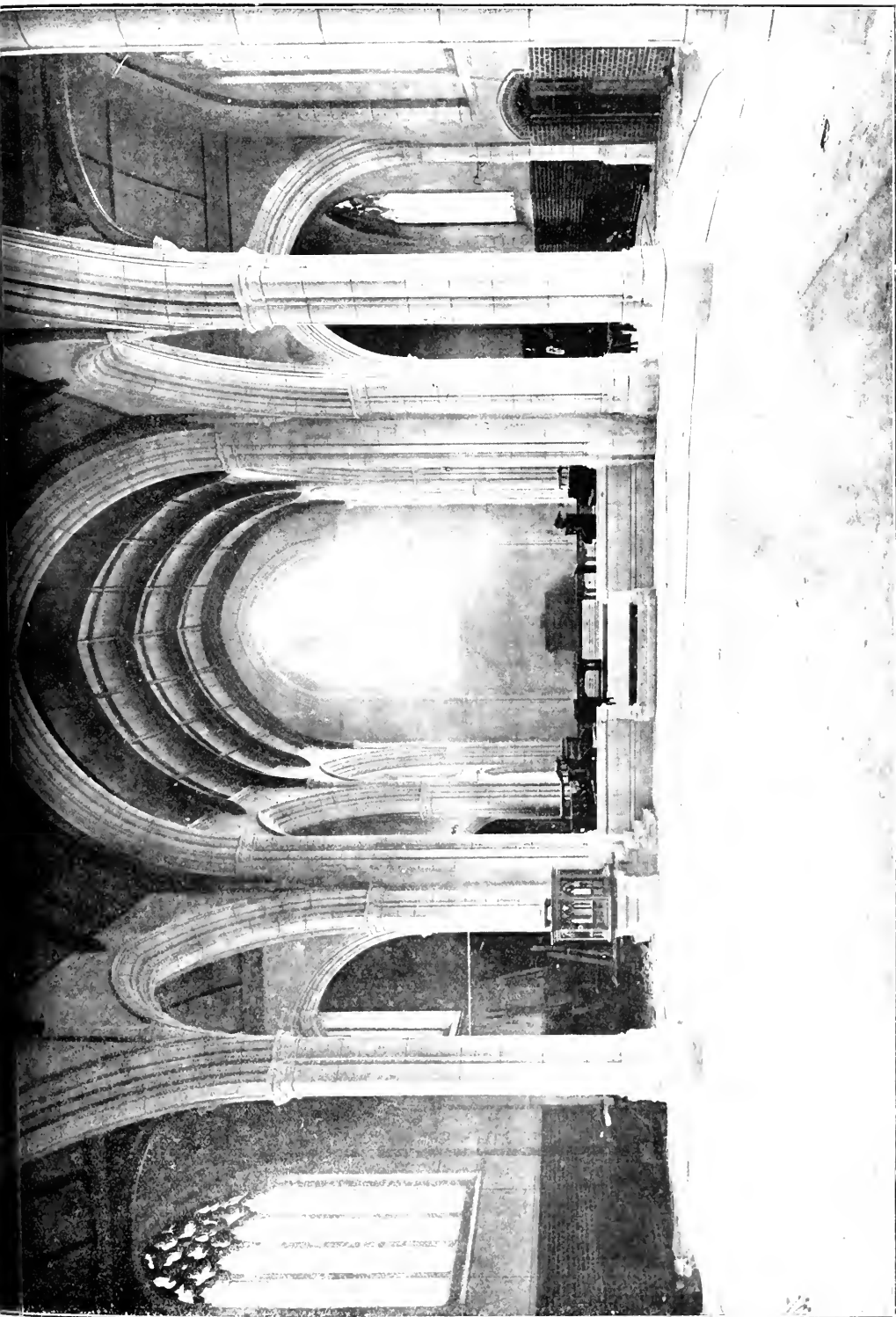

EXTERIOR OF ST. STEPHEN'S CHURCH, BUSH HILL PARK AND INTERIOR OF ST. CATHERINE'S CHURCH, NEASDEN, N.W.  
Mr. J. S. ALGER, F.R.I.B.A., Architect.

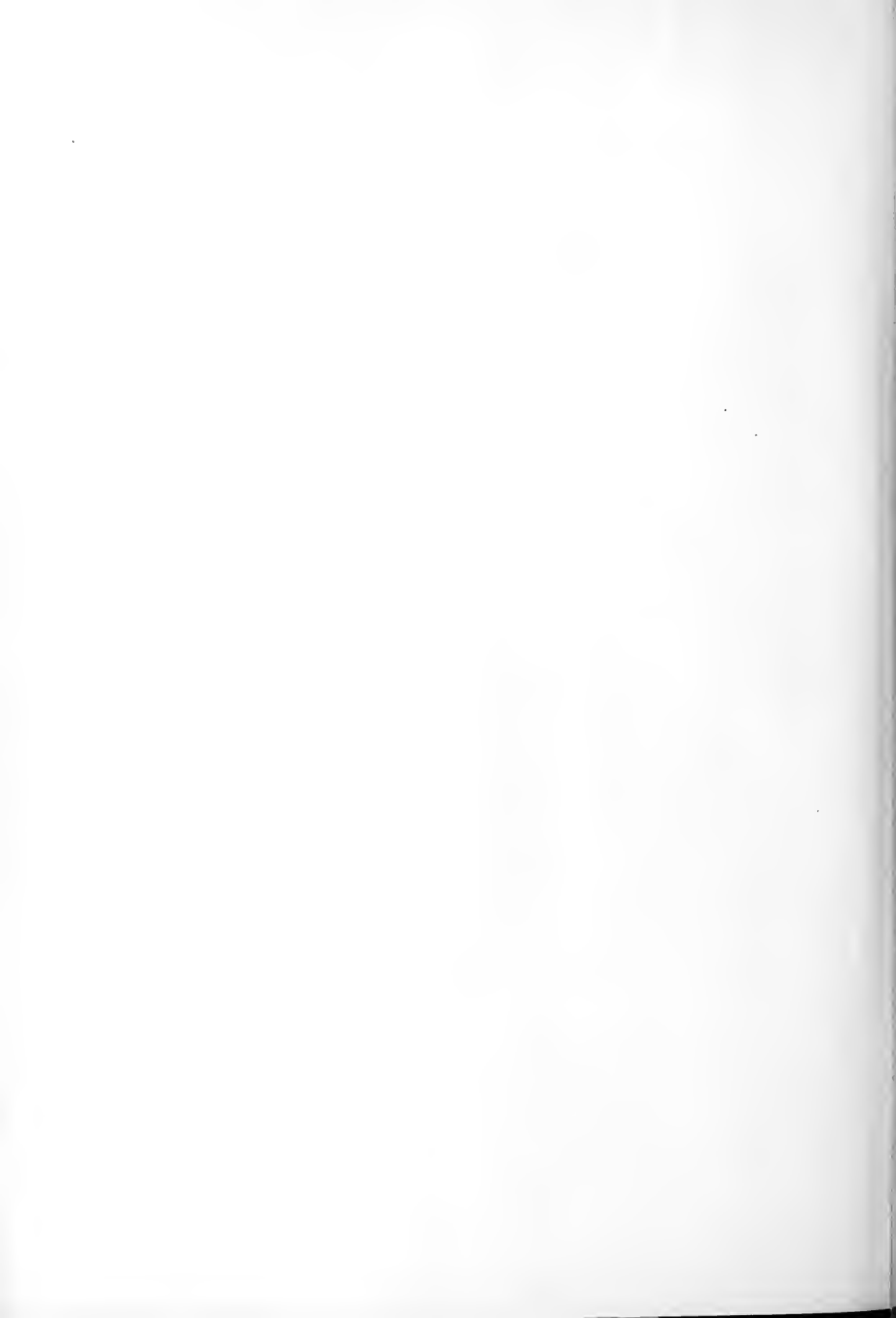

WOMEN ARCHITECTS AND THE A.A.

The decision of the Architectural Association to open its well-known school to women and give them all the facilities afforded to men (says the *Manchester Guardian*) comes at a very opportune moment. Middle-class parents are realising now that their daughters should adopt a business career, and while the cost of training at this school—£50 a year for the three or four years' course—is reasonable, the immediate outlook for women architects has become promising.

So far the few women architects who have qualified in England have not met with the encouragement they deserve. Their special value has not been recognised. But in the after-war building enterprises, when the working population will demand more comfortable and convenient homes, and when middle-class housewives will require houses or flats which can be easily managed without the aid of many or perhaps any servants, the ingenuity and understanding of women architects will have full scope.

The popular idea of a woman architect is that she dreams of cupboards, but her imagination carries her far beyond that. The suggestion is that she will be chiefly concerned with domestic architecture, but it would not be surprising to find her interesting herself in office building too; and now that so many women spend their hours in badly-designed, ill-lighted, airless offices, one may expect a revolution even in offices. Hitherto the fact that a practical architect must be prepared to scale heights and walk about scaffolding has been regarded as a handicap on women—an idea that has not survived three years of war work.

MEASURING CONCRETE CONSISTENCY.

It is common knowledge that concrete mixed to an improper consistency is apt to be lacking in strength and uniformity, but that the correct proportion of water to use varies greatly with the fineness, porosity, and wetness of the aggregates and the amount and kind of cement. Need has been felt for a quantitative method for measuring the consistency of concrete, so that this quantity might be specified more accurately than by the usual descriptive terms "sloppy" or "mushy." Prof. H. A. Thomas, in *Engineering News Record*, describes such a quantitative measure which depends on the "angle of repose" or steepest surface slope than can exist on an unconfined mass of freshly mixed concrete. It is evident that in general this slope becomes flatter as the consistency becomes wetter. A number of experiments were made at Rose Polytechnic Institute to see if a simple, certain and practical method could be found for measuring the angle of repose of a sample of freshly mixed concrete. The "heap test" specification described in the following paragraphs is the result of these experiments.

PRELIMINARY EXPERIMENTATION.

The method first tested was to fill with concrete a vessel, such as a bucket or wheelbarrow, and tip it until the concrete assumed its maximum surface slope, measuring the inclination with a carpenter's level and rule. It was found that, while this method gave slopes varying with the consistency, the surface of the concrete was in many cases so far from being plane as to make the method unreliable for practical use.

The next test devised gave more satisfactory results. In making this test, a sample of the concrete to be tested was placed in a pail and poured out in a heap on a level impervious surface, the height and diameter of the heap giving the data for determining the angle of repose. The pouring was done slowly and with as little free fall as possible. The results obtained by this test on concretes of different consistencies are shown by the dotted line in the accompanying diagram. As may be seen from this curve, the test gives a sensitive measure of the consistency of medium and mushy concretes. It is, however, not so well adapted to distinguishing between sloppy concretes, the reason being that in wet concretes the fine materials spread

out, leaving the coarse aggregate in the centre in a clean pile with steep slopes. The ratio of the height to the diameter of the entire heap, which measures half the tangent of the angle of repose, therefore changes but slowly after the concrete becomes so wet that there is a considerable separation of the aggregates.

After some experimenting it was found that the heap test would give more sensitive results in the case of sloppy concrete, when modified as follows: A pailful of the freshly mixed concrete was slowly poured out in a heap on a level impervious surface as before, but instead of emptying the pail, the pouring was stopped as soon as the concrete began to pile up so that the slope near the centre of the heap was steeper than near the edge. In the case of mushy concrete this occurred when the pail was about three-fourths empty, and in the case of very sloppy concrete when the pail was about one-fourth empty. The solid line in the diagram shows results obtained by this test. It is seen to be more accurate than the preceding test in differentiating between sloppy consistencies, there being 300 per cent. variation in the ratio of the height to the diameter of the heap, between the mushy and very sloppy concretes

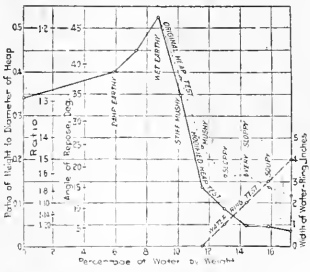

Results Obtained by the "Heap Test" for the Consistency of Concrete Description of Consistencies.—

- "Damp earthy"—Water not flush to the surface after prolonged tamping.
- "Wet earthy"—Ordinary dry concrete. Water flows to surface with moderate tamping. Quakes slightly.
- "Stiff mushy"—Water flushes freely to surface with slight tamping. Mixtures quakes considerably.
- "Mushy"—Medium consistency, wet, mushy appearance. Quakes freely. Flows easily down chute at 34 dees. Tamping not required.
- "Sloppy"—Excess water separates easily. Hard to keep aggregates together. Flows readily down chute at 17 dees.
- "Very sloppy"—Impossible to keep water and aggregates together when not in motion. Flows down chute at 13 dees.
- "Soupy"—Large excess of cement-laden water will not combine with aggregates.

experimented upon. It was found that the results of the test were not affected by considerable variations in the speed of pouring or quantity of concrete used.

SOUPY CONCRETE GAVE TROUBLE.

In the cases of concrete of "soupy" consistency, even the method just described failed to give a good quantitative distinction between different degrees of wetness, as may be noted from the diagram. In working with samples of concrete of this kind an additional peculiarity of the heap test was observed, which not only affords this distinction, but appears to give a practical measure for a property of considerable importance in wet concretes—the segregation of the cement and aggregates. The very wet concretes experimented upon showed so strong a tendency toward segregation that the heaps consisted of three distinct zones: An inner pile of clean, coarse aggregate with steep slopes, an intermediate zone of fine aggregate with moderate slopes, and an outer ring or pool of cement-laden water. When this separation occurred to a considerable extent, the ratio of the height to the diameter of the heap changed but little with increasing wetness. The width of the ring of separated water was found to increase rapidly with the general wetness of the concrete, as is indicated by the dash line in the diagram. It was quite constant for

samples of a given consistency, but increased slightly with time, one minute after pouring being taken as standard. The measurement of the average width of the ring of cement-laden water surrounding the aggregates in the heap test may therefore be used as an additional quantitative criterion for the consistency of wet concrete. It also gives a numerical indication of the tendency toward separation of the ingredients.

To see if a more precise method could be obtained for measuring the tendency toward segregation, a number of tests were made by placing the wet concrete samples in various kinds of screens and strainers and measuring the percentage of water and fine material separating. These methods were found to give less uniform results than those obtained by measurement of the width of the ring of separated water in the heap test.

SOMEWHAT SIMILAR TO AN EARLIER TEST.

The heap test is not well adapted to specifying the consistencies of very dry concrete. As shown by the diagram, in the case of dry concrete the height of the heap increases instead of decreasing with wetness, until a value is reached corresponding with the maximum internal cohesion of the damp materials. A test suitable for measuring the consistency of stiff plastic mortar or concrete is described by Cloyd M. Chapman in the Proceedings of the American Society for Testing Materials for 1913. This test "consists in depositing the mortar or concrete in a form of suitable size and shape resting on a non-absorbent surface, such as glass or metal, and then removing the form and noting the settling or sloughing down, either with or without the assistance of a jar or shock, of the unsupported mass of paste, mortar, or concrete left standing." The test is stated by Mr. Chapman to be useful only for material that is "not too fluid to have a tendency to retain its form when at rest." It is thus applicable to concrete stiff enough to require tamping for consolidation in practice.

In experimenting upon the heap test a number of trials were made, forming the heap of concrete by placing the material in a form, such as a bottomless inverted pail, and removing the latter as in the test above described by Mr. Chapman. The heaps obtained in this way with mushy and wet mixtures gave less uniform and satisfactory results than were obtained by pouring the concrete out of a pail.

THE HEAP TEST DEFINED.

The results of the preceding observations may be summarised in a specification for the consistency of concrete. The amounts in parentheses are given as illustrative for mushy concrete, and not as absolute values applicable to all materials and conditions.

"The concrete shall be mixed to such a consistency as to form a heap whose height is not less than (one-tenth) nor more than (one-fifth) of the average diameter of its base, when poured as follows: A sample of the concrete of volume not less than 2 3/4 cu. ft. is placed in a pail or tub and poured from the same slowly, in one place, on a level impervious surface, and with as little free fall as possible, stopping as soon as the concrete begins to pile up so that the slope near the centre is steeper than near the edge. If in this test water separates from the concrete so as to surround the heap in a ring more than one-quarter inch in average width at one minute after pouring, the consistency will not be considered satisfactory." A more complete specification covering this test should mention the method and place of taking an average sample, the number of occasions on which the test is to be made, and the responsibility for the labour involved.

The 2 3/4 cu. ft. specified to be used in making the heap test is intended to apply to mixtures with aggregate up to about 1 1/2 inch in diameter. For coarser aggregates this quantity should be increased. In making the test the height of the heap is most readily found by thrusting a wire or small stick down through the concrete. The point at which the concrete begins to pile up at the centre of the heap was well marked in the concretes on which experiments were made. If this point is slightly overrun in pouring out the concrete, the projecting fragments of coarse aggregate

should not be included in measuring the height of the heap.

#### CONCRETES USED IN TESTS.

The concretes used in making the tests described were 1 : 2 : 4 mixtures using local sand and screened gravel. How the numerical results would vary with other materials would have to be determined by trial. While a series of experiments applying the heap test to a large variety of materials would be interesting and valuable, those already made show the correctness of its two essential features: That for the consistencies ordinarily used in practice there is a close measurable relation between the wetness of the concrete and the height-to-diameter ratio of the heap and the width of the separated watering. The inference that the latter indicates the tendency towards segregation, while not proved, seems reasonable.

The consistency of concrete which it is best to use on any given work is a matter of judgment, depending on many variables. For this reason caution should be used in writing numerical values in the heap-test specification without knowledge of local materials or conditions. What is usually needed is something to make the results of judgment permanent and uniform, so that when a desired consistency of concrete is once secured with given local materials, it may be exactly duplicated at any time. The heap test is well adapted to this purpose.

## Building Intelligence.

WELLINGTON, N.Z.—H.M. Trade Commissioner in New Zealand reports that a contract was recently placed for the construction of new offices at Wellington for the New Zealand Shipping Company and the Cunard Steamship Company. The new building will be of considerable size, and is to be constructed on modern lines; it is estimated that it will cost some £50,000. Work on the new offices was to be commenced at once, but, owing to the difficulty in obtaining supplies of building material, and other hindrances, Mr. Dalton is of opinion that operations for the present will be limited to preparatory work. The name and address of the architects for the new shipping offices are Messrs. J. Hoguard and W. P. J. Prouse, 20, Hunter Street, Wellington, N.Z.

#### PARLIAMENTARY NOTES.

THE CHANSEL TUNNEL.—The Chancellor of the Exchequer, in reply to Mr. Fell, who asked if he could now say if the Government were in favour of the construction of the Channel Tunnel, provided that it was a condition that no work was to be done or money raised in connection with the tunnel during the continuance of the war, except with the consent and at the request of the Government, and that on these conditions the Government would support the Bill, when introduced, to give the necessary powers to link up the South-Eastern and Chatham Railways of England with the Chemin de Fer du Nord of France, said: "The Cabinet has again carefully considered the question in connection with their naval and military advisers, and they are still of the opinion that it is not practicable to proceed further with the matter during the continuance of the war. In these circumstances, it would not be possible for the Government to support a Bill of the nature indicated."

METROPOLITAN WATER SUPPLY.—Captain Barnett (U.S. Panera, West) asked the Prime Minister last Wednesday whether his attention had been drawn to the action of the Metropolitan Water Board in withdrawing water supply from occupied houses not provided with storage cisterns; whether such action was in pursuance of statutory powers conferred upon them as to continuous water supply; whether a large proportion, estimated at 15 per cent., of the houses in London were without storage cisterns; and whether, in view of the fact that such cisterns were generally considered as insanitary by medical officers of health, and were, in any case, unappealing in appearance at the present time, he would consider the advisability of introducing legislation on the subject. Mr. Hayes Fisher (President of the Local Government Board), who replied, said he was in communication with the Metropolitan Water Board as to the matter.

## Correspondence.

### CANAL CONTROL COMMITTEE.

To the Editor of the BUILDING NEWS.

SIR,—I am directed by Sir Maurice Fitzmaurice, Chairman of this Committee, to inform you that the Canal Control Committee desires to draw the attention of the manufacturers, merchants, exporters and importers to the desirability of their using the inland waterways of the country for the conveyance of all kinds of traffic which can be conveyed by water.

The principal object for which the Canal Control Committee has been appointed is to relieve the traffic on the railways by increasing the amount carried on canals. The railways have already been depleted of much of their equipment, a considerable number of their experienced workers have gone into the Army, and the quantity of traffic of all kinds with which the railways have to deal has greatly increased. As a result, they are today severely taxed, and it has become an urgent necessity that they should be afforded relief. One method of giving this relief will be to divert as much traffic as possible from railways to canals.

This Committee has appointed three Sub-Committees to assist it, namely:—

The Northern Sub-Committee—Aire and Calder Navigation Offices, Dock Street, Leeds.

The Midland Sub-Committee—Norwich Union Chambers, Congreve Street, Birmingham.

The Southern Sub-Committee—Grand Junction Canal Company's Offices, 21, Surrey Street Strand, W.C.

The canals under the control of this Committee have been placed under these three Sub-Committees in the following order:—

Northern Sub-Committee—Leeds and Liverpool Canal, Aire and Calder Navigation, Bradford Canal, Sheffield and South Yorkshire Navigation, New Junction Canal, Calder and Hebble Navigation, Rochdale Canal, Bridgewater Canals.

Midland Sub-Committee—Trent Navigation, Weaver Navigation, Staffordshire and Worcester Canal, Birmingham Canals, Coventry Canal, Loughborough Navigation, Leicester Navigation, Shropshire Union Canals, Worcester and Birmingham Canal, Severn Navigation, Gloucester and Berkeley Ship Canal, Ewash Canal.

Southern Sub-Committee—Birmingham and Warwick Junction, Warwick and Birmingham Canal, Warwick and Napton Canal, Oxford Canal, Grand Junction Canal, Regent's Canal.

The Sub-Committees are formed of representatives of the canal companies and of the carriers, with official representatives of the War Office, Ministry of Munitions, and the Railway Executive Committee, and each is presided over by an independent chairman.

Since the beginning of the war both the canal companies and the carriers on the canals have lost a considerable number of their employees, but this Committee is taking steps to provide crews for as large a number of boats as possible, and it is hoped that a greater number of boats capable of carrying traffic will be available at an early date.

It is very desirable that all engaged in sending or receiving goods of any kind, but more especially those kinds which are suitable for canal transport, should realise the difficulties in connection with transport in this country, and that these difficulties are likely to increase owing to the requirements of the war. It is also desirable that all who have wharfage accommodation on, or who are in close proximity to, inland waterways should not only use the existing facilities to a greater extent than heretofore, but should, when practicable, provide themselves with boats for canal traffic. Several firms at the present time have their own boats, but a number of boats are not in use, and it is possible that arrangements can be made to secure some of these idle boats for any firm who may be able to use them. (Information regarding these boats may be obtained on application to the Sub-Committees.) It is thought that most firms would be able to find one or two men in their own employment over military age who, after a few weeks' training, would be able to work the firm's boats.

Canal carriers are now in a better position to deal with traffic than they were, and the Committee hope that the arrangements made will enable a greater amount of traffic to be dealt with by canals than has hitherto been the case.

If there are any difficulties in the way, or if there are any suggestions you may wish to make, the Committee will be glad to hear from you.—Yours faithfully,

R. B. DUNWOODY, Secretary,  
7, Princes Street, S.W. 1.

[The "difficulties in the way" seem mainly due to the Government itself. As Mr. W. H. Joyner, who was lately asked to advise the Ministry of Munitions on inland navigation, wrote to the *Daily Mail* of Tuesday last, suggesting the use of canal boats for coal transit, which it has been proved at Cannon can be effected to London at 7s. per ton less than the railway charges, stated, a large number have been misused by the Government for conveying stone and other rubbish from the underground tunnel for the Post Office and dumping it at Uxbridge.]

Another instance of the fatuity with which the Government sends out appeals to the public for help from one Department and snubs responses when they are made will be found on page 5 of the same issue of the *Daily Mail*.—Ed. B.N.J.]

#### STATUES AND MEMORIALS.

RANGOON.—A memorial clock-tower, erected in the grounds of the American Baptist College, was dedicated on July 13 last to the memory of Dr. Adoniram Judson, the first Baptist missionary who went from the United States to Burma. The memorial is the gift of Dr. J. Ackerman Coles, a citizen of the United States, and by his wish is a facsimile of the tower of the Congregational Church at Salem, Massachusetts, where Dr. Judson was ordained. The height from the road to the top of the spire is 88 ft. The walls are constructed of ivory-white-glaze faience blocks, backed with brickwork; the dome and all enrichments are of the same material. The windows are of steel, fitted with British sheet-glass; the foundation is a reinforced concrete slab 22 ft. 6 ins. square. The lower portion of the tower—that is, for 44 ft. up to the main cornice—is of plain faience blocks, against which the entrances to the tower, surrounded by columns and pediment, stand out in bold relief. Above the main cornice relief and interest are given by a bold treatment of the orders superimposed, crowned by the dome. Internally there are four floors. The materials, with the exception of the clock and bells, have been supplied to the tower, surrounded by United Engineers, Limited, successors to Howarth Erskine, Limited. The clock has a full set of Westminster chimes, and is the work of the Seth Thomas Clock Company, U.S.A. The chimes have been made by the Mersley Bell Company, Troy, New York.

#### PROFESSIONAL AND TRADE SOCIETIES.

CAPE INSTITUTE OF ARCHITECTS.—The Kalendar for 1917-18 states that the roll of members is less by one than last year, owing to the death of Mr. F. Kirsten, Associate. During the year two members of the Council have joined the forces, viz., Mr. W. A. Ritchie Fallon, A.R.I.B.A., and Mr. H. A. McQueen. A country member, Mr. H. M. Davidson, of Kronstadt, O.F.S., is also doing war work in a munition factory in England. This makes a total of six members at present on active service. Only two general meetings were held during the Session. Registration makes slow progress, apparently mainly because of the slowness with which money comes in. The cost of securing an Act will be about £800, and the Institute has only about £100 in hand. The officers for the ensuing year are:—President, W. J. Delbridge, A.R.I.B.A.; Vice-President, F. K. Kendall, F.R.I.B.A.; Members of Council: Follows—Wm. Black, F.R.I.B.A., E. Austin Cooke (Hon. Treas.), Arthur H. Reid, F.R.I.B.A.; Associates—F. M. Glennie and John Perry.

Mrs. Katharine Sarah Macquoid (ninety-three), the novelist, and author of "Pansy," widow of Mr. T. R. Macquoid, R.I., the black and white artist, has left £619.

## Our Office Table.

The Edinburgh College of Art prospectus for 1917-18, just issued, contains full information as to courses of study in both day and evening classes. In each of the four main sections of drawing and painting, sculpture, architecture, and design, a full course is arranged for students desiring to make special study and practice of a particular art. The College is authorised by the Scotch Education Department to grant diplomas in the four sections. Candidates for the diploma must follow a prescribed course extending over not less than three years, or two years in the case of candidates who may have followed an approved course of study elsewhere, and must have produced work to the satisfaction of an Adjudication Committee, on which there is an assessor approved by the Department. Hostels for women students are provided at Craigmillar Park, and arrangements have been made for their admission to the Muir Hall of Residence, 12, George Square, and to the Masson Hall, 31, George Square. The evening classes, which are held between the hours of 7 and 9 p.m., are intended principally for those who are occupied in trades or professions during the day time. The Royal Scottish Academy School of Painting, which was established under an agreement between the Board and the Royal Scottish Academy, to provide special facilities for study from the life for advanced students of painting, carries on the work done by the Royal Scottish Academy since 1859 in their life class. Separate classes are held for men and for women.

The Controller of Timber Supplies (Board of Trade) announces that the particular cases of timber converted in town mills or sold from town retailers which have been under consideration, and that he will be prepared to allow the prices set forth in the Home-Grown Timber Prices (Great Britain) Order, 1917, to be increased in such cases by 25 per cent., when the quantity sold is 50 cubic feet or over, and by 50 per cent. when the quantity sold is less than 50 cubic feet. These increased prices are to cover delivery from the mills or yards, free on rail, or within the usual cartage radius.

Sir Tudor Walters's Committee on Working-Class Housing last Thursday decided to set up sub-committees to deal with the supply and regulation of prices of building materials; construction, with special reference to new methods and materials; the organisation of labour for economical building after the war; and plans for buildings and their lay-out. The Committee further decided to examine plans of the chief housing schemes and to take a census of building materials, ascertaining at the same time the quantity required to carry out the proposed national housing scheme.

At a meeting of the Cheshire War Agricultural Committee at Crewe last Friday Mr. Robert Shepherd, a large tenant farmer, said farmers were asked to bring another three million acres under wheat. This would mean 4,500,000 tons of additional straw. This might be used to create and develop the great industry of paper-making, which had lapsed through foreign pulp being substituted for straw. A great tonnage of straw was now assured, and means might be taken to start more paper mills. A resolution was passed asking the Board of Agriculture to take the subject up immediately. It is time something of the sort was done. At present our impression is that paper-makers neither want to see paper cheaper nor to use British-produced paper.

An old octagonal brick chimney, 125 ft. high and 12 ft. in diameter, belonging to the Solway Process Company, Detroit, had become badly weathered so that large quantities of mortar had fallen out of the joints and much of the brick was eaten away to a depth of several inches. The exterior surface was first cleared, then the removal of all loose material and the entire structure was enclosed by triangular wire mesh, furred out about 1 in. all around, and upon this concrete was shot by cement guns, forming a solid

mass with a minimum thickness of 2 ins. The air pressure employed was 50 lbs., and the cost of the job about 1,500 dollars. The cement gun has also been used with success and satisfaction for the cement lining, 1 1/2 in. thick, applied with an air pressure of 35 lb. gauge, to the interiors of five large steel smokestacks recently built for the Ford Motor Company, Detroit.

### TRADE NOTES.

Boyle's latest patent "air-pump" ventilators, supplied by Messrs. Robert Boyle and Son, ventilating engineers, 64, Holborn Viaduct, London, have been employed by Messrs. Vickers, Limited, at Crayford Works, Crayford.

Mr. C. F. Innocent desires to inform all that his offices at 22, High Street have been requisitioned by the Ministry of Munitions at short notice, and that his address is now: Rodgers Chambers, 65, Norfolk Street, Sheffield.

Some pits which were situated 20 ft. below the water level at the pumping station of Bedford Sewage Works have been successfully waterproofed with a 3 and 1 mixture of cement, rendered to a total thickness of 1 in. The cement was applied in three coats, each coat being about a bare 3/4-in. thick; 5 lb. of Pudlo were added to each 100 lb. of cement. Good results are reported from this treatment.

### TO CORRESPONDENTS.

We do not hold ourselves responsible for the opinions of our correspondents. All communications should be drawn up as briefly as possible, as there are many claimants upon the space allotted to correspondents.

RECEIVED.—W. and C.—L. G. and Co.—W. P. T. and C.—W. H. S. and Son.—I. W. H.—J. P. E. A. and Son.—G. and B.—G. and Co., Ltd.—J. D. R.

P. L.—No.

E. S.—Yes, please.

PROBET.—No space to spare for letters duplicated to other journals.

G. P. A.—Detail and not washed smudges, is what architects want. That is why a good line drawing is always preferred. When impossible, a photograph is next best.

R. AND W.—Sorry, but we are far too short-handed to do what you ask. Your proper course is to employ a quantity surveyor.

A censor of architecture for London was one of the suggestions made by Mr. Paul Waterhouse, speaking on London's architecture at Hampstead Garden Suburb last Wednesday, for improving the appearance of the streets.

Mr. Joseph Hault, a Liverpool shipowner, at the age of seventy, is distributing £70,000 to various benevolent and kindred objects. He gives £5,000 to Liverpool Cathedral "to be allocated by the Lord Bishop as he thinks best and most necessary."

A faculty has been granted by the Consistory Court of London authorising the vicar and churchwardens of the parish of St. Silas, Pentonville, to erect in the centre of the foreground of the church in Penton Street a churchyard cross of Portland stone, 17 ft. high, with a figure of Christ.

Without discussion, by 164 votes to 18, it was decided last Wednesday that the brass trellis-work known as the grille in front of the Ladies' Gallery in the House of Commons should be removed. The House was evidently unimpressed by Sir George Younger's jocular suggestion that the grille is useful to prevent the ladies falling out of the gallery.

The Liverpool Association of House Builders has resolved to assist the City Council to prepare, for the Local Government Board, a list of house-building schemes likely to mature on the declaration of peace. A resolution sent to the Local Government Board asks for the appointment of a second house builder on the Advisory Committee.

At the meeting of the Rochdale Corporation last Thursday it was reported that an inquiry had been received from the Local Government Board for statistics as to the shortage of houses in the borough, and the number likely to be required after the war, and whether the town council would be prepared to get out a scheme for municipal housing, provided they obtained Government assistance. The sub-committee have passed a resolution urging on the Government the granting of fresh powers to local authorities for the compulsory acquisition of land for municipal purposes, and this the Health Committee approved.

### CHIPS.

Lord Ronaldshay will lay the foundation-stone of the new Darjeeling Town Hall about October 25.

Mr. F. Hobson, surveyor to the Kirkburton (Works) Urban District Council, has been appointed surveyor and sanitary inspector to the Luddendoot Urban District Council.

Mr. E. W. Fritchley, architect, of Bombay, has been in Bangalore lately on an engagement to design the new town hall and market for that city.

Mr. C. Vawser, who was recently appointed surveyor to the Luddendoot Urban District Council, has accepted an appointment in Kent under the Road Board.

Mr. E. F. Sparroll, borough surveyor of Holborn, has been appointed local overseer for the borough under the Household Coal Distribution Order.

At the last meeting of the Strood Rural District Council the surveyor (Mr. L. Raper-son), who has been invalided from the Army, wrote that he would soon be returning to duty under the council.

Mr. Samuel George Isherwood, of Arnside Cottage, Arthog Road, Hale, and 10, Corporation Street, Manchester, contractor's merchant, who died on May 12, in his sixty-seventh year, left property of the value of £30,437.

Mr. John Henry Tucker, of Brentwood, Blossomfield, Solihull, Warwick, electrical fittings manufacturer, died on February 18, leaving £230,760. He bequeathed £1,000 for Birmingham charities as the executors might direct.

Mr. A. C. Bollam has been appointed chief assistant county engineer of Middlesex in succession to Mr. A. J. Lander. Mr. Bollam has acted as second assistant on light railways and the Great West Road for the past fifteen years.

Mr. John Mortimer, of Stony Littleton, Wellow, farmer, a member of the Bath Rural District Council, sued that council, at the Bath County Court lately, for £22, the value of a heifer that was killed by falling into a quarry on his farm and used by the council, which he alleged was improperly fenced. Judgment was given for the plaintiff, with costs.

At Winkley-cum-Grantley, last Wednesday, the Bishop of Ripon consecrated the new memorial church erected in memory of the late Lord Furness by his family, to replace the former parish church, built in 1822. The church has been erected from the designs of Messrs. Cannon and Chorley, architects, of Leeds, the contractors being Messrs. Armitage and Hodgson, also of Leeds.

The housing question has become very acute in Rotherham during the past twelve months. The local Housing Committee have already a scheme in hand, and attempts are being made to get the Local Government Board to sanction the erection of 500 houses without delay, while it is suggested that another 3,000 houses should be built as soon as possible afterwards. Overcrowding is very prevalent in the borough, and the difficulty of obtaining houses is very marked.

Sir Edward Letchworth has resigned the position of Grand Secretary to the United Grand Lodge of Freemasons of England, to which he was appointed in March, 1892, by the then Grand Master, the Prince of Wales, afterwards King Edward VII. The present Grand Master, the Duke of Connaught, has selected to succeed Sir Edward Letchworth Mr. P. Colville Smith, who since 1902 has been secretary of the Royal Masonic Benevolent Institution for Aged Freemasons and Widows of Freemasons.

When our new Ministers differ, who is to decide? It was reported at a meeting of the Leamington Corporation that with reference to a decision at a previous meeting to buy a new pump for the pumping station, the Local Government Board had made it a condition of authorising a loan, that none of it should be spent on repairing the present pump, while the Ministry of Munitions refused a priority certificate, and said the present plant must be repaired. The Local Government Board are sending an engineer to make an independent report.

We regret to record the death of Mr. Kevin Toole, builder and contractor, which occurred at his residence, Cabra Road, Dublin, last week. Mr. Toole carried out many important works, of which the large new church at Ranelagh was probably the chief. He also built the new Dominican Chapel and addition to the convent, Leeson Street; additions to Ballaghaderreen Cathedral; Beaumont Church, Killarney; Foxford Wooden Mills; St. Vincent's Hospital, Dublin; important work at Children's Hospital, Temple Street; additions to Aughrim Street Church, Dublin, and many other structures.

**FOR Oliver's Seasoned Hardwoods,**

APPLY TO—**WM. OLIVER & SONS, Ltd.,**  
120, Buehill Row, London, E.C.

**TENDERS.**

\* Correspondents would in all cases oblige by giving the addresses of the parties tendering, and the rate of the accepted tender: it adds to the value of the information.

**ADDISBURY.**—Structural repairs for the Education Committee.—**Wells Bros.,** 4126 15s. (accepted).

**BATH.** Alterations in Bath Street houses for the Corporation.—**Jacob Long and Sons, Ltd.,** £5,942 (accepted).

**CAVAN.** For alterations at the workhouse, for the Guardians.—**T. McQuirk, Cavan** (accepted) .. £59 17 6

**EAST PRESTON (SUSSEX).**—Alterations, etc.—For alterations, fencing, etc., in connection with the proposed conversion of the union infirmary into a military hospital, for the Guardians.—**F. Sandell and Sons,** £1,000 (accepted).

**ESRY (KENT).**—Painting.—For painting outside of hospital, for the Guardians.—**H. W. Wyborn, Deal,** 431 15s. (accepted).

**GLASGOW.**—For the erection of exhibition buildings on Bunhouse Ground, for the Corporation.—**John W. Baxter and Sons** (a) brick, cement, plumber, and painter works, £7,160 15s. 6d.; (b) carpenter, joiner, glazier, and ironmongery works, £2,851 8s. 3d.

**GROSTOR.**—For painting, etc., for the Urban District Council. Accepted tenders:—**W. G. Wilson,** £38 15s.; **J. J. Vaux,** 44 15s. 6d.; **W. G. Wilson,** £38 15s. 6d.

**HEFFORD.**—For supplying cast-iron columns, etc., for the Gasworks Committee.—**J. M. Barr and Co., Gloucester,** 31 cast-iron columns at £2 18s. 6d. each, one rolled steel joist, £10 (accepted).

**KINGSTON-ON-THAMES.**—Reinforced concrete sheet piling for the repair of Owen's Promenade, for the T.C.—**Holloway Bros.,** .. .. £2,000 0 0  
**Wallis and Sons** .. .. 1,827 0 0  
**Garnett and Sons** .. .. 1,274 0 0  
(Recommended for acceptance).

**LEANS.**—Painting work, etc., at Portmanton Park and Chapel Allerton Recreation Ground. Accepted.—**Pitts and Payne,** 191, Woodhouse Lane, Dept. 14s. Cleaning and painting Springfield Street Depot: **C. Fenton and Sons,** 49s. 6d.

**LEANS.**—For repair of walls at Pool Paper Mills, for the Corporation.—**W. Irwin and Co., Ltd.,** £280 (accepted).

**LEYTON.**—Outside work at Goodall Road and Mayville Road Schools.—**Arthur H. Bins,** 7, Devonshire Square, E.C., at £283 and £147 respectively. Interior work at Selwyn Road School: **Percy Watts,** 1, Warren Road, Leyton, at £170 15s.

**LONDON.**—The proposed extension of present factories of the British Ever Ready Portable Electric Lighting Company, Ltd., Stoke Newington, forming a dining-hall for the company's employees, according to the drawings and specifications of the company's architect, **M. Woodcock Carter, M.A.,** Lic. R.I.B.A., 43, Holloway Road, N.—**Messrs. Courtney and Fairburn,** .. £1,457 0 0  
**Messrs. Mather** .. .. 1,393 0 0  
**Messrs. Thomas and Elder,** .. 1,347 0 0  
Woodwick (Accepted).

**MARLET HURBOURGH.**—For alterations to heating apparatus for the Boardroom, for the Guardians.—**Harford and Perkins,** 444 3s. (accepted).

**OGMORE VALE (WALLS).**—For certain alterations and repairs, and for painting, colouring, etc., to the Workmen's Hall and Institute, Ogmogre Vale. Mr. P. J. Thomas, Bridgend, architect.—**P. Gaylard, Station Road, Bridgend,** alterations, etc., £280, painting and repairs, £195; **N. A. Kenyon, The Hafod Road, Tr. Hafod, painting,** £520; **S. A. Bartlett, Bryceott House, Ogmogre Vale,** repairs, £195.

**RATHDOWN (IRELAND).**—For painting Dundrum Dispensary, for the Guardians of Rathdown Union:—**J. Plunkett and Sons, Kingstown,** £33 10 0  
**M. O'Brien** .. .. 24 10 0  
**Keely** .. .. 16 10 0  
.. .. Accepted.

**SHERNESS.**—For the erection of a chimney shaft, for the Guardians.—**Hancock,** £439 (accepted).

**WOODFORD.**—For exterior work at the offices, for the Urban District Council.—**Wallace and Wallace,** £163 (accepted).

**WORSWORTHLEY BRIDGE.**—For painting, etc. (inside and out), of the institute, for the committee of the Barrow Working Men's Institute, Thomas Street, Worsworthley Bridge:—**W. Barnsley,** 12, Dalbary Street, Barnsley (accepted) .. £31 10 0  
.. .. Only tender received.

**LIST OF TENDERS OPEN.**

**BUILDINGS.**

**August 24.**—Certain alterations at the union workhouse, Holywell; and the dismantling and decommissioning of present boilers and connections and their re-erection in the proposed new buildings.—For the Guardians.—**P. H. Roberts, Clerk, Union Offices, Holywell.**

**August 27.**—Erection of a bathroom, etc., and plastering, etc., certain wards at Eastern Institution, and painting, etc., in the cottage homes at Downend, in accordance with specifications.—For the Bristol Board of Guardians.—**J. J. Simpson, Clerk, St. Peter's Hospital, Bristol.**

**Aug. 31.**—Leveling the Ground and Building Enclosure, Walls.—For the Committee of the Upwey (Dorset) Burial Ground Extension.—**Crickman and Sons,** 49, St. Mary Street, Weymouth.

**ENGINEERING.**

**August 24.**—Installation of a hot-water supply at the Bales New Road Institution in place of the existing hot-water plant.—For the Guardians of Salford Union.—**E. H. Inchley, Clerk, Poor-Law Offices, Eccles New Road, Salford.**

**August 31.**—Sealed tenders endorsed "Tender for Contract No. 225" will be received at the Town Clerk's Office, Municipal Offices, Johannesburg, not later than 12 noon on August 31, for refrigerating plant at Market Buildings, Newtown, Johannesburg. Drawings and documents can be viewed free on application to the Council's agents in London, Messrs. E. W. Carling and Co., St. Dunstan's Buildings, St. Dunstan's Hill, London, E.C., but a deposit of £1 is required for copies.

**September 12.**—The Corporation of Botlle invite designs and tenders from specialist firms for erection and completion of an overhead coal bunker in the present boiler-house; the coal bunker to be constructed in reinforced concrete, and to hold at least 400 tons of coal.—**J. S. Tumlity, Town Clerk, Town Hall, Botlle.**

**March 30.**—The Acting British Consul at Santiago reports that a decree has been issued calling for tenders for the improvement of the port of Antofagasta (Chile). By the terms of this decree the amount to be expended on this work must not exceed £1,700,000. Details may be obtained from the Port Commission Offices in Santiago, and copies are expected to be received shortly at the offices of the Chilean Legation in London, 22, Grosvenor Square, W.1. Tenders will be received up to 3 p.m. on March 30 by the Minister of Finance, Santiago.

**FURNITURE.**

**Aug. 31.**—Supplying Twelve Windsor Armchairs for the use of the inmates of the infirmary.—For the Wallingford Guardians.—**G. F. Slade, Clerk, Wallingford.**

**PAINTING.**

**Aug. 27.**—Painting the Company's Locomotive Department Offices at Dundak Station.—For the Great Northern Railway Co. (Ireland)—The Secretary of the Company.

**Aug. 28.**—Painting the Interior of the Portsmouth Radical Club, 314, Fratton Road.—**E. Farrars.**

**Aug. 31.**—Cleaning, Painting, etc., the Works Hospital.—For the Blaenavon Medical Society.—The Secretary, 35, New William Street, Blaenavon.

**ROADS AND STREETS.**

**August 25.**—Construction of a stone-paved footpath in Rectory Lane and Bishops Hall Lane, Chelmsford.—For the Town Council.—**G. Melvin, Town Clerk, Municipal Offices, Chelmsford.**

**Aug. 28.**—Steam Rolling and Sealing (Six Months)—For the Fareham Rural District Council.—**A. Laker, Clerk, 97, West Street, Fareham.**

**SANITARY.**

**August 24.**—Laying 900 yards of 6-in. stoneware sewers, 263 yards of cast-iron sewers, the construction of manholes and lamp-houses in connection therewith; and the construction of settling tanks, bacterial filters, and siphon chambers and laying out irrigation land for treatment of sewage at Pains Hill, Limsfield.—For the Godstone Rural District Council.—**C. Phillips, Clerk, Council Offices, New Oxted.**

**Aug. 25.**—Scavenging in the Township of Silverdale.—For the Lancaster Rural District Council.—**W. D. Ball, Clerk, 5, Dalton Square, Lancaster.**

**Aug. 29.**—Construction of Sanitary Conveniences and other Plumbing Work.—For the Cork Harbour Commissioners.—The Commissioners' Offices, Custom House Street, Cork.

**TO ARMS!**

**COUNTY OF LONDON VOLUNTEER ENGINEERS** (Field Companies).  
Headquarters: Balderton Street, Oxford Street, W. Officers for the Week: **By Lt. Col. C. B. Clay, V.D.,** Commanding.

**OFFICER FOR THE WEEK.**—**Pl. Comdr. C. Campbell.**

**RESIGNATION.**—**Pl. Comdr. A. Gerard** resigns his appointment.

**MONDAY, AUG. 27.**—Technical Instruction (Searchlight) for No. 3 Company, Right Half Company at Regent Street. Drill, No. 3 Company Left Half Company. Signalling Class. Recruits' Drill, 6.30.

**TUESDAY, AUG. 28.**—Lecture, 6.30. Physical Drill and Bayonet Fighting, 7.30.

**WEDNESDAY, AUG. 29.**—Drill and Elementary Bridge Construction for No. 1 Company, Right Half Company.

**THURSDAY, AUG. 30.**—Drill and Elementary Bridge Construction for No. 2 Company, Right Half Company. Ambulance Class.

**FRIDAY, AUG. 31.**—Technical Instruction (Searchlight) for No. 3 Company, Left Half Company, at Regency Street. Drill, No. 3 Company, Right Half Company. Signalling Class. Recruits' Drill, 6.30.

**MUSKERY.**—All N.C.O.'s and men who have signed the "A" and "B" agreements are required to attend during this month to re-classify in order to enable the corps to obtain the Capitulation Card. Preference will be given to these men in firing.

**ARMLETS.**—The new armlets can be obtained at Headquarters, and every enrolled man must obtain one without delay, and all old (red) armlets must be returned to the Drillery Room.

**NOTE.**—Unless otherwise indicated all drills will take place at Headquarters.

By Order, **MALCOLM VEARSLEY,** Adjutant.  
Aug. 26, 1917.



# THE BUILDING NEWS

## AND ENGINEERING JOURNAL.

Effingham House,

### CONTENTS.

Strand, W.C.2.

Currente Calamo .. .. . 161  
 The Problem of the Small Dwelling and Its Solution—XV. .. .. . 162  
 English Forestry and Commercial Timber .. .. . 163  
 Colonial and English Gardens .. .. . 164  
 Our Illustrations .. .. . 177  
 Houses That Will Not Burn .. .. . 177  
 Building Intelligence .. .. . 178  
 Correspondence .. .. . 178  
 Competitions .. .. . 178  
 Obituary .. .. . 179  
 Our Office Table .. .. . 179

Professional and Trade Societies .. .. . 180  
 Trade Notes .. .. . 180  
 Tenders .. .. . 180  
 To Correspondents .. .. . 180  
 List of Tenders Open .. .. . vii.  
 To Arms! .. .. . vii.  
 Latest Prices .. .. . viii.

#### OUR ILLUSTRATIONS.

Two Views and Plans of 35, Porchester Terrace, W. Additions and alterations. Sir Aston Webb, R.A., K.C.V.D., C.B., Architect.

A War Memorial Revoked, St. Paul's Church, Southsea, Hants. Mr. Sidney K. Greenslade, A.R.I.B.A., Architect. Mr. A. Broadbent, Sculptor.

Bank of Liverpool, Limited. New premises at Durham, Messrs. Newcombe and Newcombe, Architects.

The Problem of the Small Dwelling and Its Solution. Sheets XXVIII. and XXIX., showing typical plans by Mr. Robert Thomson, Architect.

## Currente Calamo.

The forty-sixth annual report of the Local Government Board, covering the period 1916-17, is divided into three parts, Part I. relating to the administration of the Poor-law, including special work arising out of the war; Part II. to housing and town planning; and Part III. to public health, local administration, including loans sanctioned to local authorities (mainly for purposes connected with the war), and local taxation and valuation. The report, which is a very lean one, has been still further reduced in size by the exclusion of matter relating to the normal activities of the department, and by the omission of most of the tables and statistics, and of the circulars issued during the year, which are usually given in the report or included in its appendices. As a whole, we get a record of the discouragements of local authorities, and a lack of anything doing to meet the phenomenal and rapidly-growing deficiency of housing. Only in five instances have loans been sanctioned for the immediate execution of new schemes said to have been urgently needed to meet war requirements, the total being only one-twentieth of the amount sanctioned in 1914-15. Town planning remains equally stagnant, in spite of the opinion expressed that now is the time to prepare and submit schemes for execution after the war, authority having only been given during the past year for the preparation of fifteen schemes, while preliminary notices have been given under the regulations for twenty-seven more. As regards general matters of public work and local administration, it is equally painfully evident that things are at a dead standstill. We are told, of course, returns of works needed "are being tabulated and classified," so as to avoid unnecessary delay presently, and that further proposals should be submitted as soon as practicable. We hope they may be; but any encouragement as regards priority of sanction, or who is to pick and choose the fortunate early birds on the scoot after the very small crumbs likely to reward their persistency, is lacking.

The experience gained by the Ministry of Munitions in carrying out housing schemes in connection with the national factories may be of some value to Mr. Hayes Fisher when he comes to deal with the larger problem. The department, in a memorandum submitted to the Public Accounts Committee, gives its opinions on the comparative merits of the various courses adopted. Of course, much of the housing accommodation which it has had to provide is of a temporary character, and on this class of building over a million sterling has been expended. It has also incurred considerable expenditure on permanent housing schemes. It has made contributions to corporation schemes amounting to 26½ per cent. of the total estimated cost. It has, in the form of an allowance from excess profits, contributed £73,500 towards the expenditure of £289,000 by contractors on new cottages and tenements, and, in addition, it has advanced £380,500 to contractors for housing schemes, the rate of interest varying from 4 to 5 per cent., and the period of repayment being in most cases forty years. Large housing schemes have been undertaken in the Woolwich district both by the Ministry of Munitions and the Office of Works at an expenditure approximating £1,800,000. The evidence available shows that the schemes have met with very varying success. A close examination of their defects, which we have pointed out in some cases in detail during the past three months, will, we trust, lead to their avoidance, both as regards cost and construction, and furnish guidance to the President of the Local Government Board in framing his national housing scheme.

The Companies (Particulars as to Directors) Act, 1917, which received the Royal assent on the 2nd instant, is an important measure applying the principle of the Registration of Business Names Act to all companies. The annual list and summary entered in the register of members and the register of directors, and the copies thereof filed with the Registrar of Companies, must now set out the following particulars concerning the directors:—(a) The present Christian name, or names, and surname of every director. (b) Any former Christian name, or names, or surname of every director. (c) The

nationality of every director. (d) The nationality of origin (if other than the present nationality) of every director. (e) The usual residence of every director. (f) The other business occupation (if any) of every director. Companies registered since November 22, 1916 (and, therefore, under suspicion, seeing that the object of formation may have been to evade the provisions of the Business Names Act, which was then passing through Parliament, and became law a month later), are not permitted to wait until the next annual return or copy register of directors is due, but must enter such particulars on a separate form and cause it to be filed not later than September 2. They must also, on and after November 3, set out in all "trade catalogues, trade circulars, showcards, and business letters," the names of the directors and any former names by which they were known and the nationality of any who are not British or the former nationality where a change has at any time been effected. The expression "director" is given a wider meaning with the object of bringing to light the man who "pulls the strings," and it now includes "any person who occupies the position of a director, and any person in accordance with whose directions or instructions the directors of a company are accustomed to act." A handy little sixpenny booklet, giving the above and other particulars, has been issued by Messrs. Jordan and Sons, Ltd., the well known company registration agents, of 116 and 117, Chancery Lane, W.C.2, which all concerned with public and private limited companies would do well to get at once. The Act seems to have attracted little public attention, and has been adversely commented on by some. In our opinion, its purpose is wholesome, and its operation will be beneficial. There have been too many "limited companies" of a sort in the past, and some, recently registered, appear to be of a decidedly suspicious character, and it is quite as well that the particulars now demanded should be made public.

The Special Committee of the Manchester Corporation which has been considering how to relieve the congestion of traffic in the central streets of the city reports in favour of new arterial routes

and terminals being provided for tramway purposes. Six new routes are indicated. As regards the old infirmary site, "The Special Committee are of opinion that it is necessary that some part of the area should be utilised as a tramway terminal, but they recognise that it is the primary duty of the Royal Infirmary Old Site Special Committee to prepare and submit to the City Council a complete scheme for dealing with this site. It is suggested that the terminal should be placed in a widened and lengthened Parker Street—made possible by the acquisition of the triangular block of buildings at the Mosley Street end of the site, which would add approximately 1,832 square yards to the site, thus increasing the area available as an open space—masked by a building on the north side of that street, and provision made between this building and Piccadilly for ornamental gardens or open spaces. The Special Committee are of opinion that if this arrangement were adopted and the whole site designed and treated so that any building erected would be architecturally worthy of such an important situation and harmonise with the ornamental gardens and open spaces, it would afford a solution of the contentious question concerning the use of the Piccadilly site, and would satisfy the requirements of the Tramways Committee." That should settle the matter, surely, unless the wire-pullers of the fractious opposition organise some other hindrance!

Matthew Maris, who died last Wednesday in his retreat in St. John's Wood, was like the boy in the story who was given the gift of fairy gold. His art is described by the *Manchester Guardian* as fairy gold, and, like that gold, much of it vanished from the world, for in his later years he continued to paint on his canvases till nothing was left of the original design and subject—only a maze of colour. A friend who visited him a few years ago said that he saw the tiny old man in a room very bare and well swept. He was eating chocolates and darning socks in very fine and beautiful woods. It made his visitor think of a scene in Hans Christian Andersen. All artists are partly disinterested, and get some of their reward from the joy of creation—that is to say, in the doing of the work itself; but in modern life art tends, like all things, to be an industrial process, and it is rare to find the disinterested side the strongest. But with Maris that was the whole thing. He hated the thought of art as a thing of the market. He saw the works for which he had been paid very little bring thousands of pounds to collectors and dealers, and he was at odds with the world as it is. He was an advanced Socialist. It was natural that the painter of the tenderest vision in modern art should dream of the brotherhood of man, and of another sort of world "where none may gather gold." This great "little-master," who will rank with Ver Meer, Delft, and obscurely and very poorly like Blake and Van Ruysdael and Rembrandt.

Organisation still seems the weak spot in all our Government's activities. The London Correspondent of the *Birmingham Daily Post*, whose reliability none will call in question, says:—"The other day I was in conversation with the headmaster of a secondary school who was at his wit's end to find a woman teacher to fill the place of a man called up. Yesterday a farmer acquaintance, who grows a lot of fruit, showed me with great pride a company of women—lady farm workers is the polite term—climbing ladders and basketing fruit for market. They were all educated women, and several of them were the holders of university degrees. They were housed in barns, slept on straw, and the cooking and general arrangements were primitive. At the station I bought a local paper, and the most conspicuous advertisement emanated from the barracks in the neighbourhood and appealed to the farmers to give employment to soldiers who had been brought specially from France to meet the need for agricultural labour at this season! Could anything be more ridiculous—schools wanting women teachers, women with university degrees working on the land, and soldiers from the battle zone, brought back to work on the land, waiting in barracks to be hired? One of the young women, by the way, confessed that she had been attracted to work on the land by the Government poster which depicts a damsel standing before a mare, a foal, and a heifer, pouring hay out of sacks; but she has learned now that hay won't pour. The artist was a humourist, the official who approved the poster a pure-blooded cockney—no doubt left by the Board of Agriculture."

It is said—how truly we know not—that the Government mean to have the unfinished new London County Council building for temporary occupation, probably for some new Department which is hatching. The *Leeds Mercury* says the ladies' committee were "so successful" with the Economy Exhibition that the Government has changed its mind. We are told:—"At first it seemed impracticable, as the Commissioner of Works, who is commandeering hotels and large and small blocks of premises all over the West End for Government offices, had declined to do anything with this structure. But the ladies' committee made the place quite excellent. . . . And I am told that the probability is that no great trouble will be involved in the process. The amateurs have taught the experts. There is abundance of large chambers, and the lighting is just a matter of taste."

Lieutenant-Colonel Hawdon, of Park Street, Selby, and Scarborough, has just placed a new stained-glass window—representing three Yorkshire saints—in the south aisle of the choir of Selby Abbey, in memory of his late brother, Mr. George Hawdon, and it is to be dedicated on Sunday, September 9.

A beginning has been made with the large building scheme in the east end of Port-Glasgow. Four Glasgow builders have each started on separate sections. The ground to be built upon embraces Chum Park football field and lands adjoining east and west. It is expected that the new buildings will provide accommodation for 4,000 persons, and the cost is likely to be about £200,000.

## THE PROBLEM OF THE SMALL DWELLING AND ITS SOLUTION.

BY ROBERT THOMSON.

[WITH ILLUSTRATIONS.]

The Scottish tenement system of housing is another of those frauds which, like the English types of two flatted cottage dwellings, is in existence to-day simply because no one has hitherto taken the trouble to devise anything better. Upon investigation, it looks as if these tenements and cottages had been designed for the express purpose of depriving the people of healthy, commodious, comfortable, convenient, and economical dwellings.

Fortunately, the grossly fraudulent character of the Scottish tenement type of dwelling as a means of economically housing the people can now be effectively exposed by the health-promoting class of dwelling, and the plans which on Sheet XXVIII, accompany this article furnish incontrovertible proof of the fact. One of these facts is that the four two-story cottage dwellings shown in plan Figs. 163 and 164 give more house-room than the eight dwellings in each of the four-story tenement blocks shown in plans and section in Figs. 160, 161, and 162, and that, too, within the same roofed area as that of the tenement block and its wash-house. The total house-room in the four cottage dwellings built to plan Fig. 164 would be 31,424 cubic feet, while that in the eight tenement dwellings would be 28,600 cubic feet, showing a difference of 2,824 cubic feet in favour of the cottages.

Some authorities object to four-story tenements, but approve of three-story ones. Others, again, object to the three as well as the four-story blocks, but highly approve of the tenement dwellings which are only two stories high. In Dundee the proposal in the spring of the present year was to erect tenements three stories high in one district and two-stories in another, but there have been some changes since then, and what the present proposals are I cannot say.

As the four-story type of tenement block appears to be going out of fashion and the two-story one coming in, it will be more helpful if the latter be now dealt with than that time should be wasted on the former. Let us, therefore, cut out the two middle stories shown in the sectional plan Fig. 162, in order that it may be possible to make a series of direct contrasts between the accommodation in the four dwellings which the remaining two stories would provide and that which four cottage dwellings to either of the plans Fig. 163 or 164 would give within the same roofed area. Taking plan Fig. 164 for the present example, it will be seen that the block of four dwellings built to it would provide within the habitable apartments and kitchens 31,424 cubic feet of house-room, while the four tenement dwellings would give only 14,040 cubic feet, thus showing the enormous difference of 17,384 cubic feet in favour of the cottage block. To many people these figures fail to visualise what they are intended to convey, but this difficulty at once disappears when their financial equivalent is stated. When, therefore, this difference of 17,384 cubic feet is priced at the officially based rate of 15s. per cubic foot—a rate which, by the way, is far below that which is likely to rule after the war—the value of the house-room which would be sacrificed by building two-story tenement blocks to plans Figs. 160-1 and 2, instead of cottage blocks to plan Fig. 164, works out at the substantial sum of £1,026 10s. per block. In ordinary times



that would be regarded as a very large sum to waste, but in the present spacious times, when everyone thinks of values in seven figures, it may be apt to be overlooked, and it will be well, therefore, to apply it to the present needs of the nation in order that its importance may be dealt with, not only adequately represented. This is easily accomplished, since the minimum number of dwellings which require to be built in order to make good the existing shortage is pretty generally agreed upon.

The joint committee on labour problems after the war have called for the erection of 1,000,000 dwellings within the four years immediately succeeding the declaration of peace. In the meantime, we are considering the tenement type of housing, and it has been reported that there is a shortage of 100,000 dwellings in Scotland alone. If, therefore, this shortage were met by building tenement blocks, say, for example, to plans Figs. 160-1-2, instead of cottage blocks to plan Fig. 164, the total volume of houseroom which would be sacrificed would be 454,600,000 cubic feet, and this, when priced at the officially based rate of 15d. per cubic foot, would work out at the fairly respectable sum of £27,162,500. But even that sum, respectable though it would be, would count as nothing when the question of health is considered, because the tenement blocks would provide 100,000 dwellings, which throughout the whole of their existence would, more or less, handicap their occupants by tending to promote disease, whereas if, instead of tenements, cottages were erected to plan Fig. 164, each dwelling would be as perfectly and as actively health-promoting as a sanatorium, and would never degenerate into slum dwellings. That statement in regard to health applies equally to England and Wales, and the figures dealing with the houseroom which would be sacrificed in Scotland, if multiplied by ten, will give approximately the corresponding figures for the nation as a whole.

The plans on Sheet XXVIII. should provide land reformers with a series of more effective arguments than any they have hitherto possessed. These plans conclusively prove that it is the cost of the land, and not the cost of the building, that stands in the way of cottage dwellings in Scotland.

It is here necessary to explain that the plans of the tenement blocks for which the foregoing figures are given show a class of dwelling in which the floor areas of the two larger apartments is greater and the ceiling height of the dwellings less than is the case in the class of tenement dwellings usually found in Scotland. Plans Figs. 160-1-2 have been so devised as to enable the Scottish tenement type of dwelling to be directly compared with the English cottage type in order that it may be included in the present educational series. To this end the floor area and ceiling height of each of the apartments is in exact accordance with the Advisory Committee's "desirable" standard as set forth in column II. of the table in paragraph thirty-five of their report, and in order to meet the Scottish requirements as to sleeping accommodation each of the two larger apartments is provided with a bed recess, which adds to the floor area and cubic capacity of the apartment. Each of these four-story tenement blocks comprises eight dwellings, seven of which consist of three apartments, the smallest of which is the Advisory Committee's favourite fiveless sixty-five, while the eighth dwelling consists of only two apartments, the place of the little fiveless bed-

room being occupied by the "close" which leads from the street to the stair and gives access to the washhouse in the drying-green behind the building.

The total habitable houseroom in each of these three-apartment dwellings is 3,640 cubic feet, while that in the Committee's "desirable" size of dwelling is 3,960 cubic feet. In the tenement dwelling in which all three apartments are used as bedrooms both of the two larger apartments are available as sitting-rooms, thus giving 3,120 cubic feet of air space instead of only 1,440 cubic feet in the "desirable" cottage, while by night the occupants of the tenement would have 3,640 cubic feet of air space against only 2,520 in the case of the "desirable" cottage. The width of the "close" and staircase are in accordance with Scottish requirements. If the reader will turn to the Well Hall tenement plans, Figs. 146-7-8 and 9, he will be able to judge of some remarkable contrasts between English and Scottish practice. For example, each Scottish dwelling has a good entrance lobby and a fully equipped bathroom, while the Well Hall dwellings have neither entrance lobby nor bathroom. The English tenement dwellings are separated from each other by a nine-inch party wall, and the wall enclosing the staircase is of nine-inch brickwork, whereas within the Scottish tenement building there is nothing thicker than 4½ inches, and the stair in the latter is in straight flights and invariably of non-combustible material, such as stone or concrete, while in the former it is usually of timber construction, with several winders. The probability is that if these tenement plans were built to, each block would require to have a tiled close, and each dwelling an oriel window, Venetian blinds, and a convertible close or open kitchen range. The letter A on plan 161 and section 162 shows one of the infamous box-beds which only "yesterday" was a feature in the parlour of middle-class houses.

The Scottish tenement building is a ponderous structure, its back and front walls being of stone, its mutual gables—i.e., party walls—nominally of 18-inch brickwork, but at the back of wall presses it is usually only half a brick thick, and when two presses come back to back, sometimes a 2-inch thickness of Arbroath pavement may be all that divides two blocks. The party wall, or mutual gable, shown in the accompanying plans is an arrangement devised to give deeper wall presses and a more substantial type of structure than the 18-inch wall usually employed. The tenement building being of great width, it calls for joists of great length and of heavy scantling, and as these have to be sawn from the log, they are, relatively to the English type, very costly. Its roof timbers are usually 6½ in. by 2½ in., and, as will be seen from the section Fig. 162, these also are in long lengths, and consequently their cost per foot must be higher than that of the roofing in the English type of cottage.

Externally, the Scottish tenement building, with its polished freestone front, has an appearance of strength, but when its internal structure is investigated, the most remarkable feature discovered will probably be the testimony which it affords as to the carrying capacity of 4½ brick partitions in the lower stories. No calculations are needed to prove that the partitions in the two lower stories of a four-story tenement must have a very much smaller margin of safety than those in the two-story cottage.

Passing now to Sheet XXIX., the six figures thereon comprise two series of plans, the one based on the advisory com-

mittee's "irreducible" minimum, the other based on their "desirable" standard. The wing in all six plans has an area of 100 square feet, and is thus equal in size to that of the largest size of the health-promoting class of dwelling. It will be seen that in plan Fig. 165 there are two of the committee's fiveless bedrooms, and that plan Fig. 162 has one of these disease factories. These plans are important examples in the present educational series, because they represent the two smaller official sizes of dwellings in their most economical form, and at the same time most substantial type of construction. The counterpart of the smaller of the two will be found in plan Fig. 18, and of the larger in plan Fig. 19, both on Sheet III. The roofed area of the former of these second-stage plans is 894 square feet, which compares very badly with 675 square feet in the eleventh-stage plan, Fig. 166, and that of the latter is in the second-stage plan 972 square feet, as against only 747 square feet in the eleventh-stage plan, Fig. 169.

The leviathan plans, Figs. 167 and 170, represent the advantages offered by the three-flue heat actuated system of ventilation, with which the plans Figs. 166 and 169 are respectively furnished. It may be stated that while the air supply in the living room and the two bedrooms for children would provide the ideal requirements for the number of occupants set forth in each of the apartments in plans 167 and 170, the parents' bedroom in each case falls far short of the ideal, although it goes far ahead of official requirements.

If the sole object to be attained in the housing of the people were to provide them with the smallest possible sizes of dwellings capable of meeting the requirements of the Advisory Committee as to sizes of apartments and to adequately equip them with office and other accommodation and conveniences, then the plans Figs. 166 and 169 might be regarded as perfect; but as there are other more important objects which must be met, these plans may remain as examples showing what the departmental and advisory committees have failed to accomplish.

In considering the room and kitchen size of tenement dwellings, these two plans, Figs. 166 and 169, would quite as effectively serve as arguments as have plans Figs. 163 and 164.

(To be continued.)

#### ENGLISH FORESTRY AND COMMERCIAL TIMBER.

The Council of the Royal English Arboricultural Society, as we stated last week, has had under consideration the past and present position of forestry in England and Wales and the question of the future production of commercial timber, and the following statement of that position was sanctioned for publication by the members at the annual meeting.

##### I.—BEFORE THE WAR.

The timber supply of Britain was almost entirely obtained from abroad, the price of imported timber was low, and the cost of transport small. Home-grown timber was generally in small request except for estate purposes, fencing, and certain special or inferior uses. When sold, the prices realised were such that, in many cases, the timber did not pay to grow, and the cost of transport was high.

The woodlands in England and Wales extended over about 1,834,000 acres. Had they been normally stocked, they should have produced about a load of timber per acre per annum, but there being little demand for the produce the output was very small.

The Crown woods extended over about 64,000 acres. They were managed to some extent for the production of commercial

timber, but the management of the past had been such that the balance of annual income over annual expenditure, if any, was trifling. The appearance of the woods and the results obtained did much to discourage planting by private owners. The management of the Crown woods was hindered by common rights and the New Forest Act, 1877.

The woods in private hands extended over about 1,820,000 acres. They were partly the remains of ancient forests and manorial wastes, and were often hampered by rights of common and of way. Many areas were devoted to the growth of coppice, or coppice with standards, which, a generation ago, were lucrative systems of forestry, but are now no longer remunerative owing to the decay of rural industries and the lack of the demand for firewood, bark, and other produce. This had a very depressing influence on forestry.

The Royal English Arboricultural Society since its formation in 1862, has endeavoured to represent the opinion of those interested in forestry in England and Wales. Without assistance from the Government, the Society has continuously urged the importance of forestry to the nation, and has striven to revive an interest in the subject, to improve silvicultural methods, to extend forestry operations, to encourage the growth of commercial timber, and to raise the industry to a position of greater importance in the timber supply of the country.

#### II.—THE PRESENT POSITION.

The position of forestry in Great Britain has been changed by the war. Foreign supplies of timber have been curtailed, and, though building has been stopped, heavy demands for timber have been made by the collieries and by the military authorities. The demand has to be met by home-grown timber chiefly grown on private estates. It would appear that the stock of good class ash timber is likely to be exhausted, the stock of conifers dangerously reduced, and other classes greatly diminished.

The war has shown that a sufficient stock of home-grown timber is essential, and that a large increase in the production of commercial timber is highly desirable in the national interest. The necessity for large supplies of home-grown timber, and particularly of pitwood in cases of national emergency, has been proved. If foreign imports are stopped, without such home-grown supplies our collieries would cease working, our naval and military operations would be seriously hampered, and many of our commercial undertakings would be ruined. The present supplies have been created mainly at the expense of private owners, without any assistance from the State or encouragement from consumers, and such owners are now supplying their timber at low prices. The nation is under a great obligation to the timber growers.

It would obviously be impracticable during the war to put any scheme into practice, but it is desirable that arrangements should be made for starting operations as soon as peace is declared. It is, however, essential that a thorough knowledge be had of what land is available for afforestation, so that it may be ready for preparation by demobilised soldiers, sailors, munition workers, and others after the war, should work be required for them.

#### III.—AFTER THE WAR.

Owing to the depletion of the stock of home-grown timber the United Kingdom for many years to come will be more than ever dependent on foreign supplies.

The question of the future of British forestry will need more careful consideration, but it takes a long time for timber to come to maturity, there can be no need for hasty and uncalculated action. The main questions requiring consideration will be:—

1. The improvement of existing woodlands, and the introduction of proper systems of silvicultural management.

2. The replanting of woods recently felled.

3. The afforestation of areas more suitable for agriculture than for any other pur-

When the war is over there will be a unique opportunity for the introduction of improved methods for the production of commercial timber. The State should take the fullest advantage of it by fostering forestry, and giving every possible encouragement to the planting of land by private owners. The many serious handicaps to timber growers from which forestry has suffered must be removed before any improvement can be expected, measures must be taken to minimise the risk of loss from disease, fire, and atmospheric changes, funds for assistance in planting should be available, and a bonus for planting might be offered. The State must inspire private owners with confidence that their interests will be studied and guarded, and that at least a fair return for the money invested in planting will be assured. The inauguration of a broad and generous policy is essential to the welfare of forestry.

The replanting of the areas upon which timber has been felled both in the Crown woods and upon private estates will be a matter of some urgency, but will only be a partial remedy for the position.

The replanting of private estates, in many cases, will be impossible without financial assistance by the State, and there must be confidence that planting will result in a profitable return.

The afforestation of large areas will be desirable, but will probably be difficult to private owners, and afforestation by the State may be necessary, but wherever possible private owners and municipal corporations should be encouraged to carry out extensive schemes, as these methods are cheaper to the nation than afforestation by the State.

There will be a lack of well-trained and skilled persons available to carry out afforestation immediately after the war, but useful work may be done by unskilled labour if properly directed.

The Society, taking these matters into consideration, ventures to submit the following recommendations for the consideration of His Majesty's Government:—

#### RECOMMENDATIONS.

1. That the Government, so soon as normal conditions are resumed, should carefully consider methods by which the production of commercial timber by private owners may be assisted and encouraged, particularly for ensuring the replanting of woods which have been felled, the improvement of existing woodlands, and the utilisation by afforestation of all land which is better suited for silviculture than for any other purpose. Among the many items to which attention should be paid, the most important are:—

- (a) Reduction of railway rates.
  - (b) Making rings of buyers illegal.
  - (c) Relief from liability for extraordinary traffic in carting timber.
  - (d) Readjustment of rates and taxes, especially death duties.
  - (e) The provision of a fund from which private owners may borrow money, for afforestation or replanting, at a low rate of interest, subject to the approval by the State of the plans and management until the loan be repaid.
  - (f) Generous grants for scientific research and supplying information to owners.
  - (g) Making occupiers and occupying owners of adjoining land responsible for keeping down rabbits.
  - (h) Freeing of woodlands and afforestation lands, as far as practicable, from servitudes and other rights and customs interfering with forestry.
  - (i) Readjusting the rights of tenants for life and remaindermen and the legal definition of "timber."
2. That it is an essential preliminary to the extension and improvement of forestry that a Forestry Council (unpaid) should be appointed, to be elected by the bodies interested in the subject, and responsible solely to the Minister in charge.

3. That a strong Department should also be formed and staffed by men intimately acquainted with English conditions. Such department should at once institute a survey of the country, so as to be able to speak and act with authority as to land suitable respec-

tively for silvicultural and agricultural development. In making such survey, special regard should be paid to land suitable for demonstration areas, and for small agricultural and pastoral holdings in connection with schemes of afforestation.

4. That the Department should, with local assistance, mark out areas of suitable land for afforestation, so that in the event of work being required for demobilised soldiers and sailors after the war, the Government may be prepared to acquire the land by purchase or lease, and to commence work of reclamation preliminary to afforestation, such as clearing and draining the land, road-making, etc., for which labour skilled in forestry is not necessary.

5. That in the event of a large scheme of State afforestation being decided upon, the Government should institute a more extensive system of education for all branches of forest service than is available at present.

6. That every encouragement should be given to municipal and other local authorities to afforest land, especially in connection with catchment areas for water supply schemes.

7. That the State should lay out demonstration areas and generally carry out the recommendations of the Royal English Arboricultural Society, dated 1910, which were embodied in the Report of the Advisory Committee on Forestry, 1913 (Cd. 7,613).

8. That Crown woods and forests should be so managed in future as to be a good example for the production of commercial timber upon profitable lines.

EDWARD DAVIDSON, Secretary.  
Haydon Bridge, Northumberland.

#### COLONIAL AND ENGLISH GARDENS.

Mr. T. H. Mawson, of Lancaster and London, the well-known architect and town-planner, in the course of an illustrated lecture, before the members of the Lancaster Literary Society, on "The Charm of the English Garden," having explained that the lecture was one of a number he had delivered in the universities and colleges of America, added that, although Britishers understood the art of gardening much better than the Americans did, he felt that in ten or twenty years from now America would have a much higher reputation for garden design than we had now. Some universities were devoting themselves to the study of landscape gardening, and the new gardens of the capital of Australia were being designed by a gentleman in Chicago, and those of Ottawa were being designed by another American. Thus, England was in danger of losing its position as the premier landscape gardener.

Mr. Mawson mentioned that in connection with Reading College an effort was made before the war to establish a chair of garden design, but the authorities declared it was impossible to find £1,200 for such a purpose. Now that we were able to spend £7,000,000 a day on less remunerative work, perhaps when the war was over we might be able to raise £1,200 a year for a purpose that would bring its return. It was difficult to describe in words the charm of English gardens, for unless one felt the "charm" it could not be realised or described. Every garden should possess something that was picturesque, beautiful, and sublime, and one supreme test of the "artist gardener" was his ability to create "an atmosphere." If ordinary mortals were to catch the charm, they must have the responsive mind. An English garden was pre-eminently English, in that it followed nature, whilst many foreign gardens were constructed on the principle of heeding nature to the will of the artist gardener. The interest of English gardeners was just the reverse, for they had a reverence for nature. As Ruskin said, "In a garden an Englishman expressed himself to the utmost." By means of a number of photographic slides Mr. Mawson showed what he considered the charm of English landscape gardens, particularly referring to a house and garden on Dartmoor, which he described in detail, pointing out how the architecture of the house and the garden were in complete harmony. Near the house architecture dominated, but further away nature dominated.

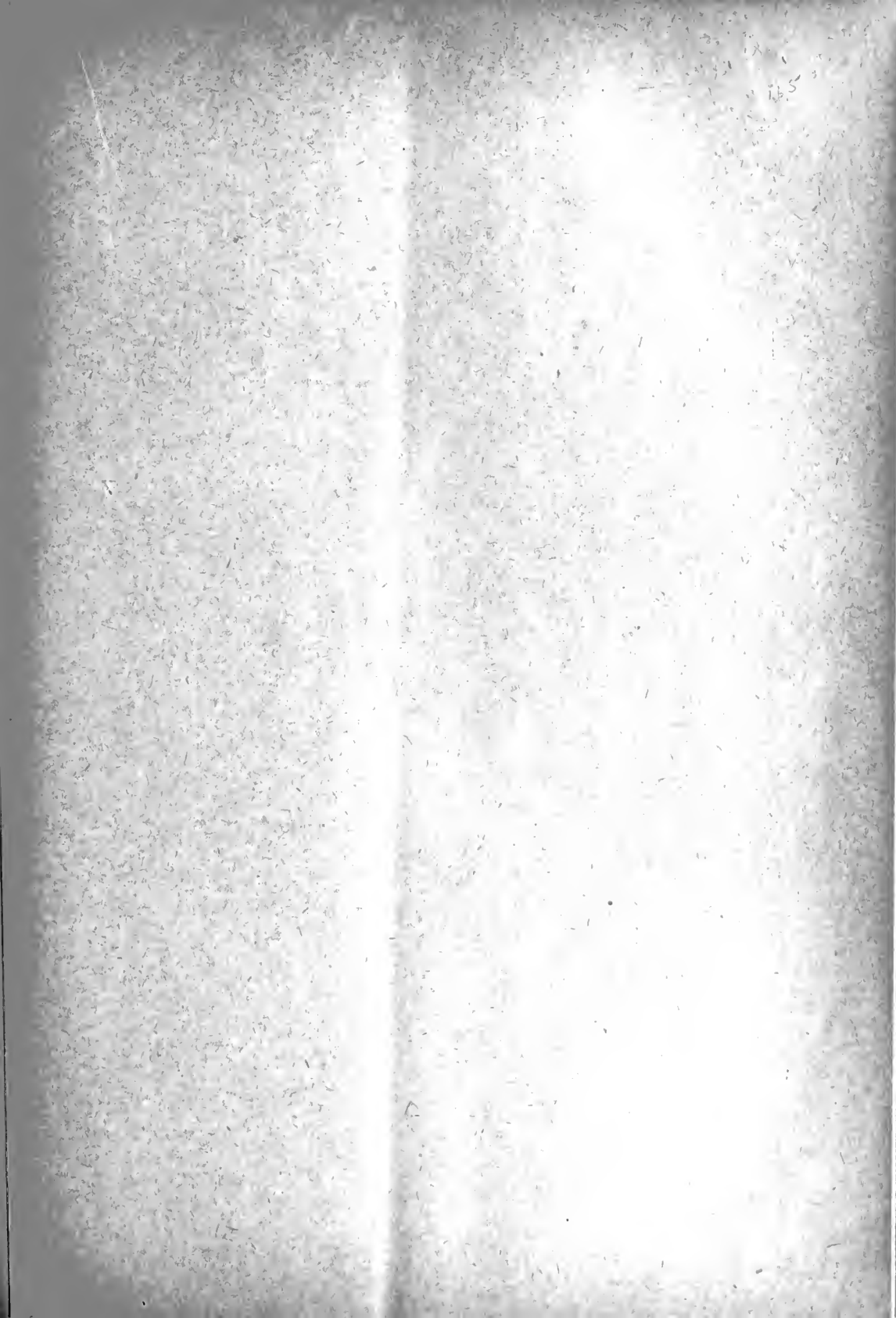

EDUCATIONAL SERIES. SHEET XXVIII

EXAMPLES OF  
TWO-STORY HEALTH-PROMOTING  
COTTAGES VERSUS FOUR-STORY  
TENEMENT HOUSES.

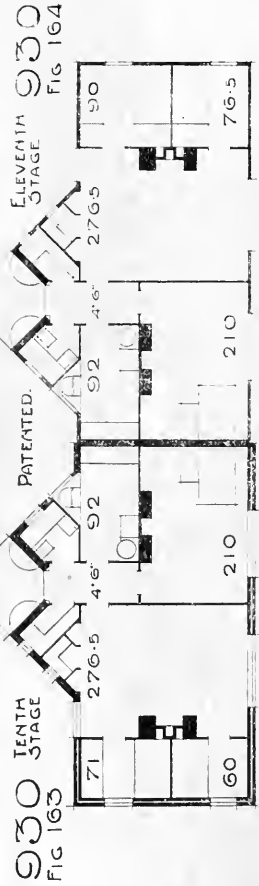

7482  
930 8-045  
12466  
930 13-406

PLAN OF ACTIVELY HEALTH-PROMOTING DWELLINGS

7856  
930 8-447  
12852  
930 13-819 FIG 162

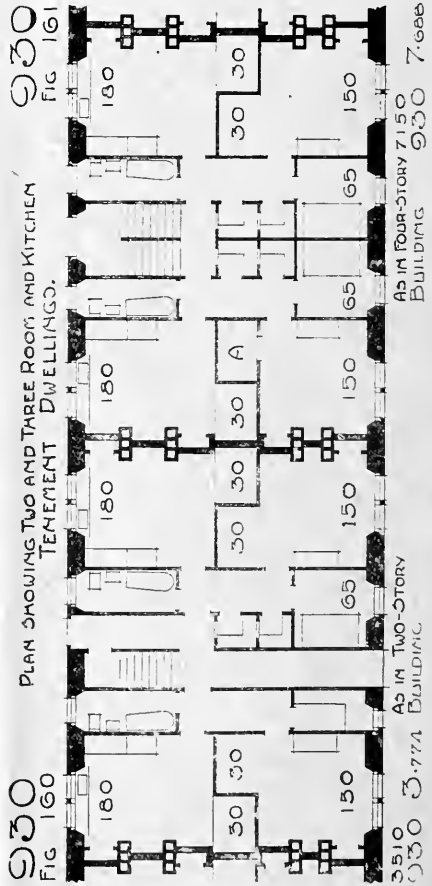

930 FIG 160

930 FIG 161

3510  
930 3-774 Building

As in four-story Building 930 7-666

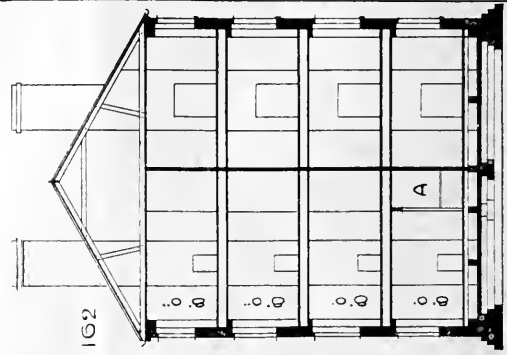

SECTION



THE BUILDING NEWS, AUGUST 29, 1917.



BANK OF LIVERPOOL, LIMITED, NEW PREMISES AT DURHAM.  
MESSRS. NEWCOMBE and NEWCOMBE, Architects.



THE BUILDING NEWS, AUGUST 29, 1917.

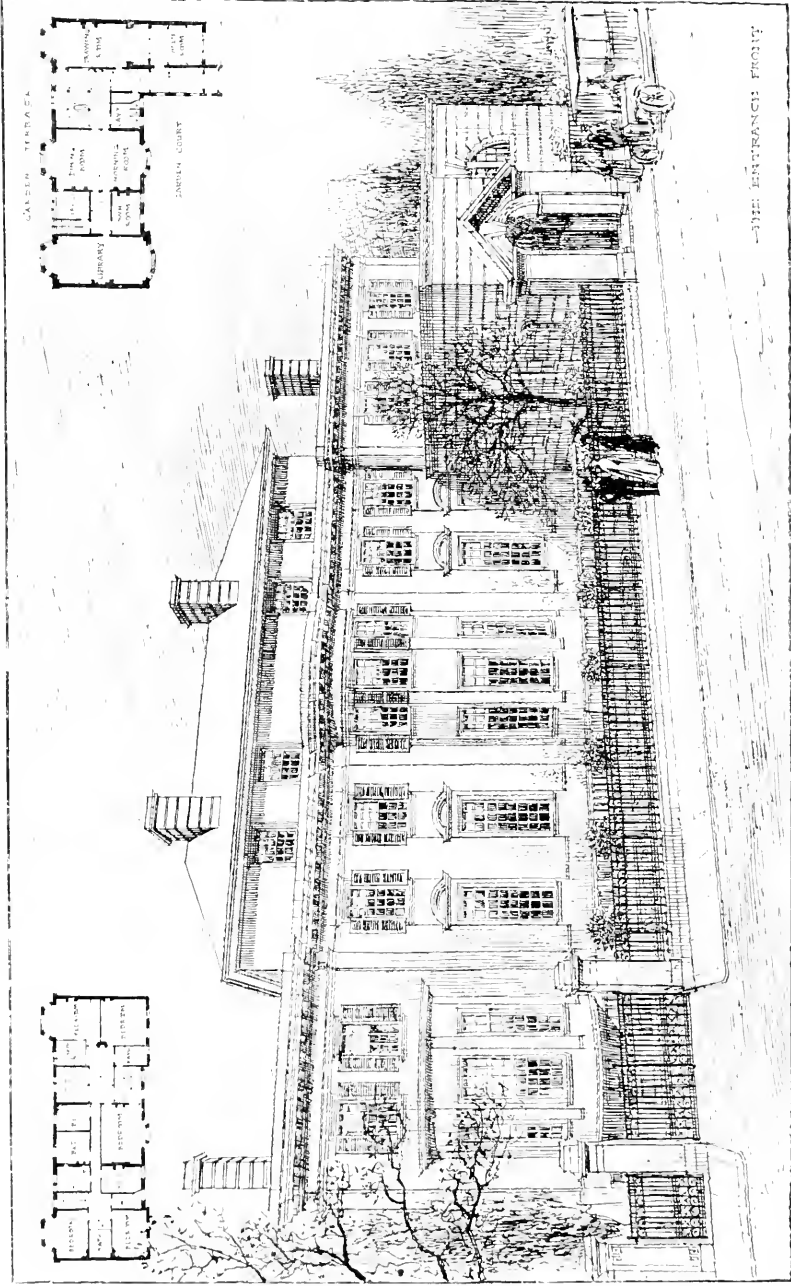

ENTRANCE VIEW AND PLANS OF 35, PORCHESTER TERRACE, W.: ADDITIONS AND ALTERATIONS.  
Sir Aston Webb, R.A., K.C.V.O., C.B., Architect.



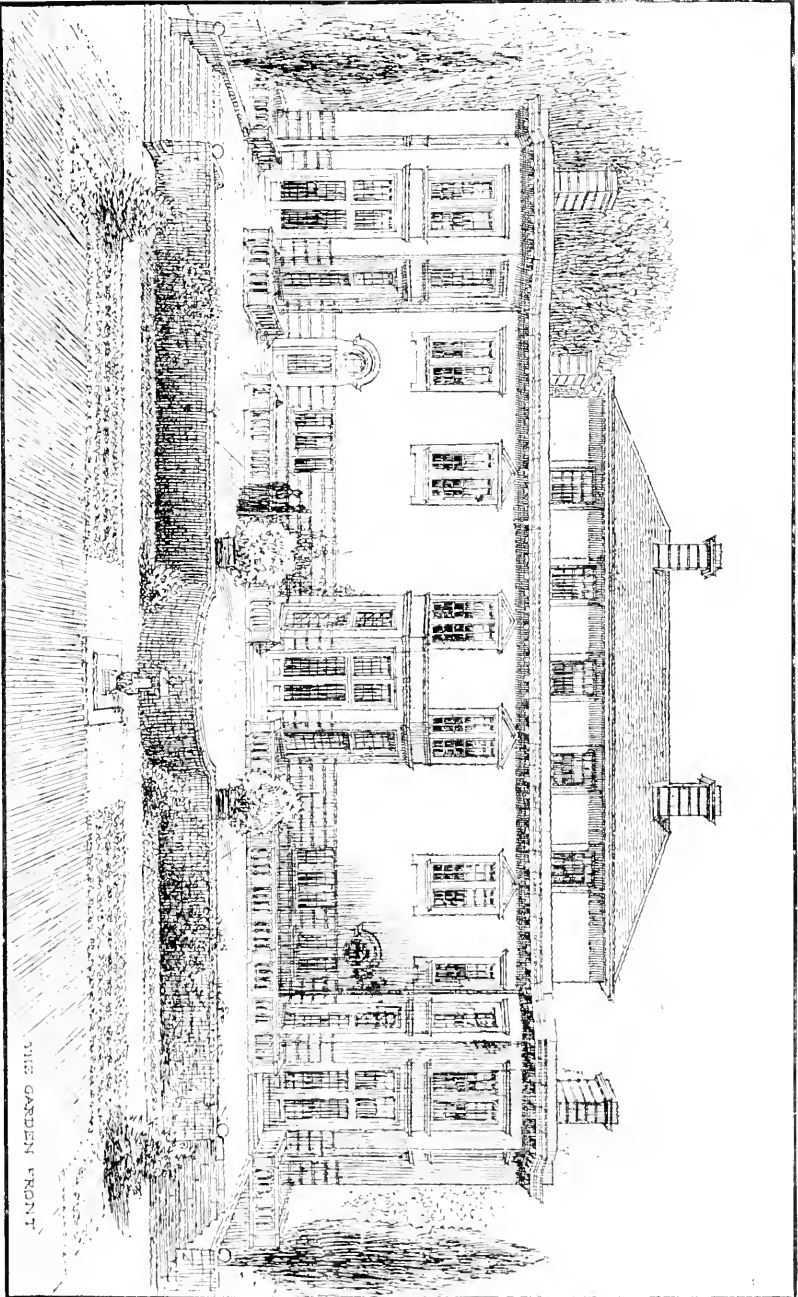

THIS GARDEN FRONT

THE GARDEN FRONT, 35, PORCHESTER TERRACE, W.: ADDITIONS AND ALTERATIONS.  
SIR ASTON WEBB, R.A., K.C.V.O., C.B., ARCHITECT.



THE BUILDING NEWS, AUGUST 29, 1917.

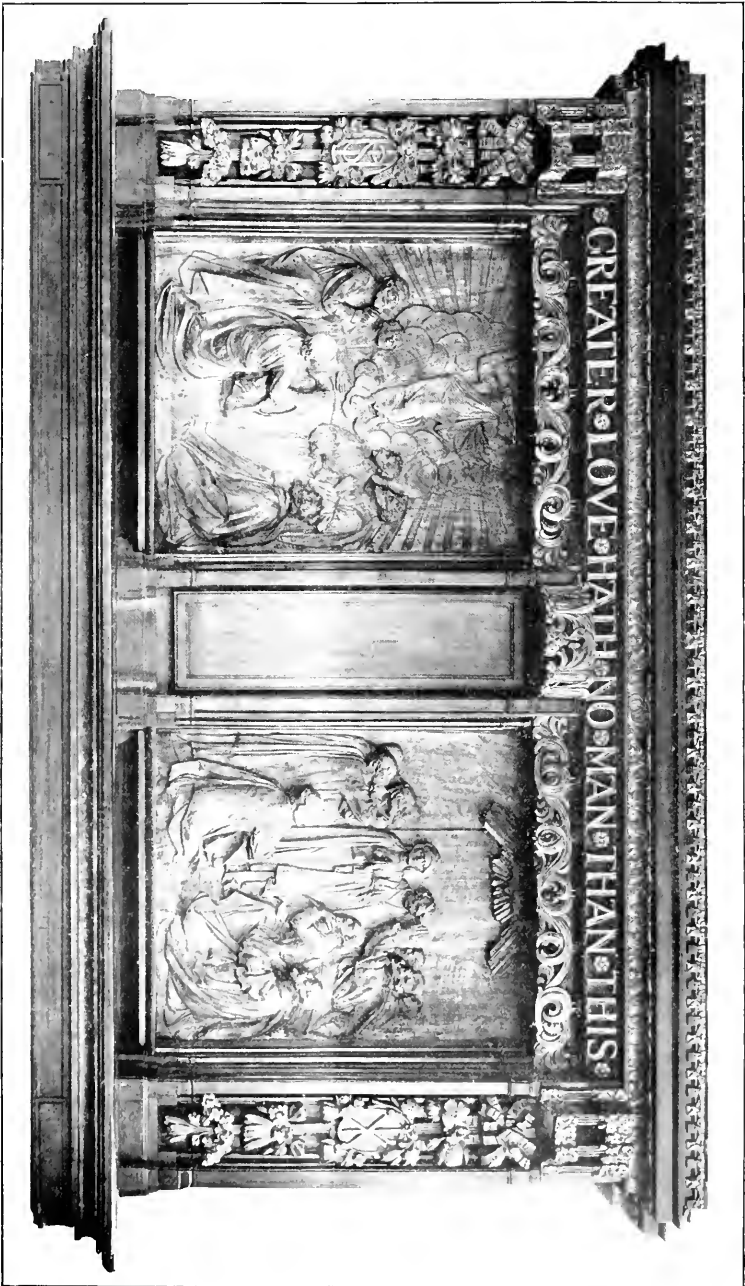

A WAR MEMORIAL, REREDOS, ST. PAUL'S CHURCH, SOUTHSEA, HANTS.  
MR. SIDNEY K. GREENSTADE, A.R.C.H.A., ARCHITECT. MR. A. BROADBENT, SCULPTOR.



EDUCATIONAL SERIES.

EXAMPLES  
SHOWING SOME POSSIBILITIES  
OF THE SMALLEST SIZES OF  
COTTAGES.



1446  
Fig 167



1728  
Fig 170

Plans Nos 167-170 show to scale the sizes of apartments which with ceilings 8 feet high and the number of their occupants there fitted in how the dwellings plan to them would require in order to provide an air supply equal in volume to that which the health-promoting dwellings built to Plans Nos 166-169 would easily give.

Ceilings  
8'0" high  
673  
Fig 165

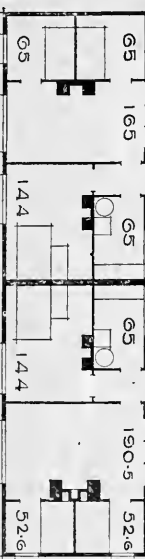

Ceilings  
10'5" high  
673  
Fig 166



Ceilings  
10'5" high  
747  
Fig 169



Ceilings  
8'0" high  
747  
Fig 168

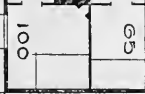

4032 5-9e1  
673 5-9e1  
Plan Fig 165 shows areas which with 8 feet ceilings give apartments in exact accordance with the Advisory Committee's "Irreducible" standard

6375 7-9e6  
673 7-9e6  
Plan Fig 166 shows areas which with 10 1/2 feet ceilings give apartments in exact accordance with the Advisory Committee's "Irreducible" standard

6109 8-4e8  
673 8-4e8  
Plan Fig 168 shows areas which with 8 feet ceilings give apartments in exact accordance with the Advisory Committee's "Disirable" standard

4600 6-157  
747 6-157  
Plan Fig 169 shows areas which with 10 1/2 feet ceilings give apartments in exact accordance with the Advisory Committee's "Disirable" standard



## Our Illustrations.

### 35, PORCHESTER TERRACE, W., ADDITIONS AND ALTERATIONS.

This pair of pen-and-ink drawings was exhibited at the Royal Academy this summer by Sir Aston Webb, R.A. The plans given with the entrance front perspective show the arrangements of the house as altered and enlarged. The central part, we understand, is mainly the only portion of the original building retained practically as it was, and forming the dining-room and morning-room leading one out of the other. To the left a new, capacious library has been built, with bay-windows at either end, with a pair of bedrooms and bathroom, also a w.c. *en suite* above. Next the service-room on the ground floor is a servants' staircase. The main staircase makes a notable feature in the scheme on the right of the centre next the admirable drawing-room, which opens through a screen into the garden-room brought forward alongside of the entrance corridor, the porch being in alignment with the street frontage. A tall attic furnishes additional sleeping accommodation on the second floor, and gives a distinctive character to the architectural character of the house, which necessarily is restricted by the style of the premises which the architect had to adapt. The architect being out of town just now, we have not received any detailed information as to the building operations thus carried into effect.

### A WAR MEMORIAL REREDOS, ST. PAUL'S CHURCH, SOUTHSEA, HANTS.

The Church of St. Paul, at Southsea, was erected somewhat early in the nineteenth century in the style of the Gothic revival then in vogue. The new reredos illustrated was very recently dedicated as a war memorial to the men of the parish who have joined the Services. It is of walnut, very slightly polished, and with many of the enriched mouldings and carvings gilded. The figure panels illustrate "The Ascension" and "The Descent of the Holy Spirit," and have been carved with about 5-in. relief. Both were modelled by Mr. A. Broadbent, and the whole of the work was executed in his studios. The central panel has been kept simple as the background of a silver cross specially designed by Mr. Bainbridge Reynolds. The extreme length of the reredos is 3 ft. 6 ins., and the height 5 ft. The name panels have yet to be executed. These also will be of walnut, and placed two on either side of the reredos; the names to be incised and gilded. The design and detail drawings were prepared by Mr. Sidney K. Greenslade, A.R.I.B.A., architect, of Gray's Inn and Exeter.

### BANK OF LIVERPOOL, LTD., NEW PREMISES AT DURHAM.

These new premises are to be erected by the Bank of Liverpool, Ltd., on a prominent site in the Market Place, Durham. The present property was purchased some two years ago and plans prepared for rebuilding, but owing to the war the execution of the building work has been postponed. The perspective view shows the ground floor front proposed to be constructed of granite (polished). The accommodation comprises, in the ground floor, banking hall, about 40 ft. by 20 ft., with manager's offices opening off; in the basement, two large strong rooms with book lift from the banking room; also on this floor coat-room accommodation is provided for both male and female assistants, boiler house, etc. The upper part of the premises is designed as a residence for the manager. The architects are Messrs. Newcombe and Newcombe, E. and A.R.I.B.A., 23, Eldon Square, Newcastle-upon-Tyne.

### THE PROBLEM OF THE SMALL DWELLING AND ITS SOLUTION.

Mr. Robert Thomson's two sheets of plans this week are figured XXVIII. and XXIX. These articles commenced on May 30, and since then, week by week, have regularly appeared, accompanied by explanatory diagrams and plans with marginal notes. The dates are May 30, June 6, 13, 20, and 27, July 4, 11, 18, and 25, August 1, 8, 15, and 22.

## HOW TO HANDLE SUB-CONTRACTS.

By A. BLAIR.\*

It would be ideal if all sub-contractors could be handled by the contractor, just as the Government handles their lettings, simply awarding the contract to the lowest bidder who properly qualifies.

In many such instances the Government loses by the transaction; not always in actual dollars and cents paid out for actual construction, but in many indirect ways that will occur to all of you; many months' delay in the completion of the building, resulting in expense for additional rent and for salary of Government superintendent, much more labour and trouble in the office of the department, unsatisfactory results that have to be accepted in the end.

Why is it that the contractor cannot strictly apply this same method in placing his sub-contracts? Because, if he expects to make his contract a profitable one, or, at any rate, expects to prevent loss on his contract, his work must go along systematically, his material must be delivered at the proper time, and the work must be accomplished at the proper stage. All the bond in the world will never enable the contractor to progress with his brickwork, for instance, if the brick have not been delivered; and if there is such a delay, the direct and indirect expense to the contractor is incalculable.

### PLACING CONTRACT WITH LOWEST BIDDER CAUSES LOSS.

It is human nature to place a sub-contract with the lowest bidder, and thereby save apparently a goodly sum of money, but how often have we each found that this course sometimes results in a loss of more than we expected to gain. It is such risks as these that justify the contractor in undertaking, so far as practicable, to develop mechanics in all the various branches of work, placing in the hands of his foreman the responsibility for the expeditious, economical, and satisfactory execution of the work.

Primarily the argument for a general contractor would be based upon his ability to get branches of his work executed properly, economically, and satisfactorily. Why should a contractor who places the responsibility on his foreman for employing bricklayers and getting brick laid, and carpenters to install the woodwork, find it necessary to make a sub-contract to have the painting done, and to what extent, and when, is a contractor justified in carrying this plan into further branches of his work?

What does he gain by sub-letting such work? The certainty of what it is going to cost, the freedom from detail, the assurance of getting skilled men—all these are good arguments, but what will such a course cost him? and in how many instances is he assured that in the final wind-up he will have secured any or all of these benefits.

Where a contractor goes into a territory that is foreign to him he feels that there is an advantage in placing this responsibility on others who will be more familiar with local conditions, but his lack of familiarity with local conditions carries with it also a lack of knowledge as to who to trust in placing such sub-contracts; and such a lack of knowledge may prove his undoing.

Under what circumstances can a general contractor ordinarily afford to place sub-contracts of this kind. One way would be by having developed sub-contractors who will go from place to place and who, by experience, he will have found able and willing to work as hard as he does and shoulder their responsibility and make good.

In the selection of a manufacturer of material the contractor may go far wrong in selecting the lowest quotation. What is he to do? He can hardly afford to say, "I will never buy from a new man," because the supply of experienced manufacturers would thereby some day be exhausted if that rule were followed generally. It is suggested that he should decline to accept quotations radically below others received, or radically below his judgment of the reasonable amount; he should protect himself in every reasonable way, and he should make a special

effort to co-operate with the material man, that the probability of errors may be reduced as much as possible.

What has the manufacturer a right to expect from the contractor? Full and complete data, prompt reply to all communications; explicit and plain information; careful handling of material at the building, prompt statement of damage to shipments, or the handling of material at the building, prompt and explicit statement of any charge that the contractor may make against him, these statements being supported by proper vouchers, freight bills, or otherwise, to show clearly why such charges are made. Full and prompt compliance with the terms of agreement as to payments. How often we hear the expression that the contractor does business on the money of the material man or sub-contractor.

What has the contractor a right to expect from the manufacturers and from the sub-contractor? Prompt handling of all correspondence; prompt and complete furnishing of the required shop drawings and samples; cheerful acquiescence in the reasonable demands of the superintendent appointed to interpret the specifications; a realisation that he, the material man, has undertaken to comply in behalf of the contractor with all the terms and conditions of the general contract, so far as they relate to his particular part of it.

The contractor has a right to expect from the manufacturer prompt delivery of materials at the time and in the order in which they are needed.

It is entirely possible to arrive at an ideal condition in respect to the transactions between contractor and manufacturer or sub-contractor. There is a legal maxim still quoted in the courts, "Caveat emptor" (let the buyer beware), but surely it must not be a case of "Caveat emptor" between contractor and manufacturer or sub-contractor, but of honest, intelligent co-operation.

## HOUSES THAT WILL NOT BURN.

Why should we build combustible dwellings and then pay insurance companies to reimburse us in case they should go up in smoke? If they do not burn, we have had no "run for our money," while if they do, we usually lose many things that money will never replace. Why not build an incombustible house to start with? A writer in *Expert American Industries* (New York) assures us that such a thing is now a reality, and he gives a description of it in minute detail, the salient parts of which we quote below. The interesting thing is that a house that will not burn costs only a little over 30 per cent. more than a quick burner, the respective prices, as given in the magazine named above, being 21 and 16 cents per cubic foot. The frame is of steel, and all walls, partitions, ceilings, floors, and roof are steel and cement. The roof is of concrete and over the concrete is placed a waterproofing which is so elastic and pliable that contraction and expansion have no effect upon it. The waterproof film is always perfect and protects the concrete. The partitions are two inches thick and are of solid concrete reinforced with a special material. In addition to being fire-retardant, like the entire structure, and proof against fire, flood, wind, and earthquake, the partitions are wonderful space-savers. Conduits, water-pipes, etc., are taken care of as easily as with hollow partitions. We read on with interest in the construction of any fireproof building, is proof against the action of flames. There is no chance for the stairway to be transformed into a vertical flue to carry fire upward, as there is nothing in it to burn.

The interior trim is of wood fastened with screws. Metal trim can be used if desired. Details of this character can be adapted to the taste of the builder without much affecting the fireproof qualities of the structure.

"The cost of the fireproof house as built is approximately 21 cents per cubic foot.

"If built with 12-inch solid brick walls with same interior it would cost 23 cents per cubic foot.

\* Before the Canadian Association of Government Contractors.

If built with stucco on hollow tile with wood interior it would cost 17 cents per cubic foot.

"If built of stucco on metal lath with wood interior it would cost 16 cents per cubic foot."

The man who wishes to build an incombustible house, however, is by no means limited to one kind. Another is illustrated and described in *The Scientific American* (New York), and doubtless there are, or soon will be, as many varieties as there now are of houses that will blaze. Says the last-named paper:—

"Boards of concrete, with joists, rafters, and stair-frames of the same material, are used in the construction of a novel building in Los Angeles, Cal., the whole being set upon a concrete foundation. Though put together after the manner of a frame-structure, the building is as fireproof and durable as the more common types of cement houses, but it requires less material and is lighter in weight.

"The various parts are poured into forms on the ground near the site, and in that way the danger of breakage is eliminated. The photographs indicate how the different parts are made: the clapboards are poured in sets of ten, the forms being securely clamped together, and the cement allowed to harden in them for several days. Then they are taken out and allowed to cure before being set up. This should be done while the preliminary work is going on, such as excavating and laying the foundation.

"The joists, rafters, and other parts are formed in the same manner, and various types of reinforcing are used for each. The boards are reinforced with mesh like chicken-wire, while the timbers have iron rods of varying thickness to strengthen them. These are allowed to project at one end in order to fit into corresponding holes in other timbers, so that the whole framework dovetails. The method of attaching the boards to the 2 by 4's is with nails, and nail-holes are bored into the cement boards before they have set, by running a wire through them. As the cement timbers will not take the nails a strip of wood about an inch and a-half thick is wired to the cement scantling."

## Building Intelligence.

RIPON.—A new Y.M.C.A. officers' hut has been erected on the confines of the North Camp, Ripon, which is of a much more attractive and substantial type than usual. At the roadside end of the long wooden building there is a spacious covered balcony. The main entrance is at the side; to the left is a well-lighted billiard-room with ample space for six tables. There is a raftered ceiling and an open fireplace that give a pleasant old-style effect, which is enhanced by the scheme of decoration, a drab greenery patternless wallpaper, panelled in unpolished teakwood. To the right is a lounge and concert hall. In the lounge there is an open buffet. The hut is quite self-contained, with its five bedrooms for the permanent staff, and the clergyman or minister who will spend a term here; with well-adapted kitchen and store-rooms. Indeed, the architect, Mr. Richard Jacques, A.R.I.B.A., of 57, Railway Street, Nelson, has contrived a very excellent rendezvous for officers, which has for its keynote cosiness and comfort.

The Duke of Bedford unveiled last Friday a stained glass window which has been created by St. Mary's Church, Lower Graydonhurst, Bedfordshire, in memory of Second-Lieutenant Evelyn East Arnold Colleson, Bedfordshire Regiment, by fellow-officers and friends.

Attention to existing types of concrete floor pans has been the lack of a suitable means of fastening wire fencing to the posts. A suggestion to overcome this is described in the *Canadian Engineer* (Toronto). A strip of tar sheathing 2 in. wide and  $\frac{1}{2}$  in. thick is inserted at one face of the post. It is claimed that the tar paper is very suitable for this purpose as it does not expand and crack the concrete in the first stage of setting, and remains solid in its bed without contraction.

## Correspondence.

### BUILDERS AND WORKMEN'S DWELLINGS.

To the Editor of the BUILDING NEWS.

SIR,—I notice in several papers paragraphs relating to the Local Government Board urging the building of workmen's dwellings and that the same must be done by the Corporations and District Councils, also that financial assistance is to be granted them from the Government for such building operations.

I often see paragraphs in a similar strain, and cannot understand why builders like myself, who have spent all our lives in building this very class of property are apparently to be almost ignored in the matter.

I have built during the past twenty years 1,740 workmen's houses, with all the best and latest improvements, and on the best plans I could obtain. I know of a dozen other builders in this city who would say something very similar.

Directly after the war is over we are ready and willing to start again, and we can soon produce the houses. Why, then, need the corporations be brought into it? They cannot possibly produce a house at the price we can produce it, and I doubt whether any officials they may appoint will know as well as we do what are the requirements of a working-man's house—or rather, what his wife requires in it, for that is the real question.

If Government assistance financially is to be given why cannot it be given to builders like myself, who have hitherto provided all the houses really necessary; in fact, fifteen years ago we were told over and over again that we built too many, and perhaps it was true at the time. HENRY VOKES.

100-104, Anlaby Road, Hull.

### NEW MATERIALS AND METHODS AS INFLUENCING DESIGN.

SIR,—I have just received the July number of the *Journal of the Royal Institute of British Architects*, in which is published a discussion under the above heading. Many most ingenious modern methods of building are mentioned, probably the greatest innovation being the use of a waterproof cement when it is used either in rendering or in concrete.

When the British Government erects hundreds of houses with 2½ in. porous coke breeze slabs, and depends upon a ½ in. waterproof rendering to exclude inclement weather, such an entirely new method of building should be given close consideration. The walls of these cottages were formed of piers which supported the roof, and the 2½ in. curtain walls were placed between the piers. An architect who recently superintended the dismantling of a factory built with these slabs told me the tenacity of the slab joint was remarkable, and he was convinced that this "slab and pier" construction, combined with a flat cement roof, would be the standard cottage, owing to the scarcity of freightage for bringing foreign timber to this country after the war.

Mr. Thos. Potter, the author of a standard work, "Concrete," wrote me recently that he had built many concrete cottages with flat roofs, and he finds that outside walls 9 in. thick and inside partitions 3 in. thick will safely carry a roof or floor 4½ in. thick up to 15 ft. x 12 ft. They can be strengthened by forming brackets under the concrete where it joins the wall at a slight angle to the roof.

Although Mr. Potter has never heard of condensation under such roofs, I am sure it will be necessary, especially in wet climates like Ireland and Wales, to form them with a bottom layer of porous aggregate, say 1 in. or so of coke breeze concrete, or the whole concrete could be of a porous aggregate, and then finished with 1½ in. of fine concrete, waterproofed.

Another new method of construction in England is the uncast concrete dome. The former British method of building a dome was to construct it of stone, or if of wood to cover it with copper, zinc, or lead. The

city architect of Manchester was probably the first well-known architect to employ Portland cement for a concrete dome. I refer to the dome on the Free Library at Chorlton-cum-Hardy. In close proximity is a similar dome on Chadderton Town Hall, designed by Messrs. Taylor and Simister.

It will appeal to your readers that, as these buildings have been erected a sufficient number of years to prove their stability and weather-resisting qualities, there are great possibilities in the use of concrete domes and similar hitherto expensive structures.

The use of a plastic material like concrete appeals to many minds, and I shall be happy to suggest more novel uses of waterproofed cement to any reader who may be interested. —Yours faithfully,

J. H. KERNEE-GREENWOOD.

King's Lynn.

### COMPETITIONS.

MONTE VIDEO.—The *Diario Oficial* (Montevideo) notifies that a competition of plans for the construction of school buildings at Union (Department of Montevideo) will take place in October. Projects will be received at the Secretaria del Ministerio de Instruccion Publica, Montevideo, up to October 15. Prizes of 1,000 pesos, 500 pesos, and 250 pesos (peso—approximately 4s. 6d. at present exchange) are offered for the best projects submitted. The maximum cost of the construction of the buildings is put at 150,000 pesos. Particulars (in Spanish) as to the buildings and the plans required may be consulted by British firms interested at the Department of Commercial Intelligence, 75, Basinghall Street, London, E.C.2.

THE WAR MEMORIAL PLAQUE.—The Government, as we have already announced, is offering prizes, amounting in all to not less than £500, in proportions to be subsequently decided, for a limited number of the most successful models for the small national war memorial plaque in bronze, to be given to the next-of-kin of those members of His Majesty's Naval and Military forces who have fallen in the war. The plaque is to have an area of as near as possible 18 square inches. It may be a circle of 4½ inches in diameter, a square of 4½ inches, or a rectangle of 5 by 3½ inches. The plaque is to be produced by casting from a model, which should be finished with precision. All designs submitted must be actual models in relief in wax or plaster of the size already indicated. No models on a larger scale will be considered, and no competitor may submit more than two models. The design should comprehend a subject and a brief inscription. It is suggested that some symbolic figure subject should be chosen, but the following inscription has been decided upon: "He Died for Freedom and Honour," and must form part of the design. Competitors are reminded that the design should be essentially simple and easily intelligible. If none of the models submitted is, in the opinion of the judges, of sufficient merit, no prize will be awarded. All competitors must be British-born subjects. No framed models can be accepted, but each model should be packed in a small box and delivered to the Director, National Gallery, Trafalgar Square, W.C.2, not later than November 1 next. The fullest information as to the competition may be obtained on application, in writing, to the Secretary, War Office, or the Secretary, Admiralty, London. The names of competitors will not be revealed to the judges, and the name of the premiated artist or artists alone will be published.

Mr. Oliver S. Piper, J.P., proposes to carry out the restoration of Glenbrook House, Glenbrook, Co. Cork (which was destroyed by fire), in accordance with plans and specification which have been prepared by Mr. James F. McMillar, M.R.I.A.I., architect, Cork.

There was unveiled and dedicated on the 21st inst. in Warneford Chapel, Highworth Church, Wilts., a memorial tablet, subscribed to by sixty-eight members of the Warneford family throughout the world, to the late Flight Lieutenant Reginald Alexander John Warneford, V.C., R.N., Chevalier of the Legion of Honour.



## OBITUARY.

The death of Mr. Arthur Thomas Draper, the surveyor of Leicester, which took place on Sunday week at a nursing home, has occasioned deep regret in professional and other circles in Leicester and the county. The deceased, who was 67 years of age, was a native of Banbury. For many years he had been in partnership with Sir Tudor Walters, M.P., at Leicester, as a surveyor, and for a great part of the period he was diocesan surveyor to the diocese of Peterborough, and hon. surveyor to the Leicestershire Agricultural Society. In earlier days he was an enthusiastic member of the Volunteers, and rose to the rank of major in the county battalion. Mr. Draper, unlike his partner, was a staunch Conservative, and did much work at one time for his party organisation.

The death is announced of Mr. William Houghton, of 58, Old Broad Street, E.C., which took place at his residence, Pine Lodge, Woodford Green, Essex, last Wednesday. He had only returned from a holiday last week, and was apparently in the best of health. Mr. William Houghton, who was 68 years of age, was one of the best-known auctioneers, surveyors and valuers in the city of London, where he commenced business in 1877. He served his articles first with Messrs. Harding and Eve, of St. Albans, and subsequently with Messrs. Debenham, Tewson and Farmer. His original office was in a Bishopsgate Street, but after three years he removed to 58, Old Broad Street, where the firm has been carried on ever since. He was for many years a member of the Surveyors' Institution, and became a Fellow in 1891. Mr. Houghton had not long been installed Master of the Leathersellers' Company, and had looked forward to a pleasant year of office. In conjunction with his old friend, Mr. Edward North Buxton, he was Verderer of Epping Forest, in which he had taken a great interest for many years. He leaves a widow and two sons—Captain Jack Houghton, now in France, and Mr. W. C. Houghton, who is also in the Army. In 1915 his son, Mr. E. Guy Houghton, was killed in action. The interment took place last Saturday at Walthamstow Cemetery, preceded by a service at All Saints' Church, Woodford Green.

Dr. W. H. Symons, Medical Officer of Health for Bath, who went to Dunster on August 8 for his annual vacation, became so unwell there that he returned to his residence at Combe Park on the 15th, and on Saturday last he expired there, at the age of sixty-two. Dr. Symons was born at Dunster, and held several appointments before being chosen for the post at Bath twenty years ago. He was a very able man, and devoted his knowledge to improving the sanitary condition of the city. Many improvements and changes had to be effected under his régime. At various scientific meetings he frequently read papers, and he was a contributor to several journals. In meteorological observations and the preparation of health statistics he took exceptional interest. Deceased leaves four daughters. Mrs. Symons died six years ago.

Mr. Alexander Bremner, whose death at Tarbert on August 25 is announced, was an engineer who for thirty years did excellent work in the development and extension of the railways of the Indian Empire. He was first employed in the eighties in Kathiawar; later he worked on the Delhi-Mumbai-Kalka line, and during the latter part of his career he was a district engineer of the Great Indian Peninsula Railway, residing first at Jhansi and then at Jabalpur. Owing to failing health, he retired in 1916. Mr. Bremner belonged to a family of engineers. His cousin, Mr. J. R. Bell, the original of Kipling's "Bridge Builder," performed in 1879-80 the feat, then unsurpassed in railway engineering, of laying the strategic line of the Ruk-Sibi Railway from a point south of Sukkur up to the Bolan Pass, 113½ miles in 101 days, through a waterless desert, the route unsurveyed and no material existing on the spot.

Mr. M. C. Duchesne, F.S.I., of Farnham Common, Slough, has been appointed honorary secretary of the Royal English Arboriculture Society.

## Our Office Table.

Norway, Sweden and Denmark have already embarked on the construction of ferro-concrete vessels, and very extensive tests of this point have been conducted by the German Concrete Union, in the United States and elsewhere. One drawback that appears to be currently accepted is the unfavourable influence of lime in the cement, which is attacked by various ingredients in salt water such as magnesium sulphate. There are, however, varieties of concrete such as puzzolana, which contain no free lime, also, if very dense concrete is used, it is not materially penetrated, and any decomposition is only a surface process. The chief precautions against prejudicial action of salt water appear to be: (1) The use of rich concrete, (2) the use of cement with little free lime, gypsum and alumina, (3) the addition of puzzolana, containing silicic acid to fix the free lime, (4) the use of coarse sand, (5) the use of dense concrete, (6) special surface treatment.

The Council of the North Wales Branch of the Welsh Housing and Development Association last week appointed Messrs. G. A. Humphreys, F.R.I.B.A., and T. Taliesin Rees, F.R.I.B.A., Liverpool and Birkenhead, to join Mr. Ruben and the secretary in the compilation of an exhaustive report on the slate quarry industry and the causes of depreciation, etc., in view of the fact that an important amount of building is likely to take place immediately after the war. The commission will endeavour to ascertain the causes of the prevailing depression and suggest methods of dealing with that and other troubles. This inquiry has been at Llanberis and Festiniog. The council also appointed a committee to inquire into rural housing conditions in North Wales, to ascertain the number of houses in each parish which have fallen into bad repair in recent years, and to make recommendations to the council.

A Proclamation has been issued prohibiting the importation into the United Kingdom, except under licence from the Board of Trade, of all machinery driven by power and suitable for use in cutting, working, or operating on wood, including sawing machines of all descriptions, general joiners, mortise, tenon and boring machines, lathes and rounding machines, box and cask making machines and all machines accessory thereto, scraping and sandpapering machines, wheelwright machinery, firewood-making and bundling machinery, wood wool fibre and pulp machinery, saw-sharpening and setting machines, saw strappers and brazing apparatus, all machines for grinding, planing or moulding irons, and electrical motors up to one-half horse power.

The quantity of "natural" asphalt, including bituminous rock, grahamite, gilsonite, wurtzite, and the natural paraffin, ozokerite produced and sold at mines and quarries in the United States during the year 1916, was 98,477 short tons, a gain of 22,726 tons, or 30 per cent. in quantity compared with 1915. The quantity of asphalt produced in 1916 by refining from crude asphaltic oils of domestic origin increased only 3½ per cent., as compared with that produced in 1915, and the quantity of similar material refined in the United States from Mexican petroleum increased 47 per cent., as a consequence of which the net gain over production in 1915 was nearly 20 per cent. California led all other states in the production of refined oil asphalt, its output from sixteen refineries in 1916 amounting to 257,930 short tons.

In pursuance of the powers conferred upon them by the Defence of the Realm Regulations, the Board of Trade are taking possession, as from last Friday, of all stocks exceeding in the aggregate 5,000 super feet of malmagony in logs, fitches, planks, and boards, and all stocks exceeding in the aggregate 5,000 super feet of American walnut in logs, planks, and boards in the United Kingdom on August 24. Return forms and instructions as to how to fill them in have been sent to all the firms known to handle these

timbers. Any firms holding stocks (amounting to more than 5,000 super feet) of either wood which have not received the necessary forms should apply to the Controller of Timber Supplies, Room 216, Caxton House, Westminster, S.W.1.

With regard to the proposal to build in the district of Ham Common Urban District Council, the council has passed a resolution to the effect that the proposed building would not only be a contravention of the council's town-planning scheme, but that it would be an irreparable blot on the amenities of a charming reach of the Thames, to preserve which large sums of money had been spent by public bodies. The council are seeking the assistance of the Surrey County Council and of neighbouring authorities to obtain an assurance that the proposed building shall only be of a temporary character, "so that the world-famed view from Richmond Hill shall not be permanently disfigured."

The use of emulsified asphalt for maintaining concrete roads is recommended by H. B. Bushnell, division engineer, Illinois State Highway Department. This method has the advantage that no heating kettle is required, and that the work can be done even when the surface of the pavement is wet, there being no necessity for having the sides of the crack dry in order to make the asphalt adhere to it. About one gallon of emulsified asphalt, thinned with a pint of water, is mixed with a cubic foot of stone chips graded for large cracks, from three-fourths of an inch down to dust, and for the smaller cracks from a half or three-eighths of an inch down. Small pebbles and sand have also been used with good results. Experience has shown that the aggregate should be so graded as to reduce the voids to a minimum. The asphalt is poured upon the aggregate and the whole thoroughly turned by hand. The mixture is then poured into the crack and well tamped to insure against settlement.

Among the numerous additions to the Scottish National Gallery recorded in its annual report is the most notable acquisition by purchase is Sir Henry Raeburn's splendid portrait of "Colonel Alastair Macdonald of Glengarry," which was for a long time on loan to the Gallery on the Mound, Edinburgh, by its former owner. Among works acquired during the year by gift or bequest are "Mrs. Leiper," by William McTaggart, R.S.A., and "Une Patricienne," by Thomas Couture, the French artist. Mr. David Erskine has lent thirty-one original cartoons by Louis Raemaekers.

A letter from the *Morning Post's* Rome correspondent draws attention to a scandal that will excite not a little painful surprise. It seems that the beautiful non-Roman Catholic cemetery in Rome—the cemetery by the pyramid of Cestius, where so many of our British dead are laid—is in German control. The ground is part of the concession made more than a century ago by the Holy See to Prussia, and the property has passed by inheritance to the German Empire. Although the majority of the graves in the cemetery are British, no British authority has any status in the control of it, and only last year the Anglican community had to pay money to the Swiss Legation, as representing the German Government, for the maintenance of the British graves. Italian public opinion has been demanding the expropriation of the ground and building, which formerly constituted the German Embassy in Rome. How much stronger is the claim that German proprietorship over a site that is made sacred by "England's overflowing dead" should be put an end to? In this burial-ground are the monuments of some of our noblest spirits, among them Keats and Shelley. Are they to be left to the Huns to defile and desecrate after their hideous fashion?

The south-east pier in the transept of St. Paul's Cathedral is being surrounded with boarding, and Canon Alexander last Monday stated that the work of preservation would begin as soon as three statues at its base had been removed. The work already done had greatly added to the stability of the Cathedral. The south-west pier, which had

been under repair for nearly four years, would, it was hoped, be relieved of its scaffolding in the next few weeks. Documents recently brought to light showed that the Cathedral authorities had been faced by similar problems in a less critical form, at the end of the eighteenth century, and that the building had then been closed to the public for about a year and a half.

### PROFESSIONAL AND TRADE SOCIETIES.

**ROYAL TECHNICAL COLLEGE, GLASGOW.**—Owing to war conditions, the annual issue of the Calendar of the Royal Technical College, Glasgow, has been suspended, and there are only issued concise prospectuses of the day and evening classes. The various subjects of study and classes are on the same lines as last year; but in view of the war the governors reserve to themselves power to modify in any way the arrangements announced for the ensuing season. For the general regulations and information as to degrees and diplomas students may consult last year's Calendar at the College.

**UNIVERSITY OF LONDON SCHOOL OF ARCHITECTURE.**—The particulars of the Session of 1917-18 are just issued, and include those with regard to architecture, town planning, municipal, civil, and mechanical engineering, painting and sculpture, archaeology, and hygiene and sanitation. The session is divided into three terms, commencing respectively in October, January, and April. An introductory address will be given by the Provost, Sir Gregory Foster, B.A., Ph.D., at 1.30 p.m. on October 8, which all Freshmen are required to attend. Admissions must be applied for not later than September 20. The courses of study include the B.A. degree course (honours in Architecture) of the University; the Certificate course in Architecture; the Seniors Design course; the Certificate course in Town Planning; Diploma course in Town Planning and Civic Architecture; and the Diploma course in Town Planning and Civic Engineering. There is a good list of scholarships and prizes. The Professors in Architecture are Mr. F. M. Simpson, F.R.I.B.A., and Mr. R. Elsley Smith, F.R.I.B.A.; and the Professor in Town Planning Mr. J. D. Ashhead, M.A., F.R.I.B.A.

### TRADE NOTES.

Messrs. George Baines and Son, architects, 5, Clements Inn, Strand, London, W.C., have removed temporarily to 121, Victoria Street, Westminster, S.W., during the Government occupation of Clements Inn for the duration of war.

Second-Lieutenant Volney Mather, assistant surveyor to the Tyldesley Urban District Council, has been killed in action. He was twenty-eight years of age, and had been in the service of the council since 1905. Lieutenant Mather was attached to the Local North Lancashire Regiment, and he was killed by machine gunfire whilst leading his platoon.

## OGILVIE & CO.

Telephone DALSTON 1364.

Many years connected with the late firm of W. H. LASCELLES & CO., of Bunhill Row.

**Mildmay Avenue, ISLINGTON, N.**  
EXPERTS IN HIGH-CLASS JOINERY.  
ALTERATIONS & DECORATIONS. ESTIMATES FREE.

FOR  
**Olivers' Seasoned**

**Hardwoods,**

APPLY TO—  
**WM. OLIVER & SONS, Ltd.**  
120, Bunhill Row, London, E.C.

### TENDERS.

\*.\* Correspondents would in all cases oblige by giving the addresses of the parties tendering—at any rate, of the accepted tender: it adds to the value of the information.

**ANNIVERSARY.**—For painting six houses at Cwmearn, for the Abercarn District Council. Mr. J. Williams, Surveyor:—  
J. E. Francis and Co., Constance Street, Newport ..... £207 4 0  
Bathfield and Stocker, Cwmearn  
F. Lawrence, Corporation Road, Newport ..... 250 0 0 .. Accepted.

**BRIDWATER.**—For piling of Anderson Road, Weston-super-Mare, for the Bridwater Rural District Council:—  
H. W. Pollard and Son (accepted) £121 12 6

**DAVENTRY.**—For work in connection with the Farthingstone Road, Weedon, water supply, for the Daventry Rural District Council:—  
Boddy (accepted) ..... £22 0 0

**DOWNPATRICK.**—For painting, supplying, erecting and keeping in repair the public lamps of the town for the lighting season 1917-18, for the Commissioners:—  
W. Noll, Irish Street, Downpatrick (accepted) ..... £39 0 0

**KINGHORN.**—For excavations of water channel, etc., for the Town Council:—  
Menzies Bros., Kirkealdy (accepted) ..... £113 0 0

**STANWAY (ESSEX).**—For repairing the Union Chapel, for the Guardians of Lewden and Winstead Union:—  
Beaumont (recommended for acceptance) ..... £35 0 0

**STRETFORD.**—For alterations to two engines at generating station, for the Urban District Council:—  
Bellis and Morcom, Birmingham £200 0 0 .. (Accepted).

**SWINDON.**—For painting wards at the hospital, for the Swindon Hospital Board:—  
H. C. Cook (accepted) ..... £104 10 0

**WINCHESTER.**—Alterations and repairs to the Child Welfare Centre, for the City Council:—  
Wise and Lansell (accepted) .. £135 0 0

Mr. Leishman, consulting architect, United Provinces, has been reappointed for a further period of five years.

In Carlisle Cathedral last Wednesday the Bishop unveiled a brass mural tablet erected in memory of the late Lord Cross, in recognition of his great work as a statesman and as a permanent record of his labours on behalf of the Carlisle diocese, where, as a result of his efforts, there are now only forty-six benefices with a stipend of less than £200 a year.

### TO CORRESPONDENTS.

We do not hold ourselves responsible for the opinions of our correspondents. All communications should be drawn up as briefly as possible, as there are many claims upon the space allotted to correspondents.

It is particularly requested that all drawings and all communications respecting illustrations or literary matter, books for review, etc., should be addressed to the Editor of the BUILDING NEWS, Elmcham House, 1, Arundel Street, Strand, W.C.2, and not to members of the staff by name. Delay is not infrequently caused. All drawings and other communications are sent at contributors' risks, and the Editor will not undertake to pay for, or be liable for, unsought contributions.

When favouring us with drawings or photographs, architects are asked kindly to state how long the building has been erected. It does neither them nor us much good to illustrate buildings which have been some time executed, except under special circumstances.

\*.\* Drawings of selected competition designs, important public and private buildings, details of old and new work, and good sketches are always welcome, and for such no charge is made for insertion. Of more commonplace subject, small churches, chapels, houses, etc.—we have usually far more sent than we can insert, but are glad to do so when space permits, on mutually advantageous terms, which may be ascertained on application.

Telephone: Gerrard 1201.

Telegrams: "Timeserver, Estrand, London."

### BACK ISSUES.

Most of the back issues are to be had singly. All back issues over one month old will be charged 6d. each, postage included. Subscribers requiring back numbers should order at once, as they soon run out of print.

RECEIVED.—H. H. and Co., Ltd.—L. B. and Sons, Ltd.—J. T., Ltd.—J. W., Ltd.—M. and Co., Ltd.—Capt. H.—W. D. K.—Practical—D. and S.—P. H.

CRAFTSMAN.—No.

M. S. A.—Please send.

ERIC.—Out of the question just now.

H. L.—A line drawing, please. It is always more appreciated by readers.

A Venice telegram reports the reopening of the church of the Barefoot Friars (degl Scalzi). A portion of the magnificent Tiepolo ceiling destroyed in October, 1915, by Austrian bombs has been reconstructed and enclosed in a frame now preserved in the church.

Mr. William Thomas Sims, of The Mount, Blaision, Loughore, Gloucester, who died on June 23, leaving estate valued at £7,591 gross, with net personalty of £3,950, has bequeathed £1,000 for the erection of a public illuminated pedestal clock at Stroud, and £2,000 to form a "W. T. Sims Fund" for providing Christmas dinners for the poor of Uplands and Stroud.

A painter sends to the *D. Decorator* the following formula for making a good cleaner for painted woodwork. Dissolve 4 lbs. sal soda in 5 gallons of boiling water, also 1 lb. carbonate of potash and  $\frac{1}{2}$  oz. bichromate of potash. Then add 3 gallons more of water, when the mass will be like jelly. This may be applied with a brush, cleaning up with a sponge. If the first treatment fails to make clean, try again. The stuff will cost about 5 cents per gallon, and it will keep good for months.

### WANTED FOR MUNITIONS.

# OLD LEAD

## FRY'S METAL FOUNDRY,

25-30, Holland Street,  
Blackfriars,  
LONDON, S.E. 1.

Telephone: Hop 4720 2 lines.  
Telegrams: "Frymetals, Friars, London."

Hargreaves Street,  
Red Bank,  
MANCHESTER.

Telephone: City 2026  
Telegrams: "Frymetals, Manchester."

The Ministry of Munitions  
has recently taken over the

## Control of Lead

fixing the maximum price which  
may be paid for Old Lead

viz.: **26/-** per cwt.

We are able to offer you this  
maximum price at your Works,  
Carriage to be paid by us. Sacks  
and special Munition labels will be  
forwarded to you if desired.

Terms:—**Prompt Net Cash.**

# THE BUILDING NEWS

## AND ENGINEERING JOURNAL.

**Efingham House.**

Currente Calamo .. .. .	161
The Problem of the Small Dwelling and its Solution.—XVI. .. .. .	182
The Workmen's National Housing Council Conference at Blackpool .. .. .	183
Zinc Balls Flushed Through Clogged Sewer Pipes Remove Silt .. .. .	183
Our Illustrations .. .. .	184
Correspondence .. .. .	184
Obituary .. .. .	184
Legal Intelligence .. .. .	184
The Housing Problem and Its Economic Solution .. .. .	197

**CONTENTS.**

Trade Notes .. .. .	195
Building Intelligence .. .. .	198
Our Office Table .. .. .	199
Clubs .. .. .	200
Tenders .. .. .	200
To Correspondents .. .. .	200
To Arms .. .. .	200
List of Tenders Open .. .. .	vii.
Latest Prices .. .. .	viii.

**Strand, W.C.2.**

Drawing-room, Mr. Andrew N. Prentice, F.R.I.B.A., Architect. .. .. .	198
National Provincial Bank of England, Taunton, Somerset. Mr. C. H. Brodie, F.R.I.B.A., Architect. .. .. .	199
Sculpture and China Hall, Bulme Art Gallery (Lady Lever Memorial), Messrs. William and Segar Owen, F.R.I.B.A., Architects. .. .. .	200
The Problem of the Small Dwelling and Its Solution. By Mr. Robert Thomson. Sheets XXX. and XXXI. (double page), giving general layout scheme in connection with the series of tenements before illustrated. .. .. .	vii.

**OUR ILLUSTRATIONS.**

Notgrove Manor, near Northleach, Gloucestershire. Garden wing extension and an interior of the

### Currente Calamo.

The Housing Conference of the Workmen's National Housing Council at Blackpool on Saturday had the advantage of the attendance of Mr. Stephen Walsh, M.P., the Parliamentary Secretary to the Local Government Board, who administered a well-deserved rebuke to those who stupidly hinder the solution of the most pressing social reform of our time by mixing up with the discussion thereof questions which have nothing to do with it. He also certainly hit the right nail on the head when he declared that "it was not a question of interest on money, but of interest taken by the people themselves." If those who are homeless as far as regards a real home had stirred themselves sufficiently to send to the right-about their representatives on the local councils who have so miserably failed to take advantage of the facilities given by existing legislation, more might have been done before this. If some of them would take the trouble to look into matters for themselves, they would discover that it is no fault of the private builder that their needs have not been provided for; and that, as a matter of fact, the biggest and best housing schemes in being have been carried out by private enterprise. They would also learn that the faddists who talk so glibly about garden cities are not much in advance, as regards really good plans and indispensable conveniences, of the "builders of the brick boxes with slate lids" Mr. Walsh denounced, and that the plans set forth by the Government Departments are in many respects as bad as they are costly. "The solution of the problem of the perfect dwelling" is to be found, and found only, in really scientific planning, and in the encouragement on sound business lines of all who will pursue it. We have hopes that the series we are just concluding will help as nothing has helped hitherto in that direction, and are glad to know it attracted favourable attention at Blackpool last Saturday.

It is evidently intended to make all "Labour"—we beg pardon, the "Employment"—Exchanges a permanent addition to the present refuges in which there

is plenty of employment but little labour for the well-paid and snugly-housed proteges of the Government, but which are utterly useless as the media of exchange of labour between the employer and the employed. The Ministry of Labour report that a joint meeting of the Employers' and Workmen's Committee recently established by the Minister of Labour to advise on the work of the employment exchanges in connection with the building trades was held at the offices of the Employment Department of the Ministry on Friday last. Mr. C. F. Rey, Director of the Employment Department, was in the chair. The Committee considered and confirmed certain arrangements, agreed to at previous meetings of the separate committees, regarding the more rapid placing of workmen in employment through the exchanges, and it was agreed that the arrangements should be communicated to building trade employers throughout the country in order to enlist their co-operation in the matter. The action to be taken by the exchanges during periods of trade disputes was also considered. The question of the accommodation to be provided at employment exchanges was considered at a previous meeting of the Operatives' Committee. We are perfectly assured that the building trade employers are little likely to co-operate for the continuance of an institution which has been a failure from the first, and which the employed have found equally wanting.

Private persons are submitting in not a few instances to unfair treatment by the Government Departments, to unfair valuations of houses, stock, and other property for purposes of the war. But it is obviously the duty of local governing bodies to resist this in the interests of the ratepayers, and to insist on "fair market value," even at the cost of litigation. The Corporation of Wigan has done so successfully, and the result should be carefully noted by all such who are being similarly treated by officials with more zeal than knowledge. The case came before his Honour Judge Spence Hogg at the last Wigan County Court, when Mr. W. H. Fryer, the Town Clerk of Wigan, appeared for the Corporation, and Mr. Tarrant, barrister-at-law, appeared for the Army Council. Evidence

was given by Mr. Gooseman, the borough engineer, to the effect that on May 6 last a lieutenant commandeered four draught horses used in the nightsoil department of the corporation, who stated that he fixed their value at £75 each, or £300. The borough surveyor protested against the price fixed, and that their proper value was £365, but the War Office representative was adamant, and stated that £75 each was the limit, and he was not allowed to give any more. His Honour, in giving judgment, stated that he had to find out what was the value of the horses impressed under the provisions of the Acts, and decided that the total value was £360, and gave a certificate for this amount with costs. Before taking the case to Court every effort was made, but without success, by the borough surveyor to secure a friendly settlement, but in vain. Perhaps the lesson will not be lost on other high-handed officials, and we sincerely congratulate the surveyor and the corporation on the result of the action, which will be of assistance to other local authorities.

An architects' registration law, similar to the present law in New York State, has been passed by the Wisconsin Legislature. The law provides that after January 1, 1918, no person doing business in Wisconsin shall use the title "architect" as a part of his business name or title, or in any way represent himself to be an architect, without a certificate of registration. The Industrial Commission, which administers the State building code, is to appoint a board of five examiners, three of whom shall be architects of at least ten years' active practice in the State, the remaining members being the State architect and the dean of the Engineering College of the State university. The members receive no compensation except expenses. This board will have full power to prescribe rules and regulations for the examination and registration of architects. Candidates for examination shall submit satisfactory evidence of having acquired a thorough knowledge of sound construction, building hygiene, architectural history, and mathematics. (This provision was substituted for the original requirement of a high school education, to which objection was made by the Legislature.)

The candidate must also have had at least five years' experience. In lieu of examination, the board may accept a diploma of graduation from a recognised architectural school, followed by three years of practical experience. The board may also accept, in lieu of examination, registration in another State or country having satisfactory standards. Any person who, at the time of the passage of the Bill, was actually engaged in the practice of architecture, may receive a certificate without examination.

There is some sound sense enshrined in the always readable "Editor's Pages" in the last issue of the *Sunday at Home*, in which the bouden duty of all of us to know and observe our own limitations is pleasantly discussed. Says the writer:—

"I have read carefully a few authoritative books on architecture, in order that I might be able to look at great buildings with intelligent eyes. I did a little investigation some time ago into the chemistry of gardening, being specially interested in the long, wonderful, and mysterious processes by which the surface of the earth has been prepared for the reception and nurture of the seeds that in the maturity of their growth sustain us all and adorn the fields and gardens with flowers. Such short and elementary studies do not do you any harm, but rather good, if they have been sound so far as they went, and if you quite frankly recognise that they did not go very far, and if you do not give yourself airs on the strength of them. But if in the niches of not little architectural studies, I presumed to criticise the technical parts of

"The Seven Lamps of Architecture" or rose up in judgment upon the editor of THE BUILDING NEWS, I should be a pretender, a charlatan, in palpable need of exposure and chastisement; or I should show that I had dangerously and injuriously deceived myself, and it would be well for me if some one should take me in hand who would make me unmistakably aware how poor and blind and naked, in the matter of architectural knowledge, I really am."

Our natural modesty—possibly enough bounded by as crass presumption as that so righteously reprobated—prompts a flattered acknowledgment of the compliment, coupled with the hearty wish that some of our critics in the ordinary Press might sometimes know their limitations better when launching their thunderbolts at the votaries of the Mother Art of which their knowledge is so superficial!

#### THE PROBLEM OF THE SMALL DWELLING AND ITS SOLUTION.

XVI.

By ROBERT THOMSON.

[WITH ILLUSTRATIONS.]

The plans on the lower half of the accompanying sheets, XXX, and XXXI, are arranged to show how four dwellings, each of which has its own entrance gate, are reached from the street. These plans are complementary to those on Sheet XXVII, which show how the one approach served two dwellings, each of which also had its own entrance gate. As compared with existing arrangements of four-in-a-block group of dwellings, the above arrangement, besides being more economical, has several other advantages, some of which have been referred to in earlier articles.

It must be clearly understood that the block plan arrangements seen on the upper half of Sheets XXX, and XXXI, are not given as examples of site planning but that they are merely intended to illustrate various methods of combining the plans shown in the lower portion of

these two sheets. The letters which appear between the rows of blocks refer to the particular combination of blocks between which they are placed. One of the points to which attention is directed is that there is a building line at a certain distance from the centre of each street to which alignment all buildings conform. The distance between the building lines on the side avenues is shown at 90 feet, that between those along the trunk roadway at 150 feet, and the distance between the building lines of two adjoining avenues is shown at 220 feet. With back gardens, each 28 feet wide, and including the area of the side streets, the density of housing works out at about ten dwellings per acre.

With adequate recreation and other necessary areas included, a density of eight dwellings per gross acre would allow of an addition being made to the length of the gardens. The point to which in these plans special attention is directed is that, although the building lines are shown at exactly the same distance apart on both sheets, the difference in the disposition of the blocks of dwellings on opposite sides of the streets provides an interesting subject for study. If the reader were to suppose himself stationed on the main roadway between the two avenues, branching right and left, and to alternately look along these avenues, he would probably come to the conclusion that the avenue on Sheet XXXI was wider and opener than that on Sheet XXX. Such a conclusion would, however, be wrong, since the widths are the same.

The narrower appearance of the avenue on Sheet XXX, is produced by the arrangement of the two four-in-a-block groups, which are directly opposite each other, producing the bottle-neck effect shown at C. The same appearance of openness seen on Sheet XXXI, can be obtained between the backs of the buildings on adjoining streets by observing the same rules in the arrangement of opposing buildings.

The arrangement shown in which the gardens abut against each other instead of against pathways which are common to several dwellings secures that measure of privacy which is so greatly prized by all garden-loving cottagers.

Turning to the four plans on the lower portion of the sheets, it will be seen that the forecourt which each of the ground-floor dwellings possesses is admirably fitted for the formation of a rock garden. By this simple means quite an unusual charm could be imparted to these dwellings.

It has been already stated in these articles that in view of the appalling waste of life which defective housing entails, the primary object of all housing reform ought to be the prevention of disease; but if we are to judge either by the dwellings which have been erected during the past two or three years or by those which are being built in various parts of the country at the present time, it would appear as if the primary object sought to be attained by the experts who are responsible for the planning of these dwellings is to impose as many handicaps on the people as possible by providing apartments which deprive their occupants of an adequate supply of fresh air. The following facts should be carefully studied by everyone interested in housing until their significance is fully understood. In the spring of last year Mr. Peter Fyfe, chief sanitary inspector of Glasgow, had some analytical tests carried out with the object of ascertain-

ing the quality of the air contents of two dwellings. Some details of these tests have already been given in one of the earlier articles of the present series, and to these the interested reader is referred. One of these dwellings had a ceiling 8 feet high, and as this is the standard height of ceiling recommended by the Advisory and Departmental Committees, and adopted by the Government in their model plans, the results of the tests of the air contents of this dwelling only will be utilised for present purposes.

During the night on which the samples were taken the window of each of the apartments was kept open 3 inches for ventilation to the outer air. The two samples of air taken showed respectively 20.3 and 23.6 parts of carbon dioxide per 10,000 volumes of air.

The legal limit of permissible impurity in the case of the humidified air contents of cotton cloth-weaving factories was, some years ago, fixed, by enactment, at 9 volumes of carbon dioxide per 10,000 volumes of air. Taking the natural atmospheric percentage of carbon dioxide at 4 parts per 10,000, the air contents of the Glasgow dwelling show an added percentage of 17.9 parts as against the 5 parts given as the permissible limit in cloth-weaving factories. These figures reveal the existence of a truly appalling state of matters in the Glasgow dwelling tested. Unfortunately, however, that Glasgow dwelling does not stand alone as an example of how the health of the people is adversely affected by the incompetently planned dwellings which they are at present forced to occupy. The Government's model plans of cottage dwellings and all those of the town-planning and garden-city types of housing experts which I have seen put forward for the housing of the people, would give, as regards their bedroom accommodation, with the same number of occupants, worse, and in some cases very much worse, results than those revealed by Mr. Fyfe.

Let us take as the first example the bedroom accommodation in the dwellings erected to the plans of Mr. William Ross Young, town-planning engineer to the County Council of the Middle Ward of Lanarkshire. In the paper by that gentleman which was last year read at the forty-second annual congress of the Incorporated Sanitary Association of Scotland, he gives tables showing the cubic contents of the various apartments in the different sizes of dwellings erected in Mid-Lanark, to plans prepared by him. I will deal only with the five-apartment size of dwelling, since, in the opinion of competent authorities, this is the smallest number of apartments that should be provided in dwellings erected by grants of public money.

The cubic contents of each of the three bedrooms in the large number of five-apartment dwellings erected are 1,033, 786, and 397 cubic feet respectively. As one of these three bedrooms, and that the smallest, is, like the unventilated box beloved of the Government Committees, without chimney flue or other adequate means of ventilation, it may be left out of account, since it has more of the qualities called for in a lethal chamber than it possesses of those required in a bedroom. Since the total air contents of the three bedrooms are 2,216 cubic feet, deducting the contents of the smallest leaves a total air capacity of 1,819 cubic feet in the other two. The significance of these figures is at once established by comparing them with the 2,208 cubic feet of air space in the Glasgow dwelling tested by Mr. Fyfe. It should not require

either a departmental or advisory committee to bring home to the authorities concerned the terrible handicap which such bedrooms impose on their occupants.

Taking the Government's model recommendations, it will be found that their "desirable" standard sizes of bedrooms contain 1,200, 800, and 520 cubic feet of air space respectively. Here again the smallest apartment must be left out of account, since it, too, has more of the characteristics of the lethal, than of the bed, chamber.

Turning to the report of the proceedings of the Congress of the Association for the Prevention of Consumption, which was held at Leeds in 1915, one would naturally expect to find some standard of bedroom accommodation set up to which architects might with confidence refer.

But in the plans of the model five-apartment cottage therein given the bedroom accommodation in dwellings erected to them would be even worse than in the Mid-Lanark cottages, and still worse than that in the dwellings erected to the Government's model plans.

The medical gentlemen also apparently favour the idea of making the third and smallest of the bedrooms of the lethal type. The following statement by Dr. Macfie, quoted from his book, "Air and Health," should be interesting in the foregoing connection:—"If only men would practise full ventilation at night. Nature would forgive them a good deal of bad air by day; but it is chiefly by night that they insist on stuffy rooms. The smell of the ordinary bedroom in the morning is enough to turn one sick. The idea that night air is dangerous is only a superstition which we have already explained away. Night air is really purer in all respects than day air."

It was my intention to have dealt with several other matters in the present article, but in view of the overwhelming importance of the subject of air supply I have decided that it will be well to defer my remarks in regard to these other matters in order that the foregoing remarks may stand alone.

#### THE WORKMEN'S NATIONAL HOUSING COUNCIL CONFERENCE AT BLACKPOOL.

Under the auspices of the Workmen's National Housing Council a conference was held on Saturday last in the Congregational Schoolroom, Victoria, Blackpool.

Mr. John Hill, chairman of the Parliamentary Committee of the Trades Union Congress, took the chair, and in opening the proceedings, said that in war time it was realised that the great need of a nation was a race of able-bodied and intelligent men and women. It was more desirable now than ever that the propaganda of the Council should be urgently continued.

Mr. J. S. Whybrow gave lantern illustrations of block buildings at Bourneville Garden Suburb, Watford, Mid Lanark, Westhoughton, and elsewhere, also of the plans of the Government's Advisory and Departmental Committees for Rural and Urban Housing, and of the health promoting dwelling designed by Mr. Robert Thomson, which has been illustrated and described in our own pages. He advocated 10 ft. 3 in. ceilings and condemned fleeced bed-rooms and baths in sculleries. Several speakers advocated development on garden city plans and cottages with allotments adjoining, not separated. One speaker said the working man was entitled to find in his home conditions as favourable as he would get if he were either an inmate of a workhouse or of a lunatic asylum. A Darlington delegate attributed much of the existing mischief to the system of land tenure. Mr. Whybrow, replying,

said no public authority could afford to build on bungalow lines, because of the expense.

#### STATE CONTROL OF BUILDING MATERIALS.

Mr. T. Bramley (Furnishing Trades Association) moved "That in view of the enormous increase in the cost of building material, and largely due to the existence of cartels and trusts, and the consequent increase in the cost of building construction which will be imposed on local authorities attempting to secure proper housing of the people, this conference demands that steps be taken by the Government to own and control materials necessary, and, by fixing maximum prices, protect the community against the danger of having reform schemes used to provide opportunities for the exploiters at present controlling the building material market."

Mr. Capper (Manchester Trades Council) seconded the motion, which was supported by Mr. Dubeay (Post Office Officials) and Mr. Ben Turner (Textile Workers) and adopted. The Executive of the Workmen's National Housing Council brought up a resolution reaffirming the Birmingham decision, which protested against assistance to private persons and limited liability companies with public money for building purposes. Delegates from various districts took part in the discussion. Mr. Jack Jones (London Gasworkers) remarked that there must be no public money without public control, and that when we have settled with our friends abroad we shall be able to tackle our enemies at home. The resolution was adopted.

The Glasgow Labour Party Housing Association advocated the passing of a motion in favour of loans, interest free, for sanitary cottages.

#### MR. WALSH'S PLEDGE ON BEHALF OF THE GOVERNMENT.

Mr. Stephen Walsh, M.P., Parliamentary Secretary to the Local Government Board, who was cordially received, said one speaker had described the housing problem as one almost entirely of interest. It was not, however, really a question of interest upon money, but of the interest taken by the people themselves in the matter. He had looked up the files and he found that in the last five years more than half a score of local councils had made representations to the Government. The public mind was vast and those who knew the question at first hand were aware of the need of providing conditions which would enable people to live a decent human life. He occupied a minor and subordinate position, but he spoke positively in saying that the Government were prepared to give very substantial assistance to local authorities. Were they going to have any longer the brick boxes with slate lids, the hovels which in the past had been provided by non-progressive authorities? The people had been hitherto held fast in a labyrinth of vested interests and of commercialism. Nothing went so much to the root of national well-being. There ought to be no house without a bathroom, no house with less than three rooms, no house without conveniences compatible with a decent Christian life. A circular had been addressed to every urban authority by the Local Government Board asking questions to be answered by October 15. (A Voice: Send neutral inspectors.) Well, neutral inspectors had already said exactly what he was saying as to existing conditions, but a Himalaya of abuses and of corruptions could not be removed without serious spate work, and the existing horrors and scandals ought not to be viewed with impunity any longer.

#### CONSCRIPTION OF WEALTH.

A woman delegate asked Mr. Walsh if he would move in the House of Commons for the conscription of all wealth over £100,000.

Mr. Walsh: No, I am not going to move anything so egregious. £100,000 would be far too high a figure at which to commence the process, and conscription of wealth demands a great deal more consideration than we have given it. We do not quite know what is meant by the term. We are so glib in using phrases without thinking out their meaning, but when a proposal for conscription of wealth comes Stephen Walsh will be one of the first.

A Delegate: Who will bring it on?

Mr. Walsh: The Government of the day. Can you imagine anything else? A previous speaker alluded to Ireland; I quite agree that the work done in Ireland has placed on the British taxpayer a burden that the Irish people could not bear because of their poverty.

Mr. Walsh was thanked for his attendance. On the motion of Mr. J. Dundas White, M.P., seconded by Mr. Raffan, M.P., a resolution was carried on land values and housing embodying a proposal of the Land Nationalisation Society in favour of extending general powers. It was further decided to ask Ministers to receive a deputation.

The delegates attending the conference numbered 250, representing 161 societies.

#### ZINC BALLS FLUSHED THROUGH CLOGGED SEWER PIPES REMOVE SILT.

Some years ago a city sewer system was constructed under the supervision of E. B. Shibley, city engineer, Owensboro, Ky. It was stipulated in the specifications that a ball 2 ins. smaller than the bore of the pipe should pass through without lodging. In making this test on a certain section of sewer the ball became lodged, and had to be flushed to the manhole below. When the ball appeared in the manhole it was found carrying a half-brick before it. Appreciating the significance of this accidental discovery, Mr. Shibley applied this principle to the cleaning of sewers, with excellent results. It is not successful where roots are encountered, but where silt and debris have collected in the sewer—due to the absence of flush tanks and catchbasins, or where the latter have been



allowed to fill—this plan has been found to be cheaper than the drag or bucket method, and entirely satisfactory.

When a sewer is flushed without a ball ahead of the stream of water, the sand or silt is pushed forward by the flow of water and the outlet is choked, thereby causing the water to back up and so lose its nozzle pressure; when a ball is used ahead of the water the outlet is kept partly open, thus utilising the pressure.

If the sewer is badly choked, a ball 5 to 10 ins. smaller than the diameter of the pipe is placed in the sewer at the manhole and a stream of water applied behind the ball until it appears at the manhole below; the deposit is removed from the manhole, and a larger ball is then started from the manhole above and carried through as before. This plan is repeated until the sewer is clean. To ensure a clean sewer the last ball to pass through should be 2 ins. smaller than the sewer. Where sewers are not badly choked, the first ball may be large, the size depending on the condition of the sewer. The ball should float, and should be as light as is consistent with strength. Those used with best results are hollow and made of two thicknesses of No. 24 gauge zinc, the seams being set at right angles. The sizes run from 4 to 22 ins. Wooden balls have not proved satisfactory.

A fork or screen with a sandbag directly in front of it should be placed at the inlet end of the lower manhole. This is to prevent the ball, together with the silt expelled from the cleaned sewer, from escaping into the next section of sewer. A line of sewer should, of course, be cleaned in sections, beginning at the upper manhole.

Last year an abandoned sewer of 15 ins. diameter was found to be almost filled with silt, there being a space of about 2 ins. only at the top to allow passage of water. In cleaning this, a 4 ins. ball was first used, and last a 15 ins. ball. With the aid of these balls five cubic yards of sand were removed from this sewer in four hours.

The accompanying sketch shows the position of the ball and its action.

—Contract Journal.



## Our Illustrations.

NOTGROVE MANOR, GLOUCESTER SHIRE.

This country house is beautifully situated, adjacent to the old church of Notgrove, near Northleach, Gloucestershire, and not far from Bourton on the Water. The late Mr. Cyril Cunard acquired the property in 1906 and decided to convert the manor into a residence. The house had for a long while been used as a farm and had become very dilapidated; the earlier portions were erected in Tudor times. The only genuine part of the Manor stands on the north-east front and is not represented in the accompanying photograph of the exterior. The masonry of the old house is characteristic of the district, and in many ways is more than merely of historic interest, being a good example of local architecture designed in a traditional way. Mr. Andrew N. Prentice, F.R.I.B.A., of Norfolk Street, Strand, made very extensive extensions as illustrated by the photographs now reproduced, and he constructed them out of old materials skillfully rebuilt by Messrs. Saunders and Sons, of Cirencester, under the supervision of the clerk of the works, Mr. C. Smith. In the right is the drawing room, with a large bay window in the gabled end. This room, of which we give an interior, occupies the position of the old kitchen, in the farm buildings, and the view shows this kitchen's ceiling beams re-erected. The walls of this apartment are panelled in dead painted white and, together with the old furniture brought by Mr. Cunard from his former residence, make a quaint interior. The pleasant environment of the house is in keeping with its picturesque and simple contrivance. Prior to the commencement of the building work we gave a bird's-eye from the other side, and also in our issue for May 6, 1916, a plan of the building was given from a drawing exhibited that year in the Royal Academy. On June 7, 1912, from the same Gallery, we published Mr. Prentice's drawing of the rear part of the premises. The new work has toned down in the meantime and the gardens laid out since have matured and greatly enhance the old-world effect of this charming manor.

THE NATIONAL PROVINCIAL BANK OF ENGLAND, TAUNTON.

This building occupies a good position in the main street exactly opposite the "Castle Hotel," and a few yards from the new General Post Office on one side and the Market on the other. It has been erected by Messrs. H. W. Pollard and Sons, of Bristol, water, and a local architect, Mr. E. W. Roberts, gave a general superintendence to the works as they progressed. The ground story of the front is of unpolished fireaxed grey Cornish granite and above that is all St. Aldham Bay Ground Bath stone. Both this and the granite were sent on the site ready worked by the Bath Stone Firm, Ltd. In the basement are a large strong room and stores. On the ground floor are the banking and consulting rooms and another strong-room with clerks' lavatory adjoining. In rear of these are the hall of the manager's house and his dining room, kitchen, and other domestic offices. There is a very large garden, on the first floor are drawing and morning rooms, a workshop and bathroom, etc., and on the second floor are four good bedrooms and two good attics, box-rooms and offices in the rear above this. The building was designed and carried out by the bank's surveyor, Mr. C. H. Brodie, F.R.I.B.A., of B. B. Shepstone, E.C., and Mr. Max. Clarke prepared the quantities. The cost was about £42,000. The drawing reproduced was shown at the Royal Academy this season.

SOUTH SCULPTURE GALLERY AND CHINA HALL, HULME ART GALLERY.

The Lady Lever Memorial Art Gallery at Port Sunlight was illustrated by an exterior view, showing the Library entrance, in our issue for December 20, 1916. To-day we publish, from this year's Royal Academy, an interior of the circular colonnaded hall, designed for the display of sculpture and other objects. The glazed dome abundantly

lights the gallery. Messrs. William and Segar Owen, F.R.I.B.A., of Warrington, are the architects.

THE DEVELOPMENT OF THE SMALL DWELLING AND ITS SOLUTION.

This double-page is figured XXX, and XXXI, and thus illustrates the series of sheets of plans commenced with Mr. Robert Thomson's articles on the subject May 25, and continued in THE BUILDING NEWS for June 6, 13, 20, and 27; July 4, 11, 18, and 25; August 1, 8, 15, and 29. The present drawing furnishes a plan for the lay-out of dwellings in which the author's patented contrivances have been incorporated.

## Correspondence.

THE PROBLEM OF THE SMALL DWELLING AND ITS SOLUTION.  
To the Editor of the BUILDING NEWS.

Sir,—I am very much interested in the remarkable and convincing series of articles now appearing in the B.N., which I have followed with absorbing attention ever since they commenced. I am very anxious that the community generally should be educated on the subject, and I beg to suggest that you issue a *cheap reprint* of the articles and plates. I am trying to interest our local leading men in the plans, but realise how tedious it is to have a pile of the BUILDING NEWS to wade through, especially where there is so much back reference required.

I was glad to notice that the Workmen's National Housing Council has drawn Lord Rhondda's attention to these plans. It will be a long, hard, up-hill job to overcome prejudices. The somewhat eccentric form of Mr. Thomson's plans will be an objection to some who only think of *appearances*. I am convinced that you are doing a splendid work for posterity by publishing these plans. Mr. Thomson's arguments are proved to the hilt. His very close reasoning may tire some who only look into a thing superficially, but it is clear that the Small Dwellings Problem is becoming an *exact science*. I have had some correspondence with Mr. Thomson on points that did not seem clear at the time, but as his articles developed I generally found that he touched on all such things. I do most earnestly hope that you will publish the articles and plates, but it must be in some *cheap form*, or the circulation will be small, and not much good done. My ideal would be to see the book on every railway bookstall and every newsagent's counter. The general public should be got at more than those immediately interested in the matter, such as architects and builders.

I should like to take the opportunity of saying that I have read the BUILDING NEWS every week since 1879. It has been my architectural guide as pupil, assistant, and master, and I am proud of it and the way it keeps to the front.—Yours truly,

T. W. T. RICHARDSON.

57, High Street, Stockton-on-Tees.

[We tear at present dear paper and the difficulty of getting it render a cheap reprint impossible; but if the author republishes presently we will facilitate in any way possible. —ED. B.N.]

## OBITUARY.

The death took place at Colechester, on the 31st ult., in his eighty-eighth year, of Dr. Henry Laver, a well-known antiquary and authority on local history and architecture. Dr. Laver was chairman of the Colne Fishery Board which manages the oyster fishery for the corporation of Colechester, and took great pains to promote its success. He was a prominent figure at the Colechester Oyster Feasts, which were held annually until the outbreak of war. He was an ex-president of the Essex Archaeological Society and contributed many articles to the Transactions of that society; he was also author of the work "Mammals of Essex." Dr. Laver was hon. curator of Colechester Museum and senior alderman of the corporation. He held the office of mayor in 1885-86.

## LEGAL INTELLIGENCE.

ILLEGAL BUILDING AT BIRKENHEAD.—PROSECUTORS, BUILDERS, AND ARCHITECTS, FIXED.—Case of importance under the Munitions Order was heard at the Birkenhead Police Court on the 28th ult., when penalties totalling £115 were imposed for the disobeying of building regulations. Messrs. J. Davis and F. Gaskell, contractors and builders, were summoned for having carried on certain building work without a licence. Messrs. D. McEwan, H. B. Wright, A. G. Wallace, and J. B. Wilkie, proprietors of the Empire Picture House, Conway Street, the building referred to, and W. A. E. Shennan, architect, were summoned for having procured and abetted Messrs. Davis and Gaskell on the work. Mr. H. D. Roome, instructed by Mr. W. L. S. Holmes, appeared to prosecute for the Ministry of Munitions, and Mr. G. Chadock Rees, M.P., instructed by Mr. F. S. Moore, was for the defendants who pleaded guilty. Mr. Roome said the charge was preferred under the Order of the Ministry of Munitions, July 20, 1916, by which it was provided that in any case of building and construction, unless the cost did not exceed £500, or the use of construction steel was not entailed, a licence must be applied for from the Ministry of Munitions before the work could be done. The defendants had not applied for a licence, though they came under the scope of the provisions. Before the regulations were published the defendants made a contract for the alterations of Nos. 50 and 52, Conway Street. It was designed to alter a motor garage into a picture-house. The building was commenced no April 1, 1916, but a licence became necessary immediately the order as to building was issued. Mr. Rees, for the defence, maintained that the proprietors were not aware of the multifarious regulations in the Order, and that everything had been done above board. The fact that the work was being proceeded with was well known. The defendants subsequently advertised the opening, and had since paid £15 a week in Government taxes on amusements. If the time originally specified for the work had been completed before the publication of the regulations, The Bench decided to inflict a penalty, considering that the work had been done deliberately. As it was the first case of the kind they would not inflict a severe fine. Davis and Gaskell were each fined £15, or fifty-one days' imprisonment; McEwan, Wright, Wallace, and Wilkie were each fined £15 each, or fifty-one days' imprisonment; £25 or eighty-one days—total £115, with £40 costs to be deducted from the fine.

MEASUREMENT OF TIMBER: MOTION TO INJECT A PEER.—Mr. Justice Sargant, sitting as Vacation Judge, last Wednesday, heard the case of "Griffin v. Ebury," in which the plaintiff, trading as T. H. Griffin and Co., timber merchants, asked for an injunction to restrain the defendant, Lord Ebury, from selling certain timber at Moor Park, Rickmansworth, which had already been agreed to be sold to the plaintiff, and which defendant threatened to dispose of elsewhere. Mr. Vivian said after the parties agreed upon the trees to be sold and the price, the timber was measured. The parties were unable to agree as to the amount the timber made, and efforts on both sides failed to bridge the difficulty, and the defendant wrote saying that as the dispute appeared to have no issue, it would not be settled he should sell the timber to someone else. Mr. Tyrrell, for the defendant, said Lord Ebury was still quite willing that the plaintiff should have the timber at the price agreed, provided the timber was measured by an expert. Mr. Vivian agreed that the difficulty was "measurement" only. Those was the only question. The defendant thought, in the circumstances, it should be measured by some practical person, and not by a valuer appointed by the Surveyors' Institution, whose knowledge would be that of a valuer rather than that of a measurer of felled timber on the land, the price of which per foot had been agreed. That was why he thought it should be measured by someone appointed by the Chamber of Commerce. His Lordship thought the proper course for him to adopt was, unless a referee was agreed to by the parties, to refer it to the Master. If he failed to appoint anybody to the satisfaction of both parties, the matter could be referred back by the Master and he would go into the matter again in Chambers.

It is announced that a Government Department contemplates building about 1,000 houses in the district of Farnborough.

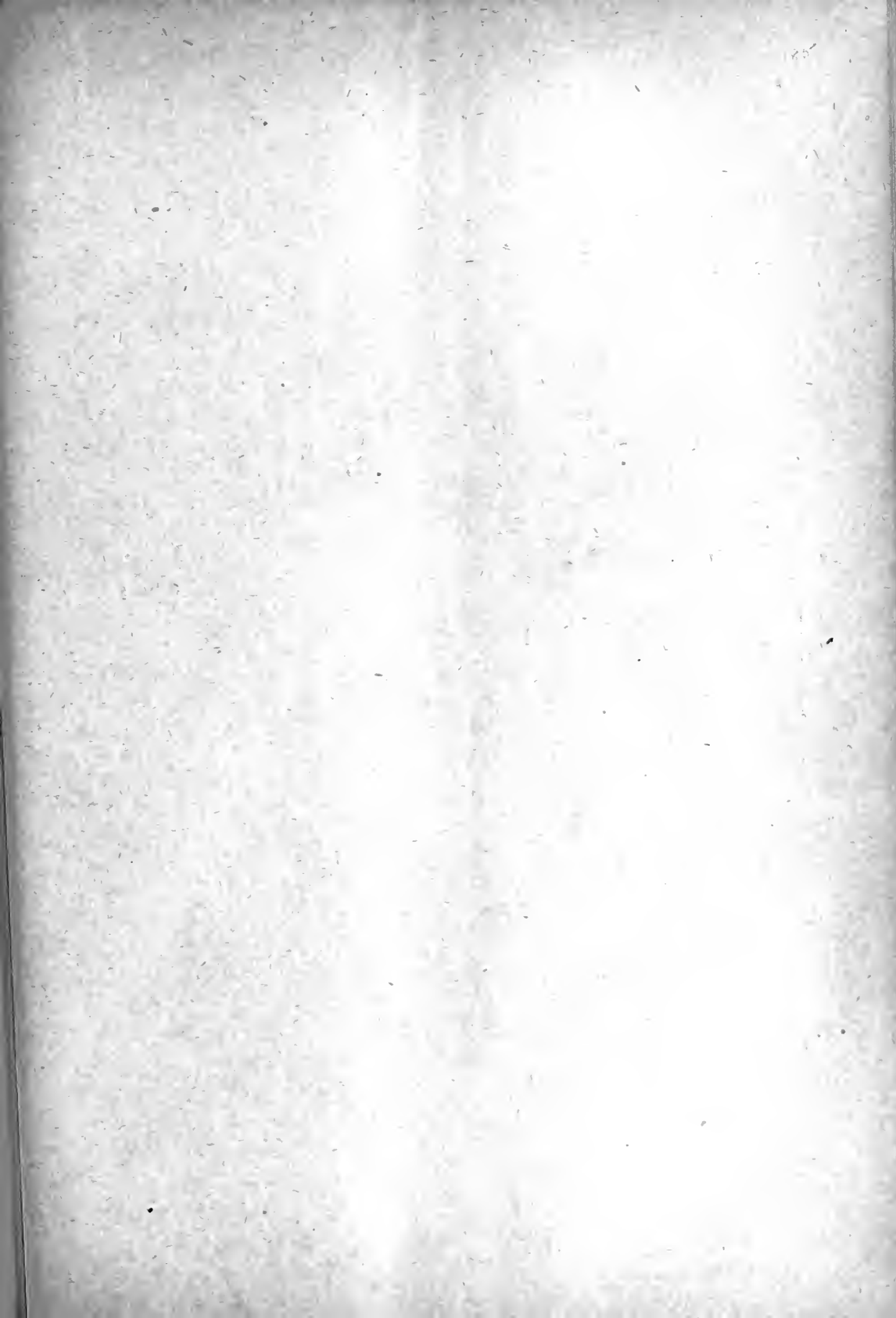

SHEET XXX

EDUCATION

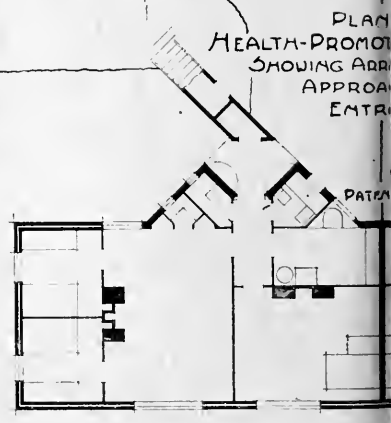
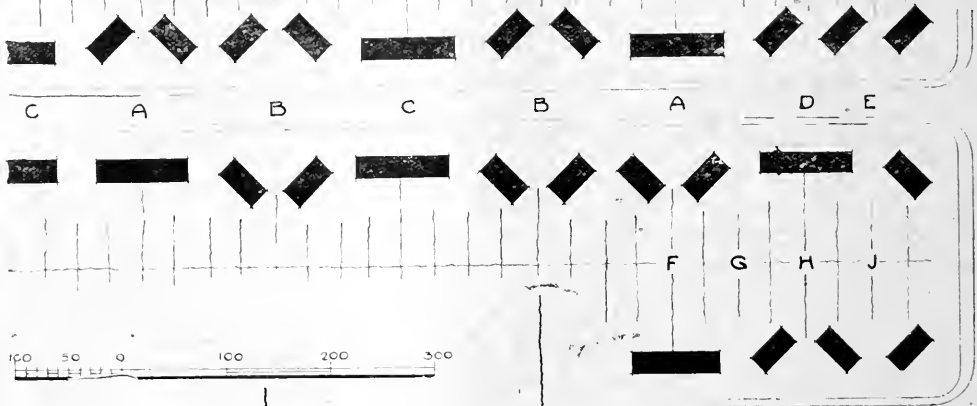

PLAN HEALTH-PROMOTING SHOWING APPROXIMATE ENTRANCE

PARTIAL

HEDGE  
FOOTWALK



SERIES

SHEET XXXI

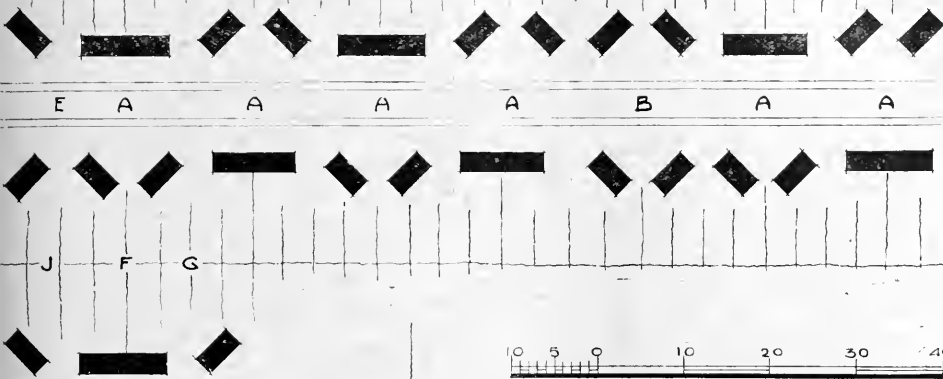

DWELLINGS  
ENT OF

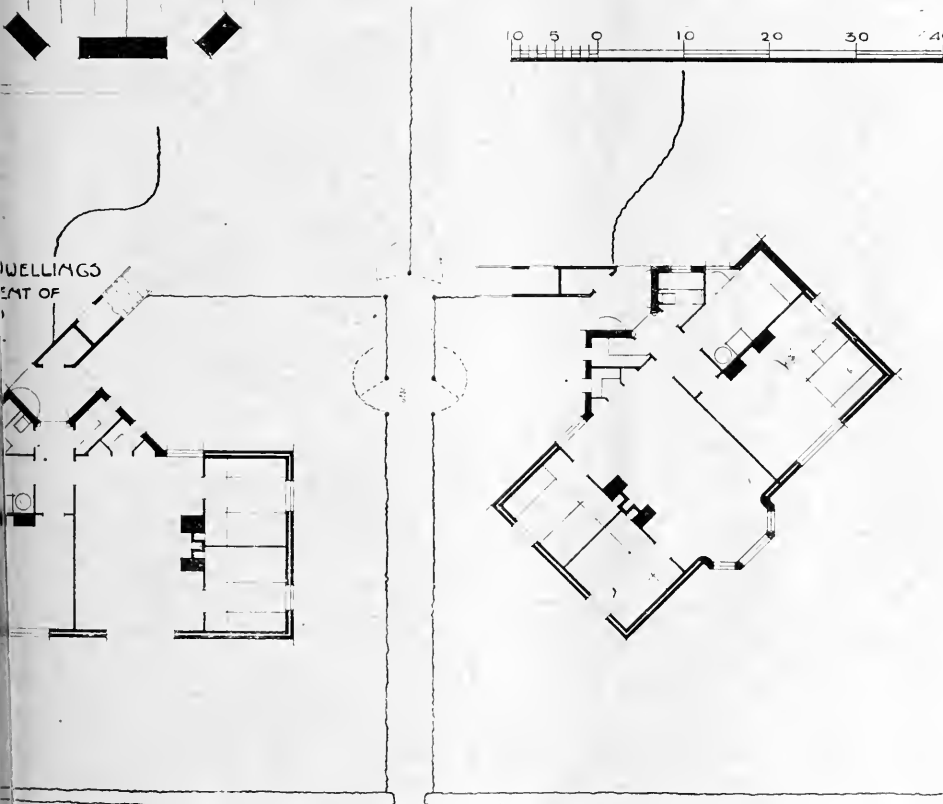

SOLUTION.—By Mr. ROBERT THOMSON, Architect.





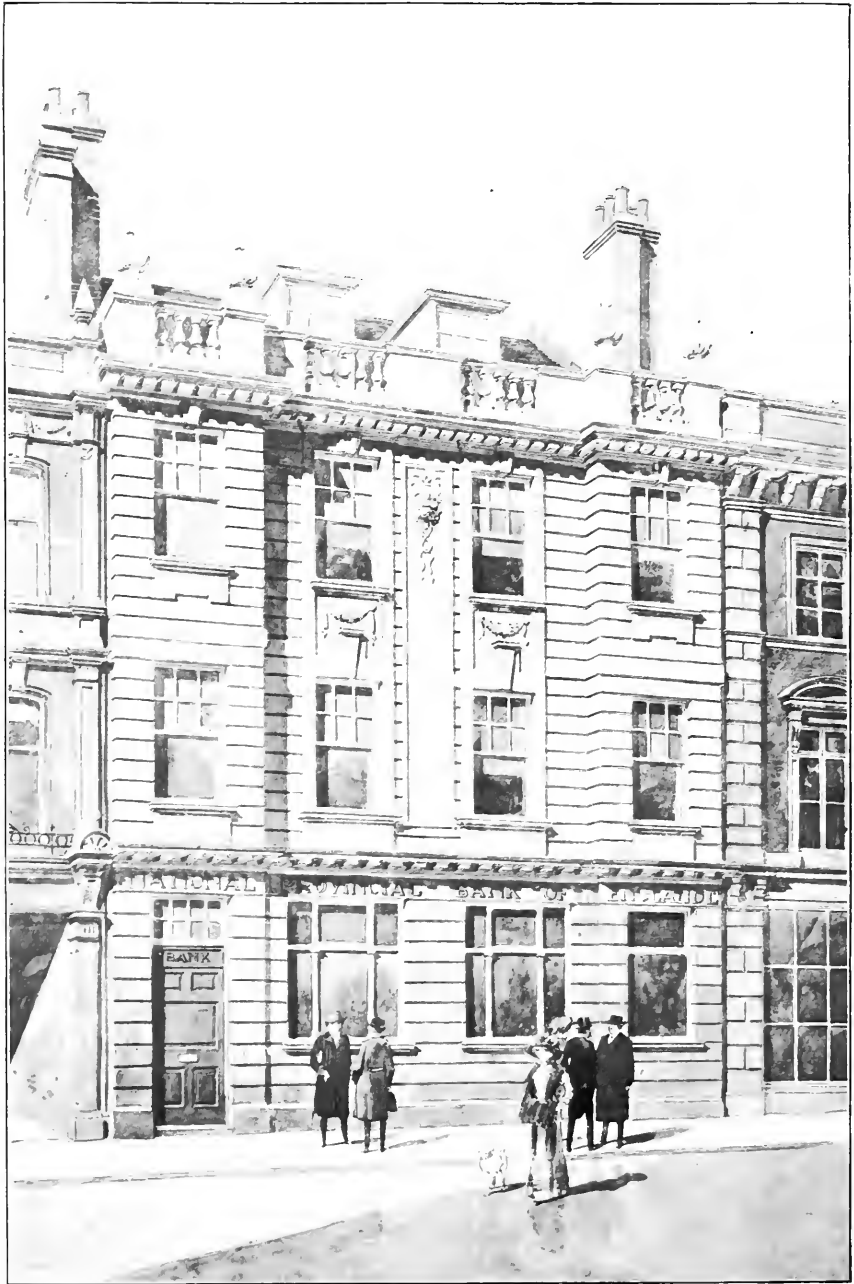

NATIONAL PROVINCIAL BANK OF ENGLAND, TAUNTON.  
Mr. C. H. BRODIE, F.R.I.B.A., Architect.



THE BUILDING NEWS, SEPTEMBER 5, 1917.

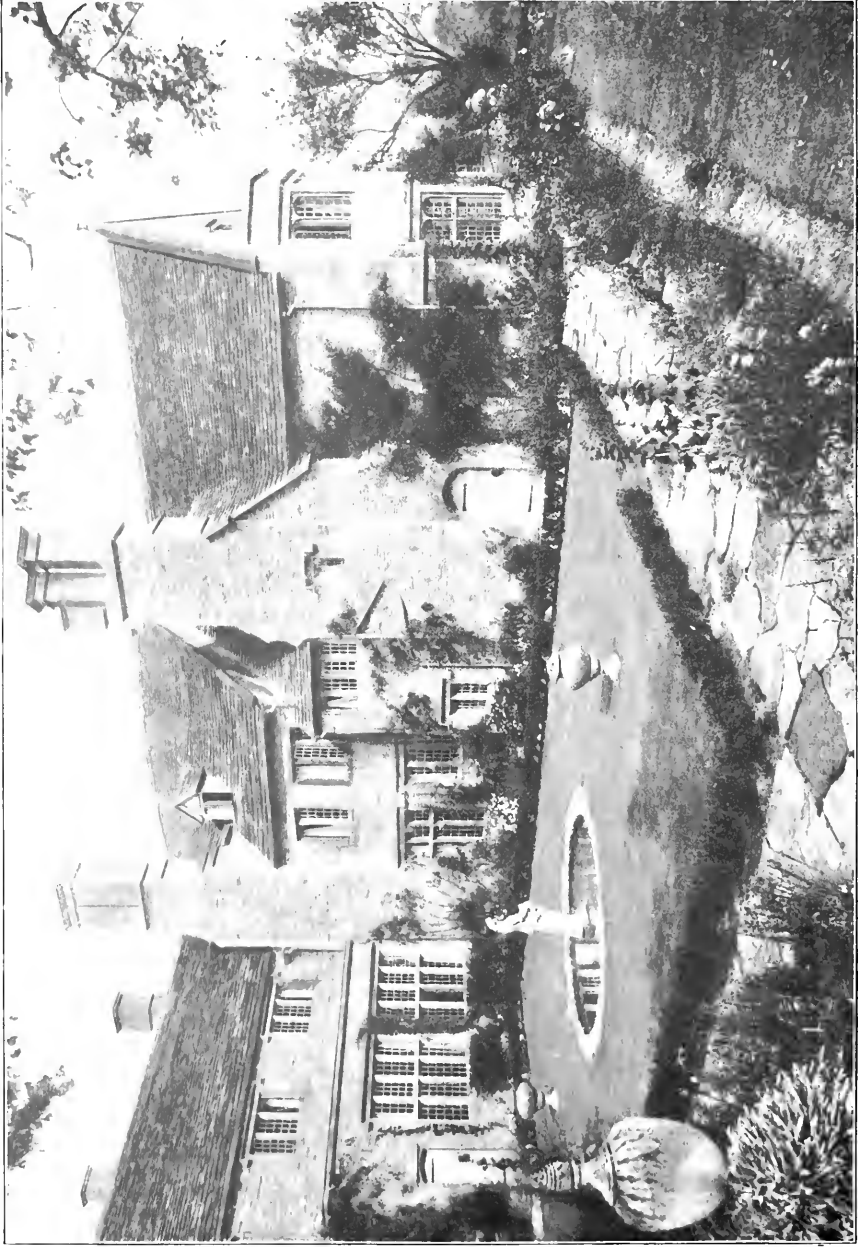

*T. Lewis, Lith., Photos.*

NOTGROVE MANOR, NEAR NORTHLEACH, GLOUCESTER: GARDEN WING EXTENSION.  
MR. ANDREW N. PRENTICE, F.R.I.B.A., Architect.



*T. Lovell, Esq., Photo.*

NOTGROVE MANOR, NEAR NORTHILFACIL, GLOUCESTER: THE DRAWING ROOM.  
MR. ANDREW N. PRENTICE, F.R.I.B.A. Architect.





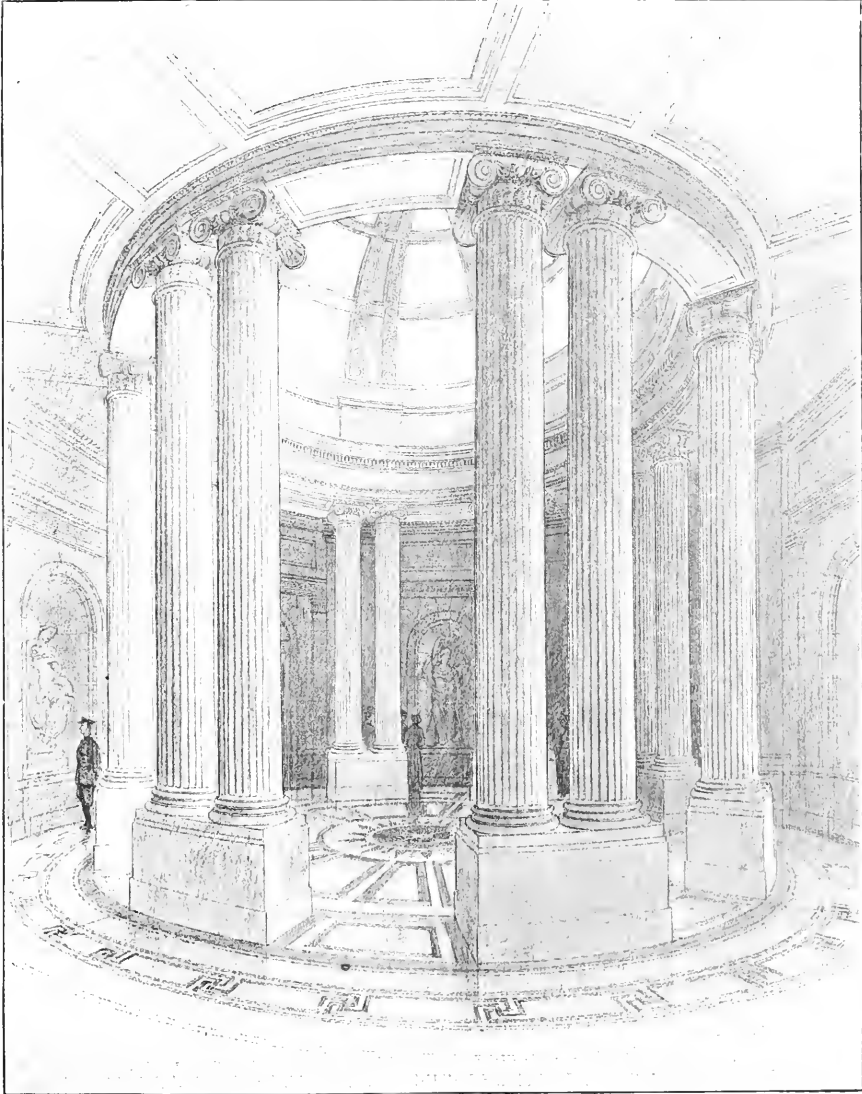

SCULPTURE AND CHINA HALL, HULME ART GALLERY (LADY LEVER MEMORIAL).  
Messrs. WILLIAM and SEGAR OWEN, F.F.R.I.B.A., Architects.

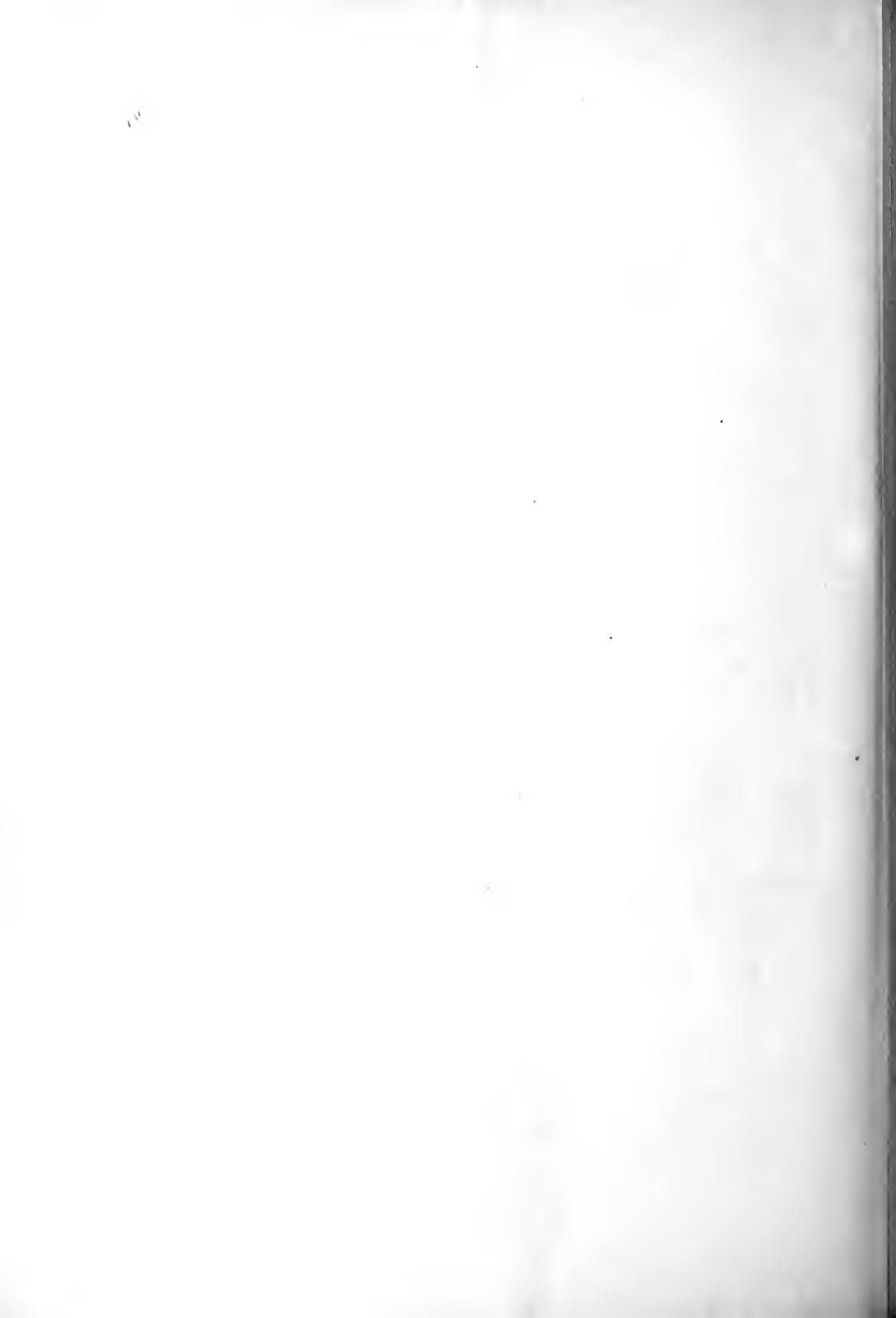

### THE HOUSING PROBLEM AND ITS ECONOMIC SOLUTION.

The following is issued by the National Federation of House Builders. It is its committee's report on State assistance to private enterprise in house building after the war:—

It has long been recognised that the efficient housing of the people is a matter of national importance. The health and welfare of the community, the existence and future of the race, depend so closely upon the conditions of housing that no responsible person who is interested in these matters can afford to ignore the demand for proper and sufficient housing accommodation. National responsibility, however, does not necessarily mean that the State should undertake the building of houses in competition with private enterprise, nor that the State should encourage or assist uneconomic schemes on the part of local authorities. State intervention in any industry which has been conducted by private enterprise is extremely dangerous, and must lead to the discouragement of those forces which have carried on the industry in the past, unless that State confines its activity to giving assistance on economic lines and in all its operations endeavours to help and encourage private enterprise to carry on the accustomed work.

The housing accommodation during the years prior to the passing of the Finance (1909-10) Act, 1910, had, generally speaking, been sufficient for the requirements of the country. This was mainly due to the enterprise of the house builder, and the type of houses erected had rapidly improved, through the exercise of free competition, until the working classes who lived in the newer property enjoyed houses which had never been approached in the history of the country for convenience and comfort. The problem of the present house shortage, and the action of the Government in dealing with the problem, should be based on the due recognition of these facts.

Acts of Parliament have been passed to enable the Government to afford help in the matter of housing; these Acts have chiefly aimed at assisting the various local authorities to build houses for the industrial population, but they have not been utilised to a sufficient extent to cope with the demand. Two main reasons are responsible for this, and it is advisable to enumerate them, for they show that the solution of the housing difficulty cannot be found in the direction of municipal enterprise. In the first place the various local authorities have found that the building of houses has generally led to an annual charge on the rates, and they have been unwilling to embark upon extensive housing schemes on that account; we believe that local authorities generally recognise that the housing of the people can be provided for more economically and more efficiently by the house builder than is possible by public effort. The second reason is that in considering the necessity for public activity the Local Government Board is directed to take into account "whether, having regard to the liability which will be incurred by the rates, it is prudent for the local authority to undertake the provision of such accommodation." In view of this direction the Local Government Board has not insisted in the past that those bodies should embark on housing schemes.

The position has now changed. The total cessation of building by private enterprise during the war has brought about a critical state of affairs, and the shortage of houses which will face the country at the conclusion of the war will be such as to force the authorities into drastic and uneconomic measures unless a remedy is found.

If there was no alternative to public building schemes, if private enterprise was unable to point to definite causes for the suspension of its activities, and if it was impossible to suggest any practical, economic remedy then the housing of the people would, indeed, be in a hopeless position. But private enterprise has not ceased to build through lack of initiative on the part of those engaged in the trade; it has been driven temporarily out of the business to a large extent by the indirect effects of legislative action on the part of the Government. The confidence of investors in

house property, which had been built up by years of experience of sound, remunerative investment in this class of security, has been shaken; until this confidence has been restored there can be no real and lasting solution of the difficulty. The object of this report is to show the manner in which confidence can be restored and how the problem can be solved on permanent and economic lines.

In the first place it is generally admitted that the future housing of the working classes must rest with private enterprise. The housing of the indigent poor cannot be accomplished on a business basis and is, therefore, outside the scope of the private builder. With the housing of the working-classes, however, the house builder is prepared to deal if he is enabled to conduct his business with any reasonable prospect of financial success.

To remove the feeling of insecurity on the part of the investing public it will be necessary to amend the Finance (1909-10) Act, 1910. When the Bill was introduced it was not proposed that ordinary trading profits made by the house builder or his customer from the sale of house property should be subject to the taxes which it proposed to bring into force, but the judgments in courts have so construed the clauses of the Act that it is now held to include principles quite foreign to the expressed intention of the promoters. The Act has ceased to be a party question, and its amendment should be approached from the plain unbiased point of view of its failure to accomplish the objects which were sought to be attained and its effect on the production of houses.

Vigorous steps should also be taken by the Government to make it clear that investors in house property will not be singled out for extra taxation and repressive measures.

There are other reasons for the decrease in house building by private enterprise, and the chief among these reasons is the increase in the price of materials and the cost of labour. The committee have gone very carefully into the question of these costs, and, while it does not appear possible to reduce the cost of building generally to any important extent, there are directions in which a considerable saving could be effected by a greater economy of materials and the elimination of waste in construction.

The committee would therefore make the following recommendations which they believe would help towards that end:—

1. The Local Government Board's model bye-laws should be amended in some details (which can be gone into on another occasion), and should be completed by including regulations governing the timbers, pipes, sewers and fittings which are now left to the discretion of individual local authorities. These regulations should be based upon the minimum requirements consistent with sound construction and safety of health. Local authorities which insist on standards in excess of the requirements of the Local Government Board Bye-laws should defray the added cost.

2. The making of roads in town-planned areas, the land for which is dedicated for the use of the public free of charge by the builder, should be done, either wholly or in large part, at the expense of the local authority concerned.

These recommendations are not made chiefly nor without due appreciation of their effect upon the local authorities. The first recommendation is in the opinion of the committee, the only practical method of bringing to an end the waste of material entailed in building to the bye-laws in many of the great centres of population. Instances can be given where the imposition of new and restrictive bye-laws have coincided with, and apparently caused, a marked falling off in the number of houses erected. The recent development of places like Letchworth has been a significant example of economy in bye-law requirements, and during the present crisis we have had striking instances in houses erected in munition areas which are deemed quite satisfactory, but which do not conform to many of the Local Government Board's Model Bye-laws or to the usual demand of city and borough surveyors. Attention may be drawn in this respect to the houses erected at Queen's Ferry, under the superintendence of Mr.

Raymond Unwin, and at Sheffield, which will form excellent examples of economy in requirements.

With regard to the second recommendation, the cost of the making of roads is a factor of the greatest importance in the building of working-class houses; under the old conditions, when houses were built with a narrow frontage to the road, the cost of road making, including gable ends and back passages, frequently amounted to £25 per house. Under the new regulations imposed by the town-planning schemes, when houses are limited in number to the acre and the roads are wider, the cost of road making will absolutely prohibit the building of cottages at reasonable rents unless the builder is relieved of the heavy expense. Here again the local authorities will find that very great economies can be observed, and, by the adoption of cheaper methods of road construction and lighter specifications, they will succeed in reducing the present cost very materially.

When confidence in house property as an investment has been restored and measures taken to obviate waste and unnecessary cost in building, the house builder will be in a position to resume his business, and will build all the houses that are required to meet the needs of the people. It is assumed that the rents obtainable for the houses will be regulated solely by the law of supply and demand, any public interference or artificial limitation of rents after the war must of necessity destroy all confidence on the part of investors and render it impossible to build property on a commercial basis.

The particular need for the moment, however, is to find the houses which will be required on the resumption of peace conditions when, with the demobilisation of the armies, a great demand will arise for housing accommodation in both the industrial and rural areas of the country.

During the first few years after the war the prices of material and labour will be in a very unsettled condition, the increase in costs over the pre-war figures will be very considerable. After careful consideration we estimate that house building will cost approximately 60 per cent. more during the first few years after the war than it did before 1914. The houses which are built under these conditions will have to compete for tenants with pre-war houses, and the rents which will be obtainable will not be very much in excess of the rents which will be obtainable for the older houses. It will be impossible for houses to be built as a business enterprise unless some special conditions are arranged during that unsettled transition period, especially in view of the fact that when normal conditions are resumed the cost of building will be considerably reduced. A builder who steps into the breach and provides the houses during the unsettled period will be doing a national service at an almost certain loss to himself, and, as the need is urgent and affects the interests of the people so directly, it is a plain business proposition to request that the State should assist the builder to provide houses during the first few years after the war.

The position of the house builder after the war will be that houses costing say, £320 each, must compete with houses built before the war at a cost of £200 each. Houses cannot be erected by private enterprise under these conditions, so that it will be necessary for the Government to assist in some manner to meet the difference in cost.

We have very carefully gone into the various methods by which State assistance can be given in this matter, and we do not recommend any heroic legislation. We believe that the problem can be solved without resorting to desperate remedies.

The policy should be based on economic principles. Under normal conditions we are of opinion that State assistance would be both unnecessary and inadvisable, but under existing circumstances some form of national intervention is unavoidable. The exact method is immaterial to the practical men in the trade; if a bonus or subsidy is granted to local authorities or public utility societies it should also be extended to private house builders of established reputation, or, if cheap money is advanced for the purpose, it should be ad-

vanced to all agencies prepared to build the houses.

Bearing in mind the importance of maintaining the freedom of the trade and the necessity of preserving economic conditions, we have been brought to the conclusion that the most practical scheme is for the Government to advance 90 per cent. of the approved cost of building working class houses, including the land at 51 per cent. per annum, repayable by instalments over a term of forty years. By this means the annual charge for interest payable by the new houses and by the pre-war houses will be brought to approximately the same basis, and the rents will be fixed accordingly. The increased costs in every direction which builders and owners will have to meet will entail a substantial increase in pre-war rents in common with the higher standard of cost of living in all directions.

The above method of meeting the difficulty has certain advantages; the effect upon the investment of private capital in house property will be invaluable in restoring confidence in this class of security as a safe and desirable investment.

The suggested advance of 90 per cent. is frequently made by co-operative societies in Lancashire with marked success, and we feel confident that if the state loans are advanced only to approved substantial house builders of established reputation, there will be little risk on the part of the State of loss of capital. The proposed rate of interest in a comparatively short period after the war will probably be a normal one for Government loans. The period of repayment is suggested at forty years, for it is necessary, in order to induce investors to purchase this class of property, that the sinking fund should not absorb all the income.

There are many details which it will be necessary to observe in formulating the scheme; for instance, the builder will require to know the amount of the State mortgage he can be assured of before he commences building, and care will have to be exercised that restrictions are not imposed on a builder to such an extent that his costs will be unduly inflated. The details of working out the method of advance can be gone into when the principle is established.

The position of the house builder, even when he is placed under conditions which will enable him to build houses in competition with those built before the war, will still be a difficult one. There is more than a possibility that, in the course of a few years, the prices of materials will have decreased very considerably from those of the transition period immediately following the war, and consequently he may find a depreciation in the value of his property to a serious amount when normal conditions once more exist. We believe, however, that the house builders of the country will be prepared to take that risk on the general understanding that their efforts to provide houses at a time when houses are urgently required will be looked upon sympathetically by the Local Government Board.

We are appreciative of the efforts which have been made by the Local Government Board to encourage the building of houses by private enterprise, and we would draw attention to the opportunity of developing and extending the operations of the Small Dwellings Acquisition Act, 1899, a measure which, in our opinion, can be made of great benefit to the building of houses in certain localities.

In conclusion, we may say that if some provision such as we have outlined is made and carried out in a broad-minded spirit with a view to encouraging the erection of houses, we are confident that the house builders of the country will loyally co-operate with the State, and that the houses which will be required after the war will be built in quantities sufficient to rapidly overtake the demand.

#### TRADE NOTES.

Recent patent "air-pump" ventilators, supplied by Messrs. Robert Boyle and Son, were lately engineers, 64, Holloway Road, London, have been employed by the Cleveland Bridge and Engineering Co., Ltd., Dulport.

## Building Intelligence.

DUBLIN.—Rebuilding in Dublin is evidently proceeding apace, and the *Irish Builder* gives a number of jobs, of which we give a few condensed particulars: The rebuilding of Nos. 74 and 75, Middle Abbey Street, for Messrs. Gaynor and Son, will shortly be started. The two buildings have a street frontage of 43 ft., with an average depth of 72 ft., and 45 ft. 6 ins. high from footpath line. Mr. Francis Bergin, B.E., Westmoreland Street, Dublin, is the architect. Bills of quantities are being prepared by Mr. Edward Smith, 57, Dawson Street, Dublin. The rebuilding of No. 15, Lower Sackville Street, together with No. 14, is now being proceeded with for the same owners. Mr. William Kenny, Drumcondra, is the building contractor for both houses. The rebuilding of No. 13, Prince's Street, has been commenced. The contractors are Messrs. Shortall and Co., Parliament Street, and the architect Mr. P. H. McCarthy, B.E., Westmoreland Street. Plans are being prepared for the rebuilding of No. 73, Middle Abbey Street. The building will occupy a frontage of 20 ft., with a depth of 80 ft., and will be four stories high over basement. Mr. Francis Bergin, B.E., 36, Westmoreland Street, is the architect. The rebuilding of No. 30, Henry Street will be started shortly. Bills of quantities are taken out by Mr. James Mackey, Dame Street, and the architect is Mr. Francis Bergin, B.E., Westmoreland Street. The rebuilding of 47, Henry Street, has been commenced. The contractors are Messrs. P. Shortall and Co., Parliament Street. The preparatory work in connection with the rebuilding of No. 51, Henry Street, for Messrs. Hayes, Cunningham and Robinson, has been started. The builders are Messrs. O'Rafferty and McGahan, Great Strand Street, and the architects Messrs. Moore, Keefe, Donnelly, and Robinson. Alterations are being carried out to the premises of Messrs. Robert Smyth and Sons, Stephen's Green, Dublin. Mr. R. Ellis is the contractor, and Mr. R. M. Butler the architect.

Last year £33,179 was spent by the City of London Corporation in respect of the paving of City streets. Asphalt cost £19,492, wood £11,811, and stone £1,875.

The death has occurred at Whitstable, at the age of seventy-two, of Mr. J. T. Reeves, who for many years carried on business as a auctioneer. He was one of the oldest local professionals.

A litany desk, placed in the "war corner" of Bainton (York) Parish Church, is constructed of pieces of carving and handiwork which previously formed part of the old chancel screen.

The Chester City Surveyor (Mr. W. Mathews-Jones) has met with a painful accident at Banzor. He was on the railway platform, preparing to return home, when he slipped and dislocated his right knee.

While trench digging at Newhaven soldiers discovered several bronze implements in the chalk in a good state of preservation. They are supposed to date from about 700 years B.C., and are now in the museum of the Sussex Archaeological Society.

The Health Committee of the Carlisle City Council last Friday considered a circular received from the Local Government Board proposing Government assistance in regard to housing schemes for the working classes. The committee decided that there was urgent need for additional housing for the working classes, and appointed a committee to submit recommendations to an early meeting with a view to such need being met at the earliest possible moment.

When the Newton Rural District Council considered the circular letter from the Local Government Board with regard to the housing question, the chairman said that it seemed to be egregious nonsense. There was a war on, and the overworked officials all over the country were asked to go forward with this matter, which could be easily dealt with during three months of the end of the war. They were setting bowing up the off-ends and return-making, and it made his blood boil.

## Our Office Table.

Experiments in France begun early in 1917 have resulted in the production of an excellent cement as a by-product of beet sugar refining. The first step in the production of sugar from beets is boiling them. It has heretofore been customary to throw away as valueless the scum formed on the cauldrons. But it has now been discovered that this scum contains large quantities of carbonate of lime. It is estimated that 4,000 tons of the carbonate can be recovered from 70,000 tons of beets. To this quantity of the carbonate 1,100 tons of clay are added, the resultant product being a cement which, according to *La Revue* (Paris), is of "perfect quality." The best scum is pumped into large reservoirs and allowed to evaporate for a certain length of time before being mixed with the clay. It is then stirred or beaten for an hour before being fed into a rotary oven, such as is used in making Portland cement.

In connection with the rebuilding of a Bridgeport, Conn., car line it was necessary to trim off a 16,000-foot stretch of monolithic pavement to an unbroken straight edge alongside the track. Faced by the prospect of employing a gang of twenty-five men with picks and shovels on this work, the company's superintendent, using only standard equipment, put together a machine that accomplished the work cheaply, rapidly, and with complete satisfaction. The business end of this home-made apparatus consisted of a cutting wheel about 20 inches in diameter, similar in construction to a glass-cutter. The heavy iron frame carrying this wheel was hinged to the side of a single-truck flat trailer, so that it would follow the uneven surface of the pavement. In order to make the wheel bite additional weight had to be supplied directly above it. This was accomplished by laying a track across the trailer car, and out on top of the frame of the cutter; and on to this was run a small track carrying two tons of old axles. The entire cost of this outfit was a dollar and a quarter, and it cut the unusually heavy pavement with complete success.

A Russian journal reports some experiments by V. Lubimenco on the introduction of various solutions into the wood of growing trees. The solutions were introduced through a glass siphon attached to holes bored with an auger, 0.2 inch in diameter and 0.6 to 0.8 inch deep. The successful introduction of the solutions was found to depend upon the exclusion of air from the holes and upon reduced root pressure, accompanied by partial desiccation of the wood. Other things being equal, the drier the wood the greater the amount of the solution absorbed and the wider its spread through the tree. The solutions spread in all directions, both lengthwise and crosswise of the fibres. Such experiments should be undertaken during the hot and dry season, when the desiccation of wood is at its height, and among the species most subject to desiccation are pear, apple and peach. The practical value of such treatment is not indicated by the writer, but applications will, perhaps, suggest themselves.

Recent experiments have shown that reinforced concrete can be examined by X-rays, so as to give a very clear indication of its internal structure and to show the condition of the ironwork after a considerable time, such as a number of years when the concrete may require to be examined for any possible deteriorations. The experimenter made use of reinforced concrete slabs of a few inches thickness, and containing ½-inch round iron. The resulting photographs clearly showed the position and arrangement of the iron and the joints, and even the structure of the concrete itself was brought out. They made another series of tests in order to show up any cracks in the concrete, and this is of great value in practice, because such cracks will admit air or moisture to the iron parts on the inside and cause them to rust. He treats the plate by injections of a hismuth salt or powder in suspension, which is well

known to be opaque to X-rays, the solution being applied under pressure, so as to fill up all the cracks with the bismuth preparation. In this way he was very successful in locating even the finest cracks, such as will cause the entry of air to the metal.

In an opinion rendered by the Attorney-General of Idaho it is held that under the law regulating the practice of architecture which was passed by the last Legislature, no distinction can be made between architects whose offices are in another State and those whose offices are in Idaho, so long as they practice their profession in that State. It is further held that any architect who was engaged in the practice of his calling at the time of the passage of the Act is entitled to a licence without examination, irrespective of where his offices may be maintained. The construction of the law is said to be contrary to the intentions of the Idaho Association of Architects, which was instrumental in having it enacted, as it is said that one of the purposes of the Act was to make it necessary for all architects residing outside of the State to secure a licence in order to be entitled to continue to do business in Idaho.

There is one thing, the London correspondent of the *Manchester Guardian* thinks, to be said for the commandeering of hotels by the Government. It promotes cleanliness in the Government service. In one hotel some of the bedrooms which are now used for offices have bathrooms attached, and as hot water is always available it is not unusual for members of the staff to break the monotony of the afternoon routine by taking a bath—a practice which does not conduce to office efficiency, as a departmental chief insisted the other day when he discovered that his private secretary was indulging in a hot bath when he should have been attending to more urgent affairs. It not infrequently happens also that the opening of the day's work is somewhat delayed by late shavers. Members of the staff take advantage of the bathrooms to shave in Government time. It looks as though the Government might have to appoint a Bathroom Controller—a Companion of the Bath, of course!

The death of Earl Grey will remind many that after his retirement from office he was the principal promoter of the scheme for converting the Strand Island site into a great Imperial centre in London. The scheme was not carried through, but the selection of a part of this site by the Commonwealth for Australia House may fairly be ascribed to Lord Grey's *idea*. But his most fruitful work consisted in the promotion of the Public-house Trust movement, the essence of which was the principle that public-houses should be run, not to push the sale of drink, but to provide comfortable entertainment under disinterested management. Local associations were formed with a constitution which provided for the limitation of dividends, the devotion of extra profits to semi-public purposes, and the elimination of any interest in the sale of intoxicants from the manager's remuneration. They have achieved in many counties a considerable degree of success, and, in our opinion, the idea should form the basis of any effective control of the liquor trade. The old "public-house" was the club of the people. Its degradation to the gin-palace level was the work of the authors of the tied-house system, whose only object was, and is, to sell as much drink as possible, and nothing else.

At the last meeting of the Barrow Board of Guardians a discussion took place on the housing question, and fears were expressed that before the week-end many people would be ejected from their houses and put on the streets, the position being the more serious by reason of the fact that part of the Barrow Workhouse has been taken over as a military hospital, leaving next to no accommodation for further inmates. Mr. Bell stated that many Belgians were buying houses, and old tenants were being put on the streets. The chairman said the landlords were becoming alarmed at the action of the magistrates and County Court judges in delaying ejections, and now the landlords were taking action in the High Court, which was most expensive for tenants. It was stated that many widows with sons at

the front, people who kept lodgers who were munition workers, were to be ejected before the end of the week. It was unanimously decided to send a telegram to the Government pointing out that aliens and others were ejecting munition workers and other citizens, and protesting against the inaction of the Government in the matter, and calling for a stay in ejection proceedings for the duration of the war.

An "enchanted window" in the Liverpool Town Hall is the object of a curious letter from "Observer," which was published in the *Liverpool Callidroscope*, dated April, 1821. He wrote: "Go to the Town Hall, and look at the east front, in the left-hand corner, and you will behold a window in the upper story without glass and unfinished. This is the identical window which neither the power nor the purse of the whole corporate body of Liverpool can complete. Mr. Foster, the town's architect, gave it up in despair twenty years ago, and in vain has his son made the tour of Athens and Rome in search of architectural knowledge to qualify him for the undertaking. All attempts are useless; there the unfinished window remains, and must remain unless his Worship the Mayor can command old Wood, the original designer of the fabric, to come forth from the world of spirits, as Aladdin did the Genius of the Lamp, and order a completion of this window, which has for years past bidden defiance to all the authorities, taste, and genius of Liverpool."

A paving mixture, patented by G. B. McGrath, 3390, 13th Street, North-West, Washington, D.C., U.S.A., is made by adding bituminous cement to pulverised material in such quantity as to coat and bind the powder without an excess or deficiency of the bitumen, and the filler thus obtained is added to mineral aggregate, the particles of which have been previously coated with bitumen in such quantity as to fill the voids. This quantity is determined by ascertaining the density of the filler and the volume of the voids, which latter may be found by taking a known weight of aggregate for a test and measuring the amount of water added to cover this. The amount of bitumen to be used in making the filler also is ascertained by a preliminary test. The aggregate is preferably graded.

There is a great scarcity of houses for the working classes in Wallasey generally, and in the Seacombe district especially. This scarcity will be accentuated when work at the proposed new shipyards is commenced upon. After considering a circular letter from the Local Government Board in regard to the question of financial assistance in the building of houses for the working classes at the conclusion of the war, the Works Committee of the Wallasey Corporation have appointed a sub-committee, with Alderman Parkinson as chairman, to consider the question and prepare a report. A letter from the Liverpool and District Association of House Builders, offering to assist the council if required, was referred to the borough engineer, who has been asked to report upon the whole subject to a special meeting of the committee, and to a subsequent meeting of the whole council in committee.

Second-Lieutenant William Hollis, M.C., R.A., died on August 22, was the only son of Lieutenant and Quartermaster W. Hollis, A.V.C., and Mrs. Hollis, of Sussex Place, Tunbridge Wells. He was twenty-five years of age, and for two and a-half years before the war was engaged as a surveyor in the Hereford Valuation Department, being a P.A.S.I.

The death took place at Harrow on the 27th ult. in his 79th year, of the Rev. W. D. Bushell, who had been for over fifty years on the staff of Harrow School. His hobby was antiquarian research, and the results of his labours in this field took shape in numerous publications relating to the history of Harrow and of Pembrokeshire, and, in particular, of the Island of Caldey, of which he was lord of the manor. The island became his property in 1903, and he did some good work on its beautiful Benedictine monastery. His research and literary work in connection with the ecclesiastical architecture and antiquities of Pembrokeshire won him a Druid's degree from the Welsh Gorsedd.

## CHIPS.

The death is announced of Sergeant B. Boothman, assistant borough surveyor of Clitheroe.

Funds are being raised for the completion of a new Wesleyan church in Parliament Street, Morecambe.

Last year the Corporation paid £94,602 for cleansing and watering the streets of the City of London.

Mr. W. H. Wykes, surveyor to the Brickwork Rural District Council, is resigning that position this month.

Funds are being raised for building a church and institute at Finsbury Park in connection with the North London Institute for the Deaf and Dumb.

The more than usually thorough shedding of their bark by the plane trees in London—due, doubtless, to the excessive wet—is being seriously ascribed by some to the "gun-firing in France!"

Removals of human remains from the City churches of St. Vedast, Foster Lane, and St. Dunstan's, Fleet Street, have recently taken place under the supervision of the medical officer of health.

In reply to the circular letter of the East Elloe L.G.B., the R.D.C. have decided to inform the Board that the council would be pleased to build houses at the same rate as they were building prior to the war.

There are 3,600 factories and workshops, with 7,900 workrooms, in the City of London, and, as the result of 4,272 inspections by the sanitary officials, 772 defects were discovered and remedied in 1916. In connection with these businesses 15,427 outworkers are engaged.

The operative plumbers of Perth recently made an application for an increase of wages. The rate was 9d. per hour, with a war bonus of 2d. per hour. The employers, after consultation, agreed to grant 1s. per hour without war bonus, and this the men have accepted.

Second-Lieutenant Charles Henry Clifford Wellings, who was killed on August 11, aged 31, was the youngest son of Mr. and Mrs. Arthur Wellings, of Glyn Taff, Leigham Court Road, Streatham. He graduated B.A. at Oxford, and qualified as a Fellow of the Surveyors' Institute.

Lieutenant-Colonel Victor Augustine Flower, D.S.O., London Regiment, who was killed on August 15, was the youngest son of the late Sir William Flower and of Lady Flower, of 26, Stanhope Gardens. He was educated at Winchester, and practised as an architect in London and Singapore.

The salary of Mr. Thomas, deputy city engineer of Hull, has been increased by £75 to £450. Alderman Larard, in replying to some objections, remarked that there was trade unionism even amongst engineers, and Mr. Thomas's present salary was not the standard rate for a city of the size of Hull.

Mr. C. E. Price, the Member for Central Edinburgh, is urging that there should be a Scottish War Museum in Edinburgh, and is suggesting that it might be granted by extension of the Royal Scottish Museum in Chambers Street. Sir Alfred Mond, for the Government, has sent polite acknowledgment of his letter.

Mr. Benjamin Hall Blyth, of Palmerston Place, and George Street, Edinburgh, partner in the firm of Messrs. Blyth and Westland, civil engineers, consulting engineer to the North British and the North of Scotland Railway Companies, who died on May 13, left personal estate valued at £31,311, of which £27,652 is Scottish estate.

We regret to record the death of Mr. T. H. Smith, surveyor to the Ilkley District Council. On the morning of Monday, August 21, Mr. Smith, who was also waterworks engineer, left home, intimating he would be back in an hour. He was not seen alive afterwards, and search parties went out on the moor. His body was found in a pool of water at the head of Backstone Beck on Ilkley Moor. At the inquest the verdict was accidentally drowned while carrying out his duties as waterworks engineer.

At Horneslede workmen unearthed a human skeleton in a good state of preservation, together with a long sword, a large spear, and a smaller one, all of iron. The sword, which is double-edged, is 53 in. long, 1½ in. wide, and tapers at the top. The spears are both socketed, and the larger one, still containing the rivets which hold the shaft, is 102 in. long, somewhat lozenge-shaped, and 1½ in. across at the broadest part. The smaller example is more knife-shaped, and is 7½ in. in length and 3 in. in width. The *Times* suggests they were brought by Anglo-Saxons from Schleswig.

FOR  
**Olivers'****Seasoned****Hardwoods,**

APPLY TO—

**WM. OLIVER & SONS, Ltd.,**  
120, Bunhill Row, London, E.C.**TENDERS.**

\* \* Correspondents would in all cases oblige by giving the addresses of the parties tendering—at any rate, of the accepted tender: it adds to the value of the information.

**BANTRY.**—For repairs to schools, for the Education Committee.

Accepted Tenders:—Goodway and Sons, Christ Church school, 25 10s.; Grimsby Council school, 24; Church of infant school, 42 15s.; crockery school, 47 15s.; F. Bernard, St. Mary's school, 43 7s. 6d.; Dabwood Road school, 16 15s.; Hawtin and Sons, St. John's school, 47 10s.

**BIRMINGHAM.**—For painting work at the houses and buildings at the higher works, for the town council.

F. Robson (accepted) . . . . . 114 9 6

**CLONES.**—For the Board of Guardians, for alterations and extensions to the infirmary.

McGoldrick and Moran, Clones 4,646 15 0  
John Tierney, Clonista . . . . . 397 0 0  
Joseph McMahon, Clones . . . . . 204 0 0  
Accepted.

**DUNDEE.**—For work to be done at the Diamond Well, Moy, and for supplying and erecting new pump thereon, for the Dundee Rural District Council.

Landland and Sons, Church Street, Dundee . . . . . 427 10 0  
A. C. Simpson, Railway Street, Armagh (accepted) . . . . . 97 0 0

**LIMSFELD (SHERBY).**—For laying 990 yards 6-in. stoneware sewer, 263 yards 6-in. cast-iron sewer, with manholes and lampoles in connection therewith, and construction of sedimentation tanks and bacterial filters, for the God-tone Rural District Council. Mr. T. C. Barralet, M.L.M.B.E., surveyor.

Whitney, Hammersmith . . . . . 41,395 0 0  
F. Harris and Co., Guildford . . . . . 1,553 0 0  
A. J. Tully, Croydon . . . . . 1,280 0 0  
T. Dickson, St. Albans . . . . . 1,233 0 0  
B. Hemmings, Thornton Heath 1,203 0 0  
Surveyors' estimate, £1,330.

**LANDED.**—For decorating the cemetery chapel, for the urban district council.

J. R. Rowlands (accepted) . . . . . 426 15 0

**NEWHAVEN.**—For painting portions of the exterior of the workhouse, for the guardians.

W. H. Callaghan, Merchiston Road, Newhaven (accepted) . . . . . 424 15 0

**NORWICH.**—For making a footpath at Ambley Steep, for the Northwiltshire Rural District Council.

J. and E. W. Bloughby (accepted) 433 9 2

**ST. PAVES.**—For repairs, etc., to nurses' home, to 11, Amphill Square, for the St. Paves Board of Guardians.

J. and B. Harris, High Street, Camden Town . . . . . 434 0 0  
Accepted.

**STIRLING.**—For painting work at the Manse.

T. Carson and Son . . . . . 426 0 0  
Accepted.

Workmen are completing a memorial in St. Giles' Cathedral, Edinburgh, to the father of the present Duke of Argyll. A slab of white marble enclosed in grey marble is being placed under a commemorative window above the interior communicating gate between the Cathedral and the Chapel of the Knights of the Thistle. An inscription on the slab records its purpose.

**TO CORRESPONDENTS.**

We do not hold ourselves responsible for the opinions of our correspondents. All communications should be drawn up as briefly as possible, as there are many claimants upon the space allotted to correspondents.

It is particularly requested that all drawings and all communications respecting illustrations or literary matter, books for review, etc., should be addressed to the Editor of the BUILDING NEWS, Effingham House, 1, Abchurch Lane, Strand, W.C.2, and not to members of the staff by name. Delay is not infrequently otherwise caused. All drawings and other communications are sent at contributors' risks, and the Editor will not undertake to pay for, or be liable for, unsought contributions.

When favouring us with drawings or photographs, architects are asked kindly to state how long the building has been erected. It does neither then nor us much good to illustrate buildings which have been some time executed, except under special circumstances.

\* \* \* Drawings of selected competition designs, important public and private buildings, details of old and new work, and good sketches are always welcome, and for such no charge is made for insertion. Of more commonplace subjects, small churches, chapels, houses, etc.—we have usually far more sent than we can insert, but are glad to do so when space permits, on mutually advantageous terms, which may be ascertained on application.

Telephone: Gerrard 1291.

Telegrams: "Timeserver, Estrand, London."

**TERMS OF SUBSCRIPTION.**

Twenty-six shillings per annum (post free) to any part of the United Kingdom; thirteen shillings for six months; for the United States, £1 10s. (or \$7 30s. odd). To France or Belgium, £10 10s. (or £12). To India, £10s. To any of the Australian Colonies, or New Zealand, to the Cape, the West Indies, or Natal, £1 10s.

\* \* \* Our Direct Subscription Agents for Australia are Messrs. E. T. Kibblewhite and Co., Printers and Publishers, 19, York Chambers, 105, Liverpool Street, Sydney, New South Wales; for Japan, The Maruzen Co., Ltd., 11-16, Nishimbashi Tori Sanchoe, Tokyo who will receive Subscriptions at £1 10s. per annum on account. Copies of this paper will be sent by us direct to the subscribers' address.

RECEIVED.—REV. F. G. T.—J. W., Ltd.—H. M. F. E. P. Ltd.—P. C.—S. E. Co., Ltd.—G. S. and Co., Ltd.—B. S. Co., Ltd.—W. and O., Ltd.—W. B. E. H.

B. L. J.—No.

Col. D.—Best thanks; yes.

R. G.—Sorry, but we have no time to search back for you.

C. M.—We have no information. Very soon you will be able to find out quite easily who were, and who still are, agents in all trading firms, thanks to the two recent Acts dealing with the registration of businesses and companies, which we believe will prove as salutary as they were badly needed.

OUR LAST BOUND VOLUME.—Our apologies are due to readers, and the trade, for the delay in publication of our last bound volume, which ended in June. It is no fault of ours, but due to the unavoidable inability of the binders to get cloth and boards. We are proud the volumes now in a few days, when deliveries shall be made at once.

The Minister of Munitions has issued an Order under Regulation 50a of the Defence of the Realm Regulations by which he declares that steel scrap of all classes and description is "war material" within the meaning of the Regulation, and cannot, therefore, be dealt with without a permit. He also issues a notice of the modification of the general permit in regard to dealing in wrought iron scrap.

**TO ARMS!**

COUNTY OF LONDON VOLUNTEER ENGINEERS (FIELD COMPANIES).

Headquarters, Balderton Street, Oxford Street, W.1.  
ORDERS FOR THE WEEK BY LIEUT. COLONEL  
C. B. CLAY, V.D., COMMANDING.

OFFICER FOR THE WEEK.—Second Lieutenant F. Bowen.

NEXT FOR DUTY.—Second Lieutenant E. A. Ullmann.

MONDAY, SEPT. 16.—Technical Instruction (Searchlight) for No. 3 Coy. Right Half Coy., at Regency Street. Drill, No. 3 Coy. Left Half Coy., Signalling Class, 6.30. Recruits Drill, 6.30.

TUESDAY, SEPT. 17.—Physical Drill and Bayonet Fighting.

WEDNESDAY, SEPT. 12.—Drill and Elementary Bridge Construction for No. 1 Coy. Right Half Coy.

THURSDAY, SEPT. 13.—Drill and Elementary Bridge Construction for No. 3 Coy. Right Half Coy., Signalling Class, 6.30. Ammunition Class, 6.30.

FRIDAY, SEPT. 14.—Technical Instruction (Searchlight) for No. 3 Coy. Left Half Coy., at Regency Street. Drill, No. 3 Coy. Right Half Coy., Recruits Drill, 6.30.

SATURDAY, SEPT. 15.—Commandant's Parade for Route March and Drill. Parade, Golden Green Station, 2.45 p.m. Uniform.—"A" and "B" men are reminded that one Route March per month is compulsory. Recruits Drill, 2.30.

UNIFORM.—"A" and "B" men are warned to attend Headquarters on Tuesday, Sept. 11, to be measured by the regimental tailor for the Service Uniform.

MISKETRY.—All N.C.O.'s and men who have signed the "A" and "B" agreements are required to attend during this month to reclassify in order to enable the Corps to obtain the Capitation Grant. Preference will be given to these men in firing. This does not apply to those who hold the proficiency badge.

ARMLETS.—The new issue armlets can now be had at Headquarters, and every enrolled man must obtain the "A" and "B" armlets. All old red armlets (now obsolete) must be returned.

NOTE.—Unless otherwise indicated all drills will take place at Headquarters.

MACLEOD YEAKESLEY, Capt. and Adjutant.

September 8, 1917.

The Eagle Hut, erected by the American Y.M.C.A. in Aldwych, for the accommodation of soldiers of the Republic visiting London, was formally declared open by the United States Ambassador on Monday afternoon.

We regret to announce the death, killed in action, on August 22, 1917, of Captain Seymour Burnell Tubbs, Gloucestershire Regiment, second son of Mr. and Mrs. Percy B. Tubbs, of 2, Moore Street, Cadogan Square, S.W.5.

Shortly after Parliament meets Mr. Fell, as Chairman of the House of Commons Channel Tunnel Committee, will seek an opportunity for the discussion of the subject, and, if possible, for a division to be taken on a motion, of which notice has been given.

The Grille has now been removed from the Ladies' Gallery of the House of Commons. It is understood that Sir A. Mond, the First Commissioner of Works, has decided that one panel of the Grille shall be kept at the House of Commons as a relic. Another is to be presented to the London Museum. The remaining panels are to be stored for future use, if possible.

Seventeen hundred new houses are required in East Denbighshire to meet the increased population and to replace dwellings condemned as unfit for habitation. This statement was made in a report by the engineer and the medical officers of health at a meeting last Thursday of the Wrexham Rural District Council. Sir Watkin Wynm, who presided, said the scheme would involve an expenditure of about half a million sterling.

**GALVANIZED CORRUGATED ROOFING SHEETS.****BEST QUALITY.**

Perfectly and thickly coated  
with zinc, insuring real  
durability.

PROMPT DELIVERY can be given,  
to any ordinary

**GOOD STOCKS**

kept at our London Works in  
all the usual lengths  
and gauges.

whether straight sheets or curved  
radius.

**FREDK. BRABY & CO., LTD.,** 352 to 364, EUSTON ROAD, N.W.1, **LONDON.**  
IDA WORKS, DEPTFORD, S.E.8.

# THE BUILDING NEWS

## AND ENGINEERING JOURNAL.

**Edinburgh House.**

Corrente Calamo .. .. .	201
The Old Houses of Parliament and Parlia- ment Square, Dublin .. .. .	202
Artificial Fuel .. .. .	203
Wood Fires .. .. .	204
Architectural Pictures at the A.A. .. .. .	204
The A.A. School of Architecture .. .. .	204
Our Illustrations .. .. .	217
Correspondence .. .. .	217
How Alkali Affects Concrete .. .. .	217
Housing Accommodation at Sunderland .. .. .	217
Column Fire and Load Tests .. .. .	218

**CONTENTS.**

Obituary .. .. .	218
The Trades Union Congress and a National Housing Policy .. .. .	218
Building Intelligence .. .. .	218
Legal Intelligence .. .. .	218
Trade Notes .. .. .	218
Competitions .. .. .	219
Our Office Table .. .. .	219
Tenders .. .. .	220
List of Tenders Open .. .. .	220
To Correspondents .. .. .	220
To Arms! .. .. .	220
Latest Prices .. .. .	viii.

**Strand, W.C.2.**

**OUR ILLUSTRATIONS.**

The Old Houses of Parliament (at present used as the Bank of Ireland) and Parliament Square, Dublin (Trinity College, where the Irish Convention is now being held), from etchings by Myra K. Hughes, A.R.E.

"Wallingford," Parly., Surrey. The Garden Front. Detail of the entrance front and plans of the house. Mr. Sydney I. Tatchell, F.R.I.B.A., Architect.

Church of St. Luke, Thornton Heath, Surrey. Mr. William A. Pite, F.R.I.B.A., Architect.

### Corrente Calamo.

It is gratifying to notice that the recent action of the Architectural Association admitting women to its school classes is attracting the commendation of the lay Press in a greater degree than anything done by the representative bodies of the profession for a long time. Says the London correspondent of the *Liverpool Post and Mercury*—

An extremely interesting innovation in view of the needs of the after-the-war period is the arrangement by which, after seventy years, the Architectural Association is to open its schools this autumn to women students. It is not a new thing that women should practise as architects, but a very few in actual work, and it has been possible for them to take degrees in architecture in various of the new universities. But the Architectural Association is so important a body in the profession that its denial of educational facilities to women must have hampered the advance of the sex in a profession which has always been considered the special province of man, and the new departure will place woman on equal educational terms for the first time. I cannot help wondering what will be the result in the architecture of the future. I think it is reasonable to assume that 1914 marks the end of a period in architecture, and that whatever may be the name given to the period it will begin with the enormous work of rebuilding Europe after the war. Architecture as an art rather than a profession has little to its credit in the last fifty years, but the work of trying to replace the glorious buildings destroyed and to be destroyed by the barbarians will open to the architect of the coming generation an impulse which in the natural evolution of mankind will probably beget inspiration. Will woman's share be that of strength or weakness in the new age? Will she be the apostle of marble or of-stucco?

That we shall see; but in no other educational body is she likely to find inspiration and good comradeship as genuine and healthy as at the A.A., which has been the real *alma mater* of the greatest of our architects of the past half century, and membership of which is a well proved guarantee of lifelong fraternal relations which no other school or institution supplies.

Not much was said at the Trade Union Congress about the project of combined action between the trade unions and the co-operative societies, and the employment of trade union funds in connection therewith. So far all previous talk about any such movement has ended there, and little wonder; for as regards the majority of co-operative societies, especially in London, articles mostly in demand by the workers are obtainable elsewhere of better

quality and at lower prices. We suggest, as we have suggested before, that a more profitable use of their funds by the unions would be found in the building of decent houses for their members, either for rental or purchase by instalments on the lines of the old building societies. As a commencing experiment the unions connected with the building trades might well move in this direction. The members of such unions are quite capable; they should know what they want, and there is the opportunity of proving to the world that good houses can be built under trade union rules, if only proper direction is available. If the trade unions "showed willing" in this business, they could go to Government for aid with a much cleaner sheet than the local authorities, who have done next to nothing, and who, whatever they may do, will only add to the burden of the ratepayers. The trade unions could also work more cheaply than the utility companies or similar organisations. Really good plans are at last at their disposal, and their adaptation to special needs should be easy under competent architectural direction. Moreover, as, an object lesson a start would be of immense service. Why should not some union get into touch with Mr. Thomson and build a dozen or a score of houses embodying the solution of the problem of the perfect dwelling, and challenge comparison with all the Departmental Committees' attempts as regards cost and fitness?

At last Wednesday's meeting of the Manchester City Council the report of the Traffic Congestion Special Committee was accepted, a resolution moved by Alderman Wilson, the chairman, "That the council, without committing itself to the details of the various schemes embodied, approves the general principles set forth in the report now submitted," being adopted. On the question of the old Infirmary site, Alderman Wilson expressed pleasure that many of the difficulties in regard to the utilisation of the site had been overcome. The proposal now was to run tram lines behind any building that might be put upon the site. In that way the citizens might have a noble building there, a tram terminus and an open space. Alderman Johnston proposed the further considera-

tion of that portion of the report which suggested the widening of Aytoun Street for traffic purposes, and thence along a proposed new road in continuation of Aytoun Street to join London Road at its junction with Whitworth Street; and the making of a new road which cut through land behind the School of Technology. Several members objected to Mr. Johnston's speaking, as it concerned details which would come up at a future time for consideration, but he insisted on his right to speak now, and this the council conceded. His proposal, however, was negatived. Councillor McLachlan moved that the debate be adjourned for a month, but the council would not assent to his proposition. Councillor Margaret Ashton, pointing to the Infirmary's old site as shown on a big cartoon on the wall of the Council Chamber, expressed the hope that care would be taken in erecting any building there not to put it on the skew. Alderman Plummer said it would be a fatal mistake not to take such care. Having got to "general principles," it is to be hoped Manchester will at last redeem its character and build the art gallery it has so long been deprived of by its obstructives on its council.

A glaring instance of the cost of land transfer is afforded by a recent transaction at Aldeburgh. On July 17 last an Order was obtained from the Court as to a plot of land for the taxation of the costs, for computation of the corporation's claim for principal and interest to the date of payment out of Court, for the payment from the £45 (proceeds of sale) of the solicitor's and auctioneer's charges, and the principal and interest due to the corporation, and for the payment into Court of the balance (if any). The result of the sale did not provide sufficient for the payment of the principal and interest due to the corporation, as will be seen by the following account:—Receipts: Sale of land, £45. Expenditure: By taxed costs of summary proceedings, £4 18s. 6d.; ditto enforcing charge, £19 1s. 8d.; ditto auctioneer's charges, etc., £6 6s. 6d.; other disbursements, £4 11s. 5d.; Court fees, £11 3s. 10d.; amount of apportionment, £6 17s. 2d.; interest at 5 per cent. per annum from date of service of demand (December 13, 1912) to July 26, 1917,



£1 7s. 6d.; total, £54 16s. 7d. The deficit of £9 16s. 7d. has to be met from the general district fund account. One is hardly surprised that local authorities hesitate to buy or sell land under such circumstances. But there is probably little chance of reform while so many lawyers sit in the House of Commons!

A very interesting account is given in a "Professional Paper just published by the Ordnance Survey (New Series, No. 4, 1917, 6d.)" of the re-levelling in 1915-17 of a hill running from Axmouth, on the English Channel coast, to three points on the southern coast of the Bristol Channel. When the last revision was made in 1837-38 by a committee of the British Association, under the direction of Mr. T. G. Bunt, of which an account will be found by him and Dr. W. Whewell in the British Association Report for 1838, the terminal points were marked with metal bolts to afford a basis for a comparison of the lines then determined and at any future period. When the revision of the primary levelling network of Great Britain was undertaken the revision of this particular line was included in order to see whether there was any indication of earth movement, and in the course of the last three years it has been found practicable to carry out this work by the reserve levelling staff which has to be maintained at Southampton. The discrepancy between the older and the new levelling from Axmouth to Perry Farm, a distance of fifty-seven miles, is but 0.92 in., though at Stolford, fifty-five miles, it reached 2.11 ins. The amount of the accidental and systematic errors of Bunt's levelling computed by the formula adopted by the International Geodetic Commission is 1.0 mm. and 0.9 mm. per kilometre respectively, against the limits of 1 mm. and 0.2 mm. per kilometre, as laid down by international agreement for precise levelling. The conclusion arrived at is that there is no evidence of any change in the relative levels of the marks near the shores of the English Channel and the Bristol Channel. The statements of the instruments used and the methods of work of the two surveys will be read with interest as indicating the differences in professional work during the two periods.

As "Bonus Bonds" for national purposes seem likely to be sanctioned by Parliament, perhaps we shall have "Bonus Building Bonds" suggested presently for the construction of perfect dwellings. The worst of it is, the only building lottery of the sort, favoured though it was by the Corporation of London and sanctioned by Parliament, was hardly a success. The *City Press* recalls the history of the scheme in its issue of Saturday last. In the early days of the nineteenth century the City determined to widen Fleet Street near Temple Bar, and incidentally to make Skinner Street and Pickett Streets. War, however, broke out again, and although the Government of the day did not stop building, prices rose and labour was scarce, and there was trouble as regards ways and means. In the end the lottery was arranged, and 15,000 tickets

were issued at £7 apiece. The tickets, however, went off so slowly that the day for the drawing had to be postponed several times. Eventually, however, the lottery was drawn, and the prize-winners found themselves the owners of more or less eligible freehold property for a mere matter of guineas. The latter-day history of the thoroughfares was not over-bright. At any rate, the City knows neither Pickett Street nor Skinner Street any more. Their identity is lost in the new thoroughfares that have since sprung into existence through the construction of the Holborn Viaduct and the clearance for the Royal Courts of Justice.

#### THE OLD HOUSES OF PARLIAMENT AND PARLIAMENT SQUARE, DUBLIN.

These two architectural etchings by Myra K. Hughes, A.R.E., have been issued just lately, and the pair forms part of a capital set of five prints illustrative of typical old buildings in Dublin. Quite apart from their excellence these companion pictures possess a very special interest at the present time, because of the Irish Convention now being held to consider the question of Home Rule for Ireland. Should such a measure be agreed upon, it may be reasonably assumed that the "Old Houses of Parliament" in College Green, represented by the one drawing, will be adapted and utilised for the new Irish Assembly. The Conference is now sitting in "Regency House," shown in the centre of the other view herewith reproduced. The room devoted to the Trinity College, just below the clock set in the tympanum of the big pediment overlooking Parliament Square.

In the year 1783 the historic Irish representative Parliament, inaugurated in 1374, gave place to that known as Grattan's Parliament in 1800, when the first election to the Imperial Parliament took place. This was just twenty years prior to the death of Grattan. Ever since the dissolution of his Parliament the Government buildings have been occupied by the Bank of Ireland, which was established by Royal Charter in 1783, during which year the Bank opened business in St. Mary's Abbey. The Old Parliament House was started under the Viceroyalty of Lord Carteret, and stands on the site originally occupied by Chichester House, overlooking College Green, at one time designated "Hoggin's Green," a place used for the execution of criminals. In 1727 George II. granted a charter to Dublin, and the erection of the Parliament House began in 1729, about the same time as George Dance the elder commenced the Mansion House in London and the "Classic Wood," of Bath, started Eagle House, Bathford, and St. John's Hospital in that city, somewhat before the execution of his Prior Park.

At this date the Irish Parliament met in the Blue Coat Hospital in Dublin. The Parliament House took ten years to build. Its architect was Richard Castle, who also went by the name of "Cassel," and still continues to be wrongly called by some writers "Castell."\* He was quite

the most accomplished and successful architect of his day in Ireland. Sir Gustavus Hume induced him to come over to Ireland from Germany in 1720. He was born of German parents in 1691, and died in 1751. R. Castle only published one pamphlet, and is not to be confused with R. Castell, the author of the folio of the "Villas of the Ancients," published under the patronage of Lord Burlington in 1728, and said to have died in the Fleet Prison in 1729. Richard Castle became very prosperous, and was long a freeholder in Dublin, living in Proud Lane at the rear of the Lord Chancellor's Garden. When he died he left a fine collection of architectural books and works of art. He commenced practice on Castle Hume, and erected the Marquis of Waterford's house, now used by the National Society's School in Marlborough Street, Dublin. Leinster House, designed in 1745, was his great Dublin work, and it is occupied now by the Royal Dublin Society in Kildare Street. The front only stands of Lord Eective's house by Castle in Smithfield, but the Lying-in Hospital, which he carried out in 1751 for £20,000, is his typical work. For the Duke of Leinster Castle also built the mansion known as Carton, in Kildare, and remodelled its pre-Georgian parts. This great house has a palatial centre block, with wings all in cut stone. Castle met with his death suddenly when superintending its erection. He was buried in Maynooth at the age of sixty. On the foundation stone of Carton his name appears as "Richardo Castello, archt."

Among his other works of importance are the houses in Henrietta Street, where Lord Blessington lived, and Montjoy House, close by. No. 80, St. Stephen's Green, now part of Lord Iveagh's large mansion, and the now Crown Hotel, in Sackville Street, formed out of his houses erected in 1750. No. 20, Kildare Street is a large residence of similar plan to "Hortland," Co. Kildare (1748). Other works by Castle include his only brick house at Ballyhaise, Co. Wick, also Tyrone House for Sir Marcus Beresford, 1740, which was the first Irish house in modern times entirely built in stone. Powerscourt House he re-erected in 1731, also Molyneux House, Abercorn House, and Hazlewood House, Co. Sligo, at other times.

Richard Castle was more under the influence of the Jacobean styles and Early Renaissance than his predecessors and contemporaries. His wall decorations in stucco were panelled and very difficult to hang with pictures, though very stately and handsome, as at Russborough for Lady Milltown, this work being very like Bowood, in Wiltshire. Castle was very happy with his Venetian fenestration. Granite was employed at Russborough from the Golden Hill quarry, from whence came also the stone used at Trinity College. David Bindon was partner with Castle at this last-named house. Summerhill he built in 1731. It is regarded as Castle's *chef-d'œuvre*, in the palatial manner of Vanbrugh, large and masterful in scale.

The official records give no reference to Richard Castle in respect to the Parliament House, while prominence is accorded to Sir Edward Lovet Pearce, the "Surveyor-General," who is said to have supervised the undertaking. This was, however, completed, in so far as the first contract was concerned, by Arthur Dobbs, his successor to the State office. The cost of this initial section up to 1739 was £40,000, but the total outlay amounted to £94,000 when the premises were finished in 1794.

\* R. Castell's "Villas of the Ancients," 1728; "History of the County of Dublin," John P. Alton, 1838; "Dublin and its Environs," 1846; Thom's "Directory of Dublin"; Black's "Guide to Dublin"; A. P. Society "Dictionary"; Gilbert's "History of the City of Dublin," 3 vols., 1854; "Calendar of Ancient Records of Dublin," J. T. Gilbert, 9 vols.; Warburton and Walsh's "History of the City of Dublin"; "Georgian Society of Dublin" publications, 6 vols.; J. T. Smith's "Archæological Rambles in the Streets of London," and Methuen's "Dublin" (Town's Series).



The additions on the east side for the House of Lords, including the portico, King's rooms, and the splendid "Composite" colonnade, were commenced in 1770 from the plans of the famous architect James Gandon, the most distinguished pupil of Sir William Chambers. He was born in 1742 and died in 1825. Like his master, he displayed a preference for Roman architecture, and evinced perhaps a rather mechanical bent in his compositions, though as an architect he certainly was distinguished by considerable imagination as well as powerful originality in constructive enterprise. The County Hall and prison built at Nottingham were his early works, won in competition when he was 28 years of age, and he received the Royal Academy Gold Medal for Architecture in 1768. The noble Custom House at Dublin (1781) and the Four Courts, with a frontage of 500 ft. along the King's Quay on the Liffey, are his masterpieces. Some chaff was indulged in owing to the free character of the Composite style adopted by Gandon when he added his well-known colonnade to the Irish Parliament House and someone asked him, "What order do you call that, Gandon?" "It is just," said he, "the simple order of the House of Lords."

He completed this extension about 1785, and two years later the west front, comprising the House of Commons, with its oval-shaped assembly hall, was commenced by Robert Parke, the architect who finished the job in 1794. These flanking additions are nearly of equal extent, and they both cost £25,000. The old Parliament House thus completed was purchased by the Bank of Ireland early in the nineteenth century for £40,000, less than half its actual cost, and the bank contracted to pay a ground rent of £240 a year. The interior has been considerably changed with the altered destinies of the buildings, and the bank as it stands is described as being approximately semi-circular in form on plan. In the tympanum of the original central pediment of Richard Castle's structure occur the Royal Arms, and on the apex is surmounted by a colossal statue of "Hibernia," supported by "Fidelity" on the west and "Commerce" on the eastern point. The style employed in Castle's façade is of the Ionic Order. Little structural alteration has happened in the building formerly devoted to the House of Lords.

The quadrangle of Trinity College, Dublin, is one of the finest collegiate enclosures to be seen in any country, being no less than 560 feet long and measuring from 212 feet to 270 feet in breadth, surrounded with monumental buildings of dignified importance. It was formed by the union of "Parliament Square" and "Library Square," and was finished in 1759. The external façade of Trinity College facing College Green to the right of the old Houses of Parliament, looking towards that front, is 500 feet long and entirely constructed of ashlar. The design is modelled on the Corinthian Order, with a vast pediment in the centre over the chief entrance leading through into the quadrangle, as depicted in the second etching given to-day. The ends of this external frontispiece are finished by bold, lofty pavilions, with attics crowned by open balustrades. On the north of Parliament Square is the College Chapel, with its dominating tetrastyle portico of Corinthian columns and capitals seen in the picture. The Examination Hall or Theatre of the College is about the same size as the chapel, and stands exactly opposite, with an elevation similar in treatment and importance.

It may be added that these etchings of

old Dublin can be had of the artist's agent, at 15, Gloucester Road, S.W., or of Mr. W. R. Deighton, 4, Grand Hotel Buildings, Trafalgar Square, W.C.

#### ARTIFICIAL FUEL.

It is not very evident to us, especially after interviewing one or two coal merchants, how the new coal regulations are going to help the consumer much during the coming winter if the war lasts. It is, therefore, much more to the purpose to do all everybody can to utilise the waste which, in spite of the liberal admixtures thereof with the coal shot into our cellars, is accumulating in the vicinity of the mines, as it always does when prices go up and cartage is restricted. The principal discouragement confronts us in the fact that of the many attempts made in the past none can be pronounced a commercial success. The number of patents taken out during the past half-century has been considerable. Most of them proved failures either because of the inventors' ignorance of the calorific value of the ingredients with which they mixed their dust or because their product proved more costly than coal itself. Most of the processes of the past may be divided broadly under two heads, viz., the fusing and the cementing methods; the former almost always applicable to bituminous coal only, the latter to anthracite dust. One of the earliest and the most promising of the former was that patented by Bessemer, which consisted simply in heating the coal dust till it was partly melted, or made plastic enough to be forced through a mould—a conical tube down which it was urged by a piston, the mass being thus compressed into cylindrical pieces, which were afterwards divided into convenient sizes. The machinery, however, so frequently gave way, and so much coal had to be burnt to heat the dust, which, moreover, was found when fused to have lost most of its volatile constituents, that the process was abandoned. Two other patentees sought to overcome these difficulties by compressing the dust without heat by powerful machines, but their cakes of coal proved so tender that they returned to dust under all but the most careful handling. One Baroulier, a Frenchman, employed a hydraulic machine to press the dust into circular moulds, open at both ends, and then placing them in an oven at a heat of 400° Fahr. Many of these moulds were baked at one time, and plates were placed between the moulds to keep in the volatile matters, so that the fuel proved more profitable in combustion than Bessemer's. But the cost of production proved the stumbling-block, and the process proved a commercial failure.

The cementing patents were the more numerous—partly, of course, thanks to the British patent system which allows inventors to patent their "discoveries" over and over again. The first English patent of this kind was taken out in 1799, and the inventor might perhaps have claimed almost everything that has been tried since as an infringement of his rights, for he included nearly everything down to "broken glass" and "any other combustible ingredient." Curiously, he does not specifically mention peat, possibly because the failures before his time to utilise that material were discouraging. A patent for using charred peat in the smelting of iron had been granted as early as 1727. The first patent for coal dust and tar was taken out in 1821, and claimed the use thereof in the proportions of one bushel of coal dust to three quarts of tar, "either in a pure state, which is best, or combined with naphtha and those other ingre-

dients with which it is generally found impregnated." The product was called "gaseous coke," and the mixture had to be formed into lumps and baked in an air-furnace heated to 350° Fahr. The same inventor had in 1820 patented a mixture of coal dust with charcoal, breeze, turf, cork cuttings, peat, or "other inflammable ingredients," which presumably was a failure, or he would not have come along afterwards with his "gaseous coke." In 1835 we come across a patent with something like a clear and definite specification as far as ingredients went, but nothing is said about the method of manipulation. The constituents were 1 ton of small coal, 50 lb. of tar, 180 lb. of dry mud, clay, or marl, 50 gallons of water, and 30 lb. of lime or chalk. Several other patents were taken out in this year, in one of which we find for the first time the mention of liquid pitch. In 1840 there is a specification for 400 lb. of tar, 105 lb. of clay, and 1 ton of small coal; and in the same year the use of pitch is again claimed by another patentee in the proportions of 20 lb. thereof to 1 cwt. of coal dust.

By this time the use of pitch as the cementing material instead of tar seems to have met with some success in France, for in 1843 M. Marais, who for ten years previously had been experimenting with tar, set up a factory near St. Etienne for the manufacture of a fuel consisting of coaldust and pitch. His trade flourished, and for many years his successors carried on the business. From 1843 to 1860 little was done here except on the lines before mentioned. In the latter year, however, an inventor came along with a mixture of ground pitch, tar, and coal, to every ton of which were added 6 lbs. of powdered resin and three gallons of boiled linseed oil—a somewhat curious utilisation of a "waste material." The dense smoke produced by the pitch rendered all these fuels detestable in houses, and in 1845 we come across the first record of the addition of salt or alum to combat the nuisance. In 1845 another inventor sought to add gutta percha or indiarubber to his auxiliary ingredients in the proportions of 3½ parts of either to 4 parts of coaldust, 2 of sawdust, and half a pound of tar. Some twelve years later rye-flour was selected by one patentee as an ingredient, and in 1860 equal parts of animal (including human) excrement, combined with sawdust, chips, small coal, and one-sixth part of clay was patented. In 1861 one aspirant solved the problem after a fashion by enclosing his coaldust in wooden boxes about the sizes of bricks. These burnt well, but with too much flare, and the cost of the wood rendered the combination too costly for the average householder. In 1864 a somewhat elastic specification proposes to unite 100 lbs. of coal or coke to from 1 to 10 lbs. of peroxide of manganese, 5 to 50 per cent. of sulphate of lime, 2 per cent. of rosin and asphalt, 7 per cent. of oil, and 12 to 20 per cent. of rosin or pitch.

With a few exceptions most subsequent processes have been more or less adaptations of previous patents. The only real progress, if any, seems to have been made in the United States and on the Continent, probably because coal is generally dearer there than here. In America one method has had some vogue by which coaldust and clay is cemented with milk of lime, the mass being formed into egg-shaped balls coated with a waterproofing composition which renders them inflammable. Quite forty years ago or more the inventor, M. Loiseau, patented the process which required somewhat costly machinery, in this country, and there was more talk about its certain success than subsequent events seem to have justified.

As regards the future it seems likely that the success of any inventors will depend less on the discovery of new and cheap ingredients than on the more perfect action of the mixing machinery, and as small as possible quantities of the combustible matters added to the waste coal. It is, of course, easier to say this than to suggest, as ere now we should probably have been on the way to the Patent Office with a more definite specification we trust than some of our pioneers, and having exercised some little care in searching the records of the office to make sure we had not been anticipated. That in the successful application of ideas we have offered a substantial return will gratify the successful inventor we have little doubt.

### WOOD FIRES.

With coal scarce and the supply of artificial fuel problematical, it becomes many of us to utilise wood as fuel where it is available, as it is much oftener than many take the trouble to discover. Properly burnt there is no fire so beautiful as the wood fire on the hearth, or so economical. Every bit of the ash, too, is valuable in the garden, the smell of the smoke is pleasant, and not poisonous, like coal and gas, and the housemaid appreciates the less labour in the removal of the comparatively small refuse and the absence of smuts.

The worst of it is wood fires will not burn in our modern grates with their narrow chimneys. But this is remediable, and not a few will thank Mr. W. Robinson, the well-known author of "The English Flower Garden," for telling us how in his new book, "My Wood Fires," just published at the offices of *Country Life*, 20, Tavistock Street, Covent Garden, at five shillings. Moreover, we hope another aim of Mr. Robinson may be successful—that he may lead all of us to think more about wood as fuel, especially in those parts of the country where woodland has been destroyed or neglected. Much land of no real arable value would grow wood well quite good enough for firewood, and the culture of it would give many thousands opportunities for healthy open-air work of the sort so many have learned to appreciate in allotment and garden lately.

Mr. Robinson soon found that, owing to closeness of construction of our chimneys, the air in our modern rooms is not always sufficient to feed a wood fire, and therefore it is essential to bring the air in from the outside under and round the grate, up the sides and into the chimney. The air is thus heated automatically, and rises just in the right place. This Mr. Robinson learned in France, where the wood fire is still much more common than here. The smaller the rooms the greater difficulty is experienced about the draught, but Mr. Robinson has tried the plan in various houses with success. It is, of course, easier to carry out when building a house, but even in old cottages it has been found to answer.

Mr. Robinson deals at length, and with the aid of fifteen excellent illustrations, with his subject in detail. He leads off with one of a hall fire in a house built for him by the late Mr. George Devey, architect, who, he suggests, may have left the details of the chimney to his clerk, for while the hearth was made for a wood fire the chimney was left so narrow that it could not be used for a wood fire, and not well for a coal one. After the endurance of the sight of it for some years, and under the benign influence of Sir Ernest George,

he rebuilt the chimney from 9 in. by 9 in. to 14 in. by 14 in., and all has been right since.

The next illustration, that of an old Dutch copper with its inviting bundles of faggots showing at the top, is alone enough to tempt one to get rid of the coal fire at once, and with it the average hideous coal-scuttle. The fireplaces in the author's hall, smoking-room, dining-room and bedroom are all excellent examples of successful adaptation, favoured by acquisitions few of us probably are likely to be lucky enough to make, or to utilise so skilfully; but there is one in a moat cottage which will send some of us searching for another of its sort with nothing in the way of a chimney "but a vast cavern going up through the middle of the house, allowing the rain and snow to come in freely," that we may convert into a tiny temple of comfort on the lines illustrated, not forgetting to add the "Bender," a simple contrivance made by a local smith for Mr. Robinson for moving a kettle in any direction without soiling the hands, and if possible a fireguard of the old French pattern shown next.

The next chapter, "Working the Wood Fire," must be carefully read by all intending wood-burners. It is practical and every hint easy of adoption, especially as regards the waste of wood. The modern maid, we fear, will still pile on the logs to three times the extent needed, and insist on a clean sweep out of all the ashes daily. Now, a good wood fire is not to be had without plenty of ashes. With them, moreover, by making a hollow and putting half-burnt sticks in and covering them over with some of the dead ash the fire can be kept in all night, and a glowing nest of fire left till morning, which makes the kindling of the brands an easier matter. Then all day the fire should be kept low and gentle, as the old people did who had no matches and no wood to waste.

Cooking with wood fires, we are assured, is easy with proper ranges, such as those made in Vienna and in Buda Pesth, where it is not the ambition of the founder to put as much iron into his kitchen as he can induce builder and user to pay for, as it is here. Even without them French-women, where wood is abundant, will cook a good dinner with a simple down fire and a small charcoal bench, impossible as it may be for the average British housewife to credit it.

One closes the book almost wishing the war may last long enough to bring the advantages of the wood fire home to everybody, and to convince us all that many of the men working underground to get us fuel would be far more healthfully employed in growing and cutting it in the woods around us, on the millions of acres that might be planted with more profit than any other crop will ever bring. Then, added to all our miseries in the next war precipitated on us by our politicians, we should at any rate not have to endure a coal famine. Nor should we need long to smother in the embraces of the smoke fiend. May Mr. Robinson's most timely book help to bring it about. If it does, verily he will deserve a statue a thousand times more than any pseudo "daylight savers!"

### ARCHITECTURAL PICTURES AT THE A.A.

A small collection, privately arranged, is now on view at the Architectural Association premises, 35, Bedford Square, which will be found admirably representative of the water colours and etchings of Mr. W. Walcot, whose name is a sufficient guarantee of much interest and individual character. The display is limited to eleven frames, four subjects only

being in colour. The foremost and most striking picture in the room represents the interior of the Cathedral of Yspensky, Moscow, where the Tsars were crowned. Mr. Walcot has chosen an ideal subject, abounding in the realities of this gorgeous sanctuary. midst the quartette of water colours on this wall of the gallery this composition exhibits his capabilities perhaps most fully. The artist has given a solemn dignity to the whole, while deepening the religious air of the scene with a distant haze; set off by the brilliant flash of sunshine pervading half of the solid enclosing tall iconostasis in front of the high altar. The three gigantic candelabra, all so massive in scale, are wonderfully well drawn with an adroit use of ultramarine blues dexterously mingled with splashes of vermilion.

The largest picture bears no title, but shows a cortile with an arched alcove behind a gallery supported by Corinthian columns and raised marble terraces right and left of the central arena. Bright emerald green, representing presumably Verde Antico veneerings to the walls, presents a foil to the brilliant ruby arras over the portal, the whole notion being eminently rococo and grandiose in the handling.

"The meeting of Antipas and Vitellino" is another stately decorative piece of colour work set within an ancient classic city wall. In the centre is a rose-tinted baldachin, carried in a procession next an emerald canopy or figure trophy. The red-brown coated figure to the front of the grouping adds emphasis to the perspective of colour which finds its completion in the crowd wending its way at the rear through the lintel-spaced dark entry in the high-light of midday. "The Arch of Triumph," from the Royal Academy (1190) this year, shows another assembly of pedestrians, while a cavalcade, bearing the military national colours, is passing under the shadow of the archway. The stately adjacent is introduced in the most elementary manner in case otherwise it might detract attention from the passing scheme of colour. A reverse etching is shown of this picture on the other side of the room. The etching of a Roman Amphitheatre, shown next to the last, we are familiar with; having seen it at the Academy and elsewhere. "Patricians arriving at the Forum" is another, but much smaller, example of Mr. Walcot's skill with the needle-point, and a further large print shows "Antony in Egypt," seated on an elephant with a massive colonnade to the right, all being Oriental in conception and richness. Six architectural little studies in the streets of London are grouped in one frame, including St. Mary le Strand and Gilbert's fountain in Piccadilly Circus. The exhibition remains on view to members and their friends till the middle of October.

### THE A.A. SCHOOL OF ARCHITECTURE.

#### PRIZE-GIVING FOR 1917.

The school prize-giving was of necessity a very modest affair this year. It was the first function held in the new premises, and owing to the general upheaval caused by the move it was not made public.

Mr. A. G. R. Mackenzie, in the absence of the president, distributed the prizes.

The awards were made as follows:—

#### PRIZE LIST, SESSION 1917-18.

FIRST YEAR.	
1st Prize (Book, £2 2s.), C. E. Cat.	
2nd Prize (Book, £1 1s.), C. M. Masters.	
THIRD YEAR.	
1st Prize (£6 6s.), V. J. Wenning.	
2nd Prize, Andrew Oliver, £5 5s., A. K. Chaudhuri.	
3rd Prize (£4 4s.), Eric Knight.	
4th Prize (£1 1s.), B. R. Edwadia.	
Jarvis Scholarship (value £40), E. C. Century.	
FOURTH YEAR.	
Book Prize, F. Reika.	
A.A. Entrance Scholarship (value 5 guineas), P. J. B. Harland, Charterhouse School.	

Herr Georg Marschall, painter and sculptor, is declared by the Berlin tribunal to be the sculptor of the statue of Hindenburg in Berlin. This apparently disposes of the claim of Herr Seigmund Menzig, Marshall's assistant, to the "honour."

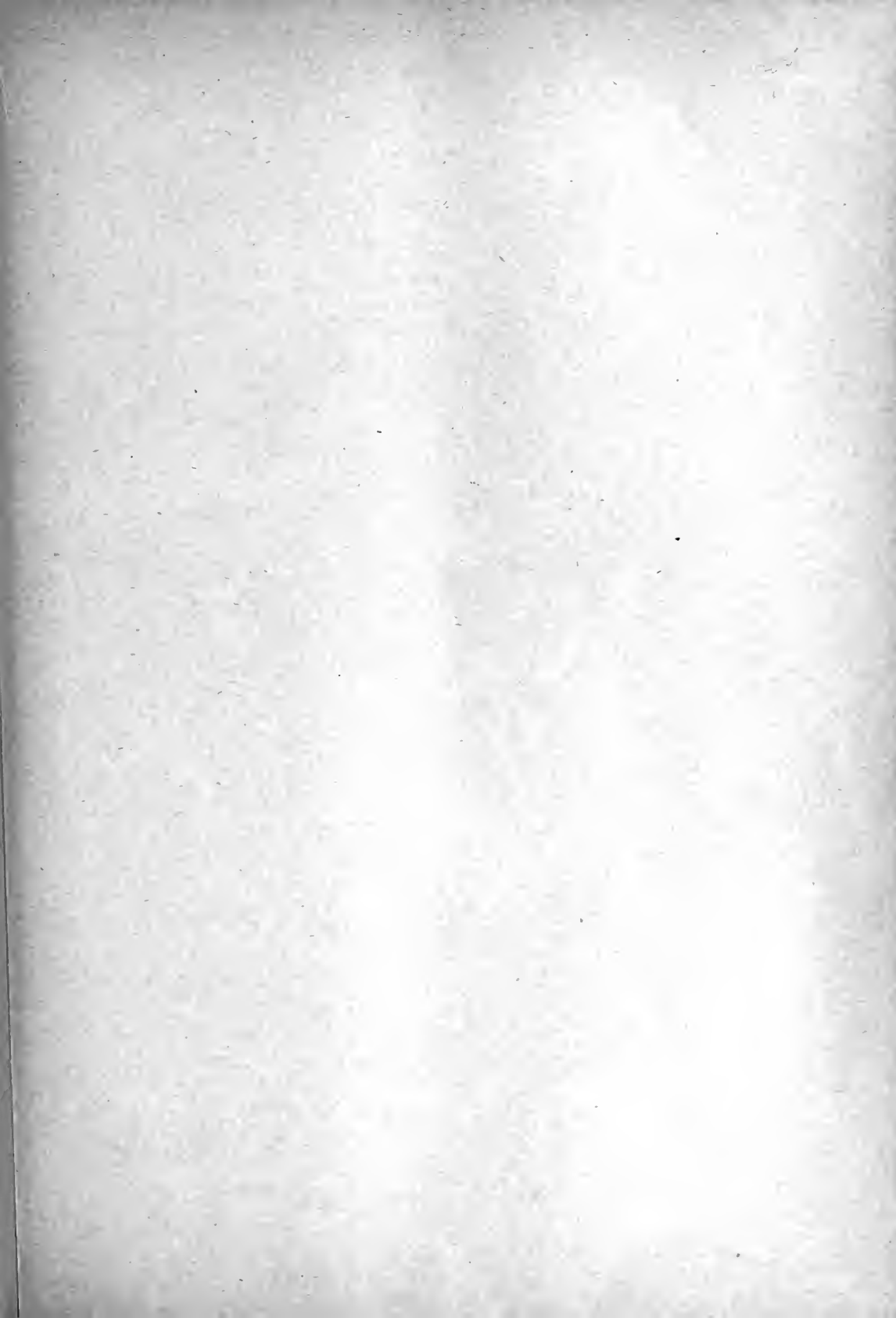



CHURCH OF ST. LUKE, THORNTON HEATH, SURREY.  
Mr. WILLIAM A. PITE, F.R.I.B.A., Architect.



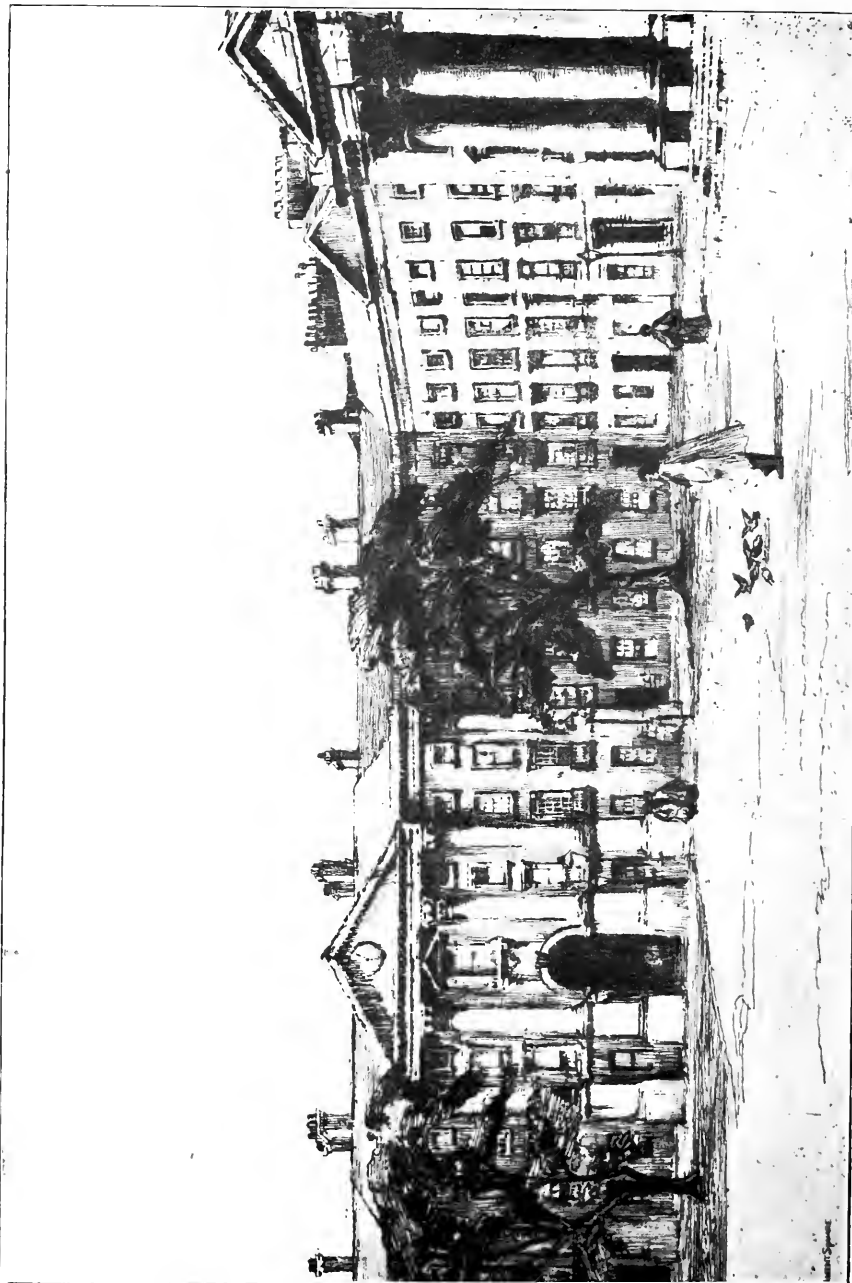

"PARLIAMENT SQUARE," DUBLIN.—From an Etching by MORA K. HUGHES, A.R.E.  
(Trinity College, where the Irish Convention is now being held, 1917.)



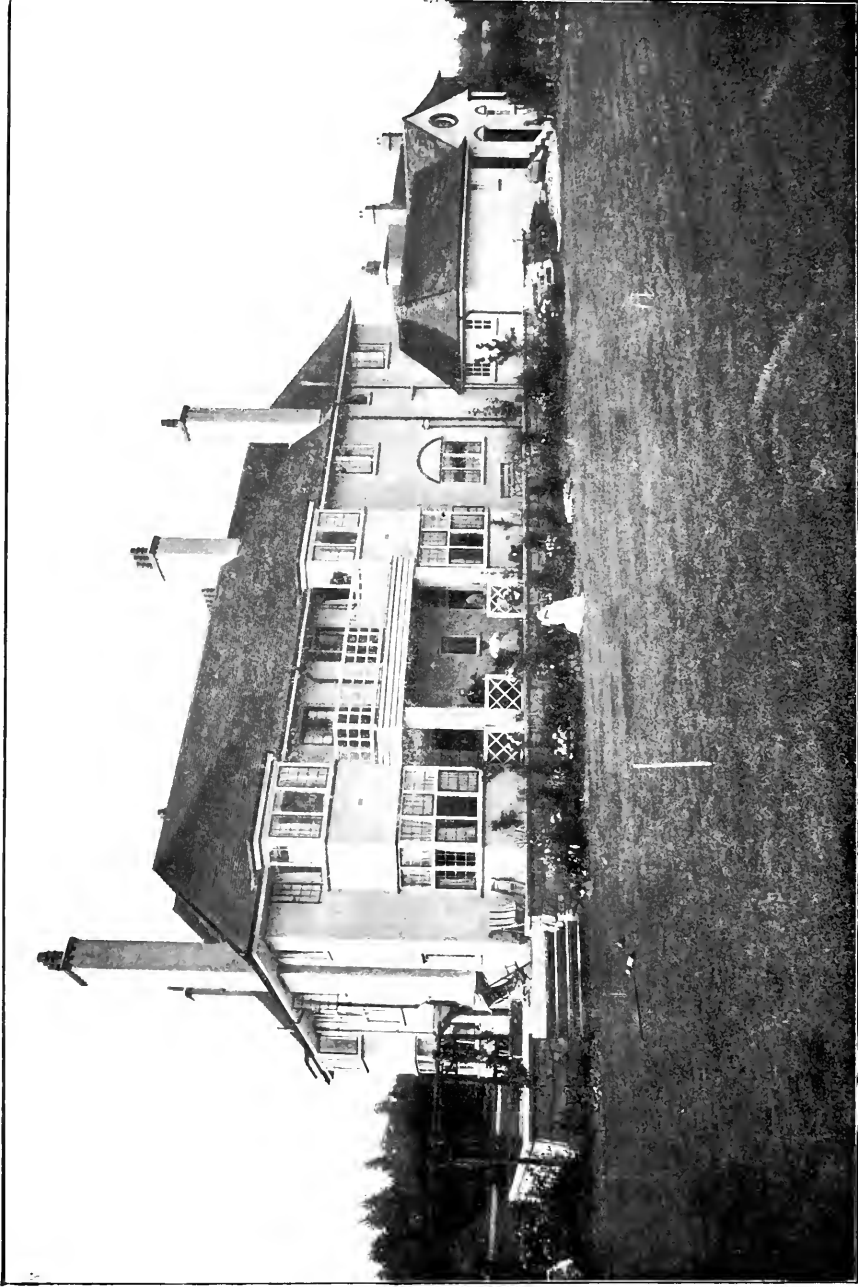

*Cyril Eltis, Photo.*

WALLINGFORD, PURLEY : THE GARDEN FRONT.—MR. SYDNEY J. TATCHELL, F.R.I.B.A., Architect.



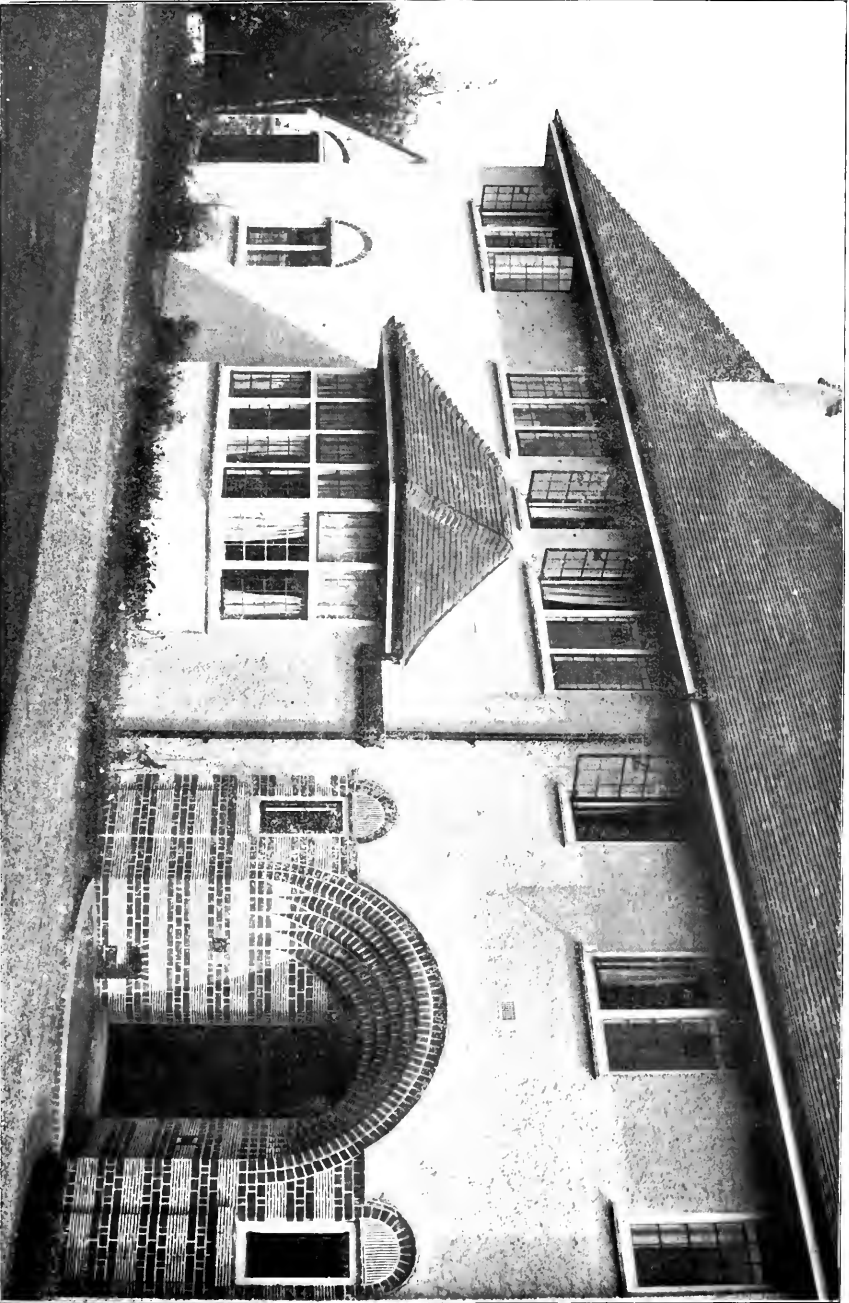

Good Brick - Portland

WALLINGFORD, PURLEY: DETAIL OF THE ENTRANCE FRONT.—MR. SNEY J. TAYNELL, F.R.I.B.A., Architect

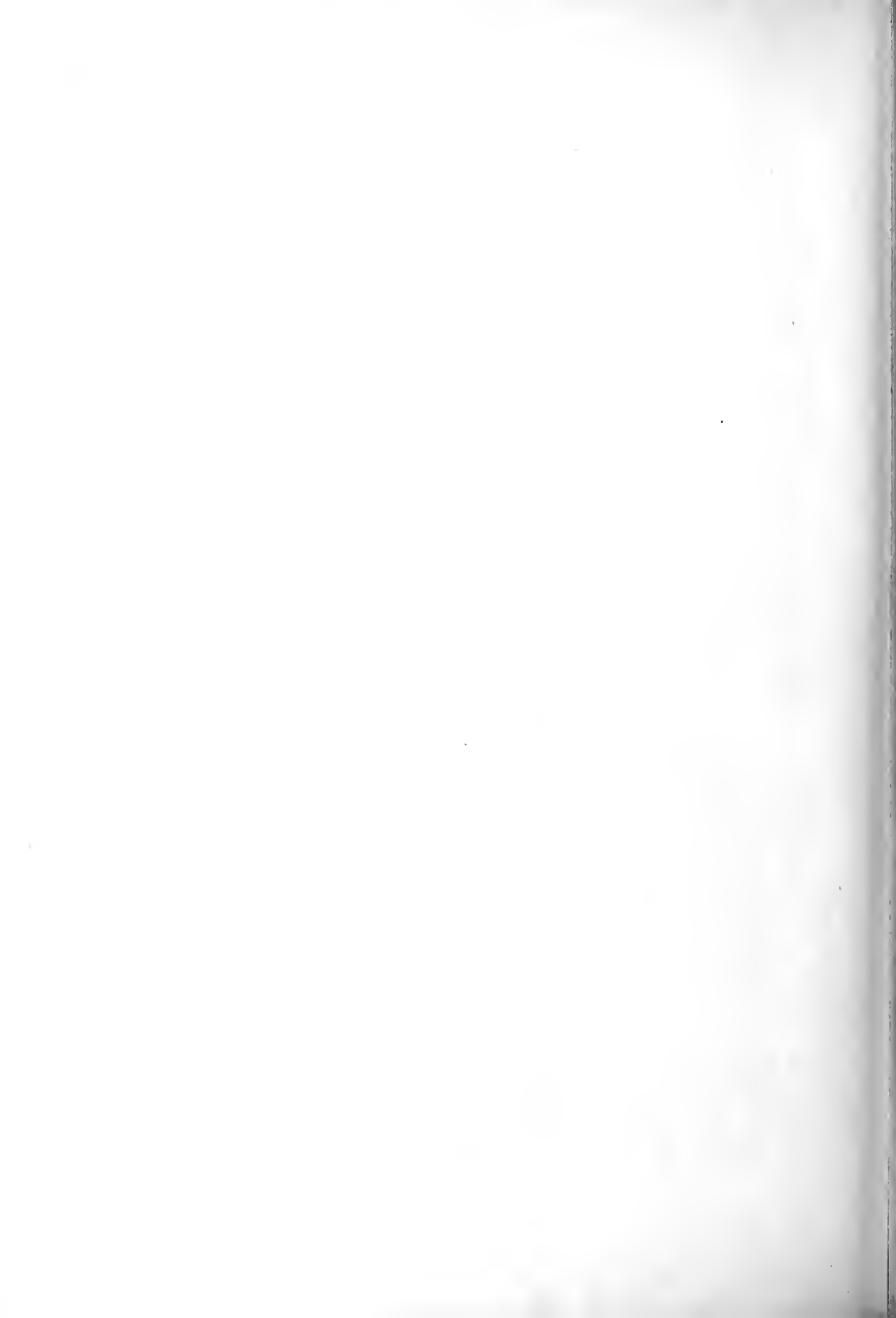

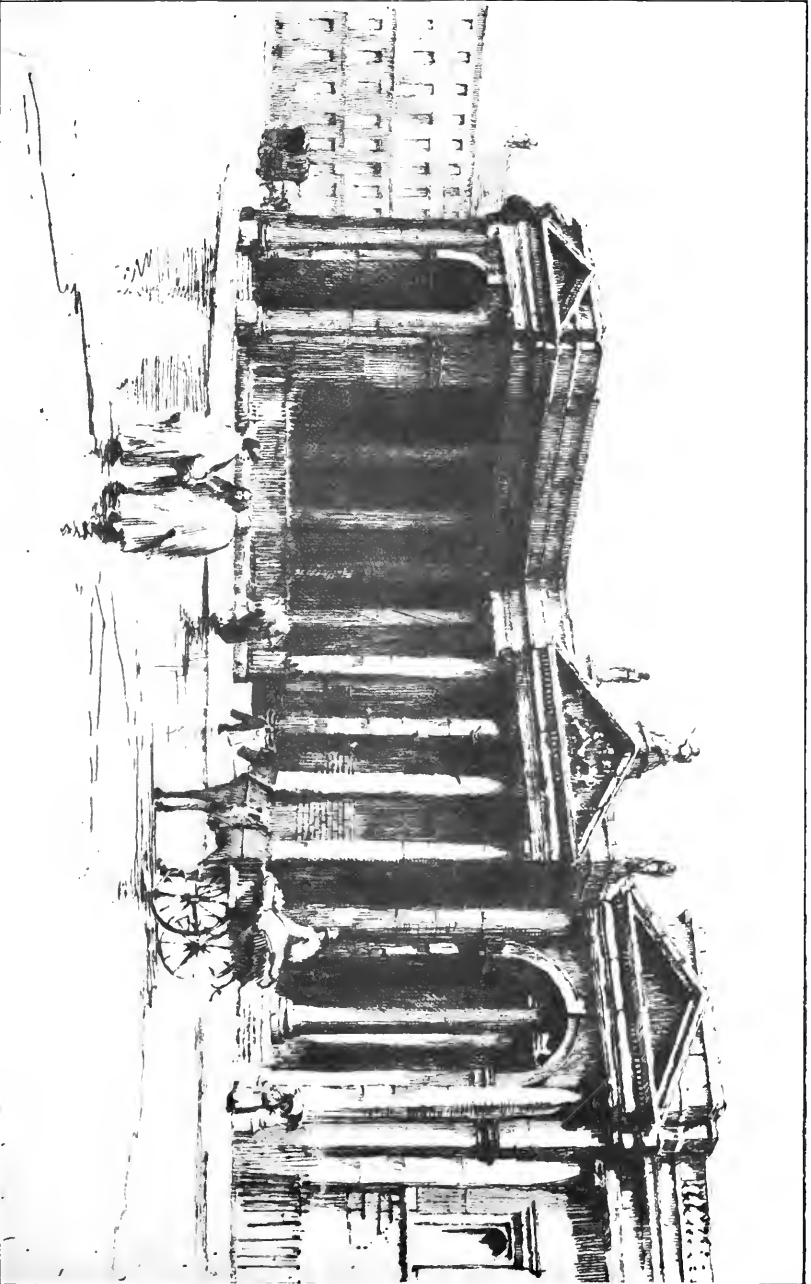

THE OLD HOUSES OF PARLIAMENT, DUBLIN.—From an Etching by MYRA K. HUGHES, A.R.E. (At present used as the Bank of Ireland, College Green) RICHARD CASTLE, Architect, 1729.



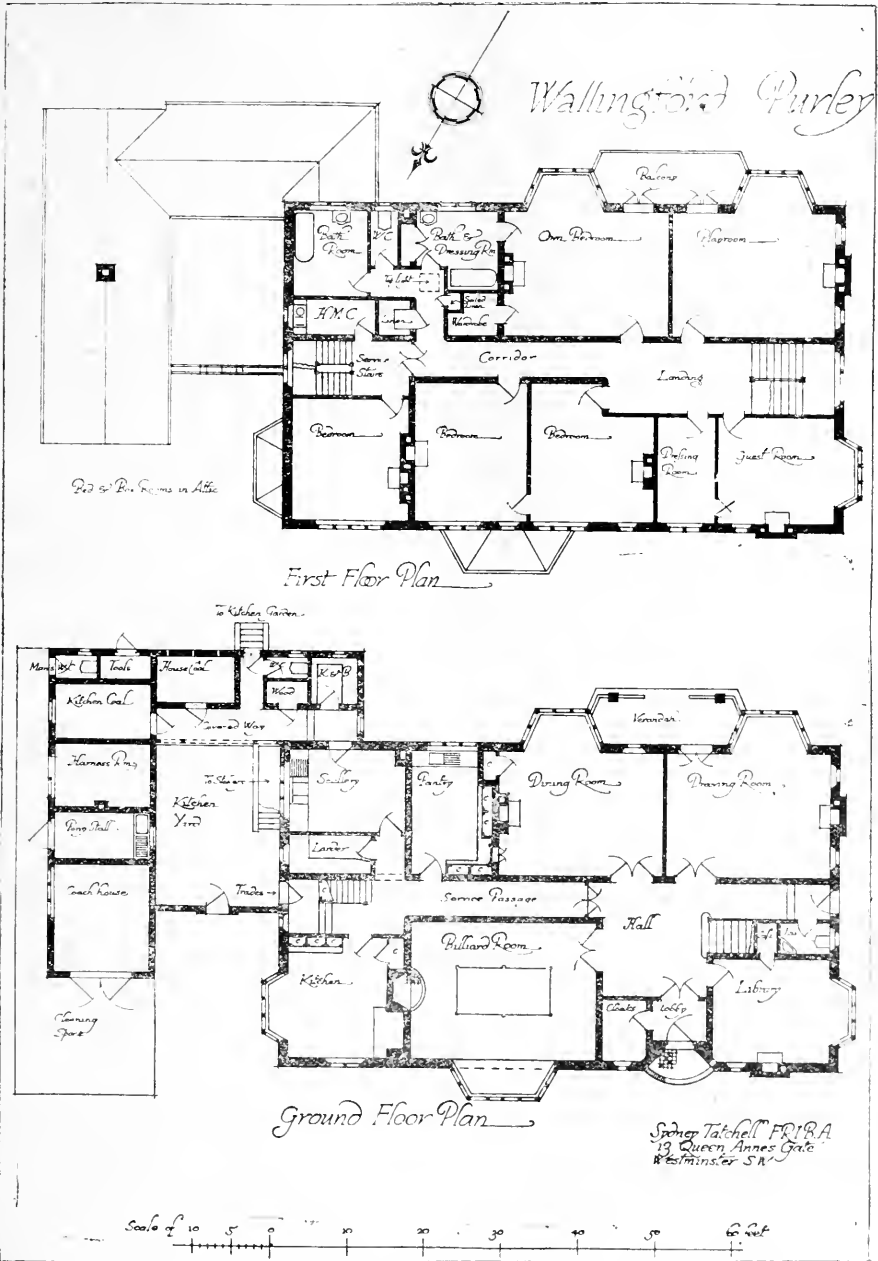

PLANS OF "WALLINGFORD," PURLEY, SURREY.

Mr. SYDNEY J. TACHELL, F.R.I.B.A., Architect.

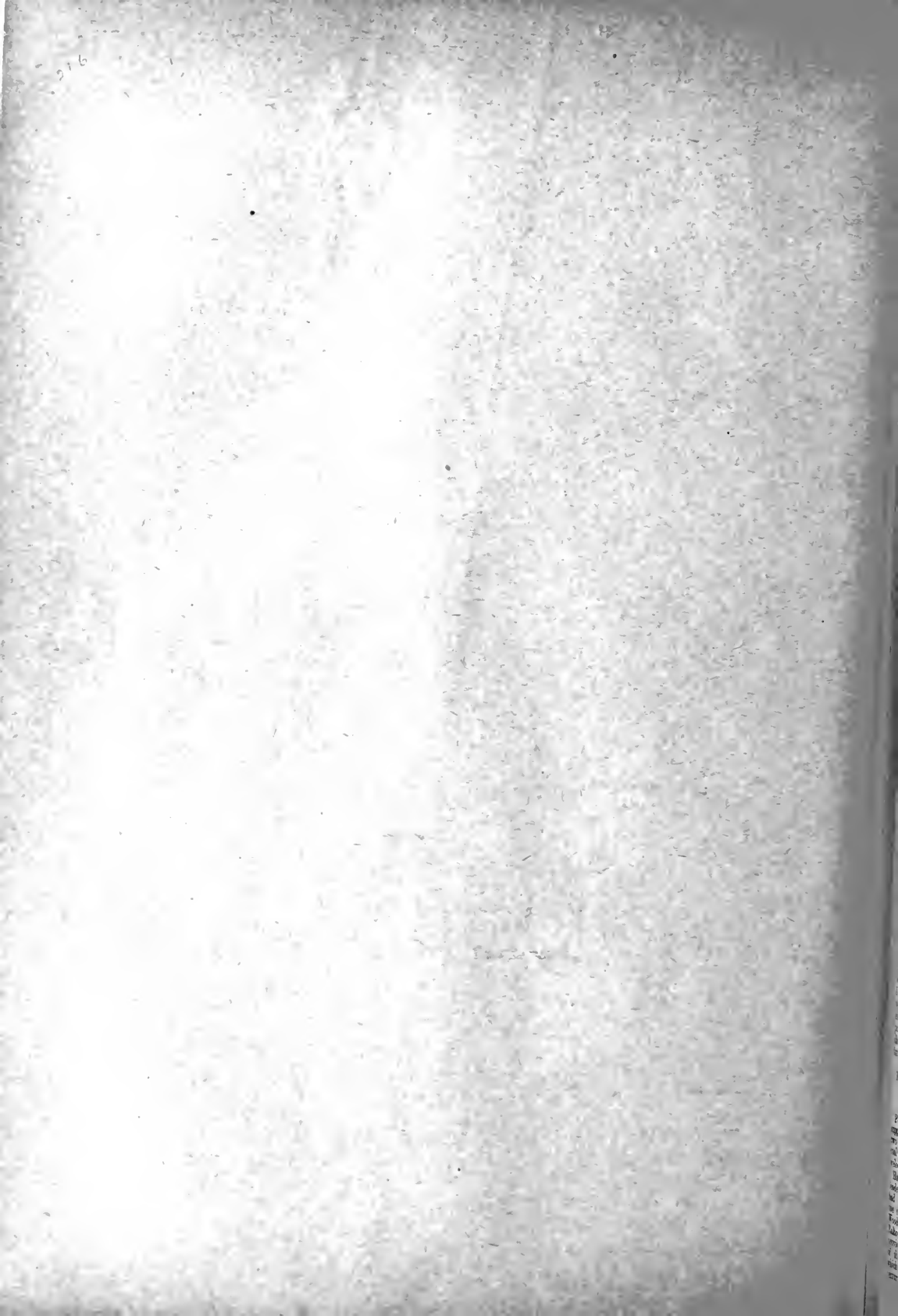

## Our Illustrations.

### THE OLD HOUSES OF PARLIAMENT AND PARLIAMENT SQUARE, DUBLIN.

A description of these two pages will be found in our first article on p. 202. More than usual interest accrues to them at the moment, as in Regency Square the present Irish Convention is now sitting.

"WALLINGFORD," PURLEY.

This house is on high ground with a slope to the south, which afforded an opportunity of forming a terrace garden. The house is planned on simple lines and with due regard to prospect and aspect. A flagged terrace, a tennis lawn and a sunk garden with a pool and fountain are formed on the south of the house, whilst on the west is a rose garden and pergola. We give the two chief plans. Messrs. Grace and Marsh, of Croydon, were the builders, and Mr. J. J. Hunt, of Mitcham, executed the garden work. The house and garden were designed by Mr. Sydney Tatchell, F.R.I.B.A., of 25, Queen Anne's Gate, S.W. These photographs by Mr. Cyril Ellis were shown at the Royal Academy Exhibition this summer.

### ST. JUDE'S CHURCH, THORNTON HEATH

The church has been planned to seat 700 persons and the site is situated in the Thornton Road adjoining the Parish Hall, which is used as a temporary church. The scheme was designed before the outbreak of the war and was arranged to be built in two sections. The architect is Mr. William A. Pite, F.R.I.B.A., of London.

## Correspondence.

### FOR THE VICTORIA MUSEUM, ALDERSHOT.

To the Editor of the BUILDING NEWS.

SIR,—A local museum has recently been instituted in this Command, and his Majesty the King has graciously consented to its being called the Victoria Museum, as it will be situated in a building known hitherto as the Victoria Soldiers' Library, which was founded by Queen Victoria in 1856. The purpose for which this library was founded is now met in other ways, chiefly owing to the creation in recent years of Command and regimental libraries.

The object of the new museum is, primarily, the preservation of records and objects of interest connected with the military camp at Aldershot since its inception in 1855, and the future maintenance of historical records connected with the place. As part of the work of the museum a brief history of the camp and of its immediate neighbourhood, including Sandhurst, is in course of preparation.

I have already received from officers and others who knew Aldershot in its early days letters and notes of the highest interest, which throw much light on a period now not easy to reconstruct. Doubtless there are in existence sketches, plans, diaries, etc., which would throw further light on this period, and I should feel grateful if the possessors of them would kindly place them at my disposal, either as a loan to the museum or for purposes of copying. In the latter case they shall be treated with the greatest care and returned as soon as possible.

ARCHIBALD HUNTER, General.  
Headquarters, Aldershot Command.  
September 6.

Pisa is now lit with natural gas, a large supply of good quality having been found some two miles from the town. The shortage of coal in Italy makes the discovery especially welcome.

Halifax Antiquarian Society, under the leadership of Mr. Alan Newell, Todmorden, had an enjoyable excursion on Saturday in the neighbourhood of Mytholm, Ralstonall Wood, Turret Hall, Castle Hill, and Lower Ralstonall, Hebden Bridge. Mr. Newell provided an interesting sketch of the history of the hamlet and manor of Ralstonall, which dates back to the middle of the 12th century.

### LOW ALKALI AFFECTS CONCRETE.

Investigations covering a considerable period have been carried out by the United States Reclamation Service, Drainage Division of the Department of Agriculture, and the Portland Cement Association of the United States, on the effect of alkali on concrete, and the results have been made public in Technologic Paper 95 of the Bureau of Standards. The investigation comprised the manufacture of some 9,000 cement drain tiles of twenty different varieties and many concrete blocks. These were shipped to various parts of the country and installed in operating drains and areas where alkali is greatly concentrated and where concrete failures had been reported.

Included in these varieties of tile were mixtures ranging from 1 part cement to 1½ parts sand to 1 part cement to 4 parts sand, both machine and hand-made, and cured in steam and by sprinkling with water. Practically all types and mixtures commonly used in the humid region are represented, as well as others of greater wall thickness and wetter consistencies than can be made by most commercial tile machines. No special compounds or treatments have been used up to this time, except that one series each of tile were dipped in cement grout and another in hot tar, while ferrous sulphate was added to the mixing water of a third.

Concrete block or short columns were moulded at Denver, using the proportions of 1:1½:3 and 1:2½:5, and a complete set of blocks were sent to eight projects of the Reclamation Service for installation in the most highly alkaline waters available on each. In addition, similar block were moulded on each project, using local materials, which were installed with the Denver block.

Crushing tests of the drain tile have been made yearly for the last three years, using a portable tile-testing machine, which can be set up at the site of the drain. The concrete block are inspected yearly, and signs of disintegration are carefully noted. Where disintegration has occurred additional block have been moulded after special treatment of the aggregates.

Samples of alkalies, soils, and drainage waters have been collected and analysed at intervals.

While complete conclusions as to the durability of concrete drain tile and concrete in alkaline soils similar to those included in this investigation cannot yet be drawn, the results of tests and observations to date may be summed up as follows:—

#### CONCRETE.

Concrete which is to be placed in alkali soils should be made of selected and tested materials, so proportioned as to produce a dense concrete. As small an amount of mixing water should be used as will allow the mix to be properly placed. Unless these precautions are taken the resistance of the concrete to alkali action will be reduced.

#### DRAIN TILE.

The following conclusions may be drawn for the use of concrete drain tile exposed to soils or waters containing alkali salts in quantities of 0.1 per cent. or more:—

1. The use of concrete tile in soils containing alkali salts in large quantities is experimental.
2. Porous tile due to the use of lean mixtures or relatively dry consistencies are subject to disintegration.
3. Some dense tile are, under certain conditions, subject to surface disintegration.
4. Disintegration is manifested by physical disruption, caused by the expansion resulting from the crystallization of salts in the pores and by softening, resulting from chemical action of the solutions with the constituents of the cement.
5. While results obtained will not permit of a definite statement as to the relative effect of the various constituents of the salts, indications are that the greater the quantity of sulphate and magnesium present and the greater the total concentration of salts the greater will be the disintegrating effect.
6. Tile made by the process commonly used, which allows the removal of forms immediately after casting, are subject to disinte-

gration where exposed to soils or waters containing one-tenth per cent. or more alkali salts similar in composition to those encountered in this investigation.

7. The hand-tamped tile of plastic consistency, as made in this investigation, are not equal in quality to machine-made tile of the same mixture, and they do not resist alkali action as well.

8. Steam-cured tile show no greater resistance to alkali action than tile which are cured by systematic sprinkling with water.

9. Tile made of sand-cement have less resistance to alkali action than tile made of Portland cement of the same proportions.

10. The tar coating as used is not effective in preventing the absorption of alkali salts from the soil.

11. The cement grout coating is not effective in preventing the absorption of alkali salts from the soil.

12. No advantage is found in introducing ferrous sulphate into the concrete mixture.

If concrete drain tile are to be used in alkali soils or water containing 0.1 per cent. or more of salts, similar in composition to those encountered in this investigation, they should be made of good quality aggregate, in proportions of not less than 1 part Portland cement to 3 parts aggregate. The consistency should preferably be quaking, which has proved the most resistant of all mixtures used. This is wetter than that generally used in commercial tile plants, and will probably require the retention of the tile in the moulds for several hours, unless some means are found to hasten the hardening of the cement.

### HOUSING ACCOMMODATION AT SUNDERLAND.

A proposal to erect not less than 2,600 working-class dwellings in the borough will be considered at to-day's meeting of the Sunderland Borough Council.

The scheme, which will be submitted by the Health Committee, is a very comprehensive one. In their report the Committee state that their interviews with the Trades and Labour Council, clergy and ministers, builders, house agents, the Property Owners' Association, lady visitors, and school attendance officers all have gone to show the need for additional housing accommodation—a fact endorsed by the Census returns of 1911, and aggravated by more recent census. There is an immediate need for at least 1,100 four or five-roomed houses, with an additional requirement of 500 houses per annum for a period of five years after the war.

Therefore the Committee recommend: That the Local Government Board be informed of this need, and, assuming that this authority will grant substantial financial assistance, a scheme for the provision of 1,100 houses is being prepared. Further, that the Board be informed that the council is of opinion that suitable sites for the erection of houses can be acquired; that no extension of existing facilities for locomotion will be necessary; that there is no probability of any houses being provided by private enterprise unless the builders are subsidised from public funds; and that the council are not aware of any proposals for the building of houses for the working classes by private owners or public utility societies.

The Committee further recommend that the Education Committee be asked whether they would be agreeable to transfer the site for the training college from the Ford Estate to another site, so that the land on the estate mentioned may be utilised for the erection of suitable working-class dwellings, and also whether the Education Committee would entertain a proposal for the site of the Bede Collegiate Boys' School being transferred from the Barnes to another site, the land to be used as an open space in connection with the Barnes Park.

Mr. Herbert J. Watson, the new president of the Land Agents' Society, passed the Associates' examination of the Surveyors' Institute in 1895, winning the institution prize, and the following year passed the fellowship examination. He succeeded his father as agent for Lord Leconfield's Cumberland and Yorkshire estates in 1907.

## COLUMN FIRE AND LOAD TESTS.

About two years ago the National Board of Fire Underwriters, the Associated Factory Mutual Life Insurance Companies, and the Bureau of Standards, acting jointly, prepared plans for a programme of testing large building columns under load, at the same time subjecting them to the usual fire tests, with the view of determining the effectiveness of different types of fireproof columns now in use or proposed. The testing machine has now been installed in the Underwriters' Laboratories in Chicago, and the tests are under way.

The collection of columns on which tests have been begun includes samples of various types. Among these are rolled steel sections, built up steel sections, steel pipe filled with concrete, and vertically reinforced and hooped columns. It is proposed also to test several wooden columns. At least one of each of the sections is to be tested without protection; others are to be partly protected with concrete, and still others will be completely protected with various thicknesses of concrete, clay tile, gypsum blocks, and plaster on metal lath, in accordance with the methods commonly employed in building practice.

## TEST EQUIPMENT OF SPECIAL DESIGN.

The test apparatus is described in *Engineering News-Record*. It is located in a fireproof building designed especially for work of this character. The central portion of the building is one storey high, with headroom of approximately 37 ft. At three sides of this portion the building is two storeys, with headroom of 17½ ft. under the second floor. The central portion of the building is provided with sliding skylights that can be opened for ventilation and with a travelling crane.

Exclusive of two shallow pits at the bottom to receive falling material and carry off the water during the fire-stream tests, the test furnace has a height of 12 ft. In horizontal cross section it is a 7-ft. square. Stationary brick walls form two of the opposite sides, while two movable brick walls in steel frames or panels suspended from overhead beams by trolleys provide the other two sides of the enclosure. The top of the furnace is of heavy fireclay blocks, supported by a steel frame. It is partly removable, to permit the installation of the columns to be tested. The bottom is formed by the fireproofing on the steel heating plate and restraining frame of the loading apparatus. Four 13-in. flues, extending from the top of the furnace out through the roof of the building, carry away products of combustion. The fixed sides of the furnace have mica-glazed observation windows, so arranged that all parts of the column under test can be observed. Eight 6-in. blast burners of special design heat the furnace.

The apparatus employed in applying the loads to the columns during the fire and the fire-stream tests consists essentially of a hydro-pneumatic ram, the pumps and tanks supplying the pressure, the necessary restraining frames and the accessory pressure-indicating, controlling, and recording apparatus.

## HYDRO-PNEUMATIC RAM APPLIES LOAD.

The ram has a rated capacity of approximately 256 tons; it is bolted to the under side of the heavy steel beams which form the top of the restraining frame, in such a manner that it will engage the top plate of the test column when that is in position. The column transfers the compression to the beams constituting the bottom of the frame, and these complete the action by transferring the stresses back to the top through steel tension cords, which form the sides of the frame. The ram is designed to maintain the load on the test column automatically and to develop characteristic deformation at the point of failure.

The temperatures within the furnace are indicated by means of thermocouples inserted through the walls near the top, middle, and bottom; temperatures at the surface of the structural portion of the test column are measured with thermocouples placed at several levels on the column.

Deformation and deflection of the column during test are taken by measuring the move-

ments of protected wires attached one on each side of the column at both ends of a 37 in. gauge length. One end of each wire is attached to the column and the other is weighted and passed over an idler at a point outside of the furnace, as far away as room conditions permit. Movement is measured at intermediate points on the wires, and true movements at points of attachment of the column are calculated from the established ratio of distances.

## EXPOSING COLUMNS TO FIRE ACTION.

For exposing heated test columns to the action of fire streams a special 4-in. hydrant is employed. There is hydrant location on each of the two sides of the furnace that have movable walls, the respective distances from the middle of the furnace being approximately 26 and 39 ft. A standard play pipe with a 1½-in. nozzle and with a pressure gauge tapped into its base will be used. The hydrants are connected with a 6-in. underground main supplied by a pressure tank and an electrically driven fire pump of 500 gallons capacity. The hose connections on the hydrants are provided with pressure gauges and 2½-in. hose valves.

After being allowed to season for a period of about a year, the column to be tested is placed in the furnace and the top and bottom bearings are adjusted for even distribution of load. The connections for temperature and deformation measurements having been made, the furnace is closed and readings on all instruments taken. The safe load is then applied, and a second set of readings is made of deformation and deflection. The gas is then ignited, and gas and air are gradually turned on, to establish the predetermined temperature rise in the furnace. It is proposed to make this uniform for all tests, although the exact temperature figure has not as yet been announced by the board.

## RECORDING OBSERVATIONS.

Readings on gauges for load, on column and furnace thermocouples for temperature and on deformation and deflection instruments are taken in regular sequence at five minute intervals up to a point near failure, the load being maintained as nearly constant as possible during the test. Observations of the visible effects of the fire on the column and its protection are made at regular intervals during the procedure.

After failure, the furnace doors are opened and the column is allowed to cool. Photographs and notes are made as a record of the general condition of the column. The covering is removed and its constituent materials investigated for deterioration due to fire.

When the fire-stream test is to be applied to a hot column, it is probable that the nozzle pressure of the hose stream will be kept at 50 lbs. per square inch and the applications maintained for five minutes, the tip of the nozzle being located 20 ft. from the column. After suitable observation of the effects of the fire and the water, the furnace doors will be closed again, and the fire-and-water treatment repeated in the same or other predetermined manner.

## OBITUARY.

We learn with much regret that Capt. George Luard Alexander, A.R.I.B.A. (Post Office Rifles, attached staff), has been killed in action. He was an architect of much promise, and was in partnership with Mr. Robert Atkinson, F.R.I.B.A., formerly of 199, Piccadilly.—Capt. Charles Gascoyne (Sherwood Foresters), whose drawings of late years have graced the walls of the Royal Academy, has died from wounds while a prisoner of war in Germany. His loss will be felt by very many architectural friends, and he was very popular among members of the Architectural Association. Mr. Gascoyne was the winner of one of the first prizes of the *BUILDING NEWS* Designing Club a few years ago.—Sec. Lieut. J. H. L. Wheatley, A.R.I.B.A. (London Regt.), has been missing since June, and is believed to be killed.—Sec. Lieut. Cecil Laurence Wright, A.R.I.B.A., of New Malden (Royal Garrison Artillery), was, we are sorry to say, killed in July.

## THE TRADES UNION CONGRESS AND A NATIONAL HOUSING POLICY.

Mr. R. Lea, Durham Miners, moved, at the Blackpool meeting of the Trades Union Congress last Saturday:

"That in view of the great shortage of working-class houses and the consequent menace to the health of the people, we call upon the Government to deal at once with this important question (1) by making it compulsory for local authorities to prepare and carry out adequate housing schemes to meet the need of their area; (2) embracing such Government grants, free of interest, as will enable local authorities to erect suitable houses for the people. Further, in view of the extreme urgency of the question, the Parliamentary Committee press for action to be taken by the Government without waiting for the cessation of hostilities."

He remarked that he came from a part of Durham where the district council had been making a return of the condition of housing. This was not quite complete, but he could tell them that in ten colliery villages with 6,780 houses 1,543 of them were overcrowded, and 1,404 did not comply with the by-laws, and ought either to be rebuilt or structurally altered. The greater part of them ought to be entirely destroyed. In the near future four district councils would be asking the help of the Parliamentary Committee to go before the Local Government Board. They intended to approach the Board to ask them to allow them to build even before the war ends. They asked the Parliamentary Committee to keep this question to the front until the people were properly housed.

Mr. F. Chandler, Manchester, who seconded, remarked that it was only recently the trade unions had given any attention to this particular question. He was convinced that private enterprise would never meet this question. They have all kinds of schemes for dealing with after-war problems, and if half of them materialised they would have a new earth.

The resolution was carried.

## Building Intelligence.

WILLINGTON QUAY.—An extension scheme in connection with St. Paul's Church, Willington Quay, which will take the form of a memorial for all young men of the district, irrespective of denomination, who have fallen in the war, has been inaugurated by the Rev. W. D. Totten, vicar of the parish. It is proposed to erect a chancel and vestries, and the additions will complete the church. A mural tablet recording the names, regiments, and place of death of Willington Quay and Howdon men who fall will be placed in the chancel. Plans are being prepared and the Bishop of the diocese has approved the scheme. The cost is estimated at £2,000, a large sum for a purely industrial district, and the vicar and churchwardens, Mr. Forster, 8, Westmorland Avenue, Willington Quay, and Mr. Lawson, 46, Armstrong Road, Willington Quay, will gratefully acknowledge any subscriptions to the fund which has been opened.

## LEGAL INTELLIGENCE.

MEASUREMENT OF TIMBER.—GRIFFIN v. EBBY.—The case of Griffin v. Lord Ebbay, Moor Park, Rickmansworth, reported in this column last week, which concerned a dispute as to the persons to be appointed to measure timber sold by the defendant to the plaintiff, was again mentioned to Mr. Justice Sargant last Wednesday. It was announced that the parties had now agreed that there should be two measurers, one appointed by the President of the Surveyors' Institute and the other by the London Chamber of Commerce, and that these two experts should have power to appoint a referee to settle any difference of opinion between them.

## TRADE NOTES.

Boyle's latest patent "Air-pump" Ventilator, supplied by Messrs. Robert Boyle and Son, ventilating engineers, 64, Holborn Viaduct, London, has been employed at the Town Hall, Bradford.



## COMPETITIONS.

WAR MEMENTO FOR RELATIVES OF THE FALLEN.—The Secretary of the War Office makes the following announcement:—The committee which has been considering the form of memento to be given to the next-of-kin of all those who have fallen in the war has decided to postpone the latest date for submitting designs for the competition to December 31, in order that those who are on active service and who desire to compete may have a greater opportunity of doing so. As we have announced the Government is offering prizes, amounting in all to not less than £500, for a limited number of the most successful models for a small memorial plaque in bronze. Copies of the instructions may be obtained on application in writing to the Secretary, War Office, or to the Secretary, Admiralty.

## Our Office Table.

The Army Council has made an Order under the Defence of the Realm Regulations which provides that such restrictions may be placed on the transport of road materials from or to particular areas or places as the Army Council may consider necessary. Contracts for the sale of road materials may be abrogated to such extent and as from such dates as may be determined by the Council to be necessary to secure compliance with their requirements under the Order. Those requirements are to be notified in the form of directions issued from time to time by the Road Stone Control Committee or any local bodies constituted for the purpose. The directions may relate to (a) the restriction or discontinuance of the transport of road material; (b) contracts which are to be abrogated with a view to facilitating compliance with directions; (c) making returns; or (d) the discontinuance or substitution of the use of any particular class or type of material. For the purpose of the Order the expression "road materials" includes all quarried stone, slag, dehydrated tar, tarred slag, or tarred stone, but not gravel or flint used as road stones.

Mr. Thomas H. Mawson, of High Street House, Lancaster, and Conduit Street, W., who had in hand at the outbreak of the war a commission for the replanning of Athens, has received a cable from M. Venizelos inviting him to undertake the re-planning of Salonika, which has been largely destroyed by fire. Mr. Mawson is organising his scheme for the creation of industrial villages and suburban settlements for partially disabled soldiers, sailors, and flying men.

The contractor in charge of certain work on the new 1,000-ft. pier in New York recently had quite a little job of pile-pulling to perform and no apparatus of recognised pulling proclivities to do it with. So he exercised his ingenuity and made his steam-hammer do the work. The procedure was simplicity itself—so simple that it would seem as though it must have been thought of elsewhere before. The hammer was merely hooked up to one of the big steel sheet-piles, and the engine induced to give a bit more of a heave than in lifting the hammer free for a stroke, and up came the pile.

The employment of wood in part replacement of coal in gas-making has lately been receiving considerable attention, and trials have recently been carried out in France on a working scale in the gasworks of Landes. The wood used was the sea pine, in the form of billets cut from the middle of the trunk. The charge of the wood was about half the weight of that of coal, and carbonisation occupied about half the usual time. When running one retort with wood to every two with coal no appreciable difference in the calorific power of the gas was noted. Of the two by-products—small coke and tar—the former amounts to 5 to 10 per cent. The tar from the combined distillation of wood and coal is much lighter than common tar, and is more difficult to separate from water in the condenser. Owing to the acid

character of certain of the products of the distillation of wood, e.g., acetic acid, trouble may be caused in the condensing plant unless the proportion of coal is sufficient to yield ammonia in the quantity necessary to neutralise the acids. The yield of gas from the wood was found to be substantially equal to that from coal.

The Minister of Munitions, in exercise of the powers conferred upon him, gives notice of his intention to take possession as from September 1 until further notice of all pig lead, whether virgin or remelted, old and scrap lead, and lead residues, situated in the United Kingdom, excepting all such lead as may be in the possession of or due under an existing lawful contract in writing for future delivery to a manufacturer for use in such manufacturer's own works, and all such lead as may be specially excepted under the written authority of the Minister of Munitions. The lead of which possession is taken until further notice will be paid for by the Minister of Munitions on delivery.

A report presented to the Ripon City Council referred to an offer to sell to the corporation the Wakeman's House in the south-west corner of the Square. This building, erected in 1604, was the residence of the last Wakeman of Ripon, and is an interesting relic of ancient Ripon. Two or three years ago the property came into the market and was offered to the corporation, but the time was considered inopportune to purchase, and the building, which is in a dilapidated state of repair, was empty for some time, being eventually purchased by a local grocer and provision merchant for use as a store room. This gentleman now offers the property to the corporation, and as there is a probability that in the near future the corporation may carry out extensive street improvements at the top of High Skelgate, which would necessitate the removal of the Wakeman's House, there is a strong feeling by many in the city that the property should be purchased. It was resolved to negotiate with the owner for the purchase of the property.

Mr. T. D. Kelly, 19, Wilbury Crescent, Hove, Sussex, has patented a hydrated Portland cement, preferably 100-300 parts, which is mixed with 5-30 parts of water glass and 5-10 of an adhesive liquid, insoluble in water and which is not readily saponified, such as oxidized or polymerized oil, with or without a filler. The resulting cement may be moulded or may be used like asphalt over large areas by rolling and smoothing by means of sliding-irons and may be reinforced with steel bars, wires, etc. Heat accelerates setting.

An agreement on the subject of enlisted apprentices who wish to complete their time after the war has been arrived at between the master builders of the kingdom and the building trade operatives. An apprentice over the age of twenty-one is to receive wages at least equal to those received by a builders' labourer, with progressive increases year by year until he has finished his apprenticeship. Apprentices on war work, or who have been working at their trade in the Army, are to be reckoned as completing part of their time. The apprentices who joined the Army during the last year of apprenticeship are to receive their indentures and be classed as journey-men. The whole agreement is subject to the provisions of the local joint boards of employers and employed, and final disputes will be settled by the National Conciliation Board.

According to determinations made by Lloyd W. Schad at the Bureau of Standards, the expansion coefficient of marble increases considerably with rise of temperature, from  $1 \times 10^{-6}$  at 0 deg. C. to  $23 \times 10^{-6}$  at 300 deg. C. The one-heated marble does not contract to its original dimensions again, but remains expanded to a degree which depends upon the temperature to which it had been raised. Heating a specimen to 300 deg. produced an increase of as much as 0.4 per cent. in its length. Fortunately marble mountings are not as a rule exposed to such high temperatures.

The Controller of Timber Supplies announces that, in addition to arrangements

previously announced, applications for licences to import timber from Canada and the United States will now be recommended to the Department of Import Restrictions on the following terms:—Shipment. (a) In any un-requisitioned space under deck of British or Allied liners or steamers; (b) in neutral steamers, subject to the approval of the Inter-Allied Chartering Executive, Holland House, Bury Street, E.C.3, to whom application for permission to charter must be made before application is made for a licence to import. Conditions. (a) The timber must not displace food-stuffs or munitions; (b) shipment is to be made within three months of the application for import licence, otherwise the licence, if granted, will become void; (c) importers must agree to be bound by the rules as to prices contained in the War Office letter of February 8, 1917, and by the communiqué to the Press dated July 20, 1917. These rules provide that in the case of softwood the timber may be sold by the importers at its cost price delivered to store, plus 10 per cent., provided that the price so calculated does not exceed by more than a third the prices current during the last week of January, 1917, for softwood of similar quality and description in the same locality. The timber may be sold by persons other than the importers at prices which are in accord with the foregoing proviso.

Dr. J. H. Thomas, J.P. for Barrow, representing the Barrow justices, and Mr. Major, the clerk to the justices, had an interview last Friday with the Minister of Munitions on the subject of the housing conditions of Barrow. Mr. Churchill stated that he had received from several authoritative quarters reports which revealed an exceedingly unsatisfactory condition of affairs and fully bore out the representations which had been made to him by the justices. He was informed that the congestion was such that both the health and contentment of the workers must be prejudicially affected if it remained unrelieved. A representative of the Ministry had therefore been despatched to Barrow with orders to prepare a scheme for the construction of temporary or permanent houses with the greatest possible rapidity, to a total if necessary of 1,600. The scheme would be carried through with the utmost rapidity, and every effort possible in the present position with regard to the supply of labour and material would be made to remove the serious and undoubted evil which existed.

The growth of mechanical transport since August, 1914, is well illustrated by the following facts:—In October, 1916, there were 220 times as many vehicles (including motor lorries, motor-cars, ambulances, and motor-cycles) in possession of the mechanical transport as there were on the outbreak of war. With regard to the growth of personnel, it is interesting to notice that in August, 1916, there were four times as many men stationed at the General Depot for available trained men, and twenty times as many men serving on the Western Front alone, as were raised from all services for mechanical transport on mobilisation. In June, 1916, there were two and a half times as many officers serving in the Mechanical Transport as were serving on the peace strength of all branches of the A.S.C. in August, 1914; and, further, that there were, in October, 1916, ten times as many men serving with the Mechanical Transport in France alone as there were on the total strength of the A.S.C. in August, 1914.

Replying to the Local Government Board's recent circular to local authorities about housing, the Epsom Rural District Council is asking all borough, urban, and rural councils to join in saying that, in the existing shortage of, in the main, due to the claims made on builders and others on land values under the Finance Acts, 1909-10, and suggests that instead of the Board proposing that local authorities should build houses, thus increasing the present heavy burdens on the taxpayers and ratepayers, it should assist in restoring private enterprise in the building trade by bringing about the repeal of Part I. of the Acts. The response should be universal; for this, as we have repeatedly shown, is the fundamental cause of all the trouble.

**OGILVIE & CO.**

Telephone DALSTON 1368.

Many years connected with the late firm of W. H. LASCELLES &amp; CO., of Bunhill Row.

**Mildmay Avenue, ISLINGTON, N.**  
**EXPERTS IN HIGH-CLASS JOINERY.**  
**ALTERATIONS & DECORATIONS.** ESTIMATES FREE.

FOR

**Olivers' Seasoned****Hardwoods,**

APPLY TO—

**WM. OLIVER & SONS, Ltd.,**  
 120, Bunhill Row, London, E.C.

**TENDERS.**

\* \* Correspondents would in all cases oblige by giving the addresses of the parties tendering—44 per cent. of the accepted tender: it adds to the value of the information.

**CORK.**—For sanitary conveniences and other plumbing works, for the Cork Harbour Commissioners:—

J. F. Cantillon, Half Moon Street £156 0 0  
 D. D. Anghue, Rocksvage . . . 127 0 0  
 Buckley and Crowley, Grattan St. 123 0 0  
 H. Cooke and Son, Turkey Street 115 0 0  
 C. McCarthy and Son, Emmet Pl. 112 10 0  
 J. Spottiswoode, 10, Georges St. 102 0 6  
 R. J. Warren, Georges Street . . . 101 15 6  
 J. Curtin, 30, Barraek Street . . . 88 15 0

Accepted. All of Cork.

**DURHAM.**—For painting outside of the scarlet fever block, etc., for the rural district council:—  
 G. A. Greenwell, Durham . . . £35 17 4½ (Accepted).

**GLASGOW.**—For repairs at Nithsdale Hall, for the corporation:—  
 J. D. Menzies and Co. (accepted) £64 10 0

**GODSTONE.**—For laying 900 yards of 6-in. stone-ware sewers, 203 yards of cast-iron sewers, the construction of manholes and lamp-holes in connection therewith; also for the construction of settling tanks, bacterial filters, and siphon chambers, and laying out irrigation land for treatment of sewage at Lumpsfield, for the Godstone Rural District Council:—  
 F. C. Barraet, M.I.Mun.E., surveyor to the council:—  
 G. Wimpey and Co., Hammer-smith . . . £1,595 2 8  
 Franks, Harris and Co., Guildford . . . 1,553 4 2  
 A. J. Tully, Croydon . . . 1,380 3 9  
 J. Dickson, St. Albans . . . 1,353 18 4  
 H. Hemmings, Thornton Heath 1,205 0 0

**GRAYS (ESSEX).**—For external painting at Grays police station, for the Essex Standing Joint Committee:—  
 Brown Bros. (accepted) . . . £63 0 0

**GRIMSBY.**—For alterations in connection with the Army slaughter-houses on the docks, for the town council:—  
 J. Jorrell, Grimsby (accepted) . . . £367 10 0

**HULLINGBORNE.**—For construction of Sutton Valence sewers for the rural district council:—  
 Higgins, £55 4s. 6d. For supply of pipes and manhole covers, Boulton and Co., at 7s. 3½d. per yard and 57s. 6d. each respectively.

Mr. G. P. Tyrwhitt-Drake, an original member of the Land Agents' Society, has entered upon his duties as resident agent at Arundel for the Duke of Norfolk's Sussex and Surrey estates.

**LIST OF TENDERS OPEN.****BUILDINGS.**

**Sept. 5-17.**—Erection of two additional classrooms at the Walthamstow Girls' High School.—For the Walthamstow Higher Education Committee.—E. T. Forrest, E.G.S., County Architect, 79, Duke Street, Chelmsford.

**Sept. 15.**—Construction in reinforced concrete of two dressing chambers and carrying troughs at the Littleburn (Durham) sewage works.—For the Brandon and Widdowles Urban District Council.—A. A. Luxmoore, 5, North Bailey, Durham.

**Sept. 19.**—Erection of a new cattle house for 20 bullocks, and other alterations, at Middle Colenso Farm (Cornwall).—J. A. Treglown, architect, Marazion.

**ENGINEERING.**

**Sept. 14.**—Improvements at intake of Buttevant waterworks, according to specification of Malton District Council engineers.—For the District Council.—M. Regan, Clerk.

**Sept. 18.**—Construction of a filter bed and works incidental thereto at the sewage farm, Berkhamstead.—For the Berkhamstead and Northchurch Joint Sewerage Committee.—T. Penny, Clerk to the Joint Committee, 147, High Street, Berkhamstead.

**March 30.**—The Acting British Consul at Santiago reports that a decree has been issued calling for tenders for the improvement of the port of Antofagasta (Chile). By the terms of this decree the amount to be expended on this work must not exceed £1,700,000. Details may be obtained from the Port Commission Offices in Santiago, and copies are expected to be received shortly at the offices of the Chilean Legation in London, 22, Grosvenor Square, W.1. Tenders will be received up to 3 p.m. on March 30 by the Minister of Finance, Santiago.

**FURNITURE.**

**Sept. 14.**—Tenders (from manufacturers only) for supply of dwarf cupboards are invited by the Commissioners of H.M. Office of Works.—The Secretary, H.M. Office of Works, Storey's Gate, London, S.W.1.

**TO CORRESPONDENTS.**

We do not hold ourselves responsible for the opinions of our correspondents. All communications should be drawn up as briefly as possible, as there are many claimants upon the space allotted to correspondents.

**RECEIVED.**—M. and C.—B. A. Co., Ltd.—D. T. and F.—Van A. and C.—M. and C.—H. and Son.—L. F. Co., Ltd.—B. M. S. Co., Ltd.—J. B. and C.—J. W. V.—E. H. G.—R. T. L., Ltd.—O. and C.—B. Bros.—K. and C., Ltd.

V. J.—Yes.

**SUB-LE.** G. H. T.—Best thanks.

T. W. L.—Little demand, except locally, we imagine.

**BUILDER.**—If your statement is true we advise you to place the facts before the Bribery and Secret Commission League, Queen Street Place, E.C. Read our note on p. 142 of our issue of August 22 last.

M. S. A.—We prefer line drawings, because they are more useful to and more welcomed by architects, who are, of course, our principal readers, for many reasons. The fanciful washed perspectives, which have had their day, are now principally supplied by those who cannot make proper architectural drawings, and in many cases reproduce very badly.

**TO ARMS!****COUNTY OF LONDON VOLUNTEER ENGINEERS (FIELD COMPANIES).**

Headquarters, Balderton Street, Oxford Street, W.1.  
**ORDERS FOR THE WEEK BY LIEUT. COLONEL C. B. CLAY, V.D., COMMANDING.**

**OFFICER FOR THE WEEK.**—Second Lieutenant E. A. Uthman.  
**NEXT FOR DUTY.**—Second Lieutenant C. E. Campbell.

**EXTRACT FROM "GAZETTE"**—County of London Volunteer Engineers. Alfred Hugh Gibbon to be temp. Lieutenant and Medical Officer, August 10, 1917.

**MONDAY, SEPT. 17.**—Technical instruction (searchlight) for No. 3 Coy. Right Half Coy. Signalling Class, 6.30. Recruits' Drill, 6.30.

**TUESDAY, SEPT. 18.**—Physical Drill and Bayonet Fighting.

**WEDNESDAY, SEPT. 19.**—Drill and Elementary Bridge Construction for No. 2 Coy. Left Half Coy.

**THURSDAY, SEPT. 20.**—Drill and Elementary Bridge Construction for No. 2 Coy. Left Half Coy. Signalling Class, 6.30. Recruits' Drill, 6.30.

**FRIDAY, SEPT. 21.**—Technical instruction (searchlight) for No. 3 Coy. Left Half Coy. at Regency Street. Drill No. 3 Coy. Right Half Coy. Recruits' Drill, 6.30.

**SUNDAY, SEPT. 23.**—Commandant's Parade for technical instruction at Escher. Parade at Waterloo Station 8.45 a.m., opposite No. 10 platform. Uniform, harness, boots, water-bottles to be worn. Midday rations to be carried. Compulsory for "A" and "B" men.

**BAND.**—All Buglers and Drummers who have not attended are required to attend on Monday or Thursday next, at 6.0 p.m.

**UNIFORM.**—"A" and "B" men are warned to attend Headquarters on Tuesday, Sept. 18, to be measured by the regimental tailor for the Service Uniform.

**MUSKETRY.**—All N.C.O.'s and men who have signed the "A" and "B" agreements are required to attend during this month to reclassify in order to enable the Corps to obtain the Capitation Grant. Preference will be given to those men in firm. This does not apply to those who hold the proficiency badge.

**ARMLETS.**—The new issue armlets can now be had at Headquarters, and every enrolled man must obtain one without delay; at the same time, all old red armlets (now obsolete) must be returned.

**NOTE.**—Unless otherwise indicated all drills will take place at Headquarters.

By order,  
**MACLEOD YEARSLY, Capt. and Adjutant.**  
 September 15, 1917.

At Hendon Petty Sessions last Friday Arthur Jackson Smith, of Nant Road, Child's Hill, was charged with covering to his own use £5 given to him to purchase paint by Mrs. Bernard Dillon (Miss Marie Lloyd), of Oakdene, Finchley Road, Golders Green. Smith was committed for trial, bail being allowed.

Mr. D. H. Buckland, of Windsor, the retiring President of the Herts, Beds, and Bucks Valuers' Association, delivered a valedictory address at the annual meeting of the association, held last Thursday. Mr. H. Trustram Eve was elected president for the ensuing year, and Mr. S. P. Wigley, of Winslow, vice-president.

According to *Scientist*, the Department of Architecture of the University of Illinois is preparing to take an active part in the reconstruction of the town of Mattoon, recently devastated by a tornado. Plans for sixteen houses, to cost from \$800 to \$1,400, are to be prepared by architects of the department, who hope to duplicate this enterprise on a larger scale in France.

**WANTED FOR MUNITIONS.****OLD LEAD****FRY'S METAL FOUNDRY,**

25-30, Holland Street,  
 Blackfriars,  
**LONDON, S.E. 1.**

Telephone: Hop 4720 (2 lines).  
 Telegrams: "Frymetals, Friars, London."

Hargreaves Street,  
 Red Bank,  
**MANCHESTER.**

Telephone: City 2026.  
 Telegrams: "Frymetals, Manchester."

The Ministry of Munitions has recently taken over the

**Fixing of Price of Old Lead**

fixing the maximum price which may be paid for Old Lead

viz.: **26/-** per cwt.

We are able to offer you this maximum price at your Works, Carriage to be paid by us. Sacks and special Munition labels will be forwarded to you if desired.

**Terms—Prompt Net Cash.**

# THE BUILDING NEWS AND ENGINEERING JOURNAL.

**Edinburgh House.**

Currente Calamo .. .. .	221
The Problem of the Small Dwelling and Its Solution.—XVII. .. .. .	222
The Architectural Association New Premises, Bedford Square .. .. .	225
Our Illustrations .. .. .	227
Correspondence .. .. .	227
Professional and Trade Societies .. .. .	227
Legal Intelligence .. .. .	227
Obituary .. .. .	227
Our Office Table .. .. .	228
Trade Notes .. .. .	228

**CONTENTS.**

Tenders .. .. .	229
To Correspondents .. .. .	230
List of Tenders Open .. .. .	240
Clips .. .. .	240
To Arms! .. .. .	240

**OUR ILLUSTRATIONS.**

Lancashire and Cheshire Miners' Hall, Bolton. Detail of main entrance. Messrs. Bradshaw, Goss and Hope, Architects.	237
King Edward VII. School of Art, Armstrong College, Newcastle-upon-Tyne. Entrance to the art school, screen on staircase, library fireplace, and	237

**Strand, W.C.2.**

two principal plans of the building. Mr. W. H. Knowles, F.S.A., Architect.	235
Architectural Association New Premises, 54 and 55, Bedford square, W.C. Plans and view of exterior. Thomas Lovett, Architect. 1284 Designs in Goad's Patent Stone.	235
Entrance to Municipal Buildings, Funchal, Madeira. Water-colour sketch by Mr. Walter Cave, V.P.R.I.B.A.	235
The Problem of the Small Dwelling and Its Solution. By Mr. Robert Thomson, Architect. Application of the patent plan to four-story buildings. Sheet XXXII.	235

## Currente Calamo.

According to the local papers, Mr. P. Macgregor Chalmers, the newly appointed architect for Belfast Cathedral, has submitted important drawings for the consideration of the Cathedral Board. Several striking and effective changes have been introduced into the original plans of Sir Thomas Drew (says the *Belfast Evening Telegraph*). The new plan shows an eight-sided central tower instead of the square tower. The front of the Cathedral is represented by a porch in the centre with two great square towers at either side. The organ will be placed in the south transept. Underneath the organ-loft will be a chapel useful for daily services. In the other transept will be a larger chapel. The *Evening Telegraph* observes that "several striking changes" are to be made, and that "it will be somewhat of a wrench to some to abandon the contemplated front with whose view they had become so familiar." The *Irish Builder* recalls the history of the proposed building, with which, from illustrations thereof in our issues of October 30, 1906, and May 2, 1902, our readers are familiar. The late Sir Thomas Drew and the late Mr. W. H. Lynn, of Belfast, were appointed joint architects; but the working out of the design was entirely in the hands of Sir T. Drew. He at first made a Gothic design, but ultimately one in the Romanesque style was adopted. In this, Sir T. Drew, our contemporary says, but followed the general trend of feeling in England at the time, it being largely held that Gothic had ceased to express the ideals and needs of a great modern town church. The architect of the great new cathedral at Westminster, Bently, one of the most refined and fastidious of modern architects, and a master of Gothic, took a similar line. After Sir T. Drew's death, Mr. Lynn was appointed architect to the Belfast Cathedral, and, it is now said, contemplated making drastic changes in the design; but it does not appear that he has left on paper any evidence of his intention in this respect. The descriptions of the lesser changes are not sufficiently explicit to enable one to form an opinion, but taken together, suggest the thought that Sir T. Drew would not

recognise his own church in its new guise, if he could see it. The Cathedral Board have passed a resolution expressing "admiration of the drawings," but stating "they do not feel able, without further consideration, to express an opinion on the detail." It is to be hoped, says the *Irish Builder*, they will, in justice to the city of Belfast and the diocese at large, give the subject all the anxious care and thought it deserves before coming to a final and unalterable decision, and will also be jealous of the memory of a very distinguished church architect who laboured for them, and gave them a fine church, so far as it has been already realised. It is a matter to which the Ulster Society of Architects might give some watchful attention, so as to safeguard from excessive post-mortem alteration the professional work of a distinguished son of Belfast, their first president, and one who received his earliest professional training in a Belfast engineer's office.

Referring to our article last week on artificial fuel, Mr. Reginald Brown, M.I.C.E., M.I.M.E., F.S.I., the engineer and surveyor to the Southall Urban District Council, draws our attention to a method of utilising house refuse as fuel, which he has patented here and in seven foreign countries, and which he described in a paper read before the Institution of Municipal Engineers. The process consists of three operations—(1) crushing, (2) briquetting, and (3) impregnation. After the preliminary removal of metal and such like, the operation of crushing reduces the refuse to a powder; this is immediately made into briquettes, which can easily be handled without fear of being altered in form, and by reason of the nature of the material they soon become dry enough for impregnation, either by simple dipping or under pressure. The dipping or impregnating mixture varies, according to the refuse to be treated, and not only permeates the whole thickness of the briquette, but also acts as a permanent binding material. The whole process is extremely cleanly and simple, and the production of the briquette in the manner described gives the enormous advantage that the moisture is removed before the addition of the binding material—an important point recog-

nised by those who know how difficult it is to mix wet crushed refuse with even hot tar or pitch, or both. In Mr. Brown's process the house refuse can be dealt with as soon as received at the disposal site, and converted into a form which can be stored without any fear of a nuisance arising, and, what is just as important, can be used as a fuel as required, when required, or where required. Obviously, the process is a competitor with the refuse destructor, and bids fair to be a severe competitor when it is in full working order, because it is utilisation, and not destruction. The impregnating material absolutely prevents any nuisance arising, the whole of the calorific value of the refuse can be utilised, and can be reinforced to any degree required, and the process is economical. Including the cost of buildings and plant, the fuel can be manufactured for 7s. 6d. per ton; but this will, of course, vary with the degree of reinforcement desired, and Mr. Brown has strong reasons for believing that the fuel will fetch 10s. per ton at least. House refuse has to be got rid of, no matter at what cost, and if a local authority has any difficulty in disposal they turn to the refuse destructor as a solution. Now, "destruction by fire" costs anything between 3s. 9d. and 5s. per ton (including buildings and plant), with very little, if any, hope of recovery of the calorific value of the refuse. Assuming, therefore, the cost of the fuel when made to be 7s. 6d. per ton, this will represent 3s. 9d. more than it would cost to destroy by fire—assuming destruction at 3s. 9d. per ton—so that, if the fuel was sold at 3s. 9d. per ton only, the cost would not exceed that by the modern destructor, and obviously any figure obtained above this would react in favour of the conversion method. The process seems well worth the attention of all interested; at present, of course, the Local Government Board will not sanction expenditure by local bodies, even to benefit the ratepayers.

In the *Times* of Thursday last there was a letter from Mr. C. Chambers Smith on local by-laws of a misleading nature. Mr. Smith quoted a previous letter of "W. F. S." asserting that "the local by-laws about building are the impediment," and that "they are a cumbrous means of

preventing definite evils," and went on to say that there is no foundation for these allegations as regards any district where modern by-laws are in operation, and he further states that the charges against the by-laws have not been substantiated in the professional Press. As an architect of nearly forty years' standing, and having practised in at least fifteen different counties, Mr. C. E. A. Voysey states in the *Times* of September 14 that he believes every word of "W. F. S.'s" quoted is accurate and true, and that an abundance of evidence has been brought forward in the professional papers and elsewhere to support the statements therein contained. Mr. Voysey adds: "I have myself written frequently to that effect. Nearly every place in which I have had to build, the local by-laws regulate the height of rooms, and make no provision for adequate ventilation. And the restrictions as to the height of rooms not only increase the cost of building unnecessarily, but ruin the proportions of cottages, and do not secure proper ventilation. The area also is increased by every inch of additional height, as well as the amount of material and labour. The higher your rooms the more space you need for staircases, etc. Further, may I add, in conclusion, that the by-laws have not prevented speculative builders from putting up insanitary and hideous cottages?"

In his new book on "Church Ornaments and their Civil Antecedents" (Cambridge University Press, 6s. net), Dr. Wickham Legg traces the use of certain church ornaments to a civil origin. For example, he shows the high probability that the mediæval Christian altar, in shape and proportion, resembles the four-footed abacus of the *Præfectus Prætorio*. He says: "It is a hard matter to resist the opinion that a mediæval altar in respect of its proportions, its coverings, its lights, and its book of the Gospels, owes something in some way to this ensign of the high official of the Roman Empire." The censor and lights carried before the Emperor appear to be the original of the censor and lights carried before the bishop. Next, Dr. Legg considers that most of the ecclesiastical vestures are a continuation of the *Consular Vestis triumphalis*. He observes: "The similarity of the dress shown by the consular diptychs to that of early ecclesiastics may be grasped when it is understood that some of these consular diptychs have, with but little change, been converted into memorials of bishops and popes." There exist a most remarkable instance in the consular diptych converted into a memorial of St. Gregory the Great, still preserved in the collection of casts in our museums. Two illustrations from casts in the Ashmolean Museum, Oxford, make this conspicuously clear. There are twelve interesting illustrations.

The seventh annual report of the Road Board states that during the year which ended on March 31 last applications were received for £1 051,905, of which £966,510, or 91.80, was for "improvement of road or streets." The income of the board in the

same period fell to £152,902, nothing being received from motor spirit duties or carriage licences. The net payments were £254,563. The report claims that since the outbreak of war great advantage has been derived from the improvements effected in important roads throughout the country with the assistance of grants and loans from the Improvement Fund. But, notwithstanding the expenditure of nearly one and a-half million, which represents the cost of special work on public roads paid for out of Army funds and other Government contributions, an extensive road mileage, used by the military traffic, has greatly deteriorated in condition. Many other roads have also suffered damage by the substitution of motor traffic for horse-drawn traffic in connection with agricultural operations in some counties. Concurrently with these things the expenditure of highway authorities on maintenance has been reduced, partly for financial reasons and partly owing to shortage of labour and materials. There will, therefore, be a considerable leeway to be made up after the war before roads can be restored to their pre-war conditions. Meanwhile, the policy of the Board in regard to making grants and loans has, it is asserted, been continued on the lines laid down by the Treasury. During the current year the Board are distributing, with Treasury sanction, a sum of £200,000 out of the Road Improvement Fund, mainly in the form of assistance to expenditure on tar treatment of main county roads in Great Britain which are in a suitable condition for treatment. It is declared that the urgent need at the present time is the reconstruction of roads too weak to carry modern traffic. The total mileage, it is stated, of roads in England and Wales is 152,000. It may be assumed that 10 per cent. of the total, or about 15,000 miles, stand in need, more or less urgent, of reconstruction or strengthening, as distinguished from resurfacing in the course of ordinary maintenance in order to enable the roads to carry the growing motor traffic. The cost of reconstruction may be estimated at from £1,000 to £4,000 per mile, or at an average of £2,000 per mile. The total cost of dealing with 15,000 miles may be estimated, therefore, at approximately £30,000,000 over and above the normal expenditure of the local authorities on current and deferred maintenance. The report states that the Board have examined the proposals of the recent Metropolitan Arterial Board Conferences for the construction of about 130 miles of approach roads to London, seventy miles being entirely new. These proposals, the Board states, "if their execution were proceeded with continuously, might involve an expenditure by all parties concerned of considerably over £10,000,000, and it might approach £15,000,000. The highway authorities concerned have made it clear that they are not prepared to provide any considerable proportion of the expenditure. No possible source of revenue is in sight.

The ideas of the members of some of our local authorities about housing are, to the least, peculiar; perhaps that is

the reason so few authorities have done anything. At last Wednesday's monthly meeting of the Conway Town Council, according to the *Liverpool Daily Post and Mercury*, one of the members of the Council, Mr. G. H. Edwards, said that when the Council were engaged on the housing schemes some years ago they paid a considerable sum of money for plans which afterwards they found would entail a prohibitive expense in construction. They seemed to come up against the professional man. He did not want to decry the professional man, who must have a living, like everybody else, but the committee thought at that time that the architect's fees were excessive. His purpose in raising the matter was to suggest that the Government should, in taking up the question of housing, simplify the machinery, and should supply plans for cottages themselves. Cottages did not require much architecture; they were not cathedrals. Why not have standardised cottages as well as standardised ships? "Hear, hear!" cried Mr. Edwards's fellow-Councillors, probably in ignorance of the fact that the Government has supplied plans of standardised cottages, the value of which has been well exposed in our pages in the series on the solution of the problem of the perfect dwelling which is concluded to-day.

#### THE PROBLEM OF THE SMALL DWELLING AND ITS SOLUTION.

XVII.

By ROBERT THOMSON.

[WITH ILLUSTRATIONS.]

The opinion is widely held that the English type of cottage dwelling such as has been recently erected in hundreds at Well Hall and elsewhere is in every respect superior to the Scottish type of tenement dwelling, but if proper investigation be made it will be found that the facts and figures disclosed do not always bear out the contentions of those who hold that opinion.

In order that the relative merits of these two so widely divergent national types of dwellings may be fairly judged of from the health point of view I have prepared the three plans Figs. 177-B and 9, shown on Sheet XXXII., which accompanies this article.

The principal object in giving these plans is to make the comparison as difficult as possible for the Scottish type and as easy as possible for the English type, and this is effected by setting up the Scottish "Room and Kitchen" type of two-apartment tenement dwelling to show that the occupants who by day use both apartments as living-rooms and by night as bedrooms have at their disposal air bodies of greater volume than those which are available to the occupants of the Government's model six-apartment parlour type of cottage dwelling. It will be well, however, before proceeding to deal with these plans in detail to glance at their principal points of resemblance and difference.

To begin with, the principal point of similarity is that both the tenement and the cottage dwellings have in common the very grave defect that their occupants, for lack of proper accommodation, are forced to use the kitchen as their living-room. Turning next to the principal point of difference between them it will be seen that this is a fundamental one. In the cottage dwellings the occupants do not use either the parlour or the living-room as

bedrooms, whereas in the tenement dwellings the exact reverse is the case, both the parlour and the living-room being used as bedrooms. It will also be seen that a characteristic feature of each of these apartments is the recess provided for the reception of the bed.

The next most important difference consists in the arrangement of the entrance doorway. Each cottage has its own entrance opening direct from the outer air, and each family is entirely independent of its neighbour; but in the tenement block the tenants are interdependent. For example, the main entrance to the building, the passageway leading therefrom, the stairway, and the back yard, are each used in common by the occupants of the various tenements, while the washhouse, of which there is one to each block, is used by each in turn.

Since the comparison between the two types is to be confined to the question of health, there would be no good purpose served by going into any of their other distinctive features meantime. Returning, therefore, to the main point at issue, it may be stated that the "Room and Kitchen" type of dwelling has been chosen to represent the Scottish tenement system of housing, because it is the type most largely in use by artisans in Scotland, and that the six-apartment parlour type of cottage has been chosen to represent the English system because its parlour and living-room respectively provide the counterparts of "The Room" and "The Kitchen" in the two-apartment type of Scottish tenement dwelling, thus enabling direct comparisons to be made between them.

In the English cottage chosen for the present example the parlour is of the official standard size set forth in column 3 of the table in paragraph 35 of the Advisory Committee's report, and each of the five other apartments meets exactly the "Desirable" standard requirements set forth in column 2 of the above-mentioned table in that report. The three sizes of the "Room and Kitchen" tenement type of dwelling shown in Figs. 177-8 and 9 are given in order that comparisons between the English and Scottish systems of housing may touch at as many points as possible. To this end the cottage plan above described has been adopted as the basis of the present series of comparisons, and the sizes of the apartments in the three-tenement blocks have been made to conform to those in that cottage.

For convenience of reference the following table gives the floor area and cubic capacity of each of the apartments in the cottage selected as the basis of comparison.

	Area, Square feet.	Capacity, Cubic feet.
Kitchen-living-room.....	180	1,440
Parlour.....	120	960
Parents' bedroom.....	150	1,200
Bedroom No. 2.....	100	800
Bedroom No. 3.....	65	520
Sewlery.....	80	640

No plan of this cottage is given at this stage, but the reader is referred to plan Fig. 17, Sheet II., and plans Figs. 50 and 51, Sheet VIII., for examples of the Government model plans of six-apartment cottages.

From these it will be seen that the roofed area of each pair of these cottages is well over 1,200 square feet, and that they therefore in this respect compare very badly with the two-apartment tenement dwellings.

Referring to the accompanying tenement plans it will be seen that in plan Fig. 177 the rectangular floor area of the living-room is 165 square feet, so that the free area of this apartment is thus in exact accordance with the "Irreducible"

standard size recommended by the Advisory Committee. To that area there falls to be added the area of the bed recess, which makes the total area of the apartment 193 square feet. In each of the plans Figs. 178 and 179 the kitchen floor area clear of the bed-recess is 180 square feet. This apartment thus conforms exactly to the Advisory Committee's "Desirable" standard. When the bed recess is added its total area becomes 208 square feet.

In plans Figs. 177 and 179 the floor area of "The Room," exclusive of the bed recess, is 120 square feet, and is thus the same area as the official parlour, and as the bed recess adds 30 square feet, the total floor area of this apartment is thus exactly that of the "Desirable" standard size of the parents' bedroom in the official type of cottage.

In plan Fig. 178 the total floor area of "The Room" is 160 square feet, and as the bed recess is dispensed with, this apartment directly conforms in size to the parents' bedroom called for in column 3 of the table already referred to.

Adopting the official standard ceiling height of 8 ft., calculations show that dwellings erected to each of the foregoing plans would respectively provide sleeping accommodation having the total cubic capacity stated below:—

	Cubic feet.
The six-apartment cottage dwelling.....	2,520
The tenement dwelling to plan, Fig. 177.....	2,734
" " " " " Fig. 178.....	2,934
" " " " " Fig. 179.....	2,864

These figures show that, for sleeping purposes, the volume of the air bodies available for the use of the occupants of the two-apartment tenement dwellings would be considerably greater than the total volume of those available for use by the occupants of each of the six-apartment cottage dwellings and in this respect these tenement dwellings are decidedly superior to the cottage dwellings opposed to them.

Following up these bedroom figures by calculations showing the volume of the air bodies which would be available in the apartments occupied by day, it will be seen that in this respect the occupants of the six-apartment cottage would be relatively even worse off than would the occupants of the two-apartment tenement dwelling. The figures for the air bodies in the living-room and parlour of each of the four dwellings are respectively as follows:—

	Cubic feet.
The six-apartment cottage dwelling.....	2,400
The tenement dwelling to plan, Fig. 177.....	2,734
" " " " " Fig. 178.....	2,934
" " " " " Fig. 179.....	2,864

In the official model five-apartment cottage the available air body in the living-room would be 1,440 cubic feet.

In his paper read at the forty-second annual congress of the Incorporated Sanitary Association of Scotland, the town-planning engineer of the Middle Ward of Lanarkshire made the following statement:—"The Scottish tenemental system as against the English cottage system has long been looked upon as a national blunder, and all leading authorities on the housing question are agreed that the death-knell of the tenemental system must be pronounced as speedily as possible." In view of that statement, it may be well to recall the fact that the total volume of the air bodies in the five-apartment cottages erected in Mid-Lanark are:—For the three bedrooms, 2,216 cubic feet; and for the kitchen-living room, 1,530 cubic feet. When these figures are compared with those just given for the two-apartment tenement dwelling, it is clear that, when looked at from the standpoint of health alone, these Mid-Lanark cottages would be

vastly inferior to tenement dwellings of the type shown in plans Figs. 177-8 and 9.

From a careful study and comparison of the foregoing figures showing areas and volumes, it must be obvious to those who are accustomed to deal with facts that it would indeed be "a national blunder" if the plans of the cottages built by the county council of the Middle Ward of Lanarkshire were adopted as Scotland's national model type of dwelling.

The shortage of space, the combined kitchen-living room, and the fireless bedroom in each of these five-apartment Mid-Lanark cottages, in common with those now being erected at Rosyth and elsewhere, prove that the authors of these plans have not paid proper regard to the ordinary health requirements of their future occupants. Since the importance of making adequate provision for meeting the vital requirements of the occupants of small dwellings cannot be overrated, I have pleasure in directing the attention of the reader to the fact that there is in the Transactions of the Royal Society for the year 1887 a report on "The Carbonic Acid, Organic Matter, and Micro-Organisms in Air, More Especially of Dwellings and Schools." That report, which deals with the exceedingly important series of investigations conducted by Professor Carnelly, D.Sc., Mr. J. S. Haldane, M.A., M.B., and Dr. Anderson, M.D., Medical Officer of Health, Dundee, contains much valuable information which ought to be assimilated and acted upon by everyone concerned in the provision of housing for the people. These scientists, who in the course of their investigations made many analyses of school air and of the air in artisans' bedrooms, write as follows:—

When we come to consider that the children who attend average Board schools for six hours a day are during that time subjected to an atmosphere containing on an average nearly 19 volumes of carbonic acid per 10,000 and a very large proportion of organic matter, and no less than 152 organisms at least per litre, we need not be surprised at the unhealthy appearance of very many of these children. It must be borne in mind that many of them are exposed for nine hours more to an atmosphere which, as we have shown, is about five times as impure as that of an ordinary bedroom in a middle-class house. They are thus breathing for at least fifteen hours out of the twenty-four a highly impure atmosphere.

If these investigators had been in possession of the information given in Article III. of the present series, concerning the gravely adverse conditions which are created in those dwellings in which the one and the same small apartment has to serve simultaneously as living-room and kitchen, it is safe to say that the concluding sentence of the above quoted paragraph would have been even more damning than it is.

If we look beyond the school age it will be found that the majority of children when they finally leave school for work enter occupations in which the atmosphere is quite as trying to their health as that of the school which they have just left, with, however, the added disadvantage that the working hours are longer than the school ones. With such adverse conditions to contend with, can there be any surprise at the abnormally excessive death rate from phthisis and other diseases of the respiratory system which statistics show occurs among the working classes? Or at the rapid deterioration which takes place in the physique of the successive generations of families who have entered and continued in industrial life? It is the combination of the bad atmospheric conditions which the people have to contend with both at home and in school or at work throughout nearly the whole of each day for the whole of their life which is respon-

sible for the deterioration. If such people were housed in actively health-promoting dwellings, as they can now easily be, the home life would effectively counteract and nullify the adverse conditions which prevail both in school and in work. The root of the trouble lies in the grossly inefficient planning of small dwellings which the Government have done their best to per-

model cottage dwelling, with its combined kitchen-living room, its shortage of space, and its inefficient ventilation, actively assists the occupation, and between the two the unfortunate worker soon goes under.

Having utilised the "room and kitchen" type of tenement dwelling to expose by comparison the vital and other

wash-house is 26,420 cubic feet, thus showing a balance of 3,732 cubic feet in favour of the cottage.

To compare a two-story block with a four-story block is manifestly unfair to the former. The comparison will therefore be more useful when taken between blocks each of two storeys and of the same total roofed area. Taking the cubic con-

*Ground Floor*

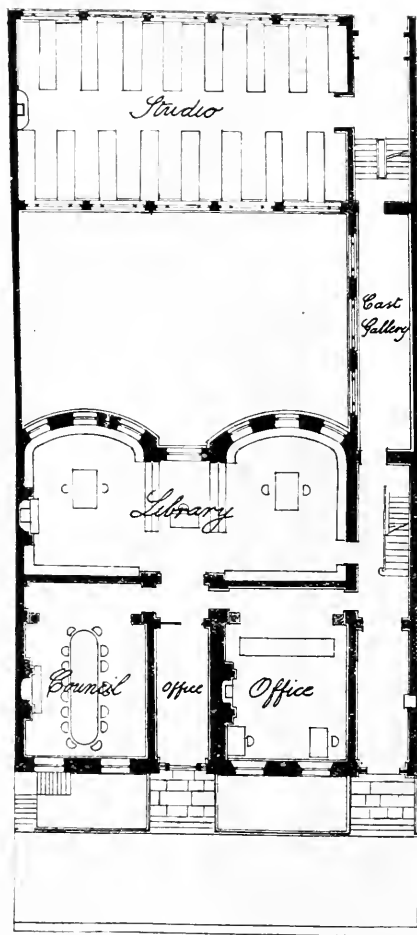

*Basement Floor*

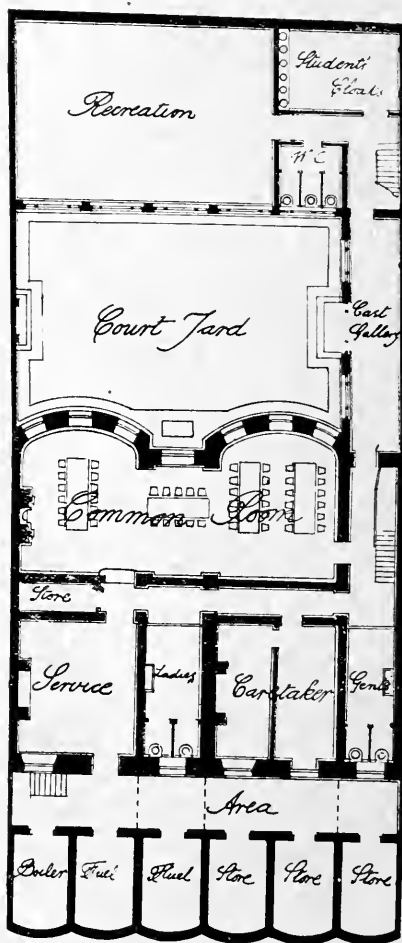

THE ARCHITECTURAL ASSOCIATION NEW PREMISES, BEDFORD SQUARE.

petuate by the issue of the rudimentary examples, some of which have been already commented upon in these articles.

Unfortunately, there are some essential industries which, despite precautions, are known to be directly and very seriously detrimental to the health of those employed in them. Were the workers in such industries housed in actively health promoting dwellings, the dwelling would largely counteract the evil effects of the employment, and the life of the worker would undoubtedly be prolonged. But, as things are at present, the official type of

defects of the Government's six-apartment parlour type of model cottage dwelling, these tenement plans will now, in turn, be themselves disposed of by the health-promoting class of dwelling shown in the plans Figs. 181 and 182. Taking the tenement plan Fig. 179, the section of which is similar to that shown on Sheet XXVIII., the total cubic capacity of the eight tenements in the block is 22,688 cubic feet, while that of the four cottage dwellings in the two-story block, the roofed area of which is exactly the same as that of the eight tenement dwellings, and their

tenements of the four cottages at 26,420 cubic ft. as before, and the four tenements at 11,232 cubic feet, shows a balance of 15,188 cubic feet in favour of the cottage. Pricing that balance at 15 pence, the officially based rate, the value of the extra house-room works out at £949 5s. in favour of the cottage block. But even these figures, favourable though they be, do not represent more than a part of the superiority which the health promoting class of dwelling possesses over the tenement type of dwelling. There is, for example, the system of ventilation, and to gain some



idea of the advantages of that attention must be directed to the diagrammatic plan Fig. 183. One point of importance is that the parents' bedroom falls far short of meeting the ideal requirements of the health-promoting dwelling. With the number of adult occupants given on the plan the carbon dioxide added to the air contents of the apartments would not in any of them exceed two parts per 10,000, thus providing ideal conditions for the occupants, who would in this way be so invigorated at home as to enable them to effectively combat the deteriorating influences either in school or at work.

[THE END.]

(Thomas Leverton, about 1780), not yet pulled up with the pride of the Brothers Adams.

Built upon a rubbish heap, a timber yard, sundry ditches and a horse pond, with trustful optimism and poor materials, the square shares with its contemporaries the defects of over-speculation. No better nor worse in that respect, it beats them in its quiet, reposeful, serene respectability, its colony of modern architects notwithstanding.

In the days when the nobility washed seldom and entertained often, the houses reflect in their immense reception rooms and mean bedrooms the domestic comfort of the times. Servants slept anywhere—godness only knows where, the men servants on truckle beds in the basement,

walls all the way up. Members, never suitably catered for at Tufston Street, will have the two large first floor rooms overlooking the gardens of the square, a luncheon room and the library.

As for the schools, the old back stable buildings abutting on Morwell Street will be demolished and a four-story studio building erected in their place, with access from Morwell Street, and connected to the main block by galleries for the exhibition of selected casts from the Tufston Street Museum. One hundred and twenty day students will be provided for, with an art classroom and an art room in addition. For their recreation, so essential in winter, the students will have a large room where fives or gymnastics can be indulged in.

*First Floor*

*Second Floor*

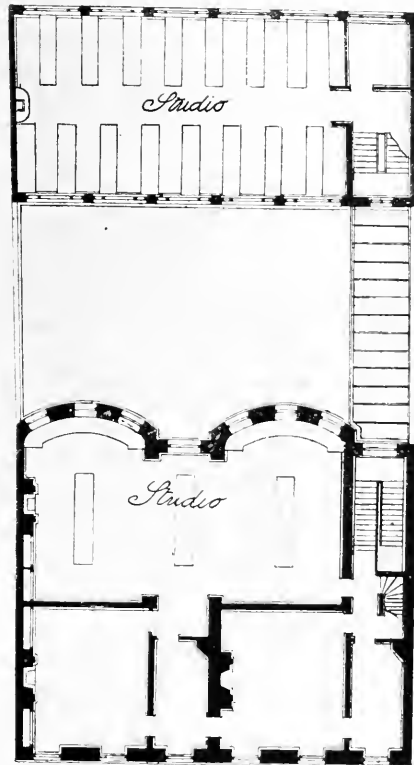
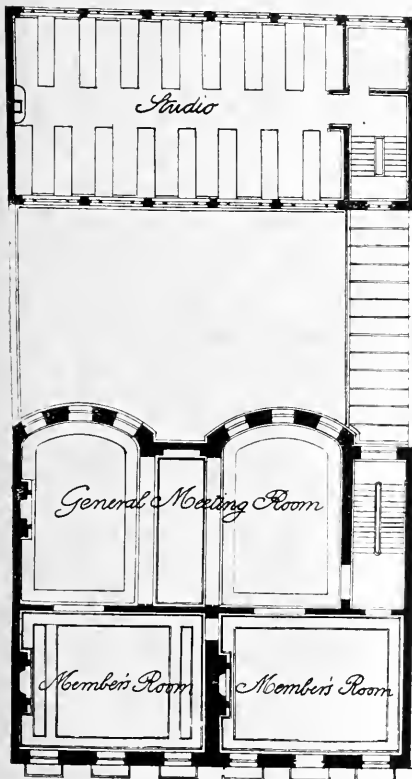

THE ARCHITECTURAL ASSOCIATION NEW PREMISES, BEDFORD SQUARE.

THE ARCHITECTURAL ASSOCIATION NEW PREMISES, BEDFORD SQUARE.

Bedford Square is the most complete of the London squares, and the least spoilt of the West Central group, with a beautiful garden, fine plane trees, good, solid, respectable buildings reminiscent of the later eighteenth century, not over-ambitious nor tawdry. Artificial stone doorways it has, and stucco fronts to the centre buildings, but treated frankly as stucco, not over-sized like Fitzroy Square, with ambitious architecture half completed and ornament stuck on with glue, but complete on all four sides. Not too severely classical or sacrificed to symmetry, a little irregular, its balconies and details all differ. No unnecessary or false ornament, a restrained design by a lesser eighteenth century architect

washed at the sink and fed in the kitchen. The doorways, dressed in Coade's patent stone—a feature in this square—are all alike, except the centre blocks, which have mainer doorways than the rest. The ground floors are large and very simple, the front room having a pair of Ionic columns and the hall has a fine cornice. A stone staircase, with an iron hand-rail, leads to the drawing room floor; magnificent apartments with long windows and light iron balconies; in one a geometrical ceiling of Adam character and a fine inlaid mantelpiece of marble; the other has an even finer fireplace, but not such a fine ceiling.

To fit the premises for the occupation of the Association only such alterations as are vitally necessary will be undertaken. To provide a meeting room and library one of the staircases will be removed with its side

Mr. Robert Atkinson, F.R.I.B.A., head master of the Architectural Association, has prepared these plans, showing the adaptation of 34 and 35, Bedford Square, and we feel confident that the scheme will meet with warm approval. We reported the first general meeting held in Bedford Square in our issue for July 25 last.

In St. Michael and All Angels' Church, Walford-on-Wye, a stained-glass window and tablet have been dedicated in memory of Richard Acton Butt, 24, and Frederick Claude Butt, 19, who were killed in action last year.

The death occurred on September 15 at 50, Marlborough Road, Chiswick, W.4, of heart failure, of Edward Bacon, artist (brother of the late John Bacon, A.R.A., M.V.O.). A life sacrificed in the struggle against circumstances created by the war.

THE BUILDING NEWS, SEPTEMBER 19, 1917.

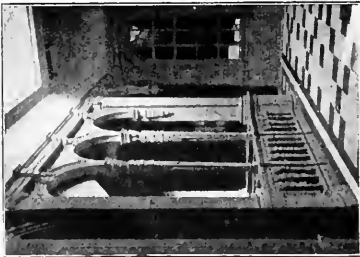

**KING EDWARD VII  
SCHOOL OF ART,**

W. H. KNOWLES, F.S.A.  
95 COLLINGWOOD ST.  
NEWCASTLE-ON-TYNE.



**ARMSTRONG COLLEGE  
NEWCASTLE-UPON-TYNE.**

Scale: 0 10 20 30 40 50 60 70 Feet

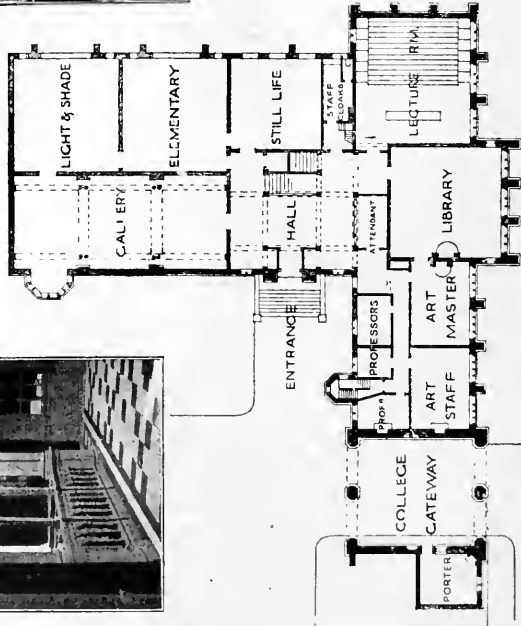

**GROUND FLOOR PLAN.**  
(SCULPTURE, MODELLING ETC. IN SEMI-BASEMENT)

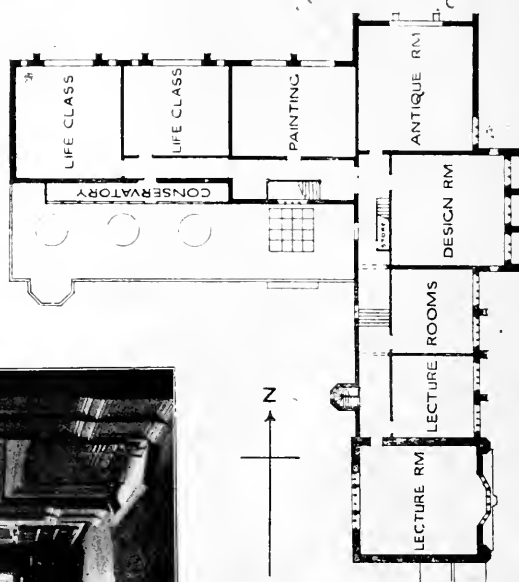

**FIRST FLOOR PLAN.**  
(ARCHITECTURE & CARTOONS  
ON SECOND FLOOR.)





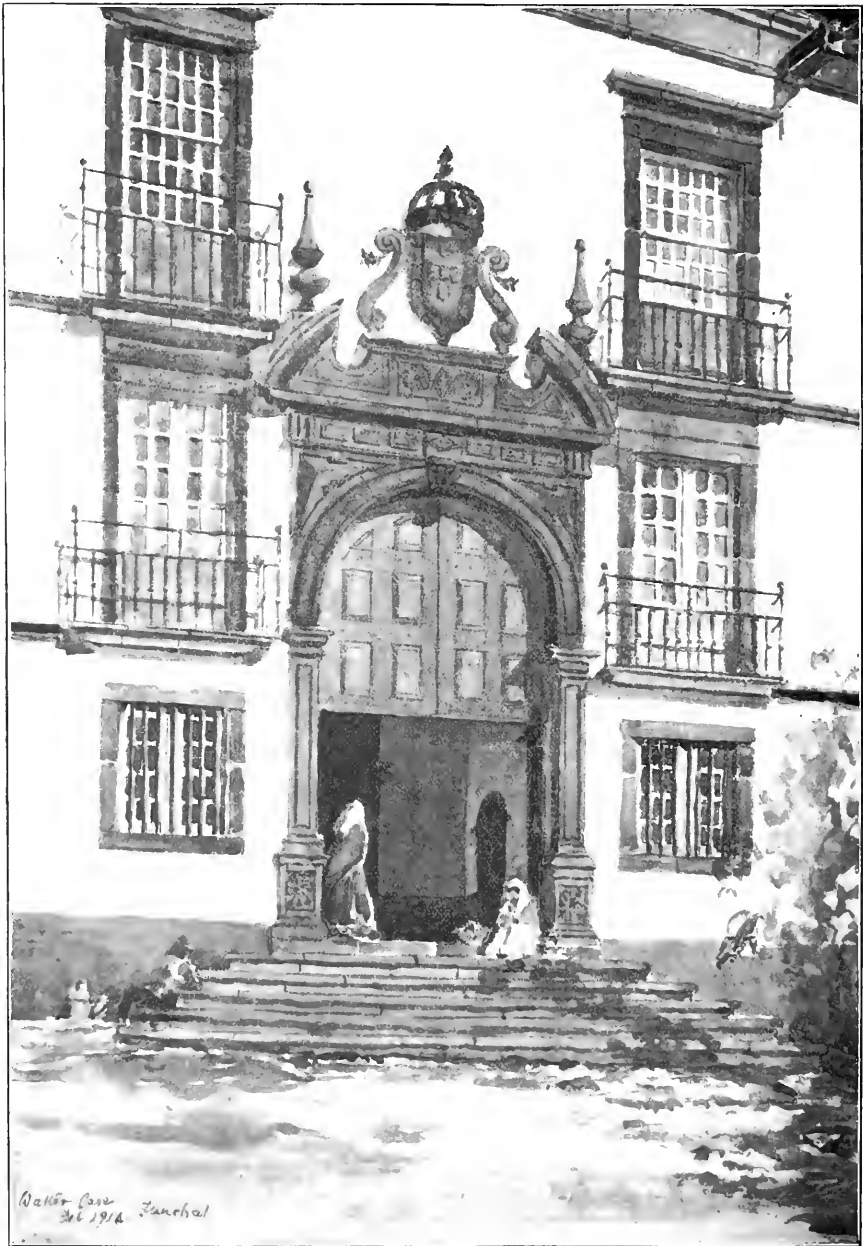

ENTRANCE TO MUNICIPAL BUILDINGS, FUNCHAL, MADEIRA.  
Water Colour Sketch by MR. WALTER CAVE, F.R.I.B.A.



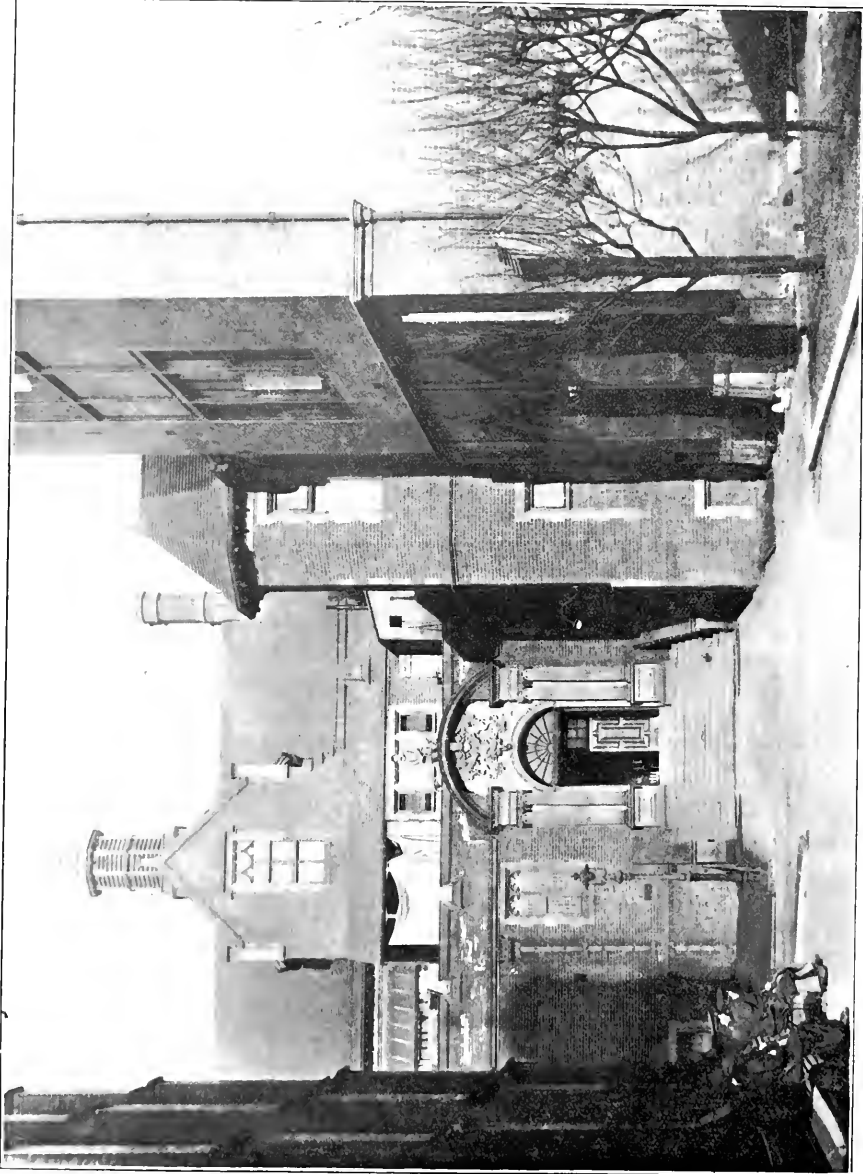

*Joseph J. Abington, Photo.*

KING EDWARD VII. SCHOOL OF ART, ARMSTRONG COLLEGE, NEWCASTLE-UPON-TYNE.  
ENTRANCE TO ART SCHOOL. MR. W. H. KNOWLES, F.S.A., F.R.I.B.A., Architect.



N.A. NEW PREMISES, 34 AND 35, BEDFORD SQUARE, LONDON, W.C.  
THOMAS LEVERTON, Architect, 1780.





*T. Lewis, Ltd., Photo.*

LANCASHIRE AND CHESHIRE MINERS' HALL, BOLTON.  
Messrs. BRADSHAW, GASS and HOPE, Architects.





EDUCATIONAL SERIES.

COMPARATIVE EXAMPLES

CHOICING COTTAGE FLATS IN TWO-STORY BLOCKS VERSUS "ROOM AND KITCHEN" TENEMENTS IN BLOCKS FOUR STORIES HIGH.

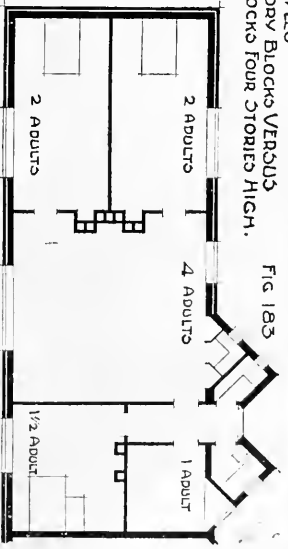
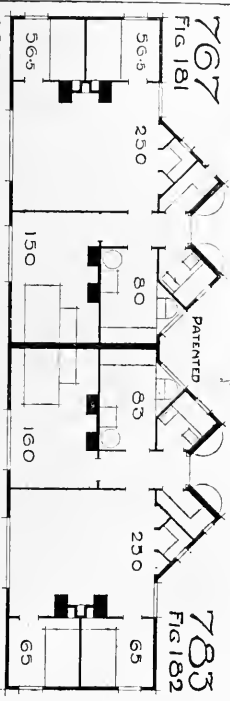

767  
Fig 181  
8.191  
Dwellings having three flue heat-actuated system of ventilation.

783  
Fig 182  
8.435

783  
Fig 183  
Plan showing sizes of apartments which with ceilings 8 feet high would be required in order to provide an air supply equal in volume to that which a dwelling built to plan Fig 182 would easily give.

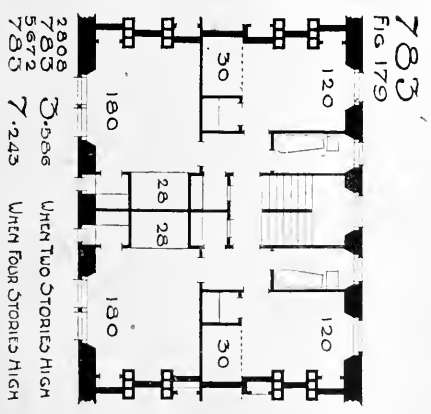
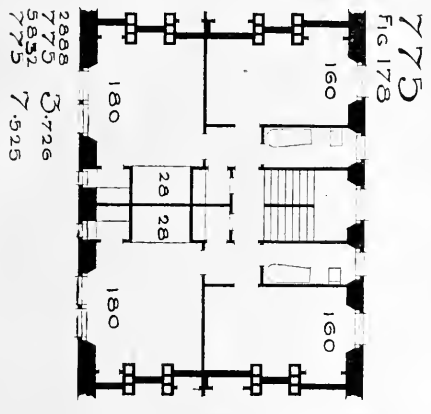
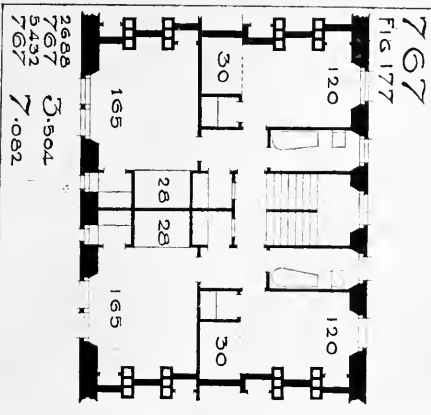

2688  
767  
767  
767  
3.504  
7.082

2688  
775  
775  
775  
3.726  
7.525

2608  
783  
783  
783  
3.556  
7.243  
When Two Stories High  
When Four Stories High



## Our Illustrations.

### LANCASHIRE AND CHESHIRE MINERS' HALL, BOLTON.

The buildings here illustrated form the centre of the Miners' Federation of Lancashire and Cheshire. This photograph of the entrance was hung in the 1917 Royal Academy Exhibition, a water-colour drawing of the whole building having previously been exhibited. Raabro brick and light, warm-toned stone are used in the building. Messrs. Bradshaw, Gass and Hope, of Bolton, were the architects, their design having been selected in competition.

### KING EDWARD VII. SCHOOL OF ART, ARMSTRONG COLLEGE, NEWCASTLE-ON-TYNE.

We give two views of this new building in our issue for June 13 last, reproduced from a set of three photographs exhibited by the architect, Mr. W. H. Knowles, F.S.A., F.R.I.B.A., at the Royal Academy this year. Some descriptive particulars appeared with our previous illustrations. We now give the plans of the school and two small inset interiors—the screen on the stairs and fireplace in the library. Our page photograph shows the entrance to the Art School, which is part of the Armstrong College. The first floor rooms are partly occupied by the Architectural School.

### THE ARCHITECTURAL ASSOCIATION, NEW PREMISES, BEDFORD SQUARE.

This illustration, together with plans of the proposed alterations, will be found described on pp. 224 and 225.

### ENTRANCE TO MUNICIPAL BUILDINGS, FUNCHAL, MADEIRA.

This water-colour drawing was made by Mr. Walter Aze at Funchal, Madeira, in February, 1914. The building has a long frontage to the principal place, and this doorway is a mere detail in the facade. The woodwork is mahogany, and the iron balustrades and shutters are painted a brilliant green. The town of Funchal does not contain many interesting buildings, and this is probably the most striking feature, and in the brilliant sunshine makes a very attractive subject.

### THE PROBLEM OF THE SMALL DWELLING AND ITS SOLUTION.

This page is added to the series of plans by Mr. Robert Thomson to illustrate Two Storey Blocks versus "Room and Kitchen" Tenements in Blocks Four Stories High. Mr. Thomson's articles on the subject appeared on May 23, and continued in *THE BUILDING NEWS* for June 6, 13, 20, and 27; July 4, 11, 18, and 25; August 1, 8, 15, and 29. The double page marked xxx. and xxxi., giving a plan for the lay-out of dwellings in which the author's patented contrivances have been incorporated, appeared in our issue for September 5. The present sheet concludes the series.

The foundation-stone has been laid of the church of St. Andrew in the Greta township, Annandale. The building will seat 375 persons, and the estimated cost is £5,700. Mr. Crickmore is the architect, and Messrs. Sykes the contractors.

The death of Mr. William Eley, of Cowbit Road, Spalding, took place on Friday week, after an illness lasting some five weeks. Deceased was one of the oldest builders in the town. He acquired the business of the late Mr. Christopher Heaton about thirty years ago, and was 76 years of age. The funeral took place on Monday week.

The decorations which have been proceeded with for some time past in St. Paul's chapel, in the south aisle of the Catholic Cathedral, Westminster, have reached a stage at which it has become possible to open the chapel to the public; the walls and arches have been lined with marble and the windows glazed. The chapel contains a gilt-bronze triptych with a figure of St. Paul in bold relief, surmounted by a panel representing his martyrdom. Beneath is an enamelled shield, bearing the arms of St. Paul. On the doors is the inscription: "Vas electionis est mihi iste, ut portet nomen meum coram gentibus et regibus et filiis Israel."

## Correspondence.

### THE GOVERNMENT AND THE TECHNICAL JOURNALS.

To the Editor of *THE BUILDING NEWS*.

SIR.—Though we are far from desiring to see the British Government everywhere adopting or imitating the innovations of Allied or other Governments, we think the Premier might well take a leaf out of the book of Governor Whitman, of New York State.

The Governor recently met in conference the editors of the various technical journals in the State, desiring to get reliable evidence upon questions of mechanical production, transport, coal and timber conservation, the provision of machinists and toolmakers, and other vital factors essential to the successful prosecution of the war. As a result, the Governor has now a committee of five editors acting in an advisory capacity.

Perhaps no class in the community has its fingers more completely upon the pulse of British industries than the men who so worthily and efficiently edit our technical Press, and we feel sure they might with advantage be called in to the State councils, where accurate information is, above all things, essential. At such a moment as this, when to take only three important branches of public service—the Air, Agricultural, and Marine Departments—there is urgent need for the wisest and sanest counsels as well as driving forces, we think nothing but good could come by the introduction of editorial assistance.—Yours truly,

HARIMAN, LTD.,  
(Scientific Welding Engineers),  
C. W. BRETT.

Managing Director and General Manager,  
10, Poland Street, Oxford Street,  
London, W.1.

### PROFESSIONAL AND TRADE SOCIETIES.

NOTTINGHAM AND DERBY ARCHITECTURAL SOCIETY.—A meeting of the Nottingham members was held at the society's room on Tuesday, September 11. There was a representative assembly of local architects present when the president, Mr. Harry Gill, M.S.A., took the chair. The president explained that the meeting had been called to discuss the subject of a civic war memorial. Although the idea of a city and county war memorial had not yet been taken up, there was a strong desire in the city that one should be erected. While it was not desirable to commence this until after the war, he felt it was very necessary that the best and most suitable sites in the city should be reserved for it and not previously occupied by any individual memorial. In his opinion, a civic memorial should be on a grand scale and worthy of the city and her sons who had given their lives for king and country. It should be architecturally and artistically treated, set in a wide space with suitable approaches and a suitable background and surroundings. He felt it should be in a public place, and strongly disapproved of putting it in a cemetery or in an enclosed space like the Arboretum. In his opinion, it would be a splendid opportunity to set back the front of the Exchange, and upon this open space group this together with the other war memorials now at the Castle and the bottom of King Street. A new Exchange would subsequently form a suitable background. If this were too ambitious a scheme, he suggested that it might be erected upon the Forest slope, where the trees would form a natural and suitable background. These were his ideas, but he invited discussion and suggestions from those present. All the members offered their opinions, and a number of useful suggestions were made. It was recognised that until the scale and form of the memorial are settled, it was not desirable to discuss detail, but it was agreed that it should be on a grand scale and architecturally treated with suitable sculpture. Eventually it was proposed that a letter be sent to the City Council, conveying the views of the society and suggesting that

the three following sites, in the order named, should be reserved for a great civic memorial to all in the city and county who have fallen in the war—1. The Great Market Place; the Exchange to be set back, and the memorial to be erected in front of a new Exchange. 2. The Forest slope. 3. The Victoria Embankment; the vacant land at present adjoining the embankment to be secured by the city and laid out as a public park, and the memorial erected therein in a prominent position. They would also beg to suggest to the City Council that the memorial to Captain Albert Ball, V.C., might appropriately be located in the district in which he lived, and they would recommend either of the three following sites:—1. The open space at the top of Derby Road, opposite the cemetery entrance; the site to be entirely cleared and the statue placed in the centre. 2. The Lenton Recreation Ground. 3. The open space at the junction of Castle and Lenton Boulevards; the site to be laid out to suit the memorial. The proposal was unanimously adopted.

### LEGAL INTELLIGENCE.

REVOCATION OF PATENT.—James Keith and Blackman Co., Ltd., v. Ralph Hancock. The full report, with diagrams of this action, tried in the High Court before Mr. Justice Sargant, June 29—July 3 last, will be found in the Supplement to the "Official Journal of Patents" of the 12th instant. In 1913 letters patent were granted to Hancock for "Improvements in Centrifugal Fans." A petition for revocation of the patent was presented by Keith and Blackman; the particulars of objections alleged want of novelty, want of subject-matter, want of utility, and insufficiency and obscurity of the specification. At the hearing, at which the patentee did not appear, the petitioners relied on the similarity of one modification shown in Fig. 6 of the specification to Fig. 3 of a previous United States specification of Hancock, and they alleged that the Hancock fan was less efficient than a fan previously patented by Keith and Blackman. The Judge held that the only respect in which Fig. 6 differed from Fig. 3 of the United States specification was that in one respect there was want of symmetry, whereas in Fig. 6 there was symmetry, but that no reason was given for want of symmetry and that the patent was invalid for want of subject-matter. Further, that there was no utility in the Hancock design. The patent was revoked with costs.

### OBITUARY.

Second Lieutenant Ernest Warneford Wray, R.E., who was killed in action on August 23, was thirty-two years of age, and the only son of the late Mr. James E. Wray, of York. He was one of the most successful students at York Institute School of Art, and in 1904 gained a National Art Scholarship, being placed first in order of merit for the United Kingdom. He gained notable honours at the Royal College of Art, and also received the Institute of British Architects Scholarship and a Travelling Scholarship. Later he was awarded the Institute's silver medal for measured drawings, and became employed in His Majesty's Office of Works, and by well-known London architects. In 1906 he submitted competitive designs for new head offices for the Port of London Authority, which were included in six selected out of 170 submitted in the final competition. When detailed plans were submitted he gained the honorarium of 200 guineas. We illustrated his design in our issues of July 19 and 26, 1912, at the time we published all the final competition designs for this undertaking, now in course of erection by Mr. Edwin Cooper. Before joining the Army in December, 1915, he resided at Wordsworth Walk, Hampstead Garden Suburb, for which estate he was for some time assistant architect. He leaves a widow and two children.

Mr. Jacob Epstein, the sculptor, has joined the Army, entering the ranks of the newly created Jewish Regiment.

The post of diocesan surveyor has been offered to Mr. W. E. Willink, and has been accepted by him. Mr. Willink succeeds the late Mr. George Bradbury, who held the office for many years.

## Our Office Table.

At the Russian Exhibition in the Memorial Hall, Manchester, last week, a lecture was given by Mr. H. D. Minton on "The Forests of Russia." It was pointed out that Russia's forest reserves amount approximately to 2,000,000 square miles, and that with diminishing supplies from the older sources in Europe and America, Russia will probably take a larger share in the supply of British timber. Her contribution has not been inconsiderable, amounting as it did to 43 per cent. of the total imports of timber. The lecturer said it was calculated that Russia could pay off the whole of the interest on her war loans in three or four years by means of the revenue obtained from the forests if they were properly worked. He suggested that British manufacturers and financiers would be welcomed by Russia in the development of her timber resources, both in the construction of railways for improving the transport and in the equipment of saw-mills to handle the raw material on the spot.

Speaking at a meeting at Taunton, Dr. S. Jacob, of Leeds, organising secretary of the National Association for the Prevention of Tuberculosis, said the disease rested upon a tripod, the three legs of which were bad food, bad housing, and bad morals. The housing condition of England to-day was something frightful. The public conscience wanted awakening to such an extent that bad, insanitary dwellings would not be tolerated anywhere. In Barrow people were paying 10s. a week for one room, and half the population of Glasgow lived in tenements of one or two rooms. They had been told that they would save the lives of 1,000 babies a week by building half-a-million houses, yet they would have to wait until after the war for this. Half-a-million would not be half enough, for more than that number were required for the big cities, according to the reports of the medical officers. People suffering from tuberculosis, which was an entirely preventable and arrestable disease, must be given the chance of a decent life to enable them to be won back to health. Dr. Graham, of Watchet (West Somerset), agreed with everything Dr. Jacob had said. Conditions were quite as bad in rural districts of Somerset as in big towns, and it would be a good thing if much of this old property was burnt down. Councillor W. J. Payne (Taunton) said they were going to have an eye-opener at the next meeting of the town council on housing conditions in Taunton. Those who had seen the report of the medical officer had been staggered at the revelation it contained. There were at least 700 or 800 houses in Taunton that wanted wiping out, houses without back doors and through ventilation and other very bad defects. Dr. Jacob remarked that however much their medical officer of health might condemn property in Taunton, the Local Government Board would step in and say, "Don't condemn any more property during the war." They must work to get public opinion on their side and then the housing question would be dealt with.

The French "Journal Officiel" of September publishes a notice to the effect that the Ministry of the Interior (Service of Reconstruction of the Invaded Regions) has decided to put in hand immediately the construction of 5,000 temporary buildings for the agricultural development of those regions of France liberated from the enemy. Tenders were invited for the erection of buildings in lots of fifty, but not more than ten lots (i.e., 500 buildings) may be constructed by the same contractor. Sealed tenders, in duplicate, had to be delivered from September 17 to 20 inclusive, so, as the Board of Trade did not send us the information till September 15, any chance for British builders was lost.

In a circular letter to London local authorities the Public Works Contractors' Association states that a recent meeting of that association came to a decision that it was advisable to review the situation so as to endeavour to obtain some uniformity of opinion as regards a general rate of labour; that the

effect of certain awards and resolutions has been to produce a state of uncertainty so far as public works employers are concerned; that this uncertainty has been intensified by the action of certain Government Departments which have authorised their contractors to pay these increased rates, irrespective of whether the work is builders' work proper or road work, and that the result is that the men are claiming (through their unions and under the protection of some Government Departments) rates of wages, with hours of labour, which were never intended or included in the recent awards above mentioned. The letter further states that it is, therefore, of opinion that no definite conclusion acceptable to the men can be arrived at without the co-operation of representatives from the Government Departments, metropolitan boroughs, statutory and municipal authorities in the London area, and that with this end in view the association invites the appointment of representatives to attend a conference, which it is suggested should be held in the autumn to fully consider the whole position.

The Birmingham Housing and Town Planning Committee have obtained estimates from builders and architects as to the cost of building six-roomed cottages (including the cost of the site and road-making), and these show conclusively, it is said, that houses which cost to build £250 before the war will in the future involve an outlay of £325—an advance of at least £75. The committee are satisfied, moreover, that builders, if they are to get a "reasonable interest return," cannot let such houses at a less weekly rent, including rates, than 10s. 6d. At present the same class of house is let at 6s. 6d.

The Frederikshavn Shipyard and Floating Dock, Jutland, Denmark, according to "Engineering," is at present building a ferro-concrete floating dock on a field facing the sea. It is being built on a foundation of boards, 100 ft. long and 69 ft. broad, on which is mounted a skeleton of 340 iron pillars, connected at the top with girders. The reinforcement of the bottom consists of a network of rods and wires. The concrete is poured in wooden moulds round the pillars; the outer and inner walls of the dock will be 4 metres thick, and the bottom will have the same dimensions. The sides of the dock are divided into six compartments, which can be filled with water by opening the bottom valves, and they can be emptied by power calculations in a small compartment in each of the six water tanks. The floating dock, when completed, will weigh some 700 tons; the work, as in so many other cases, has been retarded through shortness of raw materials, and it can hardly be launched till the end of the year. The launch will take place at high-water, straight from the field into the sea, and the structure will afterwards be towed to its place at the yard. It will be used both for the building of new vessels and for repairs, and can be connected with the present dock, so that for the future larger vessels can be repaired at the yard.

Owing to an almost total want of fuel the Danish cement industry is threatened with stoppage, and some two or three factories have already closed down. The stocks of cement are almost exhausted, and the Government has found it necessary to prohibit all sale and delivery of cement, both from works and dealers. The Danish Co-operative Cement Factory, which belongs to the large group of agricultural co-operative undertakings in Denmark, and which, through a lawsuit, was brought to a standstill, has been enlarged during this enforced idleness, whereby its capacity has been doubled, the annual production being raised from 300,000 barrels to 600,000 barrels.

At St. Martin's-in-the-Fields last Friday Mr. Douglas Eyre, of Oxford House, Bethnal Green, said that four million of our fellow-citizens in this country were living in overcrowded conditions. In London 3,000 people were living eight to a room; 7,000, seven to a room; and 26,000, six to a room. Of London's population 20 per cent. at least lived under lamentable conditions. The country needed 500,000 new houses to replace those that were insanitary, 300,000 to overtake the deficiency

in building of the last seven years, and 700,000 to provide for the increase in population. This was equivalent to the erection of 1,500,000 tenements, or 7,500,000 new rooms. In Bethnal Green 40,000 out of the population of 130,000 were living under insanitary and overcrowded conditions. The borough possessed five condemned areas, of which Brady Street—the most notorious area—had a population of 470 per acre. These conditions were known twenty-seven years ago, but the attitude of the Government Departments was shown by their requiring Bethnal Green to find the money itself.

For a good many years, writes the United States Consul-General at Hong Kong, schemes have been entertained from time to time for the erection somewhere in South China of a model city for the use of well-to-do Chinese. The latest undertaking of this sort is for the construction of a model suburb of Hong Kong along the most modern lines for the housing of wealthy Chinese. This plan involves the reclamation of a tract of land about a mile and a-half long and a third of a mile broad, the construction of wide avenues and fairly wide side streets, the erection of forty-seven blocks of high-grade apartment, tenement, and similar buildings, and the establishment of a modern sewerage system and other public utilities. In spite of war and the uncertainties of finance, the company undertaking this enterprise has been formed and its plans completed. The new suburb is to be located on the south side of the Kowloon Peninsula, the mainland portion of the colony of Hong Kong, two miles from the landing of the ferry from the city of Victoria (commonly known as Hong Kong), and along the shore of Kowloon Bay near the native city of Kowloon. The site is to cover a tract about 8,000 ft. long and 1,500 ft. broad, embracing the foreshore only, but backed by hills from which several small streams emerge, the ravines affording considerable fall for drainage purposes. The reclamation is wholly a dredging undertaking. The plan includes the erection of four piers, with space for warehouses if need for them arises, in the water front of the reclaimed land.

A new steam motor vacuum gully emptier has been successfully adopted by the Rochdale Corporation. The new machine sucks up practically every atom of filth, takes it away immediately, and re-seals the gullies with clean water, thereby preventing the escape of sewer gas. At the top of the machine is a circular vacuum chamber capable of holding the contents of six gullies. From this a long tube is put down into the gully, and with the vacuum created from the engine the foul matter is drawn up into the chamber. Below this is a tank, with a capacity of 925 gallons, into which the refuse can be emptied by the use of a valve. Below the tank again is a water reservoir, also with a 925 gallons capacity, from which the gullies are re-sealed with clean water. There is also an arrangement whereby, when the solid matter in the refuse tank has settled, the liquid is decanted off through a gully into the main sewer, the gully then being flushed out with clean water. It is estimated that by this latest method it will be possible to empty 200 gullies per shift, or, as the Cleansing Department works a night shift, 400 gullies every twenty-four hours. Roughly speaking, therefore, the whole of the gullies in the borough will be emptied once every three weeks—in the principal streets more often than that. No such frequent, and certainly no such thorough, cleansing has been possible before. The machine has been supplied by the Yorkshire Commercial Motor Company, Leeds, and the cost is about £900.

### TRADE NOTES.

Boyle's latest patent "air-pump" ventilators, supplied by Messrs. Robert Boyle and Son, ventilating engineers, 64, Holborn Viaduct, London, have been employed by the Consett Iron Co., Ltd., for the locomotive shed, Stanhope Quarries.

On September 15, at 71 Alexandra Road, Wimbledon, Surrey, the death took place of Henry Fuller, late of Associated Portland Cement, Ltd., Lloyd's Avenue, E.C., aged 87.

FOR

**Olivers' Seasoned Hardwoods,**

APPLY TO—

**WM. OLIVER & SONS, Ltd.,**  
120, Bunhill Row, London, E.C.

**TENDERS.**

\* \* Correspondents would in all cases oblige by giving the addresses of the parties tendering—any rate, of the accepted tender: it adds to the value of the information.

**AYLESBURY.**—For construction of a concrete foundation, etc., for a gas engine at the electricity works, Canal Wharf, Aylesbury, for the town council, Mr. W. H. Taylor, borough engineer and surveyor, Town Hall, Aylesbury:—  
Webster and Cannon, Aylesbury .. .. £239 0 0  
(Accepted.)

**AYLESBURY.**—For extension of the generating station buildings and other works in connection therewith at the electricity works, Canal Wharf, Aylesbury, for the town council, Mr. W. H. Taylor, borough engineer and surveyor:—  
Webster and Cannon, Aylesbury .. .. £450 0 0  
(Accepted.)

**CHELMSFORD.**—For construction of a stone-paved footpath in Rectory Lane and Bishops Hall Lane, in the borough, for the town council, Mr. P. T. Harrison, A.M.I.C.E., borough engineer:—  
B. H. Hale, Romford .. .. £83 19 9

**CORK.**—For alterations and reconstructions of premises, Union Quay, Cork, known as Buckingham House, for the Cork Timber and Iron Co., Messrs. W. H. Hill and Son, 28, South Mall, Cork, architects:—  
C. Gevee, Rutland Street, Cork .. £1,204 0 0  
(Accepted. Portion of work deferred.)

**DOVER.**—For lavatory at the river side at Charlton, for the town council:—  
Hayward and Paramor (accepted) £29 10 0

**DURHAM.**—For carrying out repairs at Nos. 9, 10, and 11, Edward Street, for the Durham City Council:—  
M. Beaver (accepted) .. .. £56 2 0

**FAYERSHAM.**—For repainting work at the town hall, for the town council:—  
E. Cutting (accepted) .. .. £08 10 0

**GLASGOW.**—For work and supplies, for the corporation.

Accepted tenders: J. G. and R. Thomson, erection of boiler-house chimney at Dalmarnock Gasworks; S. Peace and Sons, Ltd., supply of steel files; All-days and Onions, Ltd., two forced draught fans for Dalmarnock Gasworks; Davidson and Co., Ltd., one forced draught fan for Temple Gasworks; W. Baird and Son, six coke grabs for Dowholm Gasworks.

**HAMMERSMITH.**—For erection of a motor garage in Mardale Street, Hammersmith, for the Hammersmith Borough Council:—  
McManus (accepted) .. .. £62 0 0

**HAMMERSMITH.**—For repairs to corrugated iron roof of boiler house, for the Hammersmith Borough Council:—  
J. McManus .. .. £229 0 0  
D. Rowall .. .. £24 0 0  
P. Braby and Co., Ltd. .. .. £20 10 0  
(\*Recommended for acceptance.)

**KILLARNEY.**—For rebuilding portion of the main building of the workhouse lately destroyed by fire, for the guardians:—  
T. Gallivan and Sons, New Street, Killarney .. .. £1,862 18 8  
J. J. Fleming, New Street, Killarney\* .. .. 1,829 2 11  
(\*Accepted.)

**SALFORD.**—For outside painting work at the Seely Baths, for the corporation:—  
J. Evans, Broughton (accepted) .. £74 0 0

**SALFORD.**—For painting outside of dwelling-houses in Broughton Park, for the corporation:—  
J. Evans, Broughton (accepted) .. £51 0 0

**SWINDON.**—For school repairs, for the education committee:—  
A. E. Tunley (accepted) .. .. £68 0 0

**WAKEFIELD.**—For erection of a building at the new pumping station at Crigglestone, for the Wakefield Rural District Council:—  
J. H. Waite (accepted) .. .. £124 0 0

**WORCESTER.**—For converting an iron building into a six-stall cow-house, for the city council:—  
Pheps and Johnson (accepted) £133 14 0



It is proposed to convert Low Hill Primitive Methodist Chapel, Baldon Moor, into a convalescent home.

Sec. Lieut. Wilfred Holt, East Lancashires (killed), was assistant art master in Greenock Academy. On the outbreak of war he joined the Manchester Regiment as a private, and later received his commission.

John Outram, agent to the owner of a house at Walthamstow, was fined 40s. at Stratford police court for failing to prevent a waste of water. It was stated that since March about 50 gallons an hour had been lost through a defective ball-tap.

To the Municipal Council of Sydney the city surveyor has presented a report with regard to the relative costs of carting clinker by carts and motor-lorry, respectively. A trial had been made with a lorry for one whole day. The lorry removed twenty-four and a half tons in seven loads, the cost being 2s. 9½d. per ton. The cost for removal by carts was 1s. 7d. per ton. The higher cost for removal is due to the short run and the time lost by shovellers during the period the motor is away. In the case of carters, they do the shovelling.

Alderman Lazarus Hart, ex-Mayor of Ramsgate, who died on September 7, has left £10,000 to the Corporation of Ramsgate, together with an acre of ground, for the purpose of endowing and building ten havens of rest for persons of any age or sex. Five are to be of the Jewish religion nominated by the Jewish Board of Guardians in London, and five, not Jews, to be chosen by the Ramsgate Town Council. Not more than £3,000 is to be expended in building the havens, £1,000 is to be invested and the income applied to keeping the buildings in repair, and the balance is to be invested and the income divided equally between the 10 inmates of the havens.

At the last West Suffolk County Council Meeting the Rev. the Hon. A. F. Northcote proposed that the council should support the application of the county architect (Mr. A. Hunt) for the provision of a reasonable amount of petrol to enable him to assist the Standing Joint and Education Committees in efficiently maintaining county buildings. He pointed out that the architect had purchased a small car, and all the petrol he needed was six gallons a month. Mr. W. R. Butler said he only regarded it as a pious resolution, because he did not think there was the remotest chance of the petrol being granted. Mr. Walton Barrell said a bicycle was all that was necessary: he knew of older men than Mr. Hunt who cycled 70 and 80 and even 100 miles a day. The resolution, however, was carried.

**TO CORRESPONDENTS.**

We do not hold ourselves responsible for the opinions of our correspondents. All communications should be drawn up as briefly as possible, as there are many claimants upon the space allotted to correspondents.

It is particularly requested that all drawings and all communications respecting illustrations or literary matter, books for review, etc., should be addressed to the Editor of the BUILDING NEWS, Effingham House, 1, Arundel Street, Strand, W.C.2, and not to members of the staff by name. Delay is not infrequently otherwise caused. All drawings and other communications are sent at contributors' risks, and the Editor will not undertake to pay for, or be liable for, unsought contributions.

When favouring us with drawings or photographs, architects are asked kindly to state how long the building has been erected. It does neither help nor us much good to illustrate buildings which have been some time executed, except under special circumstances.

RECEIVED.—B. R. Co., Ltd.—C. E. B. K.—C. A. Y.—W. D. M.—J. G. K. and Son—W., Ltd.—W. H. S. and Son.

P. G.—No.

DATUS.—Cannon.

F. S. L.—Kindly send.

PROJECT.—Too preposterous for comment.

A. S. R.—There have been many patents, but few of these are worth anything. Your modification—it is scarcely an "improvement"—would be too costly, we expect, for the ordinary fastener.



Mr. W. Yeats, borough surveyor of Elgin, has resigned.

Mr. E. S. Haslett has been appointed acting surveyor to the Cambourne Urban District Council during the absence of Mr. C. D. Bell on military service.

A company, the Società Anonima Navi Italiane Cemento Armato, "Nica," with offices in Rome and works in Genoa, has been formed, with a capital of 1,000,000 lire (£240,000), to be raised ultimately to 5,000,000 lire (£1,200,000) for the construction of ships, particularly ferro-concrete ships.

Sergeant F. Williamson, of the 14th K.O. Yorkshire L.I., has been posted to the 2nd Officers' Cadet Battalion, Peterhouse College, Cambridge, and is in training for a commission. Sergeant Williamson was well known in Rochdale before the war as curator of the Corporation Museum and Art Gallery.

It is reported that houses are being built in France from concrete made of ground slag mixed with hydraulic lime in the proportion of three sacks of lime to one cubic yard of slag. It is rammed between wooden frames to form walls about 18 ins. thick, and is used for every kind of building, including cottages, country houses, warehouses, factories, etc.

One of the troubles of a Portland cement mill is the dust, which destroys vegetation and is injurious to breathe. By means of electric circuits the particles may be precipitated, and as the dust contains potash it is possible, by means of this system, to recover it in the form of potash salts. The process is in use in America, and it has been found that the potash salt output pays the operating plant, plus a reasonable profit, leaving the cement as clear profit.

**BRABY'S AUTOMATIC FLUSHING TANKS**

SIMPLE. RELIABLE.

**Fredk. BRABY & CO., Ltd.**

352 to 364, EUSTON ROAD, LONDON, N.W.

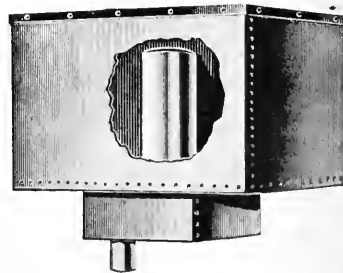

## LIST OF TENDERS OPEN.

## BUILDINGS.

**Oct. 5-11.**—Reinstating and improving the "steward's stores at the Infirmary, Lower Road, Rocherhithe, S.E., according to plan and specification of Mr. A. H. Newman, F.R.I.B.A., etc.—For the Bermondsey Board of Guardians.—E. P. Linton, Clerk, 28, Tooley Street, S.E.1.

## ENGINEERING.

**Oct. 16.**—Supplying and fitting complete steam power machinery for the Laundry at the Workhouse, Wallingford.—For the Guardians.—G. F. Slade, Clerk, 7, St. Martin's Street, Wallingford, Berks.

**March 30.**—The Acting British Consul at Santiago reports that a 4-cree has been issued calling for tenders for the improvement of the port of Antofagasta (Chile). By the terms of this decree the amount to be expended on this work must not exceed £1,700,000. Details may be obtained from the Port Commission offices in Santiago, and copies are expected to be received shortly at the offices of the Chilean Legation in London, 22, Grosvenor Square, W.1. Tenders will be received up to 3 p.m. on March 30 by the Minister of Finance, Santiago.

## MISCELLANEOUS.

**Oct. 1.**—Alteration and renovation of the old Library, King Street, Bristol.—For the Estates and General Purposes Committee.—P. Addie, City Valuer, The Exchange, Bristol.

**Oct. 8.**—Laying out land for a burial ground.—For the St. Andrew's (Dinas Powis) Parish Council.—W. D. Williams, Clerk, Parish Hall, Dinas Powis.

## PAINTING.

**Sept. 22.**—Painting certain bridges in Manchester.—City Surveyor's Office, Town Hall, Manchester.

**No Date.**—Cleaning and decorating Bentley (Dancaster Wesleyan Church).—Particulars of Mr. G. Watson, 252, Bentley Road.

Mr. J. Graham, J.P., builder and contractor, Dromore, has secured the contract for the carrying out of a big Government job at Belfast, amounting to over £12,000. The contract was secured in face of keen competition by three other of the foremost North of Ireland firms.

## CHIPS.

Mr. Samuel Haskins, of Aberdare Gardens, Hampstead, and of Samuel Haskins and Bros., Ltd., Old Street, E.C., shopfitters, has left £12,250.

It is proposed to build and equip a cottage home to accommodate thirty-two children, as a memorial to Mr. J. T. Lewis, formerly the chief engineer of the South Indian Railway, who was killed in action in Gallipoli two years ago.

With the approval of the Treasury, the Commissioners of Public Works in Ireland have appointed Mr. James Healy, Deputy Accountant, to be their secretary, in succession to Mr. Henry Williams, M.V.O., on his retirement on September 15 after nearly fifty years' service.

The Islington Board of Guardians has decided to leave in the hands of Messrs. Tallis and Co. the question of reconstructing the machinery plant at the laundry damaged in the recent air raid, and to apply to the Local Government Board for their sanction to carry out without delay the necessary works.

The death is announced at his residence in South Woodford, London, of Mr. William B. Hund, the assistant superintendent engineer of the Tower Bridge, London, and a native of Haverth. The deceased served his apprenticeship as an engineer at Messrs. Palmer's works at Jarrow. Subsequently he went to sea as a chief engineer, and thirty years ago he secured a position whilst the Tower Bridge was being constructed. On its completion he was appointed to the position of assistant superintendent, and held that office up to the time of his death.

The Board of Education give notice that, in view of the uncertainty of the position during the continuance of the war, they are unable to commit themselves to a withdrawal of any of the arrangements announced in Circular 920, dated September 13, 1916, regarding the National Competition, examinations in art, and awards in art, and the announcements made in that circular, modified as regards the Princess of Wales's Scholarships by Circular 942, must therefore be regarded for the present as applying to 1917 as well as to 1916.

## TO ARMS!

COUNTY OF LONDON VOLUNTEER ENGINEERS (FIELD COMPANIES).

Headquarters, Balderton Street, Oxford Street, W.1.  
**ORDERES FOR THE WEEK BY LIEUT. COLONEL C. B. CLAY, V.D., COMMANDING.**

**OFFICER FOR THE WEEK.**—Second Lieutenant C. E. Campbell.

**MONDAY, SEPT. 24.**—Technical instruction (searchlight) for No. 3 Coy, Right Half Coy, at Regency Street, Drill No. 3 Coy, Left Half Coy, Signalling Class, 6.30. Recruits' Drill, 6.30.

**TUESDAY, SEPT. 25.**—Physical Drill and Bayonet Fighting.

**WEDNESDAY, SEPT. 26.**—Drill and Elementary Bridge Construction for No. 1 Coy, Right Half Coy.

**THURSDAY, SEPT. 27.**—Drill and Elementary Bridge Construction for No. 2 Coy, Right Half Coy, Signalling Class, 6.30. Ambulance Class, 6.30.

**FRIDAY, SEPT. 28.**—Technical instruction (searchlight) for No. 3 Coy, Left Half Coy, at Regency Street, Drill No. 3 Coy, Right Half Coy, Recruits' Drill, 6.30.

**SATURDAY, SEPT. 29.**—Commandant's Parade for Route March and Drill, Parade at Headquarters, 2.45 p.m. Uniform—"A" and "B." N.C.O.'s and men are reminded that one route march a month is compulsory. Recruits Drill, 2.30.

**MISSEBRY.**—All N.C.O.'s and men who have signed the "A" and "B" agreements are required to attend during this month to reclassify in order to enable the Corps to obtain the Capitation Grant. Preference will be given to these men in firing. This does not apply to those who hold the proficiency badge.

**ARMLETS.**—The new issue armlets can now be obtained at Headquarters, and every enrolled man must obtain one without delay; at the same time, all old red armlets (now obsolete) must be returned.

**NOTE.**—Unless otherwise indicated all drills will take place at Headquarters.

By order,

MACLEOD YEARSLEY, Capt. and Adjutant.  
 September 22, 1917.

The language classes held at the Bolt Court School, Fleet Street, will re-open on Monday, September 24. Intending students should attend at the school for advice and enrolment any afternoon next week between 3 and 5. Particulars may be had on application to the Principal, Hugh Myddelton Commercial Institute, St. James's Walk, Clerkenwell Green, Farringdon Street, E.C.1.

When you buy ready roofings get the BEST

# ALLIGATOR ROOFING



All self-finished roofing may look alike, but there is a big difference in the wearing quality, especially after it has been exposed to the rain and sun for a few years. So don't buy a roofing until you are satisfied that you are getting durability and quality combined at the right price.

ALLIGATOR ROOFING IS APPROVED BY ALL GOVERNMENT DEPARTMENTS.

LASTS LONGER. COSTS LESS. EASY TO LAY.  
 BRITISH MADE. PROMPT DELIVERY.

BRITISH ROOFING Co. Ltd., 126, Bishopsgate, London,

Telephone: AVENUE 3682.

E.C.2.

# THE BUILDING NEWS

## AND ENGINEERING JOURNAL.

**Effingham House.**

Corrente Calamo .. .. .	241
Dear Building and Its Remedies .. .. .	242
Some Wrinkles in Wood-Working .. .. .	243
Our Illustrations .. .. .	257
Refractory Materials .. .. .	258
Liverpool Cathedral .. .. .	258
Professional and Trade Societies .. .. .	258
Our Office Table .. .. .	259
Chips .. .. .	259

**CONTENTS.**

Tenders .. .. .	260
List of Tenders Open .. .. .	260
To Arms! .. .. .	260
To Correspondents .. .. .	260
Latest Prices .. .. .	viii.

**OUR ILLUSTRATIONS.**

The Royal Exchange, Manchester, The Central Colonnade, Messrs. Bradshaw, Gass and Hope, Architects.

**Strand, W.C.2.**

"Woodland Court," Amersham, Bucks, Mr. Harold Trippell, A.R.I.B.A., Architect.  
 Proposed Branch Office for an Assurance Company, Mr. Paul Waterhouse, M.A., V.P.R.I.B.A., Architect.  
 The recent repair of the existing buildings of St. Nicholas Priory, Exeter. General plan, view of West Front, Tudor Room and oriel, and interior of the Guest Hall. Messrs. Harold Brakspear, F.S.A., and Lewis Toner, Architects. Drawings by Mr. J. Sparks, A.M.C.

### Corrente Calamo.

Probably, as a well-known M.P. remarked to us the other day, "people are sick of hearing about Barrow and housing," but they will be sicker soon if Mr. Churchill's hasty and inadequate remedies are to be taken as a settlement. The whole business is a scandal to the Government, which is solely responsible, as the Mayor pointed out at the meeting of the council on September 3. As regards ordinary needs, Barrow has done much more house-building than any other town in the kingdom of late. During the past three years 1,079 houses have been certified in Barrow, providing accommodation for 5,395 people, whilst in six years accommodation has been provided for 10,125 persons. Messrs. Vickers built 502 of the 1,079 houses erected since 1912. After 1914 the difficulty of building houses by private enterprise increased enormously. Men were required for the Navy, for the Army, for the munition works. Thousands of men and women have been brought to Barrow by the Government for munition work, and although the Government knew of this influx the Ministry did not attempt to meet the position until February of the present year, when they proposed to erect 250 houses on terms which the Council were quite ready to accept. From that time the matter has been under negotiation, and the Corporation have almost week by week pressed the Ministry to push along, and, after an interview and many letters, the scheme suggested by the Ministry was finally approved on July 4, but the agreement at the date of the meeting had not reached the town clerk, and no further official communication was received from the Ministry, though the architect has been at Barrow and the surveyor has with him inspected the Government housing scheme at Rosyth. It is hoped, therefore, that the additional 250 houses will be proceeded with forthwith. In the meantime Barrow is held up to reproach. But it was the Ministry of Munitions and the Government that were to blame. They knew the number of people coming to Barrow; the Corporation did not. They knew that private enterprise and Corporation enterprise were stopped by the

cost of material and scarcity of labour, and on them, and not the Corporation, must rest the blame.

The Parliamentary Committee of the Scottish Trade Union Congress have issued a report by a sub-committee on the Rosyth housing scheme. The laying out of the streets, and the manner in which the houses are planned in blocks, is declared "far in advance of anything yet attempted in Scotland," but the houses are not by any means ideal. The apartments are very small. The attempt to provide a habitable house with modern conveniences has led to scrimping the size of the apartments. The architect is on the right lines with regard to providing a good type of house, but it is obvious that he has been cribbed or limited to a given size. Given other 2 ft. to the width of each house, and 2 ft. or 18 in. to the length, the living apartments would be wonderfully improved. The bathroom may be described as an apology, and a very poor one. In a space of 5 ft. 3 in. by 4 ft. 3 in. there is a bath and water-closet. "It will tax the ingenuity of the grown person to wash by instalments; to bathe must be left to their imagination." The doors and finishings are of the very plainest moldings, and ornamentation is entirely absent. Another type of house visited was somewhat on a similar plan, with three apartments and scullery. The dimensions are: Kitchen, 14 ft. by 10 ft. 9 in.; scullery, 8 ft. by 11 ft. 6 in., with bathroom deduction from this size as in the former type; two bedrooms above, with floorage as below with press wardrobe on stair and press in bedroom. The rental of the first type is 9s. 5d. per week, rates and electric light inclusive. The rental of the second type is 7s. 8d. per week, rates and light inclusive. One tenant volunteered the information that in England, in the part he came from, he had a six-roomed house, scullery and bath (no hot water), at a rental of 8s. per week, rates inclusive, and that 6s. 6d. and 7s. 6d. per week was quite common in England. Another tenant said that his rent was 9s. 2d. per week, rates and light inclusive. The sub-committee feel certain that the housing problem is not being solved at Rosyth. Ground there is in abundance, but the element of profit-making enters into the production of the house, and therefore the

accommodation is limited and restricted to a given size to obtain a return by way of rent to the capital invested.

A plan has been prepared by the Acting City Surveyor of Manchester (Mr. John Lake) to illustrate the Traffic Congestion Committee's scheme for dealing with the Piccadilly site. The committee have attempted to reconcile three rival proposals by combining them. The first suggestion was to build an art gallery or library; the second was to lay out the site as an open space, and the third was to make a tramway terminal there. The committee suggest that the triangular block of buildings which stand between the site and Mosley Street should be demolished, and that the larger square should be planned so as to have a deep open space with gardens on the Piccadilly side and a tramway terminal in a widened Parker Street. There would remain a building area of about 6,600 square yards. Sir Thomas Beecham, it seems, is anxious to provide Manchester with an opera house if the city will provide a site. Asked what he would suggest if, for example, a section of the Piccadilly site were offered him for his purpose, he said that he thought this magnificent plot was one which, from its peculiar shape, admitted and even asked for the erection of more than one building. He had seen, in Athens, he thought, or somewhere in Sicily, a similar plot used very effectively by placing a large building along the major part of the most extended frontage, as it were beginning at the Mosley Street end and facing Piccadilly, while a second and somewhat smaller building of selected but not identical character would run from the opposite corner, facing the Queen's Hotel, and along the broader end of the site in Portland Street. This second building would in this case be the one he would desire to have as the opera house. A strong case had already been made out for an art gallery on the site, and he thought the larger building would, in case his suggestion were adopted, naturally be used, and would still provide ample space for the art gallery. He thought, further, that if an opera house were erected on this site there would spring up a movement for the addition of a companion concert hall, which might very well find a place fronting on to Portland Street and rounding off the rear of



the site in a way that would effectively hide from the general architectural view all the mean "back door" business which was unfortunately a necessary part of stage undertakings.

The members of the Metropolitan District of the Institution of Municipal and County Engineers had the advantage on Saturday week of an exposition on the spot by Mr. F. Baines, under whose direction it has been done, of the work of restoration of the roof of Westminster Hall which is in progress. The proposal put forward to rebuild the roof with new wood was not seriously considered, since it would have preserved neither the historical associations, the ancient appearance, nor the mechanical interest of the roof as a genuine example of mediæval construction. The method of repair chosen has been to interweave among the upper timbers of each principal a new principal of steel hidden for the most part from the view of spectators in the Hall. The new steel principals are triangulated structures, strong enough to sustain the weight of the roof timbers and the external pressure of wind, and to transmit the resulting pressures on to the walls. The old timber, now made good with new, is retained in its original position, and still contributes to the support of the roof, and in the event of decay destroying its supporting capacity wholly or in part, the steel frame is strong enough for its support. Much of the damage has been caused by the ravages of the *Xestobium Terecollatum* beetle, and steps are being taken, as already stated, to prevent this by the injection of a volatile liquid, invented by Professor H. Maxwell Lefroy, M.A., of the Imperial College of Science and Technology, South Kensington, which is retained in the timbers by means of a surface spray of paraffin wax.

We imagine, with the *Times*, that the "concern and indignation" which its correspondent records "in the highest circles" at Washington will be quite sufficient to stop the intended gift to Westminster of what seems to be a thoroughly unworthy statue of Abraham Lincoln. To most of us his message is the first news that anything of the kind was even contemplated. The arrangements were apparently made, and almost completed, between a well-meaning private donor, Mr. Charles P. Taft, in America, and Lord Weardale, chairman of the "Hundred Years Peace Committee," in England, with the sanction of the British Government. The merits of the statue seem to have been taken here on trust, and it is only at the eleventh hour that influential American opinion has shown itself so decisively against them. It is inconceivable now that this particular statue should ever reach our shores. But the public, and especially the London public, have also a right to know by whose authority so grave a blunder was committed in their name. It would have been an easy matter to make sure that some authoritative body, such as exists in the American Commission of Fine

Arts, had approved Mr. Taft's friendly offer. By all means let us have our memorial of Lincoln, whose life and achievements were never so fully recognised in England as to-day; but let it be a memorial adequate to its subject, a source of unqualified pride to Lincoln's countrymen as well as to ourselves.

The Government of India has issued a pamphlet of sixty-five pages entitled "The Work of the Forest Department of India," by Mr. R. S. Troup, in popular form, and at the price of 5d., giving an account of the forests of India and of the methods by which they are managed. The Forest Department controls one-fifth of the total area of India—viz., 249,867 square miles; but 141,882 square miles of this are so-called "unclassified" forests, where control is nominal, being restricted to the collection of revenue. Of the "reserved" and "protected" forests, 107,985 square miles in area, about one-half, 55,629 square miles, are scientifically managed and subject to sanctioned working plans. The most important commercial forests are the teak forests of Burma, the sal forests of Northern, Central, and North-Eastern India, and the deodar and pine forests of the North-Western Himalaya. The personnel of the department includes 237 officers trained in England, 231 officers recruited in India and trained at Dehra Dun, and a subordinate service of 1,610 rangers, 2,000 foresters, and 10,500 forest guards. The Forest Research Institute of Dehra Dun, which was founded in 1906, prosecutes investigations in silviculture, forest botany, economic products, zoology, and chemistry, and has already issued considerable scientific literature. The pamphlet contains a list, with short descriptions, of the forty-four most important forest trees, and a chapter on minor produce, which include bamboos, grasses, fibres, oil seeds, tanning materials, essential oils, oleo-resins, gums, india-rubber, drugs and spices, and animal products like lac, silk, horns, hides, and ivory. An account is also given of various forest industries established, such as the tapping of *Pinus longifolia* for resin and turpentine, which has now passed out of the experimental stage, the annual collection amounting to 2,592 tons. The paper-pulp industry, the manufacture of matches, the antiseptic treatment of timber, and the dry distillation of wood all appear capable of considerable development in India.

The internment of Mr. Laszlo, the well-known portrait painter, says the *Manchester Guardian*, has caused rather a stir, for he has been a prominent social figure in society in London during as well as before the war. It was his blank canvas on which he promised to paint any portrait the buyer desired which, after Mr. Sargent's, reached the highest figure in the first great Red Cross sale at Christie's. He was naturalised in 1914, and the witnesses to his application were Lord Balfour of Burleigh, Mr. Arthur Lee, and Lord Devonport. He is married to a daughter of Mr. H. Guinness, of Burton Hall, Co.

Dublin, and is a member of the Victorian Order, King Edward, Queen Alexandra, Pope Leo, Mr. Roosevelt, and Lord Milner have been among his sitters. He was born at Buda Pest in 1869, and was ennobled by the Emperor of Austria in 1912. The news of his internment comes as a great surprise to his friends. Mr. Laszlo, being naturalised, is in a different category from the others whose cases have come up in the courts.

#### DEAR BUILDING AND ITS REMEDIES.

For some years to come building will not be cheap. Even if there had been no war, and if a new Parliament—we have lost all hope of this one—repeals the clause in the Finance Act of 1909-10 which dealt such a staggering blow to our industry, it will take time for prices of material and labour to level themselves, and for all of us to adapt ourselves to new conditions. In all such buildings as come under his direction the duty, therefore, is doubly laid on the architect to ensure economy as far as he can. The more so, perhaps, because some of our critics in the daily press are harping on the real or imaginary disposition of the architect to be lavish where his client's purse will stand it, because it increases his commission; and advising building owners, especially those who want to build hotels, restaurants, theatres, and structures of their sort, to do without an architect altogether and give the work to one of the big universal providers, who keep their architects well under their thumbs on the premises, and can, moreover, furnish and decorate throughout at the lowest possible figure, and possibly take a few hundred shares into the bargain on the chance of unloading them on to the public by-and-by at a premium.

From clients of this sort, and their architects, even when they do employ one, we have little chance of attention. The client will get a lowest tender—and pay for it, in the long run. The architect may not lose much, after all. Scamped work and bad materials mean extras, and perhaps litigation. Anyhow, the cheap builder is master of the situation; and if the architect is complainant the client will probably swear, but he will have to pay, and the more certainly if there has been no quantity surveyor, or if his obliging disposition has induced him to put on more labour and load the items. When quantities are properly taken there is seldom wide tendering of the sort due to discrepancies which the builder so disposed will take advantage of. A bill of quantities or a schedule of prices arranged between the builder and the architect is the only really honest way of ascertaining the cost of a building, and it is to clients who know this, and architects who are able enough to meet their desires that we appeal at the moment.

It is useless to ignore the fact that it is perfectly easy to expend on a building hundreds and thousands of pounds which are sheer waste of money. Extravagant material or unnecessary and mostly bad ornament, both thrown away when they are not wanted, are still too common among us. Sometimes, to balance the cost of this spendthrift ostentation, other parts of the structure are starved, and to furnish a façade with useless marble or granite shafts and exuberant carving, the barest walls and the roughest make-shifts are tolerated which would disgrace



a mere factory and imperil the safety of a cowshed. The misapplication and misplacement of such vulgarised adjuncts is not seldom the fruit of the client's own vulgar fancy, and where this is so it is—especially now and for some years to come—the duty of the architect to dissuade such expenditure and to protect his client against firms anxious to recommend better materials or more costly designs for, say, ceilings, wall-linings, or floors, which add to cost but do not better the design, but in some cases spoil it.

Again, where money is not squandered as just suggested, there is not infrequently a tendency on the part of the client to suggest improvements as the building goes on. A foot or two more on a storey may doubtless increase and improve the rooms, but it may mean much more money than the owner contemplated, and he may not unreasonably say so when the bill comes in, if his architect has not made that clear to him when his suggestion was adopted. We have a case of another sort in mind where the clients—a public body—after the contract was completed, captivated by the arguments of an art-amateur on their body, came to the conclusion—and not unrightly—that the setting back of the building a few feet would vastly improve its appearance. It did, but it entailed much extra labour for excavation and concrete, the cost of which gave the architect a bad time at the finish.

"What difference could it make where a building was placed," asked one irate economist, "as long as it was built on the site selected?" and his speech elicited cheers from the Labour party, whose successful agitation for another "war bonus" had added quite as much to the cost of the building!

Very often, of course, the instructions to competing architects, especially in the case of public buildings, are so vague—sometimes so ridiculous—that anything like a correct estimate of cost is impossible. And the more this is the case the oftener a clause is added that no design will be accepted the cost of which exceeds 10 per cent. of the sum estimated—which is still more absurd and unjust. It is better to state the extreme limit of cost that can be incurred, and to make each competitor submit an estimate and give the cubic contents of his design, and how far he has calculated the same, so that something like a fair comparison may be possible. The rate per cubic foot cannot fairly be made the test unless certain rules are followed as to measurement, and therefore each competitor should be asked to show how he calculated his cubic feet, and the rate per foot. Also it should be made quite clear whether the sum named is inclusive of fittings, heating, ventilation, fencing, and the like. It is far better to make the cubic contents cover the building itself exclusively, and to state the separate cost of heating, ventilation, fittings, and decoration. In several large competitions of late years that has been done in instructions to the competing architects with good results. In some buildings, such as a town hall, the fittings bulk much more heavily in regard to cost than others, as any mere outsider will admit when he thinks matters out, which he seldom does, the Englishman's desire and delight in most transactions being to know what he is going to pay to a farthing, which is craftily humoured every year by his good friends in the House of Commons, the Estimates being priced out often to pence—and supplementary ones bunched in at the fag end of the session adding thousands to the taxes, which he seldom reads, or if he does, says nothing if his own party is in power, but vows vengeance against his

opponents at the next election if they are skimming his teeth!

It is especially necessary just now for the architect more than ever to make himself acquainted with the cost of labour and material, especially in regard to the special trades. In regard to these he is not seldom deficient, although he may have a good general knowledge of the rates per foot cube for different kinds of buildings. It is very difficult, we know, to get at the actual cost of such things and their ratio to the rest of the building. In ordinary times we and other similar sources of information are of use to all concerned—architect, builder, and client; at the moment, candidly, we are of very little, as we warn readers every week. We shall do better we hope presently; but personal inquiry of the manufacturer, after all, is the only safe guide in many cases, especially where things are supplied to special designs. Then every architect ought to be better able and willing than some have been in the past to tell within a small margin what the percentage of cost of each trade should be, and to give as well the cost of furnishing, heating, or ventilating a public hall, a church, a school, a hospital, a private house, etc. There are few aids to this kind of estimation for special branches, and therefore it is the more the duty of the architect to keep his client informed, especially when the latter is dealing more or less with firms who have made it a special study.

To some of these we should like to point out that the times will not favour the ideas of any who are imbued with the conviction that whatever else is done without, their speciality is indispensable, and that therefore its cost may be kept as remunerative as possible, and that customers may be kept waiting because the producer will not bring his plant up to date or keep his material up to the mark and supply it in reasonable time. One instance is furnished beyond all doubt in the present lamentable condition of the Welsh slate industry. For some years, with a few most creditable exceptions, lack of enterprise and want of due publicity kept the bulk of the quarry workers and owners supine in the assurance that slates *must* be had, at whatever price they chose to charge and whenever it pleased them to deliver. We have before us a speciously argued plea by somebody who has interviewed those who are doing little to mend matters, in which these, the real causes of decadence, are very lightly touched on, and in which architects and builders and their clients are adjured no longer to use substitutes, which, being forced to do, they have found better than slates, and which they are not likely to abandon because the Welsh quarry-owners and workers have come to their senses—but not yet of their own shortcomings, but of the bounden duty of those they neglected to drag them out of the pit they dug for themselves. It is little likely that any such help will be forthcoming unless the methods and manners of the past are mended, and those of the few who still study the requirements and resources of their customers are studied and followed. There are other industries which have similarly suffered, if in a less degree, from the same causes. There are some stone merchants whose attempts to establish monopolies lent more or less indirectly to the more extended use of reinforced concrete, till orders for stone fell off from clients who hardly felt it their business to confine their attention to a material which in some cases had lost its reputation and in more was only to be had at considerably enhanced cost.

Lastly, there is labour. Six hours a day may suffice, as Lord Leverhulme tells

us, for some industries—that of soap, for instance, which, presumably, can be made at any time, and the sale of which depends considerably on the depth of purse and brilliancy of imagination of the bold advertiser. It may not answer in the building trades, where weather and the seasons are sometimes adverse, and which at all times are liable to stoppage from various causes. A six-hour day will certainly hardly prove the solution of the problem of providing perfect dwellings for the workers. Just now on some of the few jobs allowed to be attempted, and with the scarcity of labour obtainable—a good deal of which is, naturally, of very poor quality—it is doubtful if even six hours a day are put in—at any rate, in real work, and little at all, even on Government jobs without a plentiful consumption of tobacco—and matches! Whether or not we are getting as well paid as munition workers or Ministers of State and their proteges, most of us who are "carrying on" the business of the country as well as we are able have found that longer hours and more intensive work have been, and are, indispensable. It will be so after peace is made for longer than many will like it, and not a few will be thankful if, when normal times return, they can with a clear conscience declare that their persistent discharge of their duty has justified the greater leisure and better emolument they may reasonably demand. But there will be no better times in the lifetime of most of us if the consumer of every degree is exploited and the influx of capital discouraged by the extravagant expectations of the worker and the greed of the profiteer.

#### SOME WRINKLES IN WOOD-WORKING.

By "CHARGE HAND."

The enlargement of plant through war-work is a necessary but harassing business just now. Apart from the question of getting delivery of the ordered machinery, this is a serious item owing to the first cost of wood-working machines. It is, therefore, necessary to utilise obsolete machinery if it is in any way possible. In a recent case in which advice was sought the old stock consisted of a 15-in. panel planer, a hand mortiser, and an untrue drilling machine. The last presented no difficulty. A new spindle was turned in the engineer's shop, and the driller was then put down in the sawmill as a vertical boring machine. The mortiser was divided base from top, and the base attached at the side of a circular saw for the purpose of using the end of the saw spindle for horizontal boring. The slides of the mortiser gave two of the three required motions, the third, a vertical adjustment, being obtained by table boards of various thicknesses, these being sufficiently accurate for the job, which was the dowel holes on board edges for glue joints. A five-eighths hole was put in the saw spindle to take the bits, which were usually broken engineer's drills. They were bevelled back considerably, both on length of point and cutting-face bevel. The drills were fitted to the spindle by means of a lead-antimony shank that was cast around them. The mould for the shank was made in hard wood, a hole being bored through the block by a drill the size of the one for which the shank was wanted. A five-eighths followed this to the depth required for the shank, Fig. 1. The broken end of the drill was then notched in the fluting to give a secure hold for the metal, then inserted in the smaller hole, and pushed up into the larger hole for a sufficient dis-

tance. The metal was poured when only just melted, to prevent it running down the fluting of the drill: otherwise clay or other stopping was necessary. When centre bits were wanted a divided block was used, the two halves being cramped together, and then drilled.

The planer was only obsolete on the score of size, and was used for something resembling cable casing and for multiple sawing. To do this, a spindle was made, Fig. 2, which in bearing diameter was one and a quarter inches. Thirteen inches of the shaft was one and a half inches diameter. One and a half inches of the thirteen was threaded for a left-handed nut. The plate saws were of the old parallel-sided type, but were bevelled back on the side of the teeth, like the machinist bevels his rebating irons. A quarter-inch square keyway was put in every saw, and these

Where the need of a four-cutter is felt, the following method of moulding on the general joiner's or vertical spindle machine has advantages. In Fig. 3 it is shown carried out on a common oak picture mould, 1 and 2 are successive stickings on edge and flat respectively. On sawing between the dotted lines the four moulds fall apart. The backs can then be planed for uniformity.

With stock work of a somewhat elaborate nature the setting has a tendency to take up a lot of time. The machinist with forethought, to avoid this, marks round the outline of the cutter on to a piece of board, which is butted up to side and edge of block. When those cutters are again wanted the man then sets them back on to his template. But on trial they are often only approximately correct, and sometimes one or two hours are spent

an hour and a quarter, it follows that a five minutes' movement represented one-two hundred and fortieth of an inch. In planing hard wood blocks for our engineer's use it was no unusual thing to work to this accuracy, as the error on these blocks was cumulative. A vernier slide rule was used, of course, in such cases. A method of ensuring parallel boards from the planer was to cut a hard wood gauge the size of four boards, a quarter inch panel thus having an inch gauge. Four boards were then planed, placed on each other and the edges tried. Any discrepancy, being thus increased fourfold, was easily seen.

The cost of planing teak is so prohibitive that where a large quantity of boxes is required in that wood it is advisable to have the sawyers exercise great care, so as to get the smallest possible margin over size for after treatment. By dint of repeated effort they were brought up to such perfection that not 10 per cent. of the boards had to be planed. The finishing off on the flint-paper disc was sufficient to bring the boxes to size.

If any thick boards were met with owing to a dull saw running out of true, the thick pieces were cut to the larger size, either side or end of the required box put temporarily on one side and afterwards planed up on the skew, as Fig. 5. By this method, instead of having to plane a board 16 to 19 ins. wide, the cutters had only about 10 ins. to run over, and that with less shock, owing to the fibres being skewed. It, nevertheless, sometimes happened that, to meet an urgent order, a batch of five-eighths teak had to be planed down to half-inch. There was no change of feed rate on our Robinson, but as there was room on the countershaft to allow the three and a half inch pulley to move up, the key was removed and two set-screws substituted. The shaft being cleaned and kept greased, it was only a minute's work to move the pulley up so that the belt worked on the one-and-three-quarter inch shaft. This left a slack belt, so an iron rod was put through the belt casing at a suitable height; on this a piece of gaspipe was put, the whole forming a jockey-pulley to take up the slack. Carborundum stones should always be used for sharpening; the coarser they are, the better. In small shops, where joiners work the machines and use their own stones, it would pay masters to get these stones for the planing machines. Paraffin oil (kerosene) should be used instead of oil for sharpening purposes. Not only does the stone cut quicker with it, but the difference in price between the two fluids soon covers the first cost.

Niggardliness in stores is no economy; the time lost in finding makeshifts is wasted time. A point in the writer's experience will illustrate how far this meaning may be carried. The spindle-belt had a lap joint, but was only 2 ins. wide, so a very fine lace was used. These laces ran out, and the machinist took first one and then another of his own leather bootlaces for repairs. For the third time it broke, and was reported to the foreman. "Well," he said, "haven't you a boot-lace you can put in?"

One useful emergency measure is to use joiner's oval nails as belt fasteners: 2-in. is the handiest size and 2½ ins. for heavy belts. The heads are ground or clipped off, and the nails bent in a vice to the shape of an E, without the centre stroke in. Holes are bored in belt with a bradawl and the nails driven through. Turn the belt end over, points upwards. Put a saw kerf into a half-inch square stick, and let the kerf hold the nail point while the one in the belt end is bent over. Having

(Continued on page 257.)

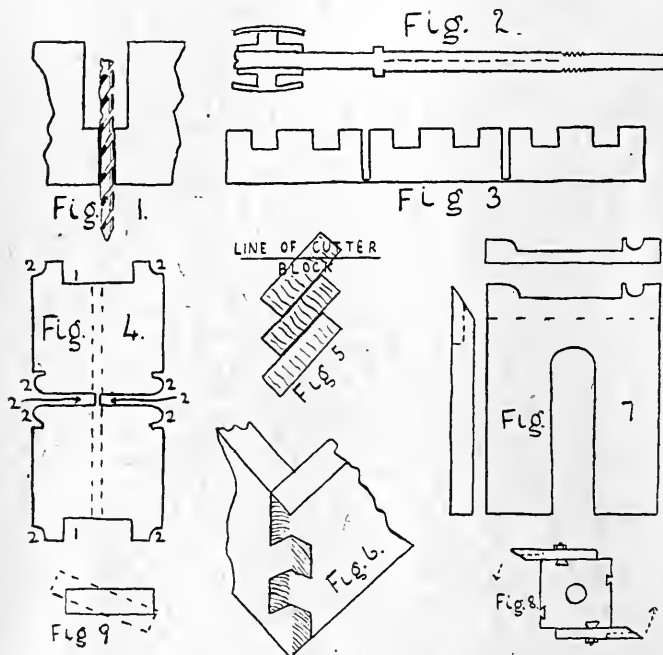

fitted on to a long key that was let into the inch-and-a-half part of the shaft, threaded part excluded. The spacing collars also had the keyway, though afterwards, for emergency collars, short lengths of gaspipe were used, which were large enough to slip over the key. To divide the casings five rip saws were also threaded on the shaft, these being just large enough to clear the pressure bars; in the given case, four and a quarter inches was the size. A flat saw file was used for truing up, the table being adjusted so that the rip saws just made contact with the file face, and then a piece of wood one sixty-fourth less in thickness than the distance between bottom of groove and outer face of casing was put under the file, and the plate saws tried on that. Under these conditions, in actual work, when the grooves were the required depth the rip saws nearly divided the board, Fig. 3. The twelve-inch boards had only been planed one side, the rough side being downward. After running through the groover, they were planed on the other side, and the six casings came off cleanly divided. Multiple sawing was done by the same method.

before they are absolutely correct. The reason for the difference is that very few blocks are really true, and only by chance does a cutter come back to the side it was on when the template was made. To ensure true setting have the block set back on the pin before tightening up. Mark the sides of the block with one, two, three, and four pops with a centre punch. Then pop one leg of each cutter to correspond with its particular side.

Much trouble can be experienced with girl or other diluted labour in regard to getting uniformity in planing. A method used with success was to compare the thicknessing wheel to a clock face. Suppose that the indicator registered the thickness at five-eighths, and the handle of the wheel stood at five-and-twenty past, on our clock face comparison. Then, after interruption, the indicator was again put to five-eighths and the handle to five-and-twenty past, with the happy certainty that it would work in with the previous batch. In poor light, to assist in seeing the indicator, the side of the oil-can makes a useful reflector. A sixteenth of an inch being represented on our machine by a turn and a quarter, that is

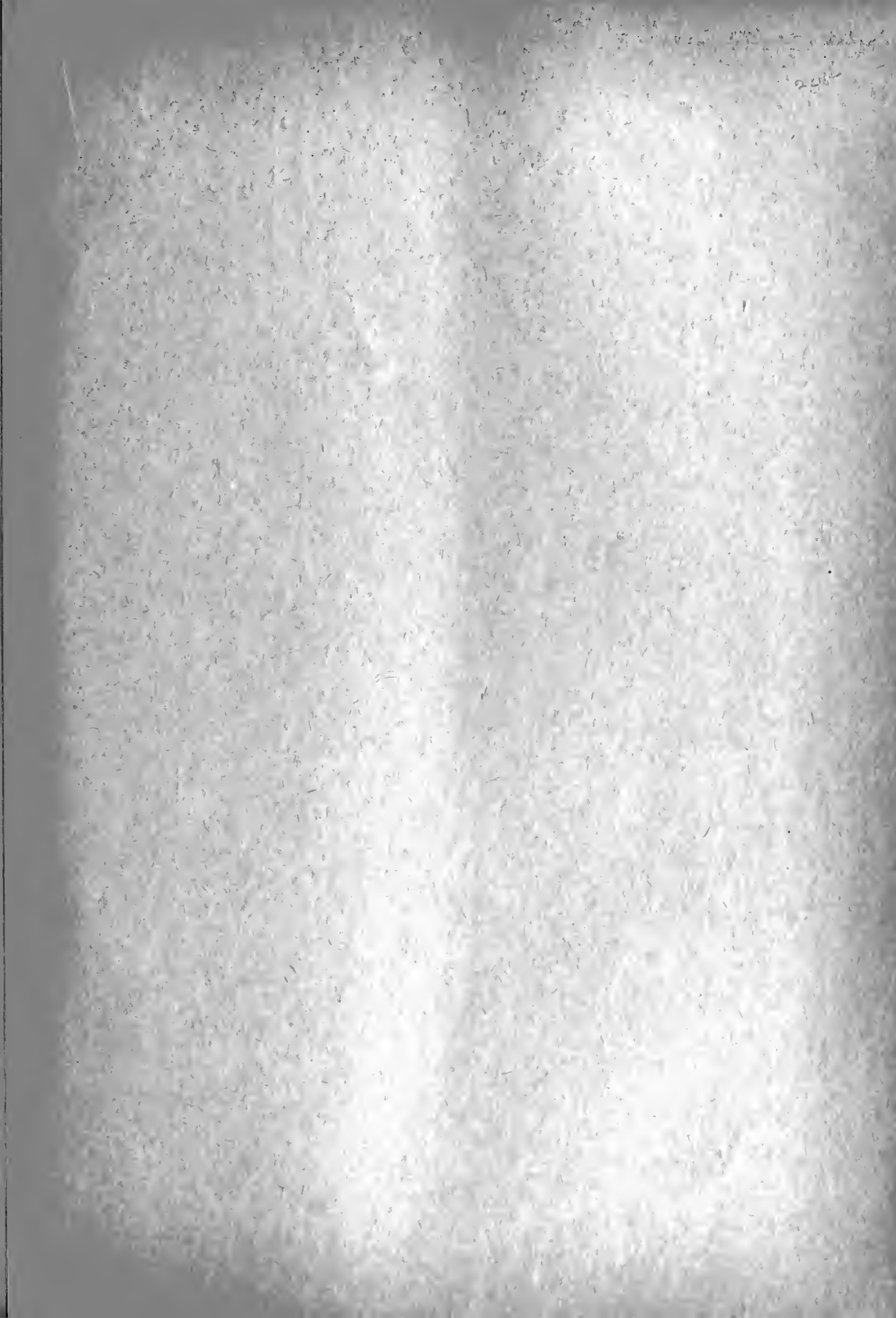

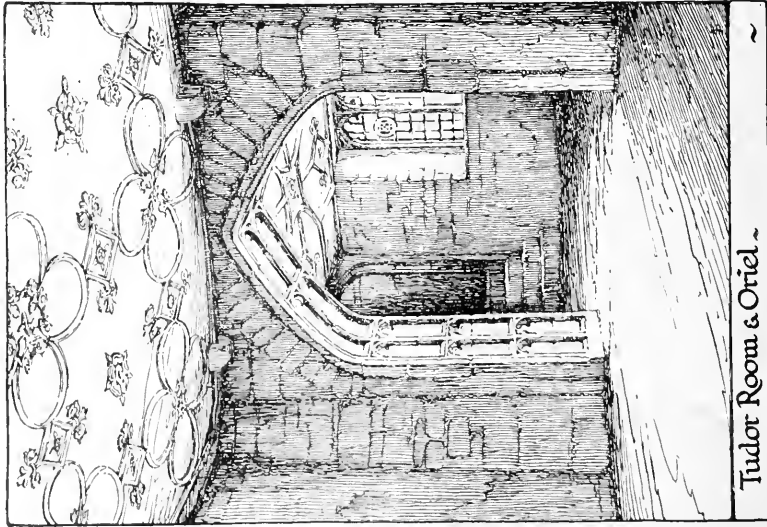

Tudor Room & Oriel ~

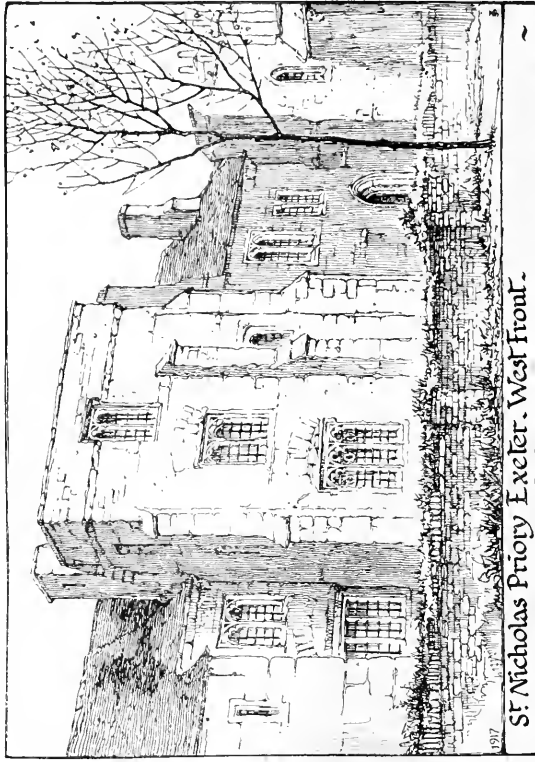

1917  
St. Nicholas Priory Exeter. West Front.

ST NICHOLAS' PRIORY.  
EXETER.

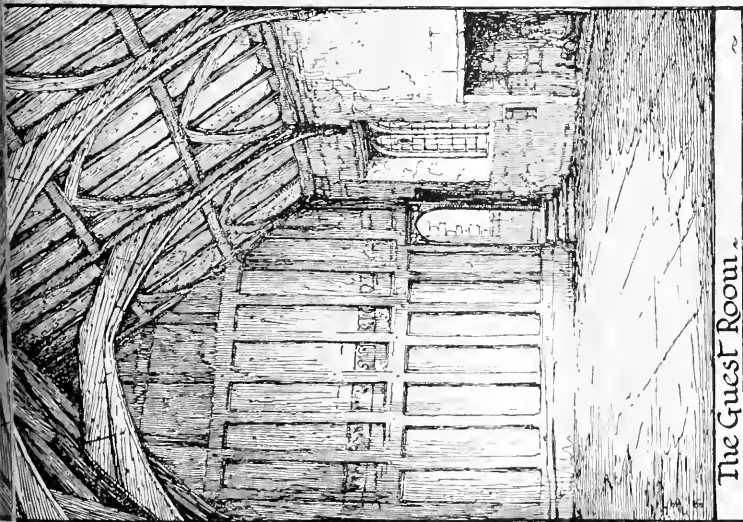

The Guest Room.

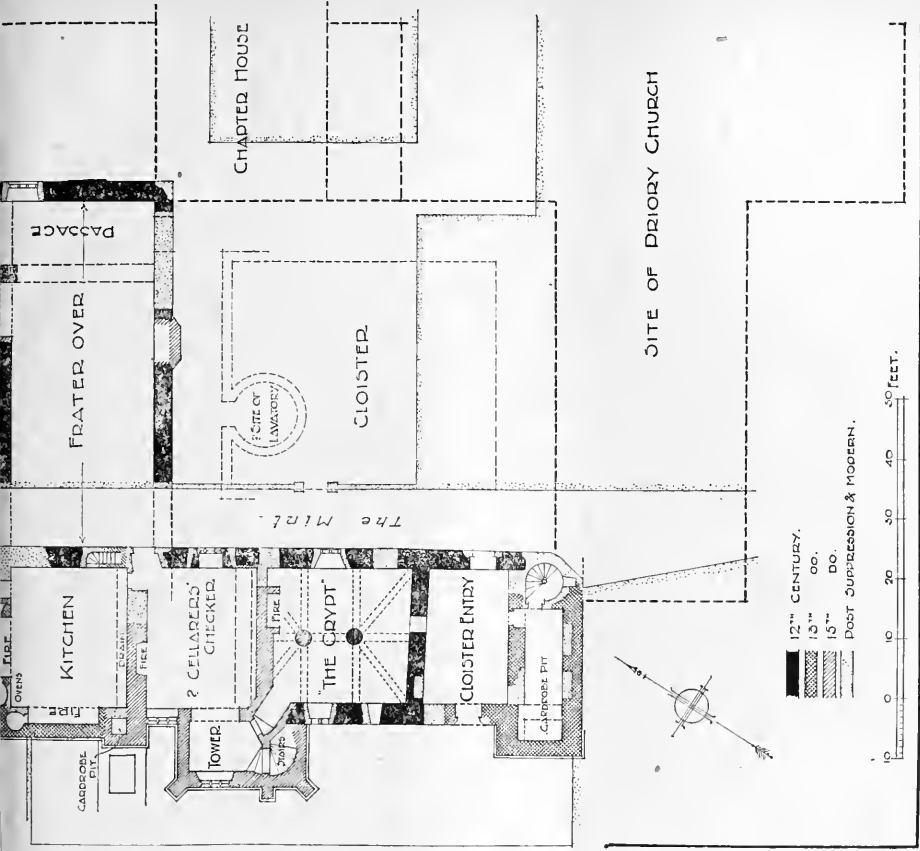

THE RECENT REPAIR OF THE EXISTING BUILDINGS OF ST. NICHOLAS PRIORY, EXETER.  
 MESSRS. HAROLD BRAKESPEAR, F.S.A., and LEWIS TOMAR, Architects.  
 Drawings by MR. J. SPARES, A.M.C.







THE BUILDING NEWS, SEPTEMBER 26, 1917.

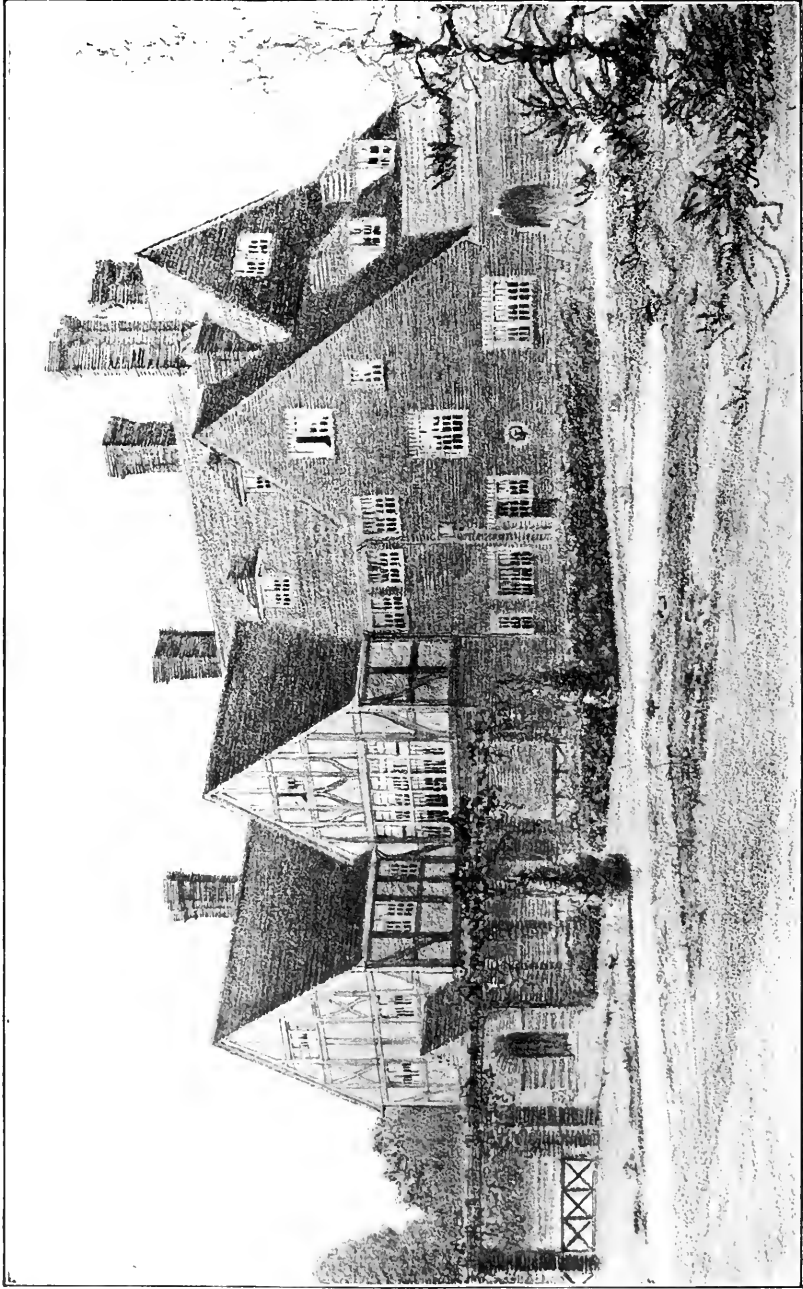

"WOODLAND COURT," AMERSHAM, BUCKS.—MR. HAROLD C. TRIMMELL, A.R.I.C.A., Architect.



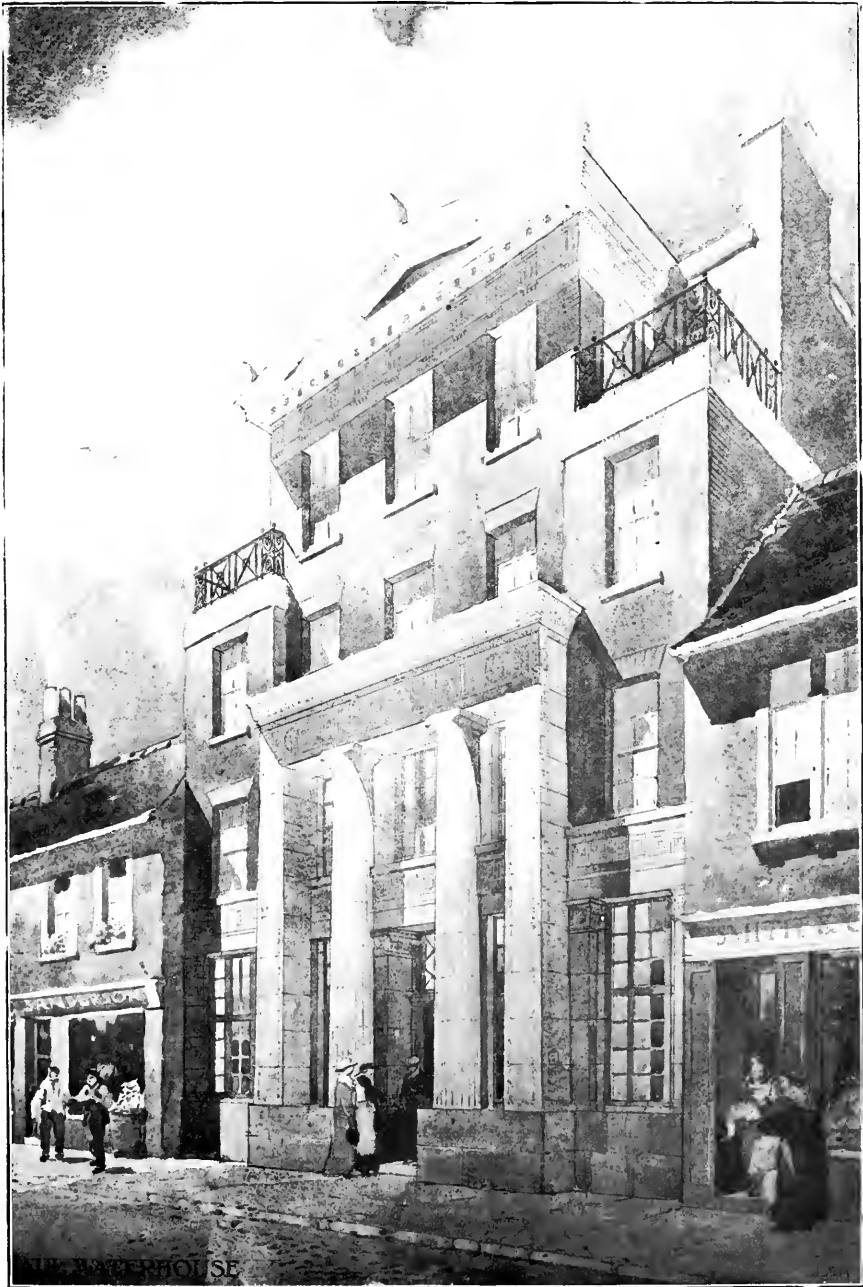

PROPOSED BRANCH OFFICE FOR AN ASSURANCE COMPANY.  
Mr. PAUL WATERHOUSE, M.A., F.R.I.B.A., Architect.







THE ROYAL EXCHANGE, MANCHESTER: THE CENTRAL COLONNADE



COLONNADE — Messrs. BRADSHAW, GASS and HOPE, Architects.



## SOME WRINKLES IN WOOD-WORKING.

(Continued from page 244.)

done one end, the other points are driven into the other end and clenched. Points should be on the inside of the belt.

Angle locking is a method of box jointing that is destined to come into greater favour. Fig. 6. The machine was originally of German make, but the London agents of the German company have made certain modifications that make a greater output possible. The essential parts of the machine are a travelling table, moving at right angles to the axis of the cutter spindle; on this bed is a clamp pivoted in the middle, so that it can be swung to two marked angles. The clamp is geared so that one turn of a handle moves it one pitch of lock, but the pitch may be varied by change gearing. The cutter spindle is not parallel with the floor line and table, the angle of cant being the same as the marked angles of the clamp. On the German machine there was one cutter block; the London modification has several heads. Owing to the canted spindle these blocks have to be graduated in size. This limits the efficiency of the device to small boxes so far as doing them at one operation is concerned.

There is no reason that the method of wood-working in which the pattern is milled into the face of the cutters should not be revived for certain classes of work, as owing to the accuracy of modern grinding machinery it is possible to keep the pitch of the bevel always the same, on which the trueness of this type of cutter depends. A typical iron of a common picture mould is shown, Fig. 7. These knives are always put on the reverse way to an ordinary one, bevel side to the face of the block, Fig. 8.

A method of using tools to cut across grain, as in square turning, is to twist the iron until the cutting edge has been turned to an angle of about thirty degrees to the plane of the body of the iron, Fig. 9. It is heated in the forge fire for the operation, and afterwards retempered. In grinding to the required shape the pattern has to be projected from the original plane on to the angled face, otherwise the mould is smaller than desired. This device was shown me by the shop foreman of a works at Old Trafford, and as I have never seen it elsewhere it may have been his own invention. For sweet cutting, either with or across the grain, there is no better method, and if any firm were to put them on the market their use could be strongly recommended.

The Carlisle Rural District Council has voted a war bonus of £20 a year to Mr. J. W. Kirsopp, the surveyor.

The 5,000-ton span of the Quebec Bridge was safely towed into position on September 17. The operation of hoisting the span began quickly, and at noon the span had been raised 8 ft. without a hitch.

Mr. W. A. Chambers, architect and surveyor, has been reappointed by the Local Municipality to be Assessor to the Tribunal of Appeal constituted under the City of London Improvement Act for a further period of one year.

The death is announced, from wounds, of Lieutenant T. W. Hooley, Labour Battalion. He was home on leave three weeks ago, and had been only five months at the front. Before joining the Army Mr. Hooley was an architect.

On the suggestion of the Rochdale Housing Sub-Committee, the Health Committee last Friday expressed their readiness to formulate a scheme for building 250 houses of the better artisan type on condition that the Government make a contribution to the expense and that the houses can be let at a rental which will avoid recourse to the rates. There is at present a shortage of 750 houses in the borough.

## Our Illustrations.

## ROYAL EXCHANGE, MANCHESTER, CENTRAL COLONNADE.

The whole of the total area of site, which is over 3,000 square yards, is now occupied by the Exchange, formed into one great hall, with a south bay corresponding to the old Exchange, which forms the north bay. These two bays are connected by the central colonnade shown by the water-colour drawing exhibited at the Royal Academy this year. While forming an important architectural feature, the colonnade divides the great floor space and gives necessary location so requisite for the members. The general lines of the old building are maintained, but the wall ornamentation throughout is brought in scale with the much enlarged Great Hall. Messrs. Bradshaw, Gass and Hope, of Bolton, are the architects, and Messrs. W. Thornton and Sons, Ltd., of Liverpool, the contractors. We illustrated the exterior of this building in our issue for January 15, 1915.

## WOODLAND COURT, AMERSHAM, BUCKS.

This house was completed for Mr. Crosfield in 1914, and the site commands a fine position looking towards Chesham. The drawing here reproduced was exhibited at the Royal Academy this year. The bricks used are "multi-colour" bricks from the Cowcroft Fields; they vary in shade considerably, the whole blending in colour very satisfactorily. The roofs are in thick, coarse tiles of rich brown shade. All outside joinery is English oak, left natural and adze-finished in the timbering. The casements are all steel made. Internally the panelling and other joinery is in Kauri pine, stained a deep rich brown and waxed. There is a good deal of modelled plaster ceiling enrichment in ribs and borders. The flooring is oak or maple to the principal rooms—wood blocks, stained dark in some cases. The general contractors were Messrs. Rust and Ratcliffe, of Chesham. Mr. Harold C. Trimmell, A.R.I.B.A., of Woldingham, Surrey, is the architect.

## PROPOSED BRANCH OFFICE FOR AN INSURANCE COMPANY.

This study for a district office of an insurance company was prepared by Mr. Paul Waterhouse for a building now in contemplation, but necessarily postponed by reason of the war. It is for a site in a Pottery town, and the intention of the design is to obtain by simple means and with the use of local materials—viz., brick and dull-glazed terra-cotta—an effect of moderate dignity without undue expenditure. It will be noted that the flanks are kept lower (by the height of a story) than the centre, so as to obviate the unpleasant effect of a tall blank party-wall rising above neighbouring buildings of low stature. The drawing illustrated was shown at the Royal Academy this year.

## THE RECENT REPAIR OF ST. NICHOLAS' PRIORY, EXETER.

Quite lately a careful and conservative restoration of these Priory buildings has been carried out under the advice of Mr. Harold Brakspear, F.S.A., acting in conjunction, as joint architect, with Mr. Lewis Tonar, of Exeter. The renovation thus carried out, dealing tenderly with the original work, is not to be understood in a literal sense as a mere transcript of the antique, inasmuch as when doubt existed the work was retained undisturbed and so left in the rough, or else a modern substitution has been put in. The town clerk, Mr. H. Lloyd Parry, and Mr. Harold Brakspear have combined to publish an authorised report, issued in a handy pamphlet, which we recently reviewed, from the illustrations of which we have made a selection for to-day. These were drawn by Messrs. I. Sparks, A.M.C., and Charles W. Long, A.R.I.B.A. We include the architects' carefully plotted plan of the ground story. Mr. Sparks made the accompanying sketches.

This ecclesiastical establishment was intimately associated with the history of the

city and its civic institutions. It grew out of the endowment connected with St. Olave's by Gytha, mother of King Harold. St. Olave's Church was affiliated with the great Sussex Abbey at Battle, and so soon as a conventual church of St. Nicholas was built at Exeter the Priory provided for six monks on this foundation, which gradually developed as time went on. The City Library at Exeter, as well as the archives belonging to the Cathedral, possess the old records of much that subsequently happened. In 1540 the city repaired the town wall in Friern Hay with a "greate store of the stones of the howse of St. Nicholas," and in addition to this appropriation of materials the town authorities "rebuyed the middle arches of the Exe bridge" by utilising a lot more of the church masonry. The Yarn Market likewise was subsequently covered in with the roof removed from the cloisters of the Priory. Ultimately, in 1549, the mayor, co-operating with some of the leading townsmen, purchased the property for the corporation for the sum of £1,477 2s. 5d., and a record is preserved of this transaction at the Guildhall. A good portion of the Priory was then converted into a dwelling-house for the mayor, one William Hurst, who held office for five years. The Tudor plaster work seen in the upper left-hand sketch on our double-page of illustrations is attributed to him, and his initials, which occur over the oriel window, give some justification to this assumption. The Guest Hall had a flat ceiling, set up after the suppression of the monastery, and the walls were decorated with a foliated design of the same period. The City Fathers gradually sold the property, until it had passed entirely out of the hands of the corporation by the end of the seventeenth century. The various owners who became possessed of what was left of the Priory cut the place about still further and spoil the remains, with the result that many interesting features were hidden up by various accretions or covered in by plaster-work and boarding, so that their existence had long passed out of recollection prior to the restoration now accomplished. The cloisters, as in all monasteries, were virtually the day-room of the inmates, and occupied a central position. They measured about 65 ft. square. That the Priory Church stood towards the north is quite certain, because parts of its north and west walls were lately discovered. Their precise position having been identified is now marked in the paved footway of "The Mint." The "trater" remaining along the north of the cloister is in two stories, the lower stage probably having been utilised as a cellarge, the dining hall, or similar above stairs. This building, incorporated in a dwelling house, is private property. We give a view of the western range, which has been bought and restored by the Corporation of Exeter, as described herein. This building includes the cloister entry and "the crypt," which latter has very handsome and massive columns carrying an archval vaulting dating from about 1100. The "Tudor room," originally a chamber of doubtful use, is supposed to have been really little more than a passage, though it may have contained a staircase to the upper floor. However that may be, it is evident that this apartment was considerably enlarged in the fifteenth century, and its fireplace is of that date. The moulded stone doorway in all likelihood was erected by William Hurst. It stands in the north-east corner, and he also fitted the room with wainscot panelling. This lining was stupidly removed in 1851. In the cloister, as indicated by the accompanying plan, there stood a circular lavatory, similar to the lavatories belonging to Durham, Canterbury, Lewes and Much Wenlock. The kitchen of St. Nicholas' Priory was rebuilt in the thirteenth century. The Guests' Hall occupies the first floor and has a charming open framed roof. The oak partition at the south end is of the same date. The west window, fireplace and entrance portal belong to the fifteenth century. The Prior's solar is situated at the north end of the Guests' Hall and has plaster decorations of Tudor character, though its ceiling long ago disappeared. The Prior's cell is within the Tower and retains its

original Tudor window. The Guests' Room of the same size has been much modernised. The garderobe, still existing on the south, dates from the thirteenth century. More accommodation was provided for guests on the second floor, also a cell for the Master of the Guests. Over the kitchen another chamber is to be seen. It was originally occupied by the servants. This, too, is contemporary with the major portion of the west wing building, which is now well cared for and in good order, as we have already stated. The pamphlet is printed by Messrs. W. I. Southwood and Co., St. Catherine Street, and copies can be had of the town clerk, at the Guildhall, Exeter. The frontispiece reproduces the eleventh, twelfth, fourteenth and fifteenth century seals of the Priory and also includes the Prior's seal, which was the counter-seal of the convent for all its authorised documents right up to the Dissolution.

#### REFRACTORY MATERIALS.\*

This volume is one of the most timely that its able author has published. There is no other like it, and there is no subject on which information was, and is, more needed. Few of us realise the fact that but for refractory materials the many additions to our comfort made during the past thirty years would have remained impossibilities, and still fewer that the British manufacturer, for the most part, with raw materials ready to his hand, or which should be superior to any available by Germans, Austrians, and Belgians, has supinely allowed all of them to produce goods of more accurate shape, less affected by severe conditions of use, and generally of better quality. The economic reasons for this were discussed by Mr. Searle in a paper in the *Journal of the Royal Society of Arts*, in January, 1915, and should be studied by all who have not seen it. The technical reasons are given in this book.

The users of such goods are only in a less degree responsible for the slackness which has spoiled the British market, for they are ignorant of the indispensable properties of such, and as the salesman's object is only to sell his goods it is a case of the blind leading the blind. When a fire-brick maker, for instance, or his agent, tells his customer that his bricks are the best on the market, and will withstand the highest temperatures, he is either deceiving him or telling him something he does not know himself. Even some of our technical contemporaries mislead their readers and contradict each other, apparently unaware that the same material will prove refractory in one furnace and not in another, though the maximum temperature is the same in all cases. The difference in behaviour is due to differences in the conditions to which the material is exposed, a "clean heat" at a high temperature being far less pernicious than laden gases at the same temperature. It thus frequently happens, as Mr. Searle points out, that bricks are condemned as not being sufficiently refractory when their real defect is inability to resist abrasion or accidental blows, or to withstand rapid cooling. In such a case a clay of lower absolute refractoriness—that is, with a lower softening temperature—may prove more durable than one of the purer clays; so that the commonly accepted idea of the average maker and user that the refractoriness of a material may be expressed in terms of temperature alone is misleading, and such a statement by a manufacturer that his fire bricks will stand 1,767° C. is meaningless unless the conditions are stated.

In eighteen chapters, illustrated by 135 figures, Mr. Searle covers the whole subject most lucidly. Not the least interesting to our readers will be Chapter XVII., on refractory mortars and cements, pp. 379-385. Some of the hints to builders of refractory structures, as is pointed out, they are needed, for, as is pointed out, the specification of the Gas Engineers' Institute, which should be authoritatively informative, is unsatisfactory in several respects, inasmuch as

it permits the use of material which will not adhere properly to brickwork or retorts and, on the other hand, excludes various cements which are valuable for refractory work.

The amount of incidental information gathered together by Mr. Searle is remarkable. Quite apart from the main purpose of the book, there is hardly a page into which the ordinary reader may dip without discovering some fact or formula likely to be of use to him in any way connected with the many industries depending on a better knowledge of refractory materials and their utilisation.

#### LIVERPOOL CATHEDRAL.

Work has now been reduced to a minimum, and the progress that can be made in the near future is so limited (says the *Guardian*) that the moment is favourable for giving some account of things as they are. The great choir, with its vault 116 ft. above the floor, and its massive concrete roof, sheathed with copper, is now structurally complete. The external carving is all, or most of it, done; the huge buttresses are duly crowned with seated angels, and the windows are flanked by Apostles in pairs.

The first great transept is well on towards completion. The limb which looks east towards Gambia Terrace, and is being adorned as the War Memorial Chapel, has its vaulting finished, a concrete sheathing protecting it from the weather till its permanent roof can shelter it. The opposite limb, looking down on St. James's Road, has not yet been raised to the spring of the vaulting, and the single shaft of the great window rears itself high in air, still an isolated column. The few men left are going on with this section.

The choir has its end square, with the sill of the window some 70 ft. above the floor. The wall space underneath is treated as itself the rededos; canopy work, carved in the solid on stones that form part of the fabric, encloses spaces to be filled with sculptured groups, a representation of the Last Supper coming immediately above the Italy Table. It is to be hoped that the error committed in the Lady-chapel of obscuring and interfering with the architectural lines and features, and of dwarfing the Table by a rededos of disproportionate size and unsuitable shape, will not be repeated in the choir. Any wood backing that may stand behind and above the Altar-table must not be too high, and should include a straight top, which will answer to and reinforce the two horizontal lines of the Table itself, which is to be 15 ft. in length. The inserted sculptures in the rededos are to be coloured, or at least picked out in gold and colour, the material being alabaster. The organ is in process of construction.

This month also an important stage in advance has been reached in connection with the glass. The figure of the seated Christ in the great rose at the top of the "east" window has been fixed experimentally for a long time, but the removal of scaffolding now shows how finely this will dominate the "Cathedral Church of Christ" in Liverpool. The Sir Alfred Jones window, the second on the "north side," has also been for some time in place. Now two more out of the four side windows of the choir are provisionally fixed. To understand the constructive idea, it is necessary to remember that the four choir-bays are, in point of structural form, four transepts set side by side—that is to say, instead of the choir being, as in most Gothic churches, made up of one central longitudinal section, the full height of the church, flanked and supported by two side sections or aisles of the same length, but much lower, it is at Liverpool built up in cross-sections, each structurally complete, and of the same height all across, while the internal "aisles" are mere sawgays cut through these juxtaposed transept-bays. The consequence is that the windows, instead of being, like ordinary clerestory windows, flush with the inner-side lines of the central space or "nave" of the choir, stand back within their enclosing transept walls, and so are not seen at all from outside the choir—indeed it is scarcely

possible to see more than one properly at a time.

Out of the six side windows, the two towards the "west" will be blocked by the two halves of the organ which will face one another over the stalls. The other four are connected with the four Evangelists, and each has a distinctive tone of colouring, while they are all built up on an identical plan. This plan is partly dictated by the extraordinary width of the lights. The designers have had to deal with a width of considerably over seven feet. Accordingly the central feature in each light is a group of figures in the characteristic colouring of the window, set in architectural framing of a light neutral tint. Thus from St. Matthew are taken the visits of the Shepherds and the Wise Men, the prominence of the Blessed Virgin Mary settling the dominant colour as blue. Opposite are shown from St. Mark in prevailing green hues the Baptism and Transfiguration, these being particularly fine compositions. Then, next to this, comes the red window, with two subjects from St. John—the charge to St. Peter and the revelation to St. Mary Magdalene. Above the groups are in each light two single figures of Old Testament types, such as Jonah and Daniel in the Resurrection window, Noah and Enoch in the Baptism window, and so on. On either side of each window are triangular spaces admirably used for the Annunciation in the Nativity window, and for Christ at the Column (a noble figure, though miniature in scale), and the Deposition from the Cross in the Resurrection window.

#### PROFESSIONAL AND TRADE SOCIETIES.

GLASGOW ROYAL TECHNICAL ARCHITECTURAL CRAFTSMEN SOCIETY.—The list of lectures for the coming session, though short, is a good one. On account of the war the society will only meet once a month instead of once a fortnight. On Friday next the President, Mr. Thomas Whyte, F.F.S., P.A.S.L., will deliver his address. On October 12 Professor Chas. Gourlay will lecture on "The Application of the Order by the Italian Masters." The timely subject on November 9 will be "Construction of Temporary Buildings," by Mr. Jas. S. Boyd, Lic.R.I.B.A. Mr. Verney Constable, A.R.I.B.A., will discourse on December 7 on "Modern Paris Architecture," with lantern illustrations. On January 11, 1918, Mr. Colin Sinclair, M.A., will lecture on "Celtic Monuments in Scotland," and on February 8 Mr. James Bryce, M.I.C.E., on "Town Planning." The business meeting and camera and sketching club exhibition will be held on March 8.

Bath and Portland stone firms attribute a loss of £4,052 on the past half-year to building restrictions.

A correspondent of the *City Press* who has used the passages adjoining the Bay Tree Tavern in St. Swithin's Lane for over fifty years as a short cut to King William Street wants to know why this "public footway" is now frequently closed. The passage, it appears, is private, and not public property, and it is, therefore, not open to the corporation to interfere with the rights of the owner.

According to the *Journal of the Royal Society of Arts* the cement industry in Japan has made rapid strides since the beginning of the war. The production has risen from 3,741,000 barrels in 1913 to 3,943,000 barrels in 1915, and the output during 1916 is understood to have been still greater. Five years ago there were practically no exports, but in 1915 upwards of 600,000 barrels were exported, and a considerable trade is being built up in India and in the South Seas.

Old Parr's cottage, situated on the Welsh hills near Shrewsbury, was put up to public auction last Friday in that town. It was the home of Thomas Parr, who is reported to have lived in the reign of ten English monarchs and to have died in 1635 at the age of 152. The purchaser of the cottage was Mr. John Parr, of Milburn House, Bromfield Road, Henton, and the price £130. Mr. Parr, who said he had never seen the place and was not a descendant of Old Parr, stated that he bought the cottage on sentimental grounds.

\*"Refractory Materials: Their Manufacture and Use" by Alfred H. Searle, (London: Charles Griffin and Co. Ltd., Exeter Street, Strand, W.C. 15s. net).



## Our Office Table.

"To whom do you suggest it is of importance that this man should remain a costs clerk—to this country or to the palaces of American millionaires?" asked Mr. A. W. Richardson, M.P. (chairman of the Law Society Tribunal), one day last week during an appeal of Archibald Buswell (31), single, C 2, employed as a costs clerk by a firm of dealers in works of art. A representative of the employers suggested that it was of greater national importance that Buswell should continue in his present employment than that he should do clerical or similar work in the Army. The man was engaged in getting out estimates for big contracts, largely with America. Some of the contracts ran into £20,000. "To whom," asked Mr. Richardson, "is his work of greater importance—to the millionaires or to this country?"—The Firm's Representative: To this country, to enable business to be carried on.—Mr. Richardson: I am afraid you will not impress us with that.—The appeal was dismissed.

Before the war our annual consumption of imported timber occupied an enormous amount of cargo space in the shipping arriving in this country, and even in the second year of the war 4,500,000 tons of wood came from overseas (says the *Yorkshire Evening Post*). The time has now arrived when we may say that home-grown timber has come into its own, and is, moreover, playing a highly important part in the war, for it is estimated that the total imports for the current year will not exceed 1,200,000 tons, and that the balance of our needs will be provided from our own native resources. According to recent estimates of production and current values, the trade this year will contribute something like £20,000,000 worth of timber towards our urgent needs, and high prices and restrictions secure that the great bulk of this material is being used for purposes of national importance. All over the country rack and circular saws are working in the woodland areas, and loading their output direct to rails. In the big munition and shipbuilding centres great extensions have been made, and there never was anything in this country approaching the number of up-to-date log saws that are now in operation. There is a vast reserve of timber still standing in the United Kingdom, and if due regard is paid to the beauty of the landscape, and discretion shown in leaving immature trees to adorn the country-side, no fears need be entertained that the country is going to be denuded of timber. If afforestation does not offer a sufficiently quick return for private enterprise, it must, nevertheless, be scientifically undertaken by the nation, and will afford a healthy occupation for thousands of discharged soldiers, and, if these are properly trained before commencing their labours, a profitable investment for the community.

Mr. F. Swirsky, architect, of Detroit, Michigan, is preparing plans for a \$15,000,000 hotel and office building. The plans are for the tallest building in the world—57 stories—capable of sheltering 10,000 people in hotel rooms and offices. The building will be a city sufficient in itself, with a post office, police station, arena seating 16,000 people, a quarter-mile track, and an auditorium. Plans call for a 27-story hotel and 57 stories of offices, running up into a tower 809 ft. high, as compared with 785 ft. at the Woolworth Building, New York. Two aeroplane landings, 50 ft. wide by 620 ft. long, will be located on the roof, according to Mr. Swirsky. There will be 4,312 rooms. In the basement will be located 504 display rooms for auto concerns and others. Sixty shops will be located on the first floor. There will be seven banquet halls, two small convention halls, one self-serve, one dining-room, two ballrooms, and a hospital on the second floor of the building.

I. Subject to the alterations mentioned below, the Board of Education have decided to continue in force for the school year 1917-18 Parts I., II., III., and V. of their Regulations for Technical Schools, etc., in England and Wales [Cd. 7996]. Part IV. of

the Regulations (Special Regulations for Grants in Aid of Instruction for Men Serving with the Colours) was withdrawn by Circular 951, dated August 11, 1916. 2. The following alterations will come into force as from August 1, 1917.—(i.) Preliminary Article.—Institutions providing instruction in preparation for a trade for students formerly in attendance at special schools will in future be aided under the new regulations for such institutions (Cd. 8505), and will not therefore receive grants under the Regulations for Technical Schools, etc. The following words are accordingly added to paragraph (a)—"or in respect of courses recognised under the Regulations for institutions providing instruction in preparation for a trade for students formerly in attendance at special schools." (ii.) Article 42.—There are a few schools of the junior technical school or nautical school type at present recognised under this article, which, owing to the exigencies of the war, have been unable to conform to the appropriate regulations. The Board propose for the present to continue to recognise these schools under paragraph (c) accordingly altered to read as follows:—"Any schools of those types which are now recognised under this article may continue to be so recognised if the managers desire, until July 31, 1918."

A resolution aiming at the protection of the sawmilling industry from foreign competition was discussed last Friday at the first annual meeting in Liverpool of the National Federation of Sawmill Proprietors of Great Britain and Ireland. A resolution was carried urging that all imported hard woods and pitch-pine, 2 ins. and under in thickness by 12 ins. and over in width, shall be subject to duty. The resolution also seeks to reserve for this country the cutting of broad boards and panels, which is the most profitable class of sawing, and does not involve economic loss.

"I was looking to-day," writes Mr. T. Percy Armstrong, "at Cleopatra's Needle, that fascinating symbol of England's Oriental Empire that rises on the bank of the Thames, amid the fog and grime of London, so full of poetry and suggestiveness. I remarked the hieroglyphics of the obelisk, its granite pedestal, that time has not been able to wear away, and the two mysterious sphinxes that keep watch and ward on either side the monument. And then it was I noticed that the pedestals of both these sphinxes were covered with advertisements. I did not stop to read these precious productions of modern commercialism, but I observed that one of them was about a cinema. And the question occurred to me, 'Have we any right to this monument?' Do we not rather deserve to lose it, to see it destroyed before our very eyes, when we put it to such vile uses? We say that we are fighting for civilisation, but are we not far behind our Allies in this respect? Is it possible for instance, to imagine an historic monument in the centre of Paris half-covered with advertisements? Surely when our capital is full of soldiers from all parts of the Empire we might show ourselves off in a better light than this." The rebuke is well deserved. What with out-of-date posters of all sorts and the questionable achievements of "pavement artists" and the like, the Embankment westward from Waterloo Bridge to Westminster is discreditably all to whom its care is committed.

Sir William Forwood, who generously undertook to build a morning chapel to the parish church at Windermere, seems to have been fractionally hindered by local objectors. In a letter to the *Liverpool Daily Post* he writes—"It was my wish to build a memorial chapel that would also serve as a morning chapel, which is badly needed. My first proposal, to place the chapel on the north side of the church, was rejected by the Chancellor after being approved by the practically unanimous vote of the vestry. I then instructed the eminent firm of ecclesiastical architects who most successfully carried out the restoration of the old church to prepare another design, which they have done, placing the chapel upon the south side. This is objected to by some of the parishioners, and particularly by the principal owner of pro-

perty in the village; and at a vestry meeting last Monday week she offered, if my gift was refused, not to build a chapel, but to give a piece of land adjoining the churchyard, upon which she 'suggests' a detached chapel could be built. A chapel erected on this side would be quite useless as a morning chapel, but the offer of the land is attractive to the villagers, as it would enable a very desirable road improvement to be carried out. With this counter-offer before the vestry my proposal did not receive fair consideration. I believe if it had not been made the memorial chapel would have been carried by a very large majority. I have withdrawn my offer, as I have no wish to cause any ill-feeling. The chapel would have formed a beautiful addition to the church, giving to it dignity and interest, and it would have been a worthy memorial of the great cause for which so many of the villagers have so nobly and so willingly laid down their lives. I have been quite accustomed to encounter, and to surmount, difficulties in church-building, but this particular form of obstruction is both novel and perplexing."

## CHIPS.

A bronze tablet in memory of Major George Dd. Macpherson, Blairgowrie House, Royal Scots, has been placed inside the east door of Blairgowrie Parish Church.

There is a deficit of £18 in the Truro "Baby Week" receipts, and the Town Council, advised by their town clerk that payment by the council would be illegal, have decided to ask the Local Government Board whether they can pay or not.

At the last meeting of the Colwyn Bay Council it was, without discussion, decided to appoint a small committee to consider the possibility of opening up St. Eilian's Well again as a source of attraction to holiday-makers, and to report.

A war shrine in memory of Second Lieutenant David Anselm Kerr, younger son of Lady Anne Kerr, and nephew of the late Duke of Norfolk, was unveiled within the grounds of St. David's Roman Catholic chapel at Dalkeith last week. A tablet underneath the crucifix is provided for names of others in St. David's parish who have fallen.

On the application of the Amalgamated Society of Carpenters and Joiners, the Northern Centre Building Trades Conciliation Board have granted increases to joiners in Norwich from 7d. to 9d. per hour, with an additional penny from January 1 next, and to joiners in Crewe from 8d. to 9d. an hour, with an additional halfpenny from January 1.

The Bishop of Winchester dedicated in St. Peter's Church, Wrecclesham, near Farnham, last week, a side chapel built in memory of Second Lieutenant Harold Charles Lindford Keable, Royal Berkshire Regiment, younger son of the Rev. C. H. Keable, vicar of the parish, who fell at Loos on September 25, 1915, aged 26. The chapel is given by his parents and brother.

The Moderator of the General Assembly of the Church of Scotland officiated in the Parish Church of Balquhinner on Sunday week in connection with the recent removal into the church of the old baptismal font and of the ancient sculptured stone associated by tradition with the name of St. Angus, the earliest Christian missionary to the parish. The former site of the old sculptured stone was in front of the altar in the ruins of the old church.

The cantilever bridge at Niagara Falls, built in 1883-84, to the designs of the late C. C. Schneider, is to be replaced by a steel arch. This bridge had to be strengthened in 1900 to meet the large increase in the weight of trains which had occurred since the design was prepared. This rise in the intensity of the rolling-load has now progressed further, and, to meet it, it has been decided to rebuild the bridge as a steel arch, with a span of 560 ft.

Sir Arthur Lasenby Liberty, of Lee Manor, The Lee, Bucks, founder and chairman of Liberty and Co., Regent Street, W., High Sheriff for Bucks in 1909, who died on May 11, aged 75, has left £235,411s. including net percentage of £235,411s. The will concludes with the following statement:—"I have not given any legacies to charitable institutions, as I consider that during my life and at my death the State will appropriate an undue proportion of my estate, which has been acquired by personal effort and thrift."

**OGILVIE & CO.**

Telephone DALSTON 1368.  
Many years connected with  
the late firm of W. H.  
LASCHELES & CO., of  
Bunhill Row.  
**ESTIMATES  
FREE.**

**Mildmay Avenue, ISLINGTON, N.**  
**EXPERTS IN HIGH-CLASS JOINERY,  
ALTERATIONS & DECORATIONS.**

FOR  
**Olivers'  
Seasoned**

**Hardwoods,**

APPLY TO—  
**WM. OLIVER & SONS, Ltd.,**  
120, Bunhill Row, London, E.C.

**TENDERS.**

\*. Correspondents would in all cases oblige by giving the addresses of the parties tendering—at any rate, of the accepted tender: it adds in the value of the information.

**ABERYSTWATH**—For improvements to the north wing of the town hall:—

John Jenkins and Sons (accepted) £222 5 0

**BIRMINGHAM**—For drainage work at Enam Town Head, for the Bakewell Rural District Council:—

D. Sheldon, Baslow .. .. £39 0 0

J. R. Grant, Froggatt (accepted) 30 0 0

**CONINGTON**—For repairs to engines, Forge Water-works, for the town council. Mr. J. H. Walters, water engineer:—

G. Saxon, Ltd., Openshaw, Manchester (accepted) .. .. £136 10 0

**LEITH**—For the construction of foundations for a new water-tube boiler at their electricity station in Walnut Tree Road, Erith, for the Urban District Council:—

H. Friday and Sons, Northford Works, Erith .. .. £460 0 0

Accepted. Only tender received.

**GLASGOW**—Repairs at Nethsdale Hall, for the corporation:—

J. D. Menzies and Co. (accepted) £64 10 0

**GRAVESEND**—Outside painting at the police station, for the Essex Joint Standing Committee:—

Brown Bros. (accepted) .. .. £63 0 0

**LONDON, W.C.**—For supplies, etc., for the Westminster City Council. Contracts continued:—H. Covington and Sons, Ltd., for ballast and sand (item D), for six months; Acme Flooring and Paving Co. (1914), Ltd., for carriage repairs (wood pavement) (items 5, 6, 7, and 9) (new work), subject to clause as to strikes, lock-outs, etc., for three months; National Chemical Works, Ltd., drysaltery (dubbin), for 12 months; Isdale and McCallum, Ltd., yellow soap (in bars), for three months.

**SHEFFIELD**—For extensions to the Moor End Hospital, for the corporation:—

J. Charlesworth (accepted) .. £89 1 10

**WEST HAM**—For the installation of hot-water heating stoves and radiators to classrooms Nos. 2 and 7 of the Upton Lane girls' school, for the West Ham Education Committee:—

Watkins and Son .. .. £114 15 0

Wilmer and Son .. .. 112 0 0

Kinnell and Co. .. .. 105 0 0

Troup, Curtis and Co. .. .. 100 11 0

J. T. Halsey .. .. 93 1 6

\*Recommended for acceptance.

Mr. William Goodwin Barnes, aged seventy-five, of Foxley, Bishop's Stortford, Herts., has left £25,000 each to the vicar and churchwardens of Holy Trinity, Bishop's Stortford, and the vicar and churchwardens of All Saints, Hockwell, for church purposes.

**LIST OF TENDERS OPEN.****BUILDINGS.**

**Oct. 2.**—Erection of hutments for the domestic staff at the hospital, Stoney Stanton Road, Coventry.—For the Committee of the Coventry and Warwickshire Hospital.—H. W. Chattaway, Architect, Trinity Churchyard, Coventry.

**Oct. 5-11.**—Restating and improving the steward's stores at the Infirmary, Lower Road, Rotherhithe, S.E., according to plan and specification of Mr. A. H. Newman, F.R.I.B.A., etc.—For the Bermondsey Board of Guardians.—E. P. Fenton, Clerk, 283, Tooley Street, S.E.1.

**Oct. 5.**—Construction of (Section 1) pump-house building, (2) reinforced concrete foundations for cooling towers.—For the Wolverhampton Corporation.—Chairman of the Electricity Committee, Town Clerk's Office, Town Hall, Wolverhampton.

**No date.**—Erection of a warehouse at St. Asaph Station.—For the Vale of Clwyd Agricultural Co-operative Society, Ltd.—For plans and specifications, apply to the Secretary, Mr. A. E. Jones, Tany-graig, Dyserth.

**ENGINEERING.**

**Oct. 1.**—Providing and laying about 285 yards of 3-in. diameter cast-iron pipes between the Silver Well and the town hall, including the construction of a pump chamber and other incidental works.—For the Cowbridge (Glamorgan) Town Council.—W. T. Gwyn, Town Clerk, Cowbridge.

**Oct. 16.**—Supplying and fitting complete steam power machinery for the laundry at the Workhouses, Wallingford.—For the Guardians.—G. F. Slade, Clerk, 7, St. Martin's Street, Wallingford, Berks.

**March 30.**—The Acting British Consul at Santiago reports that a decree has been issued calling for tenders for the improvement of the port of Antofagasta (Chile). By the terms of this decree the amount to be expended on this work must not exceed £1,700,000. Details may be obtained from the Port Commission Offices in Santiago, and copies are expected to be received shortly at the offices of the Chilean Legation in London, 22, Grosvenor Square, W.1. Tenders will be received up to 3 p.m. on March 30 by the Minister of Finance, Santiago.

**MISCELLANEOUS.**

**Oct. 1.**—Alteration and renovation of the old Library, King Street, Bristol.—For the Estates and General Purposes Committee.—P. Addie, City Valuer, The Exchange, Bristol.

**Oct. 8.**—Laying out land for a burial ground.—For the St. Andrew's (Dinas Powis) Parish Council.—W. D. Williams, Clerk, Parish Hall, Dinas Powis.

On last Friday week the Feast of Exaltation of the Cross, a new shrine was blessed at St. Augustine's, Ramsgate, to replace the one that was decorated a few months ago.

The curator of the Hull Art Gallery reported to the corporation committee last Friday that the valuable oil paintings and etchings were in serious danger of deterioration through being sealed up. They required light and air, and he suggested that the gallery should be reopened. The committee deferred its decision.

The death has occurred at Kettering of Mr. James Adams, house agent and secretary of the Kettering Permanent Benefit Building Society. The deceased, who was fifty-four years of age, had on the previous evening attended a directors' meeting of Messrs. Luck and Andrew, Ltd., of which company he was director and secretary.

**TO ARMS!**

COUNTY OF LONDON VOLUNTEER ENGINEERS (FIELD COMPANIES).

Headquarters, Balderton Street, Oxford Street, W.1.

ORDERS FOR THE WEEK by LIEUT.-COLONEL

C. B. CLAY, V.D., COMMANDING.

OFFICER FOR THE WEEK—Lieut. W. J. A.

Watkins.

NEXT FOR DUTY.—Sec. Lieut. P. Bowden.

MONDAY, OCT. 1.—Drill and Elementary Bridge

Construction for No. 3 Co. Right Half Co. 6.30.

Signalling Class, 6.30. Recruits' Drill, 6.30.

TUESDAY, OCT. 2.—Physical Drill and Bayonet

Filing, 7.30.

WEDNESDAY, OCT. 3.—Drill and Elementary

Bridge Construction for No. 1 Co., 6.30.

THURSDAY, OCT. 4.—Drill and Elementary

Bridge Construction for No. 2 Co., 6. Signalling

Class, 6.30. Ambulance Class, 6.30.

FRIDAY, OCT. 5.—Drill and Elementary Bridge

Construction for No. 3 Co. Left Half Co., 6.30. Recruits' Drill, 6.30.

SATURDAY, OCT. 6.—Commandant's Parade for

Route March and Drill. Parade at Headquarters

2.45 p.m. uniform. "A" and "B" N.C.O.'s and

men are reminded that one route march per month

is compulsory. Recruits' Drill 2.50, with Corps

Parade for Route March.

MUSKETRY.—The Range at Belvedere Road will

be open on Tuesdays, Wednesdays, and Thursdays

evening between 5.30 and 7 p.m. All N.C.O.'s and

men who have signed the "A" and "B"

agreements are required to attend during this month

to reclassify in order to enable the Corps to obtain

the capitation grant. Preference will be given to

these N.C.O.'s and men in firing. This does not

apply to those who hold the proficiency badge.

ARMIES.—The new issue armlets can now be

obtained at Headquarters, and every enrolled

Volunteer MUST obtain one without delay. At the

same time all old red armlets must be returned.

Armlets must be worn when attending drills in

plain clothes.

NOTE.—Unless otherwise indicated all drills will

take place at Headquarters.

By order,

MACLEOD YEARLEY, Capt. and Adjutant.

September 25, 1917.

**TO CORRESPONDENTS.**

We do not hold ourselves responsible for the opinions of our correspondents. All communications should be drawn up as briefly as possible, as there are many claimants upon the space allotted to correspondents.

RECEIVED.—D. Bros., Ltd.—J. T. and Sons, Ltd.—

R. C. L. P. E.—D. H. H.—A., Ltd.

REV. S. H.—Yes.

M. H. E.—Please send.

F. R. G.—Drawing will not reproduce.

D. T.—There is no such name among the architects listed in the Directories, or among the members of the R.I.B.A. or S.A.

◆◆◆◆◆

Kinver Edge, a Staffordshire pleasure resort, has been bought as a memorial to Mr. and Mrs. T. Grosvenor Lee. On Saturday it will be handed over to the National Trust for Places of Historic Interest and Natural Beauty.

There is much congestion and overcrowding in many industrial districts in South Wales, chiefly on account of the influx of munition workers. At Ebbw Vale, a controlled area, 3,000 houses are required immediately, and the district council has appointed a deputation to wait on the Minister of Munitions with a view to facilitating the erection of workmen's houses.

**WANTED FOR MUNITIONS.**

**OLD LEAD**

**FRY'S METAL FOUNDRY,**

25-30, Holland Street,  
Blackfriars,  
**LONDON, S.E. 1.**

Telephone: Hop 4720 2 lines.  
Telegrams: "Frymetals, Friars, London."

Hargreaves Street,  
Red Bank,  
**MANCHESTER.**

Telephone: City 2026.  
Telegrams: "Frymetals, Manchester"

The Ministry of Munitions  
has recently taken over the

**Control of Lead**

fixing the maximum price which  
may be paid for Old Lead

viz.: **26/-** per cwt.

We are able to offer you this  
maximum price at your Works,  
Carriage to be paid by us. Sacks  
and special Munition labels will be  
forwarded to you if desired.

**Terms—Prompt Net Cash.**

# THE BUILDING NEWS

## AND ENGINEERING JOURNAL.

Efingham House.

### CONTENTS.

Strand, W.C.2.

Corrente Calamo .. .. .	261
The Coming Industrial Revolution .. .	262
Reinforced Concrete Flat Slab Design ..	263
Our Illustrations .. .. .	277
Competitions .. .. .	278
Building Intelligence .. .. .	278
Obituary .. .. .	278
Statuses and Memorials .. .. .	278
Our Office Table .. .. .	278
Chips .. .. .	279

To Correspondents .. .. .	279
Tenders .. .. .	280
List of Tenders Open .. .. .	280
To Arms! .. .. .	280
Latest Prices .. .. .	viii.

The Great Hall, Lymepe Castle, near Hythe, Kent. Sir Robert Lorimer, A.R.S.A., F.R.I.B.A., Architect.
Christ Church, Epsom, Surrey. New wrought-iron and bronze Roof Screen. Mr. G. H. Fellowes Pryne, F.R.I.B.A., Architect.
Oakengates Technical Institute. Selected design. Plans, sections, and elevation. Mr. Herbert H. Brown, F.R.I.B.A., architect.

### OUR ILLUSTRATIONS.

The Staircase, Corridor, and the Doric Corridor, Cunard Building, Liverpool. Messrs. Willink and Thicknesse, Architects.

## Corrente Calamo.

The Land Reform Union has issued a memorandum on the housing question, which can be had from its office, 15, Lower Grosvenor Place, S.W.1, for 1s. 2d. post free. It deals trenchantly with the reasons for repeal of Part 1 of the Finance Act (1909-10), and shows conclusively that the financial policy of Mr. Lloyd George has proved the main cause of the abnormal decrease of house-building during the past seven years, and that the idiotic cry of his supporters, "Tax land and make it cheaper," is one of the most extraordinary delusions ever promulgated. By placing an annual tax on the commodity, land does not become cheaper, but merely of less value—a totally different proposition. For instance, a plot of land worth before the legislation was introduced £1,000, by the passing of the Act became subject to an increased outgoing. Let us suppose that the Underdeveloped Land Duty is £2 per annum; this at 4 per cent. per annum represents £50. If the owner now sells, he would probably not receive £1,000—in fact, the vendor would be fortunate if he received £1,000 less £50, the capitalised value of tax, but the purchaser would receive in exchange a plot of land worth at most £950, because he (the purchaser) would thereafter have to pay the annual tax. If, therefore, he wishes to borrow money for development purposes, his plot is worth at most £950, because it carries an uncertain burden of at least £2 per annum, which in the eyes of a lender would diminish the value of the security, and he would naturally advance less money or expect a higher rate of interest or further security. But this is stating the effect in the most innocuous form, because the Land Taxers have urged the Government to increase the rate from 2d. in the £ to one of 2d. or 3d., or even more, thus bringing about a great uncertainty, with the result that the depreciation far exceeds the capitalised value of the 2d. rate. There is therefore no benefit to the purchaser—on the contrary, he buys subject to an unknown burden.

Moreover, it is not the large landholder who alone suffers. The taxes have

engendered in those who had invested their money (particularly in the case of the working men and small tradesmen who were accustomed to invest their savings in small house property and building plots) a feeling that they are being unfairly treated. Land and buildings, like all other forms of property, were subject to Estate Duty on death and to income-tax, and in addition were subject to rates, so that in no sense could it be said that land was a privileged form of property. Moreover, until the introduction of the Finance (1909-10) Act, 1910, the public had been particularly encouraged to invest in this form of security: thus special statutes, such as the Building Society Acts, had been passed to facilitate the investment in land and buildings, and the Chancery Courts always treated mortgages of land as a premier security for trust moneys, and large portions of the funds of many charities, universities, colleges, insurance societies, friendly societies and trades unions, are invested in real property or leaseholds. Necessarily, therefore, the attack on these investments has aggravated the depreciation of land and led many mortgagees to call in their mortgages or require additional security. This has done more to discourage healthy thrift among the best of the lower middle classes than anything else. The spend-thrifts escape every form of direct taxation. To-day they are extravagantly dissipating their war bonuses and big wages in extravagant living and reckless pleasure. Presently, when they are pauperised, it is the thrifty members of their class that will have to keep them, and at the same time the Government will continue to rob these of every farthing it can reach which has been accumulated against old age or illness by self-denial!

A meeting of the Committee on War Damage was held at the Mansion House, London, on Friday last. The Lord Mayor, Sir W. H. Dunn, who presided, submitted a report on behalf of the committee of three—viz., himself, Lord Parmoor, and Mr. Mark H. Judge—setting out their correspondence with the Government, but regretting they were not yet able to report any definite progress. The

report closed as follows:—"We all know how occupied the Prime Minister must be, and, much as your Committee regret delay in the preparation of the scheme which is to give effect to the new policy of the Government, we must wait in patience, and we trust we shall before long be able to submit the scheme to you." On the motion of the Mayor of Tynemouth, seconded by the Vicar of Margate, the following resolution was passed: "That this meeting reaffirms the resolution passed at the meeting on the 3rd ult., and further agrees that the pronouncement made by the Prime Minister on July 13 last affords a satisfactory solution of all questions connected with compensation for damage by air raids and bombardment." The Lord Mayor of York then proposed:—"That this meeting desires our Committee of Three to meet the body authorised by the Government forthwith in order that a practical scheme to carry out the principle accepted by the Prime Minister may be formulated at the earliest possible time." The Mayor of Harrogate seconded this, and it was supported by Sir William Chance, Sir Henry Kimber, Sir Richard Stapley, Sir Robert H. Rogers, Alderman A. F. Dod, and the Mayor of Ramsgate. The resolution was passed unanimously. As nearly three months have elapsed since the last interview with Mr. Lloyd George, it is about time something was done.

A case of interest to the profession was recently decided in Melbourne, and is commented on in the Royal Victorian Institute of Architects' *Journal* for July. It has a noteworthy bearing on the matters we commented on last week on pp. 242 and 243. A claim by a lady architect, for fees for plans and specifications prepared and work done, was brought recently in the County Court before Judge Eagleson, the hearing of which raised some interesting issues. Plaintiff was Marion Mahony Griffin, of National Mutual Buildings, Collins Street, Melbourne (the wife of Walter B. Griffin, the architect for the Federal Capital), and defendant was R. H. Reeves, of Nott Street, East Malvern. Plaintiff's demand was for work, labour, and attendances performed by her at defendant's request; for sketch, plans, and specifications prepared; and for com-

mission on the erection of a house at Wattle Tree Road, East Malvern. In the alternative, plaintiff demanded damages for the copy and use of her copyright plans and designs for a suburban residence. Plaintiff claimed £105. The general defence was that a house was ordered at a total cost of £1,400; that satisfactory plans for such a building had never been forthcoming; and that plaintiff now claimed £105 for services which had not been of the slightest value to defendant, inasmuch as the plans had not complied with his stipulated requirements. Judge Engleason said the evidence showed that defendant placed a limit on the cost of the building at £1,400, and requested plaintiff to prepare him certain sketches accordingly. Plaintiff said that her terms were  $7\frac{1}{2}$  per cent. for the building complete. This was made up of  $2\frac{1}{2}$  per cent. for a sketch,  $2\frac{1}{2}$  per cent. for working drawings, and  $2\frac{1}{2}$  per cent. for final supervision of the complete building. Plaintiff knew from the first that a specific amount stipulated, including a hot-water service, was not to be exceeded. Her duty as an architect was to give the best services possible to defendant, in accordance with his requirements. But instead of producing a sketch plan for a building costing £1,400, or anything like that sum, she produced one the cost of which would be somewhere near £2,000, or over. Subsequently certain modifications were made in the plan, which amended plan, however, defendant declined to accept. In the house, as finally erected by another person, his Honour expressed the opinion that there had been no infringement of plaintiff's copyright plans. He held that plaintiff had not carried out what defendant had requested in regard to the preparation of plans of a house costing £1,400, and gave judgment for defendant, with costs. The lesson to be learned, as the editor of the *Journal* remarks, is that if architects prepare plans for buildings that will cost 40 or 50 per cent. more than the client intends to spend, he does so at his own risk, and surely most of us know this already.

The *Daily Chronicle* publishes a sumptuously illustrated and timely booklet, at five shillings net, entitled "Charing Cross to Bagdad," which is a powerful plea for the construction of the Channel Tunnel on a larger scale than yet contemplated as soon as the war is over, accompanied by the rebuilding of Charing Cross Station on the south side of the Thames, under conditions which would make it the leading railway terminus in Europe. We need hardly say both ideas have our heartiest approval. The Channel Tunnel scheme has always had our warmest support, and our opposition to the stupid policy of the S.E. and C. Railway with regard to the proposed patching up of Charing Cross bridge has always been based on the conviction of its utter futility, in view of the fact that no station this side of the Thames could ever be enlarged to the full capability of the traffic of the near future. The *Daily Chronicle's* scheme knocks the

last nail in the coffin of the obstructionists in both camps of the Philistines who want the Thames spoiled for ever, and will commend itself to all who want to see the Channel made a real high road to the rest of the world and a safe trans-Continental route to Bagdad and India. From Charing Cross the route proposed is via Paris through French towns and villages saved from devastation by the Battle of the Marne. From the Jura to the Alps it lies in Switzerland, along the Lake of Geneva, and up the valley of the Rhone. From Switzerland it will reach Italy by the Simplon Tunnel; thence by Milan, Venice, Trieste, Agram, and Brod to Belgrade; and thence through Serbia and Bulgaria on to Constantinople, and through Asiatic Turkey to Bagdad and the Persian Gulf. The eloquent exposition, by the editor of the *Daily Chronicle*, of the magnificently conceived project, and the various subsidiary benefits to the free peoples of the world that will accrue from its completion, is well supported by a series of contributions by Mr. C. P. Tempest, the engineer to the Channel Tunnel Company; Mr. Francis Fox, the consulting engineer; Lord Sydenham, Admiral Degony, M. Albert Sartiaux, Sir Algernon Freeman Firth, and others, which will be read with genuine interest and profit. For ourselves, we can conceive of no other memorial of the great war so likely to win back the wealth that has been wasted, or so worthy an international monument to the millions that have died for the freedom of humanity.

Many readers will be glad to get the "History of the Abbey of St. Alban," by L. F. Rushbrook Williams, B.A., B.Litt., F.R.H.S., M.R.A.S., etc., which Messrs. Longmans, Green and Co. have just issued at 7s. 6d. net. It was, of course, as the author admits, impossible to compass within the limits of some 250 pages the history of one of the greatest English abbeys, but by the sacrifice of much that is curious and a little that is important in the weightier works of the recognised authorities, and by the limitation of the matter to the period of the dissolution, it has been possible to produce a readable and reliable account of the work of a body of men who throughout seven centuries deemed it their duty to enhance the reputation of their patron and the glorious House over which he presided. His martyrdom and the foundation of the abbey which bears his name are alike wrapped in deep obscurity; and the masses of fictitious detail with which the early brethren sought to gratify the pious zeal of successive generations have proved to be as later and less trustworthy as the earlier versions proved unsubstantial and unconvincing. On the whole, probability points to the conclusion that somewhere about the close of the eighth century the "foundation" of the abbey consisted merely in the rehousing of St. Alban's bones, in the improvement of a church already built, and the installation of regular clergy, probably to the exclusion of the seculars already on the spot. Even

then the dates of the first nine of the thirteen Saxon abbots are uncertain, and their story is of a more or less doubtful sort; but from the time of Paul, the first Norman abbot, to that of Richard III., who had to surrender the temporalities in December, 1539, when the site of the abbey was granted to Sir Richard Lee, who razed all the buildings, except the church and the great gate, the materials from which the compilation has been made are fairly reliable and have been judiciously used. There has been, of course, little room for the architectural history of the great abbey, but that is available elsewhere, and Mr. Williams' book will satisfactorily supplement it in not a few interesting particulars.

#### THE COMING INDUSTRIAL REVOLUTION.

Is it coming, as some predict, by the agency of so-called "Ministries of Reconstruction," with all their paraphernalia of officialism and their hordes of place-hunters, living on the workers, and multiplying faster and faster into that worst curse of any people—a class distinct, and bound by the traditions of all such to sink deeper and deeper into the slough of circumlocution, and to find its only real occupation in doing as little as possible? If so, then "revolution," of the sort only understood by others who predict it to mean riot and bloodshed, is but too likely, and some fanatic may declare the word of the Lord as it went forth to Moses in Numbers xxv. 4. Some of us, at any rate, who are as sick as any anarchist of officialism, have dreamed of quite another industrial revolution, which shall ransom even the "profiteer," as well as ourselves, instead of sending him to the nearest lamp-post, from the slavery to which his own greed and self-indulgence have doomed him. For nearly five hundred years, now, "profiteering" has been the aim of the exploiter of labour. It was not so bad in Classic times, although industrial production was then mainly carried on by slaves, because things were still mostly made for use, and the needs of life were simple, and the well-to-do had leisure to cultivate the arts in the intervals between their constant wars. But things were probably worse here during the two centuries of vassalage and serfdom that followed the Norman Conquest, and preceded that wonderful outburst of secular combination of producers and distributors organised by the merchant guilds and the craft guilds. The former, at first, rather of the nature of benefit societies or friendly clubs, developed peaceably here into the corporations of the towns, but in Germany not until after sanguinary struggles. The craft guilds became the guardians and regulators of the handicrafts, and their influence was as beneficially complete by the beginning of the fourteenth century as their constitution was democratic. What was the life of the craftsmen like under their régime? Surely, in all respects, a freer and more desirable one than those of any artisan to-day? The general conditions of life were rougher, but so they were for all. Every man who would learn his craft as an apprentice had an assured future before him, for there were no "journeymen," and the apprentice became a master craftsman as a matter of course, selling his wares to those who were going to use them, and not to the middleman distributor who leaved a profit on the buyer. All, or nearly all, goods were made and bought and sold and used in the localities

of their production, and had work scarce, for the buyer knew well what he wanted, and if he did not get it the local reputation of the maker suffered.

The results are evident in such remains of work as have come down to us, more especially in those pertaining to the crafts more immediately associated with our own trades. That they were so good was mainly due to the manner and method of the work. There was none of the monotonous division of labour that makes most work wearisome to-day; and, therefore, although one man was practically bound to one craft for life, there was plenty of variety in his work; and, as he worked for his own livelihood, he had a fair amount of leisure, and he had time and inclination to endow his work with individual and artistic characteristics which are totally lacking now in the goods that are the product of machinery worked almost always by men who never see more than a piece of the work turned out thereby. That such conditions were favourable to the accomplishment of good architectural work of the time is certain. Whosoever and whatever were the "architects," they had at their disposal a body of artificers—not mere artisans—whose skill of hand and fertility of resource brought together that freedom of resource and yet harmonious co-operation evident in what remains of their work. Unfortunately, the organisation of the craft guilds did not long remain democratic and fraternal. Many causes have been assigned by different commentators. Possibly, as some say, as the towns grew bigger the craftsmen grew class-conscious, and the journeyman made his appearance—once, perhaps, a small master himself in the village from which he had been driven by want of work. But, still, the actual conditions of work did not alter much. The journeymen tried to form guilds of their own under those of the master craftsmen, but they failed—exactly why is not clear; possibly the economic conditions of the time were fatal. Anyhow, all through the fifteenth century the workman remained an artist, his wages rose, and the division of labour was hardly known.

The change for the worse came with the Tudors at the beginning of the sixteenth century, and the rot began at the root of all that was good for the worker or his work. Then, England, which had been a tillage country, cultivated for livelihood, became a grazing country farmed for profit. The prompt change for the worse in all that made life worth living, noted by Bishop Latimer and other writers of the time, went on for worse and worse till the beginning of the last century. From time to time other contributing causes—the depopulation of the villages, the robbery of the Church lands under the pretext of religious reform, and of the public lauds later on by Enclosure Acts for the benefit of the great landlords—helped to banish the workman from his home by field and stream to the factory for the greater part of the twenty-four hours, and to the festering holes and huts in which he was allowed to spend the few hours of respite from toil. Whether during the first fifty years of the last century, when machinery superseded hand labour in all our great industries, things became still worse is a matter of opinion. At any rate, during the eighteenth century men themselves were reduced to machines, but they still had much of skill, whereas later they became the slaves of the machine—when their places were not taken by women and little children, and their wages, whether they were helping to make something to use, or some wretched thing meant merely to sell

for as much as puffery and false pretence could cozen the buyer out of his wages, were the same. In our own crafts—almost alone—things were never quite so bad, though even in them "art manufacture," for the market proved fatal to any such good design or standard of excellence as those which animated the free workers of the old craft-guilds. In our own time trade unionism has won more wages for the organised workman and bettered his condition generally, albeit to his continued wonder and disgust the prices of food and clothing and housing went up as fast as and often faster than his wages.

Thus England became the workshop of the world most of us have known it, and boasted thereof, until we found that other nations were beating us, and the struggle for markets began. With the wealth thus acquired, the new-rich wanted ostentatious houses and fittings, and more gorgeous churches and public buildings, and those whose business it was to supply them from architect and artist to the humblest craftsman, sick to death of the dilettantism of the Renaissance which petered out during the days of the German Georges, set themselves to work to masquerade in long-dead men's clothes and ape the genuine work of their free forebears. And, as Morris said nearly forty years ago, while we should have laughed at the idea of a Greek workman turning out a Gothic building, or a Gothic workman a Greek one, no one saw anything preposterous in a Victorian workman turning out either. So ignorant were all but a few that the economic conditions of a time have always dominated its achievements in art, and that the whims of a mere surface-cultured society, and those it hired to gratify them, were mere sets of winds, some drifting towards beauty of the past, and others towards the logic of the future.

The cataclysm some of us predicted has come—not, as some of those thought, in revolution here at home, nor, as others hoped, in the gradual amelioration of things by social reformers. Let us be thankful—unprepared as we were to meet the storm—that our race has proved true to the instincts of our forefathers, who knew that if you wanted things done well they must be done by one's self, and that the defence of the realm must be undertaken by the nation itself, and not put out to contract and the lowest tender given to some profiteering war-making contractors. Another decade of politicians and pacifists prating about peace when there was no peace, and we might have gone to sleep and woken to find England another Belgium. It is something to know that the best blood and the best brains and stoutest sinews of the real workers of all grades have already guaranteed the victory over German brute force. It is more to be able to cherish the hope that already we are alive to the absolute necessity of supplying our indispensable and primary needs of food and clothing ourselves, by our own labour, on our own land, for our own consumption, and that we shall no longer waste our energies on the production of the things which the profiteer loves to sell at huge profits, while he conspires with his foreign profiteer to corner our food supply.

The first duty of all of us is to pursue and insist on this wholesome and indispensable revival of the primal industry of mankind. The Land shall be no longer labour-starved and given up to the huge patches of weeds some of us have called pasture. The villages and small towns shall once again be re-peopled by a

healthy and happy peasantry, supplying itself with food and enough and to spare, under proper distribution, such as that we are slowly forging our way to, and not that of the profiteer, for the rest of us. In town and village the worker shall again find scope for craftsmanship, and leisure, and desire once more to give beauty and strength to his work. From his sons and daughters, endowed with talent, shall rise our artists of all groups, inspired by the amenities of real homes and the humanising influences to which the factory town and the crowded barracks of commercialism are strangers. Let us only work on soberly and strenuously, and not play the fool at "movements" and mummerly. Seeking first, in very truth, the Kingdom of God and His righteousness, verily and indeed all else good for us shall be added to us—more abundantly, doubtless, to them that come after, but clinging fast to the conviction that beauty in art can only be based on sound economic conditions, and that our ignorance and neglect thereof during the past three centuries has been nearly as fatal to us as German "kultur" has to our enemies and those of all true civilisation. Most of us have learned to do without things of their make of late: let us carry the lesson further, and habituate ourselves to do without all home-made things except those made under proper conditions, and—especially as regards food and clothing—to take some trouble to find the real producer, dealing with him directly; and, where possible, by the labour of our own hands adding to the common stock, as so many benefited amateur food-growers have done lately and are doing. Then, instead of vulgar luxury, pandered to by machine-made "art manufacture," we shall once more know comfort ministered to by simplicity of life and real beauty. And to the solid wealth of a self-dependent people will be added a true and honest commerce of exchange with other nations of our superfluities of good things for those of theirs, unsaddled with the gains of the huckster, and rationally enjoyed without the guilty consciousness that their purchase and participation is at the cost of the lives and health of our own people, accompanied by the decay of patriotism and the despair of prostituted endeavour.

#### REINFORCED CONCRETE FLAT SLAB DESIGN.

The following are the recommendations of the Joint Committee of American and Canadian Engineers covering important features of this type of construction:—

The continuous flat slab reinforced in two or more directions, and built monolithically with the supporting columns (without beams or girders) is a type of construction which is now extensively used, and which has recognised advantages for certain types of structures, as, for example, warehouses in which large open floor space is desired. In its construction there is excellent opportunity for inspecting the position of the reinforcement. The conditions attending depositing and placing of concrete are favourable to securing uniformity and soundness in the concrete. The recommendations in the following paragraphs relate to flat slabs extending over several rows of panels in each direction. Necessarily, the treatment is more or less empirical.

The coefficients and moments given relate to uniformly distributed loads.

#### COLUMN CAPITAL.

It is usual in flat slab construction to enlarge the supporting columns at their top, thus forming column capitals. The size and shape of the column capital affect the strength of the structure in several ways. The moment of the external forces which the slab is called upon to resist is dependent



upon the size of the capital. The section of the slab immediately above the upper periphery of the capital carries the highest amount of punching shear; and the bending moment developed in the column by an eccentric or unbalanced loading of the slab is greatest at the under surface of the slab. Generally, the horizontal section of the column capital should be round, or square with rounded corners. In oblong panels the section may be oval or oblong, with dimensions proportional to the panel dimensions. For computation purposes, the diameter of the column capital will be considered to be measured where its vertical thickness is at least  $1\frac{1}{2}$  inches, provided the slope of the capital below this point nowhere makes an angle with the vertical of more than 45 degrees. In case a cap is placed above the column capital, the part of this cap within a cone made by extending the lines of the column capital upward at the slope of 45 degrees to the bottom of the slab or dropped panel may be considered as part of the column capital in determining the diameter for design purposes. Without attempting to limit the size of the column capital for special sizes, it is recommended that the diameter of the column capital (or its dimension parallel to the edge of the panel) generally be made not less than 1.5th of the dimension of the panel from centre to centre of adjacent columns. A diameter equal to 0.225 of the panel length has been used quite widely and acceptably. For heavy loads or large panels, especial attention should be given to designing and reinforcing the column capital with respect to compressive stresses and bending moments. In the case of heavy loads or large panels, and where the conditions of the panel loading or variations in panel length or other conditions cause high bending stresses in the column, and also for column capitals smaller than the size herein recommended, special attention should be given to designing and reinforcing the column capital with respect to compression and to rigidity of connection to floor slab.

#### DROPPED PANEL.

In one type of construction the slab is thickened throughout an area surrounding the column capital. The square or oblong of thickened slab thus formed is called a dropped panel or a drop. The thickness and the width of the dropped panel may be governed by the amount of resisting moment to be provided (the compressive stress in the concrete being dependent upon both thickness and width), or its thickness may be governed by the resistance to shear required at the edge of the column capital and its width by the allowable compressive stresses and shearing stresses in the thinner portion of the slab adjacent to the dropped panel. Generally, however, it is recommended that the width of the dropped panel be at least four-tenths of the corresponding side of the panel as measured from centre to centre of columns, and that the offset in thickness be not more than five-tenths of the thickness of the slab outside the dropped panel.

#### SLAB THICKNESS.

In the design of a slab the resistance to bending and to shearing forces will largely govern the thickness, and, in the case of large panels with light loads, resistance to deflection may be a controlling factor. The following formulae for minimum thicknesses are recommended as general rules of design when the diameter of the column capital is not less than one-fifth of the dimension of the panel from centre to centre of adjacent columns; the larger dimension being used in the case of oblong panels. For notation, let

$t$  = total thickness of slab in inches.

$L$  = panel length in feet.

$w$  = sum of live load and dead load in lbs. per square foot.

Then, for a slab without dropped panels  
 $t = 0.024 L \sqrt{w + 14}$ ; for a slab with dropped panels; minimum  $t = 0.02 L \sqrt{w + 14}$ ; for a dropped panel whose width is four-tenths of the panel length, minimum  $t = 0.03 L \sqrt{w + 14}$ .

In no case should the slab thickness be

made less than 6 inches, nor should the thickness of a floor slab be made less than one-thirty-second of the panel length, nor the thickness of a roof slab less than one-fortieth of the panel length.

#### BENDING AND RESISTING MOMENTS IN SLABS.

If a vertical section of a slab be taken across a panel along a line midway between columns, and if another section be taken along an edge of the panel parallel to the first section, but skirting the part of the periphery of the column capitals at the two corners of the panels, the moment of the couple formed by the external load on the half panel, exclusive of that over the column capital (sum of dead and live load) and the resultant of the external shear or reaction at the support at the two column capitals (see Fig. 1), may be found by ordinary static analysis. It will be noted that the edges of the area here considered are along lines of zero shear except around the column capitals. This moment of the external forces acting on the half panel will be resisted by the numerical sum of (a) the moment of the internal stresses at the section of the panel midway between columns (positive resisting



moment) and (b) the moment of the internal stresses at the section referred to at the end of the panel (negative resisting moment). In the curved portion of the end section (that skirting the column), the stresses considered are the components which act parallel to the normal stresses on the straight portion of the section. Analysis shows that, for a uniformly distributed load, and round columns and square panels, the numerical sum of the positive moment and the negative moment at the two sections named is given quite closely by the equation

$$M_x = 1.8 w l (l - 2/3c)^2.$$

In this formula and in those which follow relating to oblong panels—

$w$  = sum of the live and dead load per unit of area;

$l$  = side of a square panel measured from centre to centre of columns;

$l_1$  = one side of the oblong panel measured from centre to centre of columns;

$l_2$  = other side of oblong panel measured in the same way;

$c$  = diameter of the column capital;

$M_x$  = numerical sum of positive moment and negative moment in the other direction.

For oblong panels, the equations for the numerical sums of the positive moment and the negative moment at the two sections named become—

$$M_x = 1.8 w l_1 (l_1 - 2/3c)^2$$

$$M_y = 1.8 w l_2 (l_2 - 2/3c)^2$$

where  $M_x$  is the numerical sum of the positive moment and the negative moment for the sections parallel to the dimension  $l_1$ , and  $M_y$  is the numerical sum of the positive moment and the negative moment for the sections parallel to the dimension  $l_2$ .

What proportion of the total resistance exists as positive moment and what as negative moment is not readily determined. The amount of the positive moment and that of the negative moment may be expected to vary somewhat with the design of the slab. It seems proper, however, to make the division of total resisting moment in the ratio of three eighths for the positive moment to five-eighths for the negative moment.

With reference to variations in stress along the sections, it is evident from conditions of flexure that the resisting moment is not distri-

buted uniformly along either the section of positive moment or that of negative moment. As the law of the distribution is not known definitely, it will be necessary to make an empirical apportionment along the sections; and it will be considered sufficiently accurate generally to divide the sections into two parts and to use an average value over each part of the panel section.

The relatively large breadth of structure in a flat slab makes the effect of local variations in the concrete less than would be the case for narrow members like beams. The tensile resistance of the concrete is less affected by cracks. Measurements of deformations in buildings under heavy load indicate the presence of considerable tensile resistance in the concrete, and the presence of this tensile resistance acts to decrease the intensity of the compressive stresses. It is believed that the use of moment coefficients somewhat less than those given in a preceding paragraph, as derived by analysis, is warranted, the calculations of resisting moment and stresses in concrete and reinforcement being made according to the assumptions specified in this report, and no change being made in the values of the working stresses ordinarily used. Accordingly, the values of the moments which are recommended for use are somewhat less than those derived by analysis. The values given may be used when the column capitals are round, oval, square, or oblong.

#### NAMES FOR MOMENT SECTIONS.

For convenience, that portion of the section across a panel along a line midway between columns which lies within the middle two quarters of the width of the panel (HI, Fig. 2) will be called the inner section; and that portion in the two outer quarters of the width of the panel (GH and JJ, Fig. 2) will be called the outer sections. Of the section which follows a panel edge from column capital to column capital, and which includes the quarter peripheries of the edges of two column capitals, that portion within the middle two quarters of the panel width (CD, Fig. 2) will be called the mid-section, and the two remaining portions (ABC and DEF, Fig. 2), each having a projected width equal to one-fourth of the panel width, will be called the column-head sections.

#### POSITIVE MOMENT.

For a square interior panel it is recommended that the positive moment for a section in the middle of a panel extending across its width be taken as  $125 w l^2 (1 - 2/3c)^2$ . Of this moment at least 25 per cent. should be provided for in the inner section; in the two outer sections of the panel at least 55 per cent. of the specified moment should be provided for in slabs not having dropped panels, and at least 60 per cent. in slabs having dropped panels, except that in calculations to determine necessary thickness of slab away from the dropped panel at least 70 per cent. of the positive moment should be considered as acting in the two outer sections.

#### NEGATIVE MOMENT.

For a square interior panel, it is recommended that the negative moment for a section which follows a panel edge from column capital to column capital, and which includes the quarter peripheries of the edges of the two column capitals (the section altogether forming the projected width of the panel) be taken as  $115 w l^2 (1 - 2/3c)^2$ . Of this negative moment at least 20 per cent. should be provided for in the mid-section and at least 65 per cent. in the two column-head sections of the panel, except that in slabs having dropped panels at least 80 per cent. of the specified negative moment should be provided for in the two column-head sections of the panel.

#### MOMENTS FOR OBLONG PANELS.

When the length of a panel does not exceed the breadth by more than 5 per cent., computation may be made on the basis of a square panel with sides equal to the mean of the length and the breadth.

(To be continued.)



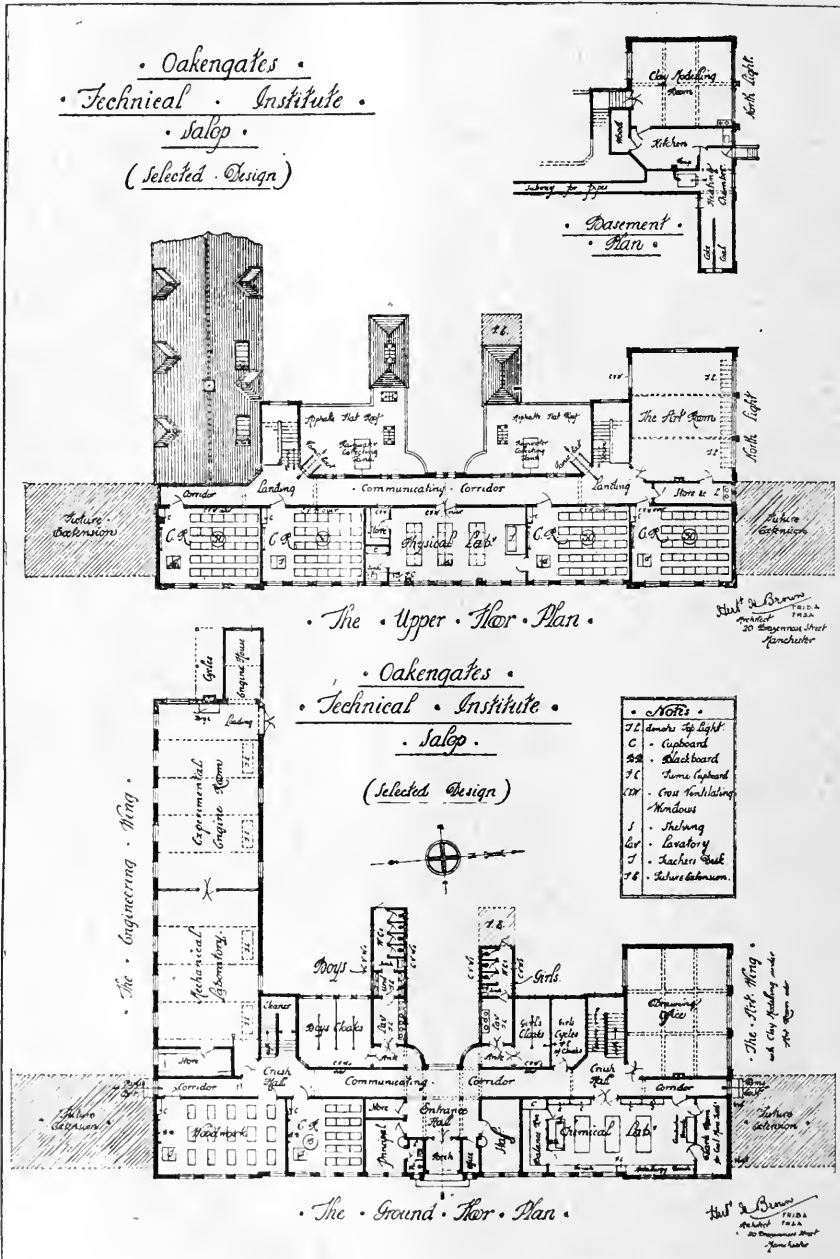

OAKENGATES TECHNICAL INSTITUTE, SHROPSHIRE.  
 Mr. HERBERT H. BROWN, F.R.I.B.A., Architect.





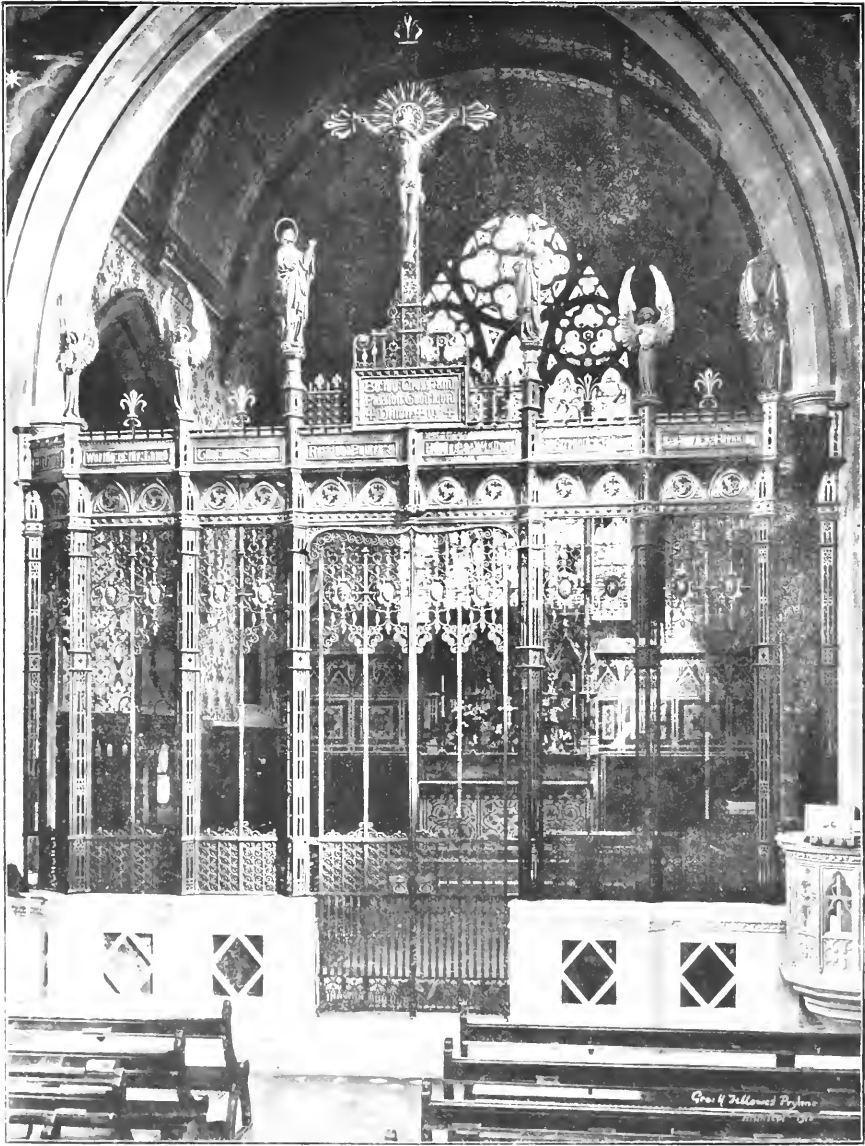

BRONZE AND WROUGHT IRON ROD SCREEN, CHRIST CHURCH, EPSOM.  
MR. G. H. FELLOWES-PYRENE, F.R.I.B.A., ARCHITECT.



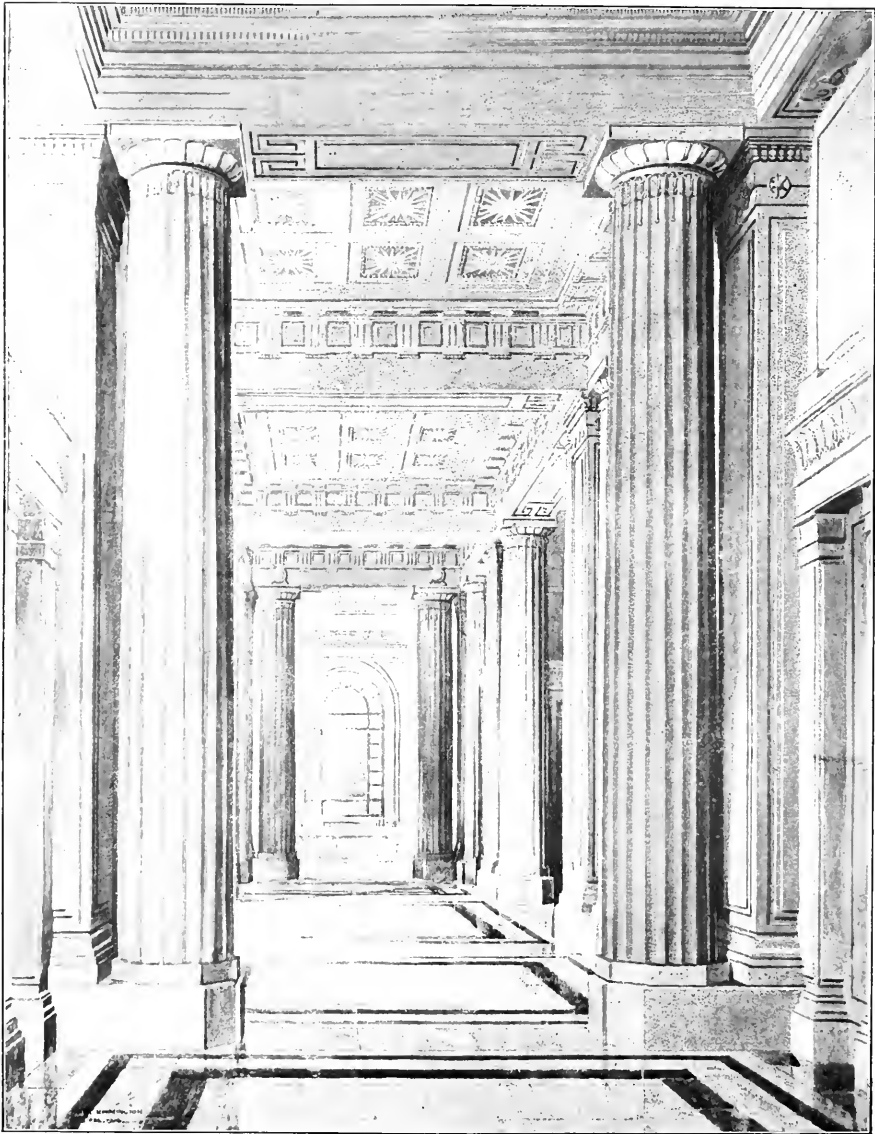

STAIRCASE CORRIDOR, CUNARD BUILDING, LIVERPOOL.  
Messrs. WILLINK and THICKESSE, Architects.

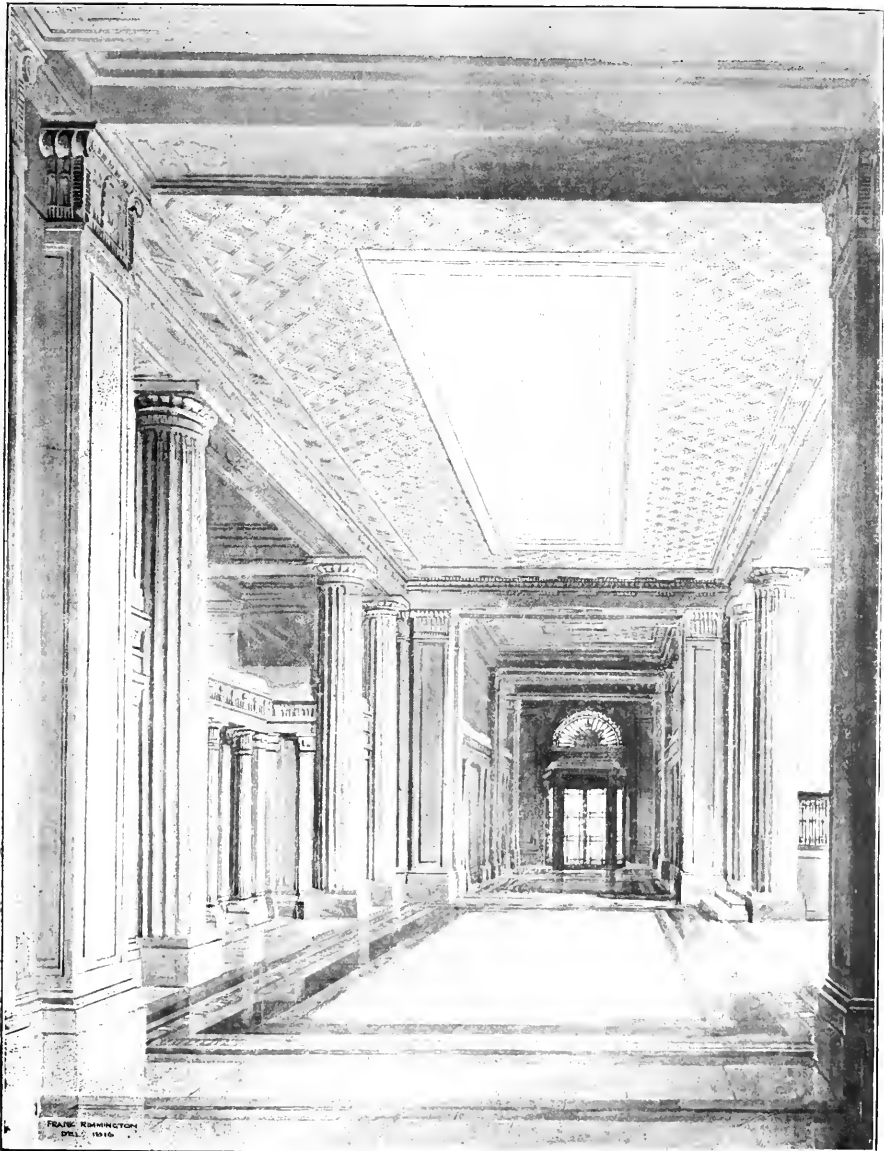

DORIC CORRIDOR, CUNARD BUILDING, LIVERPOOL.  
Messrs. WILLINK and THICKNESS, Architects.





*Belfort Le Moir, Photo.*

THE GREAT HALL, LYMPNE CASTLE, HYTHE, KENT.  
SIR ROBERT LORIMER, A.R.S.A., F.R.I.B.A., Architect.





*• Oakengates • Technical • Institute •*  
*(Selected Design)*

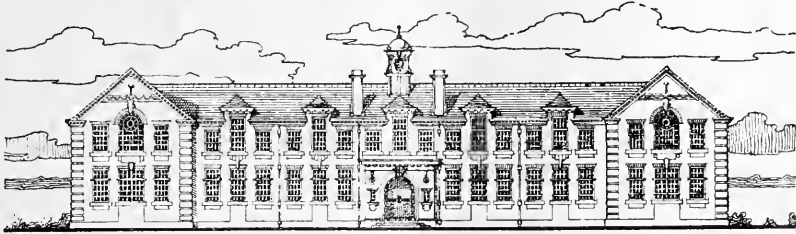

*• The • Front • Elevation •*

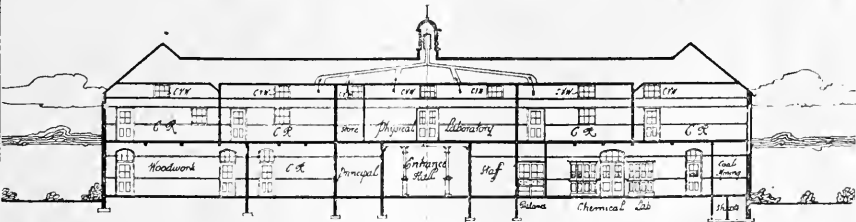

*• Longitudinal • Section •*

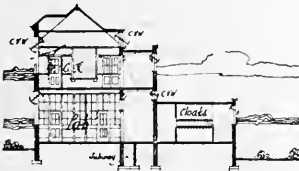

*• Cross Section •*



*• Section • No. • 2 • Engin' Wing •*

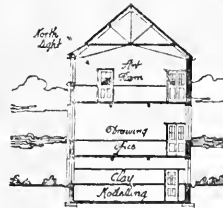

*• Section • No. • 1 • 1st. Wing •*

*Herb. H. Brown F.R.I.B.A.  
Architect  
20 Grosvenor St. Manchester.*

OAKENGATES TECHNICAL INSTITUTE, SHROPSHIRE.

Mr. HERBERT H. BROWN, F.R.I.B.A., Architect.

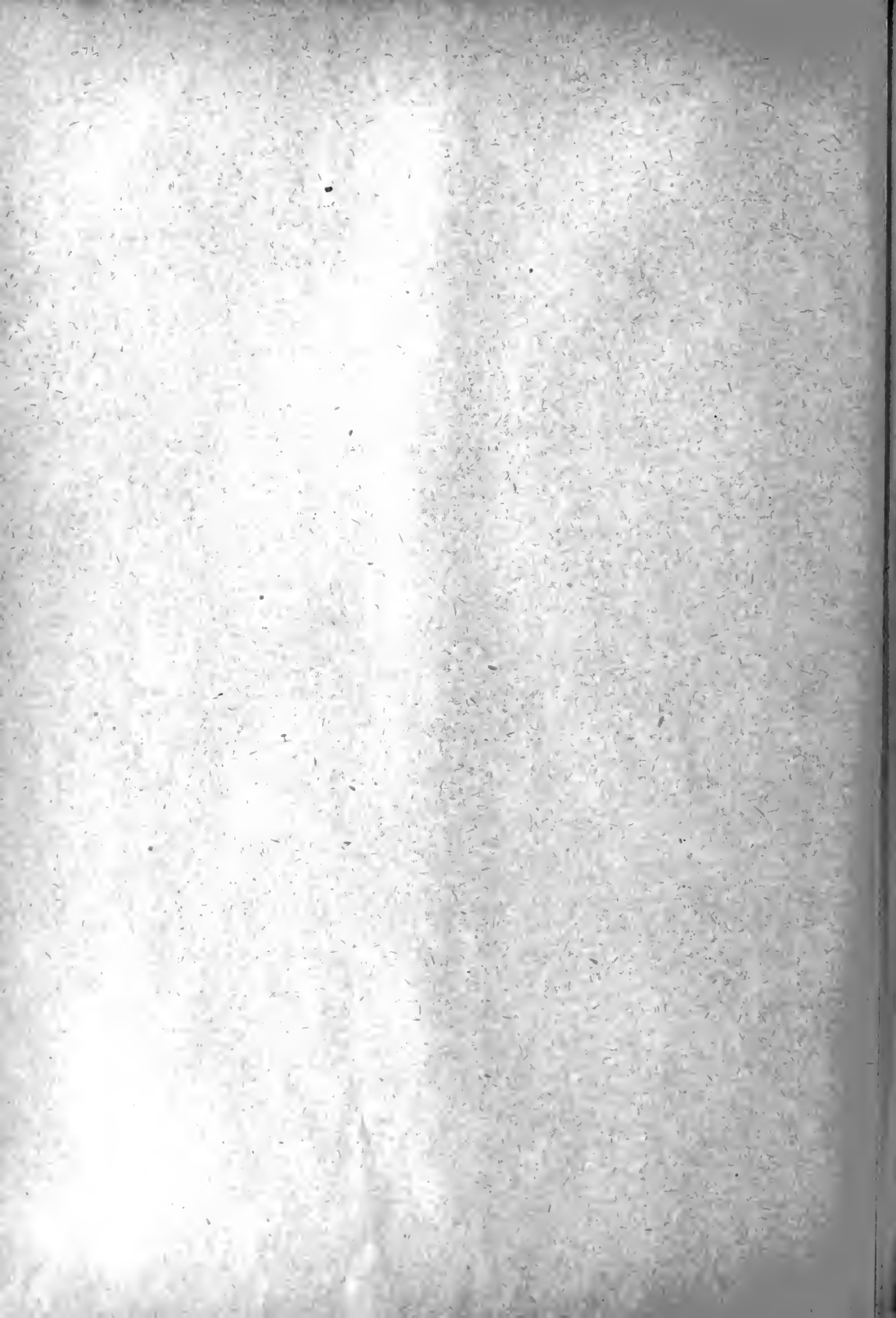

## Our Illustrations.

### TWO INTERIORS IN THE NEW CUNARD BUILDING, LIVERPOOL.

The staircase corridor is on the ground floor, and gives access to all the tenancies of the building, being the main entrance to all except the two ground-floor offices. In it are the seven lifts, which provide the approach to the upper floors and the fine, well-lighted staircase, which runs from the bottom to the top of the building. The walls of this corridor, up to a height of 14 ft., are covered with cream-coloured Subiaco marble, a material closely akin to that which was employed in the Pantheon at Rome and numbers of other ancient buildings. The floor is of marble, panelled with white, black, and Hopton-wood stone; and the ceiling, which is 22 ft. high, is richly panelled with plaster. The corridor, which is nearly 200 ft. long, is well lighted from the two ends, through the revolving doors, and the fanlights over them, and from the central staircase. The Doric corridor is connected with the private entrance to the Cunard offices from the Pier Head end of the building. The materials are as follows:—The fluted columns are of Greek Pentelikon marble, and the plain wall covering is of Crestola marble. The floor is of marble in black and white. This corridor gives access in three different directions to the general office, the first-class passengers' department, and the general manager's department, and from it rise three private lifts to the other accommodation of the Cunard Company on the fifth and lower ground floors. Both drawings were exhibited at the Royal Academy this year. Messrs. Willink and Thicknesse, of Liverpool, are the architects. We published an elevation and detail of the new Cunard building in our issue for January 22, and a plan and section on January 29, 1915. An exterior view from the Royal Academy appeared in the BUILDING NEWS on June 21, 1916, with a description furnished by the company.

### LYMPNE CASTLE, NEAR HYPHE, KENT. INTERIOR OF THE HALL.

Sir Robert Lorimer, A.R.S.A., some few years ago, greatly enlarged Lympne Castle, at the same time incorporating in the rebuilding the few features of this once considerable old Kentish house. For a good while the place had been neglected, partly ruined, and utilised as a farm. This new work has been thoroughly well done, at great expense and in excellent taste, the accommodation being modernised and no pains spared to insure its manageability as an up-to-date country residence. A generating installation was set up on the premises and a competent equipment of heating. The buildings followed the old lines, and in part are grouped on three sides of a square extending round an enclosed garden or garth, which is approached by a sturdy stone arched gate-house adjacent to the modern lych-gate in the corner of the churchyard. All the administrative arrangements of the house, the garage, and the stables are set back northwards, to allow the principal dwelling rooms to open out free on the south in order to obtain a full advantage of the magnificent prospect seaward overlooking Romney Marsh and the Foreland, with Dymchurch in the valley. The kitchen gardens are detached, extending to the left of the public approach up to Lympne Church. These gardens have a quaintly designed entry in stone fitted in a Scotch fashion, with projecting steps alternating with recessed ones. The church and the before-mentioned gate-house group very prettily with the Grange buildings. The estate comprises 533 acres of high ground, commanding the coastline almost from Hythe to Dungeness in the distance, beyond Lydd. Lympne was the Portus Lemnis of the Romans, when the river Rother, at the base of the hill on which the Castle stands, afforded an amply sufficient channel for ships. This harbour of Lympne was protected by a large Roman fortress, the ruins of which now go by the name of Studfall Castle. The character of these remains, including the Decmen Gate

and fragments of the towers, can still be seen. The present turnpike, called "Stone Street," leading straightaway from Lympne to Canterbury, is identical with the Via Strata of antiquity. An abbey, existed at Lympne, and a community of seven priests is mentioned in Domesday. Still extant Anglo-Saxon charters refer to a manery here and the conventual church standing close to the present mansion. Work of undoubted Saxon origin is incorporated in the north and south walling of the nave. The late William Butterfield was engaged on the repair of the fabric, and he was responsible for some of the stained glass, but the incongruous mosaic reredos may have been erected after his death. The ancient mural bench under the east window behind the altar, where the abbot sat, has been cut away to make room for this, and the stone seats, used by the brethren, on the north and south walls of the sanctuary, are left in situ. So rare an ancient arrangement should have been retained, for it was almost unique in England. The old bastion towers of the Castle have now been linked together by an intervening extension overlooking the weald, and the quaint farm buildings which stood in between have made way or been incorporated in this new part. The Castle for long years was little better than a ruin before the remodelling occurred. A good idea of its appearance in those days is furnished by a sketch of this beacon which we reproduced in the BUILDING NEWS for March 6, 1891, from the pen of Mr. Maurice B. Adams. Viewed from pretty much the same standpoint on the south-west, these towers still remain a distinctive and notable landmark, set off by the new terraced gardens and paved walk above the rampart stone walling. The circular contour of the western face of this old bastion, with its embattled parapet above, makes a pleasing foil to the gables of this manorial home. To-day we are able to give a photograph of the interior of the great hall, which has been used as a drawing room and hung all round the walls with fine tapestries, one of which alone, as seen in the picture, is suspended over the mantle. The hall is of lofty proportions, with a good substantial oak-timbered roof. The walls are wainscoted in old oak paneling of linenfold pattern. The wide, open fireplace is in keeping with the scale of the apartment, which measures 40 feet by 25 feet. On Wednesday next, the 10th inst., the entire property is to be put up to auction by Messrs. George Trollope and Sons, at the Mart, Tokenhouse Yard. Several buildings of various sorts and sizes are included in the sale as separate lots, such as "The Old Vicarage" in the village, "Hollybush Cottage," "Danson Cottage," as well as two bungalows and "Nightingale Cottage," etc. Lower down, on the highway leading to Hythe, is an entrance lodge, erected by Sir Robert Lorimer when he built the big house to which it belongs. Lympne Castle was originally constructed in the reign of Henry VII., and most of the houses in the village look picturesque, and some of them are very old and contrived, well befitting their position. The nearest railway station is at Westenhanger, 1½ miles distant. The owner, Mr. H. J. Tennant, carried out all the new work done during recent years at Lympne Castle, and Mr. H. B. Asquith, when Prime Minister, resided there on several occasions.

### NEW ROOD SCREEN, CHRIST CHURCH, EPSOM.

The new Rood Screen at Christ Church, Epsom, was erected from the design and under the supervision of George H. Fellowes Prynne, F.R.I.B.A., of Westminster, by the kind consent of Messrs. Sir A. Blomfield and Son, who were the architects of the church.

The screen, with the exception of the base, which is of stone with inlaid marble slabs, is entirely of wrought metal. While in the main the general form of the screen is on more or less traditional lines, the design and decorative treatment, both from a constructional and decorative standpoint. The main uprights, which are formed of four wrought iron

standards with pierced copper panels placed diagonally, are taken up through the cornice and carry the rood figures and figures of angels bearing shields and emblems of the zodiac, above the cornice. The cornice is formed of sheets of copper, bent and hammered out to the necessary curves, with panels of bronze bearing sacred inscriptions. A raised panel immediately under the rood screen bears the words "By Thy Cross and Passion, Good Lord, deliver us." The figures are of bronzed metal. A note of colour is given by the emblems of the Passion and sacred monograms, in coloured enamel, on the copper shields in the angels' hands, and on the plaques held by the wrought iron scroll-work in the panels below. The screen was erected in memory of William Sampson Trotter, late of Horton Manor, whose arms are enamelled on the extreme left hand panel. The illustration is from a photo exhibited in the Royal Academy this year.

### SELECTED DESIGN FOR THE TECHNICAL INSTITUTE, OAKENGATES, SALOP.

The accompanying drawings show a new model of equipment for a technical institute in a small town to meet the up-to-date requirements of the Board of Education. A limited competition of architects specialising in schools was held, and the Board of Education assisted the Salop County Council in making an award. Mr. Herib. H. Brown, F.R.I.B.A., F.M.S.A., of 20, Brazennose Street, Manchester, was chosen, but his design has since been modified and improved upon, as here shown, to meet the latest official proposals, particularly in the contrivance of the various rooms to allow of their being used for alternative subjects on separate evenings, and so limit the size of the buildings. The plan allows also for making suitable provision for extensions in an easy manner. The elevations show an economical treatment in local bricks, stone sills, etc., without any pretence to a monumental or an ornamental character, the effect being obtained from the arrangement of the windows and other essential features. The district of Oakengates is a very rough neighbourhood, situated in a coal-mining and engineering centre, and the accommodation is made to meet the needs of the locality. The special features provided are:—The central entrance giving immediate entry into the whole of the building, under control of the secretary or staff; easy access to the lavatories and cloak-rooms and to the two staircases; the placing of the engineering wing and the art wing to be within easy reach of and under control from the entrance, yet well disconnected from the rest of the building as far as sound is concerned; a ready provision for future extension; efficient cross-ventilation; the location of the lavatories, cloakrooms, and w.c.'s; the concentration of the plumbers' work, combined with the collection of air-water from all the back roofs to use in several ways, and thus economise on water charges; and the ample light given in each room of the best possible aspect for the various classes. The engineering wing has a floor space of 2,500 square feet, and in lieu of the old rule prohibiting skylights a more sensible view has been adopted for the lighting of a one-storey shed by placing a row of skylights along the north side, and so providing space on the wall to hang up charts, large-scale details, templates, gauges, etc., in a proper manner. The accommodation provided comprises mechanical laboratory, experimental engine room, woodwork room, clay-modelling room, drawing office, art room, physical laboratory with stores, etc., five commercial classrooms, staff rooms, chemical laboratory with balance room and dark room suitable for coal-mine teaching, with wind-up arranged to shut up and exclude all light or air, and special arrangement for rapid ventilation; benches for metallurgy will be so detailed as to be adaptable as table-tops for teaching in a little geology, ceramics, horticulture, and, if necessary, for sewing, bootmaking, and the like, so that scholars can be drawn from all parts of the town for any type of technical training. In this institute accommodation is provided for more boys than girls, in the proportion as 3 is to 1.

## COMPETITIONS.

**COLOUR DESIGN.**—The Design and Industries Association announce in another column that they are about to hold a competition for the purpose of discovering and encouraging talent for colour design among British artists, designers, and students. For this purpose the conditions have been drawn up to avoid the unprofitable waste of energy on the part of competitors usually attending such competitions. A feature of the competition is that the most suitable design will be purchased, and out of the six selected competitors for the final competition the unsuccessful competitors will receive an honorarium. The Design and Industries Association is a body formed to promote a better relation between artist, producer, and distributor and consumer, and it hopes thereby to improve the quality of design and fitness for purpose in all branches of British manufactured articles. At the recent Exhibition of Arts and Crafts held at the Royal Academy the exhibit of the Design and Industries Association was a most notable success, and it received praise from all sources.

## Building Intelligence.

**BASINGSTOKE.**—The new Church of All Saints was solemnly dedicated on Thursday evening last by the Bishop of Winchester. The plan of the church consists of a nave and choir of equal width and height, divided by a lofty chancel arch. The north and south aisles run the whole length of the church, with a tower on the south side, the lower part of which, above the choir aisle, forms the organ chamber. The Lady Chapel is a continuation of the north aisle extending beyond the main building, and filling the eastern angle of the site. The walls are faced externally with stone ashlar, narrow courses being inserted at intervals between the wider ones. The main roof is covered with red tiles, and the roofs of the aisles with grey slate. The style is English 14th Century Gothic. There is a clerestory to both nave and choir, the clerestory windows of the choir being larger than those of the nave. Internally the nave has an arcade of four ample bays on the north and south sides, and the choir three bays of lower elevation. The nave has a semicircular panelled ceiling, decorated in red, white, and brown. The choir ceiling is a rather richer design divided into smaller panels with the sacred monogram countercharged in red and white, the dividing ribs being of a soft grey colour. The aisle roofs are of simple open timber construction, coloured to a soft brown tint. The dressings of the interior are all of stone, the wall-surfaces being plastered. The contractors for the work were Messrs. Benfield and Loxley, of Oxford. The architect was Mr. Temple Moore.

**EDGEWORTH.**—St. Germain's Church, City Road, Edgworth, was consecrated by the Bishop of Birmingham on Saturday afternoon.—The architectural design of the church is developed from the Early Christian type of basilica. The nave is of lofty proportions and extends six bays in length, its columns being monoliths of red granite. The roof is of timbers, colour decorated, and it is intended to decorate the aisle roofs in a similar manner. A morning chapel and organ chamber open to the sides of the chancel with arcades, the shafts of which are green marble monoliths, with carved white marble caps and bases. The altar stands in an apse covered with a concrete semi-dome, and it is hoped to clothe the walls with marble panelling and the semi-dome with mosaic. The font is of carved stone and marble. Externally the character of the building is broad and simple, the decorative treatment being a varied use of brick and stone. The roof is covered with Italian tiles, and is surmounted by a bell-turret of teak with a lead-covered dome. The architect of the church is Mr. Edwin F. Reynolds, and Messrs. Collins and Godfrey, of Tewkesbury, are the builders.

## OBITUARY.

We regret to announce that Mr. Napier Henry, R.A., died at Falmouth last Sunday evening. He was born at Newcastle-on-Tyne on May 21, 1831, and educated at the Newcastle grammar school and St. Cuthbert's College, Durham, commencing his artistic studies at the Newcastle Art School, under W. Bell Scott, and later at Antwerp Academy as a pupil of Baron Henri Leys. After travel he exhibited at the Royal Academy at the age of 24, but dissatisfied with his efforts returned to Antwerp and stayed there till 1870. Returning to England he exhibited again at the Academy in 1881, and continuously since. Among his best known pictures "Homeward," "Lost," "The Life Boat," "Through Sea and Air," "The Traveller: Home at Last," and "Haul Aft," (bought by the Chantry Trustees) are familiar to most.

The A. A. Journal contains a letter from Captain H. P. G. Maulu, mourning the death in France of Private W. W. Locke, who was killed in August. He was an old student of the A.A. of unusual promise and individuality. His portrait is given, and that of Captain C. O. Spencer Smith, who was also killed in August. Of other former or present members Lieut.-Colonel Flower was killed in August; Sec. Lieut. J. Quekett is reported missing; and Lieut. H. W. Brittan, Sec. Lieut. D. S. Glover, and Sec. Lieut. W. J. L. Horsman have been wounded.

The death of Mr. Ralph Stokoe, engineer to the Maryport Harbour Commissioners and surveyor of the Urban District Council, occurred early in the morning of the 25th ult. Deceased, a native of Co. Durham, received the Maryport appointment in 1879. Pains-taking and energetic as an engineer, his ideas were sound and practical. His two main achievements during the long period he served the town and harbour, were the building of the sea wall and the reconstruction of the Senhouse Dock entrance. The latter, an awkward job to execute, that caused Mr. Stokoe much anxiety and thought, saved the dock from disaster, while the strong sea wall he constructed has repeatedly saved the lower end of the town from inundation by high winter tides. Deceased, who was sixty-nine years of age, leaves a widow and family of three sons and two daughters.

## STATUES AND MEMORIALS.

**FAVERSHAM.**—The memorial erected at the Faversham Borough Cemetery over the grave of some seventy of the victims of the lamentable explosion which occurred here on Sunday, April 2, 1916, was unveiled and dedicated on Thursday afternoon. The memorial was designed and erected by Messrs. Whiting Bros., of Ospringe, is executed in Cornish granite, and consists of a curbing round the grave with a Celtic cross in the centre. Owing to the immense weight involved the curbing and cross have been imposed upon concrete foundations in order that there should be no risk of sinking. The total weight of the granite used is about 36 tons, the cross and bases alone weighing 4 tons. The cross itself is 10 ft. in height, and stands upon a triple base. The curbing is relieved at intervals with ornamental terminals and at either end the grave level is reached by steps—two at the south and three at the north, the difference being due to the fall of the ground. The terminals on either side of the steps are surmounted with elegant granite vases for flowers or plants, giving an effective finish to the whole work. The length of the grave is 108 ft., and the width 14 ft., the coffins being placed in a double row.

**WOLSELEY MEMORIAL.**—Lady Wolsley occupies the Lady House-keeper's Lodgings at Hampton Court, formerly the residence of Princess Frederika, and granted to its occupant by Queen Victoria in 1839. In its front hall, which has been enlarged, Lady Wolsley has completed the flooring of black and white marble in a design of a star of six diamonds, originally prepared for the palace by Sir Christopher Wren. Within it she has laid down, in a simple oval, the arms of the Field Marshal in bedwork incised in the marble, with dates commemorating his residence in the

palace. In an upstairs room, in place of a poor ceiling, she has erected one in plaster of high relief, representing Lord Wolsley's cipher and coronet, crossed batons, and oak wreath, while in a neighbouring room, in simpler fashion, a similar ceiling, with Tudor rose ornamentation and cipher, is intended to commemorate her own residence in the house. A little turret in a downstairs sitting-room has richer decoration given to it. The pavement is of Pavonazza and Verde Antico, and the ceiling of armorial colour. The work has been designed by Mr. Davenport.

## Our Office Table.

Architectural compositions are well to the fore in the exhibition of the Loudon Salon of Photography now open at the Galleries of the Royal Society of Painters in Water Colours in Pall Mall East. Mr. F. H. Evans, who is well renowned for his architectural studies, has a fine picture of the interior of St. Bartholomew the Great, Smithfield, from aisle to altar. The sky-scraper of New York have inspired another worker, who calls his view of the towering piles "The City of Superlatives." A courtyard at Caen, the castle of Harburg, the old-world Church Square at Rye, the Victoria Memorial, with the dark iron gates in striking contrast to the whiteness of the stone, King's College, Salisbury, the ambulatory of Avila Cathedral, the font at Norwich, the north transept at Winchester, the Capitol at Hartford, the Guildhall of Stirling, and the Weigh-House at the Dutch town of Alkmaar are some of the outstanding examples in the exhibition in which the architectural interest of the subject is united to the pictorial interest of the treatment by the photographer.

At the eighteenth ordinary general meeting of the Associated Portland Cement Manufacturers (1900) Ltd., held at Winchester House, Old Broad Street, London, E.C., to-day at noon the directors submitted to the shareholders their seventeenth annual report, together with the audited accounts to June 30, 1917. The balance brought forward at July 1, 1916, was £164,107 5s. 11d. The profits, after deductions, which include £87,893 4s. for repairs and renewals, amount to £372,187 15s. 10d., making a total of £556,295 1s. 9d., from which have been deducted directors' and trustees' fees, £4,575; debenture stock, mortgage and interest, £221,381 7s. 4d.; depreciation and sinking funds, £56,641 0s. 7d.; income-tax adjustment, £20,000, amounting to £302,597 7s. 11d., leaving a balance of £253,697 13s. 10d., from which the directors recommend the usual appropriation to the general reserve and depreciation account of £50,000, leaving to be carried forward £183,697 13s. 10d. As regards the company's operations at home, there has been an increase in the cost of production for various reasons, amongst which is included reduction of output. This is largely influenced by the restrictions upon building and constructional work, which are rigorously enforced. Inadequate transport facilities have prevented the expansion that was hoped for in the export markets, and all these factors put together—added to the uncertainties of the future—make it impossible for the directors to recommend the payment of any portion of the preference dividend that is in arrear. There has, however, been some increase in the profits of the past year, which is attributable largely to the initial and very satisfactory return from the South African works in which the company is interested. The outlook for this undertaking continues promising, but there is no real improvement to report in regard to the large investments in British Columbia and Mexico. Provision has been made in the profit and loss account as usual for the annual instalments required for the redemption of the debenture stocks, as well as for sundry other charges for depreciation and sinking funds. These items amount to £56,641 0s. 7d. The directors recommend that in addition to this a sum of £50,000 be again carried to the general reserve and depreciation fund, making the total charge for the year for depreciation and sink-

ing funds £106,641 Os. 7d. The general reserve and depreciation account will then stand at £535,000. First mortgage debenture stock to an amount of £25,544 was redeemed and cancelled during the year, bringing the total redemption of that stock to June 30 last to £239,001. Of the second debenture stock £30,865 was redeemed and cancelled, making the total redemption of that stock to the same date £108,237.

Colonel Royds, M.P. for Sleaford, in a letter to the Press on the subject of housing, lays emphasis on the answers that should be given by town and district councils to the questions contained in the circular issued by the Local Government Board as to housing needs in their areas. He says that on August 15, in the House of Commons, he asked Mr. Hayes Fisher, President of the Local Government Board, if he would make special inquiry of the councils as to the cause of the failure of private enterprise in the four years preceding the war, and invite opinion as to what steps should be taken to encourage it. Mr. Fisher had replied that it was obviously open to local authorities to express opinions as to the cause of the failure of private enterprise. Colonel Royds says that if the housing question is to be properly dealt with it is vitally necessary to make careful inquiries and report to the Local Government Board, with recommendations as to what should be done to encourage private enterprise. While recognising that it may be necessary, to some extent, to look to local authorities to deal with the housing problem, he holds the view strongly that there can be no satisfactory solution of it unless private enterprise through all its available agencies and channels is encouraged and again set in motion. That view all acquainted with facts will endorse.

The difficulty of obtaining a house was emphasised in a case tried at the Birmingham County Court last week in which Miss Florence Louisa Spencer, Waverley Place, Rodway Street, Summer Lane, sought possession of a house at 135, Lennox Street. Plaintiff, a household help, purchased the house in April last, that she and her invalid mother might live there. The rent was 8s. a week, and the present occupier, Thomas Savage, his wife, and their daughter, a soldier's widow with three children, lived there. The defendant stated that he had been tenant of the house seven years, and admitted the notice to quit in June, but he could not get another house. "I have gone out on my bike morning and night," he said, "round Handsworth, Erdington, Smethwick and West Bromwich, but could not get a house. Agents only laugh at me when I go to them." Defendant asked for three months' grace, but plaintiff urged that six weeks ought to be sufficient. His Honour gave notice to quit in six weeks.

Any of your readers interested in the question of Barnard's statue of Lincoln, writes Mr. P. Gardner to the *Times*, will find engravings and a full discussion of it in the June number of the American magazine, *The Art World*. Beside it are figured the statue by Saint Gaudens, and a number of photographs of Lincoln taken at various times. Barnard's statue certainly exaggerates Lincoln's awkwardness of bearing and angularity, and caricatures the size of his hands and feet and the troubled expression on his face. The photographs show that he was careful in dress, and by no means wanting in dignity; and in his face was far more both of repose and of force than is shown in Barnard's travesty.

There is a public movement in St. Pancras to build a new town hall after the war, the alternative schemes being estimated at £30,000 for rebuilding on the present site, and £100,000 if land has to be bought. Architects will not forget the fiasco of the last century under the vacillating old Vestry, when a competition was held in which sixty designs were submitted, the winner being Mr. William Harrison, whose design we illustrated in an issue of May 5, 1893, our review of the competition having been given in that of February 3, 1893.

## CHIPS.

Mr. George Lapwood, surveyor to the Romford Rural Council, died suddenly during the air raid on Monday week, it is supposed from over-exertion due to hurrying home.

An advance of 1½d. an hour to all cabinet makers, chairmakers, and woodcutting machinists, to take effect from September 29, has been agreed upon by the Cabinet Trades Federation.

The autumn season of the Leicester Galleries, Leicester Square, will open on October 6 with an exhibition of paintings and drawings by a group of well-known artists serving with his Majesty's Forces.

A course of twenty-four lectures on "Ancient Architecture" was commenced last Thursday by Mr. Banister Fletcher, C.C., F.R.I.B.A., at the R.C.C. Centre School of Arts and Crafts, Southampton Row.

Mr. Richard Longstaff, of the firm of R. Longstaff and Co., auctioneers and valuers, of Spalding, who died on March 12, aged fifty-eight, left estate of the gross value of £16,805 13s. 10d., with net personalty nil.

West End firemen were called last Thursday to St. Mary Abbot's Church, Kensington, where a fire had broken out in a side chapel. The fire was prevented from spreading to the main building, but considerable damage was caused to the chapel.

Mr. Jacob Epstein has decided, on joining the Army, to show at the Leicester Galleries the work completed by him since his exhibition there in the early part of the year. The group will be on view on and after October 6, and will include a portrait in bronze of Miss Doris Keane.

Examinations for certificates of competency to act as district surveyor under the London Building Act, 1894, and as building surveyor under local Acts and authorities, will be held in London on October 24, 25 and 26, 1917. Applications must be sent in to the Secretary, R.I.B.A., on or before October 10.

An inquest was held at Halesowen on the 25th ult. relative to the death of Samuel Parkes (52), builder, of Woodland Road, Hales Owen, a member of various public bodies, who died from injuries sustained in a cycling accident on the 20th ult. The jury returned a verdict of "accidental death, and attached no blame to the driver of the vehicle." F. H. Newbery, Director of the Glasgow School of Art; is unable, owing to illness, to take up his duties in the school during the present session. The governors of the school have appointed Mr. John Henderson, artist painter, to act as director for the time being. Mr. Henderson, whose work as a painter is well known, has been long associated with the school as a governor.

An exhibition of photographs of women's war work which has been opened in Sheffield contains a series of pictures of the making of internal combustion engines for aeroplanes, motor-cars, or lorries, and the results of the various processes illustrated are shown in a complete rotary engine for an aeroplane which stands in the centre of the room. The greater part of the engine is women's work.

Only one application was disposed of at the last sitting of the Edinburgh Dean of Guild Court—Lord Dean of Guild Macintyre, formerly presiding in the smallest number of cases when the jurisdiction of the Court was extended. The application was for a minor alteration, and was remitted to the burgh engineer. The next sitting is on Thursday, October 4, and the Court will meet fortnightly thereafter.

The Army Council have requisitioned the Maddox Street Galleries, forming part of the Institute premises and situated at the rear of No. 9, Conduit Street, as temporary quarters for the excess staff of the Canadian Forestry Corps, which is closely connected with the Home-Grown Timber Department of the Board of Trade. The Civic Survey, which has had the use of the Galleries during the past two years, are now accommodated in the Common Room.

His many friends will be pleased to hear that at a recent examination held somewhere in France Lance-Corporal A. J. Kelly was successful in qualifying for a subaltern's commission in the Labour Battalion. Second-Lieutenant Kelly closed his Lord Street office in March and went out to France almost immediately. He still retains partnership in the firm of Abercrombie, Kelly and Kelly, who, it will be remembered, were successful in winning Lord Aberdeen's prize for the replanning of Dublin.

## TO CORRESPONDENTS.

We do not hold ourselves responsible for the opinions of our correspondents. All communications should be drawn up as briefly as possible, as there are many claimants upon the space allotted to correspondents.

It is particularly requested that all drawings and all communications respecting illustrations or literary matter, books for review, etc., should be addressed to the Editor of the BUILDING NEWS, Effingham House, 1, Arundel Street, Strand, W.C.2, and not to members of the staff by name. Delay is not infrequently otherwise caused. All drawings and other communications are sent at contributors' risks, and the Editor will not undertake to pay for, or be liable for, unsought contributions.

\* \* \* Drawings of selected competition designs, important public and private buildings, details of old and new work, and good sketches are always welcome, and for such no charge is made for insertion. Of more commonplace subjects, small churches, chapels, houses, etc.—we have usually far more sent than we can insert, but are glad to do so when space permits, on mutually advantageous terms, which may be ascertained on application.

Who favouring us with drawings or photographs, architects are asked kindly to state how long the building has been erected. It does neither our us much good to illustrate buildings which have been some time executed, except under special circumstances.

Handsome Cloth Cases for binding the BUILDING NEWS, price 2s., post free 2s. 5d., can be obtained from any Newsagent, or from the Publisher, Effingham House, 1, Arundel Street, Strand, W.C.2

RECEIVED—A. D. and Sons, Ltd.—H. A. C.—H. B. Co., Ltd.—E. W. J. M.—K. C. F. Co., Ltd.—W. and Co., Ltd.—J. and Co.—P. D. M.

D. F. W.—Yes.

REVEILLE.—Thanks, do.

S. T. (Cape Town).—No description to hand.

F. AND C.—In all probability the judge would refer it to the registrar, before whom item by item would have to be discussed. 2 No.



The death is announced of Mr. J. R. Powell, for many years surveyor and sanitary inspector to the Rhayader Rural District Council.

Mr. James Allan, of Tulloch Park Place, Cardiff, head of the firm of James Allan and Co. Limited, builders and contractors, has left a fortune of the value of £128,250, including personality of the net value of £106,370.

Mr. Howard Chaffield-Clarke, F.R.I.B.A., a past President of the Surveyors' Institution, of Inverness Terrace, Bayswater, W., and Bishopsgate, E.C., surveyor of the Fishmongers' and Cordwainers' Companies, has left £43,016.

The new marble shafting for the sanctuary of St. Finbar's Cathedral, Cork, is now being completed. Six of the main shafts are the public memorial to the late Dean Bruce, and the other two are presented by Mr. Guest Lano in memory of his wife.

M. Hilaire Degas, the celebrated French painter, died on September 27. He was born in 1834. In youth he was a follower of Ingres, and his art from first to last was in the tradition of that painter. He began with Classical and Mediaeval subjects—a fact with which Marmet always reproached him, but which he turned to modern subjects with his "Steinlechner," exhibited in London, was denounced for its sordid ugliness.

A field containing about fifteen acres, situate to the south of the coal depot at Morphett Station, has been purchased with the view of starting immediately an auction mart, the new concern to be called the Wansbeck Farmers' Auction Mart Company. The Minister of Munitions has sanctioned a considerable sum of money to be spent on the building of substantial mart premises. Messrs. Carse, Morphett, and Amble have the contract, and Mr. J. Gibson Cove, of 88, Front Street, Chester-le-Street, is the architect.

Mr. Hayes Fisher presided at the Local Government Board last Thursday at a private conference on the housing problem. As a result of the scheme which is being considered, it is expected that over 200,000 subsidised workmen's cottages will be built in various parts of the country. They will be of a "cheap but neat type," and it is expected that no tenant who does not come under the National Insurance scheme will be allowed to occupy them. Special attention will be given to the needs of the rural districts, and building will begin on the demobilisation of the Army.



**FOR  
Olivers'  
Seasoned**

**Hardwoods,**

APPLY TO—  
**W.M. OLIVER & SONS, Ltd.,**  
120, Bunsill Row, London, E.C.

**TENDERS.**

\* Correspondents would in all cases oblige by giving the addresses of the parties tendering—at any rate, of the accepted tender: it adds to the value of the information.

**ADLEY.**—Repairing roof of stables at Houghall Wall Farm, for the urban district council:—  
E. Johnson (accepted) . . . £87 10 0

**BERKHAMSTED.**—For construction of new filter bed at the sewage farm, for the Berkhamsted and Northchurch Joint Sewers Committee:—  
Truddett and Co., Colchester . . . £1,250 0 0  
Smith Bros., Burnley . . . 1,175 0 0  
H. and J. Matthews (accepted) . . . 814 15 0

**EAST COWES.**—For painting, repairs, etc., at the East Cowes Council mixed school, for the Isle of Wight Education Committee:—  
W. H. Brading, East Cowes (accepted) . . . £51 0 0

**GLASGOW.**—For reinforced concrete superstructure for one boiler-house, turbine-room, and work-shop at the new generating station, Dalmarock, for the electricity committee:—  
Train and Taylor . . . £64,539 0 0  
(Recommended for acceptance.)

**GLASGOW.**—For renewing steps of footbridge over River Kelvin, Partick, for the corporation:—  
G. Sharp and Son (accepted) . . . £72 16 6

**GLOUCESTER.**—Repairs to Hatherley Road school, for the education committee:—  
Conway, Jones and Co., Ltd. . . . £98 10 0  
(Accepted.)

**HENRIOD.**—For reinstating portion of the intermediate school for girls, for the county school governors. Mr. D. Pugh Jones, F.S.I., the county architect, Glamorgan County Hall, Cardiff. Quantities by the county architect:—  
Heary Jones, 37, Eton Road, Cardiff (accepted) . . . £1,209 17 0

**LANCHESTER.**—For new hot-water installation at the Langley Park Hospital, for the Lancashire Joint Local Board:—  
Straghan (accepted) . . . £89 0 6

**NEWBY.**—For laying certain sewers, etc., in the town of Rathfriland, for the Newry No. 1 Rural District Council:—  
J. Graham, J.P., Dromore, Co. Down . . . £4,808 8 11  
J. Robb and Son, Birkhill Avenue, Belfast . . . 4,719 8 3  
S. R. Boyd, Wheatfield Gardens, Belfast . . . 4,129 15 5  
J. Fleming, Canal Street, Newry\* 3,767 13 5  
(Accepted.)

**SHEFFIELD.**—For extensions to the Moor End Hospital, for the corporation:—  
E. Charlesworth (accepted) . . . £89 1 10

**WAR OFFICE.**—Government Contracts let during August (Ireland):—  
Inspection Bond Extension, Belfast—Wm. Dowling, 124, Belfast. Transit Shed, Belfast—John Graham, Dromore. Transit Shed, Dublin—S. H. Bolton and Sons, Dublin.

**WEALDSTONE.**—For alteration to council offices for food-control purposes, for the Wealdstone Urban District Council:—  
H. Parkhill (accepted) . . . £27 12 0

**WILMERSLEY.**—For alterations and additions to the Wilmsley Municipal Hospital, Dog Lane:—  
W. J. Maddison, Clarkson Street, Congreve Town, E. . . . £2,995 0 0  
(Recommended for acceptance.)

**LIST OF TENDERS OPEN.**

**BUILDINGS.**

**Oct. 5-11.**—Reinstating and improving the steward's stores at the Infirmary, Lower Road, Rotherhithe, S.E., according to plan and specification of Mr. A. H. Newman, F.R.B.A., etc.—For the Bermondsey Board of Guardians.—E. P. Fenton, Clerk, 283, Tooley Street, S.E.1.

**Oct. 5.**—Construction of (Section 1) pump-house building, (2) reinforced concrete foundations for cooling towers—For the Wolverhampton Corporation—Chairman of the Electricity Committee, Town Clerk's Office, Town Hall, Wolverhampton.

**ENGINEERING.**

**Oct. 15.**—Supplying and fitting complete steam power machinery for the laundry at the Workhouse, Wallingford.—For the Guardians.—G. E. Slade, Clerk, 7, St. Martin's Street, Wallingford, Berks.

**March 30.**—The Acting British Consul at Santiago reports that a decree has been issued calling for tenders for the improvement of the port of Antofagasta (Chile). By the terms of this decree the amount to be expended on this work must not exceed £1,700,000. Details may be obtained from the Port Commission Offices in Santiago, and copies are expected to be received shortly at the offices of the Chilean Legation in London, 22, Grosvenor Square, W.1. Tenders will be received up to 3 p.m. on March 30 by the Minister of Finance, Santiago.

**MISCELLANEOUS.**

**Oct. 8.**—Laying out land for a burial ground.—For the St. Andrew's (Dinas Powis) Parish Council.—W. D. Williams, Clerk, Parish Hall, Dinas Powis.

**Oct. 27.**—The Midland Great Western Railway of Ireland Co. invite tenders for complete renewal, in reinforced concrete and steel, of Newcomen Bridge, North Strand Road, Dublin, carrying the North Strand Road over the Midland Great Western Railway running lines or, alternatively, for the construction only of the reinforced concrete slabs, beams, and columns in connection with this work, erection to be carried out by the railway company.—B. A. Hay, Secretary, Broadstone Terrace, Dublin.

The Mervin Sites and Buildings Committee have given instructions for the preparation of specifications and estimate of cost for renovating and improving Dowlais Roman Catholic School.

An exhibition of special local interest at the moment owing to the probability of an extensive housing scheme being carried out in the town, has been opened in the Sunderland Art Gallery. It consists of over 300 plans, sketches and photographs illustrating town-planning, garden cities and model dwellings. The exhibits are on loan from various authorities.

With regret we announce the death, which occurred on Saturday at his residence, 40, Grange Crescent, Southwick, of Mr. Richard Kerrison, builder and contractor, aged sixty-eight years. A native of Norfolk, Mr. Kerrison went to Southwick in 1872 to work for the late Mr. James Armitage, builder and contractor. He afterwards became shop foreman and later manager, a position he held for many years and up to the winding-up of the business after Mr. Armitage's death about eight years ago. Seven years ago Mr. Kerrison commenced business himself, and since then had done a lot of work for the North-Eastern Railway Co. and the Durham County Education Authority. He was a member of the Master Builders' Association.

**TO ARMS!**

**COUNTY OF LONDON VOLUNTEER ENGINEERS (FIELD COMPANIES).**

Headquarters, Balderton Street, Oxford Street, W.1. ORDERS FOR THE WEEK BY LIEUT.-COLONEL C. B. CLAY, V.D., COMMANDING.

OFFICER FOR THE WEEK:—Sgt. Lieut. P. Bowden.

NEXT FOR DUTY.—Sec. Lieut. E. A. Ullmann. PROMOTIONS.—No. 2 Coy.: Sapper Tackley, W.A. to be Company Quartermaster-Sergeant. No. 3 Coy.; C. S. M. Rodger, J. to be Company Quartermaster-Sergeant; Sgt. Jantzen, P.H.H. to be Company Sergeant-Major. Staff: Sgt. Nelson, A.M. to be Drum-Major. (24.9.17.)

MONDAY, OCT. 8.—Drill and Elementary Bridge Construction for No. 3 Co. Left-half Co., 6.30. Signalling Class, 6.30. Recruit Drill, 6.50.

TUESDAY, OCT. 9.—Headquarters Closed.

WEDNESDAY, OCT. 10.—Drill and Elementary Bridge Construction for No. 1 Co., 6.30. Bridge Construction for No. 2 Co., 6. Signalling Class, 6.30. Ambulance Class, 6.30.

FRIDAY, OCT. 12.—Drill and Elementary Bridge Construction for No. 3 Co., 6.30. Right-half Co.

SUNDAY, OCT. 14.—Commandant's Parade for work at Esler, Parade 8.15 Waterloo Station, opposite No. 10 Platform. Uniform, haversacks, water-bottles. Mid-day rations to be carried. Compulsory for "A" and "B" men.

MUSKETRY.—The Range at Belvedere Road will be open every Tuesday, Wednesday, and Thursday evenings from 5.30 to 7.6. All N.C.O.'s and men who have signed the "A" and "B" agreements are required to attend during this month to reclass in order to enable the Corps to obtain the capitation grant. Preference will be given to these men in firing. This does not apply to those who hold the proficiency badge.

ARMLETS.—The new issue armlets can now be obtained at Headquarters, and every enrolled Volunteer MUST obtain one without delay. At the same time all old red armlets must be returned. Armlets must be worn when attending drills in plain clothes.

MEDICAL EXAMINATION.—The Medical Officer will attend at Headquarters for this purpose every Thursday at 6.

By order,  
MACLEOD YEARSLEY, Capt. and Adjutant.  
October 6, 1917.

Mr. Arthur Body, surveyor, of Plymouth, has been appointed president of the Rating Surveyors' Association, with Mr. W. P. Ryan, J.P., of Westminster, as vice-president, and Mr. Isaac Dixon, Liverpool, as hon. auditor.

The death of Mr. E. O'Flynn, building contractor, Cork, of the well-known firm of E. and P. O'Flynn, occurred at his residence, The Gables, St. Patrick's Hill, Cork, on 12th inst. at a ripe age. Mr. O'Flynn was one of the best known and most popular contractors in the South of Ireland.

The appeal of Mr. Philip Laszlo de Lombos, the Court painter, against the interment order made against him by the Home Secretary, came before the Home Office Advisory Committee recently at the House of Commons. The proceedings were private, but it is understood that the report of the committee will be forwarded to the Home Secretary in due course.

Last Sunday Sir John Dickinson, chief metropolitan magistrate, unveiled, at the Presbyterian Church, Richmond, a window in memory of the late Lieutenant William George Hobbs, LL.B., of the Royal Berkshire Regiment, who fell in action in the Battle of Loos on September 25, 1915, in his twenty-fifth year. The subject is the Resurrection.

**GALVANIZED CORRUGATED ROOFING SHEETS.**

**BEST QUALITY.**

Perfectly coated and thickly coated with zinc, ensuring real durability.



**GOOD STOCKS**

kept at our London Works in all the usual lengths and gauges.

PROMPT DELIVERY can be given, to any ordinary

whether straight sheets or curved radius.

**FREDK. BRABY & CO., LTD.,** 352 to 364, EUSTON ROAD, N.W.1, LONDON. IDA WORKS, DEPTFORD, S.E.8.

# THE BUILDING NEWS

## AND ENGINEERING JOURNAL.

Edinburgh House.

Currente Calamo .. .. .	281
The Blight of Beauty .. .. .	282
The Royal Society of Portrait Painters .. .. .	283
The Royal Photographic Society of Great Britain .. .. .	284
Our Illustrations .. .. .	284
Obituary .. .. .	288
Professional and Trade Societies .. .. .	298
Our Office Table .. .. .	298
Trade Notes .. .. .	299
Chips .. .. .	299

### CONTENTS.

To Arms! .. .. .	299
Tenders .. .. .	300
List of Tenders Open .. .. .	300
To Correspondents .. .. .	300
Latest Prices .. .. .	viii.

Strand, W.C.2.

Proposed War Memorial Chapel, Westminster Abbey, View, including the Chapter House and Henry VII. Chapel, with plan showing the relation of the scheme with regard to the boundary line of the Abbey property. Designed by Mr. William Woodward, F.R.I.B.A., Architect.
Restoration of the Old Palace and Bishop King's Palace, and reconstruction of the Priory Church of St. Nicholas, Oxford, for the Newcomen House Committee. Mr. Frederick T. Mullett, Architect.

### OUR ILLUSTRATIONS.

El Guadalupe, Spain. The entrance front, south elevation and water garden, with a general plan of the mansion. Mr. Edwin L. Lutyens, A.R.A., Architect.

## Currente Calamo.

We are glad to announce that a committee, to be known as the Architects' Reorganisation Committee, representative of all the architectural societies both in London and the provinces, has been appointed to prepare schemes for the re-organisation of the architectural profession after the war. In its deliberations it has particularly in mind the welfare of architects at present on war service and those whose practices have been destroyed by the war. The committee proposes to issue from time to time reports and suggestions for dealing with various problems which will arise in connection with the profession upon the demobilisation of the forces, and hopes that, as a result of its work, the re-establishing of architects in practice after the war will be facilitated and the position of the profession improved generally. The joint hon. secretaries of the committee are Mr. C. Macarthur Butler, the secretary, Society of Architects, and Mr. F. R. Yerbury, the secretary of the Architectural Association. The present close proximity of the offices of the two societies will render the valuable co-operation of both easy, and their past record is a guarantee that all that is possible will be done to accomplish the end in view, if the co-operation of all interested is hearty.

It is pretty plain that Mr. Neville Chamberlain's scheme of National Service, with its somewhat perfunctory appeals to volunteers to "enrol," has gone by the board, and that Sir Auckland Geddes is sailing—wisely, we think; auspiciously, we hope—on quite another tack. It is already evident that he is not enamoured of the lavish and costly machinery of his predecessor, and we believe he will save at least £100,000 a month—not, as has been incorrectly stated, on the old scheme, but on the new co-ordinated one of recruiting, registration, medical examination, and national service. What we want is, in the first place, a full and reliable statement of the actual man-power left us both for service in the field and in civil work. Next, we want a fairer and better determination of the physical and mental fit-

ness of men available; and we believe this will be officially explained shortly—possibly before these lines are read. If we get these we shall win the war. There is man-power enough, if rationally sought and utilised. It is wanted, for it is obvious to many that since last March more or less open opposition to recruiting is being fomented by the pacifists, and by the L.L.P., the I.W.W., the No Conscription Fellowship, the Union of Democratic Control, the British Socialist Party, and other less prominent but not less mischievous enemies of the country. If these are not soon check-mated, disaster will follow. Sir Auckland Geddes is evidently relying, and prudently, on the further co-operation of the trades unions for the transference of labour to localities where it is needed, and on the employment exchanges. The latter have yet to prove the value of their co-operation. Of course, it will ultimately rest with the War Cabinet to decide how the balance is to be held between the fighting and the industrial elements of man-power. The events of the near future will, doubtless, influence their action. Whether every consideration must succumb to the necessities of placing men in the field in masses, or whether continuous and increasingly paramount supplies of aeroplanes, guns, and ships are of the first importance, must depend on really good information and not on prejudice, and this good information we believe Sir Auckland Geddes is getting.

One of the most sensible remarks we have noted with regard to the scarcity of houses was made last week at a meeting of the Edinburgh Insurance Committee in the course of a discussion on a report of a special sub-committee, before which reference had been made to the circular and schedule issued by the Local Government Board to local authorities concerning this question. Mr. A. Eanson moved that a deputation of the Insurance Committee be sent to the Edinburgh Town Council in support of a resolution on housing already passed by the committee on June 28, and advocating the provision of more houses, and that the Government be asked to make advances of money to local authorities free of interest to enable them to provide more houses at reasonable rents. Mr. Eanson

pointed out that the schedule had to be sent to the Local Government Board before October 15, and it behoved that committee, as representing the insured people of Edinburgh, to see that the voice of Edinburgh was emphasised in the matter. Such a deputation to the Town Council would prove an important declaration of public opinion. Since the war we had had very little expression of public opinion in many vital matters, and it was time this loss of interest in public life and affairs was checked. If, as asserted, we needed five members of Parliament to represent Edinburgh owing to the increase in population, we needed more houses to accommodate that population. Much more, we should say. The experience of most people is that the more members of Parliament we get the less Parliament does, and the better the Government of the day is pleased. No other body in the world would have allowed Mr. Lloyd George to stop building as he did in 1910, or to fasten itself indefinitely on the electors for the sake of pocketing their four hundred a year each indefinitely. We are more than half inclined to think that the next real reform needed is the payment of members by their own constituents, as in olden times, with full liberty to each constituency to have as many or few representatives as it chooses, and to sack them at a week's notice when they will not work, or when they get into mischief.

An interesting light upon the attitude the Government is disposed to take up towards the possible coming Industrial Revolution after the war was given in a speech at Birmingham on September 17 by Mr. L. A. Paish, of the Commercial Intelligence Department of the Board of Trade. Addressing a meeting of the Birmingham Brass Masters' Association, he is reported to have said:—"The German Government were making a strenuous attempt to get all manufacturers in Germany into syndicates. They realised the advantages of syndicates, and were assuring all manufacturers that the only way in which they could regain their place 'in the sun' was to adopt that form of trading. The Board of Trade saw this tendency in Germany and America, and appointed a committee to consider the question, with the result that the Board had adopted this as their policy—that if British manufacturers were

to increase their export trade after the war and to regain the trade they had lost it was absolutely essential for them to get together into some sort of trading combination. They were prepared to face the question of trusts or combines, or whatever they were called. If we were to make a stand against combinations in other countries it would be necessary for us to adopt somewhat similar methods here. A combination of the whole of the Birmingham brass masters would be able to undertake a systematic investigation of any definite market that it wished to attack, whereas an individual firm would not be in a position to do so. If they had an association dealing with the whole of the products of the brass industry it would be possible to put a man in any market to study thoroughly the changes in the conditions that had taken place during the war. The department he represented was prepared to co-operate in every possible way in such an endeavour, even to the extent of finding financial assistance in the sending out of such a representative. It was out to give to manufacturers and traders in this country every possible assistance that they could reasonably expect. The department had instructed him to take such steps as might be found possible to get the formation of a trading association of brass masters actually going. If they were to live in the trade after the war against the organised competition of Germany, America, and Japan, it was essential that they should combine. If they did not combine, they would go under." The foregoing is all very well as far as it goes, although the past activities of the Commercial Intelligence Department of the Board of Trade have not proved very fruitful so far. But the prime need is organisation for the production of home-made needs for home use by artist-craftsmen. For that we must revive the fraternal and democratic spirit of the old craft guilds—not under Government Departments, but with all such encouragement as national and individual aid can give.

Mr. William Burrough Hill, F.S.I., F.A.I., the chairman of the Southampton School of Art, has published, for private circulation in the interests of art, an interesting appreciation of F. Lee Bridell, the young Southampton artist, whose death at the early age of thirty-three, and whose great picture, "The Coliseum at Rome by Moonlight," almost his final work, was painted at the zenith of his power, in 1860, when Bridell had then established a studio in Rome, after travelling through Switzerland and Italy. Southampton, indeed, seems careless in regard to his memory, but, as Mr. Hill remarks, "Few men are prophets in their own country. Dying so young, the artist's fame had little time to spread. Compare him to our great artist William Shayer, who lived to be ninety-two! Yet during his short span Bridell lived in Rome and elsewhere, working and studying, plodding so assiduously that he seldom paused for rest or praise. Many people think that he

was conscious of the delicacy of the frame which held the priceless jewel of genius, and felt it well to pursue his avocation almost madly while the light lasted. When he was no more the great art world awoke, and, amazed at his works, said: 'Who was this man?' He had no title, no string of letters to his name. But without such honours his works, like water, found their level. The connoisseurs clamoured for his canvases, and biddings ran fast and high at Christie's for the short life's work of this simple and almost unknown Southampton lad." A good portrait of Bridell is given, and a very satisfactory reproduction of the picture of the Forum.

At the Leicester Galleries Mr. Epstein, who has joined the Forces, exhibits a bust of himself and another of his wife, which strikes us as one of the best things he has done. How it may rank as a portrait we do not know, but if it is a faithful one Mrs. Epstein has been no mean inspirer of the mystic effects which have characterised her husband's reproductions of her sex. The bust of Miss Doris Keane is full of charm, but the smile is hardly hers—it is rather one called to order in response to applause that has become too customary to elicit much more than a conventional acknowledgment. The other busts are of "Joseph Holbrooke," "Bernard Van Dieran," and "Lieut. T. E. Hulme, killed in action." There is also on view a very interesting collection by well-known men serving with his Majesty's Forces, much of it pre-war work, but all excellent. Peaceful scenes, memories of Holland and China, glimpses of Venice and of the cave dwellings at Dieppe, English country inns and moorland, and clever studies of figures, are contributed. Lieut. Lee Hankey, Sergt. John Wheatley, Sergt. C. Maresco Pearce, Sergt. Montague Smyth, Sergt. Gerald Ackermann, Sergt. W. P. Robins, Lieut. A. E. Cooper, Second Lieut. E. L. Patison, and Lance-Corpl. Norman Wilkinson, who shows designs for "Twelfth Night" and other plays.

The Keighley Health Committee has recommended the town council to inform the Local Government Board that, in order to provide the necessary accommodation for the working classes in the borough, 150 new houses are required now, and that a further 150 should be built at the close of the war.

On Sunday week the Bishop of Lincoln (Dr. R. L. Hicks), preaching in the Cathedral on the subject of civic government, said that even before the war the houses in Lincoln were inadequate. He rejoiced to think that the general opinion of his fellow-citizens was coming round to the conviction that something must be done at once.

The Portsmouth and District Master Builders and Building Trade Association have come to an agreement with the operatives. Another penny per hour war bonus has been granted as from September 23, with the promise of a further halfpenny per hour in January if upon reconsideration the prices of the necessities of life show an appreciable increase. With the present concession the men will receive a total war bonus of 2d. per hour, the new district rates of pay, including the bonus, being therefore as follows:—Carpenters and joiners, bricklayers, plasterers, and masons, 1½d. per hour; plumbers, 10½d.; painters, 9½d.; and general labourers, navvies, and builders' labourers, 9d. per hour.

## THE BLIGHT OF BEAUTY.

Nearly thirty-five years since the late William Young in a very practical paper read before the A.A. told a very pertinent story of his experiences when engaged on a large public building, the work on which had so far advanced that they had come to the staircase. It was a big one, and capable of being treated in a really architectural manner. To carry out his idea adequately, William Young asked for some £15,000 or £16,000 to make it of marble. This was warmly denounced by some of the members of the authority concerned. "Quite unnecessary," said they; "a good easy stone stair, with a handsome cast-iron railing, and plaster walls, is all that is wanted, and it will look very handsome and spacious. What do we want with marble steps, and marble columns and wall and floor? It is extravagance and waste." However, Young got what he wanted, and, subsequently, due recognition that he had given good value for money. Soon after the building was opened at some public reception he was present, and one of the economists who had been most hostile met him on the staircase, and, with friendly enthusiasm, exclaimed: "Mr. Young, this is grand! I had no idea you intended giving us anything like this or I should not have opposed it for a moment. We are all proud of it; every rat-payer is proud of it, and not one penny of the money is grudged." Young was pleased, naturally; but, as he told his hearers at the A.A., the people after all got what they wanted and not what they asked for, and no doubt would have been quite satisfied with the stone staircase and the cast-iron railing.

A week or two later the then School Board of London, now the Education Committee of the London County Council, had a smart passage of arms with their architect, who had just submitted his design for the extension of their offices on the Embankment. He wanted to break the monotony of the proposed long frontage by a tower, and assured the Board it should be made useful as well as beautiful. The Works Committee agreed with him, especially as it was only to cost £3,600 out of a total expenditure of £220,000; but the economists on the Board took a division and sent it back to the committee for further consideration. The mover of the amendment said that at the ratepayers' meetings this clock tower would be "flung in their faces," and a supporter scornfully said "they had been asked to spend this money so as not to impair the beauty of London. What had they to do with the beauty of London?" We remember saying at the time that we agreed entirely with the economists as far as the last meant-to-be withering question went. What right, indeed, had they or any like them to have "to do with the beauty of London," and blind as they were to all considerations but those of the penny wise and the pottifogging, it was a blot on our civilisation that they should be so obtuse on questions of art or trusted with the education of the children of the people. They and their like, always grooping after the bullpence in the gutter, and incapable of seeing the sweats that might be gained in cleaner places, have done their worst to make our national education a curse instead of a blessing.

To them we owe the dead level of the so-called education we have forced on millions of children, which has turned out the junior clerk and the blind-armed boy, who, for the moment at a premium whenever they can be roughly trained to useful work for which their aptitudes should have been as apparent as was the stupidity of the denial of opportunities of



developing them, will soon once again return to their ill-paid and ill-performed drudgery, hustling each other in the race for employment and swelling the ranks of the sham genteel, who discover all too early in life that a little reading, writing, and arithmetic and the useless adjuncts to the "rudiments of education" dear to the code-makers and school inspectors, are the common property of the masses of their class, and worthless as wage-earners beyond the starvation limits fixed by the struggle for employment. From their disillusioned gaze recedes farther and farther the millennium of the black-coated scorners of the "working man," in which the emancipated lower middle classes are to sit from ten to five on four-legged stools casting up simple sums and copying or type-writing letters till it is time to seek the delights of the cheap picture palace or the music-hall. And yet in these British boys, as the war has taught us, there was pluck and latent capacity of resource and appreciation of better things that might have made them wholesome and profitable servants of the great commonwealth of real labour, in which the indispensable qualifications are physical strength, clear brains, and mechanical skill.

How shall we enlist these victims of commercialism into the army of honest, fairly paid, self-satisfying work? Not assuredly by the education of their children which is sought—should we rather say endured—by the working classes because it will "elevate" the boy or girl from their own rank into that next above it, and transfigure the mechanic's child into the clerk or small tradesman. Parents of such are already awaking to the fact that the world is not in need of small clerks or tradesmen. One in a thousand of either forces his way to the top, and becomes the "self-made man" who has mastered the art of making others work for him. The rest find that the better salaries earned during the years their fathers spent at the bench or forge, content with the wage of the apprentice, but learning their trade, vanish ere manhood is reached, or are doled out thereafter at such low levels that the rest of life is a struggle to meet heavier expenses and keep up appearances that would never have been incurred by or expected of them in the rank in which they were born, but in which, had real education been vouchsafed them, they might have been just as good, just as really cultured, just as refined as anyone else, and mainly so by the work they had to do. They would have risen, as the craftsman rose in the olden times, to the rank in their own sphere of an artist, able and willing to do their work in such a fashion that all really cultured people should and could admire it. They would have found that such admiration and real "respect"—not that of the conventional "respectable"—would have been due and paid to a man because of what he was, and not as where he was, and he would never have been troubled because the majority of the human race would have always to be where the really best of the working class is at present.

Even to-day, in its stupid fashion, the world is asking for better work, more original work, more artistic work, for which it will pay more, and for the makers of which it will, if it can get into touch with them, entertain personal consideration. What are we doing for the most part to train and encourage those whose natural aptitude and good luck lead to our science and art schools? We have shown time after time that so far the

principal end served by such training is to make black-coated science and art masters, not craftsmen, and that this latest development of snobishness will prove as pernicious as the impulse which leads the masses to seek for their children mere transfer to the ranks of the "respectable" rather than their true enfranchisement from the tyranny of the penny-wise pound-foolish masters of the people, from the parish council to the Treasury bench. What are we doing to encourage the few who really become good craftsmen? The great "Emporium" will buy one of his works and reproduce it by the hundred, vulgarising it in every detail, and satiating the demand that should have encouraged the artist to further original effort. Some of us today are quite content with the "war-shrines" we are rearing to our noble slain, reproduced to order in such fashion. More of us are doing our wretched best to stifle the inborn genius of the craftsman by our "patronage," not of him, but of the middle-man who buys his work and multiplies it by soulless reproductions by the thousand.

And all this is the bitter fruit of the blight of beauty due to the philistines who grudge a sixpenny rate to help make life profitably pleasant, and vote precepts by millions to feed the paupers—or just now, for the most part, the well-paid officials who look after them. Of our higher grades of viscerates others are launching out into house-building for the workers at double the prices they hinder the ordinary builder from erecting, and planned with the scantiest regard to fitness or good design. Must it be always thus? Many years ago we told the story of one shamelessly scandalous contrast of economy with extravagance afforded by the Government of the day in connection with the erection of the Houses of Parliament, with which probably most of our readers to-day are unfamiliar or have forgotten. The Government of the day were professing anxious that the new Palace of Westminster should be as lasting as possible, and a distinguished commission was appointed to inquire into and report on all the principal building stones in the kingdom, so that the best obtainable might be selected for the housing of the best of legislators who were destined to guard the best of constitutions. After long search and at some expense that commission made their report, and it was a valuable one. They recommended the Bolsover or Church Anston stone, which was actually used. Why, millions of Englishmen have asked ever since, has the masonry been in a continuous state of decay? The penny-wise of the period were responsible. To them the durability of the stone and the beauty of London were alike trifles. Their business was to keep down the estimates. Bolsover stone, like many others, varies in quality in different parts of the quarry. The best is very good, the worst is very bad. A clerk of the works had been appointed at a very moderate stipend to live at the quarry and make sure that only stone from the best beds was sent to Westminster. But when the £150, or thereabouts, which was to be paid to him yearly appeared in the Estimates of the year a penny-wise patriot protested against such "waste of public money." The Government yielded; the clerk of works was dismissed. He is probably dead long since, but his monument endureth, though hardly for ever, and the mouldering cornices and plinths of the Palace of Westminster have still from time to time to be patched and plastered into something like durability.

Fit witness, perhaps, to the influence of the "blight of beauty" which has followed the niggardly shortsightedness of the blind leaders of the blind who know not that the love of the beautiful is the most powerful inspiration of the loyalty to all that is good that makes or mars men and women. That has let the descendant of the British art-craftsman rot in the hovels of the slums, and stunted his body and soul in the factory. That grudges his children beauty in their schools and leaves them to learn the story of their own land from gaudy German lithographs. That will continue to make miserable the lives of the millions which Nature meant should be fragrant with the fresh air of field and forest, and inspired in the first instance by the "art that doth mend Nature; but the art itself is Nature."

#### THE ROYAL SOCIETY OF PORTRAIT PAINTERS.

The twenty-seventh exhibition of the Royal Society of Portrait Painters, which opens on Monday next at the Grafton Galleries and will close on November 3, embraces 172 works, and is of more than average merit, although we miss the contributions of at least a dozen of the more prominent members, including Messrs. Richard Jack, J. H. Lorimer, William Nicholson, William Orpen, S. J. Solomon, and others.

Mr. J. J. Shannon, R.A., R.N.A., the president, is well represented by six portraits, all of high quality, especially that of Mrs. Loeffler (27), which is one of its author's best. The others are of Mrs. J. J. Shannon, Lady Tata, Lady Lee, the Hon. Mrs. Vickers, and Jebby, son of Captain Keigwin (53-57). It is not often Mr. Shannon's admirers have the opportunity of studying so many of his portraits hung together, and none should miss it.

The Hon. John Collier shows a portrait of Alderman Sir William P. Treloar, Bart., painted for the Cripples' Hospital, Alton (26), another of Mrs. Lawrence Collier (14), and a third of "Miss Frances Torrens in 'Chu Chin Chow'" (67). We like the last the least, and the first the best. A happier conception of the best belonging to one of the best of the City Fathers, and the most practical of present-day philanthropists, has seldom been achieved. Mr. Oswald Birley has three exhibits, "Mrs. Charles Leslie" (29), "John W. Ross" (41), and a "Lady in Black" (39), the last, favoured by her attire, the most attractive, as also is "The Lady in Brown" (85), by Mr. Frank Salisbury, who is well hung with "The Late James Wright Salisbury, Esq." (7), and shows as well a portrait of the late "Lieut. L. F. Gordon Dower, killed in action May, 1917" (66). Mr. Hugh de T. Glazebrook is seen at advantage in a "Portrait of Mrs. Thornton and her Son" (8), and scarcely less so in a "Portrait of Signor Galeota" (48), and another of "Hubert Henry Davies, Esq., and his brother Edgar" (87). Mr. R. G. Eves is the most prolific contributor this year, sending no less than seven subjects, "Greenville Eves" (15) getting best placed, but "Lord Sherborne" (43), we think, is his best contribution.

Mr. J. Melton Fisher, A.R.A., has only one canvas, "Alba" (40), which is well worthy of his reputation. Mr. Maurice Griffenhagen, A.R.A., sends two, a "Portrait of Sir Henry Sinton" (42), and one of "Miss Elga Myers" (88). Mr. Arthur Hacker, R.A., is well represented by a portrait of "Gordon Thomson" (30). Mr. Alfred Priest shows

six, that of "Mrs. Radcliffe" (25) being, perhaps, his best. Mr. James Quinn has four, "Lieut. Colonel J. A. Innes, D.S.O." (38), "The Late Captain Guy Miller," a posthumous portrait (65), "Master Rene Quinn" (73), and "Mrs. Archibald Innes" (94). We do not greatly care for Mr. David Jagger's "Study of Young Girl Laughing" (11), or for "The Enchantress" (106). Second Lieut. Carey Morris has a really very creditable portrait of Mr. Walter Langley (118), which will be appreciated by the many friends of that well-known artist. Mr. Fiddes Watt sends one portrait of Sir Robert Inches, the late Lord Provost of Edinburgh (39), and another of "Francis Augustus Bevan" (90).

Among others we can but name Mr. Longstaff's "Captain Longstaff" (31) is good, and so is Mr. David Alison's "Portrait" (4). Mr. William Carter's "G. A. Holmes, Esq." (12) is satisfactory, if perhaps a little too elaborate. Mr. Leslie Ward, who sends four subjects, scores best, perhaps, with his "Portrait of Mrs. Weir" (130).

#### MINIATURES.

Conjointly with the portraits will be welcomed the twenty-second annual exhibition of the Royal Society of Miniature Painters, embracing 163 contributions. Not a few of these are of marked excellence. No. 7, "Horace, youngest son of Philip Dawson, Esq.," is one of the best, and has been hung by special invitation of the committee. Miss Dora Webb's "On the Bat's Wing Do I Fly" (19) and Miss May Malburn's "I am the Daughter of the Earth and Water" (24) will also be well appreciated. Some of the "book-markers"—they are little more—seem to occupy space unnecessarily.

#### THE ROYAL PHOTOGRAPHIC SOCIETY OF GREAT BRITAIN.

The Royal Photographic Society, of 35, Russell Square, W.C., has made an innovation in its usual procedure by holding its annual exhibition at its own premises as above, instead of at one of the art galleries, and invites the public to view the photographs free of charge.

The exhibition will be open daily (Sundays excepted), from 11 a.m. till 9 p.m., till November 24, and lantern lectures on popular and interesting topics will be delivered each Tuesday and Friday evening from 8 till 9.

An interesting feature is a large series of photographs loaned by the Royal Flying Corps. These show positions held by the enemy and, as the photographs made by flight officers have been taken at intervals, show the obliterations of the natural features of the country under heavy gun fire. Another series show our own men drawn up for attack. In one instance the troops are seen standing at ease and later on at attention before the General in Command. Large detachments of aeroplanes guarded the troops from the enemy's flying machines.

Another series show the gradual evolution of the trench system, from the simple earthworks thrown up in the early days to the elaborate system now in vogue.

The pictorial exhibits show a high level of excellence. Most of the well-known art workers are represented, and among them are many new men who have won recognition. The prevalence of light mounts and the absence of heavy dark frames give the whole exhibition a more cheerful look than was the case some years back. This is particularly noticeable in the continuation of the Pictorial

Section on the second floor, where a selection of photographs by various three-colour processes strike a warmer note.

The transparencies (also on the second floor in a darkened room), although not so numerous as in the past, are all of good quality.

The Scientific Section (on the same floor) contains some fine natural history specimens, among them being striking portraits of many of the denizens of the Zoological Gardens photographed by Mr. D. Seth-Smith. There are many fine examples of photomicrographs, most of the producers being members of the Society or of the Photomicrographic Society or of both. Radiographs are shown by the Cancer Hospital and others. A series of cloud forms taken for meteorological purposes mark clearly the distinction between the various types of clouds, and a series of stellar charts contributed by the Astronomer Royal and lunar photographs by J. H. Reynolds, F.R.A.S., call for particular attention.

Medals have been awarded by the judges to H. Y. Simmons and H. Essen-lich Corke in the Pictorial Section, to J. Copperfield in the Colour Section, and to F. Martin-Duncan and the Cancer Hospital in the Scientific Section.

## Our Illustrations.

#### EL GUADALPERAL, SPAIN.

We reproduce both of the views by Mr. W. Watcot from this year's Royal Academy Exhibition, and give a copy of the plan of this building. The architect, Mr. E. L. Lutyens, A.R.A., says—"There is not very much I can say at present about this house. Granite and stone will be used for the dress work, and the roof covered with Spanish tiles, and the exterior walls being plastered in the typical Spanish manner. The site is on high ground, with a commanding view, the difference of level between the patio and terrace being 27 ft., with steps leading down to a landing stage on the bank of the river Tago. The floors will be formed by brick barrels and vaults, except the reception rooms, which will be constructed in timber, exposed on the underside."

We may add that the entrance facade, shown in the larger scale study, is marked by its fine doorway, which is so typical of Spain, while the simplicity adopted in the planning and the dignity of the elevations give a quality which is both wonderful in its expression of character and admirably adapted to the purpose and situation of the building. A splendid feature is made of the water gardens, as indicated by the smaller picture and set out by the plan.

#### PROPOSED NATIONAL WAR MEMORIAL CHAPEL, WESTMINSTER ABBEY.

Mr. William Woodward, F.R.I.B.A., has very considerably modified his original project, of which we printed a sketch plan and view some months ago. In the meantime the Dean of Westminster has afforded Mr. Woodward every opportunity to make a survey of the Abbey and its immediate surroundings. Consequently the present scheme has been devised with the intention of meeting the objections previously entertained by the authorities in this regard. Unlike the already published plan, the one now illustrated has been arranged precisely so as to avoid intruding upon the precincts or interfere with the Abbey buildings, the present suggested site being kept entirely outside the boundaries of the property of the Dean and Chapter. Further study of the problem, too, has resulted also in material revisions of the lay-out of the chapel, and, although the objects in view remain essentially the same as before, the design now represented presents quite a differently designed building. Its erection

inevitably would involve the demolition of the row of houses in Abingdon Street, as well as the two or three residences in Old Palace Yard, occupied for business purposes. All these nondescript premises are of little architectural interest, and they certainly obstruct the view of the Abbey from the south-east. This change would open up the Abbey garden, which contains many fine trees. All this part of the precincts is now hidden at the back by these Abingdon houses. The historic "Jewel House," as well as the ancient walls of the Abbey garden, would also be exhibited, and Mr. Woodward's scheme includes the lay-out of public gardens on the west of Abingdon Street, extending up to the corner of Great College Street. This garden would be about 300 ft. long by 150 ft. wide, commencing from the south front of the memorial chapel. In this way the great improvements already effected at Millbank, in the vicinity of Victoria Tower, would be linked up with Parliament Square and Whitehall on a uniform alignment. When the Royal Commission reported on the want of space for monuments in the Abbey, long prior to the war, it was decided that a memorial chapel for future needs in this respect should be provided as an adjunct to the existing buildings. The Archbishop of that time said that such a chapel should be planned so as to also allow of services being held like any of the Abbey chapels might allow of. The plan of this chapel prepared by Mr. Woodward has, therefore, been set out with such a purpose in view. The approach would be direct from Abingdon Street or through the Abbey doorway in Poets' Corner by the lawn adjacent to the Chapter House. The height of the structure is intended to correspond with Henry VII. Chapel, and the dimensions generally are described as comparing with Gloucester Cathedral. The length of the chapel is 145 ft.; Gloucester is 174 ft. The width of the nave is 37 ft.; at Gloucester the nave is 34 ft. Including the aisles, the chapel measures 73 ft.; Gloucester scales 64 ft. The height of the chapel is 70 ft.; Gloucester is 2 ft. less. The accompanying view shows a detached memorial outside the building on the north flank, and the relative positions of the Abbey and its adjuncts are set out clearly. The semi-circular recesses in the north and south walls of the aisles are intended for statuary.

#### RESTORATION OF "THE OLD PALACE" AND BISHOP KING'S PALACE, AND ALSO RECONSTRUCTION OF ST. NICHOLAS' PRIORY CHURCH, OXFORD.

The Newman House Committee has commissioned Mr. Frederick T. Mullett, of Downing Street, Cambridge, in regard to this work. His drawing showing the group of buildings, herewith reproduced, was exhibited this year at the Royal Academy. We have received a copy of the architect's exhaustive inquiry and interesting report. The undertaking includes the renovation of the two palaces, and rebuilding of the Priory Church of St. Nicholas. The particulars got together about the premises of the Preaching Friars, and the subsequent episcopal residences, are based upon ancient records and existing old maps of the site and its environment. No care evidently has been spared in planning this renovation and reconstruction intended to be carried out by the building committee for the Newman House memorial scheme, the property having been acquired for this object. The following particulars are abstracted from Mr. Mullett's admirable review. Want of space, however, precluded our giving that in extenso. The intentions of the promoters thus outlined, include a thorough repair of all the parts which can be properly preserved, and all the work is to be done as nearly as possible in accordance with the original design, while in the inevitable rebuilding the same idea will be adhered to; also in erecting the addition of a stone oriel window to the first floor of St. Aldate's front, as seen to the left of the accompanying perspective. The existing stables at the west end are to be cleared away to make room for the new memorial chapel which is to occupy the site of the original Church of the Priory of St.

\* See "Building News," February 14, 1917.

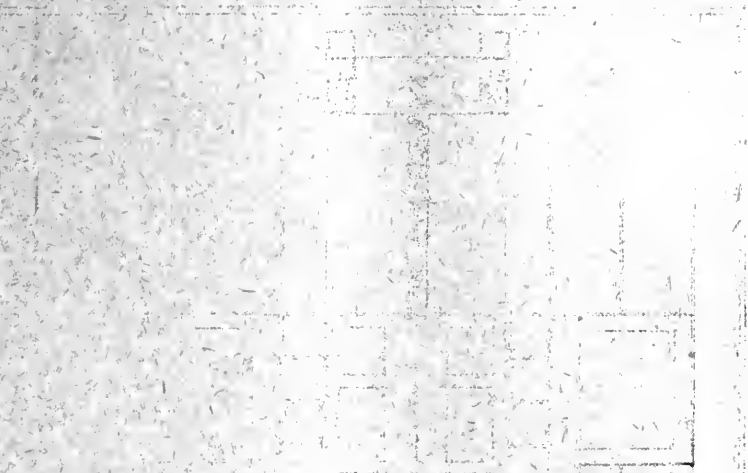

1. The object is a rectangular block with a central vertical hole. The height of the block is denoted by 'A' and the diameter of the hole is denoted by 'B'.  
 2. On the right side of the block, there is a smaller horizontal hole. The diameter of this hole is denoted by 'C'.  
 3. The distance from the center of the vertical hole to the center of the horizontal hole is denoted by 'D'.  
 4. The thickness of the block is denoted by 'E'.  
 5. The drawing shows the object in a perspective view, with the front face and the top surface visible.

THE BUILDING NEWS, OCTOBER 10, 1917.

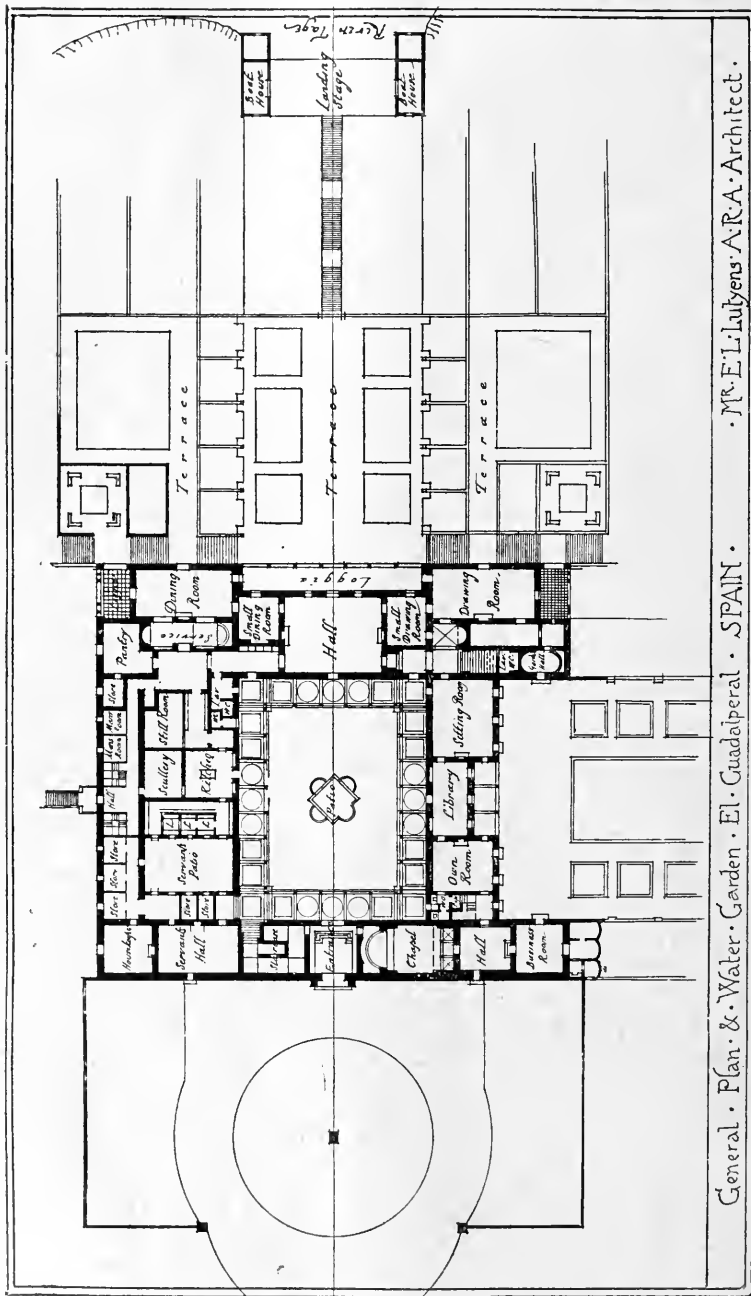

General Plan & Water Garden · El Guadalperal · SPAIN · · Mr. E. L. Lutyens · A.R.A. · Architect ·

EL GUADALPERAL, SPAIN : GROUND PLAN.—Mr. EDWIN L. LUTYENS, A.R.A., ARCHITECT.



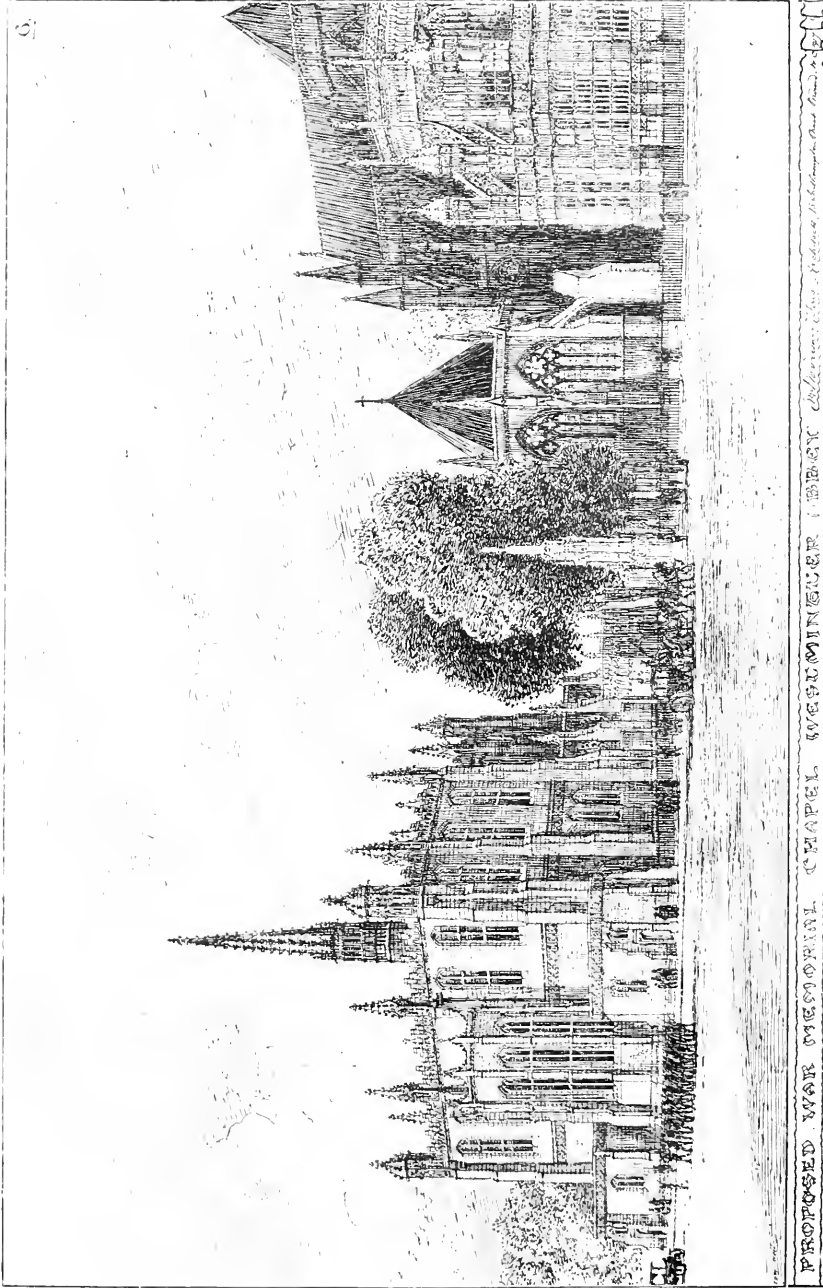

PROPOSED WARR CORPORATION CHAPEL. ARCHITECTURE BY FREDERICK WOODWARD, F.R.I.B.A., ARCHITECT.

Designed by Mr. WILLIAM WOODWARD, F.R.I.B.A., Architect.



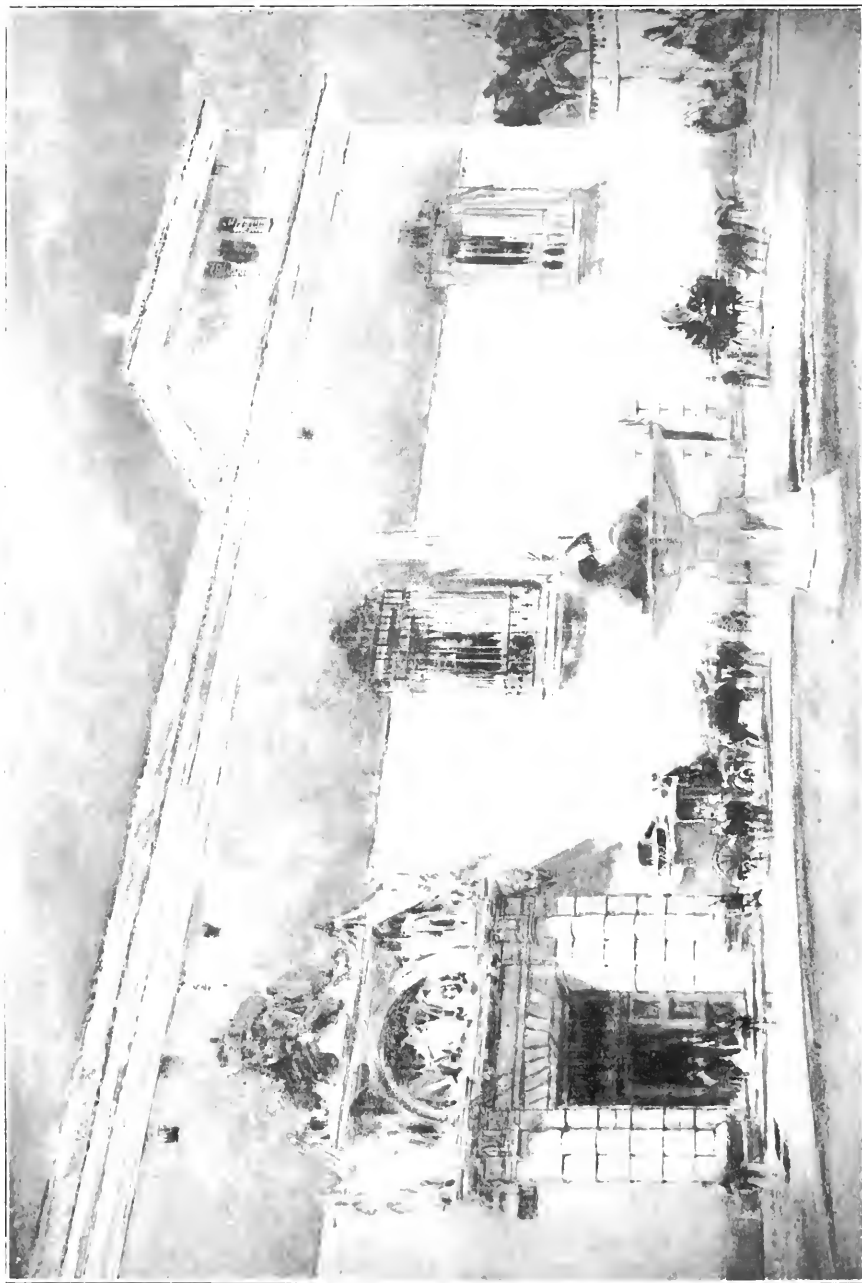

ENTRANCE FRONT, EL GUADALQUIVIR, SPAIN. MR. EDWIN L. LUTWENS, A.R.C.S., Architect.



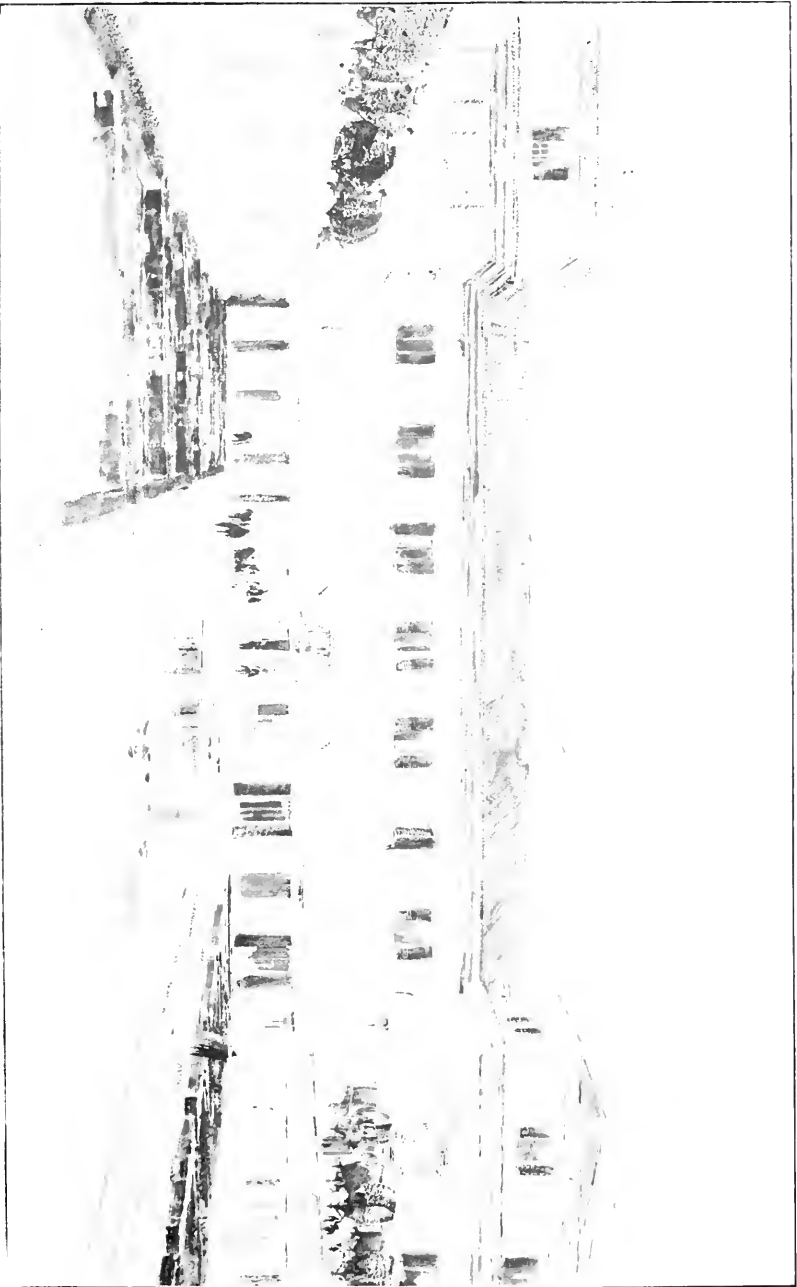

EL GRADALPERAL, SPAIN: SOUTH ELEVATION AND WATER GARDEN.  
MR. EDWIN L. DUYVES, A.R.A., ARCHITECT.



THE BUILDING NEWS, OCTOBER 10, 1917.

Plan of the proposed new building of the House of Commons, showing the position of the new building in relation to the old building and the site of the new building.

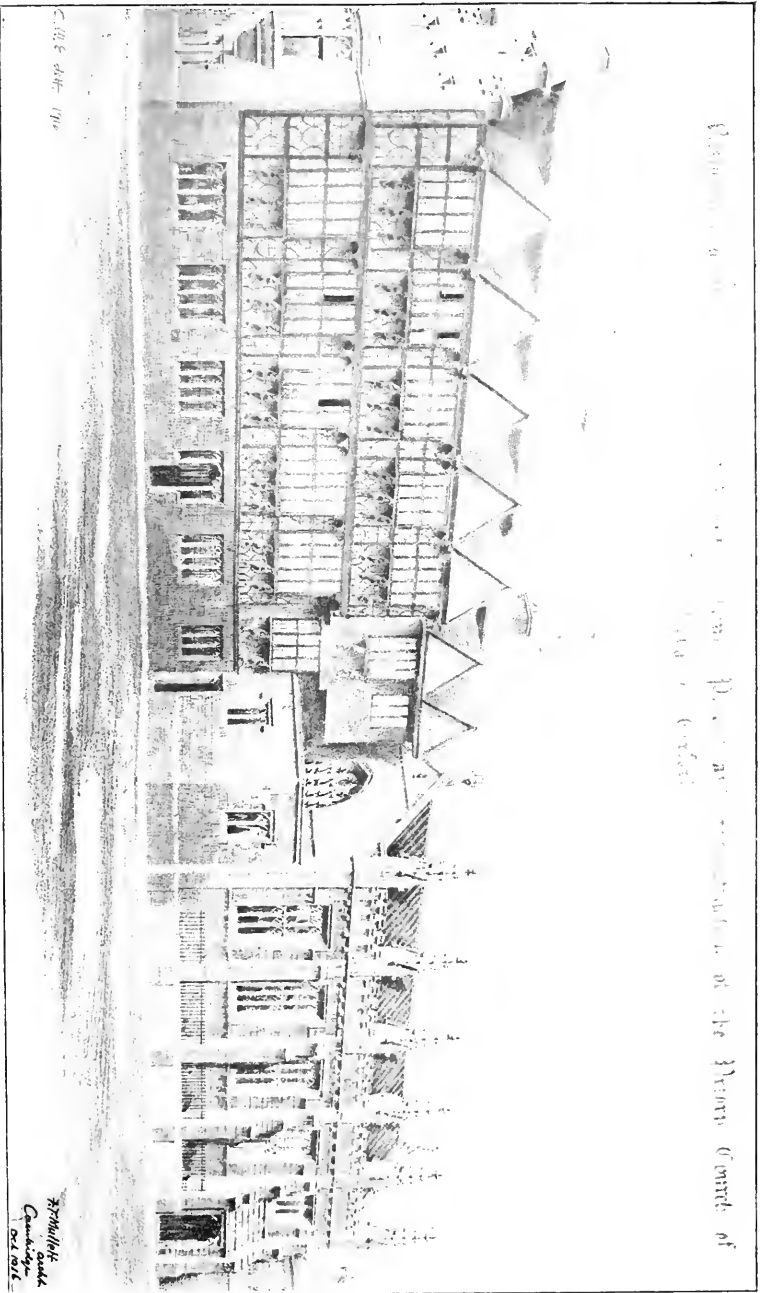

RESTORATION OF "OLD PALACE" AND BISHOP KING'S PALACE AND RECONSTRUCTION OF  
ST. NICHOLAS CHURCH, OXFORD, FOR THE NEWMAN HOUSE COMMITTEE.

Mr. FREDERICK T. MULLERTY, Architect.



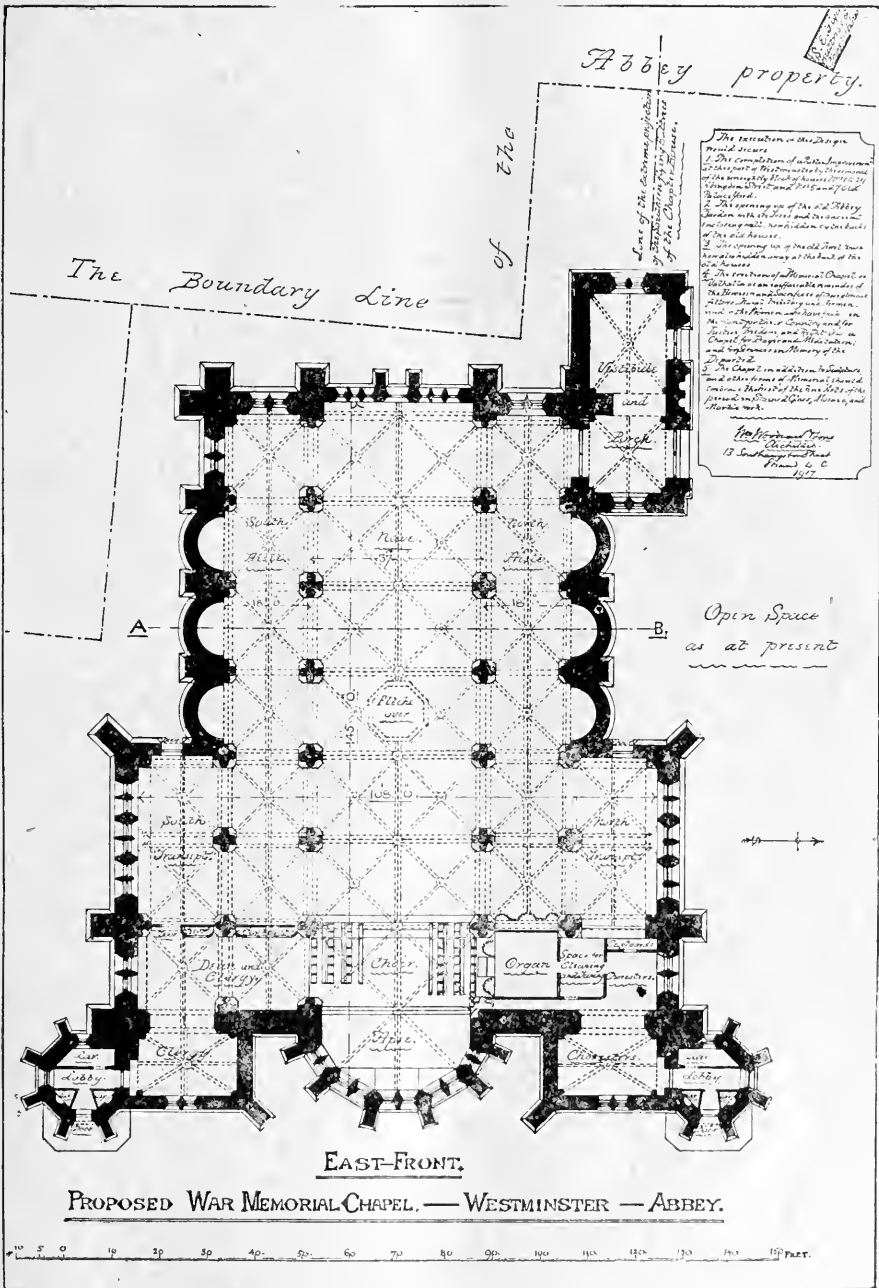

Designed by Mr. WILLIAM WOODWARD, F.R.I.B.A.



## OUR ILLUSTRATIONS.

(Continued from page 284.)

Nicholas. The style adapted for this part of the work is advisedly perpendicular in character to conform not only with the old foundation but to insure a harmony with the architectural spirit of collegiate Oxford. From time to time the whole of these buildings have been materially altered and much cut about, more particularly inside, consequently their structural stability is by no means substantial, but being of timber well framed and pinned together, Mr. Mullett has reported that the remaining portions of the ancient fabric have held together firmly, notwithstanding the changes referred to; moreover, he adds that fortunately there is an absence of natural decay in the material, in spite of the age of the buildings. The roof of Bishop King's Palace was opened into when a third story was constructed, the front portion, except the gables to the north, being removed, and reinstated, partly being incongruously enclosed, Mansard fashion, with corrugated iron to give room for the business of a photographer. At the rear it was built up square in fir with a rather good effect, and four transverse gables. These extensions were reached by a steep, narrow staircase, fitted with a dormer roof breaking out above the old work. The gable towards Aldate Street in a great part has perished, but enough exists to serve as a guide, otherwise the wall of this frontage has been more or less destroyed. A confectioner's shop was built out at the N.E. part of the north front and an entrance made in the old Palace for modern trading purposes, with other changes introduced regardless of taste and appropriateness. Bishop King erected his palace about 1548. Under a reference to 1544 William Peers and his wife, who seem to have possessed the holding, are described as "practical housebreakers and dealers in old building materials." Another reference mentions that Edward Frow was connected with the property, but his relationship with the party previously alluded to is not clear. He of his own free will gave away, however, forty loads of stone, possibly for building purposes, from "the ruins of the Black Friars in Oxen," and besides in 1553 he sold 100 loads more. The destruction of the Priory Church and a considerable part of the Mansion House is thus relatively accounted for. The Priory comprised a mansion, church, cemetery, garden or grove, two mills, and the building gifted to the Friars in 1352 by Durand de Bugwell, together with the gate situate towards Grand Pont Street. The convent precincts contained three acres according to old particulars, but the ancient maps show a larger area. The "Preacher's Bridge" did not belong to the Black Friars, but in all likelihood was erected by the Grey Friars at the crossing of Milk Street which led to the City through the "little gate." The Black Friars' property faced Grand Pont Street, and the Grey Friars occupied ground coming to the rear behind the cemetery of the Black Friars, their convent skirting Trill Mill stream, over which the "Preacher's Bridge" was built at the corner of the Grey Friars' property. When the consequent rebuilding in Grand Pont Street was carried out by Bishop King, he having presumably bought back a considerable area of the Priory site as it then stood, further changes were made, of course, under ecclesiastical ownership, but on the death of Bishop Howson the property was sold to Oliver Smyth. As to when the modifications of various occupiers and owners actually occurred it is difficult to determine. Suffice it to say that they varied considerably. The portion of the original mansion, the two-gabled building now correctly called "The Old Palace," was much altered, and the staircase recast and refixed in the north-west corner. This is thought to have been done by Bishop King, who before 1557 carried out the completion of the existing palace which bears his name, and thus he filled out the site right up to Aldate Street. The facade follows the same

lines as the remnant of the older building adjacent, but King's additions are loftier in the first-floor storey. The back or south wall and the street end are constructed of rubble stone plastered over. The north main front was all of oak framing filled with wattle and daub; the panels plastered between the timbers in the usual way inside and out. The five oriel windows oversail 21 inches, and the second floor storey projects still further. Wooden carved brackets are used below the windowsills in both stages. The fenestration of the "Old Palace" is very similarly treated. The brick chimneys possibly were rebuilt. Oliver Smyth, before mentioned, repaired the premises, and altered the facade subsequently, this work carrying also the date of "1628," as the property changed hands and was resold several times. Now the Newman House Committee has practically acquired the existing premises and the land on which they stand in order to carry out this scheme, which is illustrated to-day. When finished this renovated group will be a great improvement, and make an admirable memorial.

## REINFORCED CONCRETE FLAT SLAB DESIGN.

(Continued from page 264.)

When the long side of an interior oblong panel exceeds the short side by more than one-twentieth and by not more than one-third of the short side, it is recommended that the positive moment be taken as  $1/25 w_1 (l_1 - 2/3c)^2$  on a section parallel to the dimension  $l_2$  and  $1/25 w_1 (l_2 - 2/3c)^2$  on a section parallel to the dimension  $l_1$ ; and that the negative moment be taken as  $1/15 w_2 (l_1 - 2/3c)^2$  on a section at the edge of the panel corresponding to the dimension  $l_1$  and  $1/15 w_1 (l_2 - 2/3c)^2$  at a section in the other direction. The limitations of the apportionment of moment between inner section and outer section, and between mid-section, and column-head sections, may be the same as for square panels.

## WALL PANELS.

The coefficient of negative moment at the first row of columns away from the wall should be increased 20 per cent. over that required for interior panels, and likewise the coefficient of positive moment at the section half-way to the wall should be increased by 20 per cent. If girders are not provided along the wall, or the slab does not project as a cantilever beyond the column line, the reinforcement parallel to the wall for the negative moment in the column-head section and for the positive moment in the outer section should be increased by 20 per cent. If the wall is carried by the slab, this concentrated load should be provided for in the design of the slab. The coefficient of negative moments at the wall to take bending in the direction perpendicular to the wall line may be determined by the conditions of restraint and fixity as found from the relative stiffness of columns and slab, but in no case should it be taken as less than one-half of that for interior panels.

## REINFORCEMENT.

In the calculation of moments all the reinforcing bars which cross the section under consideration, and which fulfil the requirements given under "Arrangement of Reinforcement" below, may be used. For a column-head section reinforcing bars parallel to the straight portion of the section do not contribute to the negative resisting moment for the column-head section in question. In the case of four-way reinforcement, the sectional area of the diagonal bars multiplied by the sine of the angle between the diagonal of the panel and the straight portion of the section under consideration may be taken to act as reinforcement in a rectangular direction.

## POINT OF INFLECTION.

For the purpose of making calculations of moments at sections away from the sections of negative moment and positive moment already specified, the point of inflection on any line parallel to a panel edge may be taken as one-fifth of the clear distance on that line between the two

sections of negative moment at the opposite ends of the panel indicated in paragraph 6 for moment sections, above. For slabs having dropped panels the coefficient of one-fourth should be used, instead of one-fifth.

## ARRANGEMENT OF REINFORCEMENT.

The design should include adequate provision for securing the reinforcement in place so as to take not only the maximum moments, but the moments at intermediate sections. All bars in rectangular bands or diagonal bands should extend on each side of a section of maximum moment, either positive or negative, to points at least twenty diameters beyond the point of inflection as defined herein, or be hooked or anchored at the point of inflection. In addition to this provision, bars in diagonal bands used as reinforcement for negative moment should extend on each side of a line drawn through the column centre at right angles to the direction of the band, at least a distance equal to thirty-five one-hundredths of the panel length, and bars in diagonal bands used as reinforcement for positive moment should extend on each side of a diagonal through the centre of the panel at least a distance equal to thirty-five one-hundredths of the panel length; and no splice by lapping should be permitted at or near regions of maximum stress except as just described. Continuity of reinforcing bars is considered to have advantages, and it is recommended that not more than one-third of the reinforcing bars in any direction be made of a length less than the distance centre to centre of columns in that direction. Continuous bars should not all be bent up at the same point of their length, but the zone in which this bending occurs should extend on each side of the assumed point of inflection, and should cover a width of at least one-fifteenth of the panel length. Mere draping of the bars should not be permitted. In four-way reinforcement the position of the bars in both diagonal and rectangular directions may be considered in determining whether the width of zone of bending is sufficient.

## REINFORCEMENT AT CONSTRUCTION JOINTS.

It is recommended that at construction joints extra reinforcing bars equal in section to 20 per cent. of the amount necessary to meet the requirements for moments at the section where the joint is made be added to the reinforcement, these bars to extend to not less than 50 diameters beyond the joint on each side.

## TENSILE AND COMPRESSIVE STRESSES.

The usual method of calculating the tensile and compressive stresses in the concrete and in the reinforcement, based on the assumptions for internal stresses should be followed. In the case of the dropped panel the section of the slab and dropped panel may be considered to act integrally for a width equal to the width of the column-head section.

## PROVISION FOR DIAGONAL TENSION AND SHEAR.

In calculations for the shearing stress which is to be used as the means of measuring the resistance to diagonal tension stress, it is recommended that the total vertical shear on two column-head sections constituting a width equal to one-half the lateral dimension of the panel, for use in the formula for determining critical shearing stresses, be considered to be one-fourth of the total dead and live load on a panel for a slab of uniform thickness, and to be three-tenths of the sum of the dead and live loads on a panel for a slab with dropped panels. The formula for shearing unit stress will then be written  $v = 0.25W/bjd$  for slabs of uniform thickness, and  $v = 0.50W/bjd$  for slabs with dropped panels; where  $W$  is the sum of the dead and live load on a panel,  $b$  is half the lateral dimension of the panel measured from centre to centre of columns, and  $jd$  is the lever arm of the resisting couple at the section.

The calculation of what is commonly called punching shear may be made on the assumption of a uniform distribution over the section of the slab around the periphery of the column capital and also of a uniform distribution over the section of the slab around the

periphery of the dropped panel, using in each case an amount of vertical shear greater by 25 per cent. than the total vertical shear on the section under consideration.

#### WALLS AND OPENINGS.

Girders or beams should be constructed to carry walls and other concentrated loads which are in excess of the working capacity of the slab. Beams should also be provided in ease openings in the floor reduce the working strength of the slab below the required carrying capacity.

#### UNUSUAL PANELS.

The co-efficients, apportionments, and thickness recommended are for slabs which have several rows of panels in each direction, and in which the size of the panels is approximately the same. For structures having a width of one, two, or three panels, and also for slabs having panels of markedly different sizes, an analysis should be made of the moments developed in both slab and columns, and the values given herein modified accordingly. Slabs with panelled ceiling or with depressed panelling in the floor are to be considered as coming under the recommendations herein given.

#### BENDING MOMENTS IN COLUMNS.

Provision should be made in both wall columns and interior columns for the bending moment, which will be developed by unequally loaded panels, eccentric loading, or uneven spacing of columns. The amount of moment to be taken by a column will depend upon the relative stiffness of columns and slab, and computations may be made by rational methods, such as the principle of least work, or of slope and deflection. Generally, the larger part of the unequalised negative moment will be transmitted to the columns and the column should be designed to resist this bending moment. Special attention should be given to wall columns and corner columns.

#### OBITUARY.

The death from wounds received in action is announced of Mr. Edward Garratt, of the firm of Garratt and Simister, of Birmingham. Born in 1860, Mr. Garratt was educated at Wednesbury and Walsall, and articled to Messrs. Hickton and Turner, of the latter town. Going later to Birmingham, he worked in the office of Mr. Essex, and whilst there carried off the Pugin studentship of the Royal Institute of British Architects and the Birmingham Architectural Association Travelling Studentship. Subsequently, for Mr. B. T. Bat-ford, he made illustrations for a work upon the Tudor period by Messrs. Garner and Stratton. Mr. Garratt afterwards joined Mr. Simister in partnership, and the firm won several open competitions, including those for the Stoke Town Hall, buildings at Exeter, and the Coventry Council House. Mr. Garratt was serving at the Front with the Royal Garrison Artillery when killed.

#### PROFESSIONAL AND TRADE SOCIETIES.

**EDINBURGH COLLEGE OF ART.**—The influence of the war is again in evidence in the enrolments of the Edinburgh College of Art for the winter session, which opened last week. A considerable proportion of the younger students leave from time to time for the Army on attaining military age. The classes in the various departments, however, are being maintained as in former years. The facilities for evening study for apprentices and others are being made good use of. There is a large enrolment of women students. The impetus that the war has given to study and training for women is indicated by the difficulty which is being experienced in finding hostel accommodation, the principal hostels for women students in the city being at their full complement. Since the war commenced sixty-seven students and members of the staff of the college have been killed. One died of wounds received on active service, while fifty-four have been wounded. One student of the college is missing, three are prisoners, and one is interned in Germany.

## Our Office Table.

A reminder of how the difficulties of transportation in the mountainous region of British Columbia were overcome by the native Indians has recently been afforded by the fall of the famous suspension bridge across Hagwilget Canyon, near New Hazelton, B.C., which was the only structure of its kind in Western Canada. It was a striking attraction, especially to tourists. It had a span of 146 ft. and was 10 ft. wide. Planned by a native of the Hazelton country, and built under his supervision by scores of fellow-tribesmen, the true principle of the modern suspension bridge had been embodied in its construction. It was long an object of curiosity, and in numerous technical magazines illustrations of it had been printed. The structure was the third attempt to establish a permanent crossing over the Bulkley River, the first two having been swept away by high water. The third time success crowned the efforts of the Indians, and for many years this unique bridge, which swayed and rocked as one walked across, was used by the whites as well as natives. At the time they put the bridge together the Indians were absolutely without modern tools. They had neither nails, spikes, nor bolts. The collapse of the bridge was due to neglect.

Two thousand more houses are wanted in Bigginhead, according to those who know. The number of houses in the borough of ratable value up to £12 was 12,275; of ratable value between £12 and £20, 9,012—a total of 21,287. These figures, it is claimed, represented a percentage of about 78 of the total number of houses in the borough. Of the cheaper kind of house, 74 had been erected since 1911, and 915 of the dearer kind—altogether 989. Of the 153 demolished, 153 were of the cheaper and five of the dearer kind. The population in 1911 was estimated at 130,794, and now it was stated as 144,995, an increase of 14,199, according to the report of the Health Committee. The number of houses required is 1,248, but in order to be on the right side they are going to ask for 1,550 to be built. The report was adopted at last Wednesday's meeting of the council after a long discussion on some heavy votes of increases of salary to officials. Mr. J. H. Johnston, pointing out the need for working-class houses, maintained that the council's estimate of the number required was much too low. He suggested at least 600, which were wanted now, and 1,200 for the needs of the future. Mr. J. J. King criticised the attitude of the council when previous housing schemes were submitted, and said to carry the suggested proposals through would cost £100,000, if not more.

The Dundee Town Council held a long meeting last Wednesday on the housing question. An elaborate report was submitted in reply to the questions issued by the Local Government Board, showing the housing schemes prepared or in contemplation. It was estimated that the total cost would be £575,000, and it was calculated that the Government would give a grant in aid of 50 per cent. A series of criticisms was offered to the scheme. Bailie Kimmond said his view was that they would be perpetuating slums instead of curing them, and he added that it was quite appalling that those houses were not going to be built on a strictly business or economic basis. Bailie Archer said private enterprise had been and was being crushed out; and Mr. W. High said those houses would be put up at the expense of the majority. Mr. Crichton said if there was not an Imperial grant the rents would be such that the people could not pay. On the subject of the attitude of private enterprise to building, various members contended that private building had been stopped by repressive legislation, and it was decided in reply that the restrictions under the Finance Act of 1902 were withdrawn.

At the annual meeting of the Berwickshire Naturalists' Club Mr. T. B. Short said it seemed likely that a fine arched bridge, be-

longing to the thirteenth or the fourteenth century, would be found below the surface outside the Cowport Gate in Berwick town walls. He suggested that a small sum should be set aside for excavations. Such a bridge was marked in Steele's map of 1610 as crossing the moat there. Later, when tanks were made outside the walls for the accumulation of water for ice for the fisheries, the shallow arches probably became silted up with mud and the bridge was buried. It was decided to consider the matter of excavation and report to a future meeting of the club.

The Board of Trade have made an Order prohibiting the sale or purchase in the United Kingdom, from October 5 until further notice, of any teak logs, planks, boards, and decking, and lignum vite, except under licence or permit issued by or on behalf of the Board of Trade, but no licence or permit will be required for the purchase or sale of teak logs, planks, or boards where the aggregate value thereof purchased or sold does not exceed £50 per calendar month. All applications for a permit in connection with this Order should be addressed to the Controller of Timber Supplies, Caxton House, Tothill Street, Westminster, S.W.1.

Three public lectures, arranged in connection with the Chadwick Departments of Municipal Engineering and Hygiene and the Department of Town Planning, will be held at University College, London, as follows:—Thursday, October 18, at 5.30 p.m., "The Effect of the War on Municipal Engineering and Public Health," by Mr. H. Percy Boulnois, M.Inst.C.E.; chairman, Sir Maurice Fitzmaurice, C.M.G. Thursday, November 1, at 5.30 p.m., "Sanitary Work in the Army," by Major Arthur J. Martin; chairman, the Hon. Sir John McCall, M.D., LL.D., Agent-General for Tasmania. Thursday, November 15, at 5.30 p.m., "Some General Aspects of Town Planning after the War," by Professor S. D. Adshad, F.R.I.B.A. Applications for tickets, accompanied by a stamped addressed envelope, should be addressed to the secretary, University College London (Gower Street, W.C.1.).

A preliminary report on the mineral production of Canada for the calendar year 1916 has been issued by the Department of Mines. In a general way it may be said that Canada's mineral production for the year has increased, though two or three decreases are shown, one of the most marked of which is stone, about 9 per cent.; also sand and gravel, about 8 per cent., and cement, about 7 per cent., thus indicating the slack condition of the building trades. Pig iron, lead, and silver also show a decrease in quantities, but, with the exception of pig iron, an increase in value, owing to improved market conditions.

A meeting of the National Federation of Housebuilders was held at the Queen's Hotel, Birmingham, last Friday, under the presidency of Mr. Oldham (Manchester). Delegates were present from London, Liverpool, Manchester, Nottingham, Derby, Bradford, Birkenhead, Leeds, and other centres. The housing problem from a national point of view was fully discussed. The president said that most of the large cities throughout the country had formed local associations, and he was delighted to know that Birmingham had been one of the first to form such an association. He desired to point out the dangerous extravagance which was bound to ensue if public authorities were allowed to embark upon large housing schemes. The great shortage of houses throughout the country was not due to the failure of private enterprise to supply the needs, but was due chiefly to the legislation of 1909-10, which rendered impossible the building of houses on an economic basis. The meeting was also addressed by Mr. Sadler (Nottingham), Mr. Costain (Liverpool), and Mr. Squires (Nottingham), a member of the House of Commons' Technical Committee on Housing. At a subsequent meeting of the Birmingham Association the following resolution was passed: "That in the opinion of this meeting, if the Finance Act, 1909-10, which has been the chief cause of the present shortage of artisans' dwellings in the country, is repealed,



the freedom of contract between landlord and tenant restored, and the country is assured there will be no further vexatious legislation affecting land and house property, thereby restoring the confidence of the investing public in this class of security, private enterprise can and will—providing it receives the same facilities that must be given to other agencies—successfully, and more economically than municipal bodies, provide working-class dwellings in the future as they have done in the past."

On Thursday last, in moving the minutes of the Health Committee, Councillor Edward Thomas recommended the Council to agree to the preparation of a scheme for 250 working-class houses to be erected after the war subject to Government financial assistance. Councillor Thomas showed that, apart from displacements which would follow the demolition or the breaking through of back-to-back houses, there is now a shortage of 763 houses in Rochdale, due to deficiency in building. During the decade 1902-11 the average number of houses built per year was 232; during the period 1911-17 the average was 155, a yearly deficit of 127. Alderman Dunning said he did not think much of the scheme. He would leave the building of houses to the competition of private enterprise and encourage builders to complete something which was satisfactory. Members of the Council were amateurs as regarded house building. Planning of streets, the building of houses and maternity centres, and school nurses would have no effect unless the desire could be produced on the part of parents to keep clean and healthy houses and to look after their children better than some were now doing. The minutes were passed.

The report of the Royal Commission on the Housing of the Industrial Population of Scotland, issued last Friday night as a Blue-book, says: "The insistent demand for better accommodation after three years of war can no longer be safely disregarded, and is justified by the appalling state of congestion among all the labouring classes, rural and urban. At least 50 per cent. of one-roomed houses and 15 per cent. of two-roomed houses ought to be replaced by new erections, and if overcrowding was taken to mean that of three persons per room, it would be necessary to displace more than 24,000 of the population. The report enumerates a long list of past obstacles to reform, and in this connection blames both commercial and municipal enterprise. The Commissioners are satisfied that in the present unique disorganisation of affairs the State alone, acting through local authorities, can meet the present discontent. The Commissioners emphasise the importance of contemplating future reform, that the Scottish Ministry of Health should be independent of the English Ministry of Health and that the central authority for housing and public health should be elevated into a principal department of the State.

TRADE NOTES.

Mr. Arthur T. Bolton, F.R.I.B.A., has moved his offices from 28, Victoria Street, Westminster, S.W., to 10, Lincoln's Inn Fields, adjoining Sir John Seame's Museum, of which he has recently been appointed curator.

Mr. P. A. Benn, surveyor to the city of Lichfield, has been appointed, temporarily, as surveyor to the Lichfield R.D.C. until three months after the conclusion of the war.

Flushing Parish Church, Cornwall, erected in 1842, has recently received a welcome addition in the form of a sculptured panel in stone, replacing a plain glass tympanum, with a carved figure in high relief, representing "Christ seated in Majesty." The statue is from the studios of Messrs. Harry Hems and Sons, of Exeter, who, at the same time, carried out the work of placing a stained glass window in the east end of the church from a design by Burne Jones, and from the studios of Messrs. Morris, of Merton Abbey. Messrs. Hems have also placed under a canopy outside the west door an alabaster figure of St. George slaying the Dragon, which was found in the wall of a farmhouse by the vicar, and which is believed by competent authorities to be work of the fifteenth century.

CHIPS.

The death is announced of Mr. John Munster, building inspector to the Preston Corporation.

The Swaffham R.D.C. have appointed Mr. T. Wrigley, of Hazlegrave, to the position of temporary surveyor and sanitary inspector.

The Nieuwe Kerk, at The Hague, where the Dutch Sovereigns take the oath, reputed to be the finest Protestant church in Holland, has been severely damaged by fire.

A bishop's throne in oak has been presented to St. Michael and All Angels' Church, Bedford Park, by Mr. and Mrs. Robinson, in memory of their son, Lieutenant Robinson, killed in action.

Next Saturday a memorial tablet will be unveiled at St. Margaret's Church, Brighton, to the late Major Bloomfield. He served throughout the Crimean War, and was a pioneer in the use of bicycles for military purposes.

A memorial to the men of the 1st Training Battalion, Australian Imperial Force, has been erected at Durrington, near Amesbury. It takes the form of a massive obelisk and bases in rugged red Scotch granite, standing altogether 15 ft. high.

A memorial tablet to the late Second Lieutenant Alexander Buller Turner, V.C., has been unveiled in Thatham Parish Church. It was dedicated by the Rev. the Hon. Reginald Yardo-Buller, and a number of officers and N.C.O.s of the Royal Berks Regiment attended the service.

The new town hall at Wallasey, now being used as a military hospital, is evidently not to be completed at a less cost than £100,000. The building contract amounts to £82,142, of which £72,595 has already been paid, and the furniture, fittings, and equipment is to cost £20,050, instead of the pre-war estimate of £15,765.

Mr. William Harvey, of The Grove, Roundhay, Leeds, has decided to present to the nation his collection of old Dutch and Flemish masters, which includes pictures by Rubens, Van Dyke, and other great artists. Upwards of fifty pictures are comprised in the collection. At present they are in the Tate Gallery, and it is the donor's desire that the works shall be seen all over the country, as well as in London.

The trustees of Columbia University, according to the *Times*' New York correspondent, have expelled two members of the faculty—Professor Henry J. L. Dana and Dr. J. McKeen Cattell—whose disloyal attitude was "doing grave injustice to the institution." The action of the trustees was taken after the president of the University, Mr. Nicholas Murray Butler, had proclaimed "a last and only warning to any among us not of whole heart and mind and strength committed to fight with us to make the world safe for democracy."

Mr. George William Rowley, of Philip Lane, Tottenham, builder, who died on September 15, has left property of the gross value of £20,825. The testator gave £100, the household and personal effects, the use of his residence, and £400 a year to his wife; £100 a year to each of his children while minors, and £200 a year on their attaining twenty-one. The residuum of the property is to accumulate until all the charges are paid off, when one-half of the income is to be paid to his wife, and the ultimate residue divided between his children.

On Saturday week the memorial to the late Mr. Walter Grant MacPherson, M.B.C.M., Edinburgh, who for close on thirty years was a medical practitioner in Bothwell and district, was unveiled. The memorial occupies a commanding site at the extreme end of the village, and consists of a rustic column of Cretown granite, twelve feet in height, erected on a double base. In the centre of the western or front exposure is a bronze medal-like likeness of the late doctor, and a thistle branch entwines the upper part of the column. A panel in the lower base bears the inscription.

At the Dudley Town Council meeting last week Mr. Ballard, referring to the proposed new technical school, pointed out that it was intended to purchase from Lord Dudley 8,559 square yards, at 8s. per square yard—namely, £53,459. He considered that the price to be paid was altogether too much. Mr. Snellie (chairman of the Education Committee) said every inch of ground was made with Lord Dudley's agent to get the new site at as low a price as possible, and that half of the cost of the site was to be borne by Staffordshire County Council. Ultimately the recommendation of the Public Works Committee to purchase the site for the price named was adopted.

TO ARMS!

COUNTY OF LONDON VOLUNTEER ENGINEERS (FIELD COMPANIES).

Headquarters, Balderton Street, Oxford Street, W.1. ORDERS FOR THE WEEK BY LIEUT. COLONEL C. B. CLAY, V.D., COMMANDING.

OFFICER FOR THE WEEK—Sec. Lieut. E. A. Clifton.

NEXT FOR DUTY.—Sec. Lieut. C. E. Campbell. PROMOTIONS, REVERSALS, Etc.—Capt. Insay, W.E. to be Sergeant; 291 A. Cpl. Brooks, J.W. reverts to ranks. 120 Sapper Robinson, T.W. to be Corporal. All in No. 3 Coy. Dated 29-7-17. 40 Butler and A. Cpl. St. George, A. (Ban) to be Corporal. 118 A. Cpl. Gerry, S.H. to be Corporal, and 132 Sapper Jackson, A.E. to be Corporal. Both in No. 2 Coy. Dated 6-10-17.

MONDAY, OCT. 15.—Drill and Elementary Bridge Construction for No. 3 Coy. Left-hill Coy., 6.30. Signalling Section, 6.30. Recruits' Drill, 6.30.

TUESDAY, OCT. 16.—Physical Drill and Bayonet Fighting, 7.30.

WEDNESDAY, OCT. 17.—Drill and Elementary Bridge Construction for No. 1 Coy. 6.30.

THURSDAY, OCT. 18.—Drill and Elementary Bridge Construction for No. 2 Coy., 6. Signalling Section, 6.30. Ammunition Section, 6.30.

FRIDAY, OCT. 19.—Drill and Elementary Bridge Construction for No. 3 Coy. Right-hill Coy., 6.30.

SATURDAY, OCT. 20.—Commandant's Parade for Route March and Drill. Parade at Headquarters 2.45 pm. Uniform, A and B. Officers and Men are reminded that one Route March per month is compulsory.

MUSKETRY.—The Range at Belvedere Road will be open every Tuesday, Wednesday, and Thursday evenings from 6.30 to 9.0. N.C.O.s and men who have signed the "A" and "B" agreements are required to attend during this month to reclassify in order to enable the Corps to obtain the capitation award. Proficiency will be given to these men in firing. This does not apply to those who hold the proficiency badge.

ARMLETS.—The new issue armlets can now be obtained at Headquarters on every enrolled member MUST obtain without delay. At the same time all old red armlets must be returned. Armlets must be worn when attending drills in plain clothes.

MECHANICAL EXAMINATION.—The Medical Officer will attend at Headquarters for this purpose every Thursday at 6.

By order, MACLEOD YEARSLEY, Capt. and Adjutant. October 13, 1917.

The funeral took place on Friday last of the late Mr. Edward Wiggins, who died at his residence, High Street, Keynsham, on the previous Tuesday. Mr. Wiggins was born on the 12th of March 1849, and was well known for many years carried on the business of builder and decorator. On September 27 Mr. Wiggins was at work in the Bristol Hill, Keynsham. He was going up a ladder placed by the side of a house, when, falling at the top, a rung gave way, and in falling the ladder broke and Mr. Wiggins fell to the ground.

Mr. Thomas Hellyar Foord, of The Grange, Botley, Southampton, and of Rochester, who died on March 12, aged 95, left estate of the gross value of £345,565, including personality of the net value of £216,903, and he has bequeathed £10,000 to St. Bartholomew's Hospital, Rochester; £2,000 for the restoration of the south choir aisle of Rochester Cathedral and other improvements; furniture, pictures, plate, etc., to the corporation of Rochester for their museum, and a sum of £10,000 for a building to contain them. The residue, which will probably amount to nearly £250,000, is left for the building and endowment of almshouses for poor and infirm persons of Rochester, to be named "The Foord Almshouses."

At a meeting of the special committee on the appointment of a city engineer and surveyor of Cardiff, the vacancy for which arose through the death of Mr. William Harper, the Press wrote informed that it was moved, seconded, and resolved unanimously "that this committee, whilst appreciating Mr. F. M. Greenhill's (the deputy city engineer) long and honourable services to the corporation, regret that his appointment as a member of the special committee to the office of city engineer and surveyor." A deputation was appointed to visit the boroughs now served by the following applicants:—Mr. S. E. Burgess, M.Inst.C.E., borough engineer of North Shields; Mr. Ernest John Elford, M.Inst.C.E., borough engineer of Southdown; Mr. Frank Wilkinson, Assoc. M.Inst.C.E., borough engineer of Deptford; Mr. Francis Wood, M.Inst.C.E., borough engineer of Fulham; Mr. James Lord, M.Inst.C.E., borough engineer of Halifax; Mr. Edward Llewellyn Morgan, Assoc. M.Inst.C.E., borough engineer of Bolton. The deputation will in the course report to the special committee.

**OGILVIE & CO.**

Telephone DALTON 3565.  
Many cranes connected with the late firm of H. LANSFELLES & CO., of Buxhill Row.

Mildmay Avenue, ISLINGTON, N.  
EXPERTS IN HIGH-CLASS JOINERY.  
ALTERATIONS & DECORATIONS. ESTIMATES FREE.

FOR **Olivers' Seasoned Hardwoods,**

APPLY TO—  
**WM. OLIVER & SONS, Ltd.,**  
120, Buxhill Row, London, E.C.

**TENDERS.**

\* Correspondents would in all cases oblige by giving the addresses of the parties tendering—any rate of the accepted tender: it adds to the value of the information.

**BRANDON AND BRYMONTILES.**—For constructing two reinforced concrete dosing chambers and carrying troughs at Littleham Sewage Works, for the urban district council.

Walton Bros., Crook, Durham... 195 10 0  
(Accepted.)

**BUILDING WORKS FOR H.M. OFFICE OF WORKS.**—Albion's Supplies Commission, Queen's House, Kensington, partitions, BURGESS and Hill, Ltd., South Lambeth, S.E.; London district, erection of semi-permanent lifts, W. Lawrence and Sons, Ltd., London, E.C.; Metropolitan Marine Office, erection of temporary building, G. E. Walsh and Sons, Ltd., Haymarket, S.W.; public offices extension, extension of temporary offices in Circular Court, Thomas and Edge, Woodwich; War Office (R.F.C.), erection of temporary building, Ford and Walton, Ltd., Kilburn; War Office (I.R.E.T.), Horse Guards, erection of temporary building, Ford and Walton, Ltd., Kilburn.

**FRESHFISH.**—For erection of sub-structure and other works in connection with the erection of a small-pox hospital, and consisting of foundation work, drainage, fencing, excavation for water mains, etc., near Andrews Lane, Chesham, for the urban district council. Mr. J. E. Sharpe, engineer and surveyor.—  
C. J. Newby and Bros., Enfield... 41,820 0 0  
Jennings and Grenfell, Waltham

Cross... 1,450 0 0  
Humphreys, Ltd., Knightsbridge... 1,500 8 10  
P. K. Paul, Waltham Abbey... 1,313 0 0  
(Accepted.)

**ROTFORD.**—For sinking a well at west end of laundry, for the guardians.—  
W. and J. Cooper... 439 8 6  
(Accepted.)

**ROTHAMPTON.**—For repairs at the town quay and Royal Pier, for the Southampton Harbour Board.—Branzer and Son, exterior painting of Royal Pier, £65; painting at the board's offices and various other parts of the town quay, £270 10s. Accepted.

**STAMFORD.**—For painting the infirmary block, etc., at the union workhouse, for the guardians, Messrs. Traylen and Son, 16, Broad Street, Stamford, Architects.—  
Hart and Son, Stamford... 57 5 0  
Hart and Son, Stamford... 52 0 0  
(No tender yet accepted.)

Mr. Henry Solomon, A.R.I.B.A., of Highfield, Oak Street, Shrewsbury, who has served as a sapper in the South Midland Royal Engineers, has been gazetted 2nd lieutenant in the same corps.

The history and architecture of St. Bartholomew's Church, E.C.4, will be explained in lectures on the last two Saturdays in October (20th and 27th) at 2.30 p.m. An organ recital will be given each day at 2 o'clock. The crypt and cloister can be visited without charge, but a collection will be made for the restoration fund.

The Belgian committee, which, as a proof of gratitude to the British nation for the hospitality the Belgian people have met with in the country during the war, is arranging for the erection of a memorial in London, has received from the King and Queen of the Belgians a donation of £400. From the Belgian General Headquarters the sum of £1,000, collected among the Belgian soldiers at the front, has been received.

The Gainsborough Health Committee recommend that the council should proceed to formulate a scheme for the erection of workmen's dwellings. The clerk produced statistics showing that houses were badly needed and that the least number that would be required after the war would be 500. It was decided that a scheme be prepared for the erection of 150 workmen's dwellings, on the assumption that financial facilities would be afforded by the Government.

**LIST OF TENDERS OPEN.**

**BUILDINGS.**

**Oct. 5-11.** Rein-stating and improving the steward's stores at the Infirmary, Lower Road, Rochester, S.E., according to plan and specification of Mr. A. H. Newman, F.R.I.B.A., etc.—For the Borough Council, and of Guardians.—E. F. Fenton, Clerk, 59, Tooley Street, Southwark, E.C.

**Oct. 13.** Construction of an entrance to the college in Ferdinand Avenue, in lieu of the former entrance on Western Road, in accordance with plans of J. P. M'Allen, C.E., M.R.I.C.A., South Isle. For the Building Committee, University College, Cork, J. Downey, Secretary.

**Oct. 15.** Structural alterations at Wrexham Union Workhouse.—For the guardians.—J. G. Lowe, Acting Clerk, 10, Temple Row, Wrexham, E.C.

**ENGINEERING.**

**Oct. 16.** Supplying and fitting complete steam power machinery for the laundry at the Workhouse, Wallingford.—For the Guardians.—G. F. Slade, Clerk, 7, St. Martin's Street, Wallingford, Berks.

**March 30.**—The Acting British Consul at Santiago reports that a decree has been issued calling for tenders for the improvement of the port of Antofagasta (Chile). By the terms of this decree the amount to be expended on this work is £1,700,000. Details may be obtained from the Port Commission Offices in Santiago, and copies are expected to be received shortly at the offices of the Chilean Legation in London, 22, Grosvenor Square, W.1. Tenders will be received up to 3 p.m. on March 30 by the Minister of Finance, Santiago.

**MISCELLANEOUS.**

**Oct. 27.**—The Midland Great Western Railway of Ireland Co. invite tenders for complete renewal, in reinforced concrete and steel, of Newcomen Bridge, North Strand Road, Dublin, carrying the North Strand Road over the Midland Great Western Railway running line; or, alternatively, for the construction of the reinforced concrete slabs, beams, and columns in connection with this work, erection to be carried out by the railway company.—P. A. Hay, Secretary, Broadstone Terminus, Dublin.

**ROADS AND STREETS.**

**Oct. 22.** Private street works at Gelynos Road, Gelynos Avenue, and Penylan Avenue, Argool.—For the Bedwelly Urban District Council.—T. J. Thomas, Clerk, Bargoed.

**SANITARY.**

**Oct. 22.** Construction of percolating filters, humus tanks, sludge beds, mains, alterations to the existing works, and the supply of filtering media.—For the Hayes Urban District Council.—D. C. Eddle, Engineer and Surveyor, Council Offices, Grange Road, Hayes.

**TO CORRESPONDENTS.**

We do not hold ourselves responsible for the opinions of our correspondents (unless they are shown to be drawn up as briefly as possible, as there are many claimants upon the space allotted to correspondents.

It is particularly requested that all drawings and all communications respecting illustrations or literary matter, books for review, etc., should be addressed to the Editor of the BUILDING NEWS, Effingham House, 1, Arundel Street, Strand, W.C.2, and not to members of the staff by name. Delay is not infrequently otherwise caused. All drawings and other communications are sent at contributors' risks, and the Editor will not undertake to pay for, or be liable for, unsought contributions.

When favouring us with drawings or photographs, architects are asked kindly to state how long the building has been erected. It does neither their nor us much good to illustrate buildings which have been some time executed, except under special circumstances.

\* Drawings of selected competition designs, important public and private buildings, details of old and new work and good sketches are always welcome, and for such no charge is made for insertion. Of more commonplace subjects, small churches, chapels, houses, etc.—we have usually far more sent than we can insert, but are glad to do so whenever permits, on mutually advantageous terms, which may be ascertained on application.

Telephone: Gerrard 1291.  
Telegrams: "Timeserver, Estrand, London."

**TERMS OF SUBSCRIPTION.**

Twenty-six shillings per annum (post free) for any part of the United Kingdom; thirteen shillings for six months; for the United States, £1 10s. (or \$7 50c. post free) to France or Belgium, £2 10s. (or \$12 to India, £1 10s. To any of the Australasian Colonies, or New Zealand, to the Cape, the West Indies, or Natal, £1 10s.

\* Our Direct Subscription Agents for Australia are Messrs. E. T. Ribbleswhite and Co., Printers and Publishers, 19, York Chambers, 105, Liverpool Street, Sydney, New South Wales; for Japan, The Maruzen

Co., Ltd., 11-16, Nishonashi Tori Sanchoe, Tokyo, who will receive Subscriptions at £1 10s. per annum on our account. Copies of the paper will be sent by us direct to the subscribers' address.

\* The special rate to Canada is £1 10s. = \$7 50c. for 12 months, and 10s.=53 66c. six months. Our Direct Subscription Agents for Canada are Messrs. Sells, Ltd., 202, St. Lawrence Buildings, McGill Street, Montreal, who will receive Subscriptions, £1 10s. per annum on our account. Cheques and Post Office Orders to be made payable to THE STRAND NEWSPAPER COMPANY, LIMITED, and crossed London County and Westminster Bank.

**ADVERTISEMENTS CHARGES.**

The charge for Competition and Contract Advertisements, Public Companies, and all official advertisements is 1s. per line of Eight Words, the first line counting as two, the minimum charge being 5s. for four lines.

The charge for Auctions, Land Sales, and Miscellaneous and Trade Advertisements (except Situation Advertisements) is 6d. per line of Eight Words (the first line counting as two), the minimum charge being 4s. 6d. for 30 words. Special terms for series of insertions will be agreed on after an application to the Publisher.

**SITUATIONS WANTED AND PARTNERSHIPS.**  
The charge for advertisements for "Situations Wanted" and "Partnerships" is One Shilling for Twenty-four Words, and Sixpence for every Eight Words after.

**SITUATIONS VACANT.**  
The charge for advertisements for "Situations Vacant" is Two Shillings and Sixpence for Twenty-four Words, and Sixpence for every Eight Words after. All Situation Advertisements must be prepaid.

**REPLIES TO ADVERTISEMENTS.**

Reply to advertisements can be received at the Office, Effingham House, 1, Arundel Street, Strand, W.C.2, free of charge, up to Tuesday. Fresh copies of advertisements and alterations or stop orders for serial advertisements must reach the office by first post on Monday to secure attention.

**NOTICE.**

Bound copies of Vol. XXII. are now ready, and should be ordered early (price 12s. each, by post 12s. 10d.), as only a limited number are done up. A few bound volumes of Vols. XXIX., XL., XLI., XLII., XLIII., XLIV., XLV., XLVI., XLVII., XLVIII., XLIX., L., LXXI., LXXII., LXXIII., LXXIV., LXXV., LXXVI., LXXVII., LXXVIII., LXXIX., LXXX., LXXXI., LXXXII., LXXXIII., LXXXIV., LXXXV., LXXXVI., LXXXVII., LXXXVIII., LXXXIX., XC., XCI., XCII., XCIII., XCIV., XCV., XCVI., XCVII., XCVIII., XCIX., C., CI., CII., CIII., CIV., CV., CVI., CVII., CVIII., CXC., and CXI., may still be obtained at the same price; all other bound volumes are out of print.

Rates for Trade Advertisements on front page and special and other positions can be obtained on application to the Publisher.  
RECEIVED.—W. E. F. and Co.—W. E. F. Co.—F. E. C. Co., Ltd.—W. B. L. H.—C. and Co.—A. E. and Co.  
M. S. A.—No.  
L.T.—C1.—Please send.  
D. H. F. Sorry, cannot spare room.  
C. H. R.—We gave several articles on the best means of protecting buildings from bombs when the raids first commenced. See our issues of September 29, 1916, and October 13, 1915. The last-mentioned dealt especially with the influence of aerial warfare on architecture, which, as you suggest, is likely to be considerable. The next great war will be mainly in the air and under the sea.

The death is announced of wounds, on the 3rd inst., of Charles John Lionel, Lieut., R.F.A., dearly-loved son of Mr. and Mrs. F. M. Lutyns, 3, Giltton Road, South Kensington, and a nephew of Mr. Edwin L. Lutyns, A.R.A., F.N.A., F.R.I.B.A.

From a report of the Essex County Council it appears that the staff of the architectural department of the county is insufficient to deal with the present work, and it is recommended that Mr. Stephen Ayling be engaged as a temporary assistant at a salary of £5 10s. a week.

The death is announced of Signor Monteverde, the celebrated Italian sculptor, and member of the Senate. Among his most notable works are "A Group of Children," in the Palazzo Bianco at Genoa; "Madonna and Child," on the Campo Santeo; and a statue of Victor Emmanuel, which stands in the square in the route of Bologna.

# THE BUILDING NEWS AND ENGINEERING JOURNAL.

**Edinburgh House,**

Currente Calamo .. .. .	301
The South African Military Hospital, Richmond Park, Surrey .. .. .	302
Architecture and the Future .. .. .	303
Our Illustrations .. .. .	319
Professional and Trade Societies .. .. .	319
Trade Notes .. .. .	319
Our Office Table .. .. .	319
Tenders .. .. .	320

**CONTENTS.**

To Arms! .. .. .	320
To Correspondents .. .. .	320
List of Tenders Open .. .. .	vii.
Chips .. .. .	vii.
Latest Prices .. .. .	viii.

**OUR ILLUSTRATIONS.**

The South African Military Hospital, Richmond Park, Surrey, Mr. Richard J. Allison, A.R.I.B.A.
--

**Strand, W.C.2.**

(H.M. Office of Works), Architect. Lieut.-Col. E. N. Thornton, S.A.M.C., Commanding Officer in Charge. Mr. McFerran (Chief Engineer, H.M. Office of Works), Engineer. A general plan of the buildings, and including a block plan. View of main entrance; general view from S.W.; open-air shelter and day-room. Interior of one "38-Bed Ward"; the Operating Theatre; the Central Day-room and the "Victoria Falls" Bath Ward.

## Currente Calamo.

Mr. John B. Gass's thoughtful presidential address last Wednesday to the Manchester Society of Architects, which we give on another page, will, we trust, receive the careful perusal it deserves. His protest against the stupid response by the War Office to the patriotic eagerness of architects to assist the Government to the fullest extent in connection with the war is but too well warranted. Even now the same reluctance to employ architects in a proper fashion is costing the country millions, and the work is being done badly. Nothing, we suppose, will stop this, but it is well the whole profession should bear it in mind and should lose no opportunity of riveting public attention thereto when the next general election comes, and meanwhile at the conferences of the allied societies which are the fruit of the timely action taken by the Manchester society. Mr. Gass's remarks on the necessity for the right appreciation of the real influences that dominate their art, and the part the education of the architect must play in the fostering of a cultivated mind of our coming democracy are very much to the point; and his clear-sighted recognition that National Registration is really the natural outcome of our own demand for the recognition by the State of tested fitness on the part of those entrusted with the erection of our buildings is cogent and timely. We are less inclined, we confess, to agree with his somewhat pessimistic remarks about the future of lady architects. At any rate, when so many Associates of the Institute see no inducement to proceed to the Fellowship it is no proof of their disability, that the ladies do not think it worth their while. With regard to housing, we need hardly say we entirely share Mr. Gass's distrust of municipal enterprise, and that the instances he adduces of municipal failure justify them. Our own conviction is that, as in the past, the municipal authorities will do very little, and that badly, and without proper architectural help.

The Housing of the Working Classes Committee of the London County Council, in their report submitted yesterday, refer to the desirability of holding a conference

of housing authorities in Greater London on the question of proceeding, immediately after the conclusion of peace, with the provision of additional housing accommodation, and state that they are "not convinced that at the present time action would best be facilitated by a conference of representatives of certain public authorities." The report continues:—"Much useful information is already available as the result of inquiries made in the past into the various aspects of the housing question, and, as the Council is aware, these inquiries have not been confined to London only, but important data have been obtained in recent years bearing on the amount of accommodation provided and demolished in contiguous areas. Arrangements are accordingly being made under our direction for the particulars to be brought up to date as far as possible and for a conspectus of the efforts made to be prepared, so that at the proper time we may be in a better position to advise the Council. Similar preparation on the part of adjacent authorities, as contemplated by the Local Government Board, will enable those concerned to obtain a clearer conception of the position as it will be affected by the war, and greater value would thus attach to a conference at a later date." Any practicable proposal for dealing with the housing problem would, we feel sure, meet with the entire sympathy of the Council in common with other authorities concerned, but in the absence of a full knowledge of the facts and prevailing conditions it is obviously impossible to submit any concrete proposal which can conveniently form the basis of discussion previous to determining a line of action. The position of the Council is, fortunately, exceptional on account of its wide experience extending over a considerable number of years. Its responsibilities are such that it necessarily possesses a knowledge of conditions affecting London as a whole, and its work has in many ways formed the complement of the work of the local authorities whose activities are restricted and confined within narrower limits. The Local Government Board recognises this view, and has invited the assistance of the Council in taking a comprehensive survey of the position so far as London is concerned. We hope that may be available

while the present superintending architect is still in the service of the County Council, whose activities, supported as they have been by the Council, have done more to solve the problem than those of any other authority. It should also be borne in mind that, apart from the operations undertaken within the county under Parts I, II, and III, of the Housing of the Working Classes Act, 1890, a considerable area of land outside the county has been purchased by the Council for housing purposes and may be developed when conditions permit.

We suppose Dr. Addison's appointment of a Committee to consider supplies of materials after the war may be regarded as one of his first steps as Minister of Reconstruction. Let us hope it will be more fruitful than his own activities in connection with the Insurance Act. Evidently in the transition to peace conditions one of the most urgent problems will be the discovery and the transport of raw materials to make good the ravages and overtake the arrears of war. The needs of the Allies will necessarily have a first claim on their own resources, which, as regards most of the essentials, are likely to be sufficient. Our own accumulated shortage of cottages is estimated at over a quarter of a million, and some say that the Government have in contemplation a scheme for the provision of double that number. That in itself raises several difficult problems of material, especially of wood, for it will be difficult, in the first years after the war, to find the necessary shipping, and the unseasoned wood which has been used for army huts will not be suitable unless some means can be found of maturing it artificially. In railway construction there are corresponding arrears. The same is true of many branches of engineering. For such materials as have to be obtained in neutral countries the Central Powers will be keen competitors. Indeed, there are signs that they have already been endeavouring to extend their grasp over certain essentials, and even in Allied countries they have been at work through intermediaries. The Materials Committee will have a task of the utmost complexity, and will do well to note the lessons of the war, which, though bitter,

have been salutary. Still, latent possibilities of home production, hardly suspected in pre-war times, have revealed themselves, and these ought to be rapidly developed under the stress of post-war conditions.

A project that will be discussed at the forthcoming meeting at the Institution of Civil Engineers, on the 25th inst., has our hearty endorsement, tending, as we believe it will, to the better co-ordination of engineering training by means of the formation of a central organisation of engineers and educationists. Although engineering training has made great strides in the last twenty years, mainly owing to the good influence of the more important engineering institutes, the link between the industry and education is not as close as it should be. The scheme suggested includes the reinstatement of the best ideals of the old system of apprenticeship, and the setting up by engineering firms of a central bureau to extend the valuable influence of the engineering institutions, the universities, and the technical schools. The discussion is looked forward to with keen interest by all who regard engineering as one of the greatest of our staple industries. The honorary organisers of the movement are Mr. A. P. M. Fleming (British Westinghouse Company, Trafford Park, Manchester) and Mr. A. E. Berriman (chief engineer, Daimler Company, Coventry).

A building known to all Londoners and of special local interest has been saved by Lord Leverhulme in buying Flask House, which adjoins his Hampstead residence. It is to be used temporarily as a place of recreation for wounded soldiers, and afterwards converted into a local museum. Flask House was formerly the Upper First Tavern, and was the summer resort of the Kitcat Club, the famous Whig organisation which flourished at the beginning of the eighteenth century. The members, we are told, used "to sip their ale under the old nut-tree," which was still flourishing fifty years ago. By the middle of the eighteenth century Flask House had become a private residence, and among its occupants was George Stevens, the Shakespearean scholar. The house is made by Richard Sm in the scene of some of the episodes in "Clarissa Harlowe." Thither Lovelace took the heroine for a drive, and there she subsequently found temporary shelter when she escaped from the clutches of his accomplices. It would have been a misfortune if a house typical, in spite of its alterations, of the domestic architecture of fully two hundred years ago had been forced to give place to modern villas or blocks of flats.

Possibly owing to the war, and consequent paper shortage, the *Transactions and Proceedings* of the Birmingham Architectural Society for the first year name their appearance in a new form, the large quarto size being abandoned for octavo—a change in every way more con-

venient both for book-shelf and reading. Apart from "notes" read at the open meeting, only three papers are reproduced, but these are of interest, notably, Mr. Herbert New's contribution on Birmingham Street Names, which throws a good deal of light on how many of the thoroughfares derived their names, and how they have been altered from time to time; and not always for the better. A list is given of all the books, plans, and maps which the author has consulted, together with a facsimile of Westley's plan of the town in 1731. Mr. Jethro A. Cassin contributes a very readable paper on Ancient Bridges, Fords, and Ferries in the district, and Mr. F. T. S. Houghton for an excellent account of Low Side Windows in Worcestershire Churches, both papers being well illustrated. The committee record a slight reduction in the membership, which is now 174.

In the *Bulletin des Amis de la République*, a little paper printed especially for circulation in the army zone, appears a request from some of the poilus for a lesson in architecture. One of them writes: "In the villages or small towns where we are quartered we often discuss the style of the church or town hall of the place, but we discuss it in ignorance. Could the *Bulletin* not give us some of the essential principles of our architecture?" In response to such appeals M. Roger Miles publishes an article which in its clear analysis and brevity is an example to all teachers of the subject. It is the first of a series, and discusses the columns and arches of the Roman period with illustrations that make it easy for the soldier in the presence of buildings of this type to recognise at once the principal characteristics. Possibly the fact that the reader is a soldier applying what he has read to the object before him, testing the value of his lesson on the spot, makes it easier for the instructor to write tersely, sympathetically, and entertainingly of a subject from which too often the life is pressed out by a mass of purely technical detail.

Richmond Town Council has decided, in response to the Local Government Board's appeal, to build twenty-five houses for the working classes after the war, a proposal to make the number fifty being defeated.

The Mayor of Oxford last Wednesday unveiled a memorial tablet to Roger Bacon. It has been erected on a part of the old city wall in Oxford, on a site which is closely adjacent to that of the Greyfriars Monastery, where Roger Bacon lived and studied. There was a representative gathering of the University and citizens.

In the Heathfield (Sussex) Parish Church the Bishop of Lewes (Dr. Jones) has dedicated a stained glass window in the memory of the late Lieutenant-Colonel William Claudius Casson, D.S.O., the elder son of Mr. and Mrs. William Henry Ash, of Fernbank, Heathfield, who died of wounds received in action on September 15, 1916.

Lieutenant John Barber, Essex Regiment, attached R.E., who was killed on September 27, aged 36, was the eldest son of Mr. J. Patton Barber, M. Inst. C.E., borough engineer of Kingston. He was educated at Epsom Park College and at Queen Elizabeth's Grammar School, High Barnet. When war broke out he was a member of the Artists' Rifles, with seven years' efficiency, and in 1915 he was granted a commission in the Essex Regiment.

## THE SOUTH AFRICAN MILITARY HOSPITAL, RICHMOND PARK, SURREY.

(WITH ILLUSTRATIONS.)

This capacious and admirably arranged military hospital stands just within the park-gates on the top of Richmond Hill, not far to the left from the "Star and Garter." In a beautiful setting, its nicely retired, well-enclosed site comprises twelve acres. This spot was chosen not only on account of its handsomely wooded screened position, at so high an altitude, for health and air, but because there happened to be an existing drainage easement belonging to the town council close by, and fully adequate for the hospital's needs. Besides this advantage, the importance of an available direct approach from the rear, facing Cambridger Road, for motor ambulances and the transport of supplies settled the position. The actual floor area of the hospital is about two and a-half acres. The entire cost of the scheme was provided by the "South African Hospital and Comforts Fund." When completed, the institution was at once placed under the control of the War Office Administration Department. The commanding officer in charge is Lieut.-Colonel E. N. Thornton, S.A.M.C. The staff is almost entirely South African, including several voluntary laity workers who came over from South Africa specially to give their services in this hospital. Everything is done to enable the wounded soldiers to feel at home during their enforced stay at Richmond. All the men are South Africans, with a sprinkling of Imperialists. The corridors and patients' departments of the hospital are designated after familiar South African names of places and streets, while enlarged framed photographs from well-known towns, Government offices and public buildings, the countryside or views of notable African scenery are displayed in the day-rooms and other assembly parts of the buildings so as to afford the inmates and staff many graphic reminders of their homeland. The north, or main, entrance opens into "Adlerley Street," leading into "Market Square," in Cape Town. The main cross-connecting corridor is called "Commissioner Street," Johannesburg. The other main passages are figured "Maitland Street," Bloemfontein; "Sunnyside," Pretoria; "Pieternigter Street," and "Berea Road," Durban. Cape Town is also represented by "Adlerley Street." The equipment of the hospital is unusually complete, specially in the operative and remedial departments, which are fitted up with the very latest surgical X-radiol, and other appliances, including electric and physical treatments. These equipments were secured by Liberal South African subscriptions, and regardless of expense, the outlay being wisely incurred with the object of saving life and limb by ensuring the utmost facility, comfort for the sufferers, and efficiency of administration. Very few English hospitals possess such advantages on such a scale.

The construction throughout is of timber, elevated clear of the ground on brick piers and footings. The outsides are weather-boarded with felt linings. The walls of the interiors and the ceilings are sheeted with asbestos board lining in all the wards and principal rooms. Asbestos was thus adopted with the object of reducing the risk of fire to a minimum. The roofs are covered with specially-made felt, and when left unvarnished this material looks very well, with its dead black surface. The treatment of the façades, necessarily under the circumstances, had to be kept exceedingly plain, and the avoidance of ornament is certainly a gain. The simple woodwork exposed externally and the roof timberings inside are stained dark brown, the joinery for the most part being painted white. Mr. R. J. Allison, the architect, advisedly endeavoured to avoid the appearance of military huts as far as possible, and with this intention these hospital buildings are designed more after the manner of South African colonial timber-framed dwellings of the fairly well-to-do, such as every man likely to

be brought to Richmond Park for treatment is perfectly well acquainted with. The interiors are made to correspond in so far as a homely effect can be given to such large apartments. The dining halls, right and left of the kitchen, are particularly attractive, with excellent appointments and table ceramic ware filled with dried flowers from South Africa. One is called "Mount Nelson" (the principal hotel in Cape Town) and the other "The Carlton" (the principal hotel in Johannesburg). The day rooms are named after famous clubs, i.e., "The Ramblers" and "The Wanderers," also "The Dutsman." The walls and ceilings are distempred a light grey-green tint, except in the operating theatre wing, where white enamel faced paint is employed. A photograph of the operating theatre is included among our plates, and we print a view of one of the "thirty-eight bed wards." Each bed in the hospital is named by a donor of £25 and upwards, and a very large proportion of the beds have been endowed with money collected by school children in South Africa.

The accompanying pictures of the exteriors of the hospital furnish a fairly good idea of their simple and effective appearance previously mentioned. The double-page reproduction of the plan at once makes it evident that so vast a group of buildings, all approximately uniform in height and on one floor, cannot be shown by any single view however extended or taken from one given point. This, of course, is out of the question, and besides the surrounding big trees of the park preclude all but sectional aspects of the institution. The main entrance on the north is set at the corner as shown by one of the photographs taken from the end of the curved approach road. This feature is the only instance throughout the whole series of elevations in which a suggestion of strictly architectural style is definitely suggested. Its simple unpretentiousness is appropriate, and gives precisely the emphasis required for the chief doorway of such a hospital. On entering this portal to the left of the vestibule, in "Adderley Street," are placed the "Montague Baths," where the patients are inspected and cleansed directly they arrive, before being admitted to the hospital proper. Ample "parks" space is situated near the main entrance. The officers' entrance is at the end of "Government Avenue," where the offices are situated on the west of the buildings. Here, to the right on coming in, is the room of the commanding officer, Colonel Thornton.

The large concert hall on the north-east is a highly successful piece of construction all in timber, with linings of matched boarding stained green. The proscenium of the raised stage is effectively furnished by vertical pleated valances shaped pleasantly at the top, in lieu of the usual festoons of drapery, and curtains flank the sides. This big room with its side aisles is used for church services, having a portable altar and reredos for these occasions. In a normal way the hall is utilised for big general type-writing, book-keeping, shorthand and other vocational training classes. Cinema displays are given here, besides recreations and entertainments for the patients. The cinema operator has a sufficiently large box to allow of three or four men being taught to work the films and lantern. In order to enable these pupils to make the most of their instruction a big glass panel is provided to allow them to simultaneously see the results of the working appearing on the screen at the other end of the hall. Opening out of or immediately adjacent to this assembly room are the practical workshops, which provide the centre of the vocational training of disabled South African soldiers, who are taught various trades, such as carpentry and joinery, telephone work, electric lighting and bells and so on. A motor fitting shop is about to be built and other extensions are intended. The scheme involves the training of men who are permanently disabled at the earliest date possible, patients receiving tuition while still in bed. As soon as they are ready for discharge from hospital they are retained as Union soldiers and sent to

the hostel just outside the hospital. From thence they attend at the workshops as out-students until their training is complete. In imperial hospitals no man may be trained until he is discharged from the hospital and soldiers are enabled to become skilful artificers and as such earn good wages, often from £4 to £5 a week, whereas before the war they were only in the receipt of about thirty shillings as ordinary labourers.

The floorings of the hospital are covered generally with a light cheerful-looking patterned linoleum, of a quiet, admirable design, very suitable and clean in appearance. The windows in the wards, etc., are furnished with agreeable green curtains. Throughout this hospital the cheery and comfortable look of things is very striking, giving the place a distinguishing individuality. And we speak from a personal inspection. Of course, everything of a structural kind is regulated by the proviso that the buildings were erected for temporary purposes. The kitchen is located in a central position twixt the dining halls, and it has a carving and service room well placed and conveniently adjacent. The kitchen is well equipped, with gas cookers and super-heated steam ovens practically combined as an efficient installation. Each ward has its own supplementary kitchen with gas cookers for minor requirements, and the nurses' rooms have gas ring heaters. Verandahs are built attached to the patients' day rooms and officers' quarters, as well as to the nurses' building. One of our exterior photographic illustrations shows the open-air wards facing south, and an interior of one of the day rooms is given in evidence of the comfortable furnishings enjoyed by "the boys."

The bath ward, known by the designation of "Victoria Falls," makes a novel and special feature connected with this South African Hospital. It is the only bath ward in England of the kind, although it is already being copied in others. There is a ward on the same lines at Cambridge, but that is not so complete as this. The Chief Engineer of H.M. Office of Works, Mr. McFerran, was responsible for the technical details and electric plant which controls and keeps the water at an even temperature of 100 deg. F. The twin heating or dual cylinders attached to a small dynamo are placed in the supply chamber at the far end of this ward. The water passing continuously through each bath is regulated at a normal of 98 deg. F., but when it leaves the service tanks 105 deg. F. is maintained, because 5 deg. F. is lost in the service pipes on the way to the baths; hence the need of this marginal allowance. Should the required temperature be exceeded, the excess is rectified immediately by an automatic electric adjustment. If that should fail by any chance, and allow a further rise in the heat of the bath-water, a whistle sounds an alarm, while in the event of that not receiving prompt attention a loud buzzer goes off. With a considerable quantity of water continually and necessarily in use all hours at one uniform temperature, obviously a reliable method of regulating and sustaining the supply is of the utmost consequence. That, in fact, is the main factor. The patients recline in these baths on a suspended shallow hammock, arranged sufficiently deep in the running water to submerge the body, and waterproof air-pillows are used on which to rest the head. The patient remains immersed night and day, and sometimes this treatment in extreme cases goes on for four, five, or even six weeks at a stretch. The fact only need oiling after long immersion. The extreme pain of dressing the wounds or removing the dressings is obviated by this bath treatment, which is chiefly employed for bad shell wounds or virulent septic cases. The results have been most extraordinarily good. Wounds are cleaned up rapidly under water, and patients are saved the shock and suffering of daily dressings. The average duration of stay in these baths is from four to five days and nights; some less ordinary cases stay in up to twelve or thirteen days. It

frequently happens that great pain with wounds prevents patients from sleeping in bed, and in experience it has been found that those suffering in this way fall off to sleep as soon as they are placed in this bath ward. The same happy results also follow in cases of shell shock after the usual methods of treatment have failed. The baths look very like ordinary beds set along one side of the ward, with the coverlets on and book-rests in position. The photograph inset plate given herewith illustrates the arrangement of the baths in the "Victoria Falls" Ward at Richmond Park.

A central boiler-house for the purpose of warming the stores and operating wing by radiators and hot-water pipes, likewise the whole of the "Montague" baths and other baths (except the bath ward), the lavatories and sinks, are all supplied from this same big system. Electric lighting is installed everywhere. Fire mains and hydrants are situated in the vicinity of all buildings, and the necessary water pressure, on the top of Richmond Hill, is ensured by the erection of the large raised water-tank set in the middle of the site, as seen by the general plan.

Accommodation at present is provided for 600 patients, the orderlies' quarters having to some extent been converted for use as convalescent wards. The officers' mess and staff rooms are in a detached building on one side of the approach road at the rear, the nurses' quarters being put on the other side. The wounded officers' ward and day-room, as well as the emergency ward, will be seen on the plan to the right as distinct units of the general lay-out, appropriately self-contained on military lines.

The main blocks of the hospital were erected by two contractors—the first by Messrs. Higgs and Hill, of Lambeth, and the second by Messrs. Taylor and Co., of Hammersmith. A uniform level throughout the hospital was obtained in the usual way by stiling the buildings on piers and brick footings, which give ample air-space under the floors, except for some of the outside workshops. In traversing the whole of the hospital on the occasion of our visit we noticed that for economic reasons some of the connecting corridors were given a slight incline to accommodate little variations, but we only saw one step, and that occurs in an unimportant position, so that Colonel Thornton, the commanding officer, directed our attention to it. Mr. R. J. Allison, A.R.I.B.A., the principal architect in charge of art and science buildings (H.M. Office of Works), is the architect of the hospital.

## ARCHITECTURE AND THE FUTURE.\*

BY JOHN R. GASS, J.P., F.R.I.B.A.

Since I had the honour of addressing you at the opening of the last session, the progress of events has been of vital importance to the life of the world, our national life, and our professional life. A new world life is undoubtedly being created, a new national life is being formed. We are living under conditions hardly believable; in the State our liberties are curtailed to an alarming extent. Much that we have lived and hoped for, and much that England has always stood for, are abandoned for the time. Officials are everywhere—a great army; everything points to further increase in this army, which, like the Old Man of the Sea, may entwine and in part strangle individual effort in its great embrace, unless by combination there is strength enough to resist its insidious action. The time honoured points of view have to be adjusted to the new conditions, but the adjustments must be for betterment all round and a levelling up to the best and most efficient, not a levelling down to the worst and the inefficient.

Architects can render valuable service to the community in the national reorganisation, and every effort must be made by our profession to place it in the best position to render

\*The Presidential Address to the Manchester Society of Architects. Delivered Oct. 10, 1917.



such service. How far there is an awakening to the true condition of things time only will show.

#### THE INSTITUTE AND WAR SERVICE.

There has certainly been an awakening in the life of the Institute from its period of repose, which gives promise of much good. The three resolutions submitted to the council of the R.I.B.A. by the recent informal conferences in London, and urging a policy of public usefulness, are undoubtedly stimulating. With a strong and thoroughly representative Institute, properly supported and maintaining the present high ideals, but with a more comprehensive outlook and greater practical activities, much can and will be accomplished. No opportunity should be missed of obtaining proper professional recognition by all authorities, not only in London, but through and by the allied societies over the whole of the country.

In the scheme of the War Office (and unfortunately the military caste is controlling our present destinies) the architect does not exist, and, as you know, to the Government generally the Institute was stated to be unknown. In the military mind there are engineers and surveyors, but not architects. When it was found necessary to lay out munitions and other works for military service, the Government engaged an American engineer. The services of works architects in England do not appear to have been considered, though there are specialists fully qualified to arrange and carry out such buildings; and they would certainly have made more business-like arrangements for dealing with their creation.

We all constantly regret the number of our highly trained young men who were relegated to positions in the army altogether outside their line of training, although their specialised services were, and are still, badly required in all directions and in all branches of the service. Some of our seniors, anxious to take on work, are helping in all sorts and conditions of things—dilution offices, substitution offices, clerks and the like—positions in which they are doing useful work, but not specialised work for which they are so well fitted, and in which they were so anxious to place their services at the disposal of the State. During the last year there has perhaps been a little more consideration given to architects, but only a little. Undoubtedly in much of the building work undertaken by the State, and particularly that directly arranged by the War Office, there has been thoroughness and is still, the want of that proper direction and control which only a trained architect can supply. In these later years of the war valuable personal work has been given to the State by many architects. Mr. Ernest Newton, the ex-president of the Institute, and some others associated with him, have specially rendered important professional and semi-professional services gratuitously to the Ministry of Munitions, done excellent work, and not spared themselves in the national interest.

The present organisations of the architectural profession and the specialised training, making for the directing forces of the country, have never been properly utilised by the State, so as to make them of the greatest value in the present crises in our history. Many square pegs have been put into round holes; the good intentions with which some of the appointments have probably been made, especially in the earlier days of the war, in connection with army building work, have done a considerable amount of the paving of the hell of inefficiency.

The War Committee of the Institute, although it was at the eleventh hour, were desirous of seeing that in some manner square pegs should be fitted to square holes, and endeavoured to help towards that end, in the early stage of the ill-fated National Service scheme. Mr. Neville Chamberlain, the first Director, received a very important deputation: all the speakers emphasised the advantage to the nation of the special training of architects being utilised in the national service. He gave a most considerate hearing, and seemed to recognise our position. In the carrying out of the National Service scheme, however, the character of the service

to be rendered was not specified before enrolment was asked for, and this, with the petty jealousies between Departments (which is ever the bane of our English public service), foredoomed failure, though it might have been of national value. The revival will be followed with interest; the practical value of some of the stated objects of the new scheme, except in the dealing with aliens, is, however, doubtful. These National Service schemes, though good in intention, have not so far got to the heart of things, and certainly do not appear likely to materially help our professional position. All the Government Departments were notified by Mr. Chamberlain of the services architects could render, but the cold response of the War Office, particularly to the profession whose very name was disallowed in their organisation, led to a very unsatisfactory response. Perhaps, however, the little more consideration given to members of our profession during the past year may have been the outcome of the deputa-

#### THE ALLIED SOCIETIES.

There has also been an awakening among the allied societies during the past year, and much necessary activity has been displayed by them. In the Institute War Committee's proceeding great interest was taken, and the allied societies were fully represented in the deputation in London to Mr. Neville Chamberlain. After the deputation the representatives met together and an allied societies' conference was arranged to be held in Manchester. There was a special meeting to consider the Housing question on March 31 last, when the constitution was decided on, and the first general conference was held in our Society's rooms on April 18. The constitution of the conference states that "the objects are to strengthen the position of the profession, the Institute, and the allied societies in the world of affairs, and to aid and encourage architecture as a living and vital force in the national life." Conferences are to be held in various districts as may from time to time be arranged, and twice in each year. Each of the allied societies will have three representatives. Manchester was agreed to be the headquarters, and Mr. Isaac Taylor, F.R.I.B.A., our Society's hon. secretary, was appointed general hon. secretary with associated hon. secretary in district in which the conference is held. The President of the Society in whose district the conference takes place is to be chairman of it, and an Executive Committee was formed of Presidents of the Birmingham, Leeds, Liverpool, Manchester, Nottingham, and Sheffield Societies. At the General Conference exceedingly interesting papers were read, and animated discussion of much value followed. Resolutions were afterwards submitted by the Executive of the Institute embodying the general feeling of the allied societies. At a special meeting of the Council of the Institute held on June 18 the resolutions received sympathetic consideration, and a joint committee was formed composed of very representative members of the Institute and the Presidents of all the allied societies, with a view to consultation on matters of general interest and importance to the profession, though the proceedings are to be considered informal. The first meeting of the joint committee was held in London on Thursday, October 4, and was well attended, and the second meeting is to be held in Manchester on Wednesday, December 12. I believe it is the first time in the history of the Institute that such a conference has been held in a provincial centre.

#### ARCHITECTURE AND ARCHITECTS.

Frequently have I mentioned how architecture is ever representative of the spirit of the times, the life, habits and mode of thought of the people. We are coming into a democratic age when our architecture to be true must be expressive of such times and a record of their civilisation. Architects have the duty placed upon them of seeing that the highest and best forms of that

civilisation are expressed in the buildings, and all opportunities should be taken of increasing the importance of the profession and attracting to it the best minds so as to get a high average of attainment. Architecture is so often spoken about as mainly an expression of the emotions, a matter of scholarly research in purely academic fields, and is taken as one of the means of discussion in which graceful periods, with pleasant and interesting semi-verse generalities, can be displayed to advantage. And it has also been said that, in endeavouring to improve the status and opportunities of the members of our profession and increasing its importance in the commonwealth, a blow is being aimed at architecture itself. Undoubtedly it requires a special bent of mind to be an architect, but those with the special abilities will not be attracted to the profession if it does not give reasonable opportunities for advancement, and if it is not considered of practical value in the world. The same qualities which make for success as an architect make for success in many walks of life which do give such opportunities and offer more prizes and fewer blanks than in our profession. By far the greatest majority of practising architects have entered into the profession with a view of honourably earning a living, carrying out a career and making a success of their lives, and not because they were pre-destined heaven-born architects with high architectural ideal. The very meaning of "profession" is "one who makes his living by his art as distinguished from an amateur." Some few, without the necessity for earning a living, have taken up architecture as an agreeable and interesting form of education and as a pastime. I have known of such dilettante, but they have had few opportunities for work, and not having the stimulus of necessity, have done little of value, though there is no reason why they should not do so, and the practice of architecture still retains its fascination for some of the more fortunate brethren. Our profession is a serious one, demanding special qualities of heart and thought, a mind ready and receptive, a faculty for artistic expression with an ability for hard and continuous work, and that genius which is an infinite capacity for taking pains. An art, a science, a business, a craft architecture has been called, but the "profession" of architecture from which the best architecture, the best expression of the age, has ever to come, is a profession to which should be attracted the best of the highly educated young men of our time, alive to the wants of the age, and appreciating the combination of art, science and businesslike qualities which make our profession so fascinating and so engrossing. Instead of the improvement of the position of the architect being a blow to architecture, the converse is the case, and it is by improving the position and status of the architect that the art of architecture will get its best exponents, and give to those who practise it the position in the world the importance of the profession demands. Success the world generally measures by the amount of money a man makes—that success is achieved by few architects, and the profession never can be generally attractive on that ground. But given the right sort of natural abilities, properly trained, and reasonable opportunities for work, there is no profession in which the interests are more varied and the opportunities for usefulness and happiness greater than in the life of an architect.

#### ARCHITECTURE AND EDUCATION.

As Democracy will rule, the fostering and cultivation of a rightly informed and cultivated mind among the people will lead to a true civic pride, which will stir up amongst the inhabitants a pride in their cities, towns and villages and be most important for the future of architecture. To the children architecture and history should be taught together in all the schools as part of their general educational course, for history is expressed in architecture, and both would be made more interesting and living by a true

(Continued on page 317.)



THE BUILDING NEWS, OCTOBER 17, 1917.

# RICHMOND PARK SOUTH AFRICAN MILITARY HOSPITAL GENERAL PLAN

SCALE 1/4" = 10' 0"

*Temporary Housing*  
 Existing houses will be utilized  
 for temporary housing until the main  
 hospital is completed. The existing houses  
 are situated on the eastern side of the  
 site. The main hospital is situated  
 on the western side of the site.  
 The main hospital is situated on the  
 western side of the site. The main  
 hospital is situated on the western  
 side of the site. The main hospital  
 is situated on the western side of  
 the site. The main hospital is  
 situated on the western side of the  
 site. The main hospital is situated  
 on the western side of the site.

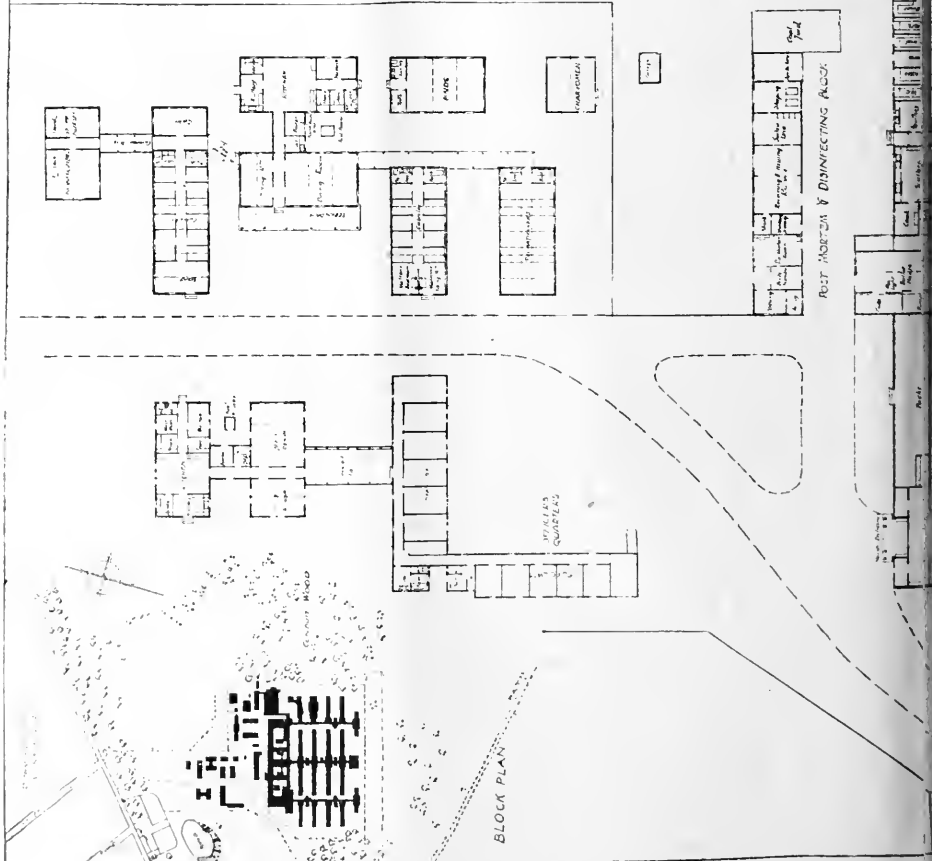

BLOCK PLAN

POST NORTH & DISINFECTING BLOCK

CHURCH BLOCK

CHURCH BLOCK

CHURCH BLOCK

CHURCH BLOCK

CHURCH BLOCK

CHURCH BLOCK

CHURCH BLOCK

CHURCH BLOCK

CHURCH BLOCK

CHURCH BLOCK

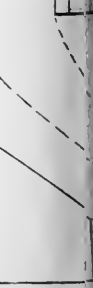
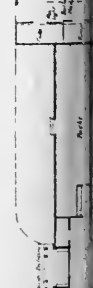









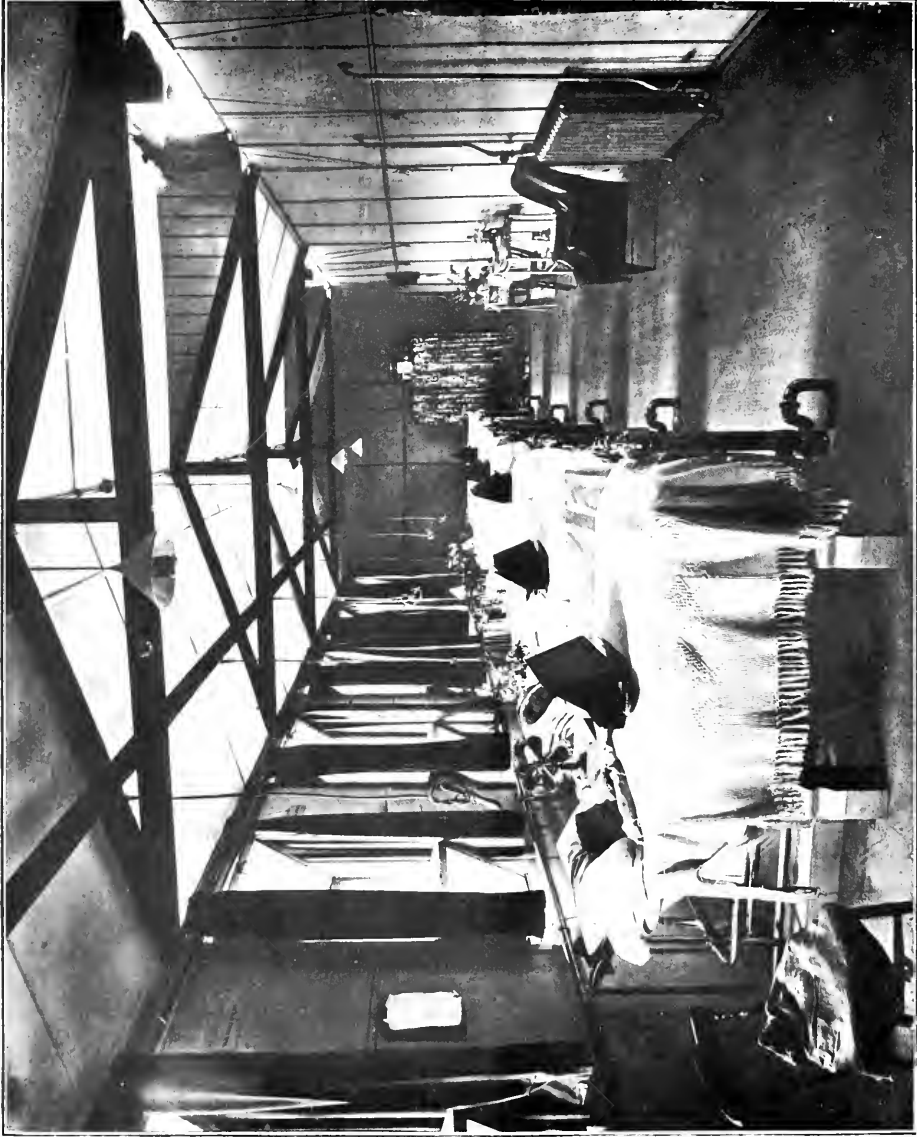

W. & A. G. B. 101

"VICTORIA FALLS" BATH WARD.  
SOUTH AFRICAN MILITARY HOSPITAL, RICHMOND PARK, SURREY.  
Mr. RICHARD J. ALLISON, A.R.I.B.A. (H.M. Office of Works), Architect.

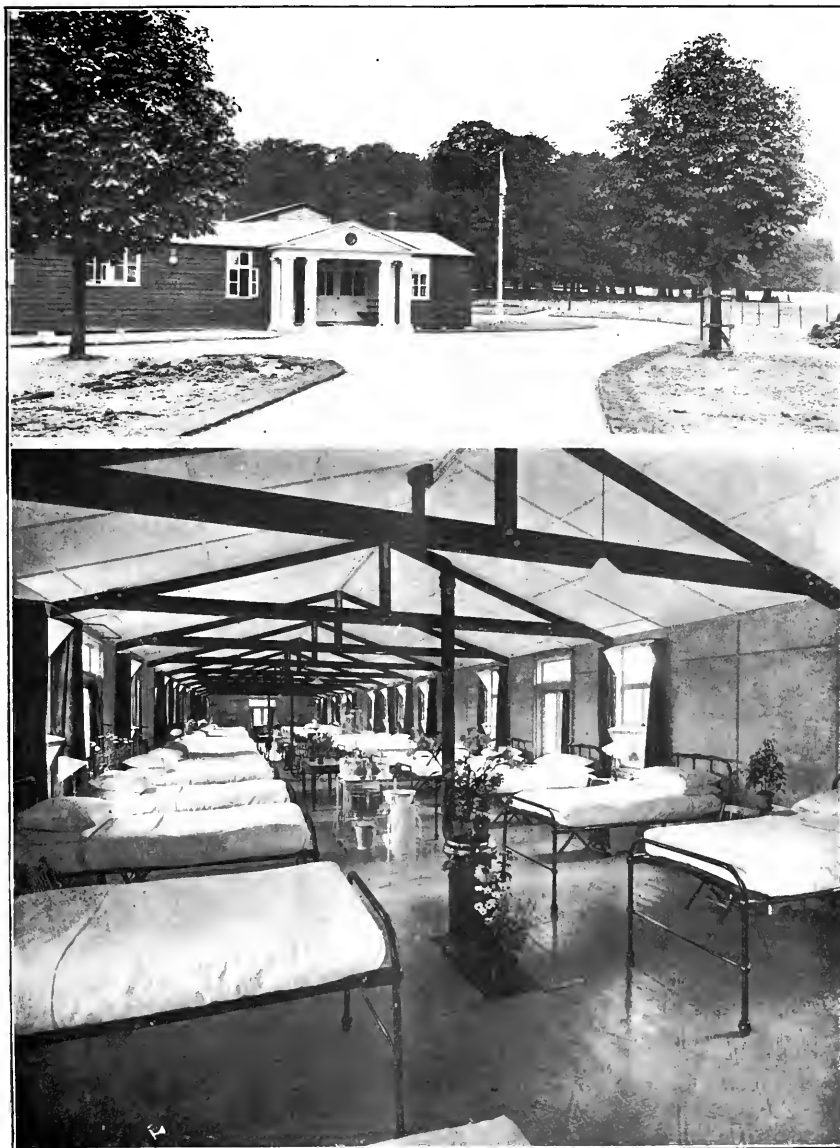

*Walsham, Ill., Photo.*

MAIN ENTRANCE AND 38-BED WARD,  
SOUTH AFRICAN MILITARY HOSPITAL. RICHMOND PARK, SURREY.  
MR. RICHARD J. ALLISON, A.R.I.B.A. (I.I.M. Office of Works), Architect.







*Williams, Leeds, Photo.*

GENERAL VIEW FROM S.S.W. AND CENTRE DAY ROOM.  
SOUTH AFRICAN MILITARY HOSPITAL, RICHMOND PARK, SURREY.  
Mr. RICHARD J. ALLISON, A.R.I.B.A. (H.M. Office of Works). Architect.



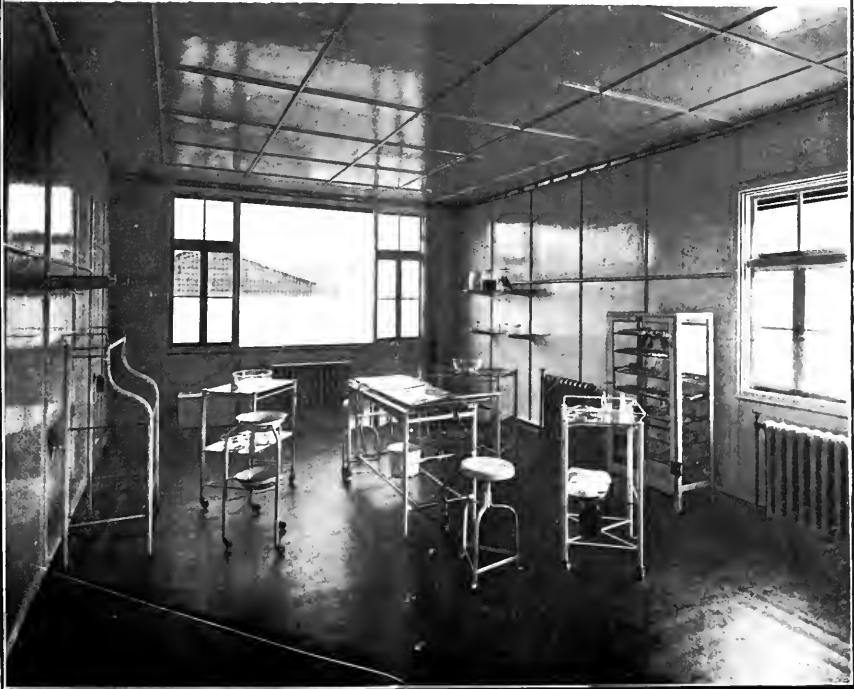

*Walsham, Ltd., Photo.*

**OPEN AIR SHELTER AND DAY ROOM AND OPERATING THEATRE,  
SOUTH AFRICAN MILITARY HOSPITAL, RICHMOND PARK, SURREY.**

Mr. RICHARD J. ALLISON, A.R.I.B.A. (I.M. Office of Works), Architect.



## ARCHITECTURE AND THE FUTURE.

(Continued from page 304.)—

combination. The future would be more hopeful by understanding minds then seeing the expression of their own time in the modern buildings growing around them, and insistence on the expression being right and true. The Institute's memorial of July last to the President of the Board of Education is one of the marks of the awakening spirit in our midst. It welcomes and urges the encouragement of the natural activities of eye and hand in the teaching of our day schools. It specially asks "that all must be taught to draw, and that manual work and comprehension of the common duties of life should be infused. That a town spirit should be inculcated as the best basis on which to build up a national spirit, and that something should be done to bring out the idea of design and strengthen initiative in the minds of the children." With a democracy truly educated in that spirit, and profiting by it, all things grow possible; though range gives a wider scope than now with the narrow view which prevails. Citizenship will have a real meaning, and the communal feeling be more fully developed in the civilisation of the coming time. A sense of the values of surroundings in the minds of the people for their living, their education, their work, their religion and their pleasures will infuse life into architecture, which will then dare to confront and break through the old and the time-endured, while profiting by their good examples.

The higher the outlook of the nation, the greater the training and skill required by those who express it in the architecture of the time. For our profession to hold its place in the ever-quickening march of events a general high standard will be even more necessary than at present. All endeavour must be made to make the profession of architecture attractive to the best of the young men of the nation, and then see that the highest special educational facilities are placed within the reach of those who can profit by them. For on the ability of the student to profit by special education depends the success of that education and its practical value in the world. There have recently been discussions at the Institute on architectural education which have been very interesting. The virile suggestions from the Architectural Association School have an artistic as well as a practical outlook of the present and for the future rather than the over-worship at the shrine of the past. It was well stated that schemes of architectural education will always remain schemes unless they coincide fairly with the sense of values of the nation at large, and also that the constructive side and artistic side of education should be run together—with both of these statements I am in full agreement. Many of the speakers, however, dealt mainly with the theoretical, both artistic and scientific, part of professional training, which is only the beginning of an architect's education.

Little was said of the vital necessity of a thorough training in the practical and business side of our profession, the only way to make a college or special school education of the real help in a man's career it ought to be, and preventing his having a true and not a false sense of values. An architect has to be in touch with actualities, and the use of practical common sense with experience are essential to a successful career. My personal experience of college-trained youths is not very convincing, unless such training has been simultaneous with office work, when it is of the greatest help and leads to efficiency.

It is probable that the education of the future will have to take into account the State and military service which will be required from our young men at the most impressionable and valuable time of their lives: one, two or three years from the age of about eighteen. In the future arrangements of State service consideration should be given to students in all the learned professions, so as to make their specialised training of value to the State. The effectiveness of the scheme of architectural education and the personal capacity of the students will be important factors in determining how far such con-

sideration will be given and maintained to our profession. The branch of State or military service which will utilise the specialised preliminary training and enable our students to take it forward should be organised in the national interests.

Surely those in authority will have learnt the value and necessity of specialised training for efficient service, both public and private, and how to utilise such special training in the country's interest. The proper organisation of the brain-power of the community is an absolute necessity if our nation is to maintain its position in the world. That is true national service when each man does the work for which he is best fitted. We have much to learn from our enemy in the way of efficiency of service and organisation. May our nation have wisdom to profit thereby, while retaining the ideals which form such a wide gulf between us and our enemy, and for which our young men are making such tremendous sacrifices and the country is being burdened with an ever-increasing and truly appalling debt, the taxation for which will cripple its activities for generations. It can only be met by greater efficiency, better organisation, a finer national spirit, and more community of interest in the whole nation.

## REGISTRATION.

For the greater share of the generation I have known the question of the desirability of the national registration of architects has been under discussion; it is unduly active discussion now, and there is undoubtedly an ever-growing feeling of the need for it throughout the country. After many years of consideration, detailed discussion of the 1905 Bill by the Institute Committee, hearing evidence on which a report was prepared, and obtaining legal advice, the Institute, at a special meeting on January 5, 1914, finally decided to proceed with a scheme of registration by charter as the only practical solution of the question which was considered as likely to be agreed to by the authorities at that time. The council's proposals for the charter were presented to a special meeting on April 27, 1914, and afterwards published in the *Journal*. This new charter provides, among other things, for the constitution and maintenance of a register of persons qualified for the practice of architecture, who would have a right to call themselves "Registered Architects" or "Chartered Architect." The register-in-chief would only be of value as a register of qualified architects, though it might be the first definite step towards obtaining national recognition of architects, either directly through a Bill or indirectly through the Local Government Board and other Departments of State. The granting of the charter by the Privy Council would not in any way preclude the Institute from going to Parliament hereafter for a National Registration Bill. The whole matter, however, remains "hung up," as, to a personal protest against the charter being applied for in the form agreed, the President wrote on August 10, 1914, that the council would not take any steps in connection with it at the present time.

The reorganisation of our national life may now give opportunity for presenting to Parliament a satisfactory Registration Bill, though undoubtedly there are many serious obstacles to its obtaining approval. National registration is the natural outcome of a proper educational system for architects, and in the public interests it is increasingly necessary. In the future, and now for the young men, examination must precede any scheme of registration—examination of the results of the theoretical and practical training of the individual. No one is fitted for the manifold duties the profession of a practising architect demands who has not the ability to profit by training and cannot concentrate his mind sufficiently to pass the ordinary examination in architecture and give evidence of his ability to design. Registration of architects would be a preliminary step in the efficient organisation of our profession, and, while conferring special privileges, must of necessity involve special duties, as with other learned professions, and the scope of influence thereby be greatly widened. As a State-recognised and organ-

ised professional body architects would always be available to be called on to carry out the special duties true national service requires. The views of the architectural profession would receive the same consideration as is rightly given to the views of the medical profession, and they would be taken into the public counsels in a way heretofore undreamt of. The public would be protected against inefficiency, and in the national reorganisation scheme a proper place should be found. Specialism would undoubtedly prevail, as in all other professions; there are diversities of gifts, and the spirit of emulation will grow stronger as the position of the profession becomes better in the State and to it are attracted the best minds of the time. The highest aims and ideals will have a greater chance of realisation, and the general average will be even better than now by the higher general standard which will arise—for there must be constant progress in all departments of our national life if Britain is to maintain her position in the world. In all the social betterments of the people, the improvement of their surroundings both in regard to their working and living and to promote the health and efficiency of the whole nation, architects' services are necessary. No plan for any building should be approved by any authority unless presented by a qualified architect, who should also give certificate of its proper completion. As a doctor has to give a certificate for death, the architect would give a certificate for life—that the building was in accordance with the requirements of satisfactory life if properly used. All the public architectural appointments (senior) should only be open to qualified architects.

The State of New York, in which such excellent architectural work is now being done, has given a good lead in their Architects' Registration Law, and the State of Wisconsin recently adopted it too. All persons professing as architects have to be registered. Those actually engaged in the practice of architecture at the time of the passage of the Bill received certificates without examination. But all future architects have to show to a State Board of Examiners their general and special architectural qualifications and knowledge, with at least five years' professional experience. A diploma of graduation from a recognised architectural school is accepted in lieu of the State examination, followed by three years of practical experience. Registration in another State or country having satisfactory standards is also accepted. State registration of architects has been brought into the region of practical politics. In the knowledge of the things achieved is the great hope of the future.

## RECONSTRUCTION AND REORGANISATION.

Reconstruction after the war is becoming a matter of vital interest in all directions, and particularly will be so to the architectural profession in the transition years of the coming time. Building will be materially affected by the general economic situation, which will call for organisation on a bigger scale, and in larger units, for purchase, sale and management in all industrial, commercial and manufacturing concerns. The shortage of materials, which is being so much felt now in the building trade, will become greater, as there will be a keener world competition for them. The most efficient plant organisation for the best way will be required to increase and cheapen production, and the main effort of the national life for some time will evidently be an industrial one. There is no profession which will be more affected by the reconstructional conditions after the war than the architectural profession, and reorganisation and reinstatement of our younger men on active service at the conclusion of hostilities will be a very serious problem. The treatment meted out to so many of them by the military authorities will make added difficulties; they have not been utilised for any branch of their professional work, as they ought to have been, and they may have lost touch with it. The Government has

generally discounted the position of architects, which has already had an effect. It is only by combined effort that reinstatement in the professional position can take place. Fortunately the national business mind, court from self-centred militarism and individualism, is found, and it is in this way that the reinstatement of architects in civil life will obtain as they prove themselves able to cope with the new conditions. There is grave anxiety on all hands to make the position of our younger men as favourable as possible on their return to civil life. Release from Army conditions will be very gradual, and may take years to accomplish. The Roll of Honour of the brave young men who have made the great sacrifice is an ever-increasing one; many of those with whom I have been associated are on the Roll of the City of all; some of those who return may not be fitted to take up the arduous duties private practice involves. Some who come through safely may obtain official positions, and I hope there will be many whose enthusiasm for architecture has been stimulated, and it is in the interests of the profession that the personnel of its practising members should be of a high average. Efforts are being made by the Institute War Committee and its Reorganisation Committee (a very active and reputable body) to help to achieve this. The Allied War Committee in Manchester, through its energetic hon. sec., Mr. Francis Jones, is getting into communication with all Army serving architects, assistants and pupils from this area, whether members of the society or not, and on their answers will depend the course which can be taken with advantage to themselves and the profession as a whole. Unfortunately, there seems a long way to go yet before peace is in sight.

#### LADY ARCHITECTS.

The position women have taken in the work of Britain during the war time shows their ability to rise to the occasion in a wonderful manner and successfully perform duties and carry on operations in connection with work of all kinds with which they had never previously been associated. In all this work they have come to stay. We admire their abilities and resourcefulness. Much has been said in the Press irresponsible though it may be—of the desirability of ladies adopting the profession of architecture. Lady architects will be welcomed in our profession, as they are able to rise to a high standard of efficiency.

For many years some of the architectural schools have been open to lady students, and though there have been students few have come forward with a professional career. Other schools are opening their doors to them now. The Institute examinations have recently always been open to them, but while there have been those who up to recent times have presented themselves for examination, only two have been successful, and they were registered as students in 1906 and passed the examination for Associateship in 1896 and 1900; they have also proceeded to Fellowship, which requires a record of executed work.

I met a few lady architects in the United States some years ago, but in general practice their careers were not of much promise. I found, however, that with proper training ladies might be successful, and my firm encouraged the idea; but those I have had to do with and their lady students I have seen, though quite capable in many ways, do not appear to develop the constructional sense which properly appreciate the practical side of the work. There are so many difficulties in the practice of architecture, as the demands of the public are manifold and varied that it is not to be undertaken in leading with work, and even to spend time there is little to be gained. In our profession, there are so many other professions which give the ladies with equal advantages and opportunities for service to the community. But once the loss will we welcome them as co-workers whenever they help to maintain efficiency and to keep the high architectural standard to which we aspire.

#### HOUSING.

The question of housing will be considered at one of our early monthly meetings, and opens out a wide field for discussion, of which our members will doubtless take advantage. A preliminary conference of the allied societies was held in Manchester on March 31 last, when the President and Secretary of the National Housing Society attended, and the proposals of the Architects' Reorganisation Committee were practically adopted, and became the resolutions of the National Housing Conference held at Oxford on April 9. The Institute Housing Committee has approved of the Manchester's suggestion for allied Committees in the various centres in close touch with the R.I.B.A. Committee. Resolutions have already been sent on the subject from our Committee to the Institute. Two of our Council were also appointed on the Organising Committee for Housing after the War, which has its centre in Manchester. A very interesting report from this Committee has been issued, to which attention is particularly called.

In the provision of cottage houses for the people the services of practising architects have been used to a very limited extent only, with consequent unsatisfactory conditions in many ways. A State-made scheme of house building seems inevitable; whether it will be carried out directly by the State, by the local authorities, by private enterprise, by public utility societies, and similar bodies, by some form of co-operation and co-partnership with a view of the occupier becoming the owner, much money will have to be found from public funds, with the wastage inevitable from such a manner of financing cottage building. Twenty millions has been the amount mentioned as necessary for housing schemes, but if carried out in the usual State managed ways and made thoroughly effective a much larger sum will be requisite. Where there is public ownership, the experience in Ireland has shown that the cost of maintenance and the general upkeep of cottages, in rural districts particularly, prevent the possibility of anything approaching a satisfactory financial result. I was also informed there that the arrangements and supervision of the buildings were not by architects—the results were therefore not so satisfactory as they should have been. The provision of better dwellings has undoubtedly been an advantage to the people, and though there is prosperity in the land there is little political peace and content.

It is desirable that, so far as possible, cottages in connection with housing schemes should be erected after the war by private enterprise, public utility societies, co-operation, and the like. The building of cottages by the State or municipal authorities should only be undertaken as a last resource. The layout of the buildings should be on town-planning lines, with such modifications as seem desirable for the various areas dealt with. Financial and other facilities should be given by the State to approved schemes, arranged and carried out by and under satisfactory professional supervision, through industrial banks or municipal, rural, and other authorities, with a view of the occupiers becoming owners of the houses through purchase by rental payments or otherwise, and the Small Dwellings Acquisition Act, 1899, should have amendments of such a character as to make it productive of greater benefits. For the effective carrying out of such schemes there would have to be alterations in the land laws, the Finance and other Acts, and also in local building bye-laws which prejudicially affect cottage building carried out on satisfactory lines.

A very important meeting of the Institute Housing Committee was held in London on Thursday October 4, when important proposals were under discussion. The very active co-operation of the allied societies and their members will be requisite, and in the best interests of the profession, from a national point of view particularly, it is necessary that there should be an adequate response.

I have spoken of a few of the many things affecting our professional life in the present

and for the future, but in no way have I exhausted the topics which are of general interest to all practising architects; among these the arrangements for the proposed Building Trade Parliament merits careful attention. Some of our members who are to read papers at our monthly meetings will probably refer to some of them, and I urge the earnest attention of all and a keen interest in the meetings so that their practical value may be as widespread as possible.

**THE OLD INFIRMARY SITE IN MANCHESTER.**  
The utilisation of the old infirmary site in Manchester has become a matter of national interest in our profession, and continues to exercise the vacillating minds of the city council. The recent decision to make it one of the tram terminals has brought the matter a step forward, but in an attempt to please the upholders of the three main schemes—art gallery and library, open space, tramway terminal—no one was satisfied, and the members of the council wisely left themselves liberty of action in the future, as it undoubtedly will be required. Since the publication of the plan of the Traffic Control Committee scheme, Mr. Thomas Beucham's offer of a great opera house to Manchester opens out another vista. The Town Planning Committee of the Manchester Society of Architects have had the matter under consideration for some time, and have prepared plans and made suggestions both for dealing with the site and the tramways. Proposals were understood to be in the air to make the site a great tramway centre, and on March 2 last the Council of our Society passed a resolution protesting against the utilisation of the old infirmary site as a tramway centre and pressed for the carrying out of the scheme for which the infirmary site was specially purchased.

It must be realised that nothing can stop the development of the tramways system in Manchester, with its ever-increasing area, except a comprehensive underground railway scheme, and the time is becoming ripe to take it into serious consideration for the near future. To that we must look to avoid disfiguring the best of the open spaces of the city by forming them into tramway terminals, with their hopelessly inartistic though undoubtedly useful shelters for the waiting crowds; something better should be done than has previously been attempted in Manchester, though it may only be temporary.

#### THE JUBILEE CELEBRATIONS.

It was to me the vision of a dream, but with prospect of realisation ever remote, that during the second year of the presidency to which you have done me the honour of election the Manchester Society of Architects might have been able to worthily celebrate together the coming of peace to the world and the jubilee of the society. But the end of the war is not in sight, and our nation has much further to go; the road is still rough and the way still long; but none the less will the nation and her great Allies travel it to victory with a good heart and a high sense of the justice and right of the great cause for which such tremendous sacrifices are being made by its sons and daughters.

While doing all in our power to uphold the national interests and cheerfully making such sacrifices as are necessary, we have our professional position to maintain; those who are in charge must worthily do this, and be not slothful in the business of it, but fervent in spirit. The future holds great things; however distant our opportunities for renewed activities may be, we still say of our work—  
"Oh, world not weary or old; sweet world, everlastingly new;  
Speed fresh pioneers to battle—there is infinite work to do."

A bust of Captain Marratt has been presented to Estling Library by Mr. R. F. St. Andrew, St. John, a local resident, whose mother was a cousin of the novelist.

In error we last week described Mr. S. E. Burgess, M.I.C.E., F.R.S.I., as "borough engineer of South Shields." Mr. Burgess resigned the borough engineership of South Shields eight years ago on his appointment as borough engineer of Middlesbrough.

## Our Illustrations.

### THE SOUTH AFRICAN MILITARY HOSPITAL, RICHMOND PARK, SURREY.

The description of this large new military hospital will be found on page 302, embracing the three exterior views and three interior photographs, including the unique bath ward known as "Victoria Falls." The general plan, accompanied by a site plan, shows the arrangements designed by Mr. Richard J. Allison, A.R.I.B.A. (H.M. Office of Works), architect.

### PROFESSIONAL AND TRADE SOCIETIES.

THE ROYAL TECHNICAL COLLEGE, GLASGOW, ARCHITECTURAL CRAFTSMEN'S SOCIETY.—At a meeting of this society, held in the F.O.S. on the 12th inst., Mr. Thos. Whyte, F.F.S., in the chair, Professor Charles Gourlay, B.Sc., F.R.I.B.A., delivered a lecture on "The Application of the Orders by the Italian Masters." After referring to the study by the Italian masters of the classic monuments in Rome, and to their having written books with the object of advancing architecture by disseminating a knowledge of the orders, the lecturer exhibited by slides a series of drawings of the Italian orders, with their mouldings and enrichments. He then pointed out that the orders should not be studied apart from buildings because their application to buildings was a fundamental point in the correct estimation of their value by students. This he emphasised by describing a chronologically arranged set of views of buildings erected by the Italian masters in Italy. The application of the orders as a means of giving varied architectural expression was clearly illustrated in the buildings shown.

### TRADE NOTES.

Boyle's latest patent "Air-pump" ventilators, supplied by Messrs. Robert Boyle and Son, Ventilating Engineers, 64, Holloway Viaduct, London, have been employed at H.M. Box Making Factory, Beddington.

In order to facilitate the output of orders consequent on their increasing business, the British Roofing Company, Limited, have removed their general offices to more extensive premises at 11, John Street, Crutched-friars, E.C.5, where they will be pleased to receive orders and inquiries for their celebrated "Alligator" roofing. This is approved and used largely by all Government departments, and besides lasting longer, costing less, and being easy to lay, has the additional advantage of being British made.

The south aisle of the R.C. church, Dornbrook, is undergoing structural improvements under the supervision of Messrs. Wm. H. Byrne and Sons, architects. The work comprises the rebuilding and strengthening of the walls underneath the floor of the church and putting in steel beams, etc.

The Building Committee of the University College, Cork, propose to construct an entrance to the college in Fernhurst Avenue instead of the former entrance on the Western Road, in accordance with plans and specification which have been prepared by Mr. J. F. McMullen, M.R.I.B.A., architect, Cork.

The Executive Council of the Amalgamated Society of Carpenters and Joiners have decided not to take part in the scheme for training disabled sailors and soldiers for occupations in the building trade, on the ground that it is the State's duty to provide for the maintenance of workers broken through the war.

The London County Council has arranged that a course of lectures on the historical aspects of arts should be given by Professor Selwyn Image at the Central School of Arts and Crafts during the session 1917-18. In previous sessions Professor Selwyn Image has been paid a fee of £75 for a similar course, and this precedent will be followed.

Captain John A. G. Shanks, Argyll and Sutherland Highlanders, who was killed on October 4, aged 27, was the oldest son of Mr. John Shanks, managing director of Messrs. Shanks and Co., Limited, sanitary engineers, of Barchin, Glasgow, London, and Manchester. He was associated in business with his father. His two brothers are also serving.

## Our Office Table.

The special committee of the Newcastle Corporation appointed to determine the best use to be made of the old infirmary site met last week under the chairmanship of the Lord Mayor (Councillor George Lunn). As previously stated, it had been proposed to erect a municipal abattoir on the ground, whilst the Co-operative Wholesale Society and the North-Eastern Railway Company had sought permission to purchase part of the site. After the subject had been discussed at length, during the course of which it was suggested that the railway company might take over the whole of the Cattle Market Infirmary site and Sheep Market, the latter and the Cattle Market to be removed to St. Peter's, it was decided to open up negotiations with the North-Eastern Railway to ascertain their actual requirements.

Keighley Town Council last week considered a recommendation by the Health Committee that the Local Government Board be informed that in the opinion of the council 150 houses are required at the present time, and that 150 more should be built at the close of the war. Mr. W. Coleman asked if it was intended to erect sky scrapers. They had thousands of acres of land in the borough, and every house ought to have 200 or 300 yards of land. Mr. Midgley said that such houses would be taken up, not by the poorest class, but by the better class of artisan, and he should object to assisting such out of the rates. It was preposterous in suggesting that a house could be erected with a quarter of an acre and let for 6s. 6d. per week. The committee's recommendation was adopted.

At a meeting of Ayr Town Council last week a report on the Government inquiry as to providing houses for the working classes was submitted and agreed to. The report showed that the estimated population of the burgh was, excluding military, 34,000; that there are 5,248 houses of four apartments and under, of which 172 were overcrowded or sub-let and 50 defective or uninhabitable. The corporation had under consideration a proposed scheme for the building of 60 workmen's houses on ground in the burgh belonging to them; and the local authority were willing to prepare a scheme to meet the wants of the burgh if the Government's financial assistance were satisfactory. In reply to the query: "What measures are necessary, in the opinion of the local authority, to induce private enterprise to provide suitable houses for the working classes after the war?" the local authority reply: "Loans of money to builders on easy terms; local authority to make roads and streets, and spread repayment over ten years with interest; alteration of terms of Finance Act, 110, taxing prices of houses when sold over their valued amount."

At a meeting of the Widnes Town Council last week it was decided to increase the price of gas by threepence a thousand cubic feet for all classes of consumers. The price of Widnes gas will be 1s. 6d a thousand feet, at which figure it retains the distinction of being the cheapest gas in the kingdom. The next lowest price is 1s. 9d. a thousand feet is charged in Sheffield.

The Council of the Royal Institute of Public Health has approved of the Barben Gold Medal, presented triennially, "for eminent services rendered to the public health," being this year awarded to Surgeon-General Sir Alfred Keogh, G.C.B., M.D., LL.D., F.R.C.P., etc., Director-General Army Medical Services; and the gold medal "for conspicuous services rendered to the cause of preventive medicine" to Professor Edward William Hope, M.D., D.Sc., Professor of Public Health in the University of Liverpool, and medical officer of health for Liverpool.

A famous State bedstead from Boughton House, Northamptonshire, recently presented to the Victoria and Albert Museum, by the Duke of Buccleuch, has been placed on exhibition in the Woodwork Galleries of the museum (Room 54). The bedstead, with hangings and upholstery of crimson Italian plush, enriched with gold fringes and ostrich plumes, is a typical example of the magnificent

bedsteads which were made in England for Royal palaces and noblemen's houses in the latter part of the seventeenth century. Boughton House was rebuilt during that period by Ralph, Duke of Montagu, who was Ambassador to the Court of France at the time of Louis XIV. The decoration and furnishing of the house were completed by 1694, when William III. and his Court visited Boughton, and it was for this occasion that the bedstead is said to have been made.

A large Philadelphia theatre is to be the first one in the world to be operated without footlights. All the stage illumination will come from above, being as nearly as possible a reproduction of ordinary sunlight. The system employed, covered by patents both in America and abroad, demands a long steel bridge, of cantilever construction and 10 ft. wide, which is thrown all the way across the proscenium arch directly behind the curtain. In the present instance this bridge will be 98 ft. in length, and the steel construction will be of the heaviest. On the bridge will be stationed eighty electricians, each handling two lamps, pointed downward and manipulated much as a soldier might aim a machine gun. The rays of light completely envelop the characters on the stage below and explore every corner of the stage. It is just as though an enormous sun were above the players. The effect is described as the most natural lighting ever seen in a theatre. The combined candle-power of these lamps is 160,000, and the electric current used at each performance would carry a submarine across the Atlantic or illuminate two large metropolitan hotels for twenty-four days.

At the seventh meeting of the Building Trades Central Advisory Committee (Operatives), which advises and assists the Ministry of Labour on matters affecting workpeople in that industry which arise in the administration of the Employment Exchanges, Mr. C. F. Rex (Director of Employment Department) was in the chair. The committee considered, among other subjects, the Central London Building Trades Exchange; and the relations between the National Service Department and the Employment Department, and the machinery which it is now proposed to set up to secure the most economical use of the national labour supply.

The recent proceedings under the Combs Emergency (Amendment) Act in Ireland instituted by the *Irish Builder* have been assisted by Messrs. G. and T. Crampton, Dublin, in respect of their pre-war contract for the erection of new buildings at University College, Dublin. The contract amounted to £86,000 and Messrs. Crampton alleged that such great hardships in the procuring of materials and labour had arisen owing to the war that it would be inequitable to enforce the contract against them, and praying for the annulment thereof, or other relief. The case was mentioned on two occasions before the Lord Chief Justice sitting as Vacation Judge (the tribunal named by the Act) is the Land Judge, with or without a jury. On the second occasion the judge was informed that an agreement as to the point involved was in process of being reached on the basis of paying the contractors their actual net outlay up to the present time, plus 7½ per cent. profit, and all future outlay plus 40 per cent. profit. The judge expressed his satisfaction, and added that the parties themselves were the best judges of what would be equitable conditions.

Birmingham has decided to erect a War Memorial Museum. Till the building is put up objects will be housed in the Art Gallery.

The London County Council has appointed Mr. A. G. Morrice to be interim district surveyor for Bittersea South and part of Wandsworth as on and from July 15, 1917, in place of Mr. Horace Cheston, who resigned as from July 14, 1917.

The first ordinary general meeting of the session of the Surveyors' Institution 1917-1918 will be held on Monday, November 12, 1917, when the president, Mr. Arthur Lyon Ryde, will deliver an opening address. The chair will be taken at 5 o'clock.

**FOR**  
**Oliver's**  
**Seasoned**  
**Hardwoods,**  
**WM. OLIVER & SONS, Ltd.,**  
**120, Bushill Row, London, E.C.**

**TENDERS.**

\* Correspondents would in all cases oblige by giving the addresses of the parties tendering—at any rate, of the accepted tender; it adds to the value of the information.

**ABINGDON.**—For supply of water fittings, for the town council:—  
 Beale and Sons (accepted) .. £20 13 4

**BATH.**—For executing the work of providing temporary baths in Bath Street, for the city council:—  
 Jacob Long and Sons, Ltd. .. £5,042 0 0  
 (Accepted.)

**EAST HAM.**—For supply of a new boiler in connection with heating apparatus at the Town Hall, for the East Ham Town Council:—  
 W. G. Cannon and Co. .. £ 4109 0 0  
 (Recommended for acceptance.)

**FRESHWATER BAY (H.W.).**—For construction of a sea wall, etc., at Freshwater Bay, for the Isle of Wight Rural District Council:—  
 W. H. Paul (accepted) .. £ 239 0 0

**GALLOWAY.**—For alterations to property at corner of Gallowgate, for the corporation. Accepted tenders:—  
 J. Raeside and Co., plumbers .. £642 2 11  
 Bone and Co. plasterers .. 322 18 3  
 Dwar and Elliott, masons .. 163 10 0  
 W. Meikle, slater .. 268 18 1

**HOLMFIRTH.**—For water-main trenches, etc., for the urban district council:—  
 Accepted tenders:—J. Bank and Sons, water-main trenches at Auston's Bank End; R. Turner and Co., laying a 6 in. sewer at Sedburgh.

**LONDON COUNTY COUNCIL TRAMWAYS.**—For the supply of electric cables for the Council's tramways:—  
 Siemens Brothers and Co., Ltd.,  
 Woolwich .. .. £1,490 0 0  
 Johnson and Phillips, Ltd., Charl-  
 ton .. .. 1,480 0 0  
 British Insulated and Helsby  
 Cables, Ltd., Prescot, Leanca-  
 shire .. .. 1,480 0 0  
 Callender's Cable and Construc-  
 tion Co., Ltd., Victoria Embank-  
 ment .. .. 1,460 0 0  
 W. T. Holey's Telegraph Works  
 Co., Ltd., London Wall .. .. 1,462 0 0  
 Western Electric Co., Ltd., North  
 Woolwich .. .. 1,430 0 0  
 W. T. Gover and Co., Ltd. (quor-  
 only) .. .. 950 0 0

The general manager's estimate, comparable with the tenders, was £1,200. Lowest tender accepted.

**MARLBOROUGH.**—For baths and painting of Crawford Place Dwellings, for the St. Marylebone Borough Council:—  
 Gray and Co., Finchley Road,  
 N.W. (accepted) .. .. £421 0 6

**MINDERSHURAN.**—For buildings of floating hospital, for the Tes Port Sanitary Authority:—  
 Clark Bros., West Hartlepool .. £2,637 0 0  
 (Accepted.)

**NEW MONKLAND (SCOTLAND).**—For alterations to heating chamber at Anzathill school, for the New Monkland School Board:—  
 London and Inglis (accepted) .. £135 0 0

**PLYMOUTH.**—For completing paving works at Kensington Lane and Southern Terrace Lane, for the corporation:—  
 J. Doney (accepted) .. .. £587 1 0

**WOOLWICH.**—For repairs to infirmatory roof, for the Woolwich Board of Guardians:—  
 Thomas and Edge, Woolwich .. .. £67 0 0  
 H. J. Vauclain, Plumstead .. .. 46 8 2  
 T. South, Herbert Road .. .. 45 0 0  
 J. Stevens, New Road (accepted) 28 0 0

**TO ARMS!**

**COUNTY OF LONDON VOLUNTEER ENGINEERS**  
 (FIELD COMPANIES).

Headquarters, Balderton Street, Oxford Street, W.1.  
**ORDERS FOR THE WEEK BY LIEUT.-COLONEL**  
**C. B. CLAY, V.D., COMMANDING.**

**OFFICER FOR THE WEEK.**—Lieut. C. E. Campbell.

**NEXT FOR DUTY.**—Lieut. W. J. A. Watkins.

**DRILLS.**—Week ending Saturday, Oct. 27, 1917:—  
**MONDAY.**—No. 3 Coy., Left-half, Recruits, Signalling, 6.30.

**TUESDAY.**—Physical Drill and Bayonet Exercise, 7.30.

**WEDNESDAY.**—No. 1 Coy., 6.30.

**THURSDAY.**—No. 2 Coy., 6. Signalling, Ambulance, 6.30.

**FRIDAY.**—No. 3 Coy., Right-half, Recruits, 6.30.

**MUSKETRY.**—Belvedere Road, Tuesday, Wednesday, and Thursday, 6.30 to 7.

**NOTE.**—The Medical Officer will attend for Examination of recruits, etc., on Thursday, at 6.

Unless otherwise indicated all drills take place at Headquarters.

By order,

**MACLEOD YEARSLAY, Capt. and Adjutant.**  
 October 20, 1917.

**TO CORRESPONDENTS.**

We do not hold ourselves responsible for the opinions of our correspondents. All communications should be drawn up as briefly as possible, as there are many claimants upon the space allotted to correspondents.

It is particularly requested that all drawings and all communications respecting charts, illustrations or literary matter, books for review, etc., should be addressed to the Editor of the BUILDING NEWS, Effingham House, 1, Arundel Street, Strand, W.C.2, and not to members of the staff by name. Delay is not infrequently otherwise caused. All drawings and other communications are sent at contributors' risks, and the Editor will not undertake to pay for, or be liable for, unsought contributions.

When favouring us with drawings or photographs, architects are asked kindly to state how long the building has been erected. It does neither them nor us much good to illustrate buildings which have been some time executed, except under special circumstances.

\* Drawings of selected competition designs, important public and private buildings, details of old and new work, and good sketches are always welcome, and for such no charge is made for insertion. Of more commonplace subjects, small churches, chapels, houses, etc.—we have usually far more sent than we can insert, but are glad to do so when space permits, on mutually advantageous terms, which may be ascertained on application.

Telephone: Gerrard 1291.  
 Telegrams: "Timeserver, Estrand, London."

**TERMS OF SUBSCRIPTION.**

Twenty-six shillings per annum (post free) to any part of the United Kingdom; thirteen shillings for six months; for the United States, £1 10s. (or \$7 30c. gold). To France or Belgium, £10 10s. (or 42*fr.*).

To India, £1 10s. To any of the Australian Colonies, or New Zealand, to the Cape, the West Indies, or Natal, £1 10s.

\* Our Direct Subscription Agents for Australia are Messrs. E. T. Kibblewhite and Co., Printers and Publishers, 19, York Chambers, 105, Liverpool Street, Sydney, New South Wales; for Japan, The Maruzen Co., Ltd., 11-16, Nishibashi Tori Sanchoe, Tokyo—who will receive Subscriptions at £1 10s. per annum on our account. Copies of the paper will be sent by us direct to the subscribers' address.

\* The special rate to Canada is £1 10s. = \$7 30c. for 12 months, and 15s. = \$3 6*sh.* six months. Our Direct Subscription Agents for Canada are Messrs. Sells, Ltd., 302, Shaftesbury Buildings, McGill Street, Montreal, who will receive Subscriptions, £1 10s. per annum, on our account.

Cheques and Post Office Orders to be made payable to THE STRAND NEWS PAPER COMPANY, LIMITED, and crossed London County and Westminster Bank.

Handsome Cloth Cases for binding the BUILDING NEWS, price 2*sh.*, post free 2*sh.* 6*d.*, can be obtained from any Newsgazer, or from the Publisher, Effingham House, 1, Arundel Street, Strand, W.C.2

**ADVERTISEMENT CHARGES.**

The charge for Competition and Contract Advertisements, Public Companies, and all official advertisements is 1*sh.* per line of Eight Words, the first line counting as two, the minimum charge being 5*sh.* for four lines.

The charge for Auctions, Land Sales, and Miscellaneous and Trade Advertisements (except Situation Advertisements) is 6*d.* per line of Eight Words the first line counting as two, the minimum charge being 4*d.* for 50 Words. Special terms for series of six insertions or more can be ascertained on application to the Publisher.

**SITUATIONS WANTED AND PARTNERSHIPS.**

The charge for advertisements for "Situations Wanted" and "Partnerships" is One Shilling for Twenty-four Words, and Sixpence for every Eight Words after.

**SITUATIONS VACANT.**

The charge for advertisements for "Situations Vacant" is Two Shillings and Sixpence for Twenty-four Words, and Sixpence for every Eight Words after. All situation advertisements must be prepaid.

RECEIVED.—C. E. B. K.—D. J. S. and Co.—J. C. and Son—P. C. B. and Co.—B. and D.—S. W. F. and Co., Ltd.—J. D. and Son—C. A. Co., Ltd.—B. R. Co., Ltd.—Sir W. H. B. and Co., Ltd.—I. L. G. Co., Ltd.—W. J. R. W.—B. Bros.

**DOMES.**—Yes.

(P. R.—Thanks. No.

P. R. M.—They are not the same.

**BILL OF SALE.**—There must, of course, be a full inventory. 2 No.

R. W. W.—Thanks; but we prefer to do our own reviews, and not to receive them from publishers' agents.

Messrs. Trollope announce they have sold Lynton Castle, Kent, by private treaty in conjunction with Mr. A. J. Burrows (of Ashford). Consequently it was withdrawn from auction. We illustrated the great hall of the castle and described the building in our issue of October 3.

The Birmingham Town Planning Committee report that there is a shortage of 10,000 houses in the city. They consider that at least 5,000 houses a year should be built for the next twenty years to meet the city's requirements. The normal increase of population requires the provision of 2,000 houses each year.

**FRED. BRABY & CO. LTD.**  
**TANK MAKERS**  
**GALVANIZED CISTERNS AND TANKS**  
**GLASGOW, FALKIRK, BELFAST, & DUBLIN.**



# THE BUILDING NEWS

## AND ENGINEERING JOURNAL.

Efingham House,

### CONTENTS.

Strand, W.C.2.

Currente Calamo .. .. . 321  
 Specifications .. .. . 322  
 The Royal Society of British Arts .. .. . 323  
 Art on the Hire System .. .. . 323  
 The Heat-Insulating Value of Roofing Materials .. .. . 324  
 Magnesia in Portland Cement .. .. . 324  
 Federation of British Industries .. .. . 327  
 Our Illustrations .. .. . 327  
 Professional and Trade Societies .. .. . 328  
 Legal Intelligence .. .. . 328  
 Obituary .. .. . 328  
 Building Intelligence .. .. . 329

Correspondence .. .. . 329  
 Parliamentary Notes .. .. . 329  
 Trade Notes .. .. . 340  
 Our Office Table .. .. . 340  
 Tenders .. .. . vii.  
 List of Tenders Open .. .. . vii.  
 Chips .. .. . vii.  
 Latest Prices .. .. . viii.

K.C.V.O., C.B., Architect Mr. Alfred Drury  
 R.A., Sculptor.  
 Organ, Stalls, and Chancel Screens, St. Mark's  
 Church, South Audley Street, W. A Memorial to  
 the late Lord Stratheona. Mr. Charles J. Blom-  
 field, F.R.I.B.A., Architect.  
 The George Inn, Norton St. Philip, Somersetshire  
 Cranbourne Towers, Cranbourne, Dorset; and  
 The Drake Monument, Musbury Church, Dorset.  
 Sketched by Mr. Edward Swales, Architect.  
 Cranbourne Towers, Cranbourne, Dorset.  
 The Drake Monument, Musbury Church. Sketches  
 by Mr. Edward Swales.

OUR ILLUSTRATIONS.  
 New Hall, Ridge Green House, Surrey, Mr. E. W.  
 Poley, A.R.I.B.A., Architect.  
 The Main Entrance, Victoria and Albert Museum,  
 South Kensington, S.W. Sir Aston Webb, R.A.

### Currente Calamo.

The Housing Committee of the Surveyors' Institution has issued a report upon the causes of the scarcity of housing accommodation, supplemental to its recent report on housing emergency schemes. It discusses the scarcity, the cost of building and capital, the price of building land, the burden of rates, the influence of recent legislation (and especially of the Finance Act of 1910), the position of building societies and other points. It is pointed out that between 1909 and 1914 the combined cost of building materials and labour increased by more than 23 per cent., and that between 1889 and 1914 the rates per head of the population went up from a little under a pound to a little under two pounds—that is to say, they were more than doubled. The committee's recommendations dealing with the land taxes suggest that if increment value duty and reversion duty are to continue they should not apply to houses coming within the provisions of Section 14 of the Housing and Town Planning Act, that increment duty should be payable only in respect of realised increases in the actual value of the bare land, and that undeveloped land duty should be repealed. They well remark that "It is a matter for serious consideration by Parliament whether it is possible to justify the retention, in their present form, of imposts on a particular industry which have had so disastrous an effect upon a prime necessity of the health of the nation."

We are very glad Professor William Rothenstein's lecture, "A Plea for a Wider Use of Artists and Craftsmen," delivered last November at Sheffield University, has been republished in booklet form by Messrs. Constable and Co., Ltd., of 10, Orange Street, W.C. It is well worth re-perusal and sympathetic consideration, first, because it admirably expounds the real basic reason for the encouragement of art, which surely means the fostering of the urgent natural craving in all healthy natures for creation of one kind or another, which, if rightly directed, is the surest escape from the sordid and degrading influences of most human lives. This the Church

and State and our public bodies have forgotten, and the result is but too painfully evident in the efforts of well-meaning people who are contented to regard the appreciation of works of art as a necessary element of general culture. Next, because just now when we are busy setting up memorials to our heroic dead, it is surely most fitting that their fine sense of self-sacrifice should be interpreted in forms most useful to their fellows. Let some at least of our memorials, pleads Professor Rothenstein, take the form of public halls, libraries, club-houses, concert halls, round which some real life may gather. Why not even a repertory theatre, such as the Abbey Theatre in Dublin, where local men and women could themselves stage and act plays? Here would be many opportunities for using the services of local artists and craftsmen. The claims of these men and women on the municipalities have never yet been fairly considered. The students, it is true, are expected to serve local commercial interests as lithographers, textile designers, silversmiths, printers, and the like; but the more creative work which our towns require is generally given into the hands of contractors, or to men from other districts. No hope is held out to the proficient students that it shall be their task to make and paint the furniture, pottery, and tiles, carve the stone and woodwork, weave carpets, embroider hangings, execute metal work, and perform a dozen other such necessary tasks for the town hall and other public institutions. Surely it is time to recognise this and to mend matters. Then, indeed, in Professor Rothenstein's concluding words: "When people come from afar to visit this cradle of political freedom, they shall see on the face of our cities, towns, and villages a spirit which represents, not its material wealth and energy alone, but the gallantry, the solid good sense, and the high ideals of justice which are the basis of its power."

Mr. H. Baker, writing from 14, Barton Street, Westminster, to the *Times* of the 17th inst., makes a very timely suggestion, which we heartily hope may bear fruit. He points out that the decision of the War Office to issue chevrons for

each year of service in the war, suggests that in these, together with the bars already granted for wounds, we have the germ of a new heraldry, and that these badges should not be put without design on the uniform, but should be charged in accordance with the laws of heraldry on a shield placed on a prominent part of the body. On the same shield there might also be charges designating crosses, medals, or other military or naval distinctions. Such shields of honour should also be inscribed on the memorial plaques (for the design of which a competition has been instituted) to be given to the next-of-kin of those who have fallen in the war. It should also be engraved on the crosses or headstones in the cemeteries and on memorial tablets elsewhere. They might also be embodied in some form of art which would be given to every soldier and sailor on his discharge, and which would be cherished by his family and handed down to his descendants. Heraldry, which in mediæval times had such a real meaning in the life of the people, is now for the greater part a dead art as far as individual heraldry is concerned, though national and regimental heraldry might be made to have a more living interest than it has. But here in these bars and chevrons and crosses of honour, and in the other badges of differentiation in our Army which are growing out of much the same conditions as the forms of primitive heraldry, we seem to have all that goes to create a very simple but a very living and real heraldic art.

None of the many trades closely allied with our own industry has been more unwisely harassed by the Government since the war broke out, and it is but too evident that the proposed State control of timber after the war is certain to aggravate the present stagnation, simply for the benefit of State controllers. More than 500 leading members of the Timber Trade Federation met last week at the Cannon Street Hotel to consider the situation which has arisen out of the present Government control, and to adopt the resolution recommended by a special committee of the federation for submission to the various allied associations. Mr. Louis Bamberger, who presided, proposed a resolution assuring the Government of

the trade's desire to co-operate in measures for bringing the war to a successful conclusion. They only asked, he said, that they should be allowed to carry on their legitimate business with the minimum of interference from the Government, consistent with the national necessities created by the war. Their business was seriously prejudiced by the action of the Government. The resolution was unanimously carried. The next resolution, proposed by Sir John Fleming, was that the timber trade viewed with alarm the "imminent practical extinction of the import trade, owing to the action of the Government in placing restrictions in the way of importers," and asked that "unrestricted importation should be permitted and Government control of stocks should be limited, both in the interests of the country and for the purposes of the war." Sir John Fleming said that unrestricted importation of wood would assure supplies for the coming year. Two amendments were defeated by large majorities, and the original resolution carried. Mr. Arthur May (Bristol) moved a resolution protesting against Government control of timber after the war. He declared that after peace had been secured no English trader would stand any Government interference with trade. Mr. Remer (Liverpool) proposed an amendment to insert the words "British and foreign." This was seconded by Mr. Bailey (Exeter) and adopted, and the resolution, as amended, was unanimously carried. The Executive Committee was instructed to bring the resolutions before the Government.

Birmingham has very wisely decided to postpone the scheme for the widening of its arterial roads, which in many respects was a hastily considered one, and financially unsound. At the meeting of the Town Council last week the report of the Public Works Committee was presented by Mr. Talbot, who moved that the proposals with regard to the widening and improvement of the main roads should be approved, and the resolution was seconded by Mr. Harrison Barrow. A long discussion followed, and several amendments were moved. The first, by Mr. Sward James, objected to a separate track system for tramways, and to 110-ft. roads in built-up areas, for which the substitution of a width of 85 ft. was suggested. Mr. Bishop's amendment was in favour of deferring the consideration of the proposals until after the war, and Alderman Clayton, moving that the further consideration of the subject be adjourned, argued that the financial view of the scheme had not been properly dealt with in the report. Alderman Clayton's amendment was carried. A report of the Housing Committee containing replies to questions by the Local Government Board on the subject of the shortage of houses was approved, and discussion of the town-planning scheme for South Birmingham was adjourned to the December meeting. Both schemes need much more public discussion before either is proceeded with. Past experience has but too incontestably

proved that previous housing schemes in Birmingham have hindered private enterprise, and retarded rather than promoted the housing of the classes who really need it.

Many who will remember his vigorous drawing of a man's head from life, which we gave in our issue of January 19, 1912, and for which he was awarded the National Silver Medal, will be interested in the Memorial Notice of Julian Gould, by his father, Mr. Frederick J. Gould, illustrated by some excellent reproductions of Julian's drawings. The volume is printed for private circulation only, but friends can get a copy for half a crown from Messrs. Watts and Co., 47, Johnson's Court, Fleet Street, E.C.4; and separate copies of "Socialists Singing," or "Byron's Elm at Harrow," may be had from Mr. F. J. Gould at Armored, Woodfield Avenue, Ealing, for one shilling, post free, or the two for 1s. 6d. post free. Born in South Hackney on July 13, 1891, Julian Gould, removing with his parents to Leicester in 1899, passed from school to the Municipal School of Art, where he worked for several years under its able Director, Mr. B. J. Fletcher. From his earliest years he had displayed a passion for line and colour, and there could be no doubt as to his future career. The family removed from Leicester to Ealing in 1910, and Julian then spent a few weeks at a studio in Paris, little dreaming, doubtless, that he would die young in the defence of France. At seventeen he had drawn a design in which the genius of humanity is represented by an adaptation of Raphael's Madonna, and had accepted the teachings of Socialism. From 1910 to 1915 he worked as a printer's designer, utilising his holidays by visits fruitful in rural sketches, and in pilgrimages to cathedrals, above all, to Lincoln. When the Lusitania was sunk he joined the 16th Middlesex Regiment as a private, unhindered by "conscientious objections," hearing only the call of the British fellowship, and recognising that humanity's peril could not be met by non-resistance maxims. In November, 1915, he went with his regiment to France, and there for the next eighteen months the story unfolded in his letters home was that familiar to so many of us: "The tale of cold and heat, thirst, and of unwashed skins, vermin and mud, lonely dug-outs and firing marches and parades and dangers unceasing." On May 25 last he would, but for absence on special duty at Arras, have been allowed his first leave. Daily expecting him, his parents learned a little later that he had fallen in action early on the morning of May 31 last, killed instantaneously by a shell. "So," writes his father, "he would never paint the vision of Emancipated Labour." That he has died for it, and for other things dear to England, is the consolation and abiding memory of all of us who share his aspirations.

Mr. Ernest Reginald Ridgway, of 11, Lenton Road, The Park, Nottingham, architect, who died on July 19, left estate of the value of £13,129 16s. 11d., with net personalty £7,391 12s. 11d.

## SPECIFICATIONS.

In more than one recent case differences of opinion with regard to specifications have cropped up on professional evidence for and against the respective suitors. That such should prevail in the practice of prominent architects may be matter of surprise to some; that it obtains among others of less experience and of less general acquaintance with their profession is probably due to several causes, but all tends to one result, and that is failure. It is, perhaps, hardly so true as it was thirty years ago, that among a dozen architects that can draw not one can write a proper specification. Things are better—mainly because there is less fuss about the superiority of the sacro-sanct character of the art-architect and less disdain of the humble factors which are indispensable to the successful completion of any building, and a more general recognition of the fact that the fitness of a building is not secured by what the architect shows—or gets someone else to show for him—in his drawings, but what he embodies in the contract of which the specification and the quantities are the fundamental bases. There is also a broader recognition—perhaps we ought rather to say that there is a more sincere desire to recognise—that the line of separation between the designer and the workmen is, or should be, an illusive one, and that, so far as it unfortunately exists, it is nevertheless not one of the sort that still disastrously divides the designer and the manufacturer. A good deal also must be credited to the efforts of the Architectural Association to make specification-writing a really practical part of the student's education. Ordinary private pupilage the young architect got scarcely any such training, and he still does not get much. He never will get much anywhere till it is really practical—that is to say, till it is recognised that general classes are of little value, so far as the teaching of the student goes, if he is not taught what to specify in a building of any special kind, and made acquainted with the special trades. No general knowledge of mason's, bricklayer's, carpenter's and plasterer's work, or reinforced concrete will give him this. In any adequate classes of construction fittings alone should receive special attention in all their various applications, as in churches, schools, theatres, museums, laundries, hospitals, and other buildings. Plumber's work, skylights, swing doors, and sanitary appliances are also matters in which some architects are vaguely weak in their specifications. In all the foregoing the student should be required not merely to describe but to illustrate his specification by detailed drawings or sketches.

There may be something to be said for the attempts which have been made to classify specifications, grouping all belonging to each particular part of the structure, such as walls, floors and roofs, and to describe the work in reference thereto, and not as regards trades. It may help the memory in associating the various component parts of the portion of structure described—as, for example, the rafters, boarding, felting and slating of the roof. But we doubt whether this compensates for the greater facilities of distribution of the written instructions to the various contractors afforded by the older plan of specifying by trades. In either case the main thing is correct and complete description, and not so much leaving things to the builder "who knows my work." That excuse, at any rate, is not one that can be offered by the young architect who is just commencing practice, and who will find little help in the hackneyed formulae in old specifications to



cover his ignorance, or to elucidate his very inadequate drawings. We have one such specification before us at the moment in which the descriptions of a door and of a cupboard merely gave the thickness and number of the panels and kind of mouldings and framing desired, but not the least hint as to the proportion of the panels, their division or design. A marginal sketch would have made all clear to the puzzled joiner, who, with neither sketch nor drawing to guide him, is left to find for himself the dimensions of the doors and the heights of panels and widths of rails. In all cases, unless a detail is supplied, which it comparatively seldom is when the contractor or sub-contractor is asked to tender, the specification should describe everything clearly, as, for instance, in the description of a French casement the section of meeting stiles and rails to keep it weather-tight, and the kind of weather-bar and bolt for closing; the casement should be intelligently described if not shown by a sketch.

With special fittings generally, the two or three lines generally vouchsafed are absolutely useless; where their makers are to be relied on it is wiser to let them describe their own work, but engineers', smiths' and ironmongers' goods are particularly open to bad description. So it often is with the clauses describing horticultural buildings, heating apparatus and the like. In the decorative trades things are often as bad. In regard to these we have often been puzzled at the needless repetition of the matters perfectly well shown in the architect's drawing, and the entire omission of indispensable directions, which no drawing can show, but which should regulate, say, the foundation for and laying of parquetry, and the fixing of wall-linings and the like.

Many years ago—we remember commenting on it at the time—Mr. Rickman, in a paper read before the Sheffield Society of Architects, said that the drawings and specifications of many architects required synthesis or putting together, and that the work of the quantity-surveyor was analysis or putting together. Probably; but the successful architect must co-ordinate both faculties; for assuredly each trade which contributes to his design as a whole must be grasped in detail and in regard to its effect on the general result, whether as regards beauty or use. And this he cannot do unless his actually acquired knowledge of materials, dimensions, various fittings, specialities and patented improvements, and the names and prices of manufacturers of reputation and their prices, is as personal and intimate as his professions of devotion to the artistic impulses of his activity are real, and not merely the excuse for the neglect of the practical demands of his calling.

#### THE ROYAL SOCIETY OF BRITISH ARTS.

The hundred and forty-eighth exhibition of the R.S.B.A. naturally suffers by comparison with many of its predecessors, but there are not a few creditable pictures. We miss, of course, the contributions of some of its leading members, and the President, Mr. Frank Brangwyn, A.R.A., sends nothing this time. Altogether there are 242 exhibits and a small case of miniatures.

Mr. Hall Thorpe leads off in the Central Gallery with a pleasant scene, "In Buckinghamshire" (1), and has two good flower-pieces, "Flowers Among the Corn" (95) and a "Bunch of Wild Flowers" (105). Mr. Francis Black, the Secretary, sends seven contributions, "On the Conway" (2) is good, and so is his "Snowdonian

Range—Morning" (82). We like Mr. E. Hamilton Jackson's "Les Bordes—a Pyrenees Village" (6) very much; and Mr. Alex. Maclean scores well with his two subjects, "Light of the Moon" (7) and "The Moon Takes up the Wondrous Tale" (23). Mr. W. E. Riley, F.R.I.B.A., is deservedly well placed with "Mazda," (11) and we congratulate him on his début therewith in portraiture, and still more so in the portrait of "Joan A. D. Riley" (66). We shall be disappointed if Mr. Riley is not tempted by his friends to further proofs of his aptitude in this branch of our art, even if we lose some of the charming sea-scapes familiar to all visitors of previous exhibitions. His smaller, but very attractive, fourth picture "The Village Cross" (195), is naturally enhanced by his capacity for architectural effect, and is one of the most attractive renderings of its title we remember.

Mr. Hely Smith, the Hon. Treasurer, is well represented. "Over Hill, Over Dale" (14) is very good, and so are "Three Maids in White" (64) and "The Cooling River" (65). Of the four sent, Mr. H. John Pearson's "The Old Fisherman" (15) is, perhaps, the most attractive. Mr. Thos. F. M. Sheard's three portraits, C. Gibbs, Esq., M.A." (16), "Home on Leave: Driver H. Shepherd, A.S.C." (38) and "H. W. Sowden, Esq." (92), all do credit to their subjects, especially the second mentioned. Mr. Christopher Williams is diversely but equally successful with all his three contributions, "Dyffwys" (4), "A Moorish Market" (22), and "Chrysanthemums" (13). Mr. Charles Ince's two Fen-country pictures, "A Fen Farm" (17), and "A Fen Village" (31), are characteristically faithful renderings of the district they represent. Mr. Morley's "Winter Moonlight" (25), is another successful tribute to the charm of our satellite, even if, perhaps, less appreciated just now when its fullest development is less welcome than at other times. His "Above Loch Maree" (76) is also a decided success. Mr. Cyril Roberts sends two portraits, one of "Alderman May, Mayor of St. Pancras, 1914-15" (42), and the second of "W. T. M. Hawkesworth, R.E.A." (100). Mr. Trevor Halden's only contribution, "Fountain of the Mosque, Cordova" (24), is happily rendered. Mr. Fred F. Footlet has done well indeed with "Italy—Vincigliata" (26), and still better "Autumn Gold" (49), one of the most attractive pictures in the exhibition. Mr. Leonard Richmond's best of his three is "In the Cotswold Hills" (39). Mr. J. Howard Hale is another fortunate devotee of fair Luna, with his "Moonrise" (43).

Mr. John Muirhead, R.S.W., sends a delightful "Summer-day—Normandy" (50). "The Village of Wyton from Houghton Hill" (52). "At the Cross Roads, Houghton" (88), and "Across the Fields of Huntingdon" (157). Many Londoners will remember how much more picturesque old Haverford Bridge was before it gave place to the present hideous railway affair which the S.E. and C. Railway is so anxious to retain, as they inspect Mr. Philip H. Newman's "Recollections of Victorian London in the Forties" (62). "High Water" (66), by Chnji Kurihara, evinces quality of high promise. There is much that is to be commended in Miss Estella Canziani's two war scenes of Reims Cathedral (122 and 123), even if a little more clarity in the rendering of each is desirable. Her "La Sposa," (216) and "The Ravine, Savoy" (222), are also good.

Among architectural subjects Mr. John Eyre's "St. Helen's, Bishopsgate" (230).

Mr. E. M. Warren's "The Nave, St. Paul's Cathedral" (225) and Mr. S. Tyrwhitt's "The Old Ashmolean Museum, Oxford" (234), deserve special mention. Mr. Warren has also a very effective rendering of "The Tomb of Maria dal Carretto" (213).

In the vestibule Mr. Frank Richards has a large group of natives of "Egypt" (242). Not a few of the figures are very well done, especially those in the lower left-hand corner, where a fruit-seller is offering her wares to some of the bystanders.

#### ART ON THE HIRE SYSTEM.

The Omega Workshops, Limited, have taken advantage of the little exhibition of modern pictures and sculpture which has been arranged by Mr. Roger Fry at the Mansard Gallery to advertise their scheme for the establishment of what they call a "Picture Exchange." The idea is that, in return for an annual payment of two guineas, subscribers should be entitled to the loan of one oil-painting (or two water-colours), which they are free to change every three months if they so desire, or to keep for a year unless the artist particularly asks for its return, in which case it will be replaced by another. The Omega Workshops undertake to keep on their premises at least fifty pictures from which subscribers may choose. The artist on his side will receive 30s. a year for each picture lent out. The pictures will be considered to be on sale, and in the event of their being sold the subscriber through whom the sales are effected and the Omega Workshops will each be entitled to 5 per cent. commission.

The plan appears to the *Journal of the Royal Society of Arts* to be a very admirable one, which should appeal to those who care for a certain type of up-to-date art. It seems, however, rather astonishing, since it comes from the Omega Workshops, that it should hold good only for pictures. It would, of course, be rather more difficult to apply to pottery, metal-work, and the products of the other artistic crafts, but with a little thought it ought to be quite possible to work out a scheme which would be applicable to works of this kind. There would, naturally, have to be some special arrangement for insurance, but it would seem imperative that there should be something of this kind also in the case of pictures. With regard to objects coming under the category of Arts and Crafts, such an arrangement would have a double advantage. It would enable those not in a position to buy such things to have something beautiful about them, and it would give the rich buyer a chance of seeing how an object which attracted him would fit in with the scheme of his house, and whether or no he wanted to live with it permanently. It is to be hoped that some such idea as this may commend itself, if not to the Omega Workshops—who, after all, cater for a strictly limited public, and who provide only a certain type of very modern productions—then by some other organisation which makes a somewhat wider appeal. It is not only painters who have usually a certain amount of unsold work on their hands which they might be willing to lend in this way. It is really rather astonishing that amongst all the schemes set forth for encouraging the artistic crafts something of this kind has not been tried before now.

Mr. William George Bryning, surveyor for the West Riding of Yorkshire, died very suddenly at his residence at Northallerton, on October 7. He was much excited over the arrival home of his son from the Front.

Miss Righton, of Disley, Cheshire, has been appointed acting surveyor to the local rural council in place of her brother, Lieutenant L. Righton, who is going abroad. She is the first woman appointed to such a public office in Cheshire.

We regret to announce the death, killed in action on October 9, 1917, of Cyril Arthur George Lutyns, Lieut., Coldstream Guards, aged twenty years, dearly loved younger son of Mrs. 15a, Newcom Place, S.W.5, and another nephew of Mr. Edwin L. Lutyns, A.R.A., F.S.A., F.R.I.B.A.

### THE HEAT-INSULATING VALUE OF ROOFING MATERIALS.

Under certain conditions, says Mr. W. M. Thomson, D.Sc., D.Eng., Armstrong College, Newcastle-on-Tyne, in *Engineering*, where extremes of temperature are to be avoided, the heat-insulating property of a roof is scarcely less important than its strength and durability. In the last but one report of the National Physical Laboratory there is an account of a test of roofing by means of measuring the heat lost from a heated room, which leads to the remarkable conclusion that the rate of emission of heat by radiation from the covering surface has more effect on the inside temperature than the rate of conduction of heat through the material.

This result is of importance in the roofing of large factories of a semi-permanent nature, where the temperature depends more upon the covering than in the case of buildings having a closed air-space under the roof.

The emission of heat as low-temperature radiation is reversible in the sense that under the same conditions heat is transmitted at the same rate inward, or outward. One is the case in hot, the other in cold, climates, but a roof that will keep a building cool in summer will be equally effective as a winter covering.

The question having arisen in connection with the use of certain roofing materials, it was decided to repeat the National Physical Laboratory test by a method the reverse of that used by them. Instead of heating a room and measuring the heat lost through the roof, a smaller chamber was made by bolting together slabs of 3-in. thick "unburned cork," and exposing its cover to strong radiation. The box was made 18 in. square and 2 ft. deep inside, so that slabs of roofing of convenient size, such as slates, could be placed in position to cover the chamber without requiring special support. A light enclosure of three-ply wood rested on the top edges of the box and served to hold the "cover" down. Upon the top of this, at 2 ft. from the cover under test, an electric radiator was fixed consisting of strips of high-resistance metal, presenting when heated by a current of 10 amperes at 240 volts a bright red flat surface, radiating energy at 5 h.p. Space was allowed around the radiator for convection air currents to escape, while the top surface of the material under test was shielded from draughts. Thermometers passed through the walls, one near the top, the other at the bottom of the chamber, and the air within was circulated slowly by a light fan driven by an electric motor placed outside the box.

The test consisted in observing the rate of rise of temperatures in the chamber from the time the radiation was applied. The temperature of a thermometer with blackened bulb resting on a blackened cover of the box was 70° C. (158° F.), equivalent to strong direct sunlight. The rate covering slab under test is the same so long as the electrical current in the radiator is constant. The rise of temperature of the air within is equal to the heat received divided by the mass and specific heat of the air contained. There were 0.561 lb. of air heated, and the specific heat at constant pressure is 0.432 British thermal units per pound of air per degree rise. Thus the heat transmitted through the slab to the air is 0.157 British thermal units per degree C. rise when this is uniform. The thermometers were graduated in degrees Centigrade. The sets of observations could be repeated within 1 per cent., that is, as closely as it was possible to read the thermometers. The method gives 2001 comparative values; the absolute rate of transmission is dependent upon the mass of air contained, which because of expansion is less at the higher temperature. Since, however, the rise of temperature inside varies the thermal gradient through the cover the rate of rise is not constant for more than ten minutes after the start of steady state being reached in about an hour. It is this initial steady rate of rise that has to be determined, and the expansion of the air does not appreciably affect the first few readings.

The results, tabulated in the next column, confirm the National Physical Laboratory

conclusion that the heat-insulating value of a roofing material, under conditions as nearly as possible those to which it is to be exposed, depends more upon the nature of its surface than upon its thermal conductivity. A sheet of galvanised iron was obtained on which the crystal surface of the alloy were fresh and bright. Such a surface is practically a mirror, and as will be seen, only 111 heat units entered per 100 sq. ft. per hour. But that the heat transmitted depends largely on surface conditions was seen at once by the increased rate of transmission caused by blackening the surface facing into the box, the outer surface being unchanged. Half as much more heat then passed. Reversing the plate, so that the outer surface was black and inner bright, more than doubled the last rate, and when both surfaces were blackened the large amount of 581 units per hour was transmitted. These results were confirmed by tests on corrugated iron taken from actual roofs. When blackened above and left solely by use below, but otherwise untouched, 472 units entered. This clearly proves that the thermal conductivity of the plates, which was the same throughout, has in the case of iron coverings less influence than the emissivity of the surface upon the heat transmitted. Old galvanised iron allows more heat to pass than glass, a remarkable result. The slates are good, but in proportion heavy. Deal boarding covered with asphalted felt, though thick, is not so heavy as Welsh slate, and is one of the best insulators. In this case its poor conductivity is evidently not negligible, and in all thick roofing materials it is probably of importance.

Heat Transmitted through Roofing Material Exposed to Strong Radiation.

Material.	Rise of Temperature in Chamber, Deg. C. per Minute.	British Thermal Units per 100 sq. ft. per hour.	Thickness in Inches.	Weight in Pounds per Square Foot.
1. Bright galvanised iron sheet	0.258	111	0.04	1.6
2. Galvanised iron, blackened below	0.40	168	0.04	1.6
3. Galvanised iron, blackened above	0.93	385	0.04	1.6
4. Galvanised iron, blackened above and below	1.40	581	0.04	1.6
5. Galvanised corrugated iron after one month's exposure to the weather	0.75	310	0.033	1.28
6. Do. one year in use	1.02	422	0.023	1.28
7. (6) painted black above and below	1.15	472	0.033	2.28
8. Roofing glass serrated	1.40	453	0.22	2.25
9. Welsh slate	0.81	337	0.17	2.9
10. Westmorland slate	0.60	248	0.25	4.8
11. Zinc, T.G. deal covered with asphalted felt	0.30	124	1.0	2.6
12. Corrugated Fibrocement after one month in use	0.78	325	0.2	1.8
13. Do. after one year in use	0.80	334	0.2	1.8
14. Do. painted dead black	0.82	341	0.2	1.8
15. Do. "Aluminium finished" outside	0.50	207	0.2	1.8
16. Do. Lead on top of zinc asphalted felt	0.51	211	0.25	2.0

In the National Physical Laboratory tests a comparison was made between galvanised corrugated iron and an artificial roofing material containing asbestos, of which "Fibrocement" is an excellent example. By the kindness of the British Fibrocement Co., of Erith, Kent, results of tests made on their roofing are also given. Two important facts are at once evident, the material has the same order of heat insulation as Welsh slates, the properties of which, in thickness and lasting power, it was presumably made to imitate. Between 35 per cent. and 50 per cent. less heat passes through it, even when it is blackened, than through old galvanised iron. Aluminium-painting the outer surface, so as to give it a brightness approaching new galvanised iron, greatly reduces the heat passing.

A suggestion was made in the National Physical Laboratory report that air-spaces in roofing materials might be advantageous. A satisfactory means of doing this is to lay corrugated asbestos cement plates on the thinnest asphalted felt or other light sheet material, supported by the roof frames. The effect of this is shown by the table to be equal to

that of an aluminium surface, and where heat insulation and lightness are of the first importance a strong and efficient roofing can be made in this way at a reasonable cost.

### MAGNESIA IN PORTLAND CEMENT.\*

In order to determine what new constituents are produced in Portland cement, when the magnesia content is raised, considerably above that permitted by present standard specifications, and in order further to determine what effect these new constituents would have upon the physical properties of the material, a number of cements were burned in the rotary kiln of the bureau. In these the magnesia content varied from 1.7 per cent. to 25.5 per cent. In all 18 different cements were produced in two series of nine burnings each. In both series the compositions were those of normal cements, excepting the magnesia content only. But in one case the silica content was somewhat higher and the alumina content somewhat lower than in the other case.

As raw materials, clay, kaolin, feldspar, limestone, and dolomite were used. In the one series, the cement of lowest magnesia content was made of a raw mix containing limestone, clay, and a small amount of feldspar, the latter being added to increase the silica-alumina ratio over that obtainable with clay and limestone alone. The magnesia in the other burns of this series was increased by replacing the limestone with dolomite. In the second series the raw mixes were composed of clay, limestone, and a small amount of kaolin, the latter being used to decrease the silica-alumina ratio over that obtainable with the clay alone. In this series, also, increasing amounts of limestone alone was used, with dolomite, until dolomite alone was used.

The department of the high magnesia cements in the kiln was very characteristic. There was a reduction of the clinkering temperature with increasing magnesia content, though to produce satisfactory clinker this was not as marked as expected. But to prevent the dusting of the clinker of the higher magnesia content cements it was necessary to over-burn to a very hard, vitreous mass. This mass in the kiln was about of the consistency of putty, and as a result there was a decided tendency to form "logs" and "rings." The clinker was also of a reddish-brown colour, which gave a decided brownish tinge to the ground cement.

A microscopical examination of the clinker showed that increasing amounts of magnesia produced an increasing size of crystals and granularity. When the magnesia exceeded 8 per cent., a constituent (monticellite) not present in normal cement was noted. When the magnesia was still further increased to an amount exceeding 10 per cent., another constituent—spinel—not present in normal cement, was also noted. It was also noted that those constituents—tricalcium silicate and tricalcium aluminate—which produced quick setting and early strength, were not materially decreased by the appearance of the new constituents; whereas, the orthosilicate of lime, which produces the later hardening and modifies the early setting of the other constituents, was decidedly decreased in amount.

The effect of the higher magnesia, when not exceeding 8 per cent., was not very noticeable in any of the physical properties. Higher amounts produced a quick initial set and an apparent slow final set. The strength both in tension and compression of neat and mortar specimens, and of concrete specimens in compression, when 8 per cent. was not exceeded, was very comparable with the strengths produced by cements of normal magnesia content. Above these amounts the early strengths were less, but showed a consistent gain with age.

Specimens are still available for examination and breaking at later periods than those reported in this paper.

The Corporation of London intend to carry out repairs and renovations at the Mansion House for the coming mayoralty at a cost not exceeding £700.

\* Communicated by the Director of the U.S. Bureau of Standards to the Journal of the Franklin Institute.



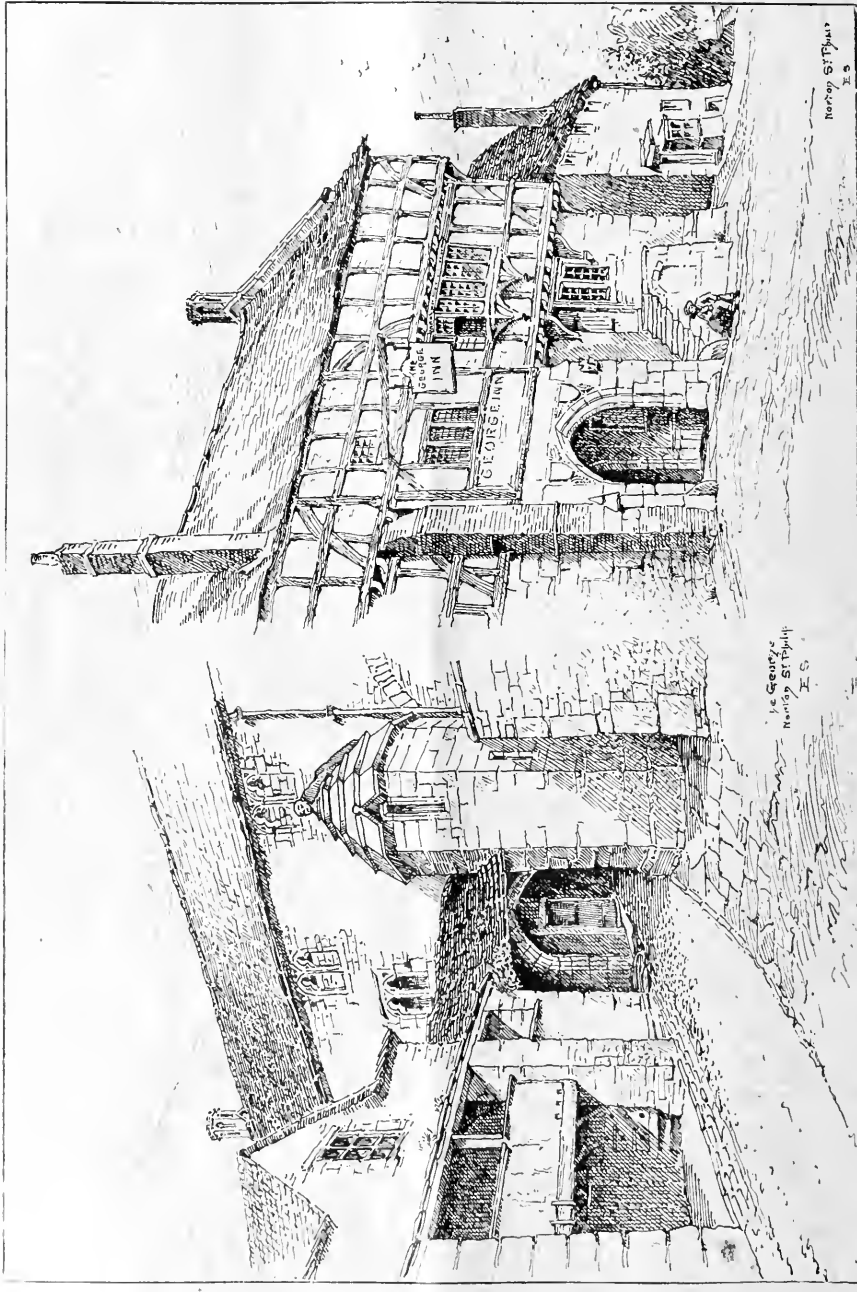

"THE GEORGE INN," NORTON ST. PHILIP, SOMERSETSHIRE.—Drawn by Mr. EDWARD SWALES, Architect.



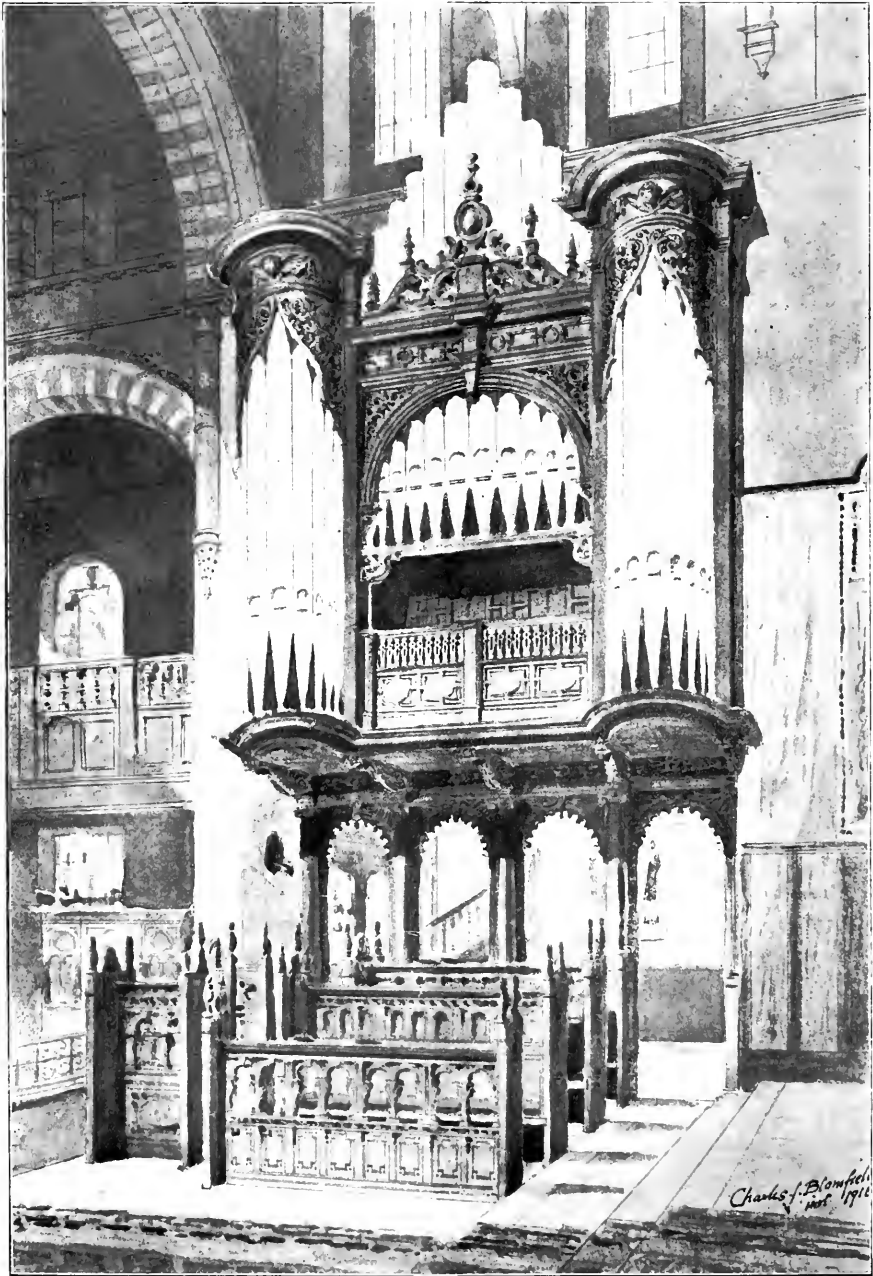

ORGAN AND CHOIR STALLS, ST. MARK'S CHURCH, SOUTH AUDLEY STREET, W.  
MEMORIAL TO THE LATE LORD STRATHCONA.  
MR. CHARLES J. BLOMFELD, F.R.I.B.A., ARCHITECT.





THE BUILDING NEWS, OCTOBER 24, 1917.

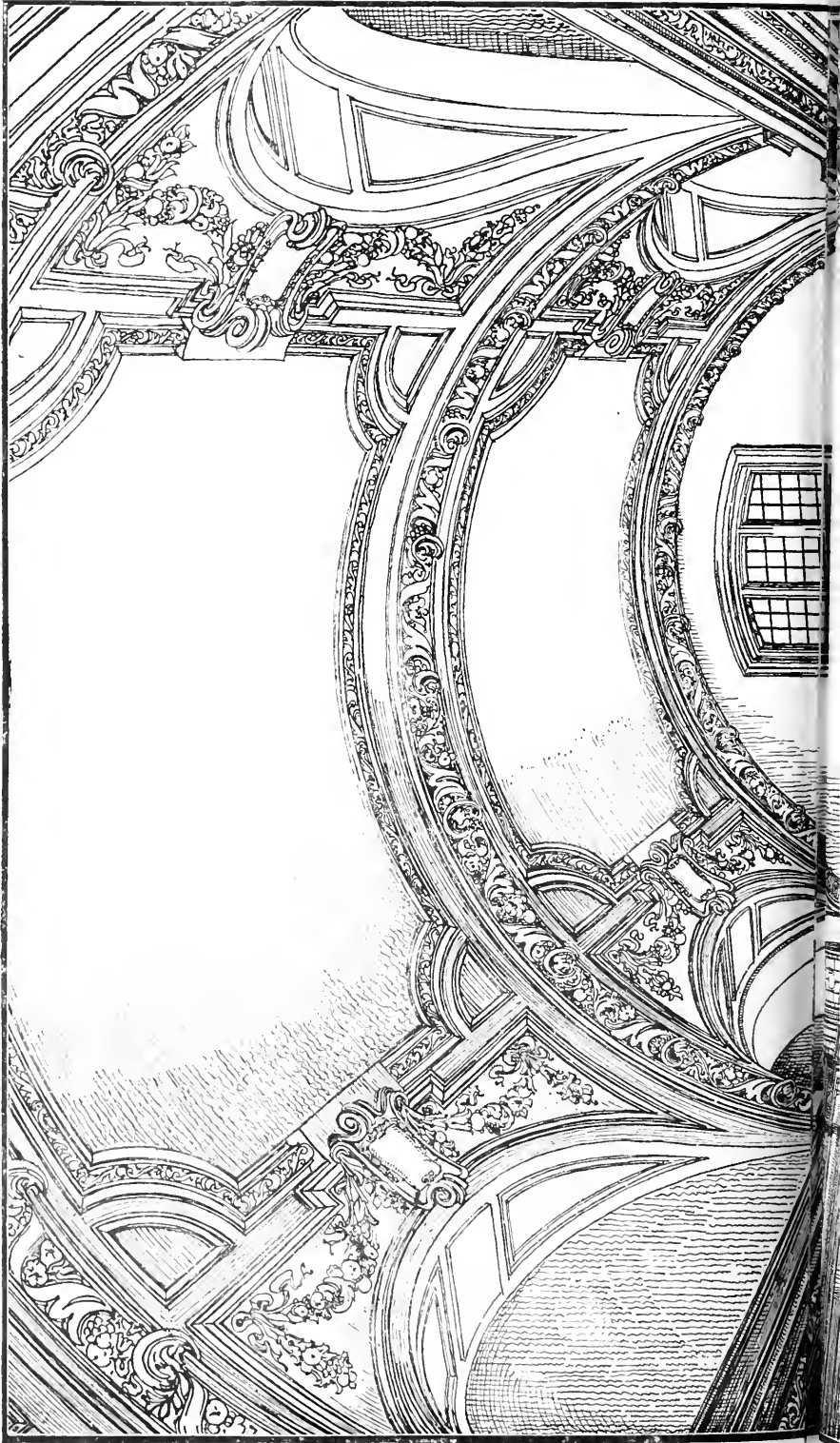



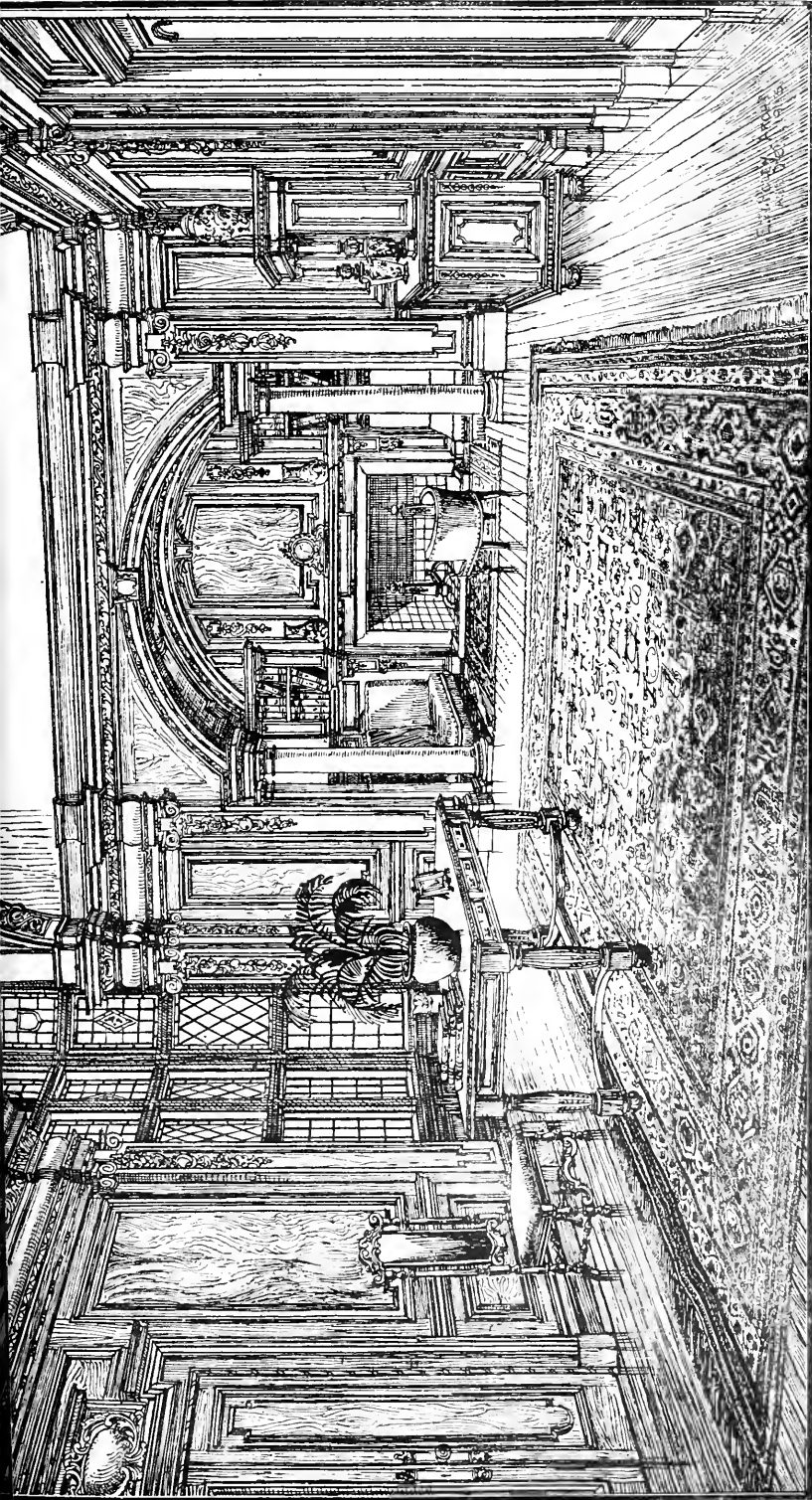

NEW HALL, RIDGE GREEN HOUSE, SURREY : PART OF PROPOSED ALTERATIONS AND ADDITIONS.

Mr. E. W. FOLEY, A.R.I.B.A., Architect.



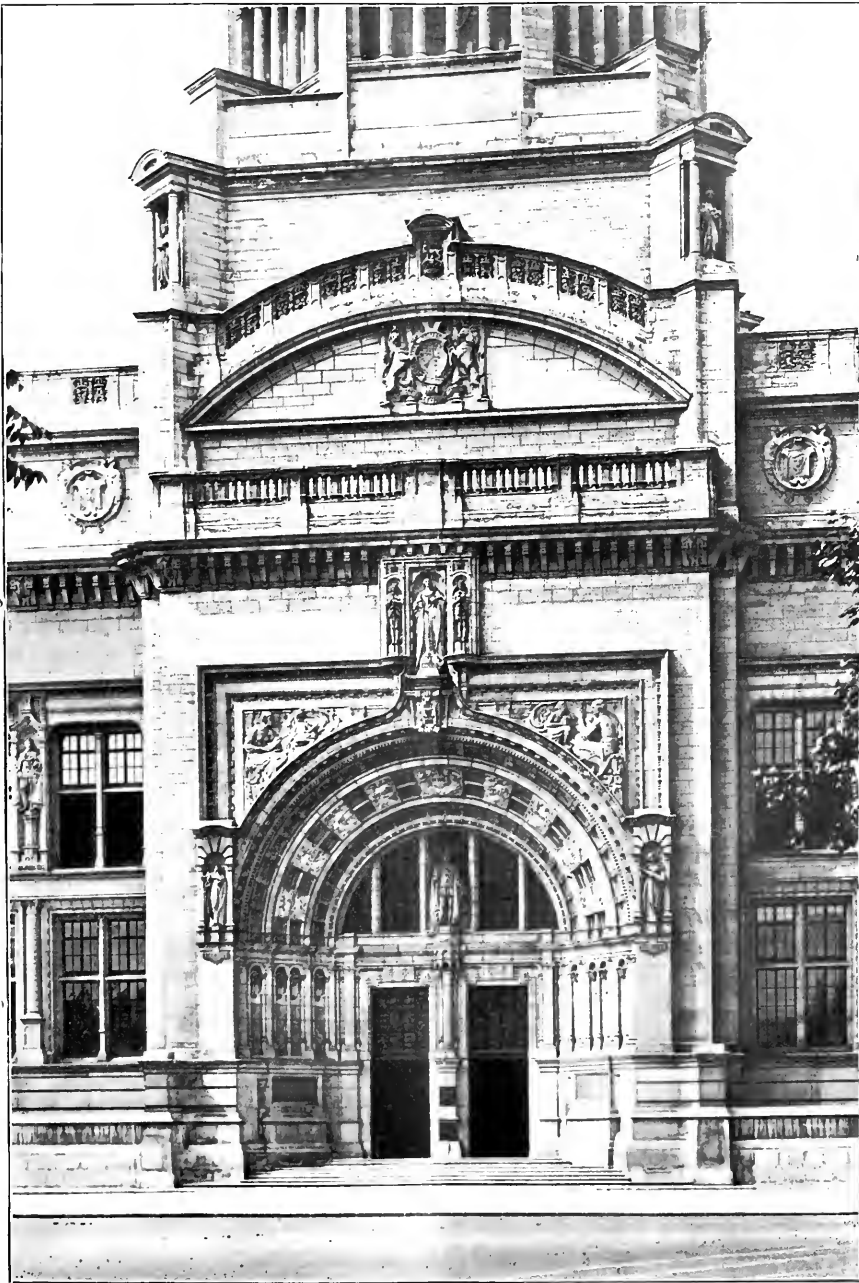

THE MAIN ENTRANCE, VICTORIA AND ALBERT MUSEUM, SOUTH KENSINGTON.  
Sir ASTON WEBB, R.A., Architect. Mr. ALFRED MURRAY, R.A., Sculptor.



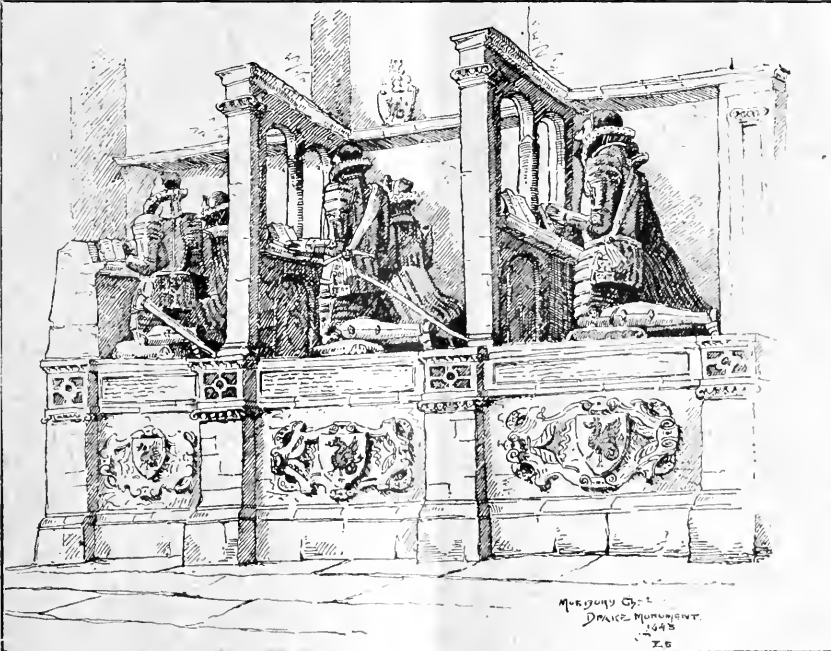
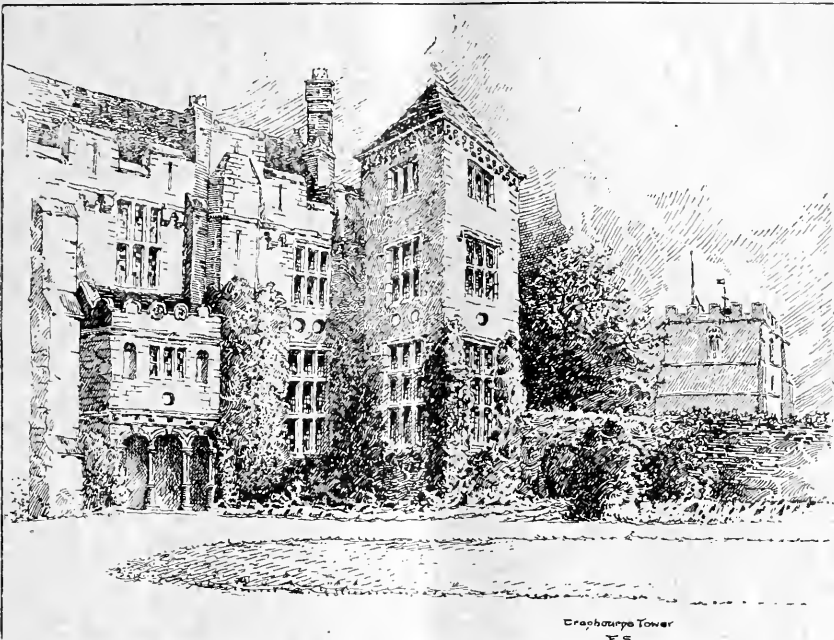

CRANBOURNE TOWERS AND THE DRAKE MONUMENT, MUSBURY.

Sketched by Mr. EDWARD SWALES, Architect.

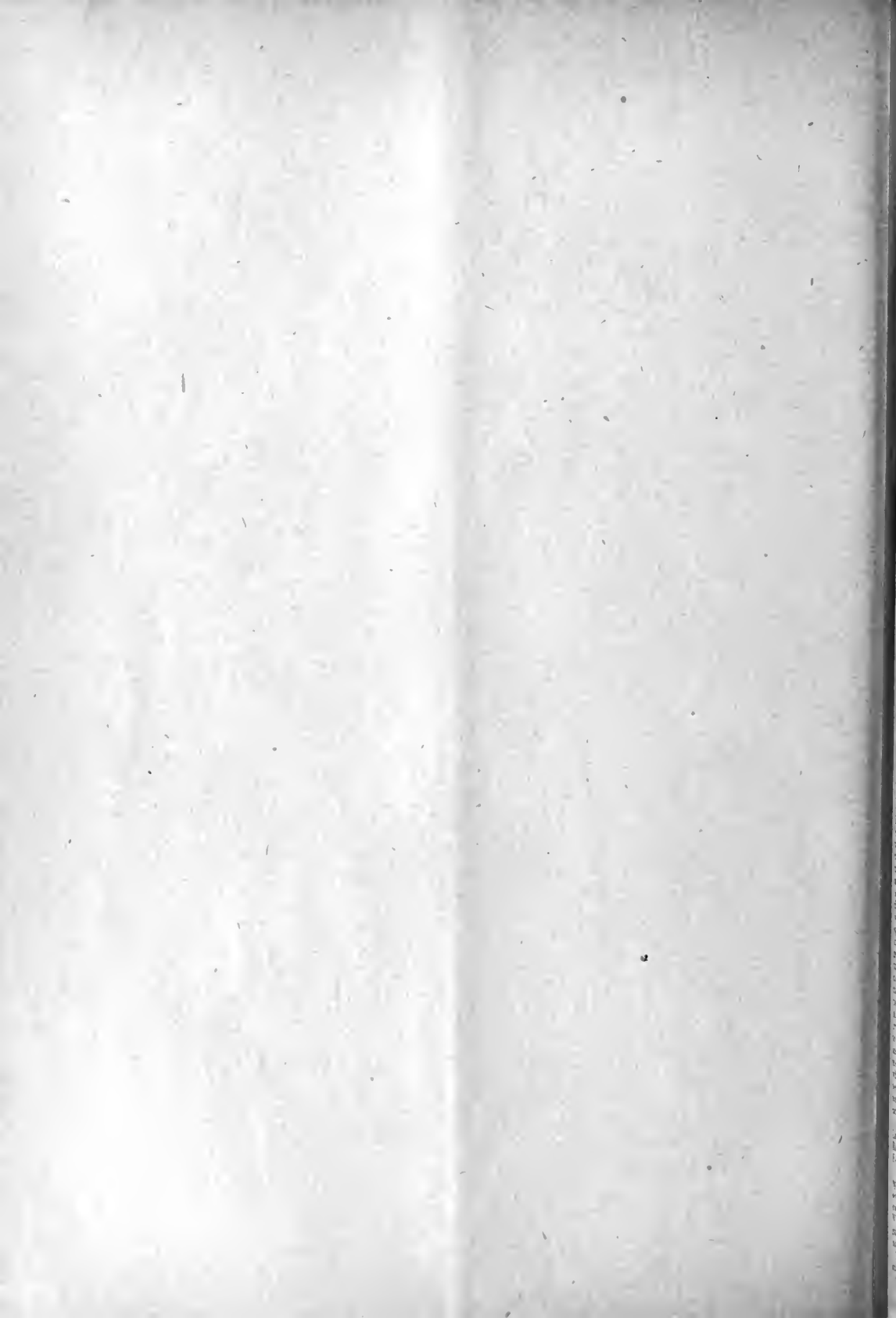

## FEDERATION OF BRITISH INDUSTRIES.

The annual meeting of the Federation of British Industries, at which over 400 representatives were present, took place on Friday, the 19th inst., at the Connaught Rooms. The retiring President, Mr. F. Dudley Docker, C.B.; in his address, congratulated all present that they had come through their first year so successfully.

He said: "A question that I know must be considered by the Federation is the policy of protecting our trade against foreign aggression. This is a subject of absorbing interest to us as manufacturers, and it is not one that can be disposed of in a rough-and-ready way. There is no summary solution. We must consider and determine if any duty should be imposed, and on what goods, and whether or not preference is to be extended to our overseas dominions, or to any and which of our Allies."

Again, we must consult with the Government as to the method by which any tariff, when constructed, can be used as a power to bargain with foreign nations. Personally, I am absolutely certain that we must have a power to bargain, but I strongly object to this procedure being called protection or tariff reform. This matter must have our earnest consideration, and I attach supreme importance to it, but there is a grave difficulty in our way. This Federation is an industrial association, and I should be sorry to see it in alliance with any political party. It would be detrimental to our interests to be labelled Liberal or Tory, or with any other political designation, and, unfortunately, the questions of free trade and protection have become party measures, and one or other is included in the respective programmes of the two great political parties. Should it become necessary in the judgment of the Federation to advocate the imposition of a duty on any article in the interests of the manufacturers of this country, I would not object to such action, for it would be done definitely in the interests of British trade, and not in the request of investigation of any politician. If such a duty were imposed, in my judgment it should be used deliberately as a means of bargaining with foreign Governments to obtain facilities and preference for British trade. I am quite ready to support action by the manufacturers, but I deprecate that this Federation should be called a Free Trader or Tariff Reformer. These terms belong to politics, from which this Federation should keep itself absolutely free.

"Another important question of pressing concern is the relation which education must bear to industry. A sub-committee has been considering the proposals formulated by the President of the Board of Education, and they have invited the members of this association to express opinions on certain subjects for the guidance of the committee. This question of education lies at the root of a great many of our difficulties. If we are to be successful in competition, we must provide for the better education of ourselves and our workpeople. One of the causes, in my opinion, of industrial unrest is the lack of knowledge; it is a fruitful agent for the generation of suspicion, and I therefore urge that the Federation should concern itself particularly in fostering in no niggardly spirit the spread of education. Allied with education is the sense of discipline. There is no doubt that the lack of discipline creates an irresponsible condition which is detrimental to all well-being. I think we should, one and all, do our utmost to help on such movements as the formation of cadet corps, which, while improving the physique of our young people, at the same time inculcates a respect for authority and a desire to play for the side rather than encourage selfish tendencies."

Sir Vincent Caillard (Messrs. Vickers, Limited) proposed the election of Sir Richard Vassar-Smith as president of the Federation for the ensuing year.

Mr. A. H. Dixon (the Fine Cotton Spinners' and Doublers' Association) in seconding the resolution, said he desired to couple himself with the remarks of Sir William Peat and Sir Vincent Caillard regarding the work and qualifications of their late president.

The resolution was then put and carried unanimously.

Sir Richard Vassar-Smith then took the

chair, and warmly acknowledged his election. As to the policy of the Federation, its objects, and the means by which they were to be attained, it was a great programme. If he came there at the end of the year and found he had given satisfaction, he should feel prouder than he had ever been in his life. He thanked them most heartily for the kindness of their reception.

Mr. E. Mauville (Association of British Motor and Allied Manufacturers, Limited) proposed that the following gentlemen be elected vice-presidents of the Federation for the ensuing year: Mr. Dudley Docker, Lord Abercromby, Sir Vincent Caillard, Mr. A. H. Dixon, Sir Algernon Firth, Sir Robert Hadfield and Mr. W. Peter Rylands.

Mr. F. V. Hiley (the Metropolitan Carriage, Wagon, and Finance Company, Limited) seconded the motion, which was carried unanimously.

Lord Abercromby (Palmer's Shipbuilding and Iron Company, Limited), in returning thanks on behalf of himself and the other vice-presidents, said he regarded this as one of the greatest movements in our commercial history, and they all regarded it as a very high honour to take part in that organisation.

## THE ANNUAL REPORT.

On the motion of Mr. F. Dudley Docker, C.B., seconded by Mr. H. B. Renwick (County of London Electric Supply Company, Limited), the first annual report was unanimously received and adopted.

Sir William B. Peat submitted a financial statement covering the period from August 25, 1916, to June 30, 1917.

The Chairman said they had every reason to be satisfied with the statement read by Sir William Peat. The financial statement was unanimously adopted.

Mr. W. Peter Rylands (the Iron and Steel Wire Manufacturers' Association of Great Britain and the Wire Netting Association) thought they would agree that the appointment of an executive council was probably the most important business with which their Federation had to deal. Having got their membership together, the next thing was to invite the members to formulate a constitution agreeable to themselves, but from the outset the executive were most anxious that members should not think they were going to have a constitution imposed upon the Federation in the choice of which they had not had a free and full share. A committee was appointed to consider the whole matter, and had made recommendations. The lines upon which those recommendations had been framed had been those of endeavouring to construct an executive which should be representative of industry by groups, so that each group of industry whose interests were more or less analogous should themselves directly elect their representatives to the executive. There were the big main groups of industries and there were sub-groups. They also got overlapping in many of the groups, such as that between engineering and the iron and steel manufacturers. Accordingly the view they took was that the best plan would be to take the big groups of industry as the basis, letting each group decide for itself the sub-divisions particularly appropriate to the group. They were proceeding upon those lines. The complexity of this question was very great, and perhaps they will extend their indulgence to the executive for not having been able to produce a scheme quite cut and dried for their meeting that day.

Mr. S. S. Somers (the Federated Forge-masters) seconded the resolution, which was carried unanimously.

Mr. Frank Moore (Messrs. Moore, Eady and Murrell Goode, Limited) proposed that the following gentlemen be elected trustees of the Federation for the ensuing year:—

Mr. H. Dudley Docker, Sir R. Vassar-Smith, Sir Vincent Caillard, Sir Algernon Firth and Sir Robert Hadfield.

Mr. H. James Yates (Messrs. John Wright and Engle Range, Limited), seconded, and the resolution was agreed to unanimously.

On the motion of Mr. F. R. Dayenport (Messrs. Williams and Robinson, Limited), seconded by Mr. Philip H. Lockhart (Messrs. W. and A. Bates, Limited), the meeting unanimously re-elected Sir Vincent Caillard as Treasurer for the ensuing year.

Mr. F. C. Fairholme (Messrs. Fifth and Sons, Limited) proposed that the firm of Messrs. W. B. Peat and Co. be re-elected as auditors for the ensuing year.

Mr. George E. Alexander (the Association of Glass Bottle Manufacturers of Great Britain and Ireland) seconded, and the proposition was unanimously agreed to.

Sir William B. Peat returned thanks, and a vote of thanks to the chairman concluded the proceedings.

## Our Illustrations.

NEW HALL, RIDGE GREEN HOUSE, SURREY.

The earliest portions of this country residence originally comprised a small old-fashioned house. In Early Victorian days that building was very considerably enlarged; extensions were then added to each front in a pleasing and picturesque manner. The work was carried out in brick and half-timber construction; black tiles of local make were used for the roof. During the past ten years Ridge Green House has been undergoing a scheme of remodelling, and the present continuation of this undertaking includes further enlargements on the north, east, and west sides. The hall will be located on the north front. Its sectional elevation internally is two stories in height. Our double-page perspective is taken from the west end of the hall to show the large angle and the adjacent bay window. A minstrel's gallery is situate at the other end. This serves also as a communication passage to the guests' chambers. Prior to the outbreak of the war it was intended to begin the work, and the intention was to carry out the joinery in African walnut, the barrel-vaulted ceiling to be in modelled canvas plaster. The architect is Mr. E. W. Poley, A.R.I.B.A. of Lancaster Place, Strand, W.C. W.C.

THE MAIN ENTRANCE, VICTORIA AND ALBERT MUSEUM, SOUTH KENSINGTON.

From this year's Royal Academy Exhibition we lately published a set of four double pages and one single-page plate illustrating the sculptures of this portal (see *The Building News* for June 27, July 4, 18, and August 8 last). These photographs were lent us by the sculptor, Mr. Alfred Drury, R.A. The archivolts figure panels are accentuated by the legend inscribed round the arch. "The excellence of every art must consist in the complete accomplishment of its purpose." As a key to these sculptured details Sir Aston Webb, R.A., exhibited in the same gallery an enlarged photograph of the central pavilion of the grand main facade, including the lantern tower. The exigencies of space determined by the war conditions prevailing just now necessitated a considerable reduction in our accompanying reproduction of the picture kindly lent us by the architect of the building. In order to show more clearly the relative positions and sequence of Mr. Alfred Drury's carvings we thought it best to only include the entrance portion of this elevational photograph, and by these means keep this part of the work to as large a scale as possible. From time to time numerous illustrations of this well-known and most excellent building have appeared in our pages. Among these we may specially name a four-page detail drawing of this great portal as issued in *The Building News* for January 3, 1903, and we published a big plate of the entire facade with plans on January 1, 1904. A descriptive note will be found in connection with the first of this series of Mr. Drury's photographs given on June 27 last.

ORGAN, STALLS, AND CHANCEL SCREENS, ST. MARK'S CHURCH, SOUTH AUDLEY STREET, W.

These additions have been erected in this church as a memorial to the late Lord Stratford, by his daughter. The work was carried out by Messrs. Dart and Francis, of Crediton, Devonshire, from the designs of



the architect, Mr. Charles J. Blomfield, F.R.I.B.A. The drawing was exhibited at the Royal Academy this year.

#### THE GEORGE INN, NORTON ST. PHILIP, SOMERSETSHIRE.

Mr. Edward Swales, an Oxford architect, has contributed three pen-and-ink sketches as well as the other pair on our second sheet of illustrations. Norton St. Philip is a little old-world market town located at the junction of two important public highways, one from Bath to Warrminster, the other from Trowbridge to Wells. The entire façade, sketched thirty years ago by Mr. Maurice B. Adams, will be found in our issue of August 19, 1887. Mr. Swales's drawing only shows the part of the street front at the right-hand of the main entry. His second sketch is of the back elevation. The over-sailing upper stories of half-timber and the bracketed bay windows give the street elevation a distinction seldom excelled, but the chief point, perhaps, about this front consists in the ground-floor stone bays to the left, not seen in to-day's sketch. In 1292 the Countess of Salisbury founded Hinton Abbey for a body of Carthusian monks. These Churchmen, with some enterprise, instituted a market at Norton St. Philip, where they dealt mostly in wool. This tavern was built by them during the fifteenth century as a guest house, though in all likelihood the premises may always have served as a hostelry. This, in all likelihood, formed an essential part of the monks' plan to foster trade for their market. The interior still possesses some capital rooms and wainscot panelling, though the house never presented much in the way of decorative finish. The original open fire-places have been bricked up and modern grates inserted. The rear of the building is very interesting, chiefly by reason of the stone stairway turret. The apex of its roof is terminated by a monk's head. The old crude gallery seen to the left of the yard is uncommonly picturesque. The Duke of Monmouth, it is said, slept at The George Inn, and narrowly escaped assassination in 1655 at the window which Mr. Swales has sketched.

#### "CRANBOURNE TOWERS," CRANBOURNE, DORSET.

"Cranbourne Towers" is the well-known manor house hard by to the small Dorsetshire town of Cranbourne, close to the parish church. The shell of the fabric is probably earlier than Henry VIII., the date usually assigned to its erection. Indications exist which have been thought to warrant the idea that the house was once fortified, and certainly the walls are of considerable thickness. Very little of the original place remains undisturbed. The towers at the corners were carried out in the time of Queen Elizabeth. These features supply the charm which characterises the appearance of the house. The porch seems to have been added rather later, together with the contemporaneous colonnade on the north side. A still later wing was built on the west, and this happened probably about two hundred years ago. This addition furnishes the most suitable part of the house for modern occupation, but the premises have lapsed into a state of disrepair. The court on this side is walled in, and a curious brick arch and two pavilions set angle-wise furnish a picturesque entrance. A beautiful colour distinguishes the old grey masonry of the walling, and the tiled roofs, protected by the few remaining battlements, harmonise quite well with the clustering brick chimneys breaking the skyline. The mansion surrounded by a well-earned for garden, so the manor furnishes a typical example of English manor in stone, recalling more eventful periods of its history, when the courts of Cranbourne Chase were held in its great hall, when miscreants were incarcerated within its dungeons as recently, perhaps, as James I. The two circular panels of the porch represent "Justice" and "Mercy." The manor still belongs to the Marquis of Salisbury. We gave a reproduction of the original drawing, by Joseph Nash, of the porch of Cranbourne Manor in THE BUILDING NEWS for September 11, 1894.

#### THE DRAKE MONUMENT, MUSBURY CHURCH.

This is an uncommonly curious and most unusual example of monumental design. Musbury Church is situated south of Axminster, on the road to Seaton, hidden among the trees, where there is an unpretentious farmhouse, the historic home of the Drake family, long known as "Ashe House." The Drakes of Ashe belonged to the elder branch of the family, and by all accounts they were proud and jealous kinsmen, who could not brook the more illustrious offshoot of their clan, best known to fame by the man who immortalised the name of Drake. It is reported that he suffered from their petty contempt at the Court of Queen Elizabeth. Authorities differ, and some have doubted this story as well as the familiar inference which gained credence therefrom to the effect that "Good Queen Bess" granted him arms with the "Red Wyvern" at the yard arm as a compensation for their insults. The owner of Ashe, John Drake, had a daughter Elizabeth, who married a Royalist named Winston Churchill. In 1650 they fled to Musbury, where a son was born at "Ashe House." He was baptised John, after his grandfather, and he became the first Duke of Marlborough, the victor of Benheim, Ramillies, Oudenard, and Malplquet. He died in 1722. His birthplace was burnt down when he was a child. The present building was erected about 1668 by John Drake, who had at that time lately succeeded to his father's baronetcy. Some fifty years subsequently the name of the family died out, and the tomb which we illustrate today is all that remains to keep the memory of it alive. A mile beyond, going south, is the hamlet of Musbury, and the sole feature of interest in the parish church there, is the monument of the Drakes of Ashe, herewith illustrated. The raised dais on top of the altar tomb is divided into three compartments by pierced screens in a picturesque way, each above the former being occupied by a knight in full armour, kneeling, accompanied by his dame, both represented in prayer, with their books in front of them set on sloping rests after the manner of faldstools. The panels of the front of the tomb below are decorated with the arms of the "Red Wyvern" in high relief, treated in the Renaissance manner with colour and gilding. These sketches are by Mr. Edward Swales, of Oxford.

#### PROFESSIONAL AND TRADE SOCIETIES.

LOWER THAMES VALLEY DISTRICT SURVEYORS' ASSOCIATION.—The annual meeting of the Lower Thames Valley District Surveyors' Association was held at the Town Hall, Twickenham, on October 6, when there were present Messrs. J. G. Carey (Heston-Isleworth), president; J. H. Briery (Richmond), T. H. Chambers (Hampton), H. G. Coates (Sunbury), C. H. Cooper (Wimbledon), M. Hainesworth (Teddington), R. W. Hindhaugh (Ham), F. W. Pearce (Twickenham), G. Stevens (Feltham), J. Stevenson (East Molesey), and Edward Willis (Chiswick). The balance-sheet and auditor's report were approved. The honorary secretary reported that the members during the past session had made excellent attendance, although busy carrying out their usual duties and the extra work falling upon them through the war. Among the questions considered were the following:—Representation on Local Government Board as to the desirability of local authorities considering at the present time works of public utility which should be carried out at the termination of the war; military road service in France; military roads and drainage of camps; lighting of public lamps during periods of aircraft raids; trough closets in connection with aircraft works; trees dangerous to users of highways; damage to wood paving by tranways; repairing of tranway tracks under war conditions; civic survey maps; discharge of effluent from sewage works into ditches and the taking of samples from same for analysis; methods of dealing with leaking sewers; the Uncontaminated Lands Order; the distribution of seed potatoes; the duties of coal overseers; the proposed national housing scheme, etc., etc. The following were unanimously

electd officers for the ensuing session:—President, Mr. F. Sadler (now on active service in France); vice-president, Mr. G. Stevens; honorary treasurer and secretary, Mr. H. C. Freed; honorary auditors, Messrs. S. H. Chambers and R. W. Hindhaugh.

THE SURVEYORS' INSTITUTION.—The ordinary general meetings of the Surveyors' Institution during the coming session have been fixed for November 12 and December 10, 1917, and January 14, February 25, April 8, and May 6, 1918. The date of the preliminary examination is January 16 and 17, and that of the professional examinations March 18-22, 1918. The President, Mr. Arthur Lyon Ryde, will deliver his opening address at 5 p.m. on November 12. Other papers which have been arranged are "Agricultural Executive Committees and their work," by Harold V. Raffety, O.B.E., Fellow; "The Metric System in its Relation to the Surveyors' Profession," by Lieutenant A. J. Martin, Fellow; "The Effect of the War on the Present and Future Cost of Building," by Mr. E. H. Selby; "The Effect of Taxation on the Development of Mineral Estates," by Captain (late Professor) David Bowen, R.E., Fellow; and "Valuations for Mortgage," by Mr. E. W. Rushworth, Member of Council.

#### LEGAL INTELLIGENCE.

NORWICH BUILDER CHARGED WITH STEALING TWO PRINCIPALS—VERDICT OF NOT GUILTY.—At the Norwich Quarter Sessions on Monday week Albert Charles Taylor (42), builder, pleaded not guilty to an indictment charging him with stealing two King Rod principals, the property of Sarah Jane Coates. A further indictment charged him with receiving the principals well knowing them to have been stolen.—Sarah Jane Coates, widow, of 37, Thorpe Road, Norwich, said the principals belonged to her, and had given no permission to sell them. Witness described a visit by defendant to her house and the conversation that took place. "I have come," said Taylor, "to ask your forgiveness for the wrong I have done you in removing these principals from your property." He then said he was sorry he had done it, and could not think how he had come to do such a thing. He said that he was willing to restore them, and he would give 25 to any charity I might like to mention. I said: "I think we will leave charity out of this business. If you don't know how you got to do it, I think I can tell you." I said, "You knew that my daughter and myself were two unprotected women living here alone, and you thought you would never be found out." He then went on to say that he was very sorry. He begged for mercy for his wife and children. I said I thought he should have thought of his wife and children before he had done this wrong to me. He then begged me to withdraw the case, and I told him that it had been placed in the hands of the police, and that I could do nothing else. Edward Marshall Hall, K.C., who defended the defendant, in his address to the jury declared that there was no justification for these criminal proceedings, unless there was somebody who had got his knife into Taylor who had been using a baneful influence on Mrs. Coates to take away from her her natural charity, and had tried to convert an honest man into a criminal.—The jury returned a verdict of not guilty, and defendant was discharged.

#### OBITUARY.

One of Hampstead's oldest inhabitants has passed away in the person of Mr. Thomas Potter, who for many years carried on business as an engineer and metal founder and medieval metal worker in partnership with his late brother, Mr. Henry Arthur Potter, at West End Lane, Hampstead, and South Molton Street, Oxford Street. The iron and brass foundries stood on land now the site of a block of flats known as Welbeck Mansions, West End Lane, and the works extended from West End Lane to the Midland Railway. It was at these foundries that much of the metal work in connection with the late Duke of Portland's riding school and underground ballroom and tunnels at Welbeck Abbey was cast and assembled. The name Welbeck Mansions perpetuates this connection: The funeral took place on Wednesday last at Hampstead Cemetery.



## Building Intelligence.

**WHITEKIRK.**—On February 26, 1914, the ancient building of St. Mary's, Whitekirk, was burned by sacrilegious hands. In the hands of Sir Robert Lorimer the building has regained much of its pristine beauty. Of the exterior changes, the most noticeable is the raising of the nave roof and west gable to their former height. This portion of the building had been re-roofed in modern times at a comparatively flat pitch, which caused it to have a dwarfed appearance beside the massive tower and high-vaunted choir. The change has added dignity and symmetry to the whole building. The gable of the south transept has been rebuilt in sympathy with the rough character of the old masonry and finished with crowssteps like the Medieval porch and east gable. Indeed, the greatest care has been taken throughout to make the character and texture of all the new masonry in sympathy with the old. The window tracery, renewed in the eighteenth century, and other similar modern work was destroyed by the fire, and in the restoration the tracery of the old choir window has been taken as a model. Happily, the beautiful south-west porch, which is unique and is one of the most striking features of the church, suffered no injury from the fire. The changes within the building are more marked than those without. Only one real structural difficulty presented itself. The walls of the tower are of great thickness and immense weight, and the sandstone arches which support it had been so severely burned that soon after the fire cracks began to develop in an alarming manner. To attempt the removal and renewal of the old arches would have been dangerous. New arches were, therefore, built within the old arches, and the piers were faced with new stone carefully squared into the old pier. Grand central grot was then forced by hydraulic pressure into the old masonry above the new arches, the whole structure of the tower being thereby consolidated. The stone walls of the choir suffered considerably, and were sealing badly in many places. No attempt has been made to reface these walls, and only the roughest of the unevenness has been removed. The walls of the nave and transepts have been covered by a plaster having a rough texture and being finished with whitewash. The high-vaunted stone roof of the choir has survived, though its surface is charred. The roofs of the nave and transepts are finished in Scottish oak boarding, divided by moulded ribs, with carved bosses at the intersections. The vaulted roof of the tower, which was formerly plastered, and had plaster ribs, has been finished with stone ribs and rubble masonry infilling. The furnishing of the church cannot be completed till the war is over, but its plan is already apparent. The gallery will not be repeated. The Haddington gallery, in the north transept, which was introduced in 1762, has gone, making way for a tracery window in the north wall, while in the absence of the staircase which led to this gallery, has allowed the vestry and session-room to be placed outside and east of the transept instead of within it, as formerly. The lean-to gallery on the north side of the nave, which was erected in 1832, and into which MacGibbon and Ross likened to a large Dutch cabinet, has been transformed into an aisle, known as the Seacliff aisle. The Classical erection in wood which was placed against the east wall of the church, where the Medieval altar and reredos stood, and which formed the pew of one of the principal heritors, has also gone, giving place to the holy table. The lovely choir, built in 1459 by Adam Hepburn of Hailes, "all arched with stone, agreeable to the mode of Peter de Main," will now be used as a choir, and will be furnished with suitable stalls, facing north and south. The stained glass window in the west wall of the church in memory of the late Countess of Haddington has been reproduced. In the Seacliff aisle a four-light window has been erected by Mrs. Lowry. The south transept has a small tracery window in the gable, it being the intention to place the organ against this wall. The little quatrefoil window at the

east end of the choir has been filled with stained glass by Sir James Balfour Paul in memory of his brother, a former minister of the parish. All the other windows are meantime filled with crystal glass in diamond-shaped panes. At the west end of the church, below the Haddington window, stands the baptismal font, and near the east end has been placed the holy table. Both of these are made of similar stone to that of the building. The pulpit, which is of Scottish oak, stands against the south-east pillar and faces nearly west. The church was reopened last Thursday by the Moderator of the Church of Scotland, Professor Cooper.

## Correspondence.

### THE WESTMINSTER MEMORIAL CHAPEL.

To the Editor of THE BUILDING NEWS.

It is satisfactory to note that Mr. Woodward has much improved on his original design for the suggested memorial chapel. In his earlier sketch he foreshadowed a repetition of the Abbey itself on a reduced scale and of a chapel of the type which already clusters in profusion about the apse. This surely would have been a blunder. He now suggests a building of the type of King's College Chapel at Cambridge. Instead, therefore, of having the addition of a building that would have been redundant, Westminster may be enriched with certain new features, in which at present it is lacking.

The drawing, as published in your recent issue, gives the impression that the chapel is too broad in relation to its length; but this effect of squareness may be an illusion due to the transepts being placed at the end of the building, giving it a T formation.

Again, are the windows sufficiently large or elaborated?

Here is an opportunity for a gorgeous colour scheme. Just as Henry the Seventh's Chapel is a poem in stone, so might the Memorial Chapel become a poem in stained glass. Being intended for ceremonial usage, the chapel would be as free as possible from internal obstructions, and, like the King's College Chapel or the Sainte Chapelle, at Paris, merely a shell of coloured glass, a proof that the twentieth century can match the craftsmanship of the thirteenth. The masonry of the outside walls might therefore be considerably reduced, and why should not each pillar buttress be continued into a pinnacle and capped by a small statue of a soldier or sailor in everyday garb?

The fleche, too: should it not crown the ridge of a high-pitched roof? In the drawing it has too much the appearance of being a steeple on its own account, unrelated to the rest of the structure.

Assuming that this Memorial Chapel succeeds in getting itself realised, the public will at length be permitted a glimpse into that closely-walled Abbey garden, at present apparently a grave scored to the east. And one day, perhaps, the canons may be moved to sow it with mignonette and with lavender and place seats for us, where we may rest and look upon the Abbey in its sunniest aspect.

Yours faithfully,

S. C.

The handsome Elizabethan mansion at Mell's Park, near Frome, the seat of Sir John F. F. Horner and his ancestors since the dissolution of the monasteries, was practically completely destroyed by fire on the night of October 13.

Private Percy Driver, only son of Mr. H. C. Driver, of 70, Bunage Hall Road, Levens, Salms, was seriously wounded on October 4 and died on October 10. He was educated at Mosley Road Council School, and later at the Salford Technical School. He was in business with his father, and was well known in the building trade. He joined the Royal Fusiliers in May, 1916, and went out to France in the following August, was invalided home at the beginning of February this year, and was again sent to France in May. He was 20 years of age.

## PARLIAMENTARY NOTES.

**THE STATUE OF PRESIDENT LINCOLN.**—Sir A. Mond, (Swinsea Town), answering Mr. King (Smeeth, N. L.) who asked whether a statue was recently granted in Palace Yard for the erection of a statue of President Lincoln; whether the right hon. gentleman had received a protest from America against the proposed monumental statue; whether before granting the site any artistic authorities were consulted; and what action he proposed to take, said:—My predecessor in office, Lord Beauchamp, offered a site in the Canning enclosure for a statue of President Lincoln, which His Majesty's Government have consented to accept from the American Centenary Committee. Having accepted the offer and provided a site, it is not the duty of the Government to question the artistic selection of the donors. No protest from America has been received by me. I need hardly add that His Majesty's Government and the country will warmly welcome a representation worthy of this illustrious American statesman in the capital of the Empire. (Hear, hear.)—Colonel Claude Lowther (Cumbria, Cuckfield, U.): Can the right hon. gentleman say what is the procedure in connection with the erection of public statues? Is this House consulted?—Sir A. Mond:—Mr. King: Are you to understand that this proposal, which has had a great deal of opposition and criticism both in this country and in America, is not considered without any delay or reconsideration?—Sir A. Mond: I think my answer shows that, having accepted the offer from America, and having granted the site, it is not the duty of myself or the Government to criticise, or act as arbiters in regard to the statue which the artists in America think worthy of President Lincoln.—Mr. Whitehouse (Mid-Lanark, L.): Has any definite statue been accepted yet?—Sir A. Mond: I am not aware what statue is definitely going to be erected.—Colonel Lowther: Why has not this house been consulted?—Sir A. Mond: It has been the practice, I understand, in the past, that the erection of a statue is in the discretion of the First Commissioner of Works.—Mr. Whitehouse: Is that the reason why our statues are all of such high artistic merit? (Laughter.)—Mr. Herbert Samuel (Yorkshire, Cleveland): Are we to understand that if the First Commissioner of Works grants a site for a statue to one who has any control as to the kind of statue to be erected for all time in the metropolis? (Hear, hear.)—Sir A. Mond: I must ask for notice of that question. On Monday last, replying to Mr. Butcher (York, U.), Sir A. Mond (Swinsea Town, L.) said: "I have not been the custom in the past for the First Commissioner to enter into formal consultation with any body of experts as to the artistic merits of any one statue to be erected on Crown property, nor do I know how any such body would be effective considering the wide divergence of views in all matters of art. Mr. Butcher next asked whether, in the case of the proposed erection of a statue of President Lincoln in London, the late First Commissioner of Works granted or promised to grant a site for the erection of such statue without having obtained any expert report on the artistic or other merits of the statue; and whether the Government were bound to give effect to a promise of that character if on proper consideration the erection of such a statue was considered undesirable." Sir A. Mond replied: My predecessor, Lord Beauchamp, offered a site to the Canning enclosure for a replica of the St. Gaudens's statue to President Lincoln on a request from the hon. member for Plymouth in this House on March 9, 1916. The statue by St. Gaudens is well known and generally considered to be of high artistic merit. I now understand that the American Committee for the celebration of 100 years of peace are anxious to send a replica of the statue of President Lincoln recently erected at Cincinnati and executed by Mr. George Gray Barnard, a sculptor of the highest standing, which they consider to be a superior monument, and I do not consider that I should interfere with the selection made by the donors, who, I understand, comprise men of well-known artistic standing. Mr. Butcher: Has the right hon. gentleman had an opportunity of seeing either of these statues or has he got any report on their artistic or other merits?—Sir A. Mond: I have seen reproductions of the statue, but I have not had an opportunity of seeing the statues themselves. I have had various accounts of their merits, and opinions differ, some preferring one and some the other.—Lieut. Colonel Sir J. Norton Griffiths (Wiltshire, U.) asked: In what circumstances and under what conditions could not be better used, Sir A. Mond thought, it extremely unlikely that tonnage could be found during the war for this purpose. Mr. Butcher: Would it not be de-

sable that the First Commissioner, who is not necessarily an expert in art, should consult some expert before pledging the Government and the country to the erection of a hideous statue? Sir A. Mond observed that it would be difficult to find anyone who was generally regarded as an expert in art.

MR. LASZLO.—Sir G. Cave (Sturrey, Kingston), replying to Colonel Faber (Hampshire, W., U.), who asked if he would state whether, seeing that Mr. Laszlo was a British subject, he would explain why he was interned instead of being put upon his trial for whatever offence he might have committed, said:—There was no legal evidence on which Mr. Laszlo could have been convicted of any criminal offence. If there had been such evidence he would have been prosecuted. But there was, in my opinion, grave reason for suspecting that he was engaged in activities which might prove dangerous to the public safety; and as he is a person of hostile origin I made an order for his internment under Regulation 14B of the Defence of the Realm Regulations. He can still be at present under consideration by the Advisory Committee in accordance with that Regulation.—Colonel Faber: Is the right hon. gentleman able to state who the neutral Minister was who forwarded the letter from Mr. Laszlo? Sir G. Cave: I had better make no statement until I have seen the report. Mr. King: Is it the fact that Mr. Laszlo was allowed to be represented by counsel before the Advisory Committee, although, as a rule, no counsel is allowed to appear there? Sir G. Cave: I understand the Committee followed the usual procedure, and no counsel appeared for Mr. Laszlo, although there was counsel in an adjoining room to be consulted by him. Mr. Hogge (Edinburgh, E. L.): Who were the eminent people who gave evidence on behalf of Mr. Laszlo, and who was the member of the War Cabinet who gave it? Sir G. Cave: I have seen the report. Mr. G. D. Faber (Clapham, U.): Will the report of the Advisory Committee be published in due course for public perusal? Sir G. Cave: No, sir.—Mr. G. D. Faber: In view of the fact that this person enjoyed consideration in well-known high social circles, would it not be very unfortunate if the public were not to be made aware of the case against him? The Speaker: That is a matter of opinion.

### TRADE NOTES.

Boyle's latest patent "Air-pump" ventilators, supplied by Messrs. Robert Boyle and Son, ventilating engineers, 64, Holborn Viaduct, London, have been employed at King Edward VII. Hospital, Newport Road, Cardiff.

In consequence of the expiration of their lease the Leeds Fireclay Co., Ltd., are on the 31st inst. removing their London offices to 357, Strand, W.C.2, adjoining the Aldwych Tube Station. Their telegraphic address is still "Fireclay, Ltd. London," and the telephone number Central 1794 (two lines).

The Bishop of St. Albans has unveiled a memorial bust and mural tablet which has been erected in the north transept of St. Albans Abbey to the memory of the late Rev. Walter John Lawrence, first Dean of St. Albans, who died in 1914.

The Bishop of Chichester dedicated recently a carved oak screen enclosing the side chapel of the Holy Spirit in All Saints' Parish Church, Hove. It was the gift of Major-General W. E. Marsland, Colonel of the 5th Dragoon Guards, in memory of all those who have fallen from the parish of Hove.

A fifth-century house in Nicholas Street, Ipswich, in which the father of Wolsey lived and in which the Cardinal was born, was sold by auction yesterday for £1,000. At the entrance to the house is an old Tudor corner-post the finest and most ancient in the borough.

The Duke of Connaught will, on November 2, move at the Royal Exchange the panel, which the Lord Mayor is presenting to Mr. E. O. Salisbury in painting, delineating scenes during the recent visit of the King and Queen to the front. Their Majesties and the Prince of Wales gave sittings to the artist.

Mr. Thomas Griffith Gwilym Castle, president of a meeting of the North Carmarthen County War Agricultural Committee, on Saturday, when it was decided that a meeting in connection with the War Agricultural Drainage Act would be held at Llanidloes, Anglesey, on Monday. It is expected that as a result of the important undertaking a large area of waterlogged marshes will be made fit for use and arable. The work will be undertaken by the Joint Agricultural Committee of Carmarthen and Denbighshire.

## Our Office Table.

Mr. Thomas H. Mawson, Lecturer on Civic Design at Liverpool University, who is interested with Sir Douglas Haig and others in proposals for the establishment of industrial villages for disabled soldiers, speaking at Lancaster, said in three weeks their proposals would be made public. After they had done all for the disabled through ordinary channels there would be 200,000 for whom no provision was made, and it was proposed to establish 200 to 250 industrial villages and settlements where a vocational training would be provided and the disabled placed in comfort and comparative independence under ideal housing conditions. Through nursery villages in connection with a huge scheme of afforestation to which the Government was committed, employment would be found for thousands more sufferers from shell shock and other complaints contracted on active service. The first of these nursery villages would be at Meathrop, near Grange-over-Sands. The Government had promised to subscribe or lend 80 per cent. of the money required for the building of the homes.

The "burial of a river" is an unusual feat, (in this country, at any rate) of civil engineering, but it has been accomplished at Hanworth Park, near Richmond, an estate of some historic interest acquired some time ago by Mr. J. A. Whitehead for the purpose of aeroplane building and testing. Across it ran the "Cardinal Wolsey" River, more generally known as the Longford River, a stream about 10 ft. wide, which, it is said, was used in Tudor times to carry fresh water to Hampton Court. In order to remove this dangerous defect the occupants of the site have had constructed a conduit, capable of passing 27,000,000 gallons of water daily, into which this stream has now been diverted, so that its bed may be filled and its banks levelled to give an unbroken flat surface for the aerodrome. The making of the subterranean passage has occupied many months, and several thousands of tons of concrete and nearly fifty tons of steel bars have been used in its construction. The size of the conduit may be imagined from the fact that just before the river was diverted fifty soldiers marched upright through the underground way. The Lord Mayor, last week, in operating the switch which diverted the stream, called attention to the unique character of the function, and congratulated Mr. Whitehead on his achievement.

The Council of the University of Bristol have considered a block plan, prepared by Messrs. Oatley and Lawrence, as a suggestion for the distribution of future buildings on the central part of the site, viz., that occupied by the Royal Fort House and grounds. In its general features the plan suggested the distribution of buildings round a large quadrangle, the length of which would be upwards of 500 ft., or double that of the famous Christ Church "quadrangle" at Oxford. Council accepted the architects' suggestion as to the site for a future new department of physics and for a future residential college, the students inhabiting which will enjoy a singularly favoured situation. The piece of land to the west of Tyndall Avenue was further placed for the present at the disposal of the botanical department for an extension of the existing botanical garden. The series of sites now in possession of the university will render it, when its buildings are completed, one of the most striking and picturesque piles of academic edifices to be found in the kingdom. Including the new Baptist College, which is in association with the university, an unbroken series of collegiate buildings will eventually extend from the front in Queen's Road to the very summit of the hill that is now crowned by the Royal Fort House, which will be preserved as a valuable example of thirteenth-century architecture.

The Government has decided that the new national housing scheme shall be controlled and directed by the Local Government Board. The returns and reports already received from the city, borough, town, and district councils throughout the country show that about

100,000 new workmen's dwellings are urgently required, but it can be stated that from 150,000 to 200,000 will be erected to meet the after-war conditions. It was intimated at the Local Government Board last Friday that the Government will be asked to make a grant of a subsidy of several million pounds for the erection of the houses, but this subsidy will be purely a temporary measure to meet the abnormal conditions that will prevail after the war. The type and size of the houses will vary according to the district in which they are built, but all the parts will be standardised, from the bricks to window fittings. In every possible case gardens will be provided for the purpose of food cultivation, and the Local Government Board will encourage the local authorities to purchase land for this purpose, it being realised that the working man's garden will be of national value in the years of world-shortage of food following the war.

Pipes made with a steel pipe driven to refusal and lined with concrete can develop not only the very considerable strength of the steel shell alone as an independent column, but the strength of the concrete core is materially increased by the shell acting as a continuous hooping, beside which there is an almost unlimited additional strength that can be obtained by the addition of vertical reinforcement bars. Such pipes, says the *Contract Record*, can endure very hard driving, can be thoroughly inspected inside, can have satisfactory bearing assured at the bottom, and can be reinforced to a high degree of strength, comparable with massive structural steel columns. This reduces the number of piles and the cost of driving, and gives freedom from all uncertainty or possible deterioration from subterranean obstructions. The large factor of safety in the shell permits the safe application of working loads before the concrete filling is hard, which is often an important advantage.

The Departmental Committee of the Local Government Board on Building By-laws, the investigations of which were suspended in consequence of the outbreak of war, is now in process of reconstruction, and its sittings, which will be resumed immediately, will synchronise to some extent with those of the inquiry which has been set on foot, under the chairmanship of Sir J. Tudor Walters, M.P., into the whole question of building construction in connection with the provision of dwellings for the working classes. The Building By-laws Committee as originally constituted was presided over by Mr. Herbert Lewis, M.P., the then Parliamentary Secretary to the Local Government Board, whose place on the Committee has been taken by the present incumbent of that office, Mr. Stephen Walsh, M.P. Another vacancy has been caused by the death of Mr. Pointer, the Labour member for the Attercliffe Division of Sheffield, and there may, and probably will, be other changes in its personnel. A deal of evidence was taken before the sittings of the committee were suspended, and this will now be resumed in the light of the fresh experience which has been forthcoming as the result of the continuance of the war.

A big improvement scheme for the Thames estuary is under consideration. It is suggested that deep-water wharves should be constructed at Canvey Island on the Essex side of the river, so as to facilitate the loading and unloading of vessels using the Thames. The island is far enough from London to escape heavy fogs, which often cause a loss of much valuable time, because ships at present are compelled to proceed higher up the river to take on or discharge cargoes.

The Thames Conservancy have granted permission to the Kingston Corporation to reconstruct a portion of their riverside promenade, extending 237 ft. beyond the present frontage.

The Holywell Rural District Council have submitted for the approval of the Local Government Board housing schemes for Peell's and Mestyn, which will cost about £15,000, and it is expected the work will be proceeded with immediately after the close of the war. The Holywell Urban Council are also preparing a scheme for the erection of new houses in the town, where they are badly wanted.

# THE BUILDING NEWS

## AND ENGINEERING JOURNAL.

### CONTENTS.

#### Effingham House.

Currente Calamo .. .. .	341
Royal Society of Painters in Watercolours .. .. .	342
" Thomas " .. .. .	343
St. Margaret's Church, Dunfermline .. .. .	343
Lettering on Green Cement .. .. .	344
Our Illustrations .. .. .	344
Correspondence .. .. .	344
Building Intelligence .. .. .	357
Miss May Morris on Design in Dress .. .. .	357
Obituary .. .. .	357
Statues and Memorials .. .. .	357

Legal Intelligence .. .. .	357
Professional and Trade Societies .. .. .	357
Trade Notes .. .. .	357
Parliamentary Notes .. .. .	357
Our Office Table .. .. .	358
Chips .. .. .	359
To Arms! .. .. .	359
Tenders .. .. .	360
List of Tenders Open .. .. .	360
To Correspondents .. .. .	360
Latest Prices .. .. .	viii.

#### Strand, W.C.2.

#### OUR ILLUSTRATIONS.

A House in St. James's, London, S.W. Entrance portal and vestibule. Ambrose Poynter, F.R.I.B.A., Lieut. R.N.V.R., Architect.
Shell Shock Special Military Hospital for Officers, Palace Green, Kensington, London, W. General plan. Views of entrance block, one of the garden courts, and the main entrance. Mr. Richard J. Allen, A.R.I.B.A. (H.M. Office of Works), Architect.

### Currente Calamo.

"It is well to clear our minds of cant," said Mr. Justice Younger from the Bench, when giving judgment in the recent case of "Graham v. Carter." And he did so then and there, in words that should ring through our Law Courts, once humorously styled the Palace of Justice. It was a trumpety action for trespass about a hedge and a ditch, which could and should have been brought in the local county court, and ended with £1 damages. The judge spoke of such a case as being always a scandal, and, in this time of war, it was an outrage. But we must quote his own words, which cannot be bettered: "The whole value of the strip of land in question cannot exceed the cost of one hour of the trial, and yet the case has monopolised the time of the Court for the greater part of four days; has kept at the service of the parties for that period the whole paraphernalia of Justice, as administered in this place; has absorbed the attention of four distinguished counsel and two eminent firms of solicitors, and has enlisted the usual complement of skilled witnesses and ancient inhabitants." Those who know are well aware that there are still many cases that pass through the Courts without comment, to which this plain speaking could also be applied! But what stung the judge most was the usual excuse that the action was brought by the trustees to protect the trust property. That was the cant to which he so strongly referred—as, in fact, an aggravation of the offence. "It is bad enough in time of war to absorb national energy in such a venture at your own expense. It is infinitely worse to embark in it the money and the property of others, who are thereby involved in the odium of the proceedings without having any voice in their institution or continuance." Such were the lashing words that fell across the shoulders of the "distinguished counsel" and the "eminent solicitors," who had to listen silently in their seats, knowing that they had advised this trumpety action to be brought and carried out solely for the costs to be incurred. The judge ordered plaintiffs to pay the costs,

but these will doubtless all come out of the "trust" funds, Mr. Justice Younger, after a fine career at the Chancery Bar, was only raised to the Bench in 1915. May we hope that, having begun so well in letting in light upon dark places, he will continue clearing away the costly cant that fills our courts of law?

The Osram Electric Lamp has won its case and is declared a valid patent. It was rather a near thing: the litigation has been long and laborious, but at last the judgment of the House of Lords, by a majority of three to two, gives it victory. The case of Osram-Robertson Lamp Works, Ltd., v. Topo's Electric Lamp Co., Ltd., has become familiar to the Courts. The plaintiff's action for infringement was heard at great length before Mr. Justice Joyce, who decided in favour of the defendants that there had been no infringement; this was confirmed by the Court of Appeal. Neither of these Courts went into the question of the validity which was raised by the defence, being content with holding that there had been no infringement, and so leaving out the real and most serious issue. But, in the House of Lords, the whole matter was dealt with faithfully and thoroughly. The main point of the plaintiff's patent was that they had applied the Welsbach system, as used with filaments of osmium, to the manufacture of similar filaments from tungsten. It had been found in practice that osmium filaments were not quite successful. The plaintiff's patent was therefore taken out to use tungsten. It is most important to note that Welsbach did not propose to employ any metals for his filaments, but those of the platinum group. As tungsten is a metal of the iron group, there was thus no anticipation in Welsbach's specification. The Lord Chancellor, in his clear and cogent judgment, pointed out all this, and also held that the application of an old method to a new substance could be good subject matter for a patent, if, as here, invention were shown. He held the plaintiff's patent to be valid on all grounds, and decided that the defendants had infringed it. Lords Parker and Atkinson agreed with him. Thus there were three strong judges against Lord Haldane and Parmoor, who held that there had been no infringement, and that

the patent was invalid for insufficiency, which is rather a technical objection. So the Osram lamp came out triumphant.

Municipal ownership would appear to be prejudiced when a city like Bristol pleads guilty to forgetting sites and losing rights. At the meeting of the Bristol City Council on the 23rd instant the only excuse worth the name seems to have been that it was all the fault "of the system"! Alderman Levy Langfield, proposing the adoption of the report of the City Lands Committee, said a number of irregularities had been discovered in dealings with corporation property, and the committee recommended that a proper record be kept of city properties and periodical inspections made. It was proposed that a new standing committee, on which other committees were represented, should have charge of this work. Alderman Gardner (chairman of the Estates Committee) said the advantage of the new system was that the same state of things would not occur again. Many properties had been forgotten. (Ironical laughter.) They belonged to committees who objected to hand over the care of the bits of land to the Estates Committee. For example, the Docks Committee overlooked the ownership of certain portions of ground remaining from improvements, and the ownership was allowed to pass into the hands of people who held possession. Alderman Gardner mentioned another case where the Floods Prevention Committee had certain pieces of land left when their work was finished. They ought to have been scheduled and transferred to the care of the Estates Committee, who had frequently been blamed for things of which they had no knowledge. Alderman Pearson held that someone must be responsible, and therefore someone must be blameworthy. Alderman Langfield said it was the fault of a system, and not of any person. The council did not wish him to go into twelve or fourteen cases, but he cited one. Alderman Pearson asked if they had not officials sufficiently sane to look after such matters. (Laughter.) Alderman Langfield answered that he was not the keeper of the sanitary officials. (Laughter.) An inquiry he made brought the whole of those matters out. Mr. Clutney urged that the duty of oversight should be handed to the Estates Committee. This

suggestion led to several speeches, and in the end the report was withdrawn to give an opportunity of consultation between the City Lands Committee and the Estates Committee, so possibly land-grabbing will not be so easy in Bristol.

We have read with great interest a small three-shilling book by Alex. Ramsay, just issued by Constable and Co., Ltd., 10, Orange Street, W.C., entitled, "Terms of Industrial Peace," in which the problems we have to face as soon as peace comes—which are mainly the evil fruits of our present industrial and economic system—are discussed with refreshing, because unusual, frankness and fairness. Mr. Ramsay has evidently practical knowledge, both as workman and employer, and he states the failings of both impartially; and, we think, realises the difficulties which bar the way to reform. It is perfectly true that the enormous profits of the large combinations have been made at the cost of the workman and the consumer. It is equally the fact that the stupid "ca' canny" policy of the workers is directly responsible in great part for our decline in production as compared with other nations. Mr. Ramsay quotes an American example of an industrial concern employing 900 men with an annual output worth £805. A sound similar British concern has an output of from £250 to £450. That is to say, the American output exceeds by two to three times that obtained here. Good organisation and well-paid labour—but labour employed to the extent of its fullest capability are the secrets. Yet, from time to time, we hear of bigger and bloodier strikes in America. Why? Mr. Ramsay is apparently in favour of State control of industry, and yet seems to recognise its failure here and now, and fully admits the slackness which is characteristic of the official. He condemns "Socialism," with its "roseate picture of garden cities . . . and brotherhood reigning supreme," and so do we; but that is not the "Socialism" which can transform Society. Very dispassionately Mr. Ramsay discusses education and environment, the mind of labour, arbitration, the limitation of profits, and moral responsibility, and in each case suggestively. If only the evil characteristics of our present system, the working for profit, and not for use, and the greed for luxury which seems almost inevitably to follow the piling up of riches, could be checked, one might hope Mr. Ramsay would be listened to. To us it still seems that the only road from impending ruin was that indicated in our issue of the 3rd instant, when we tried to suggest the only hopeful scope of the coming industrial revolution, fully recognising that the politician and the agitator will have little to do with it—except, perhaps, to cause bloodshed and distress, but that it will be wrought slowly but inevitably by the conditions of our times and the perception of their significance—aided, it may well be, by the victories of science, notably, in the equalisation of effort by the discovery and application of cheap power.

The heavy burden of local rates and their unfair incidence has become painfully obvious to us all—rich and poor alike—and there is, we think, much to be said for a proposal embodied in a paper read last Wednesday by Dr. Ebenezer Duncan, President of the Royal College of Physicians and Surgeons, Glasgow, at a meeting of the Royal Philosophical Society of Glasgow on the need for revision of the present basis of local taxation. Referring to the housing question in this connection, he mentioned that the Sanitary Congress in Glasgow had unanimously passed a resolution last month that the burden of local rates and taxes was a bar to rehousing the working classes at economic rents. The combined rates and taxes of house-owners and tenants amounted to an addition of 50 per cent to the rents. The result was to drive the poor man with a large family into the slums, where healthy life was impossible, and where the lives of the children were certain to be sacrificed, in spite of all our new sanitary legislation. He urged that they should put the whole of the present local burdens on a basis which would include taxation of wages and of income from every kind of property, personal and heritable alike. He advocated a graded income-tax down to the limit of £1 of weekly wage, with allowances for family and dependencies according to their number. Under such a system the poor man would pay much less than he did at the present time on his rental-taxation. The communal burdens would then be placed on the whole realised wealth of the nation.

Professor H. Maxwell-Lefroy, M.A., of the Imperial College of Science and Technology, and honorary curator of the insect house at the Zoo, has just presented to that institution a portion of oak timber taken from the dome of St. Paul's Cathedral, which has suffered from the unwelcome attentions of the wood-boring beetle, whose operations, frequently referred to in the House of Commons, have had so bad an effect upon the roof of Westminster Hall. At the same time a specimen of the beetle itself—the *Xestobium tessellatum*—has been added to the collection in the same department at Regent's Park, so that the general public may be able to see at first hand the destructive agent which is responsible for the spending of so much money on work of a restorative character. It will probably be news to many to learn that the roof of St. Paul's Cathedral has also been attacked by the beetle. The pieces of wood which have been placed on view afford a very good idea of the urgent need for an attack in force upon the pest.

The ways of the War Office (according to the London correspondent of the *Liverpool Post and Mercury*) are at times not without a touch of comedy. A very well-known modern artist was sent out officially to the French front to gather "impressions." On his return he held a successful exhibition of his paintings, which was visited by Royalty and the Government chiefs. He was amazed the

other day when he received a letter from the War Office asking when they might expect his drawings for publication. He replied that he had never made any drawings, and was a painter, not a pencil artist. Now a somewhat strained position exists, and as the artist is very futuristic in method it seems likely that the reproducing process will be difficult.

#### ROYAL SOCIETY OF PAINTERS IN WATER COLOURS.

We miss several veteran exhibitors at the Winter Exhibition of the Royal Society of Painters in Water Colours—notably Mr. John S. Sargent and Mr. D. Y. Cameron, both of whom are fully employed elsewhere; but there is plenty of good work on the walls, and the total of 259 exhibits is a respectable one for the times. Mr. Robert Anning Bell, A.R.A., sends five pictures, the best, we think, being "Pomona" (139). Mr. H. Hughes Stanton, A.R.A., is well represented, especially with his "The Cader Range, with Taly-Thyn Lake, North Wales" (32). Mr. Charles Sims is disappointing with "Paraphrase" (22), and not much more successful with "The Stork that Brought the Olive Branch" (67). Mr. J. C. Dollman's Sussex scenes are all good, particularly "Sussex—August" (109). Mr. W. Russell Flint has several good contributions, but "Bain Grec" (46) and "La Tour des Baig-neuses" (179) are certainly not among them. Much more welcome is his "Gareloch, Roseneath, and Clyde, above Helensburgh" (163).

Mr. Alfred Parsons, R.A., sends several of his always excellent flower pieces, including "Peach and Pear Blossom" (103), "A Group of Hardy Flowers" (136), "Clematis" (133), and a very interesting view of St. Cuthbert's, Wells, Somerset. Mr. A. S. Hattrick scores well with "The Assembly! 'Old Chelsea' Summons His Boys' Brigade" (76). Mr. A. Reginald Smith, a recently elected Associate, sends eight works all above the average, especially "A Yorkshire Farmstead" (61). Sir Ernest Waterlow, R.A., is, as usual, well to the fore with six contributions, "Plumpton Church, Sussex" (2), being among the best. Mr. W. Eyre Walker is prolific with nine, "The Isle of Wight from the Dorset Coast" (88) being, perhaps, one of the best of the many good things he has done. Mr. Claude A. Shepperson is topical with "Take Cover!" (220), a sketch in one of the tube station shelters. Mr. T. M. Rooke is characteristically fortunate with his reproductions of architecture, including "Lichfield's Spires" (19) and "The North Transept Doorway, Lichfield" (95).

A group of works by the late Reginald Barrett contains some of his best Venetian pictures and two others. There is also another group of those of the late J. Jessop Hardwick.

Captain Arthur Gerald Brian, Duke of Cornwall's L.I., was the youngest son of Mr. and Mrs. H. E. Brian, of Cairo, and of Holmby, Berkhamsted, and was 22 years old. He was educated at Berkhamsted School, and in July, 1915, gained a scholarship into the Architectural Association, Westminster. There he began the training to become an architect, but after fifteen months joined the Inns of Court O.T.C. He was gazetted to the Duke of Cornwall's L.I. in August, 1915, and went to the front in June, 1916. He died from wounds on October 15. His eldest brother, Second Lieutenant H. C. Brian, R.G.A., was killed in France on May 9, 1915.

"THOMAS."

The few architects who have found relaxation and, we hope, riches in the domain of fiction have usually pegged out their plot round some phase or personage of their own calling, or taken some incidents of its pursuit as their framework. Mr. H. B. Cresswell, F.R.I.B.A., has not much to tell us about "architecture" in "Thomas," just published by Messrs. Nisbet and Co., Ltd., 22, Berners Street, W., but he has, for all that, given us a genuinely amusing and not unconstructive story.

Mr. Thomas A. Quinn, an idle but well-connected member of the staff of the Malnutrition Department of the Statistics Office, Whitehall, whose stepmother is irritatingly anxious for him to marry and settle down, and whose domestic joys are much varied by his "dressings down" by Nita, his "half-nephew's young widow," who lives with her, is introduced to us on the eve of his holiday, which, officially, is for twenty-eight days, but which he determines by a liberal and ingenious interpretation of the rules to stretch to more than six weeks. This, though we believe a common practice in all Government departments, is mapped out with such original perspicacity that we can honestly commend the method to the careful study of all civil servants and other officials who have found the usual stale excuses pall on their chiefs. The six weeks Thomas determines to spend with his friends, the most eligible of which is the Duke of Sarum, who had peppered him once when out shooting, and was therefore surely good for a few days. The visits are to be made with the aid of Thomas's "faithful little car," "Silent Susan." Susan undoubtedly deserves a story all to herself which would speedily run through a dozen editions, if only as a *vade mecum* for motorists. She "gets there" eventually, as even his best chum, Bat Vernon, admits, but her vagaries on the road are many, as he confesses:—

"It took a little time to find out exactly what parts needed renewing, and which only repair, but since then Susan has been the delight of my heart. It adds pleasure to one's travelling to know that the excellent performance of one's car relies upon the application of a navy's leather garter to the joint of a circulating pipe; and to be aware, when the engine fails in particular way, that nothing is wanted but a new paper-fastener on the commutator lever. I once ran Susan sixty miles on a hairpin begged from a lady on a bicycle; and most of Susan's ills can be cured with a bootlace or an old rail. If you showed a bit of wire off a soda-water bottle to a Rolls-Royce the thing would hunt at you. Susan, Royce the other hand, would be grateful for it, and that is why I date on her so much."

"Thomas's" varied experiences at the homes of his various friends must be left to the reader to enjoy. On the whole, we think he gets much better treated than he deserves, for, to put it mildly, Thomas's principal care is for Number One, and some of his artless little jokes, such as his propensity for getting all the four queens out of the pack when dealing the cards at bridge—merely as "a joke!"—at the Duke of Sarum's the idea was hardly appreciated, though jokes by the ladies of the house, such as the abstracting of the men's dress trousers, compelling their owners to appear at dinner in their pyjama-legs, seem to have been quite *en rigle*.

However, there are soft places in Thomas's heart, and more than once he succumbs to the charms of youth and beauty, but fails to induce the lady to take pity on him. He was evidently reserved by a discriminating Providence for his "half-nephew's young widow," Nita, who keeps a beneficially watchful eye on

him throughout his holiday and consents to marry him on his return home.

Lady Jane Waterbury, whose experiences in house-building by "The Stores" are not perhaps so uncommon, is carried off by him during his stay "to help tell the foreman." Her ladyship begins to find fault with the house, which has been started. The foreman turns her over to Mr. Wedge, the Stores' factotum.

"He was a slim pale young man, and as he approached he raised his hat again and ventured to beam a little.

"Getting on, your ladyship, I'm glad to see."

"Yes: with the wrong house."

"Something wrong, your ladyship?"

"Tell him, please."

"M'lady says as what it's a wrong 'un, Mr. Wedge."

"Eh? Speak clear, Dawson; what are you talking about?"

"There's been a slip," I put in.

"Oh well, Dawson will see to that; what slip is it, please?"

"The Stores have delivered the wrong goods," I said.

"Ah, yes? They can be returned, of course. What do you refer to, please?"

"The House."

"Beg pardon?"

"It's the wrong one."

"Oh I—you say the house is wrong?"

"Do no; there's no complaint about the house. It seems a splendid house—so far as one can see."

Mr. Wedge smiled and bowed acknowledgments on behalf of the Stores. "But you say there is something wrong, I understand?"

"Yes."

"May I ask—?"

"It's the wrong house."

"The wrong house?"

"Yes."

"The wrong house?"

"Yes."

"You mean different from what was ordered?"

"Quite so."

"You say all this concrete and brickwork won't fit?"

"Yes."

"Then it's the wrong house altogether, you mean?"

"Exactly."

A long argument began, in the course of which Mr. Wedge discovered among his papers the letter Lady Jane had written when she ordered the house. He laid it before her with an air of noble forbearance. *Sunday.*

THE STORES.

Lady Jane Waterbury will take the house No. 2712, and it is to begin at once. She does not want any contract, but the work is to be done under a schedule (can't spell it) as the Stores suggest. She will be glad to hear how soon the work can begin and when it will be finished."

What had happened was that the design intended by Cousin Jane was numbered "two seven twenty-one," but she had described it as "two seven twelve." She had copied "twelve," however, from a Stores letter, and the whole thing resolved itself into the mistake of a typist, who had written "twelve" instead of "twenty-one." The great William had imperishably confirmed the error with his momentous signature: "One house Lady Jane Waterbury, No. 2712," had been put into the slot, so to speak, at the Stores, and its huge mechanism had been automatically thrown into action. The whole blame clearly lay with the typist."

One of the most entertaining characters in the novel is Canon Montague James Erasmus Tabb, who turns out later not to be quite such a fool as the extracts from his book on Marriage on p. 20 might induce the reader to think. Another clever contriver of accidents tending to his advantage is Mr. Bert Sutherland, the actor, who manages to bring about his own rescue from a watery grave by Thomas. At many another amusing episode the reader will laugh time after time, and will console himself at the finish with the hope that Thomas, reconciled to his chief, who rags him pitilessly for his prolongation of his holiday, may, as a married man, turn over a new leaf and tell us what follows.

ST. MARGARET'S CHURCH, DUNFERMLINE.

The members of the Scottish Ecclesiological Society visited Dunfermline Abbey on October 20, when Mr. Macgregor Chalmers, Glasgow, explained his recent discovery of the foundations and lower walls of the church which was founded there about the year 1070 by King Malcolm III. and St. Margaret. It has been established now that St. Margaret's Church was erected on what was some seventy years later the site of the great Norman Abbey nave erected by Margaret's son, King David I. The total length of the early structure was about 86 feet. But it was not homogeneous. It is recorded that St. Margaret erected "a noble church" "in the place where her nuptials were celebrated." The early church in which she was married—it may be of the ninth or tenth century—was preserved, and what St. Margaret did was to add a great square tower on the west front of the old church, and a larger church with a semicircular apse to the east end. The lower walls were built with clay. The floor of the eastern extension was probably laid with tiles. The hard mortar bed on which the pavement was laid has been preserved about 15 inches below the level of the present nave floor. One tile, 7 inches square, was found. Perhaps the most interesting "find" was the beautiful Saxon capital of the balustrade shaft of the bellry opening of St. Margaret's tower. This was reclaimed in perfect condition from the foundation wall of the north arcade of the nave. The rule in the early church of having two side altars in addition to the high altar was followed by St. Margaret. The high altar in her church at Dunfermline—in the centre of the eastern apse—was dedicated to the Holy Trinity. The altar at the south-east angle of the church was the altar of the Holy Cross, and the one at the north-east angle was dedicated to Our Lady.

St. Margaret died in Edinburgh Castle in the year 1093, and was buried in the church at Dunfermline, "as she had directed"—"opposite the altar and the venerable sign of the Holy Cross"—that is, at the south-east angle of the church. The hard mortar bed for the pavement was found to be cut away at this point, evidence that a burial had taken place here. King Malcolm was slain at Alnwick in 1093, and was buried at Tynemouth. Many years later his son, Alexander I., removed his father's bones to Dunfermline. They were placed in a tomb on the north side of the church, doubtless in front of the altar of Our Lady. There was no evidence at this point that the pavement had been cut away to form a grave. When King David I. founded his great Abbey Church in Dunfermline in the year 1123 he first erected the choir, tower, and transepts, to the east of and clear of his mother's church. The early church was not removed until about 1140, when the present nave was erected and completed about 1150. The graves of his father and mother formed the nucleus of the whole design. The sacred spot was distinguished by the rich decoration of the four pillars of the nave towards the east end, and by the erection of the stone roof screen between the two eastern pillars—a considerable part of this Norman roof screen was discovered in splendid condition and untouched since the year 1150. As the floor of the nave at this part has been lowered to near the original level, the roof screen is now exposed to view. The screen was about 11 feet high, and had two doorways, between which stood the altar of the Holy Cross. This new altar of David's foundation was in line with and a few feet north of the altar of the Holy Cross in St. Margaret's Church. David's Holy Cross altar was the parish altar, and the nave was the parish church, the conventual church being the choir and transepts. The space on the west side of the roof screen, between the four decorated pillars, enclosing the graves of Malcolm and St. Margaret, formed the "choir" of the parish church.

Mr. Chalmers described the further development of the Abbey Church through the succeeding centuries. He expressed his great indebtedness to the Right Hon. Viscount Harcourt, who as H.M. First Commissioner of Works granted permission for the



recent research, and took a warm personal interest in the work; and to the Carnegie Dunfermline Trustees for their generosity in defraying the cost of the search and of the reconstruction of the nave floor. Mr. Chalmers designed a new floor, the pavement being carried upon steel beams supported on small stone pillars, so that access may be had to the early foundations. The work of reconstruction was carried out by the Board of Works.

The visitors were entertained at luncheon by the Carnegie Dunfermline Trustees—Dr. Ross, the chairman of the Trust, presiding, and Sr. William Robertson, vice-chairman, officiating as crumpier.

The Right Rev. Dr. Coper, in thanking the Carnegie Trustees for their hospitality, said Dunfermline was fortunate in many things, and was not the least fortunate in possessing so noble a church—a church with a nave of such magnificence, and with potentialities of magnificence even greater. He should like to see the nave and choir restored for public worship. The beautiful fields between the old part of Dunfermline and Rosyth would be laid out in terraces and streets, and he had a vision of the full length of nave and choir open day in, day out, and especially on the Lord's day, and the Abbey becoming the mother church of the whole place.

Dr. Ross, in acknowledging the compliment to the Trustees, said that although Dunfermline was the home of Dissent, the people of Dunfermline were proud of their Abbey, and would not allow one stone of it to be displaced.

#### LETTERING ON GREEN CEMENT.

Finishing over cement with any material before it is properly dry is always a delicate matter. If there is water in a wall it will eventually make its way to the surface and result in sweating, flaking or mottling. Under the most unfavourable conditions no material will hold back water or completely neutralise deleterious substances in green cement. There are materials, however, the use of which prevent trouble, when the conditions are not too unfavourable by forcing the moisture in a wall to find an exit at some other portion of its surface. Where the work is on a large scale, conditions being bad, and serious risks involved, it is best for the painter or signwriter to get expert advice on the particular problem in hand, or make it clear to his clients that the work entails special risks for which he should not be held responsible.

In cases where the cement is new, but fairly promising, one may try some simple methods such as applying a weak acid solution to neutralise the alkali in the cement, a wash of water glass, or a transparent petrifying liquid. Where it is desired to retain the original colour of the surface, materials suggested are any of the following:—A wash of a solution made of 1 part water glass (silicate of soda) and 3 or 4 parts water, a wash of vinegar in full strength, a solution of muriatic acid (about 1 in 10), afterwards washed with clean water, a solution of sulphuric acid, or of bicarbonate of ammonia (2 ozs. to a gallon of water). In cases where it is intended to paint the surface, two coats of a reliable water paint serve the same purpose as petrifying liquid, and may be applied direct on to the cement. In cases where diluted acids are used, a wash down with clean water afterwards is necessary. In the case of water glass, the surface is slightly dried according to the strength of the solution, but this material offers in easy and effective means to cement where it is desired to retain the original colour of the surface. Water glass sets upon the cement and forms a coating of silicate. *The Australasian Draughtsman.*

Important building schemes under which many thousands of artisans' houses will be built are now prepared in the mining and coalfields of the counties of Swinton, Pendlebury, and Birkby, in Worsley and Atherton. About £1,000,000 is being advanced for housing of miners, cotton operatives, and other workers. In Worsley and Atherton arrangements for acquiring land will be made with Lord Ellesmere and Lord Lilford.

## Our Illustrations.

### A HOUSE IN ST. JAMES'S, ENTRANCE PORTAL AND VESTIBULE.

This house, a large part of whose main walls dates back from two centuries ago, had, at the time when its reconstruction was taken in hand, no external or visible feature dating from before the early part of the 19th century. It was entirely reconstructed and re-arranged internally, and refaced back and front. The windows of the front were altered in position, and the front itself cased with Portland stone and stock brickwork. The new entrance vestibule, illustrated to-day, was built out in front of the house. It is of Portland stone externally; the interior has a marble pavement, dado, and steps; the wrought-iron balustrade is gilt, and the handrail, as well as the glazed doors and screens, all of oak with specially designed locks of brass and copper.

The general work was carried out by Messrs. Colls and Son; the modelling and carving by the sculptor, Mr. J. Wenlock Rollins, and the wrought-iron and metal work by Mr. Bainbridge Reynolds. A view of the whole front was exhibited in the Academy this year. The architect was Lieut. A. Poynter, R.N.V.R., F.R.I.B.A., of 8, Grafton Street, Old Bond Street, W.

### SHELL-SHOCK—SPECIAL HOSPITAL FOR OFFICERS, PALACE GREEN, KENSINGTON.

We give a double-page plan and three photographic views of this temporary military hospital, which was erected last year on the Green to the west of Kensington Palace. The accommodation provides for 50 officer patients, including the requisite quarters for the nursing staff. The hospital was required in connection with Lord Knutsford's appeal, and the cost of the building was met by the War Department. The special cases dealt with are largely those of shell-shock, necessitating a separate room for each patient in as quiet a position as possible. In designing the building an endeavour was made to ensure seclusion and pleasant surroundings by grouping the patients' rooms on the south and west sides of garden courts, well away from the noise of traffic. These rooms open out to covered verandahs, which are accessible to the internal main corridors. The greatest possible expanse of grass has been provided in the courts, and beds of flowers and shrubs have been formed at intervals. A screen of high trees on the west side forms a fitting background. The sanitary annexes and a nurses' duty room are arranged to each group of patients' rooms. The accommodation also includes a dining-room for the use of a proportion of the patients whose cases are less acute, a recreation and billiard-room, a small operating theatre and X-ray room, in addition to administrative offices, etc. The general kitchen and boiler-house are arranged at the south end, and quarters for the nursing staff in a wing at the north end of the site. The building generally is warmed by means of hot-water radiators, and electric light is installed throughout. Ventilating panels are provided in the ceilings of the patients' rooms, and ducts in the roof spaces connect to extract ventilators. Hollow-brick internal partitions were used throughout with a view to counteracting sound as far as possible, and the external walls are constructed with timber framing, weather-boarded on the outside, and with 3 in. brick masonry on the inside, a space being left between the brick and the weather-boarding to deaden the noise of traffic and exclude external sound as much as possible. The whole of the wall surfaces internally are plastered, and the ceilings are of "Fiberlite." The roofs are of light timber construction, boarded and slated. Messrs. Thomas and Edge were the builders. The architect is Mr. R. J. Allison, A.R.I.B.A. (Principal Architect in Charge of Art and Science Buildings, etc., H.M. Office of Works).

## Correspondence.

### THE WAR MEMORIAL CHAPEL.

To the Editor of THE BUILDING NEWS.

Sir.—I have read the letter from "S. C." which appeared in last week's BUILDING NEWS, and for the criticism in which I am obliged.

The character of the design seemed to me to be suggested by the surroundings—the 13th Century Chapter House, with its high-pitched roof, forms a fitting centre to the later style roof of Henry VII. Chapel and my proposed chapel, and the style of the Houses of Parliament, which dominates the position, could not be ignored.

With regard to the fleche, I quite agree that it would have been better had it crowned the ridge of a high-pitched roof, but as Henry VII. Chapel has not a high-pitched roof, I did not think it right, particularly having regard to the style of architecture, to adopt a high-pitched roof for the proposed chapel.

I quite agree with "S. C." that the perspective view gives an idea of squareness of plan, but, as a fact, looking at the nave of the chapel from extreme west to extreme east, we have a length of 145 ft. and a width of 37 ft. to the centres of the nave piers; and in execution, of course, the low buildings at the north and south angles of the east front and at the north-east angle of the west front would not appear so spreading as they do in the view, which was intended rather to give a general idea of the position of the chapel with relation to Henry VII. Chapel and the Abbey garden.

As to the size of the windows, those of the nave (really clear-story windows) are each about 7 ft. in width and 22 ft. 6 in. in height, and there are fourteen of them, in addition to the transept windows, each of which has a width (apart from mullions) of about 25 ft. and a height of about 15 ft.

The polygonal apse is full of windows, each of a height of about 30 ft., whilst the west window of the nave has a width (apart from mullions) of about 25 ft. and a height of about 40 ft., and this, apart from aisle and other windows, will, I think satisfy "S. C." that there is ample opportunity for a "gorgeous colour scheme."

The main idea, I have had in view embraces a fine public improvement by the removal of the Abington Street houses, which are of no architectural value; the formation of a public garden; and the opening up of the old Abbey garden and the Jewel House, most interesting historical features now hidden away at the back of the Mews.

The War Memorial Chapel need not interfere with the other memorials suggested throughout the country, nor with the proposed War Museum, which latter would exhibit all the instruments of horrible warfare, with their necessarily sad effect upon the public mind.

The chapel would contain memorials of all the heroes, men and women, who have fallen in the war for the ultimate benefit of their country; and the chapel affords an opportunity for masterpieces of our artists in the way of sculpture, stained glass, mosaic, marble, bronze, and woodwork, constituting everlasting records of the art culture of to-day.

The chapel would, as I have said before, provide for solemn memorial services and for quiet prayer and meditation by the relatives of the fallen.—I have the honour to be, your most obedient servant,

WM. WOODWARD.

15, Southampton Street, Strand,  
October 25, 1917.

The death has occurred at his son's house in Balfast of Mr. William Drysdale Sansé, civil engineer, who for many years carried on business at Kirkcaldy. He acted as engineer for several important extensions of Kirkcaldy and Dysart Water Works, and carried out other important works in various parts of Fife. A keen naturalist he for many years held office as secretary of Kirkcaldy Naturalists' Society, and was also for some time secretary of the East of Scotland Naturalist Society.



# KENSINGTON PALACE GARDENS W.

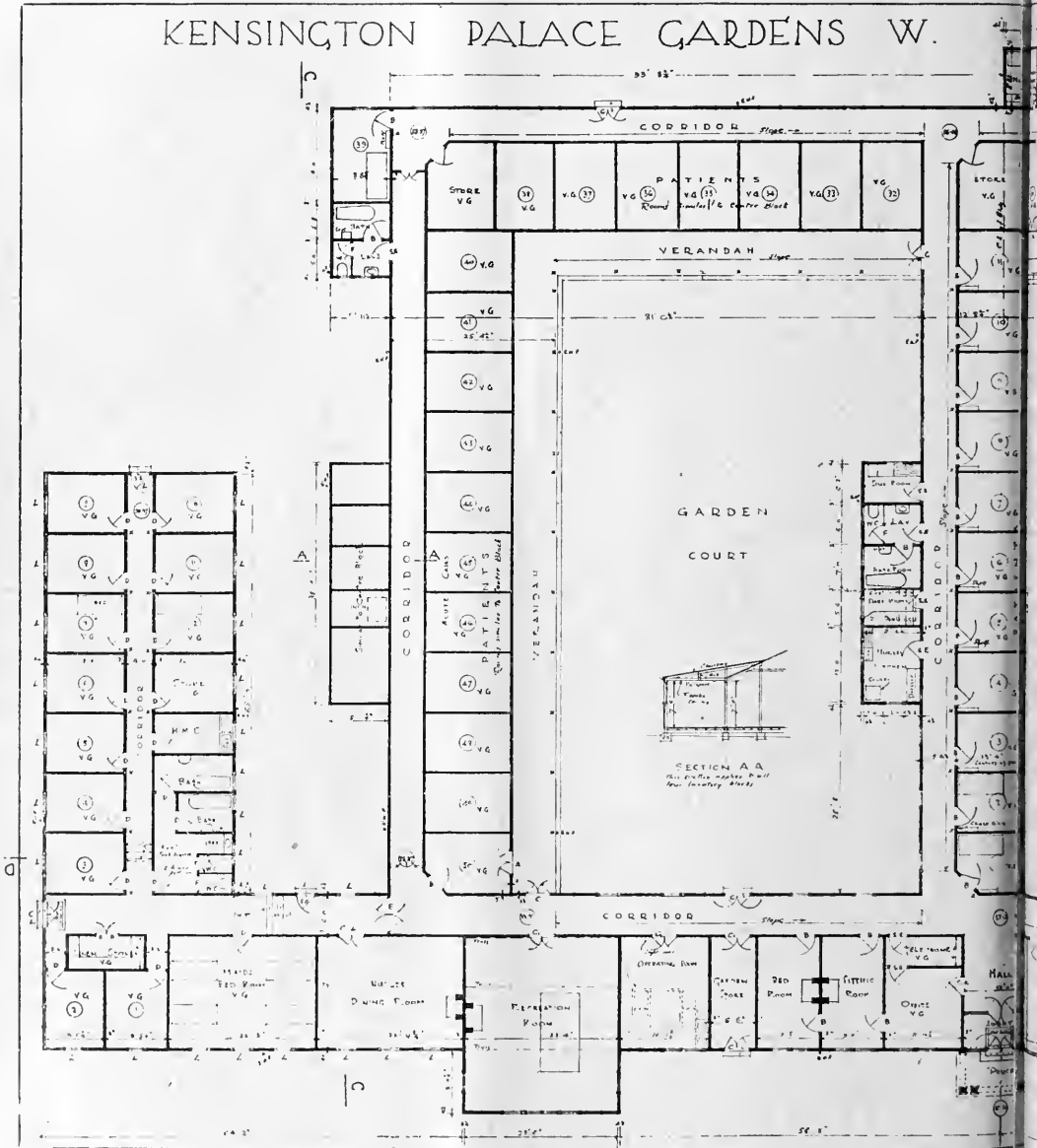

SHELL SHOCK SPECIAL MILITARY HOSPITAL FOR OFFICERS, KENSINGTON PALACE



# MILITARY HOSPITAL. GENERAL PLAN

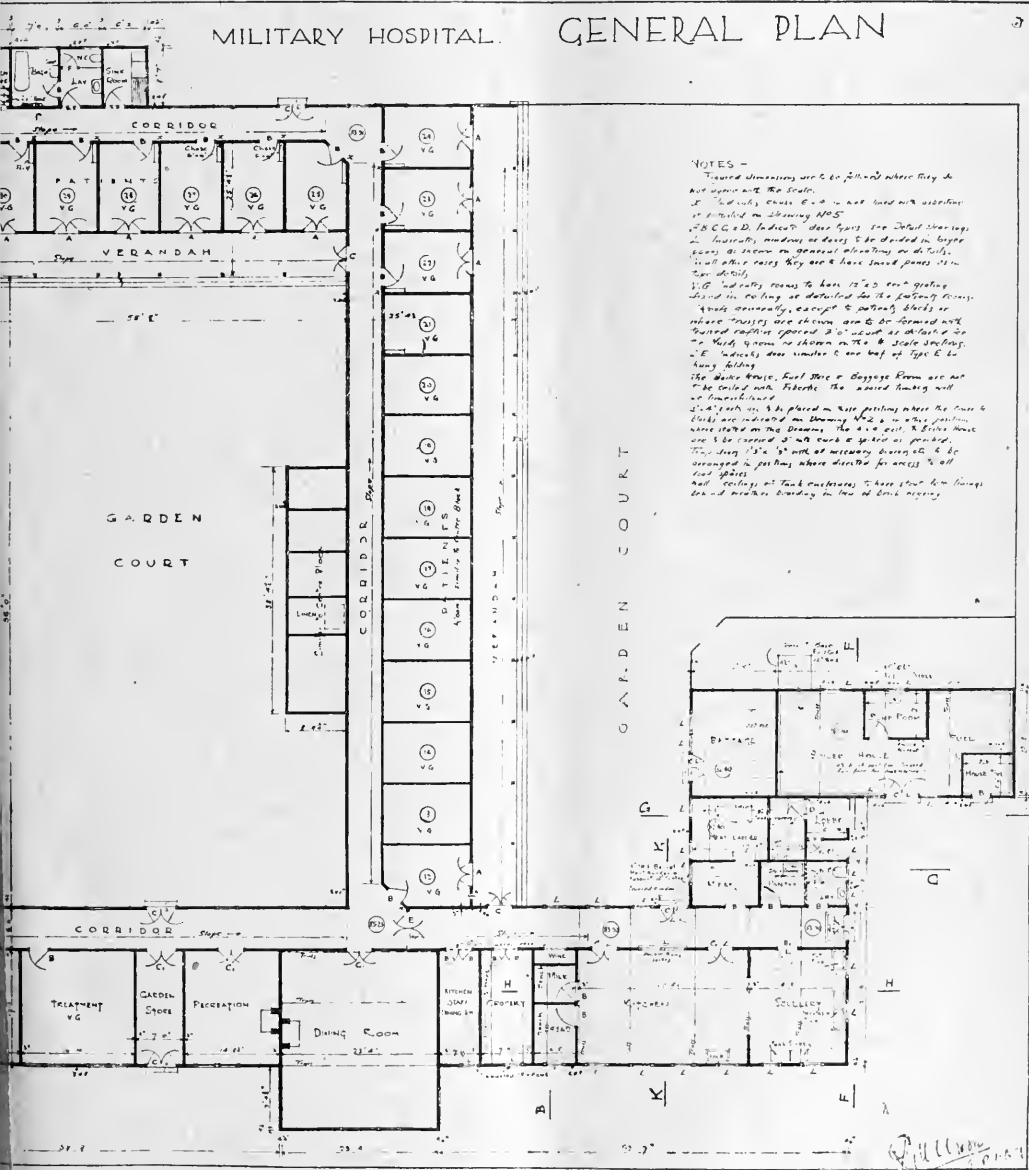

NOTES -

1. "Treated" dimensions are to be followed where they do not agree with the scale.

2. "Treated" cases 6' x 4' are not laid with asbestos or similar on ordinary floors.

3. "Treated" cases 6' x 4' are not laid with asbestos or similar on ordinary floors.

4. "Treated" cases 6' x 4' are not laid with asbestos or similar on ordinary floors.

5. "Treated" cases 6' x 4' are not laid with asbestos or similar on ordinary floors.

6. "Treated" cases 6' x 4' are not laid with asbestos or similar on ordinary floors.

7. "Treated" cases 6' x 4' are not laid with asbestos or similar on ordinary floors.

8. "Treated" cases 6' x 4' are not laid with asbestos or similar on ordinary floors.

9. "Treated" cases 6' x 4' are not laid with asbestos or similar on ordinary floors.

10. "Treated" cases 6' x 4' are not laid with asbestos or similar on ordinary floors.

11. "Treated" cases 6' x 4' are not laid with asbestos or similar on ordinary floors.

12. "Treated" cases 6' x 4' are not laid with asbestos or similar on ordinary floors.

13. "Treated" cases 6' x 4' are not laid with asbestos or similar on ordinary floors.

14. "Treated" cases 6' x 4' are not laid with asbestos or similar on ordinary floors.

15. "Treated" cases 6' x 4' are not laid with asbestos or similar on ordinary floors.

16. "Treated" cases 6' x 4' are not laid with asbestos or similar on ordinary floors.

17. "Treated" cases 6' x 4' are not laid with asbestos or similar on ordinary floors.

18. "Treated" cases 6' x 4' are not laid with asbestos or similar on ordinary floors.

19. "Treated" cases 6' x 4' are not laid with asbestos or similar on ordinary floors.

20. "Treated" cases 6' x 4' are not laid with asbestos or similar on ordinary floors.

21. "Treated" cases 6' x 4' are not laid with asbestos or similar on ordinary floors.

22. "Treated" cases 6' x 4' are not laid with asbestos or similar on ordinary floors.

23. "Treated" cases 6' x 4' are not laid with asbestos or similar on ordinary floors.

24. "Treated" cases 6' x 4' are not laid with asbestos or similar on ordinary floors.

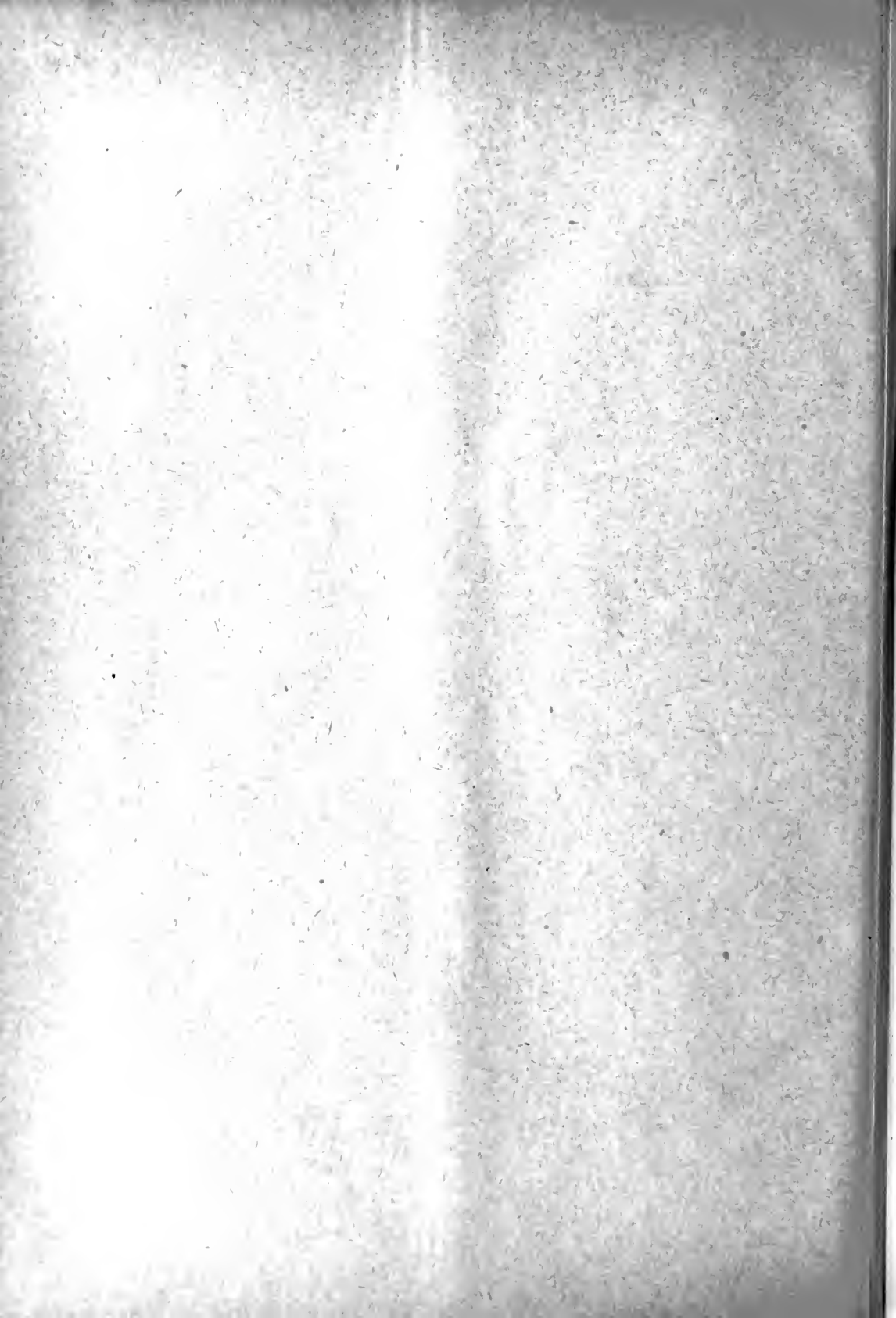



THE BUILDING NEWS, OCTOBER 31, 1917.



W. Johnson, Ltd., Photographs.

SHELL SHOCK SPECIAL HOSPITAL FOR OFFICERS, PALACE GREEN, KENSINGTON.  
MAIN ENTRANCE—MR. RICHARD J. ALLISON, A.R.I.B.A. (H.M. Office of Works), Architect

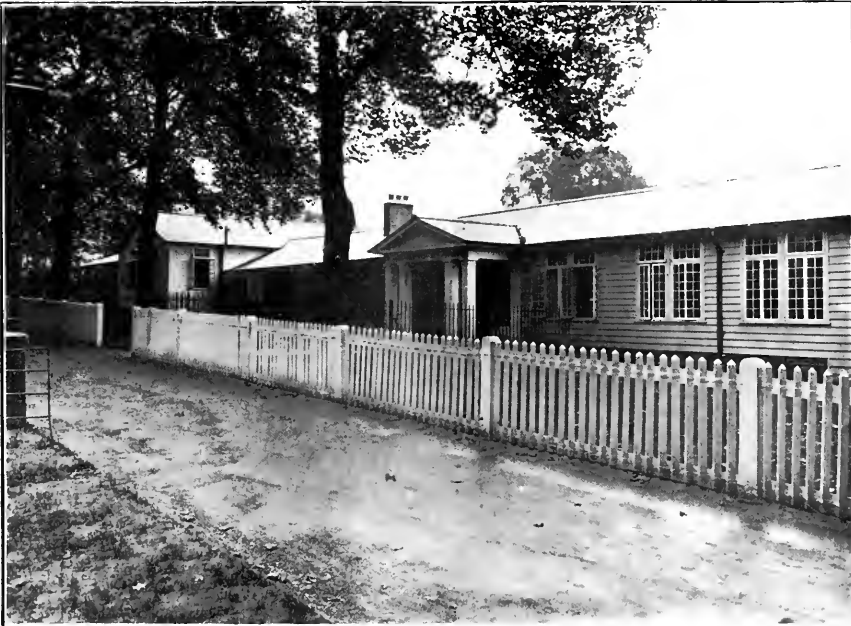

*Webb, Ltd., Photos.*

SHELL SHOCK SPECIAL HOSPITAL FOR OFFICERS, PALACE GREEN, KENSINGTON.  
ENTRANCE BLOCK AND ONE GARDEN COURT.

Mr. R. J. ALLISON, A.R.I.B.A. (I.L.M. Office of Works), Architect.







*The London Photo*

A HOUSE IN ST. JAMES'S, LONDON, S.W.: ENTRANCE PORTICO





VESTIBULE.—AMBROSE POYNTER, F.R.I.B.A. (Lieut. R.N.V.R.), Architect.



## Building Intelligence.

**HOLY TRINITY, LAMORREY.**—The screen erected in this church, to the memory of the late vicar, the Rev. J. Foster Lepine, was dedicated on October 14. It is of Gothic design. There are three panels on either side, at the base, of delicate tracery, the channel being left open, without gates. The material is oak, and there are seven compartments, each divided and flanked by moulded posts. The central one—the doorway—is carried up to a higher altitude, the crocketed gable terminating with a carved finial. The screen and brass altar rails have been designed and executed by Messrs. Hems and Sons, of Exeter.

### MISS MAY MORRIS ON DESIGN IN DRESS.

Miss May Morris, of Hanstead, daughter of the late William Morris, gave a lecture on "Dress Design" at the Municipal School of Art, All Saints', Manchester, last week.

Miss Morris said that if it was true that an age found expression in its dress, external evidence must proclaim ours martinet, devoid of colour sense and of innate feeling for beautiful lines. The nineteenth century gave us many quaint and pretty modes and many tiresome ones. It witnessed the apotheosis of crinoline and shawl, together with sundry charming absurdities for women and of pegtop trousers and other inexcusable absurdities for men. It also witnessed the triumph of dowdiness.

To-day the dress was a mixture of sense and frivolity. But Miss Morris did not think one could take seriously the taste of an era that allowed its men-folk to go about in garments so hopelessly wanting in beauty of line as the modern coat and trousers. She did not advocate effeminate draperies for men or divided skirts for women, but she wished that the evolution of men's dress had proceeded on less dispiriting and uninspiring lines. Any sort of professional dress—a dress that denoted trade or occupation had a certain interest or dignity, but indoor clothes should be expressive of mood, of character, of circumstance—delicate and full of fancy.

### OBITUARY.

We regret very much to learn that the second son of Mr. H. Percy Adams, F.R.I.B.A., 9, Woburn Place—Lieutenant H. F. R. Adams, R.F.A.—was killed in action on Saturday, October 20, at the early age of 20. He went out to the front in April, 1915, and had been there ever since. His colonel reports that Lieutenant H. F. R. Adams was "absolutely the life and soul of our battery, a truly gallant young officer, with the utmost sangfroid in any danger (and he has had some tight corners). Every officer and man turned out to his funeral. He will be sorely missed." Mr. Adams's elder son, Captain Cecil Adams, R.E., who at the start of the war immediately left England for the front, was afterwards badly shell-shocked, and was later on appointed military instructor to the Canadian Military Academy at Ontario. He was one of the first to get a Military Cross for gallantry in the field.

We regret greatly to announce that Mr. J. J. Lish, M.S.A., Past President of the Society of Architects, has received official information that his eldest son, Second-Lieut. John Robert Lish, was killed in action on October 4. The deceased officer was educated at Mr. James Hanna's school, Sunderland, and at the Grammar School, Market Rasen. Before the war he was in business as a shipbroker and coal exporter on the Newcastle Quayside. He volunteered for the front, and joined the Northumberland Fusiliers, with whom he rose to be a platoon sergeant. He was afterwards given a commission in the Lincolnshire Regiment (Special Reserve of Officers). He had previously been wounded. Our sincerest condolences are offered to his father and all friends.

Mr. James Barritt Broadbent, of Cooper Street, Manchester, architect, has left net personalty, £27,001; gross, £30,314.

### STATUES AND MEMORIALS.

**BELMONT.**—On Wednesday, October 17, the memorial to the late Bishop Hedley, Bishop of Newport, was unveiled. The monument consists of a raised tomb in the centre of the choir, constructed of white alabaster and Irish black marble, surmounted by a recumbent effigy of the Bishop. In style the whole is designed in that of the Early Renaissance. The dimensions of the tomb are: Length 6 ft. 3 in., width 4 ft. 3 in., and height 4 ft., exclusive of the recumbent figure. The sides are divided into three panels by black marble fluted pilasters with delicately-carved caps in white alabaster, and each panel contains a shield within a circular wreath, the ends of the tomb being filled with similar panels. Altogether there are eight shields, which are carried on the arms as borne by the Bishop, arms of Ampleforth Abbey, arms of the Benedictine Order, arms of the English Benedictine Congregation, arms of St. Thomas of Hereford (with differences), monogram of the Bishop (J.C.H.), arms of the Chapter of Newport and the arms of Belmont Priory. The Bishop's effigy represents him in full pontificals with his head resting on two cushions, his hands at his feet; these and the mitre, together with the other vestments, are carved with characteristic patterns in flat relief. The figure, which is in Clunch stone, rests on a moulded slab of black marble round the edge of which runs the inscription. A moulded cornice or frieze of black marble runs round the tomb beneath the slab, and the fluted angle pillars and the moulded plinth are also in black marble. The whole stands on a stone base five inches high. The monument has been carried out from the designs and under the superintendence of Mr. Frederick A. Walters, F.S.A., the effigy being carved by Mr. Best, one of the partners of Messrs. Wall and Co., of Cheltenham, while the tomb is the work of Messrs. Earp and Hobbs, of Lambeth.

### LEGAL INTELLIGENCE.

**SHORT TRIP FOR LOCAL AUTHORITIES' NOTICES TO PAVE-APPEALED AGAINST: APPEAL UPHeld.**—In the Court of Appeal, on October 23, Lords Justices Swinfen Eady, Warrington, and Scrutton heard an appeal by the Mayor and Corporation of Bristol from a judgment of Mr. Justice Neville on an originating summons taken out by them to enforce a charge for paving etc., against Mr. G. H. Simmt, of Orchard Street, Bristol, and Major Simmt, as frontagers in Bloomfield Road, Bristol. Mr. Macmorran, K.C., for the Corporation, said that under the Public Health Act, 1875, the local authority had in certain cases the right to give notice to the frontagers requiring them to do certain works, and in case of failure to comply with the notice, to do the work themselves and charge the cost to the frontagers in proportion to their frontages. Notice was given to the defendants, and, on the face of it, a perfectly good notice, to do specified work within a month. The Judge held that the time specified was too short, and therefore refused to do the work, and from this the Corporation appealed. Without calling on the respondents, the Court held that the time specified in the notice was insufficient, and dismissed the appeal with costs.

### PROFESSIONAL AND TRADE SOCIETIES.

**THE ROYAL INSTITUTE OF BRITISH ARCHITECTS.**—The first meeting of the new session will take place on Monday, November 5, 1917, when the opening address will be delivered by the president, Mr. Henry T. Hare, at 5 p.m.

### TRADE NOTES.

Boyle's latest patent "Air pump" Ventilators, supplied by Messrs. Robert Boyle and Son, Ventilating Engineers, 64, Holborn Viaduct, London, have been employed by New Huddnall Colliery Co. for their power house, Welbeck Colliery.

Whereas by force of the war there were seventy-five recognised operative plumbers in Derby, the call to the colours has now reduced the number to sixteen.

At a meeting of the North Lincolnshire Ironmasters' Association and of the local authorities at Scunthorpe recently, Mr. Lew, manager of the North Lincolnshire Ironworks, who presided, stated that in a very few hours, when the accommodation would have to be provided for 30,000 or 40,000 additional people.

### PARLIAMENTARY NOTES.

**MR. LASZLO'S NATURALISATION AND INTERMENT ON OCTOBER 25.**—In reply to Mr. G. F. Clapham, (C.) Sir G. Cave (Surrey, Kingston) said: "Mr. Laszlo's application for naturalisation was received by the Home Office on July 28, 1914, and in accordance with the prescribed procedure was supported by formal declarations as to his respectability and assets. These declarations were made several days before the application was sent in. It is not the practice to give the names of the declarants, but as the present case is exceptional I see no objection to stating that they were my right friend and the Secretary of State for Foreign Affairs, my hon. chairman of the friend the member for the Farnham division of Hampshire, Lord Devonport, and Mr. Howard Guinness. I have received no representations on Mr. Laszlo's behalf other than his own statement which was submitted to the Advisory Committee." Answering the same member, Sir G. Cave said: "Mr. Laszlo has been interned in Brixton Prison. He has been accorded no exceptional indulgences and has received the treatment of an internee of persons interned under Defence of the Realm Regulation 14B. I have received the Committee's report, and in accordance with their advice have decided to confirm the Order for his internment. I may add that, following the Committee's recommendation, I propose to reconsider the case in December." Mr. Laszlo is removed from a question to Mr. King. *The Times* understands that the announcement that his case will come up for re-consideration in December implies no promise of release. The cases of many interned prisoners are similarly reconsidered from time to time.

**WESTMINSTER HALL.**—Sir A. Mond (Swansea, L.) in answer to a question by Mr. King (Somerset, N. L.) last week, as to the progress which was being made with the roof of Westminster Hall, said that two trusses of two further trusses and two additional bays were nearly completed, and a further four trusses and three bays were about to be commenced. Spraying had been adopted in dealing with the eradication of the *Xestobium tesselatum*, and the work of restoration would be proceeded with slowly during the war.

**THE STATUE OF PRESIDENT LINCOLN.**—On Wednesday last Sir A. Mond (Swansea, Town, W.) replying to a question by Mr. King (Somerset, N. L.) concerning the statue of President Lincoln proposed to be erected in the Canning enclosure, and a request that an opportunity should be given to the House and to recognised authorities on civic art to offer suggestions before the erection of any statue offered by any private persons was accepted for erection in London, said: "I will endeavour to obtain a receipt of the intended statue of President Lincoln. I already have one of the statue by St. Gaudens, and when I have both I shall be very glad to accede to the request of my hon. friend and place the photographs in the tea-room. My jurisdiction as regards the erection of statues in London only extends to Crown property sites. I do not consider the suggestion of my hon. friend is at all practical."

**EXPORT OF CEMENT TO HOLLAND.**—Commander Leveton Harris, replying, last Wednesday, to Brigadier-General Croft, said: "The total exports to Holland from all ports in the United Kingdom during August and September last were 18,404 tons, all of which was consigned to the Netherlands Overseas Trust under guarantees against re-export. The Dutch official returns show that during the first half of this year not only has the re-export of cement to Holland from Holland to either Germany or Belgium, but that during this period Holland has received from Germany about 90,000 tons of cement, or about seven times as much as she obtained from the United Kingdom. At the present time the export of cement to Holland is prohibited under the Royal Proclamation of September 29, and no licences are now being issued." Mr. Wardle stated, in written reply to a question by Mr. W. Thorne: "The quantities of cement re-exported as exported from the United Kingdom to the Netherlands were: 20,800 tons in 1914, 4,100 tons in 1915, 1,300 tons in 1916 and 41,300 tons in the nine months ended September, 1917. I understand that no licences to export cement to the Netherlands are now being granted."

**CEMENT SENT TO HOLLAND.**—ANSWERING Mr. W. Thorne on Monday last, Sir A. Stirling said: "The average value of the cement exported to Holland as declared by the exporters

was 33s. 5d. per ton in 1915, 44s. 9d. per ton in 1916, and 54s. 8d. per ton in the first nine months of 1917. It is not possible to state the corresponding values of exactly the same quality of cement in this country owing to the absence of information as to the qualities exported, but I understand that the price of the best Portland cement delivered in London was quoted at 38s. per ton from January to May, 1915, and that it rose in value till it reached 45s. to 48s. per ton at the end of the year, at which price it stood throughout 1916 and January and February of 1917. During the ensuing seven months the price quoted was 50s. to 55s. per ton. Commander Leverton Harris, replying to a question by Colonel Yale (Leeds-Shipb.), Melton, U., said I venture to refer my hon. and gallant friend to the answer which I gave to the hon. and gallant member for Christchurch on October 24, in which I stated that no cement has been exported from the United Kingdom to Holland except under the most explicit guarantees against re-export. Consequently the reason for no export is that any of it has found its way to Germany or Belgium. Germany is still by far the largest exporter of cement to Holland, but she has been unable to maintain her full export trade this year, and an increased part of the Dutch demand has come to this country. General Caut asked whether 35,000 tons of cement had been exported to Holland in August and September, or in the last few months, and whether, in spite of the belief that licences were no longer granted, there had been in the last week two ships loaded for Holland at the Tower Bridge. Commander Leverton Harris: I understand that the two ships were loaded under licences granted before the Orders in Council were issued.

## Our Office Table.

An announcement was made at the seventh annual general meeting of the St. Austell China-clay Works, Limited, held in London, when Mr. D. George Collins, the chairman, stated that as the result of a meeting on the previous day the directors had entered into an agreement with other china-clay producing companies, the result of which was that the whole of the companies, with the exception of 2 per cent. of the industry, had joined in a great combine, the first result of which would be to ensure the regular distribution of the output of clay, according to the capability of each company to produce it and according to its quality. The result of the combine was that the price of their clay would be immediately advanced 33 per cent. No fewer than 90 per cent. of the china-clay producers in England were now banded together in the protection of their own interests, and the general outlook for the shareholders had been immensely improved.

There are to be no more seizures of London hotels for Government purposes—at present. So far there have been acquired for official needs nine hotels, four clubs, nineteen public buildings, museums, galleries, etc., thirty-three private houses, 134 commercial offices, and forty-two warehouses—a total of 291 sets of premises. Sir Alfred Mond, the First Commissioner of Works, says that "two other hotel buildings may be taken over, but as they have both been unoccupied for a considerable period the Government user of the premises will not further encroach on the available hotel accommodation in London."

A falling off in the amount of building in the thirty-five chief cities of Canada is indicated by the number of building permits issued for August compared with those issued in the corresponding month last year. Reviewing the situation as a whole, a decrease of 24 per cent. is observed. The Provinces of Nova Scotia, Quebec, Manitoba, and Saskatchewan have issued permits of greater value in August of this year than the same month last year. The other provinces, however, show decreases varying from 23 per cent. to 89 per cent. The two chief cities—Montreal and Toronto—have issued fewer permits this year. An outstanding feature is the apparent return of Western cities to normal conditions—Winnipeg, Moose Jaw, Saskatoon, New Westminster, and Victoria—all of which show a very considerable advance. The largest individual increase was

in Fort William, where the value of building permits last month was 700 per cent. in excess of the value of August last year.

House renovation and repairs have become the despair of the householder, so hopeless just now is it even to get workmen. Many are developing more or less ability—ladies mostly more and men less—as far as our observation goes, and all such will find "Renovation of the House in War Time," by Arthur Seymour Jennings, the well known editor of our contemporary the *Decorator*, a veritable gospel. The book is published by Messrs. Constable and Co., 10, Orange Street, W.C., at one shilling, and will save most buyers many pounds.

"Maybe you have heard," writes a correspondent of the *British Journal of Photography*, "some photographers grumble about the lack of light in cathedrals—particularly Durham. The 'dim, religious light' is, as a rule, most effective, but it is not so photographic as one would wish. Architectural photographers may be interested to know that a change has been made in the appearance of the interior of Durham's beautiful cathedral by the reopening of the western doorway. In olden times the western door was the main entrance to the edifice, as one would expect; but on the erection of the Galilee Chapel at the west end (1154-1194) the principal entrance—erected by the builder of the Galilee Chapel—was made on the north side. Since the early days of the fifteenth century the great double western door has only been opened on very special occasions, the last being, I believe, in 1901, for the memorial service for the late Queen Victoria. I understand that it is now to be opened every day. The result is that the western end of the interior—known to photographers as the gloomiest of gloomy spots—is now, at times, beautifully—if a little flatly—lighted from the Galilee Chapel, while the vista along the aisles has been greatly extended, and the view into the chapel is a most beautifully lighted one when seen at certain angles, especially those which reveal the fine arcades of ornamental arches within the chapel."

The Department of Scientific and Industrial Research has been asked by the Housing (Building Construction) Committee, recently set up by the President of the Local Government Board, to undertake the direction and conduct of a series of researches connected with the employment of new materials and new methods of construction in some large housing schemes contemplated by the Government in the near future. For this purpose it has been decided to appoint a small Departmental Committee to be assisted by technical advisers, as assessors, and Mr. G. W. Humphreys, the chief engineer of the L.C.C., has been invited to become a member of the Departmental Committee. The London County Council has permitted Mr. Humphreys to become a member of the Departmental Committee.

Dr. Barwise, medical officer of health for Derbyshire, dealing in his annual report with the treatment of tuberculosis, says a very different type of house is required—a house in which a patient can continue to carry out open-air treatment at home, more especially where delicate children can sleep and live practically in the open air. The Government has intimated that there is to be a national housing scheme. Advantage should be taken of this to have a type of house designed in which there is a bedroom with an open-air sleeping balcony. This should add nothing to the cost of the building, and it is essential that such provision should be made. He cannot emphasise too strongly the fact that the problem of tuberculosis is one of housing. The experience of isolating advanced cases points to the necessity of there being means of housing advanced cases at their homes in such a way that they are no danger to the other inmates. When a patient has been trained to live an open-air life it is necessary that he should be able to continue that treatment at home. Shelters for the patients to enable this to be done have been provided, but in the winter this is not altogether a suitable method of housing the patients.

A Madras journal, the *Local Self-Government Gazette*, reports the idea of diagonal streets from an American magazine. Town planners, it is said, are emphasising the advantages that would be gained, not to mention the "artistic treatment," that such triangular corners are capable of. It is the American idea, however, that diagonal streets, in addition to rectangular streets, should form part of a definite plan on which a new town should be laid out. As the *Madras Times* points out, "When you come to think of it, it is certainly a fact that when streets cross one another at right angles there are no short cuts," and if a person wants to go from one corner of a city to another, it matters not how many turnings he may take but he has to walk the length of two sides of the city. The Union Jack would apparently be the general plan on which cities would be laid out in accordance with the new idea; and there is room for patriotic pride in the thought of cities everywhere being replicas of the British flag.

A good report for the year 1916-17 will be presented at the annual meeting of the Incorporated Benevolent Fund of the Surveyors' Institution, to be held at 12, Great George Street, on November 12. The increase in the donation account during the period under review, therefore, amounts to the considerable sum of £1,101 19s. 6d., a total which compares favourably with that of last year, £144 2s., or, indeed, with that of any recent year. Subscriptions received during the year show a further decline of £9. The grants made for the immediate relief of members from this source also show a decline of about £18. The committee refer with the deepest regret to the death of Mr. Howard Chatfield Clarke, a past-Chairman of the committee, to whose generosity, initiative and energy the success of the Special War Fund was due. Grants to the amount of £280 9s. 8d. have been made from this account during the year, mainly in the support of the families of members who have been called up for military service. Assistance has also been given to other members who have suffered from the war to enable them to meet insurance premiums and other charges which might otherwise have proved beyond their resources. In two cases the widows of members killed in action have been assisted. The Special War Fund still amounts to a little over £2,500; £1,500 has been invested for the present in 5 per cent. War Loan, £500 in 5 per cent. Exchequer Bonds, £300 placed on deposit at the bank, while the remainder is on current account ready for immediate use.

At a meeting of the London Master Printers at Stationers' Hall last Friday the concession of further large bonuses to the fifteen unions in the London printing trade was approved. A report from the London Costing Committee stated that the total increase in charges for printing since the outbreak of war amounts to 60 per cent., in addition to the increased cost of materials—paper, 200-400 per cent.; ink, 50-200 per cent.; strawboards, 300-400 per cent.; millboards, 150 per cent.; glue, 200 per cent.; cloth, 100 per cent.; and leather, 75-125 per cent.

Some of our readers will be glad to know that the catalogue—or, at any rate, the draft—of the permanent collection in the Walker Art Gallery is an accomplished fact. The manuscript volumes of the catalogue were presented to the Library, Museum, and Arts Committee last Friday. The books include one volume relating to 1,037 pictures by 618 artists, and six supplementary volumes, the items embraced aggregating 2,465, not taking into account colour and other reproductions of old masters. There are 373 works by Liverpool artists, and in so far as it has been practicable to furnish it the volumes contain biographical information about the artists, etc. The catalogue comprises some 100,000 words. Needless to say, its preparation has involved an immense amount of labour, including considerable research work, historical and biographical, and the fact that this work has been done in the short space of five months reflects the greatest credit upon Mr. E. R. Dibdin, the curator, who, undertaking the lion's share of the task, has performed it in

a characteristically sound and thorough manner.

Captain Vaughan Williams, of Old Windsor, has discovered what he believes to be the site of the palace of the Saxon kings and the pre-Conquest town of Windsor. It is believed that there once stood at Old Windsor the Palace of Edward the Confessor, but although several Saxon urus have been excavated here from time to time the actual position of the palace has never been decided. Old Windsor was probably selected by the Saxon kings as a residence for the same reason as it was subsequently repurchased by William the Conqueror, on account of its convenience for hunting in the forest. King William held Old Windsor as his own demesne.

A famous Elizabethan residence in Somerset, the residence of a distinguished nobleman, is in part built over a subterranean stream. Sixty years ago when the first heating apparatus was installed, the builders of the stokehole had considerable difficulty in placing it in the sunken position which stokeholes usually occupy—for the stream was found to be flowing under the situation required. After experiencing considerable trouble, an iron tank was made, sufficiently large to contain the boiler and furnace. An additional stokehole was recently sunk adjoining the one described above. The Estate Agent and the Clerk of Works are certainly alert to modern methods, and having had considerable experience with water-proofed cement, they determined to make a drastic test of this modern method of obtaining dry interiors. The estate fire engine was utilised to divert the flowing water from the excavations of the new stokehole, an ingenious and novel method of steam pumping. The water was kept away while the work was proceeding, and for seven days and nights after the work was done, to enable the cement to set. Fine Puddoc concrete was laid on the floor, but the brick walls were only rendered with Puddoc cement mortar. The tenacity of cement plaster to an absorbent surface like common red brick is usually so great that after it has once set a considerable exterior pressure of water is required to force it off the wall. In this stokehole the reliance placed on the wall rendering has been fully justified, for in spite of the constantly flowing water the walls are as firm and dry as the floor. The Clerk of Works emphasises the following essential points for cement flooded work:—(1) To keep the water away until the cement sets. (2) To use coarse non-porous aggregates. (3) To use small washed sand for the renderings.

"Practical Structural Design," by Ernest McCullough, C.E. (New York; U.P.C. Book Company, Inc., 243-249, West 59th Street), is a reprint of a practical series of articles in the *Building Age*, with much fresh matter, written "to reach the man who cannot attend evening classes." The author has had good experience in teaching such, and has turned it to excellent account. One of his tests of progress is well worth note. Passing on one's knowledge is undoubtedly a help to the earnest student. He says: "Early in the game start teaching the office-boy, for to teach is one of the best ways to learn. If the office-boy cannot be interested, then the studying is not being done right, for a man who is studying in the proper spirit becomes somewhat enthusiastic over his progress." That is true, and Mr. McCullough's book will be found most helpful by all students who really mean business.

"Cubing Tables," by John Whiting, junr., should prove useful to architects and surveyors, timber merchants, sawmillers, box and case makers, builders and contractors, and all wood users. On a strong three-fold card, convenient for pocket, desk, or inside a calculator, sixteen tables are given from  $\frac{1}{8}$  in. by 1 in. to 2 ins. by 1 in. by  $\frac{1}{8}$  in. intervals, from 1 ft. to 100 ft. long. The card can be had for 3d., post free, from John Whiting, 66, Connaught Road, Cromer.

Mr. Richard Durrell, of Grove Lodge, South Woodley, Essex, and of The Globe Wharf, Mile End, E., packing case and timber merchant, has left £136.812.

CHIPS.

The death is announced of Mr. A. L. Hickman, the senior partner in the firm of George Munday and Sons, builders and contractors, Bodelph Lane, Eastcheap.

Mr. A. Cunes, first architectural assistant in the Exeter city surveyor's department, has had his salary increased by £10 a year, and Mr. E. Bushel, general foreman of streets, by £20.

In the 15th Century parish church at Penn, Buckinghamshire, a stained-glass window has been erected to the memory of Brevet Lieutenant-Colonel Hugh Hill, M.V.O., D.S.O.

Mr. F. B. Goodman has been appointed by the Ryde T.C. to the position of borough surveyor and water engineer, at a commencing salary of £500 per annum, rising to £550 in two half-yearly instalments.

A portrait of Mr. Alfred F. Buxton, who was chairman of the London County Council for 1915-17, was presented at the County Hall, Spring Gardens, on Tuesday, at 2 o'clock, the portrait, by Mr. Briton Riviere, R.C., has been subscribed for by Mr. Buxton's colleagues.

The new Roman Catholic Church of St. Francis de Sales, in Hale Road, Walton, Liverpool, was opened last Sunday week. The edifice is to contain a unique war memorial, for the high altar has been subscribed for in memory of the young men of the parish who have fallen in the war.

The Cantor Lectures on "Civic Architecture and Town Planning," by Professor Beresford Pite, F.R.I.B.A., are being reprinted from the *Journal*, and the pamphlet (price 1s.) will shortly be obtainable on application to the Secretary, Royal Society of Arts, John Street, Adelphi, London, W.C.

The death is announced, at the age of sixty-five, of Mr. James Carroll Beckwith, a well-known American artist. Born at Haumbil, Missouri, he resided of late chiefly in Paris, but had done most of his work in New York, where he settled in 1878. He specialised in portraits and general pictures.

Captain Archibald H. P. Davey, son-in-law of Mr. J. 21st Lord Gtch, J.P., F.R.I.B.A., of Kettering, has been killed in action. He married Miss Hester Perry Gtch, Mr. and Mrs. Gtch's only daughter, three years ago, and the bereavement comes with painful quickness after the announcement of the death at the front of their only son.

The Lord Mayor-Elect of Leeds is Mr. Frank Gott, a member of the well-known firm of land agents and surveyors, of Leeds. He is a member of the Surveyors' Institution, and is also president of the Yorkshire and North of England Land Agents' Association. Mr. Gtch's great-grandfather, Mr. Benjamin Gtch, was mayor of Leeds in 1799.

The courses of lectures on "Public Health Problems Under War and After War Conditions," which have been held at the Royal Institute of Public Health, have aroused such interest that a third course on the same subject has been arranged. The lectures are to be given, as heretofore, on Wednesday afternoons, at 4 p.m., in the Lecture Hall of the Institute, 37, Russell Square, London, W.C. 1.

At a meeting of the General Committee of the King's College School War Memorial, held at King's College, Strand, it was decided that £20,000 should be raised for the purchase of additional land, the erection of a school library and a swimming bath, and for the education of sons of old K.C.S. boys who have fallen in the war. The Old King's Club has undertaken to erect a roll of honour in the school buildings.

We regret to announce the death, on October 14, after a somewhat lingering and painful illness, of Mr. Oswald J. R. Old, who represented Vulcanite, Ltd., for many years, calling upon architects on the East and South Coast of England and S. Wales, amongst whom, and London architects, we feel many of his friends will regret his death at the age of 36.

Mr. and Mrs. Durling, the housekeepers at Wargood-Rids, Ltd., Fulmouth Road, London, S.E.1, have had the care, during the recent night air raids of several hundreds of their neighbours who have flocked into the concrete building to take protection. They feel that Mr. and Mrs. Durling have been very courteous and helpful to them, and recently made a presentation to Mr. Durling in the shape of a smoking cabinet with a suitable inscription, which was presented by Mr. Harris on behalf of the neighbours with a few suitable words.

TO ARMS!

COUNTY OF LONDON VOLUNTEER ENGINEERS (FIELD COMPANIES).

Headquarters, Balderton Street, Oxford Street, W.1. ORDERS FOR THE WEEK BY LIEUT.-COLONEL C. B. CLAY, V.D., COMMANDING.

OFFICER FOR THE WEEK.—Sce. Lieut. P. Bowden.

NEXT FOR DUTY.—Sce. Lieut. E. A. Ullmann. DRILLS.—Week ending Saturday, November 10, 1917:—

MONDAY.—No. 3 Coy, Left-half Recruits, Sig-Reg. 6330.

TUESDAY.—Physical Drill and Bayonet Exercise, 7.30.

WEDNESDAY.—No. 1 Coy., 6.30.

THURSDAY.—No. 2 Coy., 6. Signalling, Ambulance 6.30.

FRIDAY.—No. 3 Coy., Right-half, Recruits, 6.30.—SATURDAY.—Commandant's Parade for Route March and Drill. Parade 11.0., 2.45. Uniform. Compulsory for A, B, and C men.

MUSKETRY.—Belvedere Road, Tuesday, Wednesday, and Thursday, 5.30 to 7.

NOTE.—The Medical Officer will attend for Examination of recruits on Thursday, 8.0. All AB enamelled cap badges must be returned to the Quartermaster-sergeant without delay.

An Inspection of all A, B, and C men has been arranged for Saturday, November 17. Full particulars in next week's order.

Unless otherwise indicated all drills will take place at Headquarters.

By order, MACLEOD YEARLEY, Capt. and Adjutant, November 3, 1917.

Mr. R. J. Kettleborough, surveyor for the Belvoir rural district, has been appointed by the Grantham Rural District Council surveyor of the Eastern District, in succession to Mr. C. R. Lyne, resigned.

Lieutenant Leslie Scott, Household Battalion, who was killed on October 12, was the youngest son of the late John Allan Scott, of Ryde, Isle of Wight, and of Mrs. Oliver Gabell, of Brighton. He was educated at Brighton College, and afterwards practised as an architect and surveyor at Brighton.

A widely-known Scottish artist has been removed by the death of Mr. William Hole, R.S.A., which took place on the 22nd inst, at his residence, 13, Inverleith Terrace, Edinburgh. Mr. Hole was seventy years of age. For nearly a year he had been in enfeebled health.

Wythop Woods, stretching for three miles on the western side of Bassenthwaite Lake, one of the most popular tourist resorts in the Lake country, has been bought by the Government from Sir Henry Vane's trustees, and is to be felled for its timber, which is largely oak.

Government (War Office) contracts let during September:—Huts, Wood; Whyte and Co., Ltd., London, E.C. Works Services: Erection of Building; W. E. Blake, Ltd., London, S.W.; W. E. Chivers, Devises; R. Costain and Sons, Liverpool; Foster and Dicksee, Ltd., Rugby; Higgs and Hill, Ltd., London, S.W.; W. Lawrence and Sons, W.; A. Lloyd, Liverpool; F. G. Minter, London, S.W.; A. Roberts and Co., London, W.; T. Rowbotham, Birmingham; Triggs and Co., London, S.W.; Wilson, Lovatt and Sons, Ltd., Wolverhampton. Alteration of Stables; J. and W. Orr, Haadlington. Installation of Tank; S. F. Fowler, London, S.W. Maintenance of W.D. Buildings; E. Charlesworth, Hillborough, Sheffield; Strange and Son, Bechill-on-Sea. Government (H.M. Office of Works) contracts let during September:—Building Works: Avonmound Grain Stores, Building Work; W. Cowlin and Sons, Bristol. Barry Grain Stores, Building Work; H. Arnold and Son, Ltd., Domestert. Board of Agriculture, Whitehall Place and Great Scotland Yard, Erection of Temporary Building; Ford and Walton, Kilburn, N.W. Bristol Channel Ports, Steelwork; Dorman, Long and Co., Ltd., Westminster, S.W. Cardiff Grain Stores, Building Work; Fred Pitcher, Ltd., London, N. Erith, Thames Steam Saw Mills. Erection of New Timber Shed; G. H. Gunning and Sons, Erith. London District, Erection of Land Ward Erection of Temporary Building; Dardford, London District, Supply of Semi-Permanent Huts; James Byron, Ltd., Woolford, Bury. Netley Red Cross Hospital, Erection of Bath Hut; A. E. Jukes and Son, Southampton. Ordnance Survey Overseas Establishment, Erection of Hostels; E. Marshall and Sons, Ltd., Cockburn, Edinburgh. Lyne, Ordnance Survey Overseas Establishment, Joinery, etc.; J. Carmichael, Tooting, S.W.

FOR  
**Olivers'**  
**Seasoned**  
**Hardwoods,**  
 APPLY TO—  
**WM. OLIVER & SONS, Ltd.,**  
 120, Bunhill Row, London, E.C.

TENDERS.

\* Correspondence would in all cases oblige by giving the addresses of the parties tendering—at any rate, of the accepted tender: it adds to the value of the information.

**BOUENNE.**—For erection of a store for garden produce, for the Bourne Rural District Council:—  
 Roberts (accepted) .. .. . £36 10 0

**COVENTRY.**—For erection of proposed hot-baths, for the committee of the Coventry and Warwickshire Hospital:—  
 Accepted tenders: E. O. C. Howells, buildings, £125; Lees, Bessley, lighting, £75; A. Hall, heating, £125.

**DOWNPATRICK.**—For construction of a sewer in Stream Street, for the rural district council:—  
 P. Tessart (accepted) .. .. . £319 0 0

**FRASERBURGH.**—For painting wood and ironwork of buildings at the reclaimed ground, for the Fraserburgh Harbour Commissioners:—  
 J. Stuart (accepted) .. .. . £36 10 0

**GLASGOW.**—For electric lighting installation at Robertson Hospital, for the Health Committee:—  
 Johnston, Park and Co. (accepted) .. .. . £915 14 2

**ISEWORTH.**—For erecting buttresses to support boundary wall at the Gordon House Girls' Home, Iseworth, for the London County Council (Education Committee):—  
 G. W. Beattie .. .. . £167 0 0  
 (Recommended for acceptance.)

**LONDON.**—The London County Council have accepted the following tenders:—For the execution of painting and tarring works:—  
 (i.) Aske's Garden, W. Martin, £26 12s.; (ii.) Avery Hill, J. B. Bealey, £164 10s.; (iii.) Clapham Common, Triggs and Co., £116 13s. 4d.; (iv.) Ford Square and Sidney Square Gardens, G. Barker, £73; (v.) Hackney Downs, J. Hayden and Sons, £12 7s. 4d.; (vi.) Hackney Marsh, J. Hayden and Sons, £31; (vii.) Manor House Gardens, J. H. Bealey, £30 10s.; (viii.) Parliament Hill, T. Watson, £169; (ix.) Ruskin Park, A. Goldman and Son, £37; (x.) St. Matthew's Churchyard, Bethnal Green, Lole and Co., £29 5s.; (xi.) Southwark Park, Triggs and Co., £23; (xii.) Walworth Recreation Ground, H. Line and Co., £22 10s.; (xiii.) Wandsworth Common, Triggs and Co., £96.

**LONDON.**—For making good damage to a technical institute, for the London County Council (Education Committee):—  
 Rowley Bros. .. .. . £95 0 0  
 C. Wall, Ltd. .. .. . 908 0 0  
 J. and C. Bower, Ltd. .. .. . 0 0 0  
 (\*Accepted. Architect's estimate, £950.)

**LONDON.**—For removing brickwork setting of boiler at the Highbury Industrial School, for the London County Council (Education Committee):—  
 Vinton and Brockett, Ltd. .. .. . £5 5 0  
 Cannon and Sons, Ltd. .. .. . 2 10 0  
 Patowkar and Sons .. .. . 73 10 0  
 I. S. Knight and Sons .. .. . 69 10 0  
 R. H. and J. Pearson, Ltd. .. .. . 60 0 0  
 (Accepted.)

**LONDON.**—For repairs to corrugated iron roof at boiler house, for the Hammersmith Borough Council:—  
 D. Rowell and Co., Ltd., 14, Bowick Place, West-minster, S.W., £174 (recommended for acceptance, in place of F. Brady and Co., Ltd., £129 10s., withdrawn).

**LONDON.**—For repairs to chimney stacks at the Ravenscourt Park Library, for the Hammersmith Borough Council:—  
 W. Brown and Sons .. .. . £80 0 0  
 A. and F. Polden .. .. . 63 10 0  
 \*Recommended for acceptance.

**LONDON.**—For sanitary works to premises, for the Hammersmith Borough Council:—  
 43, Raynham Road:  
 G. W. Clarke, 1, Exbridge Road .. .. . £32 8 0  
 W. Chapman and Sons, Black Lion Lane .. .. . 16 10 0  
 Childley Bros., 96, Shepherd's Bush Road (accepted) .. .. . 15 0 0  
 20, Adelaide Road:  
 G. W. Clarke .. .. . 34 10 0  
 W. Chapman and Sons .. .. . 19 15 0  
 (Childley Bros. (accepted) .. .. . 16 10 0

**PERMORKE.**—For erection of shelter over the bus-rs' door, for the guardians:—  
 B. Brown, Tisbury (accepted) .. .. . £19 15 2

**WYMOUTH.**—For alterations to the premises of the technical school, Commercial Road, Weymouth, for the Dorset County Council Education Committee. E. J. Brett, architect:—  
 Accepted tenders:—Alterations to premises, A. E. Whittam, Weymouth, £375; heating system, Bacon and Curtis, Bournemouth, £334 15s.

LIST OF TENDERS OPEN.

ENGINEERING.

**Nov. 19.**—Supplying and erecting a Lancashire boiler, boiler mountings, superheater, and Green's economiser, at the Sheerness east pumping station.—For the Sheerness Urban District Council.—V. H. Stallon, Clerk, Council Offices, Sheerness.

**March 30.**—The Acting British Consul at Santiago reports that a decree has been issued calling for tenders for the improvement of the port of Antofagasta (Chile). By the terms of this decree the amount to be expended on this work must not exceed £1,700,000. Details may be obtained from the Port Commission Offices in Santiago, and copies are expected to be received shortly at the offices of the Chilean Legation in London, 22, Grosvenor Square, W.1. Tenders will be received up to 3 p.m. on March 30 by the Minister of Finance, Santiago.

FURNITURE.

**Nov. 1.**—The Commissioners of H.M. Works invite tenders (from manufacturers only) for supplying blinds during one year from date of acceptance of tender.—Secretary, H.M. Office of Works, Storey's Gate, London, S.W.1.

SANITARY.

**Nov. 12.**—For cleaning out the sewage ditch from Troston Hall to Radcliffe Road Bridge, a distance of about 1,550 yards.—For the Alwrick Rural District Council.—H. W. Walton, Clerk, Alwrick.

The Lewisham Borough Council have agreed to acquire premises at Rushey Green for purposes of a maternity home and child welfare centre. Steps are to be taken to carry out the necessary alterations.

On Friday week, at Painters' Hall, Mr. J. D. Crace, F.S.A., was presented with an illuminated address on the occasion of his retirement from the Presidency of the Incorporated Institute of British Decorators.

The Duke of Devonshire last Wednesday unveiled a monument, erected at Brantford, Ontario, to Dr. Alexander Bell, inventor of the telephone. Dr. Bell made his first successful experiment at Brantford in 1874, and the Bell Homestead, thirteen acres, on the banks of the Grand River, has been acquired by the Bell Memorial Association.

TO CORRESPONDENTS.

We do not hold ourselves responsible for the opinions of our correspondents. All communications should be drawn up as briefly as possible, as there are many claimants upon the space allotted to correspondents.

It is particularly requested that all drawings and all communications respecting illustrations or literary matter, books for review, etc., should be addressed to the Editor of the BUILDING NEWS, Effingham House, 1, Arundel Street, Strand, W.C.2, and not to members of the staff by name. Delay is not infrequently otherwise. All drawings and other communications are sent at contributors' risks, and the Editor will not undertake to pay for, or be liable for, unsought contributions.

When favouring us with drawings or photographs, architects are asked kindly to state how long the building has been erected. It does neither them nor us much good to illustrate buildings which have been some time executed, except under special circumstances.

\* Drawings of selected competition designs, important public and private buildings, details of old and new work, and good sketches are always welcome, and for such no charge is made for insertion. Of more commonplace subjects, small churches, chapels, houses, etc., we have usually far more sent than we can insert, but are glad to do so when space permits, on mutually advantageous terms, which may be ascertained on application.

Telephone: Gerrard 1201.  
 Telegrams: "Timeserver, Strand, London."

Handsome Cloth Cases for binding the BUILDING NEWS, price 2s., post free 2s. 5d., can be obtained from any Newsagent, or from the Publisher, Effingham House, 1, Arundel Street, Strand, W.C.2

BACK ISSUES.

Most of the back issues are to be had singly. All back issues over one month old will be charged each, postage 1d. Subscribers requiring back numbers should order at once, as they soon run out of print.

RECEIVED.—A. H. and Son—F. T. M.—G. St. A.—F. C. C.—J. C. S.—M. and Co.—H. and G.—V. Ltd.—R. C. C.—C. Co.—C. J. and Co.—B. and Co.—Ltd.—G. and Co., Ltd.—A. W. B.  
 R. G. L.—No.

PHILIP W. T.—Please send.  
 NEXOS.—Sorry, too long. 2. Yes.

Col. T. L.—Probably in the Proceedings of the Institution. We have no recollection of it.

UNCERTAIN.—We gave the late George Edmund Street's Academy Lectures on pp. 172, 199, 223, 236, 267, 332, 415, 446, 475, and 500, Vol. XL, his Presidential Address at the R.I.B.A. on p. 61s of Vol. XLI; and an obituary notice and biography of him on p. 813, Vol. XLII.

W. H. M.—We know of no recent good books. Some of the best books on medieval costume—all somewhat expensive—were indicated by the late William Burges in an article which he wrote for us at the time, and which appeared in our issue of August 8, 1879, more especially noticing J. R. Planché's "Encyclopædia of Costume," which at that time had just been completed.

Canon Alexander's suggestion that, after the war, a statue to Sir Christopher Wren should be erected in the neighbourhood of St. Paul's Cathedral is receiving considerable support from architects and others, and a small committee is being formed to consider the matter. A gift of £500 has already been offered towards the cost of the proposed work.

**BRABY'S**  
**AUTOMATIC**  
**FLUSHING TANKS**



SIMPLE. RELIABLE.

**Fredk. BRABY & CO., Ltd.**  
 352 to 364, EUSTON ROAD, LONDON, N.W.



# THE BUILDING NEWS

## AND ENGINEERING JOURNAL.

**Effingham House.**

Currente Calamo .. .. .	361
Popularising Art .. .. .	362
Our Illustrations .. .. .	363
Comptitions .. .. .	364
The Royal Institute of British Architects .. .. .	377
Coal Concrete from Dust or Ashes .. .. .	375
Trade Notes .. .. .	375
Correspondence .. .. .	379
Our Office Table .. .. .	375
Professional and Trade Societies .. .. .	380

**CONTENTS.**

Statutes and Memorials.. .. .	380
Tenders .. .. .	380
To Correspondents .. .. .	380
List of Tenders Open .. .. .	380
Parliamentary Notes .. .. .	380
Latest Prices .. .. .	viii.

**OUR ILLUSTRATIONS.**

Imperial College of Science and Technology, South Kensington: The Main Entrance. Sir Aston Webb, K.C.V.O., C.B., R.A., Architect.
---

**Strand, W.C.2.**

Lady Chapel Altar and Reredos, All Saints' Church, Grosford, Wrexham. Mr. William D. Caröe, M.A., F.S.A., F.R.I.B.A., Architect.
New Heraldic Frieze, Council Chamber, Edinburgh (Scottish Emblem of the Thistle). Messrs. Dobie and Son.
Lacock Abbey Stables and South Porch, Corsham Church, Wilts. From water-colour sketches by Mr. Maurice E. Adams, F.R.I.B.A.
Messrs. John Menzies and Co., Ltd., Warehouse, West Nile Street, Glasgow. Plans, section, and elevation. Mr. S. R. Lithgow, Architect.

### Currente Calamo.

All will wish Mr. Henry T. Hare a successful term of office as President of the R.I.B.A., and that it may fall to his lot to congratulate his fellow-members on the conclusion of the war before he vacates the chair. We are glad he endorses the efforts made by Mr. Newton to press forward the legitimate claims of architects and architecture to public recognition, and hope he may be more successful in the immediate future as far as the Government is concerned, which still continues to ignore us. With every word Mr. Hare said about the housing of the working classes we agree. We trust, however, that any attempt on the part of the Government to saddle the R.I.B.A. or the competitors it invites with the imperfect standardised plans already issued will be resisted; and that the premediated plans will not be commandeered for issue to all and sundry, so that they may dispense with the services of an architect, as such have been distinctly invited to do in the past.

Within a few days the settled scheme which is to put in force the principle of national responsibility for damage done by air raids and bombardment is to be laid before the House of Commons. The Committee on War Damage was formally constituted on October 28, 1915, to urge the Government to abandon their insurance scheme and in its place give effect to the principle of national responsibility to give reasonable compensation to all who may be injured in body or estate by air raids or bombardment. Repeated appeals were made to induce the late Government to accept this principle, but without any effect until November last, when Mr. Asquith stated that his Government had agreed to reconsider the matter. Then came the change of Government, and our appeal was addressed to the new Prime Minister, who received a deputation on July 13 last, when he asked the Committee on War Damage to communicate with the Government and assist them to work out the details of a scheme for giving effect to the principle accepted. This the Committee did. On October 23 the Committee were informed that the matter had been referred to the War Cabinet for decision,

and that a scheme had been agreed upon for at once giving partial effect to the principle of national responsibility. On Monday last Mr. Bonar Law stated in the House of Commons that a scheme had been prepared to give owners of property not exceeding £500 in value compensation for damage done by air raids and bombardment without payment of any premium. Owners of property exceeding £500 in value would be compensated up to £500 without payment of premium, provided that property in excess of £500 was insured under the Government insurance scheme. The new scheme was to take effect from September 1. Mr. Peto asked whether all existing anti-aircraft policies should be reduced by £500 in order to render the concession effective. Mr. Bonar Law said: "That is the effect of the announcement I have made." A somewhat lame arrangement, on the whole, we think, but better than nothing, and one for which small owners have reason to be grateful to the persistent efforts of the Committee.

The actual owners of property have more interest in its permanent improvement than those who are merely its temporary possessors. For this very practical reason our land laws are a matter of much concern to all builders and to the building trades. Failing a freehold title, it is well that those who are in possession of business premises should have them for long and certain terms. In this way the legal question as to the validity of a reversionary lease is of real interest to all concerned with building. The recent case of "Messrs. Crossman and Paulin, Ltd., v. Hind" shows what important things may lie hidden under legal technicalities. The plaintiffs, a brewery company, were in possession of public-house premises in Middlesex, for a term of fifty years from 1896, expiring in 1946. The landlord had died in 1898, leaving the property to his widow for life, with remainder to her children, now over age. In March, 1917, she, here the defendant, had, with the consent of her children, granted to the plaintiffs a reversionary lease of these premises for a further term of thirty years, to begin from the end of the existing lease, which would be in 1946, at a premium of £250, and a rental of £36 per annum. The Land

Registry raised the point that this new lease was invalid under the rule against perpetuities, because it began more than twenty-one years after the date of the grant, and the Registrar refused to give the plaintiffs a good leasehold title. There had been no previous decision of the courts on this point, and conveyancers were in great doubt about it. Plaintiffs took the case up to court, where it was argued out before Mr. Justice Neville. The question was whether the grant of a future term by a reversionary lease was an executory interest or a vested interest. If the former, it would be invalid; if the latter, it must be binding. The judge held this reversionary lease to be a vested interest, and ordered its due registration in the plaintiffs' names. The result is satisfactory; and the case is important, as many other similar matters will be governed by this decision. Those who hold such future terms will, therefore, be safe in spending money upon improving their business premises.

The Bribery and Secret Commissions Prevention League, of 9, Queen Street Place, E.C.4, in its October "News Sheet" comments on several of the recent scandalous attempts to bribe officials and others by contractors and various offenders. All should read it and make sure they are not being similarly betrayed to the wily palm-oiler who is rampant in our midst just now. It also quotes some strictures on "Varnish Graft," by the *Furniture World*, of New York, which some years ago vigorously exposed "varnish graft," and is now starting "to tackle the dirty job again," remarking that it is assured "the damnable practice of bribing the foremen finishers of the furniture factories of the United States is worse than ever." A varnish manufacturer is quoted as saying:—"Not every furniture manufacturer knows, but it is nevertheless a fact, that varnish at 50 cents per gallon looks like varnish at \$1.50 per gallon, but the difference is in the wear. When you pay, for instance, \$1.00 per gallon for your varnish, you should have a dollar's worth, just as if you bought a pound of meat or a ton of coal. Not every furniture manufacturer knows, but it is nevertheless a fact that many reputable

varnish manufacturers are to-day even unable to submit their products on account of the fact that many finishers are demanding at least 10 per cent. on every gallon of varnish used in furniture factories. The average furniture manufacturer could save at least this 10 per cent., possibly more, on his yearly purchases of varnish if he would take the trouble to exclude any form of bribery. He is likely at first to have a report that the varnish is 'entirely unsatisfactory,' but let him make it known that no commission is forthcoming for using any brand of varnish, any more than his stenographer is bribed for using any particular make of writing machine, and the present existing evil will very soon cease. . . . The furniture manufacturer gets what he pays for and no more—that's human nature the world over. He gets a 90-cent quality varnish for which he pays \$1.00, and the finisher gets \$5.00 on every barrel that goes on the premises." In pre-war times complaints of this kind were common in this country.

Greater men than the late Lord Clifford have made people sorry when they were dead. King David, of old, for instance, whose dying orders to Solomon to make an end of Joab and Shimei, hardly evinced the charity with all men that lefts the dying; but few possibly have made themselves posthumously unpleasant about comparatively small matters. In a letter left to be opened by his heir, the following instruction was found:—"A good many years ago I made an agreement with the Newton Abbot Rural District Council for a supply of water to Kingsteigton from Pitwell. They were to pay £40 a year for a certain quantity and so much per thousand gallons above that. I commuted the £40 a year for a shilling a year for my life only. They will come to you and ask you to do the same. It is my particular wish you should not. I want someone to be sorry I am dead. There are lots of things they want done for them if you wish to show them kindness, but then they may recognise what you do as your kindness and may be grateful to you. But this was my kindness, and I want them to realise it as mine." The Council made the expected application to Lord Clifford's successor, and the Hon. Charles O. H. Clifford, manager of the estate, after clipping the contents of the sealed packet, has replied: "Perhaps the late Lord Clifford was under the impression that his kindnesses were taken too much for granted. Whatever may have been his impression, his intention was quite clear. It will be obvious to you that in the face of his brother's expressed wish to the contrary, my father cannot possibly reduce the sum to be paid for the water in the future as you suggested." So the "dead hand" is to be felt as it was meant to be.

The October issue of *Floor Slab Reinforced*, issued by the British Reinforced Concrete Company, Ltd., of 1, Dickinson Street, Manchester, in addition to some very practical information and illustration of reinforced concrete floor

construction, has an interesting article on "Walls," especially in connection with their capabilities for defence against an enemy. An interesting illustration is given of a shell keep at Farnham Castle, built during King Stephen's reign, where a wall of immense passive strength was obtained by enclosing an existing earthen mound with a nearly vertical facing of stone. The defenders' quarters were at a very considerable height above the dry moat, and rested on the mound, which thus formed a solid earthen filling for the greater part of the keep. A wall so reinforced and itself supporting nothing vital must have offered unusually poor prospects of fruitful results from the ordinary enterprises of ramming and mining, and it is somewhat surprising that the plan was not more widely made use of in medieval times. Mr. James R. Wigfull, A.R.I.B.A., contributes a timely note on the advantages offered by reinforced concrete in the provision of small houses, and also two illustrations of a new Unitarian Church at Sheffield, built by him and reinforced on the B.R.C. system. He emphasises its special and unique advantages, not the least of these being the ease with which it can be laid into position by the ordinary building workman. There are no complicated arrangements of loose bars, but merely a fabric which can be fixed properly by attention to a few simple instructions. What this means will be appreciated by all whose lot it is to supervise the efforts of the ordinary workman, filled as he is by an intense dislike of all new-fangled ideas.

Sir Arthur K. Yapp's new League of National Safety will, we hope, elicit a prompt response from every reader. Any man or woman in the realm who is not wearing the Anchor before Christmas should be shunned as a food hog. Membership involves signing and fulfilling the following promise:—

I realise that economy in the use of all food and the checking of all waste helps my country to complete victory, and I promise to do all in my power to assist this campaign for National Safety.

There are no membership fees. A badge bearing an anchor as an emblem will be supplied free to every member, and cards on which applications for enrolments may be made can be obtained from Sir Arthur Yapp, League of National Safety, Ministry of Food, Grosvenor House, London, W.1. A comprehensive scheme for obtaining members is being prepared, and it is hoped to have a membership of ten millions by Christmas. Lord Rhondda, the Food Controller, will closely watch the results of the campaign, and if the present appeal for voluntary economy is not responded to by the nation generally he will not hesitate to recommend to the Cabinet a scheme of compulsory rationing.

#### POPULARISING ART.

How shall we "popularise" art? We mean, of course, how shall we sow the seeds in the minds of the masses that beauty and fitness, in the home, the city, and the village, which shall grow and fruit into the comprehension that beauty and fitness are not the mere veneer of the commonplace and the bizarre, but the fundamental elements of real culture, which beneficially provoke the desire for, and the right appreciation of, the good work of the artist and the artist craftsman, and stimulate the impulse to create and use the genuine efforts they produce?

Till we do that—all we raise real interest in the matter—all our present endeavours will fail. A couple of generations of art-education, of its sort, has done little as yet, even to attract art workers, and scarcely anything to foster the innate preference in the minds of the people generally for things of daily use on which the producer has united the qualities of real use with the charm of true art. And yet none can deny, who are familiar with the work of our forbears from the twelfth to the sixteenth century, that the English people down to the time of the decay of the co-operative trade guilds must have had the instincts of the appreciation of beauty, which were responded to, and which stimulated the work of, those who sprang from their ranks, and some have left behind them enduring proofs of their skill.

There is something, we think, to be learned from some of our American friends, who are wholesomely alive to this, lacking though they do the examples of work which their forefathers here accomplished. Mr. Dudley Crafts Watson, the Director of the Milwaukee Art Institute, is not above taking a hint from the way systematic buyers of the records of the music-producing instruments proceed almost by their own impetus. They begin with "Pretty Baby" and various dance records, and in two years they arrive at the classics. Chopin, Beethoven and Verdi are in the shops to be tried out, and these in the end are better liked than the poor stuff. Mr. Watson contends that if the great mass of the American people could be reached with pictures as vigorously as they are being reached in music, it would be found that an advance in the appreciation of art would not be "altogether a matter of education," but would come simply by opening people's eyes and giving them a chance to see. The Chicago World's Fair is declared to have done more to enlighten the masses in the United States on the subject of art than all the museums combined have been able to do. Hence Mr. Watson sees a chance to reach every year "possibly 40,000,000 of people through their own conclaves known as county and State fairs." Some efforts have been made in many States, chiefly in the way of little side-shows which attract few visitors, but the scheme which is regarded as most promising of results is that introduced by Mr. Maurice I. Flagg, director of the Minnesota Art Commission. In addition to the "real hand-paintings, no two alike," which the posters endeavoured to bait the public with, Mr. Flagg introduced "intimate" talks and demonstrations such as we see described in *The American Magazine of Art* (New York).

Mr. Flagg had prepared an outdoor studio with a platform and easel, and the landscape gardener had arranged a very attractive arbour of vines over it and chairs for about two hundred. In good weather we went out there for the demonstrations, and when it rained we moved the platform inside. This is, briefly, the way we "performed." It is so simple that it could be done in every community, or at least in every State where there

The death is announced of Mr. Charles Herbert Shoppes, architect and surveyor, of John Street, Belford Row. For upwards of a quarter of a century he had been surveyor to the City Commission of Lieutenancy, and was further associated with the City as a liveryman of the Grocers', the Armourers' and Brasiers', and the Barbers' Companies.



are artists who can demonstrate with a few lines the ways and the means to go about creating a picture. It could also be done in sculpture and in some of the crafts. I believe these demonstrations have proved in Minnesota one of the most effective ways to remove the mystery of art and make the people believe it is a part of their own expression. In the first place, we posed the model upon the platform, showing how to get an attractive pose, and then made a large drawing of the figure in fifteen minutes. The audience loved to see the work done; it meant more to them than all the talking about the pictures did. We started with the young woman and then took an old man and then a little child, and varied the programme each day. We would pose the young woman straight ahead with the head in this stiff position, making a very rapid sketch life-size, and then show how by simply loosening one side of the figure and relaxing it we could gain informality and grace.

We had one delightful old soldier with a grizzled beard and many brass buttons, and we demonstrated that the beard and the buttons were non-essentials. Then we would show with the young lady what the photographer does to-day. To-day the country photographers have all become art photographers.

monstration in the pictures and the works of sculpture. From six to half-past seven of each evening the galleries were so jammed that we had to make two tours, and we found that the same people who had been there during the day came back for the gallery tours in the evening. The first of the week the wives and daughters were there, but later the farmers themselves came in as great numbers as the women.

The first day a woman asked if we gave the talks every day of the fair. She said: "I have a daughter who has recently been married, and who always wanted to paint and wanted to take lessons. She lives three hundred miles away, but I am going to telegraph her to come." And the next afternoon the daughter and her husband were there. I have had three pictures sent me by the daughter since she went back, and she never touched a bit of printing before then except in a very amateurish way.

There are innumerable instances of that sort. One day a little girl and her father stayed a whole day; she was about twelve years of age, and when I went to speak to them she was extremely shy and hid behind her father. I asked him if she enjoyed art. He said: "I do not know what is the matter with her; she won't go anywhere else in the

Provençal literature. "I claim my goods wherever I find them," said the poet America must deliberately do the same. In the process the egg of somebody's sensibilities is sure to be broken, so that the *omlette soufflé* of American art may swell magnificently. Old Latin-speaking scholarship was shocked when Dante deliberately chose a vulgar dialect for his "Divine Comedy." He forced art to be democratic, and thereby persuaded democracy to be artistic. If democracy and art are ever to be wed, then always the latter must go a-counting of the former in the tongue of the people. Mr. Watson and his friends are courageously bridging over the awkwardness of the first few tongue-tied moments of meeting.

We heartily wish them success, and, similarly, to any here who may take a leaf out of their book. With the young we believe they are bound to find no small measure of encouragement. Nothing has more surprised and delighted us lately than our observation of the originality and resource which work in the munition factories has developed in the minds of boys and girls engaged therein, and which in not a few cases has really marvelously inspired the suggestion of quite valuable new methods and appliances which, though, of course, pool-pooled by their elders at first, has reduced labour and cost in equally wonderful proportions. We have tried to show elsewhere this week how this stimulation of invention must, if properly encouraged, tend presently to the improvement in mechanical science and progress generally. We are as convinced that its like stimulation as regards art would in like fashion elevate the true taste of creator and user of many things, and would prove—regarded only from the mere commercial point of view—an asset of no mean importance to the solid wealth of the realm.

## Our Illustrations.

MAIN ENTRANCE OF THE IMPERIAL COLLEGE OF SCIENCE AND TECHNOLOGY, SOUTH KENSINGTON.

This photograph was shown at the Royal Academy this year. Sir Aston Webb, R.A., is the architect. We published the detail of the same building to a large scale in our issue for January 1, 1915, when some particulars of the work were printed. The Commissioners of the 1851 Exhibition gave the site, which is situate at the corner of Prince Consort Road and Exhibition Road. The College includes the Mining, Metallurgical, and Geological Departments of the Royal School of Mines and the Engineering extension of the Central Technical College, the gift of the Goldsmiths' Company to the nation.

LADY CHAPEL, ALTAR, AND REREDOS, ALL SAINTS' CHURCH, GRESFORD, WREXHAM.

This oak reredos illustrated speaks for itself as regards subject. The photograph is taken from the work *in situ*, and was part of the scheme of fitting up a Lady Chapel to the memory of the late Alfred and Edith Ashworth, by their son, Philip Ashworth, of Horsley Hall, Gresford. All Saints, Gresford, holds the very foremost place among the many fine churches of Wales, and contains some admirable examples of fifteenth-century stained-glass windows, part of the most complete of which is to be seen in the published view. The reredos is from the design of Mr. W. D. Caroe, F.S.A., the architectural work being executed by Messrs. Dart and Francis, of Crediton. The sculpture by Mr. Hitch, of London. The photograph reproduced was shown at the Royal Academy this year.

NEW HERALDIC FRIEZE, COUNCIL CHAMBER, EDINBURGH.

A conventional arrangement of the Thistle forms the background of this decoration, as it was one of the stipulations by Sir Robert Maule, who presented the frieze, that the

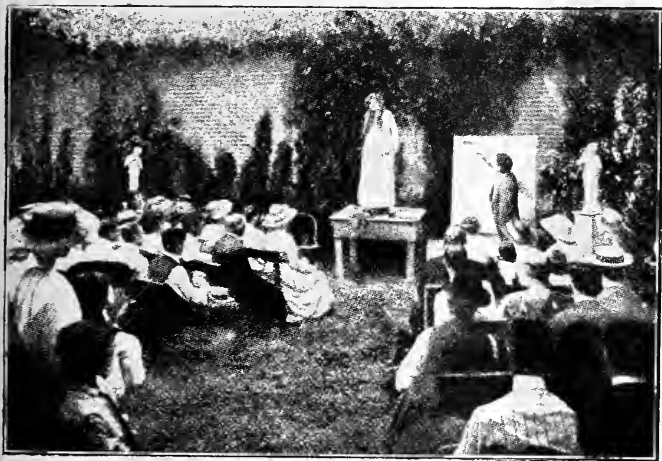

By courtesy of "The American Magazine of Art."

### AN OUTDOOR ART CLASS.

Before the art-crazing attendants of the county fairs in Minnesota an artist shows the uninitiated how men of his profession draw from a model.

and they make the model "look pleasant" or agonisingly "graceful," and we showed how silly that was. Then we would follow that with a landscape. We found to our surprise that they were not really as interested in the figure as they were in landscapes. We would draw a large landscape with a red barn in the middle and a road cutting the corners of the picture, and the trees planted at regular intervals, and would show how awkward that was, and then we would demonstrate the proper planting of trees leading up to the houses and the arrangement of buildings on the farm-grounds pictorially. We would rearrange the composition, move the barn over, and illustrate the general principles of composition and beauty. Occasionally we would follow that by taking one of the pictures in the exhibition and draw it, to show them the useful spaces, the unity of the composition, and it was surprising how rapidly they gleaned the sense of these terms.

So really attractive all this proved, that our American art demonstrators were encouraged to broaden their propaganda, and they soon found that really practical exposition of the method and means of real art-work without technical jargon or the pedantry of the schools acted kindergarten fashion on the impulses of many, and set them to work endeavouring to create like things. Says Mr. Flagg:—

We would often take crowds into the gallery and point out the same principles of the de-

grounds. I tried to take her to the show and to the automobile race, but she doesn't want to go."

At the end of a third day a minister in a community of seven hundred came about two hundred miles. He said: "You won't mind if I stay here? I have always had a notion that if I could draw a little bit I could make my people come to church on Sunday evenings." Of course we gave him all the help we could.

We have said a good deal from time to time lately about the ignorance of the masses of their real requirements in the homes they lack so badly; and how little beneficial as regards real love for the art that is, or should be, really good therein are the "standardised plans" to be from which we are told the Government is going to build houses for the workers. Might not some more enlightened friends show our homeless ones what could and ought to be done for them, and how they could and ought to make the best use of such homes. One of the more intelligent American papers, the *New York Evening Post*, commenting on Mr. Watson's efforts, says:—

Certainly nothing will ever begin without a beginning. Art probably never has anywhere come of itself, by spontaneous combustion. Dante and his circle fed on inferior

Scottish emblem of the thistle should be freely introduced in the work. The keynote of the heraldry is found in the panel over the fireplace, which contains the arms of the Scottish Monarch, and it was thought appropriate to have the coats of arms of the different Consorts of the Monarchs from the time of Malcolm Canmore down to the Union. These, of course, are, in most cases, the Queens of Scotland, but in others they are the husbands of the Queens. The space above the gallery at the end of the chamber contains a shield with the St. Andrew's Cross of Scotland as a decorative and appropriate centre, and gives a point of interest to that somewhat dull part of the chamber. The principal difficulty which had to be considered in the planning and designing of the frieze was to compose the colourings so that although producing a very rich and dignified effect, it had to be subordinate to various painted panels below which are the work of well-known Scottish artists, and represent Scottish historical scenes intimately connected with Edinburgh. The colour scheme was composed mainly of rich browns, golden yellows, and greens, which had the effect of bringing the gold pillars and the beautiful brown tone of the walnut-wood panelling together to form a harmonious combination with the frieze; the ribbons being a neutral grey white upon which are lettered the names of the respective bearers of the shields, and the blue, red and black of the shields give the necessary note of contrast. The accuracy of the heraldry has been guaranteed by the constant co-operation of the Scottish Lyon Office, who have been very kindly interested in it, and have given very valuable assistance and suggestions. The medium adopted for the painting was tempera, as used in the older Italian work, but with certain modifications. Painted on a specially prepared ground, the tempera colours produced a matt fresco-like surface which has the advantage of permanency and perfection of technique. The work was designed and executed by Messrs. Geo. Dobie and Son, of George Street, Edinburgh.

#### LACOCK ABBEY STABLES, AND CORSHAM CHURCH SOUTH PORCH, WILTSHIRE.

Lacock Abbey, the famous home of the Talbots, is beautifully placed on the banks of the Avon. It comprises the remains of one of the most complete examples of conventional arrangement and design to be found in the West of England. The abbey was founded by Ela, widow of William Longespée, a natural son of Henry II. by Fair Rosamond. The convent was of the Augustinian Order, and a plan of its ancient portions *in situ* appeared in the BUILDING NEWS for September 23, 1876, with an antiquarian description by the late E. C. Mackenzie Walcott. When Henry VIII. confiscated the abbey, Sir William Sherrington obtained the property, pulled down the chief buildings, and turned the religious house into a considerable residence for his own occupation. This was in 1540; but he retained the domestic quarters of the abbey and left the fine cloisters, which remained practically complete for a long while after his day. Sherrington's work, a good example of the Early Renaissance or Late Tudor erected in the reign of Edward VI., is represented by the octagonal tower, which has rather little detail. A sketch of this mansion is given in facsimile in Dingley's "Memorials in Marble," dated 1634. The minster or abbey church on the north side was then pulled to pieces, and has long been entirely destroyed. The cloisters stand well preserved, and not a few monastic features, incorporated with subsequent work, can still be seen. The stables, shown by the accompanying reproduction of our water-colour sketch, are of Elizabethan and Stuart times, very mixed in style but uncommonly picturesque, the range of dormer gables telling finely in perspective amidst the charming and well kept grounds, as seen from the rear of the premises. The old almshouses at Laacock have similar gables, and are equally quaint. The great Mediaeval hall was demolished by John Ivory Talbot when he came into the property in 1755, and the sixteenth-century

house also suffered badly, to give space for the present edifice, which was designed by Sanderson Miller, a scholar and very fashionable architect, also well known as the Squire of Radway Grange, near Edgell Hill. Miller was a pioneer of the so-called "Gothick Faste," and he emulated Batty Langley, whose "Architecture Improved by Rules" appeared in 1742. The existing hall, which he built at Laacock, rises upon the arches and vaulted Mediaeval crypt. The terra-cotta figures and models of the statues were the work of Victor Alexander Soderbach, who came from Salisbury and lodged at a grocer's in Green Street, Leicester-fields. Lord William Seymour, with some reputation as a decorator at this time, was employed by Talbot. Miller died in 1760, aged sixty-four, at the height of his prosperity. The parish church at Laacock is dedicated to St. Cyriac, and there is a fine barn among the adjuncts to the abbey grounds, well worthy of notice for its scale and style.

#### SOUTH AISLE, CORSHAM CHURCH, WILTSHIRE.

The periods of work represented in this building include most of the historic styles, and this diversity, of course, enhances its architectural interest. The uncommonly handsome porch, of which we give a sketch, is perhaps in its way second to no other individual feature. This is chiefly due to the Jacobean enrichments added to the embattled skyline in combination with the well-carved heraldic devices elaborating the effect. The church was restored by George Edmund Street, R.A., when he built the new tower and spire, in the doing of which he recognised the manner prevailing in Wiltshire bell-towers. A good example stands hard by at Laacock, where the church, comparatively unknown to architects, is a most interesting building, with a richly treated north chapel; also its beautiful carvings and the high-pitched gables set behind the embrasures of the sweetly shaped parapets. The Late Tudor domestic erection and the south transept group well with the spire, and when seen with the retreating street of the village the whole makes a charming picture. Somehow the modern tower at Corsham is hardly so satisfactory, though Street probably might have said, to compare his work with Laacock would be hardly fair. Corsham Church originally had a central tower. Why its position was changed is not clear. The nave arcade is Norman, and some of the windows are decorated in style; but the principal parts of the building are much later in date. The stone rood screen to the north chapel is handled in a light manner more adapted to woodwork, including the fan vaulting. Part of a timber screen divides the vestry from the chancel. The church contains memorials of the Hungerfords, and among these the more Classic tablets bear curious inscriptions of very odd terminology.

#### WAREHOUSE FOR MESSRS. JOHN MENZIES AND CO., LTD., WEST NILE STREET, GLASGOW.

The reconstruction of this warehouse in West Nile Street, Glasgow, for Messrs. John Menzies and Co., Ltd., has now been completed. The new building is fully occupied by the proprietors in the carrying on of their extensive business as booksellers, newagents and stationers. The entire scheme has occupied fully three years, and was carried through in three sections, owing to the fact that the proprietors conducted business as usual whilst the demolishing and reconstruction of the premises was taking place. The first section dealt with was the back building on north side of the lane connecting West Nile and Buchanan Streets. The next section was the building fronting West Nile Street, and the last section was the remaining portion of said building to southern boundary. The building has a frontage of about 90 ft., and consists of basement, shop and four upper floors, with flat roof (provision being made for two additional stories when required), is entirely fireproof and constructed on the Hembieque ferro-concrete system, with Dumfriesshire red stone covering columns and beams in front wall and white

enamel brick covering those in back walls. The floors are connected by two ferro-concrete stairs enclosed in brick walls, the one on northside of lane having a one-ton electric push-button lift in centre of well. There is also a small service lift from basement to upper floor for dealing with loads up to 60 lbs. The floors in warehouse are laid with "Dolomont" plastic flooring, and in private and typists' rooms with "Korkoid." The building throughout is heated on the low-pressure hot-water system and lit by electricity. The new warehouse is divided from the old portion by a brick party-wall, with openings having fireproof doors on both sides. The shop floor, north of Pend Close, is set apart entirely for the bookselling branch of the business, and the shop south of Pend Close is used exclusively as the news department. On the first floor is the book and stationery showrooms to the front, with counting-house behind. The country department is on the second floor, and the two upper flats are used for stock. The work of demolishing the old and erecting the new warehouse proved a somewhat difficult task on account of the congested area to work on and the restricted space available for doing what preparatory work was required. "So much was this the case that all the materials had to be prepared in the contractors' yards and brought to the job ready for placing in position. Then the difficulty of getting material and labour on account of the war greatly hindered the progress of the work, especially in the last section, where a license from the Ministry of Munitions had to be got before the reconstruction scheme could be completed. The architect for the building was S. B. Littlejohn, 156, St. Vincent Street, Glasgow, and the clerk of works D. C. Taylor. The following were the principal contractors:—Ferro-concrete work, Gray's Ferro Concrete Contracting Co., Ltd.; mason work, Thaw and Campbell; brick work, McDonald and Niven; wright work, Andrew Wilson; plumber work, James M. Symington and Co.; plaster and cement work, J. C. McIntyre and Co.; glazier work, Wm. Meikle and Sons; tile work, John Youden and Son, Ltd.; dolomont flooring, the British Dolomont Co., Ltd.; korkoid flooring, Rowan and Boden, Ltd.; pavement, stallboard and lantern lights, Haywards, Ltd.; electric light, Bennett and Rutherford; heating apparatus, James Cormack and Sons; painter work, G. W. Sellers and Sons; electric goods and service lifts, John Bennie, Ltd.

#### COMPETITIONS.

COTTAGES FOR INDUSTRIAL CLASSES.—In another column will be found the particulars of a competition arranged by the R.I.B.A. and the allied Societies for four specified types of industrial cottages, in six areas mentioned. Premiums of £100 and £50 for the best designs of each of three types, and £50 and £30 for the fourth will be awarded in open competition. Designs must be submitted in accordance with the conditions not later than January 13, 1918. Conditions of the competition may be obtained on and after November 10 for the Home Counties area from the Secretary of the R.I.B.A.; for the Northern area from Mr. H. L. Hicks, Hon. Secretary, Northern Architectural Society, 6, Highgate Place, Newcastle-on-Tyne; for the Manchester and Liverpool area, from Isaac Taylor, Esq., Manchester Society of Architects, 17, St. Ann's Square, Manchester; for the Midland area from Alfred Hale, Esq., Birmingham Architectural Association, 18, Bennett Hill, Birmingham; for the South Wales area from C. H. Kempthorne, Esq., South Wales Institute of Architects, Albert Chambers, King Street, Cardiff; and for the South West area from A. J. Pinn, Esq., Devon and Exeter Architectural Society, 5, Bedford Circus, Exeter.

A memorial was unveiled on October 31 in St. Paul's Cathedral Crypt to Sir George Clement Martin, who was for twenty-eight years organist of the cathedral. It consists of a white marble tablet, in the centre of which is a bronze alto relief portrait by Mr. Henry Pegram, A.R.A. The whole is surmounted by a semicircular pediment.



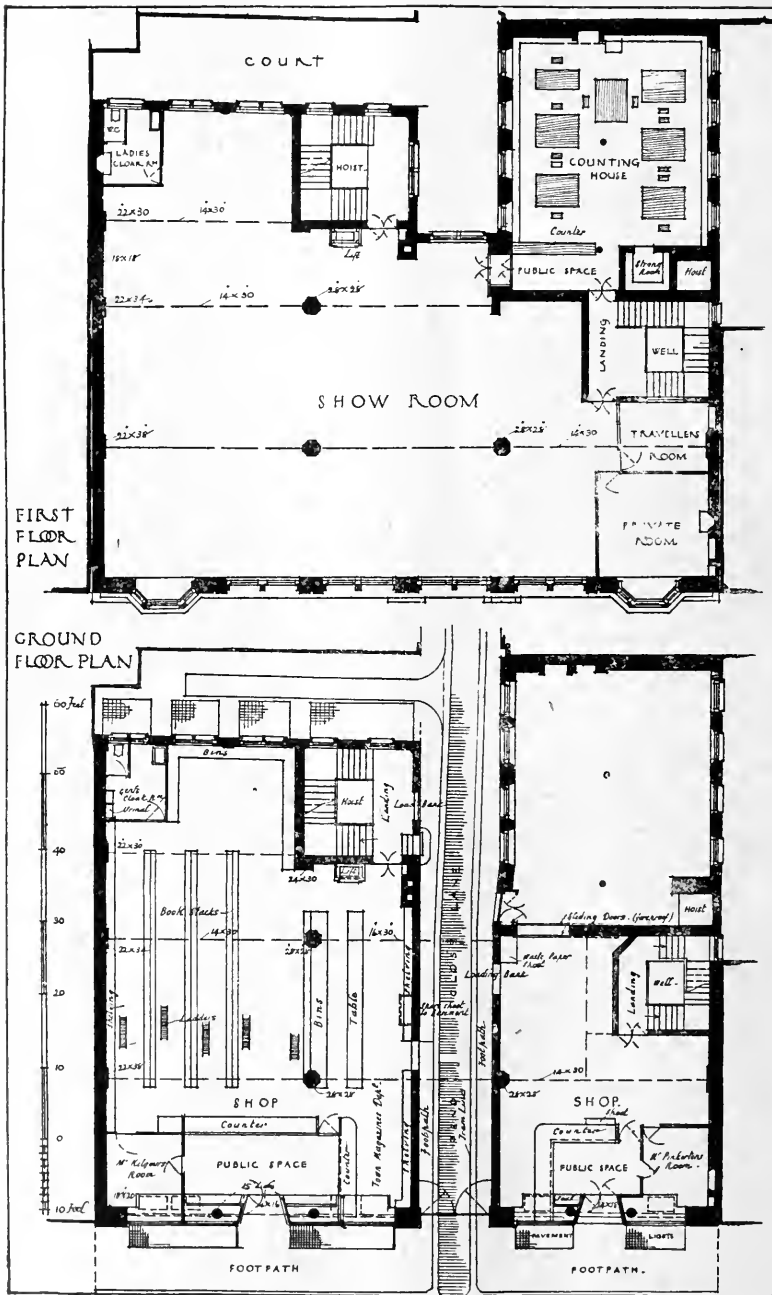

MESSRS. JOHN MENZIES AND CO., LIMITED, WAREHOUSE, WEST NILE STREET, GLASGOW.—Mr. S. R. LITHGOW, Architect.



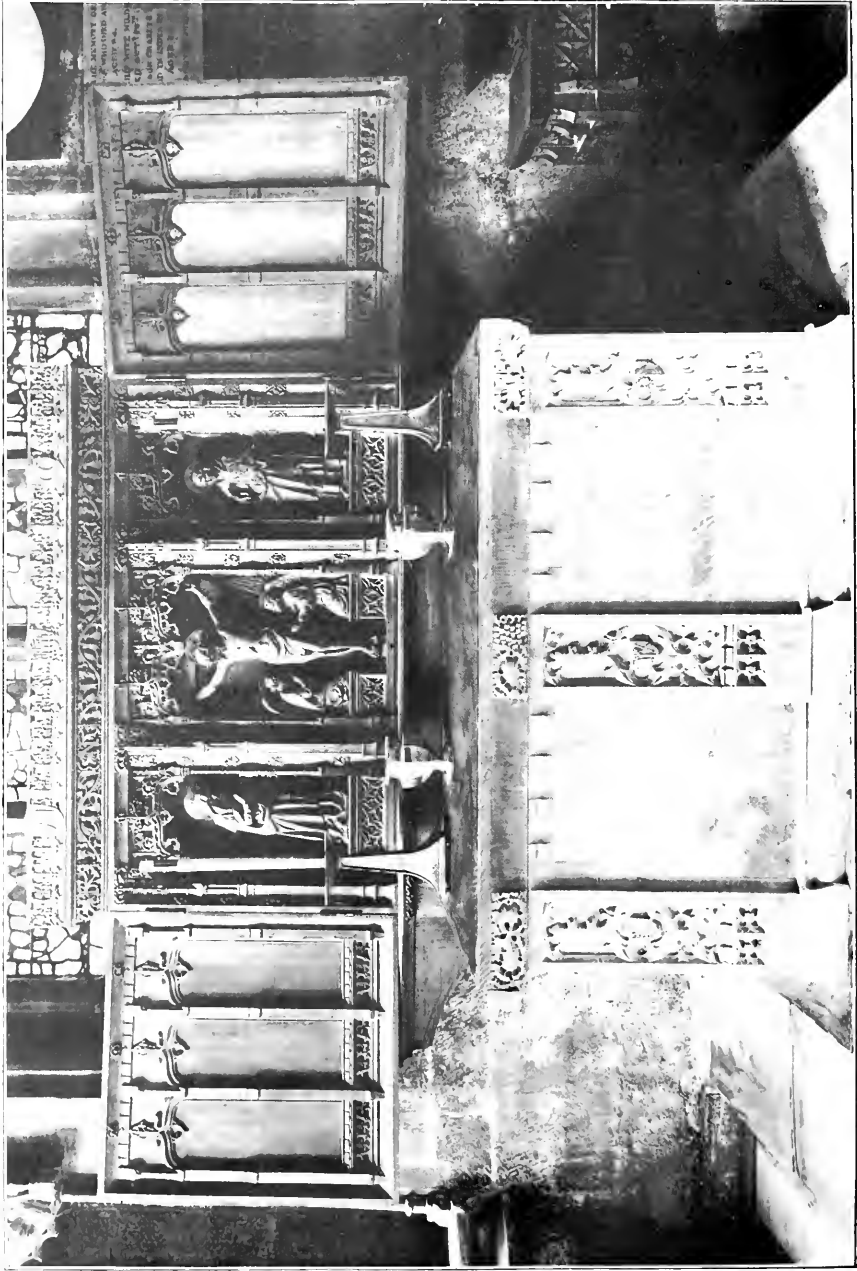

LADY CHAPEL, ALTAR, AND REREDOS, ALL SAINTS' CHURCH, GRESFORD, WRENTHAM.  
Mr. WILLIAM D. CARÖE, M.A., F.S.A., F.R.I.B.A., Architect.

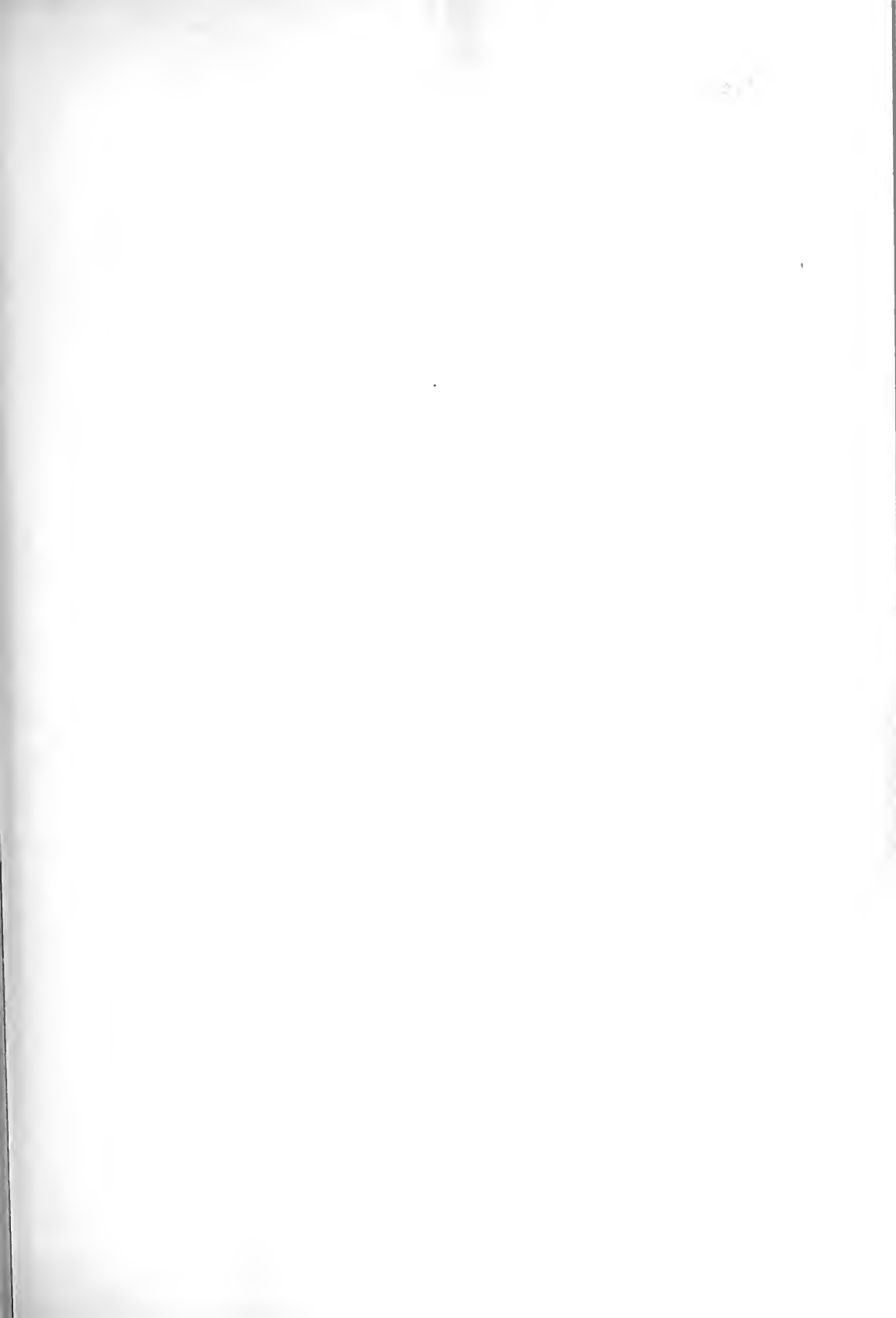

THE BUILDING NEWS, NOVEMBER 7, 1917.

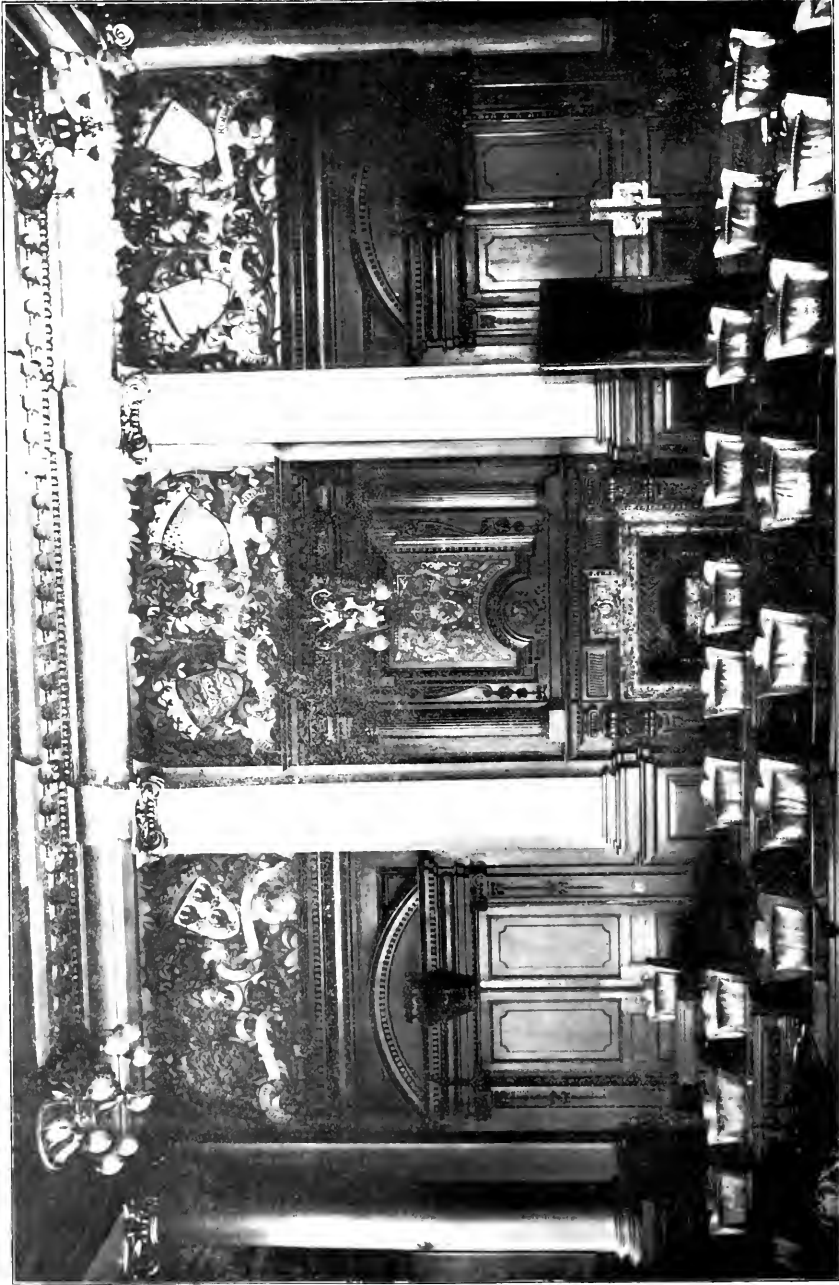

NEW HERALDIC FRIEZE, COUNCIL CHAMBER, EDINBURGH. (SCOTTISH EMBLEM OF THE THISTLE.)  
By Messrs. GEO. DOBIE AND SON.



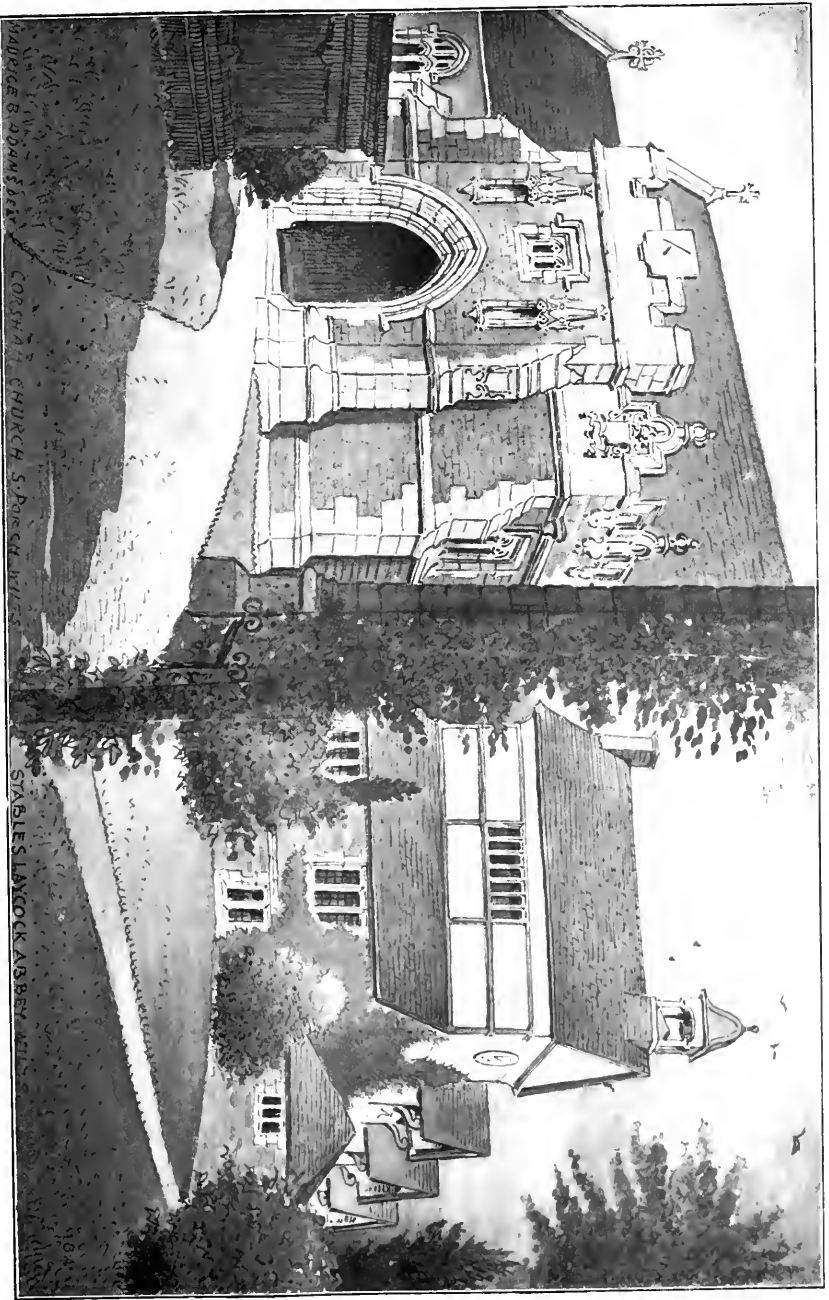

MADRICE & ADAMS ARCHT. CORSHAM CHURCH ST. PETER'S WILTS. STABLES LACOCK ABBEY WILTS.

LACOCK ABBEY STABLES, CHIPPENHAM, AND SOUTH PORCH, CORSHAM CHURCH, WILTS.  
From Water Colour Sketches by Mr. MADRICE B. ADAMS, F.R.I.B.A.



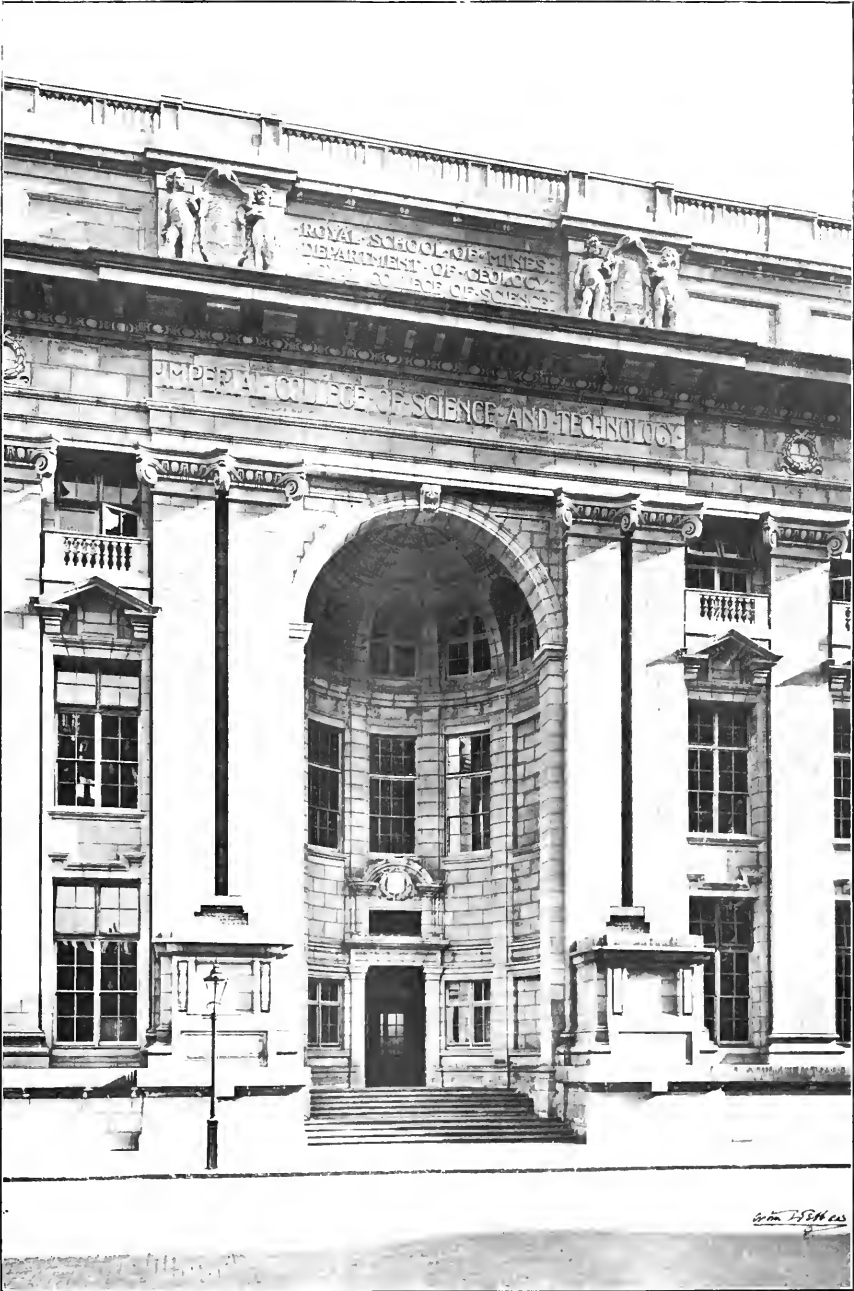

IMPERIAL COLLEGE OF SCIENCE AND TECHNOLOGY, SOUTH KENSINGTON.  
MAIN ENTRANCE.

SIR ASTON WEBB, K.C.V.O., C.B., R.A., Architect.



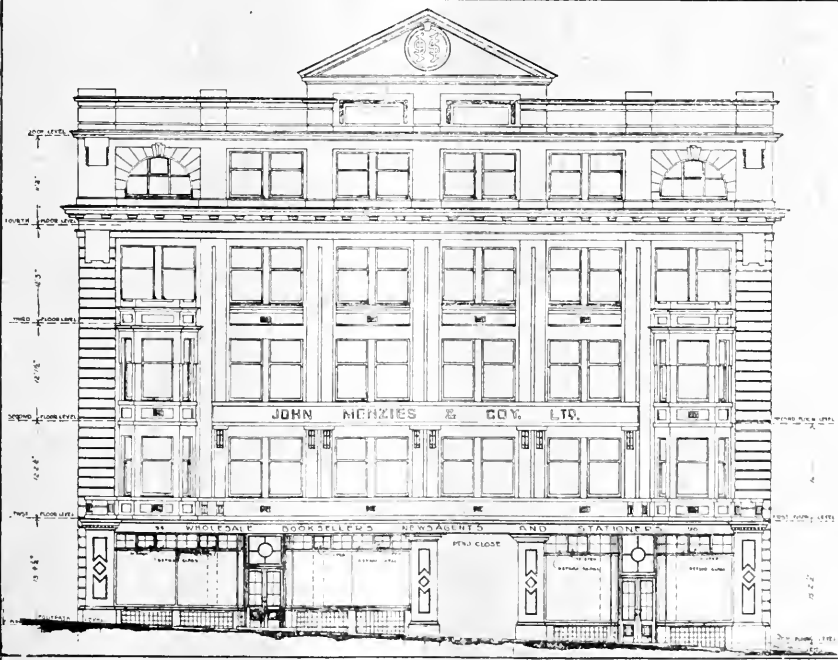
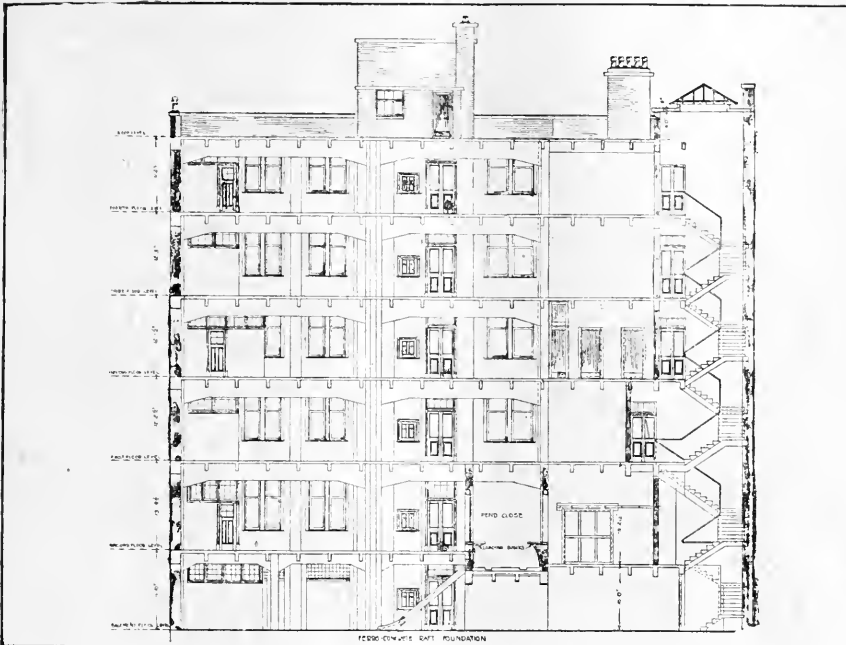

MESSRS. JOHN MENZIES AND CO., LIMITED, WAREHOUSE, WEST NILE STREET, GLASGOW.—Mr. S. R. LITHGOW, Architect.

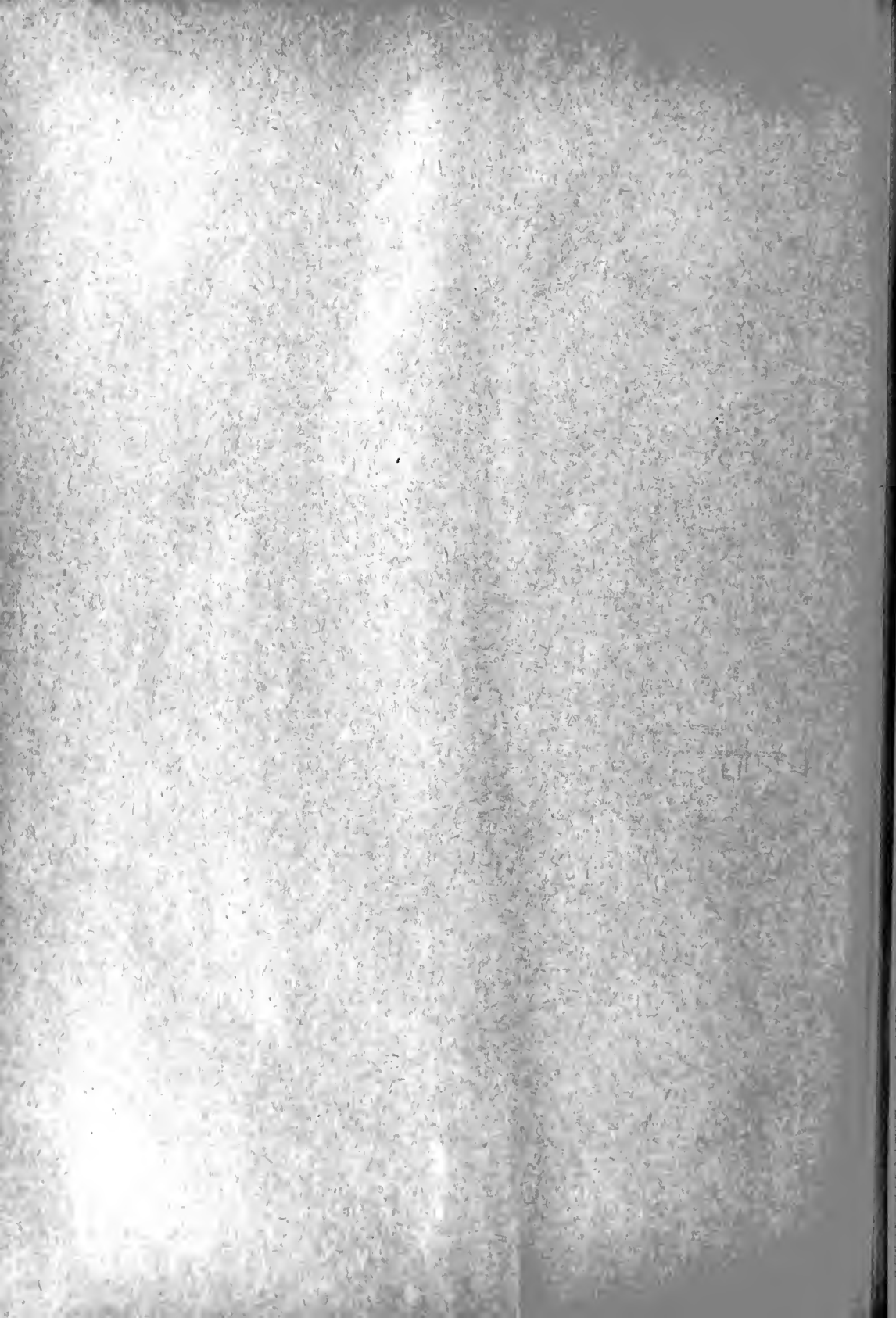

## THE ROYAL INSTITUTE OF BRITISH ARCHITECTS.

THE PRESIDENT'S ADDRESS.

EIGHTY-FOURTH SESSION—1917-18.

The following address was delivered by the President, Mr. Henry T. Hare, at the opening general meeting on Monday last—

For the fourth time our session opens under the shadow of the great war, and the conditions under which we exist as a profession have not varied from those in which our late President addressed us last year, except that there has been a material tightening up of the restrictions which limit, and indeed practically forbid, the exercise of our calling. We had hoped that we might have seen this chair still occupied by the same President who has so ably conducted the affairs of the Institute since the beginning of the war, and who held all the threads of such activities as were permitted to us, and that he would have continued until he could hand over the office under peace conditions. This, however, was not to be, and we realised that there must be a limit beyond which endurance could not be strained. I am sure I am expressing the universal feeling amongst our members, and particularly those who are members of the Council, and therefore more intimately acquainted with the strenuous nature of the work which falls to the lot of the occupant of the President's chair, when I say that the Institute and the profession as a whole are deeply indebted to Mr. Newton for the manner in which he has throughout kept before him the single-minded view of pressing forward the interests of architects and architecture, and their claims to recognition. If we have not succeeded to the extent to which we should have desired, it has been entirely due to unfortunate prejudices and want of knowledge as to our real functions in many quarters, and amongst the public generally.

These prejudices it must be one of our principal objects to remove by endeavouring to educate and interest the public, a task which is probably the work of a generation or two at least. We feel very strongly that had our special qualifications been properly understood we should have been allowed and invited to serve the national needs in many directions where less qualified, or entirely unqualified, persons have been employed.

By far the most important event which has taken place during the past twelve months is the entry of the United States into the war by our side, thus bringing together the two branches of the Anglo-Saxon race to fight for a common object. As architects we have exchanged most cordial greetings with our brother architects in America, many of whom we know well, and count amongst our personal friends. To any of these whom the exigencies of the war may bring over to this side we extend the hand of friendship and invite them to make such use of this Institute as opportunity may allow them, and we assure them they will be more than welcome.

Although the regular exercise of our profession has been restricted, or practically nonexistent, there have still been many grave and weighty questions with which we, as an Institute, have had to concern ourselves. Many of these questions still continue to exercise us, and there are many more before us which will demand most anxious and careful consideration.

### CHARING CROSS BRIDGE.

In the last address from this chair the President alluded to the Bill for strengthening and altering the Charing Cross Railway Bridge which was then before Parliament, and to the prospect which seemed to be opening of sweeping away that unsightly structure and replacing it by a really fine road-bridge worthy of our magnificent river. The hope of this, which was shared by all who have the beauty of our great metropolis at heart, has unfortunately been indefinitely postponed. I am happy to say, however, that the opposition of the R.I.B.A., and the London Society has resulted in very important modifications in the Bill, which will ensure

that every opportunity is given to the authorities to consider the possibilities of the greater scheme, which we advocate, before they are committed by large expenditure to the existing bridge and terminus. There seems to be a possibility that it may be realised in time that the bridge and terminus on this side of the river must be hopelessly inadequate to the enormously increased traffic which will result after the war, and that practical considerations alone may lead ultimately to the removal of the station to the other side. It is, however, to my mind a matter for regret that we, as a nation, should allow our decisions to be made on practical grounds alone. The beauty of our city with its great river should surely be a serious consideration, and sufficient to rule out the existence of what is ugly and intolerable; and there are many ways in which practical requirements can be complied with. It seems really a pity that a bridge of any kind should be necessary at this point of the river, as an unbroken sweep between Westminster and Waterloo Bridges would give one of the finest and most impressive views to be found in any capital of the world.

### WORKING-CLASS HOUSING AFTER THE WAR.

Perhaps the most important question to us as architects which is now under the consideration of the Government is that of the housing of the working classes after the war. We know only too well that the conditions under which they live in most cases are indeed deplorable, and any material amelioration has seemed almost hopeless under the complicated conditions and restrictions which have fenced round the problem. Impossible and unnecessary local bye-laws have contended with the economic aspect, and the result has been whole suburbs of dingy and squalid streets of mean and depressing houses, utterly demoralising to their inhabitants and conducive to inefficiency and even crime. Happily, it is now recognised that the problem must be faced and solved in some more satisfactory manner, and I am pleased to say that the Local Government Board has approached the Institute and invited our co-operation in securing the best possible plans for the houses which are to be erected in large numbers immediately after the war. They have placed at our disposal an adequate sum of money for procuring these designs, and we have drawn up a scheme for instituting a series of competitions throughout England and Wales. These are to be conducted by the R.I.B.A. and its allied societies who have entered into the scheme with great enthusiasm, and there is every reason to believe that a very satisfactory result may be arrived at. Many serious problems arise in the preparation of these designs. Not only is it essential that the houses should be healthy and comfortable, sufficiently segregated, pleasant to look at and live outside of as well as inside and as varied in design as may be practicable, but they must take into account the necessity of the most rigid economy, and the serious shortage of many building materials hitherto regarded as essential. The use of the latter must be minimised, and substitutes designed and arranged for so far as may be possible.

Apart from the question of these competitions, the Institute has a very strong committee sitting, which is considering how the interests of architects and, as we firmly believe, the interests of the public as well may be best safeguarded in the carrying out of these extensive schemes of housing. We believe that in every scheme it will be in the best interests of the public, as well as of ourselves, that the competent architect should be employed, and that within reasonable limits he should have a free hand, not only in the design of the houses themselves, but in the general lay-out and "town planning" of the area to be dealt with from its initiation. We shall do our best to ensure that this will be regarded as an absolute essential, and I think we have a fair prospect of succeeding.

### AIR RAIDS IN LONDON.

In view of the lamentable loss of life resulting from air raids over London a sub-committee of the Architects' War Committee has formulated a scheme for the examination and registration of all properties within the area of the London

County Council which were suitable or relatively safe as refuges for the public. This was very carefully drawn up, and suggested the employment of architects under the direction of the district surveyors, who would be the most competent to undertake such a work. After some trouble in finding out the proper authority, this scheme has been indicated in general terms to Sir Edward Henry, and a reply has been received saying that it is under consideration. A small committee has also just been appointed to investigate the effect of bombs falling on or striking buildings, and valuable information will no doubt be obtained as to the materials and methods of construction best calculated to resist the effect of high explosives.

### THE ALLIED SOCIETIES.

One of the most valuable features of our constitution is our allied societies, not only in the United Kingdom but also in various parts of the Empire. Many of these have their representatives on our Council, and their opinion and advice on the varied questions which arise from time to time are of the greatest value to the interests of the profession as a whole. Practice in the provinces and dependencies differs in many respects from that in the metropolis, and results in different views as to policy and many larger questions. With a view to reconciling any divergent views which may exist, it has been decided to hold a series of conferences or conversations to deal specially with questions affecting more particularly the allied societies, or on which they may have particular views. The first of these has been held here, and the second is to take place at Manchester on December 12, with others to follow at different centres as may subsequently be decided. There is no doubt that these meetings will tend to produce harmony and unity of view, and will be most beneficial. We are proposing to continue our informal conferences this session, and trust they may be as successful and useful as hitherto. It has been felt by some that we should resume our usual custom of regular sessional papers, but after careful consideration we have again decided that it will be best to continue our informal meetings. Eight of these have been arranged for during the session, and very interesting subjects are to be discussed.

### FINANCIAL.

In common with all similar societies, the war has put a severe strain on our finances, and it has been necessary to exercise great care and economy in order to keep down non-essential expenditure. We have, as you know, remitted the subscriptions of all members serving with the Forces—a constantly increasing number; and in addition to this, we have felt it incumbent upon us to deal generously with many of our members whose practice has ceased, or practically so. It may in the future be necessary to curtail our expenditure still further, and if this should involve some small measure of sacrifice on the part of our members, I feel sure we may look forward to its being cheerfully submitted to. In this connection I believe there are a few fortunate members of the profession who have actually benefited by the war in the erection and extension of factories and similar work. To these I should like to speak particularly, reminding them that we have a War Fund, which was established three years ago and which is devoted to finding employment for architects who are in need or distress. This has been administered by the Architects' Benevolent Society, and has done very useful work, but unfortunately its coffers now need replenishing in order to enable them to continue. I have every confidence that those who are able to do so will support so deserving a fund.

### AFTER THE WAR.

Though we are still in the midst of a great war, and it is still impossible to see or foretell the end, and whether it may come soon or may be long deferred, it is very necessary that we should look forward and put our house in order so that we may be ready and



prepared for the many serious problems which will confront us when the long looked-for peace arrives, problems which will be entirely new, and in which we shall have no precedent to guide us. How is our profession to be reconstructed so that we may resume normal proceedings in a reasonably favourable condition? How are our men to be released from service in the Army? Are they to have preferential treatment as being the men whose work is urgently required as a first step to reconstituting the building trades? How and when is the present control of building to be relinquished? Is it to be gradual, or will the coming of peace automatically put an end to it? How is the serious shortage of many building materials to be dealt with, and how is essential and pressing work to obtain the preference? These and many other problems confront us, and with a view to being prepared the Architects' War Committee have established a committee which is now considering all these questions. I have also thought it wise to invite representatives of the Master Builders' Association, the Surveyors' Institution, and, I hope, the civil engineers, to join with the Council in a special conference on some of the same questions, and the first of the meetings will be held here on November 12. I think there is little doubt that such a conference will lead to very useful results.

It is very sad to think how many of our most promising young architects have fallen in this terrible war, many of them those whom we looked forward to seeing in the very forefront of our profession, a few of them who already had their feet firmly planted on the first steps of the ladder. One is tempted to think that Providence in making the selection chose the best, the very best. Though no mere words can in any way console their relatives for their loss, I am speaking on behalf of the entire Institute when I say that, in no mere perfunctory sense, they have our heartfelt sympathy. These men died for their country, and that country is immeasurably the poorer for their loss.

In conclusion, although the prospects for the moment do not appear hopeful, I trust this may be the last Presidential address which will be made under war conditions, and that when the next session opens we may be busily engaged in meeting the problems of reconstruction, some of which I have indicated, an sanguine enough to think that when this time of stress has passed, and peace once more returns to the world, there will be a period of unprecedented activity, and architecture will be afforded opportunities such as have not presented themselves for generations. Larger and broader views will be taken, and it will be our duty and endeavour to ensure that such enterprises as will commemorate this critical period of our history shall be judged by after generations as worthy memorials of the great events which led to their inception.

Among those present were Sir Aston Webb, R.A., Sir Ernest George, R.A., Mr. T. E. Colcutt (past-President), Mr. John D. Cress, F.S.A., Sir Henry Tanner, C.B., Mr. Leonard Stoker (past-President), Mr. Paul Waterhouse, M.A., Mr. John Slater, M.A., Mr. H. D. Searleswood, Mr. Maurice B. Adams, Mr. E. T. Hall, Mr. William Woodward, Mr. Arthur Keen, and some other members of the Council.

In consequence of the unavoidable absence of Mr. Ernest Newton, A.R.A., the Hon. Secretary, Mr. E. Guy Dwyer, read the immediate past-President's remarks in support of his proposal of a vote of thanks to Mr. Hooper's admirable address. Mr. John Broadbent Gass, F.R.I.B.A., the President of the Manchester Society of Architects, seconded the proposition. In the course of his comprehensive speech Mr. Gass spoke of the present loyalty on the part of all the allied societies towards the institute, and he testified to the enthusiasm felt by the architects in the North in looking forward to the conferences about to be held, the first being fixed to take place in Manchester. Professor Percival Pite, Mr. Winkler Wills, and Mr. P. G. Hooper supported the vote of thanks, which was carried.

#### COAL CONCRETED FROM DUST OR ASHES.\*

The price of coal in most cases has practically doubled itself, and it is your privilege to be able to considerably ameliorate this. To-day, in one of the great coal centres of the world, separated by only a few miles, the miner has his coal delivered at 8s. a ton, while the householder has to pay £2!

Fireclay workers are frequently well situated, their grey clay being interstratified with seams of coal. These "clunches," or underclays, are believed to be the soil that produced the vegetation from which the coal was formed; in some cases the coal seam is only a few inches or a few feet thick, and it is generally thrown away as the clay is "got," because of its friability. This coal merely falls through the grate-bars of the kilns and furnaces; its calorific value, however, is generally sufficiently high to justify the time required to concrete it into a decent fuel.

All clayworkers have cinders, which mostly consist of unconsumed carbon, and either alone, or with a proportion of coal slack, it would pay them to turn these into a decent fuel.

Another grave difficulty which many clayworkers have to face is that of clinkering; in some cases it is so serious that the fires have to be drawn and restarted so that the mass of cinders may be removed. The danger and risk to the contents of the kiln are well known. This difficulty is obviated by using a concreted fuel, and if this fuel be used in conjunction with Nature's coal the clinkering nuisance is greatly diminished.

In many cases the calorific value of cinders, or bar-shales, will be 7,000 or 8,000 B.T.U.s. If an amalgam fuel be made of half bar-shales and half coal dust the resultant fuel will produce about 10,000 B.T.U.s.

From the personal standpoint all clayworkers will find it to their advantage to utilise their unemployed plant in the production of artificial coal. I have been told by brickmakers now turning out large quantities of artificial coal a week that it is unlikely that they will ever want to make bricks again.

Only a simple exposition is necessary to show that the making of artificial coal is far easier than the making of bricks. The operations are simply grinding, mixing and drying. If required for their own consumption, clayworkers will probably find the following method the most expeditious. The aggregates (slack, smudge, cinders, etc.) require to be used from a fine dust to  $\frac{1}{2}$  in. If necessary to grind, this may be done in the process of mixing with the matrices or binders. The whole should be semi-plastic; any old pug-mill will do the work. From this it can be ladled out into a truck and tipped on to a drying floor, or anywhere under cover where it will dry hard. The time required depends upon many conditions, but principally upon the amount of sun or artificial heat. On an ordinary drying floor in a day or two the fuel can be broken up and stacked ready for use. Once it is hard it weathers perfectly well.

If the fuel has to be transported, and is required for domestic or industrial use, the finishing and drying process has to be somewhat amplified. Either a stiff-plastic process or a plastic process can be employed. In the first, the fuel takes the form of bricks; in the second, it can either be wire-cut into various shaped blocks or passed through a die in a plastic band, breaking with irregular ends as it falls.

These large blocks or small nuggets of fuel have then only to be dried. This can be done by simple exposure, with protection from the weather, by drying floors, or by drying chambers or tunnels. In the tunnel process the drying requires only about as many minutes as the bricks require hours. In some districts these artificial coal blocks, the same size as ordinary house bricks, are sold at £3 a thousand. The heating value is equivalent to three tons of ordinary coal.

\* From a paper read before the Institute of Clayworkers by Mr. R. Goulburn Lovell, A.R.I.B.A., on October 31.

and already the supply is not equal to the demand.

All of these artificial fuels can be made to light from the sticks. To demonstrate this, a coal made entirely from fine coke dust is used in kindling a fire; and it will be seen to flare and incandescence like ordinary coal. Samples of various artificial fuels can be burnt and tested, and the waste aggregates from which they have been made ascertained.

SCHEDULE OF ARTIFICIAL COALS.			
Waste Aggregate.	District.	Firm	
Coal slack	Leeds	Burnmantolff's	
Coal slack	Leeds	Elland Road	
Coke dust and smudge	Covertry	Webster's	
Smudge	St. Helens	Greengate	
Smudge	Hadley	Blockley's	
Ash clinker and coal dust	Loughborough	Tucker's	
Bar-ash and coal slack			
Bar-ash	Swaincliffe	Wragg's	
Coal slack	Swaincliffe	Wragg's	
Coal slack	Doncaster	Arkell's	
Anthracite duff	Doncaster	Arkell's	
Bar-ash	Birkenhead	Seacombe Brick	
Coal slack	Loughborough	Tucker's	
Coal dust	Loughborough	Blockley's	
Bar-ash	Howson	Hill-Jones	
Oven coke dust and slurry	Wakefield	Low Laitias	
Bar-ash and coal slack	Liverpool	Saccharine Co.	
Coal slack	Birmingham	Electricity Dept.	
Bar-ash	St. Helens	Ravenhead	
Past waste	Doncaster	Blackhester	
Leather waste	Rushden	Sargent	
Coke dust and sawdust	Shoreham	Chubb's	
Bar-shales	Steamship Co.	P. and O.	
Bar-shales and coal slack	Steamship Co.	P. and O.	

Although the process of manufacture is simple, the procedure in arriving at the most satisfactory formulae is somewhat protracted. The varying qualities of clay are well known, but the varying qualities of coal are greater. As the qualities of the coals vary, so also do the qualities of the cokes, the washings, the slacks, the cinders, and the clinkers.

As our effort is to reconstitute Nature's coal, many tests are required to determine how a synthetic coal can be produced most economically. It will be readily understood that the matrix mixture has to be varied in its constituent parts and in its ratio to the aggregates, in accordance with the character of the aggregates.

To those clayworkers who are anxious to assist in this national work, the first step is to forward to the laboratories small quantities of the waste aggregates they propose to use. If the trial tests prove that a satisfactory fuel can be produced, a sample of the coal will be forwarded, and an early meeting is recommended if it be desired to manufacture the coal.

Careful consideration has been given as to the utilisation of ingredients for the matrices, which can be obtained with the least transport and the lowest price being employed. Before a formula can be prepared, a knowledge of the available machinery, plant and of the local conditions is necessary, and a further supply of the waste aggregates will be required.

It would then be possible to determine as to the advisability of proceeding with a licence or not, and also if the licence should be for the making and selling of the artificial coal alone, or for the making and selling of the matrix mixture alone, or both. Some firms are particularly well adapted for making the matrix mixtures and supplying to others who only require to make up some 20 or 30 tons of fuel a week. The matrices can also be supplied to householders, so that they can also make their cinders and coal slack into a decent fuel by what we call the C or cottagers' process.

#### TRADE NOTES.

Boyle's latest patent "Air-pump" Ventilators, supplied by Messrs. Robert Boyle and Son, Ventilating Engineers, 64, Holborn Viaduct, London, have been employed at Winscales Mines, Egremont, Cumberland.

The Brompton Town Council have selected from thirty-five candidates Mr. Godfrey T. Bradley, of Burnley, divisional engineer to the Ceylon Government, to be borough surveyor and water engineer, at a commencing salary of £220, in succession to Mr. W. H. Eloe, who has been appointed surveyor to the Litherland Urban District Council.



## Correspondence.

## THE WAR MEMORIAL CHAPEL.

To the Editor of THE BUILDING NEWS.

SIR,—In view of the interest of Mr. Woodward's scheme and design for a national war memorial in connection with the venerable Abbey at Westminster, the letter from "S. C.," published in your issue of October 24, contains criticism which deserves consideration.

The point raised as to the size and treatment of the windows is answered to some extent satisfactorily by Mr. Woodward in his reply this week, and evidently there should be ample light to enable one to view the memorials which, it is devoutly to be hoped, should be subject to careful restrictions, so that no bulky and overpowering monuments such as encumber the Abbey shall be allowed.

But when "S. C." speaks of "a gorgeous colour scheme," and refers to the Sainte Chapelle, at Paris, with its 13th Century glass, a doubt arises as to the soundness of the suggestion. The wealth of colour there, as at Chartres, would be too much for the murky atmosphere of London, and a plentiful use of grisaille and a well-considered scheme will be imperative. The Chapter House affords an example of how rich, and not thin in effect such work can look when designed by competent artists, and the Abbey itself shows a jumble of efforts which are unfortunate, with few exceptions.

The mass of colour might be placed in the East windows to subdue any glare, and it might be well to remember, also, that by the use of heraldry and separated panels each window would be capable of containing many memorials, thus adding greatly to the space available.—Faithfully yours, J. C. B.

SIR,—I am much indebted to Mr. Woodward for the lucid explanation he has given of the several points raised in my previous letter, and I trust I shall not be putting too great a strain on his courtesy in offering one or two further suggestions.

As the style of the chapel must be determined to so large an extent by the character of the surrounding buildings, I suggest that he should take the House of Lords opposite for his model rather than the more austere Abbey, and that his stonework might therefore be more florid, with the rose and portucullis and the chisel work we find in such abundance across the road. The chapel would thus appear as the connecting link between the two groups of buildings at Westminster.

A second suggestion is that he should abandon the idea of making his chapel too much of a twin to the Henry VII. Chapel, and extend it to the present frontage of Abingdon Street. Anyone approaching from Whitehall will then have facing him the north transept end, and at some distance in the rear the imposing block of offices of the corner of College Street, jutting out beyond it, in place of an extremely wide and somewhat featureless road stretching away to Millbank.

It is not for the laity to speculate on the domestic arrangements of the clergy, but I venture to surmise that though the existing Deanery may very well suit Mr. Dean, it would not equally well suit Mrs. Dean (whether at the present time there happens to be such a lady I do not know). Now, a new deanery in good Queen Anne red brick on the somewhat dismal plot in front of the Chapter House would form an interesting corner with this transept end, and contribute a pleasing domestic relief to the surrounding buildings.

My concluding comment on Mr. Woodward's plan is that the clergy and choir vestries, which occupy a considerable space in the main building, should be removed to a smaller ante-chapel projecting from the west front. This could be of two stories, allowing for a gallery beneath the large west window. Outside, a facade, rising in three stages, would afford a suitable base for the grouping of statuary. In the interior it is desirable, I think, to eliminate, where possible, many of the characteristic features of a church.—Faithfully yours, S. C.

## Our Office Table.

The camera has become useful to building contractors by its ability to prove the condition of works at a certain date. When necessary, photographs can be offered in evidence in a court of law, and progressive firms are insisting on the insertion in their contracts of a clause giving them the right to use a camera. An English sub-contractor for the woodwork in a large building recently forfeited a sum of £400 for a delay for which he was in no way responsible, simply because he was not in a position to prove that on a specified date the building had not progressed sufficiently far to enable him to commence his operations. The camera would have proved his case and saved his forfeit.

The stately church of St. Hilda, at Hartlepool, which has stood sentinel over the North Sea at this point of the coast for many centuries, is in danger of decay. The building has passed through several shakings vicissitudes during the past three years of strife, and the towers and stonework have been seriously undermined. Successive rectors have done whatever they could out of their own purses, and with the assistance of friends, to maintain the fabric, and now an effort is being made to raise a sufficient sum of money to defray the cost of preserving the fabric in all its artistic beauty. A restoration fund has been launched, and an impetus has been given to the movement by a donation of £1,000 of War Loan from a parishioner, Sir William Gray, Bart., head of the well-known shipbuilding firm in the locality. The Master of Balliol is the latest personal subscriber to the funds.

As indicating the increase which has taken place in the use of concrete in the construction of small buildings, the following item, taken from the *Scientific American*, is of interest:—"Boards of concrete, with joists, rafters and stair-frames of the same material, are used in the construction of a novel building in Los Angeles, Cal., the whole being set upon a concrete foundation. Though put together after the manner of a frame structure, the building is as fireproof and durable as the more common types of cement houses, but it requires less material and is lighter in weight."

At last week's meeting of the Edinburgh Town Council a lively discussion followed a recommendation by the Treasurer's Committee to make permanent provision in the Usher Hall for cinema exhibitions. It "battled" Baillie Macfarlane to understand how his colleagues could bring their minds to a proposal that the Usher Hall should ever descend to a place of resort for those who wished entertainment of this kind. The natural corollary would be that smoking would be allowed in the hall.—Baillie Allan Carter thought this was the beginning of a down-comer in the use of the Usher Hall.—Baillie Allan said that to see a great, beautiful hall standing night after night empty when it was gifted for the entertainment of the Edinburgh people was a shame.—Lord Dean of Guild Henry objected to tampering with the structure of a beautiful hall a few years after its construction.—Baillie Watson explained that the cinematograph was only to be used for educative purposes. He could not support the recommendation as it stood, as it referred only to "cinematograph exhibitions."—Mr. Oldrie thought the architect and the Usher family should be consulted. Subject to that, he thought the cinematograph ought to be encouraged rather than discouraged. He saw no reason why the municipality should not lead the way to a much higher use to which the cinematograph might be put. He suggested that the matter might be referred back to the Committee for the purpose indicated, and this was carried by 24 votes to 19 for a "previous question" amendment.

Mr. A. J. Jewers, who was commissioned by the Corporation in 1911 to prepare a monumental record of the City churches, is now approaching the end of his labours. So far the record contains 960 pages of manuscript, and 1,456 shields of arms, painted in proper colours. Dealing with the parishes in alpha-

betical order, Mr. Jewers has reached St. Peter-upon-Cornhill, and there are about half a dozen churches still in hand. In perpetuating the inscriptions and heraldry of the church of St. Nicholas Cole Abbey, Mr. Jewers was able to make use of a Harleian MS. in the British Museum, dealing with that church, and the associated churches (now destroyed) of St. Nicholas Olave, St. Mary Somerset, and St. Mary Mounthaw; and incidentally an archeological problem was solved. The Harleian MS. reproduced in colour a coat of arms as from the churchyard of St. Mary Mounthaw. The actual carving escaped the Great Fire of 1666, and is to be seen built into the north wall of Messrs. Calver's premises on Lambeth Hill. It is now discovered that the arms are those of Richard Gloucester, Sheriff of London in 1295. The whole record is destined for the Guildhall Library, and, when completed, will be accessible to students of archeology, heraldry, and church history.

The Minister of Reconstruction, after consultation with the President of the Local Government Board and the Secretary for Scotland, has appointed the following committee to consider and report on the question of the supply of building materials after the war:—Mr. James Carmichael, J.P., Vice-Chairman of the Munitions Works Board (Chairman); Sir John Tador Walters, M.P.; Mr. A. Shirley Benn, M.P.; Mr. J. Storrs and Mr. J. Walker Smith, M.L.C.E. The terms of reference are as follows:—

(1) To enquire into the extent of the probable demand for building material for all purposes which will arise in this country during the transition period, and the extent of the available supply and form of such material. (2) To enquire how far the quantities of material now available are capable of increase; what are the difficulties in increasing them; and how these difficulties can be removed; and to report to what extent an increase in production will affect the price of the materials. (3) In the event of the supply of material or labour being insufficient to fulfil the total building demand to consider the principles and method by which the priority of various claims should be settled; and to report what steps are necessary to ensure that the manufacture of the materials, so far as they are at present inadequate, shall be extended in time to secure sufficient quantities for use when required on the cessation of hostilities; and to recommend what steps should be taken during the war to facilitate a prompt commencement of building work at that time. (4) Generally to consider and report upon any conditions affecting the building trades which tend to cause unduly high prices, and to make recommendations in regard to any measure of control which it may be desirable to exercise over the charges, production, transport or distribution of material. Correspondence and enquiries should be addressed to the Secretary, Building Materials Supply Committee, Ministry of Reconstruction, 2, Queen Anne's Gate Buildings, London, S.W.1.

Messrs. Chapman and Hall, Limited, are issuing three good American text-books which should interest English readers. "Drawing for Builders," by R. Burdett Dale, M.E., forms an excellent basis for a problem course in architectural drawing, and should be useful to the practical builder as well. The price is 7s. "The Mechanical Equipment of Buildings," by L. A. Harding and A. C. Willard, is the first volume of a reference book for engineers and architects, and covers over 600 pages with many illustrations. It deals with heating and ventilation, and is published at 18s. 6d. A second edition, thoroughly revised, of the "Industrial and Artistic Technology of Paint and Varnish," by A. H. Sabin, issued at 16s. 6d. net, brings up to date a work which is a standard one in the United States, and has been so for the past thirty years.

"The Small Garden," by Mary Hammond (Herbert Jenkins, Limited, price 5s. net), is a good book, well written and in a workmanlike manner worthy of its subject. The author is already widely known in the gardening world for her books "Every Woman's Flower Garden"

and "Flower Culture." This is a practical manual for the use of that multitude of men and women who wish to make the best of their bits of ground; of the small gardens attached to their dwellings in town or country. It begins at the beginning, and by assuming that readers know very little about the matter, and that little, wrongly; it starts with a chapter upon "Garden Fashioning," or the laying out of the plot of ground available. And here we come at once upon the best and strongest feature of this sound book. For the author has, herself, drawn and designed twenty-five plans for small gardens which appear here as clear and complete full page diagrams which can be copied and used by every gardener doing his, or her, own work. These provide for all kinds and shapes of gardens and give, in great variety and with ample detail, ground plans which can be faithfully followed and adopted in practice. They are neither too bare nor too ambitious, and they are satisfactory as showing how much can be made in many ways of that little slice of land so often seen neglected, or confused, at the back and front of town and country houses. Besides all this, we here have chapters dealing with planning and planting rose grounds, grass, uncommon flowers, shrubs, town gardens, the work of the year, the busy man's garden, and many other similar subjects. The whole is handled with the expert, practical knowledge and common sense of the lady author who has for years done it all herself in her own gardening.

**PROFESSIONAL AND TRADE SOCIETIES.**

**THE ARCHITECTURAL ASSOCIATION OF IRELAND.**—Mr. Edwin Bradbury, F.R.I.A.I., presided at a meeting of the Architectural Association of Ireland, held at 15, South Frederick Lane last week. The President, in the course of his inaugural address, said many of their members—a very respectable portion, indeed—were now on active service in their ranks. The President then proceeded to read an interesting paper on "Rational Architecture," in which he pointed out that it was demanded of architects that the buildings they designed should possess architectural character or beauty as well as being soundly constructed, properly ventilated, heated, and lighted, and sanitary. They had no use for foppish architecture, which attempted to cloak ill-conceived and impractical work, or fundamentally wrong design, beneath expensive and overdone ornament. The impact of nations had torn aside the frivolities, the petty thoughts of men and of peoples, and had revealed, as never before, all that was bad and all that was good in mankind. From out of the strife would surely arise a new world of purity and truth. Architects must, in their appointed places, labour to produce what was valuable and useful and what was beautiful in the deepest and truest sense. They should endeavour to produce a rational architecture, which excluded unessentials and which embodied only what was true and of massifiable worth. On the motion of Mr. George F. Beckett, seconded by Mr. H. G. Leask, a vote of thanks was passed to the President for his address.

**STATUES AND MEMORIALS.**

**KING'S COLLEGE HOSPITAL.**—The Bishop of Southwark dedicated on All Saints' Day a redos erected in the Chapel of King's College Hospital to the memory of Miss Katherine Henrietta Monk, formerly the sister matron of the hospital. The Dean of Canterbury gave an address in the course of which he made touching reference to the devoted services of Miss Monk in the training of nurses and in hospital administration extending over many years. The memorial redos, which is the grateful gift of many past nurses and friends, has for its subject the New Jerusalem (Rev. xvi, xxii), with Christ in Glory, the Throne, the Foundations, and the Flow of Life on either side of the River. The work has been carried out in "Opus Sectile," designed and produced by James Powell and Sons, of Whitefriars, in collaboration with the architect of the hospital, Mr. William A. Pite, F.R.I.B.A.

Telephone DALSTON 1368.  
**OGILVIE & CO.**  
 Many years connected with the late firm of W. H. LASCELLES & Co., of Bunhill Row.  
**Mildmay Avenue, ISLINGTON, N.**  
**EXPERTS in HIGH-CLASS JOINERY.**  
**ALTERATIONS & DECORATIONS.** ESTIMATES FREE.

**FOR**  
**Olivers' Seasoned Hardwoods,**  
 SPLY TO—  
**WM. OLIVER & SONS, Ltd.,**  
 120, Bunhill Row, London, E.C.

**TENDERS.**

\* Correspondents would in all cases oblige by giving the addresses of the parties tendering—at any rate, of the accepted tender: it adds to the value of the information.

**ARGOE (MON).**—For carrying out private street works at Glynos Road, Glynos Avenue, and Penylan Avenue, Argoe, for the Bedwellty Urban District Council. J. D. P. Ryan, Glynos Road, Glynos, W. Webb, Hillrise, Hengoed, etc. 524 15 1 (Accepted.)

**BITTAVANT.**—For the execution of sewerage works at Bittavant, for the Mallow Rural District Council.

**W. CONNORS** ..... £275 0 0  
**W. Regan** ..... 249 0 0  
**J. J. Barrell** ..... 230 0 0  
**J. Thornton** ..... 229 0 0  
**J. Crowley, Mallow (accepted)** ..... 205 0 0

**CHALGROVE (OXON).**—For work at Chalgrove school, for the Oxfordshire Education Committee:—  
 Wheeler and Crump, for external painting and general repairs, £28 15s.; for repainting the outside wall of the infants' room, £39 10s. (accepted).

**CHASTW.**—Erection of 50 new dwelling-houses at Mount Pleasant in connection with the shipyards:—  
 John Boot and Son, Sheffield (accepted).

**COVENTRY.**—For C. and W. Hospital, Proposed hutments for domestic staff. Herbert W. Chantway, architect, Coventry. J. H. Jones and Son, Coventry, £2,736; Dawson and Jones, Sheffield, £2,550; H. Clark and Sons, Coventry, £2,525; Woodrill and Simpson, Oxford, £2,279 17s.; H. Goodie and Son, Coventry, £2,125; E. O. C. Howells, Coventry, £2,125. Hot-water heating apparatus:—Reynolds and Co., Coventry, £219; Brigat-side Foundry and Engineering Co., Ltd., Sheffield, £175 15s.; Mottersea, Huxley, and Watson, Ltd., Coventry, £152 15s.; A. Hall, Coventry, £128 9s. Electric lighting:—G. R. Marson, £105 5s.; H. W. Burbery and Co., £60 17s. 6d.; Reynolds and Co., £77; Lee Beeley and Co., £75 7s. 6d. (Accepted.)

**HAYES.**—For (1) the construction of percolating filters, lime tanks, sludge beds, mains, certain alterations to the existing works, and the supply of filtering media; (2) supply and installation of a sewage ejector and chamber in cast-iron tubing; and (3) the supply and erection of sewage distributors, for the Hayes Urban District Council. D. C. Fuller, engineer and surveyor.

Accepted tenders:—D. T. Jackson, Barking (1), £3,381; Amey Cross, Sanitary Engineering Co., Nottingham (3), £355; Hughes and Lancaster, 16, Victoria Street, Westminster (2), £310.

**LAXTON, S.E.**—For re-pointing brickwork of the head keeper's lodge and ladies' lavatory at Plumstead Common, for the London County Council:—  
 Thomas and Eds, accepted, .. £38 17 0

**ROSWOY.**—For sinking well on the laundry drying-ground, for the guardians:—  
 G. T. Walter, Barkingside ..... £175 0 0 (Accepted.)

**SALFORD.**—For repairs to Weaste Branch Library, for the corporation:—  
 J. Daniel and Sons, Pendleton .. £71 10 0 (Accepted.)

**WALTHAMSTOW.**—For two additional class-rooms, including a reinforced concrete roof at the County High Schools for Girls, for the Essex Education Committee:—  
 W. W. Trudgett, Colchester .... £1,520 0 0 (Accepted.)

**TO CORRESPONDENTS.**

We do not hold ourselves responsible for the opinions of our correspondents. All communications should be drawn up as briefly as possible, as there are many claimants upon the space allotted to correspondents.

RECEIVED—W. R. L.—R. W. C.—C. H. P., Ltd.—J. W. G.—A. R. F.—W. W. and Son—A. C. G.—M. L.—G. J.—and—S. M.—C. C.—D., and—S. H.—L.—J.—and—S. M.—G.—and—W. P. T.—and—T. H. B., Ltd.—W. C. Co., Ltd.—W. W. T. H. H.—Please send.  
 FREE.—It is not a system we should employ.

**LIST OF TENDERS OPEN.**

**ENGINEERING.**

**Nov. 15.**—Excavating for, laying in, and jointing about 640 lineal yards of 22-in. cast-iron condensing main pipes, etc., along the canal bank, Bridge Street, etc., Loughborough, between a point near the chain bridge and the electricity works; also construction of intake and discharge chambers, together with all appurtenant works.—For the Electricity Committee.—Plans and forms of tender of H. Walker, A.M.I.C.E., Borough and Waterworks Engineer, Town Hall, Loughborough. Sealed tenders to H. Perkins, Town Clerk, Town Hall, Loughborough.

**Nov. 19.**—Supplying and erecting a Lancashire boiler, boiler mountings, superheater, and Green's economiser, at the Sheerness East Pumping Station.—For the Sheerness Urban District Council.—V. H. Stallon, Clerk, Council Offices, Sheerness.

**March 30.**—The Acting British Consul at Santiago reports that a decree has been issued calling for tenders for the improvement of the port of Antofagasta (Chile). By the terms of this decree the amount to be expended on this work must not exceed £1,700,000. Details may be obtained from the Port Commission Offices in Santiago, and copies are expected to be received shortly at the offices of the Chilean Legation in London, 22, Grosvenor Square, W.1. Tenders will be received up to 3 p.m. on March 30 by the Minister of Finance, Santiago.

**ROADS AND STREETS.**

**Nov. 12.**—Paving with granite setts on concrete, kerbs, and asphalt, etc.—For the Louthwaite (Yorkshire) Urban District Council.—D. J. Bailey, Clerk, Yorkshire Bank Chambers, Louthwaite.

**SANITARY.**

**Nov. 12.**—For cleaning out the sewage ditch from Poston Hall to Radcliffe Road Bridge, a distance of about 1,950 yards, for the Alnwick Rural District Council.—H. W. Walton, Clerk, Alnwick.

**TIMBER.**

**Nov. 10.**—Supply of three standards spruce deals, 11 standards red deals, and 26 balks pitch pine.—For the Cleansing Committee.—R. Williamson, Superintendent of the Cleansing Department, Town Hall, Manchester.

**PARLIAMENTARY NOTES.**

**THE FLECHE ON WESTMINSTER HALL.**—Sir A. Mond, replying last Wednesday to Mr. King, who asked whether he was aware that the *Fleche* recently erected on the roof of Westminster Hall was considered by architectural authorities ill-designed, said:—The question on what course should be taken when the removal of the *Fleche* erected by Sir John Soane in 1821 was necessitated owing to the repairs to the roof of Westminster Hall was submitted by my predecessor to the Ancient Monuments Board for England. In accordance with this board's decision the present *Fleche* was erected according to designs prepared in my department. I know of no more competent architectural authority to advise on the treatment of ancient historical buildings. I am not aware that any competent architectural authority agrees with the statement made by the hon. member. The cost was £3,200.

The war memorial at Basildon, near Reading, will take the form of a new church to take the place of the present iron building. All the material, so far as possible, will come from the Basildon Park estate, and the building will be done by Basildon men.

A war memorial, erected in the churchyard of Folkestone Parish Church, has been dedicated. It takes the form of a cross with the figure of Christ crucified, below being the names of thirty-nine parishioners who have fallen in the war.

Captain Matthew Honan, South Lancashire Regiment, reported "wounded and missing" on November 14, 1916, is now officially announced to have been killed on that date. He was son of the late Robert Burke Honan, of Prince's Park, Liverpool, formerly of Cork, and was 38 years of age. He was educated at Ampleforth Abbey College, York, and by profession he was an architect (F.R.I.B.A.), and did some good ecclesiastical and municipal work in Liverpool.

A war shrine, which has been given to the church of St. Bartholomew-the-Great, West Smithfield, by a member of the congregation who wishes to remain anonymous, will be dedicated by the Bishop of Willesden on Sunday, November 18, at the afternoon service at 5 p.m. On the same occasion the Bishop will also dedicate a figure of St. Bartholomew placed in the niche between the upper windows of the gatehouse in memory of Second Lieutenant Philip E. Webb, A.R.I.B.A., R.E., younger son of Sir Aston Webb, C.B., R.A.

# THE BUILDING NEWS

## AND ENGINEERING JOURNAL.

Eppingham House.

## CONTENTS.

Strand, W.C.2.

Currente Calamo .. .. .	381
Is Art to be Ignored in Reconstruction? ..	382
The Surveyors' Institution .. .. .	383
Our Illustrations .. .. .	397
Professional and Trade Societies .. .. .	397
Correspondence .. .. .	398
Our Office Table .. .. .	398
Parliamentary Notes .. .. .	399
Trade Notes .. .. .	399

List of Tenders Open .. .. .	399
To Arms! .. .. .	399
Tenders .. .. .	400
To Correspondents .. .. .	400
Latest Prices .. .. .	viii.

Coldharbour Manor, East Grinstead, Sussex. View and plan. Mr. E. Turner Powell, F.R.I.B.A., Architect.

Waterworks New Buildings, Baden-Baden. Mr. Charles W. English, Licentiate R.I.B.A., Architect.

Bay of South Arcade of the Nave, Holyrood Abbey, near Edinburgh. Measured and drawn by Mr. James Macgregor, Architect.

## OUR ILLUSTRATIONS.

Morning Room and Billiard Room Interiors, Summerhill Court, Kingswinford, near Stourbridge. Mr. James A. Swan, F.R.I.B.A., Architect.

### Currente Calamo.

The very informative address of Mr. Arthur Lyon Ryde, the President, at the meeting on Monday last, should at once reassure any who may have felt uneasy as regards the effect of the war on real property, while it should tend to induce caution on the part of some of our "land reformers" who are apparently anxious to revolutionise the holding of an asset which, after all, commends itself to the investor as the most stable and most progressive in increase of value. Taking the County of London, it will be seen that since 1912, with two exceptions—very slight decreases, due, as Mr. Ryde shows, to very special causes—the rateable value has steadily increased from £44,774,038 to £45,320,743, and this in spite of huge reductions made on properties depending on industries demanding large consumption of coal, such, for instance, as the Gas Light and Coke Company, which has succeeded in reducing its rates by the enormous figure of £104,632—a fact, by the way, that will not be forgotten by some of us less lucky, but who have to pay its increased charges for gas. Mr. Ryde's figures concerning other property—such as the railways, etc.—will also be read with interest. We fully share Mr. Ryde's opinion that facts show that the war will not damage property in Great Britain to anything like the same extent that it will in France, Germany, Russia, Italy, or Austria, and may thankfully remember that we owe our comparative immunity from loss to the valour of our defenders on all fronts.

While admitting in his address to the Manchester Reform Club last week that 95 per cent. of the houses in this country had been built by private enterprise, Mr. W. Hayes Fisher, the President of the Local Government Board, said he and his colleagues "were persuaded that it would not be possible to coax private enterprise back just yet." He is quite right! The private builder has never yet been coaxed—all that sort of thing has been reserved for the local authorities and a pretty poor showing they have made, both as regards quantity, quality, and economy! To the circular issued by the Local Government Board 1,231 out of the 1,806 local

authorities have replied. These replies show a requirement of 150,000 houses immediately, and of 180,000 after the war; and schemes are already prepared for building 40,000, and the authorities are willing to build another 116,000. One-third of the local authorities have not replied, but it may be taken, so Mr. Hayes Fisher said, that the whole of them would be prepared to build 200,000, and he thought they could easily be induced to increase the number to 300,000, which a special sub-committee of the Reconstruction Committee had arrived at as the number which ought to be built within a year of the conclusion of the war. The local authorities, of course, would want to know precisely what was meant by "substantial financial assistance." He was not yet in a position to tell them, because the Treasury had not answered the letter he sent some little time ago asking what amount of money they were willing to place at his disposal. But it was permissible to make some kind of calculation.

In 1915, in order to induce certain local authorities to build houses for the need of great influxes of munition workers, the Government had to make free grants which averaged 22½ per cent. of the cost of building. To build 300,000 houses would cost about 90 million pounds. Supposing the Exchequer could raise 30 millions or a free grant, on what principles should it be distributed? The first guiding principle was that the local authorities must go into partnership with the State. The State, if it was wise, would neither build the houses, nor own nor control them. That had been proved by experience to be a very expensive arrangement. The local authority would have to make the contracts for the building of the houses and to fix the rents. Mr. Fisher thought there was an obligation upon the local authorities to take some risks in this matter; they should not expect the State to take the whole of the risk. Supposing, for instance, it was found in Manchester that the economic rent of the houses should be 9s., but that they would only let at 6s., he calculated that the deficiency on the rent of 2,500 houses could be made up by a penny rate. The risk was not, therefore, very serious.

In many places where employment was permanent and wages were good, with a Government grant of 20 or 30 per cent. it would be negligible. Another question was whether the bargains which the Local Government Board would have to strike with the local authorities should be the same in every case—whether, that was to say, the grant should be a flat rate, or whether it should vary in proportion to the wealth or poverty of the district and the extent to which new housing was needed. From some of the replies to the circular he was led to believe that the wealthier authorities were disposed to agree that it would be fair to take such facts into consideration. So it looks as if the ratepayer, after all, is to be saddled with the cost of housing as far as possible! Taken as a whole, Mr. Fisher's speech was a very lame one, and we suggest he had better "coax" the local authorities—especially those who have ignored his circular—a little more.

The "Model By-laws" of the Local Government Board have now come into collision with the Courts, and been seriously shaken. At all events, one of them has been declared unreasonable, unworkable, and so invalid. This should encourage owners and builders to fight any of the others which can be shown to be equally absurd. In the recent case of "Governors of Repton School v. Repton District Council," the plaintiffs had proposed to make alterations in one of the school boarding-houses. These included a projection three stories high, with a room on each floor. The council refused to approve the plans because they did not comply with their By-law 12 as to the provision of open space in the rear of these new buildings. This by-law had been adopted by the council in 1902 from the Board's Model By-laws of 1877. It declares that every person who shall erect "a new domestic building" shall provide in the rear of such building a certain amount of exclusive open space. The school said that it was obviously impossible to provide an open space in the rear of a new building which consisted of an addition to the front of an existing building, as this did. So they said the model by-law was unreasonable and *ultra vires*, and the plaintiffs went on with their work. Then the district council

cil, which, of course, had nothing to do with reason or even physical impossibility, and held tight to its By-law 12, served a notice on the plaintiffs in which they threatened to pull down the schoolhouse addition. Thus they got to the lawyers, for the plaintiffs' only way out was to apply to the Court for an injunction to restrain the defendants from pulling down their alteration. Mr. Justice BAILLIACRE, after candidly saying he would support this precious by-law if he could, found that he really could not. For the council it was argued in despair that they might call the front of the house the back, and so get out of the dilemma. But the judge would not add this absurdity on top of the others even to back up a by-law for which, he said, he saw no reason. Then he held the by-law unreasonable, and therefore invalid, and granted the school their injunction against the council with costs, which fall on the ratepayers.

But there is much more in this decision than the smashing up of one by-law. For this knock-out blow shatters the whole line of the Board's Model By-laws and leaves them all unsteady. How many of the others, made at the same time, now forty years ago, will stand a close judicial construction in the Courts? No doubt it was this view that made the judge so reluctant to give his decision and so anxious to find a way out if one were only reasonably possible! Another point raised by the plaintiffs of much general importance was that, even if valid in 1877, the Public Health Act of 1907 had effectually knocked the bottom out of its validity. For this provided in S. 23 (d) that "any addition to an existing building, by raising any part of the roof by altering a wall, or making any projection from the building," should be deemed to be a "new building." The judge neatly put the case of a house surrounded by a park of thirty acres, and the owner wished to make his front dining-room 12 ft. wider by throwing out a projection. If he did this, that would then be "a new building," and it would not have the needed extra air space in the rear, as required by this by-law, although the thirty acres remained! It is *reductio ad absurdum*, which some would more shortly call "putting the lid on," is conclusive as to the unreasonableness of the by-law since 1907. Reading such a statute as this, one can only wonder who drafts these things, and are they still doing it? The judge said he would have liked to hold that the by-law did not apply where there was ample air space for the whole structure, taking the old and new building as one, like the house in a 30-acre park; but he was bound down to the words of the by-law, and common sense could not get a look in. So he held that this by-law 12 was not only invalid as unreasonable, but had also become unworkable since 1907, and must therefore be revised. It would seem to us wiser to tear up all these model by-laws and try again, employing someone with a little real knowledge of build-

ing as well as the usual little legal learning.

On September 26 the Committee of Building Crafts for the Architectural League of New York met to consider ways and means suitable to bring about a closer and more general spirit of co-operation between skilled architects and those many industries and crafts which contribute to the construction and embellishment of fine buildings. Chief among the different forms of collective effort considered were the opportunities now offered by the League's annual exhibition for the display and commendation of the most artistic products of industrial craftsmanship to be found in the great manufactories and shops that minister to the material needs of architecture. Committees have been appointed to obtain suitable exhibits of all the forms of industrial art, without close knowledge of and intimate association with which a modern architect cannot design or build artistic structures worthy of his calling, nor the leaders in the several crafts succeed without a working knowledge of the architect's requirements and necessities. To make this mutual understanding more perfect is one of the constant objects of the Architectural League. On September 27 the Committee on Organisation for the Federation of Allied Home Furnishing Industries of America met at the Aldine Club to adopt a constitution and create a permanent organisation of manufacturers, art societies, artists, educational institutions and art museums. The constitution then presented and favourably acted on was formulated by a committee of nine selected to represent the diverse interests of the Federation. The first and the chief efforts of this new Federation will be directed towards an educational propaganda intended to develop a greater love of home and a keener appreciation of the beauties and joys of home-making among American citizens. Both endeavours have our best wishes, coupled with the conviction that similar efforts might be organised here.

#### IS ART TO BE IGNORED IN RECONSTRUCTION?

Not long before the war began we suggested a movement—which we had often suggested before—for the establishment of a Ministry of Fine Arts. It was supported at the time by many artists of all grades and aptitudes. It was urged in these columns, and elsewhere, that our past efforts to make Art a real national asset, had, to put it mildly, not been very successful—at any rate, as far as Government initiative had been vouchsafed. It was shown that the Department to which the organisation of such aid as had been conceded, had been entrusted, had for the most part quite mistaken its mission; and that the result so far had, perhaps not unnaturally, aroused a distrust in Parliament, and probably outside of it, of any further additions to the long list of well-housed, well-paid officials, whose zeal, when manifested, had been kindled by no special knowledge of or enthusiasm for the cause of which they had been created the administrators, and

whose exertions were apparently paralysed by the old taint of circumlocution.

As the war drifted along, and Lord Kitchener's death deprived us of his priceless capacity for organisation, and Mr. Asquith's resignation was followed by Mr. Lloyd George's accession to the Premiership, it became evident that, for good or evil, the old principle of Ministerial responsibility to Parliament had gone by the board, and that henceforth we were to be governed by "Ministers" chosen by nobody knows who, unrecognised as heretofore by election to the House of Commons by the vote of the people, and, apparently, answerable to nobody for failure and, as events proved in most cases, of little use. The one "Ministry" that has yet to justify its existence or follow most of the others into the limbo of lost activities is that of Reconstruction. That, so some say, is to reorganise everything, and inaugurate the great new era of prosperity which is to purify and elevate industry. As yet, it is discouraging to note that there is not the slightest sign of recognition that no scheme of reconstruction can possibly be worth twopenny to the nation which leaves Art out of its purview, and denies to artists any voice in its inception or operation. Nor is there any general conviction that it may do more harm than the calamities war has inflicted on us. Few seem aware that every industry, from agriculture down to the least useful calling, must be either an organised art or a demoralising fraud. Fewer still are alive to the fact that in the economic struggle which will follow peace Art must lead, representing as she does the most solid and enduring capital which can be utilised for really national service.

As usual, our French Allies, who knew this long ago, and have profited by the knowledge, are already far in front of us in the work already set going for the broadening of the facilities they already possess, thanks to the numerous societies founded since 1851, when, as one result of the Great Exhibition here, the Union Centrale des Beaux Arts Appliqués à l'Industrie was founded. In 1874 this society amalgamated with a new body for the creation of a museum of decorative art, and the two became the Union Centrale des Arts Décoratifs, whose work has been the organisation of the Museum of Decorative Art in the Pavillon de Marsan. In 1889, the year after the foundation of our own Arts and Crafts Society, arose the Société d'Encouragement à l'Art et à l'Industrie. This body was instrumental in securing the recognition of the claims of decorative art in exhibitions at home and abroad, it organised ambulatory exhibitions, established scholarships for apprentices, arranged competitions for the students of the various schools of decorative art, and did much to induce manufacturers to invite the co-operation of students and professional artists in their productions. Later on, in 1904, another society, called the Société des Artistes Décorateurs, was founded, whose aim was the organisation of exhibitions of schemes and projects of interior decoration and furnishing. Then came the Union Provinciale des Arts Décoratifs, founded for the purpose of reviving regional arts and industries throughout the country.

The French Ministry of Fine Arts promptly recognised the value of these organisations, and others—such as the *Comité Centrale des Arts Appliqués*, and the *Comités Régionaux d'Art Appliqué*. At the inaugural meetings of the two last-mentioned in July last year M. Dalimier expressly indicated that the new Regional Committees are to study all questions relating to the preparation of artistic craftsmen for their tasks, to sug-



gest necessary reforms in artistic and general education, to interest themselves in the work and progress of students and apprentices in the district with which each committee is concerned, to give continual support and encouragement to the principals and teachers of schools in their experiments and researches, and generally to keep the Ministry of Fine Arts constantly informed as to the needs of the district and to report progress. The Central Committee, it should be added, comprises two members of the Senate, two members of the Chamber of Deputies, a delegate from the Paris Chamber of Commerce, representatives of the three great salons, delegates from the four great art and craft societies, twelve representatives of the chief artistic industries and of the great trade houses in Paris.

As regards ourselves, it will be at once admitted that we have no present institution of the kind to which, as they exist, any Minister is likely to entrust such preponderating influence as Art must have in any real scheme of reconstruction. Some good work has been done by the Art Workers Guild and the Arts and Crafts Society, but it is not comparable for a moment with that which has been done in France, nor is that which made the Arts and Crafts Exhibition at the Royal Academy last spring such a failure. But there is no lack of individual ability. It is true the movement inspired by men like Ruskin, Morris and Crane has for the time languished, but there are others still with us who know at any rate what we lack, and that till we find it our industries will degenerate if anything they produce is conceived or produced without the help of Art. The first step any real Minister of the Fine Arts would take would be to follow M. Dalimier, who instituted a number of committees of inquiry throughout the Departments appointed to inquire into the causes of the failure or decadence of certain industries. These committees were unanimous in declaring, first, that the artistic education of the French workman is inadequate, and, second, that the need for the re-establishment of the apprenticeship system was universally recognised. They recommend that it shall be made obligatory on the master to send his apprentices in his own time to study at the appropriate trade or craft school, and that it shall be equally obligatory on the apprentices to attend. These recommendations have had one immediate practical result. The Senate has already made these two obligations, in the case of trades and trade schools, the subject of a decree. The same procedure is about to be followed, according to M. Dalimier, in the case of the crafts and artistic industries, and will apply to all craft schools and schools of decorative art.

The next indispensable act of any such Minister should be to take order that our workshops should be better planned, and made healthier and workable in, without injury to the moral of the workers. Concurrently should follow every encouragement of a great increase of small workshops, and the formation of craft and industrial villages. From the one-man workshop, working on right lines, and amid favourable associations, as from the small inventor, come the ideas and impulses on which the large establishments depend. Some of the small men will still flock to the factory. More, we trust, will cling to the freedom and independence which are the life-springs of Art. In such small undertakings many of our returned soldiers and sailors will find congenial means of securing a livelihood, instead of ornamenting the doors of shops and kindred buildings as porters.

As yet there is no sign that the Minister of Reconstruction perceives any such necessities as we have briefly indicated. If he had, he would ere now have taken counsel with the English artists and craftsmen, as M. Dalimier did with those of France, and enabled them, at the head of such an organisation, to attempt what is being done there to head the task of national regeneration. If he is content to rely on the "Captains of Industry," who have piled up fortunes at the cost of the workers, or the Factory lords who have transformed the towns and the countryside into labyrinths of standardised hovels, who have defaced and dishonoured beauty, and given us ugliness and deformity in its stead, or on the still more fevered race for new markets for rubbish that no foreigner will buy, which is the primal cause of war, and all of which together are sapping the moral and physical health of the people, the prospect is indeed a hopeless one.

THE SURVEYORS' INSTITUTION.

PRESIDENT'S ADDRESS.

The opening address by Mr. Arthur Lyon Ryde (President) was read at the ordinary general meeting of the Surveyors' Institution on Monday last.

Mr. Ryde remarked:—There was one all-absorbing subject which fills the minds of everybody, and that was the war which is at present being carried on between the Central European Powers and the principal civilised nations in the world.

There is, he continued, nothing we can do which will go further to secure progress here than, by, noting to keep our professional society the strong, progressive, and living entity which it has grown to be since its birth nearly fifty years ago.

THE WAR AND ITS EFFECT ON PROPERTY.

There is, however, a subject which falls legitimately within the province of a surveyor, and especially of a rating surveyor, viz., the present and future effect of the war upon the value of property generally in the British Isles.

There are certain properties which have been affected in very special ways, which I will endeavour to deal with later on.

For the moment I confine my attention to the effect of the war upon the total value of property in the administrative county of London. This is what the returns show.

Total assessable value of the property within the county, being the rateable value of the parishes, reduced by one-half of the rateable value of agricultural land:—

Year ending April 6, 1912.	£44,774,038.
Year ending April 6, 1915.	£45,015,238.
Year ending April 6, 1914.	£45,112,481.
Year ending April 6, 1915.	£45,252,412.
Year ending April 6, 1916.	£45,220,740.
Year ending April 6, 1917.	£45,320,745.

Having regard to the fact that the war commenced on August 4, 1914, the first being that strikes anyone in connection with these figures is the remarkable stability of the value.

It will be seen that while the figure representing millions is absolutely stationary, the figures following represent a slight but steady increase, with only one set-back. The latter is easily explained by the occurrence of the quinquennial re-assessment in the metropolis in the year 1915, the effect of which is shown in the figures given for April, 1916.

It is well known to rating surveyors that during the revision in question immense reductions were made in the rateable values of all properties having to depend upon an industry requiring a consumption of large quantities of coal, e.g., gasworks and electric light works obtained very substantial reductions on their assessments, amounting in the case of the largest property (that of the Gas Light and Coke Company) to the enormous figure of £104,632.

There was also, as is well known, a great reduction in the assessment of all licensed properties, the latter being greatly affected

by the course of legislation during the last few years. The special causes which affected the values of licensed properties were as follows:—

- (1) The increased beer duty which took effect in the middle of November, 1914;
- (2) The limitation of trading hours;
- (3) The prospect of an Act being passed to restrict the output of beer.

In spite of these facts the reduction in the total rateable value amounted roughly to only £32,000, and the total has since shown a tendency to increase as before.

In case it may be thought that the total rateable value of the metropolis has been kept up by growth in the suburbs, it may be as well to quote the figures of the cities of London and Westminster for the same years. These areas are, of course, filled up, so that it cannot be alleged that the growth in value is due to expansion of the area built over.

The figures are as follows:—

	City of London.	City of Westminster.
Total rateable value shown in valuation lists and supplementary lists	£	£
do. do. .... 1912	5,706,292	6,501,268
do. do. .... 1913	5,759,323	6,519,069
do. do. .... 1914	5,753,401	6,682,238
do. do. .... 1915	5,739,101	6,763,826
do. do. .... 1916	5,830,588	6,843,701
do. do. .... 1917	5,860,812	6,869,817

It will be seen that the rateable value shows practically a steady increase throughout.

I have purposely included six years in the above tables in order to be able to compare the year ending April 6, 1917, with the fifth year back. It will be seen that the figures show a substantial increase.

In my judgment the stability of these figures is a substantial corroboration of the view that the war will not damage property in Great Britain to anything like the same extent as that in France, Russia, Italy, Germany, or Austria. It is, of course, quite impossible to obtain access to figures showing the taxable value of property in enemy countries, but having regard to the temporary extinction of the external trade of the Central Empires, it is practically certain that the same stability cannot exist there.

THE RAILWAYS.

In considering the effect of the war upon various large types of property, the first which occurs to me is that of the railways.

In this case the arrangement made between the Government and the various railway companies precludes any possibility of demonstrating the annual value of the railways. Members will not require to be reminded that the principle of the arrangement was that the Government should guarantee to the railway companies the same net receipts as they enjoyed in the year 1913, and that they (the Government) should take over the management of the railways for the period of the war.

Immense number of troops and an immense tonnage of munitions have been conveyed to and fro without any charge being made by the companies against the Government for their conveyance. It is, I believe, common knowledge that if the railway companies had been allowed to charge for this conveyance at the same rate as they were charging before the war commenced there would have been an enormous increase in the gross receipts of the lines; and from this point of view the arrangement made by the Government appears to me to have been a remarkably economical and sensible one for the country, as the Government are, in fact, only paying for such conveyance as they require—practically the actual cost price of the work done.

It must not be supposed, however, that the railway companies' net receipts would have corresponded with the increase in the gross receipts.

The Government have found it necessary on several occasions to agree with the trades unions and concede increases in wages which were stated by Sir Albert Stanley in the

House of Commons on August 15 last to represent an additional working expense of £25,000,000 per annum.

I do not propose to follow up this subject, which is only indirectly connected with the surveyor's profession, except to express the opinion that at the end of the war very exceptional arrangements will have to be made by the Government if the present dividends are to be continued payable on the ordinary stock of English railways. In this connection it should be stated that the railway returns for 1913 give the dividends payable in the United Kingdom (a) on guaranteed and preference stock at £17,329,025, and (b) on the ordinary stock at £17,704,982; so that the dividends on the ordinary stock would be entirely extinguished, and a large part of those on the guaranteed and preference stock also, were there no increase in income to counterbalance the enormous increase in working expenses.

I further express the opinion that in any event the rateable value of railways as a whole must be considerably reduced. At the present time the companies are paying roughly upon the assessments in force at the commencement of the war, and I believe that there will be no difficulty in showing that some of these are, in present circumstances, very much above the mark.

#### GASWORKS.

With regard to the rateable value of gasworks, this was already greatly affected by the gradual increase in the price of coal before the war, and the effect of the war was enormously to increase the cost of the raw material in consequence of the rise in the cost of freight.

The Gas Light and Coke Company used in the course of the year 1913 about 2,000,000 tons of coal, most of which came from the Newcastle district, at a freight of about 3s. per ton. In a very short time the operations of the Germans had the effect of running up the cost of freight by about 10s. per ton, so that the increase to this one company amounted to about £1,000,000 per annum—a sum which is sufficient to upset all calculations and to render it extremely difficult to make both ends meet.

The gas companies, however, have two sources of income which furnish a strong recuperative power. They are:—

- (a) The power to raise the price of gas; and
- (b) The price of coke and other residual products, which always has a tendency to rise in sympathy with the price of coal.

It is, of course, the fact that the effect of raising the price of gas is to reduce the consumption, but, in spite of this fact, the power to raise the price of gas, within limits, has an immense effect in giving stability to the annual value of gasworks. It must not be forgotten also that the various companies are manufacturing explosives for the Government in large quantities.

In these circumstances the effect of the war upon the annual value of gasworks is not so easy to define as it is in the case of railways, but it has undoubtedly reduced the value substantially.

#### HORSE PROPERTY.

With regard to the effect of the war upon horse property, from the figures given above, it is obvious that there is no great slump taking place in London, and it is, I believe, the fact that if the aggregate value of houses of the value of £150 per annum and downwards could be ascertained, it could be shown that there is no falling off in the annual value of the property.

On the other hand, there is undoubtedly a considerable reduction in the annual value of large residential properties, both in London and the country. Quite apart from the expense of keeping up such properties, there has been an emigration of the occupiers into much smaller houses, a process which can be said to have taken place all down the scale. The result has been to keep up the value of small houses at the expense of the large.

I may add that the almost total cessation of building has had the effect of checking the growth of the supply of houses, and in spite

of the enormous withdrawal of men for service abroad, there is a great demand for small houses and cottages all over the country. It is well known that in the neighbourhood of the large munition works which have recently been established, the absence of housing accommodation has almost amounted to a scandal, and even in the smaller towns the effect has been to increase the amount of overcrowding in the smaller houses to a very objectionable extent.

#### HOUSING SCHEMES.

In this connection it may be mentioned that as a sequel to their recent Report on House Emergency Schemes for the purpose of providing Employment after the War, the Housing Committee were desired by the Council on December 11, 1916, to extend their inquiry to the causes which had given rise to the shortage of house accommodation for the working classes. The terms of the reference were:—

'To consider and report to the Council as to the factors which in England and Wales have been mainly instrumental in checking the erection of houses for the working classes.'

The Report of the Committee has quite recently been published, and I strongly recommend you to read it. It contains a great deal of valuable information on the various factors which have affected the cost of building during recent years, as well as on those which have tended to turn the flow of capital into directions other than the erection of working-class dwellings.

Had it not been for the Committee's Report and the exhaustive manner in which the whole subject is there treated, its urgency would have made it incumbent upon me to devote a considerable part of my address to its discussion. In the circumstances, however, I feel that it would be superfluous for me to attempt to enlarge upon the Report, beyond calling your attention to the magnitude of the subject, as evidenced by the fact that the normal increase in the population as shown by the Census requires the erection of, approximately, 76,000 additional houses per annum, or about 100,000 in all, if those worn out, destroyed, or used for other purposes are also brought into the calculation: whereas only about 60 per cent. of those required were built during the five years ending with 1915. I have no doubt that the existing acknowledged shortage will develop into a perfect famine of small houses when our new return to the war unless energetic measures are at once taken to provide more accommodation.

#### AGRICULTURAL LAND.

Although I do not presume to pose as an agricultural expert, there is some truth in the saying that lookers-on see most of the game; and it is possible that a surveyor like myself, who had many opportunities of obtaining a practical insight into farming problems on land farmed by his father, and whose business now takes him into many rural districts and brings him into touch with those intimately connected with the management and cultivation of land, may not be altogether unfitted to form an impartial opinion as to the advantages and disadvantages of the change in national policy indicated by the passing of this measure. I propose, indeed, to deal with the question of policy rather than with the actual provisions of the Act itself.

At the time of our last great war, a hundred years ago, the Government was not faced with one of the great problems which has to be met by our legislators of to-day; the country was practically self-supporting in foodstuffs, and any temporary difficulties which might arise were provided for by the many enactments of that period dealing with the export and import of coal. Political power was almost entirely in the hands of the land-owning and agricultural classes, and the policy of "Speed the plough" was the accepted line of conduct adopted by both political parties.

By the Reform Act, 1832, the great change in political power was effected. Although, perhaps, not at first recognised, its effect upon the future of agriculture in this country was to be far-reaching.

A comparison of the figures showing the

acreage under wheat and the wheat grown and imported in 1860—at the height of the railway boom—with those of 1914 is instructive.

Year.	Acreage Grown.	Home Grown.	Wheat and Flour Imported.	Percentage of Home Grown.
1860	Acres. 4,013,725*	Quarters. 13,135,124	Quarters. 7,364,439	64.1
1914	1,904,932	7,804,041	27,509,831	22.1

\* Estimated.

The result was that between 1870 and 1914 the land under the plough in the United Kingdom diminished by over four and a-half million acres, and the number of persons engaged in agriculture by over one and a-half millions. In spite of the advance of science improvements in machinery and stock, and an increase in the use of concentrated feeding stuffs, the total amount of food produced in the country was infinitely less than had been the case fifty years earlier.

Such was the position at the commencement of hostilities, nor, apart from the effect of imports upon our financial position, did it, at first, seem likely seriously to affect our liability to prosecute the war unhampered by difficulties in connection with the national food supply. Our fleet speedily cleared the seas of hostile craft, and except for some increase in prices, due to the enhanced freights which followed the commandeering of a considerable proportion of the mercantile marine for military purposes, there seemed no reason to anticipate any special difficulties in this direction.

The weakness of our position, however, soon became apparent. In the first place, the increased demands upon the world's food supply by the armies in the field, coupled with a diminution in that supply, due to the devastation of the fighting areas and poor harvests in other parts of the world, made themselves felt; and in the second place, the power of the submarine, at first not fully recognised, began to exercise a still more potent influence.

While not wishing in any way to appear an alarmist, I am strongly of opinion that the submarine menace cannot be neglected in considering the agricultural position of a great insular Power such as our own. I am strongly of opinion that our national security demands the abandonment of the *laissez faire* attitude with regard to agriculture, which has so long prevailed, in favour of a policy which will result in better use being made of our fertile lands and a far larger proportion of our food supply being produced at home.

The passing of the Corn Production Act is a proof that the Government recognise this responsibility. As a measure it has been subjected to much adverse criticism, and doubtless time will show how best it can be amended, but I venture to assert that considerations of national security prevent our listening to those who state that farmers only wish to be left alone, and who denigrate any attempt to improve our agricultural methods by legislation. Denmark, Holland, and Belgium, before the war, have demonstrated that Great Britain no longer holds supremacy in agriculture, while Mr. T. H. Middleton's classic pamphlet on "The Recent Development of German Agriculture" (Cd. 8305), showing what may be done in a country possessing neither the fertility of soil nor the climatic advantages of our own, merits the close study of all interested in this subject.

I cannot close my address without expressing my sense of the great loss suffered by the Council and the Institution generally in the death of our recent President, Mr. Howard Chatfield Clarke. It is not too much to say that there was no more popular member of the profession, as he possessed in an eminent degree the qualities of judgment, even temper, impartiality, and charm of manner. It is rarely that these qualities are so happily combined as they were in the case of Mr. Howard Chatfield Clarke, and the Council all feel that they have lost a personal friend.



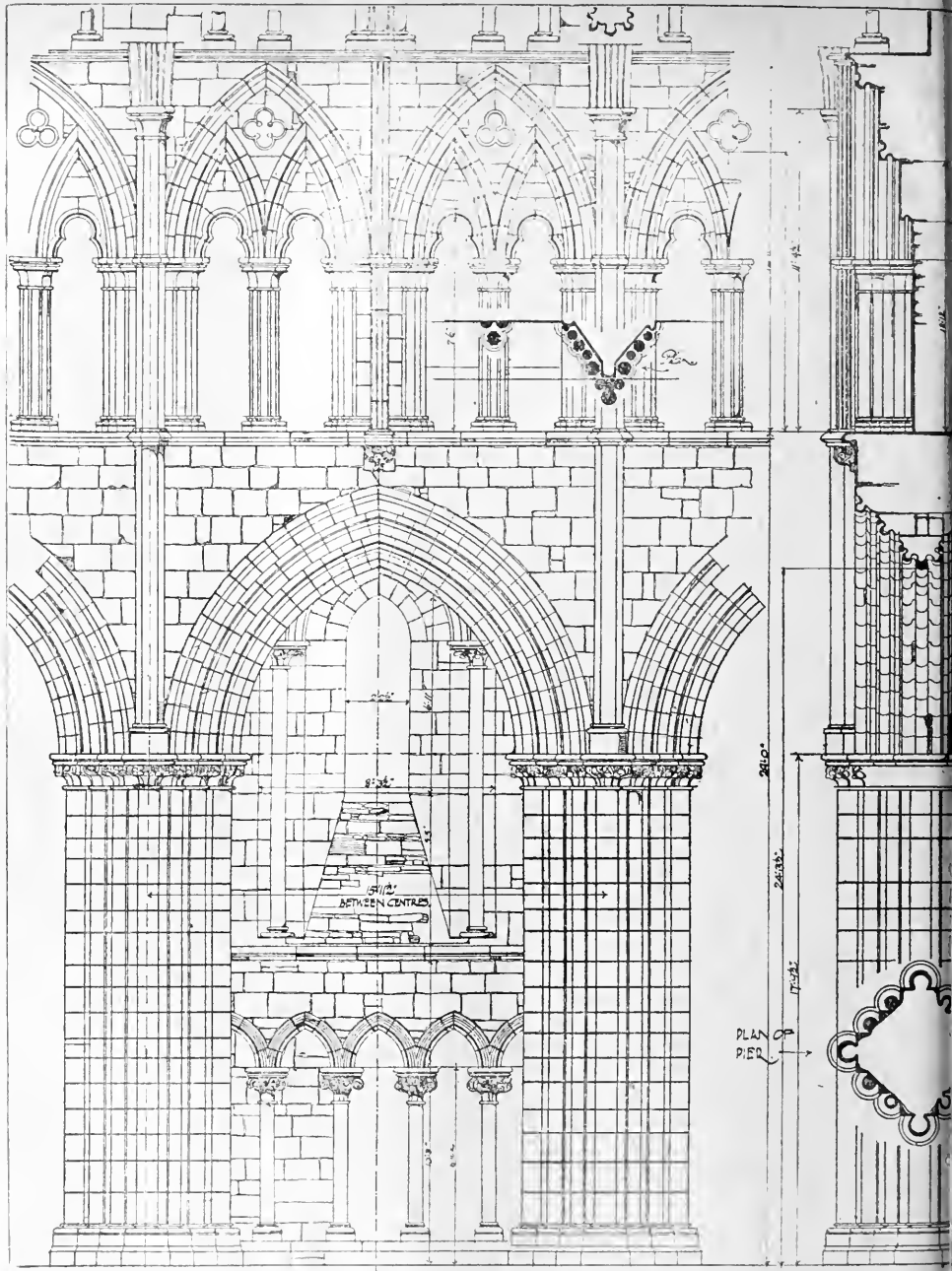

ELEVATION

HALF PLAN AISLE WINDOW

PLAN THROUGH

PLAN OF PIER

BAY OF SOUTH ARCADE OF THE NAVE, HOLYROOD ABB



OLYROOD  
CHAPEL.  
DUNBURGH  
DETAILS OF ONE  
OF THE  
PIERS OF SOUTH  
SIDE OF NAVE

MEASURED AND DRAWN  
BY MR. J. M.

*James Macgregor*

- COLOUR DENOTES TRIFORIUM ARCH
  - COLOUR DENOTES PLAN OF TRIFORIUM
  - COLOUR DENOTES ARCH MOULD NAVE
  - COLOUR DENOTES NAVE PIERS [ARCADE FULL SIZE]
- ALL DETAILS QUARTER

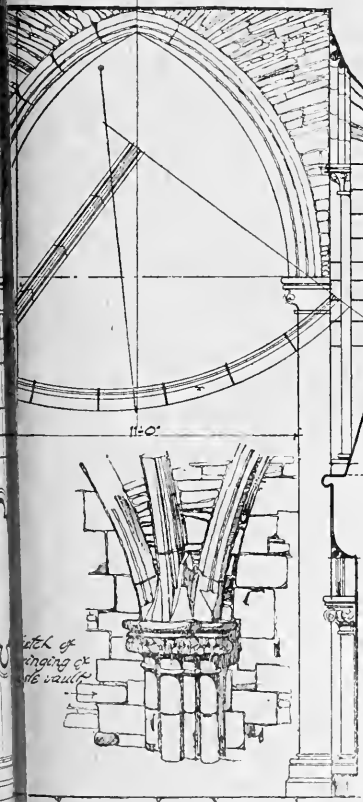
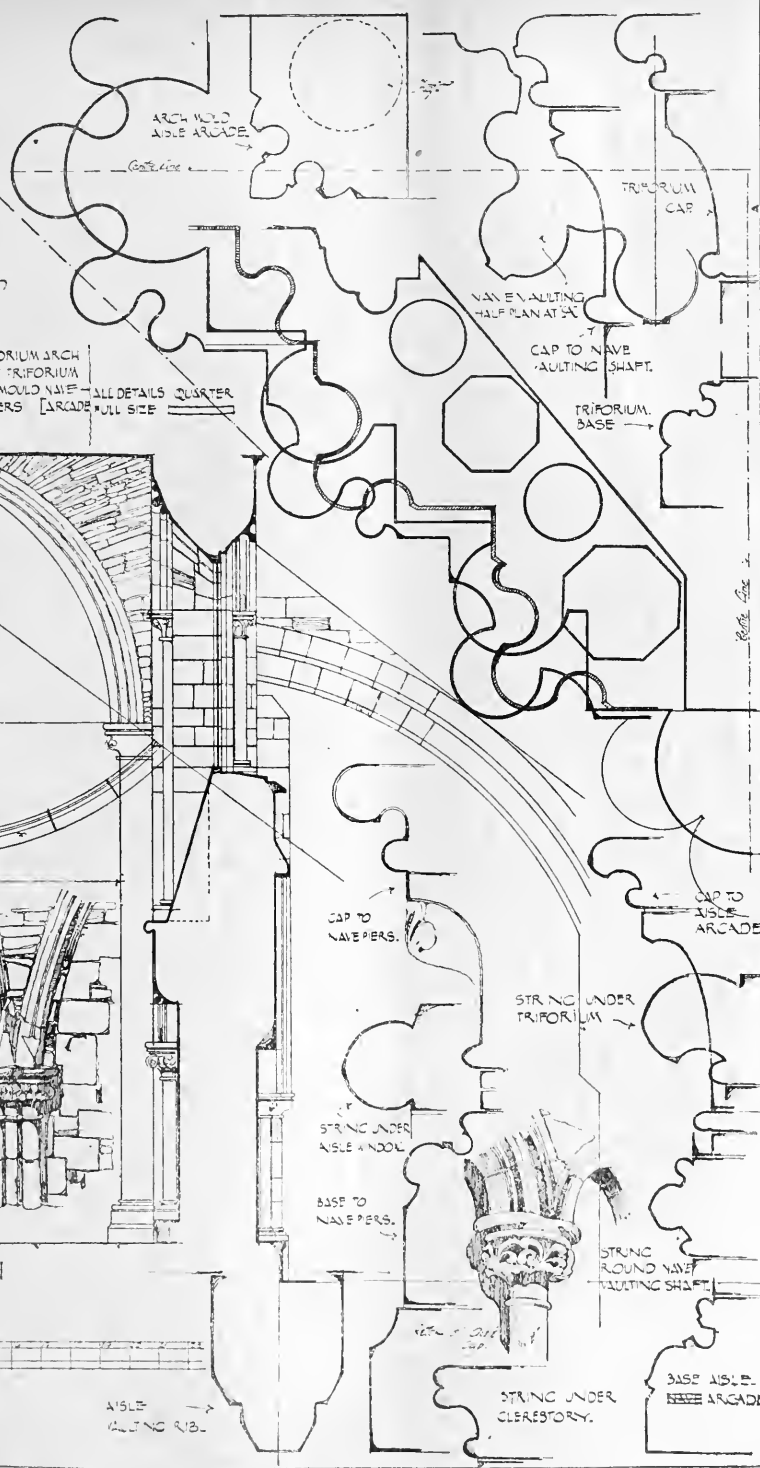





Coldharbour Manor  
East Grinstead  
SUSSEX

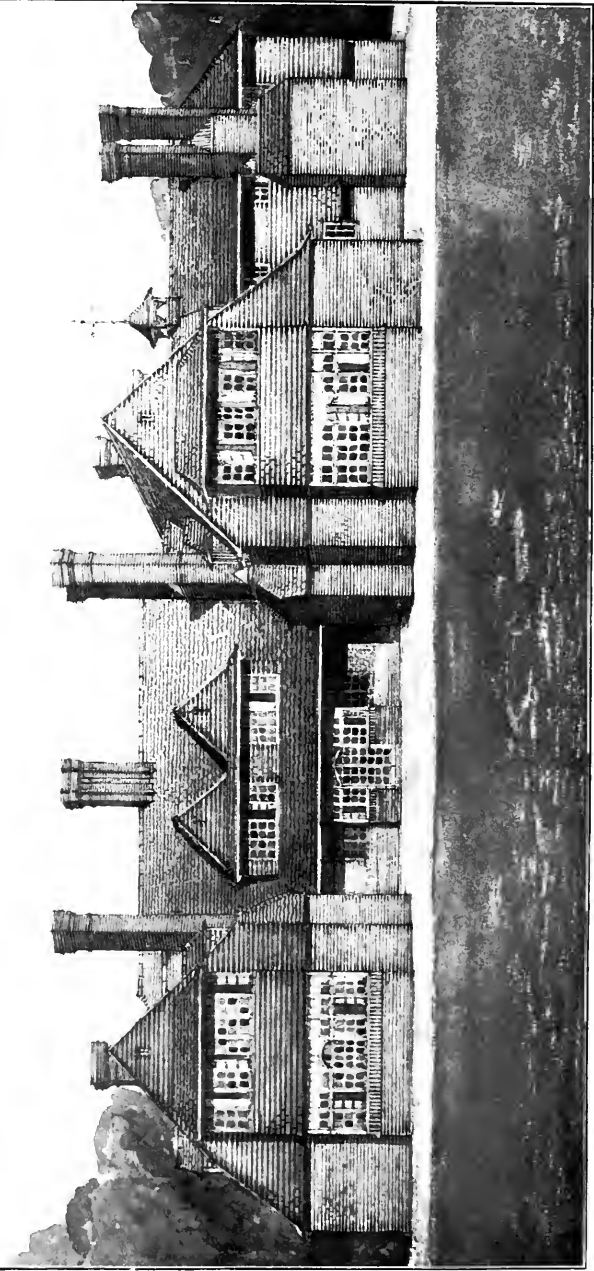

COLDHARBOUR MANOR, EAST GRINSTEAD, SUSSEX.—Mr. E. TURNER POWELL, F.R.I.B.A., Architect.





*Thos. Lewis, Ltd., Photo.*

SUMMERHILL COURT, KINGSWINFORD, STOURBRIDGE : MORNING ROOM.  
MR. JAMES A. SWAN, F.R.I.B.A., Architect.



*Thos. Lewis, Ltd., Photo.*

SUMMERHILL COURT, KINGSWINFORD, STOURBRIDGE : BILLIARD ROOM.  
Mr. JAMES A. SWAN, F.R.I.B.A., Architect.

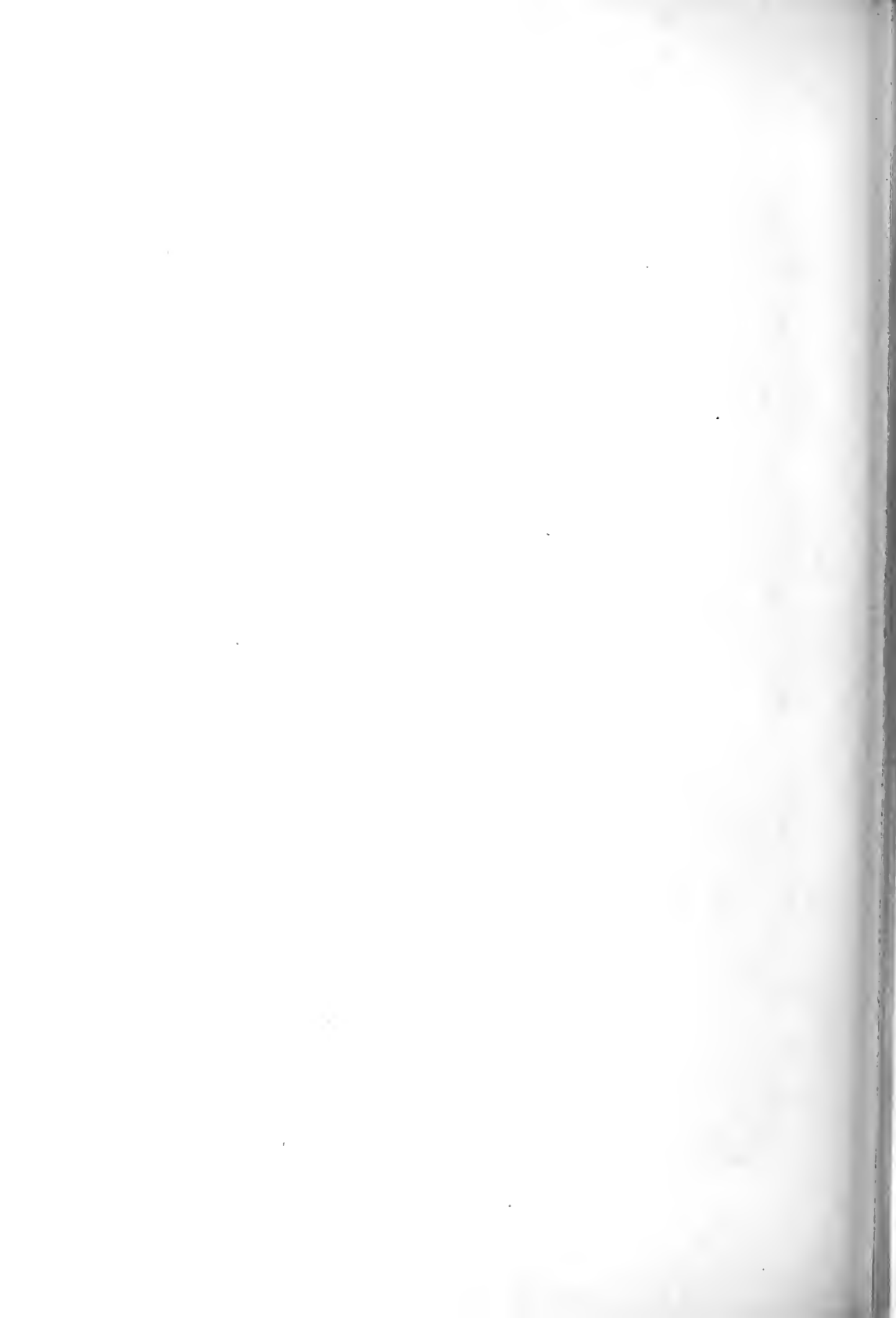



THE BUILDING NEWS, NOVEMBER 14, 1917.

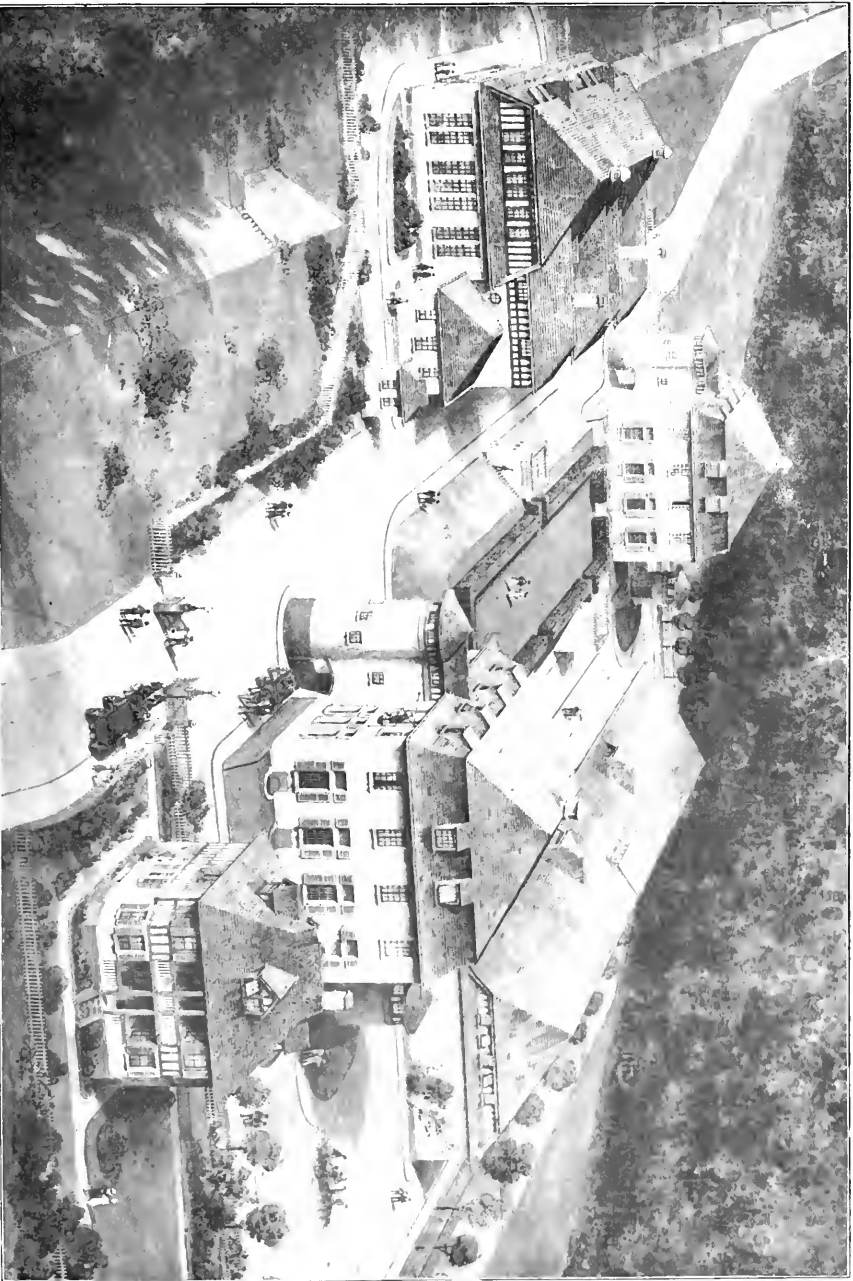

NEW WATERWORKS BUILDINGS, BADEN-BADEN.—MR. CHARLES W. ENGLISH, LICENTATE R.I.B.A., ARCHITECT.



## Our Illustrations.

### SUMMERHILL COURT, KINGSWIN-FORD, STOURBRIDGE.

These photographs, exhibited at the last Royal Academy Exhibition, show part of the additions and considerable alterations designed by Mr. James A. Swan, F.R.I.B.A., architect, of Birmingham, and carried out at Kingswinford, near Stourbridge. Summerhill Court was erected about thirty years since. The morning-room is wainscoted in oak of English growth, with fibrous plaster on enriched frieze and ceiling. The fireplace is enclosed in a Hollington tone surround. The second picture shows the ingle in the billiard-room, executed in dull polished mahogany, and panelled over mantel and dado. Grey-green leather paper covers the wall, with dull gold margins. Coloured glass designs fill the windows serving as a screen to hide the view over the rear premises. The ceilings are of fibrous plaster, ornamented. Pavoanaza marble surrounds the fireplace. The electric light fittings are in silver, oxidised. Full-size cartoons were provided for all the enrichments, carvings, leaded lights, and fittings generally by the architect.

### COLDHARBOUR MANOR, EAST GRINSTEAD, SUSSEX.

The external walls and chimney stacks of this house were built with local russet-colour bricks in 2½ in. courses, with wide joints. The roofs and weather-tiled walls are covered with old tiles, and portions of the roof are of old Sussex heeling. All the external woodwork is in English oak. The drawing-room has a decorative plaster ceiling modelled by Mr. A. Broadbent, of Fulham Studios. The principal staircase, ground floor doors, and flooring in the chief rooms are all in oak. The ball corridor and principal rooms have large open fireplaces, in which are interesting specimens of old Sussex firebricks and dogs, etc., collected by the client. Mr. E. Turner Powell, F.R.I.B.A., of Queen Anne's Gate, Westminster, is the architect. The contractors were Messrs. H. and E. Waters, of Forest Row. The drawing here reproduced was exhibited at the Royal Academy this year.

### NEW BUILDINGS FOR THE WATERWORKS, BADEN-BADEN.

This bird's-eye was shown at the Royal Academy Exhibition this year. The erection of these buildings was finished shortly before the war broke out. They comprise a scheme for supplying Baden-Baden with a quantity of water additional to the town's ordinary supply, which latter proved inadequate during the hot and dry seasons. The site is near the village Oos, and is surrounded by beautiful pine woods. The ground is permeated by water from the River Rhine, which, however, owing to its brownish colour, is not suitable for domestic purposes without filtering and de-ironing. The water is collected by trenches, and a 20 in. suction pipe leads it into the pumping station P, whence it is pumped into the Coke-filters C' and C'', where it is ventilated and de-ironed. It enters by way of the South towers, through a 16 in. pipe, and leaves by the low North towers, on its way to the gravel filter G. F., to undergo a final filtration. The water is then clear and pure, and is led into the covered reservoir B, whence it once more enters the pumping station P, to be forced under pressure to the service reservoir some distance away, and on high ground. To the north of the site are four settling-tanks, into which enters the water that has been used for rinsing the gravel filter G. F. The small house to the last contains two flats for workmen and their families. The walls throughout are plastered, and the roofs are covered with local tile of a pleasant reddish colour. Mr. C. W. English, Licentiate, R.I.B.A., M.S.A., was the architect, the engineering being by a specialist of water supply projects.

### BAY OF SOUTH ARCADE OF NAVE, HOLYROOD ABBEY, EDINBURGH.

David I. founded this abbey early in the twelfth century, for the Order of St. Augustine, and its erection was commenced about 1122. The scheme was large, and the design

was architecturally very beautiful. The choir and transepts, however, were not totally raised till after 1569. An extraordinary proposal soon after that date was made at a convocation of the General Assembly by Bishop Adam, of Orkney, to this effect, viz., that "the Abbey Church of Holyrood House had been these 20 years bygone runnous through decay of two principall pillars so that none were assured under it . . . he purposed to provide the means that the superfluous runnous parts, to wit the Quier and Croce Kirk, might be disposed to faithful men to repair the remnant sufficiently" (Wilson's Memorials, vol. II., p. 185). It appears that this drastic mode of dealing with the sanctuary at Holyrood was carried out; so the materials were sold, and the proceeds of the choir and transepts insured "funds for converting the nave into a parish church known as Canongate Kirk." Our illustration, reproduced from a sheet of measured details by Mr. James Macgregor, of Dunfermline, shows one of the bays of the arcade of the existing fabric. The north side of the building, with its eight bays, is now only represented by two or three fragments, so far as the arcade is concerned. Fortunately, the vaulting to the south aisle survives, as here delineated. Externally on this side of the church may be traced pretty clearly a portion of the cloisters, which were contrived below the flying buttresses, taking the thrust of the nave groining, now gone. The style generally belongs to the first Pointed period, and is distinctly the work of a master hand. There are, of course, earlier features in the building, such, for example, as the genuine Norman doorway leading from the church to the cloisters. This portal may be said to have anticipated the Transitional manner, and has been so described. The lancet windows in the south aisle are much shorter than those on the north side. This variation is accounted for by the necessity of accommodating the cloister roof. The cills of these windows consequently are higher up, and inside they have a very deep sloping splay, as drawn by Mr. Macgregor in his section. A series of large pointed wall arches outside this wall enclose a range of five small arches in a finely proportioned manner, the work all being of a very high order, thoroughly well detailed. The nave arcade piers take the simplest form of clustered columns, and these are crowned by foliated caps, above which are circular abaci. The arch moldings, of which sections are here fully set out, consist of rounded members, boldly divided by deep hollows. The vaulting shafts run up through the triforium to receive the groin ribs, which rested on the plain bell caps placed some distance below the string course under the clerestory. In a line with the apex of the arches of the nave arcade corbels occur to carry the wall columns, which tend to show that the vaulting over the body of the church was six-partite in form, and this likelihood is confirmed by the direction in which the surviving portions or springers of the groin ribs start at their base. The most beautiful part of the building in several respects was comprised within the facade of the west end, particularly the great portal, though, unfortunately, that has been altered a good deal, some of its best details having suffered mutilation rather badly. Consequently, this front, once so exquisite, has been shorn of its glory. The south-west tower, too, was pulled down to make room for the building of Holyrood Palace, at a time when the entrance of the nave was interfered with. An oak leaf lintel, for instance, was inserted below its tympanum, having a shield in the middle of the timber carved with the initials of Charles I. This king re-built the upper stages of this facade in 1633. Mr. Axel Haig, who was at one time engaged by Sir Rowand Anderson to prepare a series of plates in illustration of the Scottish churches, made a very charming etching several years ago of this end by illustrating the great doorway at Holyrood Abbey. A view of the same feature with plans, including many other sketches and details of the ruined church, will be found in the second volume of Messrs. Macgibbon and Ross's "Ecclesiastical Architecture of Scot-

land," together with a history of the building. In our issue of June 27 last we gave an interior of the Cathedral Church of St. Giles at Edinburgh, with some account of the destruction of Holyrood Abbey, which took place principally at the same time when similar damage by the same hands was done to St. Giles' Church.

### PROFESSIONAL AND TRADE SOCIETIES.

ROYAL ARCHITECTURAL INSTITUTE OF CANADA.—Mr. J. P. Ouellet presided at the tenth annual meeting of the Royal Architectural Institute of Canada, held at the Chateau Laurier, Ottawa. Both at the meeting of the council and of the institute there was not a quorum, but the members proceeded with certain items on the agenda. The delegates from the federated associations of architects to the 1917-18 council were reported by Mr. A. Chausse, the honorary secretary, as follows:—Alberta, Messrs. R. P. Blackey, Calgary, and W. D. Cromarty, Edmonton; Manitoba, Messrs. L. H. Jordan, Winnipeg, H. E. Matthews, Winnipeg, and J. H. G. Russell, Winnipeg; Ontario, Messrs. C. H. Acton Boyd, Toronto, A. Frank Wickson, Toronto, and J. P. Hynes, Toronto; Quebec, Messrs. D. R. Brown, Montreal, Alcide Chausse, Montreal, J. P. Ouellet, Quebec, J. Perrault, Montreal, Herbert Raine, Montreal; the Saskatchewan nomination not yet received. The question of the admittance of the Architectural Institute of British Columbia was discussed. The council, it was stated, had passed a resolution admitting the B.C. Institute, provided that satisfactory evidence be forthcoming that the B.C. Association of Architects had been disbanded. It was explained that the two associations had previously claimed to be federated, and that there had been considerable correspondence on the subject. In his annual report Mr. Chausse reviewed briefly the history of the institute, and the proceedings of the council. The balance-sheet showed a balance of \$935.40. A letter from Mr. E. Burke, Toronto, was read, suggesting that in view of the probable number of public monuments which would be erected at the close of the war, the institute might move in the matter of an appointment of an art jury to pass upon the proposed designs. If Government assistance, both federal and provincial, could be secured, making such jury or juries official and authoritative, it might be made still more effective. There would be great danger of abortions in the way of monuments if some artistic supervision were not provided. Mr. Chausse stated that he would write the provincial governments on the subject. Mr. L. H. Jordan made a number of suggestions, to be taken up at a later date. Those included the payment of cash prizes of \$100, \$75, and \$50, to be offered in lieu of the gold, silver and bronze medals proposed, but that medals be struck off as soon as practicable and awarded to such candidates as prefer them. He also suggested that the suit against the Dominion Government in connection with competition prizes be carried on at the expense of the R.A.I.C. instead of by any one provincial association. The R.A.I.C. should offer its professional services to the Dominion Government for war purposes as an organisation, either in consultation or by way of advice. Papers were read on "Why the Practice of Technical Professions in Canada should be Regulated by Law," by Mr. J. P. Hynes; "Professional Ethics," by W. A. Langton; and "The Development of Architectural Design in Canada," by Mr. Alfred Chapman.

SCOTTISH ECCLESIOLOGICAL SOCIETY.—The Scottish Ecclesiological Society met last week in St. Cuthbert's Hall, Edinburgh. Mr. Charles J. Menart, I.A.A., architect, Glasgow, read a paper on "The Lighting of Churches." With the aid of many lantern slides he illustrated particularly the method of lighting from above, instancing as perfect examples St. Sophia, Constantinople, and the Capella Palatina at Palermo, where the light falls from the lantern upon the altar, and thence to the remotest corners of the building. He emphasised the fact that windows are not meant for exterior effect, but to let in light.

## Correspondence.

## PROPOSED WAR MEMORIAL CHAPEL.

To the Editor of THE BUILDING NEWS.

SIR.—The friendly criticism which has appeared in THE BUILDING NEWS on this important proposal leads me to ask you to permit me to thank "J. C. B." and "S. C." for their letters in your last week's issue.

I do not know "S. C.'s" so would you be good enough to let him see the block plan, which I herewith enclose, which will show him that his suggestion of bringing forward the chapel to the present frontage of Abingdon Street has already been met, and therefore the North front of the chapel and the large projecting East window would be seen from Whitehall, the South front being seen coming from Great College Street, the intervening space between the Chapel and Great College Street being occupied by my suggested public garden, on the line of frontage of the Abingdon Street houses.

With regard to the position of the clergy and choir vestries, I think "S. C." would, on further consideration, agree that they must be at the East end—I have the honour to be, Sir, your most obedient servant.

WM. WOODWARD.

13, Southampton Street, Strand, W.C.,  
Nov. 9, 1917.

We sent the block plan on to "S. C." who has returned it with some remarks which he asked us to send on to Mr. Woodward; and also the following letter.—Ed. "B.N."]

SIR.—It may well be that the garden part of Mr. Woodward's improvement scheme will be considered almost as important as the chapel itself. In the block plan, which it has been my privilege to inspect, the laying out of the garden appears somewhat formal on paper, but this does not, of course, imply that it will be so in the planting. I notice a large space in the centre reserved for a fountain. Let us hope it will be a real fountain, a restful, splashing fountain, and not the occasion for dumping down several tons of the finest mortar. This garden will open out the long obscured south side of the Abbey. Save for the select few, the only satisfactory view at present is from the raised pavement at the South end of Dean's Yard (where I suggest the Corporation might place a few seats). There is a second glimpse to be had, but that is from the other side of Lambeth Bridge. The Abbey authorities have always appeared totally blind, or at least strangely indifferent, to the opportunities of the Abbey's South aspect. Judiciously hid out, its prospects can be made at a comparatively small outlay as fine a cathedral close as any in the country and this, he it noted, not hidden away in a rural district and accessible to a population of 10,000 at the most, but five minutes' walk from Trafalgar Square. Surely such an amenity should be a priceless possession, but when will Londoners recognise the things that belong to their peace? At present a high wall to the North of Great College Street effectually neutralises any latent charm that may exist. It is, I think, the worst wall that I have ever seen. If at any time the proposed public garden were extended so as to take in the Abbey garden, certain contingencies would have to be provided for. Little Alfred, for instance, and his compeers from the immediate neighbourhood must not be permitted to fill the air with their yells and war-whoops, a special domain being reserved for them elsewhere; the verminous tramp, possibly our trust incarnation of the old Greek philosophy, must, of course, be allowed to drink in his own beauty unhindered, but he should not monopolise all the seats. How many of the inhabitants of London, I wonder, have ever heard of Barton Street, or know that at the end of Victoria Street there remains at least the nucleus of an old-world cathedral which is worth preserving at any cost. Yours faithfully, "S. C."

In recognition of his position as President of the A.A., Mr. Henry M. Fletcher has been promoted to the rank of Assistant Commandant of the Red Cross Detachment.

## Our Office Table.

Addressing the seventieth annual meeting of the Birmingham Freehold Land Society last week, the Chairman, Mr. W. J. Lancaster, J.P. (Weston-super-Mare), said the past year for the society had been one of inactivity so far as the development of estates was concerned. Notwithstanding that the shortage of houses was becoming very serious, no houses were being erected, as the speculative builders, whose operations had been subjected to much criticism, had found it impossible to build remuneratively. It could not be denied that the growth of the city had been due to the enterprise of the speculative builders, who now found it more profitable to enter into contracts for the erection and extension of works. Various schemes were being formulated to cope with the scarcity of houses after the war, but he felt that such matters were better left to private enterprise, which to a large extent meant the builders. Proceeding, Mr. Lancaster remarked that a well-known builder recently stated that the six-roomed house, which before the war cost about £150, could not now be built under £300. The Birmingham Freehold Land Society was prepared to provide land, on easy terms, directly the demand justified the cutting up of an estate, and kindred societies would be prepared to assist in the erection of the houses. A noticeable feature of the war was the increasing number of large agricultural estates being offered for auction, and being acquired by tenants, a fact which he believed would tend to the further prosperity of the country.

The roof of an electric station building recently erected at Cristobal, in the Panama Canal Zone, is supported by central columns, and the side walls bear no weight, but are suspended from the eaves. Says *Engineering and Contracting*: "In order to assure the electric charging station at the Cristobal terminal of the Panama Canal against settlement, it was constructed with a continuous reinforced concrete beam which extends the length of the building on the centre columns, and from which the side walls are literally suspended by means of cantilever beams set at intervals of 10 feet. The walls are only 4 ins. thick. The wall on the sea side is made fast to the paving by means of anchor bolts. . . . The weight of the building is carried on a row of columns extending along the longitudinal axis, and these columns are supported on the steel and concrete caissons, on which rests the paving at the head of the slip. On the side next the land the paving is supported on timber piles which have settled slightly."

A special report, with relative specifications and plans, prepared by Mr. John Wilson, F.R.I.B.A., Architectural Inspector of the Local Government Board for Scotland, on the design, construction, and materials of various types of small dwelling houses in Scotland, has been presented by the Royal Commission on Housing in Scotland. The evidence placed before the Commission will not be published until later; but it is thought that the issue of part of the appendices to the evidence will help local authorities and others who are preparing housing schemes. Mr. Wilson gives the cost of two styles of houses, and in fixing the rents to be charged he explains that no profit to owners has been allowed, as it has been assumed that only local authorities can build smaller working-class houses without profit to themselves. In one example, the cost of a semi-detached cottage at July, 1914, without land, is put at £220, the rental of which would be £14 3s. 3d.; at the present time the cost would be £275, and the rental £17 11s. In the other example, the cost of a flatted house in a block of four at July, 1914, was £190, without land, but the present cost would be £237 10s., and the rent would be increased from £12 9s. to £15 7s. 6d.

The Council of The Institution of Civil Engineers have made the following awards for papers published in the *Proceedings* with out discussion during the Session 1916-1917:—

A Watt Gold Medal to Major H. S. B. Whitley, R.E. (Neath); Telford Premiums to W. C. Popplewell (Manchester); Herbert Carrington (Woodley, Stockport); Dr. A. A. Stoddard (Bournemouth); A. E. L. Chorlton, C.B.E. (Lincoln); and B. M. Samuelson (Rangoon). The Manby Premium to R. Hleazoy (Perth, W.A.). The Webb Prize to J. B. Ball (London). The Howard Quinquennial Prize to Dr. W. C. Unwin, F.R.S.

A conference on the housing problem in Rochdale, and how it is to be met during and after the war, was held at the New Masonic Rooms, Oldham Road, Rochdale, last Wednesday night, under the chairmanship of Mr. J. W. Kay, President of the local Master Builders' Association, Mr. T. Howarth, a well-known local builder and contractor, opening the discussion. Private enterprise in building, from a lucrative standpoint, had broken down, he said, and he hoped for a system whereby the builder would work for the local and national authority under the surveillance of a local advisory committee representative of all the interests and parties concerned. "He profits most, with a conscience least," was the text of Mr. Howarth's paper. If private enterprise had failed in this matter of housing, it was the duty of the municipality to step in. Land acquired by the municipality should be laid out on town planning lines, and the plots let off to the builders, who should work to the design of the public surveyors and architects. As to the kind of cottage, he thought many of the Rochdale houses better than those of the garden cities he had visited. Discussing the use of concrete and ferro-concrete, he said that in this damp climate brick walls and timber were wanted. As to design, more three-bedroom houses were wanted, and while standardisation of parts could go on, these parts should be distributed, so that, say, ten different kinds of houses could be built in one group. One thing was certain—rents all round must be higher; at least 12s. 6d. a week would be required for the sort of houses he had in view. In the course of the discussion, criticism of the "brick boxes with blue of grey lids" of Rochdale was voiced. Councillor Shawcross, admitting that the Corporation had been very conservative, said there should be no limit to the number of houses actually provided. There was intrinsically no value in land, and he thought it should be acquired on the valuation of the Finance Act, 1910, and compulsorily. The question now was, What was the Government going to contribute? Interest on money borrowed would be high, unless the Government had the sense to say they would take capital as they took men's lives. The 6s. 11d. house would be 11s. 6d. after the war.

Wimbleton Town Council, in replying to the questions of the Local Government Board in reference to the proposed scheme for the provision of houses for the working classes, raises the question whether a local authority is justified in spending rates and pledging its credit upon the erection of houses in another authority's area unless there is a reasonable prospect of such action reducing overcrowding or substantially relieving the housing shortage in its own district. As there is practically no ground available in the borough for the building of working class houses, it points out that the solution of the difficulty would appear to be such an extension of area as would allow Wimbleton to provide within its own local government district the adequate housing accommodation for those who desire to live there. Overcrowding does not exist to any serious extent in the borough. For persons of the working class living in the district new houses are not required, as there is no prospect of it changing from a residential to an industrial district, but for persons of the working class who live in Wimbleton and work elsewhere new houses are required now. The Council adds that the housing question seriously affects what is known as the clerk class, many of whom have to pay a rental far too high in proportion to their income, due to the high price that ground in the district commands.

A largely attended meeting of members of the Balcie Exchange was held last Friday, when Mr. A. R. Miles, who presided, moved the following resolutions: "That this meeting

protests most vigorously against the continued shipment of cement to Holland" and "That this meeting calls on the Government to cancel immediately any licences which have been granted and to stop all cargoes now loading." They should make up their minds not to let this thing go on. He had received a letter from General Page Croft that morning saying that he intended to get an explicit declaration from the Government that no more cement, either licensed or unlicensed, should be exported to Holland. He hoped that between them they had scotched this business. The resolutions were seconded by Mr. Marnaduke Lawtjer, who ridiculed the "assurances" that this exported cement did not get to Germany. They were tired of the partial blockade and could only emphatically reject the arguments that were used in justification of this export trade; they knew, for instance, that the plea which we might get this business after the war was empty when we considered the transit distances involved. When the resolutions were put to the meeting they were carried amid cheers and cries of "All." and it was resolved to send copies to the Prime Minister, the Foreign Secretary, the Minister of Blockade and his Parliamentary Secretary, and the President of the Board of Trade.

Mr. Arthur Fell, the Chairman of the Committee of the House of Commons formed to urge the construction of the Channel Tunnel, has issued a pamphlet protesting against the decision of the Government not to proceed further in the matter during the continuance of the war. Mr. Fell says that the peace and happiness of Western Europe now depend on the permanent friendship of France and England, of which the tunnel would be the outward symbol, and argues that the decision of the War Office shows that the Department fears that a stable peace will not be secured. While his Committee cannot admit such a possibility, they urge that the present war has demonstrated the necessity for the tunnel. Mr. Fell asks, if the war is to be renewed with Germany within a few years, does the War Office think (1) that the present situation will remain unchanged—that we shall have Belgium and France as our Allies, and that the conflict will be fought on the battlefield of to-day? (2) that Belgium and France will remain neutral? or (3) that they will join with Germany in attacking us? In the first-mentioned contingency the tunnel would greatly assist us. Military opinion is, we believe, unanimous on this point. In the second event the tunnel mouth in France would be free from attack, and, if we could defend our own end at Dover, it would then give us a most valuable means of communication with neutral States—an advantage which Germany has found to be so important a factor in this war. In the third case—which we mention but decline to discuss as coming within the region of practical politics—the tunnel on the outbreak of hostilities would be closed, and remain closed during the war. It would be a jointly owned property, and beyond blocking it securely neither country would be likely utterly to destroy it. He concludes: "The Government must make up its own mind on the subject, and on its decision will depend the commercial future of London. Whether it is to be the future gateway to the East and the railway centre of Europe, or if it is to be side-tracked and the future pass to Berlin, Paris, or Vienna."

Preaching at the dedication of marble shafts in St. Fin Barre's Cathedral, Cork, erected as memorials to the late Dean Bruce and others, the Bishop of Cork referred to the work of William Burges. He said that that Cathedral was not as ancient as some of their cathedrals, but for its age the Cathedral of St. Fin Barre enshrined a crowd of memories. At every portion to which one turned there were memorial windows, a pulpit, choir gates, an organ, vestries, and chapter house, and bishop's throne, and now the beauty of the Cathedral was to be enhanced by a series of gifts, uniting many memories in the chancel. One of the advantages enjoyed by the building was that William Burges, its architect, placed on record an extensive scheme of decoration, and those who had from time to time the charge of the Cathedral faithfully observed

his intentions, and thus every change had been devised along the lines of a harmonious plan, working up towards the thing which had been foreseen, and the new work which had been done was in complete harmony with these principles. It is very gratifying, remarks the *Irish Builder*, to hear that such respect is being paid to the intentions of Burges, who certainly gave Cork a splendour, if very small, Cathedral.

#### PARLIAMENTARY NOTES.

SHIPMENTS OF CEMENT TO HOLLAND.—Sir A. Stanley, on Monday, replying to Mr. Watt (Glasgow College, L.), said:—The facts of the case with regard to the export of cement to Holland have already been fully explained by the Minister of Blockade, Brigadier-General Page Croft (Christchurch, Ind.).—Is there an ample supply of cement in this country for our own use? Sir A. Stanley: Yes, so far as I am aware. Commander Loveton Harris (Worcestershire, E. U.), replying to Major David Davies (Montgomeryshire, L.), said: There appears to be some misapprehension regarding the objects of the recent Order in Council which made it obligatory to obtain licences for the export to Scandinavia and Holland of certain commodities which, previously, could be exported without licences. This Order, which came into force on October 8, did not preclude the granting of licences for export where that could be done with due regard to the interests of the Allied Governments. In fact, only one licence for cement for Holland has been issued, the quantity licensed being 3,110 tons, and in pursuance of the general commercial policy of the Allies no further licences are now being granted. As, however, there is no ground for thinking that any of the cement exported from this country has been, or is likely to be, directly or indirectly of service to our enemies, it is not intended to revoke the licence already granted, or to stop any ships which may be loaded under it. With regard to the inquiry as to whether any cement-boxes bearing the names of British manufacturers have been found among the German defence works in Belgium, inquiries already made into the matter by the military authorities have not resulted in a confirmation of the information in question, but further investigations are being made. At the same time, I shall be most grateful to the hon. and gallant member for Montgomeryshire if he can furnish me with any facts which may have bearing on the subject.

#### TRADE NOTES.

Boyle's Latest Patent "Air-Pump" Ventilators, supplied by Messrs. Robert Boyle and Son, ventilating engineers, 64, Holborn Viaduct, London, have been employed at the National Physical Laboratory, Bushey Park, Teddington.

The death is announced of Mr. W. Vanstone, builder and decorator, of 61, Chandos Street, Strand, W.C.2, who met with a fatal accident on Friday, November 2. The business will be carried on as usual by his son, and all matters will have prompt attention.

The degree of Bachelor of Architecture (B.Arch) was conferred upon Mr. Vincent Kelly at the last conferring of degrees at University College, Dublin. Mr. Kelly, who is only twenty-one years of age, matriculated in 1912, and is the first graduate in Architecture in Ireland.

The death is announced in action of a second son of Mr. W. E. Moorey, Second-Lieutenant W. E. Moorey, of the London Regiment. His father, who is head of the estate, survey, valuation, and insurance department of Messrs. John Barker and Co., Ltd., of Kensington, lost his son Leslie in the early days of the war, for he died of wounds on February 15, 1915, and much sympathy will be felt for the stricken parents in the second great sorrow that has befallen them.

Owing to the scarcity of metals, the necessity frequently arises of finding substitutes for use on work which cannot be delayed. The dome of the National Museum of Wales at Cardiff has been made watertight with a rendering of waterproofed cement as a temporary measure. When the war is over it will be covered with tiles as originally intended. The architects (Messrs. Smith and Brewer) state that the Puddoc cement rendering has proved quite satisfactory, which again shows that the uses of waterproofed cement are many and varied.

## LIST OF TENDERS OPEN.

### BUILDINGS.

**No. Date.**—Execution of improvements to the Tubercular Church, Glasgow, Athole.—For the Rev. Thos. Gaughran, P.M. Plans, etc., may be inspected at the Presbytery, Tubercular, or at the offices of the architect, Mr. J. V. Brennan, Belfast Bank Chambers, Belfast.

### ENGINEERING.

**Nov. 15.**—Excavating for, laying in, and jointing about 640 lineal yards of 22-in. cast-iron condensing main pipes, etc., along the canal bank, Bridge Street, etc., Loughborough, between a point near the drawbridge and the electricity works; also construction of intake and discharge chambers, together with all appurtenant works.—For the Electricity Committee.—Plans and forms of tender of A. H. Walker, A.M.I.C.E., Borough and Waterworks Engineer, Town Hall, Loughborough. Sealed tenders to H. Perkins, Town Clerk, Town Hall, Loughborough.

**Nov. 19.**—Supplying and erecting a Lancashire boiler, boiler mountings, superheater, and Green's economiser, at the Sheerness cast pumping station.—For the Sheerness Urban District Council.—By H. Stallon, Clerk, Council Offices, Sheerness.

**March 30.**—The Acting British Consul at Santiago reports that a decree has been issued calling for tenders for the improvement of the port of Antofagasta (Chile). By the terms of this decree the amount to be expended on this work must not exceed £1,700,000. Details may be obtained from the Port Commission Offices in Santiago, and copies are expected to be received shortly at the offices of the Chilean Legation in London, 22, Grosvenor Square, W.1. Tenders will be received up to 3 p.m. on March 30 by the Minister of Finance, Santiago.

## TO ARMS!

COUNTY OF LONDON VOLUNTEER ENGINEERS (FIELD COMPANIES).

Headquarters, Ballderton Street, Oxford Street, W.1. ORDERS FOR THE WEEK BY LIEUT.-COLONEL C. B. CLAY, D. O. M. S. D. I. N. G.

OFFICER FOR THE WEEK.—Lieutenant C. E. Campbell.

NEXT A FOK DUTY.—Lieutenant W. J. A. Watkins.

DRAWS WEEK ending Sunday, November 25, 1917.

MONDAY.—No. 3 Coy, Left-half Recruits, Signalling, 6.30.

TUESDAY.—Physical Drill and Bayonet Exercise, 7.30.

WEDNESDAY.—No. 1 Coy, 6.30.

THURSDAY.—No. 2 Coy, 6. Signalling, Ambulance, 6.50.

FRIDAY.—No. 3 Coy, Right-half, Recruits, 6.50.

SUNDAY.—Commandant's Parade for Heavy Bridging Instruction at Isher, Parade, Waterloo station, opposite No. 10 platform, 8.35 a.m. Uniform, haversack, and water bottle. Midday rations to be carried. Compulsory for men in Sections A, B, and C.

MUSKETEY.—Belvedere Road, Tuesday, Wednesday, and Thursday, 5.30 to 7.

NOTE.—The Medical Officer will attend for examination of recruits, etc., on Thursday, at 6.

All enamelled cap badges must be returned to the Quartermaster-Sergeant, without exception, unless otherwise indicated at drills will take place at Headquarters.

By order,  
MACLEOD YEARSLY, Capt. and Adjutant.

November 17, 1917.

The Archbishop of Canterbury has dedicated an altar in a lady chapel in the eastern crypt of Canterbury Cathedral, to the memory of the late Dr. Moore.

The St. Columb R.D. Council have approved the scheme of Messrs. Andrew and Randell, engineers, for the drainage of the village of Trevene, at an estimated cost of £1,150. The outfall will be at Pentonwarra Point, provided the float tests prove satisfactory.

Sapper Bernard W. Handley, of the Royal Engineers, the second son of Mrs. Handley, of 129, Treadole Street, Rochdale, was killed in France on October 30. As an artist and caricaturist he showed great promise, and had contributed many clever sketches to Rochdale and Manchester papers.

A committee has been formed to commemorate the service rendered by Old Millhillians in the war. It has been resolved that memorials should be established as follows:—a fund to provide for the education of the sons of Old Millhillians who have been killed or permanently disabled; the erection in some part of the school of a suitable monument of artistic beauty; and the extension of facilities for science teaching in the form of a building which shall contain laboratories and lecture-rooms.



**FOR**  
**Olivers'**  
**Seasoned**  
**Hardwoods,**

WM. OLIVER & SONS, Ltd.,  
120, Bunhill Row, London, E.C.

**TENDERS.**

\* Correspondents would in all cases oblige by giving the addresses of the parties tendering—at any rate, if the accepted tender: it adds to the value of the information.

**ADULTS-BOT.**—For furnishing clinic, for the education committee:—  
Junior Army and Navy Stores,  
Ltd. (accepted) .. £268 15 6

**DEWSBURY.**—For drainage works at the cemetery, for the corporation:—  
Crossley, J., Dewsbury (accepted) .. £43 0 0

**GLASGOW.**—For erection of a temporary exhibition building, for the British Industries Fair, for the corporation:—  
F. D. Cowie and Co., St. Rollox, bricklayers' work, £7,499; carpenters' work, £11,628 (recommended for acceptance).

**NWAIN.**—For the installation of heating apparatus at the County Council Hall:—  
Coldrick, P. (accepted) .. £70 10 0

**NORTH WOOLWICH.**—For the supply of copper piping for use at North Woolwich pumping station, for the London County Council:—  
Grisdale and Barton, North Woolwich, 3s. 6d. a lb.; Blundell's Copper and Brass Works, Ltd., West India Dock Road, 3s. 2d. a lb.; J. Dove and Co., Bromley-by-Low, 3s. a lb.; J. Hrierley and Son, Deptford, 5s. a lb. (accepted).

**OSWESTRY.**—For erecting a heating boiler in the workhouse chapel, for the guardians:—  
Ellis, T. H. (accepted) .. £19 8 0

**SHEFFIELD.**—For buildings, etc., in connection with the erection of the emergency power house at Blackburn Meadows, for the town council:—  
Accepted tenders:—J. Greenwood, buildings; Gilbert, Heathcote, and Co., structural steelwork; Clarke, Chapman, and Co., Ltd., electric capstans; Crompton and Co., Ltd., boosting sets.

**SPENNYMOOR.**—For installation of heating apparatus at the isolation hospital, for the Spenny-moor Urban District Council:—  
Emley and Sons, Newcastle-on-Tyne (accepted) .. £62 0 0

**WICKLOW.**—For a concrete wall at Fitzwilliam Road, Wicklow, for the urban district council:—  
Clarke, Wm., Church Street (accepted) .. £98 16 0

The Eastington R.D.C. have received a piece of land at Dene Mouth, near Ilford, as a site for a mortuary, and have accepted a tender for carrying out the building work.

Mr. Augustus John has attained the military rank of Major. He will shortly be occupied with his new duties as one of the official artists with the Canadian Forces in France, and his work may also take him to the Italian Front.

Private Arthur Arnold Crow, Essex Regiment, formerly of the Artists' Rifles, and Captain 5th Loyal North Lancs., killed in action on October 10, was the elder son of Mr. Arthur Crow, F.R.I.B.A., and Mrs. Crow, of "The Firs," Monkham Avenue, Woodford Green, Essex. Deceased was aged twenty-five years.

**TO CORRESPONDENTS.**

We do not hold ourselves responsible for the opinions of our correspondents. All communications should be drawn up as briefly as possible, as there are many claimants upon the space allotted to correspondents.

It is particularly requested that all drawings and all communications respecting illustrations or literary matter, books for review, etc., should be addressed to the Editor of the BUILDING NEWS, Edinburg House, 1, Arundel Street, Strand, W.C.2, and not to members of the staff by name. Delay is not infrequently otherwise caused. All drawings and other communications are sent at contributors' risks, and the Editor will not undertake to pay for, or be liable for, unthought contributions.

When favouring us with drawings or photographs, architects are asked kindly to state how long the building has been erected. It does neither them nor us much good to illustrate buildings which have been some time executed, except under special circumstances.

\* \* \* Drawings of selected competition designs, important public and private buildings, details of old and new work, and good sketches are always welcome, and for each one charge is made for insertion. Of more commonplace subjects, small churches, chapels, houses, etc.—we have usually far more sent than we can insert, but are glad to do so when space permits, on mutually advantageous terms, which may be ascertained on application.

Telephone: Gerrard 1201.  
Telegrams: "Timeserver, Strand, London."

Handsome Cloth Cases for binding the BUILDING NEWS, price 2s., post free 2s. 5d., can be obtained from any Newsgator, or from the Publisher, Edinburg House, 1, Arundel Street, Strand, W.C.2

**BACK ISSUES.**

Most of the back issues are to be had singly. All back issues over one month old will be charged 6d. each, postage 1d. Subscribers requiring back numbers should order at once, as they soon run out of print.

**TERMS OF SUBSCRIPTION.**

Twenty-six shillings per annum (post free) to any part of the United Kingdom; thirteen shillings for six months; for the United States, £1 10s. (or \$7 10c. gold). To France or Belgium, £10 10s. (or 42*l.*). To India, £1 10s. To any of the Australian Colonies, or New Zealand, to the Cape, the West Indies, or Natal, £1 10s.

\* \* \* Our Direct Subscription Agents for Australia are Messrs. E. T. Kibblewhite and Co., Printers and Publishers, 19, York Chambers, 105, Liverpool Street, Sydney, New South Wales; for Japan, The Maruzen Co., Ltd., 19-16, Nishashi Tori Sancho, Tokyo who will receive Subscriptions at £1 10s. per annum on our account. Copies of the paper will be sent by us direct to the subscribers' address.

\* \* \* The special rate to Canada is £1 10s. = \$7 90c. for 12 months, and 1*l.* = \$3 65c. six months. Our Direct Subscription Agents for Canada are Messrs. Sells, Ltd., 302, Shaftesbury Buildings, McGill Street, Montreal, who will receive Subscriptions, £1 10s. per annum, on our account.

Cheques and Post Office Orders to be made payable to THE STRAND NEWSPAPER COMPANY, LIMITED, and crossed London County and Westminster Bank.

**ADVERTISEMENT CHARGES.**

The charge for Competition and Contract Advertisements, Public Companies, and all official advertisements is 1*s.* per line of Eight Words, the first line counting as two, the minimum charge being 5*s.* for four lines.

The charge for Auctions, Land Sales, and Miscellaneous and Trade Advertisements (except Situation Advertisements) is 6d. per line of Eight Words (the first line counting as two), the minimum charge

being 4*s.* 6d. for 50 words. Special terms for series of six insertions or more can be ascertained on application to the Publisher.

**SITUATIONS VACANT.**

The charge for advertisements for "Situations Vacant" is Two Shillings and Sixpence for Twenty-four Words, and Sixpence for every Eight Words after. All Situation Advertisements must be prepaid.

**SITUATIONS WANTED AND PARTNERSHIPS.**

The charge for advertisements for "Situations Wanted" and "Partnerships" is One Shilling for Twenty-four Words, and Sixpence for every Eight Words after.

Advertisements for the current week must reach the office not later than 3 p.m. on Tuesday. Front-page advertisements and alterations or stop orders for serial advertisements must reach the office by first post on Monday to secure attention.

RECEIVED.—A. D. D. and Sons—E. and R.—L. B. and Sons, Ltd.—A. J. K.—J. D. and Sons—O. B. and Co., Ltd.—R. J. C. and Co., Ltd.—C. Bros.—T. P. Co.—V. de T. A. Co., Ltd.—B. of S.—L. Co., Ltd.—G. and B.—R. P. Co., Ltd.—L. Ltd.—McN. and Co., Ltd.—S. A. H. F.—W. O. and Son—R. I. B. A.—F. and J. L. Co.—E. W.—Dr. H. S.

B. H.—Yes.  
P. W.—Thanks, no.  
T. R. M.—Glad to have been helpful. 2. No.

News has been received that Private W. E. Wanner, Artists' Rifles, Assistant Secretary of the Society of Architects, has been severely wounded in action by a shell, and is in hospital in France.

Mr. A. Marshall Mackenzie, LL.D., A.R.S.A., F.R.I.B.A., and Mr. A. G. R. Mackenzie, F.R.I.B.A., have changed their address to 14, St. Leonard's Terrace, Chelsea, S.W.3. Their telephone number is Victoria 3070, as previously.

A collection of carved mediaeval alabasters has been recently accepted on loan by the authorities of the Liverpool Museum, and is now placed on exhibition. The collection has been made by Dr. Philip Nelson, F.S.A., of Liverpool, thanks to whom Liverpool people can study some of the choicest pieces of British mediaeval alabaster work.

The late Mr. James M. Mackay, artist, who has died at 52, Morningside Road, Edinburgh, was an elder brother of the late Mr. Alexander S. Mackay, the distinguished portrait painter, and a younger brother was the late Provost David Mackay, who was an amateur artist. He spent a good portion every year in his native county, finding subjects for his art on the banks of the rivers Ayr and Irvine, and in the vicinity of Rowallan, Dundonnald, and Crawfordland Castles.

Mr. Edward L. Morgan, Assoc. M. Inst. C.E., borough engineer and surveyor of Bolton, has been appointed to the office of city engineer and surveyor of Cardiff, in succession to the late Mr. W. Harpur. He was artist to Mr. George Watkys, Assoc. M. Inst. C.E., borough and waterworks engineer, Cardiff, and subsequently acted as his assistant. From 1859 to 1891 he held the post of assistant resident engineer of the Great Southern of Spain Railway. In 1892 and 1893 he became assistant engineer to the Barry District Council. In March, 1900, he was appointed borough engineer and surveyor of Bolton.

# THE BUILDING NEWS

## AND ENGINEERING JOURNAL.

**Efingham House.**

Currente Calamo .. .. .	401
Domington Hall .. .. .	402
Recent Experiments in Ventilation .. .. .	403
Our Illustrations .. .. .	417
Correspondence .. .. .	417
Obituary .. .. .	417
Better Houses but Higher Rents .. .. .	420
Professional and Trade Societies .. .. .	420
Building Intelligence .. .. .	420
Our Office Table .. .. .	420

**CONTENTS.**

Tenders .. .. .	vii.
Tender Notes .. .. .	vii.
List of Open Tenders .. .. .	vii.
Chips .. .. .	vii.
Latest Prices .. .. .	vii.

**Strand, W.C.2.**

A.R.I.B.A., and Mr. Herbert Ashmead (H.M.O.W.), Architects.
Rood Screen, St. Stephen's Church, Norbury, S.W.
Mr. W. Samuel Weatherley, F.R.I.B.A., Architect.
A Parisian Parlor for a Lady. Designed by Lieut. Murray Adams-Acton (Scotts-Guards).
Great Chalfield and South Wraaxall Manor Houses, Wilts. Sketches by Mr. Edward Swales.

**OUR ILLUSTRATIONS.**

Head Insurance Office, Kew, Surrey. Administration Buildings and Ledger Room, View of Principal Entrance, and of the Clerical Room. General Plan of the Buildings. Mr. Richard J. Allison.

**Currente Calamo.**

Three weeks ago evidence seemed ample — to all but the British Foreign Office — that British cement was being exported to Holland whence it could be conveyed to Germany to build "pill-boxes" from whence to shoot down British soldiers. On Monday, at last, Lord Robert Cecil announced that "pending inquiries" we had prohibited further export. Let us hope that the further inquiries may be speedy in order that British exporters may be cleared from the charge, or that we may know what further steps are to be taken; and that it may not take as long to end this scandal as it did to stop the export of cotton for German explosives.

While judges are condemning model by-laws it must be evident to many that our local governing bodies are practically immune from criticism and are fast becoming as indifferent to public criticism as Parliament itself. All elections of councillors, guardians, and the like are once again postponed, and the earliest date at which they can occur is November, 1918. Meanwhile the officers of these bodies have to a great extent become the servants of the Government, and a very thick end of the wedge is being driven into our system of local government. Our present necessities are possibly too urgent to alter all this now; but when the war is over our impression is that the battle will once more have to be fought for local self-government against centralisation and the evils inseparable therefrom. And it will be a sharp one. The ordinary official, wherever placed, is never so pleased as when he is irresponsible to his neighbours and favoured by a bureaucracy to too great a distance to be amenable to public opinion.

Is a lessee's covenant to insure the premises leased absolute and unconditional, or does it only bind him to take out the usual policy against fire issued by the companies? That was the short issue raised in the recent case of "Upjohn v. Hitchens," heard before Mr. Justice Roche, and which is of wide importance to all builders and owners of leasehold property in these days of in-

creasing enemy air raids. The true practical point, of course, is whether the loss from fire caused by aircraft falls upon the lessor or the lessee, in the absence of special insurance by either. The lease here was for a term of ninety-nine years from 1905, at a ground rent of £8, in the usual form, the lessee covenanting to insure against fire in a specified or other approved office. The question as to whether the lessee was bound to insure against aircraft had been raised between the parties by correspondence. Now, to test the matter the plaintiff claimed possession of the premises on the ground that the defendant had broken his covenant to insure because he had only taken out the usual policy, which would not cover fire caused by aircraft. The judge began by holding that the former case of "Enlayde, Ltd., v. Roberts" (33, *Times* L.R. 52), where other facts came in, did not apply to the present matter. Then he ruled that the defendant's covenant only bound him to insure against fire by taking out the usual policy of the companies in question at the date of the lease or during its currency. Evidence given had shown that the Alliance Assurance Company, in which the premises were insured against fire with plaintiff's approval, did not include, and never had included, air-raid risks. So it was decided that there had been no breach of his covenant by the defendant, for whom judgment was given. The plaintiffs' contention that a lessee's covenant to insure is absolute and unconditional will now, doubtless, go before the Court of Appeal, where the result must be awaited in a matter of much business interest.

The Modern Loan Exhibition at the Grosvenor Gallery, to which most of the distinguished living and many famous dead artists have contributed, is well worth a visit. The list includes pictures from the brushes of Conder, Corot, Beerbohm, Degas, Daubigny, Epstein, Latour, M'Evoy, Maris, Millet, Millet, Pissaro, Rossetti, Rodin, Sargent, Sims, Watts, and Whistler. Ambrose M'Evoy is well represented by several portraits of ladies. There are some nudes by Mancini, and Wilson Steer has a masterly landscape of "Richmond Castle." Quite a number of the exhibits have never been shown before,

and, among them, a series of caricatures by Max Beerbohm of Rossetti and his friends, Kaskin, Ford Madox Brown, Holman Hunt, Swinburne, Morris, George Meredith, Leighton, Browning, and others, will amuse many.

Certainly no two more inspiring addresses have encouraged all who heard them than those delivered last Thursday at the Playgoers' Club by Sir Edward Morris, the Premier of Newfoundland, and Sir Alexander Harris. Sir Edward Morris, in the course of his reminders that Newfoundland, England's oldest colony in the New World, had, in proportion to her slender population, contributed her fullest quota to the alliance of the dominions and dependencies against the presumptuous attack by the German against the liberties of the world, dwelt sympathetically on the strength of the ties that bound the Dominions to the Motherland and to her Allies in their stand against the long prepared onslaught on all that made life worth living by the demoralised Hun conspiracy against the ethics of the Sermon on the Mount, and paid a touching tribute to the self-sacrifice which had inspired the heroic stand made by England, France, Belgium, Serbia, and Italy against the conspiracy against human freedom which had been organised for forty years by the apostles of force, that had terrorised the German people, concluding by a welcome summary, gathered during his recent stay in the United States, of the wonderful unanimity of the American people in their present organisation of means wherewith to crush for ever the resources of German militarism. Sir Alexander Harris, after a well-deserved tribute to the energies of Sir Edward Morris, wound up a scathing indictment of the barbarism of German militarism by a confident assurance that Germany would be emancipated therefrom by the Allies, and would ere long raise the thankful triumphant song of Deborah, "So let all thine enemies, O Lord, perish; but let them that love Thee be as the sun when he goeth forth in his strength." A kindly reference by Sir Alexander to the services rendered by Mr. Charles E. B. Kibblewhite, the honorary secretary of the Playgoers' Club, elicited a brief response, in which members were reminded that, apart from all other con-

siderations, the events and exigencies of the present greatest drama ever played in the world's history must of necessity intensely concern and interest the dramatist, and that it was no small boon to him that that day, and at similar gatherings organised by the Club, they had the inestimable advantage of listening to the words of those who were playing principal parts therein.

It is too late, unfortunately, for any of our own readers to take advantage of this liberal offer which we clip from a contemporary, but it is probably a fair index of the procedure likely to be adopted by more local authorities presently when housing schemes are started:

The Bodwas and Machen Urban District Council invite applications from properly qualified persons for the position of architect in respect of the erection by them immediately after the war of thirty working-class houses at Bodwas and twenty at The Thomas. The remuneration payable will be a commission of £2 10s. per centum upon the cost of construction of the fifty houses, which commission will include such attendances at meetings, etc., as the Council may consider necessary, the preparation of the necessary plans and specification, the supervision of the buildings during the course of erection, and all other items of expenses. Applications, marked "Architect," must be received by Mr. C. D. Jones, Clerk, Council Offices, Bodwas, Mon., not later than 10 a.m. on November 19.

Why not save the 2½ per cent. and do without an architect altogether? With Departmental Committee plans, and probably those which will accrue from the R.I.B.A. competitions, any local authority will be able to save the money and spend it on an opening lunch!

The National War Savings Committee have arranged with several of the principal advertisers to devote half their contract space for the week ending December 8 to advertisements of National War Bonds. It will interest our readers to know that some of our own advertisers have entered into the scheme, and amongst those who have already arranged for special announcements for that week are Messrs. Lewis Berger and Sons, Limited; Messrs. J. H. Kerner Greenwood and Co., and the British Roofing Company, Limited. Many more will doubtless follow when the scheme is brought under their notice.

#### DOXINGTON HALL.

Far away inland in the heart of this precious stone set in the silver sea and "lost in heart of pathless woods" is the building which has added fresh romance to the already teeming annals of the hunting shire. Here in surroundings famous in history and fiction as the scene of historic conflicts and jousts and of knightly deeds is the place which has in 1917 once more fired the imagination and furnished the subject of popular gossip.

This delightful spot has long since enjoyed the retirement of venerable age. Since medieval times, when noble lords chose it out of all the land in which to build their stately homes, it has sunk gradually and monotonously deeper and deeper into the green glades of Charnwood Forest. To-day, after years of sylvan seclusion, it has been haled forth once more from its leafy shades into the full light of prying publicity, and has become the theme of topical conversation. To-day strange accents are heard at Don-

ington Hall. Foreign beakers thundor on the creaking board, strange healths are drunk, and new songs are sung. The Teuton has come to Donington Hall. This north-westerly corner of Leicestershire is particularly rich in historic association. The country is of wild, rugged beauty; the Trent in the adolescence of its course to the great sea tumbles in glistening cascades over shimmering rocks, and with its gushing strength turns mills and adds utility to beauty. The woods where often the wild boar was hunted stretch away southwards, imparting beauty and variety to the landscape.

Derby, to the north-west, introduces the Pennines into view, whilst Charnwood Forest, famous as the habitation of Friar Tuck and his merry men, extends from Loughboro' to Ashby-de-la-Zouch. These are the surroundings, and when night descends on forest glade and hill one may see again in pensive imagery the Sluggard Knight, Ivanhoe and the rest pass through the trees in phantom pageantry.

One would fain leave to Scott the description of the countryside. Market Bosworth, ten miles due south, witnessed the scene of the last battle of the Wars of the Roses. Here, in 1485, Richard with his army of 16,000 men was out-classed and defeated by Richmond, who afterwards became Henry VII. He had only some 5,000 men, but these were generated so skilfully that the battle was decisive and final. Shakespeare, in his "Richard III.," tells in forcible language the story of the battle. Richard was greatly disturbed on the night before the battle by the ghosts of the men he had murdered. He was apprehensive of the trend events would take.

"There is no creature loves me,

And if I die no soul will pity me.

Nay, wherefore should they, since that I myself find in myself no pity in myself?

Methought the souls of all that I had murdered

Came to my tent, and every one did threaten

To-morrow's vengeance on the head of Richard."

This engagement would have been described as "certain liveliness" on our front to-day. Stoke Golding is said to be the place where Stanley placed the crown, which had been found in a ditch, on the head of Richmond. Richard's body was thrown across a horse and brought into the town of Leicester. In later years, during the Parliamentary Wars of Cromwell in 1644, a battle was fought near the same site between Royalists and Parliamentarians, in which the former were defeated.

Gopsall Hall, where Handel composed his "Messiah"; Ashby-de-la-Zouch, with its magnificent Perpendicular Castle, where Mary Queen of Scots was imprisoned and where Charles I. sustained a long siege at the hands of Parliamentary troops; Bradgate Park, the birthplace of Lady Jane Grey; Thurgarton, where Hugh Latimer the Reformer was born, surround the now famous Donington Hall and make a fitting background for its story. This, then, is the country—little altered since medieval times—in which to set our stage.

The park (Donington Park) in which the Hall stands is some three miles south of the village of Castle Donington. It is beautifully situated on the south bank of the Trent, and is some 120 miles from London. The road turns sharply at the lodge gates, and slips down steeply to

the river. This it crosses by an old-world bridge by a mill. The mill wheel, long since rusted up and silent, now remains only to delight the eye and inspire the heart of poets and artists.

The siting of the Hall itself is not happy. The fact of its being built upon this site is probably a sentimental one, as it undoubtedly occupies the room of an earlier building.

The aspect is southern, which of course causes many rooms to face due north, the plan being regular and rectangular. The place has already been described by numerous people. Some have been harsh with it, whilst others have been too lenient.

The building itself is undoubtedly interesting from an historic rather than an architectural or archaeological point of view. It was designed by William Wilkins, architect, of Cambridge, in 1795, for the Earl of Moira. The style is Gothic and the material stone and stucco, or sand-faced cement, which now, after the lapse of over 100 years, presents no evidence of the "mellowing hand of time," but merely a dull drab exterior.

In describing the style as Gothic one must qualify the statement somewhat. Wilkins was essentially a Classic mind, as his Classic examples will show—notably the National Gallery and University College, London. To an architect of the Classic school Gothic work becomes difficult, if not high impossible. In the example of Donington Hall Wilkins has made the mistake of getting out of his style at best the inception and motif of design in Classic, the whole thing being rigged out later in Gothic detail. In this instance Wilkins, between his two schools, has badly "crashed" to earth. This example possesses all the faults that a Classic mind would make in designing a "Gothic" building. It is poor Renaissance and worse Gothic. The plan has some good points to recommend it; it is extremely simple, symmetrical, and spacious. One does not know how much the architect was influenced by his client in its design, but there are evidences of his lordship's wishes in it. The rooms are arranged in the form of a rectangle around a central "court." The Hall has a southern aspect. The library, 72 ft. by 26 ft., is ranged along the west side, the breakfast-room to the east, and the chapel extends eastward from the north wing. The whole plan and elevation is divided up with mechanical precision into doors and windows. The fenestration is painfully monotonous, the front façade being a long, low repetition of window and buttress—window and buttress—the buttresses terminating in octagonal embattled pinnacles, a slightly larger one of the same design marking the quoins.

Entrance is effected in the centre of the south façade, and is emphasised by being projected somewhat in front of the general face of the work in the shape of a square pavilion or "Gothic" entrance hall. This is the only relief in a long, low front elevation, and is in itself a dismal affair. Inside, the winding staircase, flanked by its iron balustrading, reminds one of the entrance hall of a workhouse. The "court," too, is on the same unimaginative lines, and gives the appearance more of a back area to a block of city flats. The sand-faced cement finishes the impression. The chapel, where one might expect some improved treatment, falls lamentably short of expectations—so much so that the prisoners of war have attempted embellishments on the line of "Kultur," and have painted over the woodwork, carving, etc.,



in various tints. The library and drawing-room are now altered to accommodate some 500 officer prisoners of war. The arrangements are excellent, and the building is well suited to the purpose for which it is now used. To-day numerous modern additions alter the general prospect of the place. Timber guard-rooms, offices, engine-rooms, barracks, etc., group themselves around the lodge and extend along the drive. Guards with measured tread have worn paths in the gravel of the walks.

The grounds, containing many noble old trees, have been circumvented by a thick barbed-wire fence, which divides them again into day and night enclosures. Here men who have essayed bonts with the might of Britain rest after their joustings. No sound of war penetrates their sylvan retreat. The song of birds and the perfume of flowers pervade the air and subdue all martial thoughts and feelings.

Prisoners are very happy to-day, and can be heard laughing and joking over their tennis and on the benches in the wood. Early in the morning they are up and out at exercise in the grounds, running, playing hand-ball, skipping, etc. Many don coloured shorts and vests; others wear their military uniform. Somehow the games do not look the same played by these men. There does not appear to be the same "love of sport." The exercise appears to be indulged in rather from a sense of duty than pleasure. After breakfast a meander in the woods with a book, or a letter home to Gretchen, written from a leafy glade in some quiet nook of Donington Park.

A male voice choir is singing the old German hymn, "Die Wacht am Rhein," and their voices blend very well indeed. The choir is arranged on one of the benches, tenors to left, bass to right, with conductor and all complete. They sing to commemorate the gallant deeds of the sons of the Fatherland:—

Es braust ein Ruf wie Donnerhall,  
Wie Schwertgeklirr und Wogenprall,  
Zum Rhein, zum Rhein, zum Deutchen Rhein,  
Wer will der stromes Hüter sein.  
Lieb Vaterland magst ruhig sein,  
Fest steht und treu die Wacht am Rhein,  
etc.

Their voices are good and their harmony quite pleasing. The notes die away and leave one wondering, wondering, seeking for some explanation of the kink in our natures which allows us to make song and can discern glory in the arbitrament of Huns.

Further down the valley, where the dew has collected in the shape of a fair-sized pool, a group of young officers while away the hot afternoon in idle banter and some bravado. Suddenly a challenge is given out to swim the Hellespont. It is at once accepted by a fair-haired Teuton, who, with characteristic Prussian directness, walks straight into the mud and water. Half-a-dozen steps and he is up to his neck and swimming for it. His fellows cheer him on, and he emerges dripping but smiling on the farther shore. The wager is paid over and the "muddied oaf" sprints up to his room to change. The sentry in the high guard-house looks on complacently. Fritz is fooling again, but he requires watching, and even his mad pranks may not be so harmless as they seem. And so the day passes and the retiring sun kisses the high tops of the old trees a lingering adieu. The prisoners are gathered into the night enclosure. "Old Guard,

Present arms!" "New Guard, Present arms!" Watch is kept over the wire. Dinner is presently served and the glass many times emptied, then lights out and turn in. The ghost of his lordship in his nightly wanderings round the old place pauses in perplexed wonderment at it all, and then from away in the darkness a voice calls, "No. 1 post, all's well; No. 2 post, all's well"; and finally, "Post all's well," and the moon rises once more on Donington Hall.

S. DOUGLAS MEADOWS,  
Captain, R.E.

### RECENT EXPERIMENTS IN VENTILATION.\*

By A. H. BAIKIE, B.A., B.Sc., WHITWORTH SCHOLAR.

Within the past few years the entire conception of the theory of ventilation as commonly accepted has undergone a startling and revolutionary change. The fundamental ideas underlying this change of conception are, however, almost 100 years old. It is only of recent years that the new conception has been, as it were, re-discovered, for it has probably been a re-discovery rather than a conscious adoption of old ideas.

In view of the extreme importance of this subject, it is perhaps worth while in the present paper briefly to summarise the inaccurate reasoning which led to the original misconception, and to describe the experiment which have led to its revision. It is easy enough to understand how the great mistake embodied in the popular conception came to be made. What is not easy to understand is how the original misconception came to have so long a life. How it was that this essential fallacy was so long unrecognised. It would be too much to say that even yet the new conception has permeated into the inner consciousness of the scientific world in general, or that the original one has been eradicated from the minds of any but the few.

The line of thought which seems to have led to the error of doctrine is as follows:—

To live in an enclosed and unventilated room continuously is proved by experience to be detrimental to health. If a person lives in air free from which a large part of the oxygen has been withdrawn he will die of suffocation: such air will not support life. Also, if a person continually breathes air which is mixed with too great a proportion of CO<sub>2</sub>, he will ultimately die of poisoning. When a person breathes air, analysis proves that oxygen is removed from the air, and an equivalent quantity of carbon dioxide is restored to it. Thus a deep and wide trap is laid for a subtle error in logic. It only remains to jump to the conclusion—a very small jump it seems too—that the consequence of living in an enclosed room is to vitiate the air in the room, to deprive it of oxygen, to contaminate it by CO<sub>2</sub>, so that it becomes dangerous to health. Therefore, the obvious method of avoiding these results is to "ventilate" the room, to renew the air in it constantly so as to avoid this removal of oxygen and contamination by CO<sub>2</sub>, and to judge of the efficiency of the process of ventilation by chemically analysing the air, so as to determine how much CO<sub>2</sub> the vitiated air contains.

It has been already suggested that this reasoning contains a subtle mistake in logic. The error is of the *post hoc propter hoc* order, which any person versed in logic will easily understand.

The error came to be recognised as such by a process of common-sense thinking applied to the results of analysis. The first thing that appears to have put the scientist on the track of it was probably the fact that the employees in a brewery or soda-water factory live in air containing anything up to 500 parts of CO<sub>2</sub> in 10,000 parts of air, without, apparently, any ill effects whatsoever.

Another fact revealed by chemical analysis is that expired air direct from the lungs contains not more than about 500 parts of CO<sub>2</sub> per 10,000 of air.

In order that we may have a mental picture of the proportions of CO<sub>2</sub> that we are dealing with, I will show upon the screen a proportional diagram, which shows graphically the proportion of oxygen, carbon-dioxide, and nitrogen in different sorts of air. Normal atmospheric air, expired air direct from the lungs, and also the constituents of air which will have different effects on the human organism.

Now the worst ventilated place known in practice would probably not contain more than, say, 50 parts of carbon-dioxide per 10,000 of air. It is difficult to believe that so low a proportion of this gas could have such a very deleterious effect.

When a person breathes he does not nearly empty the whole content of his lungs. The normal content of the human lungs is about 700 cubic inches, whereas the content of a complete inspiration or expiration is not more than from 25 to 40 inches (cubic inches). Now a very little reflection will show that the sample of expired air must be a true sample of the air then in the lungs, and that after a full inspiration the average CO<sub>2</sub> impurity in the lungs cannot at the best of times be less than 480 parts per 10,000, fluctuating from that to the worst at about 500 parts.

In face of these figures it appears almost absurd to suppose that one or two degrees difference in the quality of the air breathed—say, for instance, the difference between 10 and 20 parts of CO<sub>2</sub>—can make all the difference between healthy and unhealthy air. Clearly, then, it is not the CO<sub>2</sub>, as such that causes the trouble.

Are there, then, two kinds of CO<sub>2</sub>, one produced by breath and the other by fermentation, or other means? The chemist can recognise no such difference.

Hence the scientist was driven to a theory of poisonous organic exhalation given off in the breath. But the most careful chemical analysis or experiment can find no such poison in exhaled air; indeed, the normal breath of a healthy person is entirely free from poisonous products or even from bacteria or dust or anything of the kind. It consists of oxygen, nitrogen, CO<sub>2</sub>, and water vapour. If there is a trace of organic vapour it is a barely recognisable trace.

Theories about the effect of the diminution in the oxygen content of the air are similarly untenable. Indeed, the air in a mountainous region which is notoriously healthy contains much less oxygen than an equal volume of ordinary vitiated air.

It is true that air in which a number of animals have lived for some time is apt to smell, and that the smell is due to definite organic vapours emanating in minute quantities from the bodies of even healthy persons, and that this smell is very unpleasant to a sensitive nose entering such air for the first time, but beyond this nervous effect there is nothing to show that this smell is in any way harmful. Indeed, after a person has been in the air for a few minutes it becomes impossible even to recognise its smell.

Hence the theory that the cause of the unhealthiness of expired air is chemical in character has been gradually shown to be untenable. There is no proof either that it is due in any considerable degree to bacteria, for expired air contains even less bacteria than inspired. It is true that bacteria are found in all cases in air that has been inhaled by human beings, among which there may be a very small proportion of deleterious ones, such as the germs of malignant diseases, ready to pounce on any individual who is in a fit state to be attacked by them, and that a person is more liable to be so attacked in proportion to the number of such germs present. In so far, therefore, as we keep the air renewed we may count on sweeping out some or many of such germs into the open air, or at any rate in keeping down their number. In so far, therefore, here is an incontestable case for free ventilation.

It was then shown that persons living in hot and moist air, others in perfectly pure, exhibited all the same symptoms which we are accustomed to associate with defective ventilation. It was also shown that it made no difference whatever to this effect whether or not the air was heavily charged with CO<sub>2</sub>. People came to reflect on the degree of relief

\* Read before the Society of Architects, November 15, 1917.

which a lady in a ballroom experiences when the air is agitated by means of a fan. It became known that the effect of the movement of air is to increase the rate of heat lost from a body over which the air passes. The suspicion came to be entertained that it was the rate of heat loss and not the chemical properties of the air which were the cause of all the trouble.

An experiment was therefore devised and carried out by Dr. Haldane, Dr. Leonard Hill, and others, in which about eight persons were confined in a small air-tight cabinet, about one-third of the size of a railway compartment, and were allowed to remain in it breathing the same air until the air was extremely bad, so bad that a candle would not burn in it, and all the subjects were about in a fainting condition. They were allowed to breathe the pure cool air of the surrounding room through tubes, but did not experience the slightest relief. On the other hand, persons outside the chamber were allowed to breathe the air in the chamber through a tube. They hardly noticed anything except that the air had a faint and unpleasant taste. They experienced none of the symptoms of defective ventilation. After this point was reached, the air in the cabinet was violently agitated by means of a fan, and was simultaneously cooled by a cold water coil. The relief of the persons occupying the cabinet was instantaneous and complete, although the air in the cabinet was at this time so bad that a candle would not burn. To make matters worse, a large volume of CO<sub>2</sub> was introduced into the cabinet, and the occupants did not even notice any difference.

Now we must be careful not to fall into errors similar to those which have been already referred to in considering the result of this experiment. It only proves at the most that the feelings of discomfort consequent on living in vitiated air are probably physical rather than chemical in origin. The evil effects of living in bad air are not wholly measured by the feelings of discomfort at the time.

We must not again allow our conclusions to proceed one step beyond what the experiments prove. The crucial difficulty in forming reliable conclusions from the results of such experiments is that the evil effects of what is really bad ventilation do not necessarily show themselves at once. It is true that certain evil effects of a minor and temporary character do show themselves at once, such, for instance, as the feeling of oppression and the inevitable effects of discomfort, fainting, and so on, which we all know.

But how are we to be sure that this immediate effect is produced by the same set of conditions as the equally indisputable effects, such as the onset of phthisis and general debility among people who have lived in bad air? How can we be unquestionably sure that this effect is actually due to bad ventilation? May there not be more important contributory causes, bad feeding, lack of exercise, dirt, and other causes?

This is, of course, a physiological matter, and the only persons whose pronouncements on such points would be of value would be not necessarily merely an able physiologist (whose pronouncement in spite of great general knowledge of physiology might be merely an ignorant *abiter dictum*), but what may be called an historical or statistical hygienist or physiologist, one who had closely and exhaustively studied the statistical evidence which is excessively difficult to obtain.

Closely scrutinised evidence extending over 100 years or more would be necessary to establish such conclusions indisputably.

#### NATURE IS NOT CONSIDERATE.

She does not reveal secrets about her intentions, at any rate to civilised mankind. Civilization comes in some way to have decreased the instincts with which the human race was originally gifted and which generally served to protect the primal man from disobeying the mandate of Nature. If her intentions are disobeyed, whether they are understood or not, she hits and often hits hard in punishment, rarely or never the

people who are in fault, but generally somebody else. She leaves the human race to find out by experience what she means, and to act accordingly if they wish to avoid the punishment. This is perhaps the most complex problem she has ever set. Are we to form the conclusion that it is only heat and moisture which cause the trouble? As against this view we have the fact that persons who live in hot and moist climates, such as that of certain parts of the tropics, are not noticeably more attacked by these troubles than are the people in such a climate as this.

It is true that the inhabitants of great towns are noticeably more liable to these troubles than persons who live in the open air, but it is far from being proved that this fact is due to habitual bad ventilation.

Now we have to consider how far all this affects us as architects and engineers. While everybody wishes to act in accordance with the general and future well-being of mankind, we have to carry on somehow while the physiologists decide these things.

The ventilating engineer or the architect, so far as he is concerned in such matters, is concerned chiefly with immediate effects. He must fit up his buildings in such a way that they are comfortable to live in, and healthy so far as the conditions can be known in the light of present-day knowledge.

The experiments so far described then tend to show that the chief functions of ventilation are to keep down the temperature and the humidity to a certain degree, as yet undefined, with the object of regulating the rate of heat loss from the human body. To these we may add the suppression of odours. The keeping down the numbers of bacteria and particles of inorganic or harmless dust. We may disregard as an unimportant factor the degree of concentration of CO<sub>2</sub>.

The experiments have been only general in character, or as they are called "qualitative." But the engineer must have some figures to work to, in other words, experimental results to be useful to him must be quantitative. To make his calculations, he must have some idea of the relation between the degree of temperature and humidity and the rest, and their effect on subjects exposed to them. The principal difficulty is to obtain any quantitative observations from such a complicated mechanism as the human body, which is known to be provided with automatic mechanisms for adjusting itself to its environment. Such observations cannot be obtained without the help of the expert physiologists and psychologists.

In order further to investigate these very difficult and important problems several wealthy Commissions have, within the past few years, been appointed in America, endowed with unlimited resources in money and apparatus. Competent persons both on the physiological and engineering sides have been retained at immense expense in order to conduct the experiments. These have been carried out by the Health Department of Chicago, and by the New York Ventilation Commission, and other bodies, and also by private workers.

The main objects of these experiments have been not only to verify these conclusions on a practical scale, but to compare the effect of specific physical conditions of air in a room on subjects exposed to them, and the determination of figures representing exactly the qualities of the air as well as means which will enable these qualities to be certainly recognised.

Experimental rooms have been equipped with apparatus which will enable any precisely defined condition as to temperature and humidity and air movement to be maintained for an indefinite period, and to be altered and adjusted at will. Suitable subjects have been obtained and subjected to these conditions, and means devised to measure the effect of the condition on the subjects exposed to them. This is a feature of all such experiments which must of necessity make them extremely difficult to carry out.

I shall describe in a moment the methods which have been adopted in order so far as possible to measure quantitatively the effect on a human subject. The fact must again be

emphasised that in the nature of things all such experiments can only be carried out for a certain limited period, and that that period cannot be sufficiently protracted to make the experiment really decisive in regard to its ultimate effect. It might well be that some of the subjects of these experiments years after the experiments themselves were concluded might develop some prejudicial effects as a direct consequence of their experiences during such experiments as these. All such ultimate results would be entirely unknown to the present experimenters, and even to the subject, but there is no present evidence of such prejudicial effects.

If the theory is sound, it would follow at once that the air of a room need not be changed to anything like the extent which has been thought necessary in good practice in the past; that the same air can be used over and over again so long as its physical condition of temperature, humidity, movement and smell can be controlled.

To test this in a practical manner was the object of experiments devised by Professor Bass, of the University of Minnesota, Minneapolis, and described in the "Transactions of the American Society of Heating and Ventilating Engineers, 1913."

The experiment was devised in order to test the question whether a much smaller amount of recirculated air than is usually applied per head would not suffice for perfectly adequate ventilation, provided this air was supplied to the subjects at a suitable temperature, humidity, movement and free from smell.

Two exactly similar schoolrooms were selected. One was fitted out for recirculating the air of the room over apparatus specially designed to keep the moisture and the temperature both as constant as possible within limits, and to wash it and deodorise by means of ozone. This air so treated was then again introduced into the room in very small quantities immediately in the front of the face of the pupil sitting at his desk. The effect on the pupils was noted both physiologically and psychologically, and compared with the corresponding effect in an exactly similar school occupied by exactly similar class of pupil, ventilated on the ordinary system with a large amount of fresh air. The slides show the types of orifice adopted for blowing the air in a gentle stream round the heads of the pupils at a velocity of about 18" per second. The children were each supplied in the one case with 500 cubic feet of recirculated air per hour gently blown into their faces, and in the other with 1,500 cubic feet of fresh air per head per hour supplied in the usual manner through one grate in the wall. On both groups observations were taken extending over a fortnight similar to those described in detail on the next series of experiments on page 418.

It is impossible in the time at my disposal to explain in detail the methods of comparison adopted. The broad experimental results are shown in diagram form, from which it will be seen that such very slight differences as were observed between the two groups were in favour, if anything, of the recirculated air rather than the fresh air. The significance of this would be not, of course, that recirculated air is better than fresh air, but that the slight movement in the recirculated air is of greater value than the greater degree of freshness of the air supplied to the control group.

All these conclusions are perhaps of greater importance in a country where the normal temperature is lower than here. The chief object of recirculating the air of a used room in preference to introducing fresh air from the outside is to save the great loss of heat which free ventilation causes.

There is a certain quantity of heat necessary to warm the incoming air to a suitable temperature. All this heat is carried away by the outgoing air. In countries such as America, where the difference between the inside and outside temperature is great (70° or more), the importance of this saving is obviously greater than here, where a difference of 30° or 35° may be between inside and outside is the limit contemplated.

(Continued on page 418.)

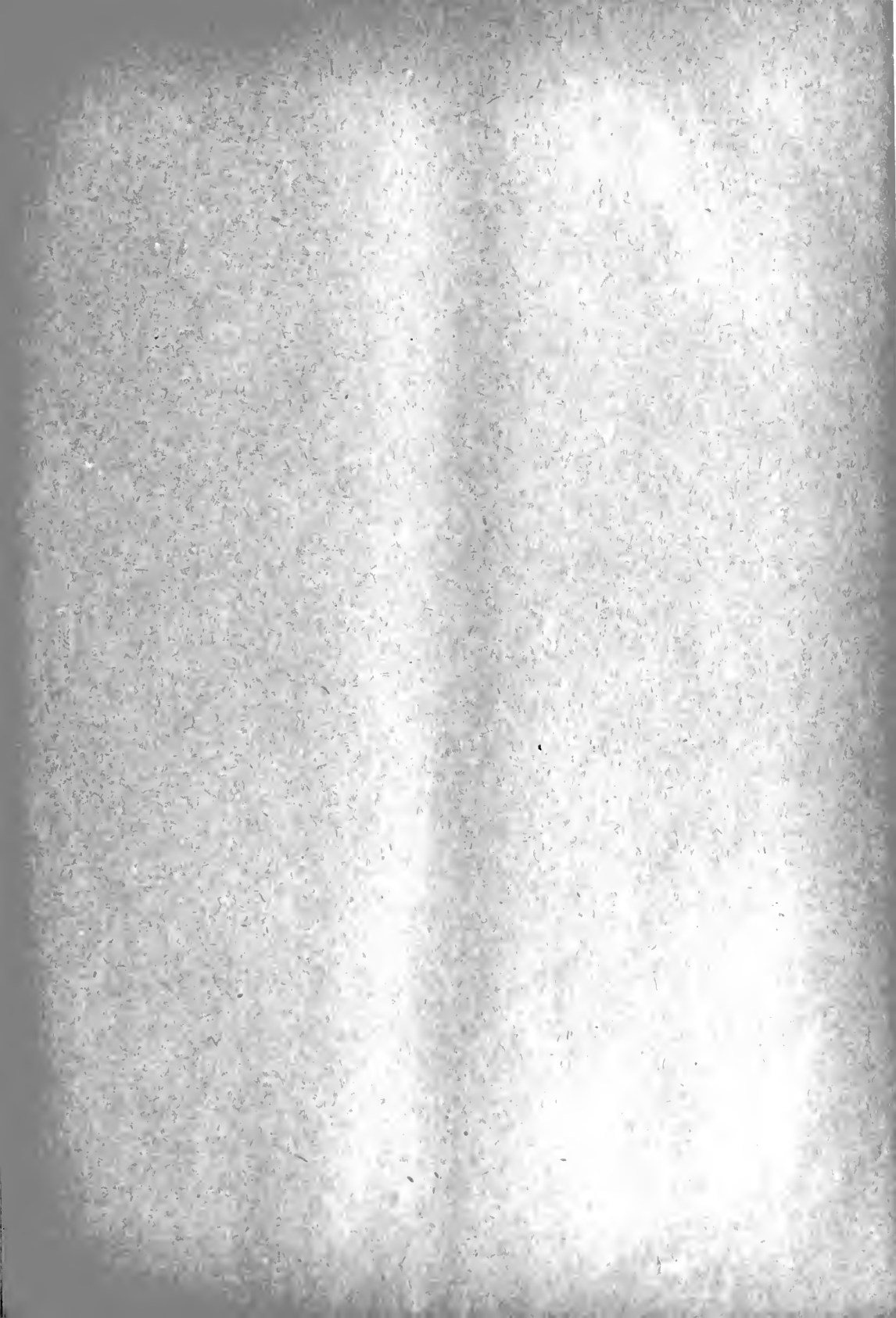

# HEAD INSURANCE OFFICE KEW.

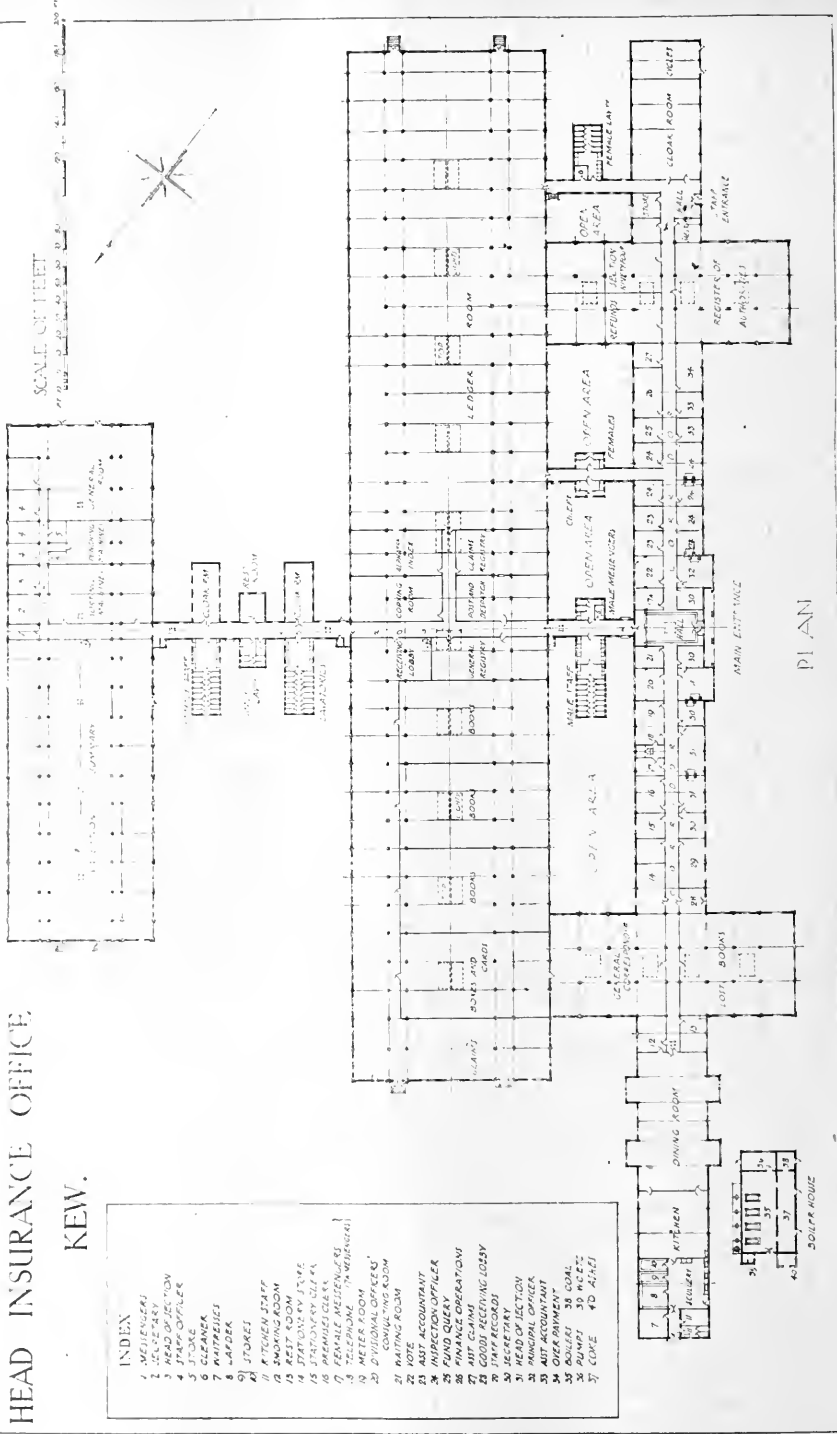

GENERAL PLAN, HEAD INSURANCE OFFICE, KEW.  
Mr. R. J. ALLISON, A.R.I.B.A., and Mr. HERBERT ASHMEAD (H.M.O.V.), Architects.



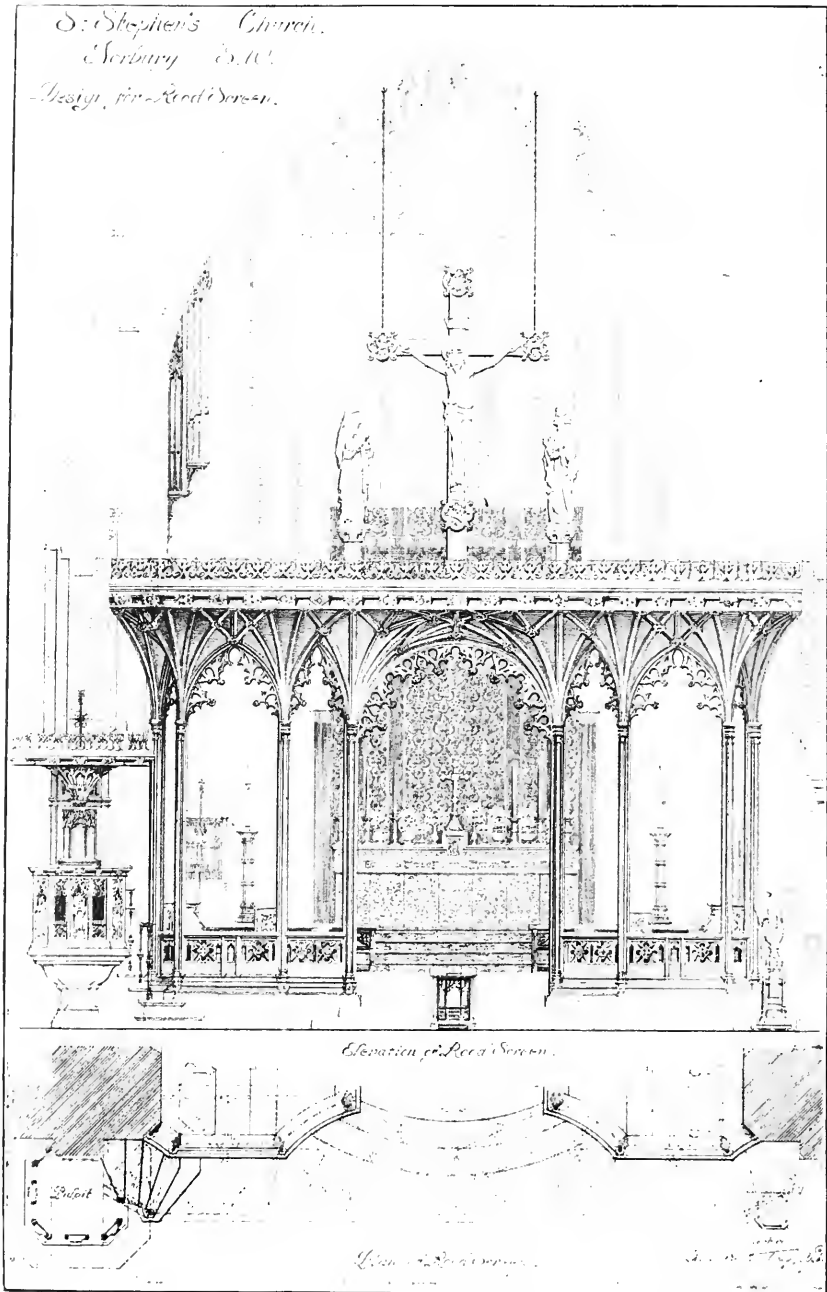

ROOD SCREEN, ST. STEPHEN'S CHURCH, NORBURY, S.W.

Mr. W. SAMUEL WEATHERLY, F.R.I.B.A., Architect.



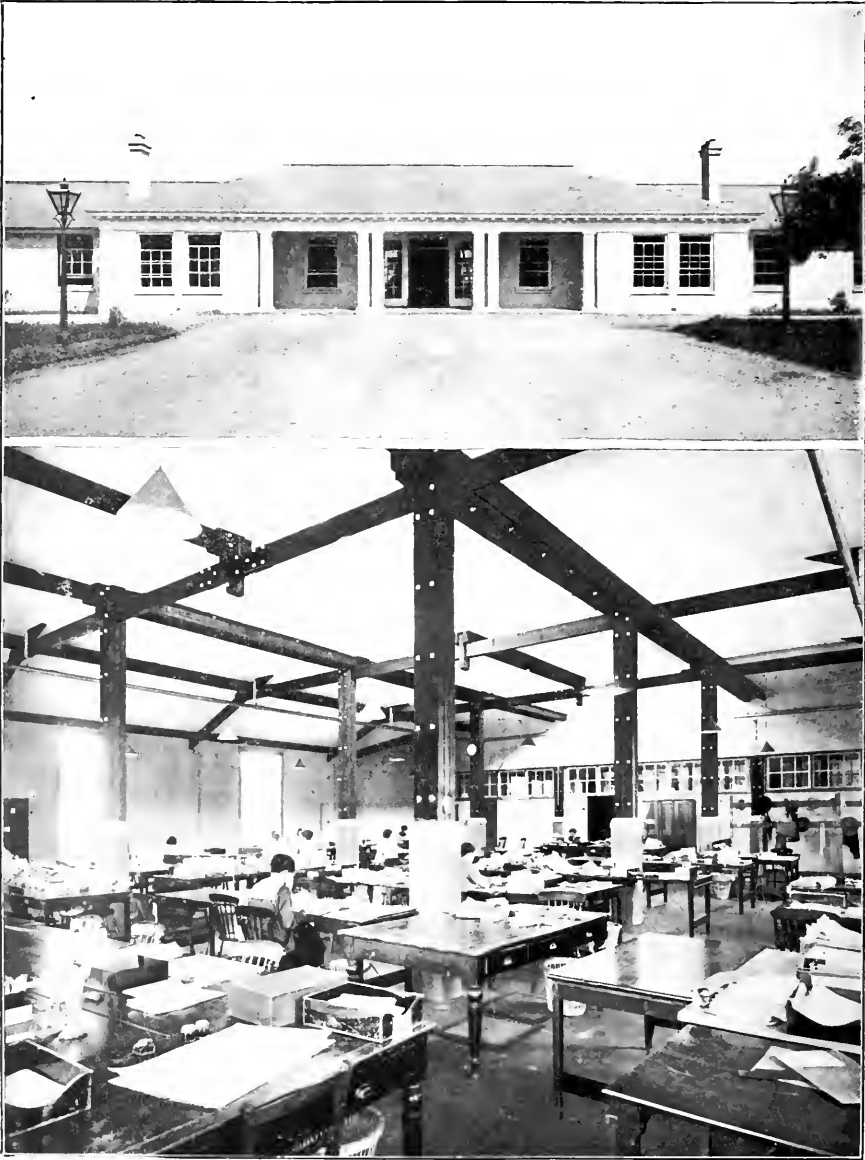

*William, L.L.D., P.A.S.*

HEAD INSURANCE OFFICE, KEW, SURREY: PRINCIPAL ENTRANCE AND THE CLERICAL ROOM.

Mr. RICHARD J. ALLISON, A.R.I.B.A., and Mr. HERBERT ASHMEAD (H.M.O.W.), Architects.





*Waldens, Ltd., Photo.*

HEAD INSURANCE OFFICE, KEW, SURREY: ADMINISTRATION BUILDINGS  
AND LEDGER ROOM.

Mr. RICHARD J. ALLISON, A.R.I.B.A., and Mr. HERBERT ASHMEAD (H.M.O.W.), Architects.





A PARISIAN PARLOUR FOR A LADY.  
Designed by Lieut. MURRAY ADAMS-ACTON, S.C.





GREAT CHALFIELD, WILTS.  
E. S.



SOUTH WRAXALL, WILTS.  
E. S.

GREAT CHALFIELD AND SOUTH WRAXALL MANOR HOUSES, WILTS.

Sketches by Mr. EDWARD SWALES, Architect.

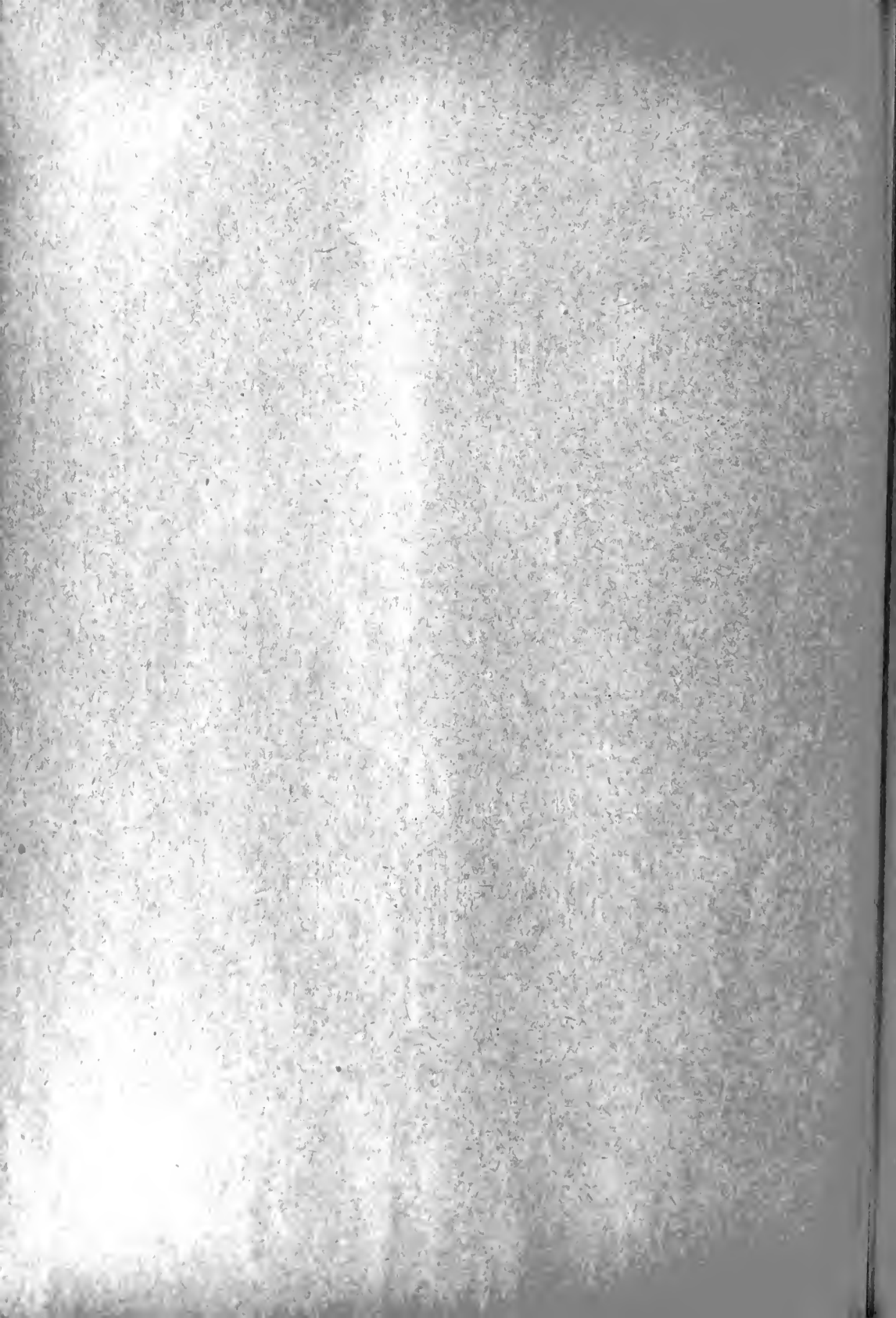

## Our Illustrations.

### HEAD INSURANCE OFFICE BUILDING, KEW, SURREY.

This building was completed at the latter end of last year, and has come into use during 1917, for the purpose of centralising the greater portion of the Unemployment Insurance Department hitherto accommodated at various centres in England, Scotland, and Wales. The plan shows clearly the lay-out of this centralised great scheme. The staff accommodated is approximately 800, and this, with space for fittings for filing cards, etc., necessitated a floor area of about three acres. The building is of one story, and arranged in three blocks; in front is the administrative block, divided into separate rooms for the chiefs of sections; at the back of this is the main block, 375 ft. by 110 ft., in which is the ledger room, with a floor area of 29,100 square feet. This vast hall, with its big span, is a very capable piece of construction, and forms one of the biggest halls to be seen anywhere. Behind this, again, is the valuation summary block, and lavatory accommodation is arranged in the spaces between these several blocks, well isolated and amply ventilated. A dining-room for the staff is provided, capable of accommodating 250 at one sitting, with the necessary kitchen accommodation and cooking appliances to serve it, set at the far end, free of the business part of the premises, and free for the income of commodities. The external walls are of brick, and the roofs are of timber construction, slated, the flats being asphalted. Timber construction for roofs of large span was adopted owing to the necessity for economy in steel for any purpose other than direct war service. The building generally is warmed by means of hot water radiators, and electric light is installed throughout. Building operations commenced at the end of August, 1916, and occupation was taken of the first section, viz., the administrative block and the ledger-room portion of the main block, early in January this year, while the whole was completed, fitted, furnished, and occupied by March 3, 1917, at an approximate cost of £85,000. We give views of the principal entrance, which is approached through some large wrought-iron gates, of good character, and of the administrative buildings. The interior of the ledger-room illustrates its structural design, though it scarcely shows its expansive size and great length. A decorative effect is given by the white colour of the bolts and ironwork on the brown roof timbering and uprights. The clerical room is shown by the second photographic interior. On the plan the accompanying index furnishes many items of information, which need not, therefore, be repeated here. The contractors for the building were Messrs. Fred Pitcher, Ltd., of 57, Ashburton Grove, Hornsey Road, N.7; and those for the lighting and heating were Messrs. W. G. Cannon and Son, and Messrs. Cecil Cooper and Co., respectively. The cooking apparatus was installed by Messrs. Carron Co., and Messrs. Fletcher Russell and Co. Principal architect, Mr. R. J. Allison, A.R.I.B.A. Architect, Mr. Herbert Ashmead, H.M.O.W.

### ROOD SCREEN, ST. STEPHEN'S CHURCH, NORBURY, S.W.

It is hoped that this Rood Screen may be erected as a Memorial to fallen soldiers in the Parish. The stone base and stones are already formed, in fact the Screen and Rood were thought out when the eastern part of the church was completed in 1913. The permanent stalls and choir seats were then added; the Pulpit and Canopy, as shown, were erected last year. The illustration is reproduced from the drawing by Mr. W. Samuel Weatherley, the Architect of the Church, exhibited in this year's Royal Academy.

### A PARISIEN PARLOUR FOR A LADY.

This apartment, designed for a lady in Paris by Lieutenant Murray Adams-Acton, S.G., is carried out in the eighteenth-century French manner in a very elegant way. The

walls are painted ivory white, with pale blue lines, and the furnishing suite, being gilt, is well in scale with the general scheme of ornamentation. A good feature is made of the pair of niches flanking the stove recess, which fitment in itself makes a very distinguishing object in the room. It is enclosed by white-glazed ceramic work, enriched delicately with coloured ferillations thoroughly French in character, and in accord with the same idea prevailing in the choice of china shown in the alcoves' shelving and table tops to the curved projecting cupboards below. This arrangement serves for setting out choice examples of works of art in the absence of a mantelpiece.

### GREAT CHALFIELD AND SOUTH WRAXALL MANOR HOUSES, WILTS.

In 1490 a fine altar tomb was erected in Corsham Church to the memory of Thomas Tropnell and his wife. This country squire has the credit of having built Great Chalfield Manor House, of which we give a sketch to-day. Its north front is nearly perfect, and certainly is to be reckoned one of the most complete facades of its kind extant in England. The beautiful oriel to what was the guest chamber, and the groined porch are its richest details. Unfortunately, this elevation is little better than a frontispiece, as it comprises nearly all that remains of the original fabric. Some vandal or other pulled down the guest chamber but left its splendid window, though the hall was cut up into rooms when the gallery and screens were destroyed. Two plans of the house will be found in THE BUILDING NEWS for August 19, 1887, when a front-view of the house appeared, drawn by Mr. Maurice B. Adams. The church, with its quaint bellocote corbelled out over the gable, stands hard by the manor house, so that, including the great barn and the gatehouse, enclosed by a moat, together with the farm buildings, the group makes up a picture of more than ordinary picturesqueness. The charm of the place is enhanced by the walled-in garden. Great Chalfield is commonly associated with South Wraxall, its rather near neighbour. Tropnell's manor house probably was erected during the reign of Henry VI. Some of its minor details indicate a later date. This seeming difference may be accounted for because the dressings or ornamentation were probably among the last finishing touches done, such as the armoured figures on the apex of the gables. Tropnell died in 1490, so, perhaps, these finishings were executed in his lifetime. The oriel, certainly, is a very like Tudor work of the development kind. The carved figures mentioned were represented in our pages when the plans and perspective appeared. The adjuncts of the house were presumably later, and look as if they were added at a subsequent date. The fireplace in the hall is at the date end, and is set prettily with a projecting breast on the front, with an embattled chimney above the main wall set off. The offices have been modernised, and the old kitchen has lost much of its old character, but the plan of the arrangements is discoverable, or was so a few years ago, when we showed it intact so far as could be determined. The bay to the hall serves as a means of communication with other rooms. The church contains some good glass as well as a handsome tomb to a Tudor Lord of the Manor. Inside, the edifice has been recently restored and renovated with no little care and taste. South Wraxall Manor has also had the advantage of a thoughtful and artistic restoration. In our issue of August 19, 1937, two plans and two views were published, and the previous week another pen-and-ink drawing by Mr. Maurice B. Adams appeared, showing the chimney-piece and rich, arched ceiling of the beautiful withdrawing-room. The original structure included the usual hall of its period, with the buttery at one end and the parlour at the other. The latter in subsequent times was divided up into three rooms. This early 15th century dwelling was materially enlarged by subsequent owners. A court was formed, but now only two sides of buildings exist, the remainder being enclosed by dwarf stone walling. The gate-house is improved by a new four-centred

arch, and in order to facilitate the approach to the front door of the house this side of the quad was lowered, the lawn garth being at a higher level and retained by terrace walls quite in harmony with the building. The two big mullioned windows with square heads and transoms to the drawing-room are Jacobean in character, and the colonnaded "conservatory" below the morning room at the rear is of Elizabeth's reign, or perhaps more recent still. The windows have now been furnished with good glazings. In the gable facing south a new window has been inserted to give the hall more light, and necessarily the opening is high up to clear the adjacent roofings. The gardens, too, have been laid out with taste. To-day's sketch shows the hall, fireplace, breast, and chimney and the gable-end window of the drawing-room, the floor of which is higher than the hall.

## Correspondence.

### SMALL HOUSES AND LEGISLATION.

To the Editor of THE BUILDING NEWS.

SIR,—The following facts are (or should be) widely known—namely, that more workers' dwellings are urgently wanted, that the cost of building such is, at the present time, totally unremunerative, that rates, taxes, and cost of repairs on existing small houses are all tremendously increased, and yet in the face of these adverse conditions recent legislation has made it illegal to raise rents.

Supplies of food, clothing, and all the necessities of life (except housing) obtain vastly increased prices, but the providers of the equally necessary dwellings are now rated and taxed out of the greater part of their net incomes which, in most cases, even in pre-war times, represented a very small return on the capital outlay. Tenants generally are getting so much more money now that they could easily afford to pay more rent.

They are presently to have houses built for them out of the rates and taxes, which property-owners pay—or will have to pay if they have not gone—to the workhouse before the war ends. I suppose I am obtuse, but I really do not see how the increased rating returns on real property are evidence of national prosperity as you make out last week in your comments on the President's address at the Surveyors' Institution.

A SMALL HOUSE OWNER.

### OBITUARY.

The death is announced, at the age of seventy-seven, of Auguste Rodin, the great French sculptor. While still a boy he became an assistant to a sculptor of architectural ornament, and when only twenty-three produced his first work of importance, "The Man with the Broken Nose." In 1870 he went to Brussels, and, in conjunction with Carrier-Belleuse, did some of the sculpture at the Brussels Bourse. After two years spent in Italy, he returned to Paris in 1877 and exhibited "The Age of Bronze" at the Salon, which was purchased by the State. Anything like a complete list of his works would fill a column. He was as warmly admired here as in France, and in 1915 was elected President of the International Society, in succession to Whistler. Early during the war he gave twenty works to the British nation as a token of admiration for our soldiers, and last year he, by a deed of gift, presented all the remaining works in his possession, including drawings and writings, and his collection of Greek, Roman, and Egyptian antiquities, to France. They are to be kept where they are at present, in the Hotel Bron, which is to become a permanent Rodin Museum.

Councillor George Taylor, timber merchant and contractor, and a partner in the firm of E. Taylor and Co., Ltd., has been added to the Commission of the Peace for the County Palatine of Lancaster.

## RECENT EXPERIMENTS IN VENTILATION.

(Continued from page 414.)

The next experiments calling for description were made by the New York State Commission on Ventilation. These experiments were made to compare the effect on groups of subjects of the following physical conditions:

Condition 1. Air temperature 86°, relative humidity 75°, with ample air supply. The air being agitated by fans.

Condition 2. 86° temperature, 75 per cent. relative humidity, no air supply, air stagnant.

Condition 3. 68° temperature, 50 per cent. relative humidity, ample air supply.

Condition 4. 68° temperature, 50 per cent. relative humidity, no air supply.

This was the intention of the observations, but unfortunately it was found that the condition of constancy for Condition 4 could not be maintained. The temperature could not be kept down to the desired point without also reducing the humidity below the desired value. There were therefore only three conditions the effect of which it is possible to compare, namely, the first three.

The time is too short to enable me to explain the whole of this interesting series of experiments and the number of different ways in which the results were sought. I can only describe the tests which were made on the subjects, both physiological and psychological, and the bare outline of the results secured by two years' work. Physiological observations were made on the following points:—

1. Body temperature. The normal body temperature is closely 98.7 deg. F. It is well known that any condition which causes rise of body temperature is undesirable, though to what extent exactly it is to be regarded as undesirable it is difficult to say.

2. The rates of respiration. The normal rate of respiration for a person in good health is about 16 or 17 per minute. Undesirable conditions will send up this rate, the increase representing Nature's effort to adjust the body mechanism to the undesirable environment. If, therefore any set of conditions send up the respiration rate it is *prima facie* evidence that such conditions are undesirable.

3. Next we have the pulse rate, to which similar observations apply. The average pulse rate is about 72 beats per minute. An unduly high rate is an indication that something is wrong. If a person is set to hard work the effect will always be an increase in the pulse rate, which rate will decline more rapidly the better the conditions. Further, the difference between the pulse rate when a person is reclining and when he is standing is also an indication of suitability or otherwise of the conditions, the greater the increase of pulse rate when a person stands the less suitable the conditions may be taken to be.

4. Next there are observations on blood pressure, which have a certain physiological significance which it is difficult for the lay mind to understand altogether. The effect on the blood pressure of a change from a reclining to a standing position is also of importance.

Physiologists have devised an arbitrary scale first proposed by Dr. C. Ward Crampton and known as the "Crampton Value," which affords a measure of vaso-motor tone. It expresses as a percentage the relation between the change in the pulse rate and the blood pressure arising from a reclining to a standing condition. A high value in this scale indicates a good tone or tension in the circulatory system with a slight rise in the heart.

Perfect conditions which are called 100 per cent. on the Crampton scale would be those in which the pulse rate on standing goes up less than five beats, the normal rate being perhaps 70, while the blood pressure increases by 10 millimetres of mercury, the normal being perhaps 110.

The zero value on this scale, that is, the very worst possible, would be represented by an increase of 40 beats in the pulse rate on standing from reclining to standing, with a corresponding drop in blood pressure of more than 8 millimetres.

It will be seen that this high artificial

value is a technical measure of condition, and that a given set of air conditions which produces a low value on the Crampton scale is undesirable.

### PSYCHOLOGICAL TESTS.

In addition to these purely physiological measurements, the scientists endeavoured to set up some psychological tests—that is, tests showing the effects on the mental powers of a subject. If the conditions are good, the presumption is that the person's mind is maintained relatively alert and active. Bad conditions may be assumed to cause the mental faculties to be dull or inert or sluggish. The tests devised to indicate the mental condition of the subjects were as follows:—

The subject was asked:—

1. To name as rapidly as possible 100 different patches of colour on a diagram placed before him.

2. To name the opposites of 100 words given to him.

3. To cancel certain digits from a sheet filled with numbers.

4. To add columns of figures.

5. To multiply mentally a number of three digits by a second similar number, the final result only to be recorded on the paper.

6. To copy on the typewriter certain extracts from a selected book.

From ten to thirty minutes were devoted to each of these tests.

It was assumed that if a subject showed himself more active in one set of conditions than in another, that set was the most desirable.

### COMFORT TESTS.

Also the subject was invited to state his opinion as to his physical comfort on the following scale:—

1. I feel as uncomfortable as I would with a severe headache or an attack of influenza.

2. My condition is half-way between 1 and 5.

3. I feel about as I usually do at the close of an afternoon of hard mental work.

4. My condition is half-way between 3 and 5.

5. I feel as comfortable as I ever do.

### FOOD CONSUMPTION.

A further test which was made consisted in observing the amount of food consumed by persons under the various conditions. The food was supplied to them as an ordinary lunch of uniform quality, and they were invited to take as much as they wanted, and observations were taken of the quantity of food eaten.

### VOLUNTARY TEST WORK.

A test was also made of the accomplishment of voluntary physical work. The subjects were offered considerable sums of money at "piece-rate" for the performance of certain work. They were allowed to do as much or as little of this work as they felt inclined, and the amount of work was carefully watched. It was assumed that the amount of work voluntarily done under certain physical conditions was a measure of the value of the conditions.

It will thus be seen how excessively artificial the tests must be in order to reduce the effect on the human subject to a numerical scale.

I will now give a general summary in the forms of diagrams of the results of these experiments. (1) Taking the body temperature as a criterion, the diagram on the screen shows the result of the calculation of a very large number of averages. It shows clearly that the temperature rises and falls exactly according to the surrounding temperature, and in so far therefore as a rise in body temperature is undesirable just in so far is a rise in surrounding temperature also undesirable. (2) Equally it is shown that the pulse and respiration are on the average increased by a high temperature, the blood pressure is less, that the Crampton value is higher invariably for the lower than for the higher temperatures.

The psychological tests do not show any very considerable difference between the two conditions. The mental activity is practically the same in two extremes.

The food consumption is invariably greater the lower the temperature.

The inclination to work responds to the temperature in an inverse sense.

Such in general is the result of this very elaborate series of tests; so far as such a comparison can go, it proves the contention of the modern physiologist that it is the physical condition of the air, and not at all its chemical condition, which determines the suitability of its qualities. It shows not only that of two specific conditions 68degs. and 50 per cent. humidity is far more suitable than 85degs. and 75 per cent., but generally how it is that the higher values react unfavourably on the physiological and psychological wellbeing.

ODOUR.—In regard to odour, one of the most difficult measurements to take in regard to the condition of a room is the degree and offensiveness of the odour arising from the ordinary occupancy of a room. Here the difficulty is that an immeasurably small amount of odorous vapour is easily noticeable by the human nose. It is not possible entirely to suppress odour otherwise than by immediately removing its cause or removing the vapour which causes it by interchanging the air with other air, or alternatively by deodorizing the air by introducing suitable chemicals into the washing water. The introduction of ozone has a marked deodorizing effect. Recent experiments which I have no time to explain have shown that the use of ozone can completely destroy very unpleasant organic odours, such as those arising from the manufacture of glue or other offensive operations, and that this destruction is not merely due, as was at one time believed by many people, myself included, by masking one odour by another more pungent; but it is due to the destruction or oxidation of the vapour which causes the odour. There are chemical deodorizers which can be used with the washing water which have a similar effect—permanganate of potash among the number, and several patent compounds.

The experiments previously described indicate two facts of great importance: (1) That a person feels warmer in a room when the humidity is high, than in the same room at the same temperature when the humidity is low. (2) They also indicate that one of the chief considerations in ventilation from the point of view of present wellbeing are the temperature, humidity and air movement rather than the chemical purity of the air.

It is at least probable that the physiological explanation of these facts is that each of these three factors has an effect on the amount of heat which the body will lose.

If then we can show that whatever the value of the individual factors may be the conditions are equally comfortable if the combination of values of these three factors produce jointly the same net rate of abstraction of heat from the body, we shall have gone far to prove definitely that comfort depends on rate of heat abstraction.

Conversely, if we can determine what combinations of conditions will produce a desirable rate of heat abstraction, we can determine what combination is suitable without reference to the variable feelings of the subject.

Thus we can reduce the whole problem to one objective variable, namely, the rate of heat abstraction. At present, criticism of the ventilation of a building may be perhaps that it is stuffy or draughty, or stagnant or oppressive. To speak in more scientific language, we may say that the thermometer was too high or the air was too moist, or that the velocity of the air in the room is too high, or that the conditions do not suit this or that class of persons. All this is vague; we have no figures to go upon. We only know that the desirable temperature depends on the humidity, the desirable temperature and humidity together depend on the rate of air movement; in other words, on the amount of draught.

If we are now on the right track we can refer all these questions to one and the same scale, we can say, for instance, that in such and such a corner of a building that is complained of as being draughty, the ventilation is the scale value 57, whereas it ought to be



at least 50; we can put our finger on the spot and direct our attention to raising the scale value in that part. A person may even know his own figure of comfort, say, for instance, that he cannot be comfortable unless the scale value is at least 50, but not below. Hitherto, we have attempted to do this solely by reference to dry bulb thermometer which is known to be most unreliable as an indication. We have regarded heating as an entirely separate matter from ventilation. We now see that it cannot be so regarded, that they are different parts of the same operation.

I have myself heard a heating engineer boast that the heating apparatus supplied in a certain church was so good that on a certain occasion many ladies in the audience had fainted from the heat, although it was freezing outside.

To reduce all these questions finally to a scale was the object of the experiments of Dr. E. V. Hill, of Chicago, which were reported in a recent number of the "Journal of the American Society of Heating Engineers." He erected an apparatus in a room which was capable of regulating the temperature, humidity, and air movement. The diagram shows a drawing of the apparatus used.

The room contained powerful radiators for maintaining any desired temperature, a vapour pipe for adjusting humidity, and a motor driven fan for setting up any desired air velocity. The observations made on the subject consisted simply of suitably pre-arranging them for the test, first placing them in still air in different dry bulb temperatures with varying degrees of humidity, and inviting them to state the degree of comfort they experienced in such terms as "very warm," "too warm," "stuffy," "comfortable," "cool," "too cold," "very cold." Their replies were recorded on a chart which showed the dry bulb temperature as ordinate and the relative humidity as the abscissa. Then those parts of the chart in which the subjects were generally comfortable were marked off by lines, and a diagram produced which shows a combination of conditions as to temperature and humidity only, which in still air produce a feeling of comfort. These conditions are found to be fairly well defined.

Now consider these results in the light of the loss of heat from the body. That loss takes place partly by convection and partly by evaporation. When the air temperature is increased the loss due to convection decreases. Also as the humidity increases the loss from evaporation decreases. The diagram given on the screen shows the amount of heat lost in still air by convection and evaporation separately and jointly, and with a constant wet bulb temperature.

So we see a probable explanation of the fact that a low air temperature can be compensated for a high humidity, and vice versa. The high humidity in this case reduces the loss of heat from the body by evaporation, while a low air temperature increases the loss by convection, the loss due to the two together being kept constant.

Now the wet bulb thermometer, which is an ordinary thermometer covered with a wet fabric, combines in its reading a sort of measure both of temperature and humidity.

It takes up a temperature such that it gains as much heat from the air by convection as it loses by evaporation. If we plot on this same comfort diagram, lines representing a constant wet-bulb temperature, we find that these lines are very nearly parallel to the lines of comfort determined from direct experiment.

We are, therefore, justified in concluding that the feeling of comfort in still air depends on the wet-bulb temperature, and not on the dry bulb. In order to show this I have plotted on the diagram various lines of wet-bulb temperature, from which it will be seen that the lines between the "comfortable" zone and the "too warm" zone approximately coincide with about 58 deg. on the wet-bulb thermometer, while the lower one corresponds approximately to about 53 deg. Half-way between these two, viz., about 55½ deg. on the wet-bulb thermometer, represents an average suitable reading for still air. Hence we say that in still air if the wet-bulb thermometer reads

somewhere about this value, whatever the temperature of the air is, and whatever the degree of humidity, the feeling of the air as regards comfort will be just about right for the average person.

So far, however, the investigation leaves out the vexed question of draughts. It is well known that moving air makes a person feel cold. If, however, the temperature is high, moving air, instead of 'being called "a cold and uncomfortable draught," is regarded as a pleasant breeze or air movement. The explanation is that a temperature which in still air would abstract a normal quantity of heat from the body, in moving air takes away too much, and people, therefore, complain of draughts.

The experiments were, therefore, continued in the following way: The floor space in front of the fan was marked off in feet, the fan was set moving, and the subject's chair was fixed in various positions so that the average air velocity passing over the subject was varied. At the same time the wet-bulb temperature was maintained at different values by suitably controlling the air temperature and the humidity, and the subject's opinion on the conditions was asked; and his replies plotted on a curve, which shows the relation between the desirable wet-bulb temperature and the air motion. The points representing the most comfortable combination of conditions was found to lie on a regular curve, which is shown in Fig. 15. This proves that the desirable wet-bulb temperature depends on the amount of air motion.

Just as a high dry-bulb temperature can be compensated in still air by a low humidity, the joint effect of the two being measured by the wet-bulb temperature, just so a high wet-bulb temperature can be compensated for a relatively high air movement, the joint effect of the two being measured by another instrument, which will presently be explained.

If, then, we fix or know the air movement we can say at once what is the corresponding suitable value for the wet-bulb thermometer reading; thus, if the movement of the air is about 6 ins. per second, we see that a desirable reading for the wet-bulb thermometer is about 57 deg., while if the velocity is 18 ins. per second, the corresponding reading of the wet-bulb thermometer is 59 deg. Both these conditions would produce the same loss of heat from the human body subjected to them.

The next step is to measure what is the magnitude of this desirable heat-loss, and to evolve some instrument for measuring the same, irrespective of the single values of the three elementary conditions, but dependent on their joint effect. In this connection the work of Dr. Leonard Hill, O. W. Griffiths and Martin Flack is of very great importance. A recent paper\* read by them before the Royal Society contains a description of investigations of great value to the ventilating engineer, and should be studied by all who are interested in this subject.

The view set out in this paper is that the rate of cooling of the human body affects the cutaneous nerve endings by determining the difference between the temperature of the surface of the skin and the blood temperature, that a bracing wind cools the skin, tones up the muscles of the body, and impels us to take exercise. That it is the disaffection of monotonous stimulation of the cutaneous nerves on the outside of the body and not the absorption of poisonous products into the blood which occasions the discomfort of badly ventilated rooms, and that, therefore, an instrument to measure the rate of cooling at body temperature is the true criterion of adequate ventilation. The important conclusion is also reached that for satisfactory conditions a state of constancy or uniformity is essentially undesirable, and that constant change is necessary to produce atmospheric conditions comfortable and healthy to man. If perfectly constant conditions are maintained, the physiological effect is to dull the nerves and to produce a sleep effect, whereas, a change of condition keeps the nerves lively and produces a feeling of freshness. A movement of air is in its nature variable, and, irrespective of all other

considerations, a certain movement of air is desirable provided it is accompanied by adequate high wet bulb temperature so as to avoid an undue feeling of cold.

It is therefore in the view of Dr. Hill not desirable to lay down one uniform condition as to heat loss, but to specify that it should vary between the two extremes. He has devised an instrument which he has called a "Kata thermometer," which measures this rate of cooling by observing the time taken by the instrument to fall between two definite temperatures. He has carefully investigated the reading under different atmospheric conditions. The conclusion reached is that for comfort the cooling power of the atmosphere as determined by the wet Kata thermometer should be between 20 and 30 milli-calories per second per square centimetre. The actual figure depends on the prevailing climatic conditions, for this determines the standard to which our bodies are tuned.

It is impossible even to indicate the general character of this important investigation in the present paper.

We have now to enquire as to the practical means at our disposal for producing such an air movement as physiological investigation has shown to be desirable.

In connection with this question, it is important to know the effect of different positions of the opening into and out of the room in producing such a movement. This point has not escaped the attention of the very strong New York State Commission on Ventilation. This Commission has investigated the effect on the air movement in a room of different positions of openings. Observations were made of temperatures in different parts of the room. Humidity, the air, amount of air supply, carbon-dioxide analysis, etc. It was shown that both heat and expired air vary proportionately with a person's weight, and that in calculating the occupation of a room, square feet of floor space for 100lbs. of flesh, is a much more instructive figure than square feet of floor space per person.

A survey of the air currents in the various rooms has been made, and diagrams similar to those which are now on the screen prepared from these observations. The magnitude of the current is indicated by the depth of the shading, and its direction is shown by the arrow. It will be understood how immensely complicated these observations are. The inlets in a room should be so designed as to maintain a subtle air movement all over the space. This subject, however, is too wide to be adequately treated in the course of a single lecture.

It will be at once evident how seriously all these considerations complicate the already difficult question of ventilation. If we could take the results of these experiments at their face value we might be entitled to conclude that a very large reduction in the amount of air now thought necessary for adequate ventilation might be made, but responsible physiologists are reluctant to form this conclusion, feeling, as they probably do, that the experiments are still too much in the air, and that reliable conclusions can only be formed as the result of very much more experience than has been obtained up to the present time.

If we are to design our ventilating plant solely with the view to comfort we are on much safer ground than we can be for many years if we consider the ultimate health as the object to be obtained. It may be doubted whether we shall ever know certainly enough on this subject to enable us to be quite sure that we are on the right lines in this regard. If we are entitled to assume, however, that what is to be sought for is the means of controlling accurately the heat losses from the bodies of the subjects, we have at least something definite to work upon, and this alone is an enormous step in advance, for hitherto we have been working almost in the dark with the aid of crude rules of thumb only.

The general question of the practical means for controlling the air movement in all parts of a room were discussed by myself in a public lecture at the University College in 1914, and reproduced in "Engineering" of December 4 of that year. The conclusion arrived at was that modern theories of ventilation, which at first sight appear to render

\* Phil. Trans. Series 15, vol. 207, p. 185.

possible a reduction in the cost of ventilating a room, in reality have a very marked tendency in the opposite direction. They increase to a very large extent the practical difficulties and the amount and extent of the plant required, and increase also the cost of upkeep. If they are to be literally carried into practice they will call for something like a transformation in the methods of building, and will certainly be regarded with acute disfavour by every architect who is interested in the interior appearance of a large building.

I have only been able to touch in a somewhat sketchy manner on the broad general results of a very few of the most important of recent investigations, but I trust that enough has been said to show what a vast unexplored field still awaits the investigator, and, more than all, that the practical methods of applying the results hitherto discussed to practice, should form the earnest study of all who have to do with building construction.

### BETTER HOUSES BUT HIGHER RENTS.

The technical conference set up by the National Housing and Town Planning Council last Friday submitted to the Local Government Board its interim report on the problems likely to present themselves for solution in housing and town planning at the close of the war.

The report says it will be necessary at the close of the war to ask the tenants of the new houses to pay higher rents than those current before the war. For this reason the new houses must be made attractive, to be well worth the extra rent charged. The following points to be observed in all plans adopted by local authorities for cottage building are presented:—

The houses should be broad rather than deep, to secure ample light.

Back extensions are better avoided; all the rooms should be brought under the main roof.

Three bedrooms should be provided in all the new houses.

The houses should, as a rule, be provided with parlours.

Each house should have a bath, with hot water.

Ample window space should be given and windows carried as near to the ceiling as possible.

A layer of concrete, or other approved impervious material, should be laid under all floors to prevent damp rising, and a proper damp-proof course should be provided to all walls.

The level of the ground floor should be above the level of the ground immediately surrounding.

The assistance of women with close knowledge of household economy should be sought in regard to details of interior construction, such as the design of the stairs, the provision of cupboards, larders, and storage accommodation.

The report recommends that the Government should be advised to lend or grant money "only when the 'lay-out' of the estate or area, on which the housing scheme is to be carried out, meets with the approval of the Local Government Board, has been prepared on town planning lines, and is in conformity with a general outline town plan for that portion of the district of which the housing scheme forms a part."

In rural planning the report urges the Government to make conditions of housing loans and grants-in-aid for rural housing schemes as follows: (1) That there shall be proper 'lay-out' scheme submitted; (2) open spaces shall be provided; (3) cottage gardens of not less than one-eighth of an acre per cottage; and (4) careful grouping for future extension.

An investigation is recommended to ascertain what, if any, can be taken to keep the brickmaking industry alive, so that sufficient stocks of bricks may be available at the close of the war. Measures of the most urgent kind should be taken to secure a great increase in the cutting and seasoning of timber in various areas of probable supply.

### PROFESSIONAL AND TRADE SOCIETIES.

**EDINBURGH ARCHITECTURAL ASSOCIATION.**—The opening meeting of the session will be held to-morrow, when Dr. Pittendrigh MacGillivray will deliver a lecture on "Sculpture, Nationality, and War Memorials." On December 13 there will be a lecture on "The Construction of the Old Scottish Bridges," by Harry R. G. Inglis, F.S.A. (Scot.); on January 24, on "Gourlay's House and its Memories," by W. Forbes Gray, F.S.A. (Scot.); on Feb. 23, on "The Tenement and its Place in Scottish Housing," by J. A. Williamson, A.R.I.B.A.; and on March 20 on "Two Lost Gems in the Crown of Old Edinburgh—Trinity College Church and the West Bow," by Henry F. Kerr, A.R.I.B.A. The annual business meeting will be held on April 17. A good list of visits and guides thereto is arranged, extending up to June 29. The financial statement shows funds in hand amounting to £404 5s. 6d.

**NOTTINGHAM AND DERRY ARCHITECTURAL SOCIETY.**—The third meeting of the session was held at the society's room on Tuesday, November 15, 1917. Mr. A. W. Shelton, F.A.I. (hon. member), who is a leading authority on the subject, then gave an address on "Working-class Housing." His remarks were largely based upon his own report submitted (by invitation) to Lord Rhondda, then President of the Local Government Board, early in May last. Referring to the causes of the present unparalleled shortage of houses for the working classes, he stated that the practically unanimous opinion of all these competent to judge was that the original cause lay in the mistaken and unnecessary inclusion of such property in the taxation provisions of the Finance Act of 1910, and also spoke of the efforts which had been and are still being made to induce the Government to redeem its pledges and to amend this legislation. Referring to methods of production, Mr. Shelton referred to the fact that upwards of 95 per cent. of all existing dwellings had been provided by private enterprise, and stated that houses produced by local authorities had hitherto cost considerably more than those erected by house builders. He considered that the difference was at least 25 per cent., and that, given the same amount of capital, experienced house builders could erect cottages in the broad proportion of five as against four by local authorities. As rents should always be based on cost of production, this meant that a local authority must charge 25 per cent. more rent for a house of similar accommodation to one provided by the house builder, and pointed out that, if economic rents were not charged, the ratepayers as a whole would be paying part of the rent of a privileged few, who in such case were forced into the position of accepting a form of outdoor relief. Local authorities, in his opinion, in the large towns should limit their operations to housing schemes for the poor, and to dealing with congested or slum areas, and in housing schemes thereby involved. They might also acquire and lay out land for housing schemes, and dispose of it to reputable builders who could provide suitable houses. The speaker stated that, in his experience, the alleged inability of tenants to pay an economic rent was to a great extent fallacious, and estimated that about 70 per cent. of the total cost of building houses was paid in some form or another as wages in connection with the building. The latter statement was borne out by a member of the society who had given special attention to the matter. Mr. Shelton was emphatic that rates should be directly levied upon and paid by all tenants, stating that the present method of inclusive rents prevented tenants from realising what true citizenship really meant and what it cost. Amongst other remedies, he suggested that the Government should immediately remove the taxation provisions of Part I. of the Finance Act of 1910, except mineral rights duty, and encourage and assist all reputable builders and co-operative effort. After Mr. Shelton had replied to various questions, a hearty vote of thanks was accorded him, proposed by Mr. E. R. Sutton and seconded by Mr. A. E. Heazell.

### LEGAL INTELLIGENCE.

**CLARIDGE'S ASPHALTE CO., LTD.—COMPULSORY WINDING-UP ORDER MADE.**—In the Companies winding up section of Court II., Chancery Division, Mr. Justice Astbury yesterday made a compulsory winding up order of Claridge's Asphalt Co., Ltd. Counsel appearing for the first petition were Mr. F. Russell, K.C., and Mr. G. A. Bennett instructed by Messrs. Langford and Redfern, of 84, Queen Victoria Street, E.C., and for the second petition Mr. F. Gore-Browne, K.C., and Mr. W. F. Swords instructed by Mr. Howard Rumney of 12, Craven Street, Strand, W.C.

### BUILDING INTELLIGENCE.

**CHURCHES FOR MUNITION WORKERS.**—The Incorporated Church Building Society held its usual monthly meeting at 7, Dean's Yard, Westminster Abbey, on November 15. Grants of money were made towards building a church at Prestwick, St. George, Manchester, £50; towards enlarging the Church at Ravenscar, St. Hilda, near Scarborough, £70; and towards repairing the Churches at Isle Abbots, St. Mary-the-Virgin, Somerset, £10; and Wyke, St. Mark, near Guildford, £10. In addition to this the sum of £506 was paid towards repairs to 33 Churches from Trust Funds held by the Society. The Committee accepted the Trust of a sum of money as a Repair Fund for the Church at Cawley Hill, St. Mark, Lancs. Applications were considered for aid towards erecting temporary Mission Churches and Hostel Chapels in certain Munition Areas. These were met by substantial grants amounting to almost the total sum available from the special fund now being raised by the Society. The Committee consequently most earnestly appeals for donations towards its Special Munition Areas' Fund, the demands upon which are most pressing, and are of national importance. These buildings will provide full Church Services and will be open for private devotion day and night.

### Our Office Table.

The Building Trades Central Advisory Committee (Operatives), which advises and assists the Ministry of Labour on matters affecting workpeople in that industry arising in the administration of the Employment Exchanges, met last Thursday, Mr. R. Wilson (Operative Slaters) presiding. The committee, discussed, among other subjects, the arrangements for setting up an Advisory Committee in connection with the proposed Central Employment Exchange for the Building Trades in London. They also considered the question whether the Employment Exchanges, in submitting men for vacancies notified by employers, should give a preference, other things being equal, to discharged sailors or soldiers. On this point the committee agreed to advise the Department that, in their opinion, it would be inadvisable to depart from the existing procedure under which purely industrial considerations are taken into account.

Lancaster is to have the first industrial village for disabled soldiers and sailors constructed on the lines set out by Mr. T. H. Mawson. The members of the Storey family have given the Westfield estate in Lancaster as the site. Plans have been prepared showing the estate laid out with workshops, houses for married men, and hostels or fraternal homes for married men, with a new church, recreation ground, garden, bandstand, a public park, etc. It is proposed to use the existing mansion as a club-house and centre of social life. Accommodation will be provided for about 300 disabled heroes, of whom half will be married men, so that it is expected some 700 people will comprise the community, and that as the disabled men pass away these places will be taken in the industry and houses by their children and relatives, thus giving permanence to the scheme. The detail plans are to be proceeded with by members of Mr. Mawson's staff during his absence in Salonika, and it is expected that the scheme will be launched early in the new year, on Mr. Mawson's return.

# THE BUILDING NEWS

## AND ENGINEERING JOURNAL.

**Edinburgh House.**

Currente Calamo .. .. .	421
The Village Builder .. .. .	422
Building a Concrete Home in Three Days .. .. .	423
Building Intelligence .. .. .	424
Our Illustrations .. .. .	427
Professional and Trade Societies .. .. .	437
Status and Memorials .. .. .	437
Correspondence .. .. .	438
Competitions .. .. .	438
Legal Intelligence .. .. .	438
Our Office Table .. .. .	438

**CONTENTS.**

To Arms! .. .. .	439
Chips .. .. .	439
Tenders .. .. .	440
List of Tenders Open .. .. .	440
To Correspondents .. .. .	440
Latest Prices .. .. .	viii.

**Strand, W.C.2.**

drawing of the facade and plans of the Bank Messrs. H. V. Ashley and Winton Newmann, F.F.R.I.B.A., Architects.
An Entrance and Staircase Hall, by Mr. Charles Wade, from a water-colour at the Royal Academy.
Church of the Holy Sepulchre, Jerusalem. (From an etching by M. K. Hughes, A.R.E. Royal Academy Exhibition of Graphic Art, 1917).

**OUR ILLUSTRATIONS.**

Comptoir National d'Escompte de Paris, 8 to 13, King William Street, London, E.C. Working

### Currente Calamo.

From a letter which is published in our columns this week from the President of the R.I.B.A., Mr. Henry T. Hare, it will be seen that Mr. Ernest Newton, chairman of the Architects' War Committee, is making an appeal for further funds to carry on the work of that committee. We hope that Mr. Newton's appeal will be generously responded to by all those connected directly or indirectly with the architectural profession who are in a position to help. The Architects' War Committee's activities have been considerable during the last three years, but probably in no direction has their work been more useful than in the relief of men who have been placed in financial difficulties in consequence of the cessation of their practice during the war. All the younger men have joined the forces, and a large number of others have been able to procure work from the Government in some form or other. There are, nevertheless, a considerable number of men who are less fortunately placed and who are left with only the remnants of a practice to carry on. We know that the scheme of civic surveys has been of great assistance to many architects of this type, but there are others both in London and various parts of the country who have not been able to accept work on the civic survey but who are equally in need of the sympathy and support of their professional brethren. Mr. Newton has so far only made one appeal on behalf of the Architects' War Committee, and after three years he finds it necessary in consequence of the state of the committee's funds again to ask for contributions. We understand that if further subscriptions are not forthcoming a good deal of assistance which is now being afforded weekly to architects and their families by payment for work done or by direct grants will have to cease entirely. It is therefore urgently necessary that those who are in a position to contribute should do so at once. The cause speaks for itself, and we are sure that Mr. Newton's appeal will not be made in vain.

One wonders when Mr. Lloyd George told a deputation of a Labour Party Conference last March that their programme

of Land Reform was simply a method of acquiring the land of the country without paying for it, and that, while they were willing to pay railway shareholders the market value of their shares, they wanted to tax land to its full value, whether he was already conscious of the failure, financially, of his own experiments in that direction. That they would fail we have always contended, and the annual report of the Property Protection Society gives facts and figures which prove that they have. The total cost of the new land value duties (apart from the mineral rights duty) from their imposition in 1910 until March 31, 1916, was over £3,389,000, while the payments into the Exchequer barely exceeded £746,000, a loss of over £2,643,000. Even allowing for alleged gains on account of an increase of estate and succession duties and of stamps on voluntary gifts of land, there remains an indisputable net loss of over £1,500,000 by March 31, 1916. During the year ended March 31, 1917, the Department cost £315,000, and yielded only £85,000, a further loss of £230,000. For the current year the cost is estimated at £370,000 and the receipts at £45,000, another and still heavier loss. Dismissing all other considerations, it is evident that no more abortive financial measures have ever been adopted by any British Chancellor of the Exchequer. The worst of it is, no one yet knows the far greater loss they have caused to all concerned, directly and indirectly, and the wonder is that Mr. Lloyd George, who knows it, does not frankly admit his blunder and repeal the iniquitous and disastrous legislation which has crippled enterprise and made so many thousands homeless.

The "Comedy of Convocation" was a clever skit about the Church, in the old days before the war. But the Comedy of the Courts of Law is far richer in humour, especially in the present period shortly styled "for the duration." As always with comedy, there is a downward tendency to farce, and in the recent case of "Tozer v. Viola" we seem to reach bottom. This all arose out of the Emergency Act, 1916, one clause of which was intended to enable men fighting for

us at the Front, to get free from the legal fetters of a lease or tenancy on which they were liable. The plaintiff was lessee of a term for twenty years from 1906, determinable by him in 1920, and the defendant was his lessor. The plaintiff had assigned this lease, with defendant's consent, in 1910. The assignee, one Spero, having joined the Army and finding himself liable under the lease for £500 a year as the rent of these London premises, in March, 1916, applied to the County Court for leave to determine the tenancy under the Emergency Act. There the judge, acting under the statute passed for this purpose, made the order ending the tenancy, as regards the assignee, and provided that the rights and liabilities of third parties should not be affected. Then the landlord, having no claim for rent against Spero, the assignee, turned to the original lessee, Tozer, the plaintiff here, who thereupon, in his turn, brought this action, asking the Court to declare that the effect of the County Court order was to end the lease altogether and so release him. Mr. Justice Asthury took this view, holding that if the plaintiff, as lessee, remained liable on the lease, the soldier assignee must indemnify him, and so would not get the discharge which the Act intended. On appeal, however, all this was reversed by three Lords Justices, who held that the lease still stood binding on the lessee, although the assignee was freed and notwithstanding the statute which was intended to meet this emergency, so there was judgment for the defendant. In fact, the Court of Appeal held on tight to the Law of Conveyance against the shock of war, and now people are asking what really is the effect of our Emergency Legislation and who moves next?

Dr. J. Charles Cox, who is contributing some interesting articles to the *Tablet* on "Some Ancient Sussex Churches," writing about the church of St. Peter, East Blatchington, remarks that it stands in a well-kept churchyard; but is somewhat spoilt by the great variety and over-luxuriant growth of creepers, most of which are not indigenous to England, and on the south side almost conceal the fabric. A good deal of the south wall of

the nave is effectively concealed, and one window completely obscured by a rampant, thick-stemmed wistaria, which is now beginning to trespass still further over the distinctly unusual surface of the chancel. In some places this well-grown and most aggressive shrub might look well, especially if it concealed the brick-work or stucco of some new or garish villa residence; but surely it is quite out of place in hiding out of sight the ancient walling of one of old England's parish churches. Other parts of the fabric, such as the porch, are blocked out of view by artificially trained masses of ampelopsis, clematis, passion flowers, and virginia and other creepers. We have ourselves protested against the overgrowth of ivy permitted on some churches, to the distinct detriment of the stonework; but, after all, as Dr. Cox says, ivy is a modest-looking creeper and eminently English; but to smother church walls with creepers is bad taste and pernicious, especially when the walling is old.

The National Painters' and Decorators' Joint Council has addressed a strong remonstrance to Mr. Churchill, declaring:—(1) That the regulation prohibiting the use of white lead without permit is not being enforced; (2) that great waste of this material is the normal condition of affairs on Government, and particularly on Admiralty, work; (3) that controlled firms are apparently free to use white lead without restriction; (4) that this valuable pigment is being used unnecessarily on temporary war structures, while its use is denied on permanent public buildings of National value; and (5) that the officials of the department have caused great loss and inconvenience by inexcusable neglect of correspondence. Each of these charges seems certainly proved by ample evidence. As regards the controlled establishments, an instance is given of a small munition works which had to be painted. Enough white lead was secured on permit to do the work, to enable the master painter who did the job to paint the outside of a mill, contract £130, to enable him to offer to sell a quantity of white lead to anyone wanting any. In the first place, the works no more needed white lead than any other job. The mill could have waited, or have been done with a substitute. Secondly, the works, in common with hundreds of others, considering the times, did not need painting. The cost is put through current account while profits are big to save payment, to that extent, of excess profits duty. In fact, an extra coat of paint was put on, and the painter told he might as well have the money as the Government. This kind of thing, it is alleged, is taking place all over the country. On the declaration of the Government that supplies were insufficient for a reasonable rationing system, the Council asked for a real and rigid application of the prohibitive regulations, and that Government departments should exercise reasonable economy in their use of this valuable material, but no such economy is practised. The painting industry is as patriotic as any other. It asks for no privilege, and is prepared for

any sacrifice that may be necessary in the National interest. But it has surely the right to ask, when regulations of a drastic character affecting the trade are introduced, that they shall be administered competently, and in such a manner that the honourable employer is at least on an equality with his less scrupulous competitor. The present position is chaotic, and the protest is a reasonable one. How far it may be heeded remains to be seen.

We hear of good results from the adoption of Mr. Kemp Prosser's curative colour schemes for hospital patients, and are of opinion that the idea is capable of very wide and beneficial application, if the co-operation of the really reliable colour-maker can be secured. As the *Engineer* remarks, most business people spend, let us say, from one-half to two-thirds of their working hours in their offices. Does it not then seem extraordinary that they should tolerate so often bare and repellent chambers that would disgrace a barracks, and be disowned by a monastery? There is no reason save indifference for this state of things, no reason why walls should not be papered, or painted, or distempred in pleasant colours; no reason, in fine, why the rooms people work in should not be as pleasant as those they live in—or if there is a reason it is a no better one than the bad old tradition that the office is made for work and not for comfort. The same tradition used to hold sway in the shops, but is being gradually worn down, and we see many a good attempt to make the surroundings of factory hands as agreeable as the circumstances will permit. Managers know full well that they cannot get the highest class of work in unlighted, ill-lighted, uncomfortable shops. Make them more cheerful, happier, brighter places, and the people who work in them will be happier and brighter, too. The work will be done more quickly, it will be better done, and there will be fewer tired faces at the day's end, which is all as true as gospel. Given good colour and the brains to use it, the decorator may well take his place in the near future as the dominant disperser of disease, and the chief apostle of renewed vitality.

#### THE VILLAGE BUILDER.

Now that the State, or the Local Authorities, or another brand new Director of Housing, are going to build houses by the thousand to standardised plans, and, too probably, with half-skilled labour of the sort that has been rushing up temporary war buildings of all descriptions of late, it is, perhaps, worth while to recall the conditions under which the village dwellings still left to us were put up, and whether we are likely to get as good at the hands of the post-war successor of the old village builder, supervised by officials of all sorts, and harassed by enthusiasts, who, on the strength of achievements in the way of "garden cities" and the like, are for the present enlightening the public with glowing exhibitions of their capability. The early village builder had no such golden opportunities of learning his business. Undistracted by railways, telegrams and newspapers, he rose to his work at sunrise and worked till sunset.

About his only recreation traceable in the records of the time seems to have been in connection with the erection of the scaffolds on which the mystery or miracle plays were performed, in which he was not above taking part with his neighbours at Lent or Whitsuntide.

But, quiet and uneventful as the mason's life was, it had its responsibilities. There was, it is true, seldom an architect or clerk of the works or parish council to bother him, or bear the blame of his sins of omission or commission. They and the clergy built the castles and palaces and churches of the Middle Ages; he lived among his neighbours, who were not slow to call him to account if the stone he had set perished because it had been edge-bedded, or his weathering was too flat and let the wet through, or his string courses lacked a proper throating, or his quoins drew out because of the wear and tear of the casements which hung on them. Before his time, which extended, say, from the fourteenth to the seventeenth century, such work of the sort as remains was mostly done by the companies of "freestone masons," who went about from place to place and bore the blame cheerfully enough—if there was any cause for such—at a safe distance from the scene of their shortcomings. Our village builder had no such scapegoats with which to saddle his sins, for bad roads made the ingress of strangers of his craft rare indeed.

He first comes into notice, as we have said, soon after the Black Death, when the old guilds of craftsmen were half destroyed, when wages were high, and when the changes of the times were, on the whole, favourable to the workers, whose wages, at any rate, never fell back to their old meagre figures, and when farmers who grew the food, and the tradesfolk who supplied the necessities of life began to find the masses their best customers, and to want barns and stores and cottages built of something better than cob, and called in the "mason," who knew something about the merits or demerits of the local stone and could chatter off an aris or splay off a sill in more or less workmanlike fashion. Little more was needed. It is the village of our own time who has been educated by cheap newspapers and board schools into civilisation who wants "ornament" and gets it, and all the other blessings of modern life.

Here and there, in the remoter and still isolated villages of the West, for instance, the village mason still survives, and his work lasts; but, for the most part, he is the representative of the Georgian and Early Victorian local builder who believed in shams of all sorts. He is already in evidence in some of the garden cities, and he will be more so presently, if, as not infrequently happens, he or his friends are in the local councils, and resolved to work "for the good of the working man" who is too busy looking after his rights if at home, and—let that not be forgotten—too gallantly and entirely occupied in the defence of the realm to have much time to spare for meditating on the nature and fitness of the houses he is assured are to be his when the war is over.

And yet, if, somehow, the Fates were kind, such an opportunity for the fostering of local craft has seldom been apparent. If, as we confidently believe, with the return of the labourer to the land and many of the local industries which minister to his needs, surely from amongst such, as of old, the trained members of the second great group of industries in the Kingdom, under the guidance

of those familiar with the wants and facilities of the widely differing districts even of this small island, might find wholesome occupation for half-a-century and write such a chapter in our history, but on a far broader scale than that which marks the 400 years during which the village builder prospered, and of whose work here and there the remnants remain?

We all know its landmarks well. There was the soft freestone district which runs across England from Somerset in the south-west to Lincoln in the north-west, pre-eminently a mason's district, because stone, sometimes ashlar and sometimes rubble, was easy to cut and work, and so the old villages were mostly of stone. There was the hard stone district in Northumberland and Durham, and the slate district in South Devon and Cornwall, and in Wales, where the self-sufficiency of the owners and the constant disputes of the masters and workers had not as yet half-ruined one of the staple industries of the Principality. There was the central forest tract reaching from the New Forest to the Scottish border, where wood was plentiful, and the carpenters and joiners and bricklayers and plasterers were always busy. There was the great Essex forest, also yielding good timber, but practically no freestone. But there were flints and bits of Roman bricks, which did duty till later times, when modern brickwork spread through the country and made carpenters and plasterers less in demand alike. Few forest cottages remained, probably because their construction was less solid than that of Greensted Church, near Ongar, built as a "temporary" house the body of St. Edmund during its slow progress to Bury St. Edmunds. Later the half-timbered cottage, with its rough filling of rough flints, or lime and gravel concrete, gave place to the cheaper and less troublesome method of plastering the dwelling all over except the roof, giving some relief to the surface by pargetting, or texture by stamping it with the ends or small twigs tied together in a bundle. Brick was little used till well nigh the end of the eighteenth century, when throughout the country the drab and dreary time befogged all architecture from the maison with its lead flats and sham paper cornices, and the rest of the shams which grew more and more hideous and unreal till a time within the memory of some.

May we escape the perpetration of something worse. May the village builder find scope and capability to write an honest, if humble, record of the revival of the English home in the villages. They well deserve it who are dying daily to keep such an apology for it as exists inviolate from the Hun, and may science give us deliverance from the smoke-laden skies and the polluted streams that have blasted the landscape and degraded the worker, so that once again art may lighten labour and comfort reward honest toil.

Funds are being raised for the erection of a pathological laboratory in connection with the Northampton General Hospital. The scheme will cost £3,000.

On Monday week, at a special meeting of Cardiff City Council, a letter was read from Mr. E. L. Morgan, borough engineer and surveyor of Bolton, declining the position of city engineer and surveyor of Cardiff, to which he was recently appointed, as the climate of Cardiff would not suit his wife's health. The resignation was accepted, and it was resolved to ask Mr. S. E. Burgess, borough engineer of Middlesbrough, and Mr. E. J. Elford, borough engineer of Southend-on-Sea, whether they would still be open to take up the appointment if it were decided to offer it to either of them.

### BUILDING A CONCRETE HOUSE IN THREE DAYS.

The American Steel and Wire Company is at the present time developing a small town site, in which the dwellings are of concrete. About 100 buildings are being erected, and the contractors have developed methods which result in great speed. By the use of steel forms and contract methods similar to those used on large construction, the completion of one house every three days has been attained. The methods of construction and the organisation are described in an article in the *Engineering News-Record*, from which the following notes are obtained:—

The success of the work is due primarily to the application of orderly contract methods to a design which was well worked out in the first place. The contractor did not come on the job until after some few houses had been completed, at great trouble and expense, by a contractor of less experience, so it is fair to assume that the methods now used are of at least as much importance as the original design. In fact, the contractor considers that in future developments changes in design could be profitably made.

#### EIGHT STYLES OF HOUSES.

The houses were designed by the Lambie Concrete House Corporation, of Boston, Mass. Eight different styles of houses are being built, containing some four, some five, and some six rooms, all with a bath and cellar. Of these, a few are being built in pairs with party walls, and the rest are all detached. The contract prices for a house complete range from 2,000 dollars to 3,500 dollars, but such costs are based on prices for some time ago, and can hardly be used for present comparison. The costs include gas furnaces and cooking ranges, electric lighting, and the usual improved kitchen and bathroom equipment. The average floor area is 26 ft. by 26 ft.

The houses are all of the box type, with 6-in. solid concrete walls reinforced vertically on both faces and horizontally on the outer face with straight rods, an intermediate partition wall cutting down the floor space to 12 to 15 ft. The floors are of the ribbed reinforced-concrete type, with the ribs or beams spanning between the outer and interior walls. These ribs are left exposed in the cellar; but in the other floors plaster board is nailed to strips left in the concrete and a finish plaster coat made. The buildings are finished at the top with a reinforced-concrete cornice, in which a gutter is formed, and on top of the ceilings a roof is built up of spruce framing covered with asbestos slate, so that the whole of the exterior of the building, with the exception of this frame, the wooden window and door frames, and wood stairs, is fire resisting.

#### SPECIAL STEEL FORMS EFFECTIVELY USED.

An important factor in the efficiency of the work is the forms. These are of the steel channel type patented by the Lambie Concrete House Corporation. They consist of 9-inch channels set up vertically and connected together with clips and wedges passing through slotted holes in the flanges of the channels. At the corner of the building a 4 by 4 inch steel angle is set up, and the forms are lined up longitudinally by means of a steel channel used to form a belt course. This not only fastens the forms of the lower floor, but is bolted into the floor reinforcement and remains in place for a support for the second-story forms, and is only stripped at the last when all the concrete is poured. The steel wall forms also support the floor forms, which are steel domes, arrangement being made by which the steel channels on which the domes are laid are bolted to the inner side of the steel wall forms. The cornice has to be built inside special wood forms supported by wooden struts reaching down to the belt-course channel form.

The cellars were excavated with a steam shovel which went down a street, taking out a strip the depth of the houses. The space between the walls of the houses is backfilled after the cellar walls are placed. The digging

was in hard pan with some shale, but all of it was taken out by the steam shovel.

#### FORMS MOVED FROM ONE HOUSE TO NEXT.

The construction of the houses proper is done in groups, to fit the number of sets of forms, which are taken down as soon as possible and moved on to the next group.

The usual method is to set the forms of one story—wall and floor together—and then to pour the concrete for this section all at once. The progress of the job is limited by the setting of the concrete. To form, pour and strip each story takes about seven days. Working at this rate, the house of two floors and cellar is completely concreted in three weeks, and with the twelve sets of forms on the job, twelve houses are concreted in this period. After this the plumbing, heating, plastering, roofing and finish are done, which take about five weeks more, so that the houses are being completed at the rate of twelve in the first eight weeks and twelve every three weeks thereafter.

During the months of May, June and July the progress made was as follows: 28 complete houses (counting double houses as one) were erected in 12½ weeks, or at the rate of a house every three days. In the last month quite a number of houses were concreted very quickly—that is, from the day starting erecting basement wall forms on the footings, to and including the day the roofs were concreted. The last houses have gone up as follows: Two in 13 calendar days, one of which could have been done in 12, except for shortage of sand, 2 in 14 days, 5 in 15 days, 2 in 16 days, 2 in 17 days, 3 in 19 days, 1 in 20 days, and 1 in 21 days. Under ordinary conditions these houses could have been built with one set of forms.

#### CONCRETE TOWER REPLACED BY SMALL HOISTS.

In the original contract for the houses, concrete was placed from a high stationary tower, with a chute. This proved inefficient, because of the number of moves that had to be made to control the whole housing area. There is so small an amount of concrete in each house, 125 cubic yards on the average, and the houses are so scattered, that the cost per yard of concrete was materially increased by the cost of the tower erection and construction. After a long study of different methods, the Abergthaw Company decided on small mobile concrete mixers, which could be placed alongside each house during concrete placing, and small hoists on each building.

The plant consists of three Koehring "Dandie" one-bag gasoline-driven mixers, two of which are equipped with side loaders, three Sagen circle swing derricks; two Novo gasoline-driven hoists, which control derrick and mixer. The slag aggregate, and sand, as well as the cement, are delivered to the mixer by means of a track, which brings the material from the contractor's unloading yard, located in the yard of the American Steel and Wire Company.

The Sagen derrick is not used for pouring the basement and first floor, but is used for all concreting above that. It is bolted securely to the best course on one corner of the building, and the concrete is hoisted in concrete buggies or wheelbarrows. Better results have been obtained with the buggies than with the wheelbarrows. Each wheelbarrow has a hook bolted to the front end, and is lifted by the derrick by means of three steel arms with rings on the ends, two of which hitch to the handles and the third into the hook on the barrow, so that it is lifted completely and level on to the floor.

#### HOW THE ORGANISATION WORKS.

The organisation on the job is a superintendent, assistant superintendent, civil engineer, material clerk, two cost clerks, time-keeper, planning department and stenographer. The formwork is under supervision of one carpenter foreman, five squad bosses, two stripping foremen, two move foremen, one reinforcing steel boss, one finish carpentry boss, three concrete bosses and one excavation boss.

It was found advisable to have a squad boss in charge of the carpenters and helpers working on each house. This boss has four carpenters and four helpers on the smaller houses; and on the large double houses, up to



seven carpenters and seven helpers. The work has been most economically done when the carpenters and helpers worked in pairs—that is, each carpenter has a helper to assist him in moving the forms, etc. It will be noticed that the reinforcing steel boss comes under the carpenter foremen. This has been found desirable, as the steel must be placed rapidly whenever the carpenters are ready for it. The planning department on the job lays out progress each day for the next three days and shows which foreman is to erect forms on each house and which concrete gang will pour them.

**FIVE CARPENTER GANGS ERECT FORMS.**

The number of men in a concrete gang varies from thirteen to fifteen, according to the type of house and the amount of concrete to be poured. The number of gangs at work at the

half a day to a day to this. Concreting the walls takes about 2½ hours, and the roof about the same length of time.

**DETAIL COSTS ARE GIVEN.**

The steel reinforcement varies from 1½ tons in the smallest type of single houses to three tons in the largest type of double houses. The labour on wall steel has cost to date 11.90 dols. a ton, and the floor steel or beam steel 7.50 dols. a ton. The cost of labour on wall forms to date has been 4.30 dols. a hundred square feet, and the stripping has been 2.10 dols. This does not include the moving of forms on to the lots, which has cost about 55 dols. per house, or about 1.25 dols. per 100 sq. feet of wall.

The quantities of concrete per house vary from 145 cubic yards for the largest double house down to 85 for the smaller single houses.

**Building Intelligence.**

**FORT AUGUSTUS.**—On Tuesday, November 13, the new Abbey Church was solemnly blessed and opened in the presence of the Bishop of Aberdeen. For the first few years the monks had their chapel in various parts of the monastery, until on August 23, 1880, a church of wood and iron was formally opened. Later on Mr. Peter Paul Pugin was requested to prepare plans for an elaborate Gothic edifice, and the first sod was cut in December, 1889, the foundation stone being laid in September of the following year. The work went on until March, 1895, when operations came to a standstill through want of funds. The building just beginning to rise

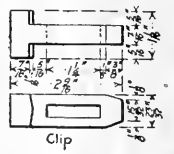
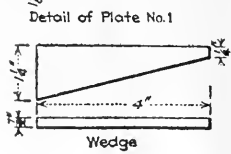
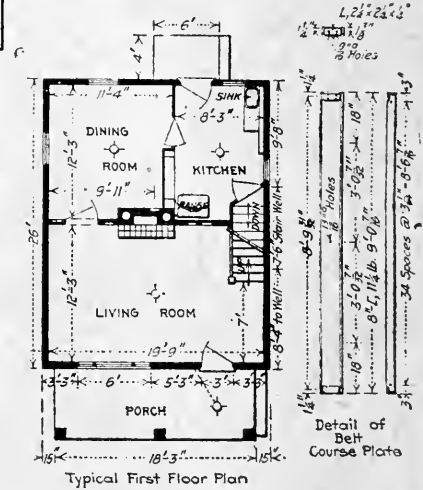
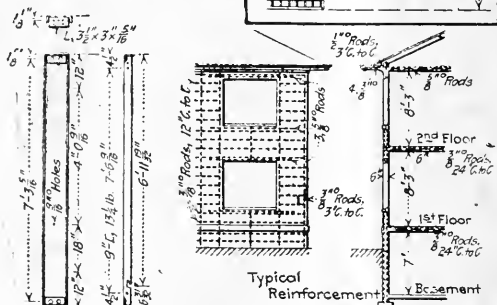
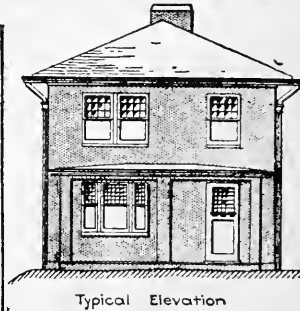
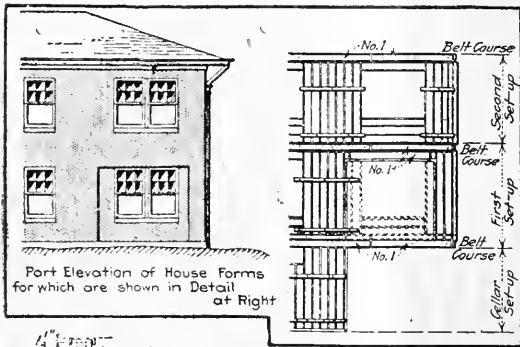

Details of houses, reinforcing and steel forms.

same time is five carpenter gangs erecting forms, two concrete gangs concreting forms, two strapping gangs stripping forms, one concrete gang concreting footings, pavings, porch floors, floor steps, chimneys, etc., one digging gang, and one finish carpentry gang, doing the turning, roof framing and roof boarding, meeting door and window frames, sash, doors, inside and outside trim, stair laying, floors, etc.

On a large type six room house group this form has taken approximately 1½ days to erect basement walls and first floor forms, including all bases, window frames, flues, etc. concreting basement walls takes about 2½ hours and 1½ hours to pour the floor. Stripping and erecting the basement wall forms on the first story takes 1½ to 2 days. The stripping of the first story walls and erecting the second story and putting on the floor takes about 1½ days, but the putting on of the ceiling is a slower operation and adds from

This includes all walls and floors, footings, pavings, porches, and chimneys. At the present time it is costing about 2.25 dols. per cubic yard to place the concrete in the first and second storey walls, which are 6 inch walls, and it costs the same for the floor slabs. The smaller houses have about 15 cubic yards of concrete in the first or second-storey walls, and 6 cubic yards of concrete in the first and second floors. The roof, including the cornice, has about 10 cubic yards. The cost of erecting the form work, including handling, stripping and cleaning, is averaging about 50c. per square foot. As no lumber is required for the wall forms, this is doubtless considerably cheaper than work of this class could be done in wood.

A large brick-kiln at Fletton, Peterborough, which has been closed for two years, is being reopened with woman labour.

stood untouched till June, 1914. In 1912, Mr. Fairlie, of Edinburgh, had been entrusted with the task of preparing new plans and he designed the church in the Norman style, which has now been realised. The war threatened to interfere with the carrying out of this plan, but slowly the choir and the various chapels have been brought to completion. Much yet remains to be done: the sanctuary is still to be built, and the nave still wanting, but what has been finished is an earnest of the stately church of the future. The contractors for the mason work were Messrs. Reid and Son, Catrine, Ayrshire. The woodwork, including the hammer-beam roof of the choir and the panelled ceiling of the Blessed Sacrament Chapel, was executed by Messrs. Grieve, Edinburgh. The heating and electric light installation are by Messrs. Mackenzie and Moncur, Edinburgh. Mr. Charles Grant, Fort Augustus, acted as clerk of the works throughout.

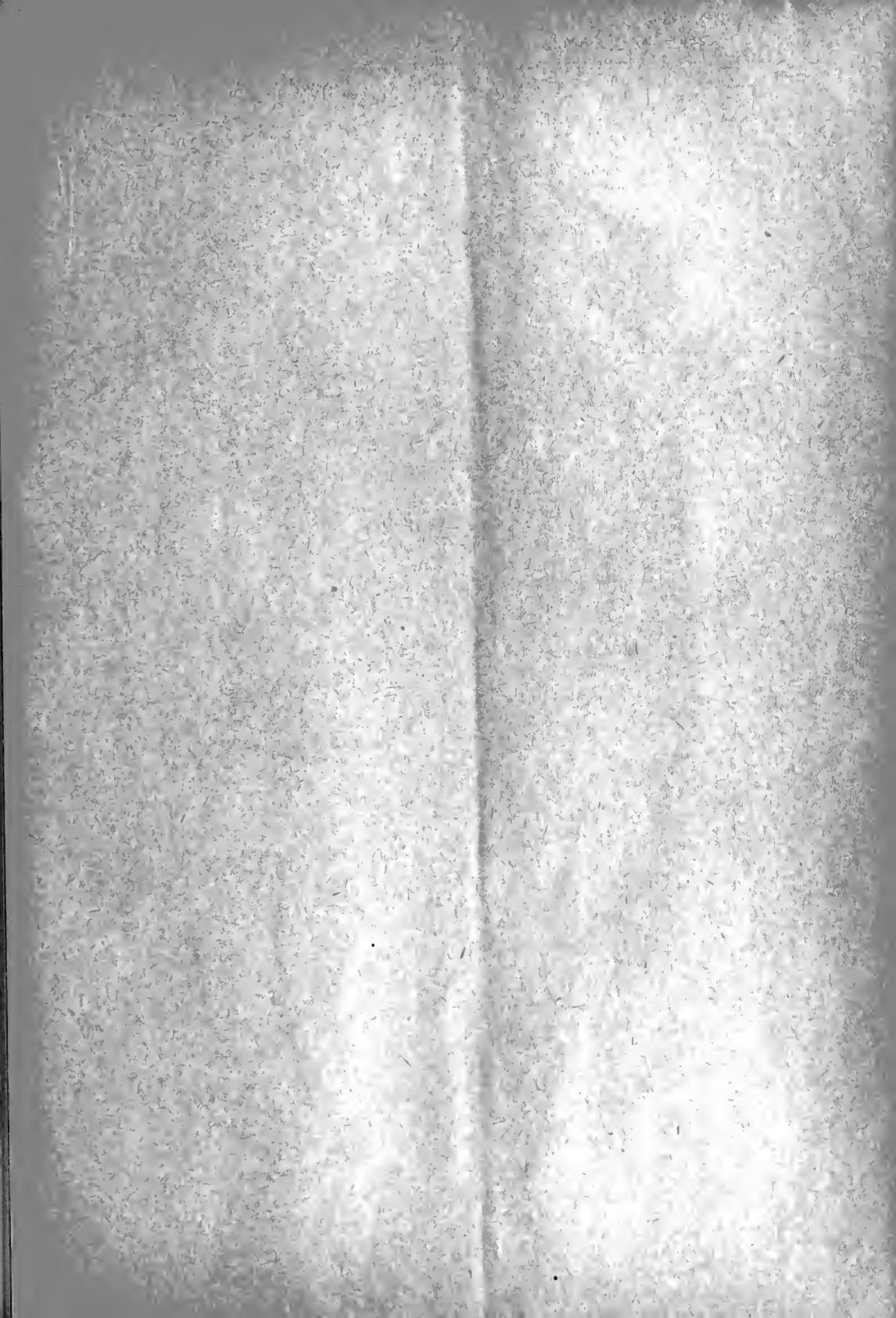

THE BUILDING NEWS, NOVEMBER 28, 1917.

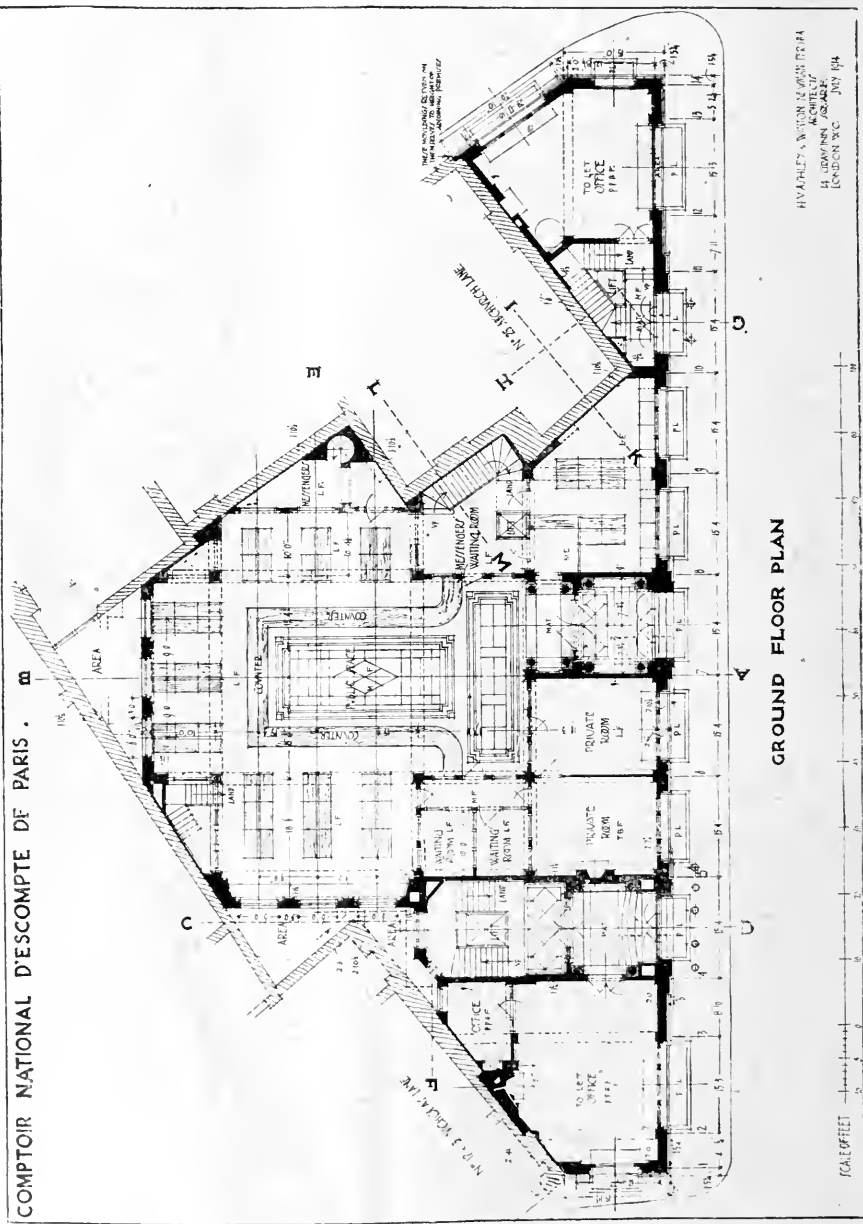

GROUND FLOOR PLAN

HIVARLEY & WILSON ARCHT. CONSULTANTS  
11, ADELPHI GARDENS, LONDON W.C.2  
JULY 1914





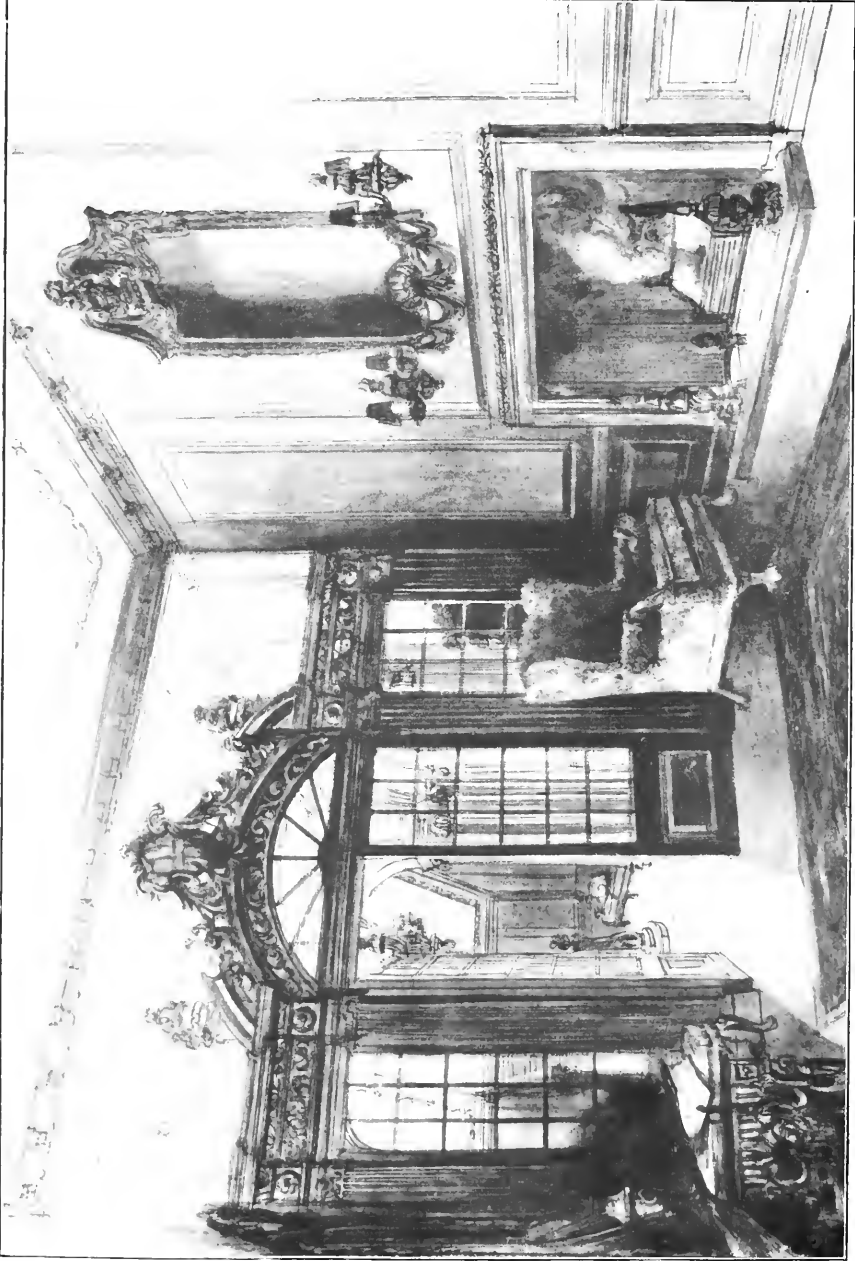

AN ENTRANCE AND STAIRCASE HALL, By MR. CHARLES WADDE.  
(From a Water Colour at the Royal Academy.)



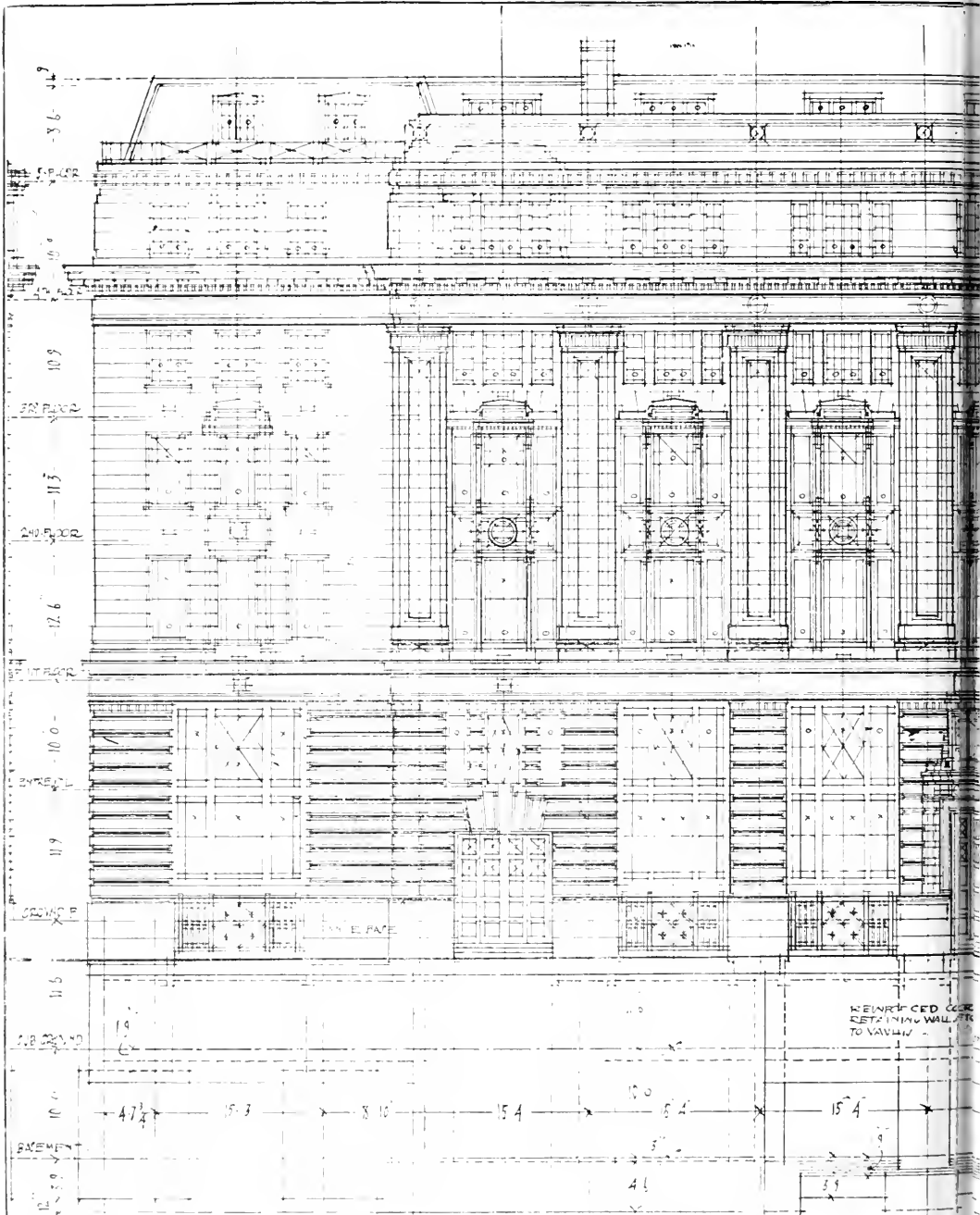

E

ELEVATION TO KING

SCALE OF FEET



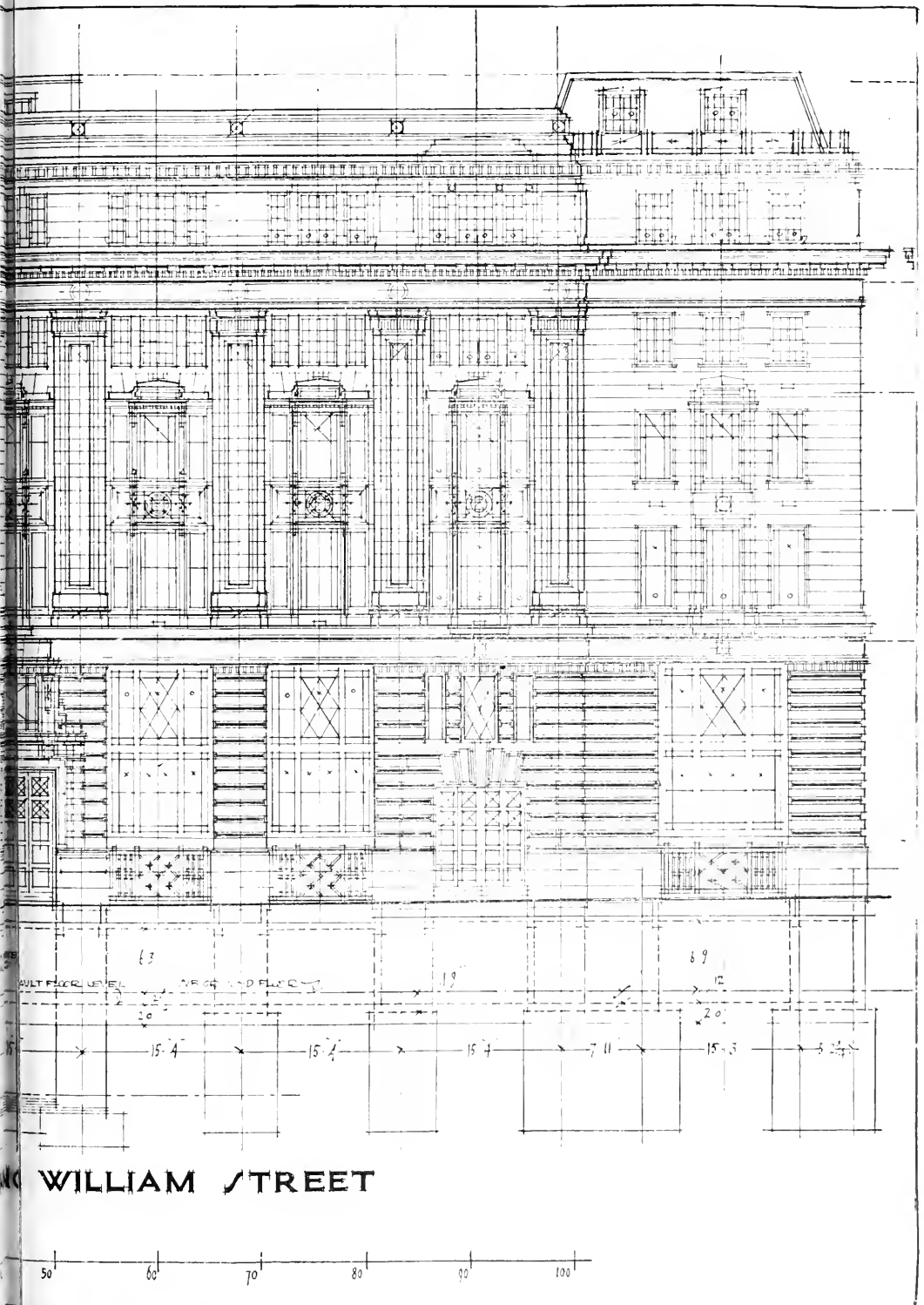

WILLIAM STREET



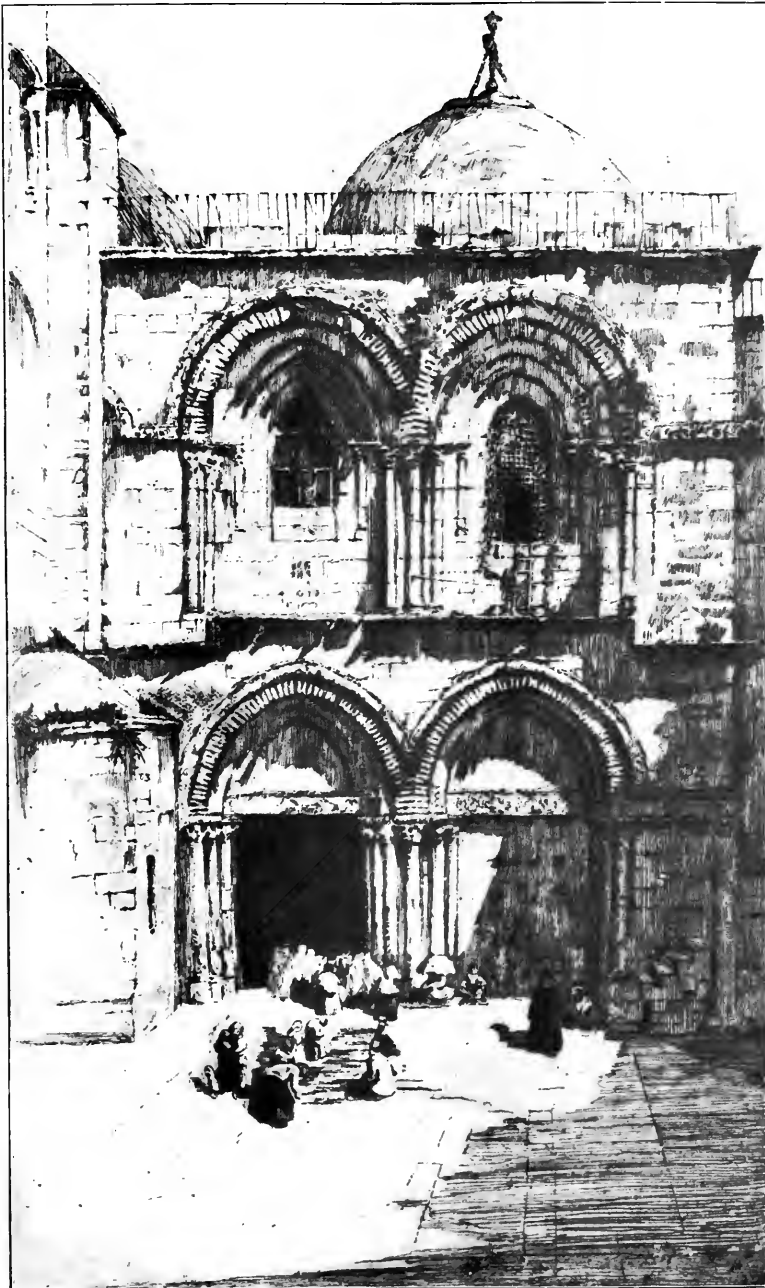

CHURCH OF THE HOLY SEPULCHRE, JERUSALEM.

From an Etching by M. K. HUGHES, A.R.E. (Royal Academy Exhibition of Graphic Art.)





COMPTOIR NATIONAL DESCOMPTE DE PARIS.

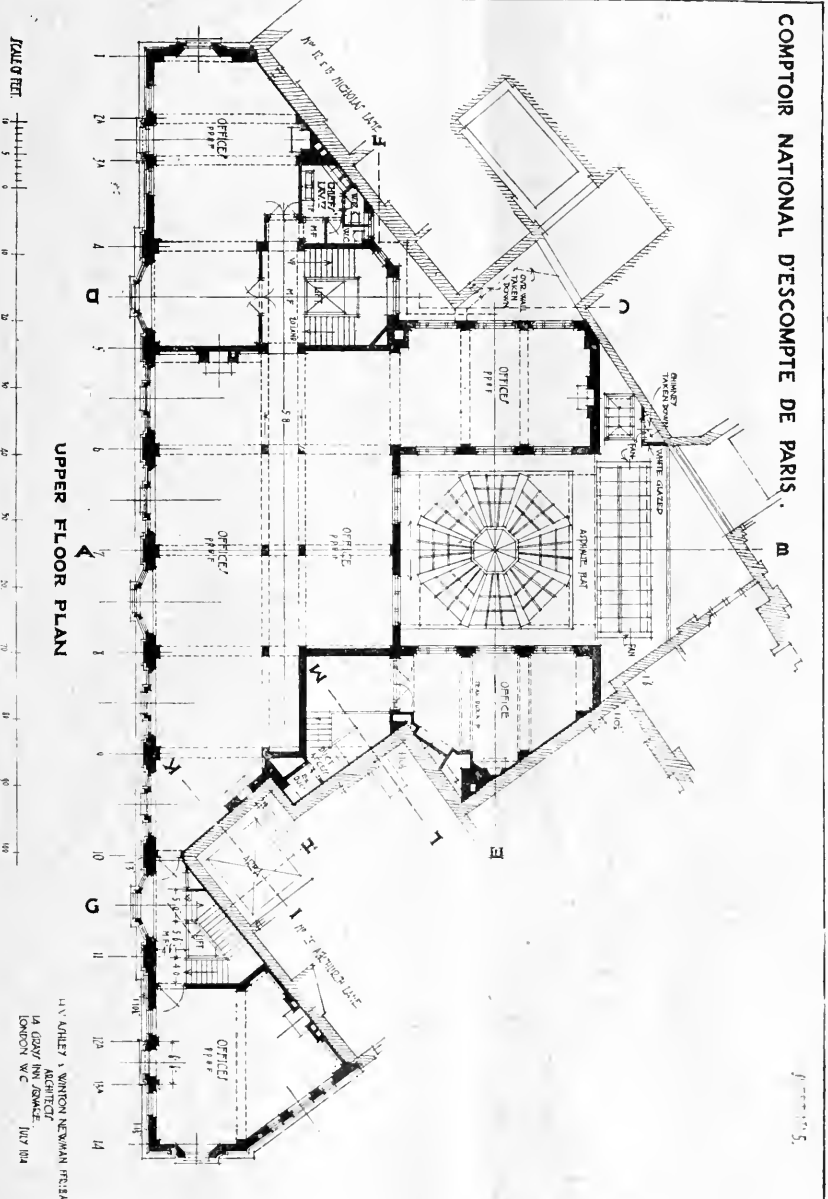

UPPER FLOOR PLAN

SCALE IN FEET



J. G. 11. 15  
L. V. GIBBY & WINTON NEWMAN ARCHTS.  
14, COVE LN. SWANSE.  
LONDON W.C.

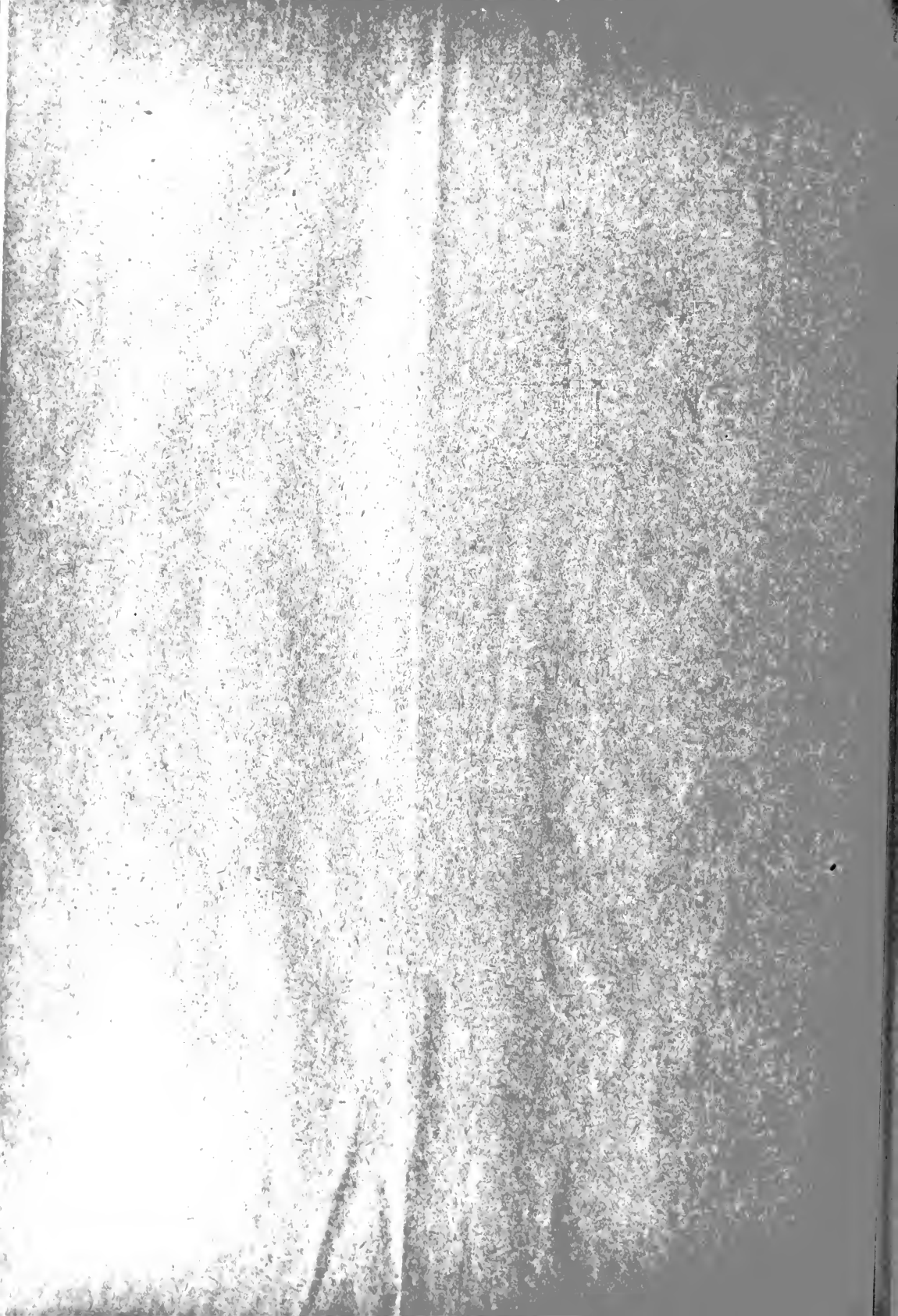

## Our Illustrations.

### THE COMPTOIR NATIONAL D'ESCOMPTE DE PARIS, KING WILLIAM STREET, LONDON, E.C.

This building, lately completed, has a fine frontage, an awkward site, and an exceedingly capable plan, (which, notwithstanding the irregular shape of the land, has symmetrical and well-arranged apartments. The architects are Messrs. H. V. Ashley and Winton Newman, F.R.I.B.A., of Gray's Inn. We give working drawings to-day of the main façade and two principal plans. Next week we propose to give the subsidiary elevations and a large section of the Banking Hall, which is placed centrally on the site. To the left of the entry are the manager's rooms, with waiting-rooms, the stock departments being put on the right, as well as the staircase leading to the board-room and sub-ground floor. The accommodation provided is for over ninety clerks on the hall level floor, and over forty more on the central level which overlooks the hall. Below stairs there are desks for seventy clerks, the cloak-rooms being placed at the rear, with messengers rooms, book storage, and strong-rooms. These latter are well shut off, and have lifts in situ. These strong-rooms are about 28 ft. by 14 ft., and consist of a series of four isolated by steel doors. Daylight lighting has been provided freely everywhere. The upper floors are planned for letting, and a separate large entrance hall and staircase opens out of King William Street with lifts. A third doorway is situated to the right of the front. The construction is steel framed of fire resisting character. The facing of the exterior is in Portland stone, and inside marble has been freely used, the walls having Piastaccia-quartered panels with bands of "second statuary," statuary veined and black, the architraves being in Ashburton (Devon) marble. The dado is in brecciated sienna. Asphalt was used for the flat roofs and slopes, reveals of windows and vertical cheeks. The coverings of the concrete ribs of the spherical light over the hall in the area formed a specially difficult problem to efficiently execute. The heating is by gas sub-divided for economic control. The Comptoir National D'Escompte is one of the leading banks in France, and the style adopted is Parisian in feeling. Messrs. Higgs and Hill, Ltd., were the builders. Messrs. Hobbs, Hart and Co. supplied the strong-room doors, and the lifts and cranes were furnished by Messrs. Waygood-Otis, Ltd. The staircases were supplied by Messrs. Hayward, Ltd.

### AN ENTRANCE AND STAIRCASE HALL.

This illustration shows an entrance hall, inspired from the work of Sir Christopher Wren. The view is from the entrance, looking towards the staircase through a dividing screen, which is adapted from the screen in St. Dunstan's Chapel, St. Paul's Cathedral. The arches are supported by Ionic columns, the frieze and ceiling are in richly decorated plasterwork, the woodwork is of oak, dull finish, and the carving on the newels and balusters of staircase are gilt. The wall brackets are gilt, and like the large centre lights are adapted to the method of lighting, and in the main hall concealed lights are set above the cornice. The window hangings are of red and gold Venetian velvet. Chippendale furniture and rich carpets give colour to the scheme. The drawing was exhibited this year at the Royal Academy. The work was designed by Mr. Alfred Chas. Wade, of Forest Gate.

### CHURCH OF THE HOLY SEPULCHRE, JERUSALEM.

The etching by M. K. Hughes, A.R.E., was shown at the Royal Academy Exhibition of Graphic Art this year, and just now the military success of the British and our Allies in Palestine, including the investiture of Jerusalem, considerably adds to the interest of this historic building. The artist writes that there is so much that is beautiful architecturally and memorable about "the Holy Sepulchre Church at Jerusalem that I do not know what to say about the

building which occupies the site of that built by Constantine. My view is of the south façade. One of the slabs in front of the doors is the tombstone of an English Crusader. To protect the pilgrims visiting this building the Order of St. John of Jerusalem owed its origin in the tenth century. The ornamentation of deep dentils enriching the archways are said to be late Romanesque. There are two big doorways with bas-reliefs over. The one still open has a bas relief of Christian subjects. Probably this is French work of the twelfth century. The other, over the walled-up door, is of Pagan design. The marble pillars most likely were taken from some more ancient temple. I made my etching from a water-colour, and the whole of the building is of a reddish stone. In the fronts are beggars and traders who sell their rosaries and such-like things to pilgrims, who are chiefly Russian peasants, and who come in their thousands, especially at Easter time. "The Church of the Holy Sepulchre, the centre of pilgrimages since the fourth century, shows a chance piece of symbolism, as early as it is unintentional, and this is connected with the main doorways. It interested me very much. The Pagan and Christian designs over the closed and open entrances, which are so very completely united together, emphasise the truth of the linking-up of all ages to Christian belief."

### PROFESSIONAL AND TRADE SOCIETIES.

**THE ARCHITECTURAL ASSOCIATION.**—At an ordinary general meeting held yesterday afternoon, at 5.30 p.m., Mr. H. V. Lancaster, F.R.I.B.A., opened a discussion on his proposals for "Social Circles for Architects after the War."

**THE LONDON ASSOCIATION OF MASTER DECORATORS.**—At the last meeting of the Executive Committee, at which were present Mr. W. Stewart Greene, Mr. T. S. Bowden, Mr. John Anderson, Mr. S. Godfrey Giles, Mr. C. E. Campbell, and Mr. J. Davidson, Secretary, a report by representatives of the Joint Council was submitted on the question of wages, country money, and the employment of disabled soldiers. With regard to wages, it was resolved to accept the recommendation of the Joint Council that the Association should become parties to Sir Wm. Robinson's awards of May 14 and October 25, 1917, so far as operatives engaged upon munitions work are concerned, whereby the rate of pay for such work has been increased by 1½d. per hour, thus bringing the rate up to 1s. 0½d. per hour, including bonus. With regard to country money, it was pointed out that as it was understood that a movement was in progress by the Government to set up a committee to deal with the wages question throughout the country, any attempt by the Association to settle in a formal manner the country money would be inopportune. It was reported that a conference was about to take place between the Secretary of the Disabled Soldiers' Pensions Fund and the Joint Council, when the question of the better training of the soldiers would be dealt with. The question of appointing a President, Vice-President, Council, and other office bearers for the ensuing year was considered, and following the course adopted by the National Association, it was recommended that during the present state of affairs the President, Vice-President, and other office bearers, as well as the Council, should be re-elected at the forthcoming general meeting. A draft annual report, as prepared by the Secretary, was considered, and, after amendment, was referred to the Secretary and Mr. Stewart Greene to complete and issue.

**SCOTTISH SCULPTOR ON WAR MEMORIALS.**—Dr. Pittendrigh Macgregor, R.S.A., gave the opening lecture of the sixtieth session of the Edinburgh Architectural Association last Thursday night in the Lecture Room of the Royal Scottish Academy on "Sculpture, Nationality, and War Memorials." The lecturer addressed evidence in support of the statement that in its higher ranges sculpture

could scarcely, after a hundred years' effort, be said to exist in Scotland. The art apparently suffered with them from lack of public encouragement and from the proximity of "Octopus London." He commented upon the fact that their National Gallery was without a sculpture section, and had practically done nothing with the funds at its disposal for sculpture, and criticised the composition of the Board of the Gallery because of its being, with one exception, in the hands of laymen. He suggested that there should be a more unimpeachably representative and better qualified Board, the majority of whom would be artist painters, sculptors, and architects. He complained of the apathy of Edinburgh towards the fine arts, and cited the experience of the R.S.A. in connection with its exhibitions. Within the last thirty years the annual return from these had gradually fallen to one-half, and the Academy stood to-day with a deficit over its exhibitions of £700. The suggestion was made that as these exhibitions are largely of the nature of a high-class communal benefit to Edinburgh the debt arising from them might well be cancelled out of the City's Common Good Fund. Great art, he proceeded to state, had at all times been the outcome of a strong sense of nationality, acting through artists whose strength lay in their being, by birthright, a medium of the soul of their people. In connection with war memorials, he drew a forcible contrast between the Latin and Teutonic works of the kind. The motives of the former were on the side of the angels, while those of the latter appeared dedicated at the altar of force and materialism, and were morose and brutal in character. The "Battle of the Nations" monument at Leipzig was instanced as perhaps the most objectionable creation of the kind in the world, and an example of what to avoid. He referred to the many projects for war memorials, and said that in all great cities there would appear some visible work of architecture and sculpture whose sole *raison d'être* would be the expression of those ideas and emotions which would bring us to victory. He advised against hurrying such work. Sir Ewing emphasised the importance of not being in too great a hurry with war memorials, and Professor Baldwin Brown moved a vote of thanks to the lecturer.

### STATUES AND MEMORIALS.

**A SMITHFIELD WAR MEMORIAL.**—On Sunday week the Bishop of Willesea was in the act of dedicating a war shrine, erected on the right-hand side of the gateway leading to the Church of St. Bartholomew-the-Great, and designed by Sir Aston Webb, and had just declared that the shrine would remain for centuries as a memorial of those who had fallen, when a voice from the crowd cried "Perhaps." A moment or two later a man shouted: "Will the Bishop read to us the Second Commandment?" Thereupon a struggle took place between the interceptors and the police, who were assisted by an Army officer and some civilians. Eventually two or three men were led away. A figure of St. Bartholomew, which has been placed between the windows of the structure standing upon the ancient entrance, was afterwards dedicated to the memory of Second Lieutenant Philip Edward Webb, who was killed in action on September 25, 1916. The second lieutenant, who was the son of Sir Aston Webb, resigned the choir vestry.

Plans have been approved by the King's Lynn E.C. for alterations and rebuilding outhouses at St. James' Street, for King's Lynn Gas Company, and conversion into offices of the Gun Inn, Baxter's Plain, for Messrs. R. and W. Paul.

The Council of the Institution of Municipal and County Engineers have nominated Mr. T. W. A. Hayward (Battersea) as president, and Messrs. H. E. Stilgoe (Birmingham), C. Brownridge (Birkhead), and Norman Scorgie (Hackney) as vice-presidents for 1918-19. Mr. Hayward has been borough engineer and surveyor of Battersea since 1904. Previously he was borough engineer of Stamford, and before that borough and waterworks engineer of Sudbury, Suffolk.

## Correspondence.

### ARCHITECTURAL ASSOCIATION BUREAU AND DRAWING OFFICE.

To the Editor of THE BUILDING NEWS.

Sir, Some time ago you were good enough to give publicity in your columns to the Association's scheme for assisting members of the architectural profession on their discharge from the Army. One of the proposals outlined was the establishment of a drawing office, in which men upon their discharge would find employment until such time as they could obtain permanent work, and in which an opportunity would be afforded to those not physically fit to take up employment elsewhere of working under circumstances specially arranged to meet their requirements.

I am now writing to inform you that the Drawing Office is established, and whilst fully aware that work in the architectural profession is scarce at the present time, I shall be very grateful to any architect who can send work to the office to be done. Any type of drawing can be undertaken, and assistants can be sent out to architects' offices for temporary work. I am sure the office will commend itself to the profession, and its existence has only to be known to ensure it receiving sufficient support to make it a success.

I would also draw attention to the fact that the Architectural Association Bureau is most anxious to help any member of the profession, being discharged from the Army, in matters connected with his return to civil life, and that special arrangements are being made in the schools to re-train and assist those whose military service has rendered this necessary.

Through the Bureau many discharged soldiers have been helped in various ways, and it is hoped that others requiring assistance will not hesitate to make their needs known. Yours faithfully,

F. R. YERBURY, Secretary.

35, Bedford Square, W.C.

### ARCHITECTS' WAR COMMITTEE.

To the Editor of THE BUILDING NEWS.

Sir,—My predecessor in the chair at the Institute (Mr. Ernest Newton) has, as Chairman of the Architects' War Committee, just issued an appeal for funds which are necessary if certain most important and useful aspects of the work of that committee are to be continued. I need not, I feel, at the present time go into the reasons, which must be clear to everyone connected with building, for the necessity of such a fund. It is sufficiently well known that the hardship incurred by many members of the architectural profession has been serious. The fund which was raised at the beginning of the war is now completely exhausted, and it will be impossible to continue the work of subsidised employment, and other means of assistance which are now being afforded, unless Mr. Newton's letter meets with the liberal response it deserves.

I should, therefore, like to associate myself with his appeal, and urge upon members of the Institute and others to come to our aid in difficult time. Unless this is done and fresh contributions are forthcoming the effect will be very seriously felt by many architects who deserve all the sympathy and support of their professional brethren.

All contributions should be addressed to Mr. Newton at No. 9, Conduit Street, W.1.—Yours very truly,

HENRY T. HAIR, President, R.I.B.A.  
 9, Conduit Street, Hanover Square,  
 London, W.1., November 25, 1917.

## COMPETITIONS.

NORTH STAFFORDSHIRE RAILWAY COMPANY COMPETITION FOR DESIGNS FOR WORKMEN'S HOMES.—The Competitions Committee of the Royal Institute of British Architects request Members and Licentiatees not to take part in this Competition, the conditions not being in accordance with the R.I.B.A. Regulations for Architectural Competitions.

## LEGAL INTELLIGENCE.

ARCHITECT AND HIS BILL OF COSTS.—Stewart-Moore v. Sprague. In the King's Bench Division, before Mr. Justice Avory, an action was brought by Mr. Henry Stewart-Moore, solicitor, against Mr. W. G. R. Sprague, architect and surveyor, Jermyn Street, to recover £80, the amount due on one or two promissory notes alleged to have been given by the defendant in settlement of a bill. The defendant admitted liability, but contended that he was entitled to have the bill of costs taxed. Mr. Simmonds said the defendant had been in the hands of moneylenders and he retained the plaintiff to defend various proceedings taken against him by them. The plaintiff from time to time delivered bills of costs, which the defendant was in the habit of settling by bills of exchange. On May 4 last the plaintiff delivered a bill of costs and cash account, and the following month he wrote to the defendant asking for a settlement, and pointing out that he could apply for taxation of the bill if he desired to do so. The defendant did not apply for taxation, and on June 21 he settled the bill by giving the plaintiff two promissory notes, one for £80 and the second for £86. When the first promissory note fell due it was not met, and the plaintiff now asked for judgment. The defendant alleged he was entitled to have the bill of costs taxed. Counsel's submission was that the bill of costs having been settled by the payment of the two promissory notes the defendant was not entitled to apply for taxation. His client, for the defendant, argued that his client was entitled to have the bill taxed, and that until it had been taxed the plaintiff had no right to sue. The defendant was willing for the plaintiff to sign judgment for any amount found due on taxation. His lordship entered judgment for the plaintiff for the amount claimed, with costs. The defendant's remedy, he said, was to apply for taxation in the ordinary way, and if it should turn out that he was entitled on taxation to have the bill of costs reduced the amount of the reduction might be raised in an action on the second promissory note when that fell due.

METROPOLITAN WATER BOARD v. DICK, KERR AND CO.—In this case, in which the question was raised whether contracts made for the reservoirs near Staines still bound the parties, or had been determined by an order issued by the Minister of Munitions under the Defence of the Realm Act, it will be remembered that Mr. Justice Bray, in the first instance, decided that the contract had not been determined. The Court of Appeal, however, held that the effect of the order of the Minister of Munitions was to make it illegal to continue the work, and that the contract was at an end. The House of Lords decided on Monday that the decision of the Court of Appeal must be upheld, and dismissed the appeal of the Water Board, with costs.

Mr. W. D. Carrio, F.S.A., has been re-elected Master of the Plumbers' Company. Sir John Knill and Mr. Edmund Knight are the Wardens.

At Westminster last Thursday Percy S. McHattie, consulting motor engineer, of Bulcray House, Irvine, Ayr, N.B., was fined £50 and ten guineas costs for corruptly offering a consideration and reward to officials of the Ministry of Munitions and the Army and Navy Canton Board, for the purpose of securing a public appointment.

The Northern Centre Conciliation Board, which met in Manchester last week, awarded the joiners of Oldham, Bury, and Rochdale an increase of one halfpenny per hour. The operatives, who secured their last increase in September, asked for an increase of 3½d. per hour. With the increase, the wages of joiners will be 1s. 1d. per hour. The masons in the Todmorden district had their wages increased from 11d. to 1s. per hour.

## Our Office Table.

At the Edinburgh Parish Council meeting last week Mr. A. M. Millar moved "That the Council call upon the Government to at once consider the serious necessity of promoting a Bill for a national scheme of housing, owing to the deplorable housing conditions of the people, which have been disclosed in the report submitted by the Housing Commission, and accordingly instruct the clerk to forward this resolution to the Prime Minister and members of Parliament for the City of Edinburgh." The housing conditions in Scotland, said Mr. Millar, were deplorable, and it was surprising that the awful state of affairs that prevailed had not brought about industrial unrest. Mr. D. Maokay, seconding, said in his own ward of St. Leonards there were no fewer than one thousand one-roomed houses. Mr. J. D. Phillips Smith proposed an amendment that the words "at once" should be deleted, and that the words "on sound financial principles" should be added. He felt that the working man was an independent man, and did not want charity. Mr. Wm. Galloway expressed the opinion that the land question would have to be settled before they could get any satisfactory housing reform. They must get the land easier than was the case at present, and it was the big trusts, of which they had a few in Edinburgh, that were standing in the way. Replying to the discussion, Mr. Millar said he wanted to do something for the men who were coming back from the war. He was, however, willing to delete the words "at once," but could not accept the other suggestion. By 13 votes to 8 the amendment was agreed to.

The Essex House Press, in conjunction with Messrs. B. T. Batsford (Limited), are publishing this month a new work on Civics by Mr. C. R. Ashbe, entitled "Where the Great City Stands." The book points a way towards reconstruction after the war, and deals with post-war labour questions, the rehousing and planning of our cities, new co-ordination, and the theories of Guild Socialism. It deals from the artist's point of view, with questions of waste in industry and in education and with the reaction of town and country life. It has over a hundred illustrations from plans, diagrams, or pictures by eminent artists. It is an appeal to the practical idealist.

The room in which the American War Commission met the members of the War Cabinet last week at No. 10, Downing Street has remained practically unaltered since the days of Lord North. There have been no structural alterations, and while double windows have been installed there has been no attempt to alter the size and location of the dismal windows. The room has, of course, been many times redecorated, but much of the old furniture remains, and the portion of the furniture which it has been necessary to renew is in perfect keeping with the atmosphere of the room. As late as in the 'fifties of the last century there were actually houses in Downing Street which were practically shops. There was a milliner's establishment in full view of the old Foreign Office, and the clerks there used to amuse themselves by flashing reflected lights upon the employees in the establishment. The matter, says the London correspondent of the *Liverpool Post*, was brought to the notice of Lord Palmerston, who issued a solemn memorandum on the subject requesting that the gentlemen of the Foreign Office should abstain from "casting reflections" upon the young ladies in their vicinity.

The arrangements for the Arts and Industries Exhibition, to be held in Madras at Christmas, are making progress, and the construction of the buildings is being undertaken by the P.W.D. Mr. Nicholls, the Government architect, is responsible for the design of the buildings. The front view will be that of an old Pathan fort, and the extension will be Mogul in design. The building will be divided into two quadrangles, each approximately 250 feet long and 220 wide. Each quadrangle will provide for

about 25,000 square feet of exhibition space, exclusive of the verandahs. Over 100 carpenters, besides a number of masons and coolies, are already at work, and the number is increasing. About 500,000 bricks, 101,000 square feet of iron roof sheathing, and a large quantity of timber posts and planks, will be required for the construction of the buildings.

In connection with the controversy concerning the proposed demolition of St. Peter's Church—the old Pro-Cathedral in Church Street, Liverpool—interest has been aroused as to the future destiny of the magnificent brown oak carvings in the church in the event of the fabric being taken down. It is a moot point whether the carvings were done by Grinling Gibbons, who executed the carvings in St. Paul's Cathedral, or whether they are "after" him—that is, in the style which was peculiarly his own. Grinling Gibbons was born in 1648 and died in 1720, and St. Peter's Church was consecrated in 1704. Hence it is thought by some quite possible that he was the artist responsible for the carvings in St. Peter's Church.

Writing to the *Times*, Mr. William Woodward, F.R.I.B.A., F.S.L., points out that for years past architects have prohibited the use of German and Belgian Portland cements because they were proved to be of far less strength than our own Portland cement. The Germans know this as well as we do, and for the purposes of concrete "pill-boxes" resistance is of the utmost importance. Whether the Germans are using our cement or not can easily be proved by bringing a piece of a recently acquired "pill-box" over here. These cements are termed "Portland" only because they resemble in colour Portland stone.

Reporting on the proposals relative to the establishment of a Ministry of Health, the Public Health Committee of the London County Council expresses objection to the setting up of, for certain purposes, hybrid committees of representatives of local authorities, insurance committees, hospital authorities, and others, as suggested under the scheme of the insurance interests. The committee holds, and most properly, in our opinion, that the appointment of such committees to administer public moneys provided out of rates or national funds is contrary to the principles of local government, and has no precedence in modern legislation; moreover, it is undesirable that the existing system of local government should be complicated by the appointment on health committees of representatives of non-elected bodies who have no direct responsibility to the ratepayers. The Council is recommended to express the view that the functions of a Ministry of Health should not be separated from those of the department entrusted with the central supervision of local powers, such as those relating to housing, drainage, water supply, and the like, which are closely and essentially connected with the health of the community, and that any further powers which may be granted by Parliament with regard to public health should form part of the existing system of local government.

Messrs. May and Rowden, writing to the *Times* from 27, Maddox Street, W.1. very rightly point out that the present seizure of property for War use is highly unsatisfactory and unfair to owners. There is a basis in existence which could be used to compensate owners for the use *per se* of commandeered buildings without reference to any further loss occasioned by the Government occupation. Any additional claim for disturbance (beyond actual out-of-pockets, which are easily arrived at) could go before the Commission, as we readily admit that some of the claims under that head are quite fanciful. Take a building commandeered when empty, where there can be no question of additional claim beyond one for actual use of the premises. Why should not the Government decide to pay a rental based on the assessment? As a general rule in London the gross assessment is arrived at by adding 10 per cent. to the rental which an ordinary tenant will pay and undertake all repairs and insurance. If, therefore, the gross assessment is taken and one-eleventh deducted, that would give

a fair and ordinary rental for the Government to pay and to undertake to deliver up the premises in as good a condition as received. A schedule of condition is usually agreed on by the Government taking possession, and it is ordinary surveyor's work to settle the amount of dilapidations accrued during the Government occupation. A surveyor could act for each side, and, in case of dispute, the dilapidations could be referred to an umpire for his decision to be final and binding on both sides. There is no necessity at all to trouble the Commission with such matters as compensation for simple occupation or to estimate damage to the building caused by the Government occupation. If this basis were adopted nine-tenths of the cases to go before the Commission would be settled almost automatically, and there would be left no sense of injustice in the minds of the owners of the properties. Besides, it would be cheaper for the Government in the long run. The period for which the Government should pay the compensation should be, in simple cases, for the period of actual occupation, and afterwards for the estimated time necessary to repair the premises into the same state of repair as they were when possession was taken. After all said and done, the Government presumably get value for their occupation of premises, and there should be no question that the owner should also get compensation based on the recognised public idea of what his property is worth *i.e.*, the assessment. Rates and taxes are collected on this basis, and the Government should pay on it.

With reference to the retirement of the late Tower Bridge Master, and recommending a re-arrangement of the staff at the bridge, under which the following proposals will be submitted for approval to-morrow by the City Bridge House Estates Committee to the Court of Common Council:—That John Gass be placed in sole charge of the Tower Bridge as Superintending Engineer and Tower Bridge Master, and that his salary be increased to £650 per annum, with residence, fire and gas. That James Gass, at present Foreman Fitter and Electrician, be promoted to 1st Assistant Engineer, at 90s. per week (his present pay), with residence, fire and gas, rising 5s. per week per annum to 100s. per week. That John Adams, at present Fitter, be promoted to 2nd Assistant Engineer, at 66s. per week, rising 2s. per week per annum to 76s. per week, with no War Bonus. That Thomas Jones, at present Bridge Driver, be promoted to 3rd Assistant Engineer, at 55s. per week, rising 2s. per week per annum to 61s. per week, plus a War Bonus, his total wages with Bonus not to exceed 63s. per week.

At the annual meeting of the Leeds Permanent Benefit Building Society last week, the Chairman said that while there was practically no building going on there was a good demand for houses. If the war should end within next year it was probable that the deficiency of houses in Leeds would amount to 3,000.

A jobbing carpenter ordered a half-pint only, instead of his usual pint. The proprietor expressed disappointment. "Tis like this," explained the carpenter. "I've allus been quite 'willin' to reduce my expenses once I saw the quality give a lead. And, just now, coming from a job of work up at the hall, I noticed that Sir Eberly's two daughters was playing music in the drawing-room, and both of 'em on one and the self-same piano."

Messrs. Sotherly announce the sale of Sir Edward Poynter's collection of about 300 drawings by old masters. The collection is not a large one, but is very choice, and includes fine examples of the work of Michelangelo, Titian, Correggio, Fra Bartolommeo, Burgkmair, Durer, Rembrandt, Van de Velde, Tiepolo, Claude, Rubens, and other famous masters. Messrs. Sotherly are preparing a full illustrated catalogue, and the sale will take place probably in March.

Some interest has been aroused by the announcement that a four-roomed cottage is to be let situated in a court off Queen Victoria Street, and although the grimy block of humble dwellings possesses nothing of the picturesque, it is obviously of respectable antiquity. Old bracket lamps are suspended at the four corners of the block, and each house has only one room on each floor, the steep, tortuous little staircase leading to the upper floors starting almost at the entrance.

## TO ARMS!

### COUNTY OF LONDON VOLUNTEER ENGINEERS (FIELD COMPANIES).

Headquarters, Balderton Street, Oxford Street, W.1. ORDERS FOR THE WEEK BY LIEUT. COLONEL C. B. CLAY, V.D., COMMANDING.

OFFICER FOR THE WEEK.—Second Lieutenant H. G. Golding.  
NEXT FOR DUTY.—Second Lieutenant P. Bowden.

EXTRACT FROM "LONDON GAZETTE."—F. G. Wood to be temporary second lieutenant (October 24), H. J. Golding to be temporary second lieutenant (October 24).

DRILLS.—Week ending Saturday, December 5, 1917.  
MONDAY.—No. 3 Coy, Left-half, Recruits, Signalling, 6.30.

TUESDAY.—Physical Drill and Bayonet Training, 7.0.

WEDNESDAY.—No. 1 Coy., 6.30.

THURSDAY.—No. 2 Coy., 6. Signalling, Ambulance, 6.30.

FRIDAY.—No. 3 Coy., Right-half, Recruits, 6.30. MUSKETRY.—Belvedere Road, Tuesday, Wednesday, and Thursday, 6.30 to 7.

NOTE.—The Medical Officer will attend for examination of recruits, etc., on Thursday, at 6.30.

Unless otherwise indicated all drills will take place at Headquarters.

By order,  
MACLEOD YEARSLEY, Capt. and Adjutant.  
December 1, 1917.

## CHIPS.

The Ealing Town Council have appointed a committee to consider the question of a town-planning scheme for the northern portion of the district.

The Bishop of Bangor is placing in Bangor Cathedral a marble tablet to the memory of the sons of clergy in the diocese of Bangor who have fallen in the war.

Mr. Arthur H. Thomas, A.R.I.B.A., county surveyor of Pembrokeshire, has been elected high sheriff for the town and county of Haverfordwest for the ensuing year.

Earl Fitzwilliam has launched a housing-scheme for Darfield village, near Sheffield. He has presented land to the local D.C. for the erection of 600 workers' dwellings and 400 villas.

According to *The Marine Journal*, New York, the American Cement Ship Company is contemplating the establishment of a line of cement steamers to ply between Boston and South America.

Birkenhead Corporation, so far as Lake Alwen is concerned, is in the "water, water everywhere" phase of the "Ancient Mariner." The new lake is now full, and has been overflowing for the first time—and at the rate of 40,000,000 gallons a day—but owing to Government prohibition the work of laying the pipeline has been stopped, although most of the pipes are actually in situ on the surface.

The Minister of Reconstruction has appointed Mr. Cloumont B. Broad and Mr. W. J. Jones to be members of the Building Materials Supply Committee. Mr. Broad was a member of the firm of Dawson and Co., Ltd. of Battersea, and is a past-President of the Clayworkers' Institute; Mr. W. J. Jones is in charge of the Bricks Section of the Iron and Steel Production Department of the Ministry of Munitions.

At the Middlesex Sheriff's Court last Friday Mr. William Henry Shepherd, a large owner of Cannon Street, was awarded £156 2s. 6d. in an action for damages for personal injuries brought by him against Messrs. C. P. and R. P. Dawson, landlords of a building in Eastcheap. Plaintiff had occupied offices in the building, and in November, 1916, part of the stone staircase collapsed, throwing him into the basement.

A local shipbuilding and iron company propose to build a hostel and canteen at High Lane Row, Huddersfield-Tyax, including three blocks of buildings, each three stories in height, a laundry, sitting and recreation-rooms, lavatories, drying-rooms, and a recreation-ground. The principal contractors are the Welsh Garden Cities, Ltd. and Messrs. Hulton and Durkin, Smith Bros., and J. Hanson, of Burnley.

The Institution of Water Engineers' winter meeting will be held in the Geological Society's Rooms, Burlington House, Piccadilly, London, on Friday, December 7, at 2.15 p.m. There will be a discussion on "Water Supplies as Sources of Power," opened by Mr. C. H. Roberts, M.Inst.C.E., and two papers on the theory and practice of air-lift pumping by Mr. C. Anthony, M.Inst.C.E., and Mr. A. H. Jameson respectively.



FOR

**Olivers'**

**Seasoned**

**Hardwoods,**

APPLY TO—

**WM. OLIVER & SONS, Ltd.,**  
120, Bunhill Row, London, E.C.

**TENDERS.**

\* Correspondents would in all cases oblige by giving the addresses of the parties tendering—at any rate, of the accepted tender: it adds to the value of the information.

**BLAYDON-ON-TYNE.**—For erection of a handrail along the footpath under the Redburn railway bridge, Derwenthaugh, for the Blaydon Urban District Council:—  
Aynsley and Sons, Newcastle .. £127 13 0  
(Accepted.)

**CAYN.**—For repairs to the County Court House, Cayn:—  
Duffy, P., and Son, Monaghan.. 4755 0 0  
(Accepted.)

**BEVIZES.**—For erection of a washhouse in Plank's Place, for the town council:—  
Smith, A., and Son (accepted).

**FRINGFORD (OXON.).**—For repairs to Fringford Bridge, for the Oxfordshire County Council:—  
Laxton and son (accepted) .. £29 5 0

**HEBBURN.**—For painting the lamp-posts and hydrants in the town, for the Hebburn Urban District Council:—  
Halliday, J. G. (accepted) .. £19 0 0

**HERTFORD.**—For repairs to the county medical office, for the Herts County Council:—  
Shepherd, H., and Co., Hertford .. £229 15 6  
Norns, H., and Son, Hertford  
(accepted) .. .. . £19 14 6

**KILLARNEY.**—For new bridge between Calma Cross and Allabout:—  
O'Connor, James .. .. . £193 0 0

**MAYFIELD (STAFFS.).**—For new wooden bridge over the Meanfield, near Hulme End, for the Mayfield Rural District Council:—  
Moss, T., Waterhouses (accepted) £40 0 0

**TRING.**—Repairs and renovation at the Maternity and Child Welfare Centre, for the Herts County Council:—  
Glenister, E. and C., Marlowes .. 485 0 0  
(Accepted.)

It is probable that a memorial exhibition of Rodin's works in England will soon be organised at South Kensington.

The Glasgow Corporation Building Regulations Committee have authorised Sir W. G. Armstrong, Whitworth and Co. to erect a building in Pterhill Road of the cubical extent of 702,566 ft., which is 352,566 ft. in excess of the maximum allowed by the Act; and Mr. Alex. Anderson to erect buildings at 24, Regent Moray Street.

The death in action is reported of Captain John Beedle Matthews, M.C. of the North Staffordshire Regiment, attached to the Leicesters Regiment. He was the third son of Major N. H. Matthews, now on active service, two of whose sons are also serving, and both of whom have been wounded. Captain Matthews was attached to Mr. C. E. Halliday, architect for the diocese of Llandaff, and when war broke out was at the County Surveyor's office at Leicester.

**LIST OF TENDERS OPEN.**

**COMPETITIONS.**

**Jan. 13.**—Designs are invited for four specified types of cottages suitable for the industrial classes. A competition under the charge of the Royal Institute of British Architects and allied societies, will be held in each of the six areas mentioned below. Premiums of £100 and £50 for the best designs of each of three types, and £50 and £30 for the fourth, will be awarded in each competition. Designs must be submitted in accordance with the conditions not later than January 13. Copies of the conditions may be obtained from the following:—Home Counties Area: The Secretary, Royal Institute of British Architects, 9, Conduit Street, London, W.1; Northern Area: Mr. H. L. Hicks, hon. sec., Northern Architectural Society, 6, Higham Place, Newcastle-on-Tyne; Manchester and Liverpool Area: Mr. Isaac Taylor, hon. sec., Manchester Society of Architects, Mansfield Chambers, 17, St. Ann's Square, Manchester; Midland Area: Mr. A. Hale, hon. sec., Birmingham Architectural Association, 18, Bennett's Hill, Birmingham; South Wales Area: Mr. C. H. Kempthorne, hon. sec., South Wales Institute of Architects, Albert Chambers, High Street, Cardiff; South-west Area: Mr. A. J. Pinn, hon. sec., Devon and Exeter Architectural Society, 5, Bedford Circus, Exeter.

**BUILDINGS.**

**Dec. 3.**—Construction of a grit chamber, etc., at the pumping station.—For the Downham Market Urban District Council.—A. H. Proctor, Acting Clerk to the Council, Council Offices, Downham Market, Norfolk.

**ENGINEERING.**

**Dec. 5.**—Dredging alongside the quays and at other parts of the upper portion of the Truro river.—For the Truro City Council.—F. A. Barnes, Engineer and Surveyor, Municipal Buildings, Truro.

**March 30.**—The Acting British Consul at Santiago reports that a decree has been issued calling for tenders for the improvement of the port of Antofagasta (Chile). By the terms of this decree the amount to be expended on this work must not exceed £1,700,000. Details may be obtained from the Port Commission Offices in Santiago, and copies are expected to be received shortly at the offices of the Chilean Legation in London, 22, Grosvenor Square, W.1. Tenders will be received up to 3 p.m. on March 30 by the Minister of Finance, Santiago.

**ROADS AND STREETS.**

**Dec. 10.**—Supply and delivery of about 600 tons of Guernsey, Leicester, or Penmachwr granite, 2 in. or 1 1/2 in. gauge (One Year).—For the Town Council.—The Borough Engineer, Municipal Offices, Chelmsford.

**Dec. 19.**—Re-paving with granite setts Cathcart Street and Cathcart Square, Greenock.—For the Corporation.—Town Clerk, Greenock.

Dryburgh Abbey, Berwickshire, where Sir Walter Scott lies buried, is to be sold, and the proposal is made that it should be secured to the public.

Mr. Thomas Livingston, of Marlborough, Wilts, auctioneer, surveyor, and estate agent, who died on July 13 last, left estate valued at £46,900.

Mr. Andrew Stevenson Biggart, M.Inst.C.E., of Inchgarvie, 39, Sherbrooke Avenue, Pollokshields, Glasgow, engineer and contractor, of Dalnarnock Iron Works, Bridgeton, Glasgow, chairman of Sir William Arrol and Co., Ltd., Glasgow, has left personal estate of the total value of £47,778.

**TO CORRESPONDENTS.**

We do not hold ourselves responsible for the opinions of our correspondents. All communications should be drawn up as briefly as possible, as there are many claimants upon the space allotted to correspondents.

**TERMS OF SUBSCRIPTION.**

Twenty-six shillings per annum (post free) to any part of the United Kingdom; thirteen shillings for six months; for the United States, £1 10s. (or \$7 80c gold). To France or Belgium, £10 10s. (or \$27). To India, £ 10s. To any of the Australian Colonies, or New Zealand, to the Cape, the West Indies, or Natal, £1 10s.

It is particularly requested that all drawings and all communications respecting illustrations or literary matter, books for review, etc., should be addressed to the Editor of the BUILDING NEWS, Effingham House, 1, Arundel Street, Strand, W.C.2, and not to members of the staff by name. Delay is not infrequently otherwise caused. All drawings and other communications are sent at contributors' risks, and the Editor will not undertake to pay for, or be liable for, unsought contributions.

When favouring us with drawings or photographs, architects are asked kindly to state how long the building has been erected. It does neither them nor us much good to illustrate buildings which have been some time executed, except under special circumstances.

\* Drawings of selected competition designs, important public and private buildings, details of old and new work, and good sketches are always welcome, and for such no charge is made for insertion. more commonplace subjects, small churches, shops, houses, etc.—we have usually far more sent than we can insert, but are glad to do so when space permits, on mutually advantageous terms, which may be ascertained on application.

**ADVERTISEMENT CHARGES.**

The charge for Competition and Contract Advertisements, Public Companies, and all official advertisements is 1s. per line of Eight Words, the first line counting as two, the minimum charge being 6s. for four lines.

The charge for Auctions, Land Sales, and Miscellaneous and Trade Advertisements (except Situation Advertisements) is 6d. per line of Eight Words (the first line counting as two), the minimum charge being 4s. 6d. for 50 words. Special terms for series of six insertions or more can be ascertained on application to the Publisher.

**SITUATIONS VACANT.**

The charge for advertisements for "Situations Vacant" is Two Shillings and Sixpence for Twenty-four Words, and Sixpence for every Eight Words after. All Situation Advertisements must be prepaid.

**SITUATIONS WANTED AND PARTNERSHIPS.**

The charge for advertisements for "Situations Wanted" and "Partnerships" is One Shilling for Twenty-four Words, and Sixpence for every Eight Words after.

Advertisements for the current week must reach the office not later than 3 p.m. on Tuesday. Front-page advertisements and alterations or stop orders for serial advertisements must reach the office by first post on Monday to secure attention.

Handsome Cloth Cases for binding the BUILDING NEWS, price 2s, post free 2s. 5d., can be obtained from any newsagent, or from the Publisher, Effingham House, 1, Arundel Street, Strand, W.C.2

RECEIVED—J. B. and Co., Ltd.—R. S. Co., Ltd.—E. C. C.—G. P. A.—H. A. R.—E. H. REWING.—No. R. P. L.—Thanks, no. CONTRACTOR.—A poor substitute, at best.

**GALVANIZED CORRUGATED ROOFING SHEETS.**

**BEST QUALITY.**

Perfectly and thickly coated with zinc, insuring real durability.

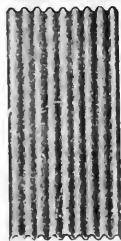

**GOOD STOCKS**

kept at our London Works in all the usual lengths and gauges.

PROMPT DELIVERY can be given, to any ordinary

whether straight sheets or curved radius.

**FREDK. BRABY & CO., LTD.,** 352 to 364, EUSTON ROAD, N.W.1, LONDON. IDA WORKS, DEPTFORD, S.E.8.

# THE BUILDING NEWS

## AND ENGINEERING JOURNAL.

Effingham House.

### CONTENTS.

Strand, W.C.2.

Currente Calamo .. .. .	441
Women Architects and Assistants .. .. .	442
Housing After the War .. .. .	443
Competitions .. .. .	444
Obituary .. .. .	444
Our Illustrations .. .. .	444
Building Intelligence .. .. .	444
Parliamentary Notes .. .. .	444
Correspondence .. .. .	457
Legal Intelligence .. .. .	457
Professional and Trade Societies .. .. .	457

Our Office Table .. .. .	458
Chips .. .. .	458
Tenders .. .. .	viii.
List of Tenders Open .. .. .	viii.
Latest Prices .. .. .	x.

### OUR ILLUSTRATIONS.

York Minister, view of the Crossing looking North, from an oil-colour sketch by Mr. Ernest A. S. Benney, A.R.C.A., exhibited at the Royal Academy, 1917.

The Reading Room, Orient Line S.S. "Otway," Mr. Andrew N. Prentice, F.R.I.B.A., Architect.  
 Heckley Sole Manor, near Folkestone. Alterations and additions. The late Lieut. Philip E. Webb, R.E., A.R.I.B.A., Architect.  
 Comptoir National D'Escompte de Paris, King William Street, London, E.C. Detail working drawing of section through the Banking Hall and elevations to Nicholas Lane and Abchurch Lane, Messrs. H. V. Ashley and Winton Newman, F.R.I.B.A., Architects

## Currente Calamo.

A new Defence of the Realm Regulation is expected at an early date prohibiting any form of constructional and decorative work, with a few exceptions, without the express permission of the Government. Under the existing Regulation a permit is necessary only in respect of work costing more than £500. The new Regulation will have a general application, and its object is, we suppose, to ensure that no unnecessary work shall be undertaken, having regard to the pressing need of men accustomed to such labour for urgent war work.

An interesting point was raised in the Chancery Division of the High Court on the 23rd ult. by a summons heard before Mr. Justice Neville, taken out by the National Trust for the Preservation of Places of Historic Interest or Natural Beauty in order to obtain a decision as to whether they could, with the consent of the Charity Commissioners, grant a valid lease for a term of ninety-nine years of Barrington Court and the lands adjoining in Somerset. Barrington Court is a place of historic interest between Hminster, Langport, and Yeovil. At present it is in a dilapidated condition, and the proposal was to grant a lease for ninety-nine years containing covenants which would give the public the same rights of visit and inspection as they had at present. By this means the place would be put in a state of complete repair. His Lordship remarked that the National Trust had to preserve this place for the benefit of the nation, and they were in the position of trustees for the nation, and what they were proposing was to get rid of possession for ninety-nine years. That might be a very good thing in the circumstances; but in his view it was an alienation, and they were prohibited by statute from alienation. Therefore he would answer the question raised by the summons in the negative.

With regard to the belated scheme of the Board of Agriculture for employing women tree-planters, which we mention on another page, it is of interest, and possibly of some use, to learn from a letter in last Friday's *Times* from Mr. J. Parry, of

the Liverpool Corporation Waterworks, that the Liverpool Corporation have, since last summer, employed three gangs of women workers in their nurseries and plantations on the catchment areas of the Vyrnwy (North Wales) and Rivington (Lancashire) Waterworks. Two of these gangs have been supplied by the Women's War Agricultural Organisation, and one has been formed locally. There is a forewoman over each gang, and all are under the supervision of a practical forester. The experiment has been quite successful, especially in the nursery branch. As to planting out in exposed places, some doubt was entertained, but so far the results are good. Instead of planting new areas, the first task to be undertaken should be the refilling of the large areas from which trees have been lately cut down. The project of the Board would have a better chance of success if it could be removed from the control of Government Departments.

The Water Board is most unlucky in its litigation, especially during war-time. Last year's deficit of some quarter of a million, as just officially announced, is likely to go on growing through its costly legal conflicts, amongst other things. But it seems too bad that every big case should have to be dragged through the courts and up to the House of Lords before we can get a decision based upon common sense reasons of justice. The latest example of this is the well-known matter of "Metropolitan Water Board v. Dick, Kerr, and Co., Ltd." There the Board had made a contract with the defendants to construct a reservoir and works for the sum of £675,000. This was in July, 1914; but in February, 1916, the Ministry of Munitions stopped the work. The Board then went to the court, claiming a declaration that, though suspended during the war, the contract was not at an end, but still existing and to be completed later. Mr. Justice Bray, acting upon the common clause by which the engineer could extend the time agreed upon, applied it to these facts and this time, and held that the contract was not frustrated, and so was still existing. Then came the Court of Appeal, which reversed this ruling, holding that as the action of the Government had made the performance of the contract illegal and im-

possible, it was dissolved. The Water Board still held on tight to their point, and now the Law Lords have confirmed this decision, but on broader and bolder lines which builders will appreciate. It was argued before them that, as the reservoir would be a permanent thing this war delay of years did not matter. But, as they said, to hold that this work could be taken up again after the war was not to maintain the original contract but to create a new one, under quite unknown terms, prices, and conditions. No one can say where the building trade will be after the war. This was always the true practical point. Now, at last, we have a final decision and the Board's big contract is declared dead.

At the present time, when so many war memorials and mural tablets are being erected to commemorate the heroes who have lost their lives on the battlefield, it may be useful to point out the need of avoiding iron by using copper or bronze cramps for fixing these monuments in position, otherwise in course of time, as experience has made abundantly evident, the marble and masonry are bound to suffer. When the beautiful series of wall tablets were removed from the Rolls Chapel in Chancery Lane some years ago, prior to that building being demolished, the late Sir John Taylor caused careful drawings to be made of each example, accurately noting down every fissure and damaged part, so that a record was made before the monuments were touched. On their removal, Mr. Barnes, who undertook the matter, discovered that almost in every instance where harm had already happened the cause was entirely due to the iron cramps and fixing hooks employed by the masons who put up these memorials in the Rolls Chapel. The iron had swollen or rusted very badly, and in some cases only about an eighth thick of solid metal remained to sustain the weight of the ornamental masonry placed against the walls. In all likelihood before long more than one of these monumental records must have fallen and been smashed had not circumstances arisen to necessitate their removal. At the present time in the churchyard of the parish church at Hammersmith a shed has been lately erected to house the remains of a series of alabaster and other mural monuments which were

not long since discovered to have been buried under the vestry floor when the new church was erected on the site of the old one. Such vandalism is inexplicable. One fine marble monument thus unearthed has been rebuilt in the chancel at the cost of one of the City Companies, and as opportunity occurs or funds allow it is the intention of the vicar and churchwardens to reinstate these memorials of the past. Judging from the fragments being now taken care of, some of these examples are of a good class and of artistic excellence.

Mr. Edward Drummond Young, in the *British Journal of Photography* of November 25, made some useful suggestions in regard to the art training of photographers, one in particular being that of making five-minute studies of the figure in various postures. The one drawback in connection with this suggestion, however, as our contemporary points out, is that the photographer is not likely to be able to draw well enough to make much out of his five-minute studies, for, to be of use, they should be fairly correct as regards proportions. A great deal of work on the figure is really necessary before this particular quality can be achieved, and in all probability experimental posing with a good lay-figure would serve the same purpose just as well, and possibly better. Such a figure would also be very valuable for studying draping—a matter which the photographer knows so little about that he has to rely on the aid of a lady assistant. It is undeniable that some art training is indispensable for the photographer, but there is some little difficulty in getting a suitable training as things are. Art schools at present are devised for the assistance of practically all craftsmen except photographers, who really want a special course designed for themselves. In theory it would be desirable for a photographer to be able both to model and draw well; but in practice even a moderate degree of skill in either requires a much longer training than he can afford to acquire. Before he can learn anything from either modelling or drawing he has to learn how to do both, and he must reach a certain degree of technical proficiency. Bad modelling and inaccurate drawing will not teach him anything, and if the student is to be a photographer, then probably the camera is the most suitable tool for him to handle. The camera is, however, usually barred in the conventional art school, and so it seems that we want a special class provided with the usual necessities of casts, lay-figures, drapery, etc., and with living models, but where the camera is recognised as the most important means of expression. There is no very obvious reason (beyond prejudice) why art schools should not establish such classes, and some day they may be persuaded to do so.

It is stated that the annual architectural report hitherto published by the Government of India is to be discontinued, or issued only triennially, for reasons of economy. If this be true it is

to be regretted, and we hope it is not really due to any such friction as was visible in the Indian Public Works Department when architects were first employed to do their proper work. To readers here we know that the report of Mr. Begg, the consulting architect, has always been of interest, and that one republication of the gist thereof, with illustrations, has been welcomed; as, perhaps, in a less degree were those of the Provincial Architects. We shall be glad to learn that the suspension of publication is merely one of the many drawbacks of the war, and that it will be resumed annually as soon as peace comes.

Some much more sensible ideas, with regard to the prospects of industry when peace comes, were put before the Sheffield Workers' Educational Association last week by Mr. W. L. Hichens, the chairman of Messrs. Cammell, Laird and Co., than some which are being set forth by the nostrum-mongers of all sorts. Mr. W. L. Hichens said it would not be humanly possible to find jobs straight away for the men who came from the front. They would find their munitions works stopped, and those who had been toiling at munitions would find there was a certain transition period before peace industries were started going again. It would be the business of everybody to make that transition period as short as possible. It was no use saying they would eliminate the employer altogether; the employer would not be there if he did not serve some useful purpose. In the course of time some better system might be found; but until then it would be highly dangerous to advance along the line of destruction. The first fundamental change was to get away from the idea that industry was primarily a profit-making affair; it was national service due by employer and workman to the community or State for the privilege of living within its borders. He agreed, of course, that the idea of material reward could not be eliminated altogether. Yet this was not the highest, the best, or the final thing. Capital must not be allowed unlimited profit. If, after the necessary charges for labour, material, and so forth, capital was paid all the rest, that was fundamentally wrong. It seemed to him that capital was entitled to a fair return on its money. But capital was not entitled to unlimited reward. All over a fair return must be a subject for excess profit taxation. Similarly, labour was not to be entitled to hold the community up to ransom by a "corner" of the labour market. It was a wrong conception that labour had a right to whatever it could wrest by force out of the capitalist or the consumer. Labour, like Capital, was entitled to a fair share in relation to the rest of the community, but no more. What was fair could only in the last resort, failing mutual agreement, be determined by the representatives of the community as a whole—that was the State. Restriction of output, Mr. Hichens added, was one of the most serious problems to face. If we could get rid of all restrictions of output, and if we were allowed fair play for

the introduction of every mechanical device which would save labour, we could open up an era of great prosperity in this country.

#### WOMEN ARCHITECTS AND ASSISTANTS.

There are not wanting those who pessimistically assure us that the tendency of the time of the willingness of women to take what has hitherto been regarded as men's work in hand is a step back in civilisation and a return to the practice of primeval folk for women to work while the men were warriors and defenders of the tribe and its belongings. Some such assure us that in the long run women will find that their new departure will not pay; and that man, freed from ordinary labour, will take his ease and leave the daily drudgery and life to the women. They admit, it is true, that in the past there followed a time when, at any rate among those who responded to the call of chivalry, the men fought and worked that women might live at ease, and that even within the memory of many of us the household was deemed her rightful and only sphere of work; but they forget that long before the present war had revolutionised matters, in France, with a diminishing population and a strict rule of army service, the women had become compelled to undertake tasks unheard of here, and that in Germany, that land of *kultur*, it was no uncommon sight to see women toiling up a ladder with a hod full of bricks, or drawing a plough with an ox for company while the shafts were held by a man.

Here, so far, till quite recently, women have not taken kindly to the rougher work of men, but have sought rather to share the higher branches thereof. We have woman doctors, woman preachers, woman lawyers, and woman architects, and although the latter actually practising are not as yet numerous, it is becoming by no means uncommon for an architect to utilise the services of his typewriter or stenographer as draughtswoman, to trace the sketches made by her principal which have to no slight extent superseded working drawings as they used to be understood, which are then traced by the assistant and reproduced to the extent of copies wanted by one or other of the usual processes. Among these lady traacers or draughtswomen there will surely be some who will start in practice for themselves, and who, with such opportunities of study as the A.A. has lately conceded, will find themselves as fully equipped for any tests qualifying bodies may offer—but cannot compel—as the men.

Such will not lack clients, nor will they, as some of us imagine, shirk the architect's often disagreeable and sometimes dangerous work of supervision of buildings actually in course of erection. They may not yet awhile build our palaces or public buildings, but they will be preferred especially by members of their own sex who want to build houses and who demand more knowledge of and capacity to provide the elements of convenience and beauty which we are told more and more frequently the mere man is ignorant of or careless about.

It is not improbable that even more may follow. Mr. Sidney Webb told some of us last week some very plain truths about the exclusiveness and behind-date characteristics of our elders, which, so far have quite seriously limited the usefulness of our professional associations. Whether these are joined by women architects or not, we venture to predict the indisposition of the few to insist on better



treatment of the many, and the concession of their rights to all will not long be tolerated by the woman-architect. She knows what women have done during the last ten years to win the vote. In not a few cases she will have helped. For half a century, at least, thoughtful, if somewhat slow-moving, men and women had made up their minds that the equal right with men of women to the franchise was indisputable, and had agitated in the old orthodox respectable fashion in vain. The woman suffragists came along and took their kingdom of heaven in very truth by violence. With the intuition of their sex they gauged men rightly. So, with little delay, if the professional societies do not move a little faster in pursuit of the three desiderata specified by Mr. Sidney Webb, it is not unlikely that the woman architects will start an association of their own—indeed, the idea is already being discussed, and we are not surprised.

For, taking Mr. Sidney Webb's three specified needs, how much our failure to secure them has been due to our own neglect to end the inertia of our associations which have been professedly working for them! State recognition might have been won long ago but for the endeavours of the R.I.B.A. to confine it to members of its own society, which Parliament is never likely to concede. Criticism of Government action is little likely to frighten any official while it is of the nature of Lord John Russell's when he rushed through the Ecclesiastical Titles Bill and "ran away," as *Punch* drew him, as the R.I.B.A. did when the Government excused its failure to employ architects properly on war work by the false declaration that such service had never been tendered.

In the course of the brief discussion last week at the R.I.B.A. on Mr. Sidney Webb's address, Mr. Hare said the R.I.B.A. "had been imposing its views on the Government" in regard to the housing competitions it has arranged in conjunction with the Local Government Board. We shall be glad to find presently that is so. At present not a few are declaring that the "imposing" has been done by the Government, and, with the concurrence of the R.I.B.A., on possible competitors. We offer no opinion as yet, but as far as we know the explanation offered this week elsewhere on behalf of the secretary of the R.I.B.A. has not satisfied many. However, we shall see presently who abstain and who compete, and what the Government does with the designs when they become its absolute property. And—last, but by no means a happy thought—if all or any of the prizes should be carried off by lady architects, who "know so much more about home and its needs," and all the rest of it, than we mere men, let us look pleasant and not say we have been "imposed" upon by anybody!

HOUSING AFTER THE WAR.

A three days' conference was held last week in St. George's Hall, Liverpool, of representatives of local authorities, insurance committees, professional and other interested organisations, and associations of employers and workmen in the north-western counties of England and Wales to discuss the best means of meeting the demand by the Government that some 300,000 new houses shall be provided at the end of the war through the instrumentality of local authorities.

In his opening address on Wednesday the Chairman (Councillor Harold Shawcross, of Rochdale) said so far the response made by local authorities to representations by the Government was very satisfactory. Up to 1914 the local authorities of the country had built only 12,000 houses. To-day those authorities had schemes ready for 40,000, and were prepared to build 116,000 more if the Government's promise of financial help proved adequate. He welcomed Mr. Hayes Fisher's announcement that the houses to be built should not exceed twelve to the acre in urban districts, and eight in rural districts. As to the terms to be given by the Government, they would have to be liberal if the Government's programme for 300,000 new houses was to be realised. A memorandum which had been carefully prepared showed that simply owing to the advance in the rate of interest from 3½ to 5 per cent. the cost of building had been so increased that it would be necessary to charge a rent of 9s. 4d. where 6s. 11d. was charged before the war. What the Government now wanted was to know the best way of giving assistance. The extent of that assistance, reading between the lines of Mr. Hayes Fisher's speech in Manchester, would apparently be one-third of the cost of building and one-half of the losses that might fall on the rates through inability to get the rents required to meet the cost.

The conference then discussed four alternative methods suggested by the National Housing and Town-planning Council in which the Government might assist local authorities. The first was that a block grant of 30 per cent. should be given to local authorities, and that any further loss on schemes should be divided equally between local authorities and the Government. The second was that the difference between the actual cost of building and the pre-war cost should be made the subject of a grant, and the third that local authorities should build the houses for the Government and administer them at agreed rents for five years, when the local authorities should acquire them at a price based upon a valuation. Lastly, it was suggested that the Government should deal with each housing scheme on its merits, that the local authorities should budget for substantially increased rents and take the risks of not getting them, and that the deficiency not covered by such increased rents should be met by grants.

Many diverse views were expressed. One or two speakers, evidently representing the building section of the conference, urged that whatever assistance is to be given by the Government should be extended to private firms complying with the requirements laid down for local authorities, but this apparently was not the general feeling.

On Thursday Mr. Nee (Carnarvon) moved that the Government be asked, as an emergency measure, to facilitate the purchase by public authorities, on reasonable terms, of land required for housing schemes, to be commenced at the expiration of the war. The motion received assent.

Mr. T. Marr (Manchester) moved a resolution calling in detail for legislation to facilitate a comprehensive housing and town-planning policy to be carried into effect on the conclusion of the war. He admitted that private enterprise builders had been hampered by the tardy and cumbersome procedure of the town-planning framed in the best interests of red-tape.

Mr. Travers (borough engineer of Wallasey) described how Wallasey had avoided the creation of a new series of congested inter-urban areas by applying town-planning powers, and thus reducing the number of

houses to the acre. For the sake of men wishing to dwell near their work, he thought that eighteen houses to the acre might be allowed in industrial areas.

Mr. Peter Jones (Ellesmere Port) moved a resolution in favour of making housing schemes compulsory instead of permissive. To remove the reproach of the slums compulsion was necessary.

Mr. Roberts (Carpenters' and Joiners' Union) seconded. The owners of slums should bear the cost of demolition.

Dr. Marsden (Birkenhead) pointed out that in his borough slum property was demolished at the cost of the owners. He emphasised the sanitary value of a hot-water supply to tenements.

The resolution was adopted.

Mr. William Gileave (Great Crosby) moved:—"That this conference is of opinion that the legislation promised by his Majesty's Government in 1913, and again in 1914, with regard to the amendment of the Finance Act of 1909-1910, should be now carried out in order that an admitted obstacle to the building of working-class houses may be removed and the provision of such houses stimulated at the close of the war."

Mr. Pemberton (Warrington), speaking as a forty years' house builder, and the son of a builder, seconded the motion. He denounced "the folly of going to the theorist to provide houses." Would any practical man ask a theorist to build him a ship or to equip a factory with machinery? Thousands of builders "thrown on the scrapheap" by the cessation of building were ready to respond to the national call, and prepared, if given reasonable facilities, to erect houses in competition with municipal councils, the State, or anyone else. "If you place house building on the same commercial basis as any other form of investment," he remarked, "and give economic wages, you will have no need to subsidise house building by grants of millions from the State Exchequer."

On Friday Mr. W. H. Hickson (Town Clerk of Rochdale) moved that local authorities should by legislation be enabled to acquire undeveloped land for housing purposes at a price not greater than the agreed valuation under the Finance Act, 1910, owners to be given the opportunity of having their land revalued. On the question of valuation, he contended that it was because there was so much uncertainty regarding the price of land to-day that the difficulties of obtaining it became so much enhanced. They ought to get rid of the speculative value of land.

Mr. Pemberton (Warrington) declared that it was only human nature that every man would get what he could for his land. For that reason, the resolutions before the conference went too far. The conference was a perfect farce. It was impossible, he said, for a delegate to discuss such far-reaching resolutions in five minutes.

The resolution was carried.

The next matter under discussion was a series of proposals that the Small Dwellings Acquisition Act should be amended so as to enable local authorities to extend facilities whereby working men and others might be able to purchase their own houses by the provision of capital for building by public utility societies and other agencies.

Mr. Ward (Shrewsbury), in supporting the resolutions, said they were principally founded on the fact that the land must be leased and not sold by the local authorities. If the corporation held the lease the property would belong to the town for all time.

A working-class opinion was voiced by Mr. Jackson (Manchester), who feared that the purchase of houses by the working classes might have a detrimental effect on wages. The municipality should be the owner, and let the houses to the workers at the lowest possible rents.

Mr. Lee (St. Annes) made the point that if municipalities started to build houses and let them at less than an economic rent they would have to build every-house, because no builder could compete with them.

The resolutions were carried.

PREFERENCE TO OVERCROWDED FAMILIES.

The Chairman (Councillor Shawcross, Rochdale), in bringing forward resolutions dealing

with special housing and town-planning problems, explained that they provided for local authorities to give preferential treatment to overcrowded families, and, if desired, to tuberculosis families. They also called for Government investigation of that most serious problem—the bad housing in mining districts, where the working classes earned the best of wages.

The resolutions were agreed to.

A final resolution called on the Government to set up housing and town-planning departments of the Local Government Board, which should be the first-class administrative departments of the State, fully equipped to guide and stimulate the work of local authorities.

#### MODEL MAISONNETES.

Many members of the conference and others interested accepted invitations to view, at the Adelphi Hotel, a model of four maisonnettes, exhibiting a registered design by Messrs. Charles Clegg and Sons, architects, Manchester. The model embraced four dwellings, each suited to the needs of a working-class family, two of the dwellings being on the ground floor and two on the first floor. A maximum of light and air space formed features of these dwellings, which were also provided with gardens large enough to provide vegetables for the tenants. The intention is to erect blocks of 200, with variation in design. At pre-war cost, the inclusive rents of maisonette and garden, with membership of laundry club, would be 8s. 6d. weekly.

#### COMPETITIONS.

**HAUGESUND (NORWAY).**—The British Vice-Consul at Haugesund reports, under date October 6, that the committee for the enlargement of the port of Haugesund has issued an invitation for a competition of plans for the harbour improvement and enlargement of the port and quay system in the port, and in this connection he has forwarded particulars of the proposed works, which, together with the names of the members of the jury who will consider the plans sent in, may be consulted at the Department of Commercial Intelligence, 75, Basinghall Street, E.C.2.

**"OWEN JONES" PRIZES.**—Competitions, under the terms of this trust, have been held annually by the Royal Society of Arts, from 1878 to 1915, in connection with the National Competition of the Board of Education. This competition not having been held in 1916, the prizes were not awarded, but a special competition was held in 1917. The Council are now prepared to offer six prizes for designs for chintzes, and other stamped, printed, or stenciled textile materials, wallpapers, and tiles. Each prize will consist of a bound copy of "The Leading Principles in Composition of Ornament of Every Period," from the "Grammar of Ornament," by Owen Jones, and the Society's bronze medal. The competition is limited to students of schools of art.

#### OBITUARY.

We regret to learn that Second Lieutenant John Titcomb Ryde, Bedford Regiment, attached Gloucester Regiment, younger son of Mr. and Mrs. A. L. Ryde, of The Hangers, Woking, who was reported wounded and missing on May 3 last, is now officially presumed to have been killed, aged 34. He was educated at St. Lawrence College, Ramsgate, and followed his father's profession, being elected, in 1912, chairman of the Junior Committee of the Surveyors' Institution, of which his father is President for the current year. He was a partner in the firm of Ryde and Sons, Parliament Street, Westminster. He had been at the front about ten months. His colonel wrote on May 12:—"He had led his men in the most gallant fashion, but was outnumbered and surrounded. Since he has been with this battalion he has made himself greatly loved. He was a first-class officer and we all deeply deplore his loss." Second Lieutenant Ryde married, in 1912, Marian Katherine, eldest daughter of Mr. Horace Dove, of Sunbury.

Mr. B. W. Head, M.A., M.I.C.E., aged four-and-three-quarters, of Woking, has left net personalty £13,923, gross £19,436.

## Our Illustrations.

### YORK MINSTER, VIEW OF THE CROSSING, LOOKING NORTH.

The capable oil-colour sketch was exhibited this year at the Royal Academy by Mr. Ernest A. S. Benney, A.R.C.A., who has undoubtedly chosen an exceedingly impressive point of view for his picture, which obtained, as will be remembered, a good place on the line. The majority of visitors to York Minster probably enter by the south transept door, from whence almost this view was drawn, and so it happens that this aspect of the cathedral may be said to be most familiar, showing as it does the north transept in full view beyond the crossing under the great central tower. The three eastern bays of the famous "Five Sisters Window" so well-known to fame just come into the sketch, the north-western pier of the tower hiding the other two. Charles Dickens appreciatively described this window when writing "Nicholas Nickleby." The glass which it contains is a priceless example, and Mr. Benney has rightly endeavoured to depict the glamour of the subdued light which the colouring ensures on a summer's day. The masonry and the vaultings are graphically represented with a grip of the fact that the effect of light and shadow varies and changes so continually in York Minster. This occurrence every photographer cannot have failed to recognise, because the countless rays penetrating through numberless windows ceaselessly change the general relationship of its fine architecture. A few years ago, when Dr. A. P. Purey-Cust was Dean, the stability of the lofty lantern and central tower was for some while the cause of considerable anxiety and the occasion for much expense under the direction of the late G. F. Bodley, R.A., the cathedral architect. The massive and beautiful screen which separates the nave from the choir is seen to the right of this view. It consists of fifteen bays with canopied niches containing full-size statues of the Kings of England from William I. to Henry VI. Above the screen rises the organ, one of the chief glories of York Minster, and upon which many thousands of pounds have been expended.

### THE READING-ROOM, ORIENT LINE S.S. "OTWAY."

The library of the "Otway" is carried out in Italian walnut. The large panels are veneered, and the carved enrichments are executed in lime wood. The walnut is finished in the natural wood colour and is slightly waxed. Direct entrance to the library is obtained from the lounge and staircase, a somewhat singular arrangement to that of the s.s. "Orvieta." Although not a sister ship to the latter vessel, the dimensions of the "Otway" are very much the same. She was built by the Fairfield Shipbuilding Company, Govan, and the whole of the joinery was set out and prepared in the shops of this well-known firm under the supervision of the architect, Mr. Andrew N. Prentice, F.R.I.B.A., of Norfolk Street, Strand, W.C.

### HOCKLEY SOLE MANOR, NEAR FOLKESTONE.

This illustration shows the alterations to a house situated in fine country some four miles from Folkestone. The additions, which consist of new entrance hall and large new library and a general remodelling of the building, were designed by the late Lieut. Philip E. Webb, R.E., and have been carried out by his firm for the owner, Major Sir Herbert H. Raphael, Bart., M.P. The library, finished in oak, is carried through the two floors. The materials are stone plinth and terraces, rough cast walls and tiled roof; all the new external woodwork is of oak. The contractors were Messrs. Strange and Son, of Timbridge Wells. Mr. Henry Gray being clerk of the works. The drawing reproduced to-day was shown at the Royal Academy this summer.

### COMPTOIR NATIONAL D'ESCOMPTE DE PARIS, KING WILLIAM STREET, E.C.

Last week we published the plans and a working drawing of the façade of this bank

just erected in King William Street, London, E.C. A description then printed gives the leading particulars of the building with its very capable plan. To-day a detail double-page sheet is devoted to a section through the banking hall with its domed light, and on a single page plate the two subsidiary elevations facing Nicholas Lane and Abchurch Lane are included. Messrs. H. V. Ashley and Winton Newman, F.R.I.B.A., of Gray's Inn, are the architects.

## Building Intelligence.

**BIRMINGHAM.**—The scheme to erect a war memorial church is progressing steadily and many of the chief details are already settled. The idea appeals to people in Birmingham and in all parts of the British Isles, as is instanced by the individual contributions that have come to hand. Father Gibbons and his committee have received very great encouragement during the last few days, through a munificent donation of £2,000. The army is supplying the architect, this being Lieutenant George B. Cox, of the well-known firm of Harrison and Cox, Birmingham.

**DARJEELING.**—On October 26 Lord Ronaldshay laid the foundation-stone of the new Town Hall and Municipal Offices which, when completed, will serve the double purpose of a memorial to his late Highness the Maharaja Nripendra Narayan Bhup, Bahadur, and the centre of civic activities. The hall and offices will be built of local stone, the main entrance facing on Mackenzie Road, while the side of the hall itself will open on to Auckland Road. The hall is nearly 100 feet by 45 feet in this section. The offices are to be constructed in three floors at the side of the hall. There will be a stage and proscenium and balconies around three sides, and a council chamber is provided. A feature is a Gothic clock tower, provided with a clock.

**GATESHEAD.**—The Shipley Art Gallery, in Prince Consort Road, Gateshead, was formally opened last Thursday. The building was designed by Mr. Arthur Stockwell, architect, Newcastle, and embraces several picture galleries, with a main gallery in the centre. It stands on a site 22 ft. from the roadway, and a carriage-drive leads to the main entrance and portico, beyond which are a vestibule and entrance hall, with a panelled dado and plaster decoration, the light being transmitted through a circular dome. The gallery, which has cost £25,000, contains 500 pictures. The builders were Messrs. J. and W. Lowry, Newcastle-on-Tyne.

#### PARLIAMENTARY NOTES.

**CEMENT FOR GERMAN PILL-BOXES.**—Lord R. Cecil, replying to Brigadier-General Croft, last Wednesday, said:—"I have made inquiries and am informed that as the result of tests and analyses of numerous samples from different factories, the artificial Portland cement manufactured in Belgium is quite equal in quality to the average English product, and equally suitable for making concrete for fortification purposes. There seems no doubt that cement of German and Belgian manufacture is used for the construction of German pill-boxes and other fortifications. In the first place a paper cement sack has been picked up on the field of battle which from the lettering stamped on it clearly comes from Hanover, and in the second, the metal label referred to in a letter by Captain Hewston to the newspapers proves on examination to be from a Belgian factory. On one side it has the words "Cannon Brand Artificial Portland," on the other "Burcht, Antwerp." This indicates, I am told, that it comes from the Cannon Brand Artificial Portland Cement Works at Burcht les Anvers, a well-known Belgian cement factory, which was taken over by the German Government before March, 1916. On the other hand, no evidence has yet been discovered that British cement has been used in the German fortifications. Brigadier-General Croft: Is the noble lord aware that people are under the impression that some of the cement used in those fortifications was imported from this country? The Speaker: How can the Minister say that impression people are under?"

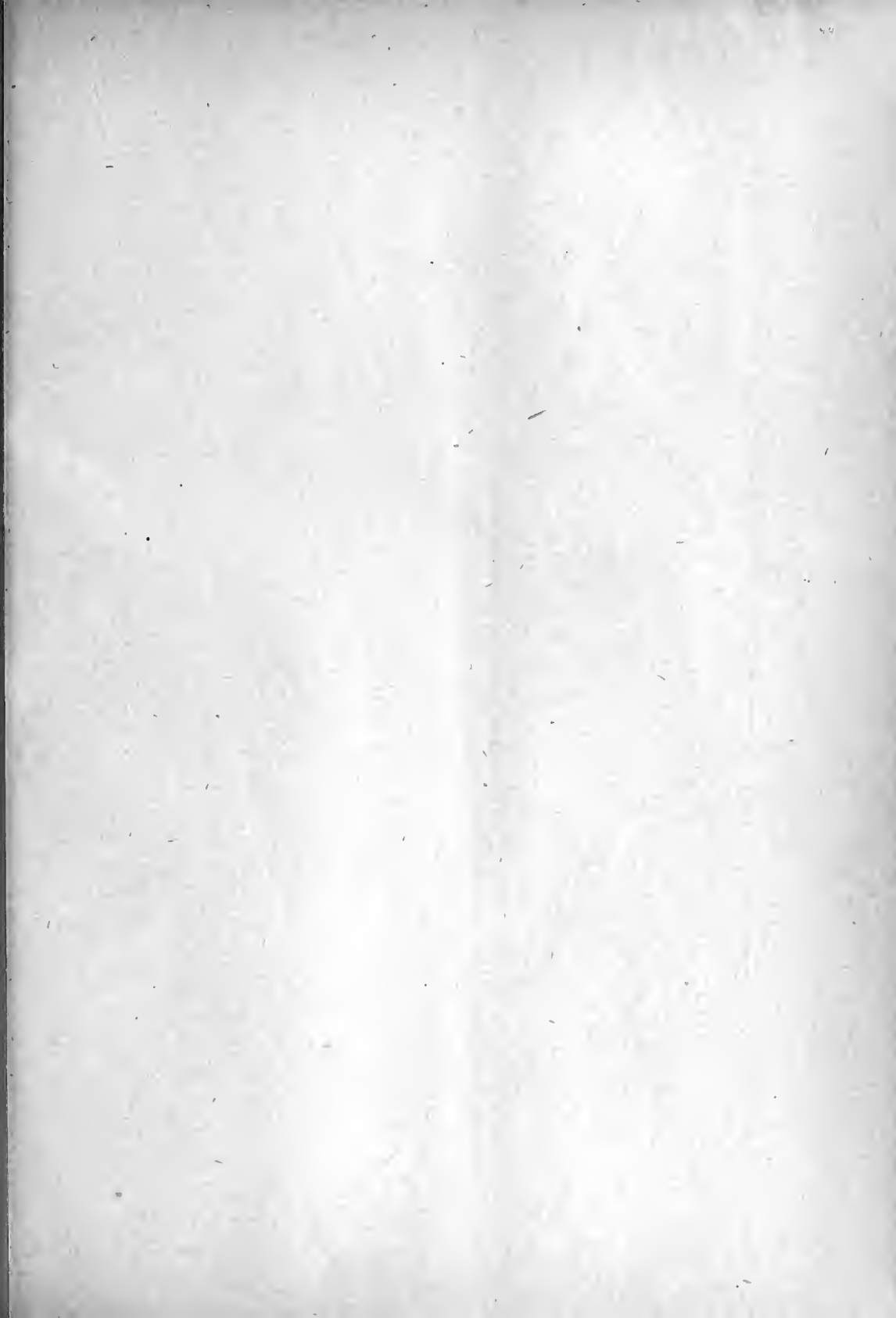

100 S. B. KING WILLIAM STREET, E.C.

SECTION THRU BANKING HALL  
SHOWING MARBLE FINISHINGS, ETC

NOTE. SEE F.S. DETAILS  
FOR ALL FINISHINGS.

NOTE. ALL DIMENSIONS TO BE CHECKED ON SITE

- B. DENOTES BLACK MARBLE
- W. " " " " WHITE MARBLE
- B.S. " " " " BARRACCA MARBLE
- P. " " " " PAVONAZZA MARBLE

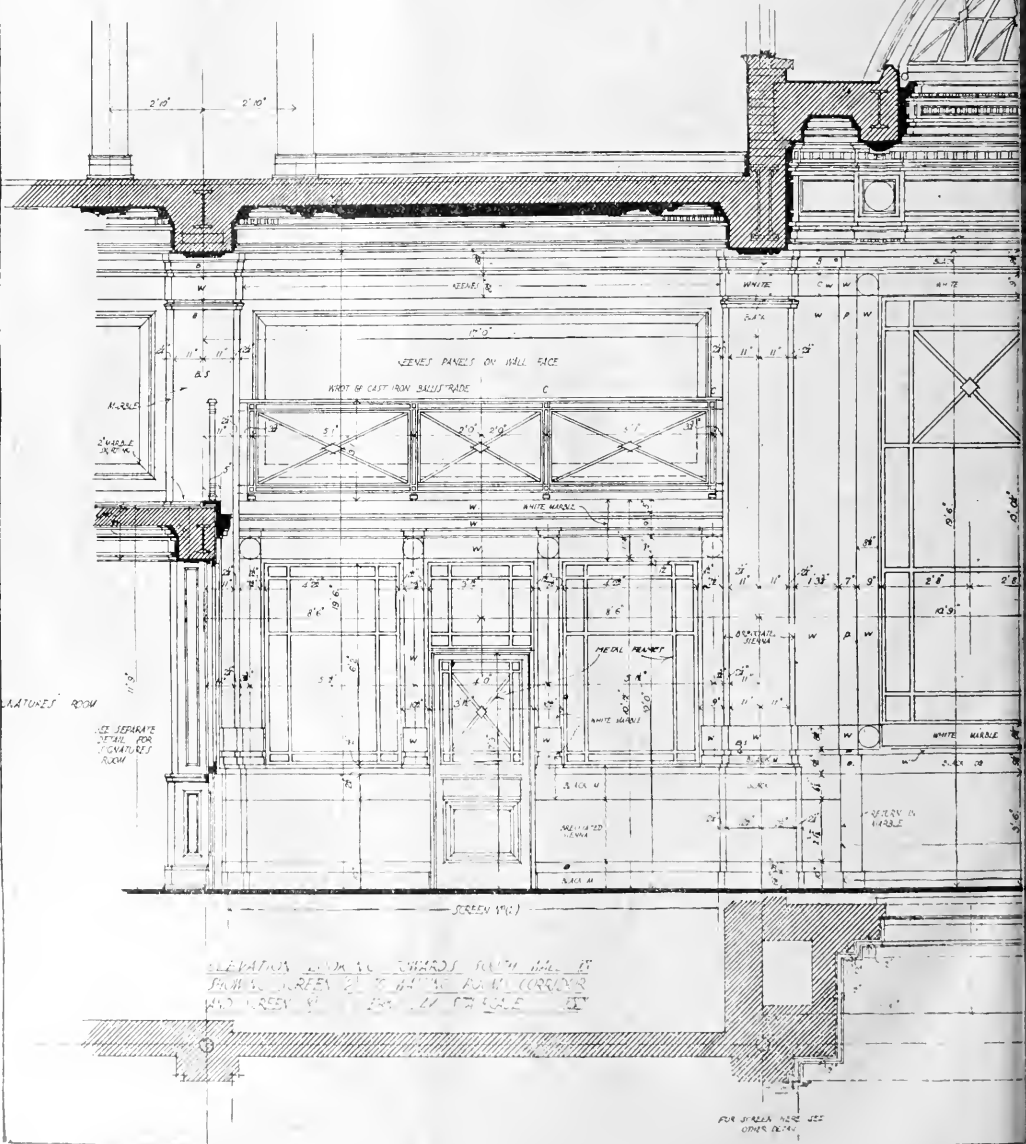

REV. NO. 62

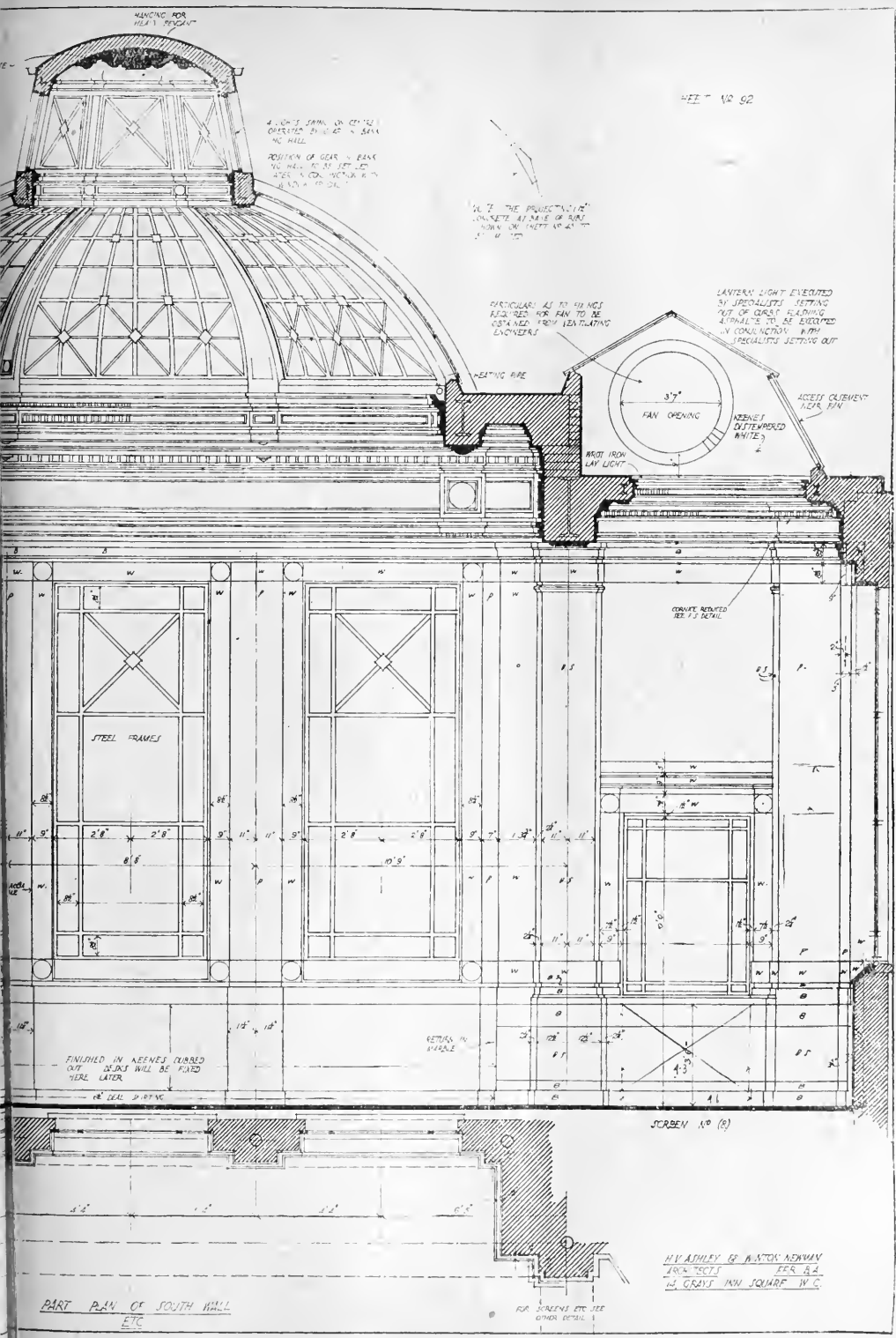

WING SECTION.—Messrs. H. V. ASHLEY and WINTON NEWMAN, F.F.R.I.B.A., Architects.







THE BUILDING NEWS, DECEMBER 5, 1917.

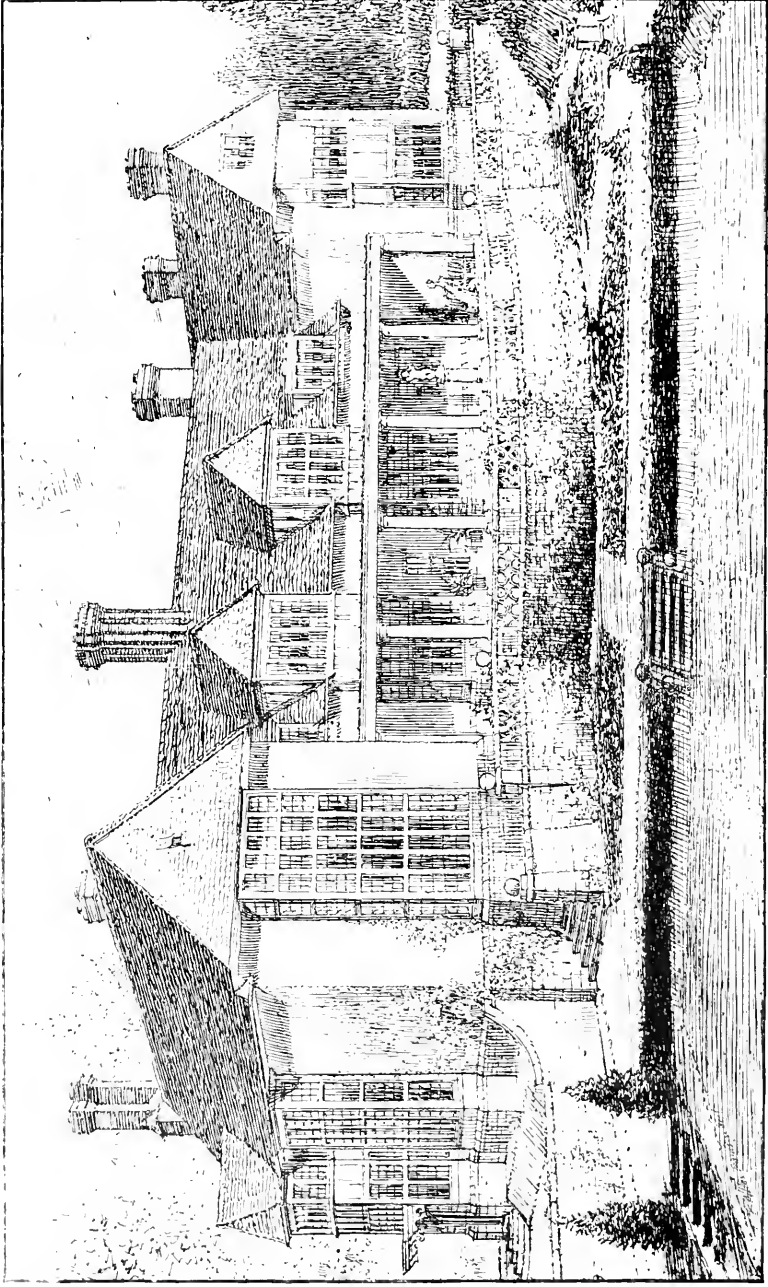

HOCKLEY SOLE MANOR, NEAR FOLKESTONE: ALTERATIONS AND ADDITIONS.  
The Late Lieut. PHILIP E. WEBB, R.E., A.R.I.B.A., Architect.





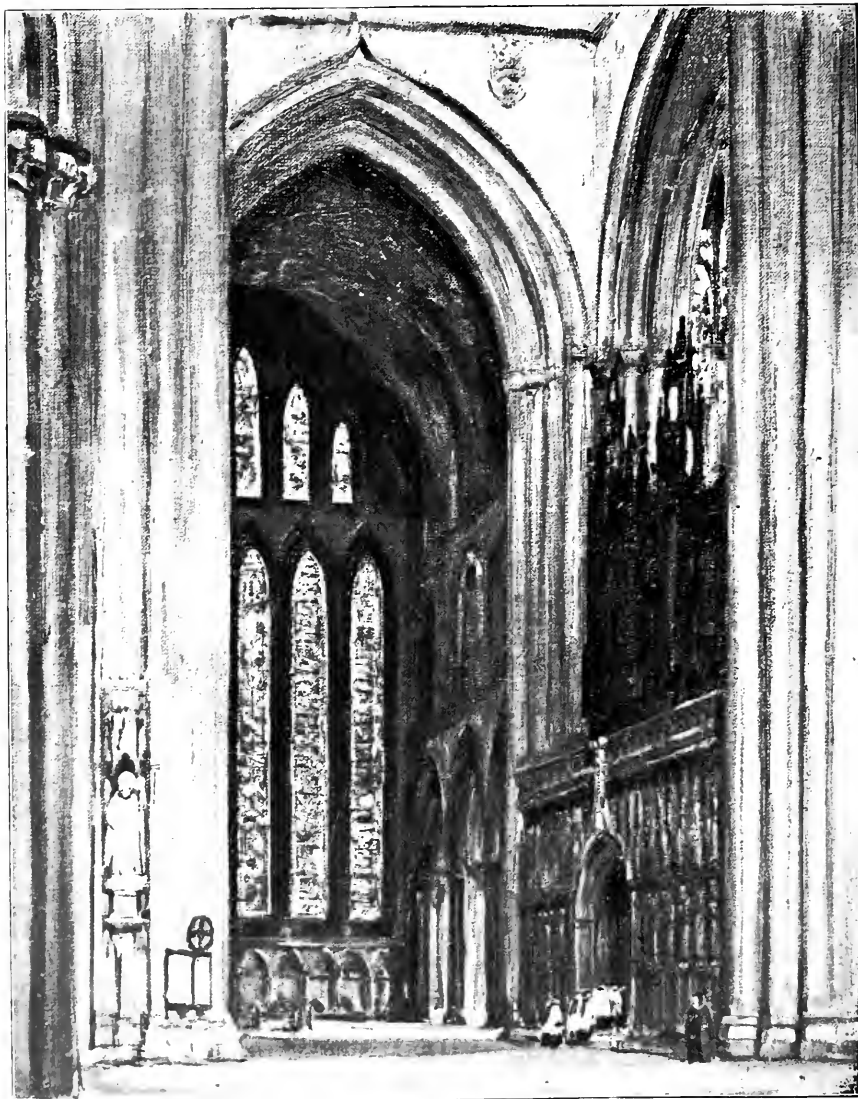

YORK MINSTER, VIEW OF CROSSING, LOOKING NORTH.  
From an Oil Colour Sketch by Mr. ERNEST A. S. BENNEY, A.R.C.A.

THE BUILDING NEWS, DECEMBER 5, 1917.

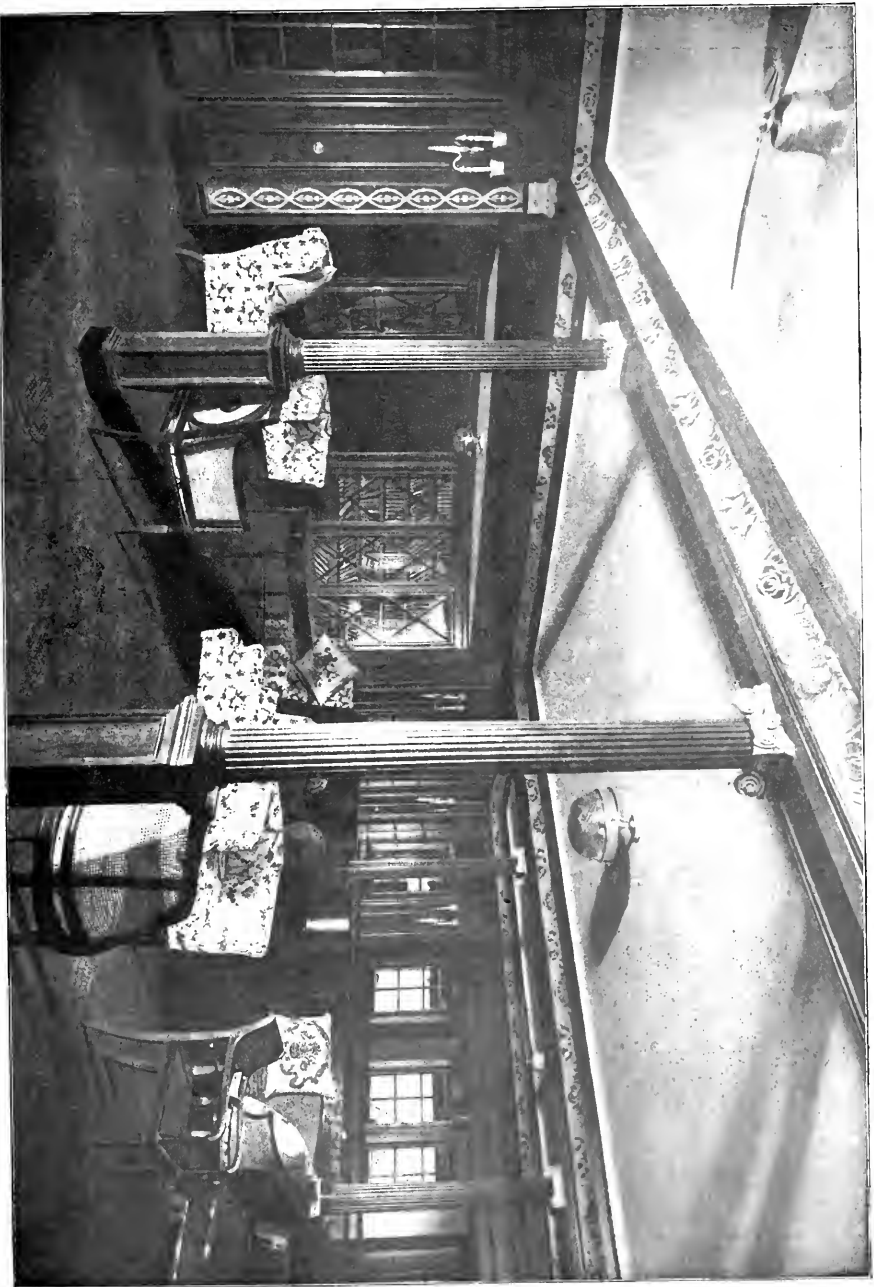

*Views, designed by Messrs. and Co., Boston.*  
THE READING ROOM, ORIENT LINE S.S. "OTWAY."—Mr. ANDREW N. PEASE, F.R.I.B.A., Architect.



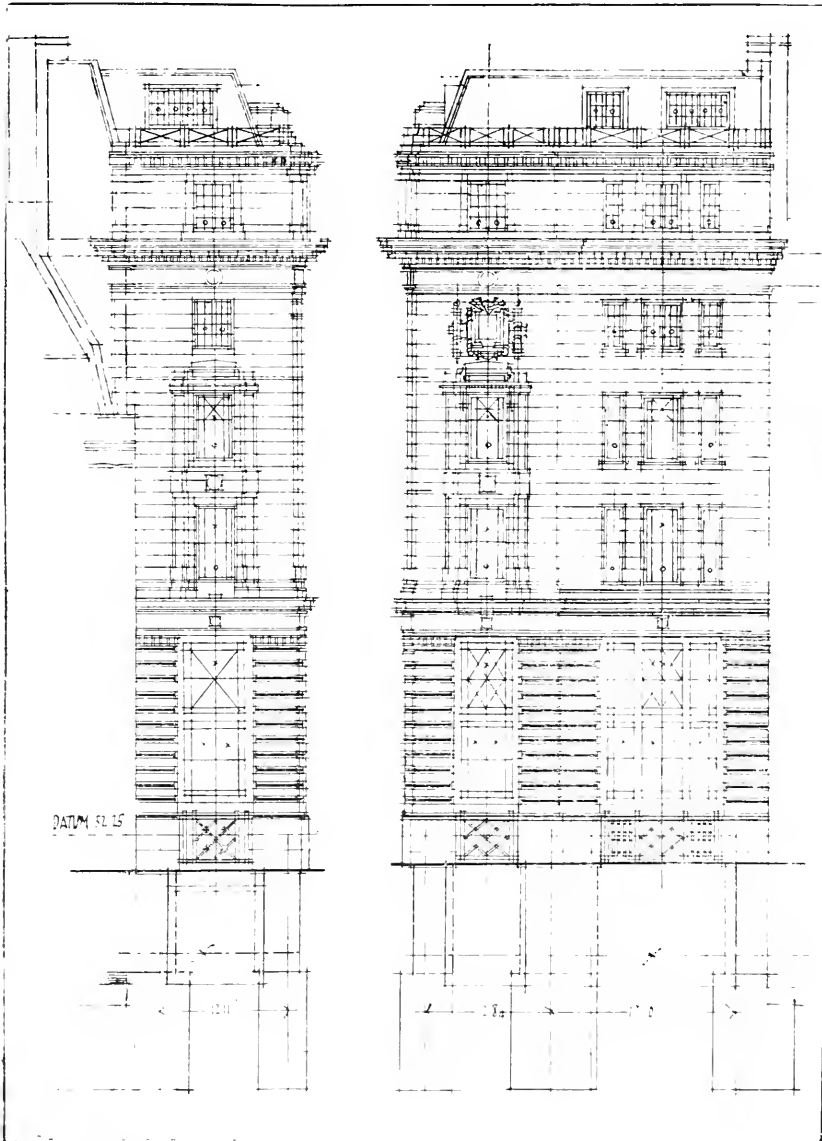

COMPTOIR NATIONAL D'ESCOMPTE DE PARIS, LONDON: NICHOLAS LANE  
AND ABCHURCH LANE ELEVATIONS.

Messrs. H. V. ASHLEY and WINTON NEWMAN, Architects.

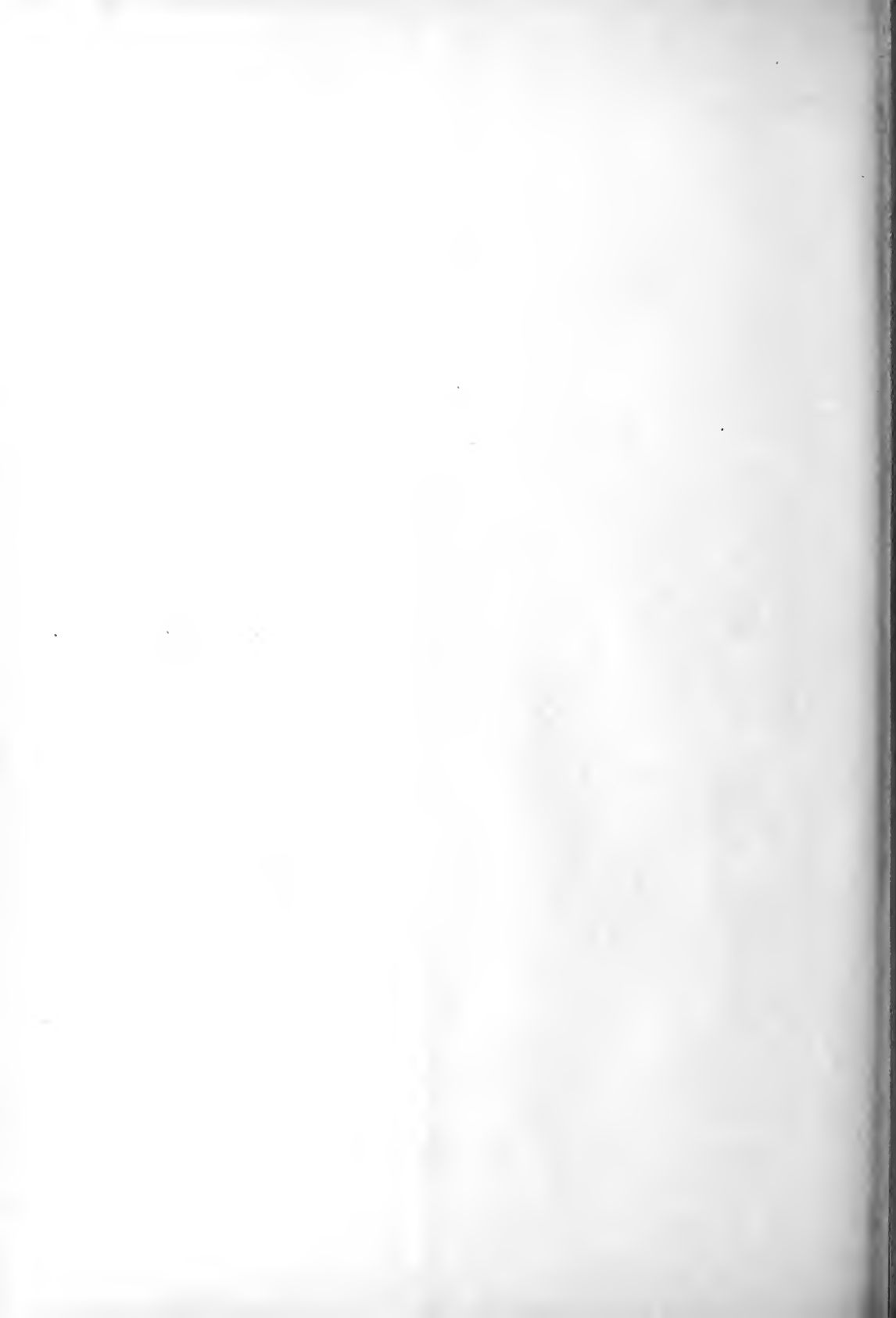

## Correspondence.

### THE R.I.B.A. COMPETITION FOR WORKING-CLASS HOUSES.

To the Editor of THE BUILDING NEWS.

SIR,—The attention of the Council of the Institute has been drawn to criticism of the conditions of the competition for working-class houses initiated by the R.I.B.A. on the ground that such conditions are in contravention of the Regulations for the Conduct of Architectural Competitions, inasmuch as no undertaking is given that the successful architect shall be employed to carry out the work. I am directed by the Council to call attention to the following facts:—

1. The Local Government Board invited the R.I.B.A. to co-operate in the housing scheme by providing the best typical plans for cottages, which might be issued as a guide to local authorities and others in charge of housing schemes, to be used as instructions to the architects to be employed by them. An adequate sum of money is to be allotted as payment for these plans.

2. The Council consider that they have acted in the best interests of architects in acceding to this request. They considered that the best way of procuring the designs was by means of a public competition, rather than by instructing a few architects to prepare them, especially in view of the fact that the great majority of architects are at present debarred from the practice of their profession.

3. Particulars of the designs asked for have been carefully prepared so that there should be no likelihood of their being used other than as types showing the kind of houses that are required. The designs do not cover or provide for the varying conditions which will present themselves in actual housing schemes, nor do they touch the matter of lay-out, a very important part of the architect's functions. Moreover, it is the intention that a competent architect shall be employed in every scheme that may be initiated by public authorities.

4. The payment offered to the authors of the successful designs is adequate to cover the exceptional conditions.

5. If the present competition had carried with it the commission for execution of housing schemes, all architects now on service would have been precluded from taking part in such work when they are released from the Colours.

6. The entire circumstances are quite exceptional, and the Council see no objection to members taking part in the competition.—I am, Sir,

Your obedient servant,

G. NORTHOVER.

On behalf of the Secretary.

9, Conduit Street, Hanover Square,  
London, W.1.  
November 27, 1917.

SIR,—It is to be hoped that the R.I.B.A. will be able to amplify and amend the conditions of the above competition. It is extremely doubtful if there is much more to be said concerning cottage-planning. During the last ten or twelve years there has been so thoroughly thought out in detail in all districts by specialists.

There was the possibility of some new treatment of available materials being forthcoming, but prevailing conditions do not justify this expectation, but rather that of a shortage of customary building-stuffs. Therefore, either as regards planning or special materials, the object of the competition is extremely limited.

The one question of vital importance, and which should not be lost sight of, is to discover the capable architects in the various areas who, being conversant with local practice and conditions, are competent to assist and advise the local authorities and building owners with their schemes. A great effort should therefore be made to arouse a keen interest in the respective areas by exhibiting the successful plans of the local winners in the chief towns of the districts. To this end I suggest that, in addition to the premiated designs, other meritorious schemes should be

exhibited also, with their respective authors' names attached.

Another matter of importance is the appointment of assessors. Could not the R.I.B.A. prepare a list of competent men who would be prepared to act as such? Otherwise, there is the possibility of the presidents of the local societies being appointed, who may or may not be devoid of any experience or knowledge of cottage-planning beyond the ordinary routine type.

The scale for the plans set down in the conditions is much too small, seeing that the positions of the various pieces of furniture and fittings are demanded. The time for sending in competing plans after receiving the replies to questions, which will probably not be before the middle of this month, and, in addition, the Christmas holidays intervene, seems too short; should not this be extended, say, to the end of February? It would be extremely unfortunate should the promoters be contented with simply obtaining the premiated plans and only exhibiting at Whitehall, or perhaps issuing them in pamphlet form to the surveyors of the various local authorities, and so lose the experience, interest, and competency of the local winning men. It would be equally disastrous should an attempt be made to work the scheme entirely from Whitehall, and not attempt to utilise the practical and experienced men.—I am, etc.,

SEMPER FIDELIS.

### YOUR WAR.

SIR,—Excepting the dear old lady who occasionally "bobs up serenely" in alleged blissful ignorance of the war, and the shepherd from the wilds of Wales who had heard we were fighting the Germans but couldn't understand why "these 'ere Australians" were arrayed against us, there remains no one, surely, in all our world-empire, who does not realise that there is a war on.

But that is not enough. It has got to be realised not only as an historical fact but as an intimately and vitally personal fact. The Kaiser is fighting you and me—are you and I fighting the Kaiser?

To the personal menace of a commercial rival seeking to destroy us we would show our teeth. We would join in bloodless battle, and nothing which could be done, legitimately, to overthrow him would remain undone. Why? because our well-being, comfort and peace of mind would be at stake—and when that is the issue the most pacific amongst us does not hesitate, but fights.

Well-being, comfort, peace of mind—and more also—are menaced by Kaiserism. Carried out, the threat would be more intimately personal in its effects than is generally realised. *You and yours* would suffer.

The only reply that many of us can make to this personal threat is to finance, each according to his means, the mighty blows which are falling on the enemy. Fortunately for those who can strike in no other way, the "silver bullet" is a missile which not only hits the enemy every time but gives him "one for you."

This is *your* war. The Kaiser is fighting you. Your money in National War Bonds will administer an individual tap, and pay the aggregate punch of millions more like it; Kaiserism cannot recover. Make it a "knock-out." P. G.

### LEGAL INTELLIGENCE.

PROFIT ON GAS ECONOMISERS.—According to the *London, Bulland, and Stamford Mercury*, at the Kettering County Court on Friday week before Judge Radcliffe, W. Tice and Co. of Southwark, sued E. E. Rice and Co., Ltd., shoe manufacturers, Kettering, for damages, 27 3s. 4d., in respect of a gas economiser supplied by the plaintiffs. Plaintiffs supplied the economiser subject to test, and defendants afterwards wrote that it had "been a failure" from that claimed for it.—The plaintiffs' representative said the "damage consisted of loss of profit." The intrinsic value of the apparatus was 15s., and £9 13s. was charged. Considering the profits on typewriters, sewing machines, etc., he did not think there was anything so remarkable about this.—His Honour held that the conditions of the contract had not been fulfilled, and gave judgment for defendants.

### PROFESSIONAL AND TRADE SOCIETIES.

#### ARCHITECTURAL ASSOCIATION OF IRELAND.

—At the meeting on November 22, Mr. R. C. Orpen, R.I.A., lectured. He started by endeavouring to define what the word "fashion" implied. He stated that the subject index in the National Library afforded him little help: "Fashion; see Costume," which was not at all what he desired to see. He endeavoured to give a definition:

"Fashion is the outward indication of varying taste." The lecturer asked, Whence comes the power which controls the various changes in taste which fashions indicate? He found the answer in the fact that intelligent beings are impelled to change that which, by its familiarity, has become contemptible, and concluded that "The authority which ordains our fashions is found in the collective mind of men." He regarded the tyranny of fashion as a benevolent tyranny, which modifies the monotony of life, which rescues us from the dull waterways of the commonplace and launches us on the wide river of adventure." He said that, in regard to art, every departure from accepted standards had its pioneer; some adventurous spirit who, finding the circle of convention oppressive, steps outside, becomes a transgressor, and, as such, finds the way he desires to travel hard indeed. Pioneers, be they a Wagner or a James McNeil Whistler, must face hostility from two sources—from those who cling to their old creeds and resent any tendency to disturb their repose; and from those camp-followers, ever an increasing host, who desire to be "in the new push," but are themselves totally unacquainted. The lecturer went on to contend that it was not until the influence of the early pioneer, or pioneers, had failed, till the change for which he or they struggled had become vulgarised, by imitators, that his general acceptance entitled it to be called a fashion. The lecturer held that since the time when medieval or traditional architectural style ceased to exist in design had become eclectic; each new cult claims that it has discovered a national style, but eventually has to yield to a new variety. He attributed the present fashion in architectural taste to the rise of university training. He said there was no style of architecture which so readily afforded a groundwork for the lecture theatre or studio. The Greek type was adopted for academic teaching as the most comfortable, as it were, to grammatical rule. He concluded by pointing out the great incentive to young architects of a change of fashion in type which synchronises with their entry on the field; they find it delightful and stimulating, and, believing it to be the true national and logical style long expected, become whole-hearted disciples. Such faith can alone produce the best art. The lecturer, somewhat sadly, confessed that older men, like himself, suffered in competition from a certain lack of enthusiasm, a degree of nervous uncertainty which must always accompany desillusion.

HAMSTEAD SELBOINE AND ARCHIOLOGICAL SOCIETY.—To conform to the times, this Society has departed from its long custom of evening fixtures, and has initiated a series of lectures, the first of which was given to a crowded audience last Saturday afternoon at Stanfield House by Mr. Samuel Gardner, president of the Harrow Architectural Club, who took for his subject the well-known and magnificent French cathedral of Chartres. He described Chartres Cathedral as leaving impressions of massiveness and brilliant glass. To the west front, with its solid towers surmounted by two of the finest spires in existence, one early and the other late, its great rose window, and triple portals filled with quaint and most impressive statues; the colossal buttresses with their wheel-like flying buttresses, the transeptal towers and great apse, in all, lastly, the wonderful north and south porches, each containing many hundreds of statues, statuettes, and reliefs, combine associations with the name of Chartres that make a visit a unique experience and the reminiscences of it a lasting addition to the richness of life. The sculptures of the western portals are the earliest, and are devoted to the story of Our Lord. The central tympanum shows the risen

Christ seated in majesty, the left hand the Ascension, and the right hand the Nativity. The elongated figures on the shafts, though quaint in their anatomy, are some of the most spiritual and fascinating sculpture in the world. The north porch is one hundred years later, but some of the statues are still of an antique character. The scheme of the sculptures is a glorification of the Virgin Mary. The central figure is St. Anne with the infant Mary, and the groups are of her Precursors and include a Jesse tree and scenes from her story—especially an Annunciation and a Visitation. The south porch is again a little later. Here the technique is more advanced and less crude, if less expressive. The central figure of Christ is very fine. On His right is the bay of martyrs and on His left the bay of confessors. Above the porch is the gallery of the Kings of Judah. The glass is splendid. There are 175 stained-glass windows. "Epithets are quite powerless to convey the beauty of the light that pours through them." The church of St. Pierre also has very fine glass. Its flying buttresses are a good example of French Gothic.

**THE SURVEYORS' INSTITUTION.**—An Advisory Committee of Surveyors has been set up by the Chief Commissioner of Police to consider and report as to the steps which should be taken to provide protection for the population of London during air raids. Sir Alexander Stenning is chairman, and other members of the committee are Mr. Horace Cheston, Mr. Fitzroy Doll, Mr. Percival Monckton, Mr. E. C. P. Monson, and Mr. Dendy Watney. The Advisory Committee is acting in conjunction with a number of Royal Engineer officers experienced in explosives. Mr. E. C. P. Monson gave evidence on behalf of the Institution before the Departmental Committee on Housing (Building Construction) set up by the President of the Local Government Board. As a result of the report on housing recently issued by the Council of the Surveyors' Institution, arrangements have been made for representatives of the Institution to lay their views in person before Sir Noel Kershaw, K.C.B., of the Local Government Board.—The Petroleum Production Bill has been receiving the careful consideration of the Council of the Institution. In view, however, of the position in which the Bill has been placed by the defeat of the Government on the subject of their proposals with regard to the payment of royalties in respect of petroleum, the issue of their report on the Bill has been deferred.

## Our Office Table.

Writing to the *Times* of the 29th ult., Mr. Halsey Ricardo, F.R.I.B.A., remarks that anyone reading that journal's article on "Country Cottages—the Lost Art of Building," in a previous issue, would gather the impression that architects consider it beneath their dignity to design cottages. This is one of the several attitudes ignorantly attributed to the profession. The architect does not consider it below his dignity to design a cottage, but considers it a great misprision of his qualities and his services when they are sought for, when a scheme of cottage building is on foot. Nor will an architect admit that "to build good cottages no great education is needed, or great knowledge." That such a view has currency is a public misfortune, and it is the parent of the widely spread, ignorantly built cottage that so frequently disgraces the locality in which it stands. The "old cottage" embodies some centuries of traditional building lore, not now easily to be found in the modern builder's yard.

At a special meeting of Cardiff City Council on Wednesday, Mr. E. J. Elford, borough engineer of Southend-on-Sea, was unanimously appointed to the position of city engineer at Cardiff at a salary of £1,000 per annum. Mr. E. L. Morgan, borough engineer and surveyor of Bolton, was it will be recalled, elected to the post a few weeks ago but afterwards declined the appointment owing to the fact that the climate of Cardiff

would not suit his wife's health. Mr. Elford was appointed to Southend-on-Sea in 1902. He served his articles with his father, Mr. J. Elford, then borough engineer of Poole. From 1890 to 1892 he was assistant to the late Mr. T. de Courcy Meade, at that time borough engineer of Hornsey, and subsequently engineering assistant to the late Mr. J. Buchan, city engineer of Norwich, and later to Mr. Buchan's successor, Mr. A. E. Collins. In 1895 he was appointed engineer and surveyor to the Portland Urban District Council.

M. Mestrovic, the Serbian sculptor, who has been in France and Switzerland, has returned to England with his new work, which is being exhibited at the Grafton Gallery. The exhibition was opened on Saturday by the Princess Patricia of Connaught. Most of the pieces are wood carvings of religious subjects. The exhibition is to aid the Serbian Relief Fund and Red Cross Society. Besides M. Mestrovic's sculptures there are paintings by M. Mirko Racki and sculptures by M. T. Rosandic. The main part of M. Mestrovic's works, which were exhibited last year at the South Kensington Museum, are still in England.

At a meeting of the Edinburgh Dean of Guild Court last Friday, Lord Dean of Guild Neil McLeod, presiding, there were twelve cases on the roll, and in regard to ten of them warrants were granted, or remits made to the burgh engineer. An interim warrant was given to the North British Rubber Company, Limited, for a canteen at Gilmore Park; and warrants to St. Cuthbert's Co-operative Association, for alterations at 85, Morrison Street; and Mr. Robert Lamb, for timber and box stores, etc., at Dunedin Street. An application was made for alterations at 25, Shadwick Place, to be carried out for the Young Men's Christian Association, and the case was continued for a full petition. The Lord Dean of Guild said he understood the work was pretty nearly completed already, and it might be that it would have to be stopped. He did not think it fair that the burgh engineer should have to hunt over the town and find out that a firm was doing such things as this. A representative of the builders who are doing the work said they had been advised that a warrant would not be necessary.

A small special exhibition of drawings by Dr. Thomas Monro (1759-1833) and other artists of his circle has been arranged in Room 132 of the Victoria and Albert Museum. Dr. Monro was the friend of many of the artists of the English water-colour school, including Turner, Girtin, De Wint, Cotman, and others, who in their early days used to gather at his house in Adelphi Terrace. So far as is known, no collection of Monro's drawings has previously been exhibited in public.

Speaking at Northfleet, Mr. H. K. G. Bamber, managing director of the Associated Portland Cement Company, defended the British cement industry against the aspersions cast upon it by the discovery of a tin label in one of the German "pill-boxes." The finder of the label had assumed, because it had British letters on it, that the cement was produced in Great Britain, but he ought to have known better. When examined it was found that the cement was known as the Cannon Brand, made near Antwerp. He believed the public were still inclined to think that British cement was being shipped to Holland for use in the German lines. There was not an iota of truth in such a suggestion, and the prohibition of the export of cement was a good thing for all of them. The directors of the Portland Cement Company would never countenance exports to help the enemy.

The St. Germans Rural District Council is faced by the housing problem in startling fashion. At the last meeting the surveyor, Mr. G. K. Foster, reported that he had received notice to leave his house by Christmas Eve, and it would break up his home, as he would have to go into lodgings for the time, and that to live at one end of the district would mean considerable inconvenience to him in carrying out his work.

## CHIPS.

Extensions are contemplated at the Royal Albert Institution, Lancaster.

The miners at Dawdon Colliery, Co. Durham, have decided to build twelve houses for aged miners as a war memorial.

Edinburgh painters have agreed unanimously to accept the employers' offer of an increase in wages of 1/4d. per hour.

The Manchester Town Council Education Committee propose to convert premises at the corner of Burlington Street and Gorton Lane, Gorton, into a school clinic.

At the Wellington (Somerset) Police Court last Friday, Colonel E. C. Sanford, C.M.G., was fined £15 and five guineas costs for failing to cultivate two acres of land on his Somerset estate.

Mr. Arthur Brown, M.Inst.C.E., city engineer of Nottingham, has completed fifty years' continuous service with the city council, of which period he has for thirty-seven years been city engineer.

Sir Charles Nicholson (who is the architect in charge of Lincoln Cathedral) has drawn plans for building a war memorial chapel opening out of the south transept of the parish church of St. James, Grimsby.

Mr. William Sheers, of 6, Logan Road, Bishopston, Bristol, formerly of Northcote Street, Cardiff, retired engineer's surveyor, whose death occurred on October 16 last, left estate of the gross value of £5,337 9s. 6d.

An exhibition of drawings by decorated painters, together with decorative furniture and other objects of art, is open, and will remain so daily from 10 to 4 (Sundays 2 to 7 p.m.), at the Burlington Fine Arts Club.

The East Ham Education Committee have instructed the architect to prepare a plan showing arrangements for a block of buildings suitable for a secondary or higher elementary school, on the site of Church Road School, Manor Park.

The honorary freedom of Chelmsford has been conferred on Mr. Frederic Chancellor, who is 92 years of age, and has been associated with the local government of the town since 1854, being the first mayor in 1883, and on six subsequent occasions.

Tenders are invited by Messrs. Fuller, Horsey, Sons, and Co. for an extensive freehold waterside factory at Hull. At present used as a seed-cleaning mill and refinery, the property has a river frontage of 325 ft. and an area of over 5,350 square yards.

We regret to record the death, killed in action, on November 19, of Mr. Kingsley Christopher Shuttleworth, Lieutenant, Suffolks (youngest son of the late Rev. Professor Shuttleworth and Mrs. Shuttleworth, Crooms Hill House, Blackheath, S.E.10), aged twenty years.

Mr. Thomas Potter, of the Foundry, West Hampstead, and Child's Hill, formerly of South Molton Street, left £100 each to St. Mary's and St. George's Hospitals and the Hospital for Sick Children, and £50 each to four other charities. His estate amounted to £22,444.

With reference to the Board of Trade Order of August 24, 1917, relating to stocks of mahogany and American walnut, the Controller of Timber Supplies announces that, following on the notification which appeared on September 7, the restriction on sales of all kinds of mahogany is withdrawn until further notice.

"Erected in ever grateful memory of the fallen" are the words boldly inscribed on one of the beams of a yeh gate erected as a parish memorial at near Luton. The structure is composed entirely of English oak with the roof of cleft oak shingles. Messrs. Harry Hems and Sons, of Exeter, executed the work.

At Frittenden, Kent, a yeh gate has been erected by parishioners in memory of Rev. R. E. Inglis, for seventeen years rector of the parish, who was killed in action near Ghinny on September 18, 1916, while assisting to bring in wounded under fire. Messrs. Harry Hems and Sons, sculptors, of Exeter, designed and executed the work.

A memorial tablet, erected in honour of the late Dr. Stopford Brooke at Rosslyn Hill Chapel, Hampstead, will be unveiled on Sunday morning, December 9, by the Rev. Dr. L. P. Jacks, principal of Manchester College, Oxford, editor of the *Hibbert Journal*, and son-in-law of Dr. Stopford Brooke. The service, which will be held at eleven o'clock, will be conducted by the Rev. Henry Gov.



# THE BUILDING NEWS

## AND ENGINEERING JOURNAL.

### Edinburgh House.

Currente Calamo .. .. .	439
Drawings of Deceased Masters and Decorative Furnitures at the Burlington Fine Arts Club ..	460
Ethics of the Architectural Profession .. .. .	461
Obituary .. .. .	462
Our Illustrations .. .. .	462
Artificial Wood from Autumn Leaves .. .. .	462
Safety in Seafolding Construction .. .. .	475
Legal Intelligence .. .. .	476
Competitions .. .. .	476
Professional and Trade Societies .. .. .	476
Trade Notes .. .. .	476

### CONTENTS.

Our Office Table .. .. .	477
To Arms! .. .. .	477
Tenders .. .. .	478
List of Tenders Open .. .. .	478
To Correspondents .. .. .	478
Latest Prices .. .. .	viii.

### OUR ILLUSTRATIONS.

New Laboratories, Wisley, for the Royal Horticultural Society. The terrace front, part of the road elevation in perspective, one of the ends of the buildings, and sketch of the staircase land-

### Strand, W.C.2.

ing, Messrs. Pim-Coffin, Inrie, and Angell, Architects.  
 Flats in course of erection in Park Lane, facing the Marble Arch, Hyde Park, W. Mr. Frank T. Venty, F.R.I.B.A., Architect.  
 Wesleyan Church, Medak, India. View and plan. Messrs. Bradshaw, Gass, and Hope, Architects.  
 Sketches of Comb-Pyne Church, Axminster, Dorset, and Bradford-on-Avon Bridge "Chapel," by Mr. Edward Swales, Architect.

## Currente Calamo.

We give elsewhere the additional particulars furnished by the R.I.B.A. in response to questions from intending competitors for the premiums offered for designs for workmen's cottages. The competition is evidently attracting attention and some criticism. The *Evening Standard*, in its issue of December 6, calls it "a misguided scheme," and says:—

It is evident that any scheme for a standard type of dwelling for the whole country would at once threaten us with a most inartistic and inconvenient formalism. Nobody desires to see England dotted over with a uniform type of cottage, standardised in material and methods of construction, and exhibiting no sign of local influence. The cottage homes of England are not mere shelters from the elements. They express the spirit of a locality, and the grey stone dwellings of the Cotswolds are as harmonious with their surroundings as are the wholly different black and white cottages and farmhouses of Cheshire. Hence, the scheme for a competition provides that the country shall be divided into areas, one for the North and North-East, a second for the Liverpool and Manchester district, a third for the Midlands, a fourth for South Wales, a fifth for the South-West, and a sixth for the Home Counties. Assuming, therefore, that a best and second-best design are eventually discovered and adopted in each area, we shall have six varieties of standardised dwellings, with two types of each variety and four modifications of each type. This provides for at most forty-eight kinds of houses, and these will fall readily into twelve main types, the difference between houses of the same type in the same area being practically negligible.

It is true, of course, that competitors are asked to arrange for the use of local materials, "where those are readily obtainable," but in the case of probable shortage of these they are invited to "consider and suggest the substitution of others with a view to facilitating and cheapening construction." Accepting this warning, our contemporary proceeds to consider its probable effect on the Home Counties:—

In this area designs are invited, such as will be suitable for erection in urban and rural districts in the counties of Norfolk, Suffolk, Cambridge, Huntingdon, Middlesex, Essex, Hertfordshire, Bedfordshire, Oxfordshire, Buckinghamshire, Berkshire, Surrey, Sussex, and Kent. In this wide area, ranging as it does from the East Coast to the middle west, and from the South Coast to the Midlands, there is to be a standardised cottage design with four modifications. The design is to apply to urban and rural areas alike, and no proper regard is shown to those local conditions, geological and other, which in the past brought about the erection of the stone farmhouses of

Oxfordshire, the lath and plaster of Essex, the brick dwellings of Norfolk and Suffolk, or the timber-framed cottages of Hertfordshire, with their filling of brickwork, known technically as brick-nogging. In view of this great range of traditional local material it is merely playing with words to suggest that the competitors in the Home Counties shall have local conditions in mind. To carry out this pious injunction each competitor would have to supply a dozen sets of designs, for the veriest layman will understand that design is governed by material. A plan which can be carried out in brickwork may be quite unsuited to the "hanging-tile" construction of Kent and Sussex. The danger is that we shall fall back upon standardised material to match the standardised designs, and so produce the monotonous and discordant ugliness of the cottages which have been built by a paternal but misguided Government for the benefit of Ireland. This experience, added to that gained as the result of the efforts of the Ecclesiastical Commissioners to provide standard vicarages, ought to serve as a horrible warning.

We trust it will, but there is no certainty that those who ignore it will not be ignored by the Government, or that their premiated designs may not be transmogrified by substitution of other material beyond recognition. We hope, anyhow, with the *Evening Standard*, that the Englishman of the future is not likely to be a willing subject for State experiments in Prussianisation. It is of the very essence of this de-humanising thing to put men to live in standardised houses, mere family barracks, wherein all individuality must wither and all perception of the beautiful be blunted.

On the whole, it would seem the Government is not going to err on the side of liberality to architects. It is said to be going to build 300,000 workmen's cottages, and £100 is offered for the best design. That sum works out at about 2½d. per house, or half-a-crown a dozen. Of all the trades and professions, none has been hit so hard by war conditions as that of the architect. There has been very little work for the designers of buildings of the ordinary kind in the past three years, and many have had to close down temporarily and find other means of getting a livelihood in the meantime. Some businesses have prospered through the war, and most of them have rejoiced over their good luck and the truth of the text that to the well-off much shall be given; but the architect is as thoroughly but more sadly convinced that from him that hath little is likely to be taken away that which he hath!

It is obvious that other considerations must also militate against standardisation of cottage development. Mr. W. H. S. Dawson, the city surveyor of Bradford, where the housing problem is probably as acute as anywhere, the number of additional houses required being estimated at something like ten thousand, points out that where the area is exposed to heavy winds and south-westerly gales, such as prevail in the Bradford district, houses must of necessity be constructed and be put together in a different way from that in which they can be built in more favoured climes. For instance, in the south the door and window-frames are simply a butt against the wall. At Bradford door openings and window openings are made with reveals. Such things must affect standardisation. Stone construction such as is usual in Bradford must also affect standardisation. "At the same time," said Mr. Dawson, "it is, of course, desirable that standardisation should be followed out as far as possible, even if it only means standardisation to meet the needs and methods of building in any particular district. There ought especially to be standard fittings for such houses in regard to drainage and sanitary arrangements. This part of the construction should be done in the best possible way—the best materials and the best workmanship."

At a discussion at a meeting of the Manchester Society of Architects last Wednesday on the cottage homes of the future, the opinion was maintained that the parlour is likely to disappear in the near future, and that the living room and the scullery, from what was said by several architects, are likely then to be given new prominence. Mr. F. B. Dunkerley, who opened the discussion, advocated that the scullery should be as large as possible, seeing that so much work was to be done there. In the living room—where three, and even four, doors were often found—there ought to be no more than two doors, and those should be placed as far as possible from the fire. He thought the management of house property by women was to be commended, and said that the present system carried on by ordinary agents was a very bad one. Some of them were too much like machines, and lacked human sympathy.

It has been manifest for long to all familiar with the matter that the deepening of our sea harbours is one of the most urgent problems of the time, and that its solution must be effected if we are ever to have cheap food again and avoid the delay which now runs up the price of all other commodities. As Lord D'Vernon pointed out last week in his address to the Dominion Royal Commission, it is an historical fact that increase of the size of commercial vessels has, on every occasion, exceeded the most extravagant expectation of technical writers and speakers. And yet it has fallen far short of what might have been achieved if proper attention on the part of Governments—particularly the Governments of the British Empire—had been devoted to the systematic and scientific development of maritime intercourse. It is clear that the responsibility for the development of harbours along great ocean routes cannot in future be left to private initiative or to the action of shipowners or shipping lines, but that it must be dealt with by superior State authority acting independently of the immediate interest of individuals. Certainly our own task is to deepen the harbours on an all-British route, and undoubtedly the route chosen should be that from the United Kingdom to Australia and New Zealand via the Cape. How can we make this route available for ships say of 38 ft. draught? We must complete the work already in hand of deepening the channel of the River Thames to the Royal Albert Dock to a depth of 30 ft. at low water, and so construct the new extensions at the Royal Albert Dock as to make them capable of accommodating ships of a draught of 38 ft. Similarly, the water at the Princes' landing stage at Liverpool will need deepening another 3 or 4 feet. As Southampton already provides for ships of 38 ft. draught, the completion of the improvements named, at an expenditure of £1,000,000, should give the United Kingdom three first-class ports capable of taking vessels of the requisite draught. Having pointed out the improvements necessary in South Africa, New Zealand, and Australia, his lordship said: "I have said enough to show how comparatively small the expenditure is. In the United Kingdom less than £1,000,000; in South Africa, £1,500,000; in Australia, £1,000,000; and in New Zealand, £600,000; or about £4,000,000 in all, estimated on a pre-war basis, to provide for vessels of 38 ft. draught at practically all the most important harbours from the Mother country to the furthestmost of the Dominions."

Plans are being raised for building a new P.M. court at Stalybridge.

A faculty is being applied for by permission to erect a war memorial chapel on the north side of the parish church at Windermer, Messrs. Austin and Paley are the architects.

The death is announced, at the age of 78, of Khan Bahadur Mincherojee K. Marzban, C.I.E., who served for many years in the Bombay Public Works Department, and who on retirement was appointed Executive Engineer of the Bombay Municipality. Many of the public buildings in Bombay were erected under his management.

#### DRAWINGS OF DECEASED MASTERS AND DECORATIVE FURNITURE AT THE BURLINGTON FINE ARTS CLUB.

No one who really values and understands the principles of the art of drawing will fail to visit this most interesting exhibition before it closes in February next, and not a few who certainly do not may find it helpful to them if they desire to grasp the spirit of the bond which unites all true draughtsmen and to understand that there is nothing new to be learnt about drawing, but that the difference between the new art and the old is the difference between one man's dream and that of another. As Mr. Henry Tonks, in his all too brief but most enlightening Introduction, puts it:—

"The pleasure of drawing is in the production of much by little means, and the pleasure grows with the development of the artist. A single line may mean nothing beyond a line; add another alongside and both disappear, and we are aware only of the contents, and a form is expressed. The beauty of a line is in its result, in the form which it helps to bring into being. Draughtsmen know this, but writers on art do not seem to. The model, though he may seem to be all that the artist requires, will set him hunting in the fields of his memory. Imagination, without which no drawing is done, is but the power to make use at the present moment of something put away in the past. The eye sees, the mind to retain, and the hand to express are the means by which works of imagination are produced. To try to find inspiration outside the experience of everyday life seems the sign of a feeble artist, or one sophisticated by too much talking. Hunting for abstract form is as likely to result in such success as a child's search for the noise in the interior of a drum. If we have exhausted the world about us we have come to the end of our art. After a period of severe study of form there is rebellion and revolution, and the artist allows his form to vaporise or to go out into meaningless formulae, until he is called to order again like a State weary of anarchy."

In the drawings of Ingres, Daubier, Degas, Keene, and Menzel exhibited, compared with those of Michael Angelo, Fouquet, Rembrandt, and Claude, the beholder can hardly fail to see this, and to realise that good draughtsmen have always been rare, and may possibly learn that to discover one in our own time requires true insight. He will find Ingres specially represented, and that no artist more fully understood that the expression of form is the true work of the draughtsman, and its arrangement to further the design. Whatever else Ingres attempted was to make the form more expressive and to clothe it in appropriate costume. This is visible enough in "St. Helena" (3), in "The Mrs. Vesey" and Miss Elizabeth Vesey" (43), "Viscount Hinchinbrook" (21), "Lady Harriet and Lady Caroline Montagu" (57), the "Apotheosis of Napoleon" (60), "Made-moiselle Benard" (70), "Herr Linné and Baron Stackelberg" (76), "C. R. Cockerell" (79), and "Lady William Bentinck" (85).

To mark the difference we must turn to the work of Tiepolo, Boucher, and Rowlandson, who, as Mr. Tonks reminds us, dealt with human beings less as individuals than as types, which they knew perfectly how to express:—

"The spendthrift Tiepolo thing broadest the magnificent heritage bequeathed him by the priestly draughtsmen of Italy, until one almost sickens under the weight of his wealth. It is as if he were born a ripe draughtsman with nothing more to learn, whereas Degas never learnt but was always learning to draw. To turn to Degas after looking at a series of drawings by Tiepolo is to face the world again, trying to attain a reputation. Degas sought things out for himself. We are attracted by one or the other as our minds are complacent or rebellious."

Of Tiepolo we have several examples: an "Allegorical Composition" (4), a

"Female Figure Holding a Tray" (34), "Three Nude Figures, Foreshortened" (36), "A Genius Precipitating Forward" (38), an "Allegorical Group" (41), "Draped Figure Foreshortened" (43), "A Genius Seated" (46), "The Virgin and Child with the Infant St. John" (48), "Study of a Crowd" (69), "Bacchus and Ariadne" (71), "Two Genii" (83), and "Three Old Men and a Panto" (84). Of those by Degas may be mentioned "A Ballet Girl" (5), "La Toilette" (6), "Woman in Bed" (19). Boucher is represented by "A Triton" (10), and Rowlandson by "A Study of a Naiad" (66) and "A Soirée at Burlington House" (7).

Of the other masters there is but one by Michael Angelo—"A Sheet of Studies" of a man in red chalk partly worked over in pen and ink, and some studies for the statue of Christ now in S. Maria sopra Minerva at Rome (56), which were exhibited at the Burlington House Old Masters Exhibition in 1879. It has been suggested that certain differences between these sketches and the executed statue may be owing to their having been made for the first version thereof, which Michael Angelo abandoned on account of a flaw in the marble. There are some good Rembrandts: "The Adoration of the Shepherds" (39), which has been several times exhibited, and which is the same composition as his picture of 1645 in the National Gallery; a "Landscape" (40), a "Child Asleep in a Cot" (44), "Moses and the Burning Bush" (45), a "Nude Youth Seated" (74), and "The Holy Family" (88).

Among others of more than general interest are two Albert Durers, "A Stag Beetle" (1), dated 1505, worked in body colour, and "A Dead Duck" (11), dated 1515, in body colour and water-colour on vellum, a pencil drawing of a "Woman Seated" (2), by Corot; a "Head of a Youth" (17), by Andrea del Sarto; a "Study of a Draped Male Figure" (42), by Van Dyck; "The Duchess of Devonshire and Lady Spencer as a Child" (50), by Sir Joshua Reynolds; "A Boarhound" (52), by Snyder; a "Classical Landscape" (59), by Nicolas Poussin; "Four Studies of Children" (80), by Coreggio; "Venice Triumphant" (77), by Paul Veronese; and "Le Printemps" (92), by Auguste Rodin. There are also a number of sketches in pen and sepia and water-colour by Charles Keene.

#### DECORATIVE FURNITURE.

The decorative furniture, which is described by Mr. H. Clifford-Smithers, has been selected to illustrate the Empire style of the early years of the last century, which he claims possesses the distinction of being the last successful effort at original design on the part of the cabinetmaker, who since then "has been little more than a plagiarist or mere copyist." The style certainly dominated the furniture fashions of the Continent, and we followed suit with a vengeance, a most exuberant example being the suite of gilt furniture presented to the Admiralty in 1813 in memory of Nelson, which has never been publicly shown before, and is lent by the Lords Commissioners of the Admiralty. It is doubtless of historic interest, but has as certainly little to recommend it otherwise. It was presented by John Fish, Esq., of Kempton Park, and consists of ten armchairs, three settees, a window-seat, a boat-shaped sofa, two card-tables, and a sofa-table, a pole-screen, and a centrepiece in the form of a pedestal, the upper part of which is supported by three dolphins, and is of bronze, partly gilt, and surmounted

by a glass vase, on which are painted the battle of Trafalgar and the apotheosis of Nelson. There are a number of other good examples of the style—mostly French—and some interesting bronzes, clocks, ornaments, etc.

### ETHICS OF THE ARCHITECTURAL PROFESSION.\*

By W. A. LANGTON.

A right understanding of the principles that should regulate the behaviour of those who practise a profession is involved in a right understanding of the nature of the profession. In considering that we shall, at the same time, be able to consider the snares that lie in wait for the inexperienced and the thoughtless; snares manufactured, for the most part by members of the profession who do not understand the nature of their calling, or by the very public for whose advantage it is that the restraints of professionalism should govern the practice of architecture.

A profession has two essential peculiarities; it acquires special knowledge so that those who want to obtain its results are obliged to put themselves in the hands of a trained practitioner; and the article which is for sale and purchase is the intangible, unassessable, and unguaranteed measure of the practitioner's power to perform an important piece of work. There are, as it were, no goods upon the counter. This latter condition is, it is true, also the case in other callings in which the thing for sale is personal service only; but the element of importance is lacking.

From these two essentials, then—that the architect alone has the talent and training required for his work, and that his possession of these requisites is always unproved for work not yet done—we may deduce the principles that should govern him in his relation to his art, to his clients, and to other members of his profession.

#### SERVING THE CLIENTS.

The first point, and the principal point, in the ethics of architectural practice is that the architect should be able to do the work he undertakes to do. He must fit himself to deserve the confidence that is placed in him. Most architects get the length of insisting that they be given the full confidence of their clients. They are always ready to exalt the architect. There are no doubt some who think that this institute is intended to exalt the architect, to take care of his interest. It is not. This institute and our provincial associations are intended to exalt the art and practice of architecture, to create high ideals of both in the minds of architects and so help them to better performance. These bodies are, therefore, really intended to take care of the interests of the clients of architects. There is no room for any other aim, for the practice of architecture is the service of clients. The architect must have not only no other aim which contradicts this, but he may give himself up whole-heartedly to this aim with the certainty that in it will be fulfilled all legitimate ends of his calling, art, honour, profit, and goodwill to men.

#### FEES NOT A CONSIDERATION.

It may be asked, in connection with this—is not the architect to think of his fee at all? In reply to this we must recognise that, though the carrying out of an architectural design is of so complicated a nature that the joy of performance can hardly obtain all through for the artist, as it does in simpler arts which are executed by the artist's own hand, yet it is creative work, and the result in its development and attainment, are an end in themselves and enough to absorb the mind of a real artist, to the exclusion of thoughts of the reward. But the architect's mind, or the composite mind of a firm of architects, must include a grasp of the means of financing the expensive operation of producing good work. He must for that reason think of his fee. But the fact is that for nearly all kinds of services there is no occasion to think of it. The schedule of fees fixed by the associations are intended to make

such thought unnecessary. They are arranged, so far as possible, to secure for all kinds of work a payment that will enable the architect to keep up the means of performing it properly.

If the provisions of the schedule prove to be insufficient, or an architect thinks he is entitled to more, he has a perfect right to fix a fee to suit his own ideas; and indeed he ought to do so. He cannot meet an insufficient fee by work to match. There is but one grade of professional work—the best; and it must be paid for. It must also be paid for by the client.

#### EXPLOITATION NOT PERMITTED.

The latter condition opens up another point of proper practice. It is not conducive to the proper practice of architecture, that is to say to the true service of the client, that the architect should receive pecuniary profit from the client, or should find pecuniary profit in building for clients in any other way than by direct payment from the client. He may not, therefore, deal in building sites, in such a way that it is to his interest that a client's building should be placed on one site rather than on another. He may not be a party in the contract or have any interest in it. He may not receive payment of any kind from any one who is concerned in the erection of the client's building, except the client himself, and, therefore, for instance, if he has made a successful invention in building material or contrivance, he had better get rid of the patent right altogether rather than make his profit in royalties on its use. He must, in short, have payment for his work so arranged that he can give himself up to it, when it is once undertaken, without thought for anything but its perfection in the interests of his client.

#### HOW FAR CAN CLIENT BE HUMOURED?

Here arises another question, which is often raised by architects, How far is the client to be humoured in wishes which interfere with good design? This question deserves a paper to itself. The answer turns upon the question, What is good design? My own opinion is that, where the client's wishes have interfered with good design, the defect is to be referred to the designer. The problem set before the designer is the client's wishes. It is from these that he must make his design; not from his own preconceived notions embodying some architectural conception. We do not look for draughtsmen's designs from architects. Taste can take precedence of precedent. The true architect takes fire most when confronted by a problem. It is the reconciling of inconsistencies that gives life to his design. Why should we find the irregularities of old work, the freedom of good classic design, the imperfections in logic of the English Gothic so charming, and yet fear to have in our own work irregularities that have a reason and imperfections that make for comfort? It is seldom that faithful effort to combine good work with attention to the client's wishes will find that the two are really incompatible; but if it does, if the architect finds at length that he must suffer opposition, he will be able to back it with good reasons.

#### SERVICE ALWAYS THE IDEAL IN VIEW.

The architect must, however, be on his guard against falling in with the wishes of his client, when the latter wishes to do something that is not decent behaviour towards a neighbour, or in the way of evading municipal regulations. It must be remembered that at the back of his mind the owner is relying upon his architect to keep him within limits in these matters. He feels out in consultation how far he may go in considering exclusively his own interest, and will not think well of an adviser who lets him go too far. It is the architect's duty, in the first place, to see if the object the client has in view can be obtained without encroaching on the rights of others by further study of the plan or by original contrivance. If it is manifestly impossible to do otherwise than wrong, it becomes the architect's duty to point out to his client that in so carrying out his wishes he would be giving

him bad service and that he must decline to do so.

Even at this pinch it must be seen that quarrelling with the client is not included. The architect must be reasonable or he is wrong. If the architect is reasonable he must be right; and he is most likely to meet with the respect which is his due and the deference to his opinion which the case demands. Where a client and his architect part in mutual anger there is room for the architect to doubt the ethical correctness of his own conduct.

#### COMPETITIONS DO NOT PRODUCE BEST WORK.

The question of taking part in competitions which exercised so much the minds of a past generation of the profession has been settled for practice by a compromise. No architect really believes that there is any real ground for the idea of the general public that the best possible design for a building is to be got by making a selection from a number of designs by different architects. One may say with certainty that the designs are not the best that can be made; for any of the same architects would produce better results, if they had an opportunity of studying the problem quietly in consultation with the clients. Nor is the selection that is made at all certain to be the best selection. But, because competitions offer such a chance of a short cut to pecuniary success there are always architects to be found who will support them. The councils of the profession have, therefore, agreed to accept, as offering some chance to be productive of good work, those competitions in which the competitors are paid for their sketches, so that they can afford to put into them a proper amount of study.

#### YOUNG MEN AS BUILDERS' DESIGNERS.

In connection with young men and their work, it is worth while to notice a question that has arisen with the advent of large commercial buildings and large building firms. The builders are said to seek the elimination of the architect, offering to be responsible for the design as well as the construction of the buildings. We know, as a matter of fact, that there is no such elimination in the case of the most important buildings of this kind; nor, in similar cases are the owner's interests likely to go unguarded for the want of an architect employed by himself; but there must be a good deal of commercial building on a large scale done in this way. The designers, who work for the builders, must have an architectural training. Who are they? There may be some doubt among architects as to the propriety of architects being thus associated with builders. Any architect in such practice as to be in the way of employment to carry out similar work on behalf of the owner is not likely to be sought as a builder's designer, and the situation of now running with the hare and now hunting with the hounds is not likely to arise. For young men, however, graduates of the architectural schools, this is quite suitable work. They supply well what the builder wants, and will gain invaluable experience for themselves. Hack-work has always been a wholesome exercise for genius in the arts, and there have been much longer walks in hack-work in the past than these modern monumental performances in commercial building.

#### ARCHITECTS SHOULD BE ASSOCIATED.

In conclusion, it is fitting to notice how important it is, in order to practise architecture with ethical correctness, that architects should be associated; not only to discuss and elucidate questions bearing upon such practice, but to give one another the support of companionship in sustaining a standard that it is hard to uphold alone. The honourable among the dishonourable is apt to suffer loss; and if we agree in approving of the honourable practice of our profession we had better agree in practising it thus together. This is the reason for professional associations, and it is also a reason why they should not be so wide open as to include practitioners who are unfit or unwilling to give good service to the public. Membership in our associations should be so obviously an advantage, not only from the professional standing it gives,

\* Abstract of paper read before the Royal Architectural Institute of Canada.

but from the interest and value of the proceedings, that everyone who undertakes to practise architecture will find it important for him to seek membership and to devote himself to the kind of professional service that the associations exist to uphold. This refers more particularly to the voluntary association; and it is not at all certain that when there is full recognition of their necessity the effort required to make them of value will not make their influence in the production of good work in architecture greater than that of a statutory association, though less widely spread.

#### OBITUARY.

Colonel Sir Samuel Swinton Jacob, K.C.I.E., C.V.O., died at Weybridge on Tuesday week in his 77th year. The son of Colonel W. Jacob, of the Bombay Artillery, he was sent out to India on the morrow of the Mutiny. In 1863 he qualified as surveyor and civil engineer, and after a short time in the Bombay Public Works Department, he accepted, in 1866, the position of engineer to the Jaipur State, which he filled continuously from the age of twenty-six to that of seventy-one. He will be chiefly remembered for his devotion to Indo-Saracenic architecture and his success in combining modern convenience with Eastern tradition in every part of Northern India. On his return to England in 1911, on retirement, his name came into prominence in connection with discussions as to the most fitting architecture for the new Indian capital at Delhi, and the Secretary of State associated him with Mr. Lutyens and Mr. Baker in preparing architectural plans, but after a short time he retired from the work on account of failing health. He married, in 1874, Mary, daughter of Mr. Robert Brown, of Edinburgh, who survives him. The funeral was at Brookwood on Saturday last.

Mr. Jethro Andie Cossins, architect and archaeologist, died suddenly last Wednesday at the Midland Institute, Birmingham. He had been attending a meeting of the Birmingham Archaeological Society, and, being taken ill, retired to the office of the Principal of the Institute, and expired before a doctor could arrive. Mr. Cossins, who was eighty-seven years of age, was born at Kingsdon, Somersetshire. He was apprenticed to Mr. Fiddian, of London, and afterwards of Birmingham. Subsequently he became the partner of Mr. J. G. Bland. In 1879 Mr. Cossins began to practise on his own account. He was employed by Sir Josiah Mason in the erection of Mason College and other works, which were built from his designs. To his firm, which was until a month ago Cossins, Peacock, and Bewlay (the new style being Peacock, Bewlay, and Cooke), much of the improvement in the architectural aspect of Birmingham has been due. Mr. Cossins designed the Norwich Union Buildings, in Congreve Street, which were originally planned for the Liberal Club, and were afterwards used for a time as a High School for Girls. Other buildings erected from his designs include the Titianian Chapel, in Bristol Street; the Jubilee Fountain, Stratford-on-Avon; Sutton Grammar School; the Cromwell Street Schools; and the Darlaston Town Hall. The firm have also done much work for the Corporation, including alterations to the Town Hall and the erection of library buildings. Under the direction of Mr. Cossins a building was erected in the West Indies for the Barbados Mutual Life Assurance Company. The deceased was president of the Birmingham Archaeological Society. He was a member of the Council of the Midland Institute, a vice-president of the Royal Society of Artists, a past president of the Birmingham Architectural Society, a member of the committee of the Municipal School of Art, and of the Society for the Protection of Ancient Buildings. He lived in Forest Road, Moseley, and leaves a widow.

Hillingdon Borough Council proposes to increase the cost of electric light by 50 per cent. on current supplied at 1d. per unit, 35; at over 1d., and public lighting from 1.54d. to 12d. per unit.

## Our Illustrations.

### NEW LABORATORIES, WISLEY, FOR THE ROYAL HORTICULTURAL SOCIETY.

These buildings were built from designs by Messrs. Pine-Coffin, Imrie and Angell, of 4, Mitre Court, Fleet Street, E.C. 4. They are constructed of oak half timbers and plaster. Two-inch facing bricks are used and old tiles for gables and roofs. The interior fittings and joinery, all specially designed by the architects, are made to suit the requirements of the laboratories. The general contractors were Messrs. J. Youngs and Son, of Norwich. The drawings reproduced were exhibited at the Royal Academy last summer.

### FLATS IN COURSE OF ERECTION IN PARK LANE, FACING THE MARBLE ARCH.

These mansions, overlooking Hyde Park, stand at the west corner of Oxford Street in Park Lane. The drawing reproduced to-day was exhibited at this year's Royal Academy. Mr. Wm. Walcott is the artist. Mr. Frank T. Verity, F.R.I.B.A., designed and is superintending the execution of this large block, which has been in hand for some time. We gave a block plan of the entire scheme, including the adjacent Cinema Hall, which runs right through from Oxford Street to North Row. A fine feature of these mansions is formed by the ground floor central entrance vestibule and columned oval hall leading to the stairways right and left. A double-page view, accompanied by this plan, appeared in our issue for May 23, 1915. The perspective given to-day shows the scheme as altered in execution.

### NEW WESLEYAN CHURCH AT MEDAK, INDIA.

The site of the new church at Medak, an important Wesleyan missionary centre, is in the middle of a large and flat enclosure of land with avenue approaches already planted. A terrace is formed round the building, with steps at the end of each avenue and opposite the porches. In the front of the main doorways a large fountain is arranged. Internally the church is open, airy, and spacious, with all the windows unglazed, excepting those at the chancel end. Over the side aisles and at the end a special feature is made of the gallery, to which entrance is given by outside staircases. In the further development of the design a late type of Gothic was adopted for the building, which is now in course of erection. Messrs. Bradshaw, Gass and Hope, of Bolton, are the architects, and the large water-colour drawing from which the illustration was made was exhibited at the Royal Academy this year. We have added a copy of the plan, including the upper terrace, which rises above a much more extensive well-arranged terrace, including the fountain seen in the perspective.

### BRADFORD ON AVON BRIDGE "CHAPEL," WILTS.

Most people know Bradford-on-Avon as a popular centre for archaeological excursions, and the subject of this sketch is familiar to many architects. Several bridges of pre-Reformation days had chantry chapels provided for pedestrians' use. A few of these travellers' rests are in existence still. There is good evidence of alterations in the arch close by this structure projecting from Bradford Bridge, which is of much earlier construction. The arch is pointed, and the pier, with corbelling, seems hardly to be contemporaneous with the super-structure. The remaining arches of the bridge are plain, with cut ribs, and are segmental in form, while the cutwaters of the piers project less. The enclosure with its curved-shaped stone roof may never have been used as a chapel, though known as a mass house in some records, while others describe the little building as a lock-up, for which purpose very likely it was employed. In the village of Laycock, in this district of Wiltshire, there is a small lock-up of similar size. Other old English bridges

have buildings of more or less quaint architectural character rising from their parapets. A sketch of this one at Bradford-on-Avon appeared in *THE BUILDING NEWS* on August 12, 1887, by Mr. Maurice B. Adams. The fireplace may have been inserted subsequent to the erection of the structure itself, though the corbelling suggests that it formed part of the original design. Whether original or not, the result is picturesque enough, and it is to be hoped that the "chapel" will be spared from demolition.

### COMB-PYNE CHURCH, AXMINSTER, DORSET.

This little village in the diocese of Exeter, situated in a secluded valley behind Lyme Regis, is not much disturbed by the passing of the few trains which still run through the station. Comb-Pyne consists of about a dozen hamlet houses and a pair of farms. At one time a flourishing convent stood hard by, but the existing remains are so scanty as to be reckoned of no importance whatever, being incorporated in the foundations of the ruins of Church Farm, which runs alongside of the curious little church, which, doubtless, was the convent chapel. The fabric has undergone additions and alterations at various times. Some of these modifications are not by any means representative of good taste. Originally the building was very crude, with hardly more refinement either in design or workmanship than that belonging to the common structures of the homestead. Evidently the local mason was responsible for both, and the result is of the simplest kind. The church is nearly square on plan, and it is carried up to an unusual height, so that the saddle-back roof gives the nave the appearance of a tower. The heavy buttresses and small, narrow lancet windows of differing lengths add to the sturdy effect. There are two doorways, facing north and south respectively. The interior is bald in character, and the porches, vestry and chancel are modern, though the sanctuary is built on the ancient footings, and therefore it is not likely that the church was ever any larger. The "nave walk" runs at the back of the chancel, and the fishpond in front still contains some capital trout.

### ARTIFICIAL WOOD FROM AUTUMN LEAVES.

Sawdust and "wood flour" have long been used for the making of artificial wood, and now an inventor has applied for a patent on a new process by which dry leaves are employed for the same purpose, the great advantage, of course, being the greater cheapness of the raw material. Any sort of leaves can be used, but oak, birch, and beech are particularly good. As described in "Neueste Erfindungen und Erfindungen" (Neuzeit) the process is as follows:

It is preferable to begin by having the leaves ground up. They are then mixed with a suitable binder; for this purpose glue (four ounces), resin, water glass, casein, etc., can be employed, but viscose is the best, and it is possible to make the viscose from a portion of the leaves used. For certain purposes, moreover, it is possible to make use of "fillers" to mix in with the mass, such as asbestos, infusional earth, wood flour, peat flour, etc. The finely ground dry leaves are boiled in soda lye, and are then without delay mixed intimately with an already prepared solution of viscose. The resultant mass is placed in suitable press moulds and subjected to a pressure of 350 atmospheres.

The shapes obtained are dried and then subjected to a warm "after pressure." The viscose can be made from the "leaf meal" by treating the latter first with soda lye and then with carbon disulphide fumes.

To increase the binding power of the viscose, in consideration of the jelly-like cellulose separated out from it, small quantities of other binders, such as glue, water-glass, casein, waste sulphite liquor, etc., can be added. Colour can be added either to the mass or to the leaf meal.

The Governors of St. Edmund's College, Liverpool, contemplate enlarging the building.



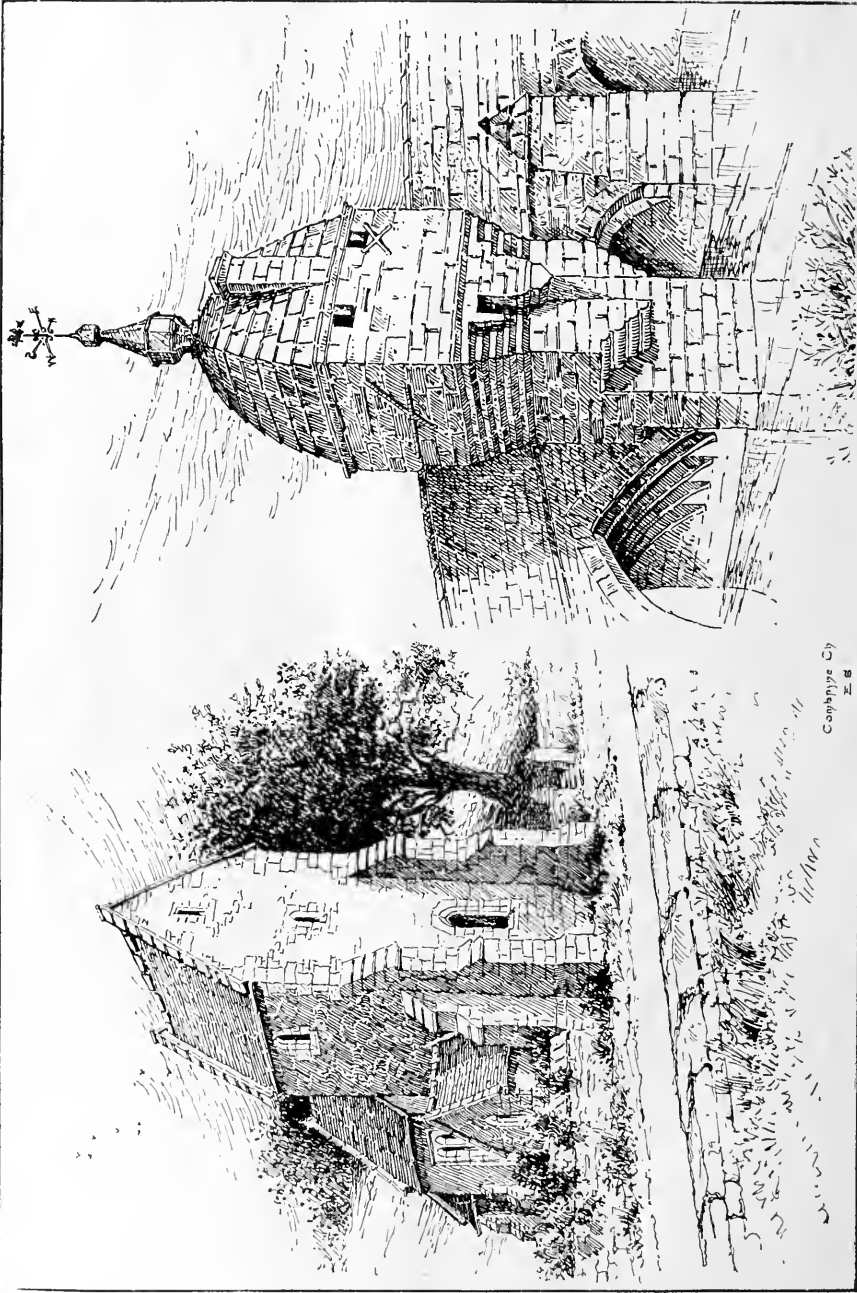

Compyne Cy  
28

COM-PYNE CHURCH, AXMINSTER, DORSET, AND BRADFORD-ON-AVON BRIDGE "CHAPEL."  
Drawn by Mr. EDWARD SWALES, Architect.





FLATS IN COURSE OF ERECTION IN PARK LANE, FACING THE MARBLE ARCH.  
MR. FRANK T. VERITY, F.R.I.B.A., Architects.





THE BUILDING NEWS, DECEMBER 12, 1917.

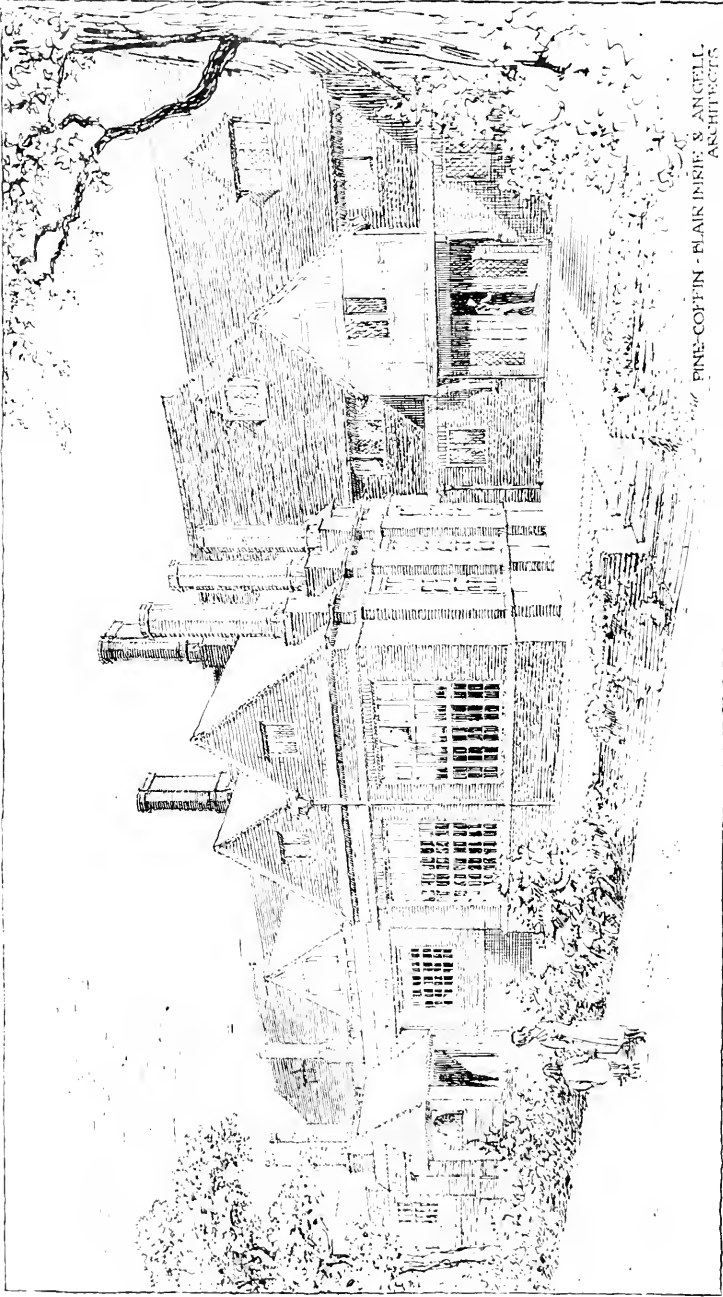

PINE-COFFIN · BLAIR INRIE & ANGELL,  
ARCHITECTS

NEW LABORATORIES AT WISLEY FOR THE ROYAL HORTICULTURAL SOCIETY PART OF ROAD FRONT

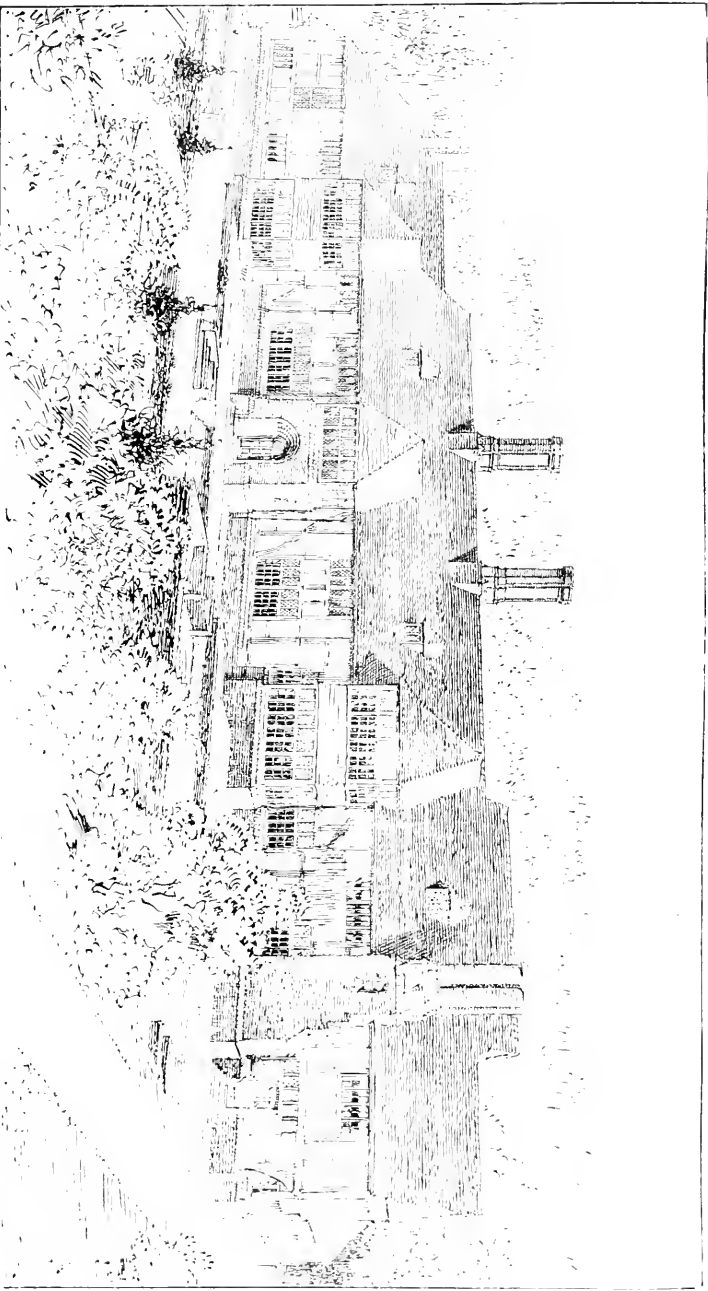

NEW LABORATORIES, WISLEY, FOR THE ROYAL HORTICULTURAL SOCIETY : TERRACE FRONT.  
Messrs. PIRN-COLLIN, LIME and ANSELL, ARCHITECTS.



THE BUILDING NEWS, DECEMBER 12, 1917.

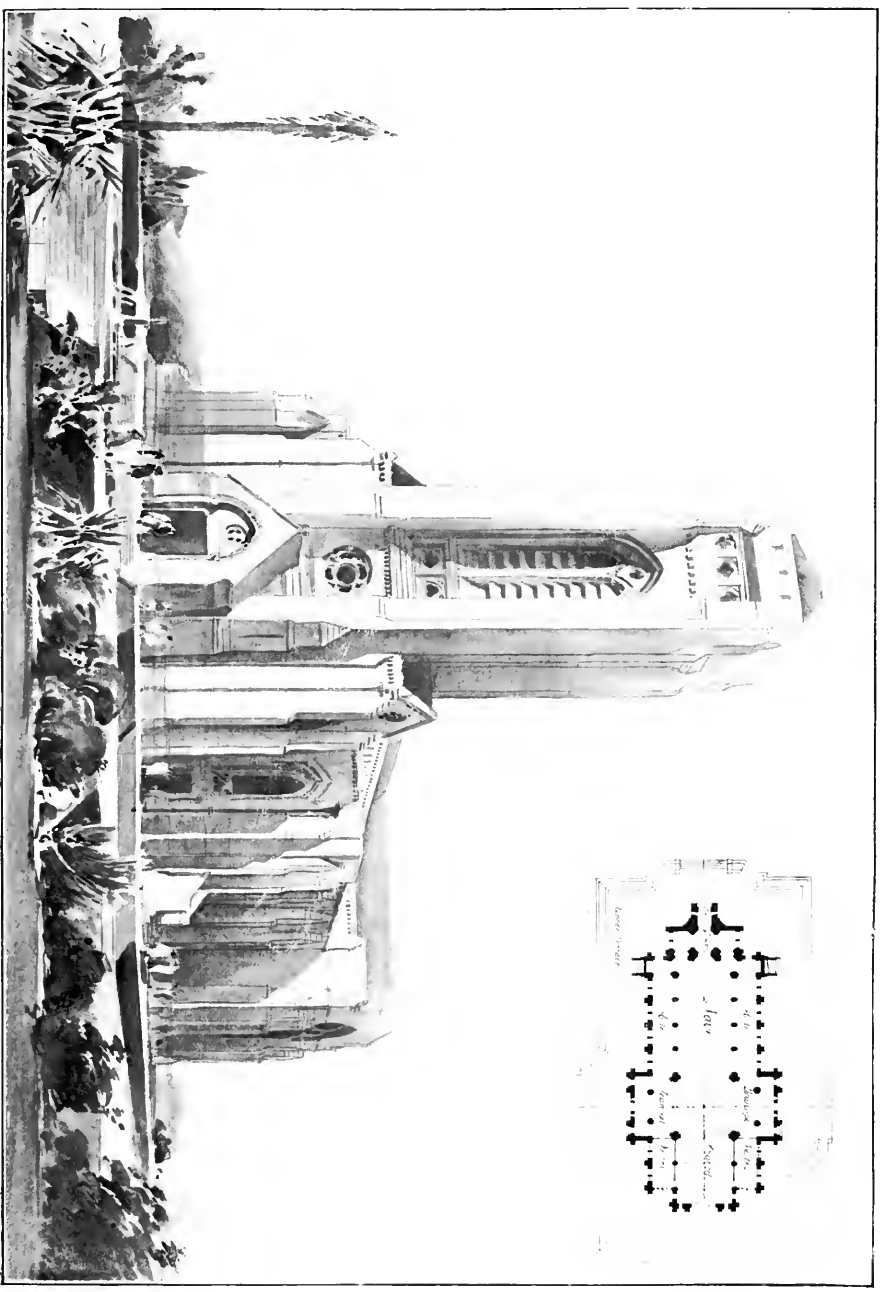

WESLEYAN CHURCH MEDAK, INDIA.—Messrs. Bradshaw, Gass and Joffe, Architects.





NEW LABORATORIES, WISLEY, FOR THE ROYAL HORTICULTURAL SOCIETY.  
Messrs. PINE-COFFIN, IMRIE, and ANGELL, Architects.

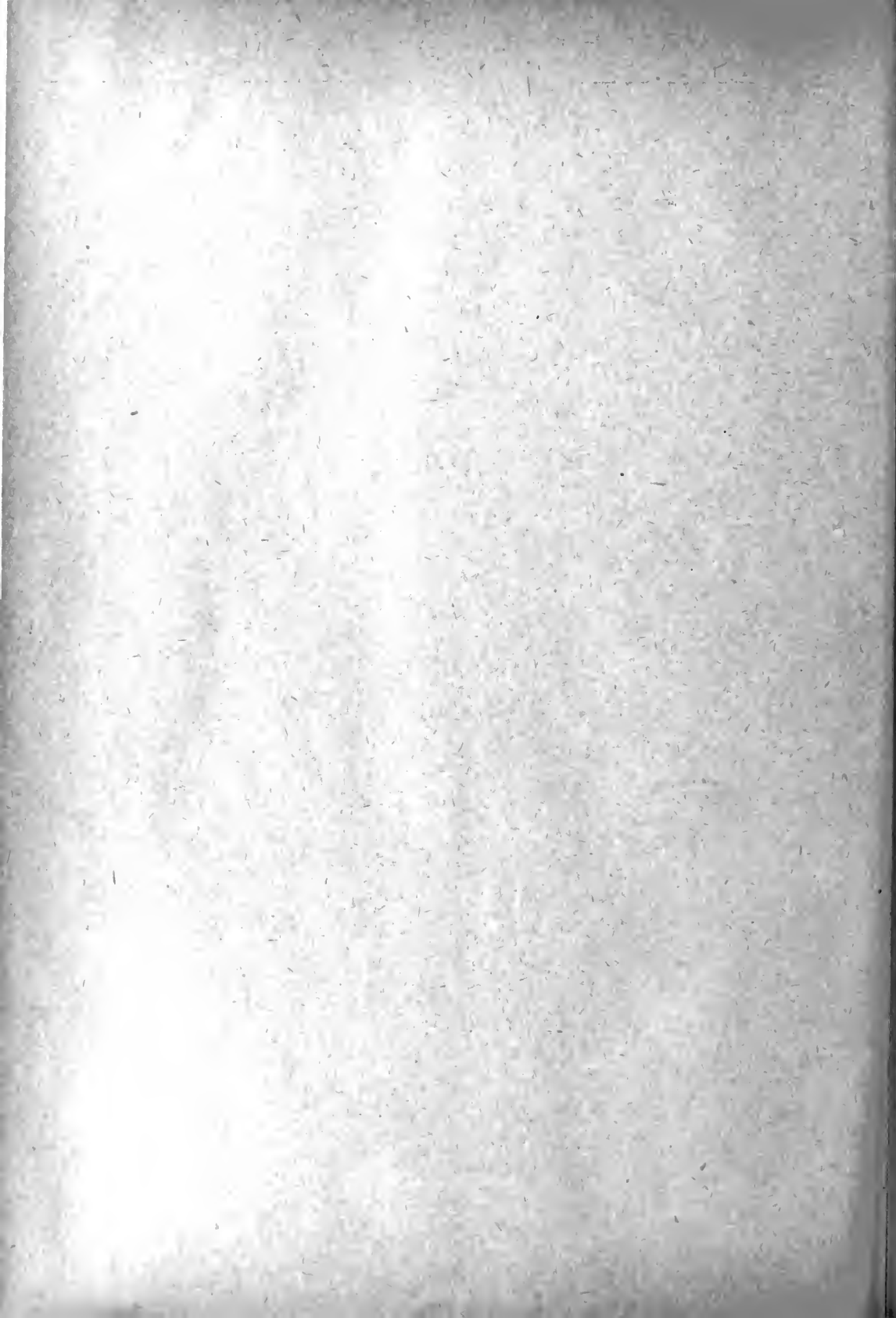



## SAFETY IN SCAFFOLDING CONSTRUCTION.

By ELMAR SPÄHR.

Little has been written concerning scaffolds with reference to safety and efficiency, considering the wide use of scaffolds and that many accidents are caused by faulty construction or overloading.

When it is considered that no building can be constructed without the use of a scaffold of some form or other, and that the men employed at the building trades perform nearly all of their labour on a scaffold, there should obviously be much thought given to careful construction.

The fact that scaffolds are merely temporary affairs, to be used only for a short time, should not preclude the idea that they should be as carefully planned as the building itself. In most cases the planning and building of scaffolds are usually done with the easy removal of the scaffold after it has served its purpose as the principal object. On this account many minor and often disastrous accidents have occurred.

One must realise that the mechanic cannot render efficient service while working on a staging that is weak or narrow or where the footing is very uneven, because under such conditions his brain is crowded with thoughts concerning his safety. This makes it impossible for him to concentrate his attention on the work he is performing.

## SAFETY LITTLE CONSIDERED.

With the exception of creating a few patented scaffolding devices, safety engineers have given this matter very little attention, although other lines of industry have received careful thought and planning to prevent the worker from injuring himself or being injured while engaged at his daily labour.

Unlike many of the other victims of industrial accidents, the workman injured from a scaffold is in no way responsible for the accident, as the scaffold is usually erected by another workman who does not intend to work from it, but who does intend to wreck it when it has served its purpose. Personal observation has demonstrated that seldom is only one person injured in the collapse of a scaffold, but frequently several, and instances of six and of ten men have been known to go down in a scaffold fall. A single collapse has been known to result in the death of several men.

The bricklayers or masons, for instance, when ordered upon a scaffold by their foreman, assume that the superintendent has provided for their safety, when it may be that the person who erected the scaffold did not consider the weight of numbers of bricks, loads of mortar and cement, and the additional live load of mechanics and their helpers. The resultant stress may be too great for an upright, a ledger, or perhaps a putlog which breaks, taking a whole section or more, precipitating the men and the mass of material to the ground below. One can readily make an estimate of the results in death and injuries, depending on the distance of the fall.

The object of this article is to call the attention of builders and others in the allied industries to the seriousness of the accidents due to faulty scaffolds, and to offer suggestions to prevent them.

## EACH BUILDING TREATED INDIVIDUALLY.

While it is true that in modern construction, each building presents an individual problem of scaffolding, there are many suggestions that can be considered to advantage in the erection of all scaffolds. The most widely used scaffold for masons is built with "horses" in their various forms. The stiff-legged "horse" is most desirable. As there is no necessity for nailing braces, it is easily constructed, and can be removed without the usual waste of broken braces. However, as such scaffolds are somewhat bulky, they are expensive to move from one operation to another, so that some contractors use a "horse" with hinges, fastening the legs to the putlog or cross-piece so that the "horse" can be folded, thus occupying less space when loaded on a car or truck. When this style of "horse" is used, it should always be toe-

nailed to the floor, as a labourer accidentally striking a leg with a barrow may wreck a section of the scaffold.

Another form used is the square, made from two pieces of 2 ins. x 4 ins. x 5 ft. for the uprights, with two pieces 1 in. x 6 ins. x 4 ft. 6 in. in length for the top and bottom. This makes a good scaffold when properly braced. The practice of driving nails only part way and bending them over when fastening braces on this kind of scaffold has been the cause of many minor accidents, because, frequently, in trying to climb on the scaffolds, workmen may pull the braces loose, causing backward falls which often result in injuries to the spine or head. Again, the sudden removal of a brace in this manner sometimes causes the collapse of a section of scaffolding with more serious results.

## POLE SCAFFOLDS UP TO SIX STOREYS.

As this form of scaffold is only profitable and convenient on the inside of buildings, or for a short distance on the outside, the pole scaffold is used for greater heights. The pole scaffold is responsible for more serious accidents than all the other forms of scaffolds combined. It is used on the outside of buildings to a height of five or six storeys, when there is no steel frame in the structure, and it is often subjected to great weight. For this reason great care should be used in its planning and construction. On four-storey buildings the poles should be of selected stock 3 in. x 4 in., straight, free from bad knots and other imperfections, sawed square at both ends, so that there may be a proper footing and that succeeding pieces may have a good bearing when spliced. The poles should have a good footing on the ground and be secured at the bottom.

As conditions vary greatly with each operation, and often on the same operation, detailed advice can hardly be given as to the method of fixing a pole at the bottom, but the practice of resting and securing them to a sill is a method that can be used in many instances to a good advantage, where the surface is soft or uneven; or, on sidewalks, on roofs of adjacent buildings, and in almost every condition encountered.

When one considers that wagons are likely to be backed against an upright, or that they can be struck by the end of a beam, or that some teamster may unload lumber against the scaffold, it will be realised that it is necessary to make the bottoms doubly secure.

## THE LEDGER AN IMPORTANT PART.

The ledger, or horizontal stringer, is another important factor in this scaffold, and the size should be governed by the weight it must bear.

When a ledger is nailed to a pole, a pole should never be left until the required number of nails (usually eight 10-penny nails) have been driven into the pole. Numerous accidents have been caused by a workman driving one nail into a ledger, leaving it to secure the other end, and then forgetting to return and properly secure the first end. It is preferable to nail the ledger on the inside of the pole, for several reasons.

It is more convenient to nail when standing on the platform, the nails being always in plain view; there is no obstruction on the outside of the pole to interfere with the braces being nailed directly to the poles; also, the shorter span for the putlog makes for safety.

The distance between the ledgers is governed by the work to be performed on the scaffold. For bricklaying and masonry, the ledgers are usually spaced five feet from top to top. Nailing a cleat under the ledger is a simple plan that is strongly recommended for safety.

In placing the putlogs, they should have at least four inches hold on the wall, and should project sufficiently over the ledger to give good bearing, but not less than six inches. The stock should be at least three inches by four in-ches, and free from knots and placed narrow-side up. Very recently in an eastern city two men were seriously injured by a frozen knot in a putlog breaking. It is impossible to use too much care in selecting good putlogs and in spacing them properly.

## THE PLATFORM.

In placing the plank for the platform, which is usually four feet wide, care should be used that the plank rests on all the putlogs, so that an even distribution of weight will be obtained. Frequently it is necessary to nail a furrowing strip to the top of a putlog to bring it to the proper height on account of the overlap of the plank. A foot board should be nailed to the outside of the platform to prevent material falling on passers-by or workmen below, and a guard rail should be at a height of about three feet six inches from the platform for the safety of the workman on the scaffold.

The bracing of this form of scaffold should receive every attention, and as frequently as possible, braces should be nailed to the floors of the building, through the windows, to prevent the scaffolding from pulling away from the building.

The poles should be inspected frequently at the bottom to ascertain whether they have been displaced from their foundation or whether they are sinking into the ground.

## SUSPENDED SCAFFOLDS ON CONCRETE AND STEEL STRUCTURES.

The suspended scaffold is a comparatively recent invention, and is used only on buildings having a concrete or steel skeleton, with a height over five storeys. As the name implies, the platform is suspended from above, usually on steel cables fastened to a thrust-on or outrigger, on the roof or some floor above the point where construction or bricklaying is being done.

Not many accidents have been reported due to the breaking of this form of scaffold. On the other hand, accidents may occur on these scaffolds due to the lack of safety precautions. As these scaffolds are nearly always used for bricklaying or terra-cotta setting, it is necessary to have a foot-board and guard-rail with a wire netting fastened between the toe-boards to prevent tools and fragments of material from falling to the ground. In most instances where these safety measures were not employed, tools of various descriptions, bricks and other material fell, causing injuries and resulting in damage suits.

To protect the men on a scaffold from objects falling from above, a roof should be constructed directly over them. This can be done where the overhead drum is used by clamping a 2 in. by 4 in. putlog on the cable and laying six inch boards. Where the drum is on the platform, the machines are provided with uprights to support the roof or covering. On some buildings planks were placed on the outriggers, in some instances six storeys above the workmen, and afforded no protection whatever.

Care should be taken in lashing the scaffold to the building, so that it will not move away when the workman pushes against the wall. This sometimes happens when putting sills, lintels and terra-cotta in place, causing the workman to lose his balance and fall between the scaffold and the building.

## CARE AGAINST OVERLOADING.

As it is customary to stack this scaffold with material after the masons or bricklayers leave in the evening, care should be used not to overload. An instance of a scaffold being overloaded is known where the cable out-rippers and platform stood the strain, but when the bricklayers came on the scaffold in the morning the roof beams upon which the outriggers rested gave way, and only by an act of Providence was a disastrous accident avoided.

The high cost of lumber, the scarcity of workmen, and the increased wage have all had a tendency to make for insecure scaffolds.

No matter what kind of scaffold is being built, a plank should never project more than a foot beyond a support unless a guard-rail is placed to prevent the workmen from walking on the unsupported platform and receiving a fall.

When the employer realises the loss, not only to the workman but to himself in material, and in time while constructing a broken scaffold; when he realises the fact that he is responsible in a measure for some-

one being a cripple; and when he also realises that a workman can only deliver the maximum amount of service when he is positive that the scaffold upon which he stands is secure, then will there always be secure scaffolds. If "speed at any price" is to be the motto, there will be scaffold accidents.—*The Contract Record.*

#### LEGAL INTELLIGENCE.

**BENNETT V. SPARGUE.—APPEAL DISMISSED.**—On December 4 Mr. W. S. R. Spague appealed before Mr. Justice Lawrence and Mr. Justice Sheehan against the judgment of the Official Referee, Mr. Folck, in an action before him by the plaintiff against the defendant, Wm. S. R. Spague, an architect, of Criterion Chambers, to recover £756 money advanced to him in regard to theatre building speculations. The defendant counter-claimed for an amount in excess of the claim for professional services. The Official Referee found for the plaintiff Bennett for £509 on the claim and counter-claim. Defendant most moved that award be set aside.—The Court, after hearing the appellant's counsel, dismissed the motion, holding that the Referee was right in his decision.

**CITY ENGINEER OF NORWICH SUMMONED FOR USING PETROL.—CHARGE DISMISSED.**—At Newmarket (Cambs) Petty Sessions, on Tuesday week, Mr. A. E. Collins, City Engineer of Norwich, was summoned for causing petrol to be used by driving a motor vehicle contrary to the Motor Spirit Restriction Order No. 2, 1917, at Stetchworth, on November 18.—Mr. Collins gave evidence that he was the City Engineer of Norwich, and was engineer and architect to the Asylum Committee, who instructed him to buy a motor van or bus to enable them to carry nurses between the city and the asylum, which was some miles outside Norwich. Since the County Asylum had been taken over by the War Office a great deal of extra work had been thrown upon the City Asylum. It was found necessary that the nurses should have more recreation, and they found it impossible to get a horse vehicle to take them to and from the asylum. A lorry, which was used to carry stores, and they proposed to use the same vehicle for that purpose. Witness got the permission of the Ministry of Munitions to buy a new car, and ordered one through Messrs. Mann and Egerton, of Norwich. They sent the order to the Ford people at Norwich, who could not supply it. The Asylum Committee were pressed upon him to buy a lorry, and he bought a second-hand car at Woking. The Corporation had three cars, for which he was responsible, and he had a license for a supply of petrol for them. He received delivery of the car in London on November 13. There was sufficient petrol in it to run it down to Norwich when he received it, and he thought it would be better to take it down by road. Had he put it on rail there might have been a month's or six weeks' delay. He would have had to empty the tank and should not have known what to do with the petrol in London on a Sunday morning—it would have been wasted. There were in the car the regular driver, a friend who had come with the driver for company, and was to return to Woking with him by train, and witness's own driver. Superintendent Winter submitted that Mr. Collins should either have sent the car down by rail or have obtained a special permit to take it down to Norwich by road.—Mr. Collins said his experience was that if he had put it on rail it would not have been delivered for a month or six weeks, and it was wanted at once. He did not think it necessary to apply for a special permit.—The Chairman: The Bench have come to the conclusion that the whole thing turns on the question of convenience. We have decided to give defendant the benefit of the doubt and dismiss the case.

T. Cecil Howitt, Lieut.-Colonel, Leicestershire Regiment, a former student at the A.A., has been awarded the D.S.O.

Nottingham Corporation have decided to ask the Government to make the city the centre of one of the large central stations to be erected in different areas of the country for generating and distributing electricity.

Lieutenant Thomas Selby Latham, R.F.A., who died on November 20 of wounds, was the youngest son of the late John Latham and Mrs. Latham, of Birch Grove, Ealing Common, W. and was educated at Christ's Hospital, and after leaving school entered the office of the Marlborough Borough Council, where he afterwards became rating surveyor. In 1911 he was first as a professional associate of the Surveyors' Institute, and in 1912, after he had passed his final examination as a surveyor.

#### COMPETITIONS.

**NATIONAL UNIVERSITY OF IRELAND.**—The assessor's decision in the architectural competition for the new buildings of the National University of Ireland has at length been announced. The designs of Messrs. W. G. Clayton and Keating, architects, Dublin, have been placed first; Messrs. O'Callaghan and Webb, second; and Mr. E. Bradbury, third. There were about nine competitors. The designs are on view at the National University Offices, Merrion Square, Dublin. One of the designs, according to the *Irish Builder*, that of Messrs. Fennell and Clarke, came from Belfast, and one, Mr. Arthur Hill's, from Cork, the others are by Dublin architects.

**THE ROYAL INSTITUTE OF BRITISH ARCHITECTS.**—In connection with the R.I.B.A. competition for housing of the working classes in England and Wales, the following supplementary particulars have been issued in response to questions by competitors—1. The floor areas given apply to all classes, and are to be net area clear of all projections. The floor of living-room should have an area of not less than 180 ft. 2. The heights of stories may be from 7 ft. 6 in. to 8 ft. in the clear. Bedrooms may be partly in the roofs, but not less than two-thirds of the ceilings must be of the maximum height; and the vertical walls must not be less than 5 ft. high. 3. The bath should be fixed, and not of the tip-up type. It is not essential that a separate bathroom should be provided. The w.c. should not be placed in the bathroom or entered from the scullery. 4. No drainage need be shown, and it may be assumed that access to the houses is from both front and back, and no garden or plots of site need be shown. 5. No alternative plans will be allowed. 6. All drawings are to be drawn with the long dimension of the paper horizontal, and each class is to be clearly marked A, B, C, or D, as the case may be. 7. Each class is to be shown on a separate sheet, and the classes may not be intermixed. 8. The drawings are not to be mounted on strainers, and are to be in black ink, with a black wash over the window openings. No perspectives are to be sent. 9. The time for sending in designs is extended to January 31, 1918. 10. The fact of a design being premiated will not prevent the author from making use of it in his practice if he so desires. 11. The two elevations asked for may be such as the competitor thinks will best illustrate his design. 12. The assessors in each competition will have the option of recommending designs of special merit for further premiums (or honourable mention), in addition to those stated in the conditions. 13. Each of the classes A, B, and C is to be designed as a block of five or six houses, of which three are to be drawn in detail, the others in outline only. Of the three which are to be fully drawn, one is to be an end or semi-detached house, another a terrace house between party walls and lighted front and back only, with frontage of 18 ft. from centre to centre of party-walls, and the third to be a house one room deep only, with long frontage, at the discretion of competitor. The grouping or composition of the block may be arranged in any way the competitor desires. A section of one house in each block, if sufficiently explanatory, is all that is required. 14. It may be assumed that water supply is available. 15. A committee of assessors will be appointed by the Architectural Societies in each area. The following points are given as desirable, but are not to be regarded as essential—Staircase should have direct ventilation; coals should be accessible under cover, and accommodation should be provided for at least one ton. Scullery should be large enough to serve as a relief to living-room, but not large enough to take centre table.

**PRIME COST SUMS IN CONTRACTS.**—The Royal Institute of the Architects of Ireland have issued the following circular letter—“The Quantity Surveyors' Sub-Committee of the Surveyors' Institute (Irish Branch) have asked the Council of the Royal Institute of the Architects of Ireland to express an opinion as to what is the maximum percentage that could be regarded as a discount for cash on 'prime cost' sums, and if the members of the Institute could see their way to embody in their specifications a clause which would limit such discounts. The Council consider a reasonable discount of 2½ per cent. to be a maximum limit, and suggest that members of the Institute should embody a clause to this effect in their specifications.”

#### TRADE NOTES.

Boyle's latest patent "Air-pump" Ventilators, supplied by Messrs. Robert Boyle and Son, ventilating engineers, 64, Holborn Viaduct, London, have been employed at the Royal Victoria Hospital, Netley.

Messrs. Robt. Ingham Clark and Co., Ltd., beg to give notice that in consequence of the Army Council having commandeered their offices at Caxton House, Westminster, their registered address is now Walter House, Bedford Street, Strand, W.C.2. Telegraphic address: "Pearline, Westrand, London." Telephone No.: Regent 3923.

The Gas Light and Coke Company have advanced the price of gas in their district north of the Thames, where there is no competition, from 3s. 4d. to 3s. 10d. per 1,000 cubic feet, as from December 1.

On Saturday evening next the Architectural Association of Ireland will celebrate its coming of age by a meeting and smoking concert in the same room in the Grosvenor Hotel, Westland Row, Dublin, in which it first saw the light—or, rather, was resuscitated—twenty-one years ago.

A calvary, following the style of the fifteenth century old village crosses, has just been erected at St. Mark's Church, Reigate, as a memorial to those of the parish who have been killed in the war. The total height of the work is 17 ft., and the simple cross, with the figure and pent, rises from a moulded and carved octagonal base, which stands on three moulded octagonal steps. The names of the memorialised are to be carved in the panels round the base; over fifty names are already cut in. The work has been sculptured by Hopton Wood, done by John Underwood and Son of Baker Street, W. The architects being Ikers and Chadwood, of Newcastle.

At Donagh Rural District Council Mr. Thomas Evans, the chairman, who has a casting vote, decided the salary of the road surveyor by tossing a penny. The vote of the Council had been equal, and neither side would agree to a compromise between £120 and £100. Mr. Evans said his Majesty should decide it, and, tossing a penny, announced that the salary would be £120.

## Our Office Table.

Professor Bode, the well-known Director-General of the Berlin Museums, has just published a fresh complaint of the artificial raising of prices for works of art. He says that German profiteers are putting their money into art partly as the safest and most profitable investment—an illuminating comment on the reputation of German War Loans—partly in order to escape taxes, and partly for reasons of display. The result, according to Herr Bode, is that the owners of pictures are having their heads turned, that genuine collectors and the museums cannot compete with the profiteers, and that works of art are going away to foreign countries with increasing rapidity. Herr Bode predicts, moreover, that the extraordinary profits which are being made by art dealers will lead to an unanswerable demand for special taxation, which will be a fresh blow to the interests of art in Germany.

The four famous gilded-bronze horses over the entrance to St. Mark's, Venice, have been removed to Rome for safety. They are supposed to have been originally erected in Rome, in the reign of Nero, for the adornment of one of the triumphal arches of the city. On the removal of the Imperial seat to Constantinople the Emperor Constantine had them taken to the new capital, where they remained till early in the thirteenth century. They were then brought back to Venice by Doge Dandolo. Here they remained for some 500 years, until Napoleon, in 1797, had them conveyed to Paris, where a place of honour was found for them on the arch of the Place de Carrousel. In 1815 they were again restored to Venice by Francis of Austria, where they have remained until their recent removal. They are now once again in the Eternal City, temporarily accommodated in the museum constructed out of the ruins of the gigantic Baths of Diocletian.

Attention has been drawn to the smallest house in London by the purchase by a well-known American of the residence in Mayfair which is universally known as "The Doll's House." The distinction of actually being the smallest dwelling in the metropolis is enjoyed by No. 10, Hyde Park Place, one of a row of houses overlooking the park. This diminutive domicile is built over a passage six feet wide, and although it has a street door guarded by an iron gate, there is only one room in the house. This architectural curiosity was built to the order of an old lady residing at No. 9 about fifty years ago for the occupation of one of her servants, and by having a number placed upon the door she endowed it with a separate existence as a house.

"French Etchers from Méryon to the Present Day" is the title of an Exhibition forming Part 2 of the "Modern Masters of Etching," which will be held from December 5 to the New Year at the Leicester Galleries, Leicester Square. The collection will appropriately contain a group of etchings by the late M. Rodin, besides a number of examples of the work of Corot, Degas, Daubigny, Forain, Manet, Millet, Steinlen and other great etchers, and will, of course, include a number of fine and rare etchings by Méryon.

The Board of Trade announce two important Orders. The first fixes maximum prices for home-grown timber at all stages from the standing tree to the plank, and the second prohibits the export of native timber from Ireland without a permit, for which application must be made to the Assistant Controller of Timber Supplies (Ireland), 6, Hume Street, Dublin. It is emphasised that as regards standing timber the maximum prices are intended to apply to timber of the best quality in the most accessible positions. Prices for other timber should be based on the maximum rates, having regard to the usual factors of quality, accessibility, haulage, and other conditions. The maximum prices per cubic foot fixed by the Order for standing trees are:—Larch, 1s. 4d., Scots pine and

Douglas fir, 11d.; spruce and other firs, 10d.; ash selected for aeroplane purposes, 5s.; ash for other purposes, 3s.; ash of inferior descriptions, 1s. 6d.; oak, well-grown selected trees, 3s. 3d.; oak, well-grown whole parcels, 2s. 3d.; oak, of inferior descriptions, 1s. 3d.; sycamore and hornbeam, 2s.; Spanish chestnut, 1s.; selected trees, 2s.; beech, 1s. 6d.; poplar, alder, and lime, 1s. 3d.; elm, 1s., and other common hardwoods, 1s. For timber felled and trimmed, lying in the wood, these prices may be increased up to 10 per cent. The Order also fixes maximum prices for timber in the round, sawn, or converted, and cancels the Home-grown Timber Prices (Great Britain) Order of July 4 last, which dealt only with certain sizes of converted home-grown softwood.

Reuter's Agency has received details of two French societies, "Le Village Reconstitué" and "Les Villages Libérés," which are engaged in the work of reconstructing the destroyed or deserted villages of France. In the case of places which have been destroyed or partly destroyed, the first of these two societies constructs a large wooden hut near each village, where the inhabitants who have returned to the ruins of their homes may have dining rooms, infirmaries, and storerooms for their use pending the reconstruction of their cottages. The principal architects of France are giving their services to rebuild villages, where possible, on the same sites as before, and to retain all the characteristics of the neighbourhood, while British societies are sending out fruit trees, vegetables, and poultry for the inhabitants.

"The Strength of Structural Elements," by Ernest H. Sprague, A.M.I.C.E. (London: Scott, Greenwood & Son, 8, Broadway, E.C., 4s., post free 4s. 6d.), is a continuation of the excellent series on "The Elements of Graphic Statics" by the author, dealing more particularly with those parts of structural material which depend on the elasticity of the material, and embodies the application of the principles there laid down and explained with regard to the design of simple structures. The importance of continuous beams in modern structures has suggested the extension of the proof of the Theorem of Three Movements, covering a wider range of cases than is usually considered, and the semi-graphical treatment adopted will be found simple and comprehensive, and of much value to the architect, engineer, and student.

Messrs. John Tann, Ltd., of 117, Newgate Street, E.C., have received a striking testimonial from one of the sufferers in a City air raid whose premises were destroyed. We are not permitted by the Censor to publish the name and address of the firm, but its books, documents, etc., were preserved intact in John Tann's "Anchor Reliance" Safes. The Secretary of the company expresses great satisfaction at the way in which the records in the two safes, although subject to the effects of the German explosive and incendiary shells, bore it so well, and even after the intense fire to which they were subjected and a fall from the first floor to the basement the keys and doors worked quite easily, and the contents were absolutely intact when opened, although the handles had been blown off and fused in the fire, and the safes had been apparently red-hot. Similar testimony is borne to the complete efficiency of Tann's safes in a big recent fire at Charleville, Queensland, and in another at Manchester, and it is very pleasurable to be able to add these to the long record of unbroken success as fire-resisters registered by the annals of this long established firm.

Professor G. Baldwin Brown gave a lecture last Friday night at a meeting of the Old Edinburgh Club in the hall of the Royal Society of Edinburgh, 22, George Street, on "Some thoughts on monumental art as illustrated in Edinburgh and in ancient Egypt." The lecturer began by calling attention to the excellent work recently accomplished by the civic authorities in the preservation of the Lawnmarket front of Mylne's Court, the interior of which had recently been remodelled at considerable cost to render it suitable for habitation under modern conditions. By this enlightened action a dated building of some historical importance had

been preserved to future generations. After some discussion of the aesthetics of the monumental in art, and a reference to prehistoric, Egyptian, and Roman structures, a series of views of the domestic buildings of Old Edinburgh were thrown on the screen, and the fine qualities of massiveness and simplicity they exhibit were pointed out.

At a general assembly of Academicians and Associates of the Royal Academy held on Monday Mr. F. W. Pomeroy, A.R.A., sculptor, was elected a Royal Academician. Mr. Pomeroy, who was elected an Associate in 1906, began his career as a student at the Lambeth School of Art, and entered the Royal Academy schools in 1881, winning the gold medal and the Travelling Studentship for Sculpture four years later. He was medalist at the Chicago Exhibition and the International Exhibition of Paris in 1900. Mr. Pomeroy has been entrusted with many important memorial sculptures in Great Britain and the Dominions Overseas, among them the Gladstone statue for the Houses of Parliament and the Duke of Westminster for Chester Cathedral, Archbishop Temple for Canterbury Cathedral, Lord Dufferin for Belfast, Dr. Guthrie for Princes Street, Edinburgh, the Robert Burns centenary work for Paisley and Sydney, N.S.W., the statue of Bonington, the Nottingham artist, in the School of Art there, and that of Francis Bacon in South Square, Gray's Inn, unveiled rather more than five years ago.

## TO ARMS!

COUNTY OF LONDON VOLUNTEER ENGINEERS (FIELD COMPANIES)

Headquarters, Balderton Street, Oxford Street, W.1.  
ORDERS FOR THE WEEK BY LIEUT. COLONEL C. B. CLAY, V.D., COMMANDING.

OFFICER FOR THE WEEK.—Second Lieutenant F. Gaywood.

NEXT FOR DUTY.—Second Lieutenant F. A. Ullmann.

DRILLS.—Week ending Friday, December 21, 1917.

—MONDAY.—No. 3 Coy., Left-half, Recruits, Signalling, 6.30.

—TUESDAY.—Physical Drill and Bayonet Training, 7.30.

—WEDNESDAY.—No. 1 Coy., 6.30.

—THURSDAY.—No. 2 Coy., 6; Signalling, Ambulance, 6.30.

—FRIDAY.—No. 3 Coy., Right-half, Recruits, 6.30.

—MUSKETRY.—Belvedere Road, Tuesday, Wednesday, and Thursday, 5.30 to 7.

—SOPH.—Christmas holidays. Headquarters and the Range will be closed from the 22nd to the 25th, both inclusive.

The Medical Officer will attend for the Examination of Recruits on Thursday, at 6.30.

Unless otherwise indicated, all drills will take place at Headquarters.

By Order,  
MACLEOD YEARSLY, Capt. and Adjutant.  
December 15, 1917.

Mr. A. A. Brown, sculptor and granite merchant, late of 79, Hamilton Place, and of Advocates Road, Aberdeen, has left personal estate, £13,950.

Captain Frank Hurrell, who prior to the war was the engineer and surveyor to the Tonbridge Rural District Council, has been promoted to the rank of Major, R.E.

A scheme for a Mid-Scotland canal to connect the Clyde and the Forth is taking shape. Messrs. Armstrong, Whitworth and Co., of Newcastle, have completed the plans for a ship canal via Loch Long and Loch Lomond, which route has official favour, but the firm has on hand alternative plans. The estimated cost is £20,000,000.

Manchester City Council have been informed that the late Mr. Leicester Collier, of Skiddaw Lodge, Keswick, has left to the city thirty-two oil-paintings, water-colours, and cartoons by the late F. J. Shields; a Malouma by Pin-turichio; water-colours by Randolph Caldecott and J. D. Watson; and a collection of porcelain and old glass for which Mr. Collier had paid fully £6,000.

Messrs. Wallis, Gilbert and Partner, architects, of Caxton House, Westminster, have made application on behalf of Mr. J. W. B. Sexton, of 53, Southwark Street, for consent to the erection of a reinforced concrete building, the erection of a factory for making tin and cardboard boxes, on a site bounded by Lavington Street on the south and Farnham Place on the north.

FOR

## Olivers' Seasoned

### Hardwoods,

APPLY TO—

WM. OLIVER &amp; SONS, Ltd.

120, Bunhill Row, London, E.C.

#### TENDERS.

\* Correspondents would in all cases oblige by giving the addresses of the parties tendering—at any rate, of the accepted tender: it adds to the value of the information.

**BEDFORD.**—For equipping No. 2 induced-draught fan with new impeller and renewing a part of the bed-plate, for the town council:—  
Davidson and Co., . . . . . £97 0 0  
(Recommended for acceptance.)

**DUMFRIES (KENT).**—For the supply and delivery of about 2,000 ft. run of British oak planking, 22 ins. by 6 ins., for the Romney Marsh Level:—  
W. Crundall and Co., Dover, Sd.; T. Brown, Ashford, Sd.; H. Toppitt and Co., Dover, 6d.; Ellis Bros., New Romney, Sd. per foot run (accepted).

**GOVERNMENT CONTRACTS LET DURING OCTOBER.**—H.M. Office of Works.—Building Works.—Board of Agriculture, new base depot, Wilsden, adaptation, screens, partitions, etc., Hall, Beddall, and Co., London, S.E.; Air Ministry, Institute of Electrical Engineers, Victoria Embankment, partitions, etc., Ford and Walton, Ltd., Kilburn, N.W.; Australian Headquarters, Horseferry Road, supply and erection of steelwork, Dorman, Long, and Co., Ltd., Westminster, S.W.; Cambridge, ordinary works and repairs, A. Nevis and Sons, Cambridge; Falmouth grain stores, supply and erection of steelwork, Dorman, Long, and Co., Ltd., Westminster, S.W.; Newport Docks, conversion of shed, Sessons and Sons, Ltd., Cardiff; Reading, ordinary works and repairs, G. S. Lewis and Bros., Reading.

**LONDON, N.**—For supply of timber for use in connection with the cemetery at East Finchley, for the Islington Borough Council:—  
Stevens, A., 19, Gossett Street,  
Bethnal Green, . . . . . £73 6 0  
(Recommended for acceptance.)

**SLEWOD.**—Alterations to caretaker's house, for the rural district council:—  
Berry, W. J., Sleaford, . . . . . £40 12 0  
(Accepted.)

**WEST HAM.**—For installation of heating system at Gainsborough Road and Holborn Road schools, for the education committee:—  
Halsey, J. T., £194 and £38 10s. respectively (accepted).

**WOLVERTON.**—For erection of second half of boiler-house and other buildings, and for reinforced concrete hopper for additional tephher plant, for the corporated electricity committee:—  
McVie, Dundas, and Whitson, £3,500 0 0 (Accepted.)

**WORCESTER.**—For improvements at the cattle market, for the city council:—  
Probert, H. J., . . . . . £498 0 0  
(Recommended for acceptance.)

The Congregational Council are considering the provision of a Congregational church house in Great George Street, Liverpool.

Mr. Adam Wood, of Troon, near Ayr, coal-master, who died on September 11, has left personal estate in the United Kingdom of the value of £301,054, including £10,000 to the Kirk Session of Troon Parish Church, to be applied in defraying the cost of adding a spire to the church, towards the cost of erecting and furnishing a hall for the use of the church.

## LIST OF TENDERS OPEN.

### COMPETITIONS.

**Jan. 13.**—Designs are invited for four specified types of cottages suitable for the industrial class. A competition, under the charge of the Royal Institute of British Architects and allied societies, will be held in each of the six areas mentioned below. Prizes of £100 and £50 for the best designs of each of three types, and £50 and £30 for the fourth, will be awarded in each competition. Designs must be submitted in accordance with the conditions not later than January 23. Copies of the conditions may be obtained from the following:—Home Counties Area: The Secretary, Royal Institute of British Architects, 9, Conduit Street, London, W.1; Northern Area: Mr. E. Hicks, hon. sec., Northern Architectural Society, 6, Higham Place, Newcastle-on-Tyne; Manchester and Liverpool Area: Mr. Isaac Taylor, hon. sec., Manchester Society of Architects, Mansfield Chambers, 17, St. Ann's Square, Manchester; Midland Area: Mr. A. Hale, hon. sec., Birmingham Architectural Association, 18, Bennett's Hill, Birmingham; South Wales Area: Mr. C. H. Kempthorne, hon. sec., South Wales Institute of Architects, Albert Chambers, High Street, Cardiff; Southwest Area: Mr. A. J. Pinn, hon. sec., Devon and Exeter Architectural Society, 5, Bedford Circus, Exeter.

### ENGINEERING.

**March 30.**—The Acting British Consul at Santiago reports that a decree has been issued calling for tenders for the improvement of the port of Antofagasta (Chile). By the terms of this decree the amount to be expended on this work will not exceed £1,700,000. Details may be obtained from the Port Commission Offices in Santiago, and copies are expected to be received shortly at the offices of the Chilean Legation in London, 22, Grosvenor Square, W.1. Tenders will be received up to 3 p.m. on March 30 by the Minister of Finance, Santiago.

### PAINTING.

**Dec. 14.**—Painting, colouring, etc., at various schools.—For the Bradford Education Committee.—Director of Education, Town Hall, Bradford.

**Dec. 13.**—Painting the railings, shelters, etc., on the Hoe, Plymouth.—For the Corporation.—J. Paton, Borough Engineer, Plymouth.

### ROADS AND STREETS.

**Dec. 14.**—Supply of materials, to be delivered between April 1, 1918, and March, 1919.—For the Bridges and Roads Committee of the Kent County Council.—W. B. Prosser, Clerk, Sessions House, Maidstone.

**Dec. 19.**—Repairing with granite setts Cathcart Street and Cathcart Square, Greenock.—For the Corporation.—Town Clerk, Greenock.

**Dec. 19.**—Supply and delivery of tar and gritting material.—For the Finchley Urban District Council.—E. H. Lister, Clerk, Council Offices, Finchley, N.

**Dec. 22.**—Supply of broken granite, etc., tar-macadam, and hauling.—For the Midhurst Rural District Council.—A. G. Gibbs, Surveyor, Council Offices, Midhurst.

Funds are being raised for the purchase of a site on which to build a new Catholic church in connection with All Souls', Weaste, Manchester.

At Bow Street Police Court, Sir John Dickinson remanded, until January 5, Eric Brotherton (manager) and five other employees of the Humber Graving Dock and Engineering Company, Ltd., Birmingham, who are charged, together with George William Smith, timber merchant, with conspiracy to defraud.

## TO CORRESPONDENTS.

### CHRISTMAS.

In order to complete publication before Christmas Day, and enable readers to get their copies at the usual time, our issue of this week will be published at 2 a.m. on the morning of December 24. The latest time, therefore, for the receipt of advertisements will be 1 p.m. on the preceding Saturday, December 22.

We do not hold ourselves responsible for the opinions of our correspondents. All communications should be drawn up as briefly as possible, as there are many claimants upon the space allotted to correspondents.

It is particularly requested that all drawings and all communications respecting illustrations or literary matter, books for review, etc., should be addressed to the Editor of the Building News, Effingham House, 1, Arundel Street, Strand, W.C.2, and not to members of the staff by name. Delay is not infrequently otherwise caused. All drawings and other communications are sent at contributors' risks, and the Editor will not undertake to pay for, or be liable for, unsought contributions.

When favouring us with drawings or photographs, architects are asked kindly to state how long the building has been erected. It does neither them nor some time executed, except under special circumstances.

\* Drawings of selected competition designs, important public and private buildings, details of old and new work, and good sketches are always welcome, and for such no charge is made for insertion. Of more commonplace subjects, small churches, chapels, houses, etc.—we have usually far more sent than we can insert, but are glad to do so when space permits, on mutually advantageous terms, which may be ascertained on application.

Advertisements for the current week must reach the office not later than 3 p.m. on Tuesday. Front-page advertisements and alterations or stop orders for serial advertisements must reach the office by first post on Monday to secure attention.

### ADVERTISEMENT CHARGES.

The charge for Auctions, Land Sales, and Miscellaneous and Trade Advertisements (except Situation Advertisements) is 6d. per line of Eight Words (the first line counting as two), the minimum charge being 1s. 6d. for 50 words. Special terms for series of six insertions or more can be ascertained on application to the Publisher.

RECEIVED.—M. and Co., Ltd.—W. G. W. M.—J. D. R.—E. P. A. and Co.—J. T., Ltd.—W. S. and Co.—R. B. and Son—M. and Co.—M. C.—P. T. C. Co., Ltd.—B. Bros.—J. H. and Co.—K. and Co.—J. T. and Son, Ltd.

ERASIAN.—Yes.

COL. F. B.—Please send.

TRADER.—There is no such limit.

W. S. R.—Yes, if brief; otherwise we cannot promise.

Mr. Oscar J. Kirby has announced his intention of resigning his position as borough engineer of Batley.

Mr. A. W. Bryson, Burgh Surveyor to the Barrhead Town Council, has reported that the housing conditions in the town may be described as bad, and that at least fifty new houses are required with a gradual extension to meet the demand. There were 315 houses so worn that their repair would cost as much as new buildings. Since 1912 thirty-seven houses had been closed as uninhabitable, and there were 100 unfit for habitation. From 1911 to 1917 only two double cottages and four single dwellings have been erected that is to say, one per annum.

# BRABY'S AUTOMATIC FLUSHING TANKS

SIMPLE. RELIABLE.

## Fred. BRABY & CO. Ltd.

352 to 364, EUSTON ROAD, LONDON, N.W.

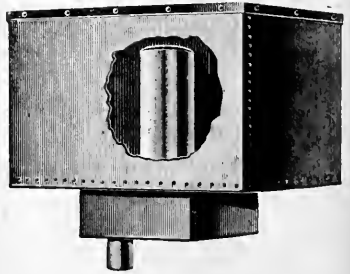

# THE BUILDING NEWS

## AND ENGINEERING JOURNAL.

<b>Efingham House.</b>	
Currente Calamo .. .. .	479
The Perfect Dwelling .. .. .	480
Our Illustrations .. .. .	495
Initiative Lacking in Architecture .. .. .	496
Professional and Trade Societies .. .. .	497
Trade Notes .. .. .	497
Our Office Table .. .. .	497
Tenders .. .. .	498

<b>CONTENTS.</b>	
To Arms! .. .. .	498
List of Tenders Open .. .. .	498
Latest Prices .. .. .	viii.

<b>Strand, W.C.2.</b>	
Entrance Building, Large Munition Factory, Birmingham. Plan, elevations, and section, Messrs. Buckland, Haywood, and Farmer, F.F.R.I.B.A., Architects.	
Canteen and Entrance to Large Munition Factory, Birmingham. Plan of lay-out and elevation of the canteen block. Messrs. Buckland, Haywood, and Farmer, F.F.R.I.B.A., Architects.	
"The Perfect Dwelling." Two sheets of typical plans, by Mr. Robert Thomson, Architect.	

**OUR ILLUSTRATIONS.**  
 The Ruislip Garden City for the estate of King's College, Cambridge. Mr. Charles R. Ashbee, M.A., F.R.I.B.A., Architect, and plan of the architectural grouping of "The Craft Museum" or "Art Institute," with the Creative Guild.

### Currente Calamo.

The injustice brought upon lessees by the working out of their covenants, insisted upon by landlords, has been for many years a crying scandal. It increases with every change made in our building law for the public benefit. It arises from the fact that the landlords made the land laws, and have since maintained them as they still are. The London Building Act, 1905, enables the County Council to require that fire-escapes should be fixed upon large new buildings, and does what it can to provide as to who shall pay the costs. But there the law as to lessee's covenants comes in with startling results. The recent case of "Monro v. Lord Burghclere" shows what may happen. The plaintiff had in 1904 taken a lease of premises in Albemarle Street of the defendant for twenty-one years, ground rent £575. By sub-letting he got rents coming to £580—a nominal profit of £5 which was more than wiped out in outgoings. There was a bad fire in 1915, and the rebuilding was done by the lessee. Then came the County Council, under the Act of 1905, and rightly required that a fire-escape should be fixed on what had become a new building. This cost £410; the question arose, who should pay? The county court judge put £160 on the under-lessees and the balance of £250 on the lessee, the freeholder landlord paying nothing. The lessee had covenanted to execute any work that might be required by any future Act of Parliament. This has become a common clause in London leases, and ground owners insist upon it. The unlucky lessee, who got nothing out of the lease, which now has only 7½ years to run, appealed to a Divisional Court. It was admitted by the judges that that fire-escape idea was not in the minds of the parties, and was also an improvement for the good of the freeholder alone. But the two judges sitting could see no way out. There was the binding covenant: the lessee must bear the burden. Appeal dismissed with costs.

The burden of dilapidations on the clergy is a heavy one, and we are glad to learn from the *Guardian* that the Salisbury Diocesan Board of Finance is deal-

ing with the matter. To obtain a proper measure of the burden in each individual case an inspection is to be made by the official diocesan surveyors—who for the purposes of the scheme are to act not in their ordinary capacity, but as inspectors employed by the Diocesan Board of Finance; and, in order to avoid as far as possible the limitations of the Act of 1871, the scheme adopts a seven-year instead of a five-year period as that over which the inspector is to make his survey of anticipation. He is to estimate at the beginning of the period what sum will probably be required to keep the property in repair during the following seven years. The measure of the task having thus been taken, a means of discharging it by equal annual payments over the seven years' period is provided by an assurance policy which secures not only the necessary total at the end of each septennial period, but also a capital sum payable at death at any time as a relief to the widow or other dependents from a debt that is too frequently crushing not only in its amount, but in the suddenness with which it may come to light. The assurance policy is to be specially arranged by the Diocesan Board of Finance with a leading office of high repute. The scheme seems a practical one, and might well be adopted in every diocese if the details are carefully thought out.

A Report of a Sub-Committee of the Devon County Council is a welcome contrast with some of the effusions of fact-dists and the folk who are talking nonsense at some of the congresses. It points out, as we have often done, that neither the county council nor the local sanitary authorities have hitherto taken adequate action to deal with existing defects, "partly because the county council's powers are rather supervisory than direct and partly because the sanitary authorities, although their powers are direct, have hesitated to incur the necessary expenditure." That is quite true, and all over the country similar defaulters are loudest in their clamour for Government aid. The Report also practically indicates how expenditure may be economising of expenditure—for instance, by adding annexes where existing cottages are fairly well built, but afford insufficient

accommodation. To this end the plans we have been giving lately by Mr. Robert Thomson might be well in part utilised. It recommends, too, that, in addition to some tied houses, which are, and always will be, essential, there should be a proper supply of houses for occupation by the working classes, whose tenancy will not depend on the nature of their occupation. Finally, that legislation should enable county councils as well as other statutory authorities and bodies to erect houses for persons whose salaries or wages they pay or contribute to, and that may be necessary to devise some scheme for State aid being given, either as grants or advances, to be repaid, with or without interest, to owners or employers who would be prepared to find the balance of cost of building or repairs for which there may be local demand. That, we are certain, would save money and speed up action in many places where talk is loudest just now, but where anything further will be shunted presently, if possible.

There is under consideration a scheme for a Scottish National War Memorial, put forward by a number of public and military gentlemen in Scotland, the Duke of Atholl taking a leading interest, which embraces two main objects. Sanction has been obtained for a War Museum of a general character, to be situated in London, and also for local museums. It is considered, however, by the promoters of the Scottish scheme that there should be a distinctive War Museum as well as a Memorial for Scotland, and the suggestion is put forward that after the war Edinburgh Castle might be made the headquarters of the Scottish National Museum and the site of the Scottish War Memorial. To a considerable extent the Castle is at present a national museum. The Banqueting Hall, where the first Scottish Parliament met, is used as a museum of armour, and the Crown Jewels, rescued from oblivion by Sir Walter Scott, are also one of the attractions in peace times. But the main feature of the Memorial consists in the erection of a new chapel, on a prominent part of the Castle site, so disposed as to form a conspicuous and dominating feature of the Castle buildings, and materially altering



the skyline. It is understood that the suggestion has been put forward that this building should be erected close to the present Queen Margaret Chapel, between the new hospital and the battery, and that its summit should reach a height to make it visible even from so far off as the Fifeshire district on the further side of the Forth. It is proposed to arrange this chapel in the plan form of a cross, and in a manner to afford a large amount of wall space—by means of recess windows, etc., and to allocate the various portions of it to the different Scottish regiments.

Representatives of central associations of employers held a conference at the Central Hall, Westminster, last Wednesday afternoon, to determine on a united policy in regard to the proposals of the Government in reference to industrial reconstruction. Nearly every industry in the United Kingdom was represented. Sir Richard Temple, presiding, said it was essential that obstacles to the working of the Government proposals should be removed by enforcing agreements between capital and labour. The law which gave immunity in this respect must be repealed. Reminding the conference that the Labour Party proposed to run 300 candidates at the next election, Sir Richard said that, working on State Socialistic lines, it must mean the destruction of private enterprise in the trading of the country. A resolution was adopted approving of the formation of joint standing industrial councils, but urging that, before they were established, legislation should be passed to enforce agreements. Mr. F. Handsham (Vehicular Trades) said the incessant muddling of the Government since the war began had landed labour in a shocking position. It would need a much stronger Government than the present one to bring affairs round. If the Government had kept its finger out of the pie the strike at Coventry would have been over in a few days. Mr. H. J. Catt (large owners) moved a resolution asking for an inquiry into the working and effects of the Trade Disputes Act, 1906, to report whether the number of pickets should not be regulated by statute, whether combinations for disorganising trading and social conditions should not be made unlawful, and whether it was not of national interest that all unions should be subjected to the ordinary law and made responsible for their actions. He said that the transportation of food at London Docks recently had been made almost impossible at times, even with the backing of a large force of police, by the action of strikers. The houses of those who chose to work had been watched, their wives molested, and their children insulted on the way to school. The resolution was carried.

We shall look out with some interest for the *Board of Trade Journal* on January 3, from which date it is to be published in "a new and extended form" and edited by a really practical working journalist, Mr. Harcourt Kitchen, the late editor of the *Glasgow Herald*. Hitherto any post of the kind controlled by the Government

seems to have been either grabbed by some minor mandarin or reserved as a sinecure for the Weary Willies of permanent officialdom; and of all Government publications, thus edited the *Board of Trade Journal* has taken the cake. Fancy the editor of any ordinary journal announcing that some specially valuable and fresh scoop had been secured, and that readers might be told what it was by applying at the office! That, in our experience, has been the case with the *Board of Trade Journal* when any bit of news in it came our way.

We hope anyone yet unconvinced of the absolute necessity of the early construction of the Channel tunnel, and of the stupid fears of the War Office, which is delaying it, will send at once for a copy of Sir Francis Fox's paper, which was read before the Royal Geographical Society, and which can be had gratis from Mr. R. D. Heckel, the secretary of the Channel Tunnel Company, 84, Tooley Street, S.E.4, together with Mr. Arthur Fell's excellent pamphlet, "The British Government and the Channel Tunnel." Sir Francis Fox establishes beyond doubt the practicability of the scheme and the vast advantages it offers to the trader, the traveller, and those charged with the defence of the Empire. Mr. Arthur Fell proves up to the hilt that, whether a long peace is to follow this war or we are at no distant date to re-encounter the German foe—quite possibly without any Allies, whose disgust with the failure of our War Office to complete at once the one bond of real unity which would so effectually facilitate the concentration of the forces of the East and West against the Prussian disturber of the world—the tunnel would save millions of lives and billions of wasted treasure. With it, moreover, the commercial future of London is inevitably associated. Given the Channel tunnel, and London will be the future gateway to the East and the railway centre of Europe. Without it, London will be side-tracked, and the future will pass to Berlin, Paris, or Vienna, and we shall share the fate of Venice and Amsterdam, and British commerce will be a dismal memory of the past and London as insignificant as Tyre.

Many who knew him will be glad to possess "The Art of Englishmen," published by the Complete Press, West Norwood, S.E.27, and compiled by his wife, of Roger Oldham, "to keep alive the memory of his thoughts and ideals, of the books he read, and of the people and the places that developed the passion for truth and beauty which characterised him so strongly, so that the lesson of his life may not be lost." Born at Lincoln on February 9, 1871, Mr. Oldham died on March 3, 1916. At the age of three years has parents moved to Sale, near Manchester, and when he left Manchester Grammar School at the age of sixteen he was articled to Mr. Charles Heathcote, architect, of Manchester, from 1887 to 1891. The five following years he spent in London, returning to Manchester in 1896, where he

set up in practice as an architect. But his office was also a studio from which many good drawings issued, such as appeared in "Picturesque Cheshire," published in 1903, and in "The Manchester Alphabet" in 1906. In 1904 Mr. Oldham married Dorothy, second daughter of Mr. Charles Scorer, of Lincoln, and enjoyed till his death the continuous sense of settlement and happiness the union brought into his life. A competent lecturer, a ready speaker, and an active worker for the good of all with whom he came into contact, his early death deprived many of a faithful friend and helpful co-worker. The volume contains his lecture on "The Art of Englishmen," delivered to the Manchester Society of Architects on November 11, 1914, and a good deal of other matter from his pen, together with six illustrations, including portraits of himself, and some selections from his drawings.

The Home Office has prepared a useful illustrated, descriptive book on "Protective Clothing for Women and Girl Workers" employed in factories and workshops, which can be ordered for threepence of any bookseller, or directly from any of H.M. Stationery offices. If the pretty girls, like the one on page 91 in the really fetching Boiler suit, would all wear one like it, not only now, but after the war, and leave the ugly and awkward ones to hide their physical shortcomings in the dear and ugly costumes of the profiteer-draper and milliner, they would save the money they are exploited of and scoop all the available husbands left worth marrying.

### THE PERFECT DWELLING.

BY ROBERT THOMSON.

Having described in past issues\* some of the defects of the type of housing which is at present responsible for the sacrifice of thousands of lives every week, I desire now to summarise the vital requirements which must be met in a dwelling in order to ensure perfect health conditions for its occupants:—

- (1) That in order to maintain the atmosphere of an apartment in a condition which is in all respects fit for human use it is essential that there be a continuous inflow of 3,000 cubic feet of pure, fresh air, and a corresponding outflow of vitiated air, per hour for each adult occupant or his equivalent.
- (2) That when either oil or gas is used for lighting purposes fumes are given off which vitiate the air-contents of the apartment so seriously that it is essential to take into account this source of pollution, as well as that due to the occupants. When calculating the total volume of the air supply required in a dwelling.
- (3) That the extent to which the atmosphere of an apartment is vitiated by either an ordinary paraffin-oil lamp of 16 candle-power, a bawsing gas-burner of similar lighting power, or a gas-burner fitted with a Welsbach mantle, is equivalent to that caused by  $7\frac{1}{2}$ , 5, and 3 adults respectively.
- (4) That unless the incoming air be warmed before admission, the air-contents

\* Mr. Thomson's previous articles on the subject appeared in our issues of May 23, 30; June 6, 13, 20 and 27; July 4, 11, 18 and 25; August 1, 8, 15, 22 and 29, and Sept. 5 and 12. The seventeen numbers can be had post free for 9s. 11d.

of a sitting-room cannot in cold weather be renewed often than about three times an hour without discomfort to the occupants, and that, therefore, it is necessary to provide in such apartments a minimum of 1,000 cubic feet of air-space for each adult occupant or his equivalent.

(5) That if the incoming air-supply be suitably warmed before admission the air-contents of a sitting-room can be renewed from five to six times an hour without creating discomfort, and that, therefore, a perfect supply of air would be provided for a correspondingly greater number of occupants.

By establishing these scientific facts on that scientific basis scientists have provided the much-needed scientific standard by which to determine either (a) the sizes of the habitable apartments in any proposed dwelling in which it is desired to provide perfect health conditions, for a stated number of occupants, or (b) the number of occupants which each of the apartments in any dwelling will accommodate under similar conditions, and it is obvious that it can be used with equal facility for any required modification of these conditions.

Had the dwellings of our people been constructed in accordance with the foregoing standard even as recently as fifty years ago, and had the maximum permissible number of occupants in each dwelling been thereafter regulated in conformity therewith, neither the sacrifice of 250,000, or any other number of lives a year, nor the appalling amount of ill-health, sorrow, and misery which is inevitable with the existing atrociously planned type of dwellings in which our working classes are forced to use their small, disease-promoting kitchens as their living-room, would have been disgracing the civilisation of to-day.

That it is economically possible to provide healthy housing, in which the air-supply in every respect fully conforms to that scientific standard, is conclusively proved by the accompanying series of plans, showing dwellings of the hitherto unknown actively health-promoting class in which every requirement in regard to health, house-room, office accommodation, comfort, convenience, and economy is fully met.

In view, therefore, of that fact, many people might think, and in my opinion think rightly, that it would be a case of misprision to erect dwellings which cut down the air ration of their occupants below that standard, because to do so would be to deliberately and unnecessarily impair the health and lives of the occupants of such dwellings by depriving them of an adequate supply of pure, fresh air—the only vital sustenance which of itself costs them absolutely nothing. The professional advisers of the Government do not, however, think so.

When the habitable accommodation in existing working-class dwellings and that provided for (a) in the plans put forward by the Departmental and Advisory Committees in England; (b) in those just issued by the Royal Commission on Housing in Scotland; and (c) in the conditions regulating the competitions promoted by the Council of the Royal Institute of British Architects is measured by a really scientific standard it is found that the air-space in the largest size of living-room is so seriously inadequate as to be incapable of providing more than one-fifth of the air-supply called for by the scientific standard for a family of only average size.

That calculation is based on the use of a Websterian mantle, the least injurious

method of burning gas, and on the assumption that the air-contents of the apartment are renewed three times an hour.

If, however, the family be a moderately large one, and a paraffin-oil lamp of 16 candle-power be used for lighting purposes, the occupants would not get one-tenth of the fresh-air supply which perfect health conditions demand, and if a closed fire-range were used for cooking purposes their plight would be still worse.

It is clear from the foregoing that the root-cause of the existing housing problem and all its attendant evils has been the lack of the plan of a dwelling which, instead of promoting ill-health, would effectively combat disease. The housing problem is, in short, a plan problem, and the solution of that problem has hitherto effectively baffled the experts of this and all preceding generations. It is necessary, therefore, to consider the question of planning from the technical standpoint.

#### PLANNING.

The efficient planning of a small dwelling, in which it is imperative that every requirement in regard to health, house-room, office accommodation, comfort, convenience, and economy be met to its full extent, is a very exacting evolutionary process, which must be conducted throughout on a strictly scientific basis.

In order to thoroughly realise what that process actually is, it is first necessary to understand clearly (a) that all defects in the plan of a dwelling are potential advantages—each defect having its corresponding advantage; (b) that these advantages cannot be secured except by eliminating the defects; (c) that as each defect is got rid of its corresponding advantage automatically appears; (d) that the process is never complete until (e) every requirement has been fully met, (f) every defect eliminated, and (g) the maximum economy which the materials selected for employment in the building are capable of giving has been secured. When this stage has been reached perfection will have been attained.

The test of perfection is a simple one: If the plan has been fully perfected, it will be found impossible to alter the relative arrangement of its component parts without creating defects which detract from one or other of its advantages.

As defects in the dwelling itself are unlike those in its plan in that they are usually fixed evils, the importance of completing the planning process before beginning to construct the building is obvious.

The eight accompanying plans give examples of the process of planning at various progressive stages.

Plans Figs. 184, 185, 189, and 190 show it completed.

Plans Figs. 194 and 195 show it approaching completion.

Plan Figs. 198-9 show it in its initiatory stages; while

Plan Fig. 200 shows the speculative builder's idea of perfection.

Plan Figs. 198-9 shows what has been given in the way of accommodation, etc., with the materials employed.

Plan Fig. 184 shows what the same materials are capable of giving when efficiently utilised.

Plan Fig. 185 shows the latter with concrete walling.

Plan Fig. 189 shows a perfect dwelling of medium size.

Plan Fig. 190 shows the latter with concrete walling.

Plans Figs. 194-5 show imperfect examples of the health-promoting dwelling, the former in brickwork, the latter in concrete.

Plan Fig. 200 shows one of the two

plans given as examples of municipal inefficiency by the author of plan Figs. 198-9. Its dimensions have been so modified as to permit of direct comparisons being made between it and plan Fig. 195.

Having been employed by its author to show up defects in the planning of some municipal flats and suburban dwellings, the plans of which are given in Fabian Tract No. 109, plan Figs. 198-9 herewith is itself, in turn, now utilised in order that the present series of comparisons may through it be carried backward to these flats and suburban dwellings.

Partly for that reason and partly because it has been issued by its author and published by the Fabian Society as a model, plan Figs. 198-9 has been adopted as the basis from which the perfect dwelling shown in plans Figs. 184-5 have been evolved.

The Fabian model, reproduced in Figs. 198-9, shows a plan which is fairly bristling with potential advantages. The w.c. breaking into the parlour is one; the simultaneous use of the one and the same small apartment for the four-fold purpose of (a) entrance lobby, (b) kitchen, (c) staircase, and (d) living-room make five; the parlour opening out of the kitchen is a sixth; the mutilation of two of the bedrooms and the waste of the space in a dark, cranked lobby make nine; the relative positions of beds and fireplaces in the three bedrooms make twelve. The position and size of the bathroom create several others, and there are many more, among which the shortage of air-space is a fatal one. In the living-room, for example, suppose there was no pollution of the atmosphere from combustible illuminants or other cause, and that its air-contents were renewed three times an hour, its total air-space would be only just sufficient for one adult and a-half when measured by the scientific standard given herein, and the total air-space in its three bedrooms would not be sufficient to provide the standard ration of air for three adults, even with perfect ventilation, giving a change of air three times an hour.

That Fabian model plan, it arranged so as to give a group of four dwellings, when built with 11-in. cavity walls, and provided with a passage-way to give direct access to the back entrance of the two centre houses, would have a roofed area of 2,202 square ft.—that is, an average of 1,101 square ft. for each pair of dwellings—and the brickwork required in their construction to give ceilings 8ft. high would be more than sufficient to erect a group of four health-promoting dwellings to plan Fig. 184, with ceilings 10 ft. 3 ins. high.

When so standardised, the house-room in the habitable apartments and kitchens of the Fabian group would be for the dwelling, with its upper floor extending over the passage-way, 5,716 cubic ft., and for each of the three others 5,284 cubic ft., the average, which thus works out at 5,365 cubic ft. per dwelling, giving a total of 21,460 cubic ft. for the four dwellings in the group. As the house-room in the corresponding apartments of the group of four health-promoting dwellings would total 35,028 cubic ft., the difference between this and the Fabian total would be 13,568 cubic ft., which, when priced at the officially based rate of 15d. per cubic foot—which, by the way, is very much less than the rate at present ruling—shows an advantage in house-room to the value of £848 in favour of the block of perfect dwellings.

Turning now to the small plan, Fig. 194, the roofed area of each pair of dwell-

mings, in which is only 835 square ft., it will be seen that the total house-room in a group of four would be 25,008 cubic ft., against 21,460 cubic ft. for the Fabian group, the difference of 4,566 cubic ft., when priced at 15d. per cubic foot, working out at £264 5s. in favour of the small, health-promoting example.

Even the very small plan, Fig. 195, with its roofed area of only 710 square ft., when built in a group of four, would give 21,932 cubic ft. of house-room, against the 21,460 cubic ft. which would be given by the Fabian model, with its roofed area of 1,101 square ft.

In addition to the difference in the amount of house-room, there is also the difference in its quality to be taken into account, and in weighing the advantages of the perfect dwelling against the drawbacks of the Fabian and the officially issued model plans, it should never be forgotten that the former would give a dwelling of the health-promoting class, while the latter would all give dwellings having living-rooms of the kitchen type, which is so largely responsible for the appalling waste of life.

Although the accompanying plans of the new class of dwelling show many advantages over those which would be given by dwellings built to plans Figs. 198, 199, and 200, they do not reveal the most important advantage of all—that is, the system of heating and ventilation which is provided for by (a), the fresh-air supply duct shown dotted and numbered 21 on plan Fig. 185; (b) the three exhaust flues shown in the living-room chimney breast; and (c) the narrow, slotted opening, of about 1½ in. in width, which is located at the top of the partition between that apartment and the two smaller bedrooms. The frequent change of air which is thereby provided for in the bedrooms gives the very atmosphere which is required for the prevention of consumption and the alleviation of consumptives. It is this system which transforms them from the merely "healthy" to the actively health-promoting class of dwelling. By its means it is possible to double the air-supply of the living-room and to nearly double the air-supply of the two smaller bedrooms.

The system of ventilation now referred to will be found described in some detail in a previous issue of this journal.

Another of the advantages which distinguish the new class of dwelling from all existing types of working-class housing is that the habitable apartments are separated from the kitchen and office accommodation by the entrance lobby, with two doors between them.

Of the five apartments, four are exclusively habitable and one exclusively working, and one advantage of the latter which is not visible from the plans is that the ceiling of the kitchen is sufficiently high to enable its upper portion to be utilised for the drying and airing of clothes without these interfering with the ordinary kitchen work going on below. Another is the combined arrangement of sink and wash-tub shown in Fig. 193, which enables the family washing to be carried through at the convenience of the housewife. The advantages which these laundry arrangements secure, by keeping the moisture out of the living room, are, from the health point of view, of vital importance to every occupant of the dwelling.

One of the special features of the health promoting class of dwelling is the provision which its sleeping balcony offers for the domiciliary treatment of consumptives. The importance of this is emphasised by the fact that our vital statistics show that in the year immediately before the war tuberculosis was responsible for

66,868 deaths, and it has been estimated that, besides that waste of life, it constantly holds within its relentless grip about 250,000 other victims, whose energies it gradually impairs.

In view of these facts it would be well if the first 250,000 houses to be erected under the Government's housing scheme were provided with accommodation for the domiciliary treatment of these 250,000 consumptives.

The accompanying plans show that this very much needed accommodation can be provided in dwellings of the health-promoting class, which would cost less to erect than the disease-promoting kitchen-living-room type of dwelling.

A newspaper cutting now before me reads as follows:—"An estimate of the net ultimate loss due to mortality from tuberculosis in England and Wales in a single year is given as £25,000,000." If to that figure there be added on a proportional basis the ravages wrought by that disease in Scotland and Ireland, the total ultimate loss for the United Kingdom would appear to be well over £33,000,000 a year.

The balcony, when not required for sleeping purposes, would provide accommodation for housing two cycles and a perambulator. In industrial areas the use of a cycle would enable the workers to live at some distance from their work, and would thus facilitate the spreading out of the dwellings over wider areas.

The covered and semi-enclosed porch, which is another of the special features of the new class of dwelling, offers every facility for cleaning the cycles without discomfort and avoids having to do any of that work inside the dwelling.

One of the special advantages of the new class of dwelling lies in the fact that, when built in groups of four, each of the four tenants has his own garden gate, which enables him to keep his garden ground and house quite private.

The importance of this arrangement will be brought out by the Secretary, Well Hall Garden Village Tenants' Association, in a letter which appeared in the *Observer* of September 2 last. After paying a well-merited tribute to the artistic faculty of the architect, he proceeds as follows:—

"We find cases where disappointed householders have been compelled to house bedroom furniture in the kitchen, owing to the impossibility of getting it up the ridiculously narrow and cramped staircases. Then, again, the houses are built in blocks, to the backs of which admittance is only possible by the use of side passages around those houses which are situate at the ends of the blocks. This fault in the design of the estate shows an unpardonable absence of knowledge of the requirements of working-class life and habit, and has led to more trouble and unneighbourly feeling than any other phase of communal life here."

The Council of the R.I.B.A., in the supplementary instructions which they have issued in connection with the competition promoted by them, state:—(1) That the living-room must not be less than 180 square ft. in area clear of projections; (2) that ceilings be not less than 7 ft. 6 ins. or 8 ft. high; (3) that a separate bathroom is not necessary; (4) that the w.c. should not be in the bathroom, nor (5) enter from the scullery.

In view of these instructions, the Council of the R.I.B.A. are clearly not authorities on the planning of small dwellings. Those who have already agreed that a bathroom is as essential in a small

dwelling as in a mansion house, and as a w.c. in a bathroom does not in the slightest degree detract from the "healthiness" of the dwelling, it appears to me that the extra outlay required to provide the separate w.c. called for by the R.I.B.A. would be better expended in adding to the grossly inadequate air space called for in the habitable apartments of their rudimentary type of kitchen-living room dwellings.

In my opinion a w.c. separate from the bathroom is a refinement which, if it involved no sacrifice to give, would constitute a defect if withheld; but as a separate w.c. entails either a separate bathroom, which is costly to construct, or the putting of the bath in the scullery, which renders it practically worthless for its proper purpose, the sacrifice of the bathroom is much too big a price to pay to gain a separate w.c.

In my evolutionary series of plans leading up to the perfected dwelling, a bathroom and a w.c. separate therefrom are provided, everything else being as shown in the plans of the perfected examples accompanying this article. By that arrangement there was loss of economy, and to reduce the cost the one apartment is utilised for both.

Referring to plan Fig. 194, it may be mentioned that its floor area is sufficient to give five apartments each of the area of the desirable apartments called for by the Advisory Committee, and that its principal defect—viz., insufficient air space in the parents' bedroom—would be overcome if the partition between that apartment and the living-room were kept three-quarters of an inch down from the ceiling, so as to enable its occupants to receive the benefit of the central air warming and ventilating system. When so arranged, this small five-apartment dwelling would meet to the full extent every requirement of the scientific standard for a family equivalent to four adults, with, of course, an additional adult on the sleeping balcony. It thus provides perfect health conditions for a family larger than the average size, while its office accommodation is exactly the same size as that provided for in the perfect dwelling shown in plan Fig. 184. Even that plan, small as it is, would give a better dwelling than the Fabian plan, Figs. 198-9. A glance will show that its principal bedroom is so arranged that there is room to accommodate the prized possessions of the housewife, which are usually found in the small parlour. It is clear, therefore, that with a living-room which is *not* the kitchen and a bedroom which protects the family treasures from the rough-and-tumble usage of living-room, there is no need for the usual parlour. In any case, no parlour should ever be provided in any dwelling until after every vital requirement of the occupants has been fully met, in accordance with the scientific health standard, in every other apartment.

Although not essential from the health point of view, the novel method of construction provided for by the relative arrangement of the chimney breasts, party and wing walls offers important advantages in regard to stability and economy. This method of construction is described in a previous issue of the *Building News*.

The Corporation of London resolved last Thursday to pay an increase of 35 per cent. on existing asphalt and wood paving contracts and 50 per cent. on future contracts for repairs and reinstatement during the war, and an increase of from 11 to 17½ per cent. on sewers, masons, and paviors' works.



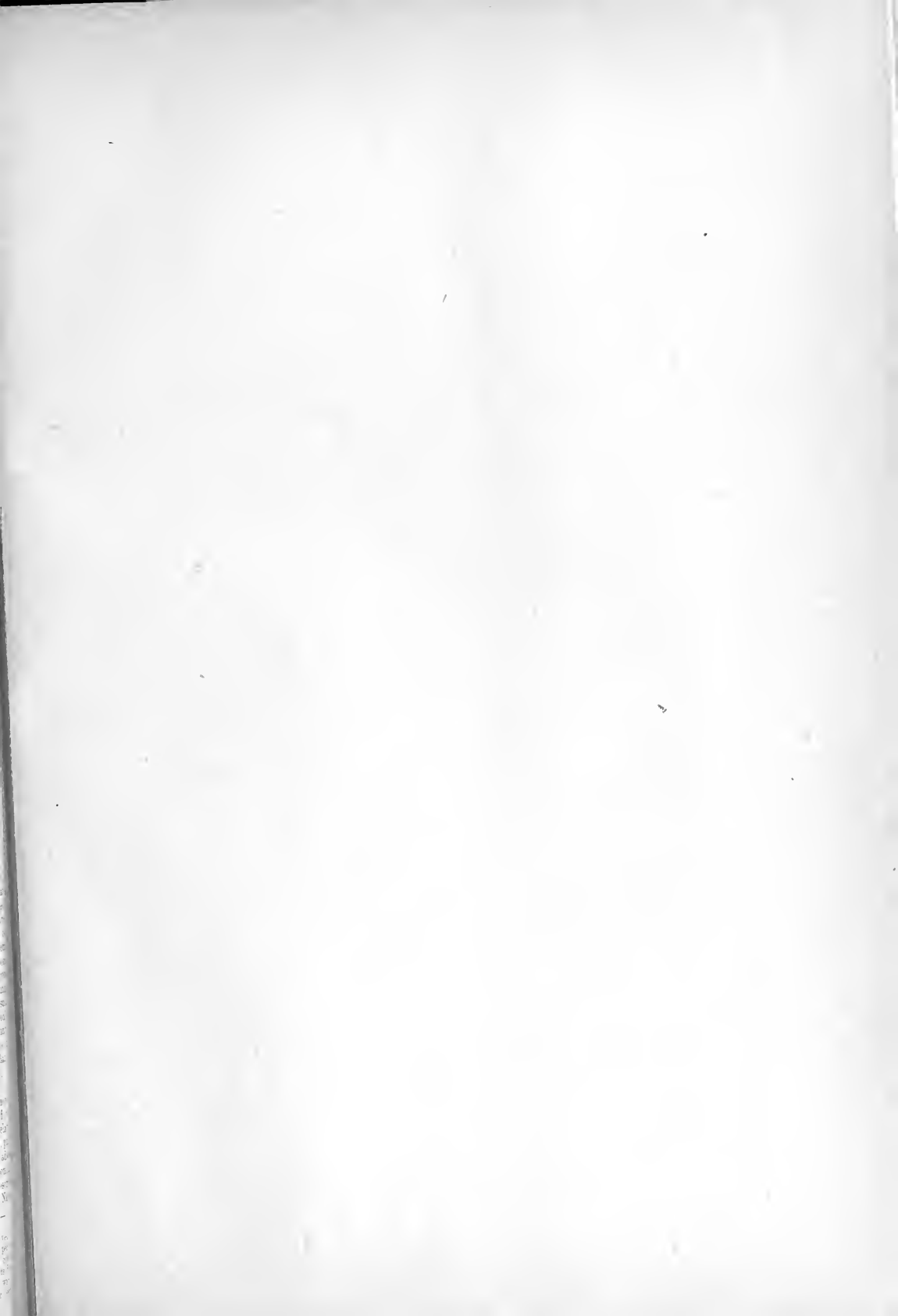

# THE PERFECT DWELLING

TYPICAL PLANS OF

THE MITALBERTO UNKNOWN ACTIVELY HEALTH-PROMOTING CLASS OF COTTAGE DWELLINGS  
WITH DUCT AND THREE FUEL HEAT-ACTIVATED SYSTEM OF WARMING AND VENTILATION SLEEPING-PORCH AND CYCLE STORE OR SLEEPING-BALCONY  
PATENTS Nos 24278-14, 10191-15, 107672.

BUILDING NEWS SERIES  
TWO SHEETS A AND B.  
SHEET A.

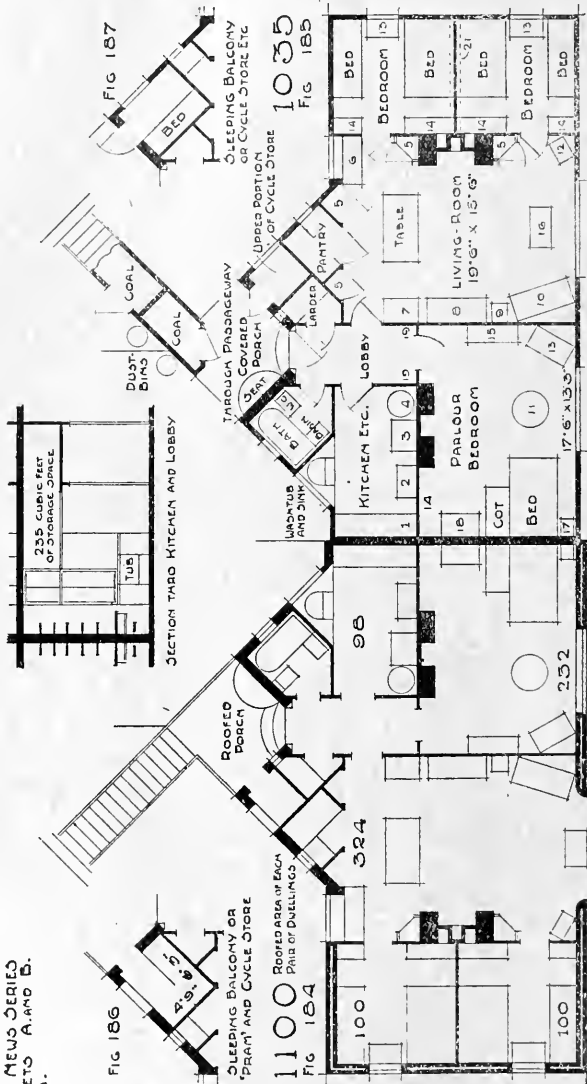

8757 7-960  
1100 1420  
1100 12-918-By-Window NOT INCLUDED  
THESE PLANS SHOW THE LARGEST SIZE OF DWELLING IT IS NECESSARY TO BUILD

THESE PLANS SHOW IN THESE DWELLINGS WHICH THEY WOULD GIVE TO BE DIRECTLY COMPARED WITH THOSE WHICH WOULD BE GIVEN BY MODEL PLAN VI OF THE FABER OCCUPYING TRACT NO 109 AND IF THE PLANS ON THIS AND NO COMMON SHEET BE CRITICALLY COMPARED WITH THE OTHERS JUST ISSUED BY THE ROYAL COMMISSION ON HOUSING IN SCOTLAND AND WITH THE PREPARED PLANS IN THE R.I.B.A. COMPETITION WHEN THE ROYAL COMMISSION ON HOUSING IN SCOTLAND AND WITH THE PREPARED ARCHITECT 52 GRANNEY LANE LONDON W.C. ROBERT THORPSON ARCHITECT

1035 8-347  
1035 14115  
1035 15-635



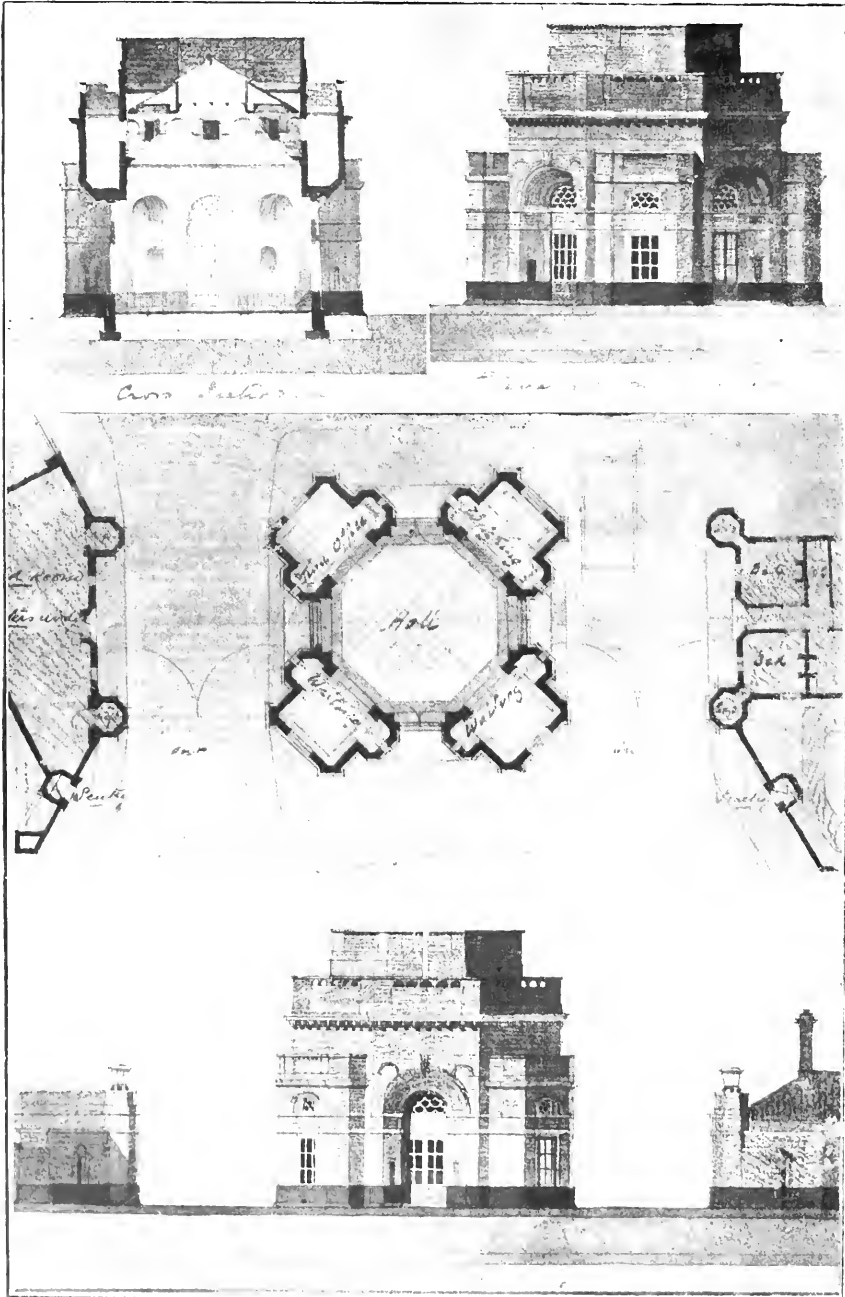

ENTRANCE BUILDING, LARGE MUNITION FACTORY, BIRMINGHAM.  
Messrs. B. LAND, HAYWOOD and FARMER, F.F.R.I.B.A., Architects.



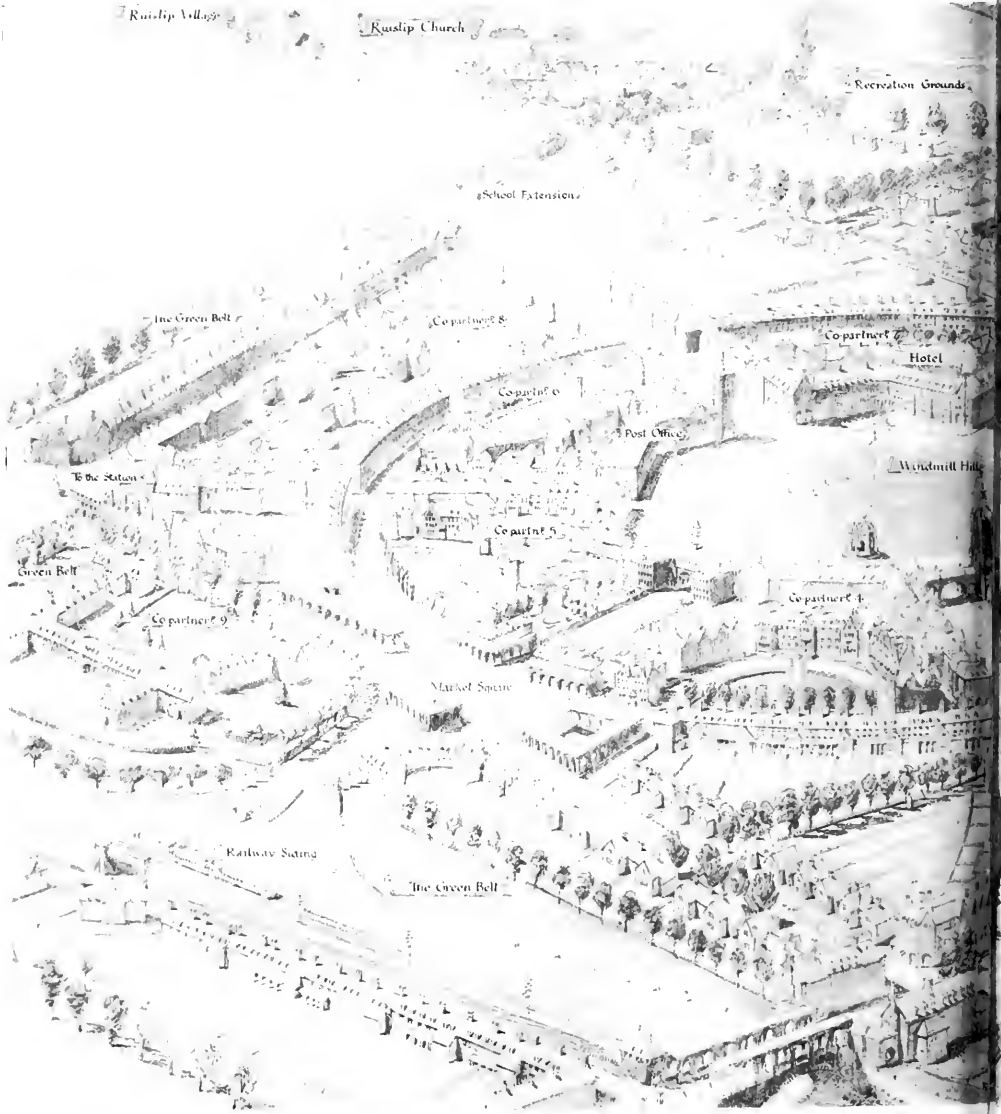

THE RUISLIP GARDEN CITY, FOR THE ESTATE OF KING'S  
(From "Where to")

DECEMBER 19, 1917.

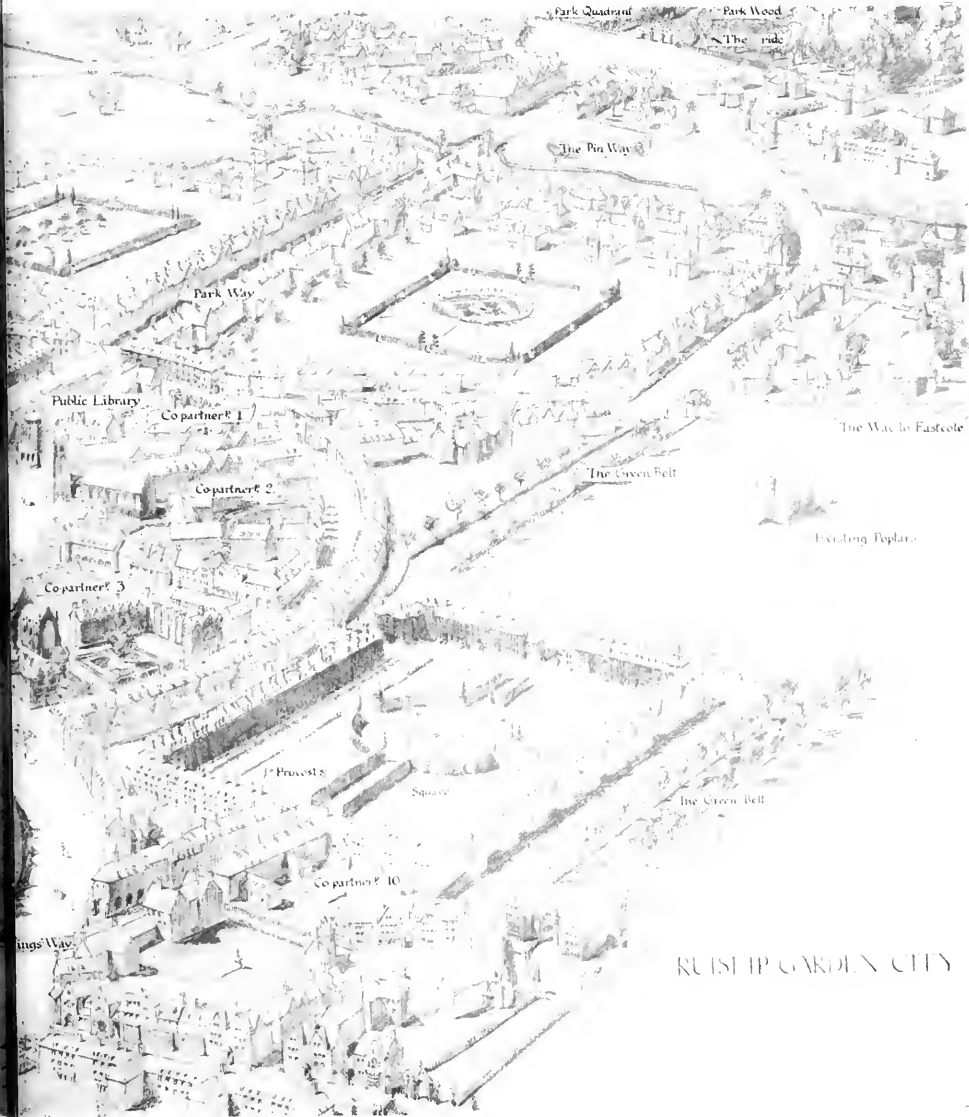

LEGE, CAMBRIDGE.—Mr. CHARLES R. ASHBE, M.A., F.R.I.B.A., Architect.  
(at City Stands.)

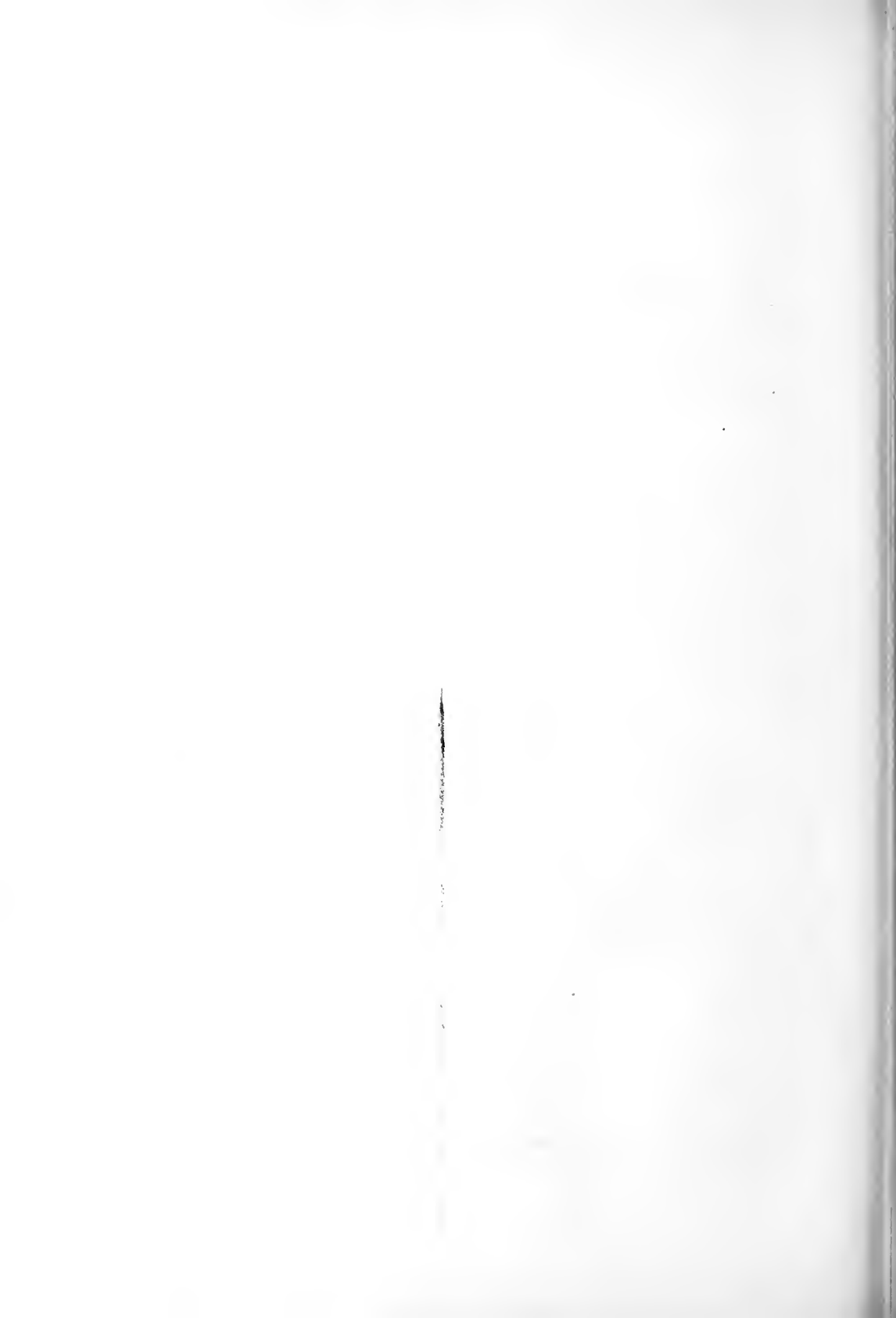



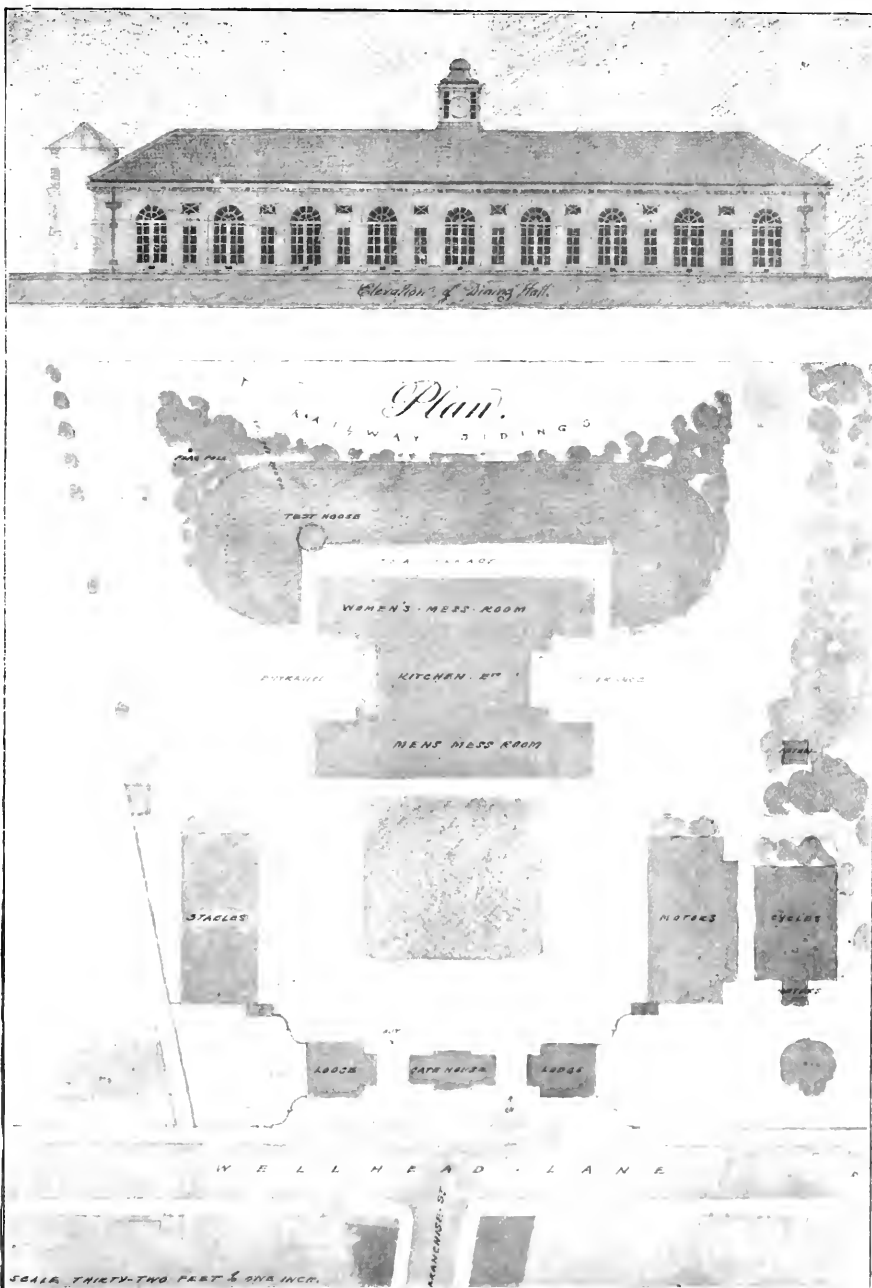

CANTEEN AND ENTRANCE TO LARGE MUNITION FACTORY, BIRMINGHAM.  
Messrs. BECKLAND, HAYES and FARMER, F.R.I.B.A. Architects.



# THE PERFECT DWELLING.

TYPICAL PLANS OF THE HITHERTO UNKNOWN ACTIVELY HEALTH-PROMOTING CLASS OF COTTAGE DWELLING WITH A SLOT AND THREE FINE HEAT-ACTUATED SYSTEM OF WARMING AND VENTILATION SLEEPING PORCH AND CYCLE STORE OR SLEEPING BALCONY PATENTS NOS. 24278-14, 10191-15, 107673.

BUILDING NEWS SERIES TWO SHEETS A. AND B. SHEET B.

COMBINED SINK AND WASH TUB

PATENT APPLIED FOR

FRONT

FIG 191  
SLEEPING BALCONY

948  
FIG 189

900  
FIG 190

FIG 192  
SLEEPING BALCONY

2031  
948  
1329  
948

7-770  
12-921

2012  
900  
1282  
900

8-124  
13-900

## IMPERFECT EXAMPLES OF HEALTH PROMOTING CLASS OF COTTAGE DWELLING

FIG 196  
SLEEPING BALCONY

835  
FIG 194

710  
FIG 195

FIG 197  
SLEEPING BALCONY

6232  
835  
6672  
835

7-267  
10-394

5496  
710  
5245  
710

7-745  
10-342

DEFECT - THE PRINCIPAL BEDROOM IS A THIRD TOO SMALL BUT THE SHORTAGE OF AIR SPACE CAN BE COUNTERACTED AS EXPLAINED

DEFECTS - THE PRINCIPAL BEDROOM IS MORE THAN A THIRD TOO SMALL AND THE LIVING-ROOM SHOULD BE A THIRD LARGER AND HAVE A WINDOW IN THE GARDEN FRONT AS IN PLAN FIG 194

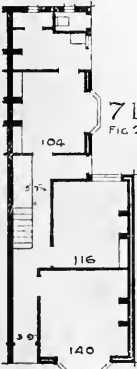

710  
FIG 200

2880  
710

4-056

## THE FABIAN SOCIETY'S MODEL PLAN

PLATE VI OF FABIAN TRACT NO 100

1101  
FIG 198 WITH PASSAGEWAY

1035  
FIG 199 WITHOUT PASSAGEWAY

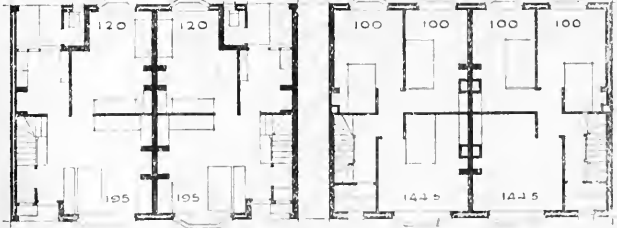

5365  
1101

4-977

5244  
1035

5-370

PLAN FIGS 198-9 SHOWS WHAT ITS AUTHORS WERE ABLE TO GIVE IN THE WAY OF OFFICE ACCOMMODATION HOUSE-ROOM COMFORT CONVENIENCE AND ECONOMY WITH THE MATERIALS EMPLOYED UNLESS THE PLANS OF THE PERFECT DWELLING FIGS 184-5 OR THE COMPANION SHEET HERETO SHOW WHAT THE SAME MATERIALS ARE CAPABLE OF GIVING WHEN EFFICIENTLY UTILISED

ROBERT THORSON, ARCHITECT 52 CHANCERY LANE LONDON W.C.



# Our Illustrations.

## THE RUISLIP GARDEN CITY, FOR THE ESTATE OF KING'S COLLEGE, CAMBRIDGE.

Mr. Charles R. Ashbee, M.A., F.R.I.B.A., has interested himself in projects for the practical development of the arts-civics, as he says, in the highest sense, and with this end in view he is about to publish a book with over one hundred and twenty drawings, photographs, and diagrams, of which B. T. Batsford, Ltd., the Essex House Press, are to be the publishers. The title is, "Where the Great City Stands: A

ment of the grouping of "The Craft Museum" or "Art Institute" with the Creative Guild. In the midst is the Central Gallery, over the power house.

## ENTRANCE BUILDING, LARGE MUNITION FACTORY, BIRMINGHAM.

This drawing, reproduced from the Royal Academy Exhibition this year, represents the preliminary sketch for the new entrance buildings to a large munitions factory, and now built. The enormous increase of traffic of all kinds to these works necessitated the provision of special control arrangements, and two gateway entrances in place of one. The scheme as executed has been altered in several ways, principally by the provision of a lodge on both sides of the gate house instead of on one side only, as shown on the

control of foot traffic, weighbridge office, and two gateways for vehicles, with a lodge on either side for constabulary. To the right and left of the court are stables and garage, with cycle storage at back, and the main block forms a canteen for men and women, the total number seated being 700; the mess rooms are specially arranged to serve both for dining and for meetings. The work was executed by the firm's own staff, and the walls are built of 2 in. blue bricks to sill level, and are plastered above; the roofs are covered with Cornish slates. Messrs. Buckland, Hayward, and Farmer, F.R.I.B.A., are the architects.

## THE PERFECT DWELLING.

These two sheets by Mr. Robert Thomson will be found described in his article

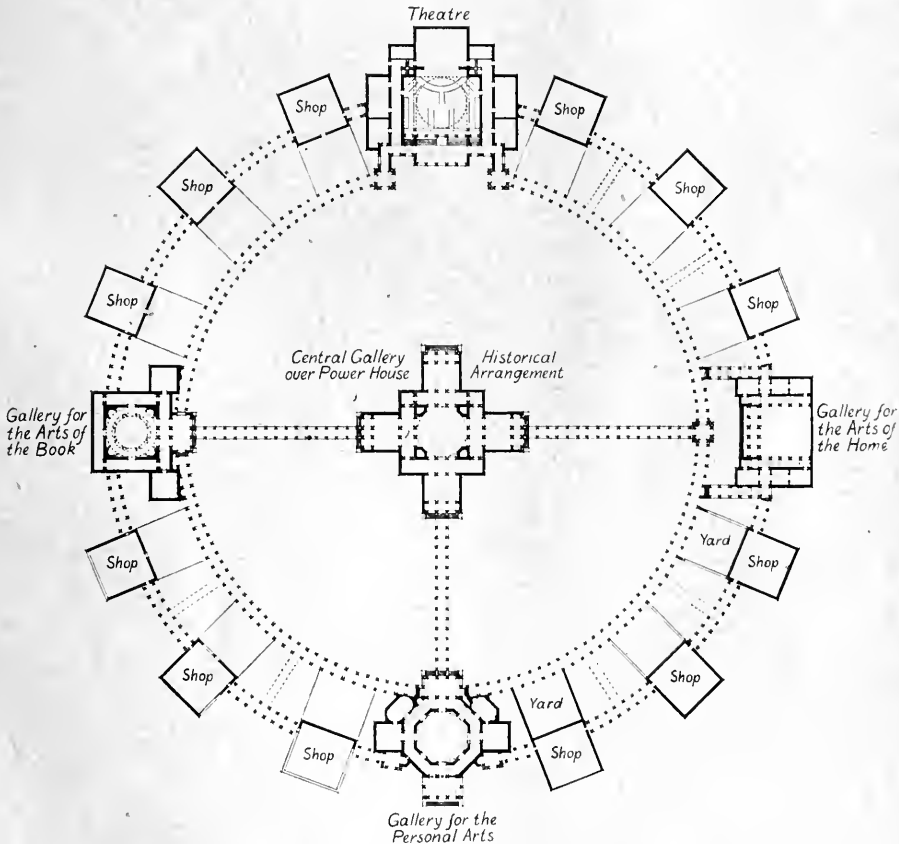

PLAN OF THE ARCHITECTURAL TREATMENT OF THE GROUPING OF THE "CRAFT MUSEUM" OR "ART INSTITUTE" WITH THE CREATIVE GUILD, DESIGNED BY MR. CHARLES R. ASHBEE, M.A., F.R.I.B.A., ARCHITECT.

Study in the New Civics," and the work will embody the results of a ripe experience and the study of English and American cities, and it will indicate ways towards reconstruction after the war. Mr. Ashbee's aim is to include standard and quality in men and things, so as to check the disintegration of society which was already in progress before the war. Among our illustrations to-day we are enabled to publish his bird's-eye view of the Ruislip Garden City for the estate of King's College, Cambridge, a comprehensive town-planning scheme grouped round Windmill Hill and adjacent to the railway station, the main approach by road being over the bridge and through "King's way," leaving "Provost's Square" to the right. The plan, also from Mr. Ashbee's design, illustrates the architectural treat-

drawing. The gate house itself has a central waiting hall, in which all pedestrian traffic is controlled by a commissionaire, who occupies one of the offices on the diagonal. The three other offices have been allotted as time office, weighing office, and police office, the police and commissionaire's offices also serving as search rooms when required. The materials used are Tucker's sand-faced bricks with wide joints, and Ames and Hunter's new Roma tiles. Messrs. Buckland, Hayward, and Farmer, F.R.I.B.A., are the architects.

## CANTEEN AND ENTRANCE TO A LARGE MUNITION FACTORY, BIRMINGHAM.

These buildings are built round a court and form an entrance to a large munition factory. They consist of a gate house, for

on page 480. They are supplementary to the series by him we have recently given, which has attracted so much interest.

The Worcester-shire County Council have referred to the General Purposes Committee proposals for a town-planning scheme which is being promoted by the Worcester City Council, affecting 3,000 acres in Claines, Martin Hussingtree, Hindlip, and Warndon.

The Court of Appeal, last Wednesday, reserved judgment in the appeal by the Cardiff Corporation from the decision of Mr. Justice Bray on a special case stated between the Corporation and Louis Philip Nott, contractor of Bristol, with regard to the construction of a reservoir for the Corporation. Although the work was only half completed when it was stopped owing to the war, over £12,000 had been awarded to the contractor for extras.

## INITIATIVE LACKING IN ARCHITECTURE.

By ALFRED CHAMBERS.

We are in the position to-day of knowing more about the science of building than has ever been known in any previous architectural era. We may possibly know more about architectural design in its broader sense, and we do not know more about the æsthetic side of architecture—that is, the effect upon the senses and emotions. When I say we may possibly know more about architectural design, I have in mind our great versatility in handling more or less intelligently anything from a skyscraper to a bungalow, or from a mantel to a cathedral, and we can dress these creations up in a Mission, Classic, Renaissance, or Gothic character. We can also make the building fit the practical requirements of the organisation to be housed, and give the building a character that more or less suggests its utilitarian purpose. We realise to-day, as we never realised before, the importance of this element of giving expression to the innermost character of the function a building serves rather than giving it a conventional, and to a certain extent meaningless, architectural expression. We have also a conception of what planning means that has in it the germ of a far-reaching development. This is clearly seen in the plans submitted for some of the more recent competitions, such as those held for the Government Buildings at Ottawa and the Winnipeg Park Buildings, where arrangement and proportion shown in many of the plans are far beyond the conception held a few years ago.

### NO INITIATIVE IN PRESENT-DAY DESIGN.

When we come to the æsthetic side of architecture, by which I mean that element that raises the science of building to the same plane as the great arts of painting, music, and sculpture, we have only to consider our dependence upon the great architectural epochs of the past to realise our weakness. How many architects to-day could, without the assistance of their libraries, design a building with the classical beauty and refinement of a Parthenon, or with the robust and simple treatment of the Baths of Caracalla, or a building with the imaginative aspiration of a Rheims or Roman Cathedral, or, again, with the luxurious and clever composition of the Louvre? If we regard the fine poetic sentiment in the English Gothic collegiate or residential work we must realise that this sprang from a deep sincerity and feeling in their work that architects of to-day are far from possessing. We cannot design on our own initiative with the perfection of any of these masters, but we have, as before mentioned, a remarkable versatility in producing a semblance to all of them; furthermore, if we wish to copy them slavishly we can reproduce them with the assistance of an extensive library, but this, after all, is archæology, not living architecture.

This is what appears to me to be the position we are in at present; and now let us trace the steps by which we have arrived at this stage, after which I would like to consider certain elements affecting our further development.

### SOLIDITY AND DIGNITY SIXTY YEARS AGO.

About sixty years ago most of our best work was done by men who were trained in England, and who brought with them a sturdy and conservative restraint in their work, which resulted in a dignified and sober treatment of Classic or Renaissance buildings and a more restraint of Gothic than we meet so familiarly with the better class of English work. Residential street residences were treated then with more restraint than in the years following, particularly in Toronto. This is a curious archæology; for consider how small the cities are at that time compared with what they are now. Our business districts were built up more substantially and with more dignity, all of which expressed the effect of the solidity and thoroughness of

English traditions. Architects of this period, however, kept carefully within bounds, and did not indulge in flights of imagination or attempts to solve new problems in new ways, and the school from which they drew their inspiration was rather dogmatic and limited, though sound and safe as far as it went.

As this period gradually passed and the flow of prosperity, occasioned by our rapid growth spread over the country, we seem to have broken away from the influence of earlier traditions. The rapid expansion necessary and the limited amount of capital to meet this expansion led us into less thorough methods of construction and less careful designing. Owing to there being no restraint upon the practice of architecture other than the rather uncertain discretion of the public, we naturally find at times like these many practising architects who had not sufficient training or equipment, and this state of affairs led to a lowering of the standard and created the darkest architectural period of Canada's career. This flow of prosperity and building activity, however, died down, and Canada became subject to a good many years of depression, in which there were not a great many buildings erected.

### WHAT ABOUT THE FUTURE?

In the earlier part of this century Canada began to realise its great future and to waken up and go ahead by leaps and bounds, and the building expansion following assumed enormous proportions. This period gave birth to higher architectural aspirations, due probably in a large measure to the great architectural development of the United States, which, in itself, was due to the European training which led to the handling of problems in a freer and broader spirit, and also led to a more penetrating study of the old work.

Undoubtedly, the development we have undergone in this last era of building activity places us farther on the road to architectural proficiency than we have ever been. We have more of a grasp of the real architectural problem, and we realise that the main element to be sought is a successful plan, and next to that an expression that leads the mind to grasp the essential character of the organisation clothed by the building. We are emancipated from the necessity of cramping the problem to suit a preconceived design. When we compare, for instance, a modern station, office building, bank, library, or school with the buildings housing similar organisations fifty years ago, we realise that we have developed a much broader grasp of the problem, but this ability is, after all, only elementary, and leaves us on the threshold of a really great architectural era. Are we going steadily forward in the great building expansion that is bound to come to Canada sooner or later, or shall we blunder along in a mediocre way? I think the threshold upon which we have stepped is also a cross-road. There are some alarming factors in present-day conditions which make me think the choice of roads at this juncture is of vital importance to our future architectural development.

### IS ARCHITECTURE NO LONGER A ONE-MAN PROFESSION.

The days of handling a large architectural practice in a small professional way are past. Consider the organisation that is required to efficiently control a large amount of building under present-day conditions. First, there is the business and administrative; then there is the structural part, the mechanical part, the supervision; and, finally, the creating and designing—in short, an efficient organisation to create and purchase an article or articles totalling in value of perhaps a million or so dollars a year. We have not many of these organisations in Canada, but we will have in future years; and, what is more, to-day we have to meet the competition of such architectural organisations in the United States, and also of large building corporations encroaching upon the architects' province. This means that architecture, to meet present-day conditions, must be a highly-organised business, and not a one-

man profession as it used to be, and I believe that this is a tendency growing out of modern economic conditions that cannot be altered.

The fact that we have to consider its influence on architectural design. Such a development as the above means specialisation and extreme proficiency in design, and this means at least ten years of training under the best of advantages. There are many in the United States being trained to fulfil these modern requirements in the way of design, but practically none in Canada. Our opportunity for training men is at a very low stage. We have not the control over the students that the old system of indenture gave us, and we have no ateliers like they have in the States, which make an excellent substitute for the former system. It is true we have our architectural colleges, but they only carry the student a short way along the road he has to go. In view of this, I venture to say that the head designers in the largest offices in Canada ten years from now will not be Canadian-trained men, and probably not Canadians, unless more action is taken in an educative line immediately after the war.

### DANGERS IN THE CONTROL OF BUILDING BY CORPORATIONS.

There is a very serious aspect to this question of the necessity of strong organisation to cope with the modern building conditions, and that is if architects do not organise to meet these conditions large building corporations, with every facility for extensive capitalisation, will. In considering what effect this would have upon design, it can easily be seen that the building corporation's interest being to sell an article at a profit, they are not going to obtain the best possible solution of the problem unless it is to their monetary advantage to do so, and it is only to their advantage to sell an article that in a general way meets the requirements of the purchasing public. Although I believe the understanding of the intelligent public is the mainspring of all great developments in art, this understanding is generally subconscious, and it is the artist's work to tap the spring and develop it. This means conscientious pioneer work, which would never be to the interest of a building corporation to undertake. Undoubtedly, then, if building gets into the hands of business corporations whose sole interest is profit, architectural design will not arrive at the development which it would if controlled by the architect whose object should be to lead the client to the best solution of the problem in hand, even if he knows his efforts may not be appreciated for several years to come. We have only to consider the increasing control of large building operations by corporations on this continent to realise that this is not an imaginary but a real danger to the existence of architecture as a great art. By maintaining the highest ideals and by educational facilities and a broad spirit of organised work, together we can maintain control of the situation and the spur of the danger, above mentioned, should accelerate the development of architectural design. We can hardly hope to realise to the full our present ideals for a decade or more, even if we rise to meet the conditions referred to above. The training of the senses for pure beauty in form, rhythm, and colour can only be accomplished by years of constant effort, backed by great enthusiasm, and this, in itself, needs to be sustained by the intelligent appreciation of the public whom we serve. To cultivate this appreciation of the public, which is the solid foundation of all art, and also to devise means whereby it will be satisfied within the bounds of Canada, seems to me our present-day duty, to which we should devote our energies.

Sapper J. H. Sagar, of the London Electrical Engineers, has been given a commission in the Road Construction Company, Royal Engineers. Before joining H.M. Forces in May, 1915, Second Lieutenant Sagar was first engineering assistant to the borough engineer and surveyor of Southwark.

A paper read before the Royal Architectural Institute of Canada.

### PROFESSIONAL AND TRADE SOCIETIES.

**ANCIENT SCOTTISH BRIDGES.**—Under the auspices of the Edinburgh Architectural Association, Mr. H. R. G. Inglis, F.S.A. (Scot.), delivered a lecture on "The Construction of the Ancient Bridges of Scotland" last Thursday night in the College of Art. Mr. Inglis stated, in regard to Scottish bridges, that in almost every case the building of a bridge had been carried out by the persevering zeal of some individual or community. In many instances, where a bridge was near a town, it was erected for the benefit of the inhabitants, and in the case of the one at Peebles the people themselves did the work. As to the oldest bridge in Scotland, those at Stirling, Perth, and Berwick seemed to have existed in very early times, though written history or chronicle did not go much earlier than the thirteenth century. The account of how Wallace cut the bridge at Stirling in 1296 clearly referred to a wooden structure; the note of the destruction of Perth Bridge by a flood in 1210 gave no clue as to whether it was of wood or stone; while the account of the fall of Berwick Bridge in 1199 seemed to point to its being of wood.

**GLASGOW'S ARCHITECTURAL CRAFTSMEN'S SOCIETY.**—Mr. Vernon Constable, A.R.I.B.A., gave a lecture on "Modern Paris Architecture," at a meeting of the Royal Technical College Architectural Craftsmen's Society, held in the College on the 7th inst. In dealing with four modern buildings in Paris—the Greater Palace of the Fine Arts, the Lesser Palace of the Fine Arts, the Galliera Museum, and the Chapel of Our Lady of Consolation—Mr. Constable showed numerous lantern views of each, and gave details of many features. The chapel, he said, was erected to commemorate the Charity Bazaar Fire, which occurred in 1897, and resulted in the loss of 130 lives. It was a fine example of the value of the study of sculpture to an architect.

**THE CROSS OF S. KENTIGERN AND THE GLASGOW LEGEND.**—At a meeting of the Scottish Ecclesiastical Society in Edinburgh last week, Mr. J. Jeffrey Waddell read a paper on "The Cross of S. Kentigern, Hamilton, and its Environment," illustrated by limelight views. The cross, the lecturer explained, was situated in the middle of a field in the low parks of the ducal estate near the Clyde. Adjoining it was a mound, the motte castle of King David I., and the site, the lecturer claimed, of the earlier castle of King Rederich, whose frail Queen was here rescued from her dilemma of the missing ring by S. Kentigern. Mr. Waddell gave it as his opinion that this cross had been erected either by S. Kentigern himself or by his immediate followers, to commemorate the conversion of this early community, and to mark the site of the Church which is known to have existed in this neighbourhood. The lecturer claimed that this cross probably stood before the west door of the early church, and cited numerous parallel examples. The ornament was described in detail. The eastern face illustrates the Creation and Fall, the western face the Redemption, while the ends of the cross are also elaborately carved. The lecturer pleaded strongly for the preservation of this stone, which at present stands neglected, and is not accessible to the public.

### TRADE NOTE.

Boyle's latest patent "Air-Pump" Ventilators, supplied by Messrs. Robert Boyle and Son, Ventilating Engineers, 64, Holborn Viaduct, London, have been employed at King Edward VII. Hospital, Windsor.

Cardinal Bourne has consecrated a memorial chapel built over the grave of Mr. Benson in the garden attached to the house at Hare Street, Buntingford (Herts.).

The question of the relation of municipal engineers and architects under the new Government housing proposals was raised at the last meeting of the Council of the Institution of Municipal and County Engineers, and it was resolved to communicate with Mr. H. H. Law, the chief engineering inspector to the Local Government Board, on the matter.

### Our Office Table.

Some new experiments on the corrosion of iron in ferro-concrete are described by W. A. Del Mar and D. C. Woolbury in the *Electrical World*, of November 10, 1917. They embedded iron rods in blocks of concrete, one or three rods in each block, and so connected the rods on a 120 volt circuit that some rods were anodes, and some cathodes, and some not joined up. The blocks were placed in pails filled with water from the mains. The anodes were afterwards found corroded; the other rods were almost intact. The resistance, i.e., the ratio volts, amperes increased during the current flow, diminished considerably when the current was broken, and rose again slowly on re-establishing the circuit. This fall of resistance the experimenters ascribe to electric osmosis, which they demonstrate in the following way: A V-tube was partly filled with iron rust and water was poured over the rust in the one limb; electrodes were inserted in the two limbs: a current of 0.05 amp, then moved 1 cb. cm. of water in four hours from the side, through 10 cm. of rust in a tube of 7 mm. internal diameter over to the other limb. By reversing the current, the water was afterwards sent back again into the first limb. This, remarks *Engineering*, is, of course, a well-known phenomenon, which the late Botho Scherwin utilised with success for dehydrating wet pulps and precipitates, and with less success for dehydrating peat. A rod of painted iron, Del Mar and Woolbury found, developed bubbles under the film of paint when cathode, but not when anode, in water, the water being forced through the paint. Hence the further corrosion is prevented, they conclude, by the making of rust which acts as a porous cell and becomes dry by enclosure, or can also be prevented by coating the iron rod with a paint which is an insulator. The paper mentions only a few experiments, all of which seem to have been made with currents of 120 volts.

The net profit of the first Garden City (Limited) for the year ended September amounted to £26,004, which, with the sum of £19,198 brought forward from the previous year, makes a balance of £25,202 to the credit of this account. Owing to the continuance of the war and the uncertainty of conditions thereafter, the directors cannot recommend the declaration of a dividend. The overdraft at the bank has been reduced by £7,312 during the year under review. Further reductions of borrowed capital have also been effected by redeeming debentures and loans. A year back the available sum, including £15,500 brought forward, was £19,220, and the full dividend of 5 per cent. was paid on the Preference shares. Last month the parochial electors resolved to support the application of the Parish Council for urban powers for Letchworth. The arrangements are being proceeded with for carrying this resolution into effect.

The Board of Agriculture for Scotland are proceeding with the development of the Farms of Borgia and Shimes placed at their disposal for ex-soldier settlements in Scotland by the Duke of Sutherland. The scheme includes works of road-making, water supplies, fencing, land reclamation and the erection of about forty houses and steadings. The work is in charge of Mr. W. G. Coles, F.S.I., the chief surveyor to the Board.

Some noteworthy information as to the cost of Washaw Dean Reservoirs, belonging to Halifax Corporation, were given at a Local Government inquiry at Halifax last week. The contract for the reservoirs, commenced in 1900, amounted to £172,000. On their completion, ten years ago, it was found that they were not water-tight, and the stopping of the leakage occupied eight years. The result of this extra work, with mine "extras" was that the cost of the reservoirs was increased to £376,000. Through this circumstance and the advanced interest now payable by the Corporation on loans, the waterworks undertaking, which formerly yielded a profit for the ratepayers, has become a considerable burden on the rates. To rectify matters the Town Council are seeking sanction to revise

the charges for water, and it was this proposal that was the subject of the Local Government inquiry.

The Building Trades Central Advisory Committee (Employers and Operatives), which advise and assist the Ministry of Labour on matters arising in the administration of the Employment Exchange affecting employers or workpeople as the case may be, in that industry, met at the Employment Department last Wednesday. At the Operatives' meeting Mr. R. Wilson, Operative Slaters, presided. The committee considered, among other subjects, the proposal that certain deductions should be made from claims of societies having arrangements under Section 106 of the National Insurance Act (Part 2), 1911, in cases where payments made by reason of a trade dispute had been included in the claim. They also received and considered a general statement as to the work of the Employment Department. At the Employers' meeting Mr. J. Storr, National Federation of Building Trade Employers, presided. The subjects discussed included proposals by the Department with regard to the co-ordination of recruiting for building trade labour by contractors and the suggestion that Employment Exchange officers should be instructed, when selecting applicants for vacancies, to give preference, other things being equal, to men who had been discharged from his Majesty's Forces through wounds or other disability. With regard to the latter question, the Committee agreed to recommend that instructions in that sense should be issued.

An Imperial War Exhibition will be held in January and February at Burlington House, by permission of the Council of the Royal Academy. The proceeds are to be given to the support of the Red Cross. At present arrangements are being made to have the exhibition open on January 7. The general committee includes Lord Burnham, chairman, Lord Rothemann, Lord Beaverbrook, Sir Arthur Stanley, Sir Charles Russell, Sir Robert A. Hudson, Sir Aston Webb, and others. The exhibition will be in three sections—official war photographs, war relics and specimens, and pictures. They will occupy about three-fourths of the space at Burlington House. A collection of camera records secured in the field has been lent by the Imperial War Museum, by the Canadian War Records, and by the High Commissioners for Australia and New Zealand. The field service relics and war specimens provided by the Imperial War Museum will include a number of naval items, the table on which Sir Douglas Haig planned the Battle of the Somme, guns of all kinds and sizes, British and German trench signs, and a number of large scale relief maps and other things. The Air Board is lending a number of exhibits to illustrate the work of the Air Services, and these will include a captured Fokker and a British triplane. The Royal Academy is making a small collection of pictures, which will occupy the west wall of the large gallery, and will contain portraits of British generals. The forefront will be given up to the big guns, and it is possible that it will also contain a tank home from the front for repairs.

In vote No. 15, submitted by the Building Acts Committee of the London County Council, there is a provision of £6,250 for expenditure in connection with dangerous structures, and of this amount £4,500 is in respect of district surveyors' fees and £1,450 in respect of hoarding and shoring. The amount actually expended and the expenditure incurred to the present time in respect of hoarding and shoring amount to about £2,438, and it is estimated that the expenditure during the remainder of the year on the basis of the orders issued during the similar period last year will amount to £700, making a total of £3,138 or £1,688, say £1,700, in excess of the provision in the estimates. The £700 is based upon normal contingencies, and is exclusive of any expenditure which may be necessary in connection with air raids during the remainder of the year. The increase in the expenditure is due to the cost of the work done by the Council's contractors in connection with air raids, and the increase since the estimates were pre-

pared of approximately 60 per cent. in the cost of timber. It is anticipated that there will be a saving of approximately £1,000 on the amount, £4,500, provided for fees to district surveyors, and the Finance Committee have agreed, under standing order No. 232, of this saving being applied to meet excess expenditure for hoarding and shoring, thus leaving £700 to be met by a supplemental vote. It is recommended: "That the supplemental estimate (No. 15a) of expenditure on maintenance account of £700, submitted by the Finance Committee in respect of hoarding and shoring works in connection with dangerous structures, be approved as an estimate of costs, debt, or liability under section 80 (3) of the Local Government Act, 1933." The Finance Committee, having considered in its financial bearings the above-mentioned estimate, submit the same as chargeable to maintenance account.

Mr. William Boardley writes, in the course of a letter, from 41, John Dalton Street, Manchester, to the *Manchester Guardian*: "It is remarkable that from an over-supply in 1909 we should now find ourselves so very short of houses. This misfortune came about owing to the experience of those who had provided 95 per cent. of the working-class houses not being utilised. It would be very regrettable if, through immaturely considered municipal action, further new legislation were also to fail in its object, and thus intensify the present shortage. If the corporation built cottages and let them at 6s. per week when commercially they ought to be let at 9s.—and it has been suggested that this should be done and charged on the rates—then those who have provided houses in the past will be forced out of the business, and the corporation will be faced with the problem of wholly continuing an enterprise which is financially bad and which cannot continue. Further than this, the long-suffering middle working class will be compelled to pay increased rates and taxes to enable the corporation to give a particular section of the community 9s. for 6s. No objection could be raised to the corporation acquiring land with a view to selling it to builders who would build according to the improved conditions required under the Town-Planning Act or on certain special conditions; neither could objection be taken to the corporation building with the private builder by under-renting their houses. It would, however, be unfair to those who have spent their lives in providing houses if they are to have no opportunity of resuming their businesses. During the war no class has suffered more than the house builder. The law has held him in absolute bondage, and there are several well-known builders in Manchester who have had to abandon their partly developed building schemes of small houses and obtain a livelihood as artisans in engineering and other trades. They are men over military age, and it will be unjust if they are denied through having to contribute to the giving to persons possibly better off than themselves 9s. for 6s."

A general discussion on "The Setting of Cements and Plasters" will be held on Monday, January 14, 1918, at 5.30-7.0 and 8.30-10.30, in the rooms of the Royal Society of Arts. The following papers will be read:—Dr. C. H. Desch (Glasgow), "The Mechanism of the Setting Process in Plaster and Cement"; Professor H. le Chatelier, "Crystallinity of Colloids in the Theory of Cements"; Mr. A. A. Klein (Worcester, U.S.A.), "The Constitution and Hydration of Portland Cement"; Mr. George A. Rankin (Craighton, U.S.A.), "The Setting and Hardening of Portland Cement"; Mr. Hartman Blount, "The Setting of Cement in Relation to Engineering Structures"; Mr. John Rhoads, "Note on the Colloidal Theory of Setting"; Mr. E. H. Lewis and Monsieur E. Deny, "The Effect of the Addition of suitable Slag on the Setting Properties of Portland Cement"; Mr. W. J. Dublin, "A Great and Modern Mortar."

The Dudley Town Council Estates and Cemetery Committee has been asked to prepare a scheme for new public baths.

## OGILVIE & CO.

Telephone DALSTON 1568.

Many years connected with the late firm of W. H. LASCELLES & CO., of Burnhill Row.

Mildmay Avenue, ISLINGTON, N.  
EXPERTS in HIGH-CLASS JOINERY.  
ALTERATIONS & DECORATIONS. ESTIMATES FREE.

FOR

**Olivers' Seasoned**

**Hardwoods,**

APPLY TO—

WM. OLIVER & SONS, Ltd.,  
120, Burnhill Row, London, E.C.

### TENDERS.

\* Correspondents would in all cases oblige by giving the addresses of the parties tendering—any rate, of the accepted tender: it adds to the value of the information.

**HELENS.**—For providing heating installations at the Granby Schools, for the town council:— £ 416 0 0  
G. Andrews (accepted).

**LAMBETH.**—For rebuilding boiler furnaces at Lambeth generating station, for the Stepney Borough Council:—  
H. Windsor and Co. (accepted). £ 98 0 0

**LONDON.**—For stripping and washing rooms after cases of infectious diseases, for the Camberwell Borough Council:—  
W. F. Mortimore, ss. bid, per room for stripping and 4s. for washing (accepted).

**MADING.**—For scavenging work, for the Malling Rural District Council, accepted tenders:—  
Thompson, for Shodland, £150; Spink, for West Malling, £150; and Norris, for Woodhull, £209.

**SARUM.**—For alterations to hot-water apparatus at King Edward VII. Hospital, for the corporation:—  
Brightside Foundry and Engineering Co. and T. Roper and Sons, builders' work, £300 (accepted).

**TAVENRY.**—For overhauling the well at the workhouse, for the guardians of Taverney Union:—  
Weeks and Son (accepted). £ 116 15 0

**WINDSOR.**—For erecting a wall, etc., at the council's yard at Clewer, for the Windsor Rural District Council:—  
W. Green, Clewer, near Windsor £60 0 0 (Accepted).

**WELVERTON (DEVON).**—For the construction of a reservoir and pipeline on the Beckham Estate, Clifton, South Devon. C. M. Ford, Tavistock, engineer.—  
M. Bridgman, Paignton (accepted) £67 7 11

## TO ARMS!

COUNTY OF LONDON VOLUNTEER ENGINEERS (FIELD COMPANIES).

Headquarters, Bolder Street, Oxford Street, W.1.  
ORDERS FOR THE WEEK BY LIEUT. COLONEL C. B. CLAY, V.D., COMMANDING OFFICER FOR THE WEEK.—Second Lieutenant E. A. Ullmann.

**CHRISTMAS HOLIDAYS.**—Headquarters and the Range will be closed from the 24th to the 26th, both inclusive.

**SATURDAY, DECEMBER 29.**—Commandants' Parade at Headquarters 2.45 p.m. for Route March and Drill. Uniform to be worn. A, B, and C men are reminded that one route march per month is compulsory.

By Order,

A. MACLEOD YEARSLY, Capt. and Adjutant.  
December 29, 1917.

With great regret we announce the death of Mr. Ambrose Willis—killed in action in Palestine. For some years Mr. Willis was the publisher and manager of *The Tablet*; but when the war came he felt it his duty to volunteer for the front, and went. As a lieutenant in the London Irish Regiment he was sent to the Holy Land, and was killed on December 8. A firm of caterers is understood to have backed the firm offer to the Ecclesiastical Commissioners of £250,000 for the St. Peter's Church gardens site, Liverpool. The Rector of Liverpool has interviewed the Commissioners in the hope of reserving a small section of the land for a chapel, and a comprehensive scheme may permit not only the erection of such a building, but also a great street improvement.

The death has occurred of the Rev. E. S. Dewick, an authority on botanical and ecclesiastical subjects. He took a keen interest in natural science, particularly botany and geology, and became a Fellow of the Geological Society. Mr. Dewick was among the promoters of St. Paul's Ecclesiastical Society, which was started in 1879 to fill the gap left by the late Ecclesiastical Society, formerly the Cambridge Canon Society.

## LIST OF TENDERS OPEN.

### COMPETITIONS.

**Jan. 31.**—Designs are invited for four specified classes of cottages suitable for the industrial classes. A competition, under the charge of the Royal Institute of British Architects and allied societies, will be held in each of the six areas mentioned below. Premiums of £100 and £50 for the best designs of each of three types, and £50 and £30 for the fourth, will be awarded in each competition. Designs must be submitted in accordance with the conditions in the programme January 13. Copies of the conditions may be obtained from the following:—Home Counties Area: The Secretary, Royal Institute of British Architects, 9, Conduit Street, London, W.1.; Northern Area: Mr. H. L. Hicks, hon. sec., Northern Architectural Society, 6, Higham Place, Newcastle-on-Tyne; Manchester and Liverpool Area: Mr. Isaac Taylor, hon. sec., Manchester Society of Architects, Mansfield Chambers, 17, St. Ann's Square, Manchester; Midland Area: Mr. A. Hale, hon. sec., Birmingham Architectural Association, 15, Bennett's Hill, Birmingham; South Wales Area: Mr. C. H. Kempthorne, hon. sec., South Wales Institute of Architects, Albert Chambers, High Street, Cardiff; Southern Area: Mr. A. J. Egan, hon. sec., Devon and Exeter Architectural Society, 5, Bedford Circus, Exeter.

### BUILDINGS.

**Dec. 24.**—Construction of reinforced concrete foundations at Capperdown sub-station, East Camperdown Street, Dundee.—For the Corporation.—Specification, form of contract, and general conditions of contract from H. Richardson, M.I.E.E., General Manager and Engineer, Electricity Department, Dundee. Tenders with H. Blyth Martin, Town Clerk, City Chambers, Dundee.

### ENGINEERING.

**March 30.**—The Acting British Consul at Santiago reports that he has issued a call for tenders for the improvement of the port of Antofagasta (Chile). By the terms of this decree the amount to be expended on this work does not exceed £1,700,000. Tenders may be obtained from the Port Commission Offices in Santiago, and copies are expected to be received shortly at the offices of the Chilean Legation in London, 29, Grosvenor Street, W.1. Tenders will be received up to 3 p.m. on March 30 by the Minister of Finance, Santiago.

### FURNITURE.

**Dec. 21—Jan. 2.**—The Commissioners of H.M. Works invites tenders (from manufacturers only) for supply of (1) 200 ward tables, (2) card boxes and desk racks.—Secretary, H.M. Office of Works, Storey's Gate, London, S.W.1.

### ROADS AND STREETS.

**Dec. 22.**—Supply of broken granite, etc., for macadam, and hauling.—For the Midhurst Rural District Council.—A. G. Gibbs, Surveyor, Council Offices, Midhurst.

**Dec. 27.**—Supply of tar, highway materials, best glazed stoneware socketed pipes and best Portland cement for year ending March 31, 1919.—For the Bexley Urban District Council.—T. G. Baynes, Clerk, Council Offices, Bexleyheath.

The Lutterkenne Urban District Council has achieved notoriety by raising the price of the municipal gas from 8s. 4d. to 9s. per 1,000 cubic feet, the "dearest gas in the world," as a member commented.

Second-Lieutenant George Claypham, R.F.C., eldest son of Mr. Fred Claypham, builder and contractor, Oswestry Ferry, is reported killed in action on December 4. He had gone to France the previous Saturday.

Mr. H. L. G. Pilkington, of the Y.M.C.A., will read the next paper to the Surveyors' Institution on January 14, 1918, entitled "The Employment of Discharged Soldiers in and by the Surveyors' Profession."

Congressman Lamm, Mayor of Schenectady, New York, has announced that his city has inaugurated a movement to rebuild Halifax. Schenectady will present Halifax, as a Christmas present, with a fund sufficient to rebuild one of the homes destroyed, and the plan is to have the United American cities each to rebuild and refurbish one home and restore it to the former owners.

At the first ordinary general meeting (season 1917-1918) of the London Society, which will be held on Thursday, December 20, 1917, at 4 p.m., in the Hall of the Royal Society of Arts, 13, John Street, Adelphi, W.C.2, Mr. John Slater, F.R.I.B.A., will give a lecture, illustrated by lantern-slides, on "Old Marylebone," dealing with the Old Manors of Domesday Book, the Ty-bourne, Tyburn Tree, the churches, the park and playing grounds, Rural Marylebone in the 18th century, amusements, notable inhabitants, etc., to be followed by discussion and votes of thanks.



# THE BUILDING NEWS AND ENGINEERING JOURNAL.

Edinburgh House,

## CONTENTS.

Strand, W.C.2.

Currente Calamo .. .. .	499
Shelter against Air Raids .. .. .	501
English Church Woodwork, A.D. 1250—1550 ..	501
Reinforced Gypsum .. .. .	502
Correspondence .. .. .	502
Our Illustrations .. .. .	502
Obituary .. .. .	502
The Deteriorating Action of Salt and Brine on ..	515
Reinforced Concrete .. .. .	516
Bricks of Cement, Clay, and Shale Burned ..	516
Under New Process .. .. .	516
Competitions .. .. .	516
Professional and Trade Societies .. .. .	516
Tenders .. .. .	517

List of Tenders Open .. .. .	517
Building Intelligence .. .. .	518
Legal Intelligence .. .. .	518
Our Office Table .. .. .	518
Trade Notes .. .. .	518
Chips .. .. .	518
Latest Prices .. .. .	VIII.

### OUR ILLUSTRATIONS.

"English Church Woodwork, A.D. 1250—1550." Roof loft, two views and detail of coving to screen. Chinnamo, Radnor; screen, Moberley, Cheshire, dated 1207; font cover base, the Coronation of the Virgin, Newcastle Cathedral of St. Nicholas;

Angels, Western type, St. Decuman's, Somerset, and East Anglian type, from Upwell, Norfolk. From "A Study of Craftsmanship during the Medieval Period," by Messrs. F. E. Howard and F. H. Crossley, published by Messrs. B. T. Batford, Limited.  
New High School for Girls, St. Martin's-in-the-Fields, Trafalgar Square, to be built at Tube mezzanine level. Mr. H. Carter, Regd. F.R.I.B.A., Architect.  
New House near Harrogate, Yorks. View and plan. Mr. Ernest W. Marshall, F.R.I.B.A., Architect.

## Currente Calamo.

Many of us will have read with delight a trenchant and timely letter in the current issue of the Journal of the R.I.B.A., by Mr. H. B. Cresswell, F.R.I.B.A., in which he asks, in view of the coming control of housing and educational schemes by the Government and local authorities, what action the Council of the R.I.B.A. is likely to take to secure that, under these circumstances, the degradation of architecture by official callousness and municipal ignorance and jobbery, will not become like a drab garment shrouding our best hopes, and establishing popular standards of unformed taste which a hundred years of resolutions of general meetings will hardly lift away. None worth mention, we fear, if, as Mr. Cresswell points out, we examine the records of the treatment the Council has in the past meted out to the carefully drawn reports and balanced recommendations of certain sub-committees, to understand what the policy of the Council has effectively been. The special problem, of course, is to secure that architectural work, undertaken by the Government or municipalities, shall be done by qualified architects. Our only hope, as Mr. Cresswell says, is prompt and general action:—

A trenchant petition, signed by members of council of architectural societies throughout the country, would command attention if only by sheer bulk, and would continue to be a stalking horse for continued sniping thereafter, and good reason for the first of our presidents who is a woman to chain herself to the railings in Whitehall. It is useless to approach provincial authorities. Without any disparagement of individuals, it may be fairly said that jobbery is not merely a habit, but a religion, on district councils and kindred bodies. All members certainly have not this devotional fervour, but the work of such councils is coloured by those members who have. These councils have, however, an unending respect for the Local Government Board. Like a dog who knows where the whip is kept, they are unconformably aware of the surcharge as of a device the mechanism of which they imperfectly understand. The ordinary district councillor has this respect for the Local Government Board's expressions of opinion, for he can be convinced either by an act of physical assault or by touches at the focus point of his sentiments and seat of reflectiveness, which is his pocket; and this last is where the Local Government Board catches him.

We should like to see that "trenchant petition" reinforced at the start by the signatures of all architects, who might easily be approached by the various

societies in their different districts, and pledged to action in every possible way. Now, undoubtedly, is the time to move, and we trust that many who do not ordinarily see the Journal of the R.I.B.A. will make a point of doing so, and will study Mr. Cresswell's letter carefully.

The *American Architect* echoes a conclusion forced upon it by the editor of the *Bulletin* of the Illinois Society of Architects that "architects are shuckers," and fail to keep themselves *en courant* with the literature of their own profession, or any movement tending to better conditions:—

The physician or surgeon keeps himself posted on every report of some new remedy, some new treatment, or some approved method of operating. The well-trained lawyer carefully files away, when once read, the digest of cases, the records of decision, the making of precedent. If professional men are to succeed they must do these things, as other successful men are always doing. It may be urged, and, in a sense, it may be true, that the proceedings of architects' meetings do not have the same educational value as those of medical men and lawyers. These meetings are what they are made. If architects will omit the non-essentials, the purely esthetic and academic, or, at least, discuss them in smaller proportion and substitute the more basic, the truly fundamental things that relate to practice, they would have less cause to regard with indifference the things they read in architectural journals and bulletins. And the man who stays away and speaks of "hot air" has a good opportunity to assert himself in a valuable way and lend some weight, if he can, as to the topics that may be discussed if he will attend these meetings.

"What is the reason?" asks the *Bulletin* editor. "Is it caused by improper education? Is it the artistic temperament? Or is it the fact that many architects are simply damn fools?" Hardly, we think. We have seldom failed to elicit interest this side, outside all societies and their literature and meetings, in regard to really vital matters; but we are hardly surprised, when, especially in times like these, architects are invited to discuss amorphous politics, that they leave it to the talkers.

At the Bangor County Court, on the 10th inst., a somewhat Gilbertian situation evolved in connection with a case in which Sir Henry Lewis and the Rev. Thomas Prichard, trustees under the will of the late Mr. Thomas Roberts, sued the Mayor, aldermen, and burgesses of the City of Bangor for £19 7s. damages, alleged

to have been caused to plaintiff's property by the irruption into his cellars of sewage from the defendants' sewers. The facts briefly were that in January of the present year Bron Eryri, a house in the occupation of Mr. W. H. Worrall, became flooded in its cellars by the irruption of water from, as alleged, the defendants' defective sewer, which caused material damage to the reversion and tended to render the house uninhabitable. It seems that Mr. Worrall, the tenant, was also sanitary inspector for the defendants, the Bangor Corporation. The tenant at once entered into correspondence with his son-in-law, the landlord's agent, with a view to getting something done to abate the nuisance, and later the agent corresponded with Mr. Gill, the borough surveyor, on the matter, having come to the conclusion that the flooding was caused by the overflow from the defendants' defective sewer. After, as was alleged, fruitless efforts to get the surveyor to attend to the matter, the agent got the necessary work, to clear the cellar and to prevent a recurrence of the nuisance therein, done by a contractor, at a cost of £19 7s., and that sum they claimed. Mr. W. H. Worrall said that he wrote the letters to Mr. Llew D. Jones (the estate agent) on the question in his capacity as sanitary inspector. The landlords went to the expense incurred not to oblige him as tenant, but on his requisition as sanitary inspector. The nuisance lasted six or seven weeks. He was now quite satisfied that the whole of the water in his cellar came from the main sewer. Cross-examined, he asserted that he had authority to order the abatement of a nuisance of this sort, even if it cost £100, without consulting the borough surveyor or the Sanitary Committee. For the defence, Mr. Graham said the plaintiff had proved no injury to the reversion, but only a casual trespass on his land by sewage water—a casual, unforeseen occurrence which, for all they knew, might never occur again. He argued that the Corporation of Bangor could not be held responsible for the construction of mains taken over by them in 1883 from the previous local board. Mr. Gill the borough surveyor, said it was a private drain that was choked, and that was why he did nothing in the matter as far as that drain was concerned in the year 1915. His Honour, after quoting a letter of Mr.

Worrall's with reference to the matter, dated February 3, said he could not see, in face of that letter, how it could be said that Mr. Worrall was writing as borough sanitary inspector. There were authorities to prove that, where an authority took over sewers from its predecessors, who had constructed the sewers according to the then known rules of science, the new owners were not liable, because they had not taken up the whole of that sewer and reconstructed it in accordance with modern ideas. Taking all things into con-

tainance. Louis N. Audet and Rene Charbonneau sued the Montreal Apartment Co., Limited, for \$5,000, this sum being due in payment, on a basis of 2½ per cent., of the cost of construction of a \$200,000 building, the plans of which had been prepared by the plaintiffs under the company defendant's instructions. It had been intended to erect the building at the corner of St. Matthew and Dorchester Streets, but the proposal was not carried out, and when the architects made a claim for the regular fees the defendants pleaded

claimed, namely, \$5,000, and the costs of the action.

We regret to announce that, on the instructions of the Board of Trade, the Paper Commission will reduce the licences for the importation of paper-making materials and of printing and writing paper in the year beginning March 1 next to two-thirds of the tonnage imported in the year ending February 28, 1918. We are also told by our papermakers that it is very possible a further reduction of

BOMBPROOF SHELTER.

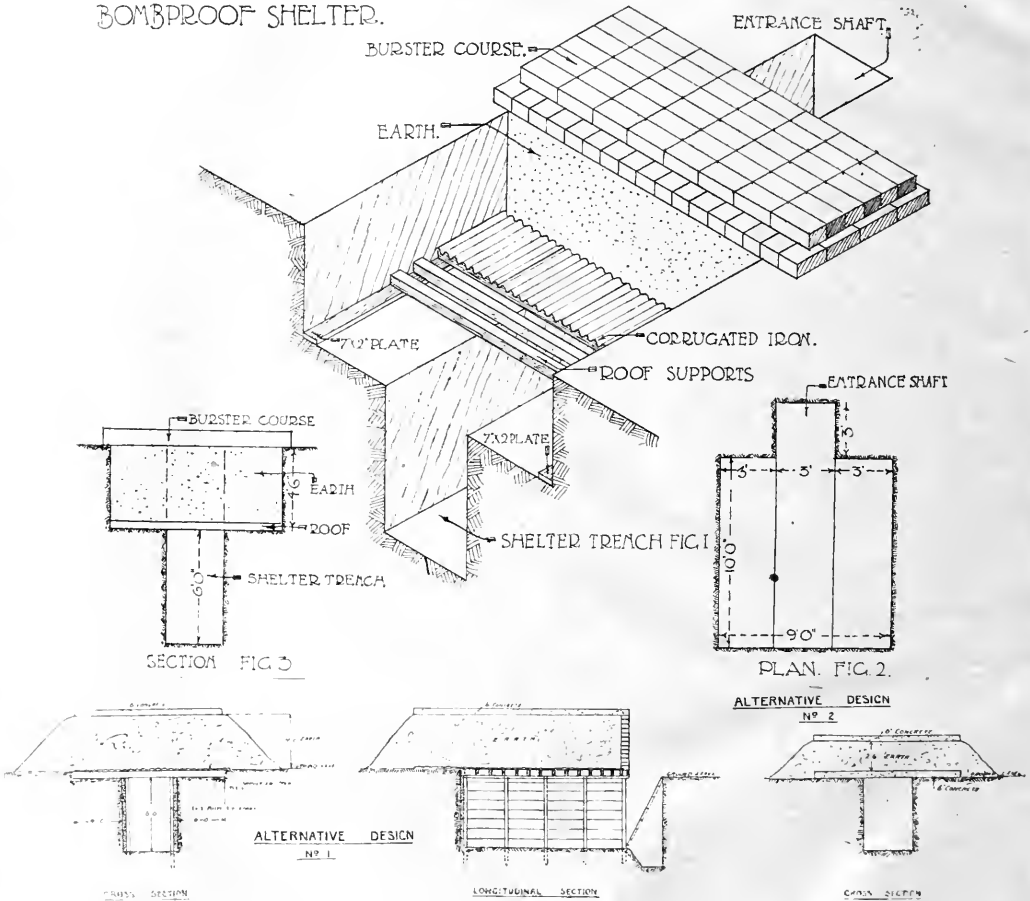

SHELTER AGAINST AIR RAIDS. (See page 501.)

sideration, he certainly could not say the defendants were guilty of negligence, having regard to the fact that the day after the matter was brought to their notice their men were at work, and that the obstruction was entirely removed twelve days later. He gave judgment for the defendants, with costs, on all points raised.

The rights of architects to payment according to scale recognised by the profession in the province of Quebec were upheld in the Superior Court in a judgment recently rendered by Mr. Justice Lafon-

tainie. Louis N. Audet and Rene Charbonneau sued the Montreal Apartment Co., Limited, for \$5,000, this sum being due in payment, on a basis of 2½ per cent., of the cost of construction of a \$200,000 building, the plans of which had been prepared by the plaintiffs under the company defendant's instructions. It had been intended to erect the building at the corner of St. Matthew and Dorchester Streets, but the proposal was not carried out, and when the architects made a claim for the regular fees the defendants pleaded

imports will soon after follow. This addition to our present difficulties is most embarrassing. At the moment it is impossible to say how we can meet the situation, except that we shall have to limit production to the utmost. We therefore beg all readers to place their subscriptions, whether with their newsgents or direct with us, at once, as otherwise they will in all probability fail to get the paper. We have also to ask advertisers to note that our space available is very limited, and that early application is necessary, especially as regards renewal orders customary with many about this time of the year.

## SHELTER AGAINST AIR RAIDS.

Hun airmen are still raiding London and other districts of Great Britain, and it is a matter of wonder that so few residents of the raided districts have attempted to provide themselves with some sort of improvised protection.

These drawings represent a simple type of shelter trench, which can readily and inexpensively be provided by the householder in his own back garden. The trench shown would give crowded protection for about a dozen people, but there is no reason why a longer trench could not be built. The labour attached to its construction, together with the small incidental expenses, could be borne between four or more neighbours and having a common shelter. There is nothing difficult in its construction, and no expert assistance of any kind is required.

Study the drawings carefully, and adhere faithfully to the following instructions. The excavation should be carried out in three operations.

Excavation No. 1.—Dig a hole ten feet long, nine feet wide, and four feet six inches deep.

Excavation No. 2.—In the exact centre of the width of the bottom of the above excavation dig another trench the full length of the previous excavation, viz., ten feet, three feet wide and six feet deep. The bottom of this last trench will thus be ten feet six inches below ground level, and will have earth terraces, steps, or shelves on either side. (See Fig. 1.)

Excavation No. 3.—At one end, outside of, but central with the width of the first excavation and in alignment with the second, dig an entrance shaft three feet by three feet by ten feet six inches deep.

Your excavation work is now complete, and the next operation is to roof in the trench. Lay two 7-in. by 2-in. wood plates the whole length of the No. 1 excavation and 9 ft. apart overall. From plate to plate and at one-foot centres lay your roof supports the whole length of the trench. These supports will be, of course, 9 ft. long and not less than 7 ins. deep and 5 ins. thick, or timbers of equivalent strength. Miscellaneous sizes can be used, but let the selection err on the side of strength. Six-inch round spars placed touching may be used. Spike all timbers to the plates.

Cover in the whole area of the excavation No. 1 and on top of the roof supports with either corrugated iron (the best) or rough boarding, and one layer of sandbags filled with earth.

Now fill excavation No. 1 to ground level with earth previously excavated. Between excavation No. 1 and excavation No. 3 it will be necessary to vertically board up the entrance shaft end of excavation No. 1 to prevent the earth filling or choking up the entrance shaft.

The next operation is the provision of, over the whole of the now level site, a "Bursting Course." This is most important. You must provide a hard top to cause an immediate burst of the bomb. The force of the latter is consequently largely expended before any penetration of the roof of the shelter takes place. This "Bursting Course" may be one of the following:—A 6-in. layer of cement concrete (much the best); two courses of bricks, setts, or paving stones; or two courses of sandbags filled with broken brick or stone.

The next requisite is a short improvised step ladder, about 11 ft. long, made by nailing a few battens across two pieces of 3-in. by 2-in. This ladder should be placed

ready in the entrance shaft. Lastly, a thick slab of paving stone or a sheet of 3-in. sheet iron should be handy as a cover for the entrance shaft. (Note.—With the average London soil the clay sides of the shelter trench will be stiff enough to stand without support.) In other and looser soils the sides must be supported by rectangular cross frames made out of 4-in by 2-in. timber and placed 2 ft. apart. Between these frames and the trench sides place vertical boarding.

ENGLISH CHURCH WOODWORK,  
A.D. 1250—1550.\*

(With Illustrations.)

After the almost universal use of timber for primitive buildings had given place to stone construction, and up to the end of the thirteenth century, the majority of artificers were constantly employed on masonry. The smith had acquired in this country, as elsewhere, an assured position, but the carpenter was relegated to a comparatively unimportant place during a considerable period. Naturally, he failed to grasp the possibilities of timber as a medium of expression. For example, the chest of that date is, with infinite labour, hollowed out of a bank of oak into the form of a stone coffin. In the early thirteenth century altar tombs of wood were doweled in solid slabs after the manner of masonry, the sides being elaborated with stone-shaped arcades. As late as 1280 an example of this can be seen at Pitchford, in Shropshire, in the monument with a recumbent effigy to Sir John Pitchford, though its proportions to some extent are due to the material employed. No doubt the craftsman, by colouring, thought to pass off the work as stone. At Salisbury there is another similar monument handled in the same incongruous manner. Other specimens show a more appropriate employment of wood, but these are more recent in date, some being covered with beautiful iron scrolls. Among the earliest screens prominently ranks the Oxford one at Stanton Harcourt, exhibiting distinct masonic forms. The desks at Rochester, and the altar-piece at Adisham, Kent, are based on like ideas. Also at Thurcaston, Leicester, and Gilston, Herts. are screens with stone motives in arcades. The misericords among the stalls at Exeter, at Hemingborough Church in Yorkshire, at Christchurch, Hants, and even in Henry VII. Chapel at Westminster, suggest that the carving was done by masons who scarcely appreciated the fibrous nature of wood, as they deeply undercut the foliations and forms to an extent impossible in stone, with the result that the worker vigorously cut away too freely. In the history of this subject the prime example of real importance at the threshold of its study is the choir woodwork at Winchester, because these most beautiful thirteenth century stalls, with their splendid detail, furnish the best and earliest employment of wood traceries used in conjunction with stiff stalked foliage so eminently typical of stone. From the methods thus in vogue at this era developments ensued such as appear in the screens of the chapel of the Clchester Almshouses, at St. Margaret's, King's Lynn, and at Lavenham, in Suffolk. These display a compromise between the former notions, and also differ from the rabid formation of earlier examples. Framed heads and bress-summer beams were thus incorporated, and framing on joinery lines followed, producing works on artistic development, which gradually revolutionised the construction of timber work. This movement became evident soon after the year 1400.

The finest fourteenth century woodwork is to be found in the North of England, such as the parolose screens at Beverley Minster. During this period the screens at Halberton, Devon, Leighton Buzzard, Beds., and Edlesborough, Bucks, are typical of the more ordinary local work which is marked by simplicity

of line. The most splendid instances of fourteenth century woodwork left standing can be counted on the fingers; but a wealth of craftsmanship still remains in spite of the wanton destruction of so much more of the highest quality. In studying our old English joinery, some leading characteristics are to be noted. Posts and beams, rails and panels did not pretend to be other than what they are, while their ornamentation aims at emphasising the construction employed without trickery or sham. In the more ornate examples supplementary enrichments were attached to the framings with delightful freedom, producing choice results, as in tabernacle work to stalls, canopies to fonts and altars or roof lift fronts. During the following hundred years, the adroit use of wall posts for the reduction of thrust, the introduction of trusses, arched braces, filled with delicate traceries in the spandril, and the development of hammer-stems marked further progress. Badingham, in Suffolk, has a nave roof accounted one of the most superb of its class. Flamborough, Yorks, possesses a splendid late fifteenth century roof, and Framlingham, Suffolk, is remarkable for a fine hammer-beam roof with a wood-vaulted cove cornice showing a perfectly legitimate use of material. Up to this date foreign influence in English woodwork was unknown. Flanders chests, like that at Wath, Yorks, imported during the fourteenth century, caused little diversion from the native style. In the southern districts, however, Continental carpentry began to make itself felt, as may be observed at Colebrook, Coleridge, and Brushford, in Devon, where a sort of flamboyant handling of tracery appeared for the first time with quaint carved shafts and linen fold panels, after the manner met with in Brittany. In the early sixteenth century much versatility of conception prevailed, and this influence, when once accepted, was seldom discarded. It was the golden age of English woodwork, and the dated screens of Englishham (1493), Wensley, Moberley (1500), Trunch (1502), Aylsham (1507), are incomparably finer than any of earlier periods. The Early Renaissance wrought further changes, with its remarkably effective combinations of classical Arcadian intermingled with arabesques and scroll work, such as can be seen at Plymtree, in Devon.

The three main schools in woodwork existing throughout the rise and development of English woodwork depended on the influence of race and historic changes. These may be described as the Midland school, the West Country, leavened by the Celts, and the Eastern school, influenced by the Danes. In this brief epitome we have brought into view some of the main points which give so much value to the able treatise which Messrs. F. E. Howard and F. H. Crossley have just published, under the title of "English Church Woodwork, A.D. 1250—1550." This copiously illustrated book is dedicated to the memory of Herbert Batsford, and as he was personally concerned in the inception of the work, its authors have appropriately associated his name with it. The volume is the result of twenty years' systematic accumulation of specially taken photographs and sketch-book studies. Very many of the numerous examples have not been illustrated before. A section is devoted to porches as well as doors, which make so great a feature. The book also includes a thoroughly comprehensive essay on roof construction, elucidated by a practical series of capital sectional drawings and diagrams set out in an eminently suggestive form. Forty pictorial views supplement these details, showing typical roofs of all dimensions in wood, including aisle coverings not often delineated. Every kind of church woodwork and fitting is shown, described, and compared from a personal acquaintance. The best idea of the attractiveness of this volume will be obtained from the seven illustrations which are arranged on one of our double page sheets to-day. The Llananno roof loft from Radnor, in Wales, is a unique example about that district, and there is no richer screen in the Principality. The famous one at Llarwst, Denbigh, is rather different, though equally beautiful. The Moberley screen, already mentioned, is dated 1500 A.D. This Cheshire variety is freely developed as to obscure the

\* "English Church Woodwork: A Study in Craftsmanship during the Medieval Period, A.D. 1250—1550," by F. E. Howard and F. H. Crossley. (London, 1917; B. T. Batsford, Ltd., 93, High Holborn, W.C. Cloth gilt.)

arched framing of the screen itself. This diversion from the orthodox mode happens also at Mawgan, Cornwall, which likewise resembles in some particulars the screens at Campsall and Hatfield, in Yorkshire. Those at Ateborough, Norfolk, and Montgomery, in Wales, are singular, inasmuch as they conceal the brasses. Angels were freely introduced for decorative features in the enrichment of churches, and the woodworker in particular elaborated his angle forms, which differ according to different localities. Types have been classified, and of these we give an East Anglian specimen from Upwell, in Norfolk, and a West Country angel from St. Decuman's, Somerset. Eveline Church, near Woodstock, Oxon, possesses a very rich ceiling over the south chapel, interspersed with angels distinguished by wide outstretched pinions. Others to a massive scale emphasise the framed principals of the nave roof at Blythburgh, near Southwold, Suffolk. Our seventh illustration represents an exquisite boss depicting the Coronation of Our Lady, surrounded by an aureole of rays, with a border of the usual mediaeval cloud ornament. It belongs to the font cover of St. Nicholas' Cathedral, at Newcastle-on-Tyne.

#### REINFORCED GYPSUM ROOFS.

A roof slab of reinforced gypsum cast in place has just been completed on a new beater-house of the Scott Paper Company at Chester, Pa. This roof, in connection with which new methods were developed for handling and mixing the material, is described in the *Engineering News-Record*. It is the second of two such roofs that the company now has. The first was constructed last winter, in cold February weather, over a paper-machine house. This is a flat roof, 47 x 130 ft., sloping  $\frac{3}{4}$  in. per ft., while the beater-house roof, 35 x 157 ft., is a  $\frac{1}{4}$  pitch roof with monitor, sloping 6 in. per ft.

Both buildings have reinforced concrete frame, steel roof trusses, steel purlins spaced 6 to 6 $\frac{1}{2}$  ft., and were intended to be roofed with reinforced-concrete slabs across the purlins. But during erection the officials of the paper company began to fear trouble with condensation on the under surface of the roof slabs, and, in conjunction with the architect, they looked around for a roof material likely to be free from such objection. Gypsum was finally settled on as the most desirable. The contractor, the Cummings Structural Concrete Company, of Pittsburgh, agreed to undertake cast-in-place construction instead of laying pre-moulded gypsum blocks.

#### NEW METHODS HAD TO BE WORKED OUT.

New methods had to be worked out for handling and mixing the material, for form construction, and for order of procedure. Experience elsewhere in casting gypsum blocks was drawn upon, and early trouble with forms sticking and having to be chopped out—because of using rough lumber and giving the vertical surfaces of the T-beams no draft—soon taught the need for special care.

The contract for the gypsum roof was taken at the price previously accepted for the reinforced-concrete roof. Whether or not the contractor lost money under this arrangement is not known. The design was made by ordinary reinforced-concrete beam formulas, but with lower compression—500 pounds per square inch, while the steel tension was held at 16,000 pounds per square inch. The T-beam stems are a trifle over 2 ins. wide, and are spaced 6 ins. centre to centre.

The gypsum was used neat—as a water paste without sand or stone. It was mixed to the consistency of a batter or thin paste.

#### SET IN 15 MINUTES.

The mixing equipment consisted of a metal tub and a stirrer or dasher. The tub was filled two-thirds full of water, a bag of gypsum was poured in, and the dasher was worked quickly to get a uniform paste. Then the mixture was poured into the form and the surface screeded off without delay, for within fifteen minutes the gypsum set so hard that forms could be stripped if desired and men could walk on the slab.

The forms consisted of a tight floor of matched boards, and lengths of dressed 2 x 4

stock nailed on flatwise, 6 in. on centres to core out the spaces between the T-beam stems. These cores were dressed to  $\frac{1}{2}$  in. draft on sides and ends. The form was shelled and sandpapered, like a foundry pattern, and before use was brushed with a clear oil (press oil), using a long-handled white-wash brush.

The roof was placed in strips 3 ft. wide running across the building, the same direction as the T-beams. The open side of the strip was closed off by a bulkhead plank, whose width was just the thickness of the slab, so that a screed moved along the bulkhead would true the gypsum to the proper surface. In each T-beam stem was laid a  $\frac{1}{2}$  in. rod, supported on little precast blocks of gypsum; these rods formed the sole reinforcement of the roof. Over the tops of the T-stems was laid a 3 ft. strip of wire mesh as bonding steel to restrain the expansion of the gypsum. The form was then ready for pouring.

#### REQUIRED QUICK WORK.

Pouring was done in one continuous operation for the 3 ft. strip clear across the building, about 50 ft. In smooth operation it took less than an hour to cast the strip, but during this time the first part of the strip had set hard before the last part was poured.

A sufficient number of bags of gypsum for one strip was brought up by hoist from the box car in which it was received on the job, and the bags were set up in a row along the edge of the strip about to be cast, standing on the strip finished last. They were then untied, making all ready for quick work. Mixing, pouring, and screeding proceeded in regular order until the strip was completed.

It was found necessary to use the gypsum fresh. If allowed to stand some weeks before use its setting power was reduced considerably.

#### STEEP PITCH INTRODUCES COMPLICATIONS.

Construction of the beater-house roof during the past month went on in the same way as just described, except for complications introduced by the steep pitch. Stepped platforms had to be set on the roof to give a working floor, and the soft gypsum paste had to be held from flowing down. For the latter purpose top forms were not successful; the thin paste came up like water through any crevice or hole. But by holding a bulkhead board on top of the screeded surface of the slab just poured, and pouring the paste from a pail against the face of this board, the gypsum was held, and could be spread out upward along the roof the moment it thickened enough to hold shape. Pouring a strip was begun at the gutter and proceeded up to the ridge, this being the same as was done in the case of the flat-pitch roof. Each of the two roofs required about ten days for the gypsum work. As already stated, forms could be taken down early, and only four sets—3 ft. strips—of form were provided.

## Correspondence.

### R.I.B.A. NATIONAL HOUSING COMPETITION.

To the Editor of THE BUILDING NEWS.

Sir,—The Council of the Society of Architects, having considered the conditions of this competition, are of the opinion that Clause 5 is wrong in principle, and that it contravenes Regulation D, which is one of the essential conditions of the competition regulations adopted by the society.

Having regard, however, to the supplementary statements issued by the Institute and to the exceptional circumstances, and on the understanding that it is not intended that these conditions, and particularly Clause 5 thereof, should form a precedent for future architectural competitions in normal times, the Council will not on this occasion object to any members of the Society taking part in the competition if they wish to do so.

C. McARTHUR BRITEN, Secretary.

28, Bedford Square, London, W.C.

December 18, 1917.

## Our Illustrations.

### "ENGLISH CHURCH WOODWORK A.D. 1250—1550."

For descriptions of the examples illustrated on the accompanying double-page plate see page 150 in our review of Messrs. F. E. Howard and P. H. Crossley's book, just published, under the above title.

### ST. MARTIN'S-IN-THE-FIELDS, TRAFALGAR SQUARE, HIGH SCHOOL FOR GIRLS, TULSE HILL.

The present school in Charing Cross Road was founded in May, 1699, by a few public-spirited parishioners, as a charity school for children of the poor. By process of evolution it has now become a Secondary School, recognised by the Board of Education, and financially assisted by the London County Council. Owing to the change in the character of the neighbourhood, it was felt that the centre of London had become unsuitable for a girls' school, and in 1914 a site of 4 $\frac{1}{2}$  acres at Tulse Hill was purchased by the Governors, and we understand the property had to be situated within the County of London, and so is within the parish of Lambeth. The site has a limited frontage to Tulse Hill, and presents an interesting problem in planning, as the fall of the ground is such that the level at the front becomes two stories above the ground at the back. The front block provides the ordinary classrooms, with steps and sloping way approaches at each end for the pupils' entrances. The back block contains the cooking and dining rooms, laboratories, etc., with communicating corridors on two floors, thus obviating the necessity of passing through the central hall. The building provides accommodation for 556 school places. Tenders were received in 1914 amounting to about £25,000, and it is intended to proceed with the building after the war. The architect is Mr. H. Carter Pegg, F.R.I.B.A., of Westminster and Croydon.

### NEW HOUSE NEAR HARROGATE, YORKS.

This drawing was shown at the Royal Academy this year. The intention for this house embodied the characteristics of a portion of the existing premises. Owing to present conditions, the work has not been put in hand. Mr. E. W. Marshall, F.R.I.B.A., of Oxford Street, W., is the architect. The plan in the corner of the picture shows the general lay-out, in which a large hall and big drawing room make conspicuous features. The last named is adjacent to an alcove with spacious arched windows, treated after the manner of a winter garden seen to the front of the perspective.

### OBITUARY.

We regret to record the death of W. Rupert Davison, of the 113th Company of the R.E., who was killed on the Cambrai front on November 20, at the age of twenty-six years. He had been successfully engaged in railway engineering in connection with the war, but was called back to help the 16th Middlesex (Public Schools Battalion), when he met with his death in the fight above mentioned. He was a pupil of Mr. Wallace Baldwin, of Lincoln's Inn Fields, and son of Mr. T. Raffles Davison, hon. associate R.I.B.A. His design was chosen in an open competition by Mr. Maurice B. Adams, as referee, for the Wakfield Public Library, in conjunction with Messrs. Alfred Cox and Trimmell, and this building has been erected. His model cottage, which formed the centre of the Ideal Homes competition at Olympia, attracted much attention, and his design for the "Daily Mail" cottage was awarded the third premium by Mr. E. L. Lutyens, A.R.A. Mr. Rupert Davison was employed on several similar undertakings, and his work always was distinguished by considerable ability and tasteful design.

It is stated by the general manager of the Midland Electric Traction Company that the power station which it is proposed to erect on the banks of the Severn at Stourport will be the largest of its kind in this country.



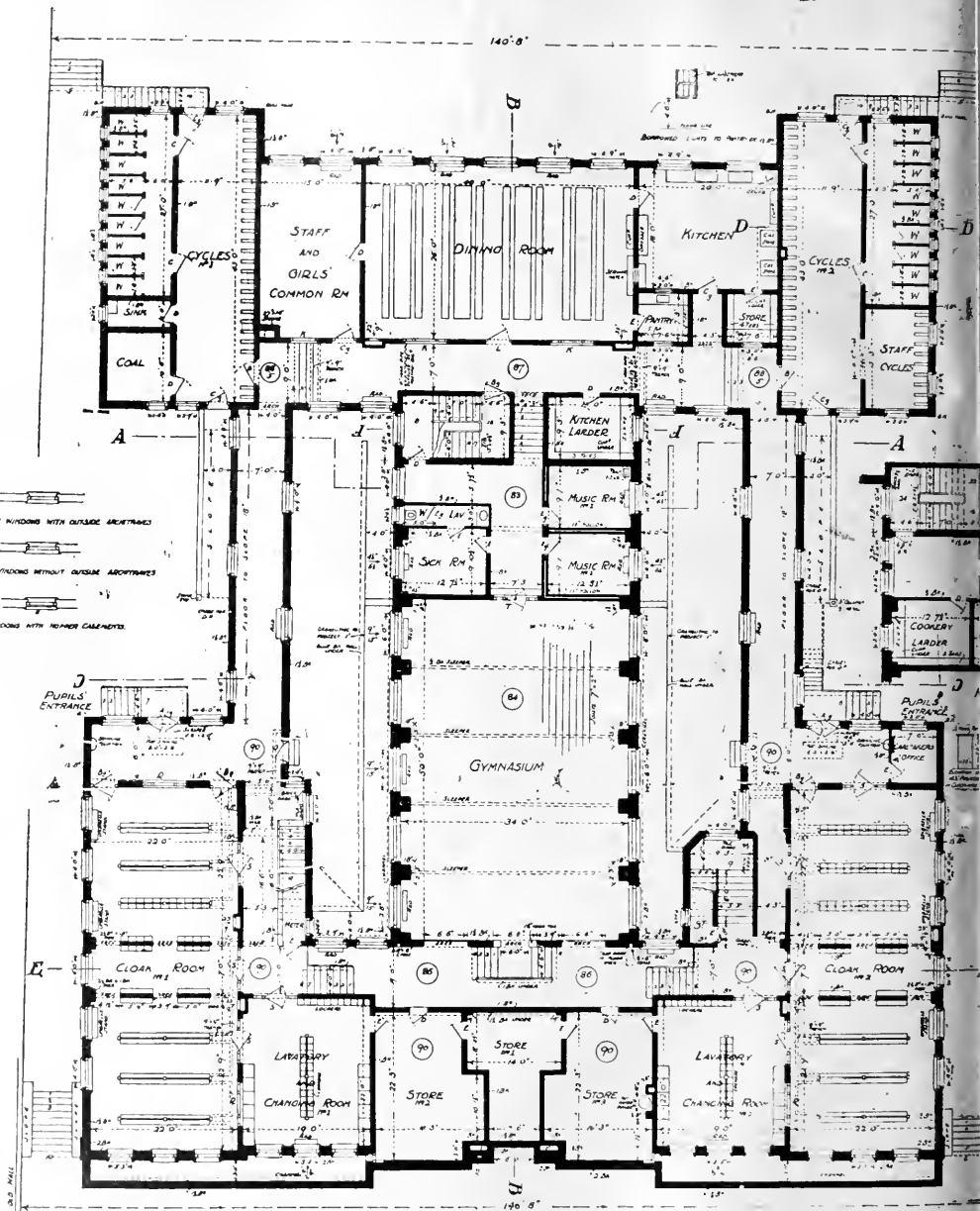

LOWER GROUND FLOOR PLAN.

# ST MARTIN'S HIGH SCHOOL, TULSE HILL

NEW HIGH SCHOOL FOR GIRLS, ST. MARTIN'S-IN-THE-FIELDS, TRAFALGAR

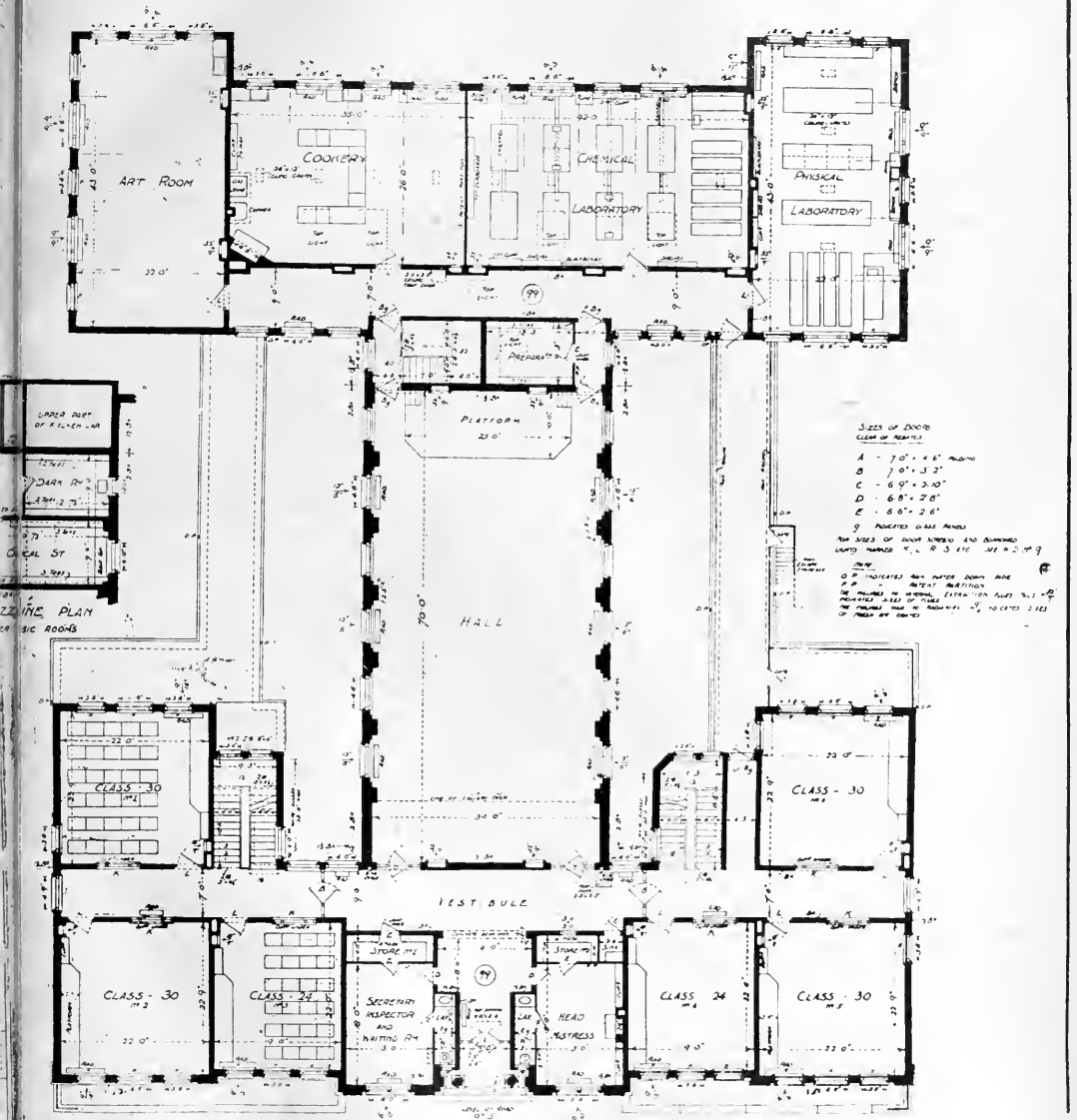

SIZES OF DOORS  
CLEAR OF PARTS

A - 7'0" x 4'6" PLATING  
 B - 7'0" x 3'2"  
 C - 6'0" x 2'0"  
 D - 6'8" x 2'6"  
 E - 6'6" x 2'6"

G - PARTIALLY GLASS PANELS

FOR SIZES OF DOOR HANDS AND BURNING  
 LEADS NUMBERED 1, 2, 3, 4, 5, 6, 7, 8, 9, 10, 11, 12, 13, 14, 15, 16, 17, 18, 19, 20, 21, 22, 23, 24, 25, 26, 27, 28, 29, 30, 31, 32, 33, 34, 35, 36, 37, 38, 39, 40, 41, 42, 43, 44, 45, 46, 47, 48, 49, 50, 51, 52, 53, 54, 55, 56, 57, 58, 59, 60, 61, 62, 63, 64, 65, 66, 67, 68, 69, 70, 71, 72, 73, 74, 75, 76, 77, 78, 79, 80, 81, 82, 83, 84, 85, 86, 87, 88, 89, 90, 91, 92, 93, 94, 95, 96, 97, 98, 99, 100

NOTE:  
 1. D.P. INDICATES NEW WATER DOWN PIPE  
 2. P. INDICATES PLUMBING  
 3. P. INDICATES PLUMBING  
 4. P. INDICATES PLUMBING  
 5. P. INDICATES PLUMBING  
 6. P. INDICATES PLUMBING  
 7. P. INDICATES PLUMBING  
 8. P. INDICATES PLUMBING  
 9. P. INDICATES PLUMBING  
 10. P. INDICATES PLUMBING  
 11. P. INDICATES PLUMBING  
 12. P. INDICATES PLUMBING  
 13. P. INDICATES PLUMBING  
 14. P. INDICATES PLUMBING  
 15. P. INDICATES PLUMBING  
 16. P. INDICATES PLUMBING  
 17. P. INDICATES PLUMBING  
 18. P. INDICATES PLUMBING  
 19. P. INDICATES PLUMBING  
 20. P. INDICATES PLUMBING  
 21. P. INDICATES PLUMBING  
 22. P. INDICATES PLUMBING  
 23. P. INDICATES PLUMBING  
 24. P. INDICATES PLUMBING  
 25. P. INDICATES PLUMBING  
 26. P. INDICATES PLUMBING  
 27. P. INDICATES PLUMBING  
 28. P. INDICATES PLUMBING  
 29. P. INDICATES PLUMBING  
 30. P. INDICATES PLUMBING  
 31. P. INDICATES PLUMBING  
 32. P. INDICATES PLUMBING  
 33. P. INDICATES PLUMBING  
 34. P. INDICATES PLUMBING  
 35. P. INDICATES PLUMBING  
 36. P. INDICATES PLUMBING  
 37. P. INDICATES PLUMBING  
 38. P. INDICATES PLUMBING  
 39. P. INDICATES PLUMBING  
 40. P. INDICATES PLUMBING  
 41. P. INDICATES PLUMBING  
 42. P. INDICATES PLUMBING  
 43. P. INDICATES PLUMBING  
 44. P. INDICATES PLUMBING  
 45. P. INDICATES PLUMBING  
 46. P. INDICATES PLUMBING  
 47. P. INDICATES PLUMBING  
 48. P. INDICATES PLUMBING  
 49. P. INDICATES PLUMBING  
 50. P. INDICATES PLUMBING  
 51. P. INDICATES PLUMBING  
 52. P. INDICATES PLUMBING  
 53. P. INDICATES PLUMBING  
 54. P. INDICATES PLUMBING  
 55. P. INDICATES PLUMBING  
 56. P. INDICATES PLUMBING  
 57. P. INDICATES PLUMBING  
 58. P. INDICATES PLUMBING  
 59. P. INDICATES PLUMBING  
 60. P. INDICATES PLUMBING  
 61. P. INDICATES PLUMBING  
 62. P. INDICATES PLUMBING  
 63. P. INDICATES PLUMBING  
 64. P. INDICATES PLUMBING  
 65. P. INDICATES PLUMBING  
 66. P. INDICATES PLUMBING  
 67. P. INDICATES PLUMBING  
 68. P. INDICATES PLUMBING  
 69. P. INDICATES PLUMBING  
 70. P. INDICATES PLUMBING  
 71. P. INDICATES PLUMBING  
 72. P. INDICATES PLUMBING  
 73. P. INDICATES PLUMBING  
 74. P. INDICATES PLUMBING  
 75. P. INDICATES PLUMBING  
 76. P. INDICATES PLUMBING  
 77. P. INDICATES PLUMBING  
 78. P. INDICATES PLUMBING  
 79. P. INDICATES PLUMBING  
 80. P. INDICATES PLUMBING  
 81. P. INDICATES PLUMBING  
 82. P. INDICATES PLUMBING  
 83. P. INDICATES PLUMBING  
 84. P. INDICATES PLUMBING  
 85. P. INDICATES PLUMBING  
 86. P. INDICATES PLUMBING  
 87. P. INDICATES PLUMBING  
 88. P. INDICATES PLUMBING  
 89. P. INDICATES PLUMBING  
 90. P. INDICATES PLUMBING  
 91. P. INDICATES PLUMBING  
 92. P. INDICATES PLUMBING  
 93. P. INDICATES PLUMBING  
 94. P. INDICATES PLUMBING  
 95. P. INDICATES PLUMBING  
 96. P. INDICATES PLUMBING  
 97. P. INDICATES PLUMBING  
 98. P. INDICATES PLUMBING  
 99. P. INDICATES PLUMBING  
 100. P. INDICATES PLUMBING

GROUND FLOOR PLAN

3

H. CARTER PEGG, F.R.I.B.A.  
 WESTMINSTER S.W.  
 MARCH 1915



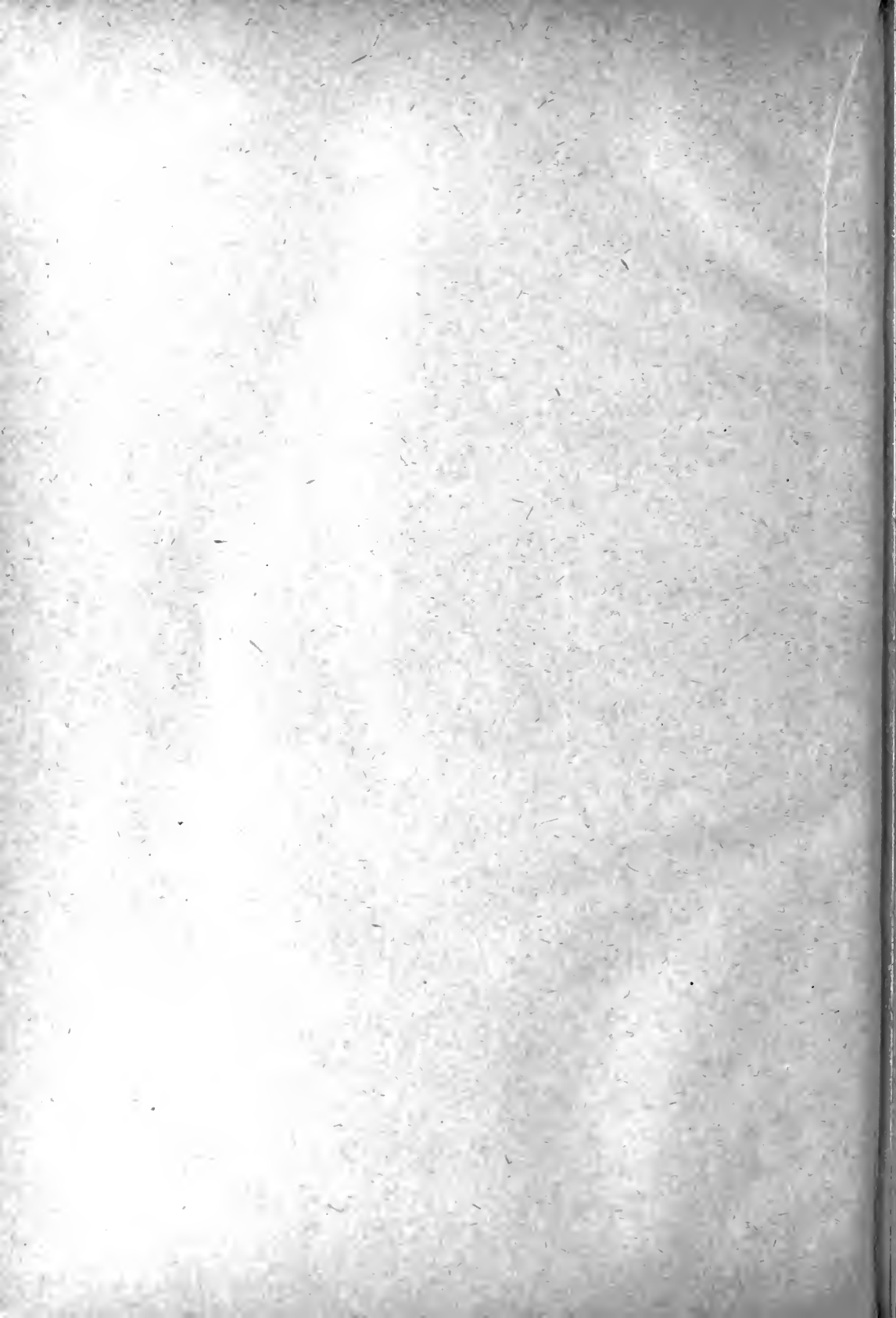





THE BUILDING NEWS, DECEMBER 26, 1917.

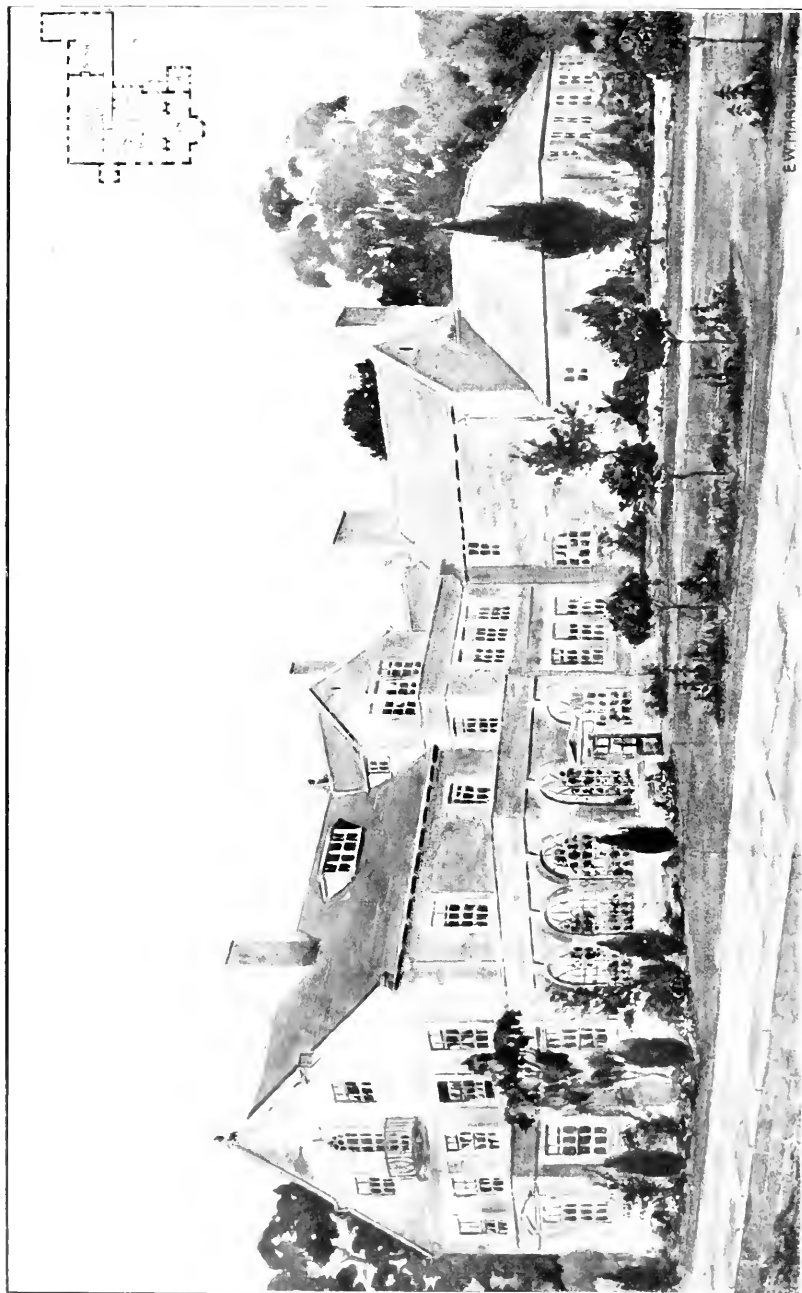

NEW HOUSE, NEAR HARROGATE, YORKS.—MR. ERNEST W. MARSHALL, F.R.I.B.A., ARCHITECT.

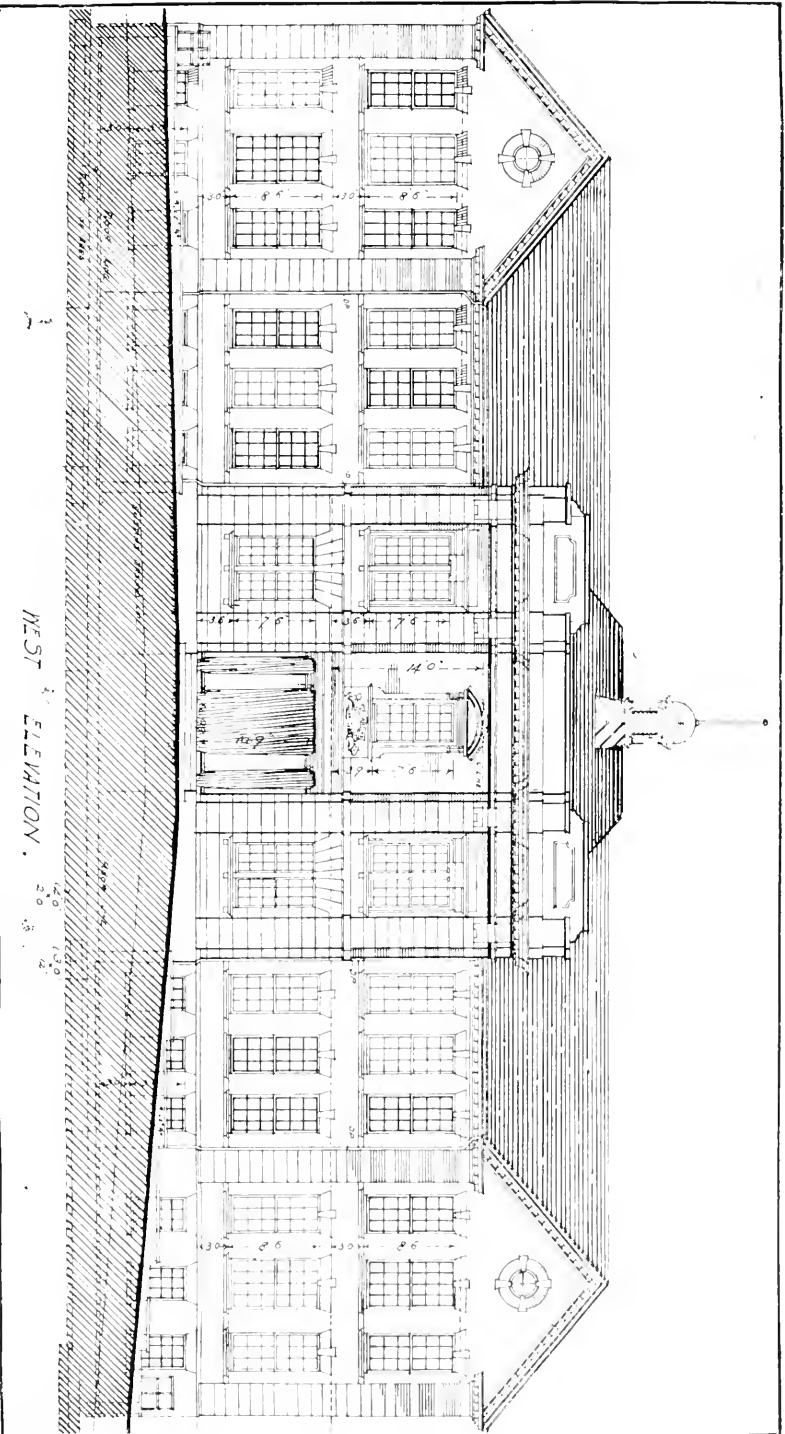

NEW HIGH SCHOOL FOR GIRLS, ST. MARTIN'S-IN-THE-FIELDS, TRAVALGAR SQUARE, TO BE BUILT AT TULSE HILL.  
MR. H. CARTER PROG, F.R.I.B.A., Architect.

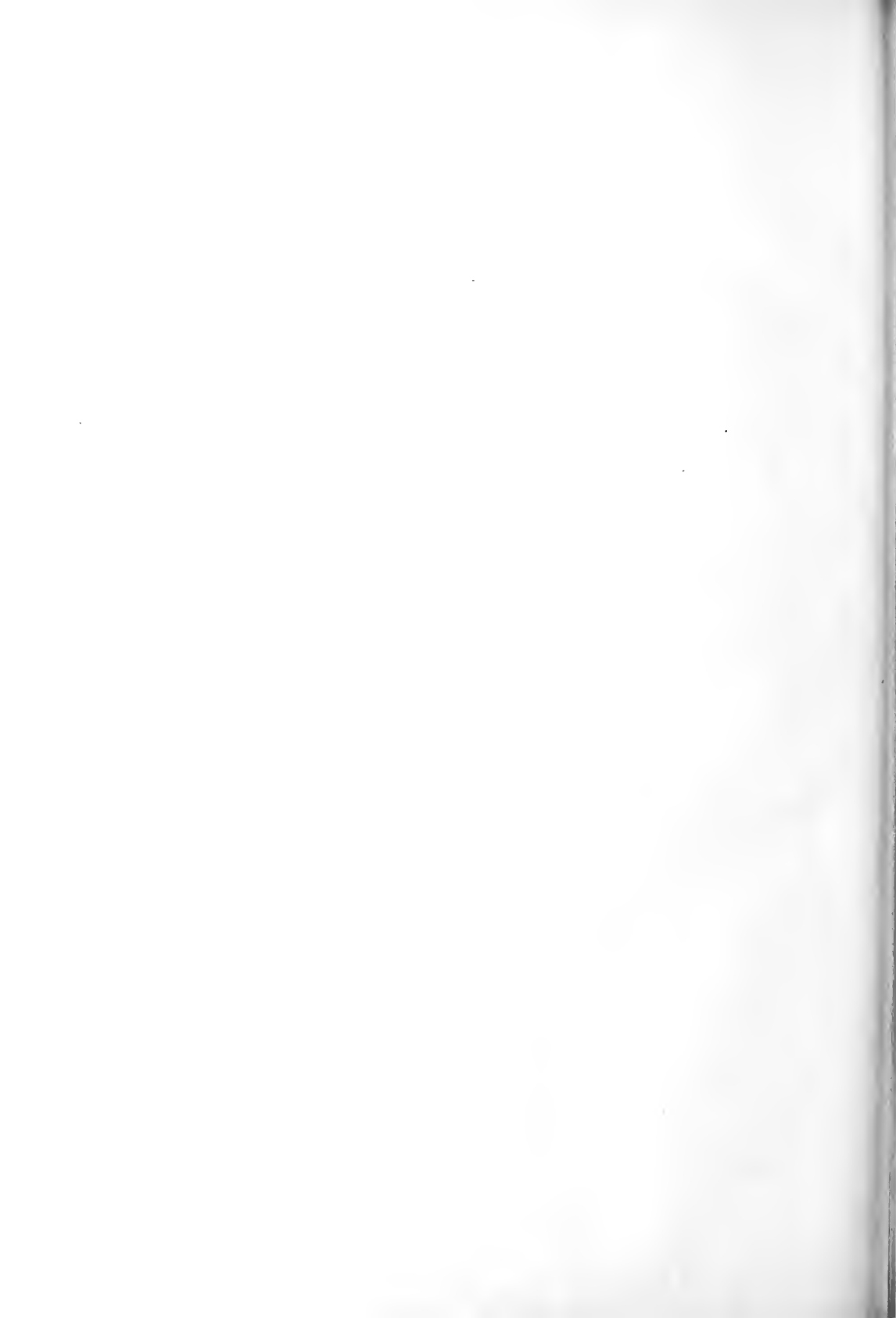



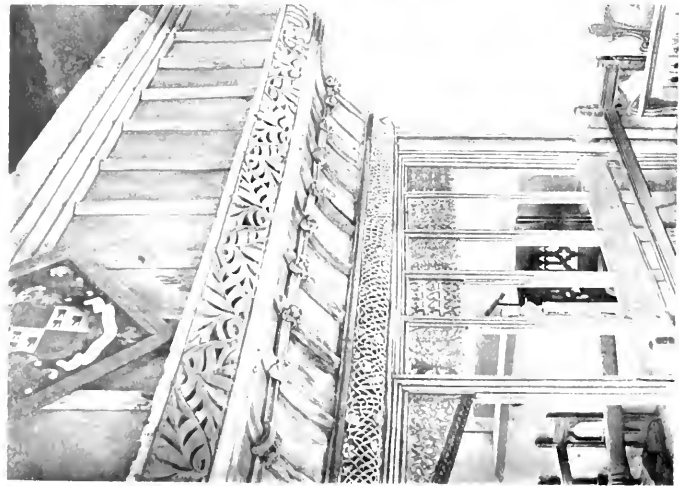

LIANINGO, RAISOR, EAST SIDE OF ROAD, LOOK

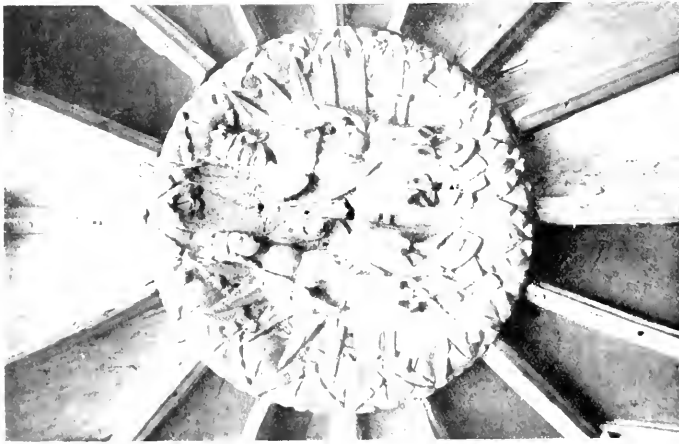

NEWCASTLE ST. NICHOLAS, BOSS OF VAULT

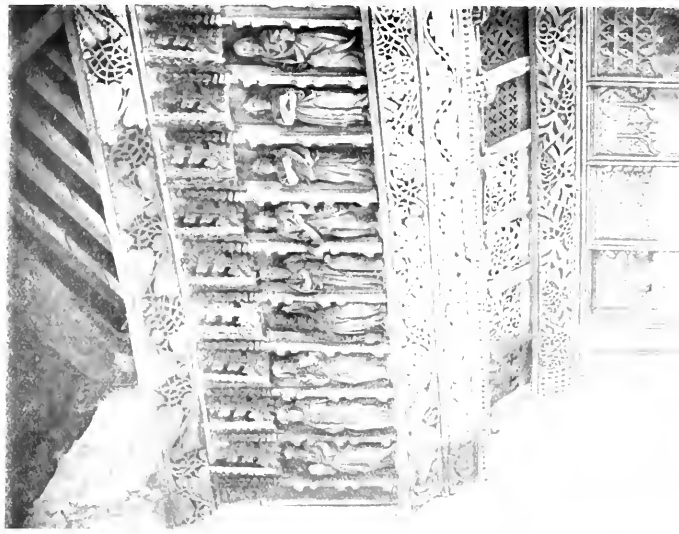

LIANINGO, RAISOR, WEST SIDE OF ROAD, LOOK



ST. DECCMAN'S, SOMERSET, WEST COUNTRY TYPE.



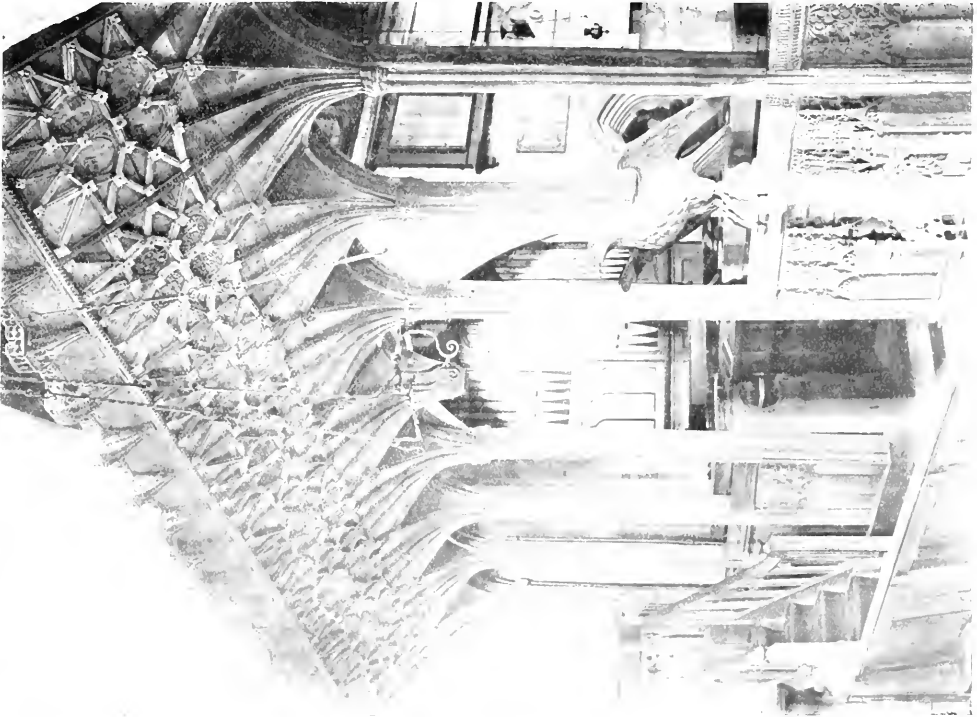

MOTTERLEY, CHESHIRE, 1870-1875.

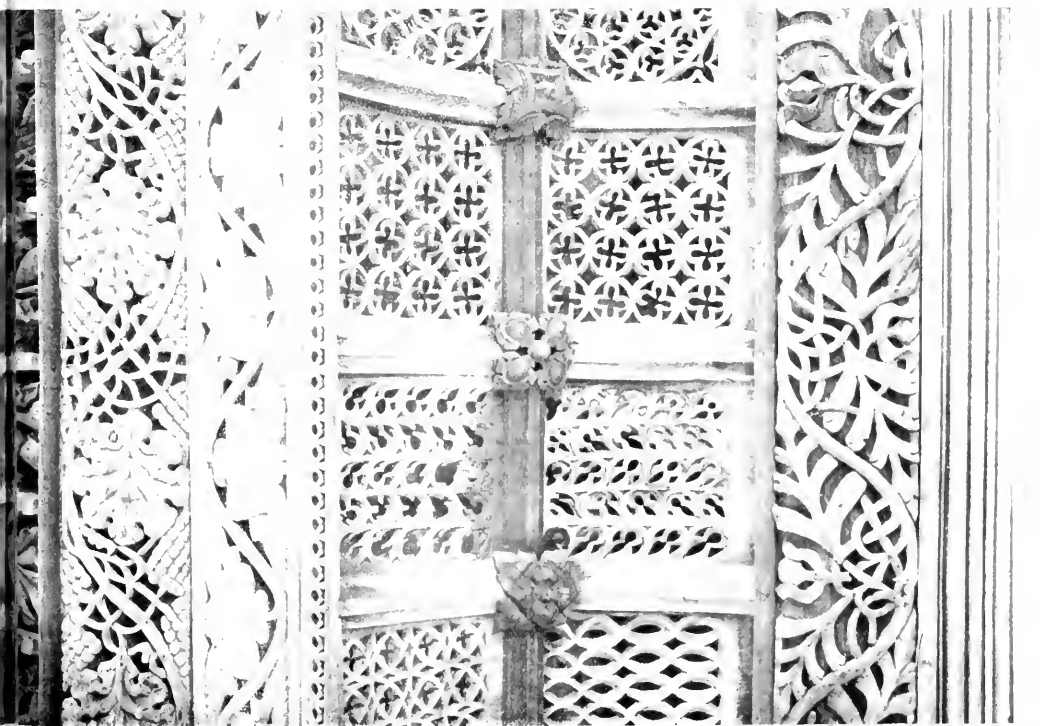

GLASBORO, ILLINOIS, 1850-1855.





## THE DETERIORATING ACTION OF SALT AND BRINE ON REINFORCED CONCRETE.\*

By HENRY JERMAN MAUDE CREIGHTON,  
Department of Chemistry, Swarthmore  
College, Member of the Franklin Institute.

During the past few years there has been considerable discussion regarding the durability of concrete, and there exists a certain amount of disagreement on the matter. There appeared in the *Engineering News*, of April 4, 1912, wherein is published a report of the American Society of Testing Materials' meeting, the following sentence: "The report of the water-proofing committee brought about some excited discussions, during which several persons affirmed their belief in the imperishability of concrete and protested against any hint of any other possibility." However, though "it is no doubt true that many diseases can be cured by a practitioner who strenuously denies their existence, and thus encourages the patient to resist and overcome them, it can hardly be expected that defective concrete walls or disintegrating piers can be strengthened by 'absent treatment,' however vigorous be the denial of the injury or however prominent the denial." It is much better to look facts in the face and attempt to find a remedy.

Sea-water, one of the agents which brings about the disintegration of concrete, attracted the attention of users of cement soon after it was first employed in marine construction. Although a great deal of non-reinforced concrete has withstood the action of the sea up to the present, and will probably continue to do so, still some of it has failed. Although the cause of this disintegration is not definitely known, Le Chatelier and others point out<sup>1</sup> that it can probably be ascribed to a reaction between the magnesium sulphate of the sea-water and the lime of the cement (formed during setting) and the alumina of the aluminates of the cement, the result being the formation of magnesium hydrate and calcium sulpho-aluminate, which crystallises with a large number of molecules of water. Notwithstanding that the other components of sea-water have usually been considered as having little effect on concrete, attention has recently been called to the fact that both sodium chloride and magnesium chloride rapidly react with the silicates in concrete.<sup>2</sup>

In the laboratory it is possible to destroy, almost completely, small cylinders or other forms of concrete or cement mortar by the action of solutions of various salts. The "Action of the salts in alkali water and sea-water on cement" has been the subject of a lengthy investigation by Bates, Phillips and Wig, of the U.S. Bureau of Standards, and their results have been published<sup>3</sup> under the foregoing title. This investigation was undertaken in consequence of disintegration of concrete, through the action of water containing magnesium and sodium sulphates, occurring in several irrigation projects in some of the Western States; and for the purpose of determining the action of various single and mixed salt solutions on concrete and cement. The salt solutions were allowed to percolate through hollow cement cylinders closed at one end, and it was found that any cement mortar may be destroyed if a sufficient amount of salt accumulates and crystallises out. It was also found that, in general, chloride solutions were more active than sulphate solutions in removing lime from concrete, but that mixed chloride and sulphate solutions were more active than solutions of single salts.

According to a recent report<sup>4</sup> by J. L. Harrison, district engineer, Iloilo, the cracking of reinforced concrete structures is markedly prevalent in the Philippine Islands. A study of this trouble has shown that not a single structure showing rusted steel has been free from salt, the percentage of which varies

considerably. In view of this, engineers in the Philippines have been advised that not only is the use of salt water dangerous in concrete structures, but that beach sand and beach gravel should be employed only after having been thoroughly washed with fresh water.

The foregoing, and many other similar pieces of evidence, indicate that salt and brine exert a deteriorating action on concrete.

In this paper the writer wishes to give a brief account of observations on the deterioration of reinforced concrete by salt and brine, which were made by him a few years ago, while examining a large number of reinforced concrete structures in different parts of the country.

In order that the deteriorating action of salt water on iron may be better understood, the probable reactions which occur when this metal comes in contact with a salt solution will be briefly discussed.

When a piece of iron is placed in distilled water it becomes negatively charged, since its electrolytic solution pressure (which is equal to  $1.2 \times 10^4$  atmospheres) causes atoms of the metal to pass into solution in the form of positively charged ions, leaving an equivalent number of negative charges behind on the bar of metal. In spite of the large electrolytic solution pressure of iron, only a vanishingly small quantity of it passes into solution in the form of ions, and, consequently, the bar of metal receives but a very small negative charge. This is due to the fact that when a ferrous-ion with its large positive charge ( $2 \times 96,500$  coulombs for every gramme-ion of the metal) leaves the bar of neutral metal the latter acquires a correspondingly large negative charge; it therefore becomes more difficult for a second ferrous-ion to go into solution, owing to the attraction between the unlike charges; and it is still more difficult for a third ion to leave the metal, and so on. Very soon, therefore, the negative charges upon the bar of metal becomes sufficient to prevent further ferrous-ions from going into solution, and equilibrium occurs; and, unless these negative charges are removed from the metal no more iron can pass into solution. Suppose, now, that common salt be added to the water containing the bar of iron. On dissolving, this electrolyte largely dissociates into its ions, and it may be assumed that hydrolysis takes place, although to a most limited extent, in accordance with the equation—

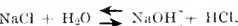

The concentration of these new substances being extremely small, they dissociate practically completely and give rise to negatively charged hydroxyl ions and positively charged hydrogen ions:—

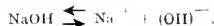

The hydroxyl ions then unite with the ferrous ions that have passed into solution from the bar of metal, to form undissociated ferrous hydroxide:—

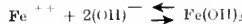

which gradually precipitates as an hydrated oxide. The presence of dissolved oxygen in the solution would, of course, gradually convert the oxide and ferrous hydroxide into the corresponding ferric compounds.

The negative charges upon the bar of iron, which were in equilibrium with the ferrous ions before the addition of the sodium chloride, now attract the positively charged hydrogen ions, the electrolytic solution pressure of hydrogen being much less ( $99 \times 10^{-4}$  atmospheres) than that of iron and very much less than that of sodium ( $>10^4$  atmospheres). In consequence of this attraction, hydrogen ions move towards the negatively charged iron bar, touch it and become neutral, gaseous hydrogen atoms. The negative charges on the bar being thus diminished, more iron enters the solution in the form of ferrous-ions, and the foregoing process occurs again, and so on. In this way the bar of iron gradually disappears, and iron oxide and hydrated oxide accumulate.

The nascent hydrogen which is produced on the bar may be absorbed by the iron; it may be oxidised by the oxygen dissolved in the solution, or it may be liberated as a gas. In order to determine whether gaseous hydrogen is ever liberated under the foregoing conditions, the writer immersed a number of pieces of iron in dilute aqueous solutions of sodium chloride contained in glass tubes with a capillary top, and connected at the bottom with a small glass tube bent upwards at right angles.

Before being introduced into the glass tubes, the salt solution was boiled to remove the air, and afterwards, before sealing off the tip of the capillary, a high vacuum was applied to the solution for some time. It was found that in all the tubes a grayish-green deposit slowly accumulated near the bottom, and at the end of several months a small quantity (0.1 to 0.2 C.C.) of gas had formed in three of the tubes. This gas proved to be mostly hydrogen.

In addition to the corrosion of iron through the action of brine by the processes just outlined, auto-electrolysis may occur on account of the presence of segregated impurities which are responsible for the differences of potential established in certain areas. These potential differences being about a galvanic action which causes the iron to go into solution at certain points with the formation of rust.

From what has been said, it is clear that reinforced concrete which comes in contact with brine or sea-water, unless rendered absolutely impervious, will commence to deteriorate as soon as the brine comes in contact with the reinforcing rods; for, as both iron oxide and the hydrated oxide occupy a larger volume than the corresponding amount of iron, there will be developed an enormous expansive force which is sufficient to crack the strongest concrete and force it away from the reinforcing rods. The more porous the concrete, the more rapidly will this action take place. Indeed, the writer is familiar with cases of cinder concrete structures, in contact with brine, which have shown signs of advanced deterioration at the end of a year.

Regarding the waterproofing of concrete, it should be pointed out that an impervious concrete is probably never obtained outside the laboratory. The average concrete is practically never waterproof. Although there are many substances on the market for rendering concrete waterproof, the majority of them are far from satisfactory. A number of such instances have been investigated by Brown<sup>5</sup>, who points out that all waterproofing materials will sooner or later hydrolyze, crack, or disintegrate.

Since most concrete is more or less porous to moisture, and since iron undergoes gradual decomposition, in the presence of salt water, with consequent expansion in volume, it is to be expected that reinforced concrete which comes in contact with brine or salt and moisture will ultimately disintegrate. It is not surprising, therefore, to find throughout the country reinforced concrete piers, sea walls, and buildings in the neighbourhood of the ocean in various stages of deterioration. The cracks which occur in such concrete usually run parallel to the reinforcing rods. These cracks are very narrow at first, but as the decomposition of the iron progresses they become iron-stained, gradually increase in width, and, finally, the concrete is forced so far from the reinforcing rods by the pressure of the accumulating iron oxide that large pieces of it break off.

In many parts of the country to-day there are reinforced concrete structures, housing industries that use large quantities of salt and brine, which are constantly spilled on the floors. In order to ascertain whether the concrete of such buildings has undergone any deterioration, the writer a few years ago examined a large number of them in different cities throughout the country. In practically all the buildings inspected reinforced concrete floors which came in contact with brine had iron-stained cracks on the under side. Usually these cracks were very narrow, but they indicated, nevertheless, deterioration of the reinforcements, and would continue to grow as the disintegration of the iron progressed. In many instances the

\* Communicated by Professor Creighton to the *Journal of the Franklin Institute*.

<sup>1</sup> Le Chatelier, *l'Industrie Zeitung*, 33, 93; Chandlot, "Ciments et Chaux Hydrauliques," p. 306; Michaelis, *Bull. de la Soc. D'Encourap. de l'Ind., June, 1897*.

<sup>2</sup> Chandlot, *loc. cit.*; Michaelis, *Bull. de la Soc. D'Encourap. de l'Ind.*, 682, 1890; D'Roian, *Eno. Record*, J. 20, 1910.

<sup>3</sup> Bur, of Standards, Techn. Paper 12, *Jour. Franklin Inst.*, 175, 65.

<sup>4</sup> *Bulletin of the Bureau of Public Works*, October, 1916.

<sup>5</sup> *The Electrician*, 69, 915 (1912).

cracks were found to vary from  $\frac{1}{8}$  to  $\frac{1}{4}$  inch in width, and in some cases deterioration had progressed so far that large pieces of concrete had fallen, or were about to fall, leaving the badly corroded reinforcements exposed. An examination of a number of pieces of this fallen concrete showed that in every case a quantity of iron oxide adhered to the concrete where it had come in contact with the reinforcing rods, and that it was sometimes as thick as  $\frac{1}{4}$  inch. Where the concrete had broken away from the reinforcements the latter were usually so badly corroded that it was possible to remove thick layers of oxide with the fingers. In a few cases the deterioration had progressed to such an extent that the reinforcements had been completely converted into oxide.

A few details regarding particular cases of deterioration met with in some of the reinforced concrete structures examined may be of interest.

The ceiling of a machine shop of a large reinforced concrete plant in East St. Louis was found to be very badly damaged. This building at the time of inspection was about ten years old. The upper side of the ceiling was continually wet with brine, which constantly leaked through to the under side and wetted it in a number of places. On this ceiling large brown ironstains were numerous and in at least twenty places pieces of concrete had fallen, leaving badly corroded, net-iron reinforcements exposed. In one place a piece of concrete 12 ft. long and varying from 2 to 18 inches in width had broken away. The reinforcements of this ceiling were imbedded at a depth of about  $\frac{3}{4}$  inch from the surface.

At a plant in Kansas City there was found a very interesting cracked reinforced concrete pillar which supported a reinforced concrete platform at the top of an outside staircase. Large quantities of salt were used in the plant, and the platform was often wet with brine. The cracks on the pillar ran parallel to the longitudinal reinforcing rods. In some places the concrete had fallen away from the rods, which were badly corroded, and in others portions of the concrete were easily pulled away.

At another plant in this city there was a long outside platform, from which cars were loaded, covered by a reinforced concrete roof. At one end of this roof there was a pile of rock salt, which was partially protected from the weather by a wooden roof. Rock salt had been stored in this place for years. For a number of yards beyond where the salt was stored it had been spilled continually on the concrete roof, and, owing to rains, perhaps a quarter of the roof was frequently wet with dilute brine. On the under side of the roof, directly below this place, there were many brown iron stains, wet patches, salt deposits, and in one place the concrete had fallen, leaving the net-iron reinforcements exposed. These had deteriorated to such an extent that the outer portions crumbled on touching and some of the rods were easily pulled away. The area from which the concrete had fallen was at least one square foot.

The individual rods of the exposed net-reinforcing originally about  $\frac{1}{2}$  inch in diameter, had increased to about  $\frac{3}{4}$  inch in diameter, owing to the conversion of the iron into oxide. Some of these rods had disintegrated to such a degree that the sound iron core was less than 1.25 inch in diameter. Near where the concrete had fallen, it was evident that the expanding reinforcements were gradually forcing the concrete downwards. At the far end of the ceiling, where salt had not been spilled above, there was no evidence of deterioration and the concrete was in an excellent condition.

At a third plant in Kansas City, a five-year-old reinforced concrete basement ceiling was found to be in a very bad condition. This ceiling was reinforced with  $\frac{3}{4}$ -inch twisted iron rods. The floor above was more or less wet all the time, and, in places, salt came in contact with the water, forming brine. There were many cracks on this ceiling, some of which were sufficiently wide to insert a lead pencil. One such crack was twenty to thirty feet in length. In several places large pieces of concrete had fallen,

leaving corroded reinforcements exposed. In one place a large piece of concrete which was almost dropping, and which weighed about 25 lb., was easily pulled away from the reinforcements. The under side of this, as is usually the case, had a large portion of the corroded reinforcements adhering to it.

The writer examined a building in Kansas City which contained a large quantity of reinforced under concrete that came into contact with considerable amounts of brine. This concrete, which was thirty years old, was in a very damaged condition, and in many places very large pieces had fallen.

In one of the Chicago plants examined, a whole floor had collapsed about a year previously, owing to the weakening of the reinforcements by disintegration.

Similar cases to the foregoing have been found by the writer in a number of cities in different parts of the country.

When concrete construction is carried out in winter, it is sometimes the practice to add salt to the concrete to prevent freezing, often as much as 20 per cent being added. The writer has examined a number of reinforced concrete structures where salt had been mixed with the concrete during construction. As is to be expected, where the concrete comes in contact with water or moisture, there are manifold evidences of deterioration; but, on the other hand, where the concrete has been kept dry no damage has been observed.

The following conclusions are drawn by the writer from his investigations of the action of salt and brine on reinforced concrete:—

1. All concrete which is not water-proofed in some way is more or less porous to water and brine.
2. Brine readily softens the surface of concrete and, therefore, more easily penetrates to the reinforcements, on which it exerts a disintegrating action that, owing to the attendant expansion, gradually weakens the concrete, causing it to crack and split, and in some cases to fall away from the reinforcements.
3. The more porous the concrete, the more rapid the disintegration of the reinforcements through the action of brine.
4. Reinforced concrete floors which come in contact with brine will gradually develop leaks. These will be followed by incrustations of discoloured salt on the under side, where, later, iron-stained, hair cracks will develop running parallel to the reinforcements. As the deterioration progresses, the cracks will widen and, owing to the great expansive force of the accumulating iron oxide, the concrete will be gradually pushed from the corroded reinforcements and ultimately fall.

#### BRICKS OF CEMENT, CLAY, AND SHALE BURNED UNDER NEW PROCESS.

A new era in brick-making has begun with the manufacture of bricks composed of portland cement and clay and shale burned under a new process. After long years of study and experimental work, and under most rigid testing, the brick has been demonstrated to be fully the equal of the present-day commercial clay or shale brick, and is superior in many of the more important features.

**BURNING OF CLAY AND SHALE THE FIRST STEP.**  
The first step in the process of manufacture of this brick is the burning of the clay and shale. A 16 ft. portable rotary kiln, with a capacity for burning approximately 100 cubic yards of material each twenty-four hours, is used for the purpose. From 1,700 to 2,200 degrees Fahrenheit are required to sufficiently burn the clay and shale, the variance being governed by the class of clay and shale being handled. The burned material is allowed to remain where discharged from the kiln to cool in the air, and is then well sprinkled with water to slack any lime particles that may be present. The second step of the process is the reduction of the burned material to pass a half-inch mesh screen, which produces four sizes—i.e., impalpable dust to that passing a 60-mesh screen, that passing a 10-mesh screen, that

passing a 4-mesh screen, and that passing a 2-mesh screen.

The material is then ready to be mixed according to formula worked out to best meet, in combination with portland cement, the requirements for the brick to be made. Proportioning the aggregate to the cement is the next step. This follows closely the practice for sand and stone concrete. The only notable feature of the mixing is the amount of water used, which approximates 20 per cent, by volume, and which is ample to start the chemical action in the cement. The mixer is located directly above the press, the mixed concrete being conveyed from the mixer to the press through metal chutes. The brick are discharged from the press on pellets which are stacked and allowed to remain undisturbed for from twelve to twenty-four hours, when the bricks have attained sufficient strength to be "hacked" into piles to cure. With the exception of an occasional sprinkling to prevent too rapid drying out, the brick need no further attention. After from eight to fourteen days the brick are ready for delivery to the building, sewer, or other work in which they are to be used. When completely cured, the bricks are several shades lighter in colour than the usual "concrete" gray.

**SAVING OF 1,500 POUNDS PER THOUSAND.**  
These burned clay and shale concrete bricks will strongly appeal to the building and construction industries. The fact that they weigh but approximately four and one-half pounds as against the standard six-pound clay and shale brick—a saving of 1,500 pounds per thousand of brick—will solve much of the sometimes vexing problem of loading the deadweight in buildings. The light weight of these brick will also recommend them in many other particulars to the architect and engineer. They readily recommend themselves to the builder and contractor because of the rapidity with which they can be laid and the true and even walls which it is possible to construct with them.

For the brick manufacturer, burned clay and shale concrete bricks should prove most acceptable, as they are said to possess all of the desirable features of concrete, some desirable features not possessed by concrete, and yet they have the flexibility of brick and are a better brick than can be manufactured with clay or shale in their natural state. At a very small expense for additional equipment and without interfering in any way with the production of regulation clay or shale brick, the brick manufacturer can very profitably add these new concrete bricks to his line.—*Contract Record.*

#### COMPETITIONS.

**COMPETITION FOR MODERN HOMES.**—A competition under the direction of the Columbus Chapter of the American Institute of Architects in co-operation with the Columbus Real Estate Board and the Builders' and Traders' Exchange will be held in January next. Designs will be received up to December 26, 1917. There are seven prizes offered, ranging from a first prize of \$200 to a seventh of \$10, with honourable mention for work placed eighth to fifteenth. The committee in charge is composed of Frank J. Packard, George H. Bullford, and Charles S. Inscho. Programme and full particulars of this competition may be had by addressing the Columbus, Ohio, Chapter of the American Institute of Architects.

#### PROFESSIONAL AND TRADE SOCIETIES.

**ARCHITECTURAL INSTITUTE OF AMERICA.**—At the sixteenth annual meeting of the Architectural Institute of America the following officers were elected:—Dr. Charles D. Wolcott, president; Henry White, Mabel Borden, Robert M. Thompson, and Mrs. H. F. Dimock, vice-presidents; Althell Carroll, secretary; John B. Lerner, treasurer. The guest of honour at the meeting was Victor Horta, the Belgian architectural director of the Royal School of Fine Arts and honorary president of the University of Belgium. His topic was "The Cathedrals and Public Buildings of Belgium and Northern France as Affected by the War."

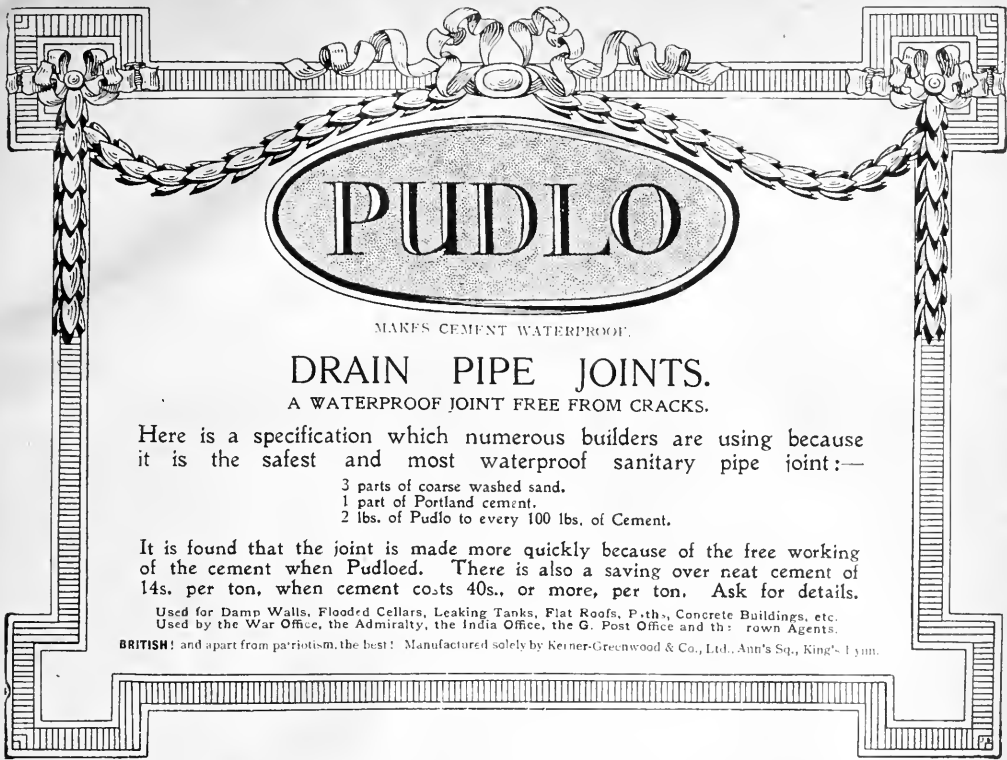

# PUDLO

MAKES CEMENT WATERPROOF.

## DRAIN PIPE JOINTS.

A WATERPROOF JOINT FREE FROM CRACKS.

Here is a specification which numerous builders are using because it is the safest and most waterproof sanitary pipe joint:—

- 3 parts of coarse washed sand.
- 1 part of Portland cement.
- 2 lbs. of Pudlo to every 100 lbs. of Cement.

It is found that the joint is made more quickly because of the free working of the cement when Pudloed. There is also a saving over neat cement of 14s. per ton, when cement costs 40s., or more, per ton. Ask for details.

Used for Damp Walls, Flooded Cellars, Leaking Tanks, Flat Roofs, P.th., Concrete Buildings, etc. Used by the War Office, the Admiralty, the India Office, the G. Post Office and the Crown Agents.

BRITISH and apart from patriotism, the best! Manufactured solely by Kerner-Greenwood & Co., Ltd., Ann's Sq., King's 13m.

### FOR Olivers' Seasoned Hardwoods,

APPLY TO—  
**WM. OLIVER & SONS, Ltd.,**  
120, Buahill Row, London, E.C.

#### TENDERS.

Correspondents would in all cases oblige by giving the addresses of the parties tendering—at any rate, of the accepted tender: it adds to the value of the information.

**ALLOA.**—For painting works. For the Town Council. Accepted tenders:—

Repainting Pond Hall, Johnman, £80; ditto, entrance and vestibule at the public baths, Arncliffe, £39 18s. 7d.

**CASTLETOWN (DURHAM).**—For painting, varnishing, and distemping. For the Castletown Workmen's Club and Institute:—

W. H. Raper, Gamble Street, Southwick-on-Tyne (accepted).

**NORTH SHIELDS.**—For painting the outside wood and iron work at the Guardians' Hall. For the Guardians of Tynemouth Union:—

M. Fleming and Co., 41 and 42, Nile Street North Shields (accepted) £17 10

### LIST OF TENDERS OPEN.

#### COMPETITIONS.

**Jan. 31.**—Designs are invited for four specified types of cottages suitable for the industrial classes. A competition, under the charge of the Royal Institute of British Architects and allied societies, will be held in each of the six areas mentioned below. Premiums of £100 and £50 for the best designs of each of three types, and £50 and £20 for the fourth, will be awarded in each competition. Designs must be submitted in accordance with the conditions not later than January 13. Copies of the conditions may be obtained from the following:—**Home Counties Area:** The Secretary, Royal Institute of British Architects, 9, Conduit Street, London, W.1; **Northern Area:** Mr. H. J. Hicks, hon. sec., Northern Architectural Society, 6, Higham Place, Newcastle-on-Tyne; **Manchester and Liverpool Area:** Mr. Isaac Taylor, hon. sec., Man-

chester Society of Architects, Mansfield Chambers, 17, St. Ann's Square, Manchester; **Midland Area:** Mr. A. Hale, hon. sec., Birmingham Architectural Association, 18, Bennett's Hill, Birmingham; **South Wales Area:** Mr. C. H. Kempthorne, hon. sec., South Wales Institute of Architects, Albert Chambers, High Street, Cardiff; **South-west Area:** Mr. J. Egan, hon. sec., Devon and Exeter Architectural Society, 3, Bedford Circus, Exeter.

#### ENGINEERING.

**March 30.**—The Acting British Consul at Santiago reports that a decree has been issued calling for tenders for the improvement of the port of Antofagasta (Chile). By the terms of this decree the amount to be expended on this work must not exceed £1,700,000. Details may be obtained from the Port Commission Offices in Santiago, and copies are expected to be received shortly at the offices of the Chilean Legation in London, 22, Grosvenor Square, W.1. Tenders will be received up to 3 p.m. on March 30 by the Minister of Finance, Santiago.

#### TO CORRESPONDENTS.

We do not hold ourselves responsible for the opinions of our correspondents. All communications should be drawn up as briefly as possible, as there are many claimants upon the space allotted to correspondents.

It is particularly requested that all drawings and all communications respecting illustrations or literary matter, books for review, etc., should be addressed to the Editor of the BUILDING NEWS, Elingham House, 1, Arundel Street, Strand, W.C.2, and not to members of the staff by name. Delay is not infrequently otherwise caused. All drawings and other communications are sent at contributors' risks, and the Editor will not undertake to pay for, or be liable for, unsought contributions.

When favouring us with drawings or photographs, architects are asked kindly to state how long the building has been erected. It does neither them nor us much good to illustrate buildings which have been some time executed, except under special circumstances.

\*Drawings of selected competition designs, important public and private buildings, details of old and new work, and good sketches are always welcome, and for such no charge is made for insertion. Of more commonplace subjects, small churches, chapels, houses, etc.—we have usually far more sent than we can insert, but are glad to do so when space permits, on mutually advantageous terms, which may be ascertained on application.

Advertisements for the current week must reach the office not later than 3 p.m. on Tuesday. Front-page advertisements and alterations or stop orders for serial advertisements must reach the office by first post on Monday to secure attention.

#### ADVERTISEMENT CHARGES.

The charge for Auctions, Land Sales, and Miscellaneous and Trade Advertisements (except Situations Advertisements) is 6d. per line of Eight Words (the first line counting as two), the minimum charge being 4s. 6d. for 50 words. Special terms for series of six insertions or more can be ascertained on application to the Publisher.

#### SITUATIONS VACANT.

The charge for advertisements for "Situations Vacant" is Two Shillings and Sixpence for Twenty-four Words, and Sixpence for every Eight Words after. All Situation Advertisements must be prepaid.

#### SITUATIONS WANTED AND PARTNERSHIPS.

The charge for advertisements for "Situations Wanted" and "Partnerships" is One Shilling for Twenty-four Words, and Sixpence for every Eight Words after.

#### REFILLS TO ADVERTISEMENTS.

Replies to advertisements can be received at the Office, Elingham House, 1, Arundel Street, Strand, W.C.2, free of charge. If to be forwarded under cover to advertiser, an extra charge of Sixpence is made. (See Notice at head of "Situations.")

RECEIVED.—W. J. D. V. and Co. T. B. H.—W. L.—E. S. G.—H. H. C.—J. G. J. E. and Son—E. H. G.—C. B. and Son—J. G. K. and Son—T. M. O.—G. M. H. and Co.—W. Ltd.—A. V.—W. D. H.—Yes.

T. L. J.—Please send S. W. G.—We know nothing of them.

DELAY.—Possibly, will inform. The rid enviously early date at which this issue had to go to press has unavoidably delayed many more important things.

Plans are under consideration for alterations to the Theatre Royal and the Grand Theatre, Clunelgate, Bolton, for Mr. J. F. Elliston.

The Finsbury Licensing Justices have sanctioned plans for alterations at the Red Lion, Rosoman Street, and at the Eagle, Seven Sisters Road.

## Building Intelligence.

**NORWICH.—SCHOOLS.**—The Norwich Education Committee have adopted a scheme for the utilisation of the Clare House estate for the education of tuberculous, pre-tuberculous, cripple and mentally defective children, and the plans will be submitted to the Board of Education for approval. The scheme includes an open-air residential school for pre-tuberculous children, at an estimated cost of £1,672; an open-air residential school for spinal cases and cripples, at an estimated cost of £1,125; an open-air day school for children similar to those now attending the Clare House School (accommodation 100), at an estimated cost of £1,643; an open-air day school for 100 mentally defective children on the Paddock, at an estimated cost of £1,643. Other items of expenditure are: Alteration to barn, £400; alteration to house, £300; gardener's cottage, £300; and furnishing, £1,000.

**WASHINGTON, D.C.**—The new building in Washington, D.C., one of the war series for the Council of National Defence, is completed and occupied. This structure was built in sixty days at a cost of \$225,000, and is located at Eighteenth and C Streets, Northwest. It is a wooden frame building with wire lath in structural exterior and board finish interior. In its construction, speed and economy were first considered. More than one million board feet of lumber were required, and 450 men of all classes of workmanship were employed. The complete cost, it is stated, is at the rate of less than \$225 a square foot. As this building is occupied for use for a minimum period of two years at this cost, its rent is practically saved. Mr. Waddy B. Wood was the architect. The building is considered a model, admirable for its purpose.

### LEGAL INTELLIGENCE.

**DAMAGES FOR A FALL.**—Mr. Justice Atkin gave his reserved judgment in the Nisi Prius Court of the Birmingham Assizes last Wednesday in the action brought by Thomas Jackson, who described himself as an inventor and model builder, living at Rotunda Terrace, Cheltenham, against Mrs. Welsh, "Maudslayi," Lansdowne Place, Cheltenham. Plaintiff claimed damages for personal injuries which he received by falling down the basement stairs when engaged in carrying out certain business—the discharge of the coachman—for which he had written authority from Mrs. Welsh, on behalf of the defendant. Plaintiff contended that the stairs were dangerous and that the lighting was bad, while the defendant replied that the stairs had been constantly in use by the inmates of the house and the servants without any accident previously, and that the servants considered the stairs were exceptionally good and convenient. His Lordship found for plaintiff with £150 damages and costs, and gave judgment accordingly. Mr. Sailer asked for a stay of execution, and this was granted on condition that the money be paid into Court within twenty-one days, notice of appeal to be given within that time.

## Our Office Table.

In view of the First Lord's statement that barges of about 1,000 tons capacity are being built of concrete in this country, some particulars received by the *Times* respecting the Norwegian Fougner Company are interesting. The company is described as being pioneers in the use of ferro-concrete for the construction of sea-going ships. It was founded by Mr. N. K. Fougner, an engineer, who is the managing director. The first vessel built on the Fougner system was of 200 tons deadweight, and was driven by a Bolinder crude oil engine, 80 B.H.P., which gave her a speed of 7½ knots. Three months ago she was tested in a heavy gale in the Christiania Fjord, with Norwegian shipping authorities on board. It is stated that the vessel had "wonderful stability," and that there was practically no vibration from the engine. She has since been trading on the coast and in the Christiania Fjord with various cargoes, such as sand, flour, and lumber. The present capital of the company is £133,000, and the yard has been enlarged so that it will be possible to produce about 30,000 tons deadweight per annum when the whole plant is completed. It will also be possible to construct floating docks able to lift vessels of 15,000 tons deadweight. The practical advantages of the new shipbuilding system are described as being, especially, the lower cost, greater rapidity of construction, and reduced working expenses, since no painting is required for the hull except some composition to prevent growth. The vessels are fireproof, and, it is declared, neither rust nor rot. Mr. Fougner is at present in the United States, and will return to Norway *via* this country in order to complete the final arrangements in London for a separate British company, which is to take up his system of construction in Great Britain.

Under the title of "The Use of Mean Sea-level as the Datum for Elevations," Mr. E. L. Jones, of the U.S. Coast and Geodetic Survey, has collected the opinions of a number of engineers and others throughout the United States on the datum to which elevations should be referred. All agreed that mean sea-level should be chosen, and that it should be adopted without further delay. Great confusion arises in some places owing to the number of datum lines used. Thus, in Salt Lake City the corporation, the weather bureau, and the two railway companies all use different levels of reference. To facilitate the adoption of mean sea-level as the standard, Mr. Jones points out that it is essential that precise levelling should be extended over the whole of the United States. At present it is entirely inadequate, being only 1.2 miles per 100 square miles of territory. The extension of the net, as quickly as possible, would allow arbitrary data to be discarded, and would result in

increased usefulness in American maps. The paper is published as No. 60 of the United States Coast and Geodetic Survey Series.

At the last meeting of the Manchester Literary and Philosophical Society, Professor W. Boyd Dawkins exhibited examples of pre-Roman bronze-plated iron from the Pilgrim's Way. The examples were an iron snaffle-bit, an iron harness-ring, and an iron hub of a wheel, covered with a thin layer of bronze, discovered in 1895, on the site of a village in Bigbury Wood, about two miles due west of Canterbury. The village is of prehistoric iron age, and is traversed by the Pilgrim's Way, an *dhas* yielded a considerable number of implements to be seen in the Manchester Museum. Of these the three above mentioned are of peculiar interest, because they show that the art of plating iron with bronze was known at that remote period, ranging in definitely backward from the Roman conquest. The implements found along with the plated articles consist of iron spears, axes, adzes, hammers, ploughshares, billhooks, and sickles, of the types found in settlements elsewhere of the same age, such as Hnnsbury, near Northampton, and the Lake Village at Glastonbury. In addition to these there were also fetters and a chain for a chain-gang of six, with six rings to put round the neck. Similar bronze-plated iron articles have been met with elsewhere.

### TRADE NOTE.

Boyle's latest patent "air-pump" ventilators, supplied by Messrs. Robert Boyle and Son, Ventilating Engineers 64, Highbury Viaduct, London, have been employed at King Edward's Memorial Hospital, Ealing, W.

### CHIPS.

Mr. Marshall King, of High Street, Brentford, auctioneer, who died intestate, has left £29,019.

Sir Aston Webb has been invited to address the Royal Geographical Society on the subject of the Arterial Roads of London.

In view of the requirements of a new factory, the Burton-on-Trent T.C. have agreed to extend the electricity works, at an estimated cost of £42,250.

The death has occurred of Mr. H. T. Tubbs, who has for many years sat as a Justice of the Peace at Highgate. He was a member of a City firm of auctioneers.

The Kirk Session of Troon Parish Church have received a legacy of £10,000 for adding a spire to the church and towards the cost of erecting and furnishing a parish hall.

Sir A. Mond, replying last week to Mr. P. A. Harris, said: The new buildings in St. James's Park are being constructed of brick because of the impossibility of obtaining the requisite amount of timber and other building materials. It is not intended that these buildings in the park shall be permanent, and they will be removed as soon after the declaration of peace as the interests of the State will allow.

ALL OUR CISTERNS,  
TANKS & CYLINDERS

**FREDK BRABY & CO<sup>LD</sup>**  
**TANK MAKERS**  
**LONDON.**

GALVANIZED  
CISTERNS  
AND  
TANKS

ARE BRANDED  
"SUN" BRAND

Chief Offices: 352 to 364, EUSTON ROAD, LONDON, N.W.    Telegrams: "COURTEOUS, EUSROAD, LONDON."    Telephone: MUSEUM 3032 (5 lines).

