



SAN FRANCISCO HISTORY ROOM



BOOK No.

ACCESSION

f720.5 P11<sup>23</sup>

205943

NOT TO BE TAKEN FROM THE LIBRARY

FORM No. 37 2M-2-24

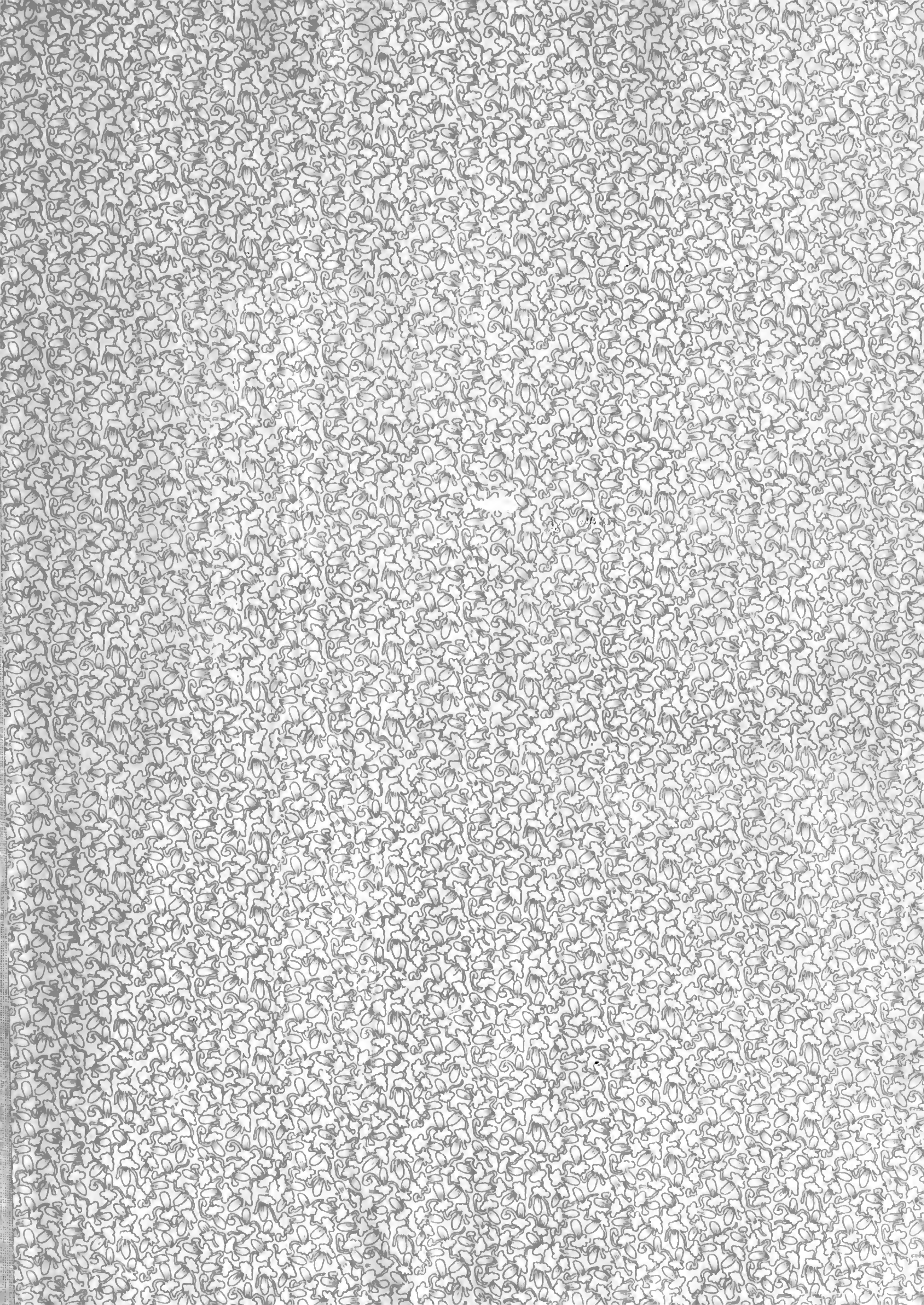

Digitized by the Internet Archive  
in 2010 with funding from  
San Francisco Public Library

INDEX TO THE BUILDING REVIEW FOR THE YEAR 1923

Volume No. XXIII, January-June, 1923

COVER ILLUSTRATIONS

- January—Superintendent's Residence, Whittier State School, Whittier, Calif.; Geo. B. McDougall, Architect.
- March—A California Version of Italy.
- April—Residence of Mr. Clyde Beal, St. Francis Wood, San Francisco, Calif. Henry H. Gutterson, Architect.
- May—Residence of Mr. W. P. Hanson, Flintridge, California. Harwood Hewitt, Architect.
- June—Spanish Sketch by Roger Blaine.

PLATE SECTION

	Plate No.
Matson Navigation Company Building, San Francisco, Calif. Bliss & Faville, Architects.	
Market Street Elevation .....	1-
Perspective .....	2-
Basement and First Floor Plans .....	4-
Pacific Gas & Electric Company Building, San Francisco, Calif.; Blakewell & Faville, Architects:	
Perspective .....	3-
Basement and First Floor Plans.....	5-
Ceiling of Main Lobby .....	6-
Whittier State School, Whittier, Calif.; Geo. B. McDougall, Architect:	
Superintendent's Residence .....	7- 8- 9
Industrial Court .....	10-
Boys' Cottage .....	10-
Main Elevation, Hospital Building.....	11-
Main Elevation, School Building.....	11-
Entrance Detail, School Building.....	12-
University Club, Los Angeles, Calif. (For plans see page 39) .....	13-25
Friday Morning Club, Los Angeles, Calif.....	26- 28
Palo Alto Union High School, Palo Alto, Calif.....	29- 34
Elementary School, Colton, Calif.....	35-
Union High School, Santa Maria, Calif.....	36- 37
High School, Santa Paula, Calif.....	38-
Wild Rose Elementary School, Monrovia, Calif.....	39-
University of California (Southern Branch), Los Angeles..	40- 46
Greater Whittier College, Whittier, Calif.....	47- 48
Wilmington High School, Los Angeles, Calif.....	49-
Elementary School No. 1, Glendora, Calif.....	49- 52
Elementary School No. 2, Glendora, Calif.....	52- 53
Elementary School No. 2, Azusa, Calif.....	54- 55
Elementary School, Oxnard, Calif.....	56-
Ynez School, Alhambra, Calif.....	57-
Marengo Primary School, Alhambra, Calif.....	58-
Central Elementary School, Alhambra, Calif.....	58- 59
Elementary School, Spadra, Calif.....	60-
Elementary School, Little Lake School District, Los Angeles, Calif. ....	61-
Elementary School, Ranchito, Calif.....	61- 62
High School, Burbank, Calif.....	63- 64
Elementary School, Burbank, Calif.....	65-
High School Group, Santa Monica, Calif.....	66- 76
Grammar School, La Canada, Calif.....	76-
John Adams School, Santa Monica, Calif.....	77-
McKinley School, Santa Monica, Calif.....	78-
John Muir School, Santa Monica, Calif.....	79-
Colton Union High School, Colton, Calif.....	80-
Lincoln Junior High School, Santa Monica, Calif.....	81- 83
Union High School, Oxnard, Calif.....	84-
Union High School, Merced, Calif.....	84- 85
Colonel School, Los Angeles, Calif.....	86- 87
Jefferson Junior High School, Long Beach, Calif.....	88-
Luther Burbank School, Long Beach, Calif.....	88- 89
Atlantic Avenue School, Long Beach, Calif.....	88- 89
High School, Chandler, Ariz.....	90- 91
Murphy Memorial Hospital, Whittier, Calif.....	92-
Harbor General Hospital, San Pedro, Calif.....	93-
Union High School, Fowler, Calif.....	94-
High School, Monrovia, Calif.....	95-
Colton Union High School, Colton, Calif.....	96-
High School Group, Orange, Calif.....	96-
High School, Van Nuys, Calif.....	97-
Union High School, Redondo, Calif.....	98- 99
Washington School, Pasadena, Calif.....	100-101
Church of the Messiah, Los Angeles, Calif.....	102-
Saint John's Episcopal Church, Los Angeles, Calif.....	102-
First Methodist Episcopal Church, Monrovia, Calif.....	103-
Department Store, Hollywood, Calif.....	104-
Packing House, Santa Paula, Calif.....	104-

Residence of Mr. J. C. Daniels, Pasadena, Calif.....	105-106
The Chautauqua of the Pacific, Los Angeles, Calif.....	107-108
Berkeley Country Club, Berkeley, Calif.; Walter J. Ratcliff, Architect:	
Perspective View .....	109-
Main Floor Plan .....	109-
Exterior View .....	110-
Exterior View .....	111-
Lounging Room .....	112-
Lounging Room .....	113-
Residence of Mr. C. M. Hartley, Vacaville, Calif.; Reed & Corlett, Architects:	
Front View of House .....	114-
Entrance Detail .....	115-
Garage .....	116-
Exterior .....	116-
Living Room .....	117-
Dining Room .....	118-
Main Hall .....	118-
Bedroom .....	119-
Residence of Mr. Chas. Heyer, Jr., Piedmont, Calif.; Reed & Corlett, Architects:	
Two Exterior Views .....	120-
The Work of Lewis P. Hobart:	
Y. W. C. A. Building, San Francisco, Calif.....	121-
U. S. Postoffice, Portland, Ore.....	122-123-124-125-126-127
War Memorial for Territory of Hawaii.....	128-129
Residence of Mrs. Sidney Ehrman, San Francisco .....	130-131
Residence of Col. Poole, Peeble Beach, Calif.....	132-
The Work of Harwood Hewitt:	
Marion Grammar School, Los Angeles, Calif.....	133-
Owensmouth Grammar School, Owensmouth, Calif.....	134-135
Cheremoya School, Los Angeles, Calif.....	136-
Junior High School, Ontario, Calif.....	136-
Palms Grammar School .....	137-
24th Street School, Los Angeles, Calif.....	137-
Parochial School, Hollywood, Calif.....	138-
Chatsworth Grammar School .....	138-
Frankenfield Stores, Los Angeles, Calif.....	139-
Loft Building for Mr. Harris, Los Angeles, Calif.....	139-
Residence of Mr. Jas. Shultz, Los Angeles, Calif.....	140-141-142
Residence of Mr. W. P. Hanson, Pasadena.....	143-144-145-146-147
Residence of Mr. Lynch, Los Angeles, Calif.....	148-
Spanish Sketches, by Roger Blaine.....	149 to 164, inc.

SPECIAL ARTICLES

	Page
Castles in Spain and Cottages in the Country. The first of a series on small Western homes; by Clara Fassett...	1-
Embellishing the Telephone Corner; by Mary Robinson Thomas .....	4-
Editorial .....	6-
Announcement .....	6-
The Garden. Notes on Berried Shrubs; by Katherine Jones	7-
New Office Building for Pacific Gas & Electric Co.....	7-
The Whittier State School.....	8-
Monthly Bulletin, San Francisco Chapter, A. I. A.....	12-
Monthly Bulletin, Washington State Chapter, A. I. A.....	XVI
The Work of Allison & Allison, Architects, by Irving F. Morrow .....	15-
A Glimpse into the Future, by John J. Donovan.....	22-
Two Schools in California, by Peter B. Wight.....	27-
Editorial .....	30-
School Kitchens, by Mary Robinson Thomas.....	31-
Educational Value of School Architecture, by Horace M. Rebok .....	34-
Honor Awards for Best Designed Buildings in Los Angeles .....	36-
Growth of Western Metropolis, by Morris M. Rathbun.....	40-
Monthly Bulletin, San Francisco Chapter, A. I. A.....	42-
A Spanish-Colonial Bungalow Electrified (the second of a series on small western homes), by Clara Fassett.....	50-
The Rainbow Garden, by Ellen S. Collier.....	50-
City Surveying—Its Problems and Importance, by A. Malkin, Civil Engineer .....	53-
Hemway Terrace, a New Residence Tract.....	55-
Editorial .....	52-
Editor's Book Shelf .....	VII-
Architects Monthly Bulletin .....	58-
Some Varied Work by Lewis Hobart, by Harris Allen.....	59-
The Honolulu War Memorial, by Harris Allen.....	61-
The House on the Hillside (the third of a series on small Western homes), by Clara Fassett.....	62-
Own Your Own Home Idea on Silver Screen, by Paul Green .....	66-

# THE BUILDING REVIEW

Editorial .....	64-
Editor's Book Shelf .....	VII-
Architects Monthly Bulletin .....	70-
Why Is an Architect?.....	VII-
The Creative Instinct, by Harris Allen.....	71-
Suburban Home of English Cottage Type, by Clara Fassett .....	75-
Editorial .....	76-
The Editor's Book Shelf .....	VII-
Architects Monthly Bulletin .....	81-
Washington Chapter A. I. A. ....	XX-
While Sketching in Spain, by Roger Blaine.....	83-
"Casa Ramona," by Clara Fassett .....	87-
The Anonymous Architect .....	93-
Architects Monthly Bulletin .....	94-
Builders Code of Ethics .....	XII-
Why Contractors Erode on Architect's Field, by J. C. Edwards .....	XVI-
Contractor and Architect .....	XX-
Editor's Book Shelf .....	VII-
Foreign Sketches by Roger Blaine, by Harris Allen.....	VII-

## INDUSTRIAL SECTION

Outlook for 1923 as Reported by Western Industrial Centers .....	Page 10-
Carquinez Bridge Aid to Industrial Development of Northern California .....	11-
New Method of Measuring Sand Makes Concrete More Reliable .....	XIII
Lassen County Leads California in Lumber Production.....	XIV
New Patented Window Device.....	XIV
Problems Relating to the Hardening of Steel.....	XVI
Safe Construction of Built-In Garages.....	56-
Digest of Western Industrial Activities.....	XVII
Fireproof Walls—A Recent Demonstration.....	XVIII
Important Laws Governing Construction Work in Calif.....	68-
Re-Forestation Plans Announced by Redwood Association	69-
Recommendations for Small House Construction.....	69-
Government Tests for Weathering Limestone.....	XII
Los Angeles Building Activities, by Ellis Wales.....	XVI
Sacramento's New Industrial Service, by A. S. Dudley.....	XVII
Bungalow Court Equipped with New Heating Appliances.....	XVII
Procrastination Steals More Than Time .....	XX
New Home for Geo. H. Tay Company.....	79-
Mono-Rail Conveying Systems in Demand.....	VII
United States Civil Service Examination.....	XV
Conditions in Common Brick Industry.....	XVI
Reward for Oldest Shingle .....	XVII
Bids Asked for New Courthouse .....	XVII
Linoleum Adapted in Modern Homes .....	XVIII
Students in Architecture Awarded Prizes.....	XX

Volume XXIV, July-December, 1923

## COVER ILLUSTRATIONS

July—By Homer Ansley.
August—Residence of Mr. P. J. Walker, Piedmont, Calif.
September—Model of "Mr. God," Panel, Grauman's Metropolitan Theatre, Los Angeles, Calif. Mr. Lee Woollett, Architect.
October—Entrance Detail, Residence of Mr. Robert Webber, Hillsborough, California.
November—Entrance Detail "El Zenzontle" Apartments, Berkeley, California.
December—Residence of Dr. J. W. Calkins, Oakland, Calif.

## SPECIAL ARTICLES

Residential Work of Johnson, Kaufmann & Coate, by Harris Allen .....	Page 1-
Two Stately Gardens, by Esther Matson.....	5-
Small House of Delightful Features, by Charles Alma Byers .....	7-
A Model Portland Home, by Ethel G. Peterson.....	9-
New State Housing Act, by Mark C. Cohn.....	11-
Modern Floors .....	11-
Nurseries for Redwoods, by Frank Mulgrew.....	12-
Editor's Book Shelf .....	VII-
Editorial .....	6-
Remarks About California School Architecture, by John J. Donovan .....	13-
Art in the Small Shop, by Clara Fassett.....	16-
Miniature Models of Cardboard, by Jockemo Casassa.....	19-
The Relation of Radium to Architecture, by William H. Day .....	20-

Responsibilities of the Architect and the Engineer in Timber Conservation .....	21-
Tests Point Way to Safer Elevators.....	24-
Los Angeles Building Activities, by I. C. Tichenor.....	XVIII-
Quick-Setting Lime Blocks Developed by Bureau of Standards .....	XX-
Aluminum Paint Makes Radiators Less Efficient.....	XX-
United States Civil Service Examination.....	XX-
Editor's Book Shelf .....	VI-
Editorial Page .....	18-
Pioneers, by Harris Allen .....	25-
The Metropolitan Theatre, a Digest from the Local Press	27-
A Farm in the Foothills, by Clara Fassett.....	29-
Inviting Doorways, by Mary Robinson Thomas.....	34-
Paint Company Opens San Francisco Office.....	XVIII-
The Relation of Radium to Architecture, by William H. Day .....	XIV-
Editorial Page .....	30-
Gardening of Our Country Homes, by Donald McLaren.....	37-
Credit to Whom Credit Is Due, by Harris Allen.....	41-
Minutes of San Francisco Chapter, American Institute of Architects .....	42-
Description of the Model Residence Being Built in Glazenwood, Calif., by Will H. Toepke, Architect.....	44-
Notes of San Francisco Architectural Club.....	46-
Japan Faces Gigantic Building Program .....	48-
Aero-Photography, by George E. Russell.....	49-
Gardening of Our Country Homes, by Donald McLaren. (Continued from the October issue).....	52-
"El Zenzontle" Apartments," a California Court, by Clara Fassett .....	55-
Minutes of the San Francisco Chapter, American Institute of Architects .....	56-
San Francisco Architectural Club Notes.....	58-
Every Knob a Point of Interest, by Marjorie Spencer.....	60-
The California Memorial Stadium, by Harris Allen.....	61-
The Intimate Bedroom .....	64-
Pacific Coast Jockey Club .....	65-
The Gough School, by John Reid, Jr.....	65-
Editorial, by Harris Allen.....	66-
San Francisco Architectural Club Notes .....	68-
Index to Building Review for the Year 1923.....	71- 72

## PLATE SECTION

Illustrating the Work of Johnson, Kaufmann & Coate.	Plate No.
Illustrating the Work of Geo. W. Kelham:	
Residence of Mr. P. J. Walker, Piedmont, Calif.....	17 to 21
Standard Oil Building, San Francisco, Calif.....	22 to 28
Illustrating the Work of Mr. Lee Woollett, Architect, Los Angeles, Calif.:	
Grauman's Metropolitan Theatre, Los Angeles, Calif. Photographs by Albert J. Kopec .....	29 to 40
Residences Built by S. A. Born Building Co., Near San Francisco, Calif. ....	41- 56
"Castle Rea Villa" Apartments, Berkeley, Calif. W. J. Wilkinson, Architect .....	57- 59
Residence of Mr. R. H. Hubbell, San Francisco, Calif. Ashley and Evers, Architects.....	60- 64
"El Zenzontle" Apartments, Berkeley, Calif. A. M. Milwain, Architect .....	65- 68
Gough (Oral Deaf) School, San Francisco, Calif. John Reid, Jr., Architect .....	69- 71
Residence of Dr. J. W. Calkins, Oakland, Calif. Bernard Maybeck, Architect .....	72- 74
Pacific Coast Jockey Club, San Bruno, Calif. George Applegarth, Architect .....	75- 77
The California Memorial Stadium, Berkeley, Calif. John Galen Howard, Architect .....	78- 80

## INDUSTRIAL SECTION

San Diego Seeks New Industries.....	Page XVI-
The Use of Douglas Fir for Sash and Frames.....	XII-
Western Pacific Builds Up .....	XXI-
New Industries Aid Oakland .....	XXI-
Nobody to Guide Them .....	XXII-
San Jose Proves Prosperity .....	XXII-
Prepared Roofing Simplified .....	XXIII-
Simplified Hospital Beds .....	XXIV-
Notes on Lighting .....	III-
Tests of "Composition" Floors and Stuccos.....	XVII-
Small Brick House Competition .....	XVIII-
United States Department of Agricultural Forest Service .....	58-
Paraffine Co., Inc., Have New Main Office and Plant.....	59-
An American Scourge .....	IV-
Le Brun Traveling Scholarship Competition Year 1924.....	VI-
Housing and Construction .....	67-
How to Own Your Own Home .....	67-
Resolutions Passed by American Construction Council.....	70-
Metal Lath Notes .....	70-

*Plans of a Small Home in the West*

SAN FRANCISCO  
PUBLIC LIBRARY

# THE BUILDING REVIEW



**JANUARY, 1923**

Vol. XXIII

No. 1

*Published at*

*50 Main Street, San Francisco*

**Price, 25 Cents**

NEW SERIES

NOW READY

# MEASURED DRAWINGS

Authentic Colonial Types of Architecture

We shall be pleased to mail a set to interested Architects

*Kyanize*  
KYAN-IZE

VARNISHES

ENAMELS

*Boston Varnish*  
Company  
KYAN-IZE

San Francisco Office and Warehouse: 1151 Mission Street

A. L. GREENE, Local Manager



# THE BUILDING REVIEW

VOL. XXIII

JANUARY, 1923

No. 1

Published Monthly by the Building Review Company,  
50 Main Street, San Francisco, California  
Douglas Building Los Angeles, California

Editor—Harris Allen

Industrial Editor—Howard Hoyt

Business Mgr.—H. R. Braden

## CONTENTS

Cover—Superintendent's Residence, Whittier State School, Whittier, Calif.  
Geo. B. McDougall, Architect

### PLATES

Plate No.

Matson Navigation Company Building, San Francisco, California Bliss & Faville, Architects	
Market Street Elevation.....	1
Perspective .....	2
Basement and First Floor Plans.....	4
Pacific Gas and Electric Company Building, San Francisco, California Bakewell & Faville, Architects	
Perspective .....	3
Basement and First Floor Plans.....	5
Ceiling of Main Lobby .....	6
Whittier State School, Whittier, California Geo. B. McDougall, Architect	
Superintendent's Residence .....	7-8-9
Industrial Court .....	10
Boys' Cottage .....	10
Main Elevation, Hospital Building.....	11
Main Elevation, School Building.....	11
Entrance Detail, School Building.....	12

### TEXT

Page

Castles in Spain and—Cottages in the Country. The first of a series on small Western homes. By Clara Fassett.....	1
Embellishing the Telephone Corner. By Mary Robinson Thomas	4
Editorial.....	6
Announcement.....	6
The Garden. Notes on Berried Shrubs. By Katherine Jones.....	7
New Office Building for Pacific Gas and Electric Company.....	7
The Whittier State School.....	8
Monthly Bulletin, San Francisco Chapter, A. I. A.....	12
Monthly Bulletin, Washington State Chapter, A. I. A.....	XVI

### INDUSTRIAL

Outlook for 1923 as reported by Western Industrial Centers.....	10
Carquinez Bridge Aid to Industrial Development of Northern Cal.	11
New Method of Measuring Sand Makes Concrete More Reliable	XIII
Lassen County Leads California in Lumber Production.....	XIV
New Patented Window Device.....	XIV
Problems Relating to the Hardening of Steel.....	XVI

Yearly subscription—United States, \$2.50—foreign, \$3.00. Single copies, 25 cents.

Entered as second-class matter in the San Francisco Postoffice under the Act of August 24, 1912. Previously entered as "The Architect."

The editors will be pleased to consider contributions of interest to the Industry. When payment of same is desired, this fact should be stated.

News stands and dealers supplied through San Francisco News Co., San Francisco, Calif., or American News Co., New York, N. Y.



ENTRANCE COURT, RESIDENCE OF C. E. GREENFIELD, SAN ANSELMO, CALIFORNIA HARRIS ALLEN, ARCHITECT

County, to many, means a place to hike, and to camp week-ends; each year, however, sees more all-the-year homes built, tucked in the sunny valleys, perched on hillsides, or crowning hill-tops. It is surprising to those who are accustomed to pass through these towns via the highway or railroad, to discover back of the main thoroughfare in canyons and on hillside slopes homes, permanent all-year dwelling-places whose occupants have faced the

journey by boat and train to the city for years, happy in possession of a Cottage in the Country which modern transportation has placed within the reach of all city conveniences.

More thought is being given to architectural features in the building of these houses than formerly, as one would naturally require more in the way of comfort and beauty in a year-round house than in a summer cottage. Charm in a country house, small as well as large, depends not only on beauty of line and form, but on suitability to location and environment. The house should present a complete picture in harmony with the size, shape and elevation of the lot, with surrounding trees and shrubbery.

A traveller in European lands will notice the marked difference between the small houses there, and here in America. Many of these cottages were built to last for generations. Consequently they have acquired an atmosphere that only time and long habitation by many people can give. Here, we are apt to regard the small home as a sort of temporary dwelling, a stepping stone to the more pretentious house which we will have as soon as the family grows larger, when the neighborhood becomes tiresome, or when we can "afford it." But now, happily the little house is coming into its own. The architect is giving more time and study to this problem of the small house designed to fit the needs and taste of Mr. Would-be-Home-Owner who desires something lasting and beautiful and within the limits of a moderate purse.

In so-doing the profession is rendering an important service to the people in encouraging the own-your-own-home movement. The



THE SITE FROM THE FRONT



ELEVATION OF HOUSE

average small house, built by contractors or building associations in blocks, all alike, varying only in minor details, we buy because we must, and not because we wish a home that expresses not ours—but a sort of miscellaneous personality.

An interesting little country house designed by Harris Allen, is in process of construction on a hill-top in San Anselmo. Mr. Allen likes to plan country houses which fit into their environment, which look as though they "belonged"; which is after all when you analyze it, the appealing quality in those aforementioned cottages of the old world. The owner's idea of course must be taken as the starting point. The idea for this home as conceived in the owner's mind was a bungalow of Spanish type. Many of the distinctive Spanish features, such as plaster walls, tiled roof and enclosed patio would have been unsuited to this particular location. So it will be built of redwood stained a warm grey with steep-gabled roof designed to shed rain, elevated front terrace and rear patio sheltered on two sides. With some Spanish features it is an adaptation and entirely well-suited to the site.

Crowning the top of a hill, over-looking a wooded canyon, the lot lies, a pie-shaped section of land commanding a gracious and expansive view of Mt. Tamalpais—with its grey-green sides, jagged top and frequent halo

of filmy fog—a California Fujiyama. The rear of the lot is higher than the front. Considering this in situating the house, an elevated terrace is planned at the front which leads directly through the living room to the patio at the back. The house will face south embracing view of mountain and valley and will be exposed to the sun the entire day, owing to its

(Continued on page 8)



THE SITE FROM THE SIDE



THE BUSINESS MAN'S DESK TEMPORARILY TRANSFERRED TO A DELIGHTFUL CORNER IN HIS OWN HOME

## Embellishing the Telephone Corner

MARY ROBINSON THOMAS

No one questions the convenience and efficiency of the telephone! How annoyed and inconvenienced we are when it is out of order for even a few hours! And how human and inconsistent we are when we are equally annoyed and inconvenienced by its incessant ringing!

Every detail should be considered from the double point of view of use and charm. If the telephone is centrally located with all accessories nearby, and the grouping of the utilitarian makes a pleasing picture, a double function is performed, each of which is valuable. In order to meet its constant demands

it must have a central location in the home. In the formal home there are usually several to answer the telephone bell and usually more than one telephone, but in the small home, where, perhaps, the mistress is housekeeper, too, the placing of this connecting link with the outside world must be carefully considered so that its use will fulfill its mission of helpfulness. In a two-storied house this cannot be satisfactorily accomplished without an extension telephone on the second floor. If one telephone is used, it is often put on a landing in a stairway. If one is on the first floor, she must climb a half flight of stairs, and if she is on the second floor, she must descend a half flight of stairs; which, of course, saves ascending or descending an entire flight of stairs each time. In the one-storied house the ideal situation for this necessity is between and adjacent to the living room and kitchen. In ministering to the house service the accessories; table, light, directory, scratch pad, calendar and pencils must be placed exactly right, in order to complete the telephone's efficiency.

In a doctor's home, which is also an auxiliary office, the problem of placing the telephone conveniently has been solved satisfactorily. This was accomplished by placing a stationary instrument in the hall of the second floor, and another telephone which



NEAR THE FRIENDLY WARMTH OF THE OPEN FIRE



A CLOCK IS OFTEN A VALUED ACCESSORY IN THE TELEPHONE CORNER

“plugs in” either in the dining room, living room or sub-office. This arrangement makes it convenient at any of these points and also makes it possible to hold a professional or private conversation shut away from the family. When not in use it can be put out of sight like the toaster or any electrical appliance, but while using it, one is sure of pleasant surroundings.

The accompanying illustrations show very clearly telephones placed in living rooms and they also show very distinctly doors leading into the kitchens.

One picture shows the window-sill telephone corner in a charming mountain cottage. Good light, both day and night, is secured here by the large window and the Russian candleabra. The window also gives a beautiful view of mountains beyond. Its proximity to the kitchen is indicated by the door to the right. Here the utilitarian enters into the composition of a real picture.

In another window-sill telephone corner the door to the kitchen will have to be imagined at the right where the window ends. This picture had to include many features so it was impossible to show the door. In locating this particular telephone the thought of meeting the inevitable interruptions during meals made a busy business man decide to place it near the dining table. In other words, what could not be avoided must be endured, and in answering the many business calls, he, at least, did not have to leave the table, and many times accomplished two things at once; eating his food and listening to a protracted monologue. The window-sill is broad and provides plenty of room for the

directory, etc., while the windows give an abundance of light and delightful vistas. A calendar hangs near for ready reference. In the evening, a lantern artistically provides light for note-taking. This dining room is really an alcove off of the living room so that the mistress and housekeeper reaches it with few steps from either the living room or kitchen. It fills the need of this particular household completely.

Two steps up to a landing on the way to the sleeping porch and dressing room above and one calls the number. The stairway is narrow and the landing small so the corner is provided with a shelf for the telephone when its presence should be heard and not seen. If a protracted conversation ensues one sits on a step. The window gives the needed daylight and a candle in a copper sconce hanging close by gives a soft evening light. The door at the foot of the stairs leads into the pantry. Whether the telephone is showing or not, this is a very attractive part of this room.

Another illustration shows an arrangement of telephone and accessories placed in an alcove of a living room. A Chinese tea table holds the utilitarian. As companion pieces to the table true Oriental art is displayed in the Satsuma plaque and the light suspended from a gnarled and twisted bough with a basket

(Concluded on page XIII)



ALL THE REQUISITES FOR A COZY CHAT

# EDITORIAL

One of the most serious problems which has arisen in the business life of a large city is that of parking and garage space. The amount of motor traffic increases even faster than population or business; the available land space constantly decreases.

There are only two solutions; deliberately devoting valuable office space to a building entirely for garage purposes, with elevators, ramps and turntables or using as much basement space as possible under office buildings. And even a combination of both schemes is likely to prove inadequate in the not far distant future.

In the two new office buildings, illustrated in this issue, it is noteworthy that garage space

has been reserved in both basements. Not only should all new city business structures include such provision, but it would undoubtedly be well worth while to remodel many large existing buildings so as to permit a ramped entrance to their basement stories and the utilization of extra space therein for machine parking.

The fact that many business streets, arteries of traffic, have finally been widened at tremendous cost, shows that the apparently impossible can be done when necessity commands. The impossibility of putting ten cars in the space for one, will sooner or later force this issue; and it is a wise owner who fore-stalls the inevitable.

## A GREAT ISSUE

The Building Review for February will present the work of Allison & Allison, architects of Los Angeles. The reputation of this firm is not confined to Southern California, nor to this State, nor to the West. It has a place among the two or three great school specialists of the entire country. For an adequate, though not complete, showing, more than 150 cuts have been prepared, including plans and details, beside a number of articles by competent writers, reviewing the architectural and technical excellence of these buildings. "Cameo" heavy-coated paper with a special grade of ink will be used, and no pains spared to make this the finest publication of its kind that has yet been produced in America. Extra copies of this issue may be procured at the price of One Dollar each, until the issue is exhausted. Reservations are now being made.

### A Partial List of the School Buildings to be Illustrated

University of California, Southern Branch.  
 Elementary School, La Canada, Colorado.  
 John Adams School, Santa Monica, California.  
 McKinley Elementary School, Santa Monica, Cal.  
 Central Ave. Elementary School, Santa Monica, Cal.  
 High School, Santa Monica, California.  
 Elementary School, Spadra, California.  
 Elementary School, Ranchito, California.  
 Elementary School, Little Lake, California.  
 High School, Burbank, California.  
 Elementary School, Burbank, California.  
 Santa Paula High School, Santa Paula, Calif.  
 Wild Rose Elementary School, Monrovia, Calif.  
 Whittier College, Whittier, California.  
 Union High School, Santa Maria, California.  
 Elementary School, No. 1, Glendora, California.  
 Wilmington High School, Los Angeles, Calif.  
 Elementary School, No. 2, Azusa, California.  
 Elementary School, Colton, California.  
 Elementary School, Oxnard, California.  
 Ynez Elementary School, Alhambra, California.



Marengo Primary School, Alhambra, California.  
 Central Elementary School, Alhambra, Calif.  
 Union High School, Oxnard, California.  
 Coronel School, Los Angeles, California.  
 Atlanta Ave. School, Long Beach, California.  
 Jefferson Jr. High School, Long Beach, Calif.  
 Luther Burbank School, Long Beach, Calif.  
 Union High School, Redondo, Calif.  
 High School, Chandler, Arizona.  
 Union High School, Fowler, California.  
 High School, Monrovia, California.  
 Colton Union High School, Colton, California.  
 Lincoln Jr. High School, Santa Monica, Calif.  
 Union High School, Merced, Calif.  
 Washington School, Pasadena, Calif.  
 High School, Orange, California.  
 Van Nuys High School, Los Angeles, California.  
 Union High School, Palo Alto, California.  
 Wilmington High School, Los Angeles, Calif.  
 Gallatin High School, Los Angeles, California.  
 Fremont Ave. School, Alhambra, California.

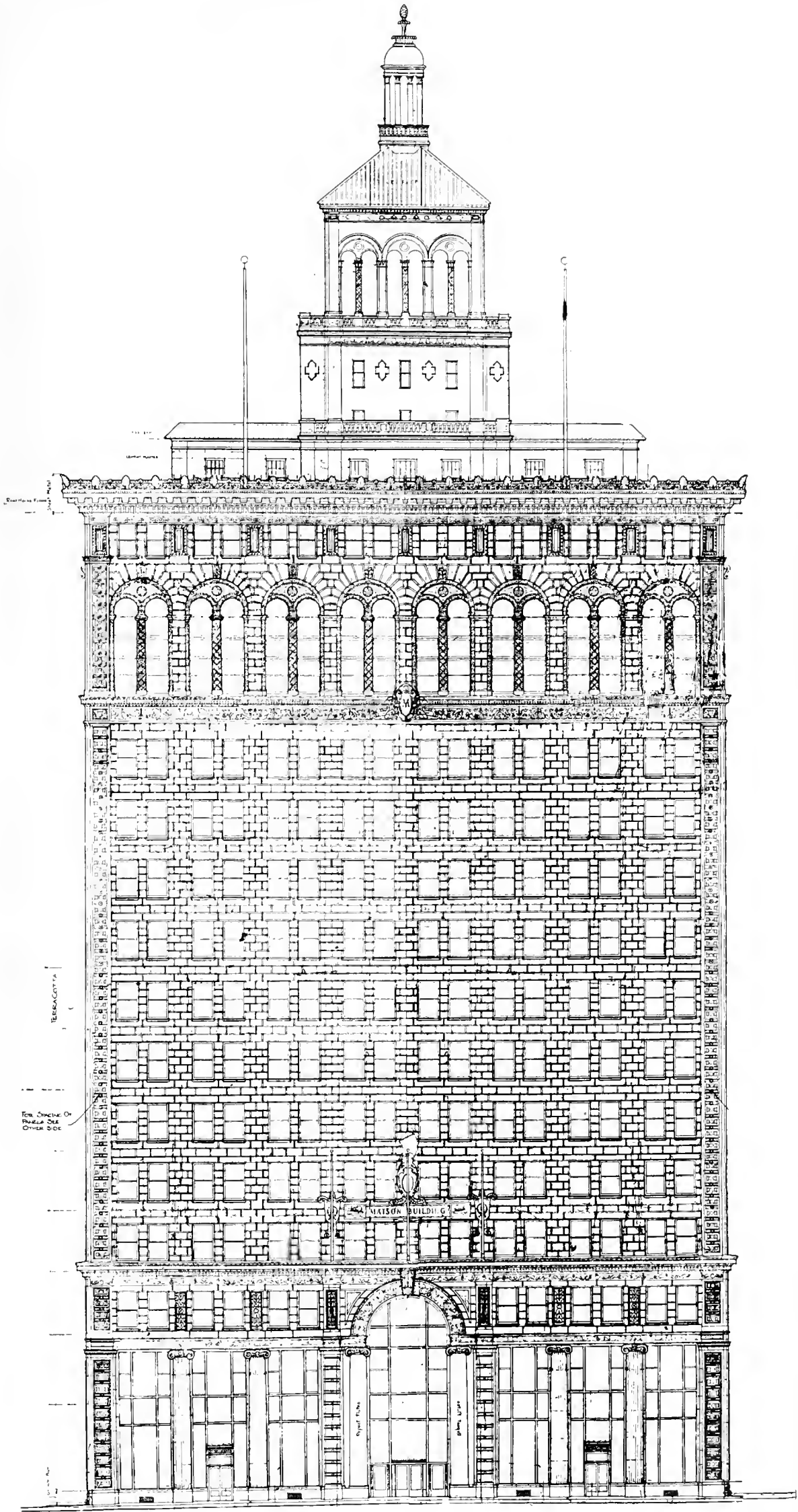

MARKET STREET ELEVATION,  
MATSON NAVIGATION CO. BUILDING  
SAN FRANCISCO, CALIFORNIA  
BLISS & FAVILLE, ARCHITECTS



PERSPECTIVE  
WATSON NAVIGATION CO. BUILDING  
SAN FRANCISCO, CALIFORNIA  
GLISS & FAVILLE, ARCHITECTS





PERSPECTIVE  
PACIFIC GAS & ELECTRIC CO. BUILDING  
SAN FRANCISCO, CALIFORNIA  
BAKEWELL & BROWN, ARCHITECTS

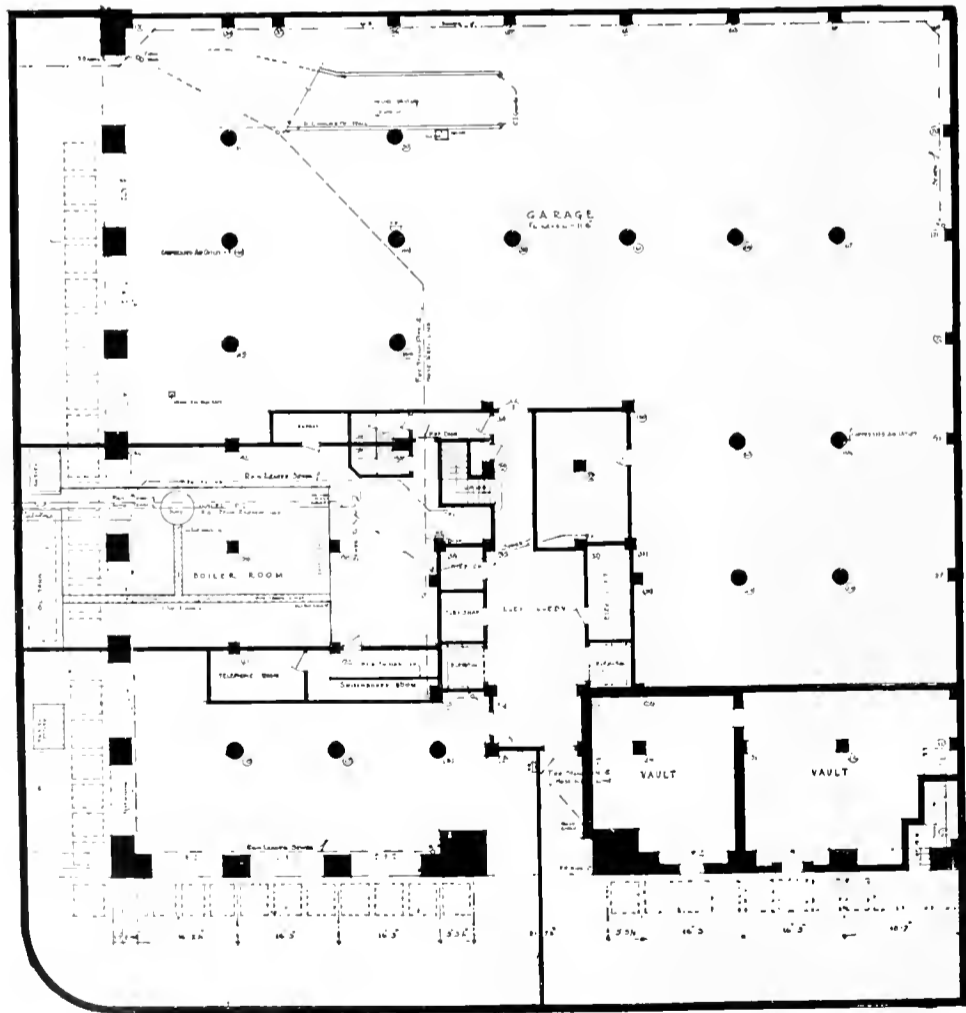
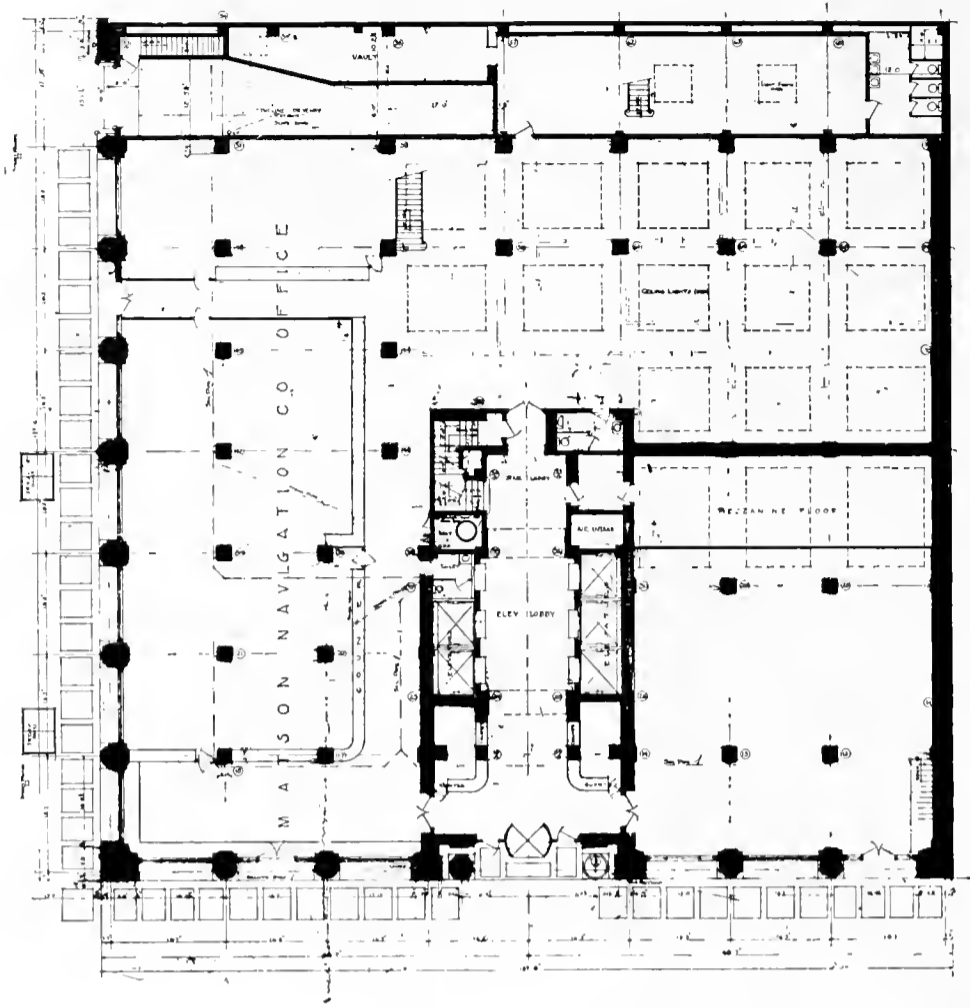

BASEMENT AND FIRST FLOOR PLANS  
MATSON NAVIGATION CO. BUILDING  
SAN FRANCISCO, CALIFORNIA  
BLISS & FAVILLE, ARCHITECTS

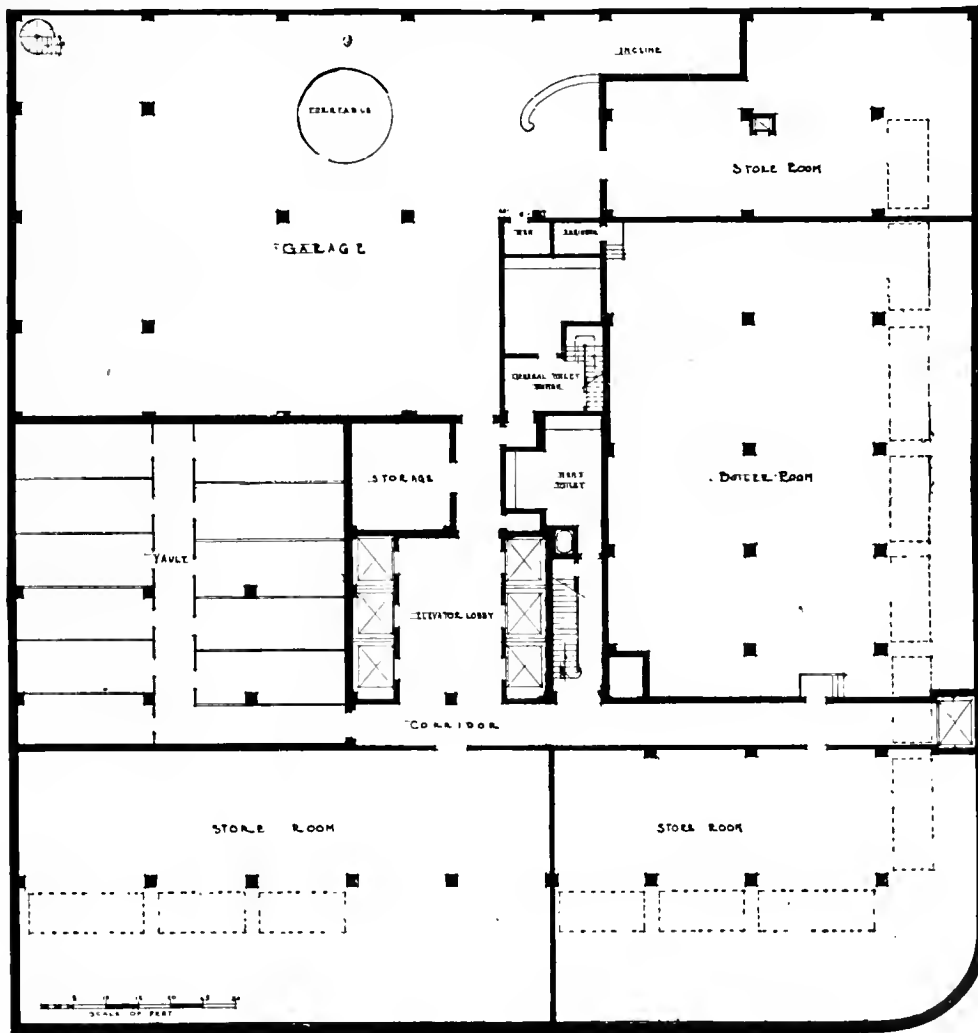
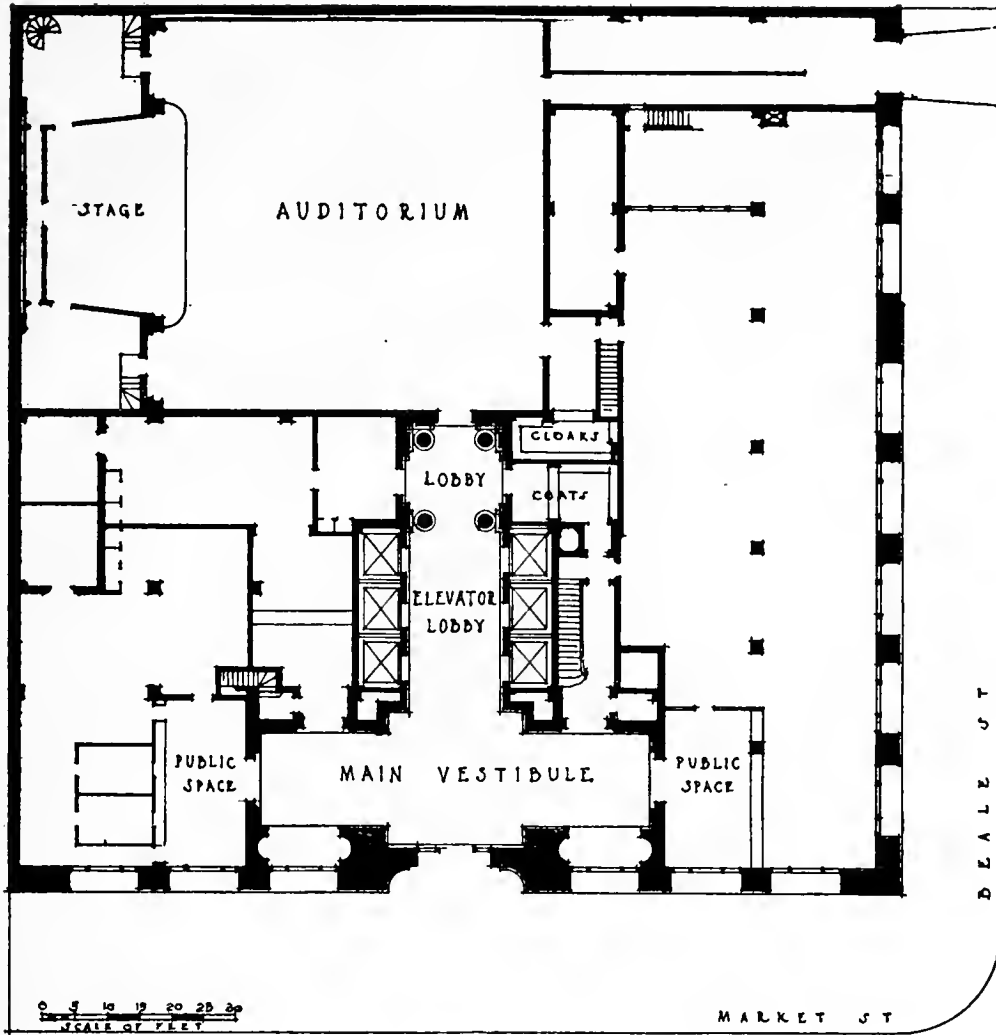

BASEMENT AND FIRST FLOOR PLANS  
PACIFIC GAS & ELECTRIC CO. BUILDING  
SAN FRANCISCO, CALIFORNIA  
BAKEWELL & BROWN, ARCHITECTS

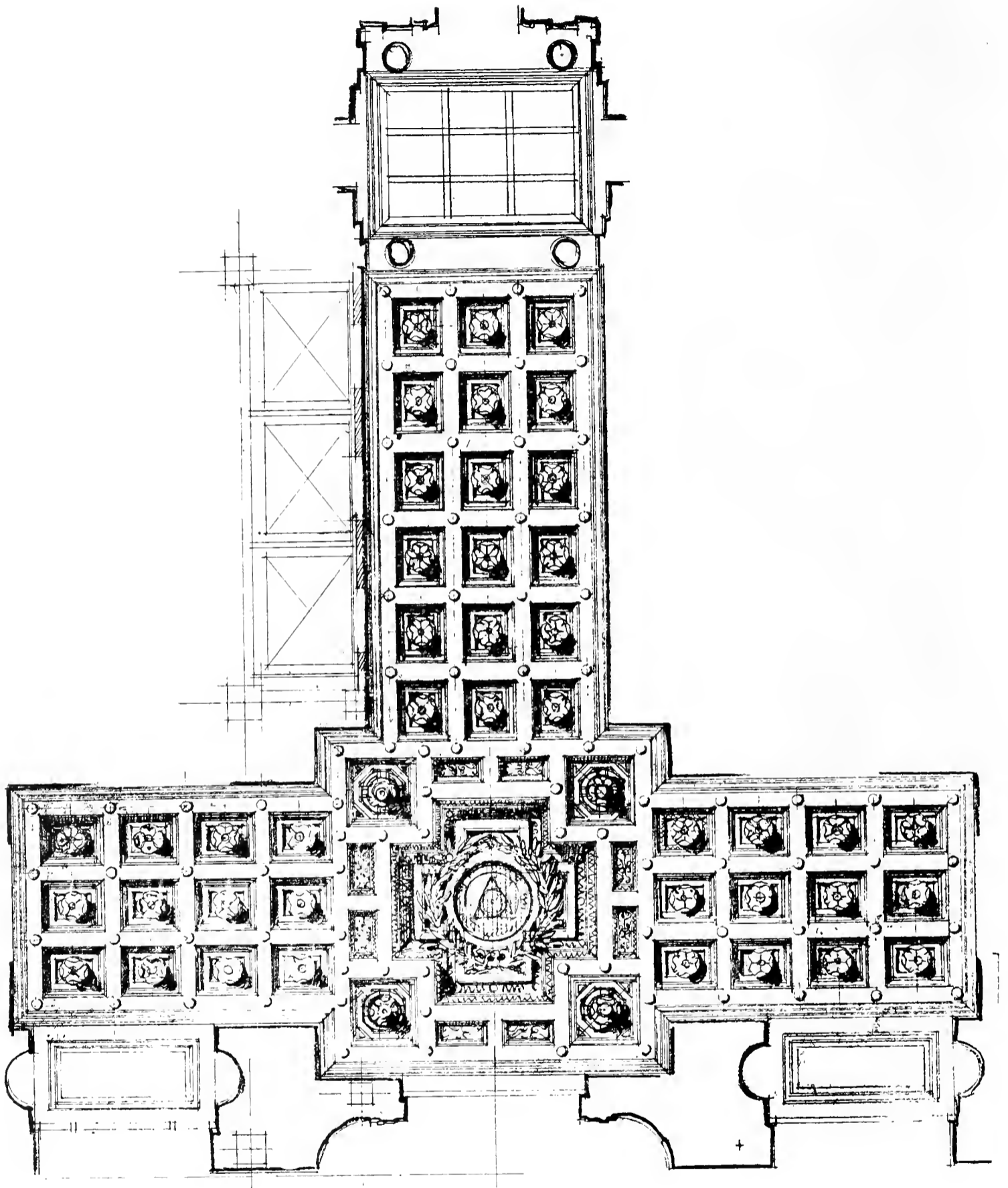

CEILING OF MAIN LOBBY  
PACIFIC GAS & ELECTRIC CO. BUILDING  
SAN FRANCISCO, CALIFORNIA  
BAKEWELL & BROWN, ARCHITECTS



SUPERINTENDENT'S RESIDENCE,  
WHITTIER STATE SCHOOL,  
WHITTIER, CALIFORNIA.  
GEO. B. McDOUGALL, ARCHITECT

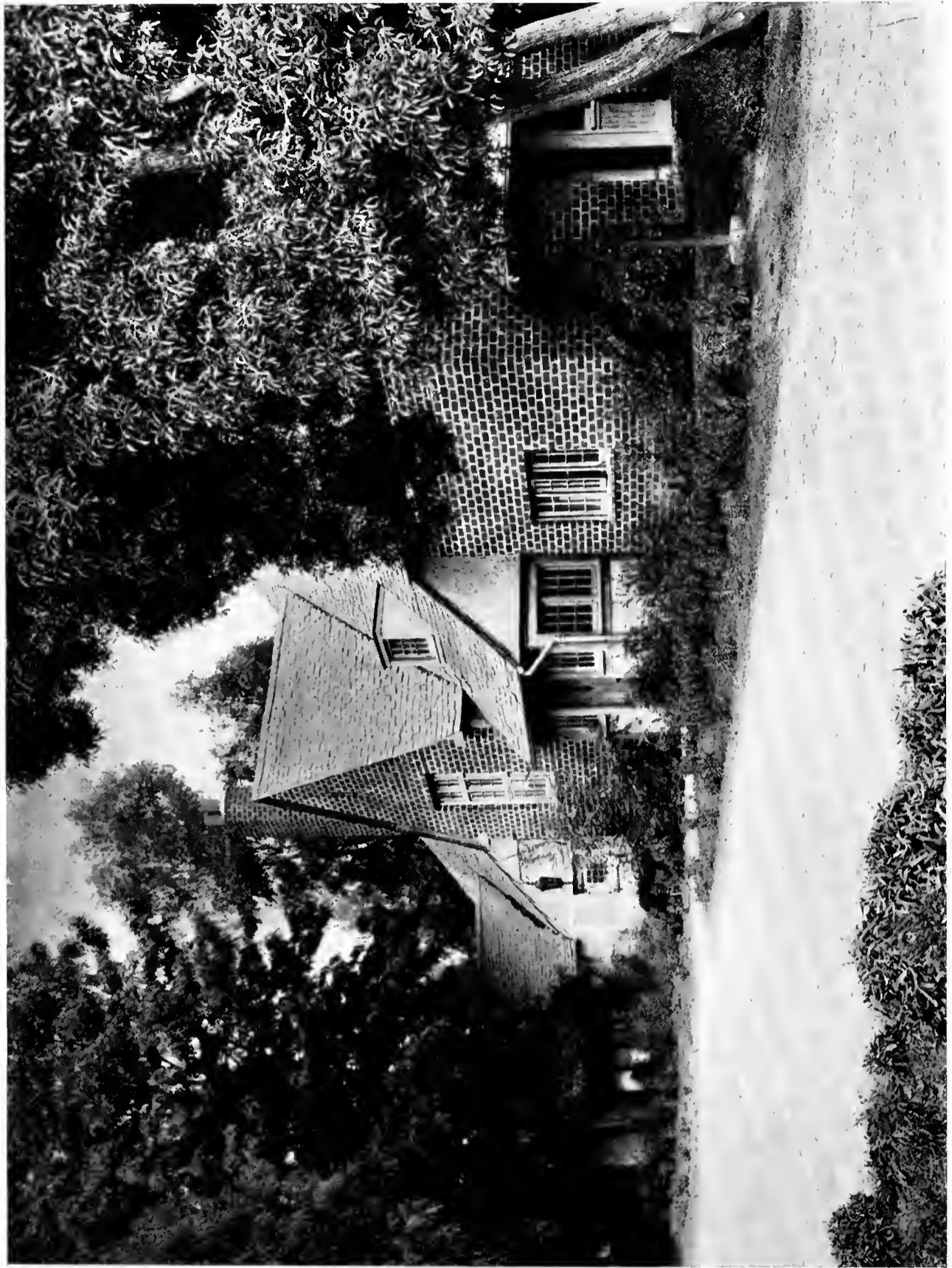

SUPERINTENDENT'S RESIDENCE,  
WHITTIER STATE SCHOOL,  
WHITTIER, CALIFORNIA  
GEO. B. McDOUGALL, ARCHITECT



SUPERINTENDENT'S RESIDENCE,  
WHITTIER STATE SCHOOL,  
WHITTIER, CALIFORNIA  
GEO. B. McDOUGALL, ARCHITECT



VIEW OF INDUSTRIAL COURT, SHOWING POWER HOUSE, LAUNDRY,  
BOILER AND PRINT SHOPS



REAR OF BOYS COTTAGE No. 10





MAIN ELEVATION, HOSPITAL BUILDING



MAIN ELEVATION, SCHOOL BUILDING

WHITTIER STATE SCHOOL,  
WHITTIER, CALIFORNIA  
GEO. B. McDOUGALL, ARCHITECT

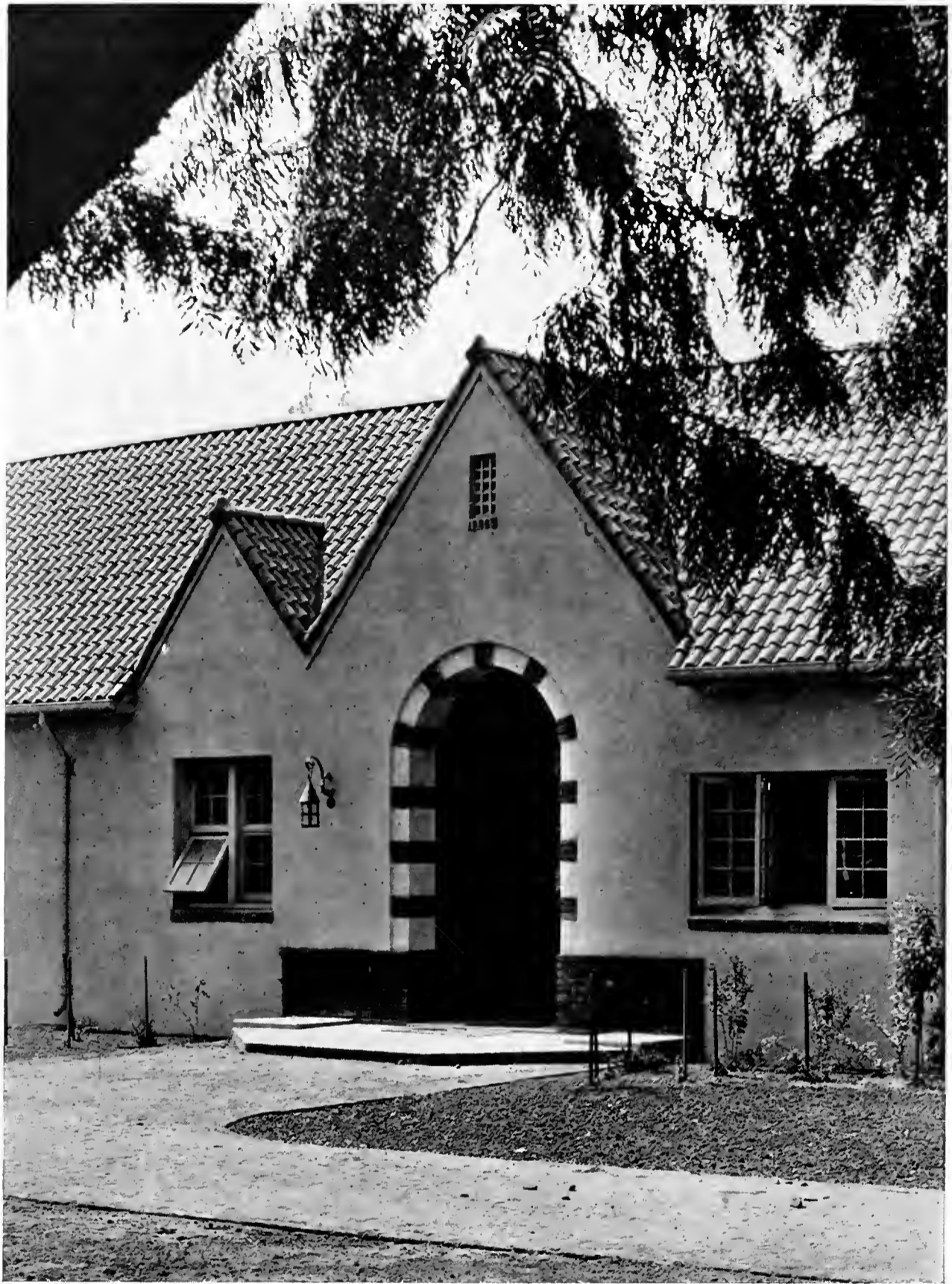

ENTRANCE DETAIL, SCHOOL BUILDING  
WHITTIER STATE SCHOOL,  
WHITTIER, CALIFORNIA  
GEO. B. McDOUGALL, ARCHITECT

# THE GARDEN

## NOTES ON BERRIED SHRUBS

BY KATHERINE JONES

(Concluded from December Issue)

**PUNICA GRANATUM.**—This is the variety that produces the edible Pomegranates. The flowers may be either red or white and the foliage is a yellow-green in color, which is distinctly different from the greens generally about it. It may therefore be used as an accent plant or a specimen plant, as its bright fruit forms a pleasing contrast with the leaves. It is hardy and largely grown in the hot interior valleys, where it is particularly welcome, both for fruit and for ornament.

The one with variegated leaves is called *Madame Legrellei* and the dwarf form is called *P. granatum nana*.

Pomegranates are free flowering and bloom most of the summer. Their leaves are deciduous.

Used as pot plants in France, as a wall plant in England, and in masses and as a specimen plant in California.

Propagated from cuttings of hard wood or from layers.

**PYRACANTHA ANGUSTIFOLIA.**—This plant is always attractive. It has an abundance of foliage to set off the fruit, the flowers are fair but it is the berries that are the crowning glory. They begin to show a yellow color in September and usually by November are a brilliant orange. This color they retain until June. A well-cultivated shrub full of berries, as the Japanese know how to grow it, is a handsome thing. To bring the berries to perfection a certain amount of fertilizers must be applied while the berries are filling out and they must also be watered freely at this time. However, these are the last to bring forth their berries and usually the winter rains are sufficient to bring them to their maturity.

In Southern California this year there were many complaints about this shrub—it is dying out as soon as it reaches maturity, due to some insect. This trouble has become so prevalent that it is hard to buy it, the nurserymen being unable to keep it in stock. It is said to be a borer from our native chaparral.

Good for specimen shrub, for picturesque effect and fine as an accent shrub back of two other shrubs.

**PYRACANTHA CRENULATA.**—(Nepalense White Thorn.)—A fast growing berried  
(Concluded on Page XVIII)

## NEW GENERAL OFFICE BUILDING OF THE PACIFIC GAS AND ELECTRIC COMPANY

The new general office building which the Pacific Gas and Electric Company is preparing to erect at the southeast corner of Market and Beale Streets, in San Francisco, will be an outstanding addition to the lower Market Street business district. Rising to a height of seventeen stories, it will be exceeded by only the Hobart and the Standard Oil Buildings. The new building will stand on the west half of the block between Beale and Main Streets the other 50-vara lot on the Main Street corner being occupied by the new 16-story building of the Matson Navigation Company, now under construction. The two structures combined, will present one of the most striking blocks in the city.

Architecturally, the design is a straightforward treatment of the problem in a simple dignified and monumental manner. The notable features of the exterior are the first story arcade with its central entrance arch, the plain and simple shaft and the interesting colonnade at the top. The windows are so grouped as to carry vertical lines from the base to the cornice, these lines being accentuated by the colonnade and the broken cornice. This treatment of the upper portion gives interesting shadows and a pleasing and graceful effect. The monumental scale adopted is particularly in keeping with this simple and dignified scheme of treatment.

The first floor covers the entire site and is devoted to those departments most frequent and intimate contact with the public, and to an auditorium for general assembly purposes seating 500 people. The main entrance lobby is handled as a distinct architectural feature giving ready access to the elevators, the assembly hall, and the departmental offices on either hand.

Above the main story, the floors are ell-shaped, forming a large well-lighted court in the center, opening upon a similar court in the Matson Building to the east. Consideration has been given to possible expansion by provision for the future construction of two additional bays in the main shaft along Beale Street, and an additional wing across one side of the court. When necessary either or both of these expansions can readily be made without interrupting the occupants of the building.

The construction of the building will be Class "A" in every particular, steel concrete

(Concluded on Page XVII)

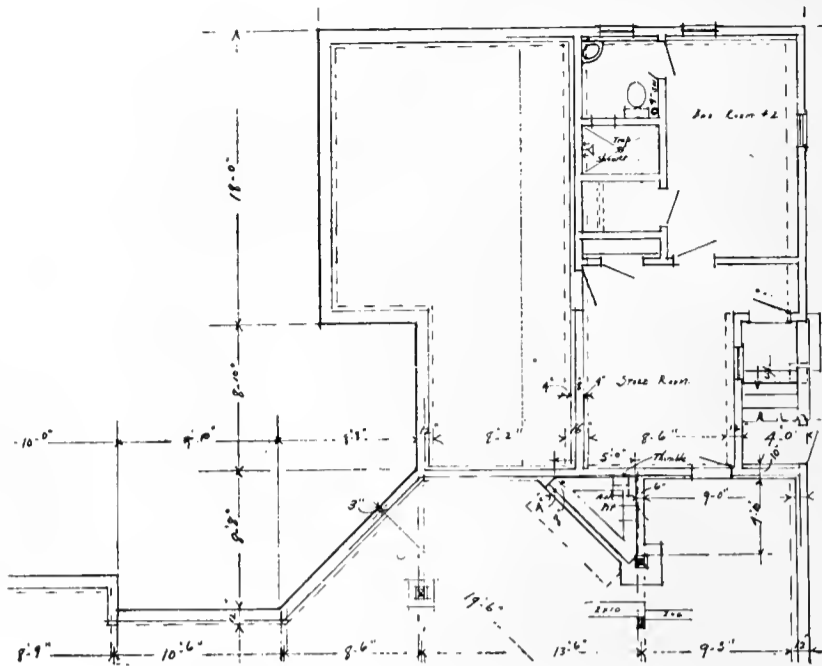

BASEMENT PLAN  
HOUSE OF C. E. GREENFIELD, SAN ANSELMO, CALIFORNIA

(Concluded from page 8)

elevation. A live-oak draped with Spanish moss grows where the front of the house is to be. This tree, the largest one on the plot, must be preserved, so it will be allowed to grow up through the floor of the terrace.

The patio idea, which turned to resemble more the Mexican "precita," was incorporated very harmoniously into the plan by placing it at the rear of the living-room enclosed on two sides by the bed-room and kitchen wings. The arrangement of rooms is expressed happily in terms of the site. The front of the octagonal living-room is almost entirely of glass; the opposite side also, in the form of French doors leading to the "patio", paved with irregular cement flagstones. This room, the keystone of the house, completely fulfills one's idea of a country home, with its ceiling of solid beams, walls of rough plaster and cobblestone fireplace.

The bed-rooms consist of two parts—sleeping porch and dressing room, which is a sanitary and comfortable way of planning the house in the country so as to conserve space and heat and also include the benefits of outdoor sleeping.

This house is designed for comfort. It is well-planned for a rather unusual and difficult location. With its grey-green sides and touch of varied colors in roof-shingles it is in sympathetic harmony with the tints of surrounding shrubs and trees. Not a distinct "type", neither "English Cottage", "French Cottage", "French Peasant" or "Mexican-Spanish"; but contrived to express, by the adaptation of features from these styles, the individuality of the owner, at a moderate cost.

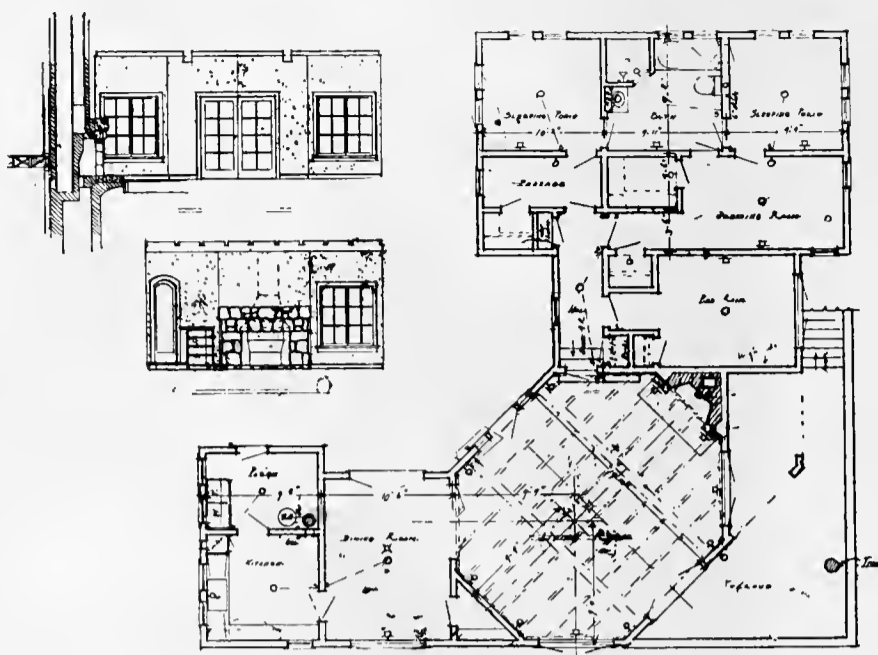

MAIN FLOOR PLAN  
HARRIS ALLEN, ARCHITECT

### THE WHITTIER STATE SCHOOL

The treatment of the new Whittier buildings, including their setting, is noteworthy. There is little of the "institutional" about this institution; it does not present the picture which appears mentally in connection with that word, of a series of factory-like units, cold, dreary, forbidding. This, on the contrary, is essentially home-like, and its influence on its inmates should prove similar to that of a good home. The effect of environment is unquestionable; it should be reflected in a growing spirit of interest, energy, ambition, self-respect, among these boys.

And the buildings are constructed for safety and comfort as well as for appearance. A few brief descriptive notes will be of interest:

*Superintendent's Residence.* This residence is built of brick exterior walls with wooden floors and partitions. The exterior brick walls are of common brick especially selected for color and laid flat in the wall. The roof is laid with slates with irregular courses. The majority of the slate used was salvaged from an old chapel building recently torn down and this material had taken on a nice color due to its exposure to the weather. The balance was made up of new black slate which gave a two-tone effect to the roof. Some interesting wrought iron work will be noted as used for door hinges, escutcheons, lanterns, etc. These were designed and executed by some of the boys in the blacksmith shop at the School. The garden entrance shows a little graffi to detail done in black and grey, which was designed on the job as the work was executed. Much of the success of the house is due to the landscape



WHITTIER, CALIFORNIA

BOYS' COTTAGE, No. 11, WHITTIER STATE SCHOOL

GEORGE B. McDOUGALL, ARCHITECT

work which was performed by the school gardeners.

*Hospital Building.* This building is built with cherry red ruffled brick exterior walls and red Spanish tile roof. This building at present houses on the second floor the hospital activities of the School, and on the first floor the administrative offices.

*Cottages Nos. 10 and 12.* These two cottages are honor cottages and each one provides accommodations for about forty boys; each contains a living room, dining room, play room, kitchen, officers' quarters, dormitories, baths, etc. The exterior walls are of red ruffled brick and the roofs of red Spanish tile.

*Boys' Cottage No. 11.* This cottage is built of the same materials as the boys' cottages mentioned above but is used to house the receiving and the detention units. It is designed to furnish the usual living accommodations for the boys and is planned so that the units surrounding two interior courts are used as playgrounds and exercise courts for the boys.

*Power House, Laundry, Tailor Shop and Print Shop.* These buildings are all built with red ruffled brick walls and accommodate some of the industries needed for the School; all are provided with up to date equipment, are well lighted and ventilated. The power house provides heat and hot water for the institution, and adjoining this building are the carpenter shop, the blacksmith shop, the machine shop

and the paint shop. The laundry has new modern equipment and does all the work for the institution. The print shop has adequate presses, etc., and prints several journals distributed by the School. The exterior of the print shop is more or less unique in that the facade somewhat accuses the saw tooth lighting used.

*School Building.* This building provides five class rooms, a laboratory, principal's office, conference room, etc. Exterior and interior walls are Heath Tile, those in the corridor being left exposed. The walls are plastered and painted with a warm grey color; the roof is of small Spanish tile.



SUPERINTENDENT'S RESIDENCE

## INDUSTRIAL

## Building Program for 1923 Largest in History of Western States

*Summary of Proposed Activities Outlined by Various Industrial Centers*

## STOCKTON

Indications point to a record breaking building year for Stockton. Within a few weeks construction will start on two civic buildings, a city hall and an auditorium, which together will cost approximately \$1,000,000.

Plans are now being prepared for seven two-story reinforced concrete brick and terra cotta college buildings for the College of the Pacific, which will cost \$650,000. Construction will be started about June 1st.

Announcement has been made of the construction of a pre-cooling and cold storage plant, costing \$260,000. The plant will be located on the Stockton waterfront and is expected to be completed before the summer months.

Favorable recommendation has been given the proposal for increasing the size of the Stockton postoffice building. This work is estimated to cost \$180,000.

Many business blocks have been planned and bids will be called for immediately. The year also promises one of the most active home building programs that has been carried out in some time.

## SEATTLE, WASH.

Seattle begins 1923 with more building in sight than in 1922, when all previous records were smashed with the issuing of \$20,000,000 in permits.

Some of the larger projects which will be put up this year are a \$3,000,000, 1,000-room office structure for Dexter Horton Bank interests; the \$2,800,000 "Olympic" Hotel; a million-dollar vaudeville theatre and several substantial store buildings.

In addition to this, apartment house construction will continue on a big scale. There is also considerable building, both in concrete and frame structure, in the industrial sections.

## LOS ANGELES

The building forecast for Los Angeles in 1923 would be astonishing were it not a continued, natural development. Even the natives, who have been here since the "Eighties" are no longer surprised at anything. They have seen their old land marks go with a heart throb, they have endured the ravishing of famous "squares", but now they have accepted with common sense, not to say resignation, the tremendously progressive building program that seems to have no ending.

According to performance of 1922, wherein the building total reached \$121,206,787, and plans now listed with the Los Angeles Chamber of Commerce, it is not a wide estimate to figure \$150,000,000 as the total for this year. School buildings to the amount of from nine to twelve million, are scheduled for 1923 and the new public library, the new Hall of Justice and City Jail at a value of \$1,500,000 and \$3,000,000 respectively add to the big start.

Recorded at this writing, not including contemplated buildings, are: nine office buildings, totalling \$7,940,000, which includes the Los Angeles Chamber of Commerce building, costing \$2,500,000 twelve store and loft buildings to total \$3,725,000; eleven warehouse, factory and garage buildings, \$2,805,000; industrial: Borax refinery and Union Pacific shops: \$2,250,000; hotels and apartments, six hotels, \$3,225,000 and seven apartment structures, \$5,325,000; this includes two one-million dollar, ten and thirteen-story buildings in the Wilshire district, and the great cross-shaped structure in Hollywood, 350x250 feet, \$1,500,000. Hospitals four, totalling \$1,100,000; churches, eight, total, \$2,594,000; club and lodge buildings, seven, \$3,950,000; theatres, two, \$1,300,000.

For the first nine business days of January 1,692 permits had been issued totalling in value close to \$4,000,000. Housing and mis-

(Continued on page 14)

## Carquinez Bridge Aid to Industrial Development of Northern California

The building of a bridge across Carquinez Straits appears to be near realization. It will connect Contra Costa and Solano counties and for the first time provide a direct highway between the northern and the central parts of the State—and that means great things in the way of industrial development.

There are several bridge projects before the people of the San Francisco Bay district, but the Carquinez Straits project is by far the most advanced. The awarding of a franchise for Carquinez bridge is to come before the Supervisors of Contra Costa County on January 9. If the award is made at that time, and there is every reason to believe it will be, there is at least one company, now seeking the franchise, that has announced its readiness to begin work on the structure immediately and have it open for traffic in the Spring of 1924.

There are three applicants for the Carquinez Straits bridge franchise. The project was pioneered by the San Francisco Transit Company and that company, evidence so far taken by the Contra Costa Supervisors, shows, is best prepared to start immediately on the construction work. It has had two years to get ready for the job, its plans and specifications are complete and these have been approved by the War Department.

The magnitude of the project is evidenced by an examination of the plans prepared by the engineers of the Transit company. This engineering staff is headed by Charles Evan Fowler, of Detroit and New York, one of the leading bridge engineers of the world. Associated with him are Dr. D. B. Steinman, of New York, probably this country's greatest authority on long span bridges; Edwin Duryea and H. L. Haehl, of San Francisco. All are members of the American Society of Civil Engineers.

The bridge is to cross the straits from Eckley, midway between Crockett and Port Costa, to Dillon's Point, midway between Benecia and South Vallejo. The structure is to be of the suspension type, 3000 feet in length, and 135 feet above mean high water. The middle span, for navigation, is to be 1500 feet, with two shore spans of 750 feet each.

The bridge towers are to arise 300 feet above the foundations that are to be sunk to rock at the bottom of the stream. These foundations will go down approximately 100 feet,

will have a width of 90 feet and a breadth of 20 feet.

The two main cables which will support the big structure are to be 11½ inches in diameter, and each will be composed of seven strands containing 350 No. 6 R. G. (0.192 inches in diameter) galvanized steel wires. The cables are to be continuous over the towers and each is to be wrapped with No. 9 soft annealed galvanized steel wrapping wire. The suspenders are to be 1½ inches in diameter.

The total weight of the steel in the towers, cables, stiffening trusses, etc., is estimated at 8,925,000 pounds. The cables alone will weigh 1,750,000 pounds. The total weight of the bridge, not including the foundations and the anchorages, will be 14,105,000 pounds. In the anchorages there are to be 1,034,000 pounds of steel and 10,000 cubic yards of concrete. In the two tower foundations there will be in excess of 8000 cubic yards of concrete.

Across the bridge there is to be a roadway thirty feet in width and the bridge is designed to carry a moving load of 4,500,000 pounds. A paved roadway is to connect each bridge-head with the State highway on either side.

When this bridge is completed it will be possible for vehicular traffic to move in practically a direct line between Northern California and Central California. At the present time this cannot be done, except by going around by way of Stockton and crossing the Sacramento river at Sacramento on a bridge—or by using a ferry. The Stockton route means many excess miles of travel; the ferry means delay, and there are various commodities such as explosives and gasoline that are forbidden transportation on the ferries.

It is not difficult to visualize the fact that the bridge will prove a great boon to industrial and agricultural interests throughout a great part of the State. Direct traffic is now impossible. The ferries are slow, their accommodations are limited and they operate only during certain hours. The farmer in the northern counties cannot reach the early morning markets in the Bay cities without at least 24 hours delay and spoilage often results. With a bridge, open all day and all night and over which he can cross within three minutes, this costly delay will be avoided and the result is certain to be intensive development in Solano,

(Concluded on page XV)

SAN FRANCISCO CHAPTER AMERICAN INSTITUTE OF ARCHITECTS  
MONTHLY BULLETIN

OFFICERS

Geo. W. Kelham, President.  
Henry H. Myers, Vice-President.  
J. S. Fairweather, Secretary-Treasurer.



DIRECTORS

Wm. Mooser, three years.  
J. H. Blohme, three years.  
A. J. Evers, two years.  
Harris Allen, two years.  
S. Schnaittacher, one year.  
Morris M. Bruce, one year.

NEXT MEETING

The next meeting will be held Thursday evening, January 18, 1923, at the Architectural Club Rooms, 77 O'Farrell Street, at 6:30 p. m., and will be preceded by a Directors Meeting at 5:30 p. m.

The President will endeavor to have some person at the next meeting to talk on a subject of interest to the members.

DECEMBER MEETING

The Board of Directors feel in this meeting at this season of the year a general feeling of good fellowship and extend a Happy and Prosperous New Year to all members of the Chapter.

The Directors and Regular Meeting of the San Francisco Chapter of the A. I. A. was held Thursday evening, December 21, 1922, in the Architectural Club Rooms, 77 O'Farrell Street. The meeting was called to order by Vice President Henry H. Myers. The following members were present: E. B. Hurt, J. H. Blohme, Morris M. Bruce, Herbert Schmidt, Wm. O. Raiguel, Harris Allen, A. J. Evers, Wm. Mooser, S. Schnaittacher, J. S. Fairweather.

NEW BUSINESS

A draft of a Circular of Information was made by Harris Allen which was read and a copy was ordered sent to each Director for his comments.

COMMUNICATIONS

A letter from the Spring Valley Water Company was read and ordered published in the Bulletin.

A letter from Albert Schroepfer relative to the Chapter and Industrial Relations received and placed on file.

ADJOURNMENT

There being no further business before the Chapter the meeting adjourned.

J. S. FAIRWEATHER,  
Secretary.

San Francisco, December 14, 1922.

S. F. Chapter of Architects,  
Care J. Stewart Fairweather, Secy.,  
Balboa Bldg., S. F.  
Gentlemen:

From time to time we receive complaints of poor service from consumers in various parts of the City, our latest being from owners who have installed flush valve toilets and instantaneous heaters.

This condition is usually due to the installation of too small a house pipe for the water pressure at that particular point, and to the character and number of fixtures to be supplied. In order to overcome this a considerable expenditure must be entailed by the property owner in making the necessary changes.

The pressure conditions, which vary considerably in various parts of the City on account of the topography, must be taken into consideration when determining the sizes of the house piping if a satisfactory service is desired.

With a view to co-operation we respectfully request that you notify your membership that we will be glad to furnish such information as is necessary in determining sizes of pipes for various classes of houses, based on the pressure conditions existing.

Very truly yours,  
SPRING VALLEY WATER COMPANY,  
By V. E. Perry, Asst. Mgr. Water Sales Dept.

ARCHITECT CHOSEN BY MILLS COLLEGE

At the December meeting of the Board of Trustees of Mills College, Walter H. Ratcliff, Jr., was appointed supervising architect of Mills College. For the progressive development of the campus, Ratcliff will use the general architectural plan drawn by Bernard Maybeck in 1918. This plan was the gift of the late Mrs. Hearst and is known as the Phoebe Apperson Hearst general plan for Mills College. Each building to be construct-

ed in the future will conform to the outlined scheme. The new roadway recently made from the Beulah Gate, on the line of the San Francisco-Oakland Terminal Railways, to the heart of the campus is a part of this general plan. It will make the north and south axis, crossing the east and west axis near the present "College Hall." Work has already begun on the second roadway which will begin at Seminary avenue opposite Trainor street, and end at the proposed site for the new College Library on Aliso Hill. Planting also will follow the extensive designs of Mr. Maybeck.



# There are no better Plumbing Fixtures



TRADE MARK REGISTERED

*Specify*

**PACIFIC**  
PLUMBING FIXTURES

## Western Building Activities

(Continued from page 10)

cellaneous building has not been included in this article, but operations are being continued on a very extensive scale. It is estimated that dwelling permits will total 25 per cent more this year than in 1922. In last year's report there were 16,754 permits for single dwellings 275 for apartment buildings, and 505 for flats up to December 1.

In the metropolitan area of Los Angeles factory and industrial buildings totalled about \$12,000,000, one-half of which was in Los Angeles proper. Figuring the building cost at approximately \$1.50 per square foot, this area covered 9,000,000 square feet.

Los Angeles' neighbor cities in Southern California piled up a total in 1922 of approximately \$100,000,000 in building and this year it is expected they will increase this aggregate.

---

### DENVER, COLO.

Conservative estimates are that at least \$16,000,000 will be expended for building here this year, in addition to residences and business houses which are now in course of construction.

The most extensive educational building program ever planned in Denver will be launched by the Board of Education this year. During the year construction work will be started on three new high schools, two new junior high schools and several elementary schools. A two and one-half story school administration building will be completed before the summer.

The State Medical School and Hospital of the University of Colorado is being constructed at a cost of \$1,850,000. The hospital will have seven buildings and it is probable that the institution will be near completion by the end of 1923.

The Presbyterian Hospital now being constructed will cost a million dollars or more.

Burlington Railroad shops at a cost of \$2,500,000, the 16th street viaduct at a cost of \$470,000, the Broadway viaduct at a cost of \$380,000, the Patterson office building at a cost of \$500,000 and the Myers Pulp and Paper factory at a cost of \$550,000 and various other projects that are now under way will be completed during the year 1923.

### SAN JOSE

The building activities within the corporate limits of San Jose during 1922 aggregated \$1,971,660, an increase of more than \$700,000 over 1923, and construction in the city but outside the municipal lines reached approximately \$1,000,000 more. Similar activity characterized the year in the smaller cities throughout the country. Continuation of present work and plans for the immediate future will keep all the building trades mechanics in city and county busy for a least the next six months. Residence construction is steadily increasing in San Jose and its suburbs; other 1923 structures now certain are Parochial School, \$100,000; Scottish Rite Temple, North Market Street, \$300,000; First Presbyterian Church addition, \$75,000; J. S. Mise Hotel, 60 rooms; Williams Binder business block, South Market Street, \$75,000; new business structures covering entire block, site of old Eagle Brewery, by T. S. Montgomery syndicate; Commercial Club, eight-story modern structure, adjoining Bank of San Jose, \$400,000; Knights of Columbus building, adjoining Commercial Club building, \$160,000; new Science Hall, Santa Clara University, \$148,000. The Hotel Company of Palo Alto expects to finance a \$275,000 tourist hotel this year, and several school districts in the county, who during the past two years have sold bonds aggregating approximately \$2,000,000 for new grammar and high school buildings, will continue their building program throughout the present year.

---

### COLORADO SPRINGS, COLO.

The building program for Colorado Springs for 1923 will be the largest in the history of the city. Under construction now are the one-half million dollar Municipal Auditorium; Day Nursery, costing \$250,000; the Deaf and Blind Institute at a cost of \$150,000; the Stratton Home, at a cost of \$100,000; the Broadmoor Hotel costing \$75,000 and several other large projects, including housing contracts amounting to several hundred thousand dollars.

There are to be built this year school buildings for which the bond issue for \$1,100,000 was recently voted. The Methodist General Hospital which will cost \$2,500,000; a new office building which will cost about \$400,000, besides additions and alterations on local banks and commercial houses.

## SACRAMENTO

Building expansion in the field of civic, business, industrial and private endeavor, which will exceed by many millions the record for 1922, is forecast for the coming year in Sacramento.

Plans were just approved in Washington for a million dollar auxiliary post office building; the State of California has begun active work on the erection of Capitol Extension Buildings costing over \$3,000,000 and a State Printing Office costing \$140,000; the city of Sacramento is planning extensions to its school buildings and will also take action on plans for a million dollar Civic Auditorium.

The new business structures to be erected are the twelve story California State Life Insurance Building, a new department store and club building costing over a million dollars, a public market costing \$200,000 and extensive additions to the John Breuner Company furniture store. The Sutter Hospital now under course of construction will cost \$500,000.

A consistent demand for new homes running in value from \$7,000 to \$15,000 is continuing unabated.

## BUTTE, MONTANA

Butte's 1923 building program, thus far announced, includes the construction of a new million dollar hotel and a \$350,000 Masonic Temple annex. The work of tearing down the old Finlen hotel, which the new structure will replace, is scheduled to begin January 15, while excavation for the Temple annex is nearing completion. It is hoped to finish both buildings within the year.

Because of cold weather, construction never gets well under way in Butte until spring and for that reason it is rather difficult at this time to predict with any degree of accuracy, just what the building program will include. In 1921, building permits totaling 181 were issued by the city department of public works and involved property valued at \$91,448. In 1922, permits to the number of 272 covering a property value of \$314,000 were issued, the year's building program including five large business structures and apartments. Architects and contractors expect that 1923's construction work will average about \$3,750,000.

## WACO, TEXAS

The building permits for 1922 showed an increase in total valuation over 1921 of 69 per cent. We anticipate a still greater building for 1923. Among the prominent activities are the additional buildings to be erected at Baylor University; the new plant of the Southwestern Portland Cement Company; the \$2,000,000 M. K. & T. locomotive shops; several large commercial and industrial buildings and a number of residence structures.

Active plans are being formulated looking toward making Waco the textile center of Texas. Waco has a cotton mill and twine mill, both of modern construction and equipment and it is proposed to erect several more mills, the construction of which is expected to start this year.

## PORTLAND, ORE.

Residential building is proceeding at the remarkable pace established in 1922, together with large modern apartment houses and extensions to some of the office buildings that were built with the intention of enlargements at a later date. The value of building permits of 1922 was close to \$23,000,000.

The industrial growth is substantially reflected in the net increase of power supplied by the utilities which has shown a uniform growth since the close of the war. This is not caused by any one particular line, or in one particular plant, but by many small accretions covering the widely diversified industrial community.

## FRESNO, CALIF.

With a record of more than \$7,250,000 in buildings for 1922, several large office buildings now under construction, and plans announced for a number of similar structures, to be erected the present year, Fresno may be expected to support a building program of considerable importance in 1923.

The Patterson block, will be completed within three months. The Californian, on which work is under way will be completed by September. The Power Company building and the Fidelity Bank building, two large office buildings will also be completed during the year.

Better types of apartment houses will be erected, as there is a particular need in this field. The home building program, will doubtless fill the greater portion of the entire program since the demand is still very active and the field not yet covered.

INDEX OF ADVERTISERS

# Floors of Tile



enduring and attractive for Stores, Public Buildings and Residences

## Tropico Quarry Tiles

are made in several warm-toned permanent colors. They create an atmosphere of dignified richness as well as provide a sanitary and long-lived floor material. A color chart will be forwarded upon request.

Tropico Tiles are sold by the better Tile Dealers. Look for "Tropico" on each tile.

## TROPICO POTTERIES

GLENDALE - CALIFORNIA *Inc.*



	Pages
ASBESTOS SHINGLES AND BUILDING LUMBER .....	VI-IX-XV.
ASBESTOS CORRUGATED SHEATHING .....	VI-IX-XV.
ASBESTOS ROOFING .....	VI.
BARS, REINFORCING .....	XV.
BRICK, FIRE AND REFRACTORIES...	V-IV-XIV-OB COVER
BRICK, PRESSED .....	V-IV-XIV-OB COVER
BUNGALOW PLAN BOOKS.....	XII
COLD STORAGE INSULATION.....	XV.
CORK FLOOR .....	XV.
ELECTRICAL SUPPLIES—ASBESTOS..	VI
FURNITURE—SCHOOL, LODGE AND CHURCH .....	III-IV
FLOORING .....	1-XII-XV
GLASS .....	I-XIII
INTERIOR DECORATORS.....	X-XII
IRONING BOARDS .....	VIII
JEWELRY AND SILVERWARE.....	VII
KITCHEN—SINKS .....	III
LIGHTING FIXTURES .....	IV-XII
LUMBER .....	XVII
MACHINERY AND SUPPLIES.....	XVII
MATS .....	VIII
MILL WORK .....	IV-VIII
NURSERIES .....	IV
ORNAMENTAL IRON .....	X
PAINTS, ENAMELS AND WOOD FINISHES .....	I. F. Cover-I-XV-XVII
PLUMBING EQUIPMENT.....	69
PIPE, WOOD.....	VIII
PORTABLE HOUSES .....	VIII
RAILROADS .....	VII
REINFORCING STEEL .....	XV.
ROOFING .....	I-VI-XV
SAND .....	XII
SEWER PIPE AND CLAY PRODUCTS..	IV
SLIDING DOORS .....	VIII
SINKS .....	III
STEEL .....	XV
STUCCO .....	XII
TANKS—WOOD .....	VIII
TERRA COTTA .....	XII
TILE .....	III-XII
TILE—ROOFING .....	XII
TILE—HOLLOW .....	XII
TIN .....	XVI
TREES, PLANTS AND SHRUBS.....	IV
VARNISHES .....	I-I.F. Cover-XVII
WALL BOARDS .....	IV-VIII
WATER HEATERS.....	67
WATERPROOFING .....	I-X
WINDOW SASH (Steel) .....	X

## Stillwell PLAN BOOKS of CALIFORNIA STYLE All Climate HOMES

—show pictures, Floor Plans and Estimated Costs of Building over 200 Selected Designs.

"West Coast Bungalows"  
50 Houses—6 and 7 Rooms—\$1  
"Little Bungalows"  
75 Houses—3-4-5 Rooms—\$1.

**SPECIAL OFFER:** Send \$2.50 for any three of these books and get Garage Folder FREE.  
*Books and Blueprints sold with Money-Back Guarantee*  
**E. W. STILLWELL & CO., 790 California Building, Los Angeles**



"Representative California Homes"  
50 Houses—7 to 10 Rooms—\$1.  
"The New Colonials"  
60 Houses—6 to 10 Rooms—\$1.

DEL MONTE AND FAN SHELL BEACH

## WHITE SANDS

DIRECT FROM PITS or FRESH WATER  
WASHED AND STEAM DRIED

Best and Cleanest Natural High Silica Sands on this Coast for Stucco, Fine Plasters, Foundry and other Building and Industrial Purposes

DEL MONTE PROPERTIES COMPANY

Phone Sutter 6130 401 Crocker Bldg., San Francisco

Phone Franklin 2492

## A. C. WOCKER

INTERIOR DECORATOR

1370 Sutter Street

San Francisco, Cal.

## Welfare of the Rising Generation

Boys and girls may owe to the architect, to a large extent, the robust physiques and alert mentality they attain with youth. Sunshine and air are indispensable and dominant influences in behalf of growing youngsters. The architect can perhaps do as much as any other human agency in assuring that they get it.

The playhouse, play room or nursery should have an extra area of window glass, to the extreme limit allowed by heating considerations,

A fitting finish to well drawn plans, involving an assurance of plentiful air and sunshine, is to specify American Window Glass Company's Products. An assurance of beauty, clear vision and strength is thus added.

American Window Glass is carefully graded under double inspection, well flattened and of uniform strength. Architects who know this will, of course, not fail to specify American Window Glass Company's Products and not just "single or double strength glass."

For your protection and assurance of quality this long ellipse appears on every box of genuine American Window Glass, together with the grade marking, A, or B. Specify the best and see that you get it.



# AMERICAN WINDOW GLASS CO.

GENERAL OFFICES: PITTSBURGH, PA.

BRANCHES IN PRINCIPAL CITIES

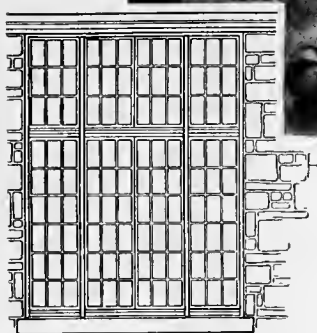

Exterior of playroom window frame. Sunlight and ventilation were foremost thoughts.

### NEW METHOD OF MEASURING SAND MAKES CONCRETE MORE RELIABLE

The reliability of concrete construction is likely to be increased, and the cost in some cases reduced, by the application of a newly developed method of measuring sand, which is now being tested at the Bureau of Standards of the Department of Commerce. The method has been termed the "inundation method" and consists of measuring sand in a container which has been partly filled with water before the sand is put in, so that when the sand is in, the water is up to the top and the sand completely soaked.

The volume occupied by a given amount of sand when shoveled into a measuring device varies with the moisture content of the sand; the difference in measured volume between dry and moist sand being usually from 10 to 15 per cent and occasionally running as high as 50 per cent. But it is found that if the sand is completely soaked or "inundated" uniform measuring results can be obtained no matter how much the original moisture content may have varied.

### TELEPHONE CORNERS

(Concluded from page 5)

shade as a finishing touch. There is a large casement window providing daylight over the right shoulder of the one sitting on the hour-glass stool. The door with the distinctive hardware leads to the kitchen.

Because telephones are not pleasing to the eye as to color and out-line fashion has tried in several ways to camouflage their existence so that unlike the well-behaved small child they are heard but not seen. This holds true principally in the formal home.

In the days when the telephone hung on the wall and we hung on to it, pictures like these could not have been created. Then it was purely utilitarian and ugly! Now the chief requisites for a convenient and attractive telephone corner are that it shall be central, well-lighted, day and night, it shall be provided with a table or shelf for note-taking and holding the directory, a calendar near by and the surroundings harmonious in coloring and decorative in nature.

## LASSEN COUNTY LEADS STATE IN LUMBER PRODUCTION

*Reforestation Insures New Growth Each  
Seventy-five Years*

Susanville, Jan. 3, 1923.—With an annual cut of over 300,000,000 feet Lassen County now claims to be the leading lumber producing county in the State of California. Over 5000 men were employed in the lumber industry in Lassen County this year and over 1600 car loads of lumber and lumber products shipped out of the county each month to market. Three big lumber companies are largely responsible for this cut. The Red River Lumber Company at Westwood cuts 200,000,000 feet; the Fruit Growers Supply Company at Susanville 75,000,000 feet; the Lassen Lumber and Box Company at Susanville 40,000,000 feet. This is the first year of quantity production for the Fruit Growers Supply Company and next year the cut will run 400,000,000 feet. It is hard to understand these immense production figures unless translated in ordinary terms.

The cut of the Fruit Growers Supply Company this year, for instance, would, if placed in one shipment, make a freight train eighteen miles long. Figuring that it requires 6000 feet of lumber to build an ordinary house the products of this one mill would be sufficient to erect 60,000 homes. Counting an average of five persons to a family this would mean the accommodation of 300,000,000 people. Figuring the cut of the entire county in the same proportion the lumber produced in Lassen County each year will build a city big enough to house 100,000,000 people.

It is only within the last five years that Lassen County has grown into a lumber producing county. The Red River Lumber Company located in Westwood in 1912 and built a city of its own with its own railroads, power plants, and highways. Now the Red River Lumber Company employs 3200 men and is one of the biggest producers of lumber in the west. The Lassen Lumber & Box Co. located in Susanville five years ago and from a very small beginning has grown into an industry employing 600 men and adding to its capacity each year. The Fruit Growers Supply Company with 11,000 stock holders in southern California located in Susanville two years ago and began building the most modern box factory and lumber mill in the world. This company employed 1200 men this year and next year will almost double that force while the capacity of the plant is being increased.

Susanville has grown in the last five years from a little mountain hamlet to a modern town of 4000 people and is now pointed to as the most progressive and prosperous community in Northern California. Lassen County has 533,023 acres of timber land and estimated at the present rate of cutting this timber will last for over two hundred years, but the lumber companies of Lassen County are leading the way in reforestation and through the methods now employed, with the assistance of the forest service, they expect to make their source of supply permanent with a new growth of pines coming up each seventy five years for cutting. Several new lumber manufacturing and allied industries are now contemplating locating in Susanville.

## PATENT DEVICE FOR WINDOWS IS INVENTED

A device that will lower the upper sash by means of the lower sash has been patented by Henry C. Trost, of the architectural firm of Trost & Trost, of El Paso.

Four parts of metal, all stamped from the same piece, constitute the device. To engage the upper sash the user pushes the lower one upwards until a clicking sound occurs, which is the contact made between the pendulum device on the lower sash and the beveled surface of the metal attachment on the upper.

The upper window can be lowered or raised any distance.

Mr. Trost said he realized the need of inventing a device that would eliminate the inconvenience of raising or lowering the upper sash. It can be adapted for all sizes of windows.

“Just Christian science,” said Mr. Trost, explaining how he had worked it out after years of study. He threw many designs away before he was successful, he said. It will be manufactured soon.

Read the

**ANNOUNCEMENT**

on page six

## Carquinez Bridge

(Concluded from page 11)

Napa, Sonoma and parts of Sacramento county.

To the manufacturer who controls a fleet of trucks—and most of them do—the bridge means bringing close a vast and growing market. The products of the factory can be loaded on the trucks and sent direct, and without delay, to any part of Northern California—night or day the bridge will be open to the manufacturer who seeks quick delivery.

Naturally the proposed bridge will be a private enterprise and tolls will be charged, but it is stated that these tolls will average about fifty per cent less than the present ferry charges. The franchise proposal of the San Francisco Transit Company opens the way for future public ownership. It is provided that the bridge may be purchased by the counties or the State at any time at a price to be fixed by a joint board of appraisers, three to be appointed by the company, three by the public and a seventh by the six. At the end of thirty years—the life of the franchise—it is provided that ownership of the bridge will revert, without charge, to the counties or the State as may be desired. The life of the bridge is estimated at 200 years.

The actual construction work on the bridge itself will bring a period of extra prosperity to several industries and localities. The San Francisco Transit Company's engineers have announced that they desire to place their orders for materials with local firms. The Cowell Cement Company, whose plant is located at Mt. Diablo, and the Columbia Steel Company, of Pittsburg, Contra Costa County, have already been consulted. The construction plans as prepared by the company call for the employment of 200 men at the start of the bridge building job and the increasing of this force as rapidly as possible to 600 men. The housing of these men, and in some instances their families, in Contra Costa and Solano counties is going to be a problem. The building of the bridge will take from 15 to 18 months.

To the localities in the vicinity of the bridge site the construction of the bridge means added prosperity from the very start. To a great part of the State the completion of the bridge will open new avenues for trade, greater territory for the autoist to explore, and mark the dawn of a new era of prosperity for many industries.

# WESTERN ASBESTOS MAGNESIA CO.

INSULATING ENGINEERS AND CONTRACTORS

Asbestos Roofings, Asbestos Built-Up Roofings, Asbestos and Asphalt Slate Surface Individual Shingles and Roll Roofing, Mastic and Magnesite Floorings.

Magnesia and Asbestos Pipe and Boiler Coverings

Cold Storage Insulation

"Linofelt", sound deadener

Wall Board

## SECTIONAL EXPANSION JOINTS

to fit all requirements for all types of paving, bridge work, etc.

21-29 SOUTH PARK

Bet. 2nd and 3rd Sts.

SAN FRANCISCO, CAL.

Telephone Douglas 3860

Note: We employ a force of skilled workmen and contract for the application of our coverings, roofings, cold storage insulations, waterproofings and mastic floorings



Acoustic Corrector, Insulator, Sound Deadener, and Plaster Base.

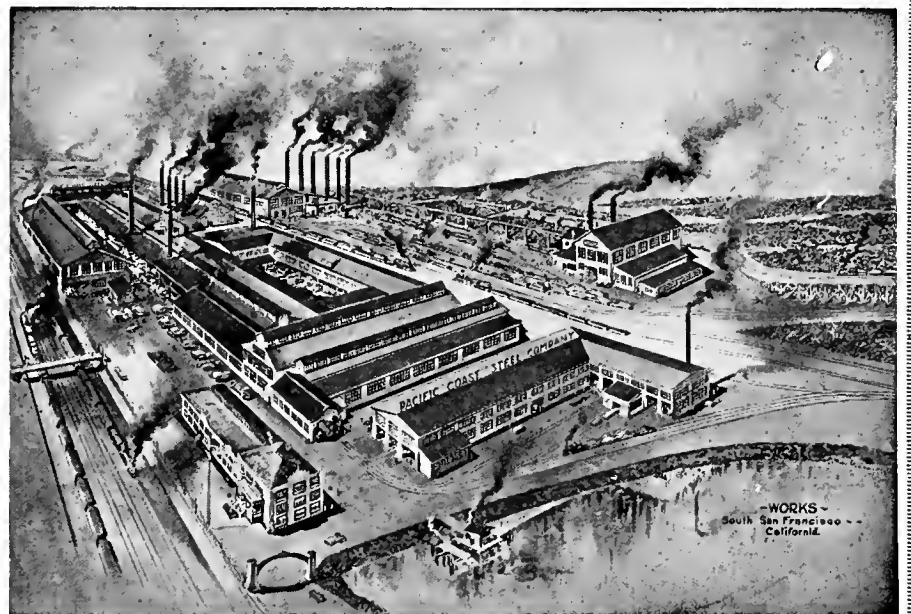

## SHAPES MANUFACTURED

Bolt Rods, Rivet Rods, Wire Rods, Bands, Flats,  
Billets for Forging, Plain Squares, Plain Rounds

Square and Round Corrugated Bars for Reinforcing  
Angles—Equal and Unequal Legs

Stock Lists will be Furnished Upon Request

## Pacific Coast Steel Company

OPEN HEARTH STEEL PRODUCTS

General Offices, Rialto Building, San Francisco

## Washington State Chapter

### NOVEMBER MEETING

John W. Roberts headed a committee from the Associated Industries and presented to the Chapter the situation as to Union Labor, requesting that the architects assist them to prevent the establishment of closed shop conditions. President Gould referred the entire matter to the Executive Committee for recommendation to the Chapter.

J. A. Blackwell, the new City Engineer of Seattle, spoke upon the problems of his office, shedding some new light on the work necessary for the accomplishment of any engineering work within the municipality. He also complimented the architects on the fact that they alone are largely responsible for the development of the city plan.

Mr. Naramore reported progress on the work of the Chapter's special committee on the Elks' Competition.

Resolutions upon the death of Mr. Whitney Warren were referred to the Executive Committee.

Harlan Thomas gave an interesting address on the evils of non-zoning, which he has been studying. He was very forcibly impressed with the results of non-zoning after his visit to twenty American cities. Mr. Thomas felt that the architect in his training should be equipped to advise, not only as to the planning of the building, but as to the proper type of building to be constructed in a given location. This of course more particularly applies to public and commercial buildings. He believes that stores, theatres, banks, wholesale buildings, etc., should be localized in given districts in order to reduce the growing traffic problem and to make the transactions of the business day more economical in the matter of time expended.

### DECEMBER MEETING

C. H. Alden, the Chapter's member on the Ordinance Commission, gave a preliminary report of the work of the Seattle Zoning Commission and suggested that the proposed ordinance be considered by the Chapter with a view to offering constructive criticisms to the Zoning Commission. The Chapter endorsed the general character of the ordinance and referred the review of it to the Ordinance Committee with instructions that they appear before the Zoning Commission with such suggestions as might develop therefrom. Mr. Siebrand, chairman of the Ordinance Committee, has held several conferences with the Zoning Commission which have resulted in a number of needed changes in the proposed ordinance.

The subject of the December meeting was "Architectural Education," in the course of which President Gould called upon Messrs. Blogg, Huntington, Knox and Sexsmith, each of whom gave an interesting account of their opinions regarding architectural training and their personal experience in acquiring what architectural education they have. The talks given by these men proved very interesting in the unknown sides of their characters which they revealed. Each showed himself to be a man of varied parts.

Mr. Alden reviewed the matters which were coming before the Institute Board at its meeting in Denver on December 16th and 17th, which he was leaving shortly to attend.

### ANNUAL MEETING

The Chapter's Annual Meeting will be held late in January, upon a date which will be convenient for President Faville of the Institute to be present.

It is planned to hold a business session beginning at 10:00 in the morning to take up committee reports and routine business.

The afternoon session will be given over to architectural education and talks on the creative side of architecture. Members from various sections of the state will be requested to discuss their local problems. Members are asked to furnish slides of work done by them during the year to be shown during the afternoon for the interest of the meeting.

An appropriate evening program will be arranged.

## PROBLEMS RELATED TO THE HARDENING OF STEEL

One of the most fascinating and yet obscure subjects in ferrous metallurgy concerns the problem of the hardening of steel by a suitable quenching treatment and a subsequent tempering of it by slight heating. The interest is centered around the hard constituent or structural condition, known as martensite, the name being derived from the noted German metallurgist, Martens. An investigation has recently been completed by the Bureau of Standards which has a bearing on this general subject, and Scientific Paper No. 452, entitled "Structure of Martensitic Carbon Steel and Changes in Microstructure Which Occur Upon Tempering". This paper may be secured at 15 cents per copy from the Superintendent of Documents, Government Printing Office, Washington, D. C.

The study with which this paper deals was based upon the microstructure of a series of steels of progressively increasing carbon content when hardened under different conditions of temperature and heating periods, and the changes in structure which ensue in the same upon tempering.

Practically nothing is gained in hardness by using very high temperatures or very long heating periods prior to the quenching of steel, provided that the "critical" temperature is exceeded upon heating. This conclusion was based upon small specimens treated in the laboratory, in practice, of course allowance must be made for the size and shape of the pieces treated. The general conclusion is valid, however.

The changes which take place in a hardened steel upon tempering occur in well defined stages. Until the temperature of reheating exceeds 250° or 300°C (480-570°F) or marked change is to be noted in the visible microstructure, even at very high magnification, although pronounced changes in the dimensions and density often do take place even at much low temperatures. About 250°C, the separation of the carbon-bearing compound, cementite, from martensite begins and at 400° to 500°C (750-930°F) the steel shows a very fine granular structure under the microscope. As the temperature of reheating is increased, the granules increase in size, although a high magnification is still required for seeing them, and the steel becomes softer and finally loses all of the high tensile properties it gained by the hardening treatment.



## NEW OFFICE BUILDING

(Concluded from page 7)

and brick being employed throughout except for the exterior which will be of terra cotta, with a granite base. Marble will be used extensively on the first floor and marble tile in the upstairs corridors. For the upper stories, the elevator lobbies have been designed to serve as entrance vestibules so that those having business on any floor can be promptly and effectively directed.

Provision is made on the 16th Floor for a general employes' lunch room. Other employes' activities are amply provided for, in the way of a library, rest rooms and conference rooms. The elevator machinery, tanks and other necessary mechanical equipment are placed in the attic story, so that the roof will not be disfigured by pent houses and other unsightly structures.

The mechanical installation for the building will be extremely modern. Forced ventilation has been adopted for the lower stories, to obviate noise and dust entering through open windows on the street fronts. The telephones, pneumatic tubes and other means of communication are being particularly studied with a view toward unifying the activities of the huge organization to be located in the building. Investigations are being made as to the adaptability of alternating current elevators, in which remarkable field advance has been made in the past few years. A battery of six high speed cages will be required for adequate service. One of the more novel features of the design is the provision of a parking space for automobiles in the basement, access to which is obtained by way of a ramp descending from Beale Street.

This structure will house the general offices of the Company, which are now scattered among five buildings in all parts of the City, the entire 120,000 square feet of effective area being necessary for the purpose. The San Francisco district offices will doubtless be retained in their present location at 445 Sutter Street, but all departments of a general nature operating throughout the system will be concentrated at the new site.

The architectural design is by Bakewell and Brown, Architects, of this city, who have associated with them C. H. Snyder, consulting structural engineer and Hunter and Hudson, consulting mechanical engineers. The Company is being represented in the arrangements through its Department of Engineering, of which Mr. A. H. Markwart is the vice-president in charge.

The Jones Bros. Asbestos Supply Company, Inc., have been appointed Distributors for The Philip Carey Company of Cincinnati, Ohio, for California and Nevada.

# Carey

## Asbestos Roofing and Magnesia Products

Attention to Architects, Contractors and Builders

OUR PRODUCTS CONSIST OF

PIPE AND BOILER COVERINGS

ASBESTOS ROOFING

ELASTITE EXPANSION JOINTS

ASFALTSLATE SHINGLES

CAREY FIBRE ROOF COATING

DURABLA SHEET PACKING

DURABLA ROD & VALVE STERN PACKING

A complete stock of all Asbestos and Magnesia products will be carried in San Francisco

We maintain an engineering contract department for the application of all our materials.

## JONES BROS. ASBESTOS SUPPLY CO., INC.

512 Second Street, San Francisco, Calif.

Telephone Garfield 156

Ed. F. Jones, Pres. F. E. Jones, Vice-Pres. C. L. Jones, Sec.

# BALL BEARINGS

## SKF INDUSTRIES OF CALIFORNIA

Incorporated

115 NEW MONTGOMERY ST.

San Francisco, Calif.

Phone Sutter 4196

DEEP GROOVE AND SELF-ALIGNING BEARINGS  
HANGER EQUIPMENT

PORTLAND

LOS ANGELES

SEATTLE

## R. N. NASON & CO.

PAINT MAKERS

151 Potrero Ave.—SAN FRANCISCO—436 Market St.

Makers of

### NASON'S OPAQUE FLAT FINISH

A flat oil paint made in soft Kalsomine Tints, that is washable; a practical article for walls, ceilings, etc., that is most economical and durable.

Agency for

Tamm & Nolan Varnish Works High  
Grade Varnishes and Finishes

Goods made on the Pacific Coast for the climate of this Coast

THE GARDEN

(Continued From Page 7)

shrub that may be grown in all parts of California excepting, perhaps, the mountainous districts. Its berries are kept well in sight and are borne on the old wood. They are scarlet and abundant if given plenty of water and good care; but if neglected the berries are small and dark colored. It is among the first of our berried shrubs to ripen in the fall. It will grow in the shade but prefers the sun. If a low ground cover is desired the main stem must be pruned back vigorously before it becomes so large as to show an ugly stump.

It may be used as an accent plant, as a hedge, as a picturesque specimen plant and in small groups. The Japanese use it with delightful effect to partially hide upright stones in the gardens. Propagation from cuttings or seeds.

**PYRACANTHA COCCINEA LALANDII.**—The variety *lalandii* is said to have larger leaves and berries than the type itself. In Southern California it has an abundance of berries until about Christmas time, but in Berkeley the berries either drop earlier or the birds pick them long before the holiday season, because their other food is scarce.

*Pyacantha coccinea lalandii* will grow in the shade, but in that case does not berry well. The berries are borne on the old wood. Since it stands pruning well, it is sometimes used as an ornamental hedge. It can also be used as an accent plant, or as an individual specimen or as a picturesque shrub.

Propagation from cuttings or seeds.

**RUSCUS ACULEATUS.**—(Butcher's Broom.)—The foliage is puzzling. These are not leaves but are branches that assume the form and function of leaves. Botanists reach this conclusion because the flowers are borne in the axil of a scale and the foliage therefore must be branches or cladophylla (singular cladophyllum). Male and female flowers on different shrubs. To secure berries plant one staminate among several pistillate ones. In Italy it is called a "rat sticker" because it is inserted in rat runways to prevent their entrance into a house—a novel use for the sharp-pointed leaves.

It is used both as a berried shrub and as a non-flowering shrub where a small rounded-headed effect is desired. It is used in the interior valleys, but must be sheltered, not from the cold but from the heat, since it burns in the hot sun. Will grow in dense shade.

The leaves are colored by a red dye and

used as house decorations. One pleasing effect was seen in a hotel where a receptacle containing the decoration was lighted by electric globes and gave a soft red glow in an otherwise somber room. Propagation by division.

**SAMBUCUS GLAUCA.**—(Blue Elderberry.)—This native of California is really a tree but can be used as a shrub for a number of years. Its compound leaves group well with redwood and the Coast Live Oak and the Wild Cherry. It blooms for months and is followed by decorative fruit or it is more often in fruit and flower at the same time.

It is deciduous for about two months, but even when leafless it is a subject of interest. It is drought tolerant and useful to Landscape Architects in many ways, especially about large estates or small home grounds where it can be used far from the hose or where the owner has little time to devote to his garden. Looks especially well with Redwoods.

McLaren says use it as a shelter shrub in exposed situations and in poor soil. Hence must be wind resistant.

Propagate by cuttings.

**SOLANUM PSEUDO-CAPSICUM.** — (Jerusalem Cherry).—Two or three and occasionally five feet high on old specimens. Its best use is as a pot plant on account of its large red berries which are ripe at Christmas time. It may also be used in a hardy border bed or as a facer in shrubbery mass. Its foliage is apt to be poor and thin unless given good care.

**SORBUS AUCUPARIA.**—(Mountain Ash).—A small tree with bright red berries in large clusters which last all fall and nearly until Christmas. May be used either as a specimen plant in the lawn or in the background of shrubbery or as a street tree.

Since it has been cultivated in Europe for centuries there are several forms, some erect, others pendulous, and still others with orange colored berries. Propagated from seed.

**SYMPHORICARPOS ALBUS.**—(Racemosus)—Low shrub to three or four feet. Grows in sun or shade. Pink flowers in spring are not especially ornamental. Cultivated for its white berries which last many months, beginning to ripen in August. Berries said to be poisonous to children. Under cultivation the fruit often becomes large and heavy. Tendency of gardeners is to enlarge berries at expense of the shrub as a whole. Deciduous for about three months, then come the flowers and tender leaves about February. Native shrub. Said to group well with *Rosa rugosa*, which has its red tips ripe at same time.

*THE  
BUILDING  
REVIEW*



The work of  
ALLISON & ALLISON

February 1923

Published in San Francisco

Vol. XXIII No. 2

Price One Dollar



# THE BUILDING REVIEW

VOL. XXIII

FEBRUARY, 1923

No. 2

## CONTENTS

### The Work of Allison & Allison, Architects

PLATE—	No.	PLATE—	No.
UNIVERSITY CLUB, Los Angeles, Calif.....	13- 25	LUTHER BURBANK SCHOOL, Long Beach, Calif.	88- 89
(For plans see page 39.)		ATLANTIC AVENUE SCHOOL, Long Beach, Calif.	88- 89
FRIDAY MORNING CLUB, Los Angeles, Calif....	26- 28	HIGH SCHOOL, Chandler, Ariz.....	90- 91
PALO ALTO UNION HIGH SCHOOL, Palo Alto, Calif. ....	29- 34	MURPHY MEMORIAL HOSPITAL, Whittier, Calif.	92
ELEMENTARY SCHOOL, Colton, Calif.....	35	HARBOR GENERAL HOSPITAL, San Pedro, Calif.	93
UNION HIGH SCHOOL, Santa Maria, Calif.....	36- 37	UNION HIGH SCHOOL, Fowler, Calif.....	94
HIGH SCHOOL, Santa Paula, Calif.....	38	HIGH SCHOOL, Monrovia, Calif.....	95
WILD ROSE ELEMENTARY SCHOOL, Monrovia, Calif. ....	39	COLTON UNION HIGH SCHOOL, Colton, Calif...	96
UNIVERSITY OF CALIFORNIA (Southern Branch) Los Angeles, Calif.....	40- 46	HIGH SCHOOL GROUP, Orange, Calif.....	96
GREATER WHITTIER COLLEGE, Whittier, Calif.	47- 48	HIGH SCHOOL, Van Nuys, Calif.....	97
WILMINGTON HIGH SCHOOL, Los Angeles, Calif.	49	UNION HIGH SCHOOL, Redondo, Calif.....	98- 99
ELEMENTARY SCHOOL No. 1, Glendora, Calif...	49- 52	WASHINGTON SCHOOL, Pasadena, Calif.....	100-101
ELEMENTARY SCHOOL No. 2, Glendora, Calif...	52- 53	CHURCH OF THE MESSIAH, Los Angeles, Calif.	102
ELEMENTARY SCHOOL No. 2, Azusa, Calif.....	54- 55	SAINT JOHN'S EPISCOPAL CHURCH, Los Angeles, Calif. ....	102
ELEMENTARY SCHOOL, Oxnard, Calif.....	56	FIRST METHODIST EPISCOPAL CHURCH, Monrovia, Calif. ....	103
YNEZ SCHOOL, Alhambra, Calif.....	57	DEPARTMENT STORE, Hollywood, Calif.....	104
MARENGO PRIMARY SCHOOL, Alhambra, Calif..	58	PACKING HOUSE, Santa Paula, Calif.....	104
CENTRAL ELEMENTARY SCHOOL, Alhambra, Calif. ....	58- 59	RESIDENCE OF MR. J. C. DANIELS, Pasadena, Calif. ....	105-106
ELEMENTARY SCHOOL, Spadra, Calif.....	60	THE CHAUTAUQUA OF THE PACIFIC, Los Angeles, Calif. ....	107-108
ELEMENTARY SCHOOL, Little Lake School District, Los Angeles, Calif.....	61		
ELEMENTARY SCHOOL, Ranchito, Calif.....	61- 62	TEXT—	Page
HIGH SCHOOL, Burbank, Calif.....	63- 64	THE WORK OF ALLISON & ALLISON, ARCHITECTS, by Irving F. Morrow.....	15
ELEMENTARY SCHOOL, Burbank, Calif.....	65	A GLIMPSE INTO THE FUTURE, by John J. Donovan .....	22
HIGH SCHOOL GROUP, Santa Monica, Calif.....	66- 76	TWO SCHOOLS IN CALIFORNIA, by Peter B. Wight .....	27
GRAMMAR SCHOOL, La Canada, Calif.....	76	EDITORIAL .....	30
JOHN ADAMS SCHOOL, Santa Monica, Calif.....	77	SCHOOL KITCHENS, by Mary Robinson Thomas .....	31
McKINLEY SCHOOL, Santa Monica, Calif.....	78	EDUCATIONAL VALUE OF SCHOOL ARCHITECTURE, by Horace M. Rebok.....	34
JOHN MUIR SCHOOL, Santa Monica, Calif.....	79	HONOR AWARDS FOR BEST DESIGNED BUILDINGS IN LOS ANGELES.....	36
COLTON UNION HIGH SCHOOL, Colton, Calif..	80	GROWTH OF WESTERN METROPOLIS, by Morris M. Rathbun.....	40
LINCOLN JUNIOR HIGH SCHOOL, Santa Monica, Calif. ....	81- 83	MONTHLY BULLETIN, SAN FRANCISCO CHAPTER, A.I.A. ....	42
UNION HIGH SCHOOL, Oxnard, Calif.....	84		
UNION HIGH SCHOOL, Merced, Calif.....	84- 85		
CORONEL SCHOOL, Los Angeles, Calif.....	86- 87		
JEFFERSON JUNIOR HIGH SCHOOL, Long Beach, Calif. ....	88		

Editor, HARRIS ALLEN

Industrial Editor, HOWARD HOYT

Business Mgr., H. ROBT. BRADEN

Published Monthly by the Building Review Company,  
50 Main Street, San Francisco, California  
Douglas Building Los Angeles, California

Yearly subscription—United States, \$2.50—foreign, \$3.00. Single copies, 25 cents.

Entered as second-class matter in the San Francisco Postoffice under the Act of August 24, 1912. Previously entered as "The Architect."

The editors will be pleased to consider contributions of interest to the Industry. When payment of same is desired, this fact should be stated.

News stands and dealers supplied through San Francisco News Co., San Francisco, Calif., or American News Co., New York, N. Y.

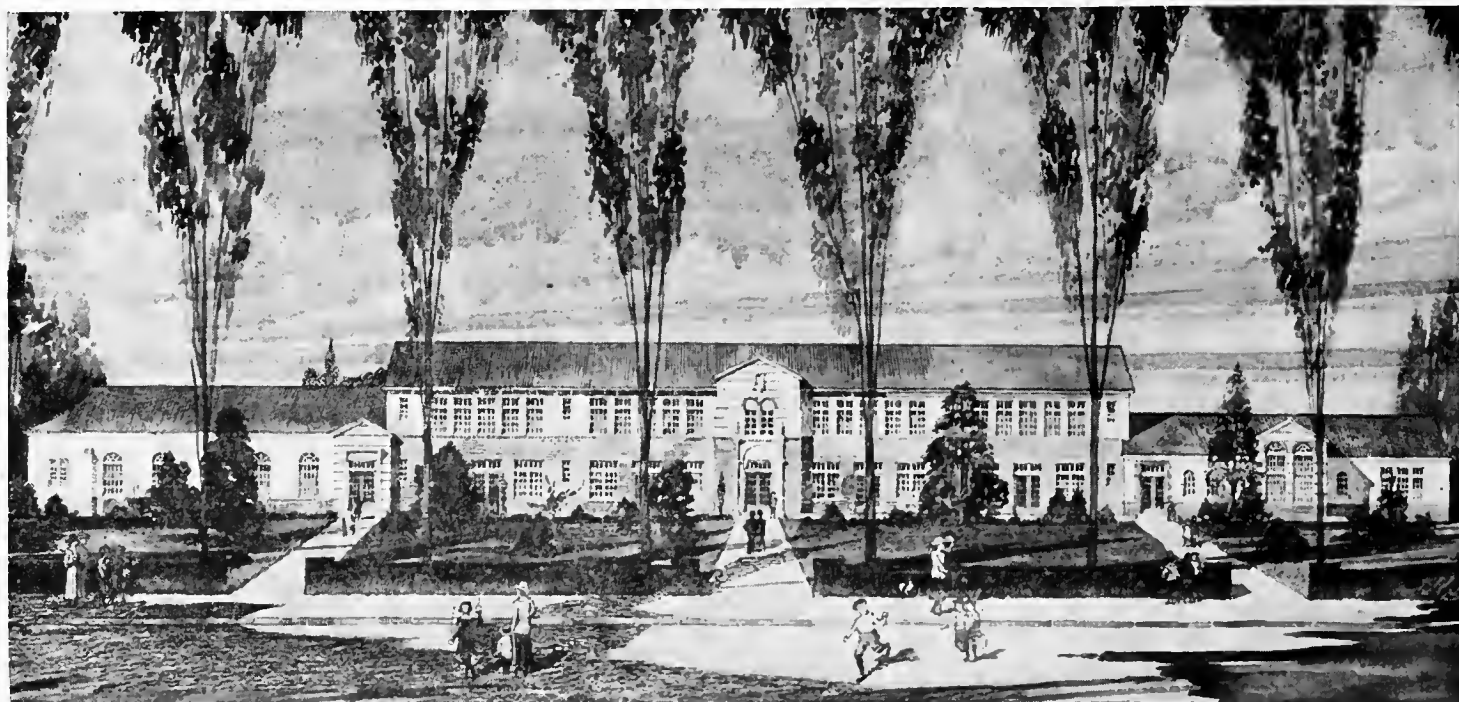

MCKINLEY SCHOOL, SANTA MONICA, CAL.

ALLISON &amp; ALLISON, ARCHITECTS

FROM the days of the "Little Red School House" to the modern and beautiful architectural conceptions of school edifices today, such as the outstanding work of Allison & Allison, is a story as romantic as any ever told of the progress of our nation. These Temples of Learning, equipped with every facility for the dissemination and advancement of knowledge and representing the expenditure of millions of dollars are a happy prophecy of what the future holds in store for us. ? The perpetuity of these institutions is the concern of us all. ? The preservation of these buildings against the ravages of time and the elements is our particular concern. "Saving the Surface" with paint and varnish and adding beauty with the magic of color has been our work for nearly 40 years and today we are engaged in that task on a larger scale than ever before. ? We are glad to be listed among those who are translating into reality the great architectural conceptions of Allison & Allison.

## A. QUANDT & SONS

PAINTERS AND DECORATORS

SINCE 1885

SAN FRANCISCO

LOS ANGELES

# The BUILDING REVIEW

VOL. XXIII

SAN FRANCISCO, FEBRUARY, 1923

No. 2

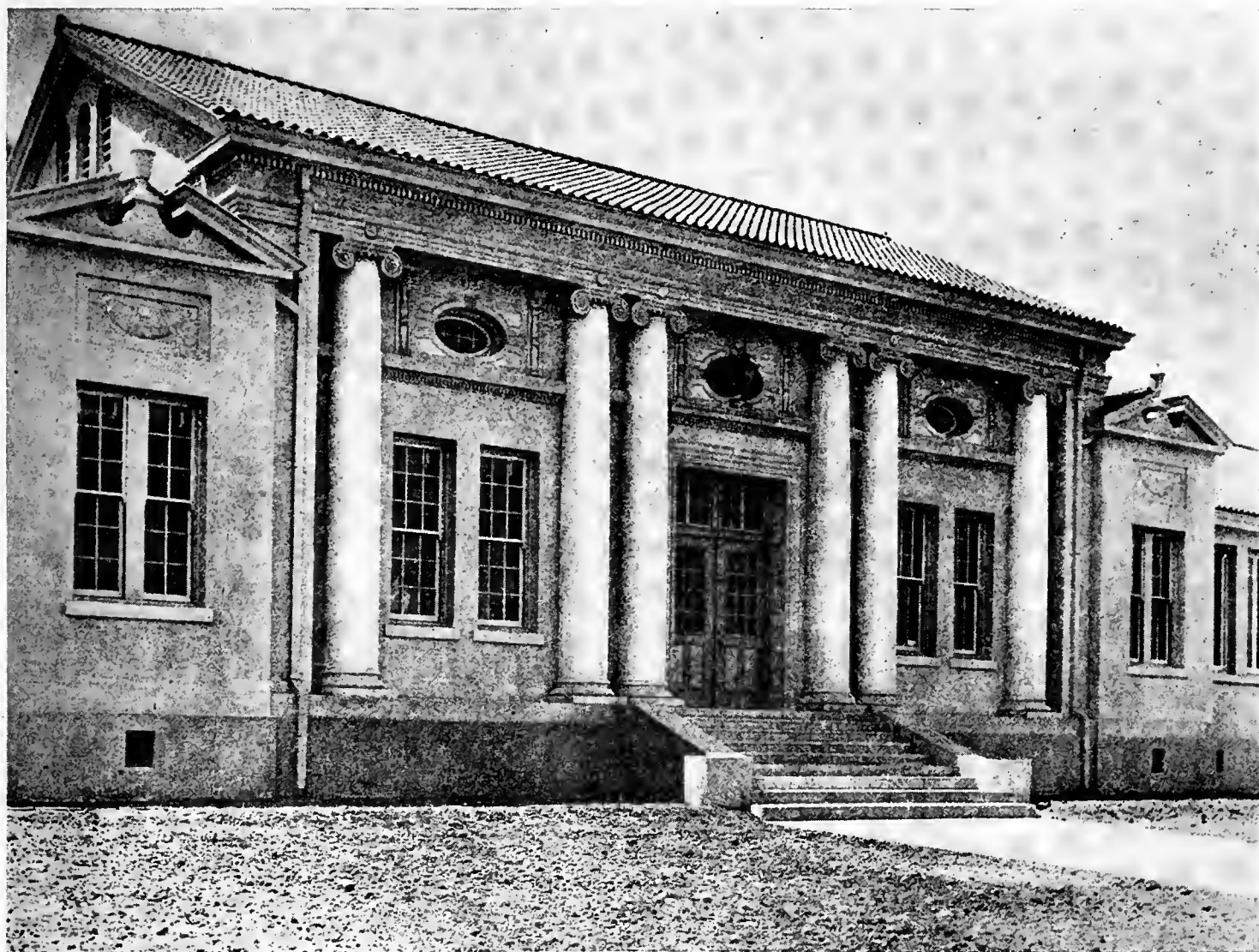

GRAMMAR SCHOOL.  
OXNARD, CALIFORNIA.

ALLISON & ALLISON, ARCHITECTS

## The Work of Allison & Allison, Architects

By IRVING F. MORROW\*

At the mention of Allison and Allison one thinks of schools. This is a tribute, when there are so many successful architects whose names evoke nothing more specific than a vague sense of voluminous but indefinable output. To have one's name suggest a definite achievement is in itself an achievement. But it is also here a misfortune.

Architects with a lively feeling for architectural realities, a personal and versatile sense of design, and a proved capacity for handling large undertakings, deserve freer scope than can be afforded by any one line of work. Nor should such a restriction be necessary. There are fields of human activity where specialization in one degree or another is the only alter-

\*Member of the firm of Morrow & Garren, Architects.



UNION HIGH SCHOOL,  
SANTA MONICA, CALIFORNIA.

native to an ineffectual dissipation of resources or powers. It does not follow that every corner of the field of knowledge which can be independantly named is a necessary, or even a reasonable subject of specialization. Specialization is a restriction of vision and interest, which is unquestionably an evil, however inevitable it may become in many situations.

Specialties are only properly circumscribed by the limits of human capacity. A subject whose complexity exacts all the attention of which a mind is capable precludes activity in other fields. Now it is not plausibly arguable that the complications and detailed exactions of schoolhouse design are of such formidable volume or intricacy as to incapacitate a well trained architect from mastering them and giving serious attention to other phases of building to boot. Indeed, as much might be said for any and every other sub-head embraced within architectural practice. Where any thoroughgoing specialization exists it is chargeable either to unfortunate circumstances or to flagging initiative and curiosity. In other words, architects specialize either under pressure of business necessity or from spiritual indolence. The latter is unthinkable in the present case. A public which limits Allison and Allison to the designing of schools is itself the loser. Their abilities are of a kind which should be given freest scope and the most varied application.

It is not to be questioned that school designing deserves the highest of trained intelligence, nor that they have rendered exceptional service in this field. Nor is it to be denied that their unusual experience in this line is a tangible and valuable aid to the work. The mistake is in assuming that they produce good schools by virtue of this experience only, rather than through careful reasoning, analysis, and vision. One has but to recall that the Santa Monica High School, produced almost at the outset of their career in Los Angeles, still remains one of its high points. This does not mean subsequent stagnation. On the contrary, they have exhibited unflinching resources, adaptability, versatility, creative imagination.



UNIVERSITY OF CALIFORNIA, (SOUTHERN BRANCH)

LOS ANGELES, CALIFORNIA.



They have blown a gust of fresh air through the musty precincts of educational design. They have applied the findings of the experts with ample grains of sense, common and artistic. They have accomplished as much as—it might reasonably be said more than—any architects in the country to redeem the practice of school architecture from the appearance of a conspiracy in restraint of design. The human side of school structures has been amply safe in their hands, and the educational factory has been ruled out.

Their school experience has been remarkably wide, and the output is remarkably varied. For all that their work is readily recognizable, there is no stereotyping of schemes or mannerisms. Even the well known and used plans are handled with freedom and individuality. The center element and end pavilion type has been given a variety of expressions. More conspicuous success has been obtained with U court schemes, as notably in the exquisitely lovely elementary school at Glendora. Their most significant contributions have been the irregular, freely developed plans, such as the High Schools at Palo Alto and Santa Maria. These are certainly to be regarded as two more high points of their career. This type of school planning is significant because it stresses oft-neglected dynamic human aspects and minimizes the stifling formality of organization. Their handling of it is conclusive evidence that arbitrary regularity is not essential to order and efficiency. Symmetry is not the sole manifestation of



JEFFERSON JUNIOR HIGH SCHOOL,  
LONG BEACH, CALIFORNIA.

order; it is only the most obvious one and hence the easiest to attain. There are occasions aplenty when a spurious outward symmetry cramps and does violence to inner needs for a freer type of order. Nor must it be forgotten that schools are to house childhood and youth, which are times of sensitiveness, quest, high hopes and great imaginings. It is hard to believe that the tentatives of development



BURBANK HIGH SCHOOL,

BURBANK, CALIFORNIA.

have not freer play in such mobile surroundings than in the educational factory. These considerations apply as well as to the group schemes, such as Whittier College, and the admirable Southern Branch of the University of California.

A touch of romance in the architectural handling also pervades the best and most characteristic of their work. Their natural bent is in favor of the more informal types of design, those styles which are unfinished, historically speaking, and which consequently leave ampler room for the play for a personal imagination. Phases of the Romanesque of northern Italy have won their habitual preference and furnished their happiest inspiration. Elements from the earlier, more naive phases of the Renaissance have often been mingled with this earlier feeling, and given piquant, unsophisticated turns to bring them into line. Their outstanding examples of the Romanesque inspiration are the High Schools at Santa Monica, Palo Alto, and Santa Maria, and the Southern Branch of the University of California (originally built as the Los Angeles State



CENTRAL MOTIF,  
UNION HIGH SCHOOL,                      MERCED, CALIFORNIA.



LOGGIA,  
ELEMENTARY SCHOOL,                      BURBANK, CALIFORNIA.

Normal School). All of these are masterly designs; no more meritorious as compositions, perhaps, than many a smaller structure which might be cited, but more conspicuous by virtue of their greater size and consequent impressiveness. They are clear, orderly, well poised, amply diversified, picturesque in the best sense of the word. They are also modern in spirit. Use of the word Romanesque in this connection must not be taken to imply subservience to archaeological proprieties. Precedents have not been ostentatiously shunned, but they have been used creatively. There is much in their work which may shock the theoretical purist; but then, why should one go out of the way to avoid shocking a purist? Their ideal has not been the sterile one of historical consistency, which is a mere matter of scholarship, but a rational eclecticism, spiritual consistency, which is creative.

If the human and architectural aspects of their schools have been stressed to the ap-



ELEVATOR HALL,  
UNIVERSITY CLUB, LOS ANGELES, CALIFORNIA.

parent exclusion of technical considerations, it is neither because the buildings are deficient on this score, nor because this aspect of the matter is unimportant. It should and generally does go without saying that a first class school must meet exacting practical requirements in more than merely passable fashion. It should also, but by no means always does, go without saying that analogous human obligations are equally imperative. In other words, while the technical point of view is in no lack of able and aggressive champions, the spiritual case is in danger of being allowed to go by default.

More recently Allison and Allison have been enjoying opportunities for other types of work with increasing frequency. They have shown examples of residences, hospitals, industrial buildings, commercial buildings, churches and clubs. All of these evidence the same analytical attack, the same scrupulous

respect for requirements, the same creative imagination and the same vigorous self-criticism for which their educational work has previously been notable. Each new essay emphasizes the point that a too specialized application of their abilities has meant the public's loss. One of the loveliest of their non-educational works is the recent open air theater on the grounds of the Santa Monica High School. This is a striking and instructive example of an old and almost stereotyped problem envisaged in a fresh manner, as well as of old materials put to novel but happy uses. The idea that an open-air theater is Greek is a preconception so ingrained that few people could have been found to entertain the possibility of a Romanesque Greek theater. With a slight brush at the cobwebs they have given us a thing of great beauty, a work richly meriting the overworked popular appellation of "gem", veritably lyrical in quality.

Their most significant recent contributions



LOGGIA OFF MAIN DINING ROOM,  
UNIVERSITY CLUB, LOS ANGELES, CALIFORNIA.

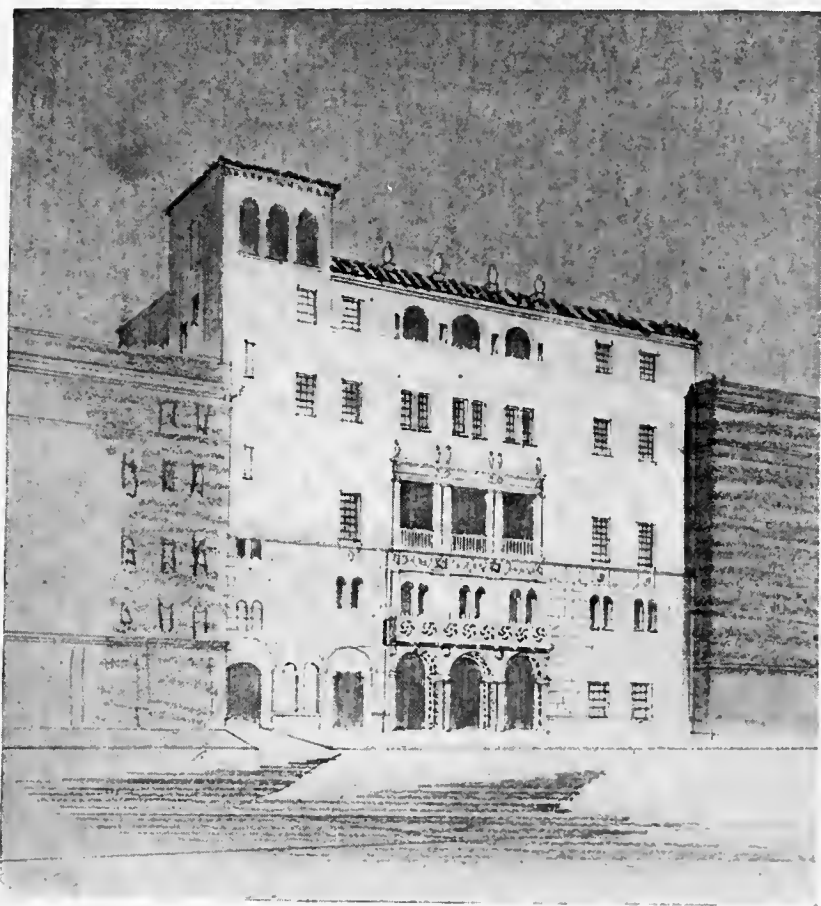

PRELIMINARY SKETCH,  
FRIDAY MORNING CLUB, LOS ANGELES, CALIFORNIA.



PRELIMINARY SKETCH,  
FRIDAY MORNING CLUB, LOS ANGELES, CALIFORNIA.

are two Los Angeles clubs. Of the Friday Morning Club, which exists as yet only on paper, it is still too soon to write in any detail. Suffice it to say that the design is one of quiet distinction and holds great promise.

The University Club of Los Angeles is not only one of the outstanding achievements of its architects' career; it is one of the most substantial additions to our architectural heritage which has been made for some years past. It is a building deserving the closest analysis, although anything like an adequately full treatment is obviously impossible in the present connection. It would be an unpardonable oversight, however, to leave the subject without calling particular attention to two salient aspects. The use of the lot—in other words, the fundamental conception and composition of the scheme, the "parti"—is an impressive example of close-knit, logical, creative architectural thinking. Few observers, lay or architectural, above all those who are by native bent or habit predisposed to the honorific amenities of the classical tradition, will fail to grant enthusiastic credit for the manner in which a large and varied amount of material is naturally and decently disposed within a limited space. Strict economy has been found

—or made—compatible with spaciousness and airiness, inside and out. Clarity and order co-exist with romantic picturesqueness and absence of formality. The plan is firmly knit but generous and free; the section line is conceived in a large continuity and modulated with delightful subtlety. No less noteworthy than the "reality" of the conception is the reality of the material handling. That dualism of masked structure and furred finish which pervades contemporary architecture to the point of inciting (and doubtless warranting) charges of sham has to a striking degree been eliminated. What is in effect a concrete structure has been embraced as an opportunity for designing a concrete building. Exterior and interior are thus invested with a comfortable and satisfying sense of substance and durability—in a word, with reality. The building is quiet, poised, hospitable, powerful with no suggestion of arrogance. And from these broader generalities which have been emphasized, down to its smallest details of form, color and furnishing, it has been the object of unfaltering and consistent attention.

It has manifestly been impossible in the face of so large and homogeneous a body of work to pass individual comment on every item. A

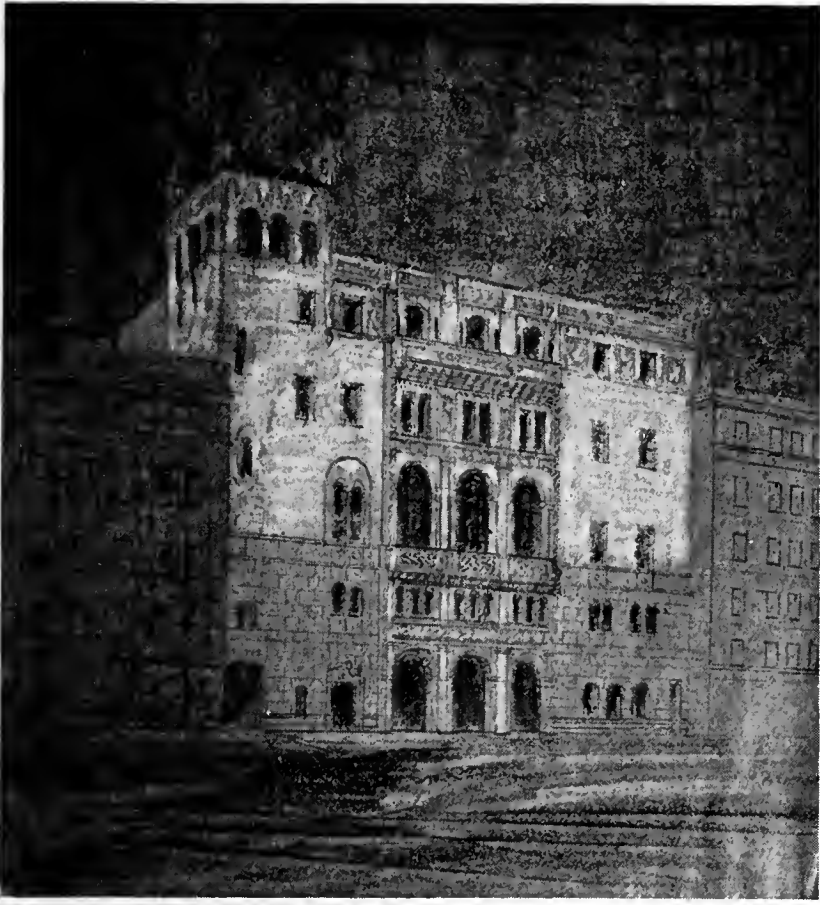

PRELIMINARY SKETCH,  
FRIDAY MORNING CLUB, LOS ANGELES, CALIFORNIA.

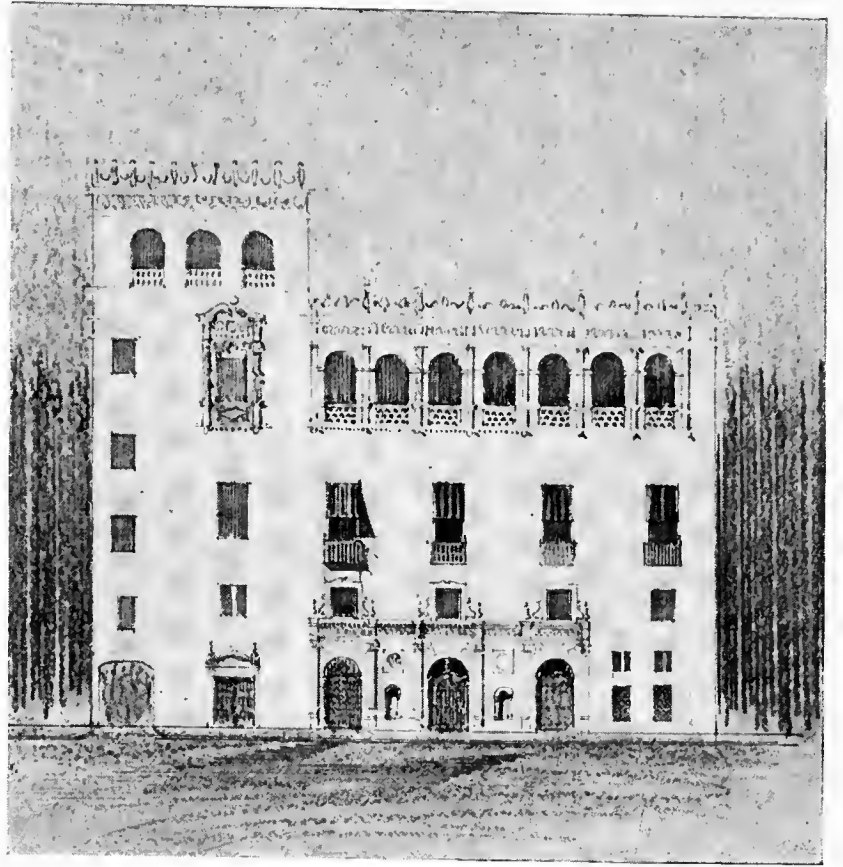

PRELIMINARY SKETCH,  
FRIDAY MORNING CLUB, LOS ANGELES, CALIFORNIA.

length catalogue would result. It has scarcely been possible to touch upon all the outstanding examples. Rich work is doubtless yet in store, and there is satisfaction in feeling that it promises to be of a wider range, more fully representative of the larger services a community should exact from its architects, and more consonant with their demonstrated ability. As this work increases in variety there will undoubtedly always be those who, accord-

ing to native bent, will incline to see in Allison and Allison school specialists, or commercial specialists, or club specialists, or exponents of sundry other so-called specialties which modern requirements seem to make feasible. The person who envisages the field of architecture seriously and critically in its entirety will prefer to know them simply as Architects.



# A Glimpse Into the Future

By JOHN J. DONOVAN, *Architect*  
 Author of "School Architecture"

**T**HIS splendid issue illustrating the excellent work of Allison & Allison, Architects, who are responsible for so many delightful landmarks throughout the State of California, leads one not only to reflect upon the immediate achievements of the past, but to draw the curtains of the future aside and to look out upon the possibilities of times soon to come.

California's population today is close to four millions of people, 3,462,861, according to the census of 1920. California's population in 1935 will be ten millions of people, if the estimate of so conservative a man as Julius Kahn, who knows California as well as any of the present generation, holds good. Other predictors, including no less a prophet than Arthur Brisbane, have estimated the growth of California's population far in excess of Mr. Kahn's figure. However, for our purposes, we will attribute these forecasts to the inspirational glow of the California sunsets, or the invigorating warmth of her hospitality, and will admit only the colder and more conservative statements for our consideration here.

Ten million people in twelve years—a period immediately at hand—means an increase of more than two and one-half times the present population. Now notice:

California's school enrollment for the school year 1921-22 was:

For the kindergarten .....	40,131
For the elementary school.....	571,678
For the high school.....	227,190
For the private schools.....	46,659
For colleges and universities.....	20,983
For teachers' colleges.....	6,505
.....	.....
Making a total of.....	913,146

The astonishing conclusion from this complication is that almost one-quarter of the present population of the State of California is at school.

Editor's Note: Dr. Hart and Professor Peterson are associated with Mr. Donovan as educational experts in rendering service as consultant to Boards of Education and their architects.

The amount of bonds voted in California for educational buildings for the year 1921 for elementary and high schools in forty-eight counties was \$11,741,497.95\* and for the year 1922 for elementary and high school \$33,772,900.00. This does not take into consideration the amount of money spent in these two years for private institutions, such as parochial schools, military schools, etc., nor does it include the amount of money spent for colleges and the universities in California.

This is as far as we will go into these interesting and astonishing statistics; but if Mr. Kahn's estimate of ten millions of people in 1935 is at all accurate, and if the present ratios between population and school attendance continue to hold,—then we may make an estimate of pupil and student attendance and expenditures of money for education buildings.

Kindergarten attendance by 1935.....	113,570
Elementary school attendance by 1935.....	1,617,848
Junior and Senior high school attend. by 1935...	642,947
Junior College attendance by 1935.....	15,400
College and university attendance by 1935.....	40,000
Private school attendance by 1935.....	132,044
Normal schools and teachers' colleges.....	17,000

The average yearly expenditure for buildings is very likely to be \$40,000,000.00 or a grand total of \$480,000,000.00 for the 12-year period 1923 to 1935. This estimate is a conservative one and was derived in the following manner. For the average well constructed school building, the cost per pupil is somewhat as follows: High school, \$450.00 per pupil; Junior High School, \$350.00 per pupil; Elementary School, about \$250.00 per pupil. The latter is probably a trifle high, but it is a fairly accurate estimate. Taking these three sums altogether and striking an average, is \$350.00 per pupil. For an increase of 1,665,653 pupils and students, I have assumed a further reduction in the average cost or \$300.00 per pupil which brings the total amount of money to be spent as an estimate of

\*Note: 1921 was a lean year financially and industrially.

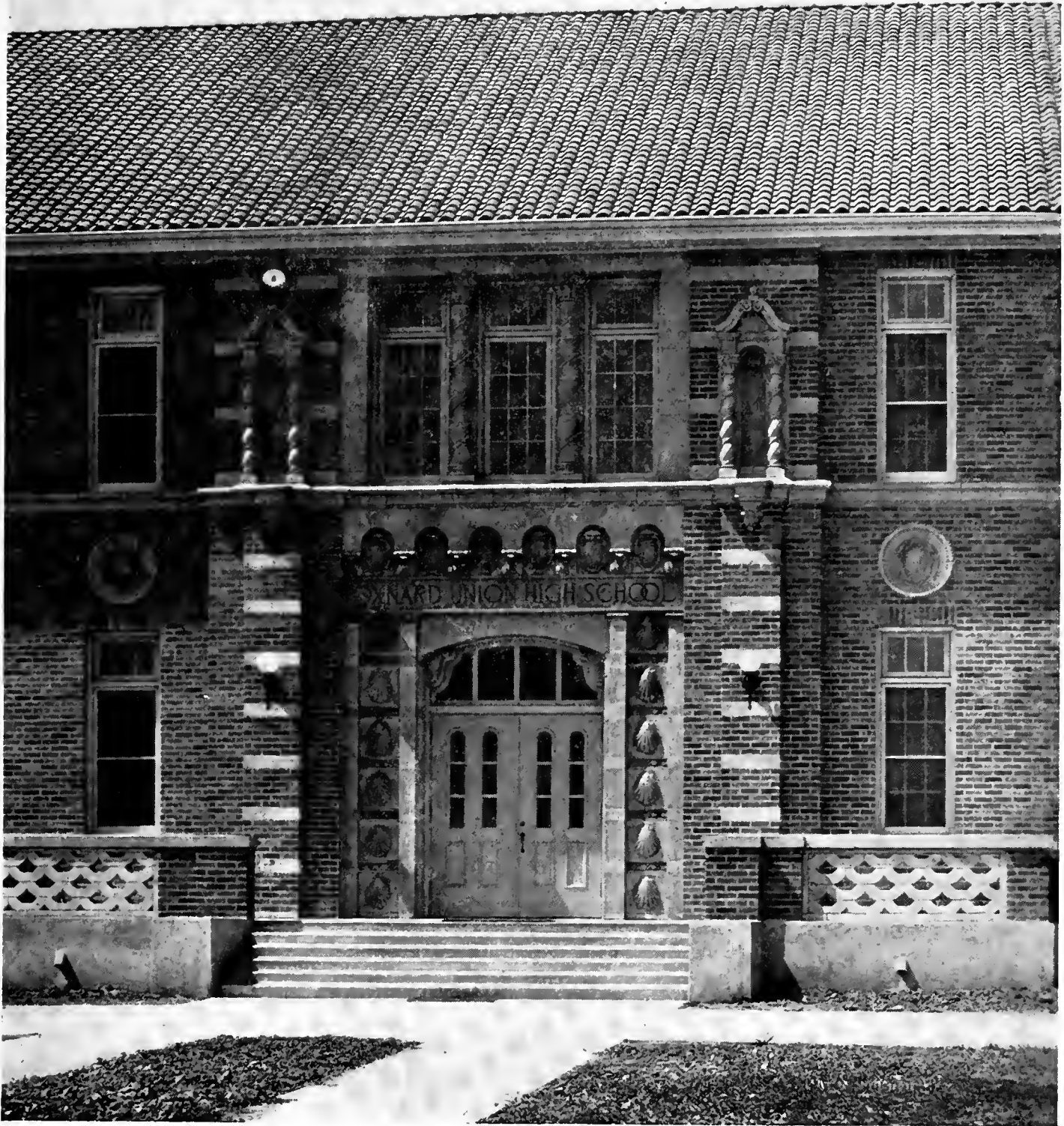

DETAIL,  
UNION HIGH SCHOOL,

OXNARD, CALIFORNIA.

about \$499,695,900.00 and that divided by twelve gives an annual expenditure of \$41,641,325.00. I have reduced this further to \$40,000,000.00 per year or a total of \$480,000,000.00 to be spent in the next twelve years for educational buildings.

Again these figures, which are conservative, are simply astonishing and astounding and yet they are facts to face in thinking of the future.

The writer is indebted to Dr. Frank W. Hart, Professor of Educational Administration of the University of California and Professor L. H. Peterson of the Department of Education of the University of California, for the data on the present enrollment, the amount

of money appropriated for elementary and high school buildings during 1921 and 1922 and also for the estimate of pupil and student attendance 1935.

Now, just how are these sums to be spent, and by whom? It is easier to respond to the latter question first. The money will be handled by the school officials and by the architects of California. Just how it will be spent is far more difficult to predict and can be dealt with here but briefly. During the last decade a decided change has come into the educational system of not only California, but of the Nation. The Junior High School, or what is sometimes termed the Intermediate School has

taken a definite and undoubtedly a permanent position in the school system. Formerly the elementary or grade school was composed of the first to the eighth grades inclusively and sometimes the kindergarten, while the high school included the ninth to the twelfth grades inclusively. With the introduction of the junior high school, the grading is generally as follows: elementary school grades, first to sixth inclusive; junior high school, grades seventh to ninth inclusive; senior high school, grades tenth to twelfth inclusive. There are some variations to the above, but, on the whole, this grading is quite general.

The purpose of this change was to bring like-age-groups into closer relationships in their school work. Such an arrangement has been found to possess many advantages from the standpoints of discipline, school organization and social living of the students. The whole arrangement has been based upon the general principle that children and young people of like ages form more easily disciplined, more easily organized and more easily self-governed social bodies than do children of wide variation in age and interest.

It was further realized that to hold the larger percentage of pupils to completion of the eighth grade, it was necessary to enrich the curriculum or course of studies by providing a variety of shop work such as auto mechanics, forge work, sheet metal work, printing and mechanical drawing in addition to the simply equipped Sloyd or bench wood-working course so common in the former grammar schools. Likewise, the home economics, art, music, commercial, science and other courses have been enriched and extended. Physical education has been made obligatory by law. The State law advanced the age of compulsory education; school attendance grew mightily; educational research disclosed the facts of individual differences in educational needs of children and departmentalization penetrated the lower grades. A careful, almost nationwide study of these, and other circumstances brought forth the new junior high school plant which has much the semblance of the high school, yet is considerably different.

A factor unforeseen and not fully recognized by all is the value of shop work to the life of industry, and as time goes on this value will be recognized more and more by those who have to deal with youth in employment. No contractor or employer of labor is prone to employ apprentices and to move them on to the learning of trades, for the reason that for the first year and a half they are a burden, and

it is not until they have almost completed their apprenticeship that they become of any special value to the employer at all. Now the junior high school is rectifying this condition so that the results will be beneficial not only to the employer but to the employee as well, and especially will it be beneficial to the State, which is paying the bill.

The junior high school shop work will give the student a sense of co-ordination between hand, muscles, nerves, eye and mind, so that when he leaves the junior high school, or ninth grade, which some will do, he will be able to step into the trades and quickly pick up the finer points which deal with relation between hand and mind. Everybody is aware of the awkwardness of a child learning to write. Something like this appears in the apprentice when he first attempts to use tools or to work machinery without some previous training. It is not the purpose or intention of the school system to teach the boy or girl trades. That would be outside the possibilities of the school's capabilities, or, if it should attempt this function, the product would be more or less half-baked, because practical experience is not obtainable in a school. The job, the varieties of the job and the conditions surrounding the job will always vary between the school and the working world. Besides, the time required to train boys for trades would conflict disastrously with the just time required in school for the pupil's general education. Consequently, the junior high school boy can be taught only the elementary features of the various trades. But inasmuch as he is compelled to take shop work, it means that, even should he go no further than junior high school, and should then be forced to leave and to earn his own living, he will be better prepared to succeed than was the boy of the past. This holds true for girls as well. This increased chance for success in life is conducive, of course, to improved citizenship, which is the principal aim of all education. What is really happening is that the junior high school is likely to develop into a great human research laboratory for vocational or better yet, for pre-vocational training, so that the boy or girl may discover himself or herself.

As a consequence of the junior high school, the senior high school assumes a decided change. Courses required in the junior high school which are extended into the senior high school become elective in the latter and in some instances are not at present popular, such as cooking and sewing and some of the shop work, since they appear repetitious. Also,



some of the subjects formerly appearing in the high school curricula are now taught in the junior high school, consequently these revisions necessitate modifications to the senior high school plant.

And now another step forward is well established as to educational policy by the introduction of the junior college, an institution intended to relieve the university of the first two years' work, thereby making the university more effective and keeping the students of the first two years nearer home and in smaller groups.

The junior college has been established in a number of high school districts and becomes a part of that particular district, but it will soon assume larger and more important proportions because it will have to become a county—a bi-county or a tri-county institution in order that the resources in student population and finance may amount to something more than a side issue of the high school. As a matter of interest, the state law has already provided for this.

Furthermore, each high school district has so much financial burden to provide for the expense of buildings, equipment and teaching that the junior college must look further afield for its support, that is, must depend upon larger financial and population areas.

A resume of the school system shows, (a) the kindergarten; (b) the elementary schools; (c) the junior high schools; (d) the senior high schools; (e) the junior colleges; (f) the State normal schools, and, (g) the universities, to say nothing of the numerous private schools and colleges already established. With such a classification and with each division becoming more and more enriched in its curricula, it is evident that the educational building program will increase greatly, not only in magnitude and in complexity, but almost in its very character.

An estimate has been made of the annual expenditure in buildings and equipment and this should hold forth most inviting allurements to the members of the architectural profession to apply their talents and skill to the handling of this great task so that the achievements of the next decade will surpass those of the last ten or twenty years. And it is the writer's firm belief that this will come to pass, because of the virility and youthful strength and better training of the younger men of the profession. (Note: lest some feelings be hurt, this includes all those under sixty-five.)

While we are mentioning the possibilities of opportunities for effort, love of work,

achievements and happiness, let us consider also the seriousness of the obligations entailed in such undertakings. These are too many to be enumerated and dilated upon here, nor can we see more than a few of them at this distance, but the matters of health or hygiene, comprehension of the different organizations, true economics and meritorious architectural composition or creations may be mentioned and briefly discussed.

How many are aware that non-promotion, retardation or what is sometimes called retention of pupils, for the year 1921, cost the State of California approximately seven millions of dollars. In other words, pupil failures in that year cost the State that vast sum of money; but what has it cost the cause of good citizenship in its disheartening effect upon the child who is soon to be a man or woman and who in school was not able to keep pace with his fellows?

To substantiate the above statement, permit me to quote in part, from an address by our very able State Superintendent of Public Instruction, Mr. Will C. Wood, before the Conference on Educational Research and Guidance at San Jose, California, May 30, 1922: "Last year ten per cent of the boys and girls enrolled in the elementary schools of California were repeaters. Over seventy million dollars was spent on education in California last year. Ten per cent of this seventy million dollars was spent on re-education of repeaters. I am convinced we shall have to find some way of cutting down the number of repeaters when the tax payers begin to examine our work more carefully. Is it necessary to have ten per cent of our young people each year repeat their work?"

Now, all this is not due to sub-normalcy, backwardness, stupidity or sickness on the part of the child, nor is a large part of it due to poor teaching. Some of it is due to all of these, but I dare say a large part is due to overcrowding of classrooms so that neither the teacher or child can do justice to the subject matter, and I do know from personal observation that a great deal is due to wretched ventilation. Who has not sensed the state of coma endeavoring to study in a stuffy room, and what trained mind can work to advantage under such conditions, to say nothing of the plastic moulding minds of children which like water turn to the avenues of least resistance.

Then there are the developments and simplifications of equipment. A field almost untouched except by the manufacturer whose concern is largely influenced by the commer-

cial aspect of the equipment. The architect should be the leader in such developments that will make the school a healthier and happier place for living and working.

Now as to comprehending the pedagogical organization within the several divisions no better suggestion can be offered than that of hitching one's wagon to an alert minded educator, be he or she an educational administrator, a superintendent, a principal, or a teacher, just so long as they know where they are going and the way to get there. In other words, collaboration between architect and teacher to the fullest extent will go far towards solving the problems at hand and ahead.

It is quite beside the question for a member of any one of these professions to keep abreast of the progress and details of the two professions. This holds true for the members of the teaching profession just as it does for those of the architectural profession, notwithstanding the training and inclination of both.

It is curious to note that even among the leaders in school administration that they are not fully and confidently agreed as to the best methods of teaching, courses and particularly equipment in all the departments of the school, especially those of the high school. The reason for it is that the several departmental heads and teachers manage the departments, arrange and direct the courses of study while the administrators have their hands full managing the plant or plants as a whole. This is as it should be, for it isn't within the realm of humanity possible for any school superintendent to be able to teach and guide the work in all the departments. Life is too short. Therefore, how is it possible for the architect to presume that he can do it alone, and, of course, he doesn't which leads to the matter of right planning and worthy economies in handling the vast funds and buildings involved.

No attempt will be made here to offer advice regarding structural economies, because

the great majority of the members of the architectural profession always have that in mind anyway. But great economies can be exercised in the size of rooms, types and design of equipment, the story heights of shops, and a great many other matters which soon become evident with familiarity with the problem. It is as easy to err overloading a department with superfluous apparatus, as it is to inadequately equip it. It is the happy medium that the well trained departmental head and the architect will arrive at from their combined study and tests.

It isn't necessary to hold fast to the Coue theory for we know that "in every way and day by day School Architecture is getting better and better." It is the result of greater distribution of the work among the members of the architectural profession. It is proverbial that with the diffusion of knowledge the general average improves and the leaders step faster, or are out-distanced by the new arrivals. It is the struggle for leadership that is bringing forth orderly conceptions in plans, pleasing compositions in exteriors, better relation in buildings to grounds, finer color harmony between interiors and furnishings, keener selection of and more permanency in materials and so on ad infinitum. But what has all this to do with the glimpse into the future? Nothing more than to say that all which has been said here is being done this minute by both the teaching and architectural professions and that their combined efforts will bring forth the finest school and educational buildings the world has yet seen and they'll be better and better in every way because of the more complete understanding of the many great problems with their innumerable details. And the fine fellowship so evident with the return of peace and prosperity is enhanced with exchange of ideas and data. All this means a glorious future with continuous opportunities for exercise of talents, training, experience and good taste, all of which will make the world happier.

---

NOTE: Mr. John J. Donovan designed many of the finest schools in Oakland, California, while City Architect, and numbers of other schools, since then, throughout California and neighboring states. Besides compiling an exhaustive treatise on "School Architecture", which is used as a reference and authority by all school boards and school architects. Mr. Donovan has served on the Committee on School Buildings of the National American Institute of Architects, and on the State Board of Architecture for Northern California.



SANTA MONICA HIGH SCHOOL,

SANTA MONICA, CALIFORNIA.

## Two Schools in California

*Allison and Allison, Architects*

By PETER B. WIGHT, F.A.I.A.

When about ten years ago the important development of school architecture in California began to be known throughout this country the most detailed information about it was sought with avidity. It was coincident with the growth of the agitation for public play grounds. They were established in all the centers of advanced education, in which Chicago took the lead. There they were not connected with schools but were generally located in congested neighborhoods, while at the same time there began to be developed a system of small parks in outlying neighborhoods, supplementing the large parks which were for the enjoyment of those able to drive and have landscape and scenic surroundings. But soon it began to be advocated that the play grounds should be connected with schools. This could not be done in closely built districts and was only feasible in the suburbs of large cities.

In California the great change not only consisted in enlarged school grounds, but was a radical one, in so far as concerned the planning of the buildings. School buildings which before had been erected with basements above ground and two or three stories above them

were reduced to two stories without basement; and soon the one story school appeared. This was the greatest innovation; and the architectural journals were active in reproducing their ground plans and arrangements as fast as any new ones were built. It was more practicable to do this in Pacific Coast cities than in the middle and eastern states, because there were larger areas of unimproved property in those cities, and land was cheaper. But the one-story school was the most attractive improvement, and there were more reasons for its practicability on the Pacific Coast and in the milder climate of Southern California than anywhere else. The cheaper construction of one and two story buildings was an offset to the greater cost of the enlarged play grounds around them. But the greatest economy in the one story schools was due to the elimination of the expense of stairways and the fact that they were so safe as against fire and panic that fireproof building materials could be wisely dispensed with. Another improvement was the elimination of all halls, the rooms being reached by open corridors which became architectural features

capable of artistic expression. The planning of schools became a new art and most of the old conventions disappeared in them.

The influence of this reform soon began to take root all over the country, and instead of continuing to build expensive three and four-story fireproof schools in cities such as New York, Chicago, St. Louis and others, most of the new schools were reduced to two stories and covered larger areas of ground, under the advice and influence of such architects as Snyder of New York and Ittner of St. Louis. At the present time the two story school is the standard in all eastern and middle west cities. But in California the one story school is now the standard, and the high schools are seldom more than two stories high.

In California larger grounds in proportion to the school attendance are provided than in any eastern cities. They are not altogether for exercise and play, but are partly treated and improved as gardens, and provision is made for enlarging the buildings to any extent to meet the demands due to increase in population.

Among the first architects to study the new problems was the firm of Allison and Allison, two brothers, of Los Angeles. Up to the present time their experience in designing grammar schools and high school buildings in California has been larger than that of any other architects on the Pacific Coast. Most of their works have been published, but there is still much to be said of them that is new.

Santa Monica, on the Pacific Coast, eighteen miles from Los Angeles, enjoys the possession of one of the finest high schools ever built. It is large enough to provide its children with the higher education for many years to come, and its grounds are so large that they will answer their purpose for all times. They are only about half a mile from the sea beach, and, as the street grades have a gentle rise of about 120 feet for the whole distance, there is not only a magnificent ocean view covering twenty miles of the coast, from the main building, but from every part of the grounds.

These comprise about sixteen acres facing toward the Pacific Ocean on the west side of Fourth Street and extending east to Seventh Street, a distance of three blocks or about eleven hundred feet. They are bounded by Michigan Avenue on the north and Fremont avenue on the south. The lot has a width of 500 feet on Fourth Street and 600 feet on Seventh Street. Two north and south streets

abut upon it, where there are four entrances. There is an additional entrance to the athletic field at the west end. The ground continues to rise from the west and to the east and the main building is at the highest point, where its frontage to the west is 465 feet.

Fremont Avenue had not been graded when the plans for the whole improvement were made, but the grade established by the city engineer contemplated a very slight cut. The development of the plans convinced the architects that the group of buildings should be treated symmetrically; that is, the two end buildings should be of about the same general design, height and dimensions, which would require an addition of sixteen feet for the general cut of Fremont Avenue and the removal of approximately seventy-five thousand yards of earth from the high school site. They made their plans accordingly; included the grading in the general contract, appeared before the City Council of Santa Monica and successfully urged the change in the street grade, so that the site now has a gentle slope in all directions from the main building.

Fremont Avenue grade is very much improved as a result, and the wisdom of the change is very apparent not only in the effect of the completed buildings, but in the grade of Fremont Avenue.

The memorial gateways, which are the north and south entrances to the athletic field at Fifth Street, were donated by the heirs of two prominent Santa Monica pioneers; that at the south entrance, known as the Elliott gateway, by the heirs of Robert P. Elliott; and the one at the north entrance, known as the Vawter gateway, by the heirs of Williamson D. Vawter.

All of the landscape and planting was designed in the architects' office under the direct supervision of the junior member of the firm, David C. Allison, with the assistance of Mr. John D. Shaw, landscape architect, who was consulted with reference to the shrubbery, trees and other planting. The planting scheme is not yet completed. The architects prepared a complete plan and specifications for this, designating by number the location of every plant and its kind. It is now being developed gradually, as funds are available, and is about seventy-five per cent completed. The whole scheme for planting alone involves an expense of about \$10,000.

In an article so extensively illustrated as this it seems hardly necessary to describe the plan and architecture of the several buildings; all

that will be necessary for some time to come having been completed.

But there are features in the exterior design which are well worthy of comment. But the fact is that there are no materials used in any part of the exterior of these buildings except rough red brick and cement, the cement mortar with which the bricks are laid. No special shapes of bricks are used, and in few instances have bricks been cut to carry out the designs. All trimmings and copings are of cast concrete. The bricks are uniformly rough, of a dark red color, and large size, twelve inches long, five inches wide and three inches high. These are of unusual size, but in proper scale for such large buildings. When white appears in the pictures it is the light gray cement color, and beautiful mosaic effects are obtained on a large scale by setting the bricks back an inch and filling the sinkage with cement as the bricks are laid. Thus the grandeur in effect is obtained in the simplest possible manner; but the art which produced it was the conception of the architects alone.

One of the results has been that they were enabled by strict economy to keep the cost of the buildings within the appropriations, which were apparently meager for the purpose. The hardest problem was that of keeping the cost of the enormous amount of excavation required within the appropriations made for the buildings alone. But the foresight of the architects has been appreciated by the people of Santa Monica, who see that the improvement in the grade of the surrounding streets is a public benefit to the surrounding property, which is now being rapidly improved in a better manner than would otherwise have been the case.

The bricks of which these immense buildings are built are made of the same clay as that on which they stand, as if they had literally come out of the ground as things of beauty; and conceived as such; for their architecture is native to California and not patterned after any of the so-called historical styles of architecture. It is another evidence of the continued existence of a rational and progressive architecture in America.

## THE GLENDORA SCHOOL

The Glendora grammar school, which the writer discovered by accident, not expecting to find architecture under the brow of the Sierra Madre range in the beautiful little village where it is located. It is about sixty miles east of Los Angeles at the terminus of one of the electric railroads which converge in that city.

This is one of the latest examples of one story school houses spread out on a large lot with surrounding playgrounds, which, when improved, will be a beautiful city park.

The building is of rough red brick, with overhanging Spanish tiled roof. All the trimmings are of cast concrete, and the walls under the loggia are stuccoed with cement. The whole thing is indicative of simplicity, and its beauty is found in the good proportions of its parts. Such a building speaks for itself and is easily described. But it is typical of what California is doing for its children, aided by the blessings of a mild climate, in which, of course, it has an advantage over other parts of our country. At the north and east the rising generation could only be provided with equal educational and recreative advantages at much greater expense.

In closing the account of these fine buildings, it is a pleasure to be able to record the fact that at a meeting of the Southern California Chapter of the American Institute of Architects held at Los Angeles on the 12th of March Allison and Allison were awarded the Chapter Medal of Honor for distinctive and meritorious architectural design in the miscellaneous building class for 1918, within the jurisdiction of the Southern California Chapter; the Los Angeles State Normal Schools, erected about the same time as those herein mentioned, being the particular buildings mentioned by the jury, which was composed of William B. Faville, William Charles Hays and George W. Kelham of the San Francisco Chapter.

At the Fifty-first annual convention of the American Institute of Architects held in Philadelphia, in April, James E. Allison, senior member of the firm, was raised to the grade of Fellowship (F.A.I.A.)

(Note: This article is reprinted by the courtesy of the "Western Architect".)



## EDITORIAL

To present as nearly complete a review of the work of a leading architectural firm as is given in this issue of *The Building Review*, is an important contribution to the advancement of architecture in this country. We believe that the consistently high quality of Allison and Allison's work as here shown, is bound to be a revelation and an inspiration. Their ability has long been recognized, and their spheres of activity have been steadily spreading; but now a really comprehensive idea can be formed of their record of accomplishment.

There will be found here no great variety of styles, and no vague experimental essays. Neither is there slavish imitation, nor stupid repetition of hackneyed motif or meaningless detail. The designer of these buildings has chosen an architectural alphabet of established excellence, with which he is on terms of intimate familiarity, and has skillfully arranged his elements into new combinations that have meaning and interest; that carry a distinct message; that please and edify.

To do this once might be the result of happy chance, of a flash of inspiration. But there is no chance behind these designs. There is knowledge and power.

Such a demonstration of the essential virility, vitality, of good architecture is welcome and opportune. There is a frequent, false cry that architecture is dead, which leads, on the one hand, to complacent (and often corrupt) copies of past glories, and on the other, to the unfortunate results which have come from attempts to create new forms of art.

It is well that the class of work in which this firm has become a specialist is one through which the influence of good design is most far-reaching. Public school buildings are not only the daily environment of the growing generation, but more and more are coming to be community centers. It is probable that the design of all future local architecture will be affected by the schools of Allison and Allison.

The University Club of Los Angeles is a joy to an architect, a pleasure to a guest, and a home to its members. From bottom to top, it is a harmonious unit; without a suspicion of hotel-style "Period" decoration, it is consistent throughout in its Italian inspiration. Walls, ceilings, floors, fittings, all the component parts compose well together. It has not at all the air of a museum, but there is on the contrary a distinctly restful atmosphere, due in some degree, no doubt, to the admirable and restrained color scheme. And, if there is a more charming spot in the midst of a great city than the cool green garden hedged by cypress and orange trees and bougainvillea vines, which floats above the garage forming an out-doors annex to the great lounging room, it has been well concealed.

In contrast, the description of the Zenith Athletic Club House in "Babbitt", by Sinclair Lewis, is worth quoting:

"The entrance lobby of the Athletic Club was Gothic, the washroom Roman Imperial, the lounge Spanish Mission, and the reading room in Chinese Chippendale, but the gem of the club was the dining room, the masterpiece of Ferdinand Reitman, Zenith's busiest architect. It was lofty and half-timbered, with Tudor leaded casements, an oriel, a somewhat musician-less musicians'-gallery, and tapestries believed to illustrate the granting of Magna Charta. The open beams had been hand-adzed at Jake Offutt's car-body works, the hinges were of hand-wrought iron, the wainscot studded with hand-made wooden pegs, and at one end of the room was a heraldic and hooded stone fireplace, which the club's advertising-pamphlet asserted to be not only larger than any of the fireplaces in European castles, but of a draught incomparably more scientific. It was also much cleaner, as no fire had ever been built in it."

*Allison Allen*



UNIVERSITY CLUB,  
LOS ANGELES, CALIFORNIA  
ALLISON & ALLISON, ARCHITECTS  
EDW. L. MAYBERRY, ENGINEER

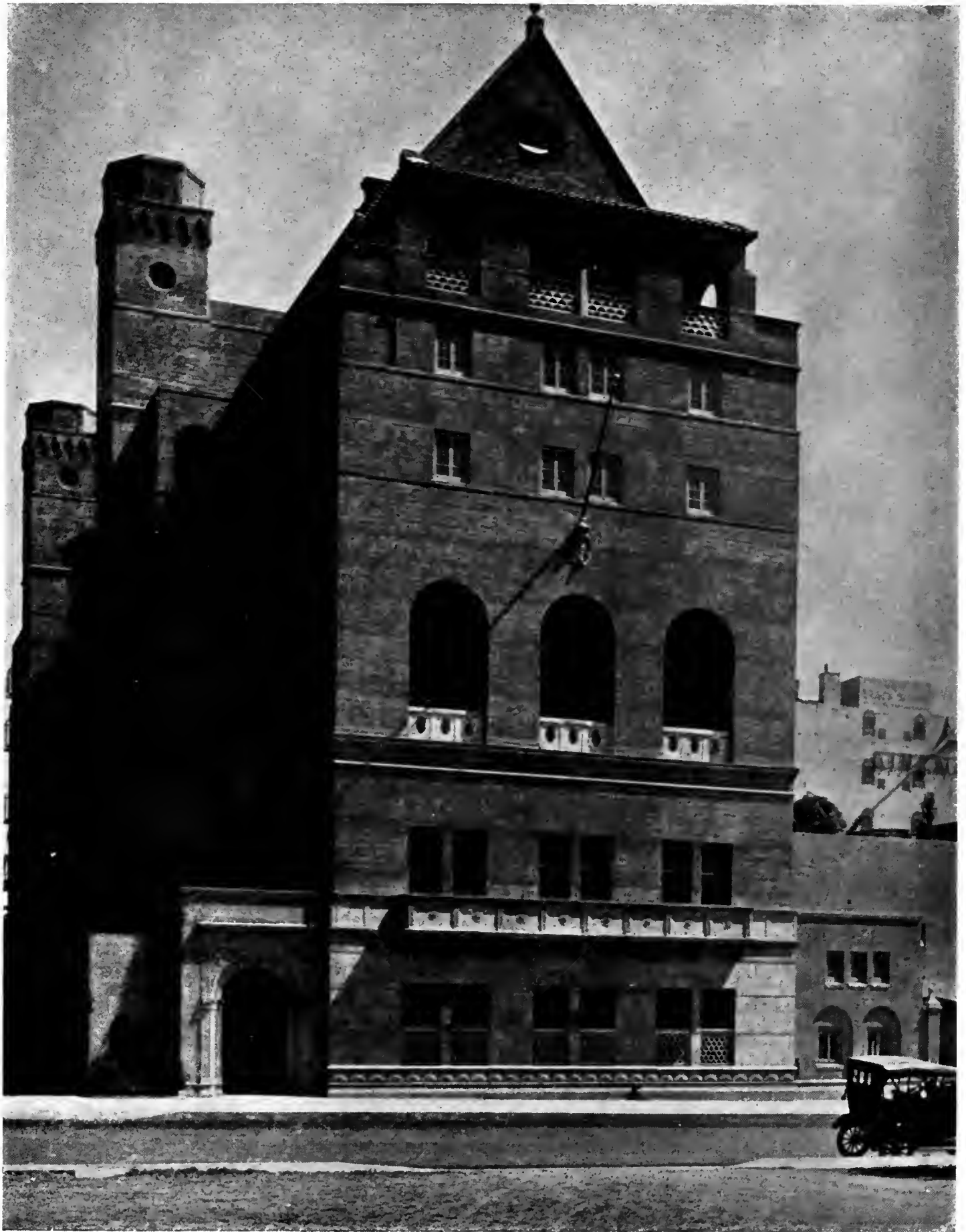

HOPE STREET FACADE,  
UNIVERSITY CLUB,  
LOS ANGELES, CALIFORNIA  
ALLISON & ALLISON, ARCHITECTS  
EDW. L. MAYBERRY, ENGINEER



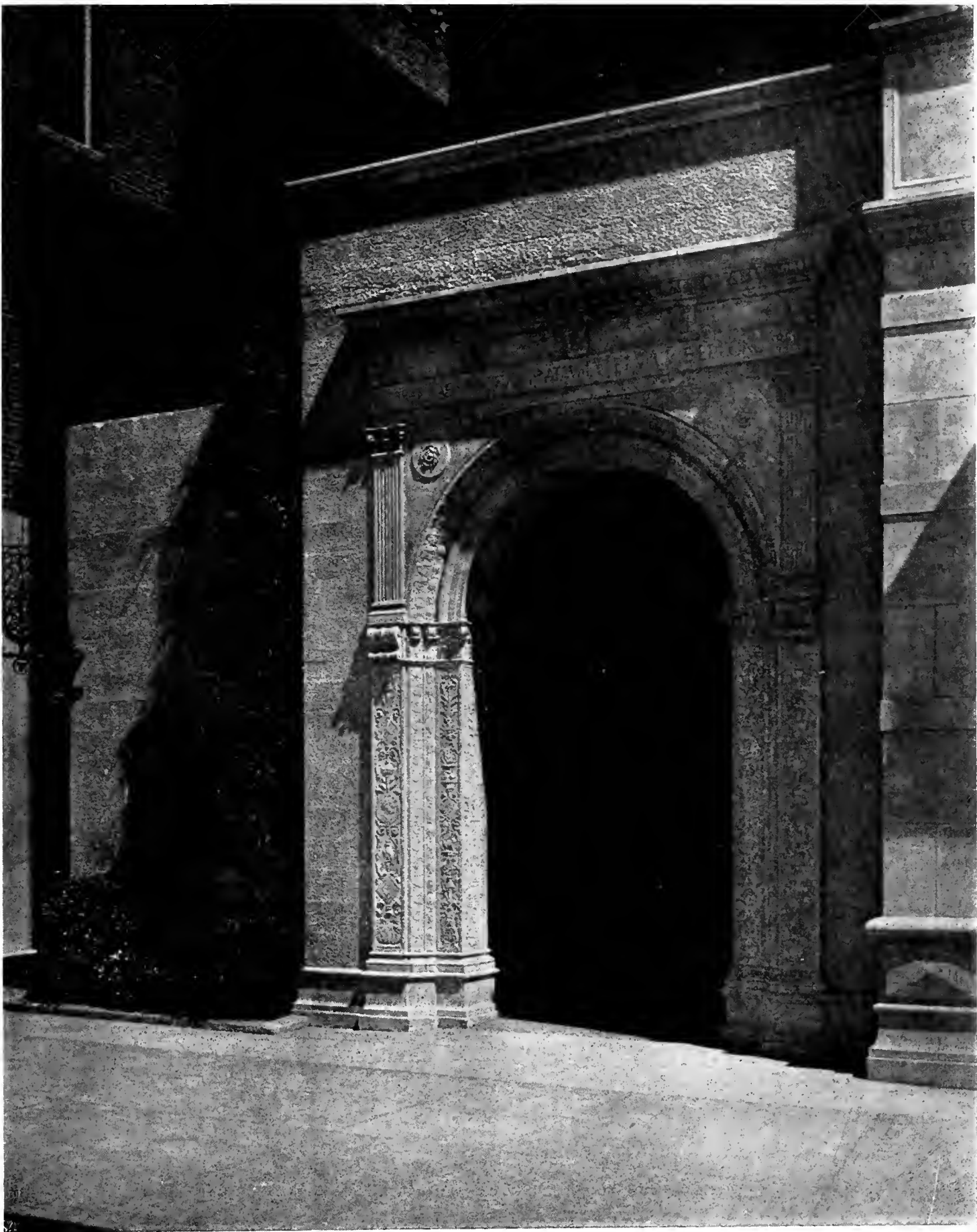

MAIN ENTRANCE,  
UNIVERSITY CLUB,  
LOS ANGELES, CALIFORNIA  
ALLISON & ALLISON, ARCHITECTS  
EDW. L. MAYBERRY, ENGINEER



ROOF GARDEN,  
UNIVERSITY CLUB,  
LOS ANGELES, CALIFORNIA  
ALLISON & ALLISON, ARCHITECTS  
EDW. L. MAYBERRY, ENGINEER



LOGGIA IN ROOF GARDEN,  
UNIVERSITY CLUB,  
LOS ANGELES, CALIFORNIA  
ALLISON & ALLISON, ARCHITECTS  
EDW. L. MAYBERRY, ENGINEER



GARAGE ENTRANCE,  
UNIVERSITY CLUB,  
LOS ANGELES, CALIFORNIA  
ALLISON & ALLISON, ARCHITECTS  
EDW. L. MAYBERRY, ENGINEER

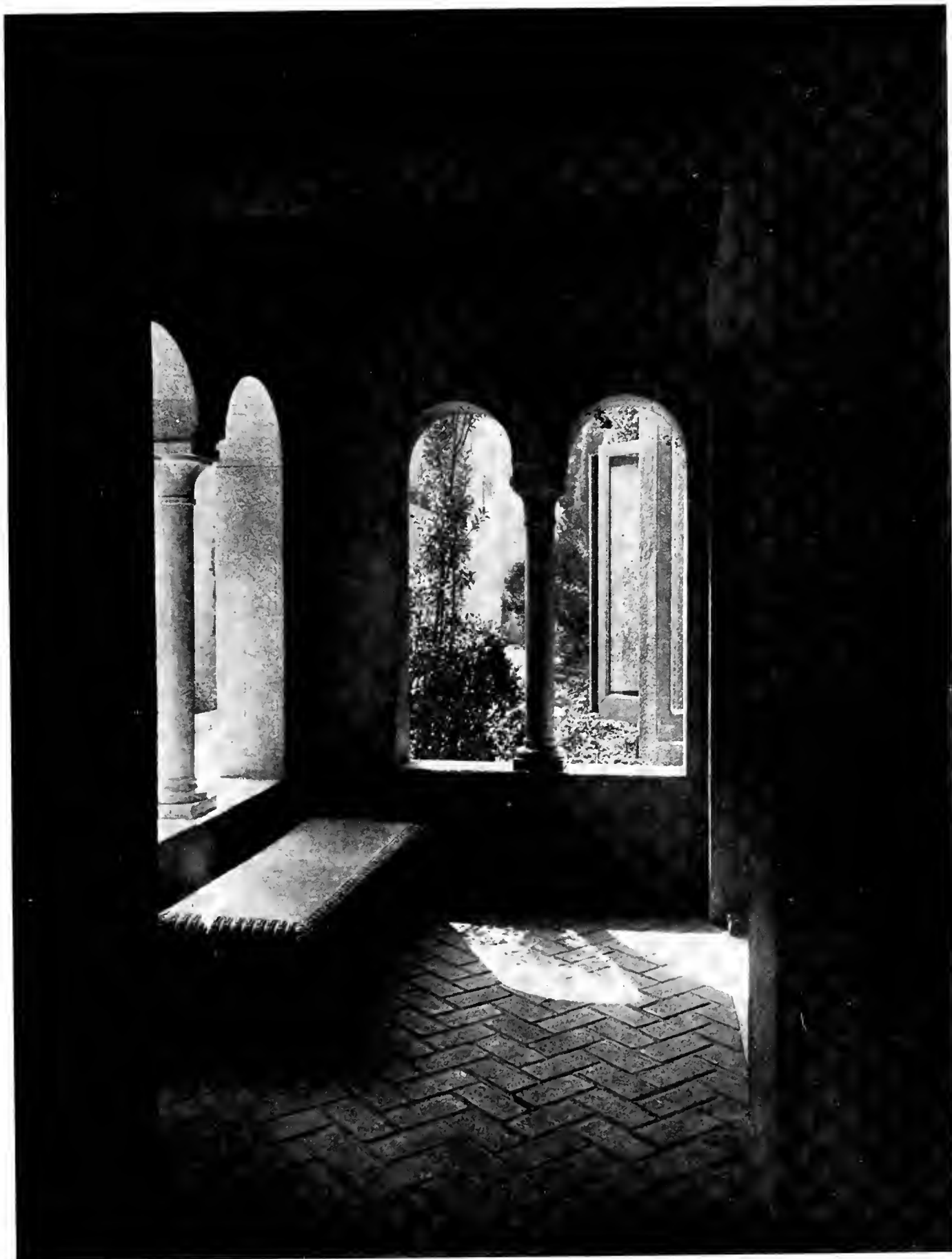

WOMEN'S ENTRANCE,  
UNIVERSITY CLUB,  
LOS ANGELES, CALIFORNIA  
ALLISON & ALLISON, ARCHITECTS  
EDW. L. MAYBERRY, ENGINEER

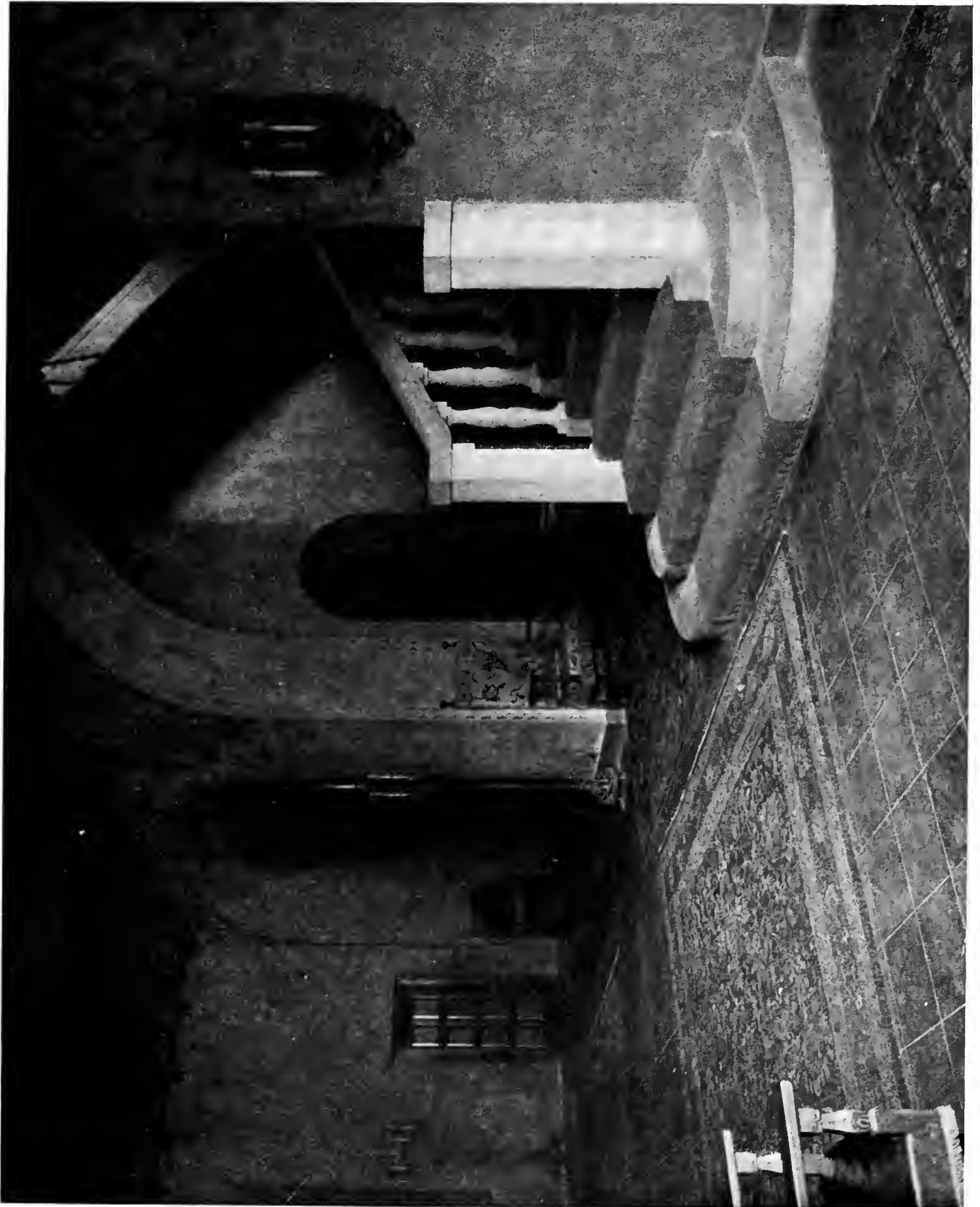

MAIN LOBBY,  
UNIVERSITY CLUB,  
LOS ANGELES, CALIFORNIA  
ALLISON & ALLISON, ARCHITECTS



MANTEL IN LOUNGE,  
UNIVERSITY CLUB,  
LOS ANGELES, CALIFORNIA  
ALLISON & ALLISON, ARCHITECTS



DINING ROOM,

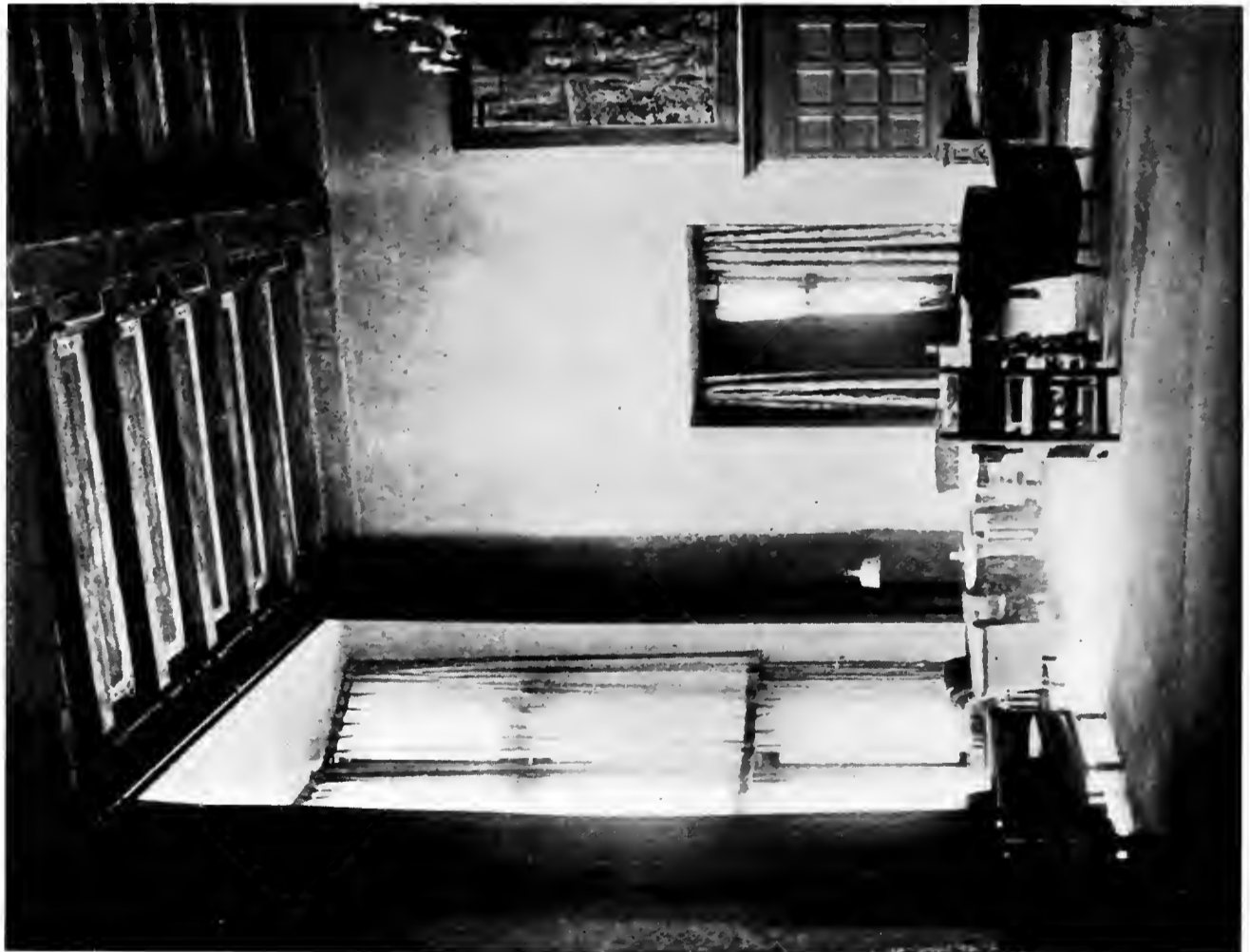

LOUNGE

UNIVERSITY CLUB,  
LOS ANGELES, CALIFORNIA  
ALLISON & ALLISON, ARCHITECTS





WRITING ROOM



MANTEL IN SILENCE ROOM

UNIVERSITY CLUB,  
LOS ANGELES, CALIFORNIA  
ALLISON & ALLISON, ARCHITECTS

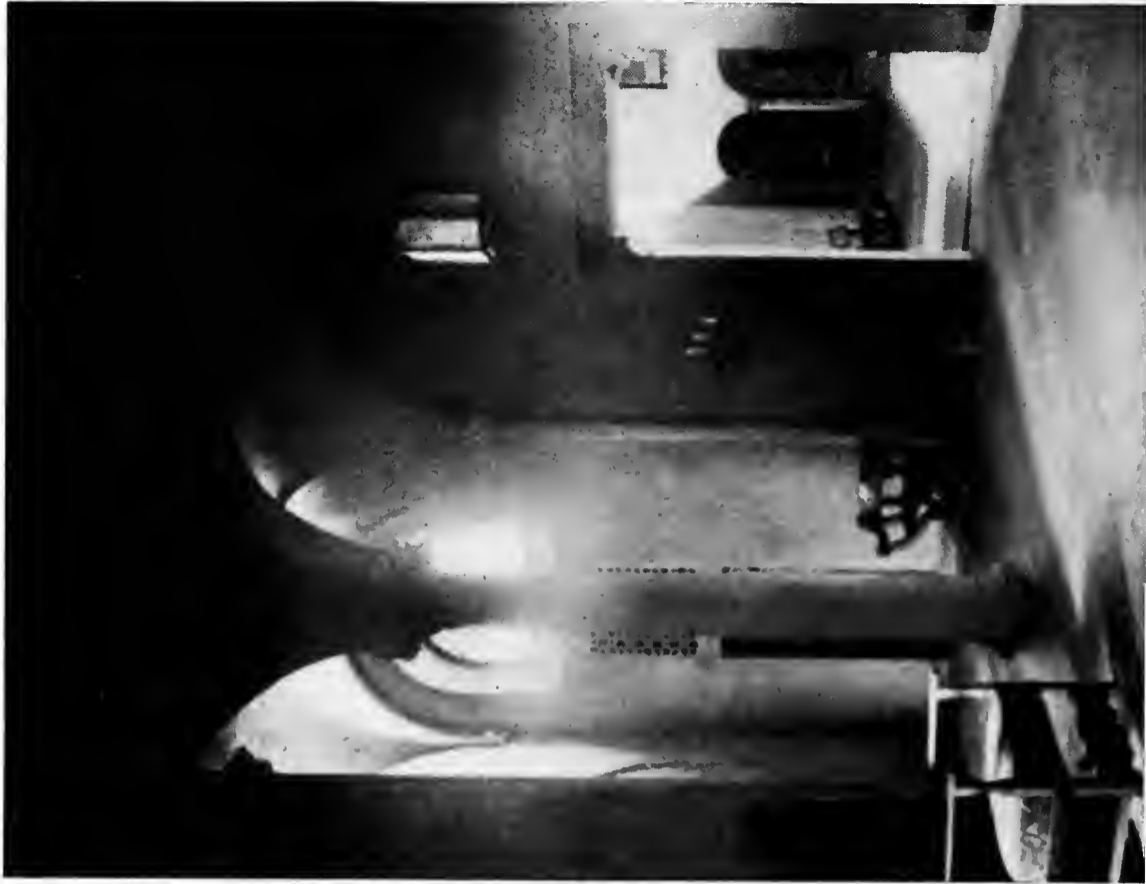

GREAT HALL,



ELEVATOR HALL,

UNIVERSITY CLUB,  
LOS ANGELES, CALIFORNIA  
ALLISON & ALLISON, ARCHITECTS



GREAT HALL,

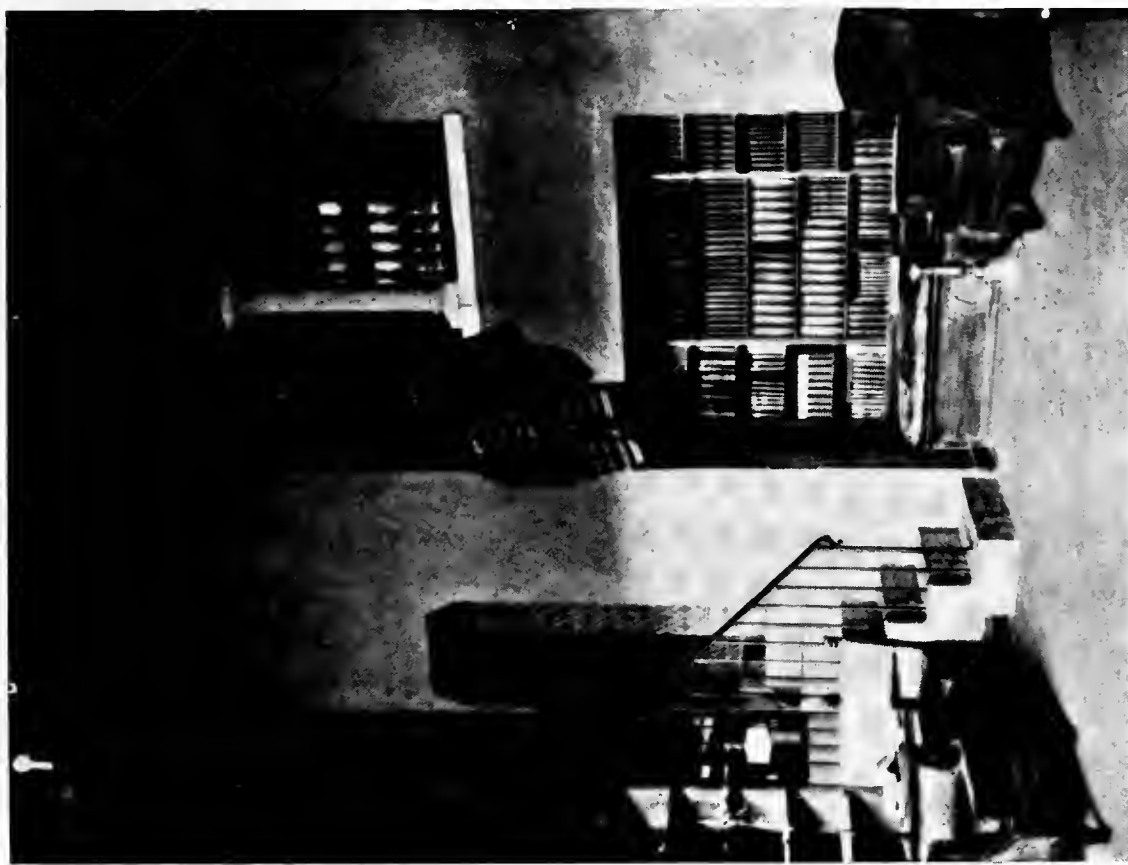

LIBRARY,

UNIVERSITY CLUB,  
LOS ANGELES, CALIFORNIA  
ALLISON & ALLISON, ARCHITECTS



THE FRIDAY MORNING CLUB  
LOS ANGELES, CALIFORNIA  
ALLISON & ALLISON, ARCHITECTS



MAIN ENTRANCE TO THE  
FRIDAY MORNING CLUB  
LOS ANGELES CALIF.

THE FRIDAY MORNING CLUB  
LOS ANGELES, CALIFORNIA  
ALLISON AND ALLISON, Architects

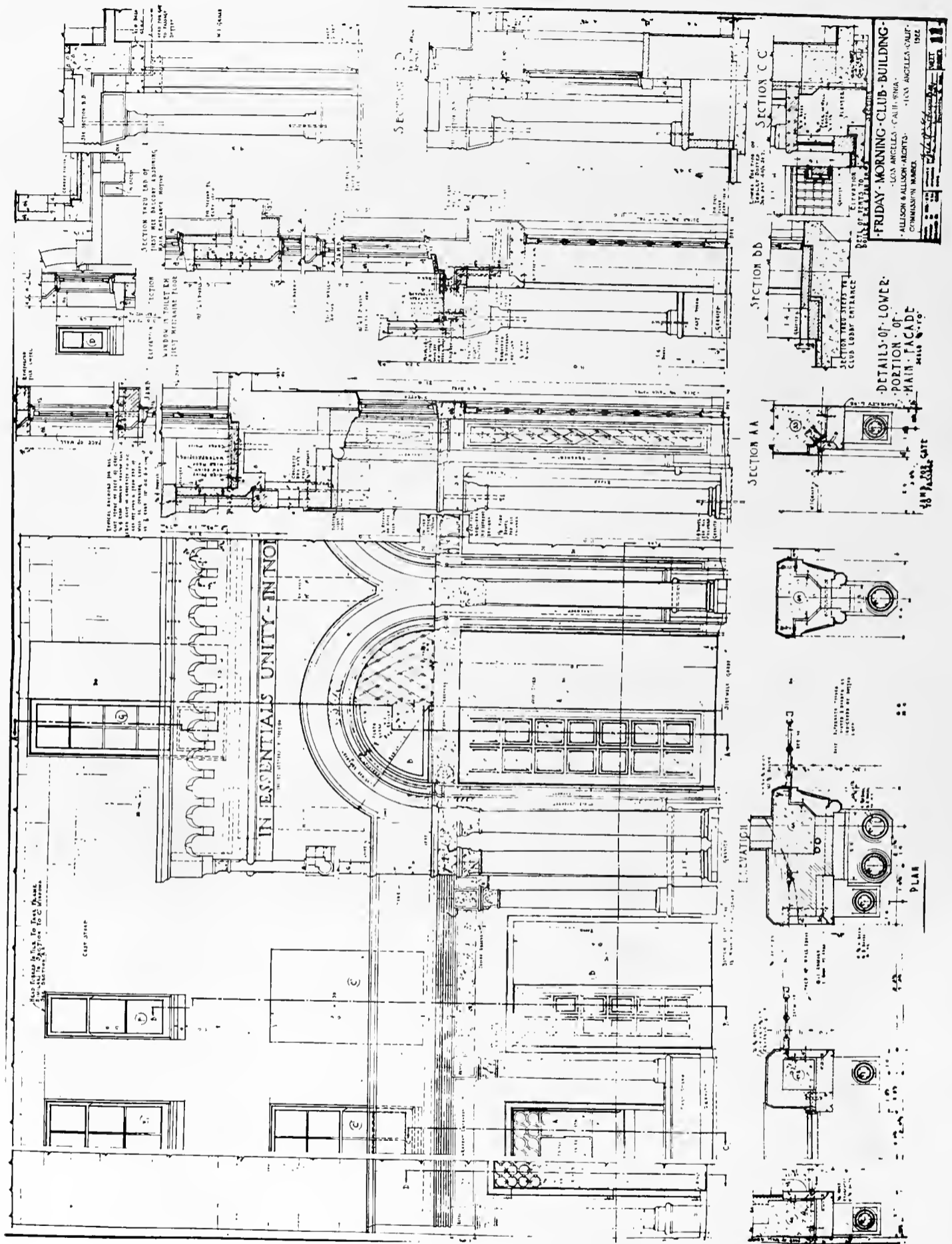

DETAIL, LOWER PORTION,  
 OF MAIN FACADE,  
 THE FRIDAY MORNING CLUB  
 LOS ANGELES, CALIFORNIA  
 ALLISON & ALLISON, ARCHITECTS



ADMINISTRATION BUILDING,  
PALO ALTO UNION HIGH SCHOOL,  
PALO ALTO, CALIFORNIA  
ALLISON & ALLISON, ARCHITECTS



AUDITORIUM FROM CLOISTER,  
PALO ALTO UNION HIGH SCHOOL,  
PALO ALTO, CALIFORNIA  
ALLISON & ALLISON, ARCHITECTS





WEST ENTRANCE,  
ADMINISTRATION BUILDING,  
PALO ALTO UNION HIGH SCHOOL,  
PALO ALTO, CALIFORNIA  
ALLISON & ALLISON, ARCHITECTS



LIBRARY



AUDITORIUM

PALO ALTO UNION HIGH SCHOOL,  
PALO ALTO, CALIFORNIA  
ALLISON & ALLISON, ARCHITECTS



VIEW OF GROUP FROM STANFORD ENTRANCE  
PALO ALTO UNION HIGH SCHOOL,  
PALO ALTO, CALIFORNIA  
ALLISON & ALLISON, ARCHITECT

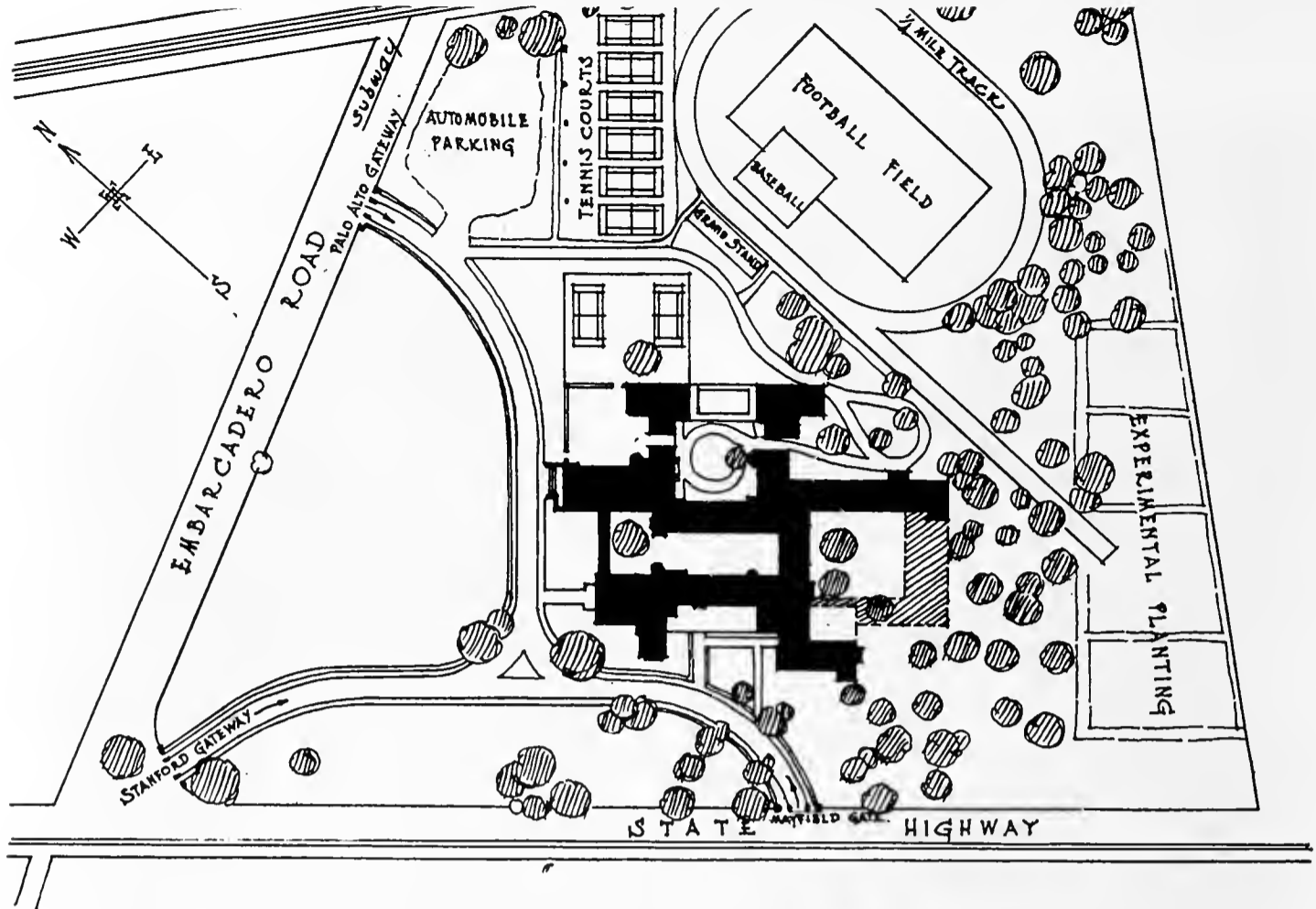

LEGEND

- |                     |                               |
|---------------------|-------------------------------|
| 1 CLASS ROOM        | 21 DINING ROOM                |
| 2 OFFICE            | 22 LOCKER & WASH R.M.         |
| 3 WORK ROOM         | 23 GREEN ROOM                 |
| 4 BOARD             | 24 ART METAL R.M.             |
| 5 REST "            | 25 BOYS' TOILET R.M.          |
| 6 STUDENT BODY      | 26 MECHANICAL DRAWING         |
| 7 SUPPLY ROOM       | 27 FINISHING R.M.             |
| 8 GIRLS' TOILET     | 28 CABINET SHOP               |
| 9 APPARATUS R.M.    | 29 MILL                       |
| 10 CHEMISTRY LABY.  | 30 LUMBER ROOM                |
| 11 LECTURE ROOM     | 31 FORGE SHOP                 |
| 12 PHYSICS LABY.    | 32 MACHINE SHOP               |
| 13 BIOLOGY LABY.    | 33 TOOL ROOM                  |
| 14 GERMINATING R.M. | 34 LOCKER & WASH R.M.         |
| 15 TYPEWRITING R.M. | 35 KITCHEN                    |
| 16 OFFICE PRACTISE  | 36 BOYS' LOCKER & SHOWER R.M. |
| 17 BOOKKEEPING R.M. | 37 GIRLS'                     |
| 18 SEWING CLASS     | 38 PARLOR                     |
| 19 FITTING ROOM     | 39 DIRECTOR'S ROOM.           |
| 20 COOKING CL. R.M. | 40 EXAMINER'S ROOM.           |
|                     | 41 OAK TREE                   |

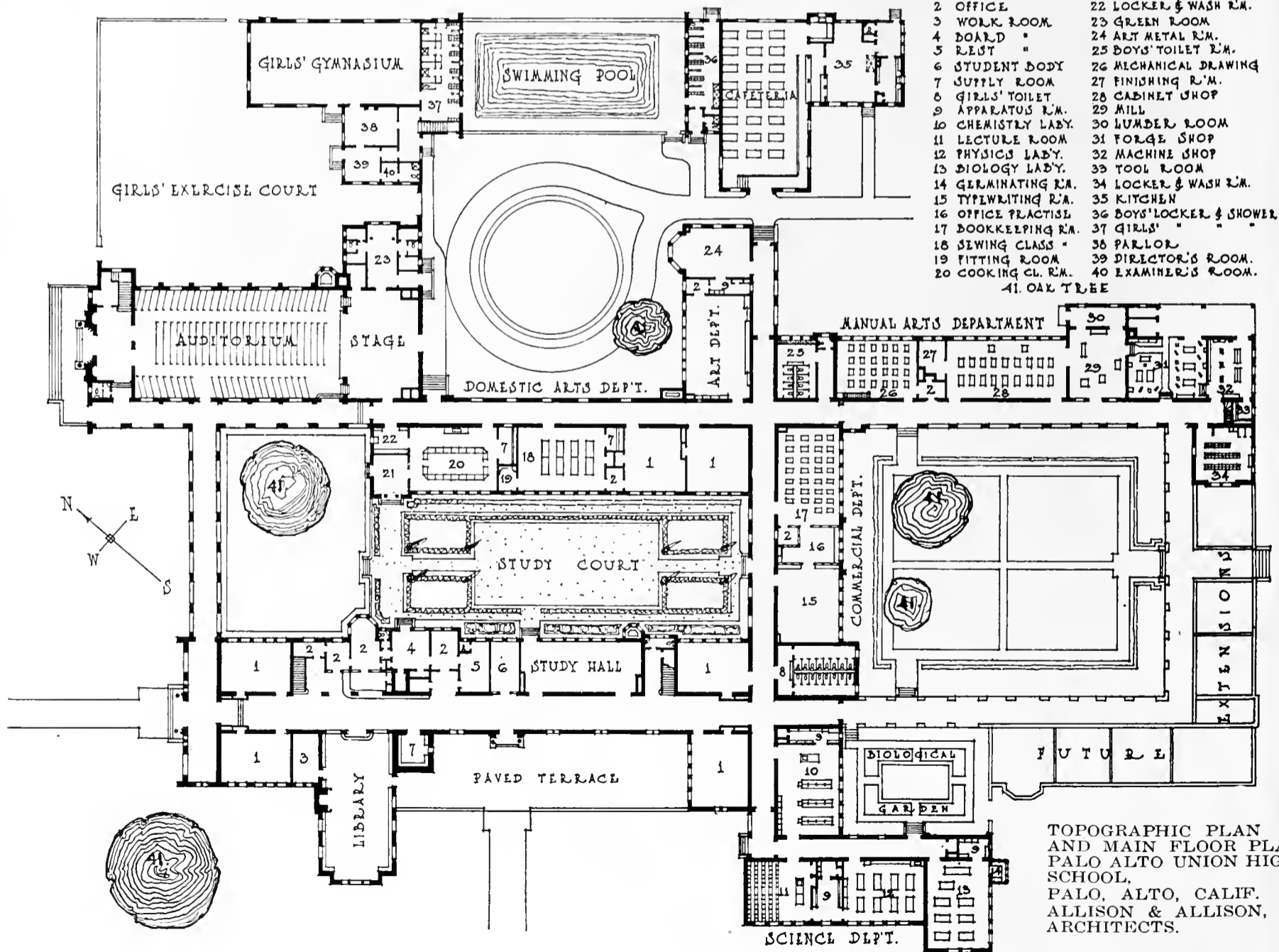

TOPOGRAPHIC PLAN AND MAIN FLOOR PLAN. PALO ALTO UNION HIGH SCHOOL, PALO ALTO, CALIF. ALLISON & ALLISON, ARCHITECTS.

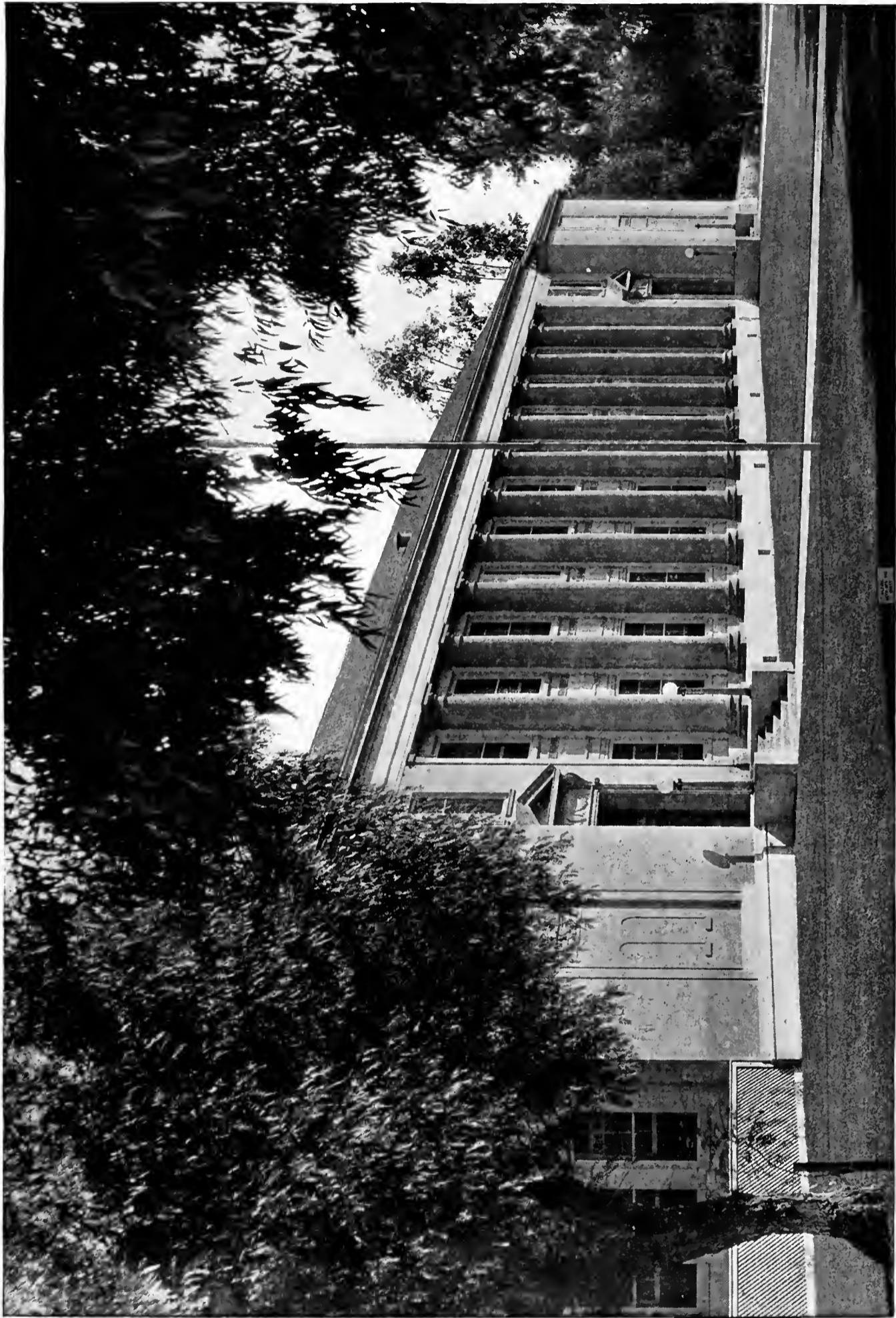

ELEMENTARY SCHOOL,  
COLTON, CALIFORNIA  
ALLISON & ALLISON, ARCHITECTS



MAIN ENTRANCE



DETAIL

UNION HIGH SCHOOL,  
SANTA MARIA, CALIFORNIA  
ALLISON & ALLISON, ARCHITECTS

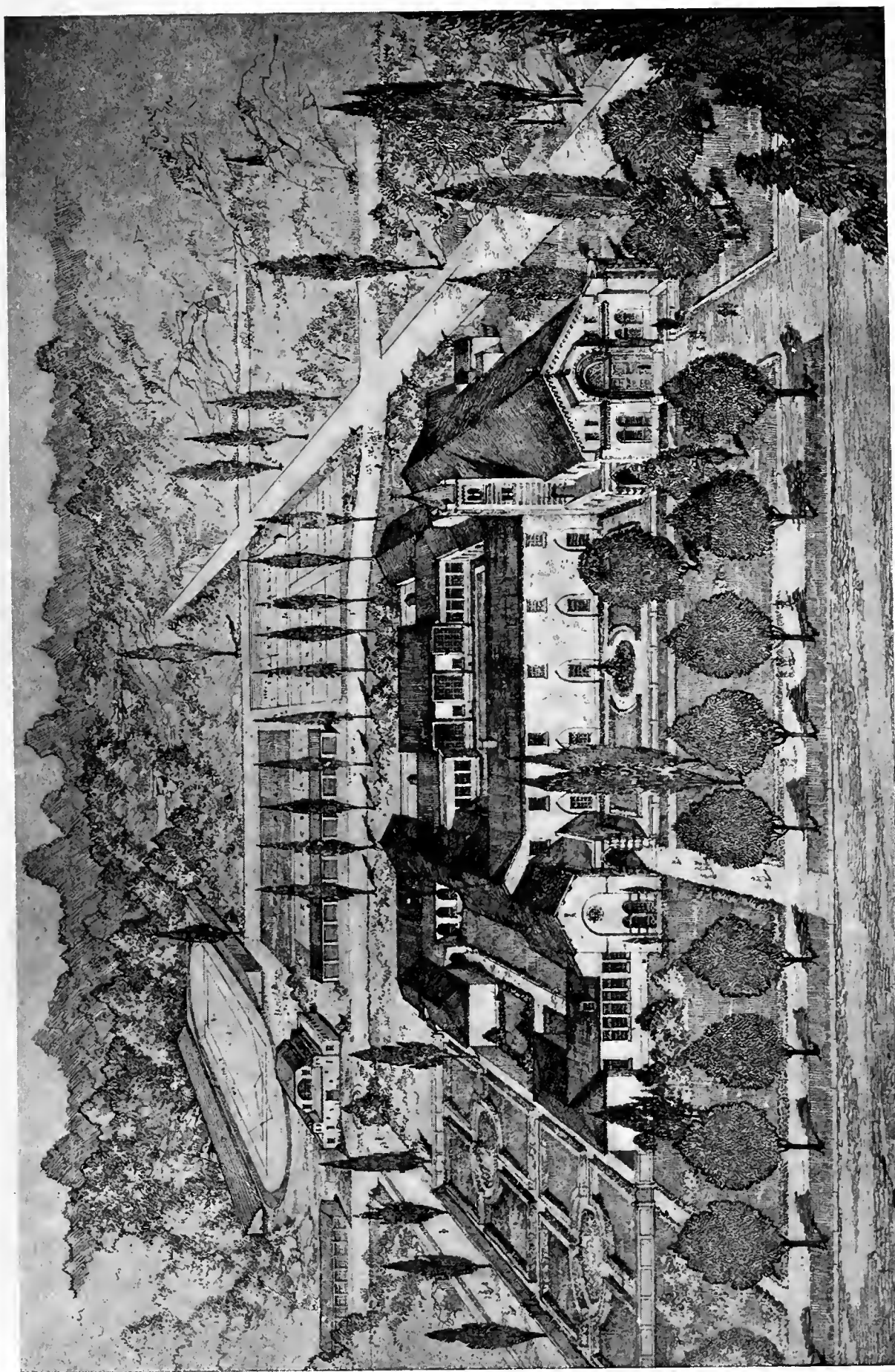

PERSPECTIVE,  
UNION HIGH SCHOOL,  
SANTA MARIA, CALIFORNIA  
ALLISON & ALLISON, ARCHITECTS

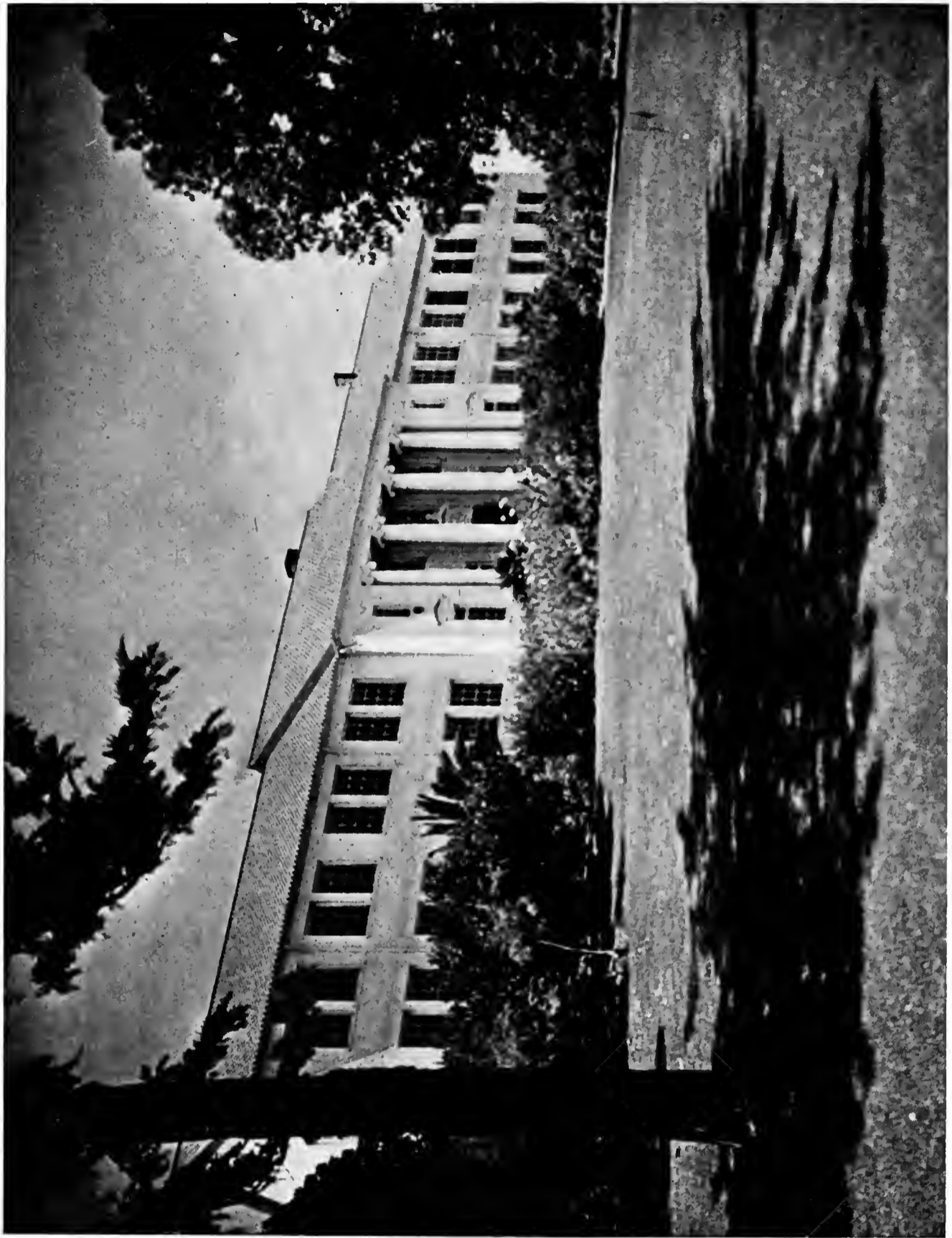

HIGH SCHOOL,  
SANTA PAULA, CALIFORNIA  
ALLISON & ALLISON, ARCHITECTS



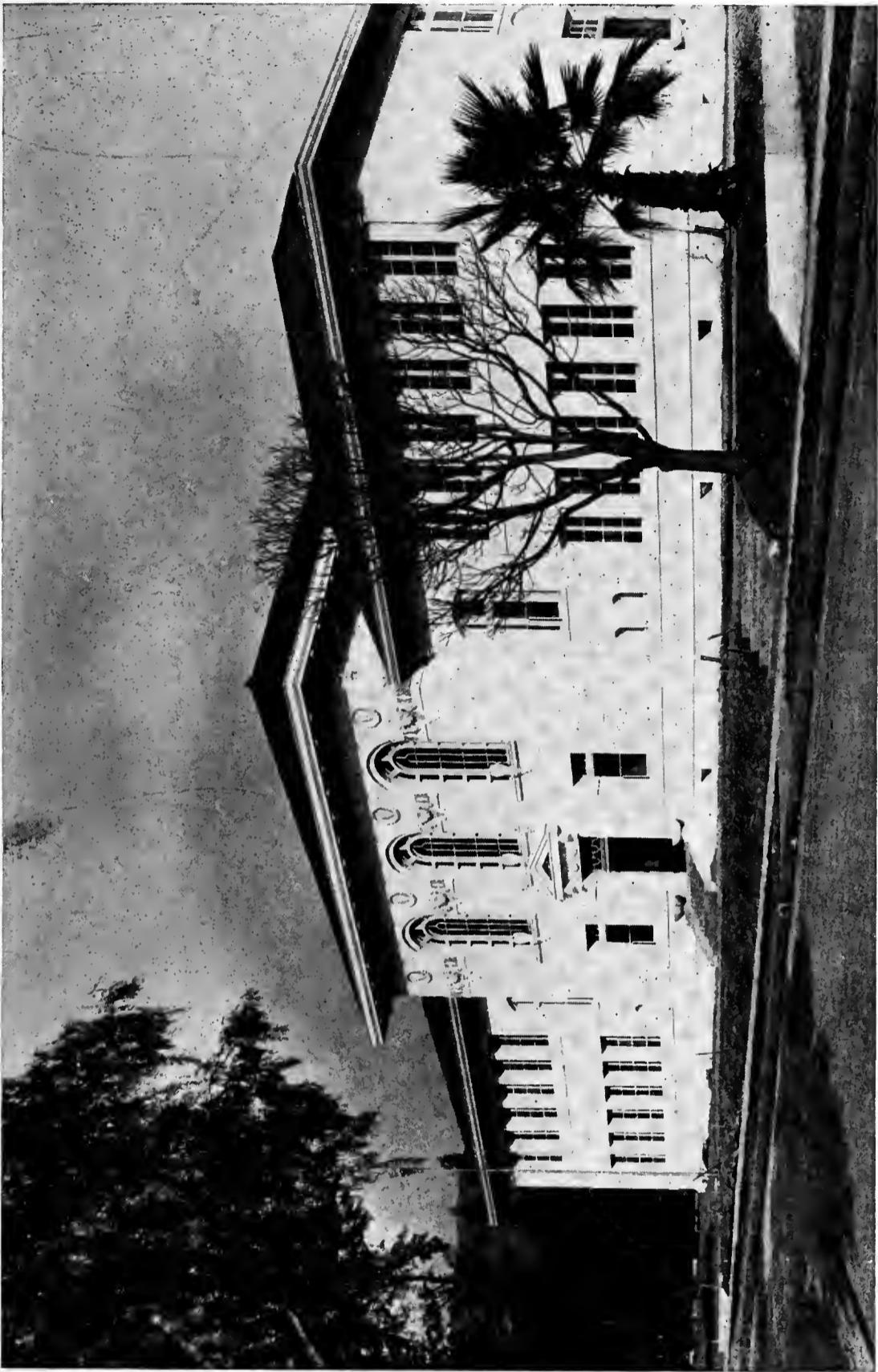

WILD ROSE ELEMENTARY SCHOOL,  
MONROVIA, CALIFORNIA  
ALLISON & ALLISON, ARCHITECTS

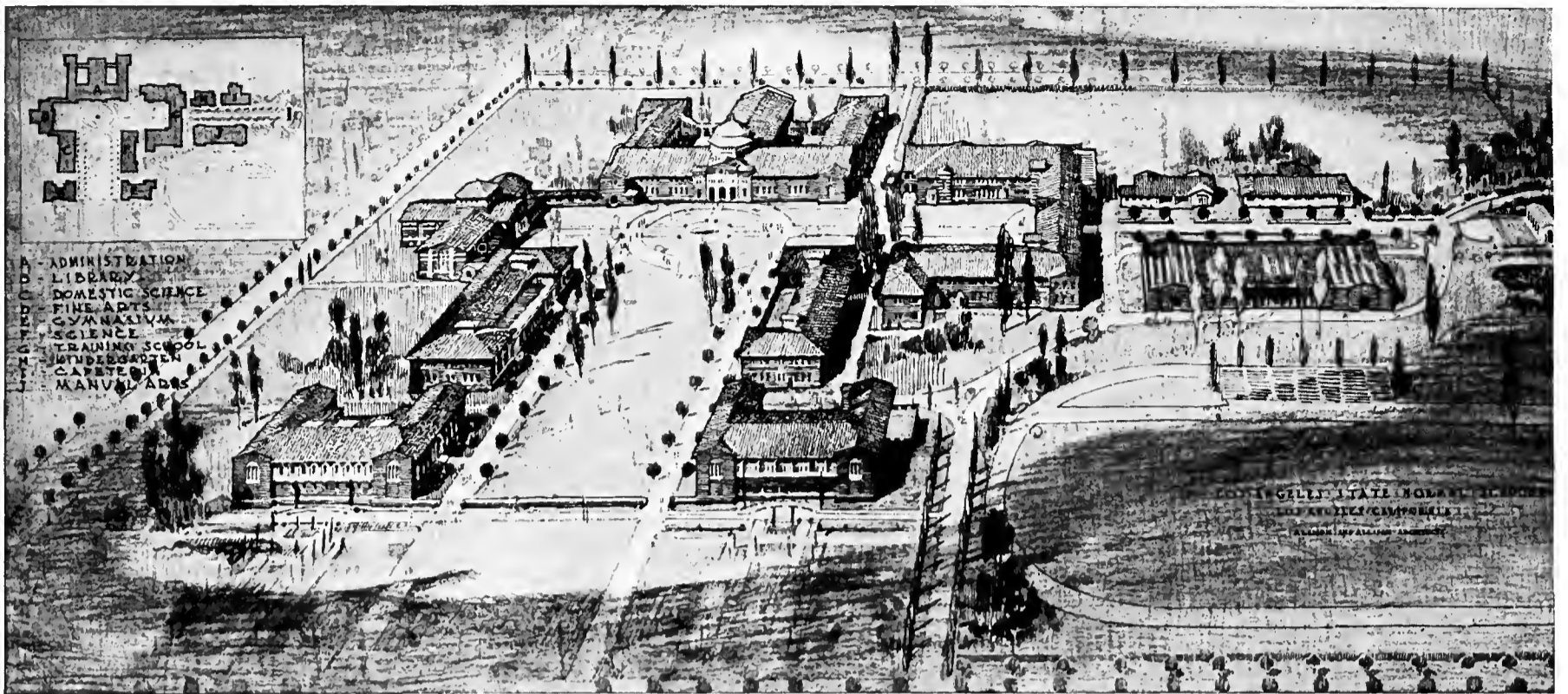

PERSPECTIVE,  
LOS ANGELES STATE NORMAL SCHOOL,



LIBRARY,  
UNIVERSITY OF CALIFORNIA (Southern Branch)  
LOS ANGELES, CALIFORNIA  
ALLISON & ALLISON, ARCHITECTS

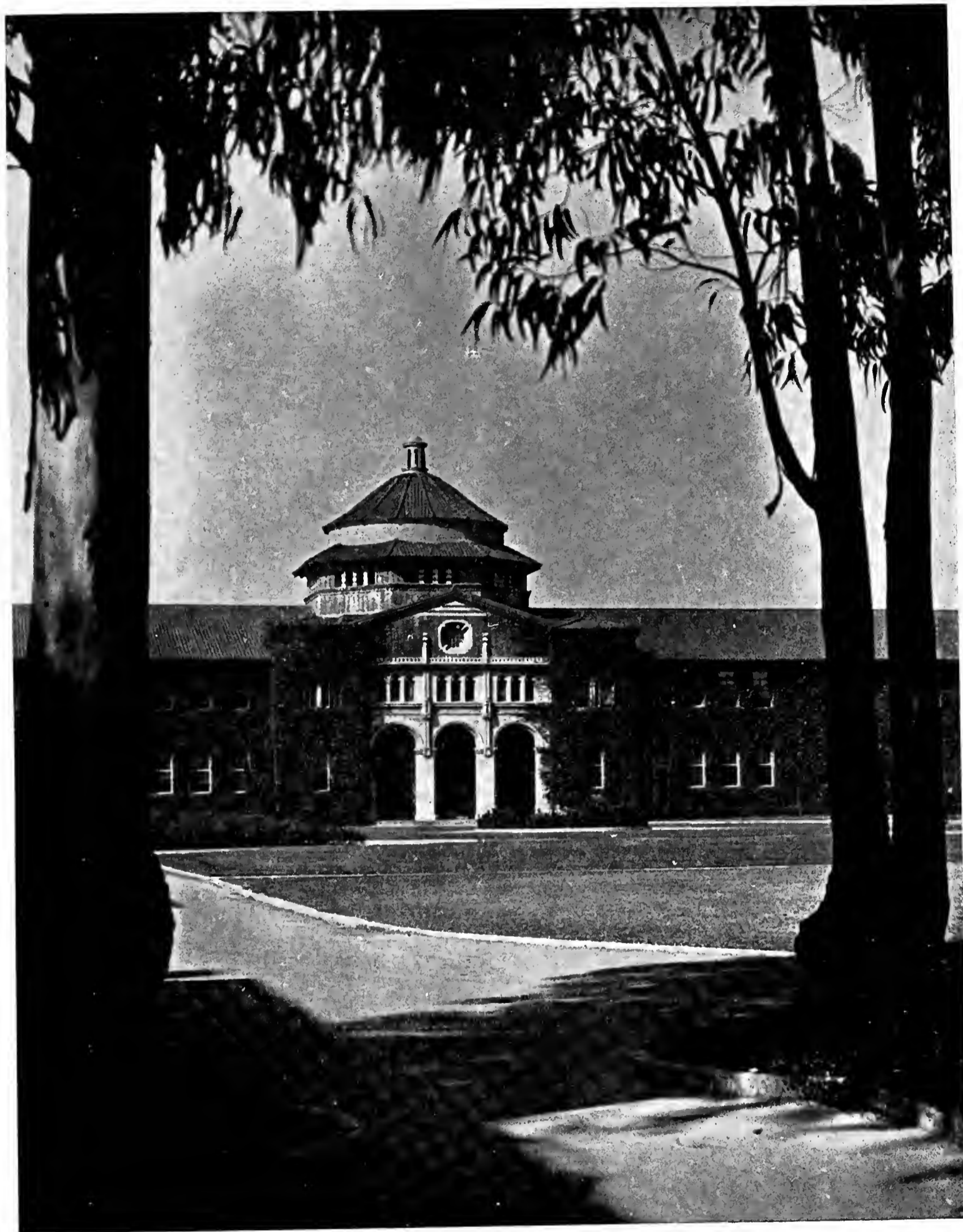

MILLSPAUGH HALL,  
UNIVERSITY OF CALIFORNIA (Southern Branch)  
LOS ANGELES, CALIFORNIA  
ALLISON & ALLISON, ARCHITECTS

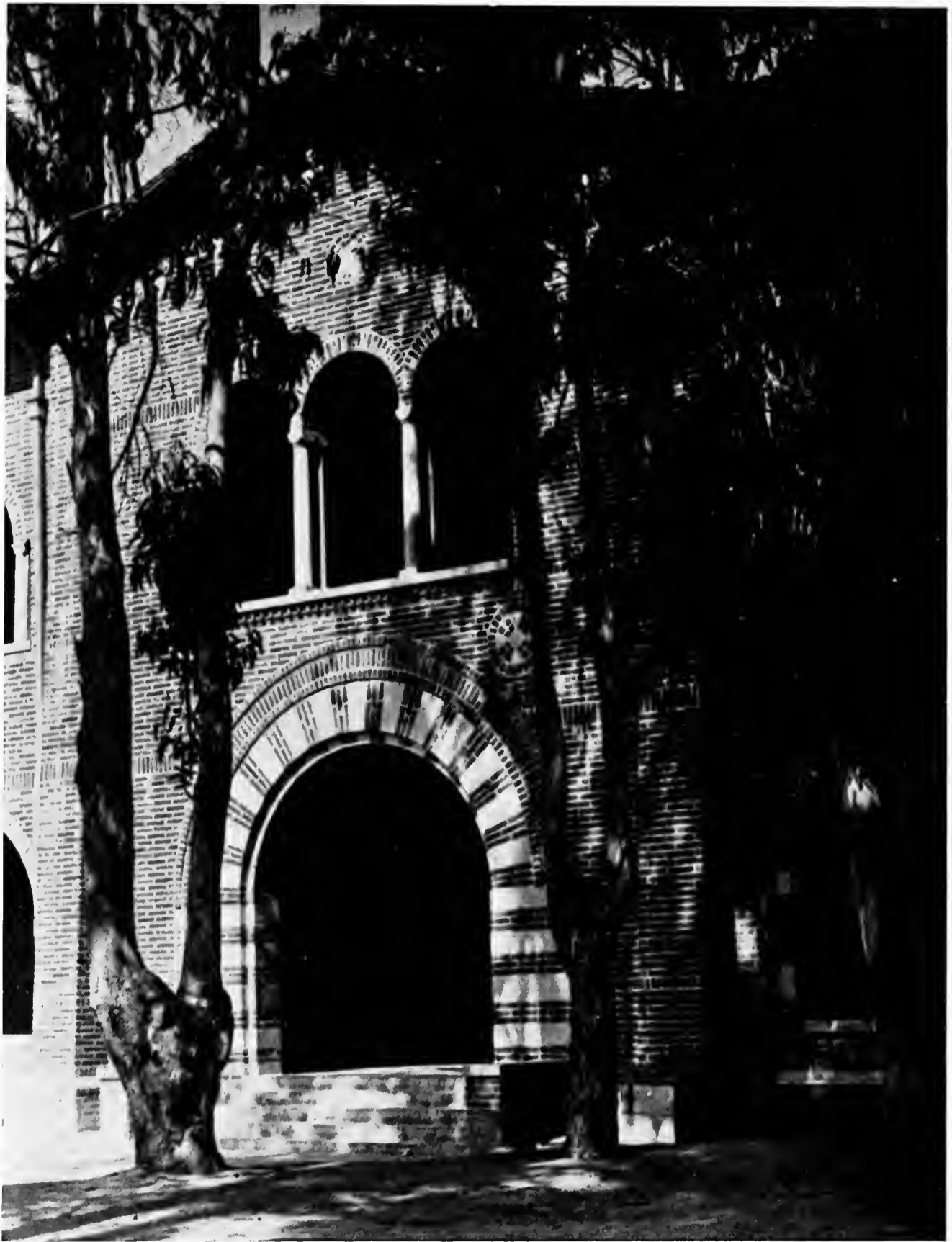

ENTRANCE TO TRAINING SCHOOL,  
UNIVERSITY OF CALIFORNIA (Southern Branch)  
LOS ANGELES, CALIFORNIA  
ALLISON & ALLISON, ARCHITECTS



SCIENCE BUILDING,  
UNIVERSITY OF CALIFORNIA (Southern Branch)  
LOS ANGELES, CALIFORNIA  
ALLISON & ALLISON, ARCHITECTS



FINE ARTS BUILDING,  
UNIVERSITY OF CALIFORNIA (Southern Branch)  
LOS ANGELES, CALIFORNIA  
ALLISON & ALLISON, ARCHITECTS

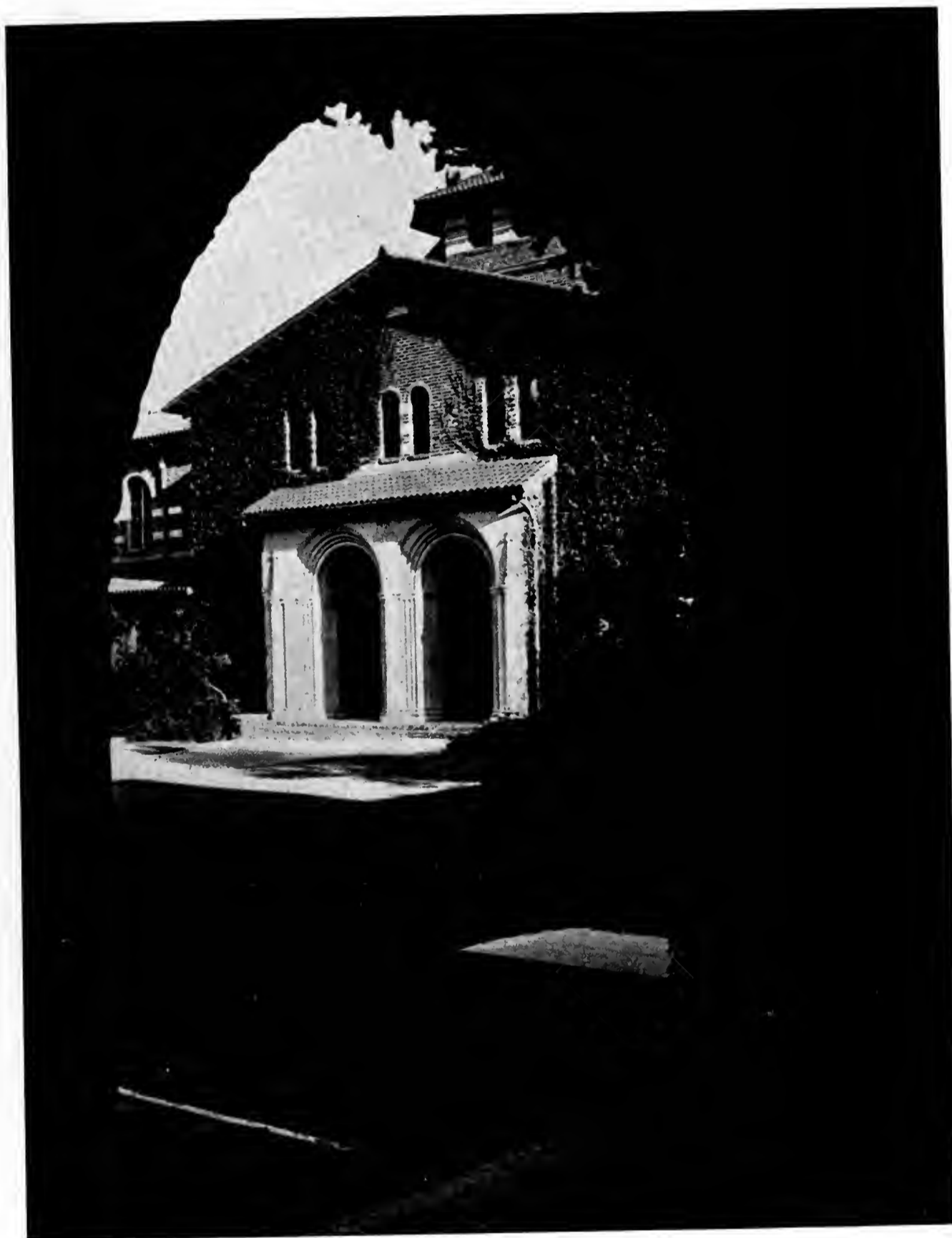

LIBRARY FROM CLOISTER,  
UNIVERSITY OF CALIFORNIA  
(SOUTHERN BRANCH)  
LOS ANGELES, CALIFORNIA  
ALLISON & ALLISON, ARCHITECTS



"SCIENCE"



"DOMESTIC ARTS"



"DOMESTIC ARTS"



"SCIENCE"

MEDALLIONS,  
 UNIVERSITY OF CALIFORNIA  
 (SOUTHERN BRANCH),  
 LOS ANGELES, CALIFORNIA  
 ALLISON & ALLISON, ARCHITECTS



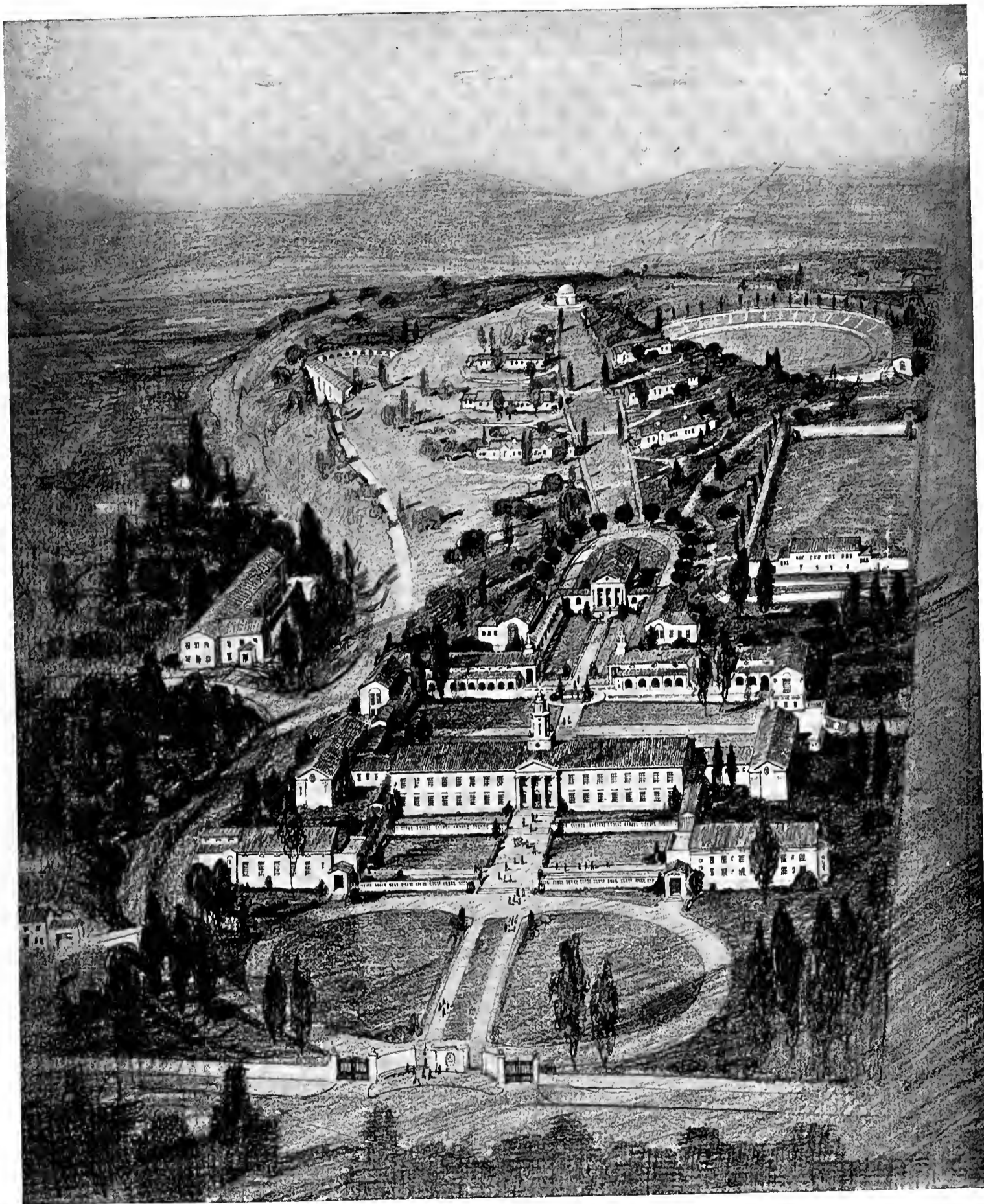

GREATER WHITTIER COLLEGE,  
WHITTIER, CALIFORNIA  
ALLISON & ALLISON, ARCHITECTS

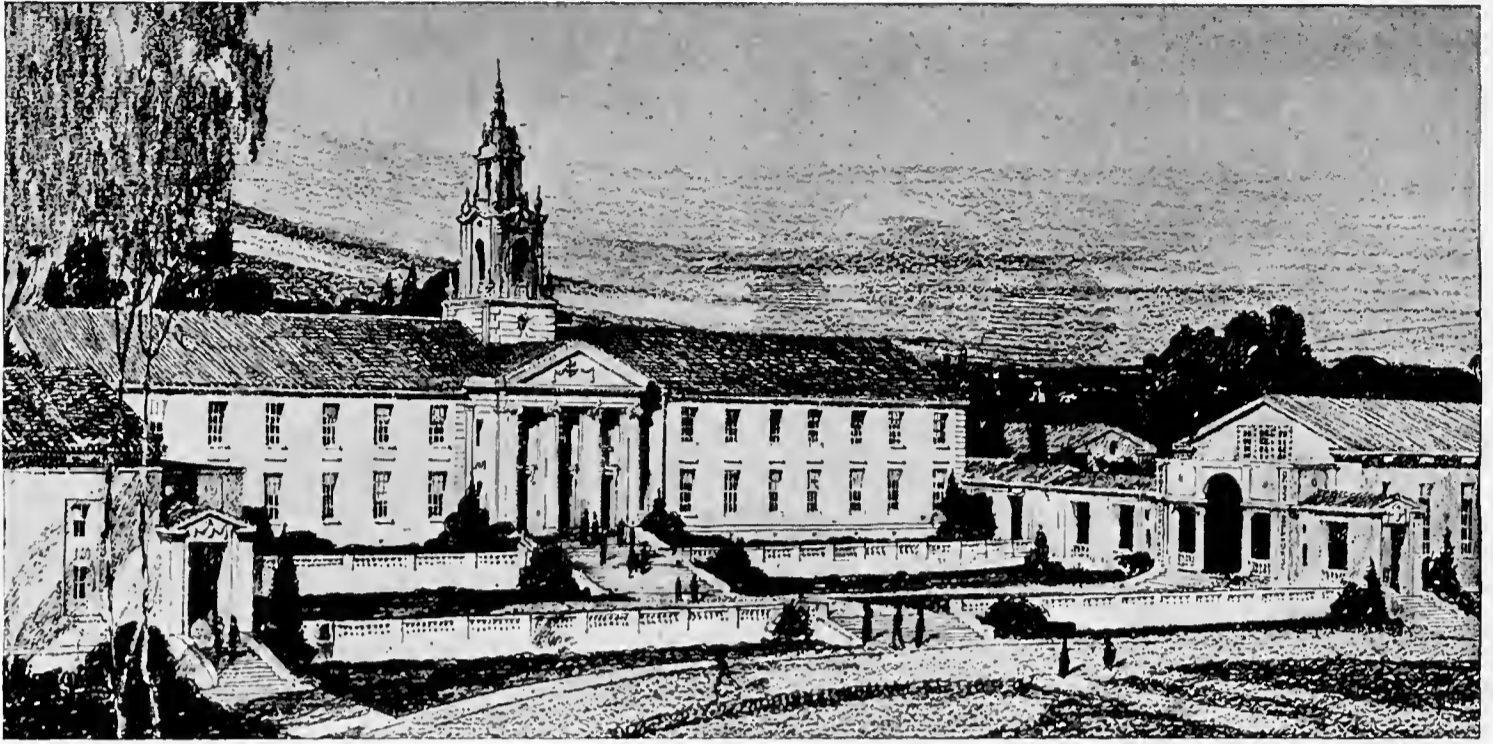

FORECOURT,  
WHITTIER COLLEGE,  
WHITTIER, CALIFORNIA  
ALLISON & ALLISON, ARCHITECTS



LOGGIA, NAYLOR HALL,  
WHITTIER COLLEGE,  
WHITTIER, CALIFORNIA  
ALLISON & ALLISON, ARCHITECTS



ELEMENTARY SCHOOL NUMBER 1,  
GLENDDORA, CALIFORNIA  
ALLISON & ALLISON, ARCHITECTS

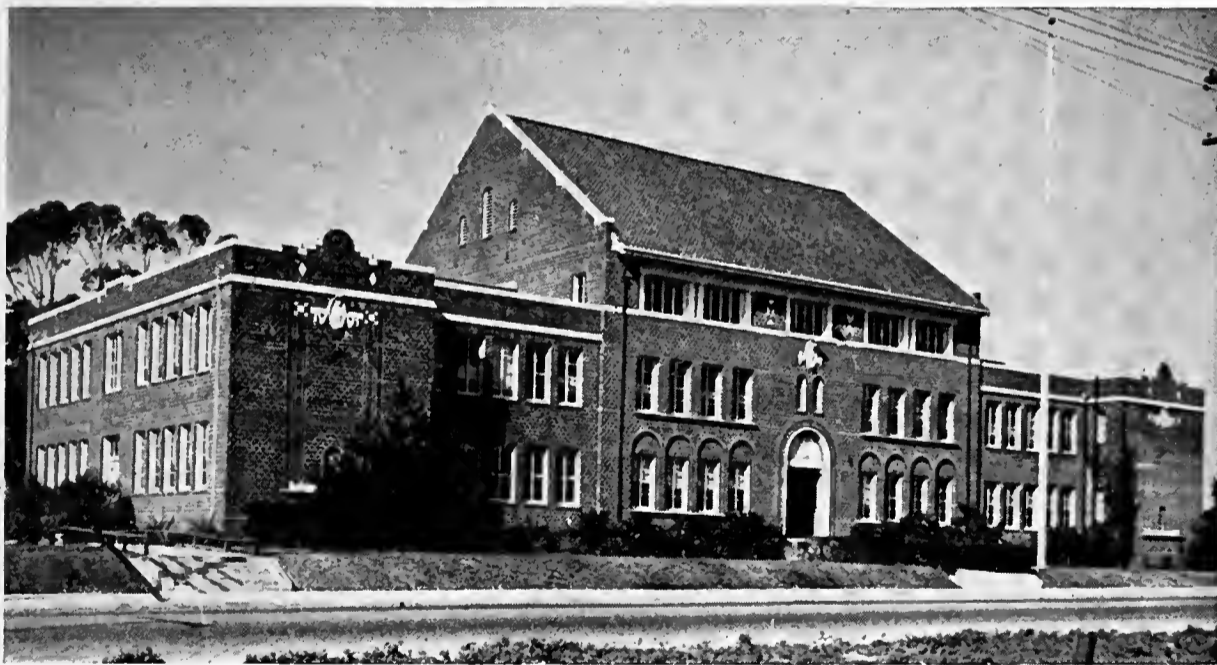

WILMINGTON HIGH SCHOOL,  
LOS ANGELES, CALIFORNIA  
ALLISON & ALLISON, ARCHITECTS



ELEMENTARY SCHOOL NUMBER 1,  
GLEN DORA, CALIFORNIA  
ALLISON & ALLISON, ARCHITECTS

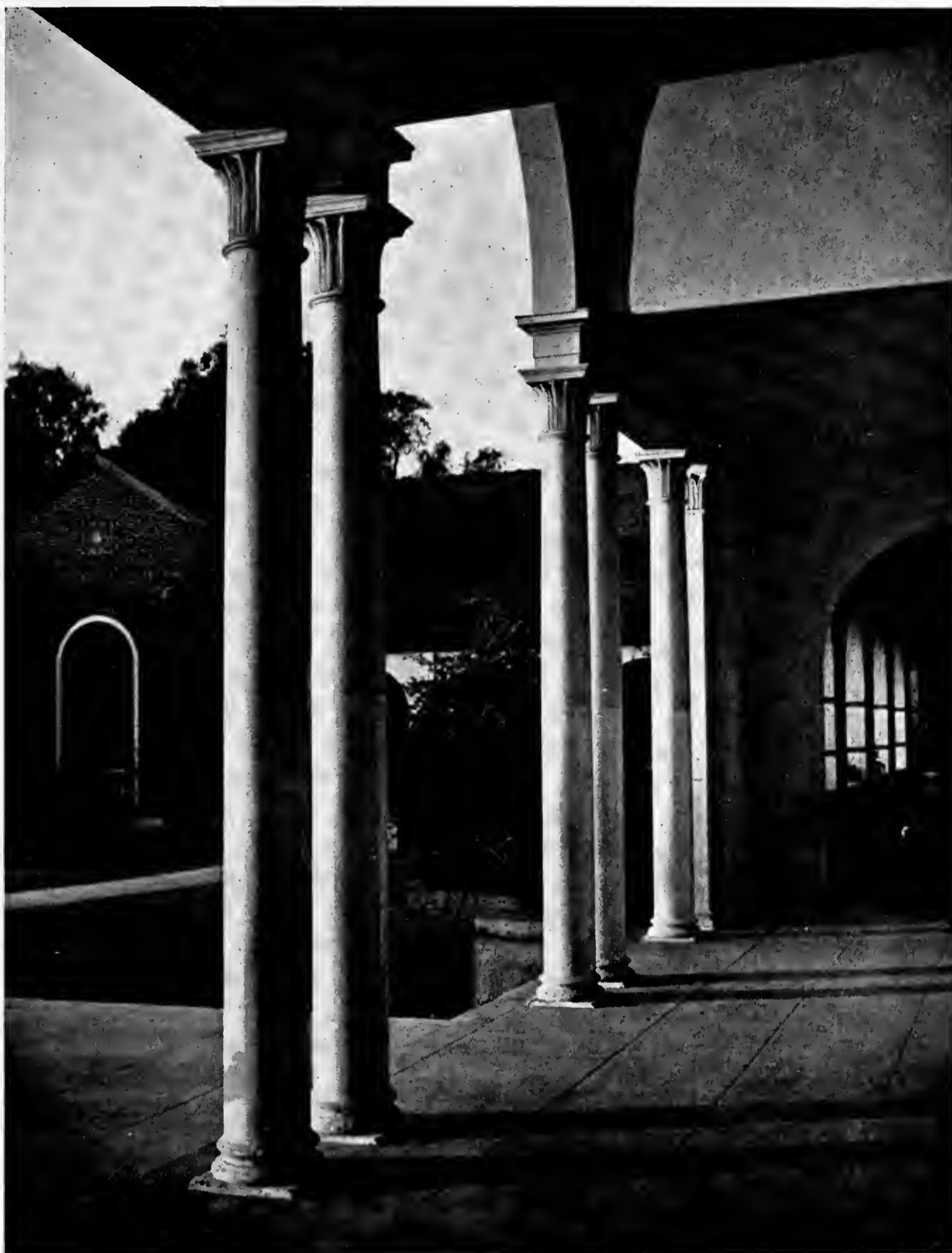

LOGGIA DETAIL,  
ELEMENTARY SCHOOL NUMBER 1,  
GLEN DORA, CALIFORNIA  
ALLISON & ALLISON, ARCHITECTS



ELEMENTARY SCHOOL NUMBER 1,  
GLENDDORA, CALIFORNIA  
ALLISON & ALLISON, ARCHITECTS

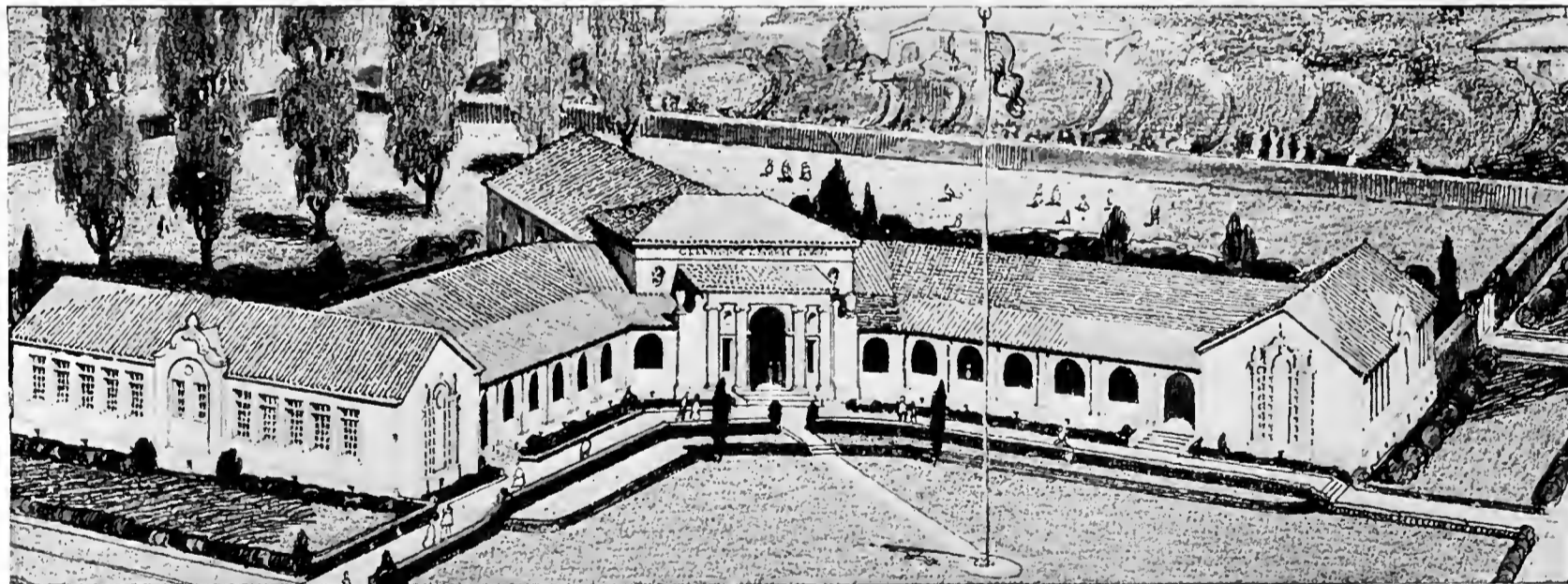

ELEMENTARY SCHOOL NUMBER 2  
GLENDDORA, CALIFORNIA  
ALLISON & ALLISON, ARCHITECTS

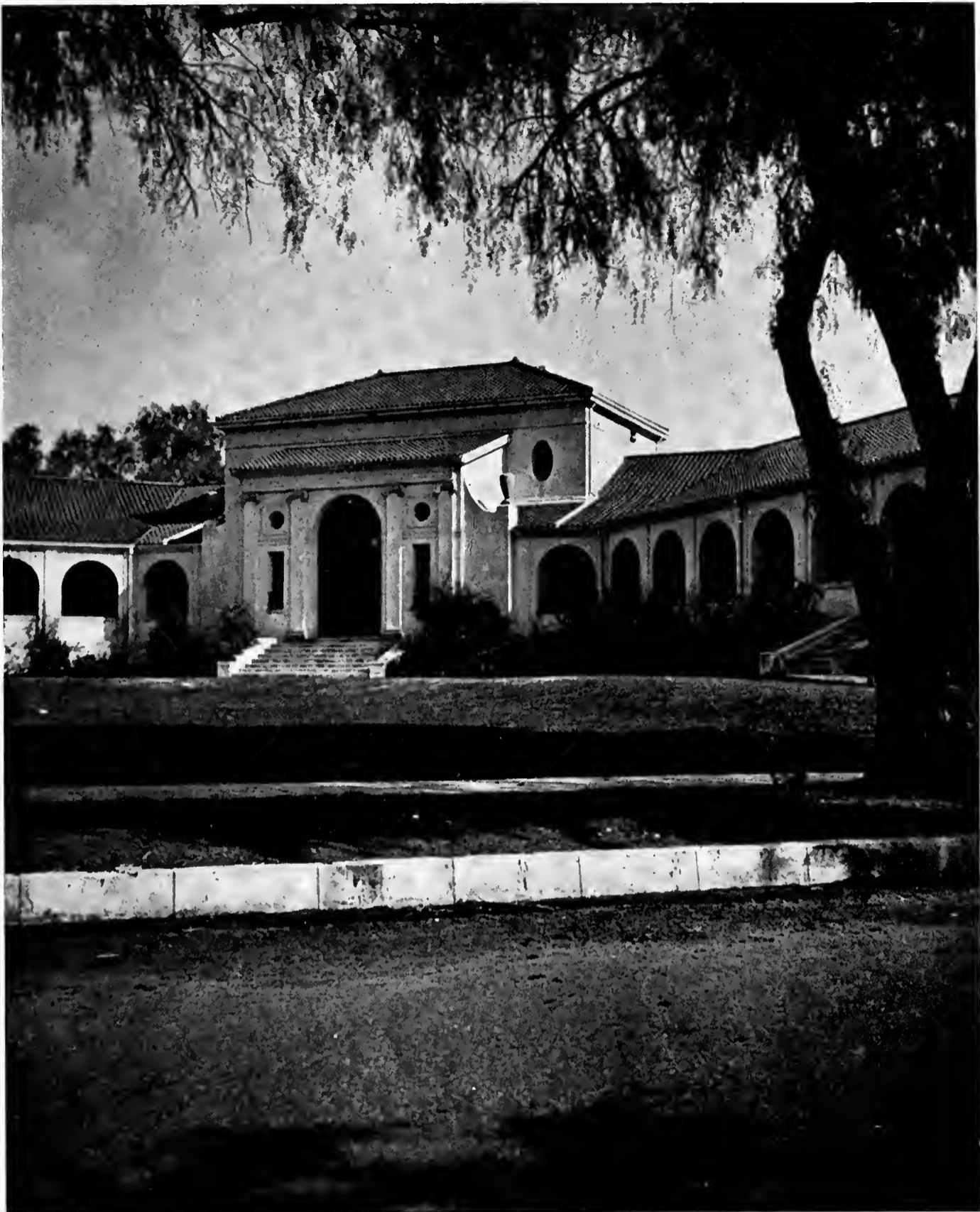

ELEMENTARY SCHOOL NUMBER 2  
GLENDDORA, CALIFORNIA  
ALLISON & ALLISON, ARCHITECTS



ELEMENTARY SCHOOL NUMBER 2,  
AZUSA, CALIFORNIA  
ALLISON & ALLISON, ARCHITECTS



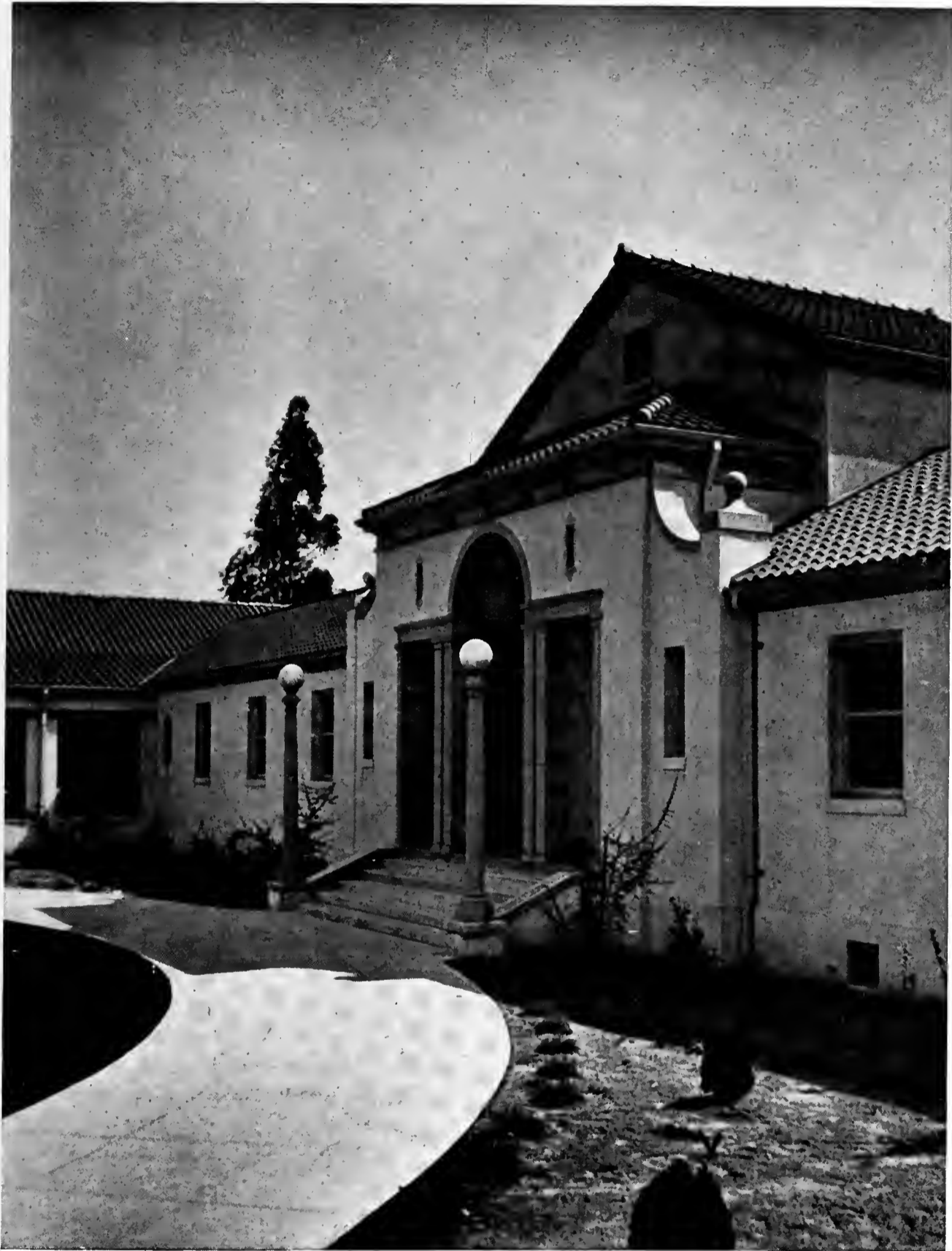

ELEMENTARY SCHOOL NUMBER 2,  
AZUSA, CALIFORNIA  
ALLISON & ALLISON, ARCHITECTS



ELEMENTARY SCHOOL,  
OXNARD, CALIFORNIA  
ALLISON & ALLISON, ARCHITECTS

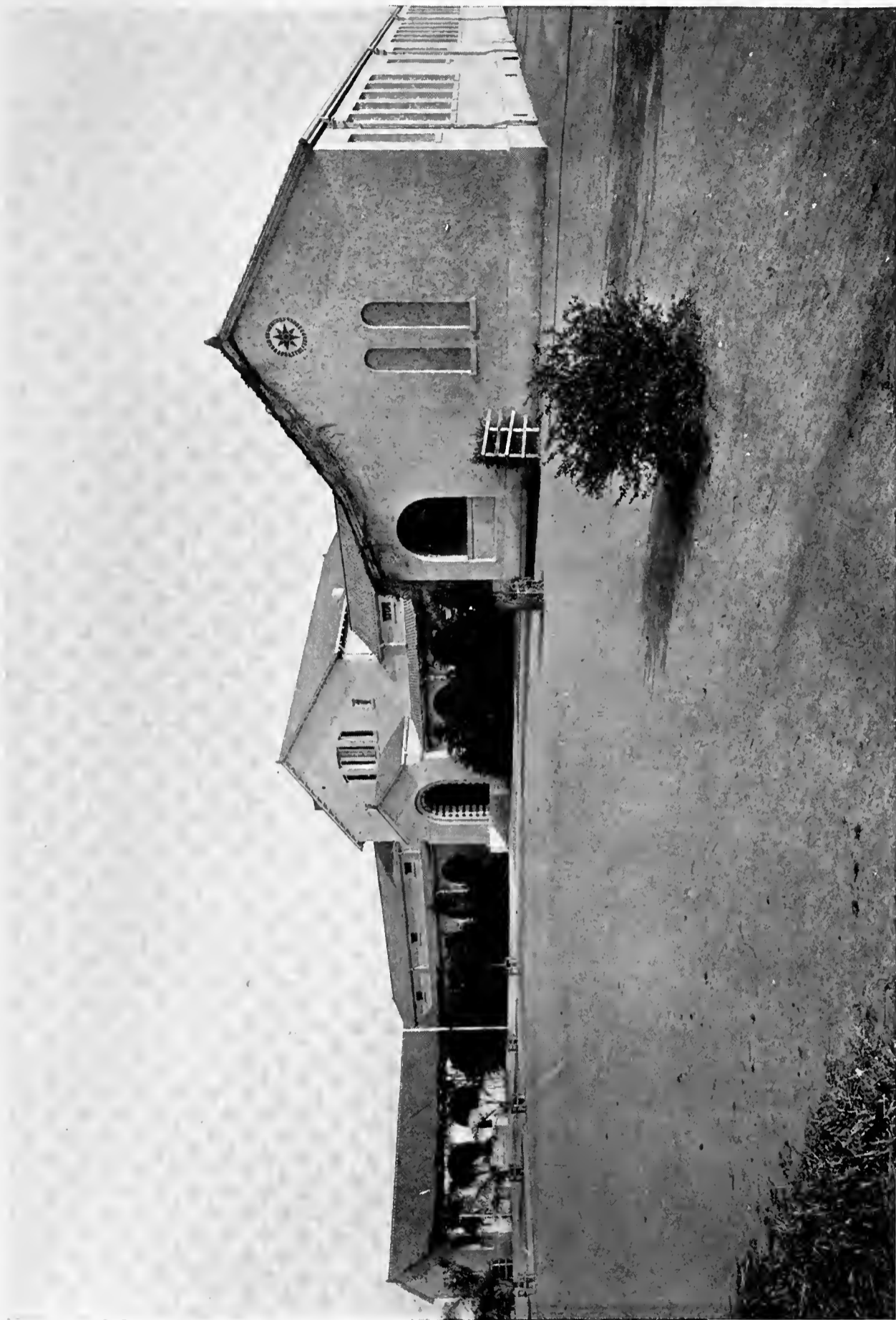

GENERAL VIEW,  
WYNNE SCHOOL,  
ALHAMBRA, CALIFORNIA  
ALLISON & ALLISON, ARCHITECTS



MARENGO PRIMARY SCHOOL  
ALHAMBRA, CALIFORNIA  
ALLISON & ALLISON, ARCHITECTS



CENTRAL ELEMENTARY SCHOOL,  
ALHAMBRA, CALIFORNIA  
ALLISON & ALLISON, ARCHITECTS

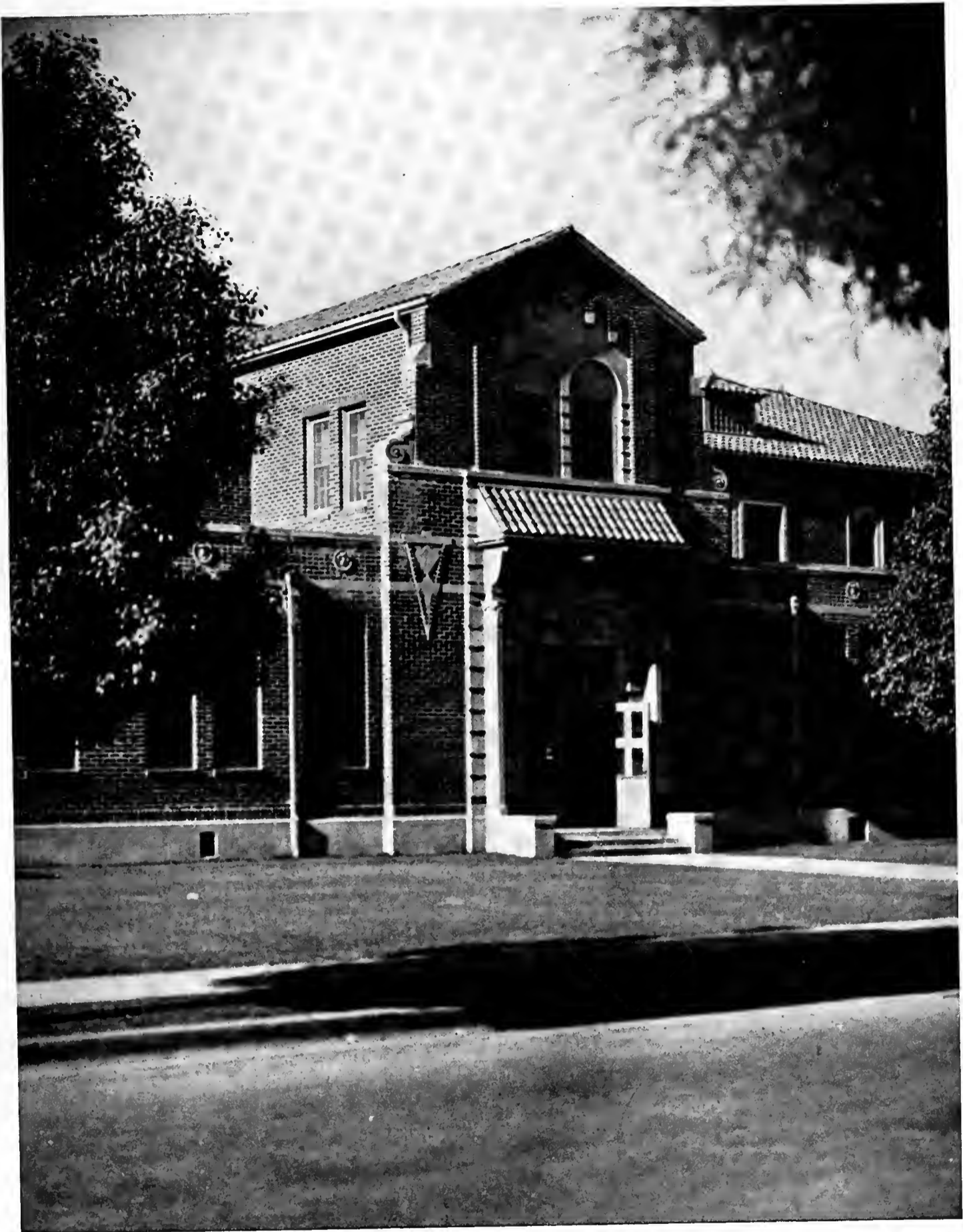

DETAIL,  
CENTRAL ELEMENTARY SCHOOL,  
ALHAMBRA, CALIFORNIA  
ALLISON AND ALLISON, Architects



ELEMENTARY SCHOOL,  
SPADRA, CALIFORNIA  
ALLISON & ALLISON, ARCHITECTS



DETAIL,  
ELEMENTARY SCHOOL,  
SPADRA, CALIFORNIA  
ALLISON & ALLISON, ARCHITECTS



ELEMENTARY SCHOOL,  
RANCHITO, CALIFORNIA,



ELEMENTARY SCHOOL,  
LITTLE LAKE SCHOOL DISTRICT,  
LOS ANGELES COUNTY, CALIFORNIA  
ALLISON & ALLISON, ARCHITECTS



ENTRANCE DETAIL,  
ELEMENTARY SCHOOL,  
RANCHITO, CALIFORNIA,  
ALLISON & ALLISON, ARCHITECTS.





ENTRANCE MOTIF,  
HIGH SCHOOL,  
BURBANK, CALIFORNIA  
ALLISON & ALLISON, ARCHITECTS.

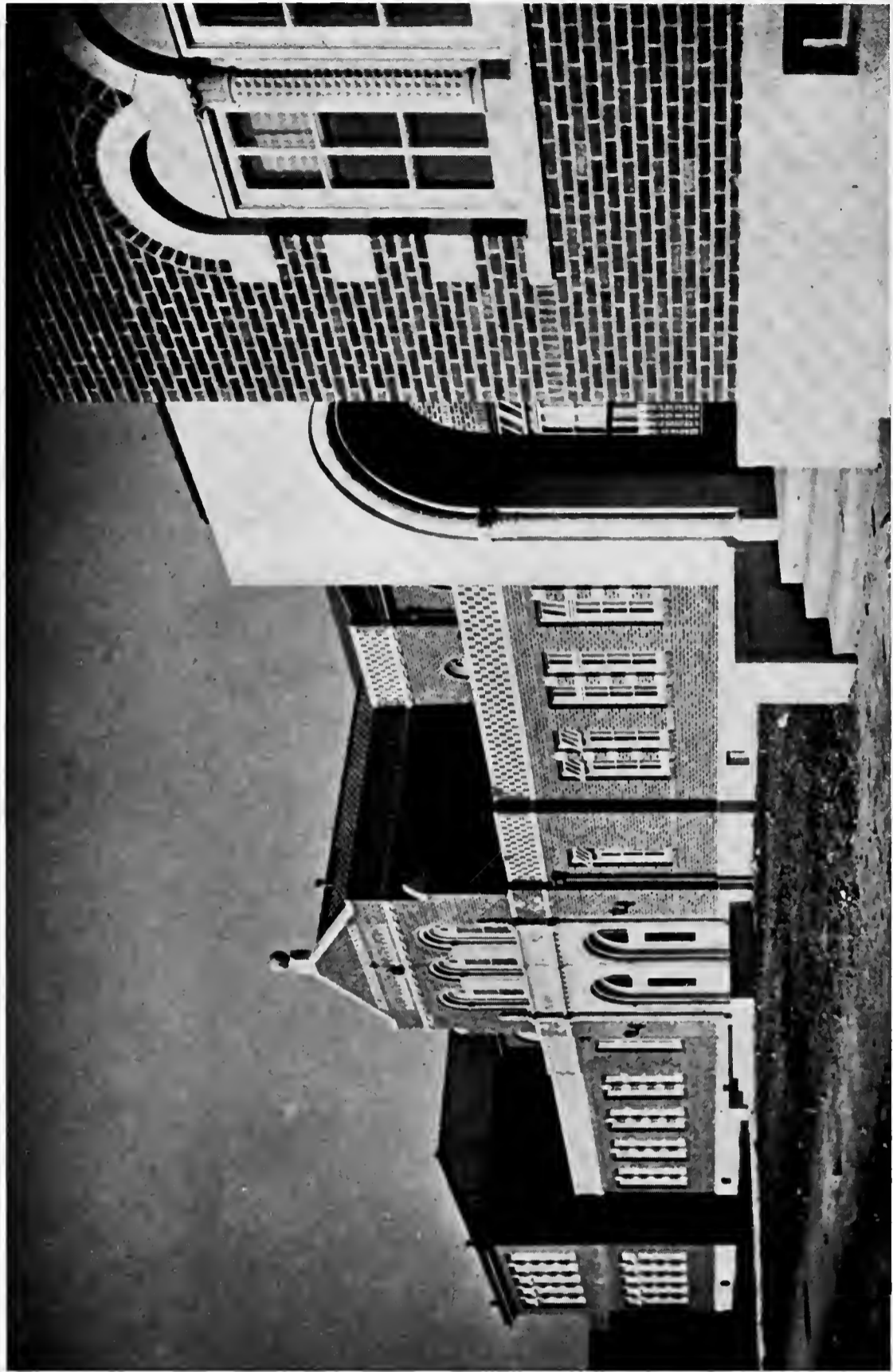

HIGH SCHOOL,  
BURBANK, CALIFORNIA.  
ALLISON & ALLISON, ARCHITECTS

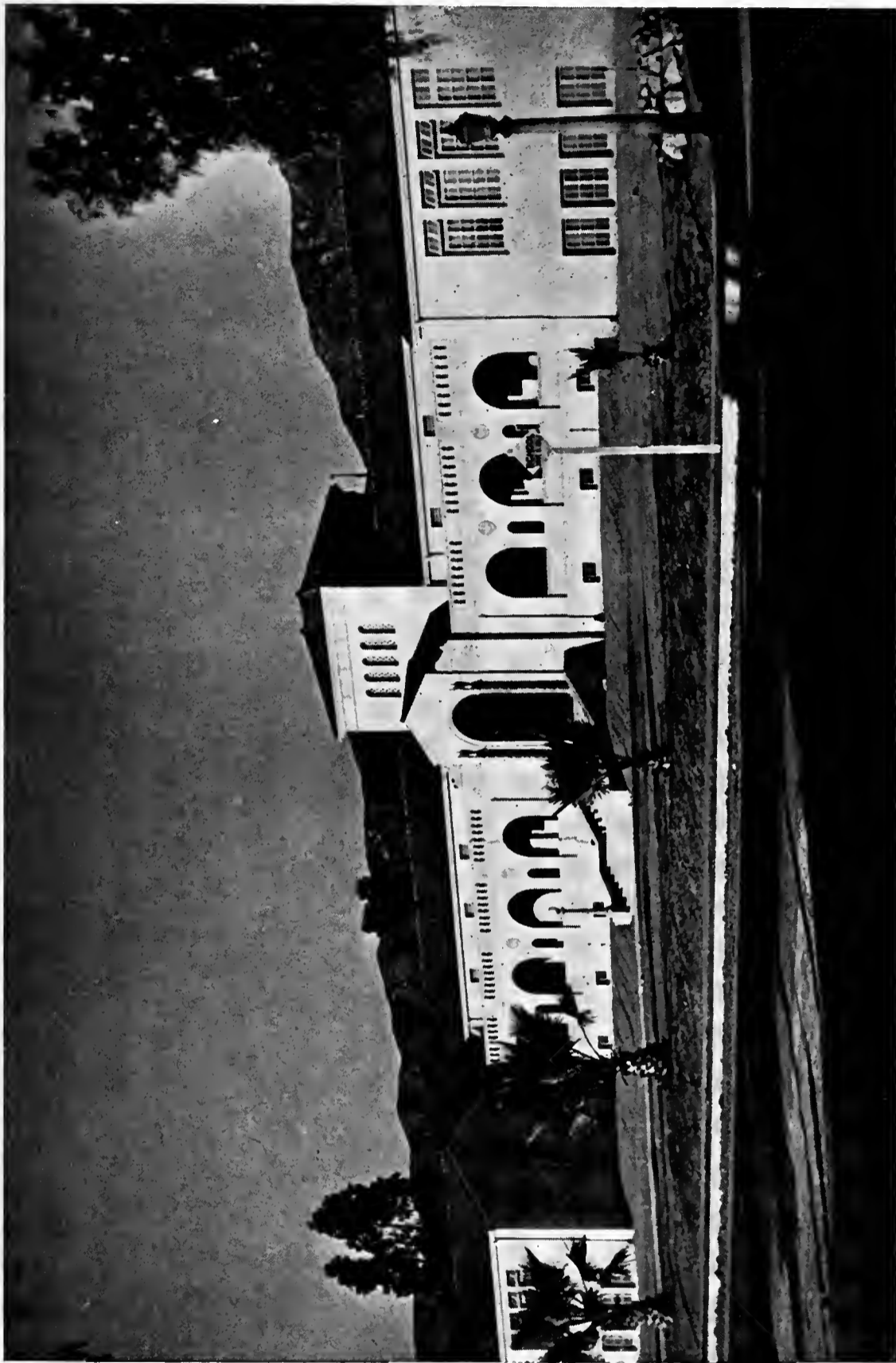

ELEMENTARY SCHOOL,  
BURBANK, CALIFORNIA.  
ALLISON & ALLISON, ARCHITECTS

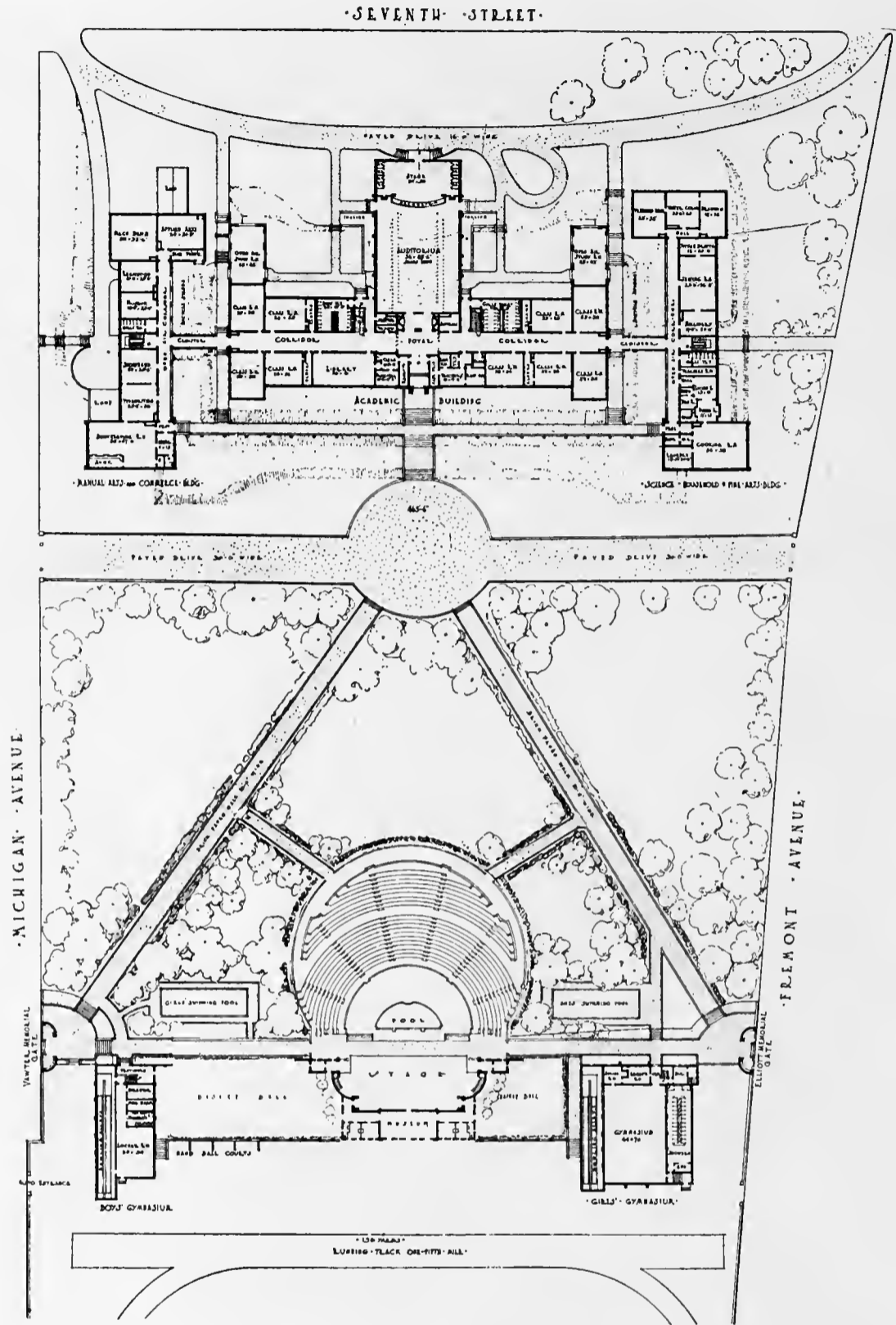

Plan of the  
 HIGH SCHOOL IN SANTA MONICA CALIF.  
 Allison and Allison Architects

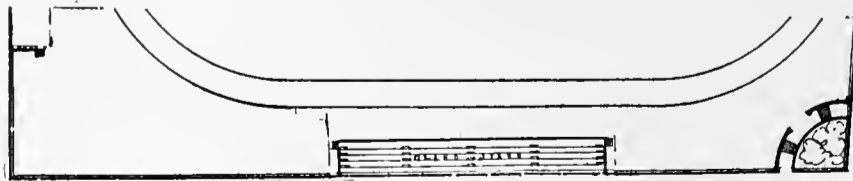

PLAN OF HIGH SCHOOL GROUP,  
 SANTA MONICA, CALIFORNIA.  
 ALLISON & ALLISON, ARCHITECTS.

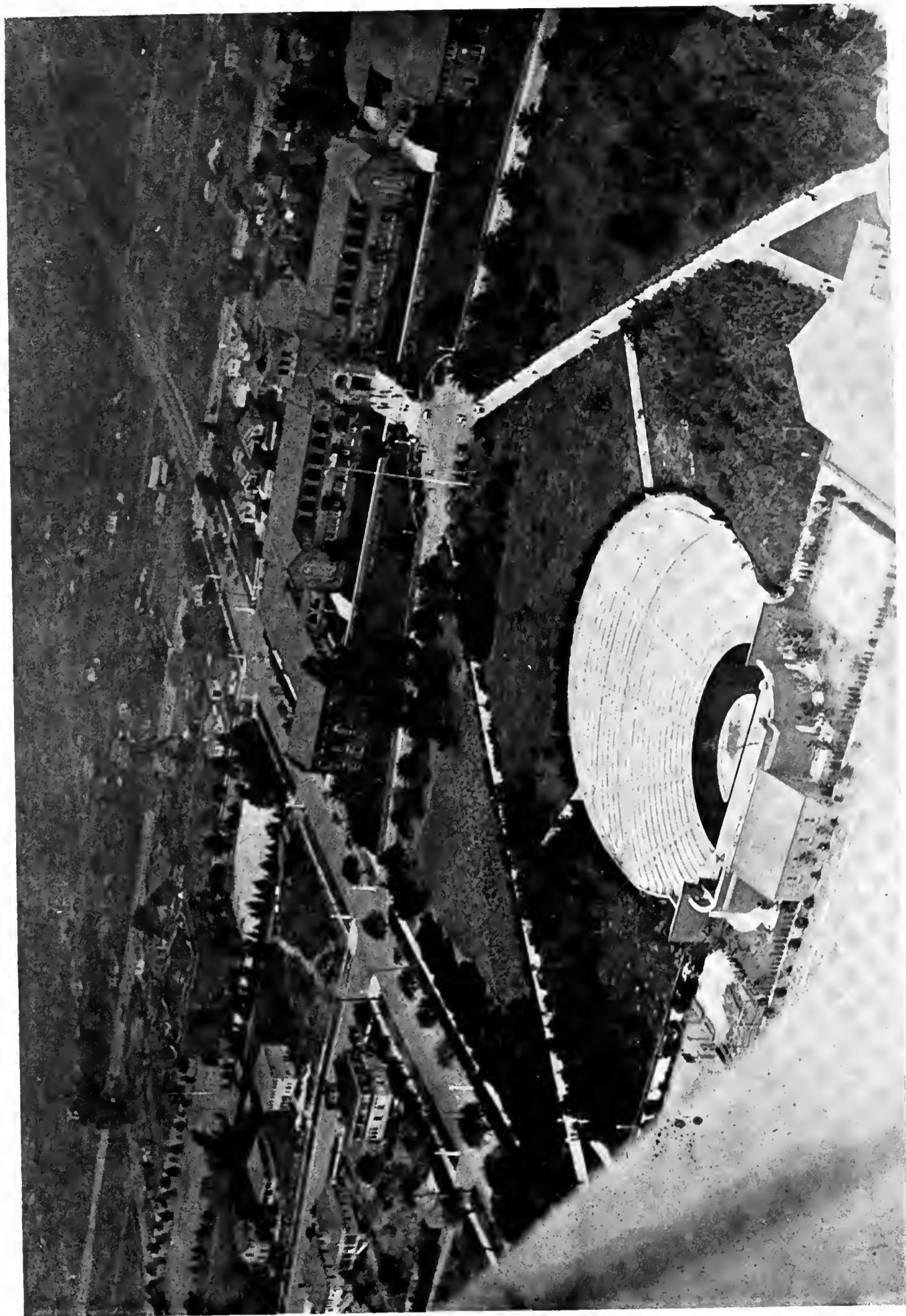

AIRPLANE VIEW,  
HIGH SCHOOL GROUP,  
SANTA MONICA, CALIFORNIA.  
ALLISON & ALLISON, ARCHITECTS.

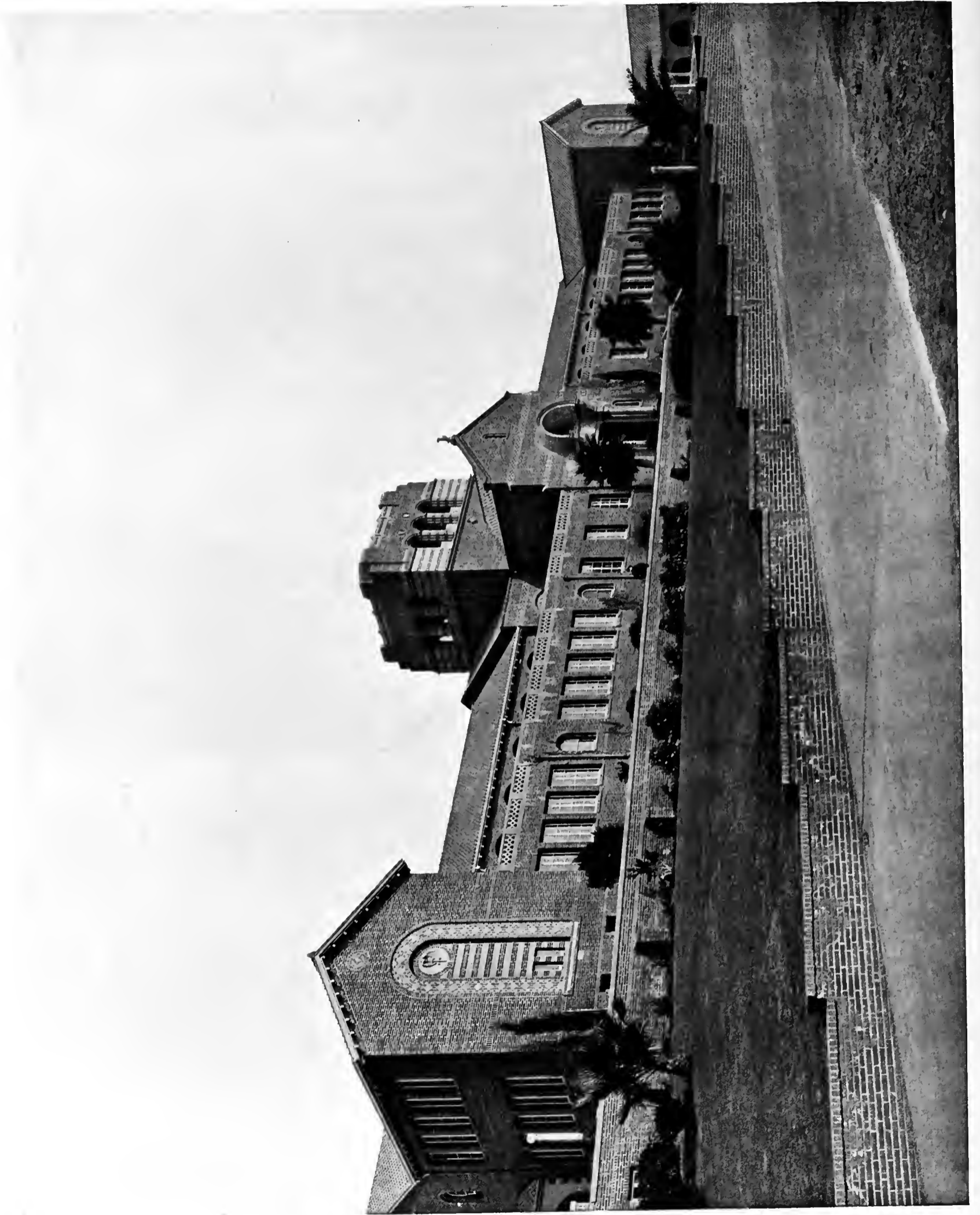

GENERAL VIEW,  
SANTA MONICA HIGH SCHOOL,  
SANTA MONICA, CALIFORNIA.  
ALLISON & ALLISON, ARCHITECTS

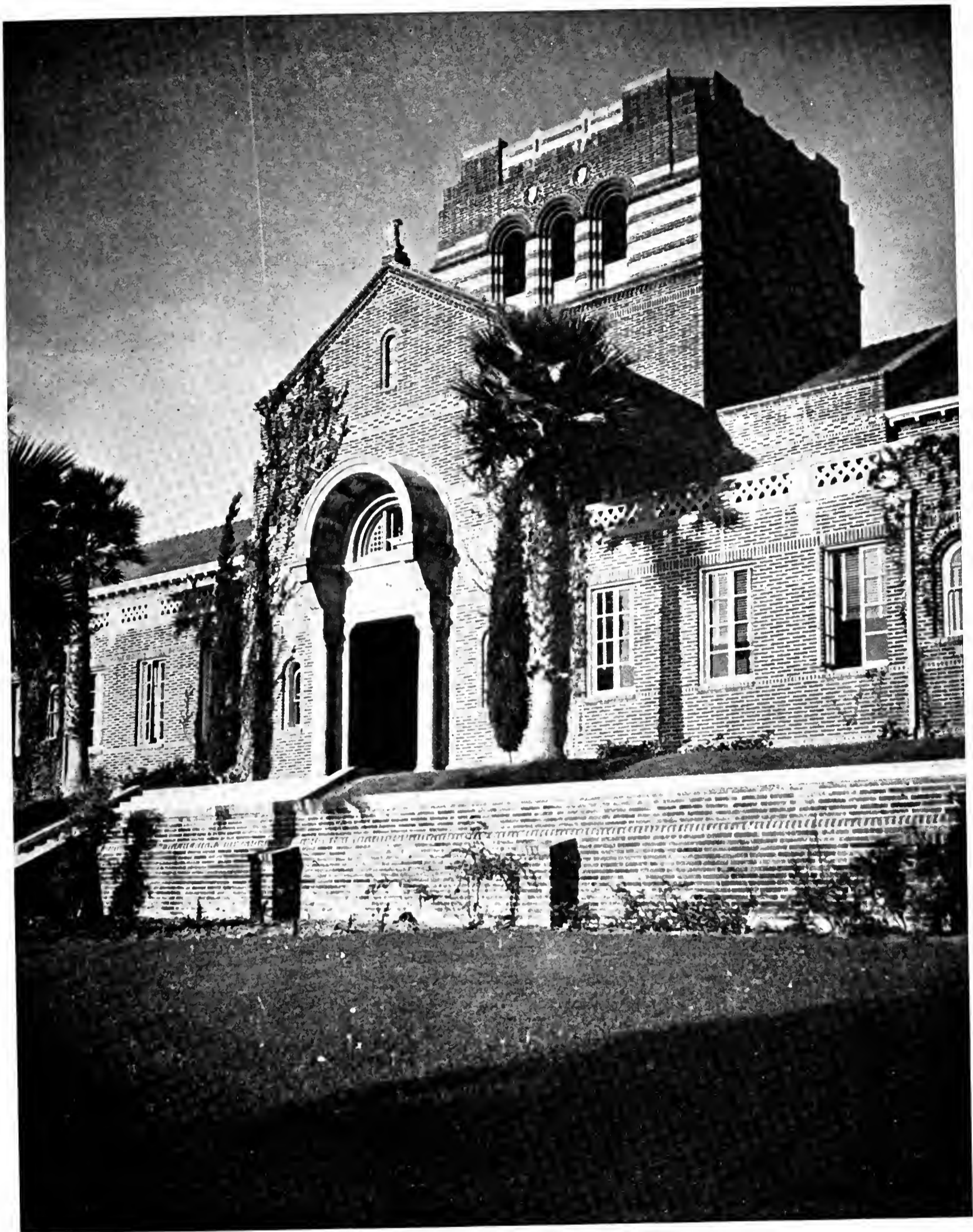

ENTRANCE AND TOWER,  
HIGH SCHOOL GROUP,  
SANTA MONICA, CALIFORNIA.  
ALLISON & ALLISON, ARCHITECTS

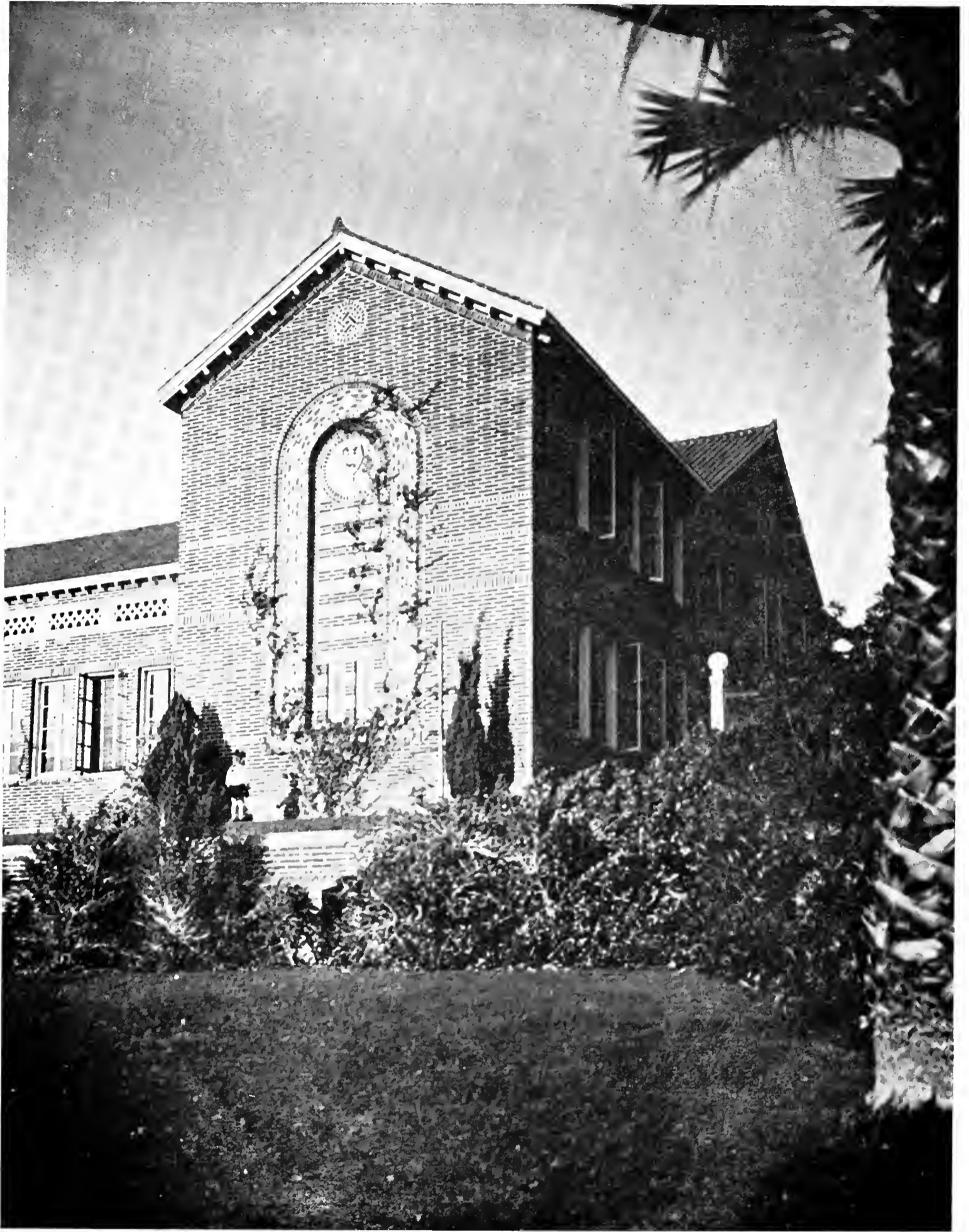

END PAVILION,  
HIGH SCHOOL,  
SANTA MONICA, CALIFORNIA.  
ALLISON & ALLISON, ARCHITECTS.



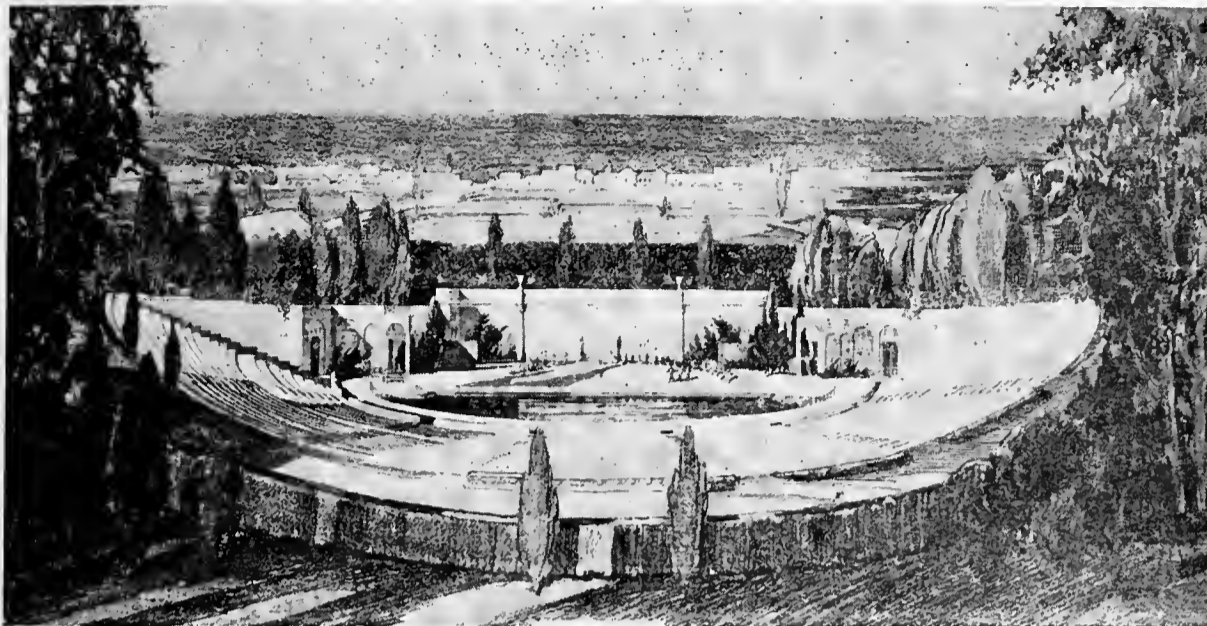

PERSPECTIVE SKETCH OF THE BOWL.



THE BOWL.

MEMORIAL OPEN AIR THEATER,  
HIGH SCHOOL GROUP,  
SANTA MONICA, CALIFORNIA.  
ALLISON & ALLISON, ARCHITECTS.



THE POOL.  
MEMORIAL OPEN AIR THEATER,  
HIGH SCHOOL GROUP,  
SANTA MONICA, CALIFORNIA.  
ALLISON & ALLISON, ARCHITECTS

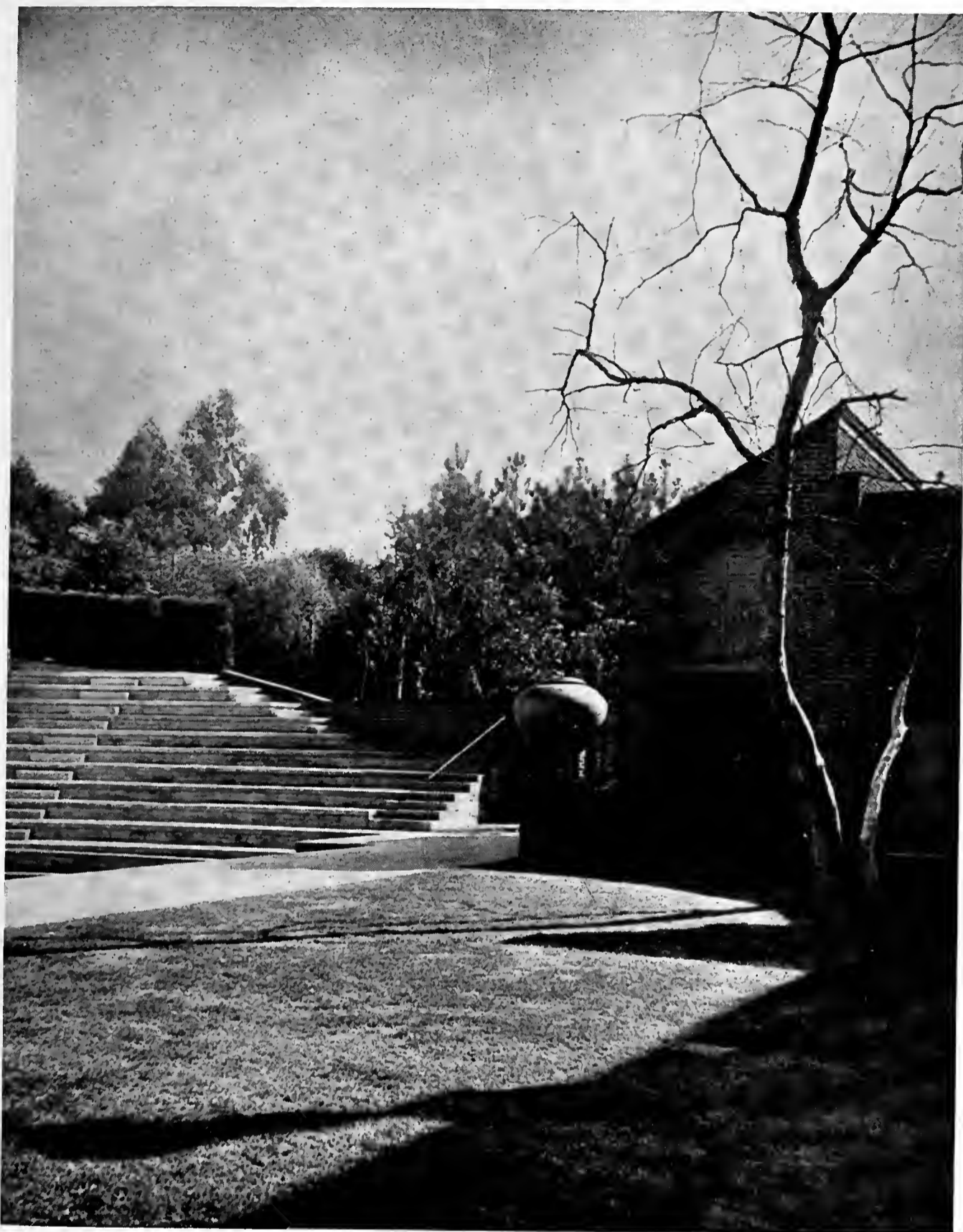

THE STAGE.  
MEMORIAL OPEN AIR THEATER,  
HIGH SCHOOL GROUP,  
SANTA MONICA, CALIFORNIA.  
ALLISON & ALLISON, ARCHITECTS



VAWTER MEMORIAL GATE.

HIGH SCHOOL GROUP,  
SANTA MONICA, CALIFORNIA.  
ALLISON & ALLISON, ARCHITECTS.



ELLIOTT MEMORIAL GATE.

HIGH SCHOOL GROUP,  
SANTA MONICA, CALIFORNIA.  
ALLISON & ALLISON, ARCHITECTS.



OPEN AIR STUDY HALL,  
HIGH SCHOOL GROUP,  
SANTA MONICA, CALIFORNIA.



GRAMMAR SCHOOL,  
LA CANADA, CALIFORNIA.  
ALLISON & ALLISON, ARCHITECTS

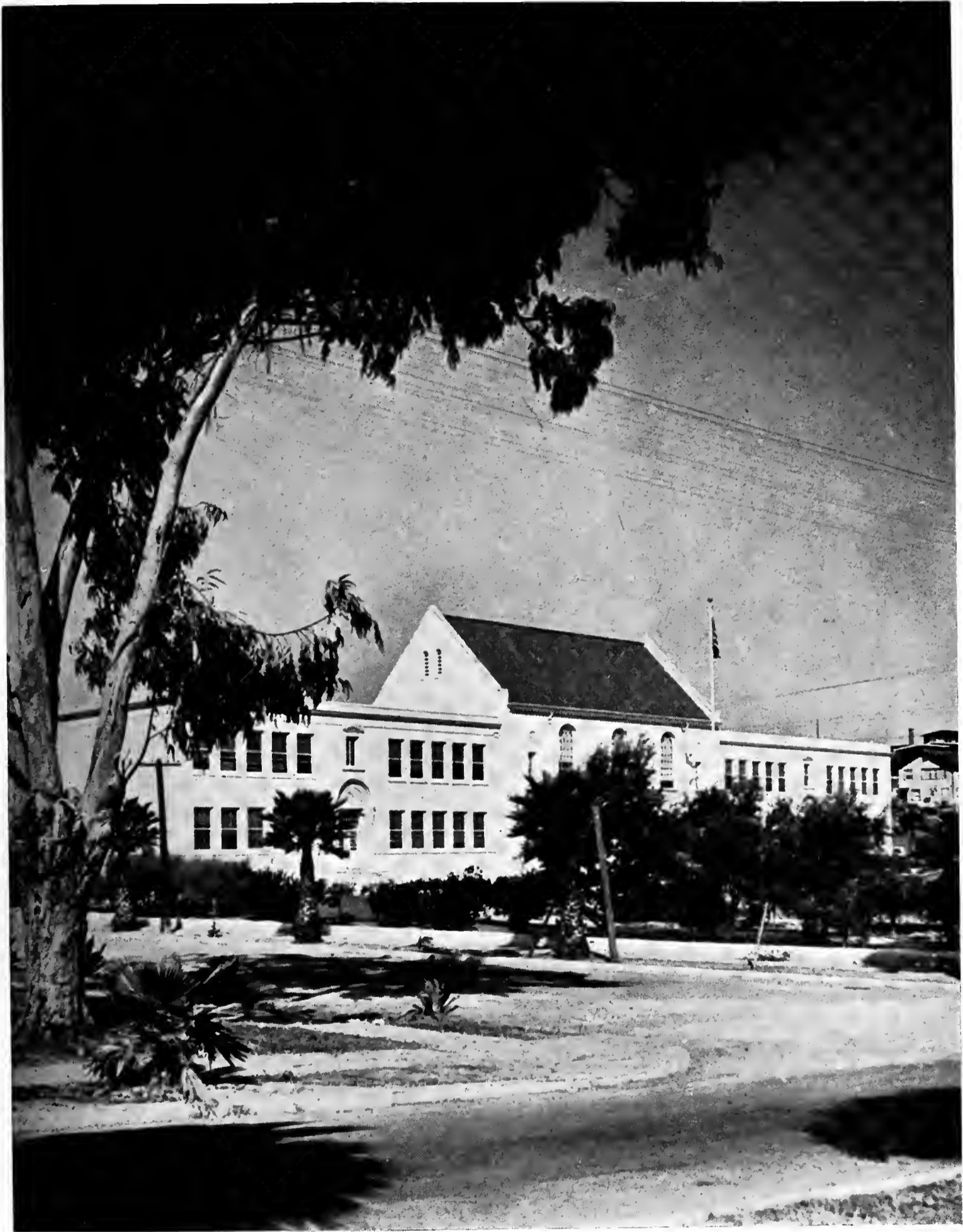

JOHN ADAMS SCHOOL,  
SANTA MONICA, CALIFORNIA.  
ALLISON & ALLISON, ARCHITECTS.

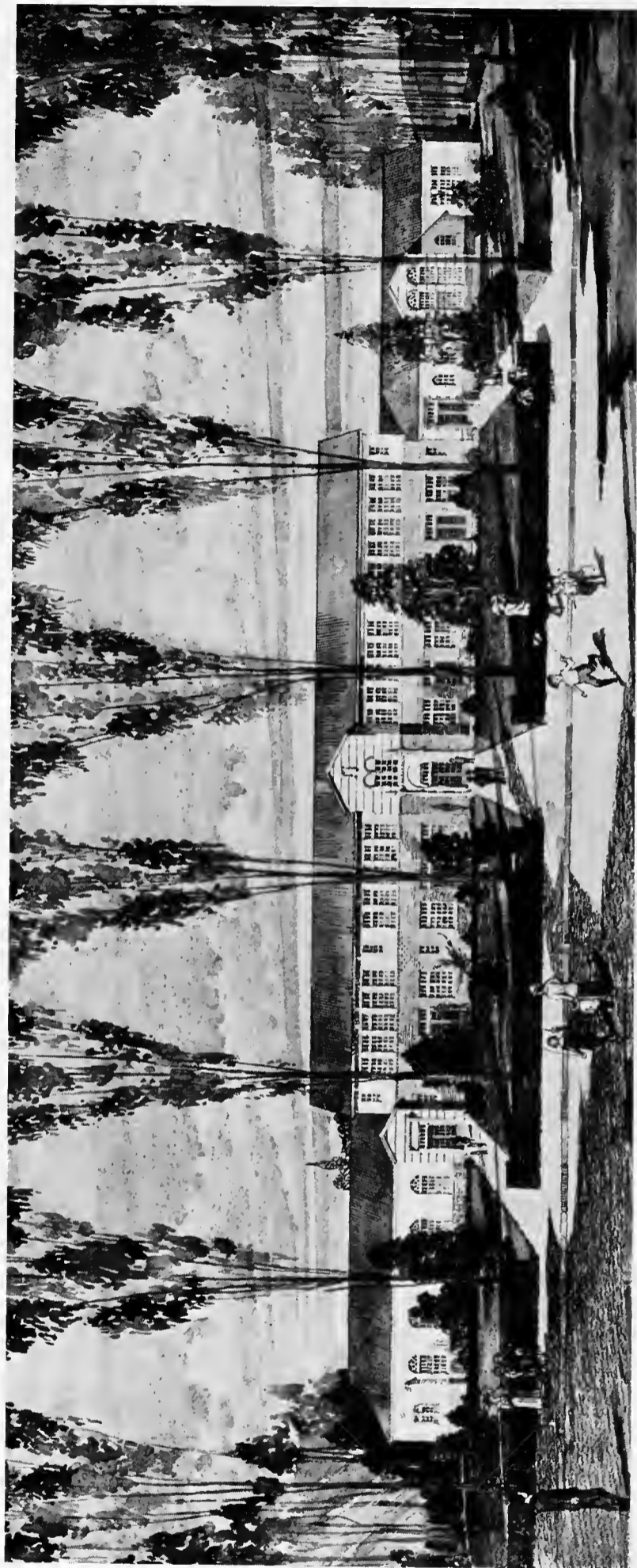

McKINLEY SCHOOL,  
SANTA MONICA, CALIFORNIA.  
ALLISON & ALLISON, ARCHITECTS.



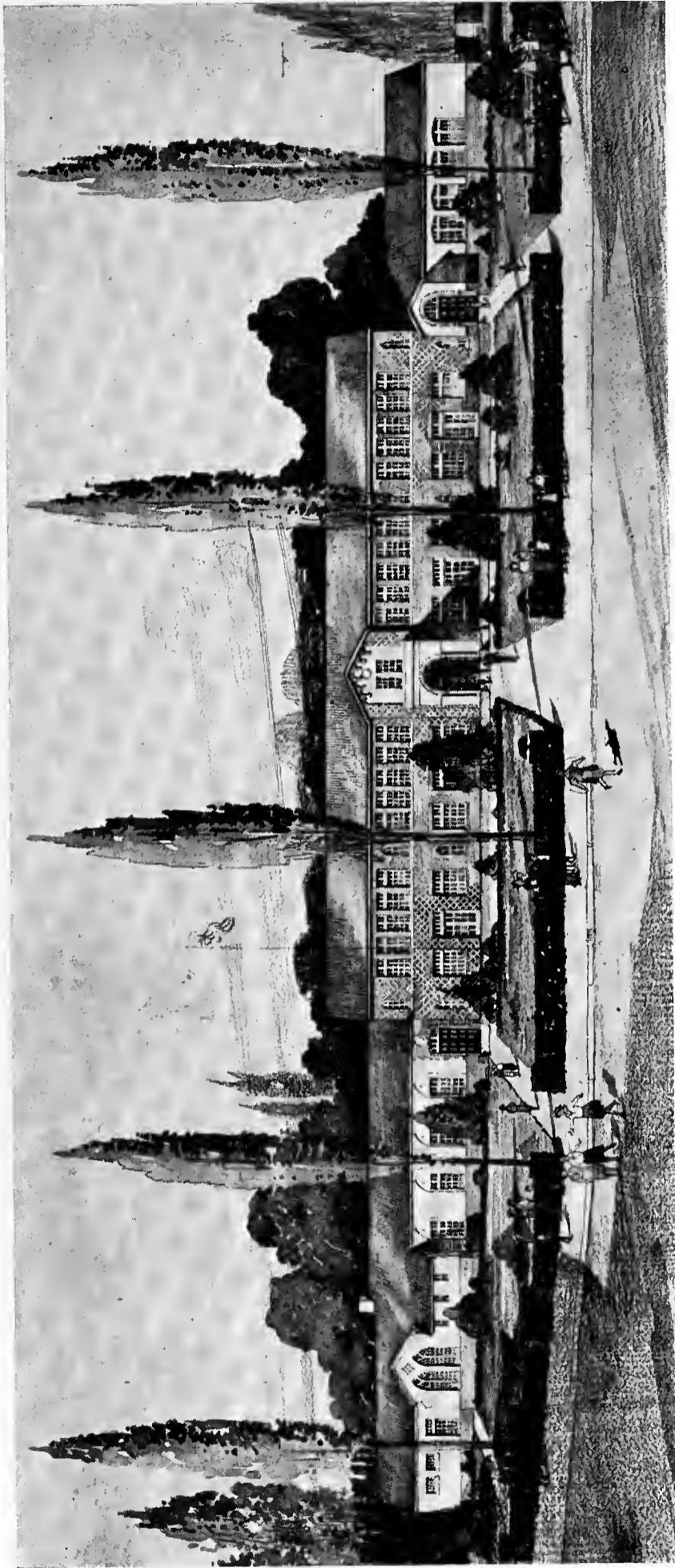

JOHN MUIR SCHOOL,  
SANTA MONICA, CALIFORNIA.  
ALLISON & ALLISON, ARCHITECTS.

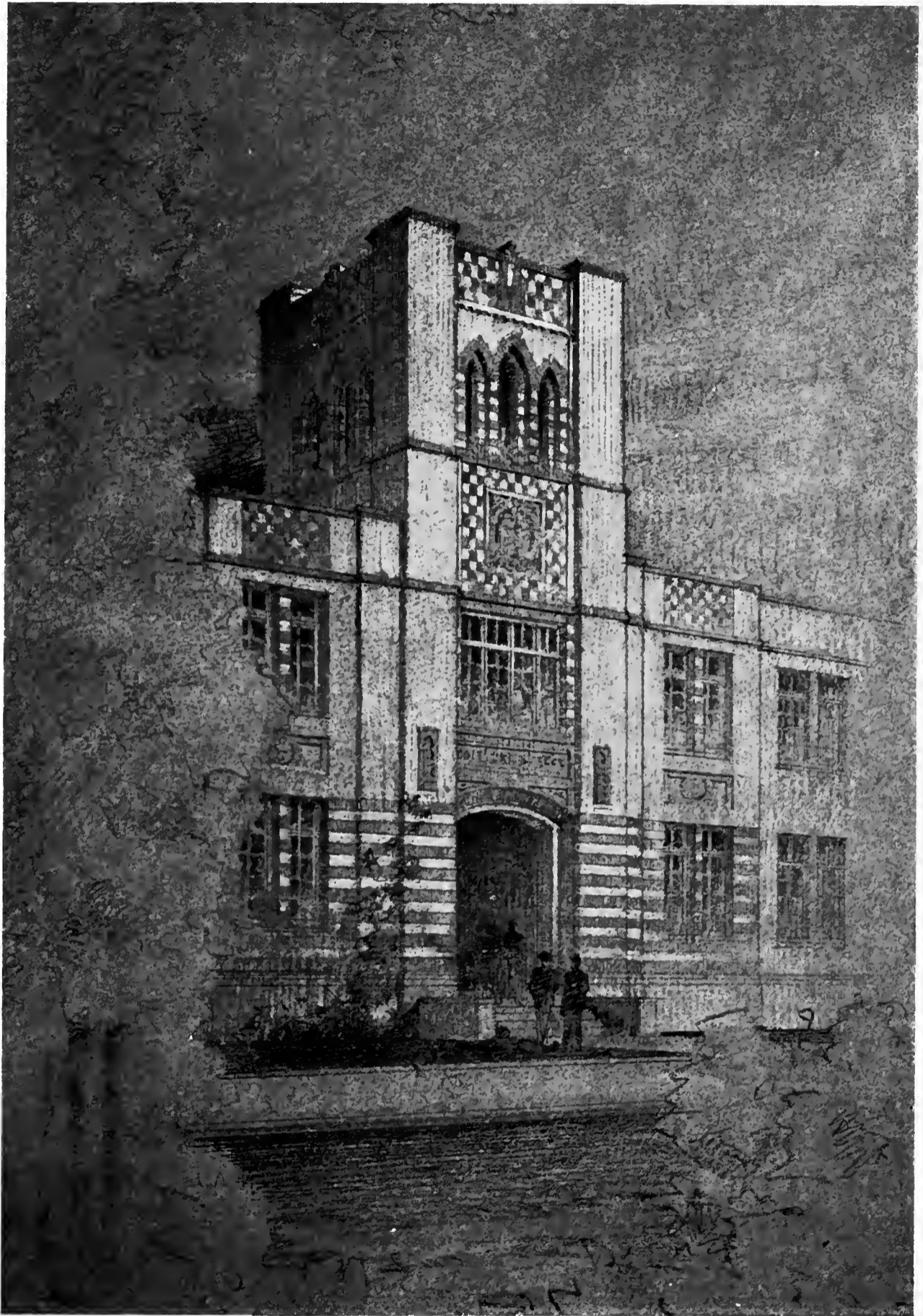

TOWER,  
COLTON UNION HIGH SCHOOL,  
COLTON, CALIFORNIA.  
ALLISON & ALLISON, ARCHITECTS.

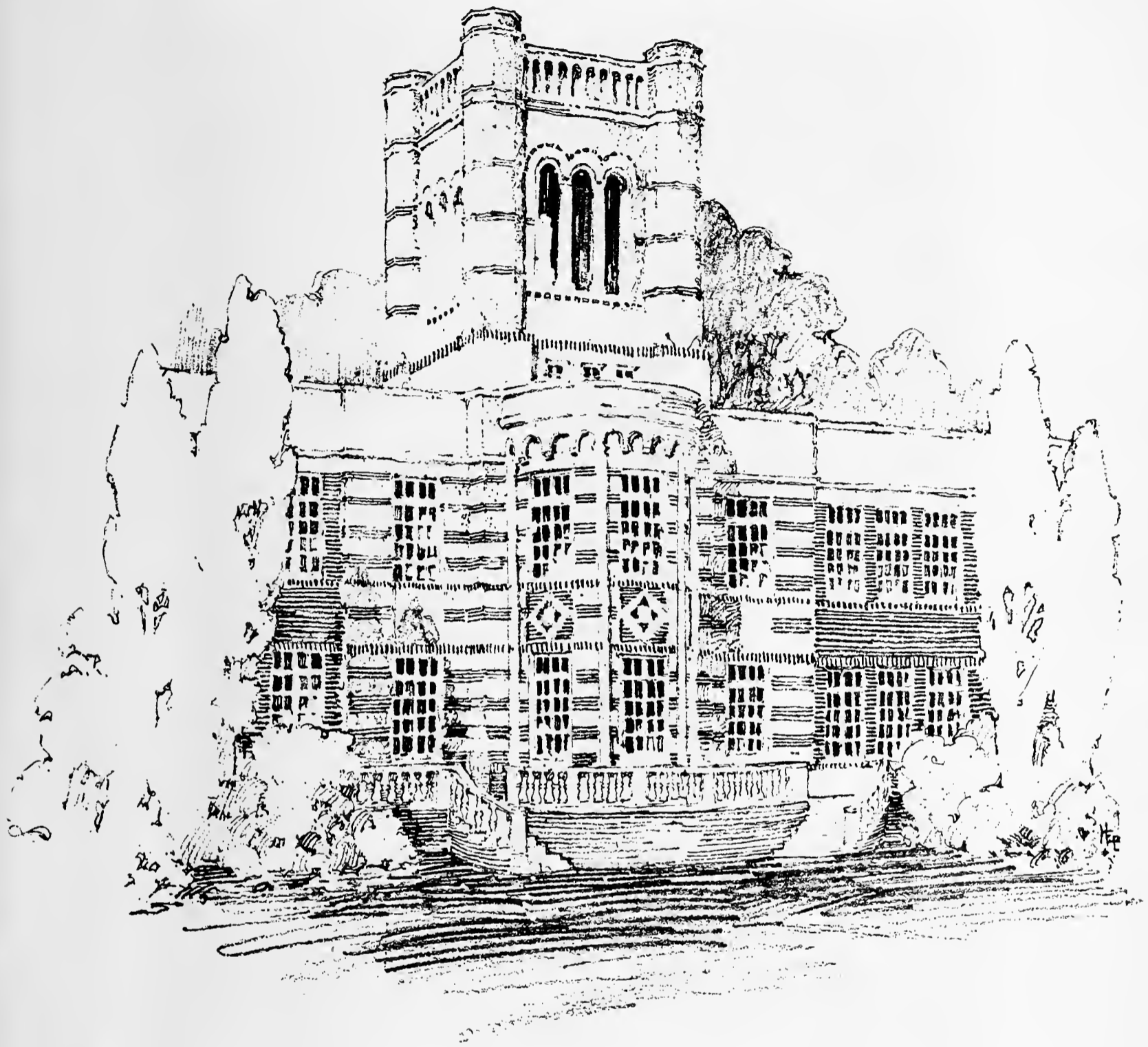

POWER,  
LINCOLN JUNIOR HIGH SCHOOL,  
SANTA MONICA, CALIFORNIA.  
ALLISON & ALLISON, ARCHITECTS.

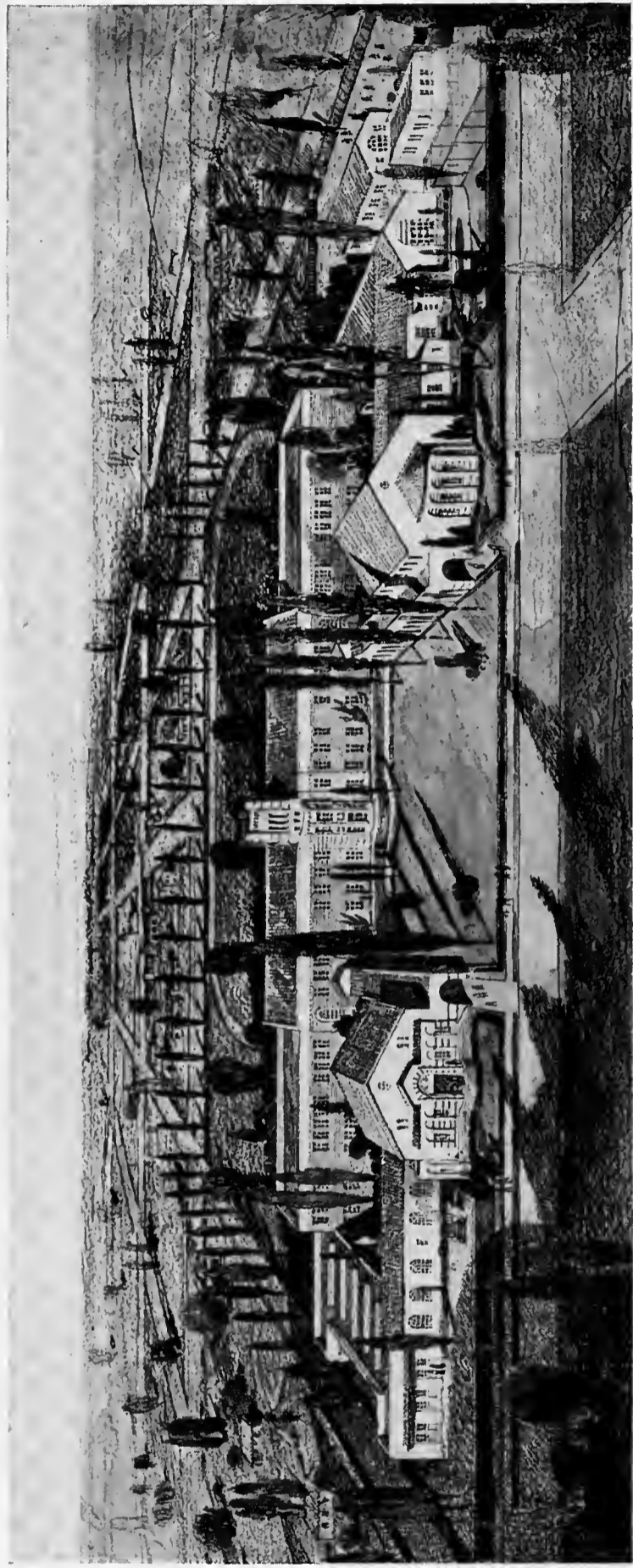

LINCOLN JUNIOR HIGH SCHOOL,  
SANTA MONICA, CALIFORNIA.  
ALLISON & ALLISON, ARCHITECTS

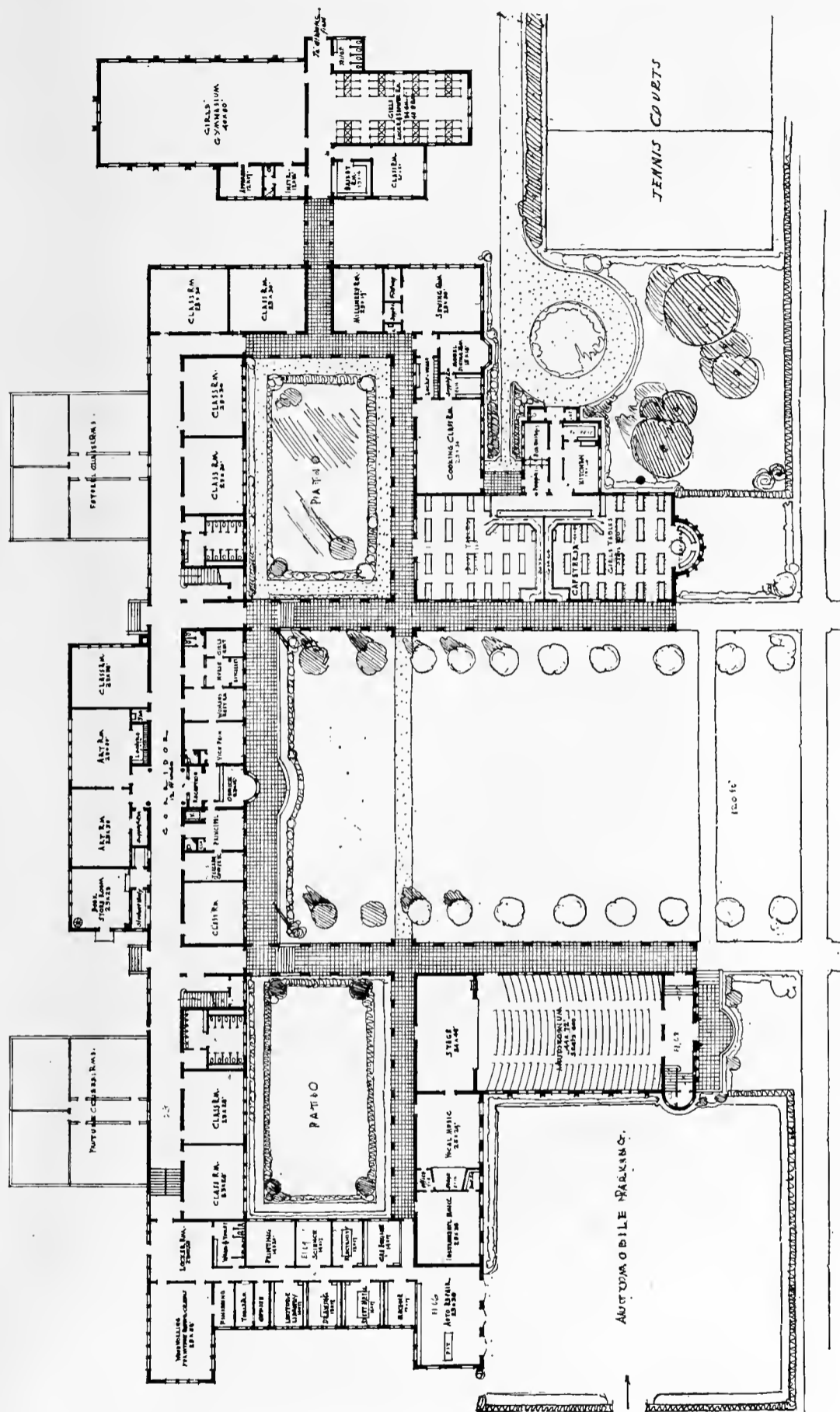

AN,  
NOLN JUNIOR HIGH SCHOOL,  
NTA MONICA, CALIFORNIA.  
LISON & ALLISON, ARCHITECTS.



UNION HIGH SCHOOL,  
MERCED, CALIFORNIA.



UNION HIGH SCHOOL,  
OXNARD, CALIFORNIA.  
ALLISON & ALLISON, ARCHITECTS



CENTRAL MOTIF,  
UNION HIGH SCHOOL,  
MERCED, CALIFORNIA.



CORONEL SCHOOL,  
LOS ANGELES, CALIFORNIA.  
ALLISON & ALLISON, ARCHITECTS.





CORONEL SCHOOL,  
LOS ANGELES, CALIFORNIA.  
ALLISON & ALLISON, ARCHITECTS.

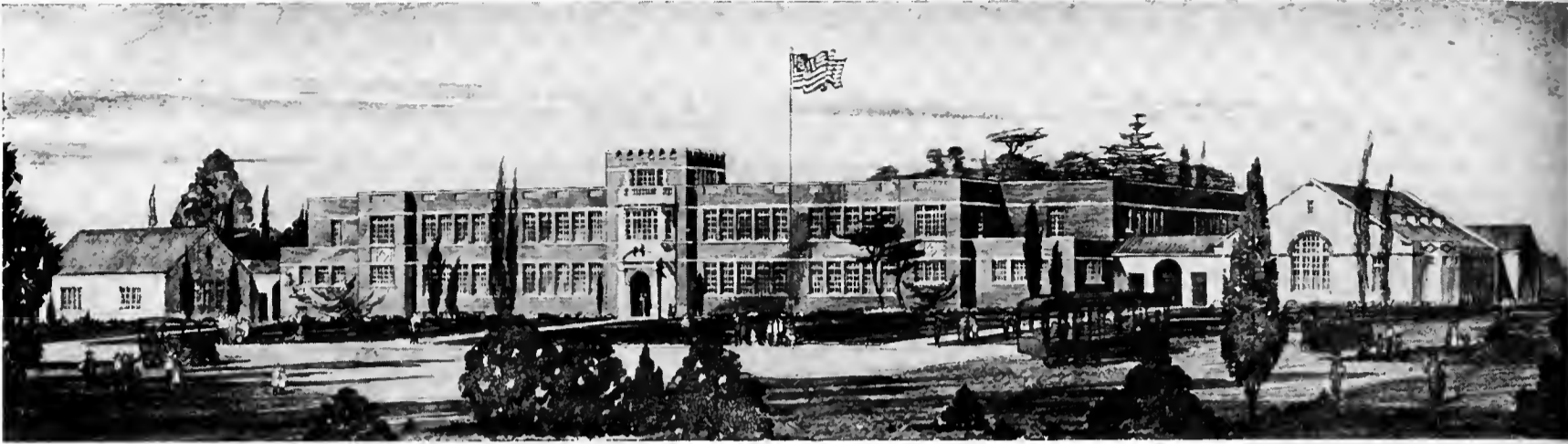

JEFFERSON JUNIOR HIGH SCHOOL,  
 LONG BEACH, CALIFORNIA.  
 ALLISON & ALLISON } ASSOCIATE ARCHITECTS  
 H. ALFRED ANDERSON }

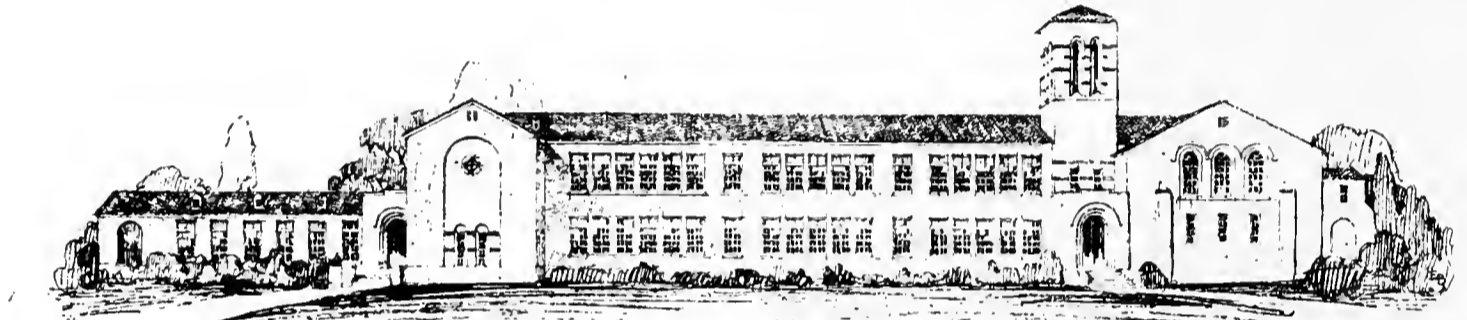

SKETCH ELEVATION OF LUTHER BURBANK SCHOOL, LONG BEACH, CALIFORNIA.  
 ALLISON AND ALLISON ARCHITECTS

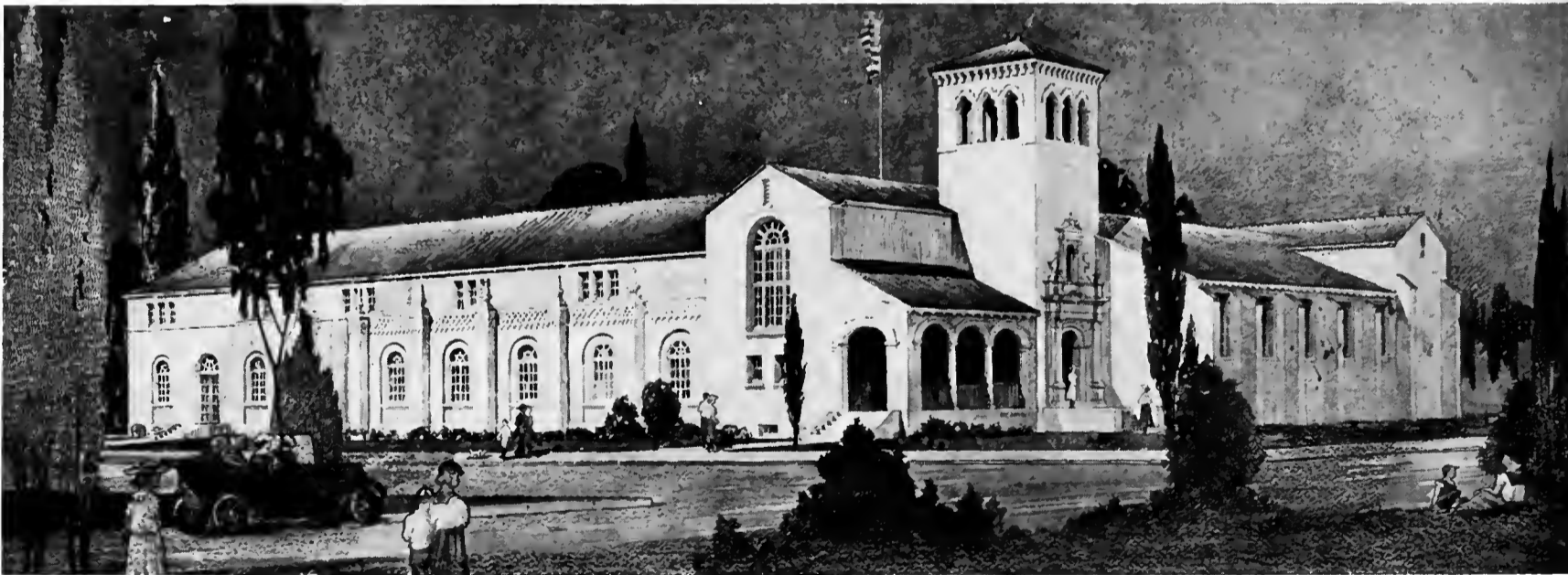

ATLANTIC AVENUE SCHOOL,  
 LONG BEACH, CALIFORNIA.  
 ALLISON & ALLISON } ASSOCIATE ARCHITECTS  
 H. ALFRED ANDERSON }



LUTHER BURBANK SCHOOL,  
LONG BEACH, CALIFORNIA.  
ALLISON & ALLISON, ARCHITECTS.



ATLANTIC AVENUE SCHOOL,  
LONG BEACH, CALIFORNIA.  
ALLISON & ALLISON } ASSOCIATE ARCHITECTS  
H. ALFRED ANDERSON }



HIGH SCHOOL,  
CHANDLER, ARIZONA.  
ALLISON & ALLISON, ARCHITECTS.

SAN FRANCISCO  
PUBLIC LIBRARY

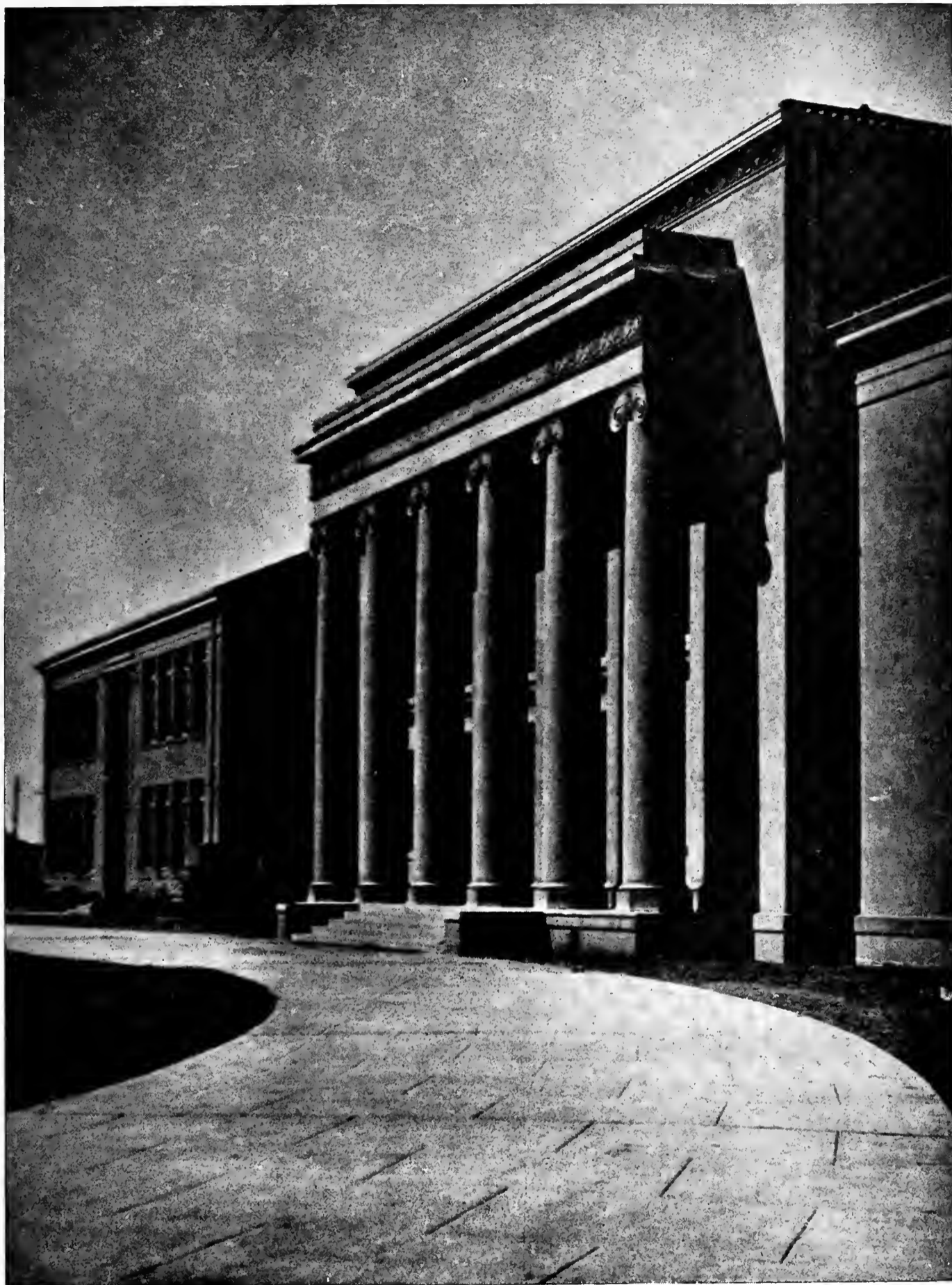

ENTRANCE MOTIF,  
HIGH SCHOOL,  
CANDLER, ARIZONA.  
ALLISON & ALLISON, ARCHITECTS.



MURPHY MEMORIAL HOSPITAL,  
WHITTIER, CALIFORNIA.  
ALLISON & ALLISON, ARCHITECTS

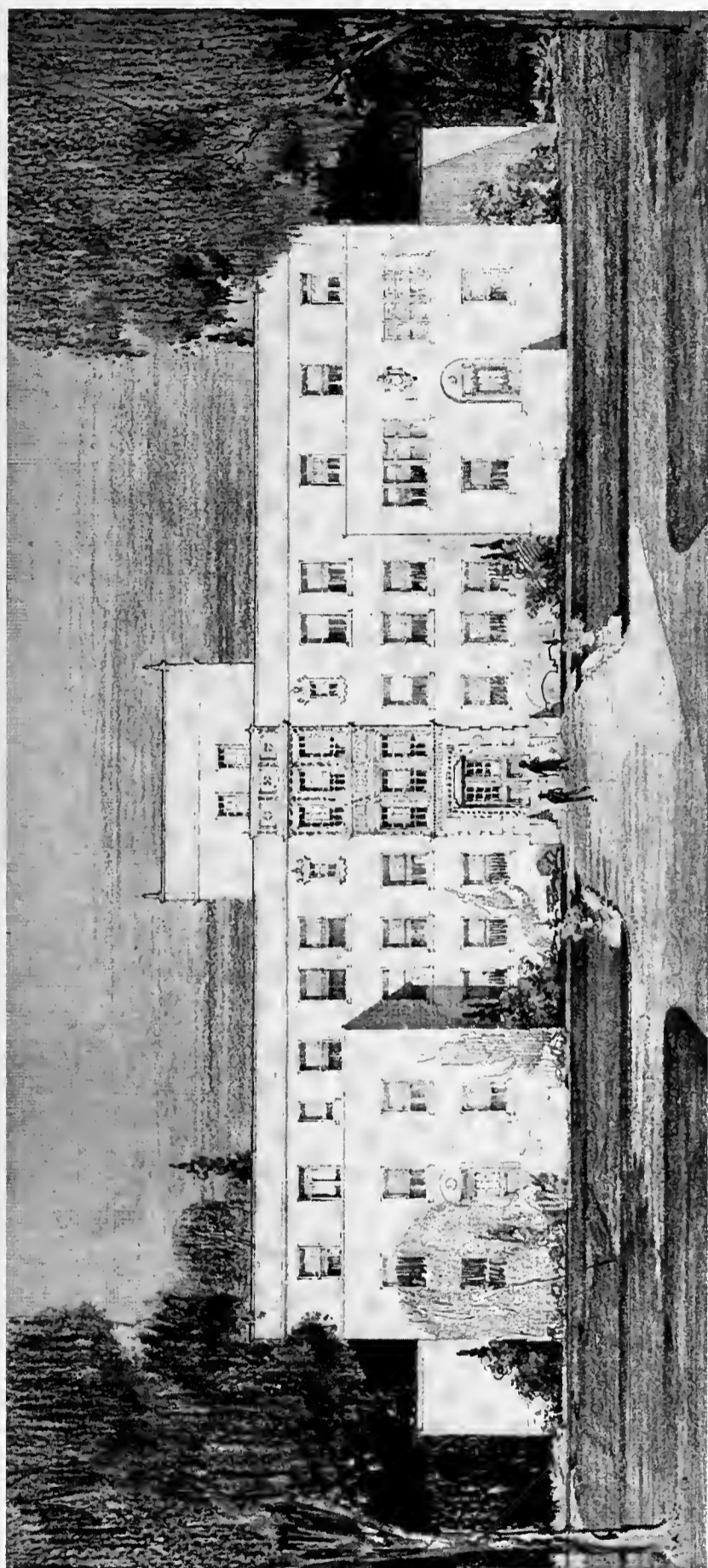

HARBOR GENERAL HOSPITAL,  
SAN PEDRO, CALIFORNIA  
ALLISON & ALLISON, ARCHITECTS.



MAIN VIEW.



DETAIL OF END PAVILION.

UNION HIGH SCHOOL,  
FOWLER, CALIFORNIA.  
ALLISON & ALLISON, ARCHITECTS.



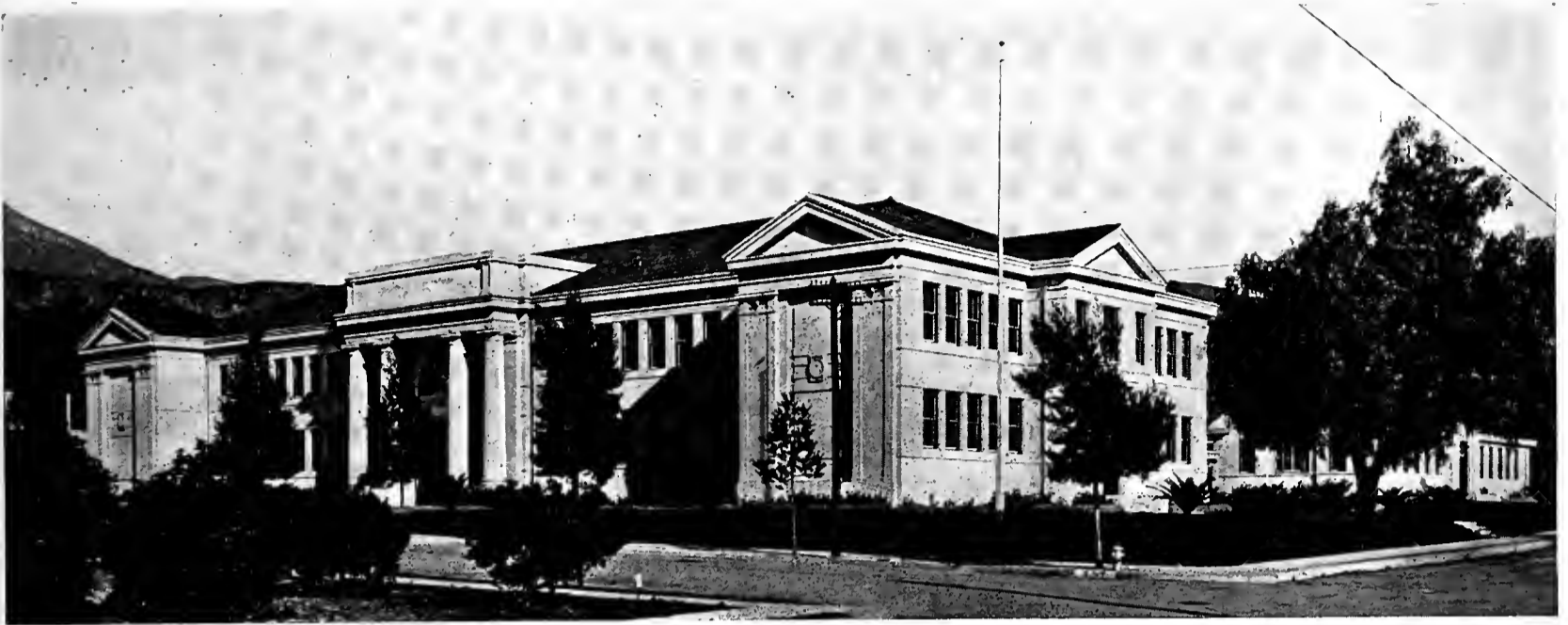

MAIN VIEW.

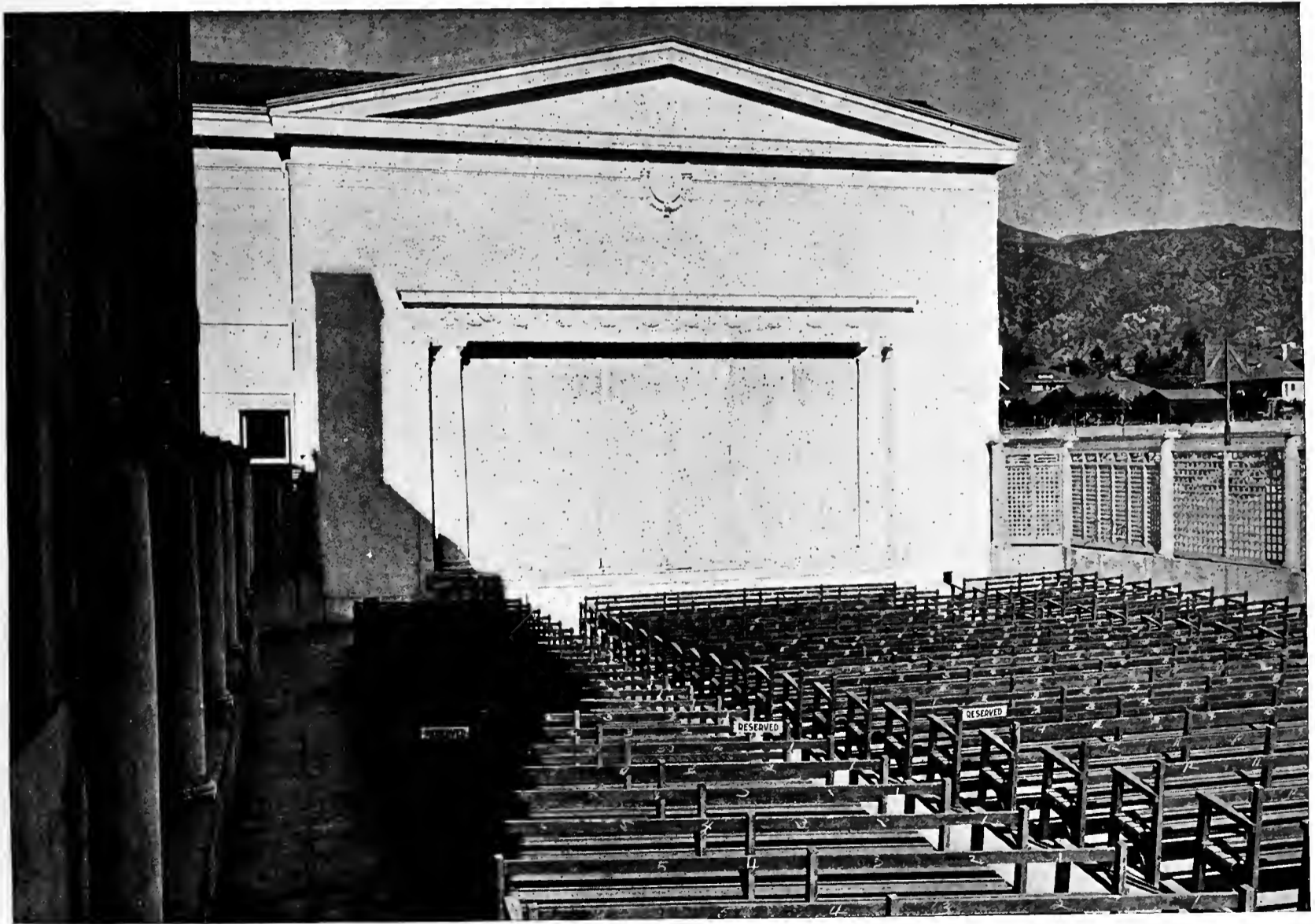

OPEN AIR STAGE.

HIGH SCHOOL,  
DUNROVIA, CALIFORNIA.  
ELISON & ALLISON, ARCHITECTS.



COLTON UNION HIGH SCHOOL,  
COLTON, CALIFORNIA.  
ALLISON & ALLISON, ARCHITECTS.

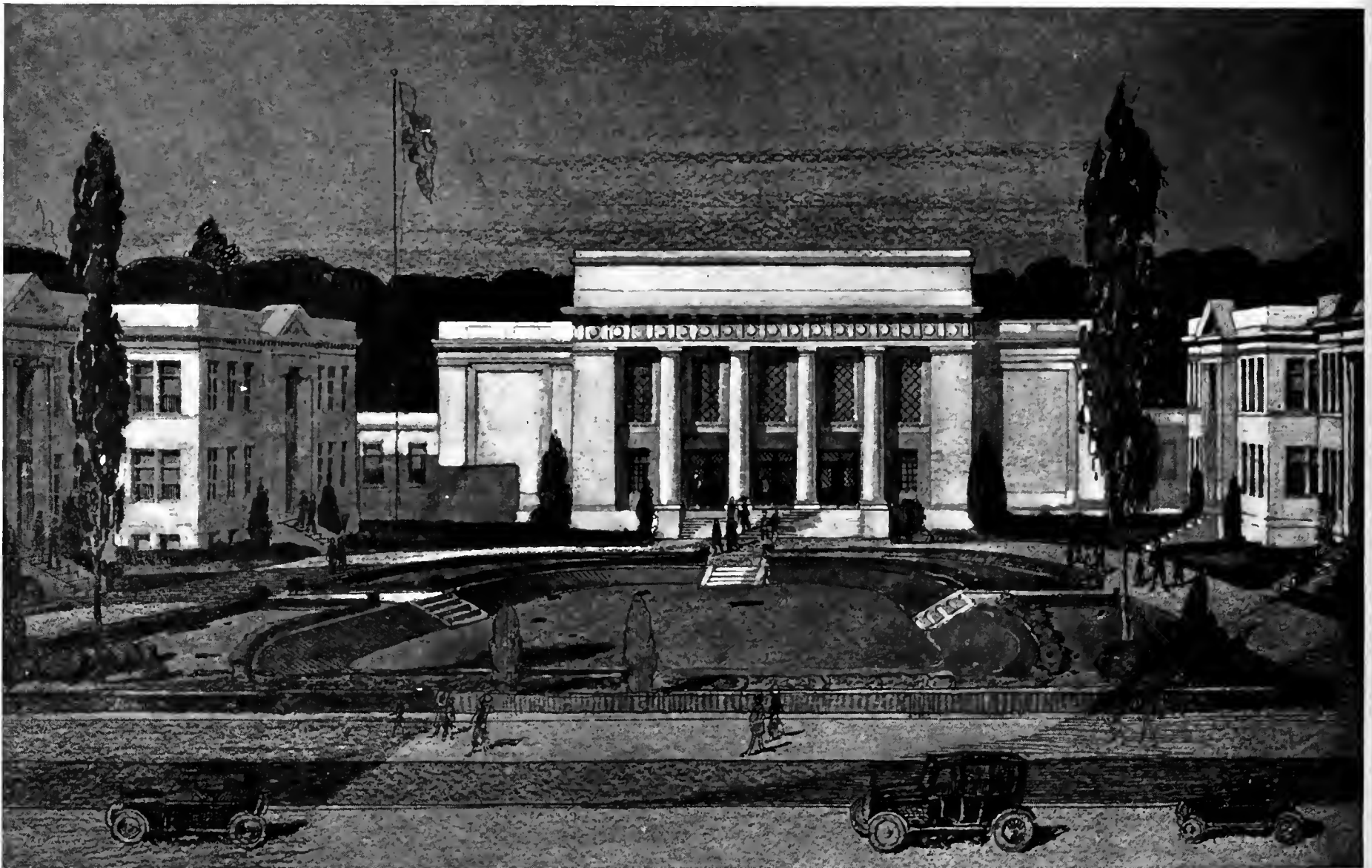

HIGH SCHOOL GROUP,  
ORANGE, CALIFORNIA.  
ALLISON & ALLISON, ARCHITECTS.

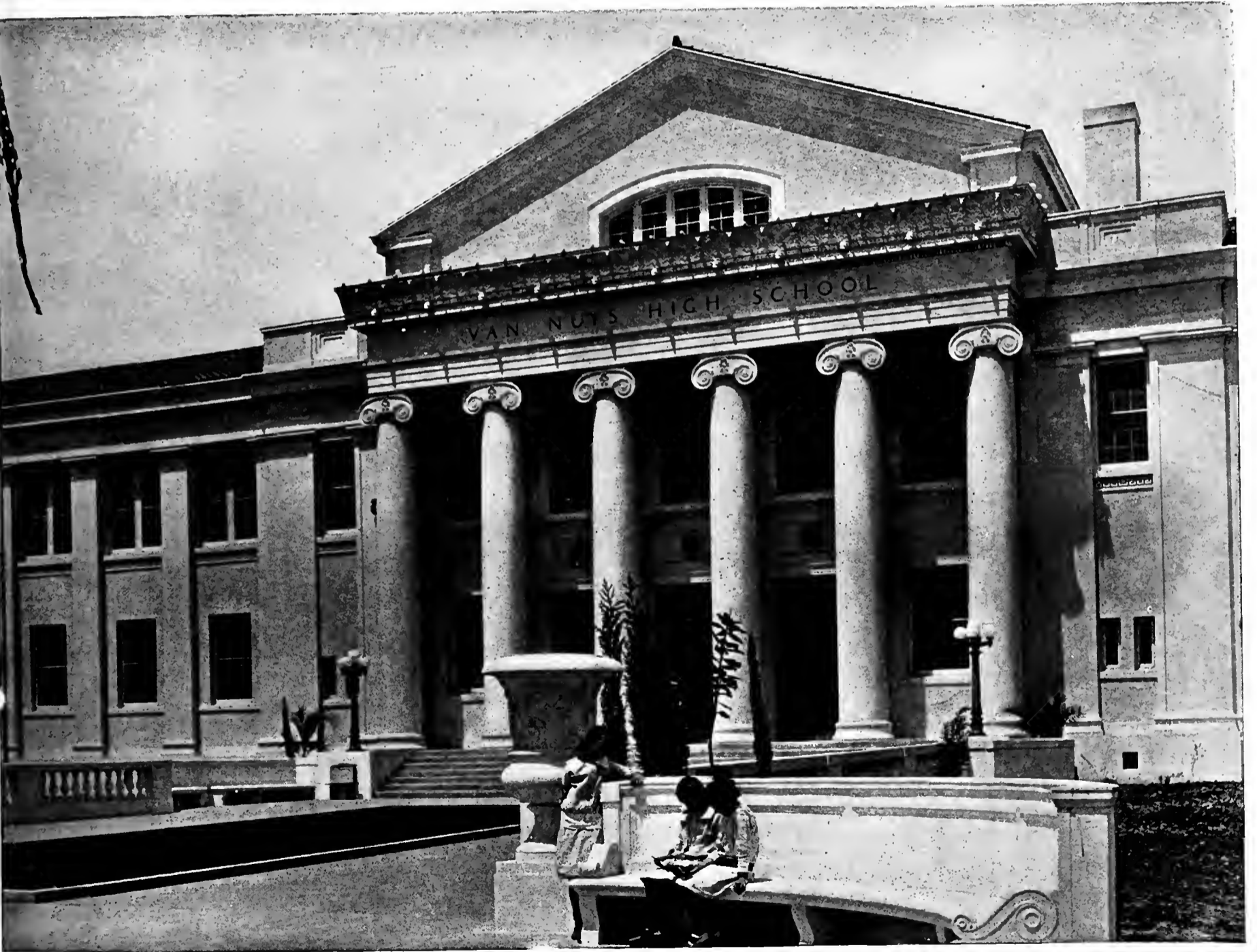
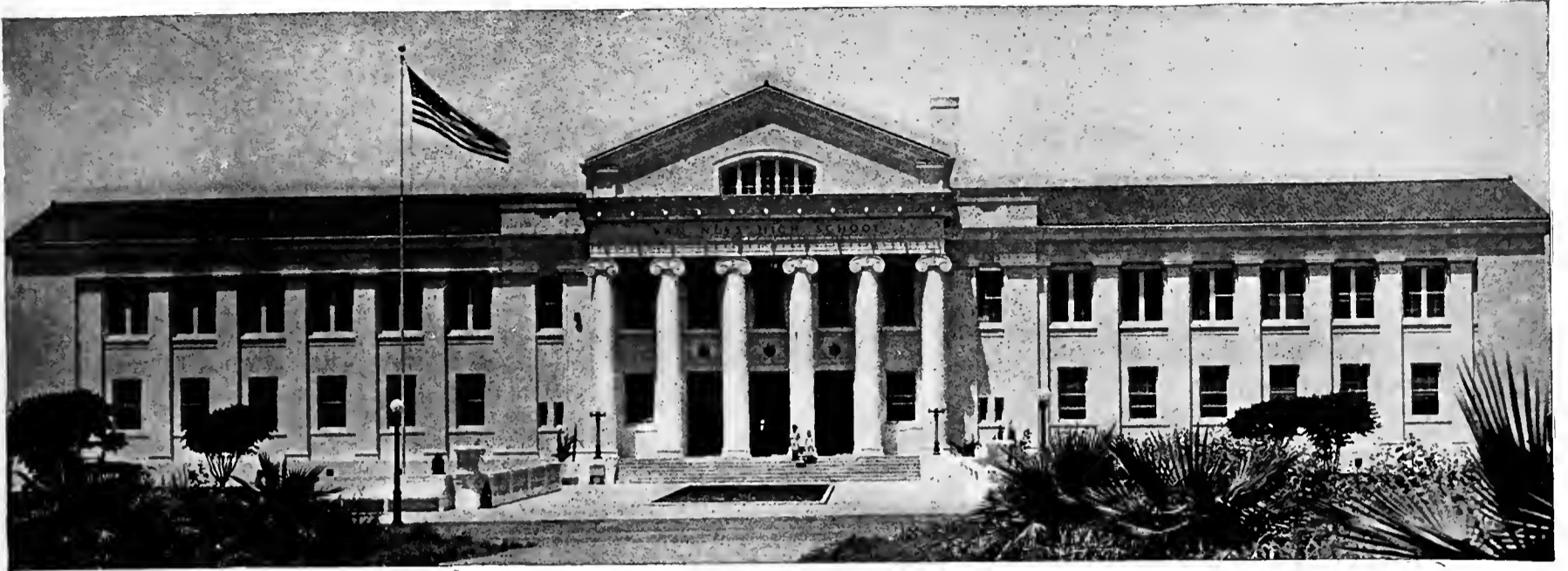

HIGH SCHOOL,  
VAN NUYS, CALIFORNIA.  
ELLISON & ALLISON, ARCHITECTS.



ENTRANCE DETAIL,  
UNION HIGH SCHOOL,  
REDONDO, CALIFORNIA.  
ALLISON & ALLISON, ARCHITECTS.



MAIN VIEW.

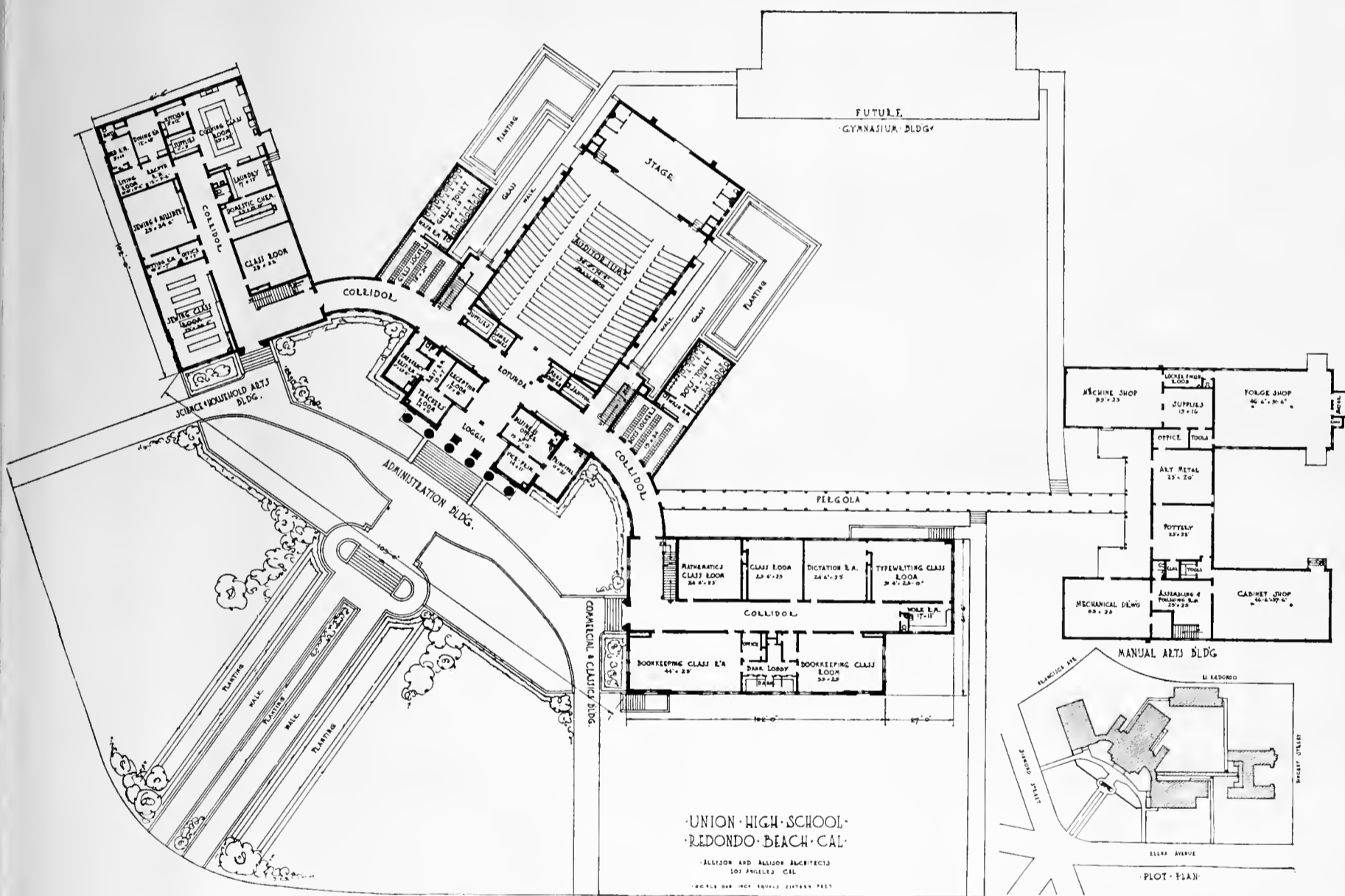

FIRST FLOOR PLAN.

UNION HIGH SCHOOL,  
REDONDO, CALIFORNIA.  
ALLISON & ALLISON, ARCHITECTS.

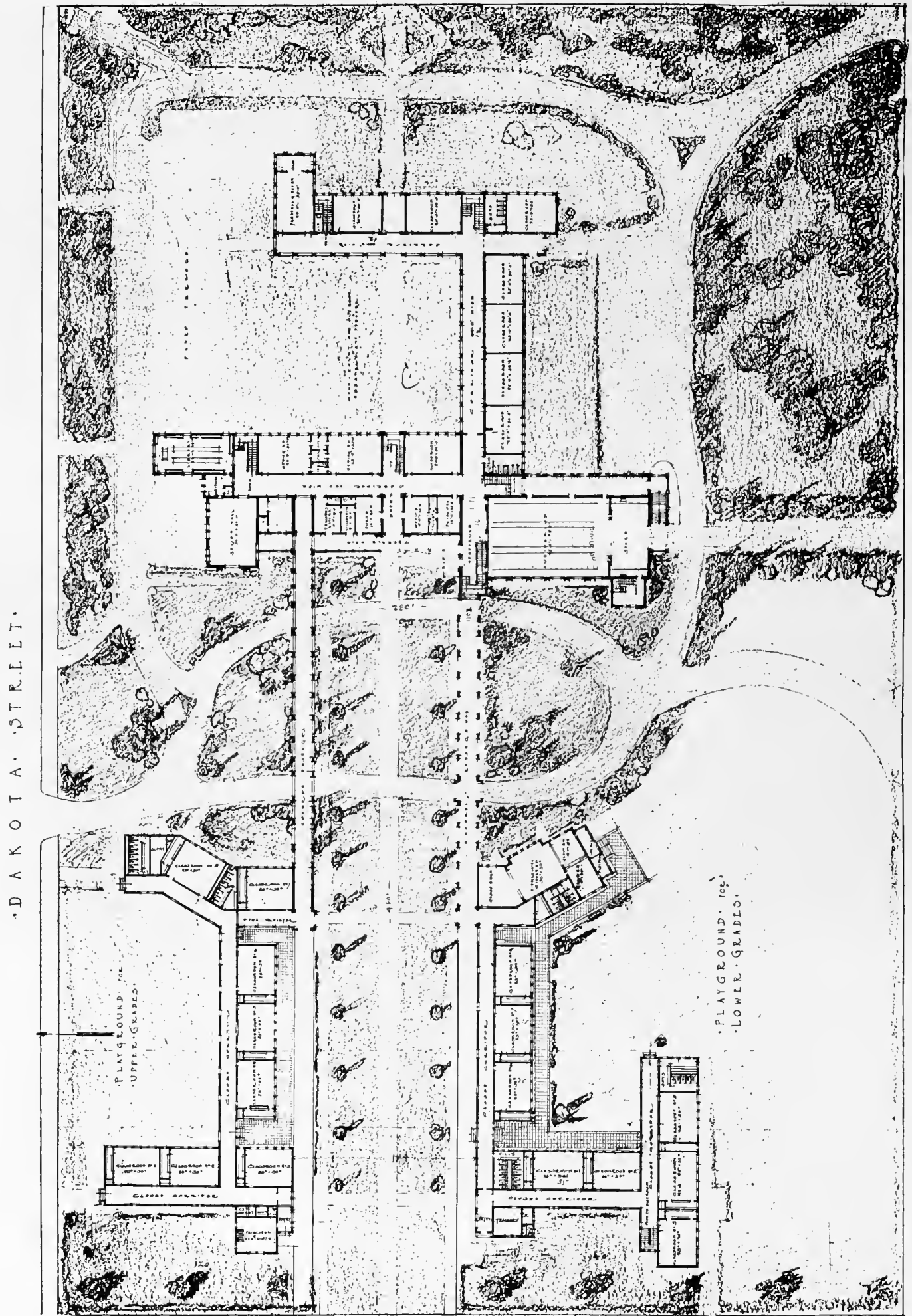

PLAN FOR SCHEME "A"  
WASHINGTON SCHOOL,  
PASADENA, CALIFORNIA.  
ALLISON & ALLISON, ARCHITECTS.



SCHEME "A"



SCHEME "B"



CHURCH OF THE MESSIAH,  
LOS ANGELES, CALIFORNIA.  
ALLISON & ALLISON, ARCHITECTS.

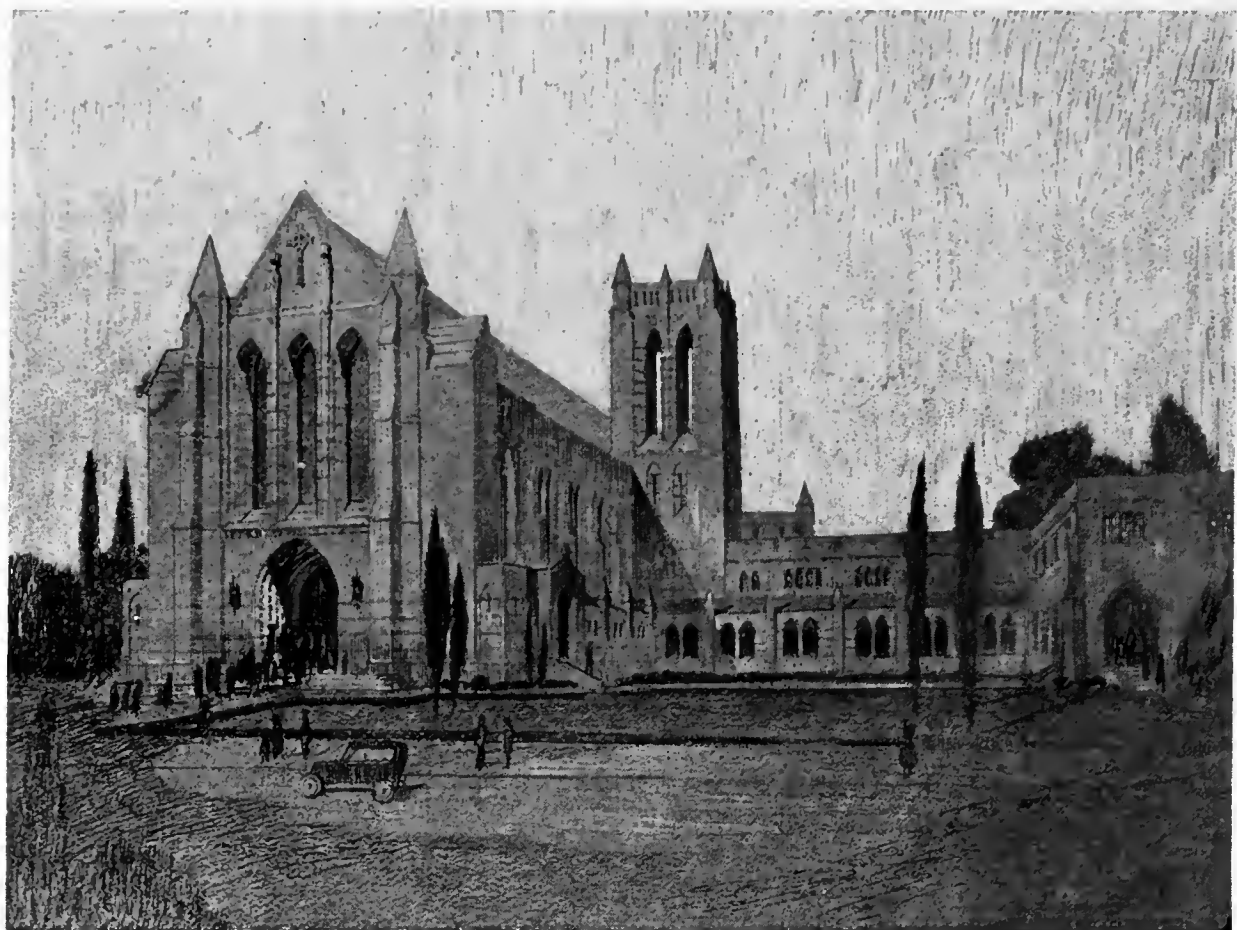

COMPETITION DESIGN,  
SAINT JOHN'S EPISCOPAL CHURCH,  
LOS ANGELES, CALIFORNIA.  
ALLISON & ALLISON, ARCHITECTS.



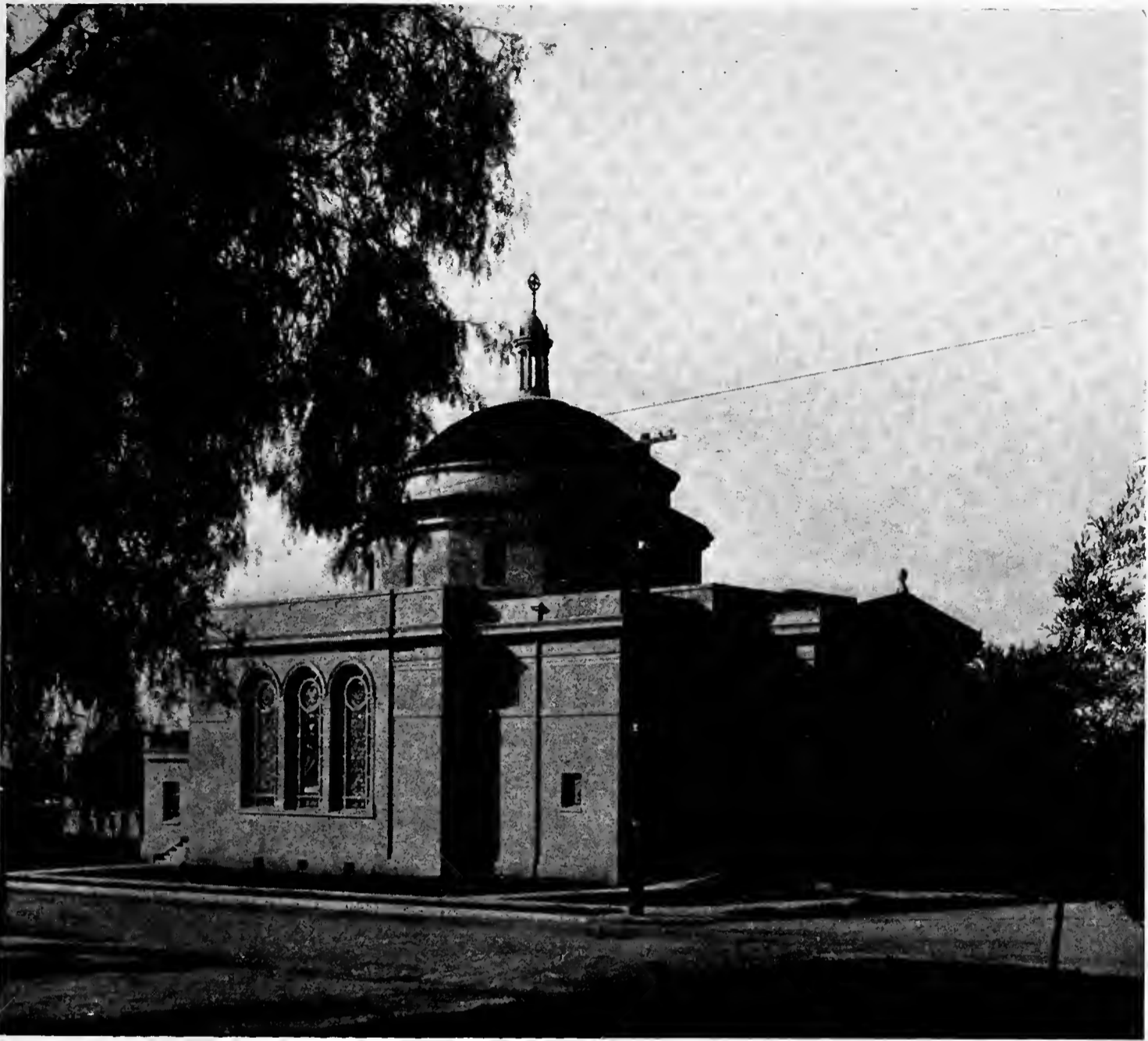

FIRST METHODIST EPISCOPAL CHURCH,  
MONROVIA, CALIFORNIA.  
ALLISON & ALLISON, ARCHITECTS.



DEPARTMENT STORE BUILDING FOR  
DR. E. O. PALMER,  
HOLLYWOOD, CALIFORNIA.



PACKING HOUSE,  
LIMONEIRA CITRUS ASSOCIATION,  
SANTA PAULA, CALIFORNIA.

INDUSTRIAL BUILDINGS,  
ALLISON & ALLISON, ARCHITECTS.



PORTICO, NORTH FRONT.



FRONT VIEW.



CORNER OF GARAGE.



GATEWAY.

RESIDENCE OF MR. J. C. DANIELS,  
PASADENA, CALIFORNIA.  
ALLISON & ALLISON, ARCHITECTS

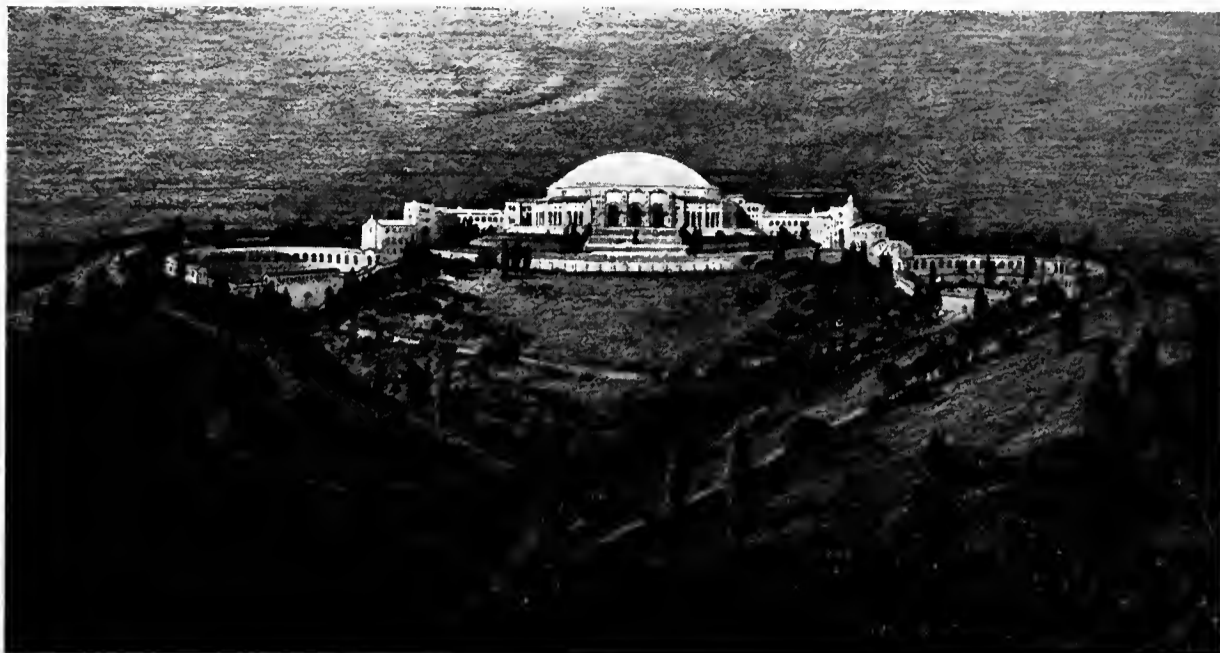

SKETCH, GENERAL VIEW.



SKETCH, AUDITORIUM ENTRANCE.

STUDIES FOR  
THE CHAUTAUQUA OF THE PACIFIC,  
LOS ANGELES, CALIFORNIA.  
ALLISON & ALLISON, ARCHITECTS.

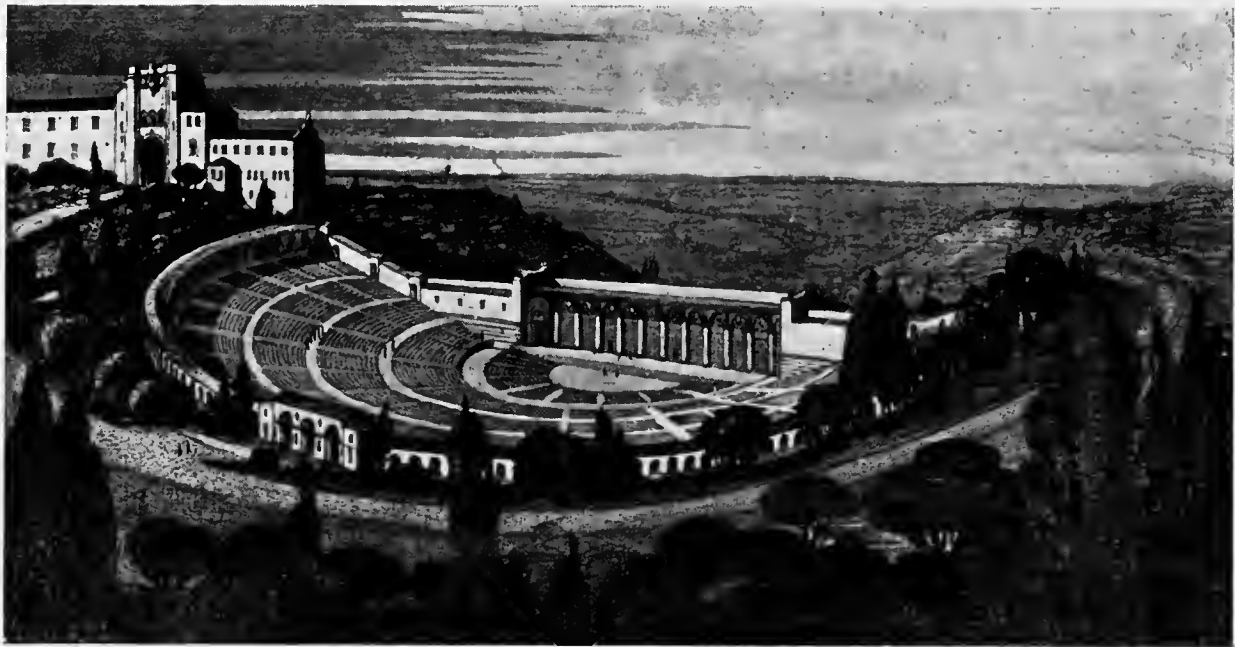

SKETCH, OPEN AIR THEATER.

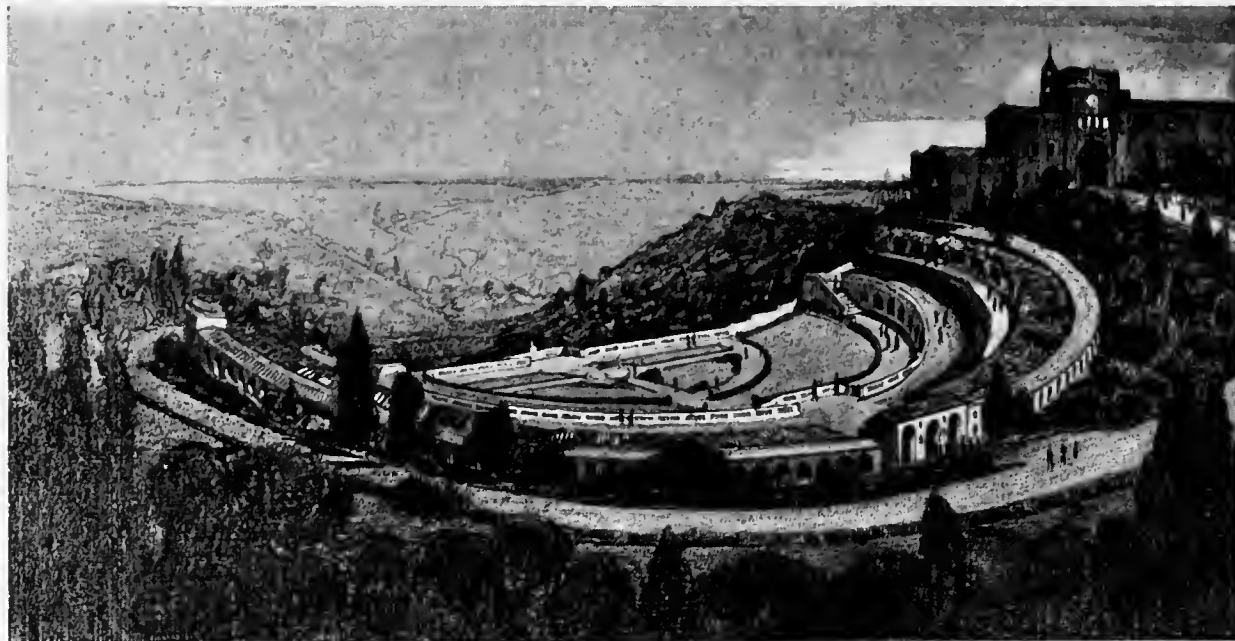

SKETCH, STUDY GARDEN.

STUDIES FOR  
THE CHAUTAUQUA OF THE PACIFIC,  
LOS ANGELES, CALIFORNIA.  
ALLISON & ALLISON, ARCHITECTS.



COOKING CLASS ROOM

## School Kitchens

By MARY ROBINSON THOMAS

There is so intimate a connection between the kitchen and the home that the story of the kitchens of the world would tell very clearly and truly that of the homes of the world. The mainstay and mainspring of comfort in life is the kitchen. The rise of the kitchen, from the outdoor arrangement of savagery to the modern completeness of the well-ordered home, is no more marked than the corresponding growth of the nations in home graces.

The inception of the school kitchen was brought about by the old law of demand and supply; the homemakers' demand for knowledge of not only the how, but the why created the supply of modern laboratories and forceful instructors which are found throughout the civilized world. Like all beginnings the first school kitchen was crude, but with the invention of mechanical devices and sanitary materials for construction it has kept up with the times and the present-day result of this evolution is a monument to scientific teaching and invention. It has been said that the highest modern civilization is shown not so much by costly monuments and works of art as by perfection of house conveniences.

Whether the home kitchen or the school kitchen is to be equipped the four fundamental and most important considerations are

light, ventilation, open plumbing, and non-absorbent, washable table-tops, walls and floors. The portable equipment justifies careful consideration, too; working space for each pupil must be adequate as to table, cupboard, stove and sink, and all of these at the proper height for ease in execution. This latter point will vary according to the grade of work and age of pupil, but the other points should be adhered to for all grades and ages. The size of the class is governed by the demand for instruction and the facilities for accommodating. Most class-rooms are equipped for twenty or twenty-four students, but most teachers agree that the ideal class is sixteen students.

At first the arrangement of the working tables was the hollow square with the teacher's desk at an opening at one end. The progress of the work was watched by the teacher from the inside or courtyard of this square. Individual stoves were supplied for kettle cooking while the baking was accomplished by one large oven at the end of the room near the teacher's desk. One large sink was near the stove. One stove and one sink only made congestion inevitable and this proved a great disadvantage in efficiency. These were the experimental days so cheapness of equipment was too often the first consideration, so wood was used for nearly all

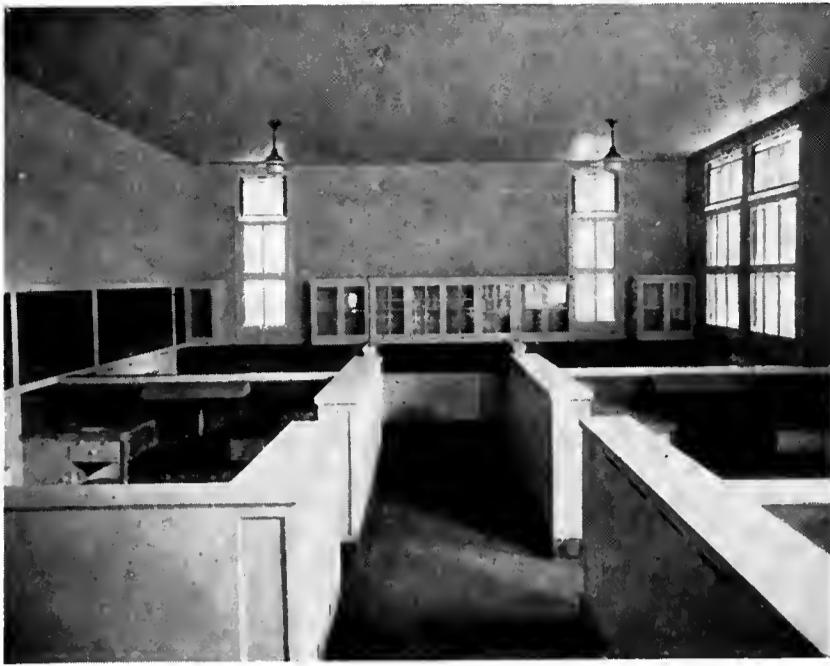

COOKING LABORATORY

construction purposes. Usually the pupil worked separately and with very minute quantities. This dividing, sub-dividing and dividing again of a receipt did not give uniform results and did not teach either principle or process that could be taken home and applied to every day living. Unless a practical subject has a practical application to life it fails utterly in its purpose. A prune is a small thing in itself, but when it is divided into quarters or thirds it becomes too infinitesimal for use in practical or aesthetic cookery.

The transition from this stage to the next came very quickly and decisively. More large stoves were supplied, also sinks, and the tables either accommodated two or four pupils, or two long tables accompanying lockers and openings at each end supplanted the "hollow square" idea. Zinc was often used to cover the wooden table top and so, save the constant scrubbing necessary to keep it clean. The need



COOKING CLASS

of frequent demonstrations by the teacher proved that a model table for this purpose was a necessary adjunct. The group method was most often used, so, that at least, one-half of a recipe could be used by two or four students. These were steps in the right direction.

The next great change came more particularly in the materials used in construction and the more general use of gas and the introduction of electricity for cooking. One of the illustrations shows very clearly a high school class working in a very up-to-date kitchen. This kitchen is part of an equipment in a school for home-making, known as the Lux School of San Francisco, California. In this school not only cookery is taught but all the allied subjects.

Both individual and group methods were used and the subject took on an especially practical aspect because the well-cooked foods not only demonstrated sound teaching, but helped supply the needs of the cafeteria. Proper serving and the aesthetic value of good table manners were particularly emphasized.

Individual electric discs were installed and two large baking ovens. Sinks at the end of each side of these long tables (four in all) reduced the congestion, and a lavatory for hand-washing for each side of the room made cleanliness not only a possibility but a probability. The demonstration table faced the teacher's desk at the opposite end, and yet, in each instance, space was allowed for free passage back and forth. Vitrolite, a non-absorbent, acid and alkali resisting substance which is easily kept white, clean, and shining, was used for the tops of these tables. Underneath this top was a small shelf of the same material and some nickel hooks, upon which each girl



CAFETERIA KITCHEN



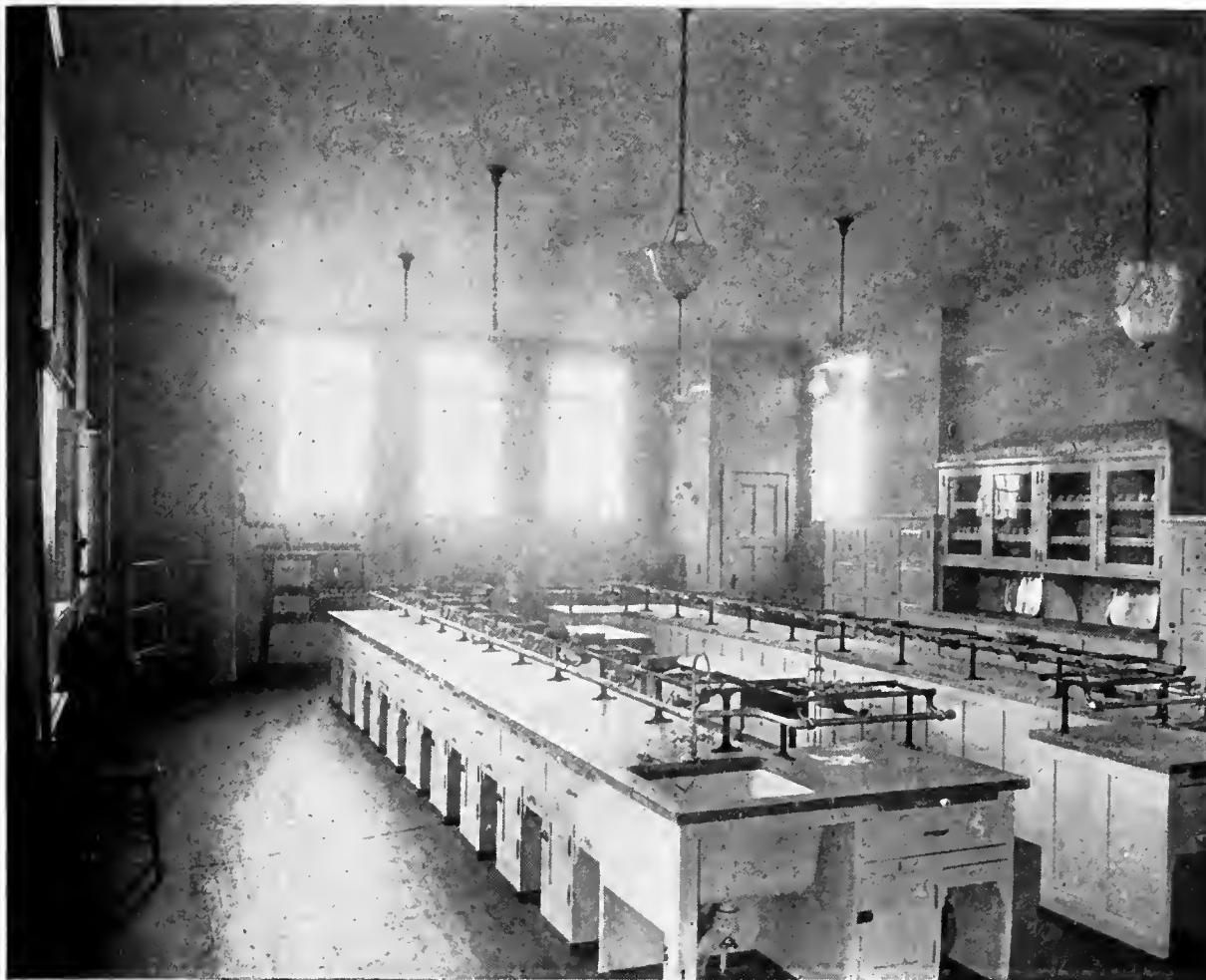

COOKING LABORATORY

kept her utensils. These open shelves made a quick inspection from the teacher's desk possible. Closed lockers are the ban of every home economics teacher's existence, because, it is an universal trait to close the door upon disorder. The teacher, whose ideas went into this installation believed and proved that order, system and thoroughness were better educational factors than uncreative routine work.

Another illustration shows the very latest idea in school kitchen architecture; the unit system. Here the room is divided into virtually five compartments, or cubicals, accommodating four pupils each. These miniature rooms are supplied with work-tables and lockers for four girls. The table tops are made of German stone in a buff color. Two small gas ranges supply boiling surfaces for four saucepans, an oven and broiler for each group of two. In each little room is a sink. In the center of the main room are the supply and demonstration tables. Adjoining this class kitchen is a practice kitchen, a pantry and store closet and dining room. The whole idea back of this equipment is to make the working conditions similar to the modern home kitchen and with this, goes the idea of using full sized recipes that will satisfy the average family, no matter whether the girl of twelve or the woman of thirty uses it. The Piedmont High School of Piedmont, California, is the proud possessor of this superior department.

Mothers, the world over, will agree that it is very easy for children to help in creating a dish and are usually very proud of such an achievement, but when the routine, mechanical work of cleaning up comes they avoid it, if possible. Mechanical devices such as the clothes washing machine, dish washing machine, vacuum cleaner and iron together with sanitary construction reduce the tediousness of every day work to a minimum so that time and energy are saved for wider achievements. If the Home Economic classes are learning these cardinal points, the whole world is the gainer!



ELECTRIC WASHER



GALLATIN DISTRICT SCHOOL,  
LOS ANGELES CO., CALIF.

ALLISON & ALLISON, Architects

## Educational Value of School Architecture

By HORACE M. REBOK

*Superintendent of Schools, Santa Monica, California*

The people of California are spending money more freely today for school buildings and for the expansion of public education than ever before. The same may be true of most of the other states of the union and undoubtedly is true in many of them.

The tremendous significance of the doctrine, that whatever we would have appear in the nation's life, we must put into the people's schools, is today strongly impressed upon the public mind. We are beginning to realize this philosophy in a very vital way; and as a corollary, we are also beginning to see that whatever we would have appear in the personal life of the citizen, whatever we would have appear in the home life of the individual, and whatever we would have appear in the community life, we first must put into the life of the public schools.

School days are impressionable days in human life. The child shapes his career from both suggestion and interest, and we do not yet know whether heredity or environment is the most dominant factor in determining human careers.

Surround a child with good buildings, attractive landscape, good pictures, and he will cease to care for the bad. He will learn to love the true, the beautiful, and the good, when during these wonderful years of childhood he sees and hears and lives in the en-

vironment of the true, the beautiful, and the good. If the ideals of these sentiments are embodied in terms of brick and stone, and landscape, their interpretations cannot but be impressed upon the mind and heart of the child and become a part of his character. The value of good school environment has its fruition later in life when the school child has become a citizen. He will then want beauty in the streets, parks, and the public buildings of his city, and the poor or the bad in such matters of community life will not satisfy him. From the standpoint of the individual and from the standpoint of the community and the state, no investment in education can pay a higher dividend than the investment in sound methods, good architecture, beautiful environment, for from these things the citizenship of tomorrow will gather the ideals of the democracy which tomorrow's citizens will build. From the child's present environment he builds up bit by bit, his conception of the dignity and character of citizenship in our republic.

The public school buildings of the twentieth century should be expressive of our finest sentiments and attitudes toward our type of government which is represented by the schools of the people. Our public schools embody the very essence of our democracy. They are the foundations of our community and

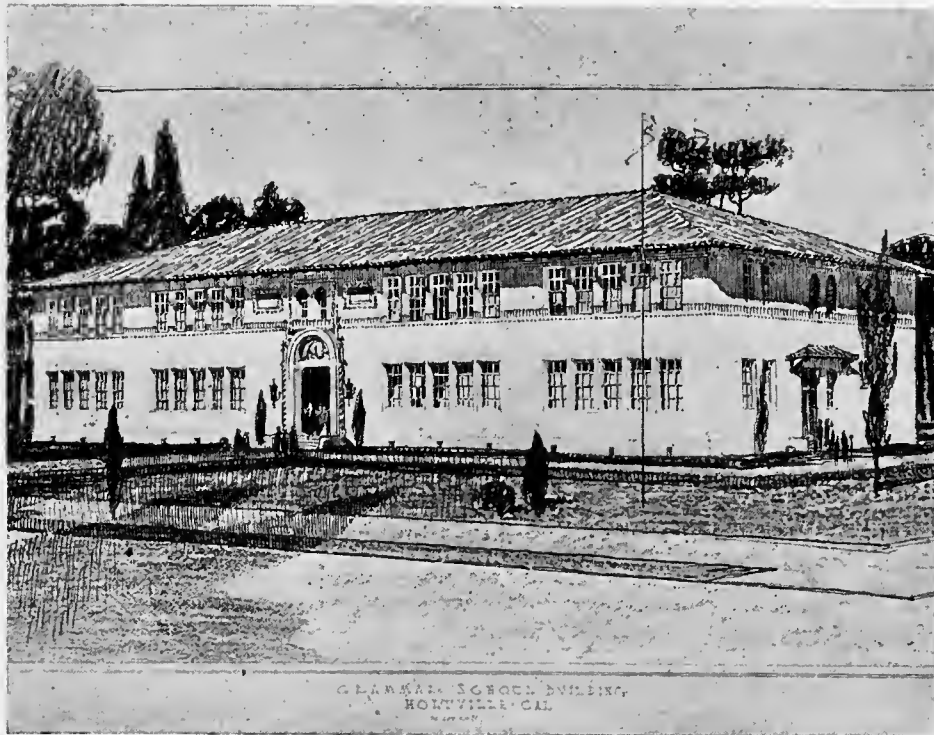

GRADE SCHOOL, HOLTVILLE,  
IMPERIAL CO., CALIF.

ALLISON & ALLISON, Architects

state. Under our theory of government the state exists for the welfare of its children and the public school is both the heart and the model for the rest of our governmental institutions. In spirit and in interpretation the architecture of the public school should typify the liberal, generous, hopeful, idealistic attitudes of a modern state.

The public school concerns all of the people. Of all public buildings the school alone is directly associated with the daily life of the masses. In plan, design, and equipment, school buildings contribute to the welfare of all, and in these things every member of society has both personal and financial interest. No school should be built in the twentieth century that does not lend itself to the service of the whole community.

The school plant of any community at any time becomes at once a gauge of the community's interest and intelligence in education. The village school house, built on the box plan; poorly ventilated, uninteresting or offensive in design, with unkept school yard, barren of plant or verdure, is typical of the community that built the school plant. It has been generally true that the homes, and the streets, and the other public buildings of a community in which such a school house has been found, correspond in type and character to the unattractive and unkept school house. The development of interest and ideals in community life have made the repetition of such mistakes scarcely possible today. The school has been doing its work. The level of intelligence of the community has risen and

community interest has quickened. The people generally, now approve only the best.

The State enjoins heavy obligations upon the public school in the teaching of morality, truth, justice, and patriotism. By legal mandate the State demands training of children for the best citizenship. With this objective in view, I hold it positively immoral to house its school children in homely, unkept buildings, or to assemble them daily on commonplace, neglected school grounds. How can a child, quick as he always is to sense injustice, be expected to embrace noble sentiments when his sight and other senses are daily offended by an example of community infidelity, insincerity, and niggardliness, as these moral qualities find expression in bad school architecture and in poorly kept school premises.

The child who comes to school from a well appointed home has the right to enter a school as good, at least, as the home from which he came. The child who comes from a neglected home, and is equally responsible for the future welfare of the State as is his more fortunate friend, has the right to enter the best school the community and state can produce. The school buildings of every community should be made temples of democracy. The lessons of community welfare exemplified in good streets, beautiful and well-kept playgrounds and parks, and beautiful and serviceable public buildings, should have their inspiration and inception in the environment of the school.



UNIVERSITY CLUB,  
LOS ANGELES, CALIF.

ALLISON & ALLISON, ARCHITECTS

## Honor Awards for Best Designed Buildings In Los Angeles

Honor awards for the best examples of architecture in 25 classified types of buildings, and best examples of group and city planning and landscape work, were a feature in connection with the exhibit held under the auspices of Southern California Chapter, American Institute of Architects, January 4 to 31, 1923, inclusive, at the gallery in the county museum at Exposition Park, Los Angeles. These awards were made only on work actually executed within the jurisdiction of the Chapter subsequent to the time of previous awards of honor. The various types of buildings are grouped in six sections as follows: Single dwellings, multiple dwellings, commercial buildings, semi-public and cultural buildings, school work and public work; three other sections comprise group planning, city or community planning and landscape work. A special award was given in many of the fine arts as distinguished from architecture.

The program of honor awards was arranged by the committee in charge of the exhibit, consisting of Edwin Bergstrom, chairman; Harwood Hewitt, David J. Witmer, H. C. Chambers, H. F. Withey, S. M. Spaulding and William Clarke.

Three leading architects of San Francisco comprised the jury of awards. They were: John Galen Howard, Ernest Coxhead and Arthur Brown, Jr.

The exhibit was not confined to drawings and pictures of executed work, but included also unexecuted work. The hanging committee, which determined the exhibits and was responsible for their proper framing, hanging and coherency as a unit when hung, was composed of the following architects: D. C. Allison, chairman; W. M. Clarke, H. C. Chambers, Pierpont Davis, W. J. Dodd, Robert Farquhar, Fitch Haskell, Harwood Hewitt, Myron Hunt, Elmer Grey, Reginald Johnson, Templeton Johnson, Robert Murray, E. C. Neff, S. M. Spaulding, Winsor Soule, A. C. Zimmerman.

Following is the circular on honor awards as prepared by the committee in charge of the exhibit of which Edwin Bergstrom is chairman:

The Southern California Chapter of the American Institute of Architects, desiring to encourage the appreciation of architecture and the fine arts in Southern California by extending its recognition of exceptional merit in any executed work in those arts, does hereby establish a series of awards to those by whose ability, skill and co-operation such works were created.

The conditions governing these awards are hereby fixed as follows:

CONDITION 1. These awards shall be known as the "*Honor awards of the Southern Cali-*



UNIVERSITY CLUB.  
LOS ANGELES, CALIF.

ALLISON & ALLISON, ARCHITECTS

*for*nia Chapter of the American Institute of Architects in architecture and fine arts.”

CONDITION 2. The awards shall be of two divisions: *Classified Awards*, made under the regular sections fixed in Conditions Four and Five, hereof, and *Special Awards*, made in accordance with Condition Eight hereof.

CONDITION 3. Awards of either division shall be made only for work actually executed within the jurisdiction of the Southern California Chapter of the American Institute of Architects subsequent to the time of previous Awards of Honor.

CONDITION 4. *Classified Awards*, provided for in Condition Two, shall be made for exceptional architectural merit in the sections and classes fixed in this Condition Four, and shall be confined to the work of members of the Southern California Chapter of the American Institute of Architects.

Section I—DWELLINGS, SINGLE:

Class A—Single detached dwellings, 6 rooms and under.

Awarded to Henry F. Withey.  
Awarded to Witmer & Watson.

Class B—Single detached dwellings, 7 rooms to 12.

Awarded to Soule, Murphy & Hastings.  
Awarded to Harwood Hewitt.

Class C—Single detached dwellings, 13 rooms and over.

Awarded to Pierpont & Walter S. Davis.  
Awarded to Harwood Hewitt.

Section II—DWELLINGS, MULTIPLE:

Class A—Multiple dwellings, individual kitchens, 4 apts. and under.

No award.

Class B—Multiple dwellings, individual kitchens, 5 apts. and over.

No award.

Class C—Multiple dwellings, hotel type, city.

No award.

Class D—Multiple dwellings, hotel type, country.

No award.

Class E—Multiple dwellings, club type, city.

Awarded to Allison & Allison.

Class F—Multiple dwellings, club type, country.

Awarded to Myron Hunt & H. C. Chambers.

Awarded to Edwin Bergstrom.

Section III—COMMERCIAL BUILDINGS:

Class A—Mercantile buildings, 4 stories and under.

Awarded to Henry F. Withey.

Class B—Mercantile buildings, 5 stories and over.

No award.

Class C—Industrial buildings.

Awarded to Allison & Allison.

Class D—Commercial buildings, not included in Classes “A”, “B” or “C”.

Awarded to Myron Hunt & H. C. Chambers.

Awarded to Morgan, Walls & Morgan.

Section IV—SEMI-PUBLIC AND CULTURAL BUILDINGS:

Class A—Religious.

No award.

Class B—Libraries, Academies, Colleges, Universities, etc.

Awarded to Allison & Allison.

Awarded to Myron Hunt & H. C. Chambers.

Class C—Hospitals, Detention Homes, etc.

No award.

Class D—Semi-Public and Cultural Buildings, not included in Classes “A”, “B” or “C”.

No award.

Section V—SCHOOL WORK (Built by civic taxes or bonds):

Class A—High Schools.

Awarded to Allison & Allison.

Class B—Intermediate Schools and under, 8 class rooms and under.

Awarded to Allison & Allison.

Class C—Intermediate Schools and under, 9 class rooms and over.

No award.

Section VI—PUBLIC WORK (Built by civic taxes or bonds):

No award.

CONDITION 5. *Additional Classified Awards* provided for in Condition Two, shall be made for exceptional merit in the sections and classes fixed in this Condition Five, viz:

Section VII—GROUP PLANNING:  
No award.

Section VIII—CITY OR COMMUNITY PLANNING:  
No award.

Section IX—LANDSCAPE WORK:

Class A—Residential sub-divisions, functioning as part of the civic plan or regional development.

No award.

Class B—Parks, functioning as part of civic development.

No award.

Class C—Private estates of less than one acre.

No award.

Class D—Private estates of more than one acre.

Awarded to Paul G. Thiene, Landscape Architect.

Awarded to Johnson, Kaufmann & Coate, Architects

Class E—Landscape work not included in Classes "A", "B", "C", or "D."

No award.

Section X—Any of the Fine Arts as distinguished from architecture.

Awarded to Wm. M. Clarke.

CONDITION 6. Only one award in any year shall be made in each class or unclassified section, unless, in the opinion of the Jury of Award, the educational value of these awards could be better presented by more than one such award; in which case the Jury may make not to exceed three awards in any class or unclassified section in any year.

CONDITION 7. The manner of presenting the work to the Jury of Award shall be determined by the Executive Committee of the Chapter; however, nominations for awards in any of the sections and classes of *Condition Five* may be made to the Jury in writing by any person.

CONDITION 8. A Special Award of "*Distinguished Honor in Fine Arts*" may be made for any executed work of pre-eminent merit in any of the fine arts to the author thereof. Not more than one such award shall be made in any one of the fine arts in any year. A classified award shall not bar a special award if the Jury shall so find. A *Special Award of "Distinguished Honor in Architecture"* may be made to the architect for any executed work of pre-eminent architectural merit if the Jury shall find sufficient merit to warrant such distinction above all other work of all classes. Not more than one such award shall be made in architecture in any one year. A classified award shall not bar a special award if the Jury so find.

CONDITION 9. The awards shall be made by a competent Jury of three architects, members of the American Institute of Architects, who are not members of this Chapter. This Jury

may, in considering awards in the city or community planning or landscape classifications, wherein the architectural problems is not predominant, call in special judges from the other professions to assist in making its award in such cases. The Jury shall be appointed by the Executive Committee of the Southern California Chapter.

CONDITION 10. As one of the paramount purposes for which the awards are to be made is that of encouraging the creation of better architecture of our members and a finer art, awards must be rigidly confined to merit as shown; thus creating year by year a visible history of progress of the arts of California. An Honor Award must not be made unless in the opinion of the Jury the work is of sufficient merit to be honored and so set apart, and when an award cannot be made the Jury shall state in its report either that no exhibit was entered in the classification or that, if entered sufficient merit had not been shown. The Jury shall be ever impressed that it is its duty and obligation to thus forward the educational value of the awards.

CONDITION 11. The Jury in making its awards must consider the work in its entirety, though this shall not be construed to prevent an award being made upon any detail of such work. The Jury shall, in making its decision as to merit, consider whether the work is an adequate solution of the problem involved. The Jury shall have the right and power to require the submission of additional information upon any exhibit submitted to it, and shall assure itself that the work is actually executed before making an award.

CONDITION 12. A unanimous vote of the Jury shall be necessary to make an award.

CONDITION 13. The Jury shall report in writing to the Executive Committee of the Chapter its findings, conclusions and recommendations, and the Executive Committee shall thereupon approve and accept the report, make the awards and publish said report as a part of the records of this Chapter.

CONDITION 14. The Chapter, under its seal and the signatures of its officers, will present, as evidence of the Classified Awards, "*Certificates of Honor*," and as evidence of the Special Awards, "*Certificates of Distinguished Honor in Architecture*" or "*Certificate of Distinguished Honor in the Fine Arts*" as the case may be, properly setting forth the appreciation of the Chapter for the meritorious work done.

THE BUILDING REVIEW

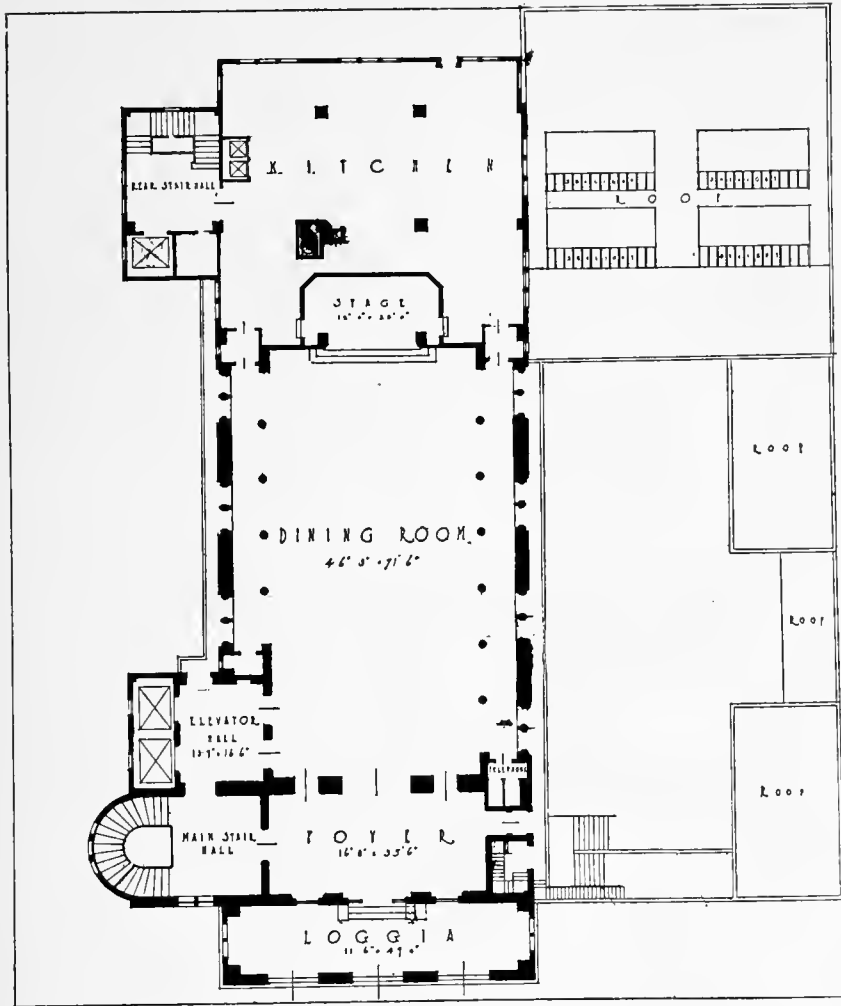

THIRD FLOOR PLAN  
UNIVERSITY CLUB

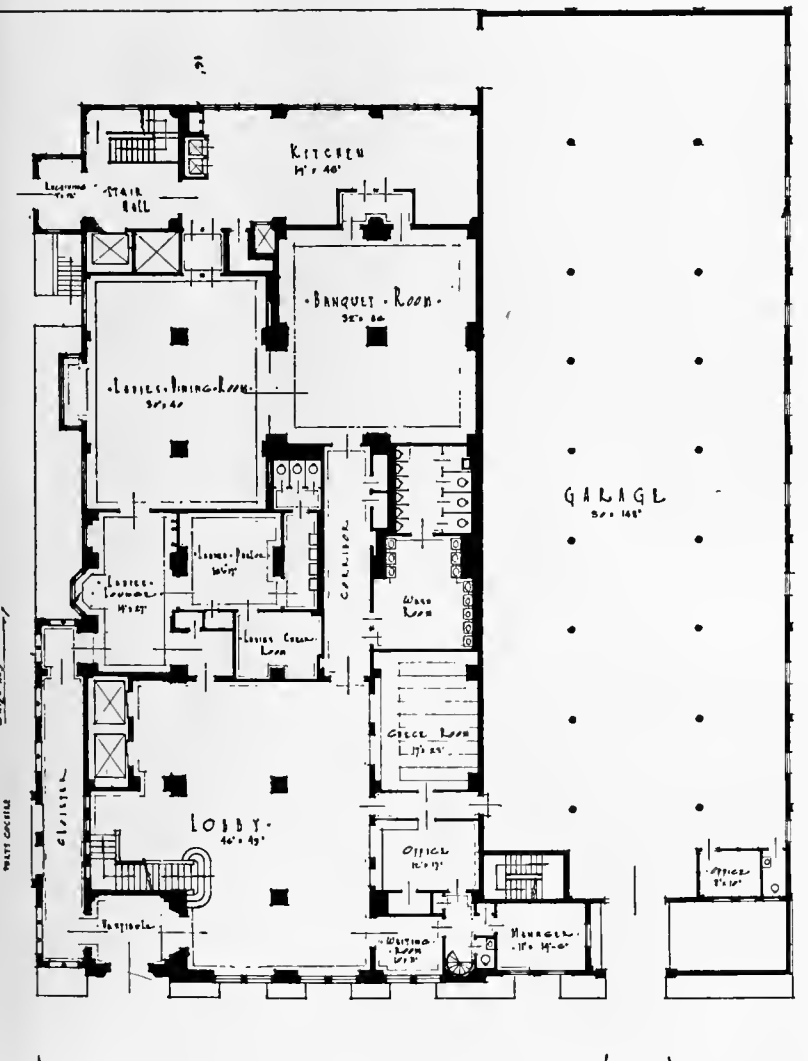

FIRST FLOOR PLAN  
UNIVERSITY CLUB

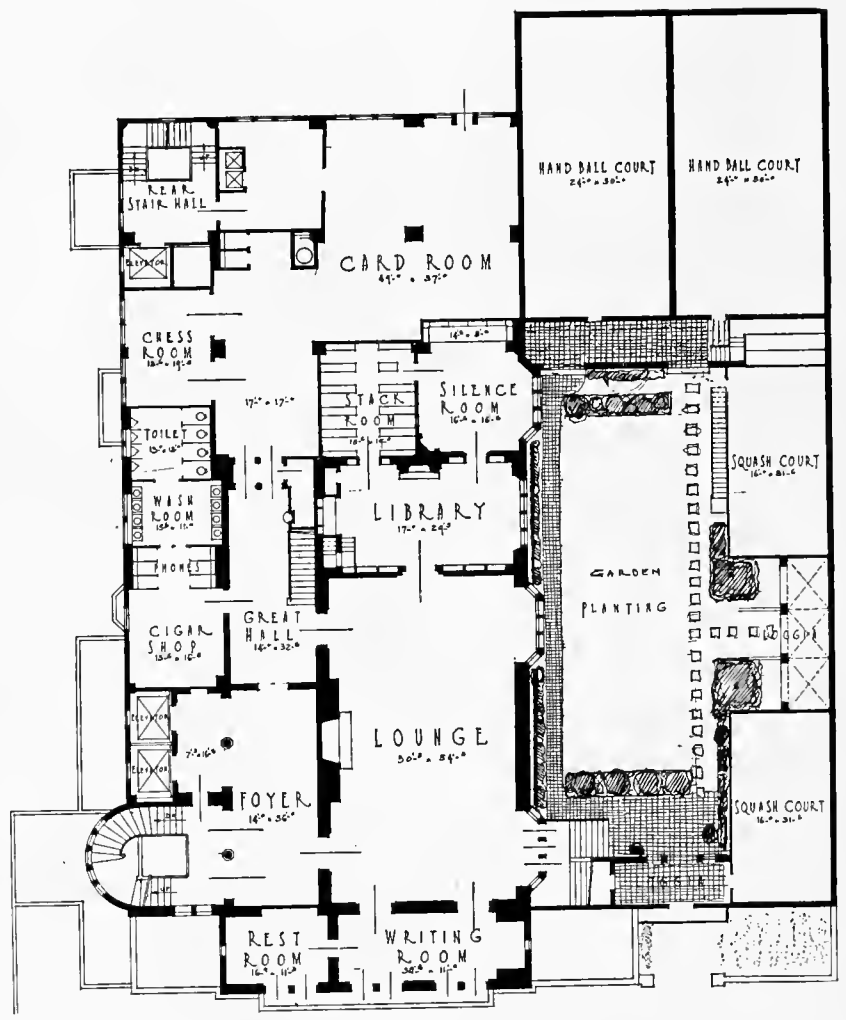

SECOND FLOOR PLAN  
UNIVERSITY CLUB

UNIVERSITY CLUB,  
LOS ANGELES, CALIFORNIA  
ALLISON AND ALLISON, Architects

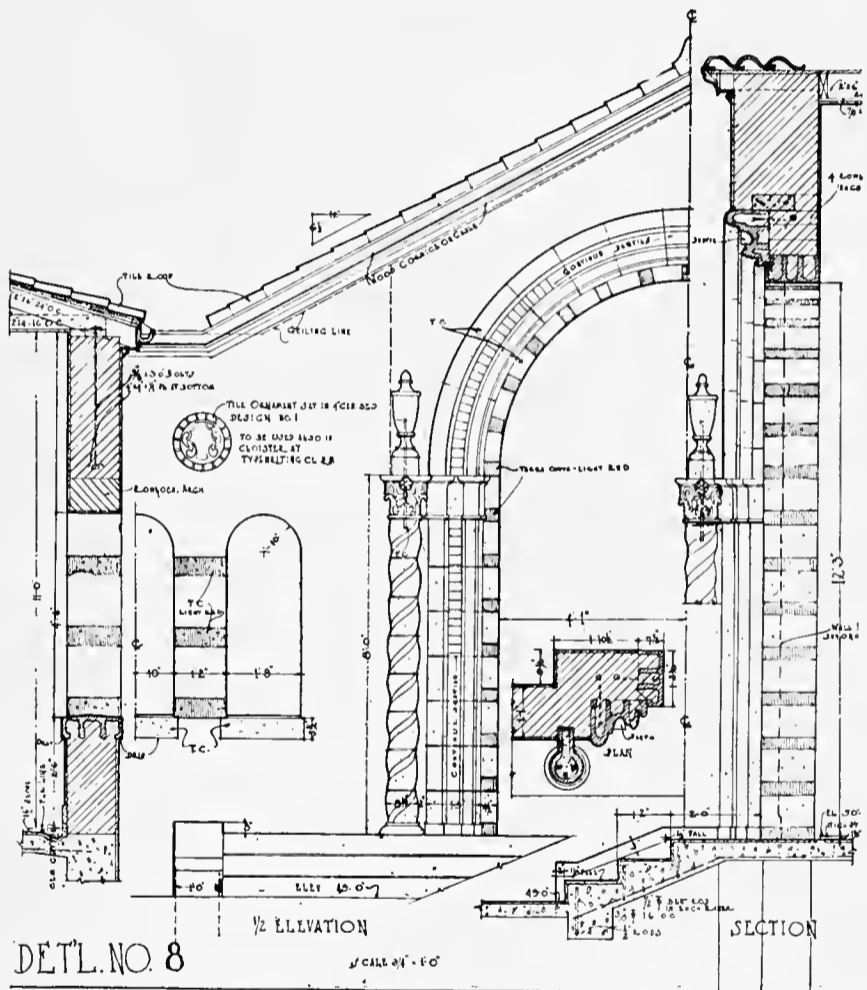
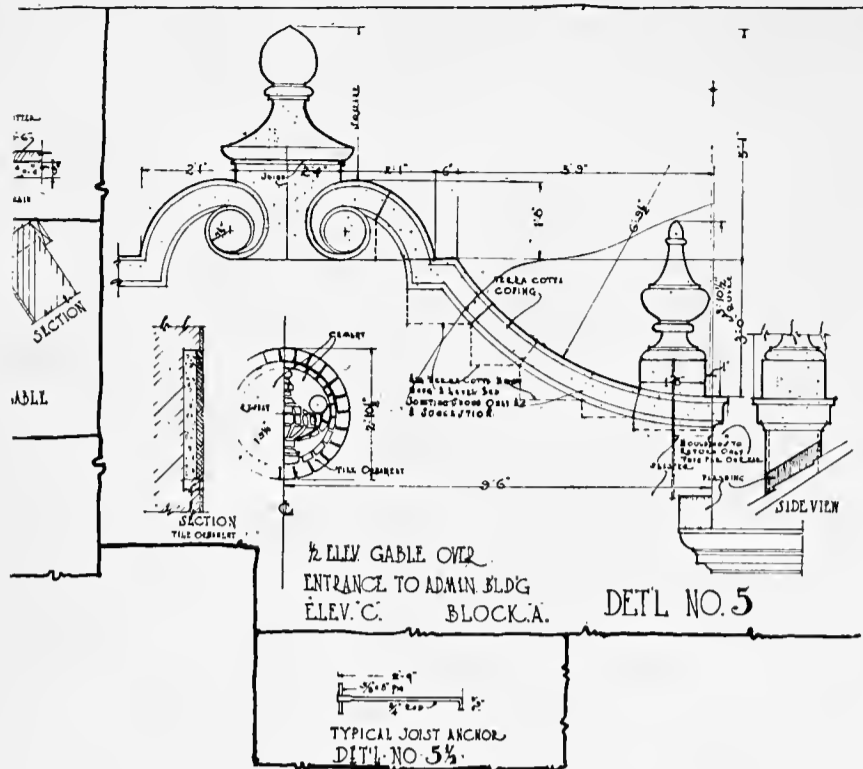

UNION HIGH SCHOOL, PALO ALTO, CALIF. ALLISON & ALLISON, Architects

GROWTH OF A WESTERN METROPOLIS

By MORRIS M. RATHBUN

If the casual traveler were asked for his deepest impression concerning Los Angeles, he doubtless would reply in the stereotyped phrase that its sunshine, fruits and flowers form the outstanding triumvirate. If the alert resident were asked the same question, he would reply in effect that the industrial development of the city during the past few years is the outstanding feature.

The industrial development of the city, beginning in 1914, did not come by chance, but

was the logical outcome of well organized community effort. This effort was made deliberately after a careful survey of the city as a whole, which indicated that although offering exceptional advantages in manufacturing, this phase of community life was sub-normal. Effort was concentrated through the Industrial Department of the Chamber of Commerce. An educational campaign was waged throughout the country. Manufacturers were told of the amount of their commodities finding a market in the city and its environs and of the total production. There was no indiscriminate effort made to promote industry nor were false hopes held out to industrial enterprises. Encouragement was given only to those which would fill a well defined want and which reasonably could expect to find a ready local market for their output.

Amazing results followed, when the ending of the world war in 1918 permitted industry to resume its normal functioning. With a population increasing at the rate of 100,000 a year there was room not only for many new industries, but for the expansion of those already existing. The new population arrived in a steady stream and demanded service and this demand was met by the established industries and by the new ones.

The year 1922 is indicative of the past four years in Los Angeles' industrial development. More than 500 new industries were added within the Los Angeles industrial district. Nearly \$7,000,000 of the \$120,000,000 building program for the year went into factory buildings and extensions. The variety of new industries was almost equal to the number, although in established and demonstrated lines such as petroleum products, food products, wearing apparel, auto accessories, furniture, clay products, motion pictures and containers, the percentage of increase was large.

It was but recently that Los Angeles' leading industry was classified as an industry. This is the manufacture of motion pictures, the annual output of which amounts to \$140,000,000 in value. This city is the capital of the motion picture world and produces approximately 75 per cent of all screen productions manufactured in the country. This industry is so closely allied with the arts that it was only considerable persuasion that the United States recognized it as having a part in the industrial life of the community.

It is a unique industry in that the raw material utilized in a million dollar screen production can be encased in an ordinary soap box. The raw product utilized consists of a few



rolls of celluloid film, which, if produced by a leading star, has a potential value of several million. The money supporting this industry is gathered from all corners of the globe in small amounts. There are more than fifty studios in and around Los Angeles producing pictures, and an average of one hundred photoplays are under way continuously. Some of the studios are equipped to take pictures as apartment houses are for tenants. The producer may rent all essentials except his actors and cameramen. The motion pictures are the romantic side of Los Angeles industry. In fact, the glamor of the pictures is so great that the casual observer does not realize that petroleum products are a close second in value, with more than \$100,000,000 in output annually and that the food products, if confectionery, canned fish and fruit and vegetables are included, are a formidable rival of the pictures in value.

The industrial census of the government in 1914 gave Los Angeles 26th place in cities of the United States. The population census gave it 10th place. It is believed that intensive activity of the past few years has brought Los Angeles' industrial rank commensurate with its population rank and that it is now functioning normally as a community so far as industry is concerned.

In the educational campaign for industry, it was pointed out by the Chamber of Commerce that peculiar advantages were offered by the city to manufacturers. Cheap hydroelectric power, unlimited water, any quantity of fuel oil, fine transportation facilities by sea and land, the salubrious climate, reasonably priced industrial sites and open shop labor conditions combine in attractive array. There is also the added lure to the manufacturer of a steadily increasing population not only in the city but throughout the distributing area.

Those familiar with the industrial development marvel at the progress made, but the earnest students in research point out that hardly a beginning has been made. They point out the \$298,000,000 annual mineral production of California as an evidence of the raw material supply. This total is from the 51 minerals now being taken from the ground. The encouraging part for Los Angeles is that the seven southern counties of the state contain the vast majority of the mineral deposits, so that future development of raw materials in this section is certain to produce industries adjacent to the source of supply. They point out the further fact that while more than fifty raw products now are being taken from mother

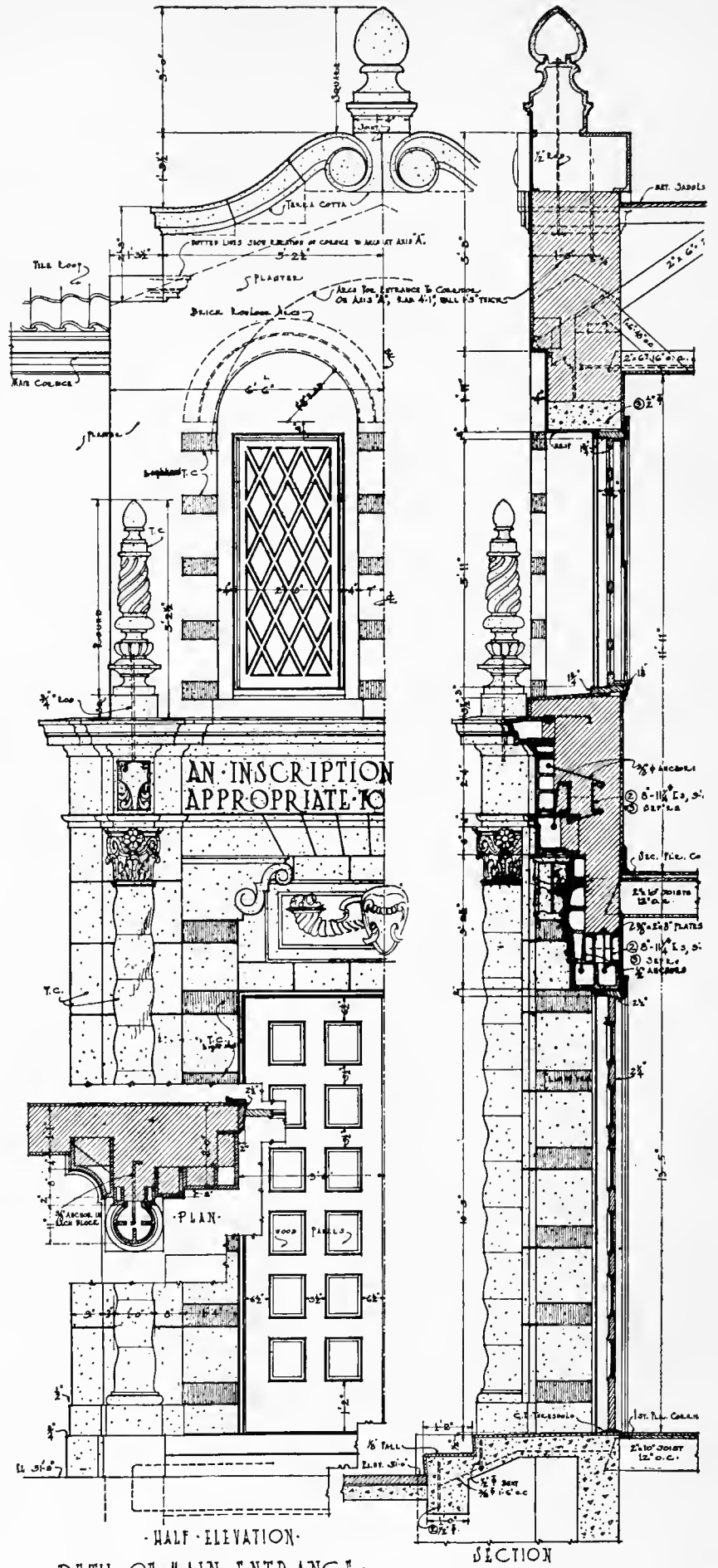

DETAIL OF MAIN ENTRANCE  
SCALE 1/4" = 1'-0"  
DETAIL NO. 13

UNION HIGH SCHOOL,  
PALO ALTO, CALIF. ALLISON & ALLISON, Architects

earth, in Southern California, there remain some 25 commercial raw products which have not yet been utilized but which eventually will be in the ordinary progress of humanity.

Steadily increasing population, introduction of labor saving methods, ever widening markets, overseas, and unlimited raw materials are held as a basis for predicting that Los Angeles industry is destined to become as famous as have its sunshine, fruits and flowers.

SAN FRANCISCO CHAPTER AMERICAN INSTITUTE OF ARCHITECTS  
MONTHLY BULLETIN

OFFICERS

Geo. W. Kelham, President.  
Henry H. Meyers, Vice-President.  
J. S. Fairweather, Secretary-Treasurer.



DIRECTORS

William Mooser, three years.  
J. H. Blohme, three years.  
A. J. Evers, two years.  
Harris Allen, two years.  
S. Schnaittacher, one year.  
Morris M. Bruce, one year.

NEXT MEETING

The next meeting will be held Thursday evening, February 15th, 1923, at the Architectural Club Rooms, 77 O'Farrell Street, at 6:30 p. m. and will be preceded by a Director's Meeting at 5:30 p. m.

JANUARY MEETING

The Directors and Regular meeting of the San Francisco Chapter of the A. I. A. was held Thursday evening in the Architectural Club Rooms, 77 O'Farrell Street. The meeting was called to order by President Geo. W. Kelham. The following members were present:

Morris M. Bruce, Geo. W. Kelham, William Mooser, H. H. Meyers, S. Schnaittacher, H. E. Burnett, E. B. Hurt, Chester Miller, W. O. Raiguel, W. J. Wilkinson, A. J. Evers, W. B. Faville, Wm. Newman, H. Schmidt, J. S. Fairweather.

OLD BUSINESS

It was the consensus of opinion of the board that the Circular of Information be made more condensed in form and that each director report his opinion at the next meeting.

The committee duly appointed to draft the new State Housing act made a study of the three existing housing laws, made a new draft which closely follows the act of 1921 and reported back to the full committee. After a general discussion January 10, 1923, a few minor changes were made and the bill sent to Sacramento to be taken up by the legislature now in session.

COMPETITIONS

The committee on competition begs leave to report that a limited competition for a Golf Club for the Olympic Club had been approved.

An Interesting Competition

Mr. Kelham reported an interesting competition held in New York City, for a building for the Johns-Manville Company, which is quite an economic way of competing when one stops to consider that the cost to the architectural profession for a competition such as the Chicago Tribune building with two hundred and forty competitors was anywhere from \$300,000.00 to \$400,000.00.

Don Barber, Wells W. Bosworth, Carrere & Hastings, Cross & Cross, Delano & Aldrich, Cass Gilbert, Helmle & Corbett, Robert D. Kohn, Ludlow & Peabody, McKim, Voorhees & Gmelin, McKim, Meade & White, Benjamin W. Morris, Kenneth M. Murchison, L. F. Pilcher, John Russell Pope, George B. Post & Sons, James Gamble Rogers, Starrett & Van Vleck, Trowbridge & Livingston, D. Everett Waid, Warren & Wetmore and York & Sawyer, were invited to a luncheon given by T. F. Manville, and each one drew an envelope with the words "you won" enclosed in one. The building was won by Ludlow & Peabody.

The Small House

The Department of Commerce has gotten out a booklet entitled "Recommended minimum requirements for small dwelling construction", which can be had by a request addressed to the Superintendent of Documents, Government Printing Office, Washington, D. C., and enclosing cash or money order for 15 cents per copy.

There being no further business the meeting adjourned.  
J. S. Fairweather, Secretary.

To the Members of the San Francisco Chapter of the A. I. A.:

According to the By-laws, privileged communications upon the desirability of the following applicant to membership in the San Francisco Chapter of the American Institute of Architects is requested.

Every such communication shall be signed and objections must be accompanied by reasons therefor.

Applicant: O. R. Thayer, 110 Sutter Street, San Francisco.

November 17, 1922.

Mr. John S. Drum, President,  
Board of Trustees, War Memorial Committee,  
Mercantile Trust Co.,  
San Francisco, Calif.

Dear Sir:

At a meeting of this Chapter held yesterday, request was made to the Board of Directors for information regarding the proposed War Memorial Buildings.

At the time, as you will recall, our Committee last met with you, we were informed that we would be notified before you were ready to take up this question for definite action.

Since this is a matter of the greatest public concern, insofar as the architecture is concerned, we again take the liberty of offering the services of this Chapter in any way that may be helpful to your Committee, and refer to our former communication sent to you on June 1921; a copy of which is enclosed.

We feel that where, as in this case, work steps outside the bounds of private ownership, our experience in the matter of the architectural problem and the selection of an Architect cannot but be of value to you.

If you are able at this time to give us any information regarding the project it will be much appreciated.

Very truly yours,

George W. Kelham,  
President.

December 20, 1922.

Mr. George W. Kelham, President,  
The American Institute of Architects,  
San Francisco Chapter,  
1001 Balboa Building,  
San Francisco.

Dear Sir:

At a meeting of the War Memorial Committee a few days ago your letter of November 27 was read and the Committee desired me to express to the Chapter its appreciation of the co-operation that your organization has given, and to say that the following Committee, made up almost entirely of members of the Institute, has been selected as an Architectural Advisory Committee to consult with the Building Committee of the War Memorial Committee in matters relating to the War Memorial buildings:

Bernard Maybeck, chairman; Willis Polk, Arthur Brown Jr., Ernest Coxhead, John Galen Howard, J. W. Reid Jr., G. Albert Lansburgh and F. C. Meyer.

Very truly yours,

(Signed)

John S. Drum.

FAMOUS as were some of the baths  
of Old Rome, no one would change  
to the equipment of those days after know-  
ing the convenience and rare beauty of

**PACIFIC**  
PLUMBING FIXTURES



*For Sale by All Jobbers*

DOYLE

THROUGH THE AGES

# THE BUILDING REVIEW

## REPORT OF THE SECRETARY OF THE WASHINGTON STATE CHAPTER, AMERICAN INSTITUTE OF ARCHITECTS

The Secretary reports that the activities of the Executive Committee have been greatly diversified during the past year and that the members of the Executive Committee have devoted practically two weeks of their time to Chapter affairs, thus making it possible for the Chapter at its regular monthly meetings to devote much more time to subjects of greater interest than the routine business which must be taken care of.

Among the activities which have received their attention, the following list will give some conception of the things which have absorbed Chapter interest during the past year:

1. The Aberdeen Elks' Club Competition.
2. Instituted a Special Chapter Fund at the suggestion of Mr. Albertson, and through the efficient work of a committee headed by Mr. Cote, this idea is proving to be a great success in the providing of funds much needed for activities which formerly have been cramped for the lack of money.
3. Aided the Parent-Teacher Association of the state in the establishment of a model School Building Code.
4. Upheld the report of the Building Code Commission relating to a special ordinance which was eventually passed to permit the construction of a building not in accord with the Code and thus going on record as a Chapter against changes in the Code.
5. Reviewed the competition for the Elks' Building in Spokane and refused the endorsement of the competition because it was not in accord with the Institute Code on competition.
6. Studied the problem of newspaper publicity for architects and held a very helpful meeting with the newspaper men as guests.
7. Held a meeting with Robert Proctor and Mr. Fowler of the Building Department to assist in maintaining a

friendly relation between the Chapter and the office of Mr. Proctor.

8. Requested that the Tacoma Hotel Association follow the principle that a Tacoma architect be engaged for their project.

9. The Executive Committee was instrumental in establishing a proper competition program for the Seattle Elks' proposed building. This program which has been accepted by the Building Committee of the Elks, is not yet approved by the Lodge at large.

10. Helped to prevent the proposed cut in the personnel of the Building Department by interviews with Mr. Proctor, the superintendent, and by letters to the Council.

11. Took active interest in the work of the Zoning Commission providing a review of certain portions of the zoning ordinance through our efficient Chapter Committee on Ordinances, headed by Mr. Siebrand.

12. Offered the assistance of the Chapter to the Association of Building Construction.

13. Provided Chapter membership in the National Council of Architects' Registration Boards.

14. Instigated the move which was finally instrumental in securing the nomination and election of Mr. Faville, the first Pacific Coast president of the Institute.

15. Through the Civic Design Committee of the Chapter sought the providing of spaces for future architectural and sculptural groups for the proposed Montlake bridge.

16. Through the Publicity Committee provided a campaign of publicity for Chapter members through window displays, which campaign is now under way.

17. Asked the City Council that it either abolish the office of City Architect or, if maintaining the office, make the City Architect a member of the Board of Public Works.

18. Among the speakers of the year were Dean Stephen I. Miller of the University and Mr. Blackwell, the new City Engineer.

PEERLESS—BEAUTIFUL—UNIQUE

## NATURAL WHITE SANDS Del Monte and Fan Shell Beach

**F**OUND only on the Ocean frontage of this company's Monterey Peninsula holdings. These sands are unequalled and largely used for high grade Stucco, Plaster, Mortar, Artificial Stone Work, Golf Tees, Bunkers and Greens, as well as for many industrial and other purposes requiring absolutely clean, pure, sharp sand. Shipped either crude direct from deposits, or washed in fresh water and dried by steam.

### Del Monte Properties Company

CROCKER BUILDING

SAN FRANCISCO, CALIF.



Palo Alto Union High School  
Palo Alto, California  
Allison & Allison, Architects

Fittingly Crowned with

## Spanish Roofing Tile

**A** ROOFING Material which will carry the beauty and charm of your conception way into the future years.

Here and there, all over California, this colorful, time and weather defying roofing material is to be found built into many of the most attractive homes and public buildings. It's rich, harmonious color and design has been aptly termed, "The Crowning Glory".

**United Materials Company**  
Sharon Bldg. San Francisco

**Los Angeles Pressed Brick Co.**  
Frost Bldg. Los Angeles

Face  
Brick

Enamel  
Brick

Paving  
Brick

Fire  
Brick

Common  
Brick

Hollow  
Bldg. Tile

Mantel and  
Floor Tile

Atlas  
White Cement

REVIEW OF TRADE LITERATURE

SELLING ARGUMENTS FOR TIN ROOFING

An interesting book of 80 pages containing over 100 illustrations and diagrams of various types of tin roofs showing their ready adaptation of different types of architecture. Among the Chapter titles are the following: "Information for the Architect, How a Tin Roof Should be Laid, How Roofing Tin Should be Made, Roofing Tin Tables for Estimating," etc. Special attention is given to the longevity of tin roofs and several buildings are shown where the original roof is still in good condition after over a century of exposure to the elements. Another chapter is devoted to showing the reduction of fire hazard where tin roofing is used. The book is well bound in a heavy cover and will prove a valuable addition to the architects or builders working library. The N. & G. Taylor Company, Philadelphia, Penna.

WIRE GLASS

A set of books descriptive of the advantages of wire glass will be sent upon request by the Mississippi Wire Glass Company. Among them are "Why Wire Glass Should be Used for Fire and Breakage Protection, Maze Glass, Efficiency of Wire Glass Windows, Pentecor, The Proper Glass for Factories, Handbook of Various Sizes and Types of Wire Glass and a 90-page book the Earthquake and Fire of 1906, in San Francisco." This book concerns the fire resistance of building materials tested in San Francisco in 1906 and covers in detail the opinions, criticisms and comparisons expressed in letters and interviews by men whose experience and observations warrant consideration. The effect of the fire on the various materials is graphically shown in a number of illustrations.

PORTLAND CEMENT STUCCO

This book has been prepared especially for architects and builders. In addition to the many photographic illustrations of stucco-finished residences and of various types of finishes possible with stucco, it contains instructions recommended for use in the application of this material and drawing of typical construction details for stucco coverings on various types of buildings. Portland Cement Association, Chicago, Ill.

Stillwell  
PLAN BOOKS  
of  
CALIFORNIA STYLE All Climate HOMES

—show pictures, Floor Plans and Estimated Costs of Building over 200 Selected Designs.

- "West Coast Bungalows"  
50 Houses—6 and 7 Rooms—\$1
- "Little Bungalows"  
75 Houses—3-4-5 Rooms—\$1.



- "Representative California Homes"  
50 Houses—7 to 10 Rooms—\$1.
- "The New Colonials"  
60 Houses—6 to 10 Rooms—\$1.

SPECIAL OFFER: Send \$2.50 for any three of these books and get Garage Folder FREE.

Books and Blueprints sold with Money-Back Guarantee

E. W. STILLWELL & CO., 790 California Building, Los Angeles

Phone Franklin 2492

A. C. WOCKER

INTERIOR DECORATOR

1370 Sutter Street

San Francisco, Cal.



WAREHOUSE  
POTRERO and  
DIVISION

SUTTER  
2 8 2 1

We suggest that architects and engineers avail themselves of the service offered by our corps of engineers, who are at all times ready to furnish estimates and details.

Our warehouse is equipped with power driven facilities that enable us to cut down handling cost to the minimum. This advantage naturally has its reflection in our prices.

Remember Soule Steel Service

EDW. L. SOULE' CO.  
RIALTO BUILDING  
SAN FRANCISCO

PORTLAND

LOS ANGELES

SEATTLE

R. N. NASON & CO.

PAINT MAKERS

151 Potrero Ave.—SAN FRANCISCO—436 Market St.

Makers of

NASON'S OPAQUE FLAT FINISH

A flat oil paint made in soft Kalsomine Tints, that is washable; a practical article for walls, ceilings, etc., that is most economical and durable.

Agency for

Tamm & Nolan Varnish Works High Grade Varnishes and Finishes Goods made on the Pacific Coast for the climate of this Coast

BALL BEARINGS

SKF INDUSTRIES OF CALIFORNIA

Incorporated

115 NEW MONTGOMERY ST.

San Francisco, Calif.

Phone Sutter 4196

DEEP GROOVE AND SELF-ALIGNING BEARINGS  
HANGER EQUIPMENT

*THE  
BUILDING  
REVIEW*



*MARCH, 1923*

*Vol. XXIII No. 3*

*Published in San Francisco*

*Price Twenty-five Cents*



INTERIOR VIEW  
ENTRANCE LOBBY

STRAND THEATER  
SAN FRANCISCO

F. LORENZEN  
Interior Decorator

Finished  
Throughout  
With

**Kyanize**  
KY-AN-IZE

Celoid  
Finish

Our new books "Recent Pacific Coast Architecture" and "Recent Eastern Architecture",  
containing Practical Specifications, mailed on application

**Boston Varnish Company**  
KY-AN-IZE

San Francisco Office and Warehouse: 1151 Mission Street  
A. L. GREENE, Local Manager



# THE BUILDING REVIEW

VOL. XXIII

MARCH, 1923

No. 3

## CONTENTS

Cover—A California Version of Italy

### ART SECTION

#### BERKELEY COUNTRY CLUB, BERKELEY, CALIFORNIA

Walter J. Ratcliff, Architect

Perspective Sketch .....	109	Exterior View .....	111
Main Floor Plan.....	109	Lounging Room .....	112
Exterior View .....	110	Lounging Room .....	113

#### RESIDENCE OF MR. C. M. HARTLEY, VACAVILLE, CALIFORNIA

Reed & Corlett, Architects

Front View of House.....	114	Living Room .....	117
Entrance Detail .....	115	Dining Room .....	118
Garage .....	116	Main Hall .....	118
Exterior .....	116	Bedroom .....	119

#### RESIDENCE OF MR. CHAS. HEYER, JR., PIEDMONT, CALIFORNIA

Reed & Corlett, Architects.

Two Exterior Views.....	120
-------------------------	-----

### TEXT

	Page
A SPANISH-COLONIAL BUNGALOW ELECTRIFIED (the second of a series on small western homes) By Clara Fassett.....	50
THE RAINBOW GARDEN, By Ellen S. Collier.....	50
CITY SURVEYING—ITS PROBLEMS AND IMPORTANCE, By A. Malkin, Civil Engineer.....	53
HEMWAY TERRACE, A NEW RESIDENCE TRACT.....	55
EDITORIAL .....	52
EDITOR'S BOOK SHELF.....	VII
ARCHITECTS MONTHLY BULLETIN.....	58

### INDUSTRIAL DEVELOPMENT SECTION

SAFE CONSTRUCTION OF BUILT-IN GARAGES.....	56
DIGEST OF WESTERN INDUSTRIAL ACTIVITIES.....	XVII
FIREPROOF WALLS—A RECENT DEMONSTRATION.....	XVIII

Editor, HARRIS ALLEN

Industrial Editor, HOWARD HOYT

Business Mgr., H. ROBT. BRADEN

Advertising Manager, SIDNEY J. WOLF

Published Monthly by the Building Review Company,

50 Main Street, San Francisco, California

Douglas Building Los Angeles, California

Address All Communications to San Francisco

Yearly subscription—United States, \$2.50—foreign, \$3.00. Single copies, 25 cents.

Entered as second-class matter in the San Francisco Postoffice under the Act of August 24, 1912. Previously entered as "The Architect."

The editors will be pleased to consider contributions of interest to the Industry. When payment of same is desired, this fact should be stated.

News stands and dealers supplied through San Francisco News Co., San Francisco, Calif., or American News Co., New York, N. Y.



HEMWAY TERRACE, SAN FRANCISCO, W. L. HEMMINGA, OWNER, ARCHITECT AND BUILDER.  
A. QUANDT & SONS, PAINTING CONTRACTORS.

# 100 per cent a FULLER Job

**A**BOVE you see a picture of a recent attractive addition to the residential section of San Francisco—16 houses in all—two are apartment houses of nine apartments each, and the other 14 houses each contain two flats. This entire job—houses, sewers, etc.—was all completed in 10 months' time—a record. The cost was \$350,000.

All of the paint products used on Hemway Terrace were supplied by W. P. Fuller & Co. The following items of the Fuller line covered all surfaces, interior and exterior:

PIONEER WHITE LEAD  
CONCRETA  
FULLER ENAMELS

PURE COLORS IN OIL  
UNDER COATS FOR ENAMELS  
FULLERWEAR VARNISH

Because of the purity of the materials used in all Fuller Paints and Varnishes, the whole line may be specified by all architects, as it was in this case, with full confidence that the results produced will reflect credit upon the Architect.

Detailed information on approved methods of applying Fuller Paints and Varnishes will be gladly furnished upon receipt of a request addressed to the Fuller Service Department.

## W. P. FULLER & CO.

San Francisco  
Oakland  
Sacramento  
Stockton  
Fresno

Los Angeles  
Hollywood  
Pasadena  
Long Beach

San Diego  
Santa Monica  
San Bernardino  
Santa Ana

Portland  
Boise  
Ogden  
Salt Lake City

Seattle  
Tacoma  
Spokane  
Yakima  
Walla Walla

# FULLER



# PAINTS and VARNISHES

EDITOR'S BOOK SHELF

*The Students' Edition of the Georgian Period\**



THE original collection of plates known as "The Georgian Period" is sufficiently well known. An explanation for the present reprint of a portion of that work is best given in the words of the preface:

"The Georgian Period, in its years of existence, has become the Standard work of reference in its field. From its inception, the demand for it has been steadily increasing and it has passed through eight large editions. To this book we may accredit the awakening of our interest in the buildings left by our forefathers, and it is today the only record we have of many structures that have been destroyed since its publication. To the architect and student it has been a source of knowledge and inspiration.

Shortly after the publication it became evident that, however invaluable the work might be, it would not fulfill its mission unless it could be placed in the hands of all who needed it. The large size of the complete work and consequently its cost, made it impossible for many to secure it. To remedy this condition, after consideration, it was decided to make a careful selection of plates from the complete work and publish them as a Students' Edition. While this would not take the place of the complete work it would, however, place before the student, the draftsman and the young architect a source of inspiration that otherwise he would not have.

"With these ideas in mind the Students' Edition was conceived and the selection of plates was left in the hands of the Editor of the larger work, Prof. William Rotch Ware . . . ."

These one hundred plates, mostly of measured drawings, constitute an excellent working library of a certain style of architecture popularly known as "Colonial" and recently acclaimed as "American" or "Early American". None of these titles is accurate. With this edition is included an interesting paper, originally a thesis written by a Columbia graduate, Olof Cervin, which is a comprehensive survey of the building activities within the English Provinces of America during the 17th, 18th, and part of the 19th centuries.

The manner in which the best of our early builders modified the details of their former homes in the old country to suit the materials and needs of the new, is clearly indicated herein. There is a country-wide, apparently insatiable, demand for homes of this type; and since many of these are pitifully crude in both mass and detail, the publication of such a portfolio is timely and welcome. It is devoutly to be hoped that wide circulation and careful study of these refined and charming details will bring about a truer interpretation of the Georgian-Colonial-American house.

\*The Students' Edition of the Georgian Period, U.P.C. Book Company, New York City.

**SPECIAL OFFER**

THE BUILDING REVIEW, .....1923  
 50 MAIN STREET  
 SAN FRANCISCO, CALIFORNIA  
 Gentlemen:

Please send me the BUILDING REVIEW for one year commencing with the .....1923 number. This includes the special \$1.00 February School Issue and two recent copies covering:

- .....Domestic Buildings
- .....Public Buildings

I am enclosing \$2.50 (Foreign \$3.00) in full payment for the above.

Name.....Address.....

Profession.....City and State.....



# What is FLOATINE



Floatine is the perfect roof asphalt. It will not soften, run, leak or slide despite weather conditions or steepness of roof.

Free yourself from roof troubles. Specify Pabco Ten or Twenty Year Roofs, which require the use of Floatine and produce the most satisfactory roofs.

**THE PARAFFINE COMPANIES, Inc.**

SEATTLE

PORTLAND

SAN FRANCISCO

LOS ANGELES

*A \$12,000,000.00 corporation operating  
16 plants on the Coast*

**SPECIFY PABCO 10 and 20 YEAR ROOFS**

# *The* BUILDING REVIEW

VOL. XXIII

SAN FRANCISCO, MARCH, 1923

No. 3



RESIDENCE IN LAKESHORE HIGHLANDS,  
OAKLAND, CALIFORNIA.

REED AND CORLETT, ARCHITECTS.

## A Spanish-Colonial Bungalow Electrified

*By* CLARA FASSETT

(The second of a series on small Western homes)

Many people, while averse to building houses, regard with envious admiration owners of homes, and plan in a rather indefinite way to sometime acquire one for themselves; a dwelling-place whose atmosphere and surroundings express their taste and preference, pleasing to the eye, comfortable, and which shall provide a gathering place for the family. But they dread the process of building, of trying to incorporate a vague idea into

concrete form. The expense, always somewhat greater than planned for, deters many from realizing this ideal; while finding and being able to buy something approaching their standard in the location they have chosen to live, which someone else has built to suit his own needs, is not likely to happen often. Consequently our cities and suburbs have become crowded with houses, flats and apartments, rows of "standardized" buildings

into which we flock because we must live somewhere.

In the days of cave-dwellers, our ancestors found a nice, ready made cave, and straight-way took possession. Now-a-days a speculative house-builder erects, flats, apartments or detached bungalows, and says to us, "Here is a cave for you, not perhaps in every way your ideal, but since you won't or can't build, and you must have shelter, it will be necessary for you to take this dwelling-place we have provided."

But our requirements are increasing, our taste is improving; we are not at all happy in our cramped and ill-lighted cave. And one day we will sit down and survey our sheaf of rent-receipts and ask ourselves if we cannot do better than to toil to help support our landlord getting for ourselves such meager returns in comfort and satisfaction. And we can do better. The next thing to building a house for yourself is to have it built ready for you. It is quite possible to buy a house of individual design, of maximum convenience and minimum expense, finished, equipped and ready to move into, in an exclusive residential district, improved and restricted. This way of acquiring a home has been made possible by the better class of building firms, who in dealing with a somewhat discriminating class of purchasers have established high standards in design and construction.

A type of architecture for which Cali-

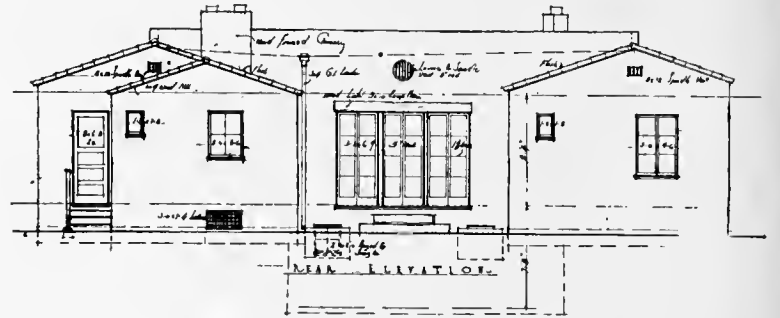
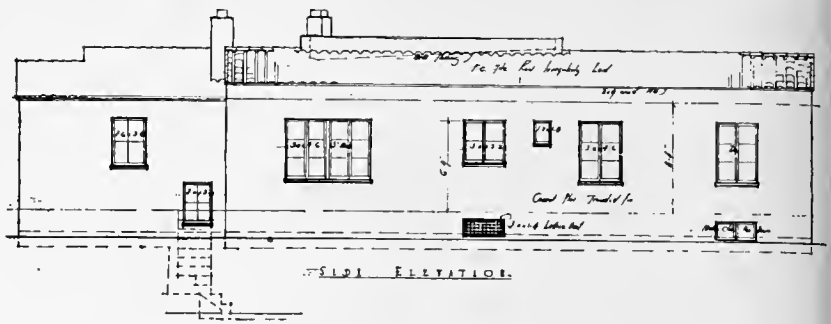
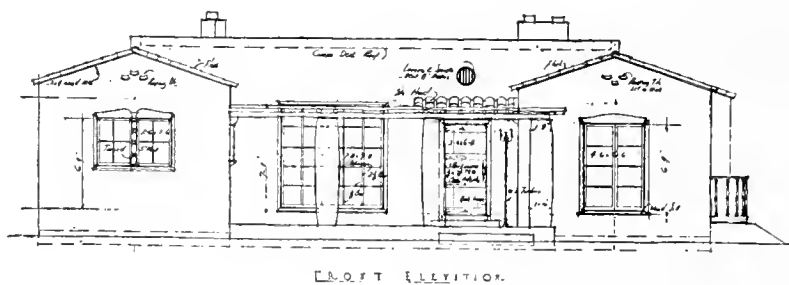
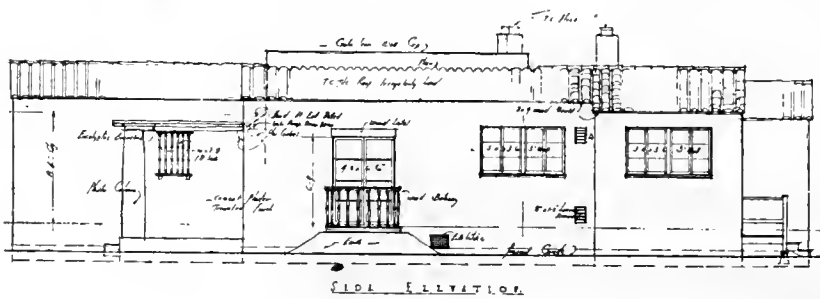

fornia has been held responsible, in the minds of many people the only style distinctively Californian, is that of the early Missions. But by far the more pleasing and livable and altogether more home-like is the style known as Spanish Colonial. Based on their homes in Old Spain, those early settlers evolved a type of house in which were traces of Mexican simplicity, Spanish formality, and, of course, features native to location which included landscape settings and material of which they were builded. Instead of adobe, native to Southern California, now tinted plaster is used with great effectiveness, relieving the severity of design. Combining with the greenery and colorful gardens, these tints react most pleasantly to the vision, appealing to our fundamental delight in joyful color.

Just fancy a California Colonist observing the charming little house described, of orange-terra cotta stucco, with its entrance terrace of concrete "flagstones", roof of rustic beams supported by heavy pillars; he would appreciate the design of the wooden grill of Spanish type which screens a bedroom window looking out upon the terrace. Imagine his amazement as he steps inside to view the most modern of interiors, and is introduced to the "genie of the button", that most up-to-date housemaid; for this is an electrical house. With all of the charming features, exteriorly of a period when time was not a factor in the day's work, when living was simple and leisurely, this house represents

## THE BUILDING REVIEW

the last word in modern labor-saving devices. It is equipped with every sort of electrical appliance designed to lighten the toil of house-work. The builders have not overlooked the fact that whatever style or period is represented in a house, whether humble or pretentious, plain or elaborate, there is one point on which all housewives are insistent, that it shall be planned to minimize labor. Electrical conveniences provide for a comfortable home, and a comfortable home is usually a happy one. Wall heaters are installed in all the rooms and labor-saving equipment such as toasters, percolator and ironer, silver buffer in the kitchen; an electric sewing-machine, phonograph, and piano are provided for. Appliances are installed in the bedrooms to attach curling-iron, hair-dryer and a milk-bottle heater.

Designed by Reed & Corlett of Oakland, the house is pleasing as well as convenient in its layout. The large living room is the central point of interest and is provided with French doors and full length windows on opposite sides. A hooded fireplace of artificial stone is built across a corner; built-in bookcases flanking the full length south window, the space between providing a sunny nook in which to lounge and read, is an attractive feature.

The dining room to the right opens out to a garden through French doors. The kitchen contains a breakfast-nook, and is related conveniently to laundry and maid's

room. The two bedrooms to the left with connecting bath are entirely separate from the service quarters, and are light and airy, each having a double exposure.

Ample lawn space and room for a tiny garden in the rear add to the appeal of this delightful little house. One hopes that a wisteria will be allowed to drape itself over the pergola, as the pinky-orange plaster needs just this touch of complementary color to perfect the picture of a dwelling of Colonial days brought up-to-date.

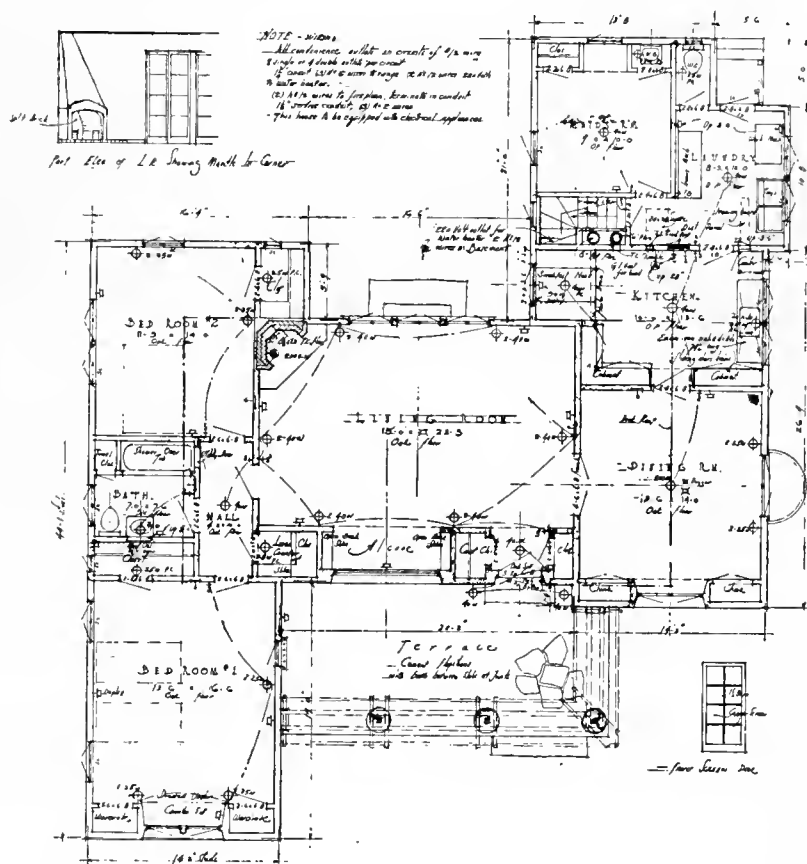



DIENER'S GLADIOLUS

## The Rainbow Garden.

By ELLEN S. COLLIER

Color, sunshine, summertime! That's the undercurrent in every one's mind now the season of flowers is drawing near. Many of us are putting the thought into action. Even if we have only a few feet of ground we can plan some striking, satisfying color combination altogether different from last

year's garden. Be thankful for the background of dark cypress, or conifers, the stationary shrubbery with which your house was graced in building, but let the eternal, experimental child in you rejoice that annuals can make a gay new foreground to your picture.

If you want to satisfy the eye's demand for symmetry and the heart's plea for color you may try this year gladiolus with a bedding of petunia. Perhaps you never thought of the combination. But it's more probable that you've not spent many seasons on the Bay without hearing of Richard Diener, the foremost gladiolus and petunia producer in the world. At your very door in his laboratory, at Kentfield, Marin County. It is an immense garden where from June to September some four hundred varieties of Diener's own gladioli flaunt their shimmering spikes under the purple shadow of Tamalpais.



DIENER HOUSE,  
KENTFIELD, CALIFORNIA.

Everyone knows the common salmon-



colored gladiolus and some of us remember the little old fashioned petunia. Mr. Diener's gladiolus and petunia are different matters. Even before its success at the Exposition in 1915, his gladiolus had taken the red-orange-yellow half of the rainbow and shaken it into four hundred fragments, while his petunia has the rainbow fringe, blue-violet-red, throttled, fainting, helpless. Don't forget there's a lot of pure and creamy white among gladioli and petunias alike. The size and texture of both flowers is just a little bigger and finer than before Mr. Diener took them in hand. Now gladioli run from four to seven feet in height, and the petunias, for all they're called "Ruffled Monster" are quaint and more velvety than their Victorian ancestors. Tall gladioli, dwarf petunias, you see why we suggest them for this summer's garden. The garden of today has no tall flowers without a bedding plant to hide the ground and lower stalks. Exhilarating spikes of gladiolus above and full flowered, soft cheeked petunias below—it's new, prismatic, and you'll agree when yours are in bloom—thoroughly artistic.

Mr. Diener says you can't indicate color combinations to the garden lover nowadays. Each has his—or her—original and determined ideas about color. Just turn these enthusiasts loose in the Richard Diener catalogue. There are sixteen varieties of petunia seed listed: apple blossom pink, lilac and orchid shades, black centered red, blue, purple and white are some of the colors. Certain petunias have strongly veined centers. Others are marked by their frilled edges. "Diener's Pink Glory" is a rose pink without a trace of purple, which grows compactly and since it is continually covered



RUFFLED PETUNIAS.

with flowers has a great future as a bedding plant.

The choice among gladioli is so wide that it is baffling "Diener's American Beauty" has the color indicated by its name, with the added charm of a creamy throat. Ashes of roses, salmon and shell pink, crimson scarlet, turkey red in the brighter shades, canary yellow, sulphur yellow, magenta, maroon and white in quieter tones hint that gardeners could go gladiolus mad and not bore you with monotony. The blending, striping, shading of the gladiolus flowers makes their unfolding a time of breathless interest. Both the gladiolus and petunias are better adapted for cutting than people generally realize, and are a shaft of light in the shaded rooms of summertime.

The secret that will guide a choice of species in our case is that our gladioli and petunia must harmonize. Mr. Diener sketched for us such combinations as lilac petunia with crimson gladiolus, deep pink gladiolus with pale pink petunia, or the "Geraldine Farrar" gladiolus, which is a clear sky blue, with blue and lavender petunias. White should be used sparingly as it gives a blotchy effect. We don't need to elaborate on color harmonies, as to be a modern gardener is to be a person with color imagination.

Right now in the month of April is the time to plant the petunia seeds and gladiolus bulbs. During the last two weeks in April and the first week in May you can set out such a bed as we have suggested. So tear yourself loose from climbing sweet peas, hollyhock, pansies and forget-me-nots, just this one season and be a little reckless. Startle yourself, and your friends, with the glory you can add to the color and sunshine of summertime.



JUNE ROSES.

## EDITORIAL

England is a land of respect for tradition. There the dignity and power of time-honored precedent has been maintained for centuries; such changes as have come have been so gradual as to be almost imperceptible.

But the cataclysms of the last few years have also shaken the bulwarks of British business customs, and our brother architects in England have awakened to the fact that the dignity and safety of the profession is being endangered. Accordingly a bill has been drafted by a special committee of the Royal Institute of British Architects, which provides for the registration of and regulates the qualifications of architects in the tight little island.

This bill has teeth. It is not going to be healthy to violate its provisions. The preamble states: "It is expedient that persons requiring professional aid in architecture should be enabled to distinguish qualified from unqualified practitioners; architecture is of public importance, and it is in the public interest to prevent untrained and incompetent persons, styling themselves architects, from imposing upon the community to its material loss and detriment."

Partnership is prohibited between registered architects and persons not registered, excepting members of the Surveyors' or Civil Engineers' Institutes. False representations to secure registration, and wilful practice unregistered, calls forth a penalty of from fifty to one hundred pounds. Certificates given by unregistered persons are not valid, nor can they recover charges for services.

The Governing Council and the Advisory Board are composed almost entirely of architects chosen by the Institute and various allied societies, and its control of affairs is safeguarded by very definite provisions. It will be interesting to see if this bill becomes a law, and to observe its effect after being put into effectiveness.

In the rush of building activity that is upon the country, a word of caution is not amiss.

Architects must guard against letting stability of construction and proper study of design be endangered by pressure of business. It is with the profession as it is with a trade; when the lean years come, the man whose work stands up in all respects will get what jobs there are. And greater than the economic, selfish motive, we must never lose sight of the high standard of professional ethics, the obligation to protect the public, physically and aesthetically. If architecture lets down from that standard, it opens the door to all the evils of untrained competition which threaten its very life.

The owner, if he is wise, will be patient with delays, bound to be due from shortage of men and materials, and will assist the architect by giving more of his personal attention to the job, during construction, than is required in normal times.

And labor must not lose its head and kill the golden goose by unreasonable demands and inefficient service. Labor—including contractors and sub-contractors under that general head—is entitled to its fair share of prosperity and profit, for work done according to its contract. If labor, or material, shirk, and reduce quality and quantity of production, they will be responsible for an inevitable return to stagnation.

People who advise and caution are seldom popular. But prevention still remains better than cure.

---

Note—Unintentionally, in the February issue, several photographs of the Domestic Science Department in the Piedmont High School were shown, without credit being given to the architect. Mr. W. H. Weeks designed the building, which is a fine specimen of modern school architecture and has received much favorable comment.

*Morris Allen*

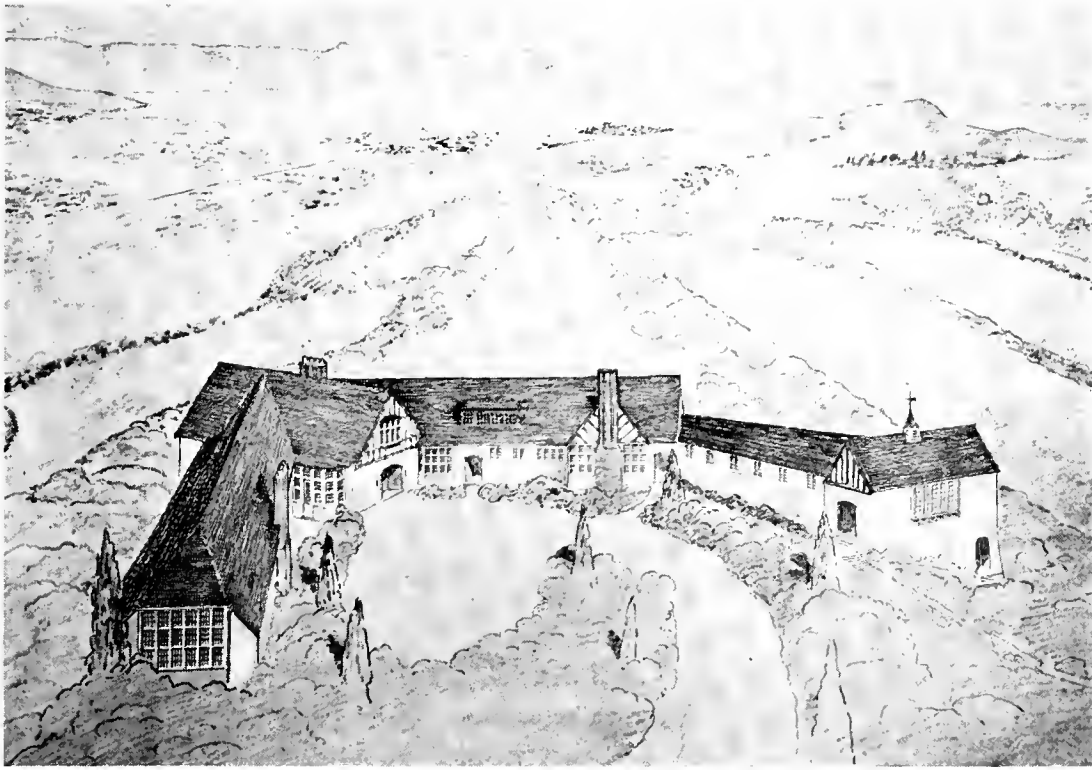

PERSPECTIVE SKETCH

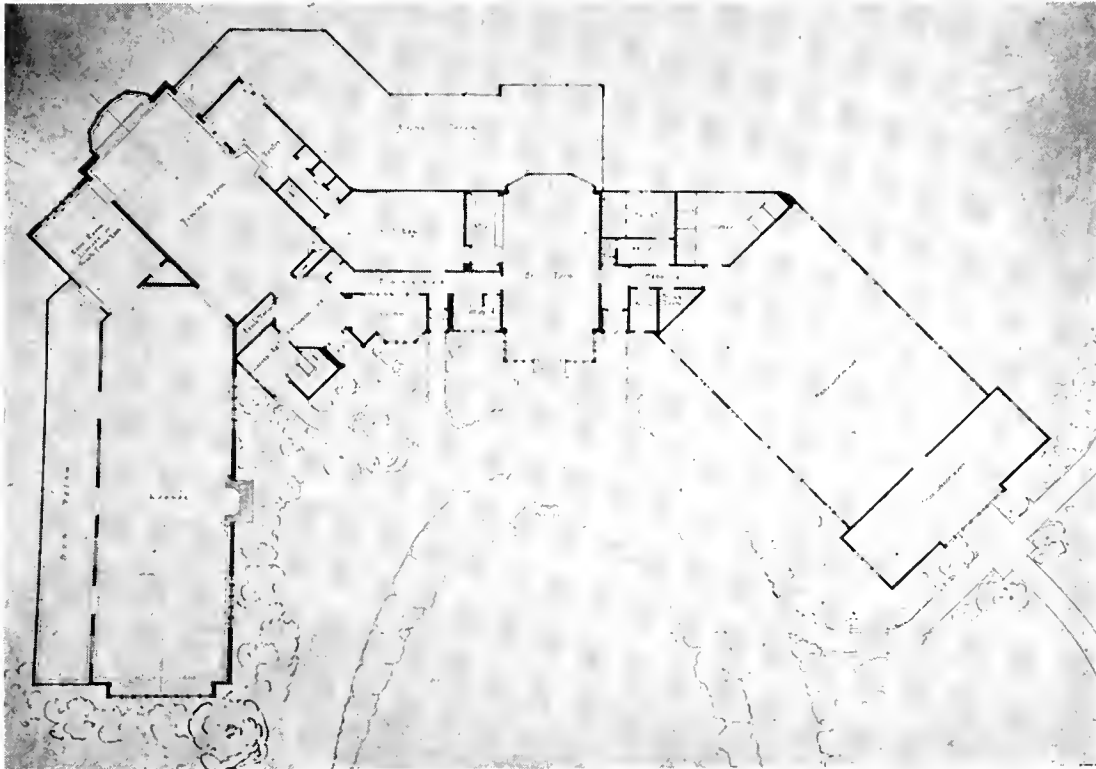

MAIN FLOOR PLAN

BERKELEY COUNTRY CLUB,  
BERKELEY, CALIFORNIA.  
WALTER J. RATCLIFF, Architect.



BERKELEY COUNTRY CLUB,  
BERKELEY, CALIFORNIA.  
WALTER J. RATCLIFF, Architect.



BERKELEY COUNTRY CLUB,  
BERKELEY, CALIFORNIA.  
WALTER J. RATCLIFF, Architect.



LOUNGING ROOM  
BERKELEY COUNTRY CLUB,  
BERKELEY, CALIFORNIA.  
WALTER J. RATCLIFF, Architect.



DINING ROOM  
BERKELEY COUNTRY CLUB,  
BERKELEY, CALIFORNIA.  
ALTER J. RATCLIFF, Architect.



RESIDENCE OF C. M. HARTLEY,  
VACAVILLE, CALIFORNIA.  
REED & CORLETT, Architects.





RESIDENCE OF C. M. HARTLEY,  
VACAVILLE, CALIFORNIA.  
REED & CORLETT, Architects.



GARAGE



RESIDENCE OF C. M. HARTLEY,  
VACAVILLE, CALIFORNIA.  
REED & CORLETT, Architects.



LIVING ROOM



RESIDENCE OF C. M. HARTLEY,  
SAN FRANCISCO, CALIFORNIA.  
WELLS & CORLETT, Architects.



DINING ROOM



MAIN HALL

RESIDENCE OF C. M. HART  
VACAVILLE, CALIFORNIA.  
REED & CORLETT, Architects



BEDROOM ALCOVE



BEDROOM

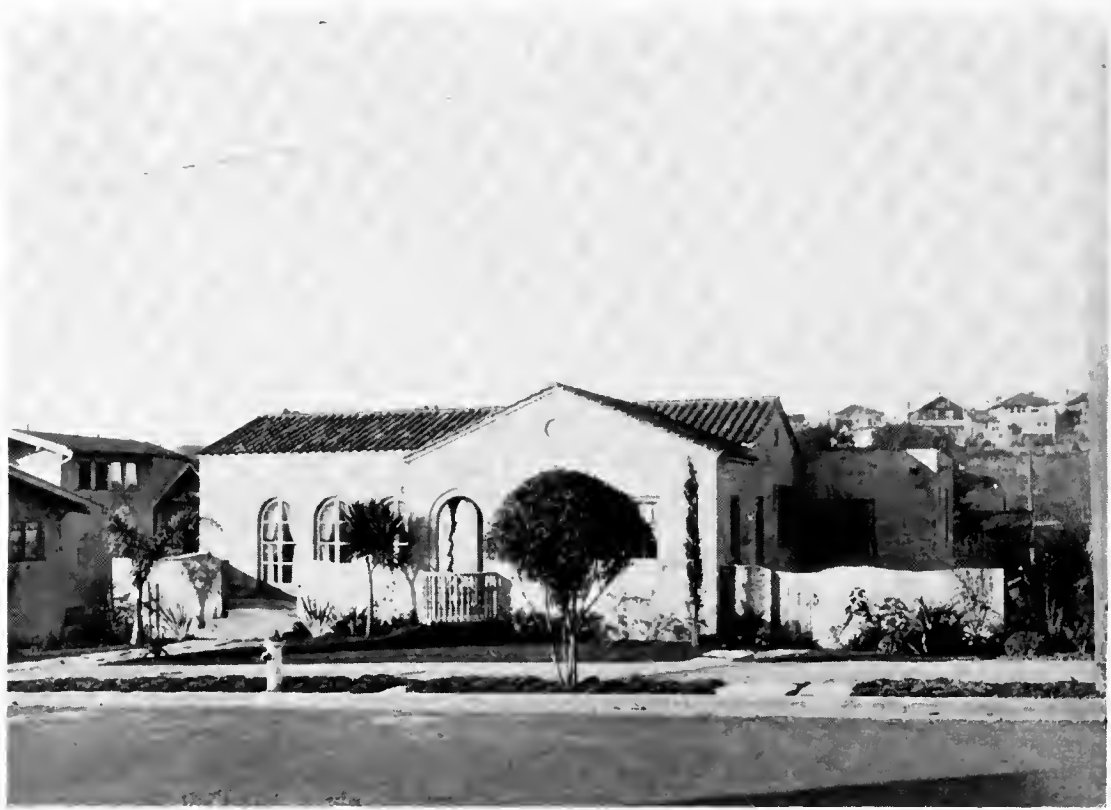

RESIDENCE OF CHAS. W. HEYER, JR.  
PIEDMONT, CALIFORNIA.  
REED & CORLETT, Architects.

# City Surveying—Its Problems and Importance

By A. MALKIN, *Civil Engineer,*  
Detroit, Michigan



HERE are two distinct phases in city surveying: The first is the original establishment of property lines and the second, the re-establishment of the original property lines.

In establishing the original property lines subdivision layouts are made which consist of the division of farm land into blocks accessible on all sides to streets or alleys. These streets and alleys are deeded to, and become the property of the municipality in which the subdivision is to be included. These blocks are further subdivided into smaller parcels each abutting on a street. The parcels are called lots and the dimensions of a lot measured along the street it abuts are termed its frontages.

The boundaries of blocks which are also the boundaries of the public streets and alleys are established by the placing of monuments at each and all of the breaks in the boundary line which is at the point of intersection of the two straight lines forming the break. The subdivision of the block into lots is done in a similar manner. The types of monuments used are of stone, iron and wood.

The most common type of monument used is the wood stake, one to two inches square and from eighteen to twenty-four inches long. In many instances round iron pipes from one to one and one-half inches in diameter are required to be used for locations of street corners or block boundary lines.

When the subdivision has been staked out a plat showing the dimensions and locations of principal monuments and sizes of lots together with the bearings of streets and alleys is filed with the proper authorities of the state, county and municipality in question. When approved, the layout goes on record and marks the completion of the first phase of city surveying.

The second phase begins where the first leaves off. In attempting to re-establish the original property lines, it is important to note that the controlling factor is the location of the original monuments witnessing the boundary lines regardless as to whether they agree with the dimensions of the recorded plat line.

To understand the principal problems confronting the engineer in this phase of survey-

ing, it is well to analyze the growth and development of a city. From a surveyor's viewpoint a city may be looked upon as the outgrowth of an original farm settlement formed along a highway which acts as its only or principal street. To this nucleus the continuous additions of subdivisions form its growth. While the city in its endless development has its corresponding variations in the care with which new subdivisions are incorporated, we can safely for our purpose divide it into two stages.

First, when the municipality is too small to supply the proper supervision for the purpose of examining and correcting the proposed new subdivisions; second, when the old more or less haphazardly built up city becomes sufficiently important to afford competent men to pass on its proposed additions (and in many large cities there is a city planning commission which arranges all proposed new subdivisions to facilitate the future expansion of the city).

During the first period of a city's growth, there is a very important factor which tends to upset if not nullify the work of the original layout of the various subdivisions. That factor is the relative cheapness of property when measured by the standard of foot frontage. This comparative lack of value causes laxity on the part of those who are the pioneers of the city. Very few, if any, of them would pay for the services of an engineer if he was at all to be conveniently procured.

In a number of non-monumented American cities, where all traces of original monuments of a subdivision are gone (and that is only a short time in the history of a city) there are two main sources by which the engineer is expected to read the past. The first is the public streets and alleys. The second, existing old buildings some of which date to the time when the original monuments must have been existent.

The boundaries of city streets may be determined from the curbs which separate the roadway from the sidewalks. This roadway is, whenever possible, located in the center of the street, leaving on either side equal widths for sidewalk purposes. When adjoining subdivisions do not provide for continuous straight streets and when the variations are

(Continued on Page 57)



W. L. HEMMINGA  
BUILDER AND OWNER.

A. QUANDT & SONS,  
PAINTERS AND DECORATORS.

## Hemway Terrace

*A New Addition to San Francisco's  
Housing Facilities*

A recent unit of San Francisco's building program to be completed is Hemway Terrace, located in the Western Addition adjoining the Park Panhandle and erected by W. L. Hemminga.

This tract represents an expenditure of over \$350,000 and was completed and all of the houses sold within a period of ten months.

Hemway Terrace is nearly a block in length and is free from car tracks and other traffic, making it an ideal play ground for the younger tenants.

At the entrance are two piers of colored brick decorated with panels of red, green and yellow tile. This is capped with white cement over which is a 500-watt ornamental light. The end of the street is closed with a high fence. At the base of the fence a garden plot extends the full width of the street. Here are planted a variety of climbing vines and trees.

The tract contains 16 houses in all, eight on each side of the street. Fourteen of them are two-family houses and two contain two nine-family apartments. One of the distinctive features of these houses is the fact that every room is an outside room, thereby insuring the occupants a full measure of air and sunshine.

Heat for the entire tract is supplied from two central distributing plants. These plants are located in the basements of the end houses at the entrance of the tract and are equipped with Ray Fuel Oil Burners.

The rapidity with which this tract was completed and the houses sold is a good indication of the rapid influx of people from other parts of the country in answer to the publicity broadcasted throughout the East by the many active Western Booster Associations.



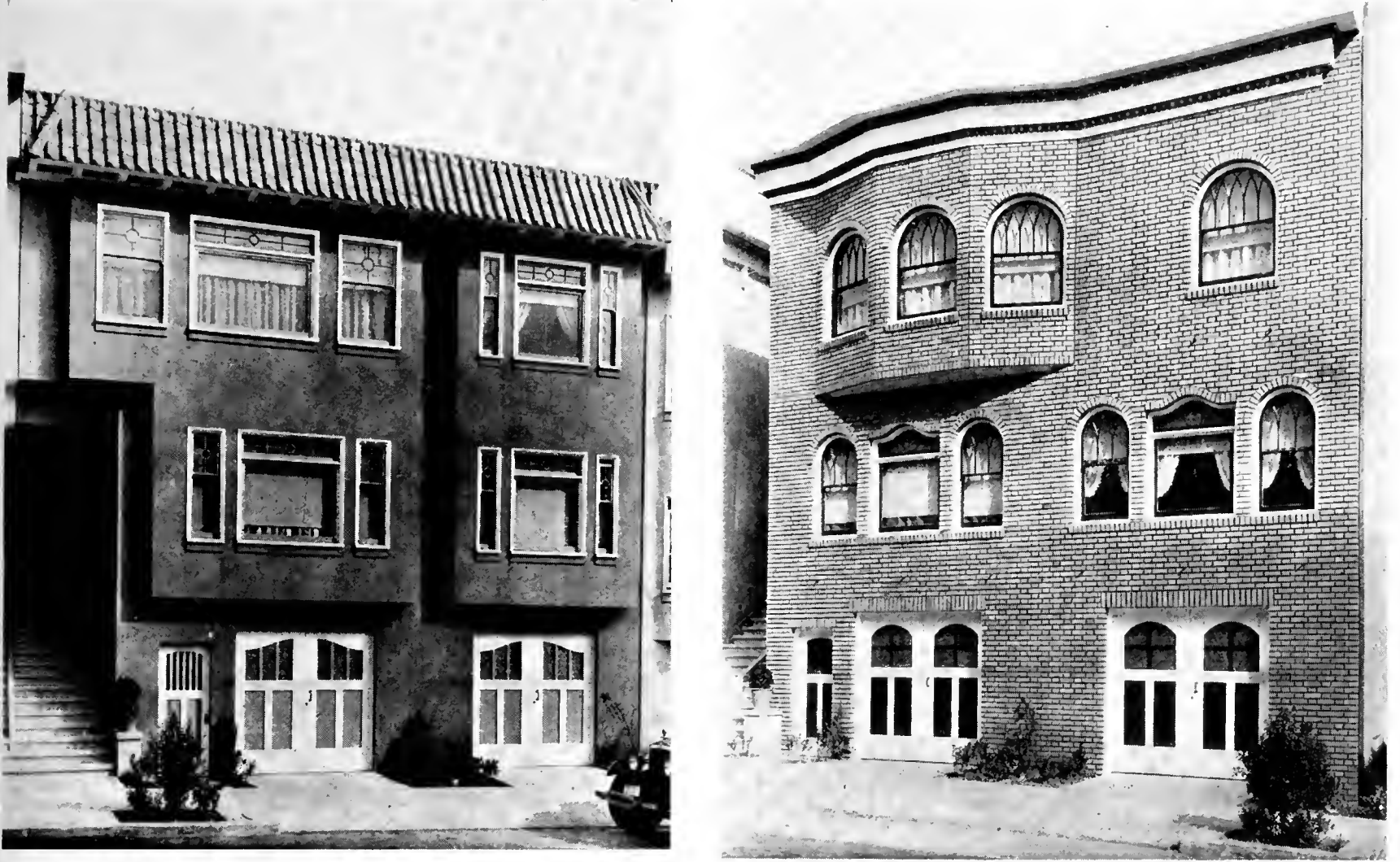

TYPICAL HOMES IN HEMWAY TERRACE, SAN FRANCISCO, CALIFORNIA.

# INDUSTRIAL DEVELOPMENT

## SAFE CONSTRUCTION OF BUILT-IN GARAGES EXPLAINED BY COMMERCE DEPARTMENT

"Motorists who keep their cars in built-in garages, or garages attached directly to the side of their dwellings do not run an undue fire risk if they follow certain elementary precautions," states Mr. Ira H. Woolson, chairman of the Building Code Committee of the Department of Commerce, and consulting engineer of the National Board of Fire Underwriters, in an interview just given out. "We covered the subject of built-in garages for one and two-family houses quite thoroughly in the Recommended Minimum Requirements for Small Dwelling Construction that have just been published by the Department of Commerce," states Mr. Woolson, "and gave directions for constructing them safely, that can be followed by any competent builder.

"If a built-in garage is not properly constructed, it is a menace to life and property. Our investigations showed that if a fire does start in a single or two-car garage, it is not likely to be more severe than would be withstood by the construction classed as affording one hour fire resistance by the Bureau of Standards of the Commerce Department, the Fire Underwriters Laboratories, and other authorities. It follows that with an incombustible floor, and the garage separated from the rest of the building by unpierced partitions and ceiling that will meet the one hour fire test, there is no unreasonable fire hazard. Of course, the outside walls must be fire resistant too, and so must outside windows and the garage doors, in order to prevent flames from breaking out and spreading fire through windows, or to exterior wood work above. The code does permit, under stringent safeguards, a single swinging, self-closing fire door leading from the garage directly into the house, but we strongly advise that there shall be no opening whatever between the two. It is much safer to enter the garage from the outside."

For the sake of motorists and builders who desire complete directions, Mr. Woolson has

prepared below a statement, giving the six rules from the code, together with the directions for carrying them out, as given in the appendix, with a few changes to simplify the wording, which was a little more technical in the original in order to make the rules more practical to enforce. The rules are here arranged by Mr. Woolson "from the ground up" starting with floor construction, walls and partitions, then outside doors and windows, and dealing finally with the permissible case of a door directly between the garage and the dwelling.

Rule 1—Garage floors shall be of concrete or equally fire resistive and impervious material.

For convenience in cleaning and to prevent dangerous accumulations of water, oil or grease, all parts of the floor should drain naturally.

Rule 2—Walls and partitions shall be built to meet the requirements of the standard one hour fire test (mentioned above).

Many materials are acceptable under this rule, such as brick, hollow tile, concrete block, or gypsum block four inches thick, or reinforced concrete three inches thick. As a minimum requirement, walls may also be constructed of wooden studs spaced 16 inches center to center, with metal lath attached outside and inside. The outer lath is to be plastered and back-plastered with Portland cement stucco, and the inner lath plastered with three-quarter inch Portland cement or gypsum plaster. For interior partitions separating the garage from the rest of the dwelling, three-quarter inch Portland cement or gypsum plaster on metal lath, on both sides of studs spaced 16 inches apart, is satisfactory. The specifications for metal lath and plaster to be used are given fully in the Code Committee's Report.

Rule 3—The combined floor and ceiling construction directly above the garage shall be unpierced, and shall have a fire resistance of one hour. The same rule applies to the

(Continued on Page xvi)

## CITY SURVEYING---ITS PROBLEMS AND IMPORTANCE

(Continued from Page 53)

small, the city lays its curbs so that the roadway is kept straight, leaving unequal distances between curbs and street boundary lines. Thus any reference that might have been of some use in locating the block boundary lines from curbs is destroyed. The location of existing old time buildings would have been a proper key to the situation were it not for the carelessness of the pioneer city builders in whose interest the law of adverse possession is in force.

In addition to the above two causes which contribute to the complications of re-establishing boundary lines there has been a third and most essential condition which unfortunately reflects also upon the original surveyor of the subdivision. Up to very recently and even now in only a few states surveyors are required to be registered by the state which tests their ability before unloading them upon the public. In the past, therefore, there were two grades of men in practice: the intelligent and reliable practitioner who would not render his services unless the compensation enabled him to give it the necessary care and employ the proper help. However, the demand of real estate operators for lower charges who did not grasp the importance of a correct layout as a duty to the future property owner and the city as a whole caused some men unfit by their education and experience to enter the field of surveying. In many instances while the principal of a firm of engineers was a man of proper training and experience he was forced to employ an organization below his standard due to the low compensation received.

These inaccurate surveys did much towards the creation of what is now termed discrepancies which are shortages and surpluses according to the actual measurements in the field as compared with the dimensions of the original recorded plats.

As an illustration of the above we have recently been called upon to survey seven adjacent lots which form a part of an old subdivision in the outskirts of the city. On record were two survey plats made subsequent to the original layout of the subdivision. These plats did not agree with each other nor with the original and all three had practically no relation to the actual measurements in the field. Upon investigating the

situation we found that the ground was first staked out in accordance with a proposed layout which was subsequently changed before it was placed on record. A second staking out was made in accordance with a new layout which was duly recorded. However, the owner of the subdivision refused to pay for the removal of old stakes relating to the first survey so that at the present time there are two sets of stakes causing confusion in determining the property lines.

It can readily be seen that when the city lays its streets according to this cross information and when this section is built up and all possible reference to old stakes destroyed, it will require a superman to determine the boundaries of the property and yet there seems to be no attempt to correct the description in the various abstracts of title to the property at a time when there is yet a possibility of straightening the matter out.

Another instance where a shortage of seven inches in a block caused a great deal of trouble including court action and financial loss to the builder was brought to us for final certification.

According to the description in the abstract covering this property, a set of plans were drawn by an architect for an important apartment building which was duly approved by the city authorities. The property in question is located on a corner so that the foundation was laid out in relation to the two streets and the rear alley. When the footings were completed an injunction was granted the adjacent property owner restraining the builder from encroaching on his property. A survey was made and it was found that there is a shortage in the block and in view of the fact that all existing buildings and fences indicate that the lots were all measured from the other side of the block, this corner property owner was forced to take what was left between the last property line and the street line.

In the above case if the abstract during its various examinations of title would have had its description of property corrected and certified to by an engineer it is probable that the shortage might have been traced and recorded as belonging to some other lot. In any event, the present owner would have known exactly what he was buying, paying only for the actual frontage instead of an imaginary one, and would have finally been spared a great

(Continued on Page xii)

SAN FRANCISCO CHAPTER AMERICAN INSTITUTE OF ARCHITECTS  
MONTHLY BULLETIN

**OFFICERS**

Geo. W. Kelham, President.  
Henry H. Meyers, Vice-President.  
J. S. Fairweather, Secretary-Treasurer.



**DIRECTORS**

William Mooser, three years.  
J. H. Blohme, three years.  
A. J. Evers, two years.  
Harris Allen, two years.  
S. Schnaittacher, one year.  
Morris M. Bruce, one year.

**NEXT MEETING**

The next meeting will be held Thursday evening, March 15th, 1923, at the Architectural Club Rooms, 77 O'Farrell Street, at 6:30 p. m., and will be preceded by a Directors Meeting at 5:30 p. m.

**MINUTES**

The Directors and regular meeting of the San Francisco Chapter of the A.I.A. was held Thursday evening, February 15th, in the Architectural Club Rooms, 77 O'Farrell Street. The meeting was called to order by President Geo. W. Kelham. The following members were present: Harris Allen, S. Schnaittacher, Morris M. Bruce, H. E. Burnett, Geo. W. Kelham, E. B. Hurt, J. S. Fairweather.

**OLD BUSINESS**

On account of the National Body of the A.I.A. publishing a circular of advice, it was resolved that our Chapter await this document before further action.

**NEW MEMBERS**

The following being duly advertised were elected to membership in the San Francisco Chapter, A.I.A.: Wm. M. Bliss, O. R. Thayer and G. F. Ashley.

**DELINQUENTS**

The Treasurer reported the members delinquent as of February 15th, 1923. Each has received statements of account during the current year, and a personal letter from the Treasurer.

RESOLVED, that those delinquent for more than two years be given until May 15th, 1923, to make payments in whole, or in part, or to reach some agreement with the Treasurer as to future payment. Otherwise, the membership of each delinquent coming under his resolution shall be terminated on May 15th, 1923, upon notice to him from the Secretary to that effect.

**CLUB ROOMS**

The Secretary was authorized to write to the Directors of the San Francisco Architectural Club and invite them to meet with us at our next meeting.

**JUNIORS**

The Secretary was instructed to write E. C. Kemper in regard to the standing of Juniors in the Chapters.

**CONVENTION AT WASHINGTON, D. C.**

To the Members of the San Francisco, Chapter, A.I.A.:

In accordance with the by-laws delegates must now be chosen to represent the San Francisco Chapter at the next Institute Convention to be held at Washington May 16-17-18, 1923.

Delegates attending the convention will receive partial reimbursement for their traveling expenses as has been customary during the last few years.

San Francisco delegates reduced from nine to six.

Can and will you attend the convention, if elected as a delegate?

Please notify me by return mail as per enclosed postal card.

Very truly yours,  
J. S. FAIRWEATHER,  
Secretary.

Mr. C. Howard Walker, of Boston, lecturer on Architecture at Harvard and the Boston Institute of Technology, gave a lecture on "Appreciation of Art and Its Importance in Education," at Mark Hopkins Institute, California and Mason Streets, Wednesday, February 14th, 1923, at 8:15 p. m. The speaker was introduced by Mr. Arthur Brown.

Inspired by the remarks of Mr. C. Howard Walker the Directors hope that each architect procure the Institute's Book, "Significance of the Fine Arts", which can be had from M. J. Hetherington, 46 Kearny Street.

This book, as you know, has been sponsored by the Institute and prepared under the direction of one of its committees. It is intended to awaken the interest of the laymen and student to the true importance of art in our daily life. The art impulse exists in America today. To insure its development into a worthy expression appreciation of art in all its phases by our people is essential. Art in general, and the art of architecture in particular, is the first and lasting flower of every civilization. The "Significance of the Fine Arts," in 500 pages, with many illustrations, simply and concisely tells the great story of man's effort at self-expression in the arts through the ages. It will interest the general reader and should, therefore, be in every public library. It will be of service to all groups or societies who are taking an interest in the physical or aesthetic development of their community. The book can also be the basis of a course in art appreciation in college or high school, to which end it should be recognized by the department of public instruction of the several states.

The book is divided into ten chapters. These, with their authors, are as follows:

Part I.—Classic Architecture, C. Howard Walker; Mediaeval Architecture, Ralph Adams Cram; Renaissance Architecture, H. Van Buren Magonigle; Modern Architecture, Paul P. Cret.

Part II.—Painting, Bryson Burroughs; Sculpture, Lorado Taft; Industrial Arts, Huger Elliott; Landscape Design, Frederick Law Olmsted; City Planning, Edward H. Bennett; Music, Thomas Whitney Surette.

The distinguished writers of these papers have contributed them with a lively realization of the great service which the book may render. Their compensation has been but trifling. Their real reward, therefore, will lie in the book's success. We hope that all members will aid in bringing this about. The success of the book means that it must find its way into the hands of all who think.

As members of the American Institute of Architects you are requested to do your part in making the book a success by giving it the widest possible publicity.

If it's  
*quality*  
you want



TRADE MARK REGISTERED

*Specify*

**PACIFIC**  
PLUMBING FIXTURES

## CITY SURVEYING

(Continued from Page 57)

deal of inconvenience and loss of time and money.

In a recent survey of an important business frontage in a small town near Detroit, we found the block to be two feet longer than the total recorded frontage for that block. In this instance, it was an interior lot, one side of which was bounded by a building whose frontage measured the total recorded frontage to the corner while on the other side the lot line was clearly determined by an old brick building located on the lot in question. It was evident that the building on the lot in question was laid out in relation to one end of the block whereas the other building assumed the other corner as correct, leaving a surplus of two feet which no one can legally claim but may be occupied and used by the owner of the vacant lot in question, without interference by adjoining property owners because they have no ground for court action. In this case the owner is the gainer but whether gaining or losing the fact that the description in the abstract is not reliable depreciates from the value of the abstract.

Another view of the importance of a survey is the general information furnished by a surveyor as, for example, the proposed condemnation of property. Recently, in two similar cases in different parts of the city the lack of information of the proposed condemnation for the purpose of street widening caused great financial loss to the builders concerned. In both cases plans were drawn for an ordinary store and apartment building where the certainty of its approval by the building department of the city caused the builders to complete basements for the structures prior to obtaining a building permit.

In the city of Detroit in cases where the condemnation of property is only in its proposed stage and carries no certainty of its being approved, the building department will issue a permit for the erection of a building upon the property at the risk of the builder.

The builders in both of these cases found it too risky to proceed according to original plans so that whatever could be salvaged of the material in the basement walls was used for the new structures built according to new plans assuming the proposed future front property lines.

It is a fact that so far in the examination of abstracts at the time of transfer of title no attempt has been made to bring the descrip-

tion of the subject property to date simultaneously with its legal ownership.

Even if there were no new buildings erected on the property since its last transfer a survey would show whether the adjacent property owners did not encroach on the property in question which would require legal action to cause their removal.

It is gratifying to note, however, that a number of our financial institutions and all the way down to the smallest property owners and builders are beginning to realize the importance of establishing the accurate boundaries of their properties. The cost of the service is usually so very low as compared with the safety and peace of mind it affords that it leaves practically no case where it might or should be dispensed with.

The present practice of requiring surveys of vacant property in the case of loans on new structures and further surveys showing the location of buildings in relation to property lines for both new and old structures on which mortgages are issued is well expressed by Mr. N. M. Gross, Vice President of the Federal Bond & Mortgage Company, one of the foremost first mortgage houses in the state of Michigan:

"We consider the survey of a piece of property one of the most important essentials in the safeguarding of our mortgages; in fact, we require two surveys under each loan we make. The first survey is of the real estate itself—the second survey shows the building within the lot lines. We have always adhered strictly to this policy."

In a reply to our request, Mr. J. L. Hirschman, associate to Mr. Albert Kahn, prominent architect and engineer of Detroit, writes:

"Referring to your request from us for an expression as to the necessity of a survey in connection with building construction work. Such an inquiry is merely putting in other words whether it is necessary to know accurately the location and the size together with the levels of a piece of property in order to plan a building to be erected on the same. We believe the condition speaks for itself."

The H. G. Christman & Company, prominent Detroit builders of wide experience, has this to say:

"In our opinion a survey is a cheap form of insurance against damages which may arise from improper location of a structure. In several cases where we have had contracts to add to existing buildings, we have found the existing buildings to be encroaching on adjacent property. Such conditions if not prop-

(Concluded on Page xv)

## Greater Income From Better Windows

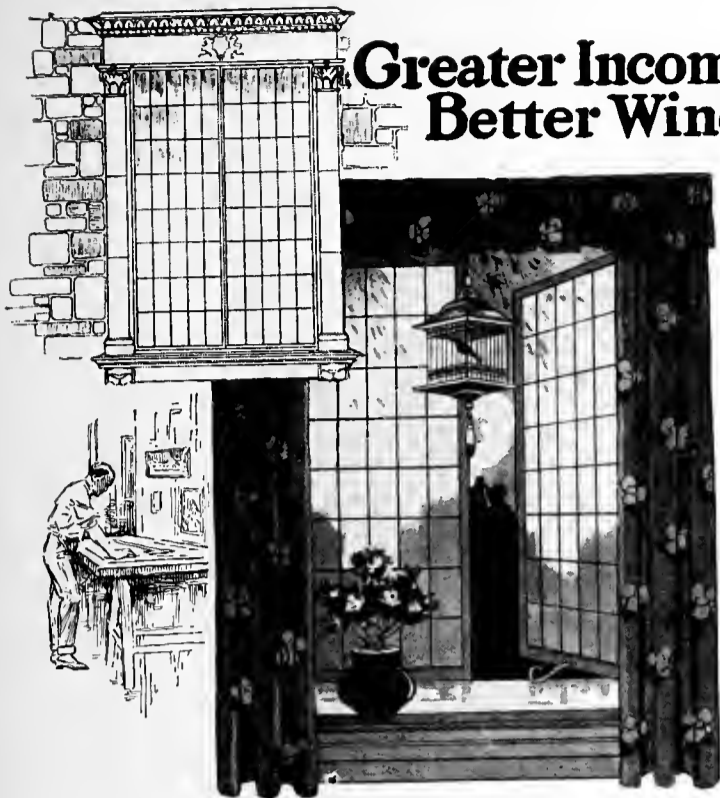

IN great cities, where huge apartment houses crowd in upon each other, sunshine and air are precious, oldest yet most modern of conveniences which make apartments worth more.

Window area, at one time but a tiny percentage of floor area, has been increasing as civilization has progressed. It is still increasing. Perfection of heating systems allows for still greater expanse of window glass; public health and opinion demand it.

Why not?

The more window glass the more reason for specifying the make and grade. The greatest beauty, strength and clearness is assured if you specify the American Window Glass Company's products.

We maintain the highest grading standards under double inspection methods and then mark every box for your guidance and assurance of quality.

American Window Glass grades higher than other window glass having the same grade markings. Specify the best, it costs no more.

# AMERICAN WINDOW GLASS CO.

GENERAL OFFICES: PITTSBURGH, PA.

BRANCHES IN PRINCIPAL CITIES

862 Mission Street, San Francisco, Calif.

## CITY SURVEYING

(Concluded from Page XII)

erly safeguarded against, may be the cause of considerable financial loss to the contractor."

Mr. F. J. Beyer, Assistant Cashier in charge of real estate mortgage loans of the Bank of Detroit, expressing the policy of the bank on the question of the importance of surveys to the mortgages, clearly emphasizes the most important point:

"The Bank of Detroit is not satisfied merely with having the abstract of title brought down to date in connection with safeguarding its mortgage loans. While the abstract gives assurance as to the correct legal ownership, it does not vouch in any manner for the description of the subject matter covered by the abstract. Too often the piece of property itself, which is the security of the loan, is found, upon having it surveyed, to be materially different from what is called

for and described in the abstract of title. Consequently, we have learned by experience to rely not only upon the abstract of title to give us our legal protection but equally as important upon a competent survey of its subject matter to give us our corporeal rights."

The Union Trust Company, through its Vice-President and Real Estate Officer, Mr. B. H. Manning, in charge of the real estate and mortgage departments which handles a great volume of loans on behalf of a prominent eastern insurance company sums up the situation in this very clear manner:

"The survey furnishes a means of accurately checking the description in the mortgage or other conveyance; gives assurance that the buildings appraised are actually situated upon the property covered by the mortgage; and in addition shows whether or not existing building restrictions and the building code have been violated. We have found it not only highly advisable but almost essential to insist upon a survey in connection with mortgage loans."

### SAFE CONSTRUCTION OF GARAGES

(Continued from Page 56)

roof when the garage is attached to the side of the dwelling.

Ceilings or roofs or reinforced concrete, or some other type of incombustible construction that meets the fire test, are best and most reliable. In the case of true built-in garages, a good, inexpensive overhead construction is as follows:

Ordinary 2 inch or thicker floor joists may be used, spaced not more than 16 inches center to center, and properly bridged. The ceiling should be of heavy metal lath weighing not less than three pounds per square yard, and Portland cement or gypsum plaster not less than three-quarter inch thick. The metal lath is to be attached to the joists by sixpenny nails driven nearly home and the heads turned over against the lath, and is to be bent down six inches along the walls on all sides and securely attached to them. The flooring above the ceiling is to be double, or seven-eighth inch rough and finished floor boards, with a layer of asbestos or other high grade floor felt between.

Rule 4—When a garage is located beneath a dwelling, all outside doors and windows with their frames and sash shall be of standard fireproof construction, and glazed with wired glass.

Only products approved by competent authorities should be used. A large variety of fire doors and windows have been tested and approved by the Underwriters' Laboratories, and are a standard commodity in the building material market. It is important that such devices should be installed in metal frames, and that the same hardware be used as that with which they were equipped when tested. If not, they may fail during a fire. Fire doors are made in both swinging and sliding types, and many of the former are as artistic as wooden doors. Wired glass glazing is required in all outside windows and doors to prevent flames from a fire in the garage from breaking through and endangering the structure or windows above.

Rule 5—Openings from a dwelling into a garage shall be restricted to a single doorway. This opening shall be protected by a standard swinging, self-closing fire door, with approved fire resistive frame and hardware. No glass shall be permitted in such a door.

A self-closing fire door is one that normally swings shut by a mechanical device. A swinging door is required because

it fits closely into its frame, and thereby prevents passage of heat and smoke when attacked by fire. Wired glass is not allowed in this door because it is liable to soften and sag from its fastenings at a temperature of about 1600 degrees Fahrenheit, which is a heat easily produced by burning gasoline or oil. But, as stated above, it is better to have no opening in any of the partitions.

Rule 6—When a doorway connects directly with a cellar or basement on the same or lower level in which there is any heating device or gas fixture, the door sill shall be raised at least one foot above the garage floor level, or the doorway shall lead into a vestibule which connects with the cellar or basement by a second door.

This is to prevent fumes from gasoline which may leak or be spilled upon the floor from reaching a furnace fire or gas light that might be located in any lower portion of the building. It is well known that gasoline vapors are heavier than air, and will accumulate on a floor like water, and flow to any lower level, and if they come in contact with fire of any kind—even a spark—will ignite and flash back to the starting point, and cause an explosion. Hence the high door sill.

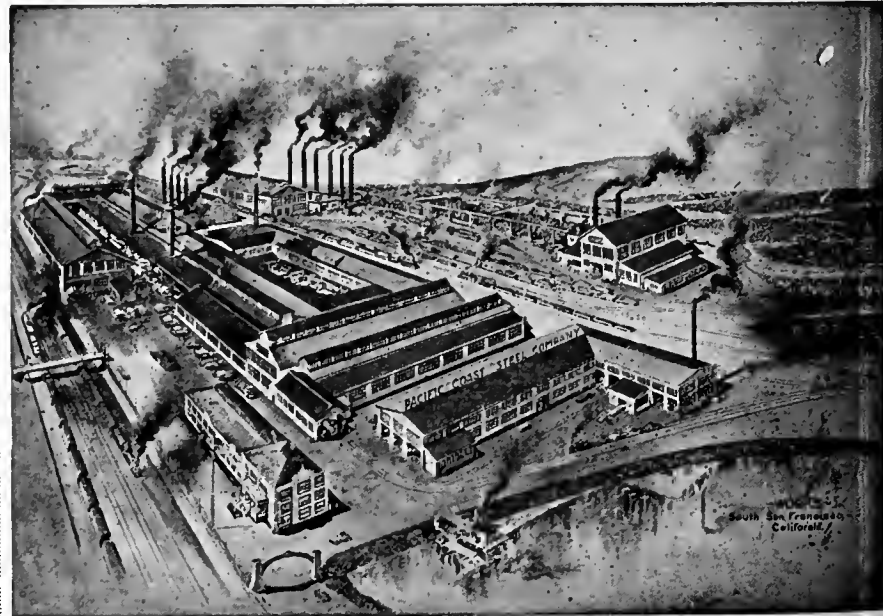

## SHAPES MANUFACTURED

Bolt Rods, Rivet Rods, Wire Rods, Bands, Flats,  
Billets for Forging, Plain Squares, Plain Rounds  
Square and Round Corrugated Bars for Reinforcing  
Angles—Equal and Unequal Legs  
Stock Lists will be Furnished Upon Request

## Pacific Coast Steel Company

OPEN HEARTH STEEL PRODUCTS

General Offices, Rialto Building, San Francisco



## DIGEST OF WESTERN INDUSTRIAL ACTIVITIES

**SALT LAKE CITY, UTAH**

The building program in Salt Lake City in 1923 promises to exceed that of 1922 by at least \$2,000,000. Foundation has already been dug for a \$1,000,000 structure.

Numerous real estate firms are planning extensive home building campaigns, also apartment houses and numerous business blocks.

The state will experience a decided building boom with the construction of the Columbia Steel Company, planned at Provo, contracts for which will be let shortly and will cost over \$4,000,000.

**HOUSTON, TEXAS**

Houston is entering into its greatest period of industrial expansion. Since the operation of the city's deep-water port facilities, on an extensive scale, Houston has had all of those natural advantages necessary for industrial expansion, such as, adequate rail and water transportation facilities, quality and quantity labor, cheap and abundant fuel and the center of a vast and virtually undeveloped area of raw material.

Harris County has approved a \$4,000,000 bond issue for the extension and improvement of Houston's port terminal facilities and now that her chain of industrial advantages is complete, a program of industrial expansion has already begun.

An industrial engineer of national reputation has been engaged to take charge of Houston's industrial needs. An industrial committee whose personnel consists of men prominent in the industrial life of the city, has been appointed. A policy has been adopted to finance meritorious local concerns needing assistance and thus make attractive those industrial investments already established.

Coincident with the announcement by the cotton mills of New England that no further plans of expansion will be carried out in that section, with the specific declaration that new mills will be in the South. Houston stands ready to prove why these mills can advantageously locate here. For years Houston has been the largest inland cotton concentration point of the country and now in the short space of three years she has advanced to the position of second cotton port.

**PASADENA, CALIFORNIA**

Industries related to the building trades are expanding their facilities to keep pace with the continued building activity. Permits for 82 residences were issued in the first two weeks of January and plans are being prepared for two bank and office buildings of about ten stories each, to be erected soon.

A tile factory and a soap factory are among the several new industrial projects which appear to have substantial backing. A company manufacturing beverages and candy has had a successful year and will soon enlarge its plant. A factory specializing in concrete garden furniture will be enlarged this year after having doubled its capacity a year ago.

Two successful local enterprises, one making nursery furniture and the other producing articles for interior decoration have greatly increased their factory space and will have a large output this year.

Other light manufacturing establishments are for the most part in a thriving condition and anticipate an active year's business.

**SAN DIEGO, CALIFORNIA**

Construction of a second municipal pier was commenced January 15th, and it is expected that one side will be completed and ready for use in October.

The Navy Department has asked for a pier, to be located just south of the present municipal pier with direct connection to the Navy Supply Depot Warehouses, and the Blackman Companies are now engaged in the construction of a bulkhead and pier south of the U. S. Navy Repair Base.

Work is now under way on the extensive paving program which has been outlined for this year.

One large hospital, an Army and Navy Y.M.C.A. that costs \$750,000, two new theatres, two cotton mills, a vitrified products plant, a packing plant for pimientos,

a factory for the manufacture of agar-agar and a large gas tank are either under construction or contemplated.

The Navy, in furtherance of their plans for increased activities at this port, have let contracts for more buildings at the Naval Training Station.

Reconstruction work on the Exposition Buildings in Balboa Park is being continued into the year 1923. The cost of repairs and alterations upon these buildings is being paid by public subscription.

Building permits for 1922 totaled \$12,004,037.00, being more than \$100 per capital, and for this year an increase to more than \$13,000,000.00 is expected.

**GALVESTON, TEXAS**

Galveston has had one of its biggest years in construction work, including residence construction, industrial plants, and protective works. A steady growth in the number of new residences under construction has been apparent since the war. The industrial development has been largely confined to new wharves and warehouses. Public works completed include the newly rehabilitated causeway and the east end seawall construction.

The residence construction has for the most part been cottages costing from \$4,000 up to \$20,000. There are very good prospects for a continuation of this development during 1923.

The industrial plants completed during the past year include new construction approximating \$5,000,000. This includes three warehouses in the Pier 35 unit as well as an addition to one of our grain elevators of 1,462,000 bushels capacity. Crespi & Company, a large foreign cotton firm have completed a \$250,000 warehouse.

Prospects for 1923 are encouraging. Many cotton firms propose expansion and several now renting their space propose to build their own facilities. The Galveston seawall will be extended approximately 2500 feet at an estimated cost of \$670,000.

**ANTIOCH, CALIFORNIA**

Work has begun on the new half-million dollar addition to be built to the Paraffine Company's plant at Antioch, Contra Costa County. A building of concrete and brick construction will be erected to house new machinery which will increase the plant capacity fifty per cent. It is expected the work will be completed and the new unit in operation by September 1, 1923.

Work on the new Hartley building has been commenced and the foundation has been completed. This building is to be of concrete brick construction of one-story with provision for the addition of a second story.

**TACOMA, WASHINGTON**

A year of unprecedented industrial development for Tacoma is presaged by announcements of the first two weeks of January.

The Gregory Furniture Company, one of the most important factors in Tacoma's industrial life, has begun work on additions to their plant which, when completed, will enable them to double their production and give Tacoma one of the largest furniture factories on the Pacific Coast.

The Walker Cut Stone Company are beginning construction on a plant that will cover three and one-half acres and make Tacoma a center for building stone of all kinds.

Another modern lumber mill on the water front with capacity for turning out foreign cargo orders, financed by experienced lumbermen, is a project well under way.

The Milwaukee car shops are now turning out 250 cars a month and have a program that calls for at least six month's production.

Plans are being drawn for erection of a United States Veteran's Hospital at Camp Lewis that calls for the erection of 28 permanent buildings at a cost of \$1,500,000, and that will require a force of 500 attendants for maintenance.

Preliminary work on the Cushman Power Plant to be built by the City of Tacoma is being rushed and the year will see this project well under way. Development of the Cushman Plant will give the city more than double

(Continued on Page XIX)

## FIREPROOF WALLS

*The National Fibreform Company Gives Fire Test in Presence of Architects, Builders and City Officials From San Francisco, Oakland, Berkeley and Other Cities.*

Unusual interest was shown in the recent public fire demonstration given by the National Fibreform Company of San Francisco. A small house was constructed of wood frame, then finished inside and outside with Granitite Walls. A roaring fire was kept burning inside the house for an hour and twenty minutes with a maximum temperature of 1920 degrees Fahr.

After the fire, a close inspection was made by City Fire Officials when the exterior walls were found completely intact and had in no way been harmed by the fire. Examination of the interior showed the wood frame had been so thoroughly protected, not to show even discolorization from the intense heat.

Another remarkable thing was the fact that the temperature on the exterior walls did not exceed 80 degrees Fahr. This demonstrated that the walls were highly insulated against radiation of heat.

A comparative test was made simultaneous, and in the same way, with a house constructed of standard stucco and plastered walls. The stucco house was on fire in thirty minutes' time and at the end of an hour and twenty minutes; this house had completely collapsed. The resistance of Granitite walls, as compared to the usual type of wall, was very convincing.

The test was made under the supervision of Chemical Engineers Robert W. Hunt. Pyrometer readings were kept and these records are available to any one interested.

*Described Product and Company.*

An officer of the company, in his talk before the crowd at the demonstration, briefly described the products as follows:

The Granitite Walls are constructed by using a combination of three products: Fibrelite, Granitite and Sealkote.

The Fibrelite is an improved form of insulation, which is nailed direct to the stud-

ding instead of sheathing and laths. This product gets its highly insulated qualities from the large amount of dead air incased with the fibre formation. The Fibrelite panels are coated with Granitite, which is a cement compound. The Granitite is applied in a mortar stage and permits a white trowel finish for the inside walls, and the stucco style finish for outside walls.

This cement compound has powerful strength, and gets its remarkable fire resistance from the fact that the material has very little expansion or contraction. Exterior walls are finished with three-eighths of an inch coat Granitite over the Fibrelite. Interior walls are sufficiently strong with one-eighth inch coat of Granitite. The test house was constructed under the specifications.

The Fibreform laboratories have also developed a waterproofing which is used on the exterior Granitite Walls. The waterproofing, Sealkote, is a colorless liquid of mineral base, which penetrates the wall surface and permanently seals the surface against moisture.

The National Fibreform Company's large plant at 16th and Arkansas Streets, was recently finished, from which they claim to have already shipped several carloads to different parts of the State. One of the buildings at the California Sanitarium has just been finished with Granitite Walls. Several other jobs are in the course of construction, including a large building project at San Diego.

The company is being financed by a group of San Francisco business men, among whom are R. W. Salsbury, Cyril Tobin, Dr. Max Rothchilds, J. F. Judge, W. P. Scott, Charles W. Clark, George Clough and Harry Hunt.

President R. W. Salsbury, when interviewed, said they had advanced far enough to satisfy themselves that Granitite Walls were meeting a general building need, and would be used extensively throughout the country. He said the company had an extensive expansion program calling for additional plants in California and other sections of the United States.

**INDUSTRIAL ACTIVITY**

(Continued from Page XVII)

its present amount of electric power, and, since Tacoma enjoys the lowest power rate of any city in the United States, the completion of the Cushman Plant means much for Tacoma's industrial future.

Many other Tacoma industries have announced plans for expansion and increase of output during the year, and 1923 will see a notable increase in the industrial interests of all kinds.

**TUCSON, ARIZONA**

With the resumption of the copper mining industry, the industrial outlook for the year 1923 is indeed very bright. With mining activity, the communities of Arizona are always very prosperous.

The Building Program for 1923 in Tucson is very well outlined. Bids are now being received for the finest High School in the Southwest, to cost \$750,000. A new library building for the State University to cost \$175,000 is now on the Architects' boards. Two administration buildings for the Presbyterian Indian Training School are about ready for the Architect. The foundation for a beautiful Christian Science Church has been completed and the building will be constructed in the very near future. The United States Government has let a contract for the construction of an enlargement to the U. S. Veterans Hospital No. 51, located about three miles out of Tucson. Plans for the financing of a five or six-story office building have practically been consummated, and the outlook for the construction of a large tourist hotel near our city is very promising.

There are several important city improvement plans to be considered, and it is expected that Tucson will have let many miles of pavement this year. The Tucson Rapid Transit Company are now spending some \$40,000 in paving between the tracks on two of the important newly paved streets of our city and have plans for extending their franchise out into other parts of the city.

**LOS ANGELES, CALIFORNIA**

The year 1923 has started with such pep and promise that it is evident the total building for the year will far exceed the total of over \$121,000,000 of 1922. Some building men say this year should reach around \$160,000,000.

January started the optimists figuring. It should. The total building permits figured 4,646 and the valuation \$11,258,517, which was an increase over the same month last year of \$3,283,349. Buildings solely for families amounted to \$7,361,862 or 65.5 per cent of the grand total, thus providing homes for 3,071 families. Some of the important highlights of the Building department's report are as follows:

Classification	Number	Valuation
Apartment buildings .....	39	\$1,111,380
Single dwellings .....	1,559	3,864,767
Double dwellings .....	358	1,679,065
Flats .....	62	706,650
Churches .....	4	270,300
Factory Buildings .....	7	53,100
Garages .....	1,183	358,567
Industrial Buildings .....	15	1,045,850
Mercantile Buildings .....	65	490,078
Public and Office.....		171,000

One of the biggest features in building on the entire Pacific Coast that will be started this Spring will be the transformation of an entire street, once owned by the city in the heart of the retail section and a block in length, into a twelve-story office building, through which the "street" will run as a highly ornamented arcade, its renaissance ceiling 30 feet above the promenade. In a later issue this will be treated of at some length. Another great building that will deserve special detailed mention is that of the \$2,500,000 Chamber of Commerce edifice, for which ground will be broken this Spring.



SUMMIT APARTMENTS

**PITCHER'S  
DISAPPEARING DOORS  
ADJUSTABLE HANGERS AND FRAMES**

MEET THE DEMAND  
FOR APPEARANCE,  
QUIETNESS AND  
DURABILITY

NO EXTRA WALL THICKNESS REQUIRED

Manufactured by

**NATIONAL MILL &  
LUMBER COMPANY**

318 MARKET STREET SAN FRANCISCO, CAL.

## DIGEST OF WESTERN INDUSTRIAL ACTIVITIES

**STOCKTON, CALIFORNIA**

Bank of Italy officials announce plans to erect a fourteen story office building. Additional frontage of 25 feet has been purchased, giving the new building a frontage of 75 feet on Main Street and 100 feet on Hunter Street.

Construction work on the administration and liberal arts building for the College of the Pacific will start within a few weeks. The main building will cost \$100,000 and be ready for occupancy by September 15th. The structure will be erected along collegiate Gothic lines, and built of red brick, with white terra cotta trimmings and slate roof.

Work of razing present buildings to make way for modern garage to cost \$50,000 at the corner of Hunter and Channel Streets in Stockton has started. The property is owned by the Henry Cowell estate, which also plans to remodel a three story building in the same block, at a cost of \$30,000. Henry Meyers of San Francisco is architect for the estate.

**DINUBA, CALIFORNIA**

Building in Dinuba for 1922 totaled \$1,250,000. Among the larger building projects were a number of fruit packing plants. One of the largest single building projects completed was that of the Strand Theatre erected at a cost of over \$100,000, with a seating capacity of 1,500 and which is considered one of the finest of its type in California. The Hadden Hotel has been completed and architects plans have been made for the \$250,000 Sun-Maid Hotel. Over 200 new homes were erected during the past year, a new grammar school built as well as an addition to the high school. Churches also have been represented, the Presbyterian Church having been completed and the Baptists have their new edifice now under construction.

**AUSTIN, TEXAS**

Through the efforts of the Chamber of Commerce another hotel has been financed for Austin and on April 1st the construction of this hotel of 220 rooms—to be

400 rooms later—will begin on Congress avenue. This lot cost \$160,000. The hotel will cost in the neighborhood of \$800,000.

The Masonic bodies are planning to build a Masonic Temple costing \$500,000.

The Labor Unions are planning to build a building costing \$75,000.

A seven-story office building is under contemplation. Other buildings contemplated will cost in the neighborhood of \$1,000,000 and the building permits for 1923 will be in the neighborhood of from \$3,000,000 to \$4,000,000.

**EUGENE, OREGON**

Eugene spent nearly a million dollars in building operations during the past year, one-half of which was for residences. There were 409 permits for new constructions and the indications are that a much larger building program will take place for the ensuing year.

Eugene is now a city of about 15,000 people and being located at the upper end of the Willamette Valley bids, fair to triple its population in the next few years owing to the promised railroad development in Oregon and especially the Natron Cut-off along the Willamette river pass which will connect Eugene and Western Oregon with Southern and Eastern Oregon and which will make a physical connection that will be of much value to both territories. This together with its great lumbering and agricultural opportunities and development will insure Eugene a steady and continuous growth.

Phone Franklin 2492

**A. C. WOCKER**

INTERIOR DECORATOR

1370 Sutter Street

San Francisco, Cal.

## The Achilles Heels of Your Home

Pay particular attention to the material used for gutters, valleys, flashings, decks, and other vital spots in your roof, for these are the places where trouble starts and expensive leaks occur, because these are the places where your roof proper is cut through to allow for chimneys, your dormer windows and the like (requiring "flashings"), or where two roofs come together increasing the flow of water from rain or melting snow ("valleys"), and finally where all the water from rain and melting snow is carried to the rain conductors leading to the ground ("gutters")—

*protect them with*

### TARGET AND ARROW

*Look for this Trade* →  *Mark on every Sheet*

### ROOFING TIN

and make these places the most lasting and weathertight parts of your roof—unless your entire roof is of Target and Arrow. No matter what roofing material you use, you would do well to send for "THE ACHILLES HEELS OF A BUILDING"—a graphic chart showing where gutters, valleys, flashings, and other vital spots occur in the roof of a building, and explaining how Target and Arrow is made by an old Welsh process which gives it the lasting and weatherproof qualities so necessary to these important places.

## N. & G. TAYLOR COMPANY

308 Chestnut St., Philadelphia

Headquarters for good roofing tin since 1810

J. A. DRUMMOND, Western Manager

508 Douglas Building, Los Angeles, California

1744 Folsom Street, San Francisco, California

2225 Fresno Street, Fresno, California



SAN FRANCISCO  
PUBLIC LIBRARY

*THE  
BUILDING  
REVIEW*



*APRIL, 1923*

*Vol. XXIII      No. 4*

*Published in San Francisco*

*Price Twenty-five Cents*



*Kyanize*  
KY-AN-IZE

WHITE ENAMEL

WRITE FOR COMPLETE ENAMEL SPECIFICATION BOOK

*Boston Varnish*  
Company

San Francisco Office and Warehouse: 1151 Mission Street  
A. L. GREENE, Local Manager

# THE BUILDING REVIEW

VOL. XXIII

APRIL, 1923

No. 4

## CONTENTS

COVER—RESIDENCE OF MR. CLYDE BEAL, ST FRANCIS WOOD, SAN FRANCISCO, CALIFORNIA. HENRY H. GUTTERSON, ARCHITECT.

### PLATES AND ILLUSTRATIONS

#### THE WORK OF LEWIS P. HOBART

	Plate
Y. W. C. A. BUILDING, San Francisco, Calif.....	121
U. S. POSTOFFICE, Portland, Ore.....	122, 123, 124, 125, 126, 127
WAR MEMORIAL FOR TERRITORY OF HAWAII.....	128, 129
RESIDENCE OF MRS. SIDNEY EHRMAN, San Francisco, Calif...130, 131	
RESIDENCE OF COL. POOLE, Pebble Beach, Calif.....	132

### TEXT

	Page
SOME VARIED WORK BY LEWIS HOBART, by Harris Allen.....	59
THE HONOLULU WAR MEMORIAL, by Harris Allen.....	61
THE HOUSE ON THE HILLSIDE (the third of a series on small Western homes), by Clara Fassett.....	62
OWN YOUR OWN HOME IDEA ON SILVER SCREEN, by Paul Green	66
EDITORIAL .....	64
EDITOR'S BOOK SHELF .....	VII
ARCHITECT'S MONTHLY BULLETIN .....	70
WHY IS AN ARCHITECT?.....	VII

### INDUSTRIAL DEVELOPMENT

IMPORTANT LAWS GOVERNING CONSTRUCTION WORK IN CALIFORNIA .....	68
RE-FORESTATION PLANS ANNOUNCED BY REDWOOD ASSOCIATION .....	69
RECOMMENDATIONS FOR SMALL HOUSE CONSTRUCTION.....	69
GOVERNMENT TESTS FOR WEATHERING LIMESTONE.....	XII
LOS ANGELES BUILDING ACTIVITIES, by Ellis Wales.....	XVI
SACRAMENTO'S NEW INDUSTRIAL SERVICE, by A. S. Dudley....	XVII
BUNGALOW COURT EQUIPPED WITH NEW HEATING APPLIANCES .....	XVII
PROCRASTINATION STEALS MORE THAN TIME.....	XX

---

HARRIS ALLEN, Editor  
HOWARD HOYT, Industrial Editor  
SIDNEY J. WOLF, Advertising Manager

Published Monthly by the Building Review Company,  
Chronicle Building, San Francisco, California  
Douglas Building Los Angeles, California

Address All Communications to No. 426 Chronicle Building, San Francisco, California

---

Yearly subscription—United States, \$2.50—foreign, \$3.00. Single copies, 25 cents.

Entered as second-class matter in the San Francisco Postoffice under the Act of August 24, 1912. Previously entered as "The Architect."

The editors will be pleased to consider contributions of interest to the Industry. When payment of same is desired, this fact should be stated.

News stands and dealers supplied through San Francisco News Co., San Francisco, Calif., or American News Co., New York, N. Y.



## Figure the Cost of Paint Correctly

The cost of paint should not be figured by the gallon, but by the number of square yards covered and by the length of service.

Fuller Paints and Varnishes flow easily and have exceptional covering qualities. Because they are scientifically mixed from materials of proved quality, they give a remarkable length of service—even when they must resist exceptionally hard wear.

Architects who specify Fuller Paints; Contractors and Builders who use them; and Home Owners who pay the bills, will find that the wearing and surface-covering qualities in Fuller products mean economy and satisfaction.

*There is a Fuller dealer or agent in nearly every town. If you cannot readily locate one locally, write for information.*

## W. P. FULLER & CO.

San Francisco  
Oakland  
Sacramento  
Stockton  
Fresno

Los Angeles  
Hollywood  
Pasadena  
Long Beach

San Diego  
Santa Monica  
San Bernardino  
Santa Ana

Portland  
Boise  
Ogden  
Salt Lake City

Seattle  
Tacoma  
Spokane  
Yakima  
Walla Walla

1-223

## ANNOUNCEMENT.....

The BUILDING REVIEW has established its Business Office and Editorial Rooms at 426 Chronicle Building, San Francisco, California. Our new phone number is Douglas 1956.

¶ We appreciate the co-operation extended us by our many friends during the past years and extend to all a hearty invitation to visit our new offices.

Sincerely yours,

The BUILDING REVIEW

*Please address all communications to our new address.*



## EDITOR'S BOOK SHELF

## NORTHERN ITALIAN DETAILS\*

This collection of photographs and drawings rejoices in an introduction by John Mead Howells, since become famous as winner of the Chicago "Tribune" tower competition. It is well written, as was to be expected from William Dean Howells' son, Architects may not accept Mr. Howells' ideas *in toto*—as, for example, when he says, "I think for our architectural health just now in America an exact reproduction of a good detail is usually better, both for the architect and for the public, than a denatured or 'improved' reproduction"; but they will all agree as to the usefulness of these plates in the drafting room.

If this is true in Eastern offices, it is vastly more so in California, this western, modern Italy. This volume employs the excellent method of giving photographs and measured drawings of the same details, side by side. The details are well chosen, for the most part simple and adaptable and typical of the best development of Northern Italian architecture.

\*"Northern Italian Details," by Walter G. Thomas and John T. Fallon, U. P. C. Book Co., N. Y.

## AN OWED TO A BUILDER

By JOSH BUILDINGS

Said the Architect to the Builder  
With a large and chesty sigh;  
"I'd like to give this job to you  
But Hully Gee, you're high."

"O, Never mind," the builder said,  
"I'll take it any way.  
"I'll just cut off ten thousand bucks  
"And make the 'suckers' pay."

The subs came flocking round the job  
Like flies around a pie,  
But all the builder said to them  
Was, "Hully Gee, you're high."

He took their hide, he picked their bones  
And scraped their carcass dry,  
They found the money, brains and skill,  
He found the air and sky.

And when they all got through the job  
They owed him ten per cent  
For hauling rubbish, watchman's fees  
And sup-er-in-ten-dent.

## WHY IS AN ARCHITECT?

It is a natural thing for man to plan his own house, whether for his family or his business. Because he alone knows exactly what he wishes incorporated into such a structure he is apt to feel he can dispense with an architect's services on much of his work.

Is this a sensible viewpoint or is the better one shown by the building restrictions of our richest suburbs—the building laws of many of our cities specifying that architects must be consulted?

Building is essential to every phase of human life. For perfect harmony between the building and its use a complete knowledge of materials, forms of construction, types of design and details is needed. Except for the architect's influence our cities would be choked junk piles, our factories would be uneconomical time wasters, our homes would be ugly, uncomfortable, unsafe.

Why is an architect? The answer is found in our city's skyline, in the modern and efficient office, factory and store, in the attractive home.—From "The Building Outlook for 1923."

# Storm King Stucco

Crack Proof  
Weather Proof  
Fire Proof

No matter whether building a simple bungalow or a large public building, there is a Storm King Stucco finish which will meet every demand.

Storm King Stucco is guaranteed by the Manufacturers to be crack-proof, weather-proof and fire-proof. It can be applied by any plasterer.

Storm King, the highest type of Magnesite Stucco, comes to you in bags, ready for use, direct from the manufacturer.

Reserve your copy of our booklet  
"Storm King Stuccos".

# Storm King Stucco Co.

79 Sefton Bldg.

San Diego

**No more leaky roofs,  
No water can penetrate**

**PABCO**

**10 & 20 year**

**ROOFS**

**which require the use of**

**FLOATINE**

**The improved roof asphalt  
that will not soften  
run, leak or slide.**

one of  
the  famous

TRADE MARK  
**PABCO**  
PRODUCTS

**The PARAFFINE  
COMPANIES, Inc.**

SAN DIEGO  
OAKLAND

LOS ANGELES  
PORTLAND

SAN FRANCISCO  
SEATTLE

THE BUILDING REVIEW

# The BUILDING REVIEW

VOL. XXIII

SAN FRANCISCO, APRIL, 1923

No. 4

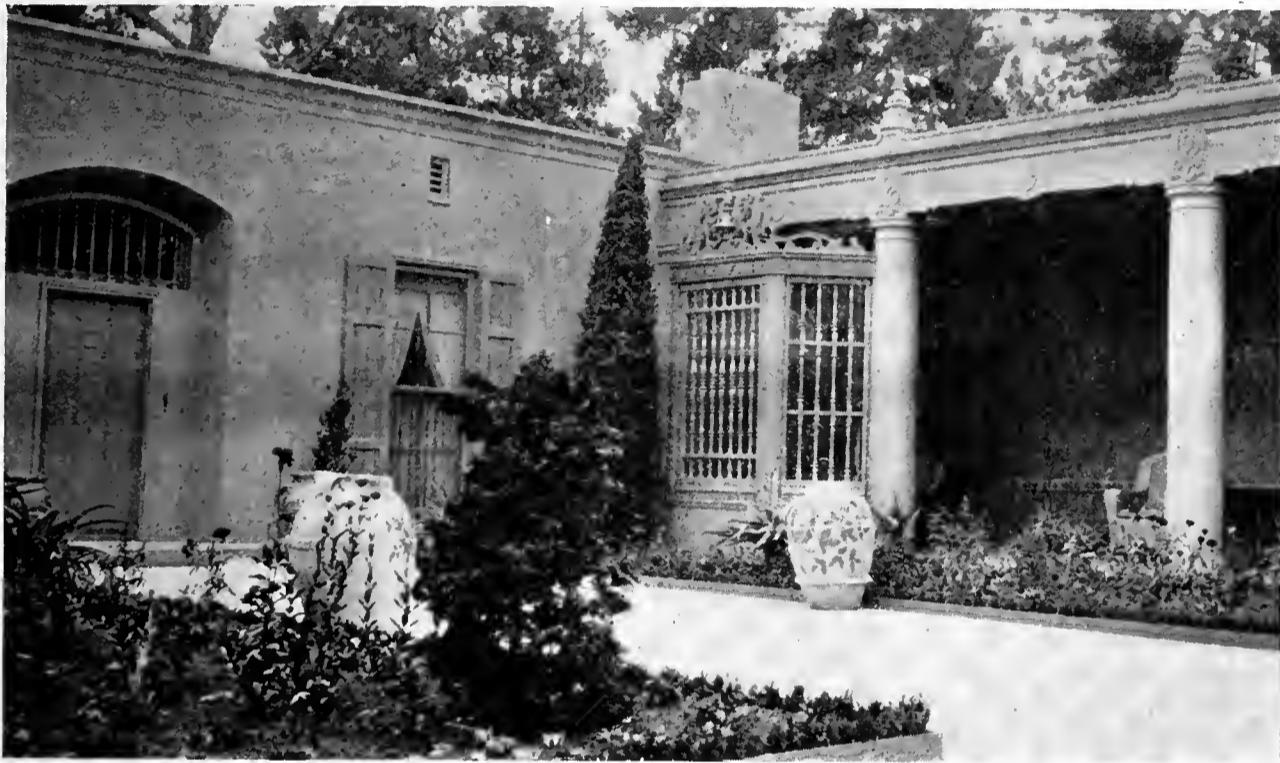

PATIO, COL. POOLE'S HOUSE,  
PEBBLE BEACH, CALIFORNIA.  
LEWIS P. HOBART, Architect.

## Some Varied Work by Lewis P. Hobart

BY HARRIS ALLEN

It is by no means easy to pick out a Hobart building. This is not because of any lack of originality, for the charge cannot be made against Mr. Hobart that he has appropriated the design of another architect, past or present, or has even incorporated the essence of any such design into his composition. But he does not confine himself to one type or style; nor does he specialize in any class of building. All is grist that comes to his mill, and his versatility, restrained by his good taste, has resulted in a remarkable output of varied and yet creditable work.

There are illustrated herewith a postoffice, an institutional club, a memorial park, and two private residences. Hardly a trace exists of similarity in style or treatment among the group. Yet there is evident throughout a trained mind and hand, a feeling for proportion and scale, a discriminating sense of refinement. Apparently each problem is worked out to a logical conclusion and determines its own fate, unhampered by preconceived prejudices of style.

The ability to work in this manner and to achieve such a large measure of success, in-

dicates a very thorough architectural training, to say the least. There is no uncertainty about Mr. Hobart's buildings; rather, a crisp sureness of touch, a confident handling of detail and material, that could be attained by no dilettante, that deserves, in fact, the much used and abused term "scholarly." And something of experience is vital; Mr. Hobart's earlier work did not possess these qualities noticeably.

Two of the buildings here shown were won in competition. The Honolulu Memorial is as yet a vision, but in the process of realization. Some interesting data are appended to this paper. We may expect the Temple of Music to be executed with the same brilliant delicacy which characterizes so many of the recent essays in classicism from this office.

The Portland postoffice is a case in point. Large in mass and dimension, it is surprisingly refined in detail. This is not carried to the point of attenuation, nor is it fussy or finicky or inconsistent in scale or character. It is unusually well studied, and will repay study.

Comparison with the original competition drawings brings the conclusion that the problem was very completely thought out beforehand, for there is very little change. What possibly won the competition was the



PATIO, COL. POOLE'S HOUSE

very practical and effective proposal to make the main public entrance to the postoffice space, which was necessarily off center, the axis for the office building above, instead of spreading offices along the entire street frontage. This treatment, too, will repay study.

The interior effect is consistent, with dignified travertine walls and a rich—but not heavy—coffered ceiling.

As most of my readers are doubtless familiar with the Y. W. C. A. building in San Francisco, it is unnecessary to make further comment than what has been said in general. Whoever did the terra cotta work deserves credit for excellent workmanship; it is very lovely.

Colonel Poole's house is still quite new, but it is easy to picture this delightful patio in a few years, when the foliage has grown and the walls have weathered. The detail here is obviously Spanish, yet the ensemble is somehow Italian in effect. One is vaguely reminded of cortiles in Northern Italian villas—or, at least, of their charm. In a later article, dealing with Mr. Hobart's recent residential work, further news of this house will be shown, also of the Ehrman house. The present illustrations are intended as examples of the architect's versatility and thoroughness.



PATIO, COL. POOLE'S HOUSE

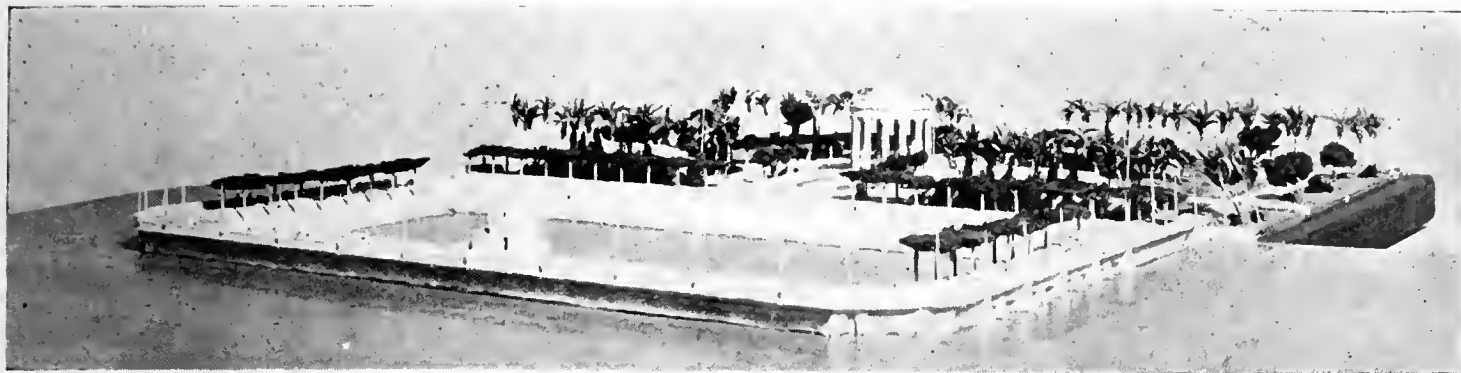

### THE HONOLULU MEMORIAL

The territory of Hawaii, desiring a war memorial for the American Legion, asked in their competition program for a natatorium not less than 100 meters long, with dressing rooms for both men and women, to be built over a channel already dredged in the coral formation at Waikiki Beach, opposite Kapiolani Park, and also for a Temple of Music in the park adjacent to the natatorium.

A portion of this park, about 300 feet wide, is on the beach and separated from the remainder of the park by a broad boulevard running from Honolulu to Diamond Head. On this narrow strip to the north of the site are the public baths and aquarium. These are about 1,000 feet from the site. On the other side of the boulevard there is a polo field, tennis courts and a zoological garden.

The architectural solution of the problem was to tie the various elements together and keep the Temple of Music in composition with the natatorium, also in harmony with climatic conditions, where shade is extremely desirable.

The site is a most beautiful one—looking towards the park and the green mountains in one direction, and the deep blue of the tropical waters with white clouds along the horizon, in the other direction. The color is wonderful in all directions.

The natatorium is 330 feet long and 150 feet wide, surrounded by tiers of seats accommodating 6,500 people, and is of concrete construction. There are starting platforms 14 feet wide at either end. The diving tower is also of concrete, the height being determined by the rules of the athletic association. The promenade is protected from the sea spray by an overhung outer wall below the parapet.

The sea water in the pool is kept constantly fresh by the flow through openings at either end, which is checked so there will be no current. There is a rise and fall of the tide at Honolulu of only 22 inches.

In building the pool over the channel we have two advantages—the extra depth of water in the pool and the shallow water on which to build our foundations for the seating.

In further developing the scheme with the authorities at Honolulu, it was decided to make the natatorium for Olympic games only. These professional meets will be held only at night and at such times the pool will be illuminated by lights strung across the pool from cables on removable poles. When there is no professional swimming the public will be allowed to use the pool, there being a public bath with dressing rooms adjacent.

The bath houses are developed as open sheds behind high enclosing walls, with small gardens inside these walls. The men's bath house will accommodate 150 men and contains showers and toilets, with alcoves for the various swimming clubs. The women's bath house contains the same accommodations for 50 women, also storage space for electrical equipment, a small office, and an electrical control room. There are no lockers, all clothes will be hung from hooks on the wall.

The Temple of Music is of concrete construction, oval in plan, 40 feet in diameter on the main axis and 50 feet the other dimension. The total height is 70 feet.

The Temple will be used as a band stand. The finial is of bronze in the form of a pineapple, with the upper portion of the roof in tile. There are medallions on the parapet—the two on the main axis being the Coat of Arms of Hawaii, the two on the secondary axis the Coat of Arms of the United States. The ceiling is a hung ceiling of hard plaster, slightly convex to avoid the sound being caught in the dome, and is covered with canvas, which is decorated.

The floor of the Temple of Music is tile in decorated pattern—in the center a bronze plaque of the emblem of the American Legion.

(Concluded on Page XII)



RESIDENCE OF MR. CLYDE BEAL,  
ST FRANCIS WOOD,  
SAN FRANCISCO, CALIFORNIA.  
HENRY H. GUTTERSON, Architect.

## The House on the Hillside

*The third of a series on small Western homes*

By CLARA FASSETT

Since to many of us the fact has been satisfactorily proved that we can live and be entirely comfortable in small houses, witness the exodus of hitherto apparently satisfied apartment dwellers to the suburbs and outside residence districts. Now even in restricted allotments small houses are permitted, even encouraged. In order to live in a desirable and modern location we do not have to build largely and elaborately—it is possible to build modestly a house suited to our desires, family and income—only of course our small house must have charm and variety, it must not be commonplace. Very often the house which is considered most attractive and is most appealing to the prospective buyer, is the “little house”, compact, cozy and just a bit different.

In a region of hills and steep-sided canyons, the problem of house-building on sloping ground or perched on the summit of a hill becomes somewhat complicated. How many times has the eye recoiled from the sight of a

beautiful hillside dotted with an array of un-beautiful houses sprawling up its sides, a collection of buildings suitable for a city or flat land, distorted, cut down here and piled up there, showing no thought of symmetrical placing with relation to each other—the contour of the hill or the growth of vegetation. This unpleasant arrangement is too often the result of hasty and thoughtless laying out of many suburban home-sites. But give a difficult location, as—a lot lying on the slope of a canyon with but a few feet on the level—to a designer who will thoughtfully consider the problem, the result may be a revelation of the possibilities for beauty and appeal in hillside architecture.

First of all the suburban or country house large or small, wherever located should appear to “grow out” of its surroundings. The house described is built upon a hillside in St. Francis Wood, a suburb of San Francisco; it stands out, as yet there are no buildings near

THE BUILDING REVIEW

it, presenting a complete unit with its surrounding landscape features—from whichever side it is viewed. From the front with broad and substantial base it appears to be firmly standing on its foundation—no suggestion of being balanced on the edge—and from the rear the perpendicular wall is pleasingly broken by an out-jutting bay window, which presents an agreeable view from the opposite side of the canyon. In short it strikes the eye as a complete and symmetrical little gem of a house from whichever side it is viewed. And that is why it has been so much admired and

with open ceiling, boarded, glazed in blue-green tones, walls rough-cast plaster glazed, and tinted cement fire-place of Elizabethan pattern, is well-adapted to its purpose of music and living room. Being exposed on three sides affords ample space for lighting which is expressed in terms of French windows. The dining room is approached from the living room through an open doorway flanked by built-in book-cases, down a short flight of steps. French doors separate it from the narrow hallway extending from the kitchen at the left to the maid's room on the op-



ORIGINAL SKETCH

pointed out as a model of hillside-house construction in this region.

The house is rather unusual in that it cannot be described as a story-and-a-half, or a two-story, but is really one story and two halves. It is constructed of plaster tinted terra-cotta with green trim, entrance wing and door of green and blue glazed finish. This door is delightful in its panelling and color. It is a door which leads you to expect something a little different, out of the ordinary, and you are in no way disappointed as the interior amply fulfills this promise. We enter a tiny irregular alcove to the living-room, which

posite side. The north wall of this room which is designated by the owner as a "small dining room or large breakfast room", is a bay window overlooking valley and opposite wooded slope, with a glimpse of ocean to the left—an amazing wealth of pleasing outlook. Partaking of one's morning coffee and toast in this gay little room with its flowered wallpaper and white painted wood work can not fail to start the day properly. The kitchen with the same outlook would be apt to tempt any housewife to linger over the monotonous tasks of cooking and dish washing.

(Concluded on Page 65)

# EDITORIAL

The spring elections bring many candidates for office in Boards of Education.

In considering qualifications for these offices, it has not been sufficiently emphasized that school building has become one of the largest factors in the building industry. The amount of money spent in California on new school construction is assuming staggering proportions. Quoting from Mr. Donovan's interesting and suggestive article in the February "Building Review," "The average yearly expenditure for buildings is very likely to be \$40,000,000 or a grand total of \$480,000,000 for the twelve-year period 1923 to 1935. This estimate is a conservative one \* \* \* not including the amount of money spent for private institutions, nor for colleges and universities."

To this must be added the running expense for equipment and supplies, amounting to from 10 to 15 per cent of total operating cost, which was \$70,000,000 in 1921.

The disposition of these sums is at the discretion of a *majority* of the Board of Education in each district. Usually the honesty and good intention of candidates need not be disputed. But what of the question of business efficiency?

Do the people of California wish to have this huge public business managed by men and women who have had no business experience, or whose private experience has brought them failure or but moderate success?

It is futile to deny that in many instances there have been excessive overhead costs, lack of system, lack of economy in every form of expenditure. As a result, many classes must be housed in flimsy, portable shanties, insufficiently equipped, inadequate from every standpoint. Your children pay the penalty.

Surely it must be clear that voters must *vote*, and vote for those candidates who are best qualified to handle business efficiently. We must get into our heads that this is *business*, and not *sentiment*.

It is not impossible to elect Boards of Education which shall contain both persons familiar with the requirements and theories of modern education, and men whose practical business training will insure the greatest possible efficiency and economy in the operations of the Board. And it is the duty of all voters to inform themselves intelligently of the qualifications of all candidates.

*Harris Allen*

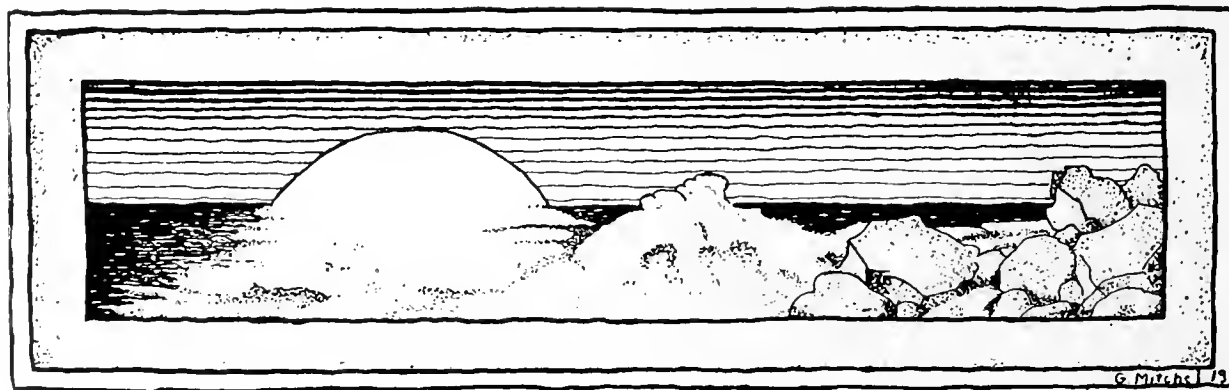

G. Mitchell '13





Y. V. C. A. BUILDING,  
SAN FRANCISCO, CALIFORNIA.  
LEIS P. HOBART, Architect.



U. S. POSTOFFICE,  
PORTLAND, OREGON.  
LEWIS P. HOBART, Architect.

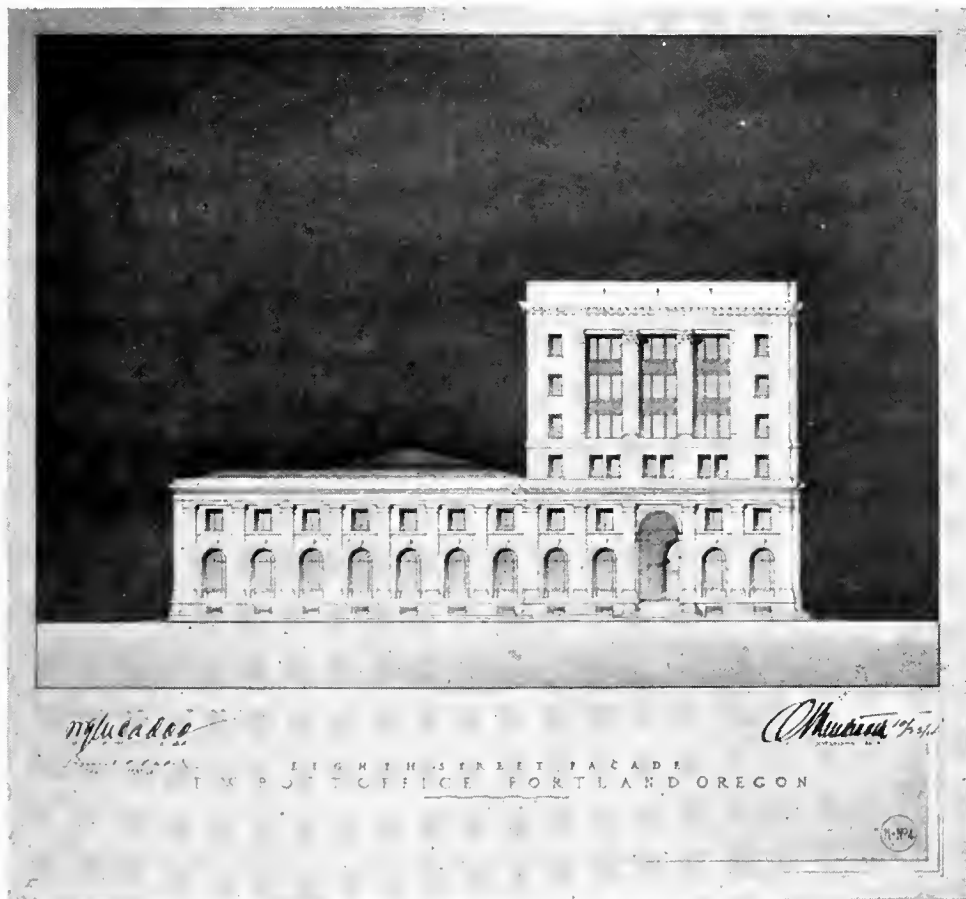

COMPETITION DRAWINGS,  
S. POST OFFICE,  
PORTLAND, OREGON.  
LEWIS P. HOBART, Architect.

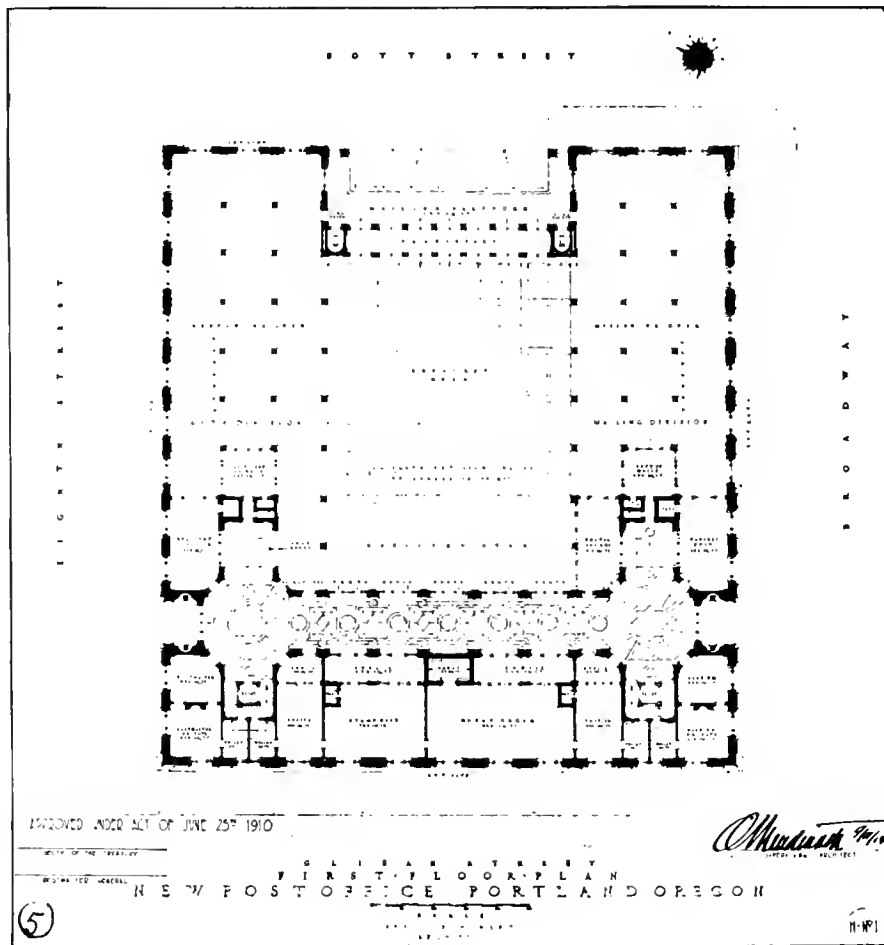
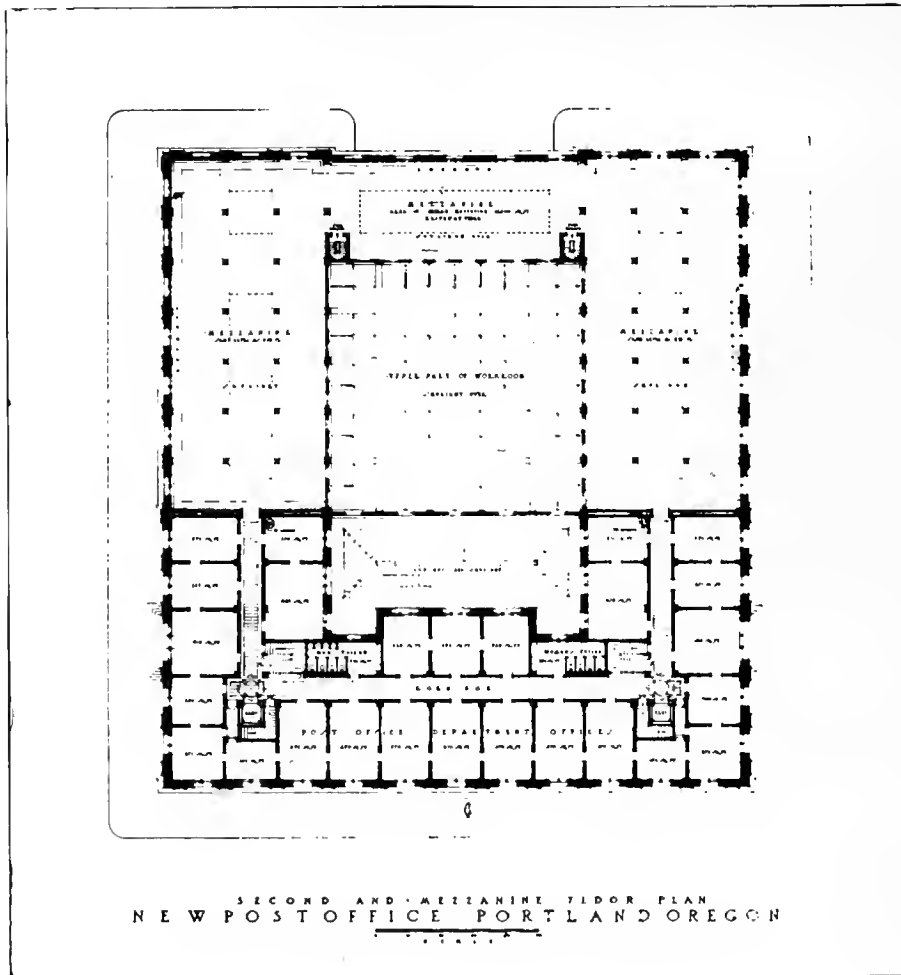

U. S. POSTOFFICE  
PORTLAND, OREGON.  
LEWIS P. HOBART, ARCHITECT.

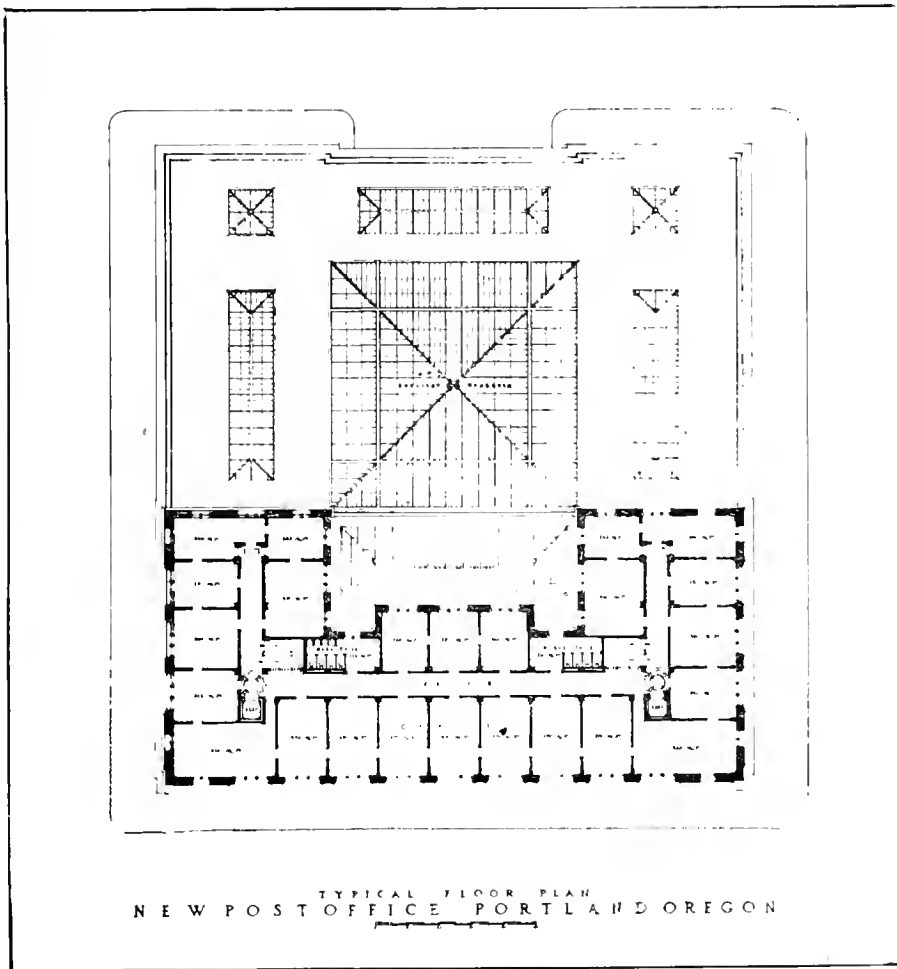

S. POSTOFFICE,  
PORTLAND, OREGON.  
LEWIS P. HOBART, ARCHITECT.



MAIN PUBLIC CORRIDOR  
U. S. POSTOFFICE,  
PORTLAND, OREGON.  
LEWIS P. HOBART, ARCHITECT.

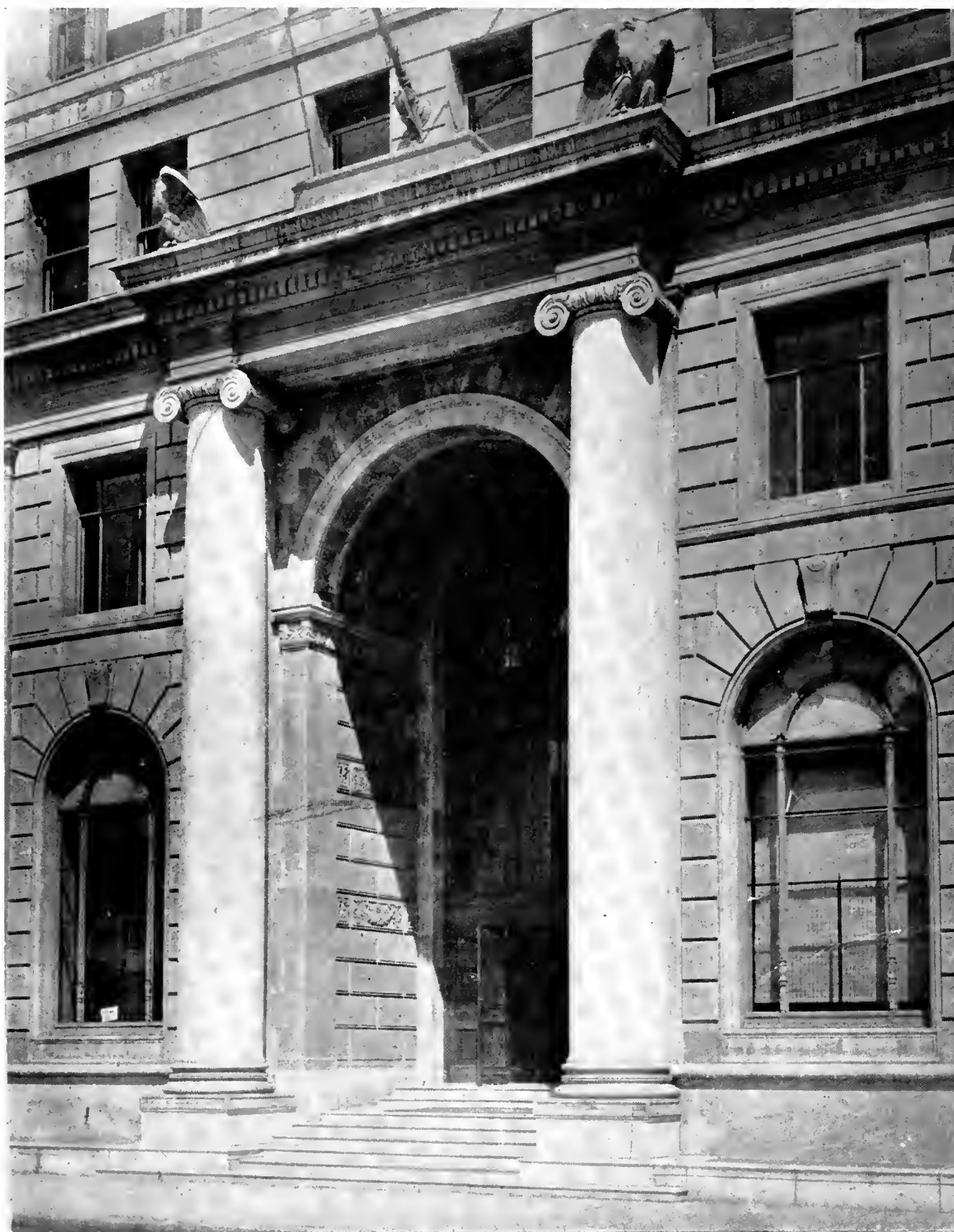

DETAIL OF MAIN ENTRANCE,  
S. POSTOFFICE,  
PORTLAND, OREGON.  
LEWIS P. HOBART, ARCHITECT.



WAR MEMORIAL FOR TERRITORY OF HAWAII  
HONOLULU, T. H.  
LEWIS P. HOBART, Architect.





McKINLEY MEMORIAL FOR TERRITORY OF HAWAII  
HONOLULU, T. H.  
DESIGNED BY P. HOBART, ARCHITECT



RESIDENCE OF MRS. SIDNEY EHRMAN  
SAN FRANCISCO, CALIFORNIA.  
LEWIS, P. HOBART, ARCHITECT.

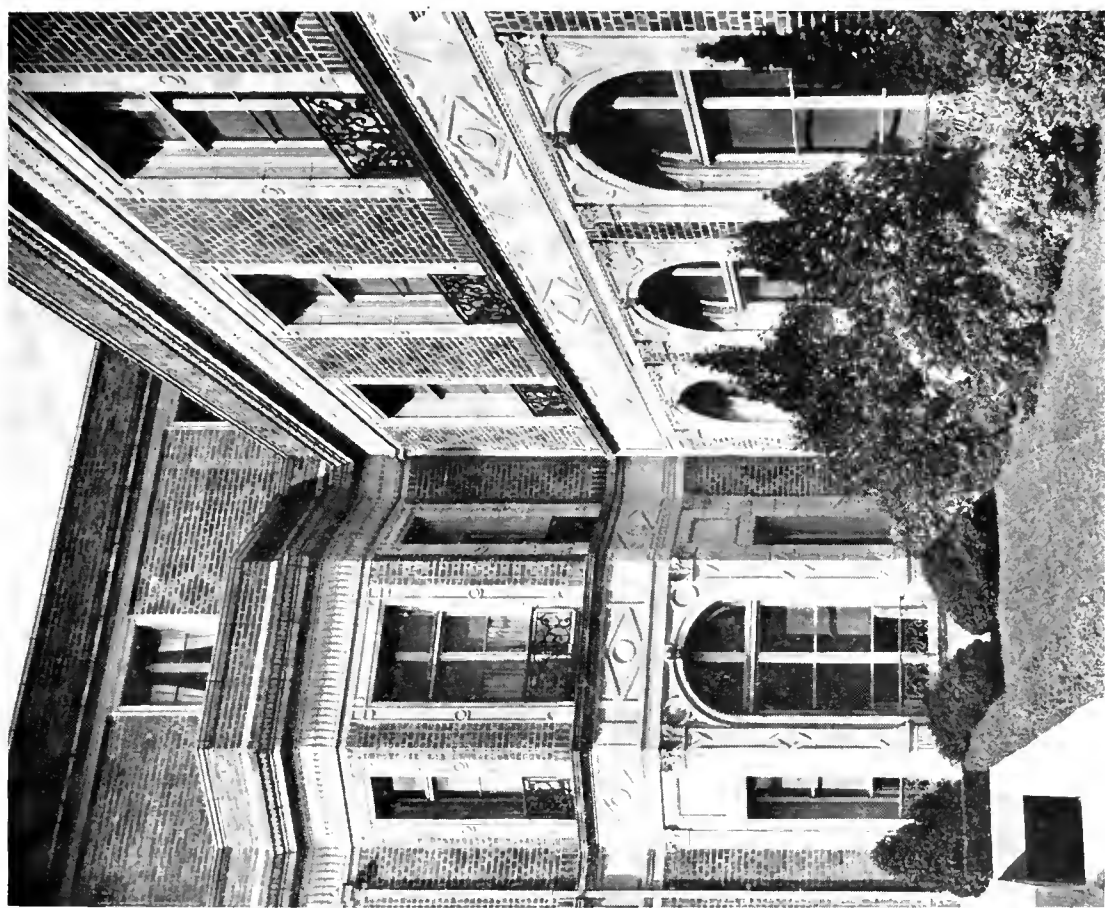

RESIDENCE OF MRS. SIDNEY EHRMAN,  
SAN FRANCISCO, CALIFORNIA.

DESIGNED BY JAMES H. HOBART, ARCHITECT.



PATIO COLONADE,  
RESIDENCE OF COL. POOLE,  
PEBBLE BEACH, CALIFORNIA.  
LEWIS P. HOBART, ARCHITECT.



LIVING ROOM

(Continued from Page 63)

A cunning little stairway with a turn, separated from the living room by a railing, leads to the bedrooms and bath; it is a most easy flight of steps to climb and gives to the sleeping apartments a feeling of privacy and separation from too-close contact with the rest of the house. One of these bedrooms was planned for a nursery, but can be utilized as an extra sleeping room being provided with a wall bed.

There are so many intriguing little nooks

and corners about this house; a tiny small-paned window in the entrance alcove with its quaintly pierced shutter obviates the necessity of glass in the door; an oblong of brick pavement in a sunny corner under a protecting pine which is allowed to caress the green shingled roof with its branches. It is in these effective bits that a note of individuality—of daring—is shown by the architect, which arrests our attention; demonstrating how it is possible to plan the small house with distinction as well as comfort and convenience.

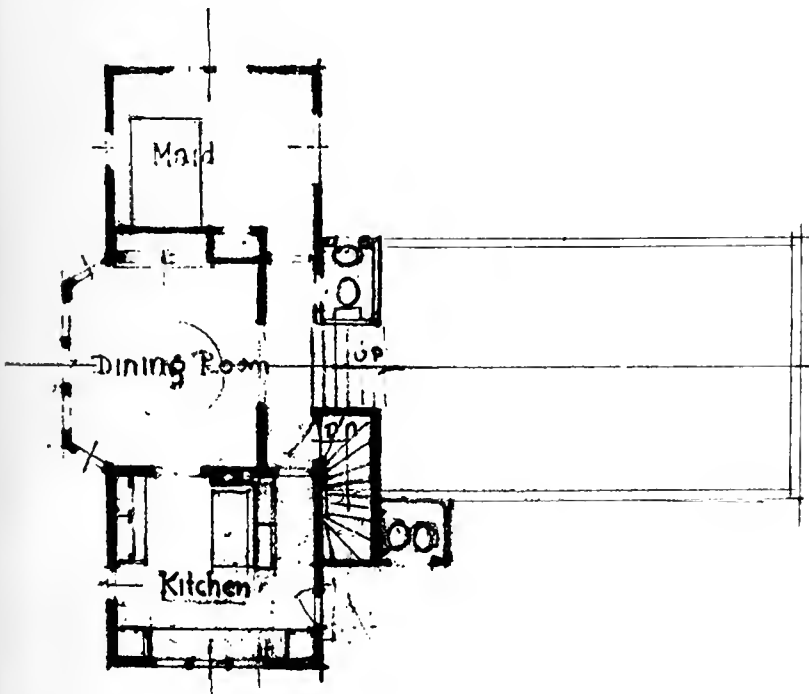

LOWER FLOOR PLAN

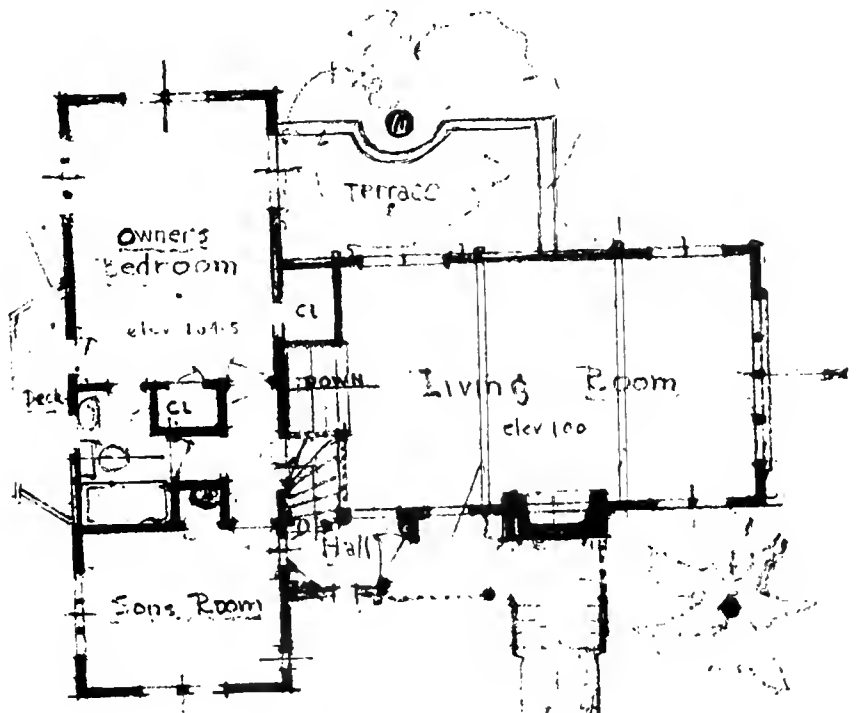

UPPER FLOOR PLAN



## “Own Your Home” Idea on Silver Screen

BY PAUL GREEN  
*of the Atlas Educational Film Company*

The “Own Your Home” idea is not a new one, but it is rare to find it so ably treated as is the case of the new “Own Your Home” film and its attendant “Own Your Home” campaign as is now being made available in all localities.

This film, unlike many attempts along this line, takes into account the services rendered by the Architect. He is portrayed as one of the very necessary steps in the building of one’s home. The film is thoroughly educational in theme, and, while it is backed by building interests in general, yet the material has been handled so carefully as not to offend the observer by any obvious ulterior or advertising motive. The treatment is entirely ethical, and in this sense is a decided step in advance over anything that has ever been attempted.

In the planning and production of this film, the various manufacturers and building associations have lent their very hearty support and counsel. The plot of the story

hinges on the experience of a young couple. The husband is content apparently to go on from year to year piling up rent receipts and accumulating, incidentally, a highly aggrieved state known as “apartmentitis.” He, of course, is not aware of what it is that ails him, but matters are brought to an abrupt climax by the state of his business and the raising of their rent, together with the aggravations inflicted upon them by the fact of their having children.

Agnes and Robert are an unusually devoted couple, but the “apartmentitis” is getting a firm hold on them, and peculiar to this disease, they are gradually growing apart. Robert’s business is in need of re-financing and he appeals to Agnes after being turned down by the banker, for assistance. Agnes has bought a very attractive lot in one of the city’s suburbs through her individual efforts and pin money. The breach is widened by her refusal to allow him to tie up the property by using it as collateral for a loan.

THE BUILDING REVIEW

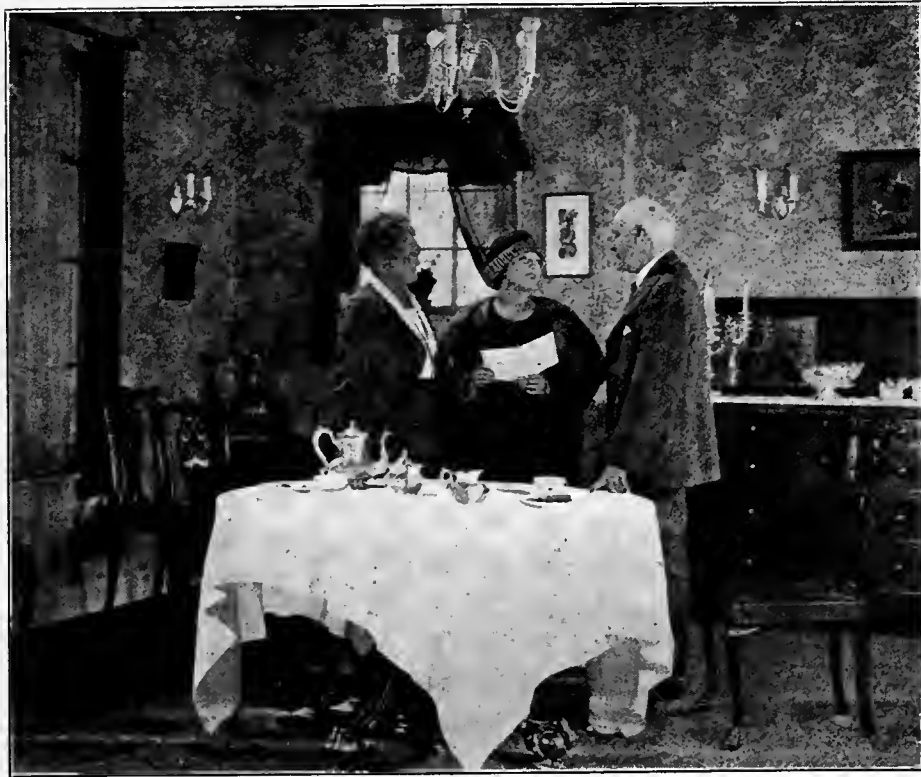

Like many another husband, his prejudice to home ownership is partially, at least, founded on ignorance of the fundamentals in the case. Agnes realizes that once the lot is tied up, building will be out of the question.

A business trip to Denver becomes a protracted stay and Agnes is given the opportunity of investigating the possibilities of building. A family friend—an Architect by the way—is generous enough to start the ball rolling by making a few sketches. At this period in the story the realtor who sold Agnes the lot some years past, enters the scene, and it is he who makes it clear to Agnes how, by selling a portion of her big lot, she will be in a position to finance the home building project.

Like many other good stories, Robert at this point writes and gives his consent to building. Being away from home has sharpened his appreciation of his little family and he feels ashamed, surrounded as he now is, with all of the comforts of home life of his brother-in-law's home, to think that he has stubbornly held out against the dearest desire of Agnes'.

To make a long story short, he returns at Christmas time not knowing that the house has been built, and finds his little family surrounded by all of the home atmosphere that he has learned in his absence to love.

You may ask at this point, "Where does the love story come in?"

Many of the best love stories ever written were those in which a revised love comes about through such simple means as the building of a home, the establishing of home ties, the surrounding of one's dear ones, by those things which all healthy-minded people yearn for—the children with their pets, the mother and father with something permanent, which they can work on as a thing of their own.

The film is a sermon directed in bold, aggressive form at the popular feeling so common at present—that happiness can be accomplished without home ownership. How many of us have heard a banker say, "It costs more to own a home than it does to rent?"—quite ignoring the fact that he is deliberately giving advice which violates the most sacred of human instincts.

Distribution of this film, it is planned, will be secured through real estate boards, civic organizations, newspapers and all others interested in promoting home building and home ownership. Very complete plans for putting on the local campaigns, using the film and such other material as the plan embodies, are rapidly nearing completion.

The film may be obtained direct from the film company—the Atlas Educational Film Company, 1111 South Boulevard, Oak Park, Ill.

There is no thought of profit in the distribution of this film, as it has already been amply financed by the building interests.

# INDUSTRIAL DEVELOPMENT

## IMPORTANT LAWS GOVERNING CONSTRUCTION WORK IN CALIFORNIA

At the last session of the legislature the following four laws governing construction work were enacted and their enforcement placed under the jurisdiction of the Industrial Accident Commission:

### *The Use of Dangerous Equipment and False Work Is a Misdemeanor*

Section 402 (c) of the Penal Code as amended, provides that any person employing another in the construction, alteration, repairing, painting or cleaning of any building or other structure, who furnishes unsafe equipment or scaffolding, or obstructs any officer inspecting such equipment, or removes any notice of the Industrial Accident Commission posted thereon, shall be guilty of a misdemeanor.

### *Elevators Used in Buildings During the Course of Construction Must Be Made Safe*

Chapter 332 provides that every hoist used in buildings during the course of construction shall use a system of signals as specified by safety orders to be made by the Industrial Accident Commission, and such hoists shall be constructed so as not to endanger the lives of workmen.

### *All Suspended Scaffolds Ten Feet Above the Ground Must Have Safety Rails*

Chapter 333 provides that all suspended scaffolds more than ten feet above the ground shall have a rigid railing forty-two inches above the platform and shall be of sufficient strength to support workmen, tools, appliances and materials thereon.

### *Temporary Floors and Safety Nets to Protect Workmen From Falling and From Falling Materials*

Section 1 of Chapter 334 provides that any building more than two stories high shall have the joists, beams and girders of floors below the floor where any work is being done, planked or covered as follows:

(a) Reinforced concrete buildings shall have each floor filled in either with forms

or concrete before commencing work on the walls of the next story. Any building having wooden floors, other than a steel frame building, shall have the underflooring, if double flooring is to be used, laid on each floor before commencing work on the next story above. Where single wooden floors are to be used, each floor shall be planked over before commencing work on the next story above.

(b) In steel frame buildings every other floor shall be covered with two-inch planks.

(c) If spans of floors exceed thirteen feet intermediate beams shall be used to support the temporary flooring.

(d) If the distance between planked floors exceeds twenty-five feet, intermediate floors or safety nets shall be provided.

(e) The erection gang shall at all times have a planked floor below them not more than two stories distant.

(f) The riveting gang and steel painters shall at all times have planked floors below them not more than two stories distant. Men working below riveting gangs must at all times be protected from falling materials.

Section 2 provides that if the steel columns in a building are spliced at every story the erection gang shall in no case be more than two stories distant from the riveting gang. If the columns are spliced every second or third story the erection gang shall not be more than four stories from the riveting gang.

Section 3 provides that planked floors shall consist of planks tightly laid together, of No. 1 common lumber, not less than two inches thick and eight inches wide, free from protruding nails or other objects. Nets shall consist of at least \*one and one-half-inch manila rope with \*three-quarter-inch borders and four by four-inch mesh. The borders of the nets shall be provided with loops so that they can be readily combined or attached to convenient points on the structural frame.

\*Circumference and diameter.



## Re-Forestation Plans Announced By California Redwood Association

Thousands of California acres, laid bare by the timberman's axe, are to be replanted with redwoods as a result of a program announced by the California Redwood Association in conjunction with the observance of Tree Planting Week.

Extent of the replanting plan inaugurated by the association is revealed by the statement that already growing in Humboldt and Mendocino counties nurseries are upwards of 2,000,000 young redwoods from which will be drawn the initial consignment of young trees to be reset in selected areas between Monterey county and the Oregon line.

The first planting will be undertaken within a few days under the direction of Major David T. Mason, former government forestry man and University of California professor, who has been engaged as permanent head of its re-forestation department.

Figures recently compiled by the University of California's forestry division, after a study of three years, are said to have warranted the conclusion that an acre of cut-over redwood timber land, replanted un-

der scientific direction, will produce 139,000 feet, board measure, within 60 years. This production, lumbermen say, exceeds by 30 per cent any second growth obtainable in any other timber producing region in the United States.

Although but one-quarter of California's redwood forest area has been utilized for commerce, as shown by Federal figures, it is reasoned that the Redwood conservation program adopted has started early enough so that posterity may be assured a continued redwood supply, due to the multitudinous uses this wood is now put to.

Redwood as a shade and ornamental tree is employed to a moderate extent in some parts of the state and the association is urging that this use become more general due to the long life, beauty and quick growth the tree possesses.

The California plan of redwood re-forestation is said to be the first in the United States wherein practically all the prominent lumber manufacturers of any one region have joined in a serious movement to make their industry permanent.

---

## Recommended Minimum Requirements For Small Dwelling Construction\*

Investigations by a Congressional Committee during 1919 and 1920 disclosed that existing building laws through variations and inconsistencies of their provisions and through unduly restrictive or expensive requirements, were operating to prevent needed activity in the building industry. That these conditions might be remedied, a committee of experienced architects and engineers was organized by Secretary Hoover to investigate building practice and code requirements and to prepare standard building regulations based on the latest and best information, which might be recommended to cities and states adopting or revising building codes.

The first report of this committee presents recommendations for the construction of one and two-family dwellings having exterior

walls of solid or hollow masonry, concrete, and frame, the latter including veneer and stucco surfaces.

In order that its recommendations might have sound bases of information and opinion, the committee obtained the co-operation of nearly 100 architectural and engineering societies, builders' exchanges, and industrial organizations producing building materials. Special questions also were referred to large groups of individual engineers, architects, building officials, to the Bureau of Standards, and to others whose experience qualified them to discuss such subjects. Tentative recommendations were drafted and submitted widely for discussion and criticism by those interested in the work, and the final

(Concluded on Page XII)

SAN FRANCISCO CHAPTER AMERICAN INSTITUTE OF ARCHITECTS  
MONTHLY BULLETIN

OFFICERS

Geo. W. Kelham, President.  
Henry H. Meyers, Vice-President.  
J. S. Fairweather, Secretary-Treasurer.



DIRECTORS

William Mooser, three years.  
J. H. Blohme, three years.  
A. J. Evers, two years.  
Harris Allen, two years.  
S. Schnaittacher, one year.  
Morris M. Bruce, one year.

NEXT MEETING

The next meeting will be held Thursday evening, April 19th, 1923, at the Architectural Club Rooms, 77 O'Farrell Street, at 6:30 p. m., and will be preceded by a Directors' Meeting at 5:30 p. m. The principle business will be the election of delegates to the Convention in Washington in May.

MINUTES

The Directors' and regular meeting of the San Francisco Chapter of the A. I. A. was held Thursday evening, March 15th, 1923, in the Architectural Club Rooms, 77 O'Farrell Street. The meeting was called to order by President Geo. W. Kelham. The following members were present: Harris Allen, S. Schnaittacher, Morris M. Bruce, Wm. Newman, Geo. W. Kelham, Geo. E. Ashley, E. B. Hurt, A. J. Evers, Ernest Norberg and Stanton Willard.

CLUB ROOMS

The Architectural Club was represented by Mark T. Jorgensen and E. B. Hurt, President and Vice-President respectfully, they joined in a discussion regarding new Club quarters. It developed that the present lease had until October, 1925, before expiration of same and while nothing definite was demanded, the President was authorized to confer with other bodies regarding a consolidated building, with quarters for Club Rooms.

INDUSTRIAL RELATIONS

After a discussion in regard to the benefit to the Architectural profession derived by the workings of the Industrial Relation Board, it was moved and unanimously carried that the Architects attend a luncheon meeting with members of the Industrial Relation Board. It was also hoped that each Architect, whether he belonged to the Chapter or not, would attend this meeting.

It was moved and carried that State Bill No. 57, providing that "Any person may gratuitously copy plans for any high school building, which must be filed with the Superintendent of Public Instruction, be referred to the Board of Directors, with power to act if it be deemed necessary.

STATE BOARD

The following resolution was offered and carried, and the Secretary was authorized to send a copy to each member of the Legislative Committee:

WHEREAS, it is proposed by Assembly Bill No. 442 to abolish the State Board of Architecture and substitute a Department of Professional Standards, the duty of which Department shall be the administering and enforcing of all laws regulating the practice of certain professions, be it

RESOLVED that this Chapter request the earnest consideration of the State Assembly and Senate of the fact that the Northern and Southern District Boards of the State Board of Architecture have administered and enforced the laws regulating the practice of Archi-

ecture for a period of twenty-two years to the full satisfaction of the public and the Architectural profession; that the State Board of Architecture is maintained solely from fees collected from the Architectural profession and that it costs the State nothing and that the members of the Board serve without remuneration, and

FURTHER, that laws concerning professional standards can best be administered by those qualified by practice in the same profession.

IT IS FURTHER RESOLVED that copies of this RESOLUTION be sent to the following:

- Hon. John B. Badaracco, State Assembly, Sacramento.
- Hon. Henry E. Carter, State Assembly, Sacramento.
- Hon. Harry Lyons, State Assembly, Sacramento.
- Hon. Elmer P. Bromley, State Assembly, Sacramento.
- Hon. Sidney T. Graves, State Assembly, Sacramento.
- Hon. Dwight Hart, State Senate, Sacramento.
- Hon. Ed. P. Sample, State Senate, Sacramento.
- Hon. Edw. A. Mueller, State Assembly, Sacramento.
- Hon. P. A. Whitacre, State Assembly, Sacramento.
- Hon. Harry A. Chamberlain, State Senate, Sacramento.
- Hon. Lester G. Burnett, State Senate, Sacramento.

There being no further business to come before the Chapter, the meeting adjourned.

J. STEWART FAIRWEATHER,  
Secretary.

WASHINGTON CONVENTION

March 17, 1923.

Mr. George W. Kelham,  
President of San Francisco Chapter,  
San Francisco, Calif.

My dear Mr. Kelham:

Mr. William B. Faville, the President of the Institute, proposed and the other Officers and Directors of the Institute have approved of a ceremonial pageant to be held in Washington on May 18, 1923.

The Fifty-fifth Convention, you will remember, unanimously voted to confer upon Mr. Henry Bacon the Institute's gold medal. It is planned that this highest award of the Institute to a distinguished member of the profession shall form the crowning feature of the coming Convention, and in connection with the Lincoln Memorial, serve as the inspiration for an impressive spectacle which will take the form of a processional at the close of the banquet, which will culminate upon the steps and platform of the portico entrance to the Lincoln Memorial.

At this point it is hoped that the President of the United States will confer the medal upon Mr. Bacon, or in case of the absence of the Chief Executive from Washington that the ceremony shall be performed by some other prominent official. High dignitaries of Church and State, Officers of the Army and Navy, and of the Institute will, by their presence, add lustre to the ceremony.

It is planned that the procession shall be com-  
(Concluded on Page XV)

This is  
the symbol  
of the highest  
plumbing  
fixture  
quality



TRADE MARK REGISTERED

*Specify*

**PACIFIC**  
PLUMBING FIXTURES

## BUREAU OF STANDARDS TESTS WEATHERING OF LIMESTONE

A series of tests to determine the resistance of limestone to frost action is now under way at the Bureau of Standards.

Small samples cut from the stone are soaked in water and are then frozen. After freezing they are put back in the water to thaw.

Of the samples tested, many showed serious disintegration after they had been frozen 75 times. Others have now been frozen as many as 800 times and show as yet no serious disintegration. The samples come from different localities, and when the tests are completed the data will be of value to architects in the selection of building stone.

Limestone is now used extensively as a facing stone. It is less expensive than granite and more easily cut, which makes it quite popular. It is not so durable as granite, however, and is apt to show surface weathering within a hundred years.

Other tests being undertaken at the bureau have to do with waterproofing compounds. The purpose of such compounds is to lengthen the life of the stone and prevent the absorption of unsightly stains.

(Continued from Page 61)

The Temple will be lighted from the floor, illuminating the decorated ceiling, and also by side lights behind the plaque that will pick up the bronze and tile top.

Besides the broad steps that approach the Temple leading to the general level of the public space at the natatorium, there are four ramps that give easy access to the promenade.

The planting will consist of two rows of palm trees, as shown on the photographs and drawings, and these already exist on the site. The low, flat trees planted for shade are Hau trees, which grow profusely in the islands and are well adapted for this purpose, being used at several other places at Waikiki Beach. The other planting will be selected for color. There are already on the site two very beautiful Banyan trees.

The work is in charge of Lyman H. Bigelow, superintendent of public works for the territory, and the model was made by B. V. Gerow of San Francisco.

(Continued from Page 69)

report reflects the influence of this consideration.

The committee recommends that building codes permit eight-inch solid brick and six-inch solid concrete walls for two and one-half and three-story dwellings accommodating not more than two families each; that eight-inch hollow building tile, hollow concrete block, or hollow walls of brick (all rolok) shall not exceed twenty feet in height to the gables; and that frame construction be limited to two and one-half stories. Metal lath and plaster on wood studs properly fire-stopped is approved for party and division walls, but at least every alternate wall in row houses must be eight-inch solid brick or concrete or twelve-inch hollow building tile, concrete block, or hollow wall of brick.

Requirements for quality of hollow masonry units agree.

The Building Code Committee includes representatives of the principal architectural, engineering and other interested professional societies.

This first report of the committee deals with the construction of one and two-family houses of masonry, concrete and frame types, the latter including veneer and stucco. The value of such construction in the United States amounted to well over a billion dollars in 1922. It is expected that general adoption of the code, with consequent modification of present unjust and wasteful requirements, will result in substantial conservation of materials, and the saving of many millions of dollars.

In addition to the requirements in the code itself, the appendix contains valuable information in the quality of materials and workmanship, which should be used for good results. The report may be obtained from Superintendent of Documents, Washington, D. C., for 15 cents.

(Note: A preliminary draft of this code was submitted to the S. F. Chapter, A. I. A., and approved, with certain suggestions.)

\*—Abstract of a report by the Building Code Committee of the Department of Commerce, published for the committee by the Bureau of Standards. The complete paper may be purchased from the Superintendent of Documents, Government Printing Office, Washington, D. C., price 15 cents.

Phone Franklin 2492

**A. C. WOCKER**

INTERIOR DECORATOR

1370 Sutter Street

San Francisco, Cal.



NEW HOME OF AUTOMOBILE CLUB OF SOUTHERN CALIFORNIA  
LOS ANGELES, CALIFORNIA

AMESS & BERG, Painters and Decorators,  
2723 WEST EIGHTH ST.,  
LOS ANGELES, CALIF.

HUNT & BURNS, Architects,  
LAUGHLIN BUILDING,  
LOS ANGELES, CALIF.

THIS NEW CLASS "A" BUILDING, JUST COMPLETED WITH EVERY MODERN DETAIL, IS FINISHED THROUGHOUT WITH BRININSTOOL'S QUALITY PAINT PRODUCTS.

All interior plastered walls and ceilings finished with **Vel-Va-Cote** (soft tone) Sanitary Wall Finish.

All lockers finished with **San-a-Cote**, semi-gloss, sanitary, washable wall finish.

All interior cement floors waterproofed and beautified with Brininstool's **Cement Floor Enamel**.

Interior oak trim and furniture finished with **Flexi-cote Rubbing and Polishing Varnish**.

THIS IS ANOTHER ADDED TESTIMONIAL TO THE LONG LIST OF SATISFIED USERS OF BRININSTOOL QUALITY PRODUCTS.

THE BRININSTOOL COMPANY

WALL FINISH SPECIALISTS

908 SOUTH MAIN STREET

LOS ANGELES, CALIF.

STATEMENT OF OWNERSHIP, MANAGEMENT, CIRCULATION, ETC., REQUIRED BY THE ACT OF CONGRESS OF AUGUST, 24, 1912,

Of The Building Review, published monthly at San Francisco, Calif., for April 1st, 1923.

State of California, County of San Francisco—ss.

Before me, a Notary Public, in and for the State and County aforesaid, personally appeared Howard Hoyt, who, having been duly sworn according to law, deposes and says that he is the Business Manager of The Building Review, and that the following is, to the best of his knowledge and belief, a true statement of the ownership, management (and if a daily paper, the circulation), etc., of the aforesaid publication for the date shown in the above caption, required by the Act of August 24, 1912, embodied in section 443, Postal Laws and Regulations, printed on the reverse of this form, to-wit:

1. That the names and addresses of the publisher, editor, managing editor, and business managers are:

Publisher, The Building Review Company, 426 Chronicle Building, San Francisco.

Editor, Harris Allen, 426 Chronicle Building, San Francisco.

Industrial Editor and Business Manager, Howard Hoyt, 426 Chronicle Building, San Francisco.

2. That the owners are: (Give names and addresses of individual owners, or, if a corporation, give its name and the names and addresses of stockholders owning or holding 1 per cent or more of the total amount of stock.)

Harris Allen, 426 Chronicle Building, San Francisco.

A. Hoffman, 345 Battery street, San Francisco.

J. A. Drummond, 1744 Folsom street, San Francisco.

H. R. Braden, 50 Main Street, San Francisco.

3. That the known bondholders, mortgagees, and other security holders owning or holding 1 per cent or more of total amount of bonds, mortgages, or other securities are: (If there are none, so state.)

None.

4. That the paragraphs next above, giving the names of the owners, stockholders, and security holders, if any, contain not only the list of stockholders and security holders as they appear upon the books of the company but also, in cases where the stockholder or security holder appears upon the books of the company as trustee or in any other fiduciary relation, the name of the person or corporation for whom such trustee is acting, is given; also that the said two paragraphs contain statements embracing affiant's full knowledge and belief as to the circumstances and conditions under which stockholders and security holders who do not appear upon the books of the company as trustees, hold stock and securities in a capacity other than that of a bona fide owner; and this affiant has no reason to believe that any other person, association, or corporation has any interest direct or indirect in the said stock, bonds, or other securities than as so stated by him.

5. That the average number of copies of each issue of this publication sold or distributed, through the mails or otherwise, to paid subscribers during the six months preceding the date shown above is (This information is required from daily publications only.)

HOWARD HOYT, Business Manager.

Sworn to and subscribed before me this 9th day of April, 1923.

D. B. RICHARDS,

(SEAL)

(My commission expires May 26, 1925.)

INDEX OF ADVERTISEMENT

	Pages
ASBESTOS SHINGLES AND BUILDING LUMBER .....	VI-IX
ASBESTOS CORRUGATED SHEATHING .....	VI-IX
ASBESTOS ROOFING .....	VI-IX
BARS, REINFORCING .....	XVI-O. B. COVER
BRICK, FIRE AND REFRACTORIES...	V
BRICK, PRESSED .....	V
BUNGALOW PLAN BOOKS.....	XIV
CEMENT .....	IV
ENAMEL .....	I. S. FRONT COVER-I-XIV
FURNITURE—SCHOOL, LODGE AND CHURCH .....	III
FLOORING .....	XIX
GLASS .....	I-XV
HEATERS .....	III
INTERIOR DECORATORS.....	X-XIV
IRONING BOARDS .....	XIX
KITCHEN—SINKS .....	III
LANDSCAPE ENGINEERS .....	X
LUMBER .....	XIX-X
MACHINERY AND SUPPLIES.....	XIV
MILL WORK .....	VIII-X
NURSERIES .....	X
ORNAMENTAL IRON .....	O. S. BACK COVER
PAINTS, ENAMELS AND WOOD FINISHES .....	I. S. F. COVER-VIII-III-XIV VIII
PLUMBING EQUIPMENT.....	XI
PIPE, WOOD.....	VIII
PORTABLE HOUSES .....	VIII
REINFORCING STEEL .....	XVI-O. S. BACK COVER
ROOFING .....	VI-IX-XIX-VII
SAND .....	XIV
SCHOOL FURNITURE .....	III
SEWER PIPE AND CLAY PRODUCTS. V	
SLATE .....	IX
SLIDING DOORS .....	XIX
SINKS .....	III
TANKS—WOOD .....	XIX
TERRA COTTA .....	V-III-I. S. B. C.
TILE .....	V-III-I. S. B. C.
TILE—ROOFING .....	V
TILE—HOLLOW .....	V
TIN .....	XX
TREES, PLANTS AND SHRUBS.....	X
VARNISHES .....	I. S. FRONT COVER VIII-I-XIV
WALL BOARDS .....	III
WATER HEATERS.....	III
WATERPROOFING .....	I. S. FRONT COVER-I
WINDOW SASH (Steel) .....	XVI-O. S. BACK COVER
WOOD FINISHES.....	I. S. FRONT COVER-III

DEL MONTE -- FAN SHELL BEACH  
 CLEAN  
 WHITE SAND

Del Monte Properties Company  
 Sutter 6130 Crocker Building San Francisco

Braden Printing Co.  
 50 Main St., San Francisco

Clay Products  
 Gladding, McBean & Co.

SAN FRANCISCO  
 LINCOLN  
 LOS ANGELES

CUTS BY GRAPHIC ARTS ENGRAVING CO.  
 345 Battery St., San Francisco

# Welfare of the Rising Generation



Boys and girls may owe to the architect, to a large extent, the robust physiques and alert mentality they attain with youth. Sunshine and air are indispensable and dominant influences in behalf of growing youngsters. The architect can perhaps do as much as any other human agency in assuring that they get it. The playhouse, play room or nursery should have an extra area of window glass, to the extreme limit allowed by heating considerations,

A fitting finish to well drawn plans, involving an assurance of plentiful air and sunshine, is to specify American Window Glass Company's Products. An assurance of beauty, clear vision and strength is thus added.

American Window Glass is carefully graded under double inspection, well flattened and of uniform strength. Architects who know this will, of course, not fail to specify American Window Glass Company's Products and not just "single or double strength glass."

For your protection and assurance of quality this long ellipse appears on every box of genuine American Window Glass, together with the grade marking, A, or B. Specify the best and see that you get it.

## AMERICAN WINDOW GLASS CO.

GENERAL OFFICES: PITTSBURGH, PA.

BRANCHES IN PRINCIPAL CITIES

Exterior of playroom window frame. Sunlight and ventilation were foremost thoughts.

862 Mission Street, San Francisco, Calif.

### ARCHITECTS' BULLETIN

(Concluded from Page 70)

posed of Officers and members of each of the Chapters of the Institute, members of the Royal Institute of British Architects, members of other architectural organizations, painters' and sculptors' societies, workers in the Allied Arts, and craftsmen interested in building.

A later announcement will be made as to the detail arrangements. The procession will march on the two sides of the Lagoon to the meeting point on the plaza in front of the Memorial. Electric lighting, in the sense of obtaining the utmost in dramatic effect, will be arranged, as well as a suitable musical accompaniment. The co-operation of prominent Government officials has been promised and it is believed that the whole affair can be conducted by befitting the dignity and importance of the Institute and with respect to the important character of exercises appropriate to the award of a medal to the designer of this distinguished Memorial.

It is believed that a national interest in architecture will be stimulated by making this effort of the American Institute of Architects as splendid and as magnificent as possible. Assurance of that result is had in the fact that Mr. Howard Greenley, assisted by Mr. J. Monroe Hewlett, has consented to take charge of the pageant. As you are aware, Mr. Greenley and Mr. Hewlett are not only well known as architects, but have distinguished themselves by being the authors of some remarkably beautiful pageants which have been notable in their dramatic use of costumes and color and brilliant lighting effects.

Special attention is called in the present announcement to the fact that each Chapter is urged by President Faville and the Pageant Committee to provide itself with a banner and pennon as shown in general

design on the accompanying blueprint. It is recommended that the colors of the state in which the Chapter is situated shall be utilized in the design of the banner, which in other respects can be in accordance with the discretion of the designer. Architectural or Chapter seals or other symbolic attributes may be incorporated in the design. Robes of office are considered essential for the heads of Chapters, and it is hoped that provisions can be made for a simple colored blouse or robe for each architect attending the Convention.

Will you not be good enough to take such steps as may be necessary to secure a banner and pennon as a contribution to the occasion. It is proposed that these banners will be in permanent possession of the Institute and be carefully preserved for the use of future Conventions and banquets. It is suggested that the date of the organization of each Chapter be shown on its banner.

Very sincerely yours,  
WM. STANLEY PARKER, Secretary.

### Stillwell PLAN BOOKS of CALIFORNIA STYLE <sup>All Climate</sup> HOMES

—show pictures, Floor Plans and Estimated Costs of Building over 200 Selected Designs.

"West Coast Bungalows"  
50 Houses—6 and 7 Rooms—\$1

"Little Bungalows"  
75 Houses—3-4-5 Rooms—\$1.

SPECIAL OFFER: Send \$2.50 for any three of these books and get Garage Folder FREE.

Books and Blueprints sold with Money-Back Guarantee

E. W. STILLWELL & CO., 790 California Building, Los Angeles



"Representative California Homes"  
50 Houses—7 to 10 Rooms—\$1.

"The New Colonials"  
60 Houses—6 to 10 Rooms—\$1.

## LOS ANGELES BUILDING ACTIVITIES SHOW STEADY INCREASE

BY R. ELLIS WALES

From the steady increase in the number of permits issued to Angelenos since the first of the year, and the attendant valuation, it appears that the original estimate of \$160,000,000 for the year by the Los Angeles Chamber of Commerce will be found conservative in the extreme. The permits issued March 9 totaled 200 flat, with the valuation \$1,100,635, this bringing the total for the first nine days, including Saturday afternoon and Sunday, of the month to \$8,657,987, the permits totaling 1,802. Total for the year up to and including March 9, 10,552 permits; valuation, \$31,996,814.

March indicates, considering certain propositions in the offing, a possible total of \$25,000,000. These figures appear to be sensational, but an inspection by the writer the first of this week, driving through all sections, revealed building activity on nearly every block. Rampart boulevard, for instance, in the heart of the city, unimproved lots held for years for investment, now presents, for three blocks, an array of new flat and apartment buildings whose architecture and color suggest a composite atmosphere of Venice, Italy; Naples and Monte Carlo.

The general building activity, however, is well spread over office, mercantile, industrial and residential structure and it is interesting to note that 39 new industries and commercial houses were established in Los Angeles during January, incomplete tabulations indicating even more for February. Last year new concerns averaged about 1.70 per cent per day.

Some of the workmen here are getting \$11 per day on an average, while \$11 in permit valuation is recorded by the city every second. Continuing this further, it reaches \$668 a minute, \$40,083 per hour, and \$961,998 per day. The total for February for Los Angeles reached \$12,080,310, the same month last year \$7,579,798. With Long Beach, Glendale, Pasadena, Alhambra and Whittier, the Los Angeles figure for the month totals \$17,205,320, which is almost double that of the same month in 1922. Sixteen other towns in Los Angeles county totaled \$1,815,947, thus making the entire total for the county approximately \$19,021,267 for February.

PORTLAND

LOS ANGELES

SEATTLE

## R. N. NASON & CO.

PAINT MAKERS

151 Potrero Ave.—SAN FRANCISCO—436 Market St.

Makers of

**NASON'S OPAQUE FLAT FINISH**

A flat oil paint made in soft Kalsomine Tints, that is washable; a practical article for walls, ceilings, etc., that is most economical and durable.

Agency for

Tamm & Nolan Varnish Works High Grade Varnishes and Finishes

Goods made on the Pacific Coast for the climate of this Coast

## BALL BEARINGS

**SKF INDUSTRIES OF CALIFORNIA**

Incorporated

115 NEW MONTGOMERY ST.

San Francisco, Calif.

Phone Sutter 4196

DEEP GROOVE AND SELF-ALIGNING BEARINGS  
HANGER EQUIPMENT

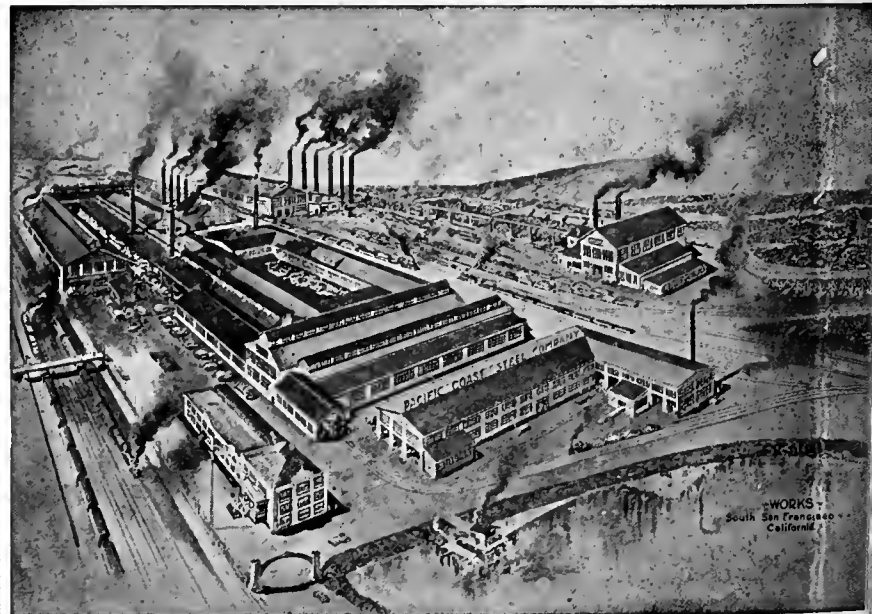

## SHAPES MANUFACTURED

Bolt Rods, Rivet Rods, Wire Rods, Bands, Flats,  
Billets for Forging, Plain Squares, Plain Rounds

Square and Round Corrugated Bars for Reinforcing  
Angles—Equal and Unequal Legs

Stock Lists will be Furnished Upon Request

**Pacific Coast Steel Company**

OPEN HEARTH STEEL PRODUCTS

General Offices, Rialto Building, San Francisco



## SACRAMENTO ANNOUNCES NEW INDUSTRIAL SERVICE

BY A. S. DUDLEY

Sacramento will seriously enter upon a very definite program of industrial development during the coming year. The office organization of the Chamber of Commerce will be shaped to concentrate its principal efforts in that direction. Development of industry is one of the big problems confronting Sacramento today.

Our investigations have revealed that the percentage increase in growth of industry has not been as great as the increase in population. This should not be taken to mean that industries which have been established in Sacramento are not operating successfully. As a fact, these industries have been unusually successful it is shown by an analysis of Federal reports and statistics. Their importance is proved by the census figures showing that of the total value of industrial output—\$46,000,000—approximately \$20,000,000 was added by manufacture. This percentage is higher than that for the State of California taken as a whole.

The reason Sacramento has not made greater industrial strides is because time and effort were centered upon other highly essential local problems. Now, we are prepared to carry on the industrial program. We have started by appointing an industrial advisory committee, the personnel of which includes leaders in various lines of activity. This committee will advise with the Industrial Department of the Chamber of Commerce which will make a comprehensive survey of the industrial situation covering the entire Sacramento Valley with particular regard to raw materials, markets and distribution. Co-operating with the Industrial Department will be a Research and Statistical Department.

During the past five years Sacramento has expended more than \$10,000,000 in public improvements practically all of which will be of direct benefit to industrial establishments. The figure includes \$2,700,000 for a new water pumping and filtration plant which assures industries of one of the essential requirements—an abundant supply of excellent water at unusually low rates. At a cost of millions of dollars one of the power companies serving Sacramento and vicinity has added more than 100,000 horsepower to its plant capacity. Many thousands of dollars have been expend-

(Concluded on Page XVIII)

## BUNGALOW COURT EQUIPPED WITH NEW HEATING APPLIANCES

As an added instance of the popularity of "Firelight," a new and practical gas heater for the fireplace, and Hall Junior Gas Floor Heater, an efficient single unit heating agent, both of which are manufactured by the D. H. McCorkle Co. of Oakland, Calif., the firm of McWethy and Greenleaf, Oakland builders, is installing these heating agents in their new bungalow court series of houses, which includes a square of ten bungalows situated at Jean and Perry streets in Oakland. A "Firelight" gas heater is installed in the living room of every family in the court, while an electrically controlled Hall Junior Gas Heater, placed in the dining room, will keep an even, healthful temperature there and in the kitchen, bedroom and bath.

Scientific tests have demonstrated that the D. H. McCorkle "Firelight" product produces three times as much heat as a gas log four times as much heat as a gas grate, and nine times as much heat as a wood or coal fire. All tests imply "at the same distance" as the other agent in comparison.

One of the reasons for "Firelight's" great heating capacity is that it sends all of the heat out into the room, while a separate flue discharges the combustion products in the chimney. Under intense heat from gas burners placed below them, the composition radiants become an incandescent mass and produces a beautiful old-fashioned driftwood fire effect. This point, coupled with the strong, penetrating heat of the "Firelight," gives it many advantages that are novel in the gas heating field.

Hall Junior Gas Floor Heater is capable of heating three rooms, according to McWethy and Greenleaf. Its intense heat was novelly used by them in drying out the plaster while the houses were in the process of construction. It is a convenient, inexpensive heater which may readily be installed in any home, new or old. Being thirty inches in height, it has a register of fourteen inches square in the floor of the room. This is sufficient to flood a room or suite with air warmed to personal desires.

McWethy and Greenleaf chose "Firelight" for their bungalow court because of the simple and graceful design, which includes andirons to match the heater. The

(Concluded on Page XVIII)

## WINNERS IN HOSPITAL CONTEST ANNOUNCED

Butler & Rodman of New York City received the first prize in the international competition recently conducted by *The Modern Hospital* magazine for the plans of a small general hospital. Three awards of \$500, \$300 and \$200 and two honorable mentions were made.

Second and third places in the contest were won by John Roth of Atascadero, Cal., and Ernst Hoedtke of Cambridge, Mass. Selection was made from 51 sets of plans submitted by hospital architects of the United States, Canada and England, judgment being on the bases of economy in construction and operation, integrity of designs, health values and flexibility.

Cervin & Horn, hospital architects of Rock Island, Ill., were given first honorable mention in the competition, the other honorable mention going to Lemuel Cross Dillenbach of the School of Architecture, University of Illinois.

The jury of award, composed of Dr. S. S. Goldwater of New York, Asa S. Bacon of Chicago, Clarence H. Johnston of St. Paul, William Buck Stratton of Detroit and Miss Adelaide M. Lewis of Kewanee, Ill., met in Chicago in March to study the plans.

Announcement of the winning architects will be made in the April issue of *The Modern Hospital*, and in the succeeding number will appear the prize plans with the interpretations of the judges. Subsequent publication, with critical comments, will be made of fifteen or twenty other of the more interesting designs for their educational value.

Mr. Charles Butler, who drew the design awarded first place, is a graduate of Columbia University and of the Ecole des Beaux Arts in Paris. He is a fellow of the American Institute of Architects Chevalier of the Legion of Honor, France; Officer of St. Sava, Serbia, and the president of the New York chapter of the American Institute of Architects. He and his firm have planned a number of important hospitals in New York and the East, as well as abroad.

## ANNOUNCEMENT

Lloyd Rally, architect, announces the opening of his offices at 1019 Wright & Candler Building, Fourth and Hill streets, Los Angeles. Telephone 12681.

## LARGEST ROOFING ORDER SHIPPED TO ORIENT

The largest single order of roofing ever shipped to the Orient left San Francisco March 20 for Bombay, India, on the steamer Diana Dollar.

The shipment consists of 51 carloads of reinforced Malthoid Roofing for Pabco Roofs and will be used on the warehouses of the Port Trust Cotton Depot, Bombay, India.

It was manufactured by The Paraffine Companies, Inc., in their Emeryville plant, which is the largest single roofing plant in the world.

(Concluded from Page XVII)

"Firelights" installed were finished to harmonize with the color scheme of the bungalow interiors.

On the "Firelight," a patented grid that prevents back-firing into the gas chamber; a patented burner that insures proper gas combustion in a quiet but intensely hot flame; a handy orifice thumbscrew, which permits the office to be cleaned in an instant without distributing the adjustment of the burner, and a convenient valve lever, placed at the side of the heater where it may be safely and comfortably turned by hand, are some of the excellent features.

All of the McWethy and Greenleaf bungalows are built in the four-room arrangement. The attractive double-quintette of cheery, warm houses has been occasioning much interest in continental side real estate circles. Having two gas heaters for four rooms is a forward stride in this type of comfort appointing.

(Concluded from Page XVII)

ed for improvements on the Sacramento River, the importance of which is indicated in government figures showing that approximately one million tons of commerce are carried on this stream annually.

The tremendous increase in population on the Pacific Slope, for which Sacramento is an ideal distributing center by reason of its geographical location, and the equally great increase in volume of agricultural, mineral and timber production, is constantly improving the market and supply of raw materials for articles manufactured in Sacramento.

Now that Sacramento has prepared itself with complete requirements demanded by industries, we will devote the greater part of our activity toward attracting and securing manufacturing plants.



# “A Stitch in Time Saves Nine”

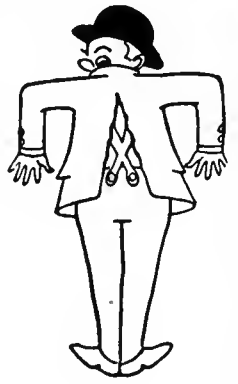

**R**OOFs are like clothes—allow the small holes and rips to go unmended and serious trouble is sure to ensue.

And, like clothes, the best materials are the cheapest in the long run. Whether you use tin for the entire roof or for lining valleys and gutters, it will pay you to specify

## TARGET AND ARROW

Look for this Trade  Mark on every Sheet

### ROOFING TIN

made by an old Welsh process of hand-dipping that gives it that extra-heavy, closely knit coating which has enabled it to withstand the ravages of the weather for generations. No need for patching and mending roofs of Target and Arrow for they outlast the buildings they cover.



**N. & G. TAYLOR CO.**

Offices: Philadelphia, Pa.

Mills: Cumberland, Md.

Established 1810



SUMMIT APARTMENTS

## PITCHER'S DISAPPEARING DOORS ADJUSTABLE HANGERS AND FRAMES

---

MEET THE DEMAND  
FOR APPEARANCE,  
QUIETNESS AND  
DURABILITY

---

NO EXTRA WALL THICKNESS REQUIRED

Manufactured by

## NATIONAL MILL & LUMBER COMPANY

318 MARKET STREET SAN FRANCISCO, CAL.

## PROCRASTINATION STEALS MORE THAN TIME

We all know the story of the man who didn't shingle his roof because the sun was shining and so it wasn't necessary. Of course, when it started raining he didn't like to climb up on the roof because he'd get wet.

At the beginning of 1923 the sun is still shining. Even though building is already active, and railroads are even now suffering a car shortage, the demand is not so heavy nor the car shortage so stringent that present requirements cannot be filled in a reasonable time.

But once the rain starts the man whose roof isn't shingled is going to get wet—even if he stays inside his house smoking his pipe.

Business students tell us we face a year of unprecedented building. The productive capacity of the cement industry is ample to handle an increase of even 50 per cent more than the heaviest demand of any individual year so far—ample to take care of the probabilities of the year in which we now are. But transportation is the neck of the bottle.

Railroad executives warn us "there is at present a serious transportation shortage" and "the shortage will doubtless continue." Not only building, but other business activities are on the increase—and will demand their share of the railroads' already overburdened facilities.

Those who wish to build, those who wish to supply the materials for building, will do wisely to make sure of their supplies beforehand. This always wise policy was probably never so vital as in the present season—for the season has already started.

The protection such a policy affords is twofold. When a car shortage produces a scarcity of any commodity, the laws of supply and demand frequently raise the price. But far more essential is the ability of the dealer to supply materials to his trade, the ability of the builders to continue building. Every man connected with the building industry is all too familiar with the costliness of delay once a structure is actually started.

Briefly, that sums up the problem before us, before you. 1923 is here, a year of promise, a year of opportunity. We face it fully able to supply its demands—if we only plan ahead and prepare accordingly. It promises to be a good year for all of us—but it holds the possibility of being a banner

## UNITED STATES CIVIL SERVICE EXAMINATION

The United States Civil Service Commission announces the following open competitive examination:

### *Checker Draftsman (Architectural)*

The receipt of applications will close May 15. The examination is to fill a vacancy in the Public Works Dept., U. S. Naval Station, Pearl Harbor, Hawaii, at \$8 a day, and vacancies in positions requiring similar qualifications. The appointee to the position at Pearl Harbor will receive, in addition to the salary, an allowance of 96 cents a day while employed at the station. He will be furnished transportation to Honolulu.

The duties are charge of the drafting and checking work on one or more important projects, including responsibility for engineering or architectural features of the design, or other comparable supervisory work.

Competitors will not be required to report for examination at any place, but will be rated on their education, training and experience on a scale of 100. Full information and application blanks may be obtained from the United States Civil Service Commission, Washington, D. C., or secretary of the board of U. S. civil service examiners at the postoffice or custom house in any city.

## BUREAU OF STANDARDS TO MEASURE FATIGUE OF STONE

It has long been known that a load much below its apparent breaking strength would cause failure of stone after a long time. The Bureau of Standards is now undertaking a series of tests to determine the extent of this effect and to see how much load can safely be borne by stone for indefinite periods.

Samples of stone will be tested both in straight compression and in bending. Loads will be put on and left there, and the deflection of the stone will be measured from time to time.

Marble has the peculiar quality of sagging slowly, even under its own weight. Thus many cases are known in which marble slabs placed in horizontal position for a hundred years or so have sagged down several inches; and thin tombstones of marble have bent over.

---

year for the far-sighted man. It is to that man we are addressing this word.—From "The Building Outlook for 1923," Atlas Cement Co.

*Recent Work of Harwood Hewitt*

THE  
BUILDING  
REVIEW

SAN FRANCISCO  
PUBLIC LIBRARY



MAY, 1923

Vol. XXIII

No. 5

*Published in San Francisco*

*Price Twenty-five Cents*



Entrance to Main Book Room  
**PAUL ELDER'S BOOK SHOP**  
 San Francisco, California  
 GEORGE BONELLI, Decorator

C. C. DAKIN, Architect  
 BERNARD MAYBECK, Consulting Architect

Finished  
 Throughout  
 With

**Kyanize**  
 KY-AN-IZE

Celoid  
 Finish

Our new books "Recent Pacific Coast Architecture" and "Recent Eastern Architecture",  
 containing Practical Specifications, mailed on application

**Boston Varnish Company**  
 KY-AN-IZE

Office and Warehouse  
 1551 MISSION STREET  
 SAN FRANCISCO, CALIFORNIA  
 A. L. GREENE, Local Manager

Distributors for Southern California  
 SUNSET PAINT COMPANY  
 627 SOUTH MAIN STREET  
 LOS ANGELES, CALIFORNIA

# THE BUILDING REVIEW

VOL. XXIII

MAY, 1923

No. 5

## CONTENTS

COVER—RESIDENCE OF MR. W. P. HANSON, FLINTRIDGE, CALIFORNIA. HARWOOD HEWITT, ARCHITECT.

### PLATES AND ILLUSTRATIONS

#### THE WORK OF HARWOOD HEWITT

	Plate
MARION GRAMMAR SCHOOL, Los Angeles, California.....	133
OWENSMOUTH GRAMMAR SCHOOL, Owensmouth, California.....	134, 135
CHEREMOYA SCHOOL, Los Angeles, California.....	136
JUNIOR HIGH SCHOOL, Ontario California.....	136
PALMS GRAMMAR SCHOOL .....	137
24th STREET SCHOOL, Los Angeles, California.....	137
PAROCHIAL SCHOOL, Hollywood, California.....	138
CHATSWORTH GRAMMAR SCHOOL .....	138
FRANKENFIELD STORES, Los Angeles, California.....	139
LOFT BUILDING FOR MR. HARRIS, Los Angeles, California.....	139
RESIDENCE OF MR. JAS. SHULTZ Los Angeles, California.....	140, 141, 142
RESIDENCE OF MR. W. P. HANSON, Pasadena, Calif.....	143, 144, 145, 146, 147
RESIDENCE OF MR. LYNCH, Los Angeles, California.....	148

### TEXT

	Page
THE CREATIVE INSTINCT, by Harris Allen.....	71
SUBURBAN HOME OF ENGLISH COTTAGE TYPE, by Clara Fassett....	75
EDITORIAL .....	76
THE EDITOR'S BOOK SHELF.....	VII
ARCHITECT'S MONTHLY BULLETIN .....	81
WASHINGTON CHAPTER A. I. A. ....	XX

### INDUSTRIAL DEVELOPMENT

NEW HOME FOR GEO. H. TAY COMPANY.....	79
MONO-RAIL CONVEYING SYSTEMS IN DEMAND.....	VII
UNITED STATES CIVIL SERVICE EXAMINATION.....	XV
CONDITIONS IN COMMON BRICK INDUSTRY.....	XVI
REWARD FOR OLDEST SHINGLE.....	XVII
BIDS ASKED FOR NEW COURTHOUSE.....	XVII
LINOLEUM ADAPTED IN MODERN HOMES.....	XVIII
STUDENTS IN ARCHITECTURE AWARDED PRIZES.....	XX

HARRIS ALLEN, Editor

HOWARD HOYT  
Industrial Editor  
And Business Manager.

SIDNEY J. WOLF  
Advertising Manager

Published Monthly by the Building Review Company,  
Chronicle Building, San Francisco, California

Address All Communications to No. 426 Chronicle Building, San Francisco, California

Yearly subscription—United States, \$2.50—foreign, \$3.00. Single copies, 25 cents.

Entered as second-class matter in the San Francisco Postoffice under the Act of August 24, 1912. Previously entered as "The Architect."

The editors will be pleased to consider contributions of interest to the Industry. When payment of same is desired, this fact should be stated.

News stands and dealers supplied through San Francisco News Co., San Francisco, Calif., or American News Co., New York, N. Y.

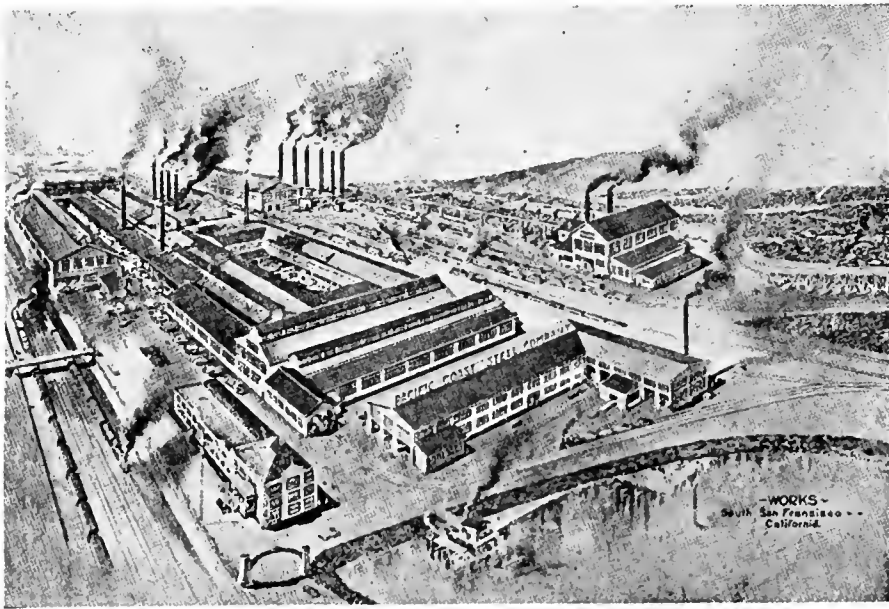

## SHAPES MANUFACTURED

Bolt Rods, Rivet Rods, Wire Rods, Bands, Flats,  
Billets for Forging, Plain Squares, Plain Rounds

Square and Round Corrugated Bars for Reinforcing  
Angles—Equal and Unequal Legs

Stock Lists will be Furnished Upon Request

## Pacific Coast Steel Company

OPEN HEARTH STEEL PRODUCTS

General Offices, Rialto Building, San Francisco



Homes at "Sea Cliff," San Francisco—exteriors finished with Concreta  
Allen & Co., Architects W. A. Farrell, Painting Contractor

## SPECIFY CONCRETA

*for Concrete, Stucco  
or Brick Homes*

CONCRETA is a reliable, damp-proof coating for surfaces of Stucco, Concrete or Brick. It is widely used by Architects who have given careful thought to the matter of selecting the best coating for these surfaces.

CONCRETA satisfactorily covers rough surfaces, adheres where ordinary lead and oil paint would not hold and, in drying, forms a tough elastic film that provides a dependable protection.

### *Specifications*

Dark shades, particularly Dark Grays, should be thinned for first coat with as much Pure Boiled Linseed Oil as possible without impairing the hiding qualities of the paint. Second coat should be thinned with a mixture of one part Pure Linseed Oil and two parts Coal Oil.

Two thin coats of Concreta, brushed out well, will look better and wear better than two heavy coats. Not less than two coats should be applied. For the first coat on new surfaces, thin each gallon of Concreta with from one to two quarts of Pure Boiled Linseed Oil. For second coat thin each gallon of Concreta with one-half pint of pure Raw Linseed Oil and from one to two pints of Coal Oil.

Fuller Service Department will be glad to furnish architects with specific or special information on Concreta.

# FULLER

PAINTS  VARNISHES

W · P · FULLER & CO ·

San Francisco  
Oakland  
Sacramento  
Stockton  
Fresno  
Los Angeles  
Hollywood

Pasadena  
Long Beach  
San Diego  
Santa Monica  
San Bernardino  
Santa Ana  
Portland

Boise  
Salt Lake City  
Seattle  
Tacoma  
Spokane  
Yakima  
Walla Walla

**FIREPROOF**  
**Gates Hotel**  
**Los Angeles**  
**300 ROOMS**  
**250 BATHS**  
OUR OWN CAFÉ  
RATES FROM **\$1.50** PER DAY  
*Holladay & Collins*  
Owners.  
Sixth  
at Figueroa



EDITOR'S BOOK SHELF

**T**HE Next-to-Nothing House."\*

It is impossible to resist the spontaneity and naive enthusiasm of the author's description of her home, as she takes you through, room by room, in a very personally conducted tour. She is a lover of antiques, and her home is an old New England cottage which has housed Daniel Webster and other celebrities, and now shelters a collection of old furniture whose acquisition at bargain prices the author frankly and triumphantly details.

Many illustrations show the exercise of good taste and considerable discretion in arranging these pieces, and deciding the accessories of wall and floor coverings, hangings, color schemes and so on. The author's personality makes the book interesting, even so far from its natural environs. Many people will find useful suggestions herein.

\*—"The Next-to-Nothing House," by Alice van Leer Carrick, The Atlantic Monthly Press, Boston.

**STORM KING STUCCO**

**CRACK-PROOF!**

It is unreasonable to expect a thin veneer of cement plaster, totally unaided by reinforcement or expansion joints, to withstand even the slightest building strain without checking or cracking.

Storm King Stucco is composed of minerals, most of which are inert. The magnesite and magnesium chloride are the binder materials, and when set are elastic, while a stucco made from cement, gypsum or lime is brittle. **STORM KING STUCCO IS GUARANTEED BY THE MANUFACTURER TO BE CRACK-PROOF.**

Our Catalog is on the press, reserve your copy today.

**FOR A PERMANENT BUILDING SPECIFY STORM KING STUCCO**

**Storm King Stucco Co.**

JOHN F. SHANLEY, Pres.

Sefton Bldg.

San Diego

Crack - Proof — Weather - Proof — Fire - Proof



Genuine Hyloplate Backboards  
Mouthrop Movable Desks  
Sheldon Manual Training Benches  
Domestic Science and Laboratory Furniture

**C. F. WEBER & CO.**  
Exclusive Agents

SAN FRANCISCO  
RENO

LOS ANGELES  
PHOENIX

**BATCHELDER TILES**

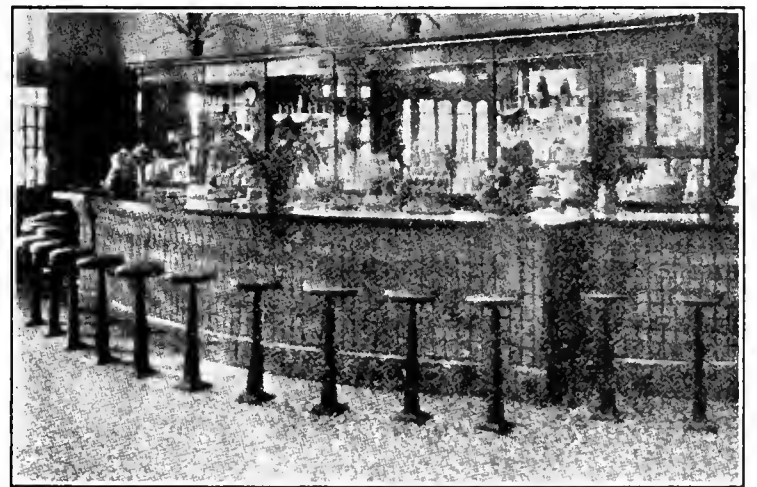

A Tile Counter offers an exceptional opportunity for the use of a design rich in variation of form and color. For a candy store or a drug store such a counter is an attraction worth considering.

**BATCHELDER-WILSON CO.**

2633 Artesian Street

Los Angeles

**No Roof  
come - back  
when you specify**

**PABCO**

**10 & 20 year**

**ROOFS**

**which require the use of**

**FLOATINE**

**The improved roof asphalt  
that will not soften  
run, leak or slide.**



**PABCO  
PRODUCTS**

**The PARAFFINE  
COMPANIES, Inc.**

SAN DIEGO  
OAKLAND

LOS ANGELES  
PORTLAND

SAN FRANCISCO  
SEATTLE

# The BUILDING REVIEW

VOL. XXIII

SAN FRANCISCO, MAY, 1923

No. 5

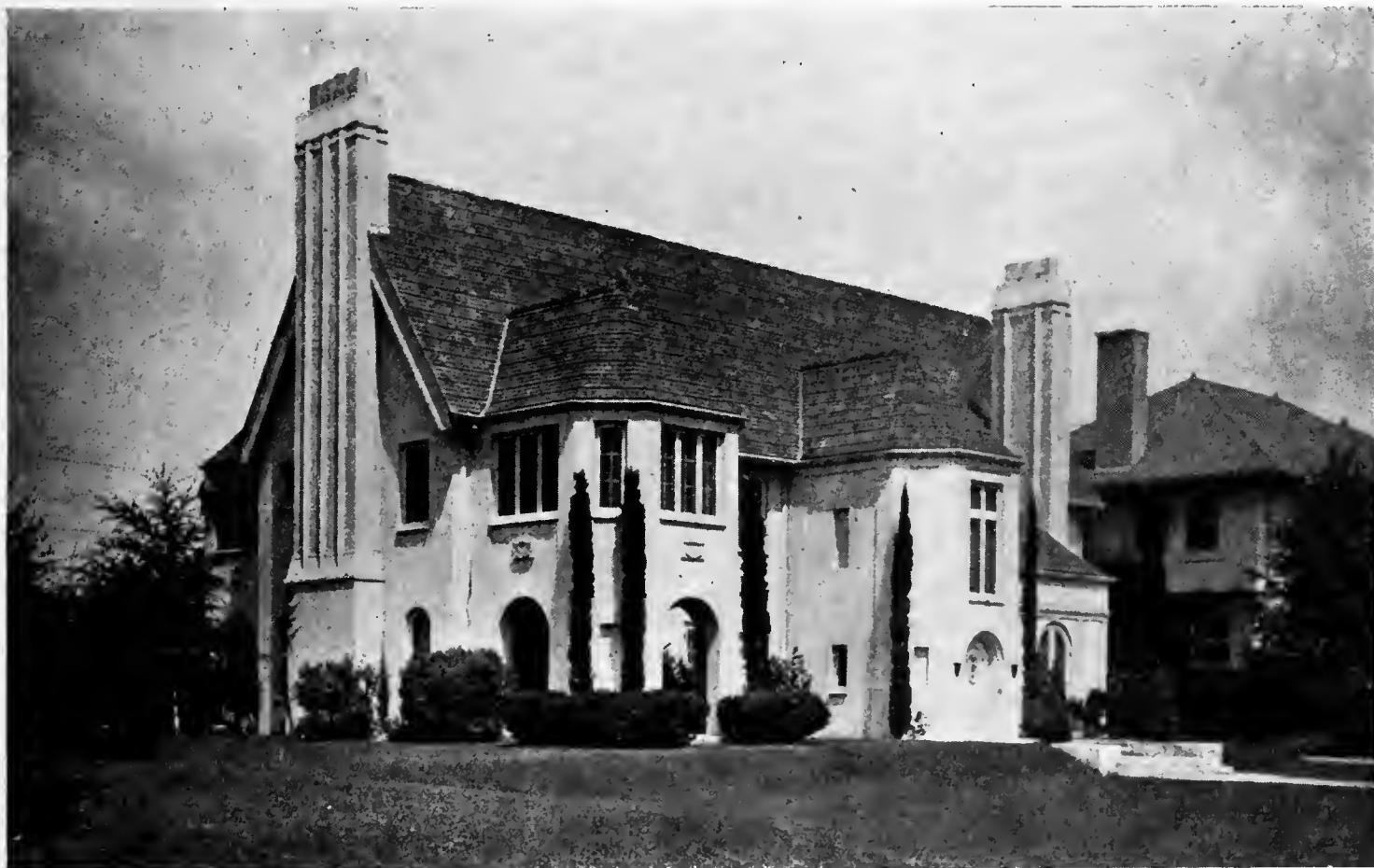

RESIDENCE OF MR. GLOVER,  
LOS ANGELES, CALIFORNIA.

## The Creative Instinct

By HARRIS ALLEN

“YOUR old men shall dream dreams.  
your young men shall see visions.”

Since the prophet Joel, twenty-eight centuries have flown by, during which many young men have seen visions, and some have seen them come true. The joy of seeing one's mental picture brought into being—the exquisite travail of a thought—these moments are rare, are given to comparatively few mortals. The world is richer for these visions made real. In painting,

sculpture, architecture, these have been sources of inspiration, of a higher civilization. The audience does, surely, profit by the artist's genius.

Here and there through our new western world are shooting up sparks of this divine fire, the creative instinct. We do not always recognize the truth; nor are visions daily visitors. But where Beauty has been welcomed and honored she may well come now and again.

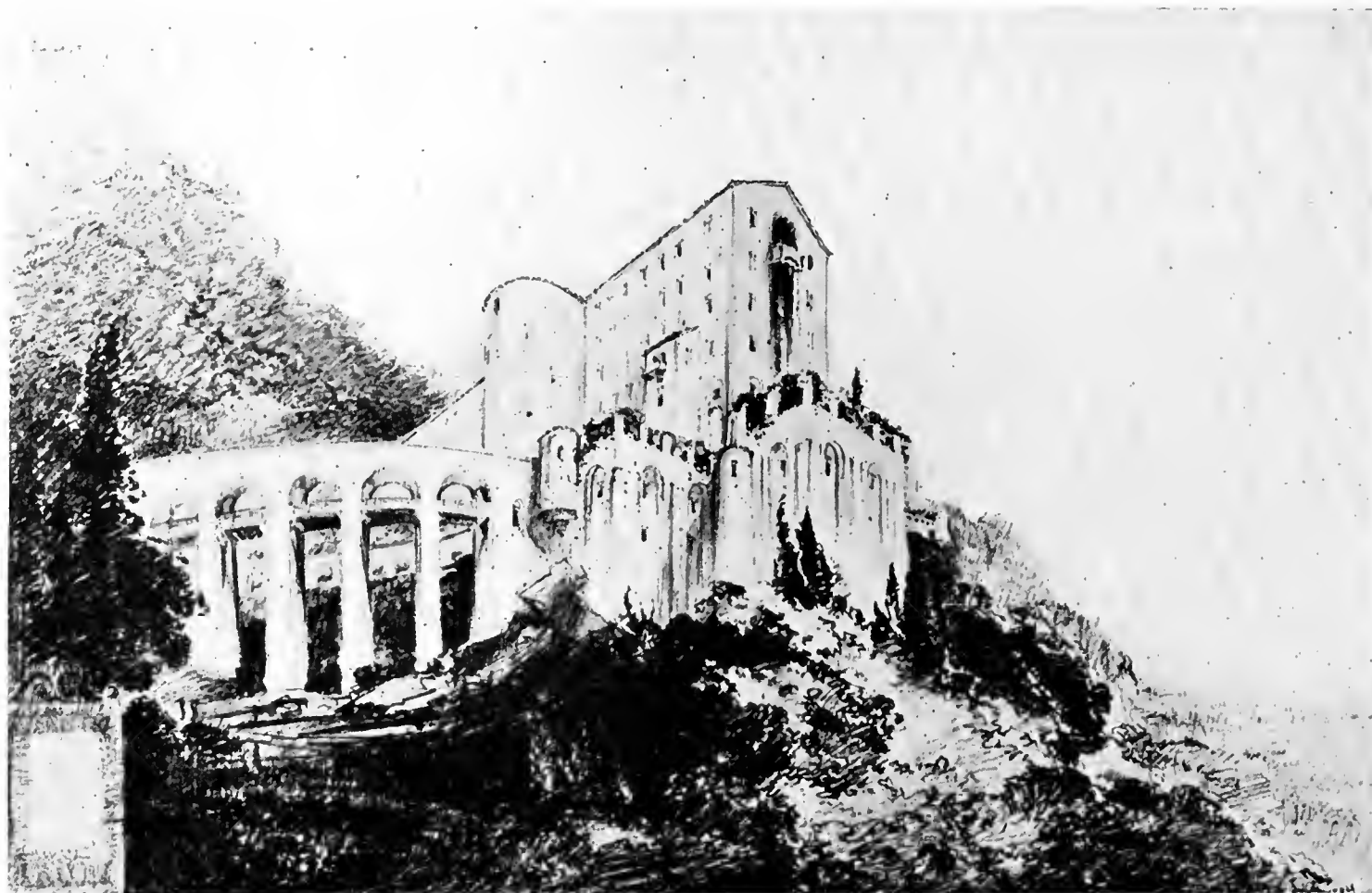

MAIN WING, PROPOSED HOTEL IN HOLLYWOOD HILLS



MAIN ENTRANCE VESTIBULE,  
 MARIAN GRAMMAR SCHOOL,  
 LOS ANGELES, CALIFORNIA.

These thoughts, and others in this vein, call for utterance when one is faced with a real work of art. Harwood Hewitt, young architect of Los Angeles, has created some real works of art. His products are uneven: there are buildings credited to him which it is hard to believe he had any part in designing. Of these are most of the schools: with many good points, with some weak features, such as spots of incomprehensible ornament, they lack special distinction. We may except the designs shown only in sketch form, for the Ontario High School and the Parochial School. These have the impressiveness and beauty of solid mass and well proportioned openings. In fact, the Parochial School is likely to become a new model for wall design, if it is carried out as Mr. Hewitt knows how. I hope it will, for the good of us all.

The same note of sturdiness and sincerity is carried into his few commercial buildings, but still it is obvious that all these practical structures are what is inelegantly known as "pot-boilers."

Some years ago photographs of a modest house, in Los Angeles, by Harwood Hewitt, were published, and received much attention. It was both praised and criticized; it was a bold departure from all the canons of

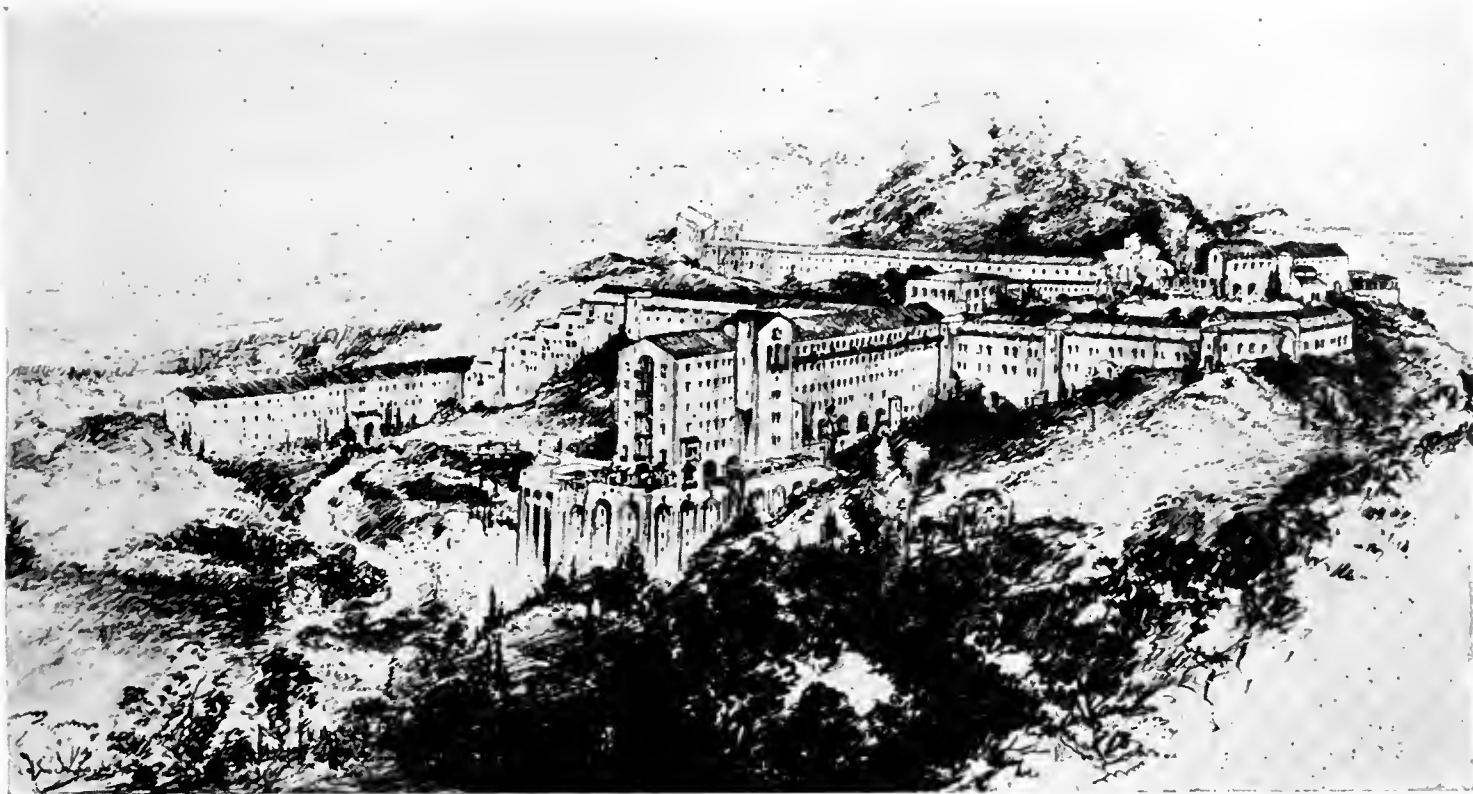

PROPOSED HOTEL IN HOLLYWOOD HILLS

current work, and could not be overlooked. In it were shown clearly the love for lines of height which has characterized Mr. Hewitt more and more.

With practise, and confidence, he has grown more eloquent. The Glover house was more suave. The Schultz house nearly hit the bulls-eye; it has been published all over the country, and is admired more, perhaps, than any other house in the city. It is wonderfully charming both in mass and detail, and in texture and color, and in fascinating unexpected bits of pure design here and there. But one must confess, after a time, the sense of a difference in scale between the corner containing the Great Hall or Studio, and the rest of the house. Lovely as it is, it is not perfect, because it lacks perfect harmony and unity.

Such a shadow of criticism can not be cast upon the house for W. P. Hanson. It is hard to see how any one could find a flaw in the composition of this delightful structure. It is Romance made real; a Vision incarnate. And how marvellously exact the reproduction of the vision! Compare the architect's sketch with the photograph of the finished building; seldom, if ever, does one see such striking similarity, down to the most minute detail of shadow, of planting, of reflection. One does not need to be told that Mr. Hewitt had charge of the entire scheme, including garden design and decorative treatment, both indoors and out.

The house lies along a ridge from which

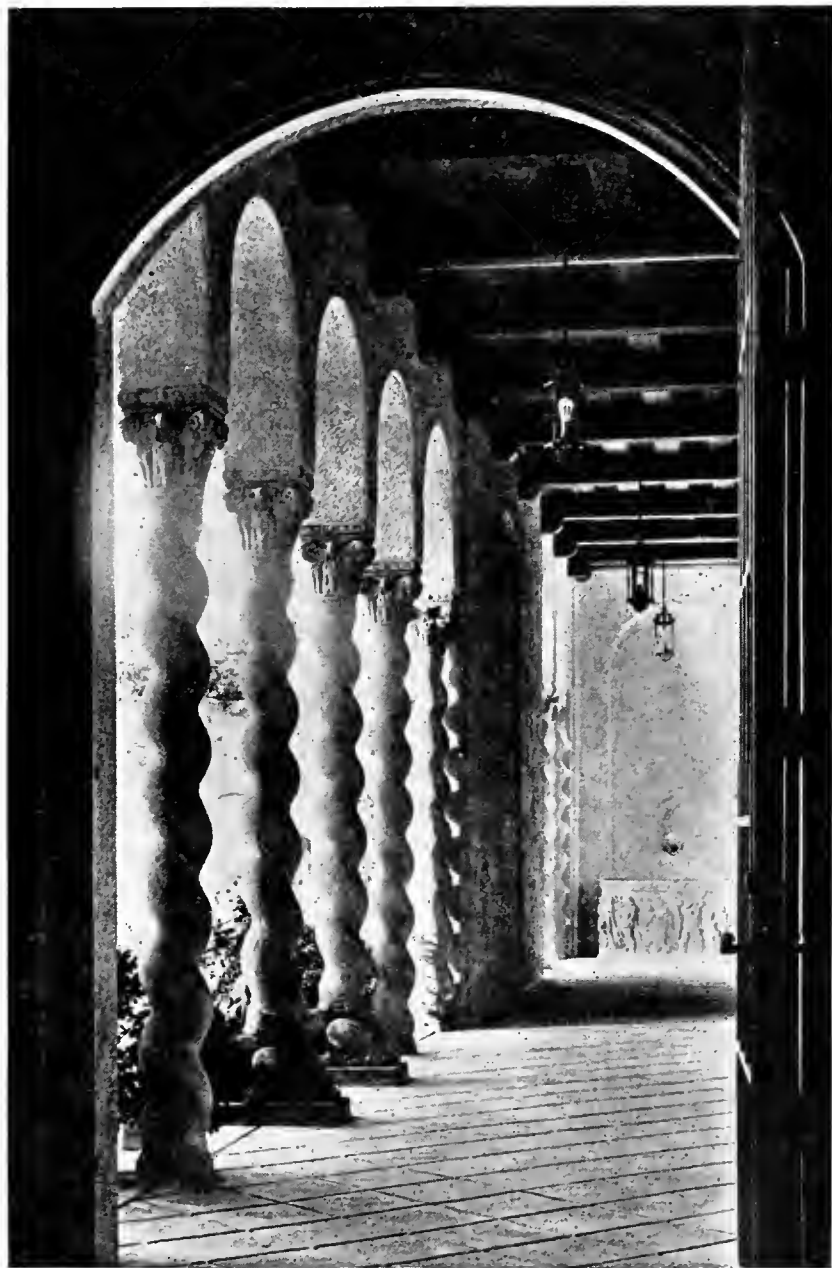
VESTIBULE,  
RESIDENCE OF MR. JAMES SHULTZ,  
LOS ANGELES, CALIFORNIA.

the ground falls away in every direction. The view from terrace and tea-house is over a wide and splendid expanse of valley, bounded on the far side by the Sierras. Only a portion of the grounds is shown in the plan. It is a superb site, to whose contours the picturesque profiles of the building have been wedded with consummate skill. The entourage of trees and shrubs and accessory planting leaves nothing to be desired; art is the handmaiden of Nature.

Within, the Great Hall carries on the note of romance, with its noble height and quiet, almost austere, dignity of treatment.

As a conception of pure beauty, this house is one of the most noteworthy structures that has been erected in America.

The proposed hotel in the Hollywood

hills reveals the same inspirational quality. Suggestive of a great Alpine Monastery, it clings to the contours of the hills, rising tier upon tier and thrusting its crest "unbelievably high into air." This is a vision yet to be realized, a project of great scope, but one to which the designer of the Hanson house is assuredly equal.

A hacienda for Mr. Lynch, built of adobe by Mexican labor, has caught the quaint charm of its type—in its way, it is a very perfect thing. The play of shadow on wall, the inviting gateway hinting at cool recesses beyond, the surrounding, sheltering trees—all go to make up an alluring picture, a vision of content, as these other products of Mr. Hewitt's creative instinct are visions of aspiration.



RESIDENCE OF MR. EHRBAR,  
LOS ANGELES, CALIFORNIA.  
HARWOOD HEWITT, Architect.

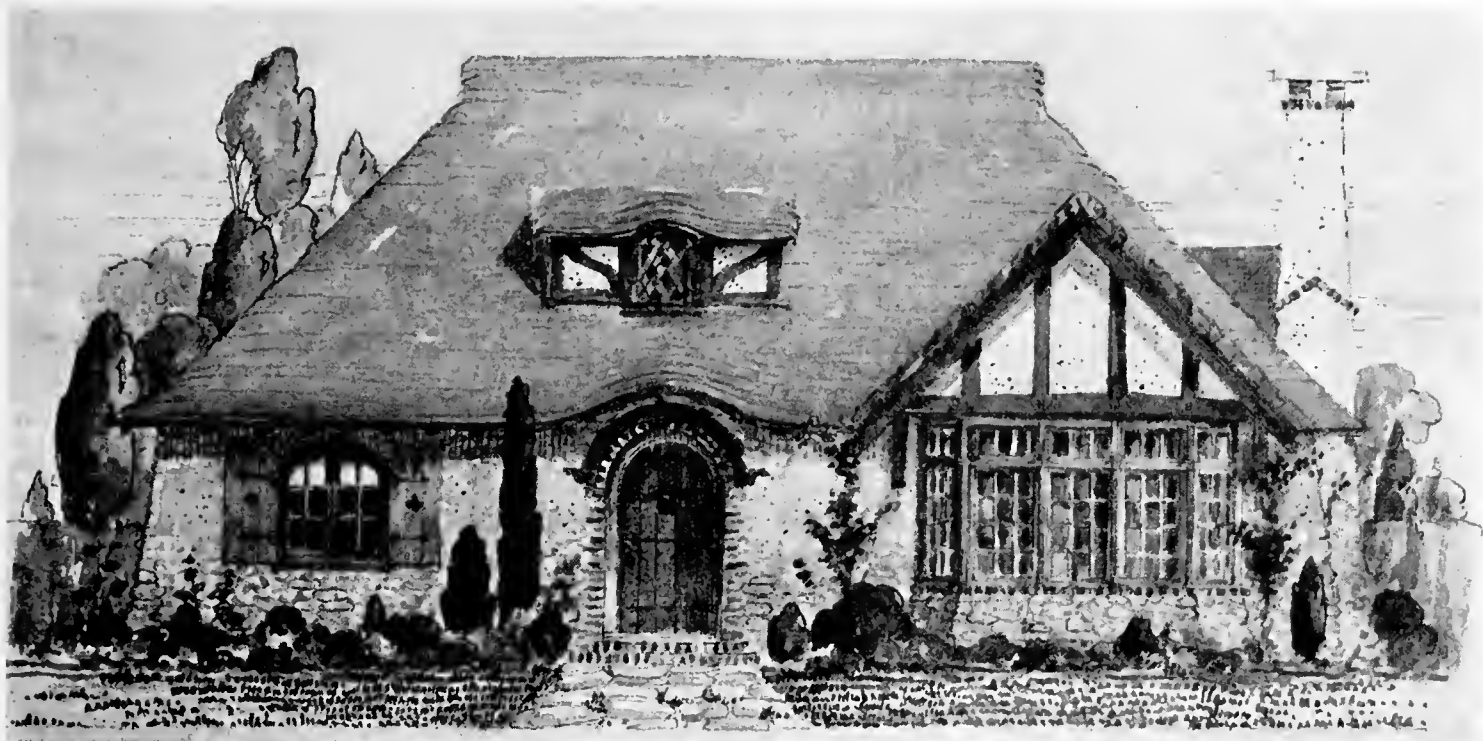

A SUBURBAN HOME,

HAROLD G. STONER, Architect.

## A Suburban Home of English Cottage Type

By CLARA FASSETT

**I**N DESCRIBING California houses, the type which naturally suggests itself is the adapted Spanish or Mexican or perhaps the modified Italian. So many examples of these, set amidst semi-tropical gardens are found throughout this state. And in the little home-cottage or bungalow, whichever it is, many are the examples of beautiful simplicity, convenience and economy of space to be found in this style of dwelling.

Since the small house has come to stay, to avoid monotony in design we have gone abroad to search for inspiration, for of course there is less chance for variety in a dwelling of from four to nine rooms than in a house of fifteen or twenty. Since we have discovered picturesque and home like qualities in the peasant cottages of Europe, we have now the Swiss Chalet (adapted) for our hillside sites; French peasant houses, English cottages, modernized and equipped with the indispensable modern devices for lightening the labor of house-

work which must necessarily be done with the help of one servant, or in many cases with none. Successful and charming, moderate in cost, adding variety and interest to our suburban landscape, the growing individuality of the small house has converted many a casual renter to an enthusiastic home-owner.

The house described here is a modified English Cottage style. The word "cottage"—to Americans—means a small inexpensive dwelling of temporary sort, or a summer house; the Englishman, however, builds a simple and unostentatious home planned to follow no particular architectural style, but to suit his ideas of a comfortable house with an exterior arrangement of beauty and symmetry subordinated to the interior idea, and calls it a cottage though the cost may run into five or six guineas.

As the accompanying illustration shows, the feeling of this cottage is of a rather small compact house whose beauty lies in

(Continued on Page 78)

## EDITORIAL

**T**HE San Francisco Chapter, American Institute of Architects, has gone on record as favoring open competitions for public buildings.

From the standpoint of pure theory, of essential equity, there can be no question about this. In a free democracy, every citizen is entitled to compete for public work, providing he has met all requirements of law and government for ability to perform such work.

One objection to the open competition is based upon the uncertainty as to proof of such ability. All states do not require licenses to practice architecture, and it is obvious that a young draftsman or a student has not the requisite practical knowledge to execute an important building, however gifted he may be artistically.

This contention fails to take into consideration the judgment of the jury. To an experienced architect, and no jury can lack such technical advice, the drawings tell the story of a man's training. It is impossible to deceive a capable jury as to knowledge of construction and material. If, however, a brilliant design stands out above others sufficiently to be given first place, and still shows evidence of inexperience and inadequate practical knowledge, it is easy enough to associate with the winner another man to supply that deficiency.

Memory refuses to recall any young, unknown architect who has won a competition and failed to execute it satisfactorily. Yet they would shut this gate in a young man's face! Almost the only outlet to early success. And our communities are far from being surfeited with works of genius. If a young man has the inherent ability to win out in an open competition—the better for the public!

The other voiced objection relates to the expense sustained by the architects in preparing drawings. This happens to be great, **only**, in established offices with large overhead expense. And since it is by no means compulsory to enter any competition, the loss in these cases hardly calls for sympathy.

The educational effect of competitions is unmistakable, as any architect will admit after the natural disappointment of losing has subsided. The country still echoes with the discussions following the Chicago Tribune competition. Hysterical wails of woe alternate with enthusiastic paeans of praise. Who shall decide when doctors disagree? But at any rate, a standard of beauty has been raised, and countless thousands of minds have advanced in some appreciation of the tenets of good architecture.



HOTEL,  
ALBUQUERQUE, NEW MEXICO.

TROST & TROST,  
Architects and Engineers.



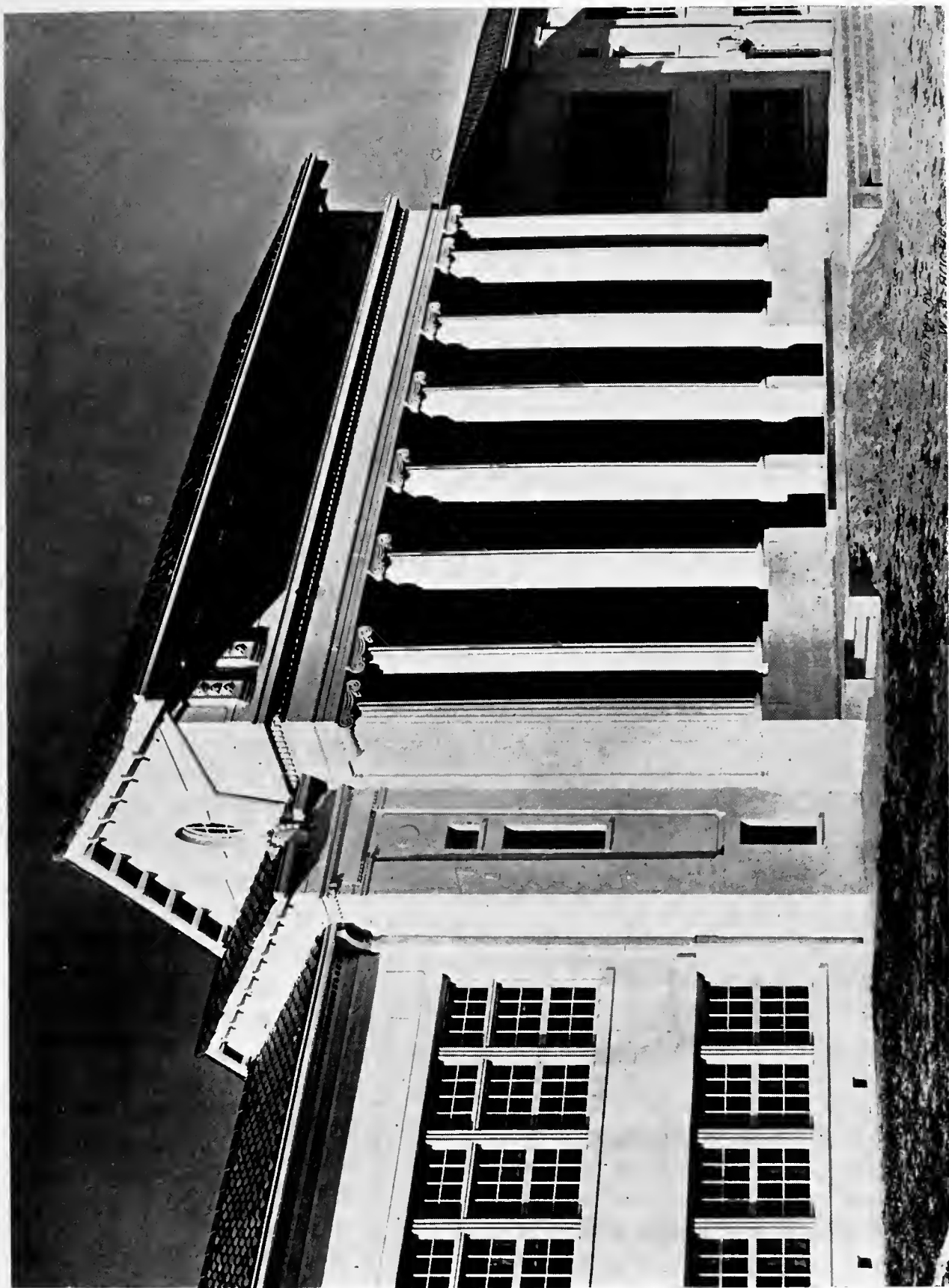

MARIAN GRAMMAR SCHOOL,  
LOS ANGELES, CALIFORNIA.  
HARWOOD HEWITT, Architect.

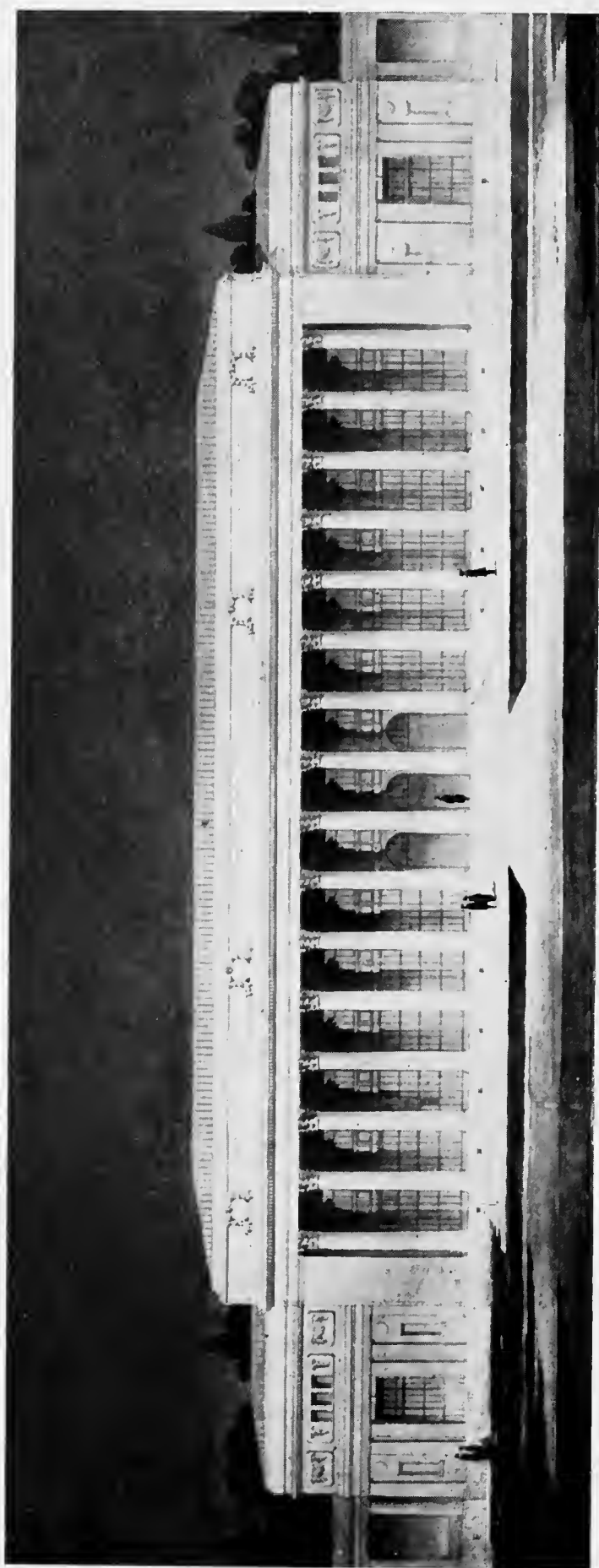

OWENSMOUTH HIGH SCHOOL,  
OWENSMOUTH, CALIFORNIA.  
HARWOOD HEWITT, Architect.  
O. P. DENNIS, Supervising Architect.

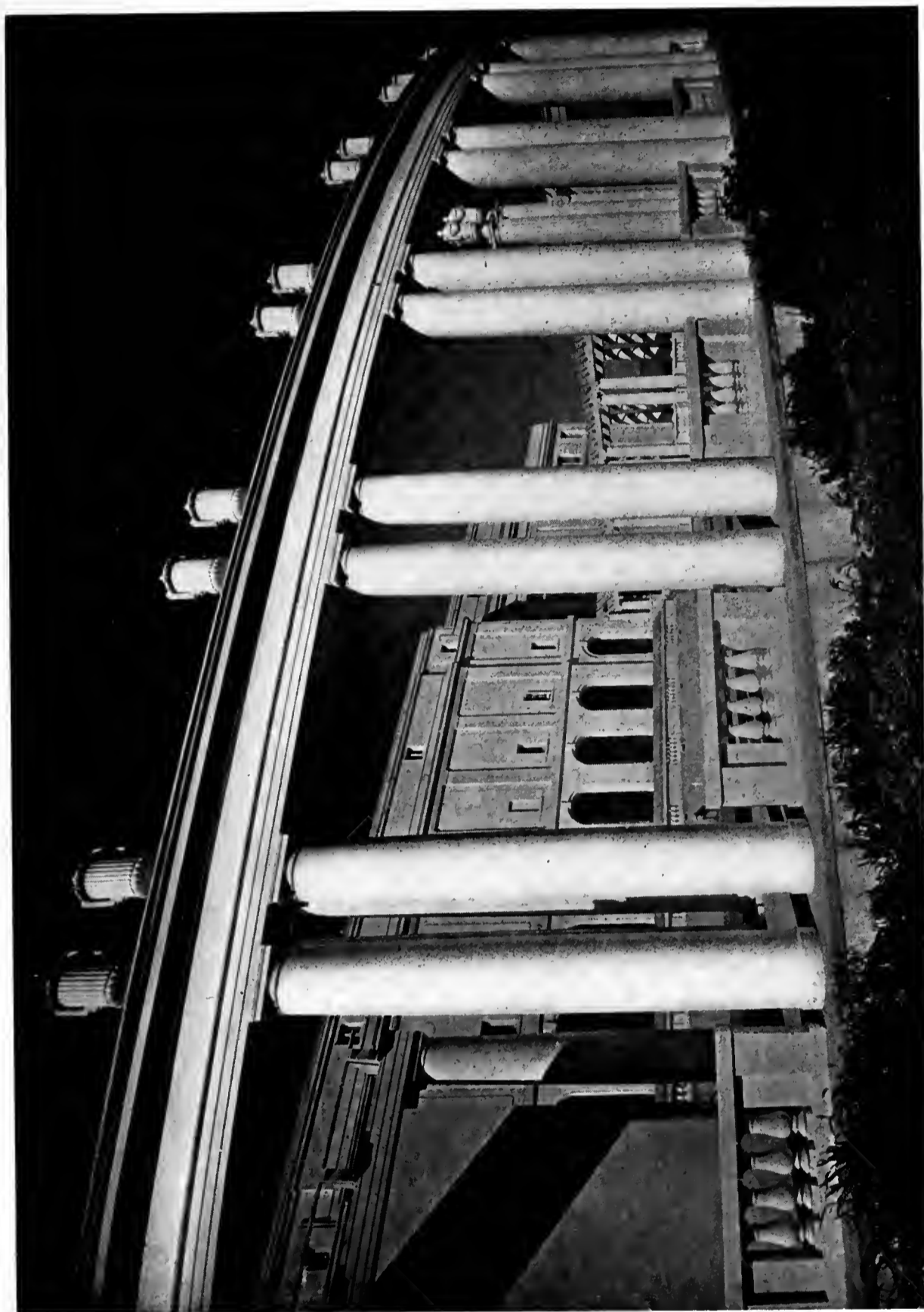

WENSMOUTH HIGH SCHOOL,  
WENSMOUTH, CALIFORNIA.  
ARWOOD HEWITT Architect.  
P. DENNIS, Supervising Architect.

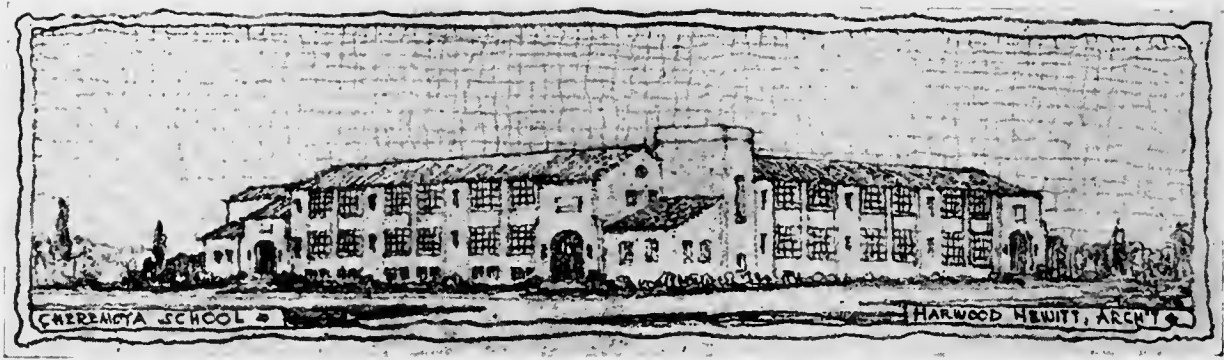

CHERMOYA SCHOOL,  
LOS ANGELES, CALIFORNIA.  
HARWOOD HEWITT, Architect.



JUNIOR HIGH SCHOOL,  
ONTARIO, CALIFORNIA.  
HARWOOD HEWITT, Architect.



PALMS GRAMMAR SCHOOL,  
HARWOOD HEWITT, Architect.  
O. P. DENNIS, Supervising Architect.



4th STREET SCHOOL,  
LOS ANGELES, CALIFORNIA.  
HARWOOD HEWITT, Architect.  
O. P. DENNIS, Supervising Architect.



PAROCHIAL SCHOOL,  
HOLLYWOOD, CALIFORNIA.  
HARWOOD HEWITT, Architect.  
M. L. BARKER, Associate.



CHATSWORTH GRAMMAR SCHOOL,  
HARWOOD HEWITT, Architect.  
O. P. DENNIS, Supervising Architect.



FRANKENFIELD STORES  
LOS ANGELES, CALIFORNIA.  
HARWOOD HEWITT, Architect.

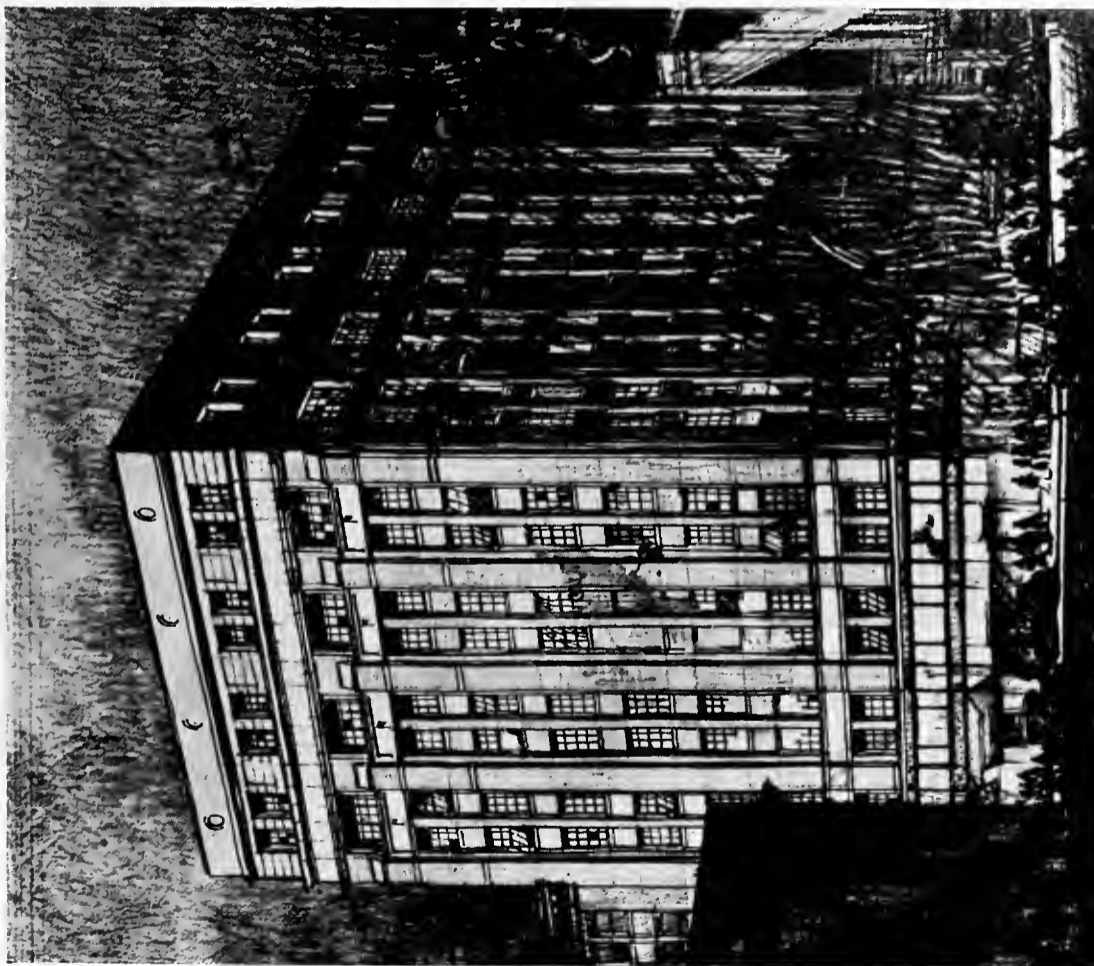

LOFT BUILDING FOR MR. HARRIS,  
LOS ANGELES, CALIFORNIA.  
HARWOOD HEWITT, Architect.



RESIDENCE OF MR. JAS. SHULTZ,  
LOS ANGELES, CALIFORNIA.  
HARWOOD HEWITT, Architect.





RESIDENCE OF MR. JAS. SHULTZ,  
LOS ANGELES, CALIFORNIA.  
HARWOOD HEWITT, Architect.



MAIN HALL TOWARD ENTRANCE,  
RESIDENCE OF MR. JAS. SHULTZ,  
LOS ANGELES, CALIFORNIA.  
HARWOOD HEWITT, Architect.



REAT HALL,  
ESIDENCE OF MR. W. P. HANSON,  
LINT RIDGE, PASADENA, CALIFORNIA.  
ARWOOD HEWITT, Architect.



PERSPECTIVE STUDY OF GARDEN FRONT.

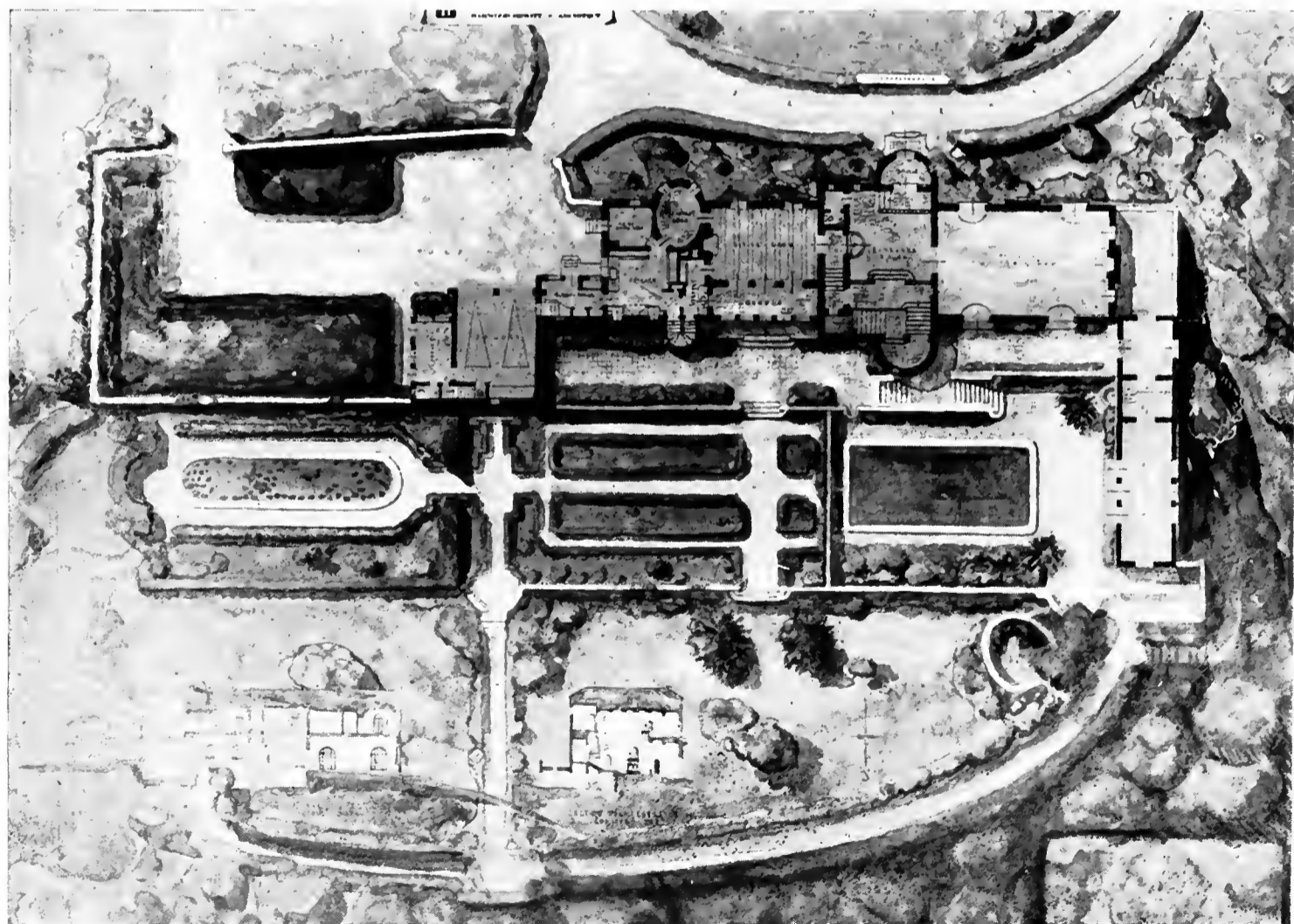

PLAN OF HOUSE AND GROUNDS,  
RESIDENCE OF MR. W. P. HANSON,  
FLINT RIDGE, PASADENA CALIFORNIA.  
HARWOOD HEWITT, Architect.



GARDEN FRONT,  
RESIDENCE OF MR. W. P. HANSON,  
FLINT RIDGE, PASADENA, CALIFORNIA,  
HARWOOD HEWITT, Architect.



MAIN ENTRANCE FRONT,  
RESIDENCE OF MR. W. P. HANSON,  
FLINT RIDGE, PASADENA, CALIFORNIA.  
HARWOOD HEWITT, Architect.



TEA HOUSE TERRACE.  
RESIDENCE OF MR. W. P. HANSON,  
FLINT RIDGE, PASADENA, CALIFORNIA.  
HARWOOD HEWITT Architect.



RESIDENCE OF MR. LYNCH,  
LOS ANGELES, CALIFORNIA.  
HARWOOD HEWITT, Architect.



# THE BUILDING REVIEW

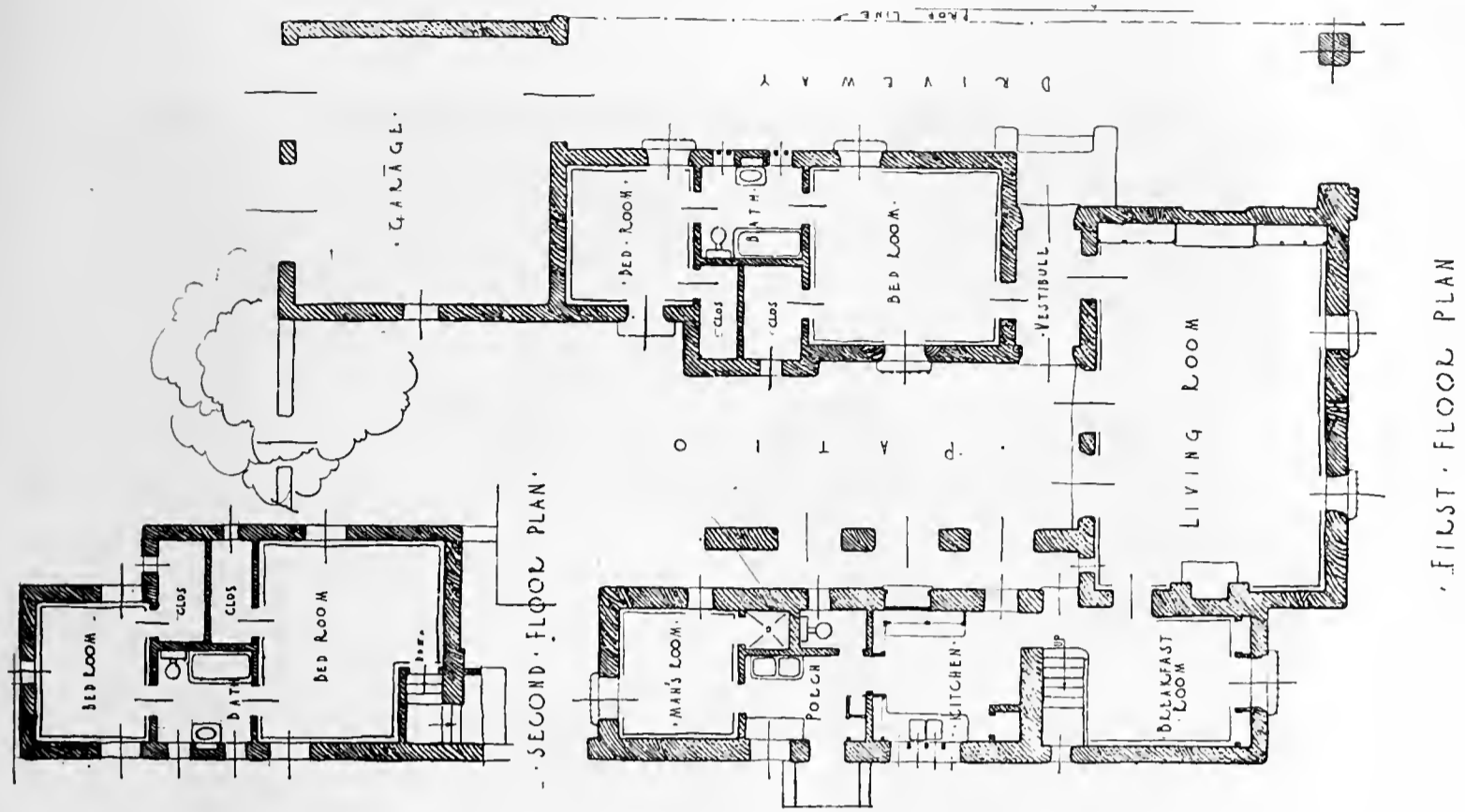

RESIDENCE FOR MR. LYNCH,  
LOS ANGELES, CALIFORNIA.  
HARWOOD HEWITT, Architect.

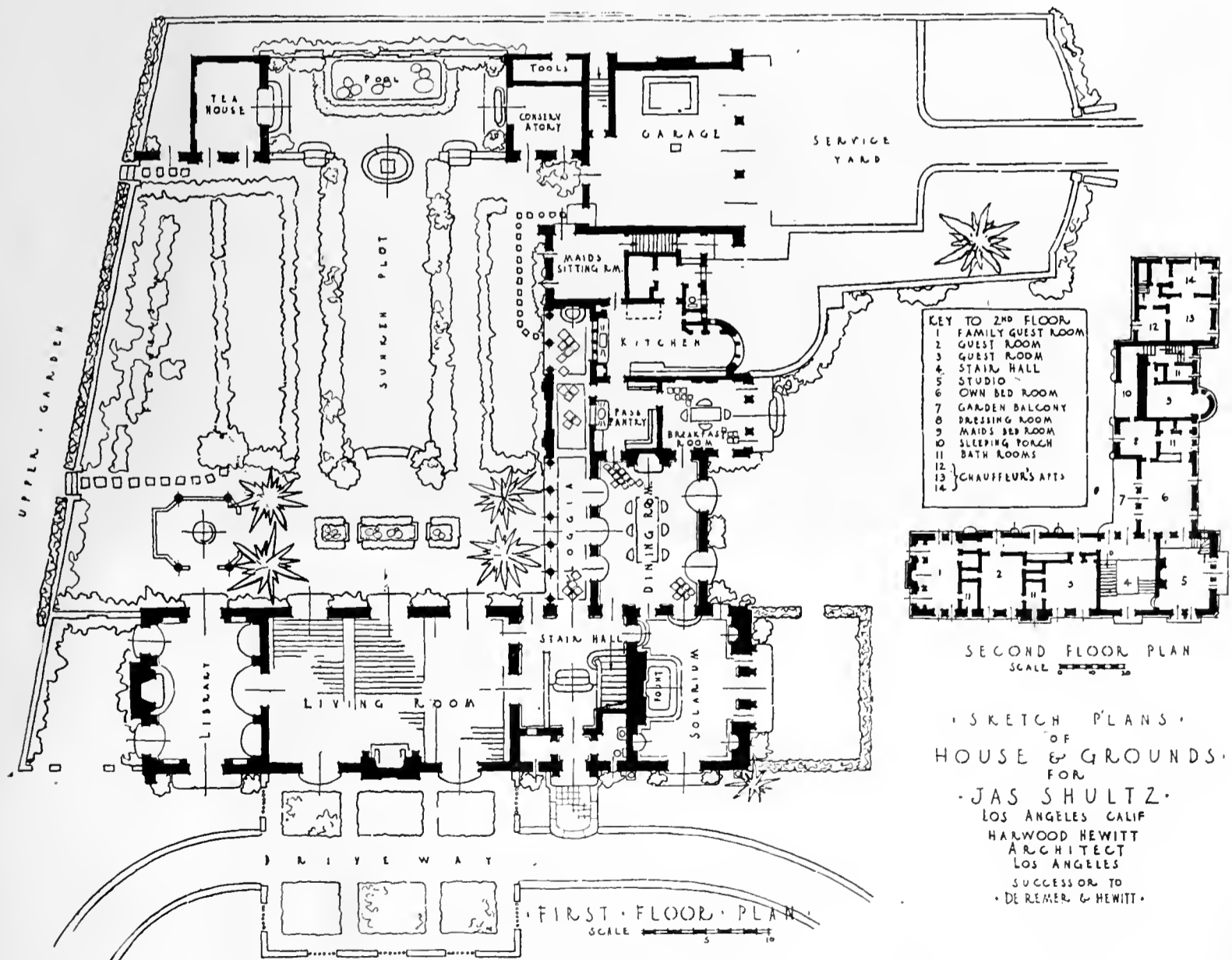



SIDE VIEW.

HAROLD G. STONER, Architect.

(Concluded from Page 75)

its proportions, the material used in construction, and the extremely convenient arrangement of its units. Built of cobblestones with red brick trim, or of stucco in cream, buff or grey with just sufficient color to suggest the subtle toning which Time gives, and with the half-timber portion of weathered oak sand-blasted—the house will be distinctive. Shingles or clapboards would of course be out of keeping with the whole idea. Then, too, while the cost of exterior plastering is slightly more than shingled or clapboarded siding the upkeep of the latter would more than offset the initial expense of the plaster. There is an air of solidity about this house with its slightly spreading base and over-hanging eaves. When built of stone it seems to declare itself for permanency, announces that it is here to stay for more than one generation. Many small houses look so “temporary”; they have a sort of Canary Cottage expression of a gay and colorful but capricious personality. Today with a red roof and blue trimmings; tomorrow that is a little out of date—shall we have an orange roof with black and white trim, or shall we build a new house?

To build a home, even though small and avoid the fad of today, but to incorporate in suitable materials something that shall last until tomorrow and a little beyond, has been the aim of the designer of this house. Harold G. Stoner, the architect, embodies in

his design the true English feeling for comfort and convenience—plus effective and pleasing exterior. The house plan is rectangular, broken by the addition of sleeping and rear porches, and is provided for enlargement in the attic area which contains front and rear dormer windows. These attic rooms need not be finished with the first construction, but may be completed later at comparatively little expense. The outstanding feature of the layout is the easy accessibility of the main rooms to each other, by means of an inner hall which connects the two parts of the house, bed-room section and living-room quarters, and thus obviates the necessity of passing through one room to get to another. The entrance is approached by a cement flagstone walk which leads to the tiny brick paved porch. The doorway is interestingly bordered with brick and sheltered by an arch of room. Reception hall opens to living-room at the right, while directly back is the inner hall into which lead the kitchen, bed-rooms and stairway. The sleeping portion is cut off from the living-room part by cement plastered arches. The floor of living-room, dining-room and hall are to be of natural pressed cork in two tones of brown. Besides the two ground-floor bed-rooms is a sleeping porch which may be used as a nursery or play-room. Off the dining-room is a sun parlor, delightful in its black and white linotile floor and gay window boxes. French doors which separate it from the dining-room can be folded so as to throw the two

rooms into one when extra dining space is needed in entertaining.

In the kitchen convenient relationship of sink to cupboards and stove is noted; also that it is somewhat more roomy than is usually thought necessary in a small house. The stairway leading from the kitchen opens on the landing of the main stairway, which logically places the servant's quarters upstairs where there is ample headspace for two rooms besides bath and sleeping deck.

As to the cost of building, this of course varies in different localities. In California for good construction about \$1000 per room is the present rate. The shingle-thatch roof, which is one of the most typical features of an English country cottage, costs about five or six hundred dollars more than an ordinary shingled roof. If stucco is used a hand trowelling effect is interesting. Many times a house-builder prefers to use the best of materials and cut down the initial expense by adding extra features such as sleeping porches and attic rooms later. To many an adventure in home-planning this

is part of the charm of house-building, to start with a plan that may be added to as he feels he can afford it. This gives him something to look forward to. House-building is, after all, an adventure like traveling abroad, or marriage. Who wants to see the end of adventure? So we are happier and more satisfied if we can look forward to adding something to our house or our garden.

Color as used about this house, red in brick trim and tinted roof shingles, the odd little shutters of green, give the satisfying touch which completes the picture. One of America's best known architects, says: "The difference between an ugly house and a beautiful one is caused entirely by the form, arrangement, proportion and color of the detailed parts." And I do not consider that he put color last because of its least importance. When this house is carried out in a pleasing color scheme, and complemented by a landscape setting laid out according to a definite and harmonious design, it will prove a most successful example of "transplanted architecture."

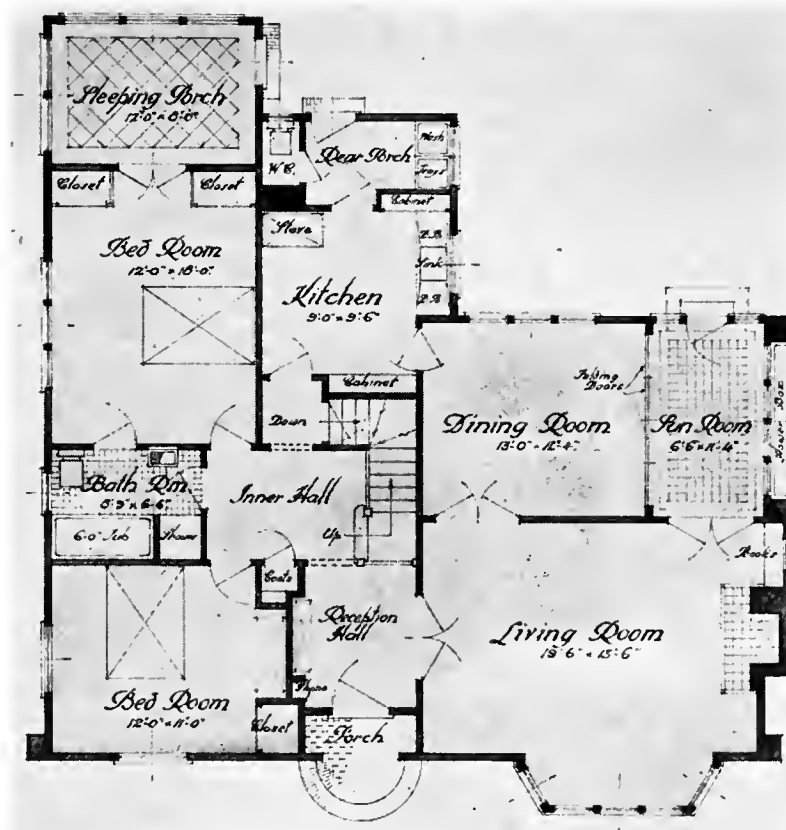

PLAN OF SUBURBAN HOME.

# INDUSTRIAL DEVELOPMENT

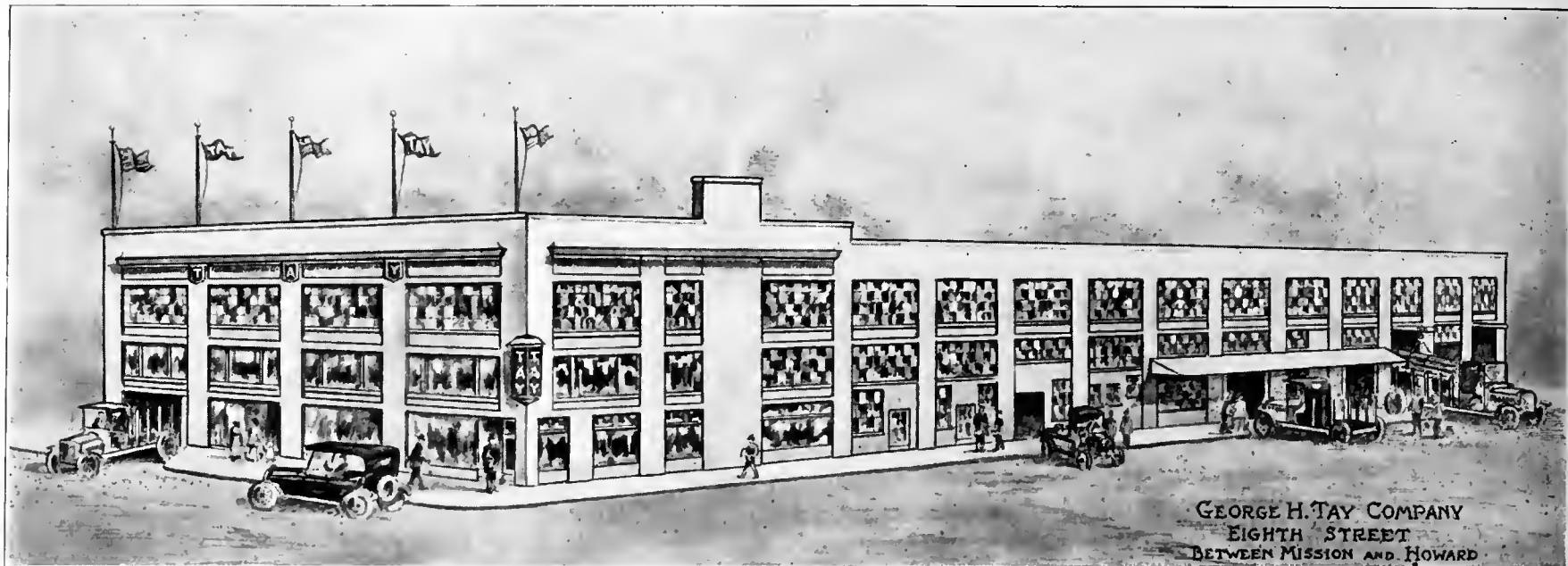

NEW HOME OF GEO. H. TAY COMPANY,  
SAN FRANCISCO, CALIFORNIA.  
KRAFFT & SONS, Architects and Engineers.

## George H. Tay Company Builds New Home

One of San Francisco's Oldest Mercantile Firms Pioneers  
a New Wholesale District

Congested streets and traffic conditions are driving the large supply houses which carry large stocks of heavy material away from the downtown section of San Francisco. George H. Tay Company, one of the first to make the move, are pioneers in a new district having just completed the construction of a modern and practical supply house building on Eighth Street, between Mission and Howard Streets.

### New Home a Monument to Efficiency

As one views the new Tay Home it is readily seen that every effort has been put forth to make this supply house the last word in efficiency and convenience in taking care of a large volume of business.

The building is seventy-five feet in width and two hundred and seventy-five feet in length. It is two stories in height and built of reinforced concrete of the flat slab type. A mezzanine floor covers over one-fourth of the first floor and a large basement affords ample boiler accommodations.

The offices are on the first floor, in the front section of the building. Above, on the mezzanine floor, is a spacious sample

room where a complete line of samples are on display. In back of the offices is the city call-delivery counter. Also, in this room are the bins containing such stock as malleable, cast iron screwed and drainage fittings and nipples, also soil pipe fittings and valves of all kinds. In back of the city room is a vast room containing the shipping department and the stock room. Here are stored the stock of cast iron soil pipe and wrought steel pipe in sizes from  $\frac{1}{8}$ " to 16". The brass goods are stored on the mezzanine floor and the entire second is used for the company's stock of enameled iron and vitreous china ware as well as galvanized boilers and various other merchandise.

### Modern Equipment

The building is equipped with Louden Overhead Carrying System and Cantilever Girders for 10-ton hoists to transfer pipe and other heavy materials from the trucks into the building. An Otis Plunger Electric Freight Elevator with 8 ft. by 10 ft. platform and with a capacity of 5000 lbs. moves the heavy freight between floors. A hot water heating system, vacuum cleaning sys-



PIPE STOCK ROOM AND  
COUNTRY SHIPPING ROOM.

RECEIVING ROOM.

CITY SHIPPING AND STOCK  
ROOM AND CITY DELIVERY COUNTER.

tem, incinerator, telephone system, burgler and fire alarm systems, etc., make this building one of the most modern of San Francisco's new industrial buildings.

#### Started in '1849

George H. Tay Company is among San Francisco's oldest concerns, Mr. George H. Tay having come to California from New York City during the gold rush and commenced in business as a mercantile house in October, 1849, at the corner of Montgomery and Washington Streets.

The firm remained at this location until burned out in a serious conflagration, May 4th, 1851, when twenty-one blocks were destroyed. After the fire the company erected what was then considered a thoroughly modern building at 614 to 618 Battery Street, where the business continued under the firm name of George H. Tay & Company.

Some years later the company found it necessary to move into larger quarters on First Street, near Market Street, where they remained until the earthquake and fire of April, 1906. Immediately after this

disaster the company erected two large warehouse buildings in the Potrero district, where they conducted their business until such time as building conditions permitted them to return to the downtown section of the city.

They then located in Mission Street at the corner of Second Street, where they have been until the first of this month. Their business, both in the plumbing and heating supply line and the pipe, valves and fittings line has grown to such proportions that it was imperative that a new and larger building be constructed for their exclusive use.

All of the employees were interested in the planning and construction of their new home, and many of their ideas for economical and efficient methods of handling and shipping material were incorporated in the design of the new quarters.

The George H. Tay Company are fully confident that when they are firmly established in their new home they will hold an unequalled position in their line of business for efficient handling and shipment of material.

SAN FRANCISCO CHAPTER AMERICAN INSTITUTE OF ARCHITECTS

MONTHLY BULLETIN

OFFICERS

Geo. W. Kelham, President.  
Henry H. Meyers, Vice-President.  
J. S. Fairweather, Secretary-Treasurer.



DIRECTORS

A. J. Evers, two years.  
William Mooser, three years.  
J. H. Blohme, three years.  
Harris Allen, two years.  
S. Schnaittacher, one year.  
Morris M. Bruce, one year.

NEXT MEETING

The next meeting will be held Thursday evening, May 17th, 1923, at the Architectural Club Rooms, 77 O'Farrell Street, at 6:30 p. m. and will be preceded by a Directors' meeting at 5:30 p. m. As this is the last meeting until after the summer vacation of three months it is hoped members make it their duty to attend.

MINUTES

The Directors' and Regular Meeting of the San Francisco Chapter of the A. I. A. was held Thursday evening, April 19th, 1923, in the Architectural Club Rooms, 77 O'Farrell Street. The meeting was called to order by Vice-President Henry H. Meyers. The following members were present:

Harris Allen	S. Schnaittacher
Wm. Mooser	Morris M. Bruce
H. E. Burnett	A. J. Evers
Stanton Willard	W. M. Bliss
E. B. Hurt	Herbert Schmidt
Geo. Ashley	Wm. Newman
Henry H. Meyers	W. J. Wilkinson
J. Stewart Fairweather	

It was moved and carried that the Chapter indorse the Housing Bill passed by the Senate and that the Secretary write the following expressing our approval of same. The Committee on Public Health and Quarantine:

Earnest Dozier, Chairman	L. Fulweider
George Cleveland	Chester Kline
Joseph Pedrotti	C. C. Spaulding
Mrs. Cora Woodbrige	Sidney Graves
T. A. Mitchell	

Moved and carried that the Chapter indorse Supervisor Frank Robb's suggestion for a competition for the Relief

Home, and that the Secretary be instructed to write to him a letter to that effect.

A letter from Senator Burnett in regard building laws read and placed on file.

A letter from the National Conference on City Planning regarding their convention read and placed on file.

CONVENTION

The following were unanimously elected delegates to the Convention at Washington, May 16th, 17th and 18th: Ernest A. Coxhead, Jas. T. Nabett, S. Schnaittacher, Geo. Kelham, and all the other Institute members of the Chapter were elected alternates.

It was proposed and carried that the San Francisco Chapter participate in the Pageant and that W. B. Faville be appointed a committee of one to design and order a banner for the San Francisco Chapter.

It was proposed and carried that all delegates be un-instructed.

COMPETITIONS

There was a general discussion on competitions and it was proposed and carried that the San Francisco Chapter go on record as favoring the open form of Competition.

EXHIBITION

There was a general discussion on the prospect of an exhibition of Allied Arts, and it was moved that this be made the order of business at the next meetnig.

There being no further business, the meeting adjourned.

J. S. FAIRWEATHER,  
Secretary.

*Specify*  
**PACIFIC**  
PLUMBING FIXTURES

*Get the  
Best  
For Sale by all Plumbers*



TRADE MARK REGISTERED

*Specify*

**PACIFIC**  
PLUMBING FIXTURES

# "CALIFORNIA STUCCO"

Is the material used on all Stucco Buildings  
illustrated in this edition representing  
architectural work by

**HARWOOD HEWITT**

*Sold by all Building Material Dealers*

MANUFACTURED BY

**CALIFORNIA STUCCO PRODUCTS CO.**  
LOS ANGELES

**ATLAS MORTAR CO.**  
SAN FRANCISCO

**RHODES, JAMIESON & COMPANY**  
DISTRIBUTORS FOR  
ALAMEDA COUNTY

## MONO-RAIL CONVEYING SYSTEMS IN DEMAND

Supply Much Needed Want in Handling  
of Heavy Freight

There is an ever increasing demand for Overhead Mono-rail Conveying Systems for handling heavy loads of 3000 lbs. and over for use where the heavier I-beam construction with traveling cranes is too expensive or the equipment is designed for heavier loads than it is required to carry.

The Loudon Overhead Mono-rail System has been in use for a number of years and is designed to meet these conditions and to afford a carrier system for garages, machine shops, brick yards, automobile factories, warehouses and foundries; and in fact any place where heavy merchandise is to be moved from place to place.

The Loudon System can be installed with curves and switches so that any part of any building can have a Mono-rail Track, enabling the carrying of articles from some central station to the various bins or racks for storage or display. Systems are also

installed for the moving of freight from building to building or to and from loading and unloading platforms at the railroad tracks.

Several typical instances of the installations of these systems in the San Francisco territory can be seen in operation in the Ford Factory, Chevrolet Factory, plant of the Durant Motors Company, Marwedel & Company, and the new home of the George H. Tay Company. In Los Angeles one of the largest installations is in the plant for the Hercules Foundries. The Los Angeles Pressed Brick Company will soon install a complete system.

The California Hydraulic Engineering & Supply Company, San Francisco, distribute the Loudon Line, and are prepared to give recommendations for proposed installations and to submit estimates.

PHONE FRANKLIN 2492

**A. C. WOCKER**

INTERIOR DECORATOR

1370 SUTTER STREET

SAN FRANCISCO, CAL.





GENERAL OFFICES, SOUTHERN CALIFORNIA TELEPHONE COMPANY,  
LOS ANGELES, CALIFORNIA.

AMESS & BERG, Painters and Decorators,  
2723 WEST EIGHTH STREET,  
LOS ANGELES, CALIFORNIA.

RICHARD D. KING Architect,  
317-19 VAN NUYS BLDG.,  
LOS ANGELES, CALIFORNIA.

Another 100% job, finished with Brinistool's Quality Products.

All Interior wood trim (Birch), finished with **FLEXICOTE RUBBING AND POLISHING VARNISH.**

All Interior smooth plaster walls and ceilings of Offices, Corridors, Toilets and Elevator Shafts, made sanitary and beautiful with **VEL-VA-COTE.**

ARCHITECTS and BUILDERS: We want your plaster wall troubles, our Departments of Tests and Research are at your service. Our latest book is the key to successful painting of rough or smooth and jazz plaster in semi-gloss or soft toned effects. Write for this book and we will mail it at our expense.

THE WALL FINISH SPECIALISTS

**The Brinistool Company**

908 MAIN STREET

LOS ANGELES, CALIFORNIA

LARGE CONTRACTS AWARDED TO LOCAL PAINTERS

Three of the largest painting jobs on the Pacific Coast, the Federal Reserve Building, George W. Kelham, architect; the Fitzhugh Building, Reed Brothers, architects; and the Cebrian Building, George Applegarth, architect, have recently been awarded to A. Quandt & Sons, of San Francisco and Los Angeles. The Federal Reserve Building and the Fitzhugh Building are being erected under the direction of P. J. Walker & Company of San Francisco.

DEATH CLAIMS NOTED BUILDER

Friends in and out of the building industry are mourning the death of William L. Hemminga, widely known San Francisco contractor and builder, who died May 4th in Lane Hospital.

Mr. Hemminga was the pioneer builder of the western addition and recently completed Hemway Terrace, which was named in his honor. His own home was at 12 Hemway Terrace.

Born in Chicago, Hemminga came to California with his parents when but three years old. Some years ago he became interested in the building industry, and his rise in this work was rapid.

**nails**

In addition to carrying all kinds of  
**WIRE NAILS**

We carry a complete stock of  
Deformed Reinforcing Steel Bars  
Electrically Welded Wire Fabric  
Flat and Corrugated Galvanized Sheets  
Black and Galvanized Pipe  
Black and Galvanized Wire  
Merchant Steel Bars

Remember, Soulé and Steel are  
Synonymous

**EDW. L. SOULE' CO.**  
RIALTO BUILDING  
SAN FRANCISCO

PORTLAND                      LOS ANGELES                      SEATTLE

**R. N. NASON & CO.**

PAINT MAKERS

151 Potrero Ave.--SAN FRANCISCO--436 Market St.

Makers of

**NASON'S OPAQUE FLAT FINISH**

A flat oil paint made in soft Kalsomine Tints, that is washable; a practical article for walls, ceilings, etc., that is most economical and durable.

Agency for

Tamm & Nolan Varnish Works High Grade Varnishes and Finishes

Goods made on the Pacific Coast for the climate of this Coast

**A. KNOWLES**

**Contracting Plasterer**

Call Building

San Francisco

Del Monte                      --                      Fan Shell Beach

**CLEAN WHITE SAND**

**Del Monte Properties Company**

Sutter 6130 Crocker Building San Francisco

**Clay Products**  
Gladding, McBean & Co.

SAN FRANCISCO  
LINCOLN  
LOS ANGELES

## UNITED STATES CIVIL SERVICE EXAMINATION

The United States Civil Service Commission announces the following open competitive examination:

### Construction Foreman

The receipt of applications will close on June 5. The examination is to fill a vacancy in the Indian Service for duty at the Five Civilized Tribes Agency, Muskogee, Oklahoma, at an entrance salary of \$1,500 a year, plus the increase of \$20 a month granted by Congress, and vacancies in positions requiring similar qualifications.

Applicants must have had at least six years general experience in the various building trades or in architectural work, including not less than one year of experience as foreman, inspector, superintendent, or architect. Applicants may substitute each year of a course in civil engineering, architectural engineering, or architectural drafting, in a college of recognized standing for one year lacking of the required preliminary experience in the building trades.

Competitors will not be required to report for examination at any place, but will be rated on their education, training, and experience.

### Draftsman, Architectural and Structural Steel

The receipt of applications will close on June 12. The examination is to fill vacancies in the Lighthouse Service, at Detroit, Mich., and Milwaukee, Wis., at an entrance salary of \$1,800 a year, plus the increase granted by Congress of \$20 a month, and vacancies in positions requiring similar qualifications.

Applicants must have graduated from a four years' high-school course, or completed a course of study equivalent to that required for such graduation; and have had at least four years of engineering experience of which at least one year must have been architectural or structural steel experience. Each successfully completed year of an engineering course in a college or university of recognized standing will be accepted as equivalent to nine months of the preliminary engineering experience.

Competitors will not be required to report for examination at any place, but will be rated on their education and experience, and drawings to be submitted with the application.

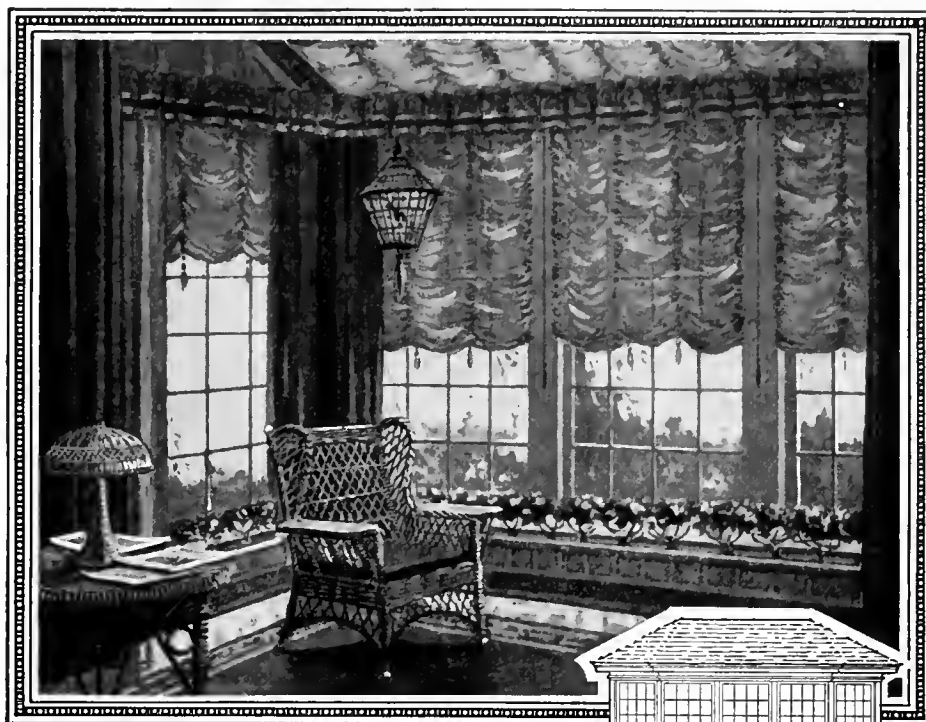

## ARCHITECTURAL HOME MAKING

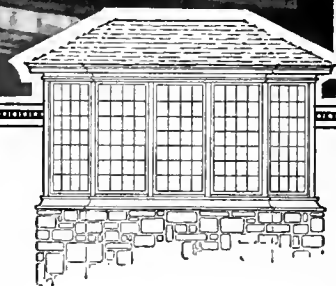

**T**HE attractiveness of home life begins in the drafting room. Long after the fee is paid and forgotten, the thoughtfulness of the architect is remembered.

It is notable how many sun parlors are added to houses long after they have been built. It is but the addition of something which had been forgotten.

There is an ever-increasing trend "sunward", towards the enjoyment of sunshine and air made possible by the judicious but liberal use of better window glass. Cater to the "sunward" movement and reward will follow; principles of health, sanitation and human happiness will have been recognized.

### *The Mark on the Box*

The long ellipse that appears on every box of genuine American Window Glass is an assurance of quality.

Within the ellipse is the grade mark, A or B. The B glass is of as consistently high quality as the A grade of ordinary glass and our A grade is correspondingly superior. Demand the beauty, clarity, evenness and strength assured by this mark on every box.



**AMERICAN WINDOW GLASS CO.**  
GENERAL OFFICES: PITTSBURGH, PA. BRANCHES IN PRINCIPAL CITIES

862 Mission Street

San Francisco, Calif.

# CONDITIONS IN THE COMMON BRICK INDUSTRY

If there is a reaction from the present high volume of building, the blame cannot be placed upon the brick manufacturer. Throughout the construction field there is an apprehension that the high price of some materials and of all labor may result in slacking the pace of building during the last half of the year.

The demand for every type of building material is heavy and this applies with full force to clay products generally. Reports from 102 manufacturers, representing every brick producing center in the United States, which are tabulated below, show that there is a marked increase in orders on the books with a slight falling off of stocks on hand of common brick. Only two plants report an advance in price since last month, bringing the maximum today to \$22. These are at Massachusetts points. There has been an equalizing of prices in other districts so that the composite price at this date is practically the same as last month, and that was not out of line with prices prevailing throughout the last half of 1922. The prices of common brick generally throughout the United States today are lower than they were a year ago today, which shows that the brick manufacturers are not attempting to take advantage of the strong demand and are setting an example that, if followed by all other materials, would do much to maintain a high volume of construction throughout 1923. The stabilized prices of brick emphasizes stronger than ever before the

economy of using this permanent material. Under present scales there is practically no difference in the first cost of brick and the less enduring materials. Especially is it folly at this time to accept the substitutes for brick which flock into the market when the real thing can be purchased at prices that do not show an advance over last year's rate.

There is nothing but optimism in the reports of the manufacturers of the Common Brick Manufacturers Association this month and the volume of orders on the books is the largest for more than a year. Due to weather conditions and a March that has been unusually cold, fully one-third of the plants in the northern part of the country are still closed. There is only one section in the country that still lags behind in the parade, and that is the strong agricultural section just west of the Mississippi, where the volume of building is light. Out of the 102 manufacturers reporting only one indicates that the outlook is "poor" and one other that it is "bad." All the others are in the "fair" and "good" column. Manufacturing costs are increasing slightly and there is a shortage of labor in some sections. A few manufacturers apprehend a car shortage. This feeling is especially strong in the central southern states. As a whole the outlook for 1923 for the common brick industry is most favorable, the enormous volume of home building and the increased use of brick in this class of building being an important factor.

## Pacific Manufacturing Company

Branches:

117 Stevenson St.  
SAN FRANCISCO

Manufacturers of and Dealers in

**Doors, Windows and Mouldings**

General Millwork

1001 Franklin St.  
OAKLAND

Branches:

908 Washington Bldg.  
LOS ANGELES

58 West Santa Clara St.  
SAN JOSE

Factory and Main Office: Santa Clara, Calif.

## REWARD OFFERED FOR OLDEST SHINGLE

The humble, utilitarian shingle, which the voters of California overwhelmed with sympathy when its existence was threatened last election by the State Housing Act, is again challenging public sentiment. This time the shingle is to occupy a place of distinction in the M. H. de Young Memorial Museum in Golden Gate Park, San Francisco, along with the relics of the Pharaohs and the pottery of the Ming dynasty. But it will be a shingle of epoch making importance. It has not yet been found, but the cash reward offered by Gus Russell of the Santa Fe Lumber Company, San Francisco, is expected soon to bring it to light. He wants the oldest sawn shingle in California.

Following are the conditions surrounding the contest: All entries must be submitted by a retail lumber dealer in California. They must be accompanied with brief statements of origin, so that their authenticity may be proved by affidavit. A committee of lumbermen will be selected to pass upon the entries. All exhibits must be in by June 1st.

## U. S. ASKS FOR BID ON COURT HOUSE

Treasury Department, office of Supervising Superintendent of Construction, room 402, U. S. Postoffice Building, San Francisco, Calif., May 5, 1923. Sealed proposals will be opened in this office at 12 o'clock M., June 14, 1923, for remodeling for Internal Revenue Bureau, etc., at the U. S. Court House, Postoffice and Custom House, Los Angeles, Calif. Drawings and specification may be obtained from the Custodian at Los Angeles, Calif., or at this office, in the discretion of the Superintendent. Wm. Arthur Newman, Superintendent.

## BALL BEARINGS

### SKF INDUSTRIES OF CALIFORNIA

Incorporated

115 NEW MONTGOMERY ST.

San Francisco, Calif.

Phone Sutter 4196

DEEP GROOVE AND SELF-ALIGNING BEARINGS  
HANGER EQUIPMENT

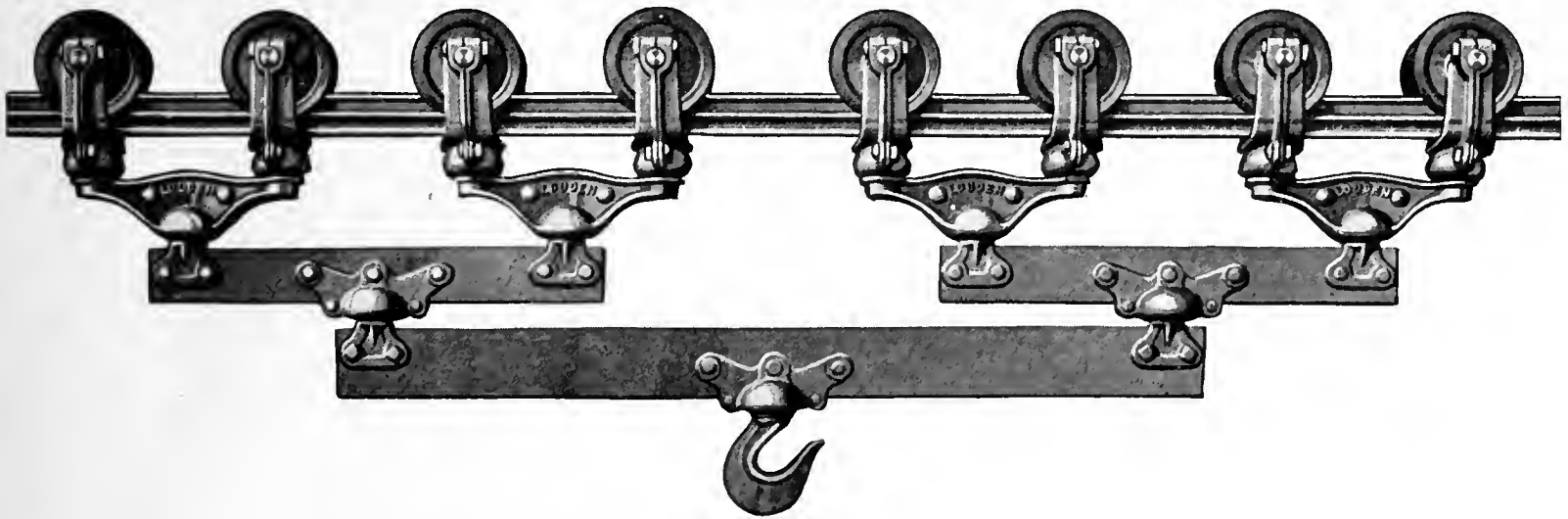

## Louden Overhead Conveying Mono-Rail Conveying System

FOR HANDLING UP TO 4,000 LBS. SPECIALLY DESIGNED FOR WAREHOUSES, FACTORIES, GARAGES, MACHINE SHOPS AND ALL OTHER PLACES WHERE WEIGHTS to be carried do not warrant installation of travelling frame. Curves and switches enable installation system to move goods to any part of building; also from building to building, and from unloading and loading platforms. We will be glad to furnish catalogues, illustrations of typical installations, or will send engineer to figure requirements for either new buildings or for buildings already erected. SEE ILLUSTRATIONS, PAGES 80-81. This system recently installed for GEORGE H. TAY BUILDING, as described in this issue.

### CALIFORNIA HYDRAULIC ENGINEERING AND CONSTRUCTION CO.

70-72 FREMONT STREET, SAN FRANCISCO

### AMERICAN PUMP CO.

420 EAST THIRD ST., LOS ANGELES

## LINOLEUM NOW ADOPTED IN OUR MODERN HOMES

Linoleum as a floor covering for all the rooms in the American home is really coming into its own. For years past, linoleum in the eyes of most people has been a floor covering to be used only in the kitchen or bathroom. But it has served its apprenticeship well in these quarters of the house because it has been found to be durable, easy to clean and comfortable. Its true value in the other parts of the house is now being recognized.

Europe has used linoleum for many years—used it all over the house. Europeans have waxed their linoleum floors and put rugs over them. In France, for instance, linoleum mingles with the politest society. And it is considered the ideal floor material, not only for the kitchen and bathroom, but for every room because it is less tiresome to the feet and it is far easier to clean than any other floor material.

Now that in America a new type of room is coming into vogue, that is, rooms which try to bring some of the outdoors into the house—the breakfast room or sun room, there is an increasing demand for linoleum. Statistics show that in many of the larger stores the sales of linoleum frequently exceed those in any other line carried.

In the smaller apartments linoleum is frequently used in the living-room, breakfast room or dining-room, in the kitchen and in the bedroom. In the larger houses, linoleum is being used more extensively on the second floor rooms, and frequently, as has been said, in the sun room or breakfast room.

Naturally, the patterns which have become common to us in the kitchen and bathroom are not suitable for other rooms in the house, but modern manufacturers have overcome this by introducing many new and charming designs. There are colorings and color combinations which will contribute much to almost any scheme of decoration. As all types of home furnishings must be used with discretion if they are to be effective, so it is with linoleum. Its decorative points must be safeguarded and color combinations studied with care. For some rooms a large black and white block design might be strikingly effective; in other rooms a monotone effect in a soft striated pattern

will be found to contribute to the quiet restfulness of the surroundings.

It is necessary in using linoleum as a permanent floor to have it laid right. Experience has proven that the ideal way of laying linoleum is to cement it firmly to the floor over a layer of builders' deadening felt. This is an especially good practice if the floor is at all rough or if the floor boards are susceptible to expansion and contraction because of climatic conditions. But it is also an admirable method where the utmost of quiet and comfort is desired. The felt layer gives a slight cushion to the floor, deadening the sound of footfall and subtracting from fatigue. The joints, too, of a linoleum floor laid in this way are practically invisible, in fact your floor is almost one uniform whole.

There are other advantages, too, in floors of linoleum. The woman who cares for her own home finds that floors of linoleum are easier to clean because when waxed they require only a dustless mop to keep them in spick and span condition. They require no expense of refinishing and this is an important point where the scuffing feet of children leave their marks on a finely finished hardwood floor.

Interior decorations and architects are more and more taking into consideration these points and are advocating linoleum more generally throughout the house. They find that a well selected linoleum floor is the finest background for Chinese and Oriental rugs and that for ease in maintenance and for durability linoleum cannot be surpassed.

The Paraffine Companies, Inc., handled more tonnage in March than any other month in its history.

Three thousand and fifty-one carloads were handled in their sixteen Pacific Coast plants. A daily average of 112 carloads was maintained, as contrasted with their normal average of 78, or an increase of close to 44% in their volume.

### Stillwell PLAN BOOKS of CALIFORNIA STYLE All HOMES

—show pictures, Floor Plans and Estimated Costs of Building over 200 Selected Designs.

"West Coast Bungalows" 50 Houses—6 and 7 Rooms—\$1

"Little Bungalows" 75 Houses—3-4-5 Rooms—\$1.

"Representative California Homes" 50 Houses—7 to 10 Rooms—\$1

"The New Colonial" 60 Houses—6 to 10 Rooms—\$1.

SPECIAL OFFER: Send \$2.50 for any three of these books and get Garage Folder FREE.

Books and Blueprints sold with Money Back Guarantee

E. W. STILLWELL & CO., 790 California Building, Los Angeles



"Representative California Homes"

50 Houses—7 to 10 Rooms—\$1

"The New Colonial"

60 Houses—6 to 10 Rooms—\$1.



## "Better Late than Never"

**E**VEN after furniture and fittings have been ruined through leaky valleys and gutters—even then it is not too late to mend!

Seldom, if ever, are the contents of a whole building ruined by roof leaks, and it is better to put on



## TARGET AND ARROW

Look for this Trade  Mark on every Sheet

### ROOFING TIN

after damage has been done than never to have it put on at all.

When Target and Arrow is used for valleys and gutters and flashings it is verily like taking out a roof insurance policy, for it will outlast the roof itself unless the whole roof is of Target and Arrow.

## N. & G. TAYLOR CO.

Offices: Philadelphia, Pa.

Mills: Cumberland, Md.

Established 1810

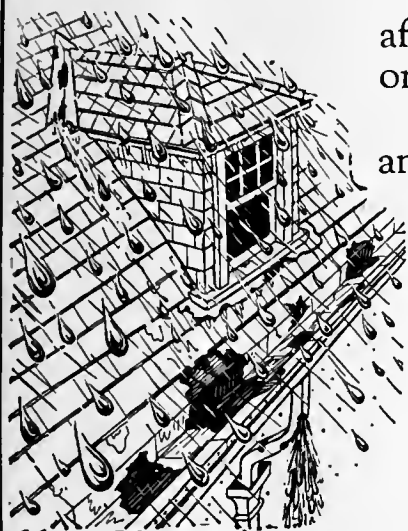

## PITCHER'S

### Disappearing Doors

### Adjustable Hangers and Frames

MEET THE DEMAND FOR  
APPEARANCE, QUIETNESS  
AND DURABILITY

NO EXTRA WALL THICKNESS REQUIRED

Manufactured by

## National Mill and Lumber Company

318 MARKET STREET, SAN FRANCISCO, CAL.



SUMMIT APARTMENTS

STUDENTS IN ARCHITECTURE TO  
GET PRIZE

Award to Be Made for Best Design for  
Berkeley C. of C. Building

Announcement of a prize to be given by the Architectural Alumni Association of the University of California to students in architecture offering the best design for the new Berkeley Chamber of Commerce building, was made this morning. The official announcement, in speaking of the work being done by the local chamber, said in part:

"The Berkeley Chamber of Commerce is endeavoring to foster the artistic life of the community, as well as its industrial and commercial prosperity, and is trying to prove that art and commerce must be interdependent if either is to add anything enduring to life.

Center of Activities

"The intention of this problem is to provide for a building that will enshrine this heroic purpose, that will be a place for gathering and directing these forces, which are determined to make this city worthy of its heritage."

The site chosen is directly opposite to the future main entrance to the university, at the southwest corner of Oxford and Addison streets. The project calls for a two-story and basement building, with a garage 800 feet square in the basement, together with heating and fuel room, janitor's room and workshop and storage room.

Commodious Lobby

The first floor provides for an entrance lobby 500 to 1000 square feet in size, a reception room of 400 square feet, and information bureau and telephone exchange of about 150 square feet, the offices of the executive director, three rooms of 150 square feet, the office of the secretary for industrial and commercial development, 200 square feet, the office of the art secretary, 200 square feet, the office of the secretary for public welfare and education, 200 square feet, the room for files and statistics, 400 square feet, the council room with coat room and lavatory, 400 square feet, and the

WASHINGTON CHAPTER, A. I. A.

The 288th regular meeting of the Washington State Chapter, A. I. A., was held at the College Club, Thursday evening, April 12th.

Mr. Alden stated that two petitions had been made up and signed by a number of members; one nominating Mr. William B. Faville for president and Mr. Robert D. Kohn for first vice-president of the Institute, and the other nominating Mr. W. E. Fisher of the Colorado Chapter for regional director for the 8th District. He stated that Mr. Faville, from the West, and Mr. Kohn, from the East, made a logical combination, and also that Mr. Kohn should be advanced to first vice-president. Mr. Fisher had the hearty endorsement of the Colorado Chapter and that he was a very live man with high ideals. A motion carried that the Chapter unanimously approve these nominations.

Mr. Borhek of Tacoma requested that the Chapter "start the ball rolling" for the holding of a national convention of the Institute in Seattle. After a round of discussion it was agreed that the Chapter should start action looking toward the holding of such a convention in Seattle in 1925.

The question of increasing the scope of the Chapter Bulletin so as to make it of general interest to the building public was brought up for discussion. It was suggested that such a paper could be made very effective if gotten before the prominent and influential men of the state. Mr. Field stated that to do this would put the Bulletin upon a commercial basis and that this would entail a great deal of work and expense.

The president, Mr. Gould, introduced A. M. Young of the firm of Shack, Young & Myers, who read a very complete and thorough paper on Cast Stone. Mr. Young illustrated and amplified his paper by lantern slides of some very excellent examples of cast stone, among which were illustrations of the Fountain of Time in Chicago by Lorado Taft.

Mr. Schwartz of Everett, who has been doing some very excellent work in cast stone in his plant in that city, spoke of his experience in the manufacture of this material, and answered a number of questions by the members present.

Mr. Field read a letter explaining the manner in which the cast stone work for the Ambassador Hotel in New York was made and installed. This work, done by Warren and Wetmore, has proven very satisfactory.

Mr. McAdams of Galbraith & Company then gave a short talk on cement plaster stucco and its application and water-proofing. He had a number of very interesting samples which were passed for general inspection.

---

Berkeley handfract shop, about 1200 square feet.

Galleries Provided

The second floor is to be devoted to a large gallery and several smaller galleries for the exhibition of pictures, models, relief maps, etc. The smaller galleries will house permanent exhibitions and models showing the development of the city. The large gallery will be used for special exhibits and for social purposes. It should have a small stage and lavatories. The plan should provide for one elevator and a stairway of monumental character.

The project calls for a building of Indiana limestone with a tile roof.



SAN FRANCISCO  
PUBLIC LIBRARY

*Sketches in Spain*

THE  
BUILDING  
REVIEW

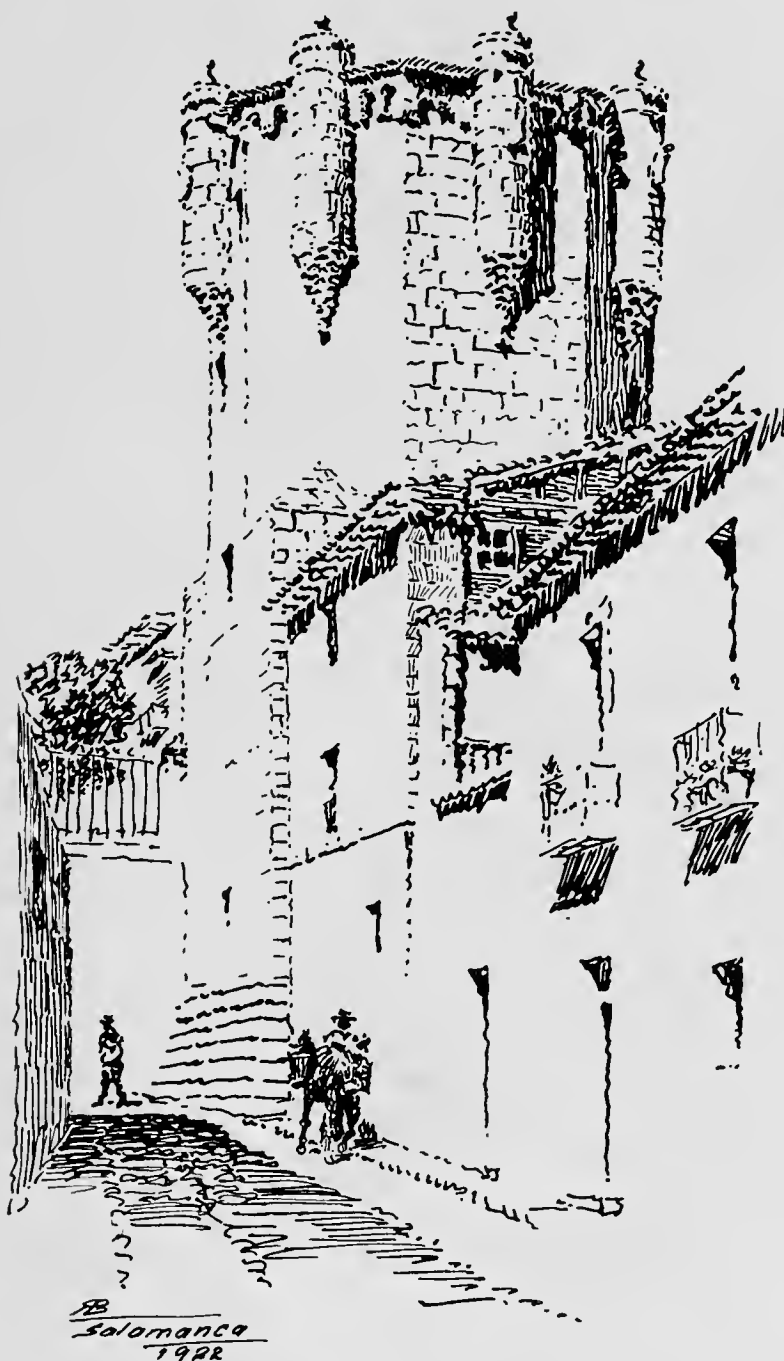

JUNE, 1923

Vol. XXIII

No. 6

*Published in San Francisco*

*Price Twenty-five Cents*



GIRLS' TRAINING SCHOOL  
Salem, Oregon  
KNIGHTON & HOWELL, Architects  
Portland, Oregon

TRANCHELL & PARELIUS, General Contractors  
Portland, Oregon  
C. A. BRODERSEN, Painting Contractor  
Forest Grove, Oregon

Finished  
Throughout  
With

**Kyanize**  
KY-AN-IZE

Celoid  
Finish

Our new books "Recent Pacific Coast Architecture" and "Recent Eastern Architecture",  
containing Practical Specifications, mailed on application

**Boston Varnish Company**  
KY-AN-IZE

Office and Warehouse  
1551 MISSION STREET  
SAN FRANCISCO, CALIFORNIA  
A. L. GREENE, Local Manager

Distributors for Southern California  
SUNSET PAINT COMPANY  
627 SOUTH MAIN STREET  
LOS ANGELES, CALIFORNIA

# THE BUILDING REVIEW

VOL. XXIII

JUNE 1923

No. 6

## CONTENTS

COVER—SPANISH SKETCH BY ROGER BLAINE.

### PLATES AND ILLUSTRATIONS

SPANISH SKETCHES, by Roger Blaine.....Plates 149 to 164, inc. Plate

### TEXT

	Page
WHILE SKETCHING IN SPAIN, by Roger Blaine .....	83
"CASA RAMONA," by Clara Fassett .....	87
THE ANONYMOUS ARCHITECT .....	93
ARCHITECT'S MONTHLY BULLETIN .....	94
BUILDERS CODE OF ETHICS .....	XII
WHY CONTRACTORS ENCROACH ON ARCHITECT'S FIELD, by J. C. Edwards .....	XVI
CONTRACTOR AND ARCHITECT .....	XX
EDITOR'S BOOK SHELF .....	VII
FOREIGN SKETCHES BY ROGER BLAINE, by Harris Allen.....	VII

HARRIS ALLEN, Editor

HOWARD HOYT  
Industrial Editor  
And Business Manager.

SIDNEY J. WOLF  
Advertising Manager

Published Monthly by the Building Review Company,  
Chronicle Building, San Francisco, California

Address All Communications to No. 426 Chronicle Building, San Francisco, California

Yearly subscription—United States, \$2.50—foreign, \$3.00. Single copies, 25 cents.  
Entered as second-class matter in the San Francisco Postoffice under the Act of August 24, 1912. Previously entered as "The Architect."  
The editors will be pleased to consider contributions of interest to the Industry. When payment of same is desired, this fact should be stated.  
News stands and dealers supplied through San Francisco News Co., San Francisco, Calif., or American News Co., New York, N. Y.

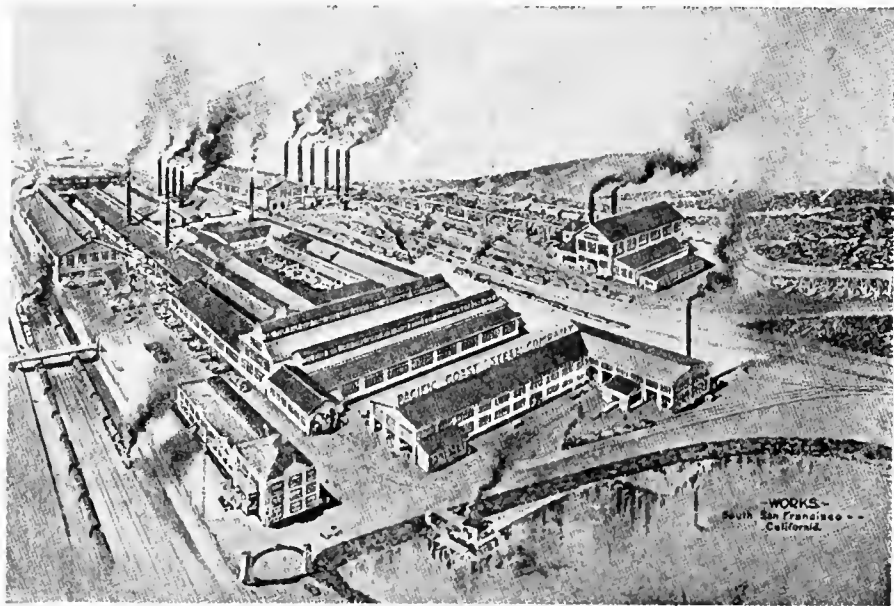

## SHAPES MANUFACTURED

Bolt Rods, Rivet Rods, Wire Rods, Bands, Flats,  
Billets for Forging, Plain Squares, Plain Rounds

Square and Round Corrugated Bars for Reinforcing  
Angles—Equal and Unequal Legs

Stock Lists will be Furnished Upon Request

## Pacific Coast Steel Company

OPEN HEARTH STEEL PRODUCTS

General Offices, Rialto Building, San Francisco

**FIREPROOF**  
**Gates Hotel**  
**Los Angeles**  
**300 ROOMS**  
**250 BATHS**  
OUR OWN CAFÉ  
RATES FROM **\$1.50** PER DAY  
*Holladay & Collins*  
Owners.

*Sixth*  
at Jigueroa



Pasadena home, designed by Harold H. Martin, Architect.  
Fuller Products used.

## Specify Pioneer Shingle Stain

**PIONEER SHINGLE STAINS** are high in the regard of many Architects. Tests have proved them to be of dependable quality and to be thoroughly satisfactory when applied to Shingles, Shakes and other rough-sawed lumber. The colors are mellow, soft in tone and durable.

The correct percentage of Creosote in Pioneer Shingle Stains preserves the wood. Other essential ingredients stain the wood fibre, fill the surface and prevent moisture from creeping in and decaying or warping the shingles.

### *How to Use Pioneer Stains*

For applying with a brush, one gallon will stain approximately 20 square yards, one coat; or fifteen square yards, two coats.

When the shingles are dipped it will require approximately two and one-half gallons of Pioneer Stain for every 1,000 shingles dipped to eight inches of the shingle length.

Architects who desire specific information concerning Pioneer Shingle Stains, their wide range of usefulness and approved methods of application, should write for this information to the Fuller Service Department.

# FULLER

PAINTS **Since 49** VARNISHES

W · P · FULLER & CO ·

San Francisco  
Oakland  
Sacramento  
Stockton  
Fresno  
Los Angeles  
Hollywood

Pasadena  
Long Beach  
San Diego  
Santa Monica  
San Bernardino  
Santa Ana  
Portland

Boise  
Salt Lake City  
Seattle  
Tacoma  
Spokane  
Yakima  
Walla Walla

## EDITOR'S BOOK SHELF

## GOOD PRACTICE IN CONSTRUCTION\*

**T**HIS volume continues the basic idea of the Pencil Points Library to provide at moderate cost practical working data to cover all problems which center in the drafting room. It consists of 52 plates, well drawn and annotated in a very complete and lucid manner, which have been assembled from detail sheets made in various well established offices, for actual buildings starting with walls and waterproofing, these plates cover exterior and interior construction up to kitchen cases and bank screens. The book is bound to be useful in a drafting room. It is well indexed. A preface by Thomas Hastings praises the material, presentation, and thoroughness of the book.

\*—Good Practice in Construction, by Philip G. Knobloch. The Pencil Points Press, Inc., New York.

## FOREIGN SKETCHES BY ROGER BLAINE

**N**O REPRODUCTIONS can do justice to the charming pencil sketches which Mr. Blaine, a young architect of Oakland, California, made during his recent trip abroad. He was in Europe nearly a year, much of the time in Spain, and his portfolios are full of drawings, mostly pencil, in which he has caught the spirit of the land to an unusual degree. These comprise individual and grouped buildings, studies of masses and of details, including a profusion of measured drawings.

Mr. Blaine has developed a technique of his own. Firm, yet delicate, his pencil drawings are like fine steel engravings. He has not sacrificed accuracy to picturesqueness, but has made each subject an essential composition in itself, both in the choice of elements and angle, and in the treatment on lighting. Never in a photograph, and seldom in a drawing, does one find the visual relation of foreground, middle, and distance, presented without distortion, as it actually appears to the human eye. and as Mr. Blaine has succeeded in doing with some of these sketches.

The originals should be seen to be appreciated. It is next to impossible to reproduce their particular quality, even with the excellent processes of photo-engraving now at our command.

HARRIS ALLEN.

## STORM KING STUCCO

## CRACK-PROOF!

It is unreasonable to expect a thin veneer of cement plaster, totally unaided by reinforcement or expansion joints, to withstand even the slightest building strain without checking or cracking.

Storm King Stucco is composed of minerals, most of which are inert. The magnesite and magnesium chloride are the binder materials, and when set are elastic, while a stucco made from cement, gypsum or lime is brittle. **STORM KING STUCCO IS GUARANTEED BY THE MANUFACTURER TO BE CRACK-PROOF.**

Our Catalog is on the press, reserve your copy today.

FOR A PERMANENT BUILDING SPECIFY STORM KING STUCCO

## Storm King Stucco Co.

JOHN F. SHANLEY, Pres.

Sefton Bldg.

San Diego

Crack - Proof — Weather - Proof — Fire - Proof

## BATCHELDER TILES

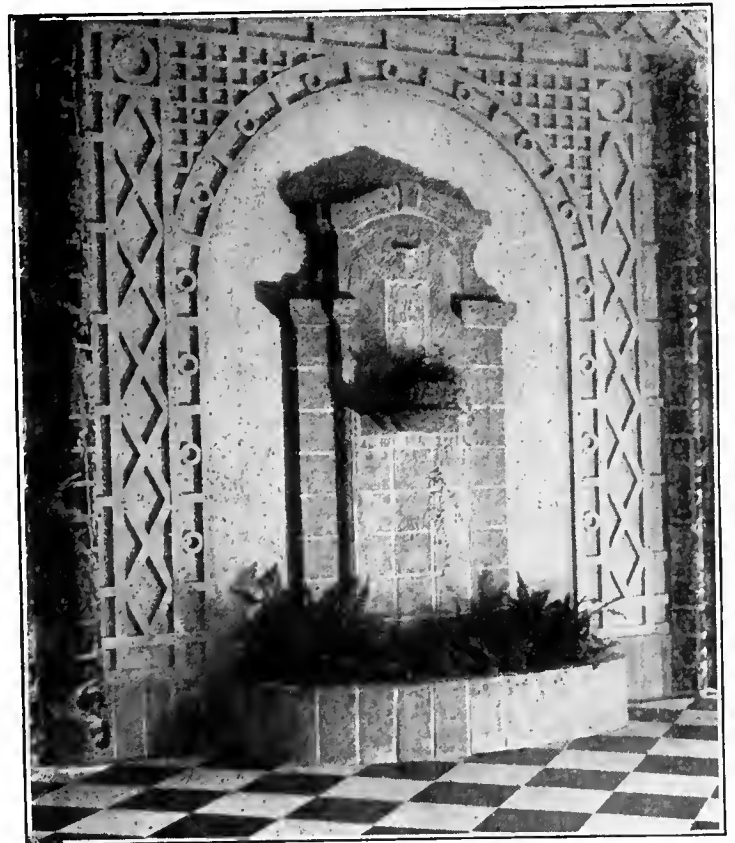

A Fountain of unique character built up entirely from stock material. A modelled design, rich in color.

BATCHELDER-WILSON CO.

2633 Artesian Street

Los Angeles, Calif.

Freedom  
from roof troubles  
*is found in*

**PABCO**

10 & 20 year /

**ROOFS**

which require the use of

**FLOATINE**

The improved roof asphalt  
that will not soften  
run, leak or slide.



TRADE MARK  
**PABCO**  
PRODUCTS

The PARAFFINE  
COMPANIES, Inc.

SAN DIEGO  
OAKLAND

LOS ANGELES  
PORTLAND

SAN FRANCISCO  
SEATTLE

# The BUILDING REVIEW

VOL. XXIII

SAN FRANCISCO, JUNE, 1923

No. 6

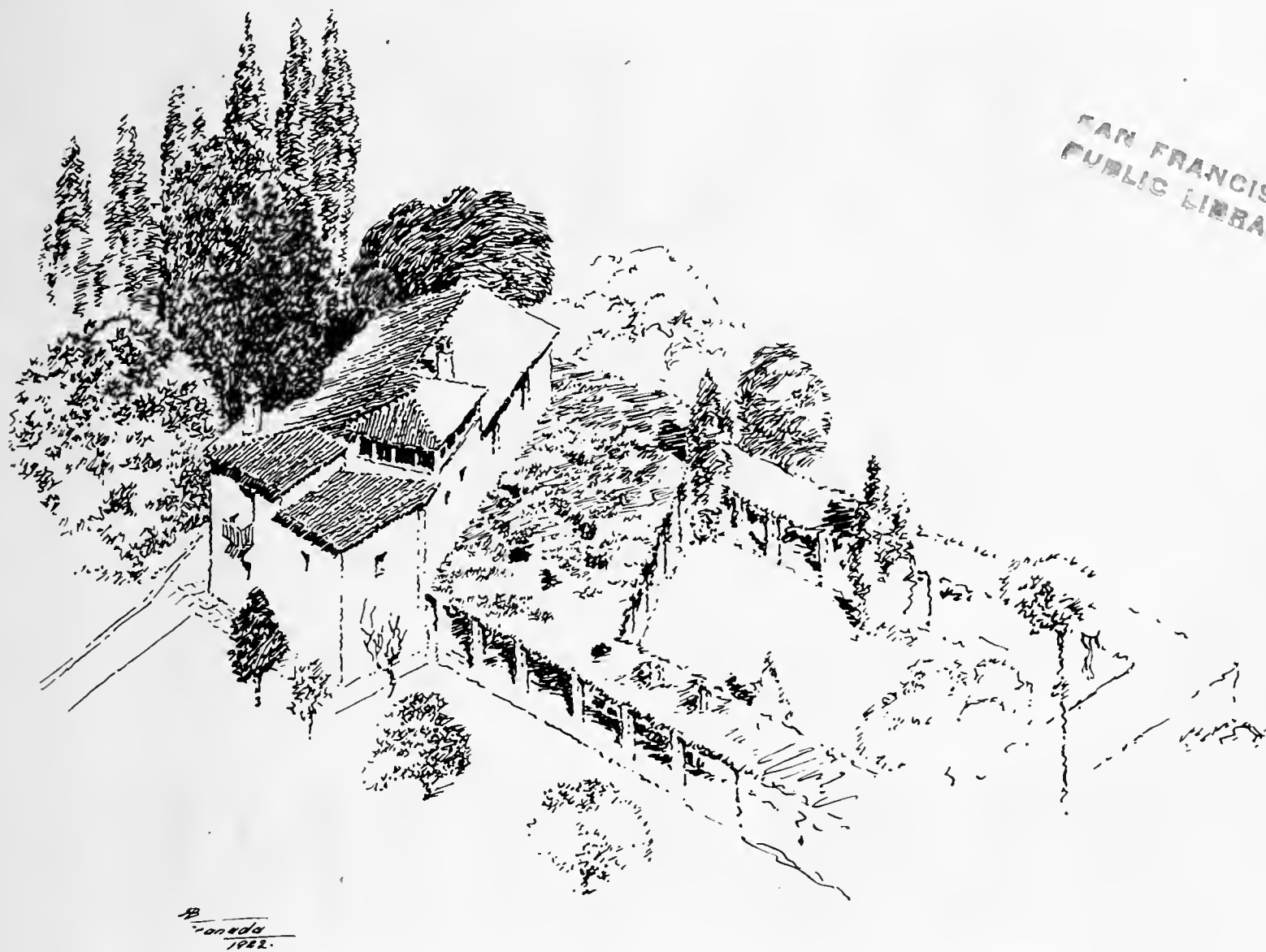

## While Sketching in Spain

By ROGER BLAINE\*

WE HAD become quite seasoned tourists by the time we had reached Spain; months of wandering thru France and Italy, to say nothing of an excursion into the semi-barbarism of Northern Africa, had hardened us to things conventional, and it was with a real thrill that in Spain we made our first "discovery." Now the trouble with traveling in most of Europe is that it is too well known. Visiting town after town had merely meant the seeing of sights with which we were al-

ready only too familiar thru books and photographs, so it was with something of the feelings of real explorers that we first invaded what to us was unknown territory. Of course the Spain of the tourist routes is quite well known; Salamanca, Segovia, Toledo, or Granada are well advertised and well patronized; but how many know Tarragona, Toro, Ubeda, or Moron? Few, I imagine.

We had approached Spain with a satisfied feeling of relief as regards their spoken

\*—Architect, Oakland, California.

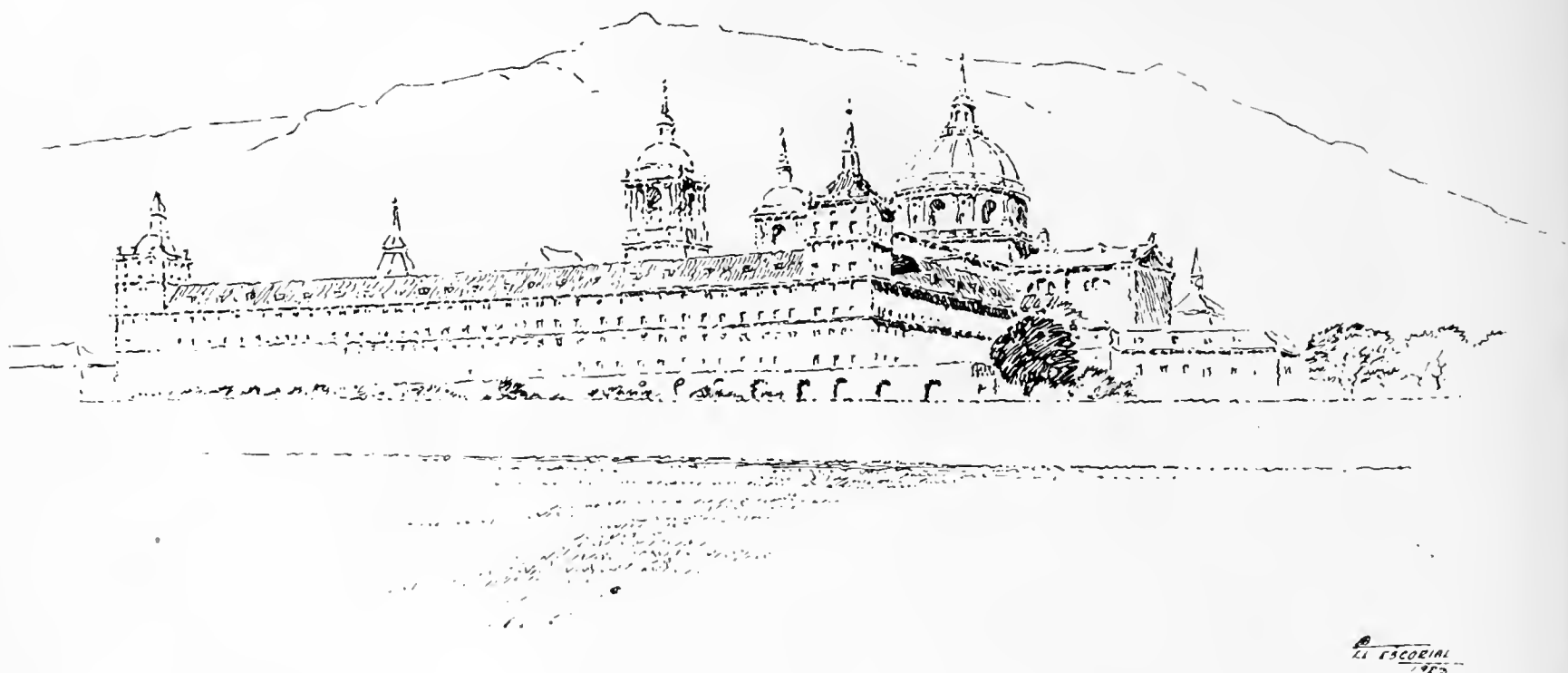

Escorial  
1923

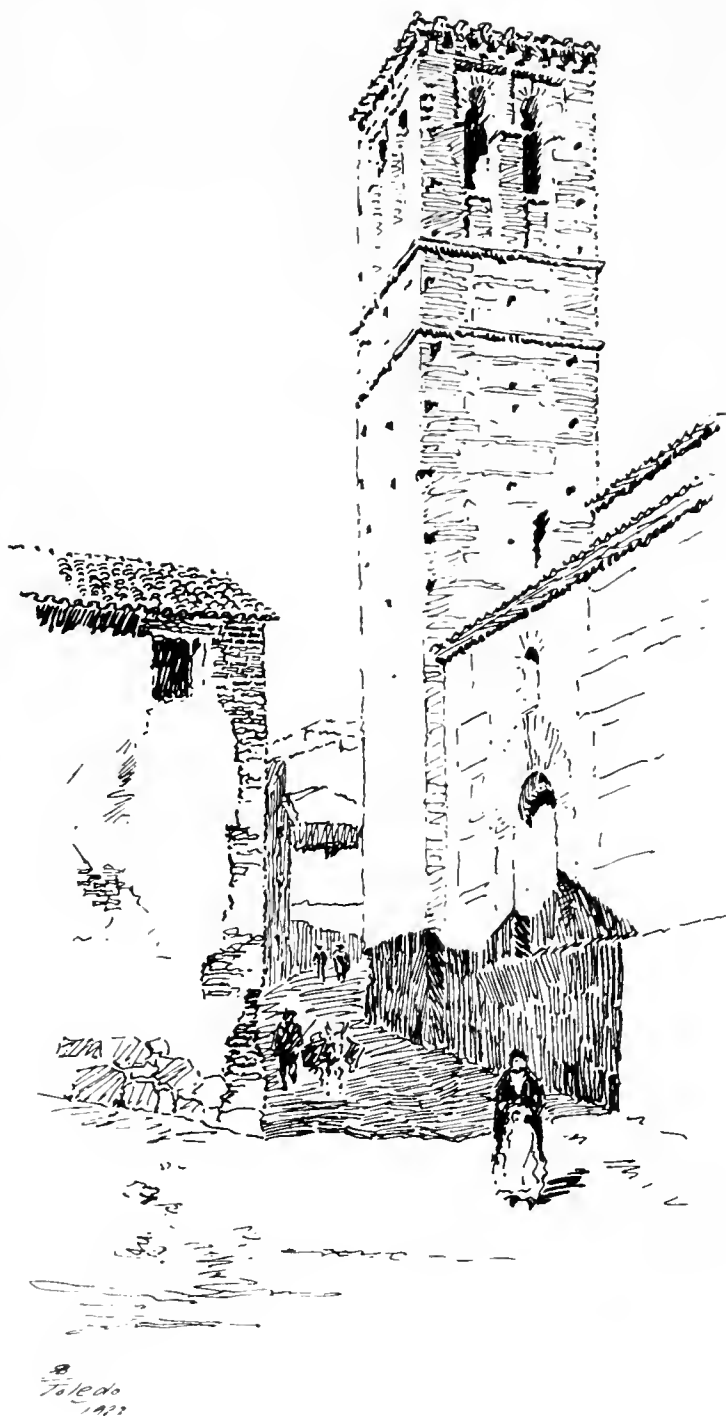

word. For months we had been relying largely on some French, a little Italian, and much sign language, but having spent many arduous hours in studying Spanish, we expected an easier existence. The blow fell quickly, almost immediately, in fact, when our carefully acquired "Castilian" collapsed completely under the strain of getting thru the customs at Port Bou, so back we went to the signs, and there we staid for many weeks, until by constant trying we finally acquired some of the dialect of the natives.

Now a word as to travel. We have tried everything once, trains, stages, and private automobiles, and without the least hesitation will back the Spanish railways as being the slowest means of conveyance in the world, and we speak from experience. We tried 1st, 2nd and 3rd class, and on "Luxo," "Rapido" and "Mixto," and when you consider that the best trains do some twenty-five miles an hour, you can be prepared for conditions on the slow trains. And to reach the towns off the beaten track one takes the slow trains. "Mixtos" they are called, but freight trains we'd call them, with a passenger coach or two attached somewhere in the line. However, we had expected that and were prepared accordingly. Equipped with a "kilometric" ticket, much sketching material and ample time, we simply wandered at will, going from town to town as our fancies dictated, or sometimes spending days in searching out mysterious places reputed to be of exceptional interest. Of our equipment the sketch books were of greatest value. No, not for what we put in them,



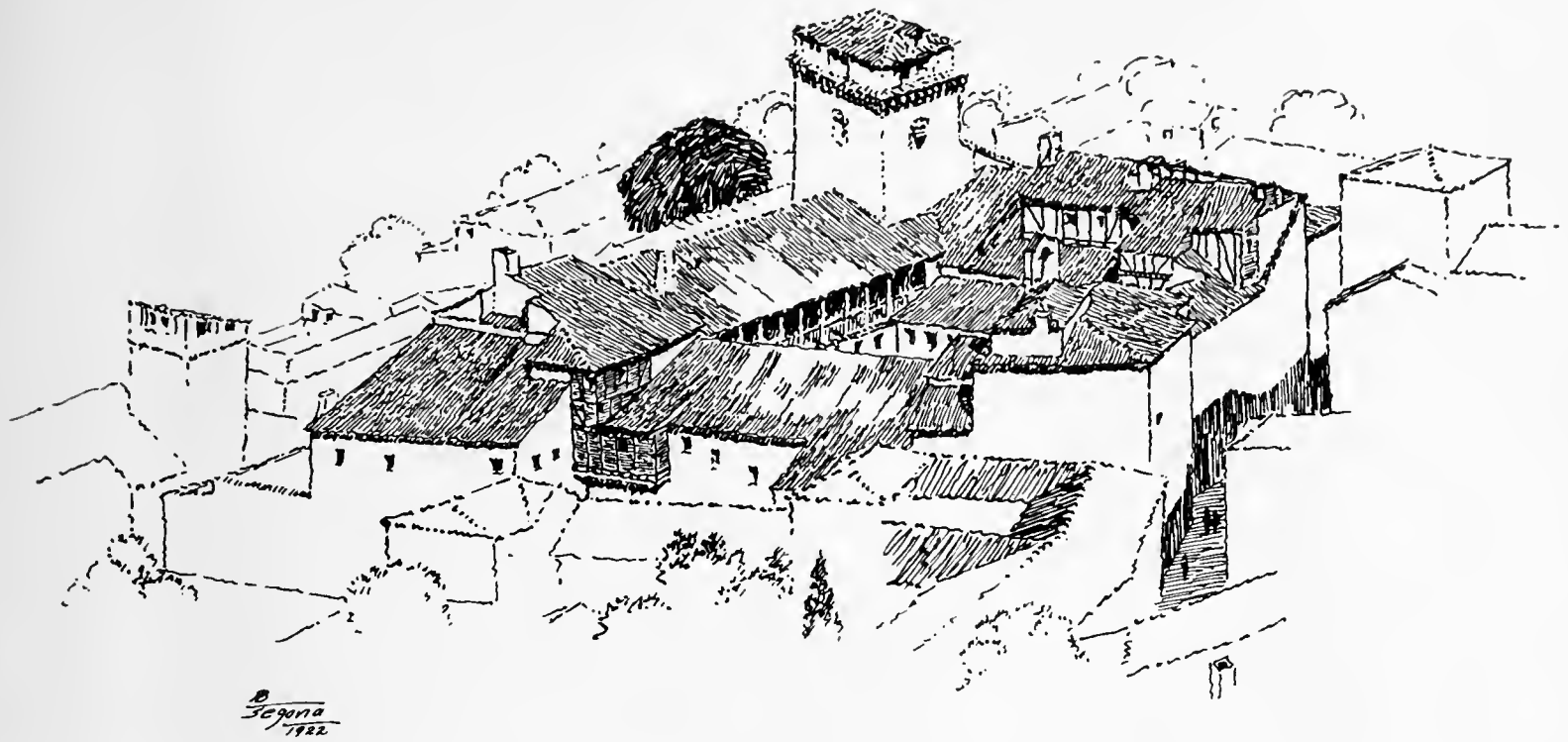

but as proof of our calling. We were not and never will be the artists under whose guise we masqueraded, but long experience had taught us that an artist, proverbially poor, is welcome everywhere. Guides and beggars, normally a pest to the tourist, would merely pass us by with a smile or cheerful greeting at sight of our "traps." Numerous were the invitations that we received to inspect patios, fine interiors, old pictures; and on one occasion, to the delight of the lady in the party, the family heirlooms, consisting of old laces, embroideries, etc., were brought out for our inspection.

We had been in the country but a few days before chance directed our footsteps to as picturesque a town as has been our good fortune to find. Tarazona isn't much of a place in size, but its situation on the precipitous side of a narrow valley, and the perfect placing of its principal palaces and church, make as fine a sketch composition as could be desired. Founded by the Romans, ruled for a time by the Moors and finally reconquered by the Spaniards, it shows plainly the various changes thru which it has passed. Palaces supported high on the hillside by huge arched buttress bespeak the strength and boldness of the Romans, a tall tower recalling clearly in its ornamented brickwork the minarets of the Moors and the later varied handiwork of the Spaniards. Romanesque, Gothic and Renaissance, mostly in brick. It was Sunday, and the main street and the Plaza Mayor were filled with men, most of them dressed in the old time costume of the Aragonese; coarse stockings, tight fitting

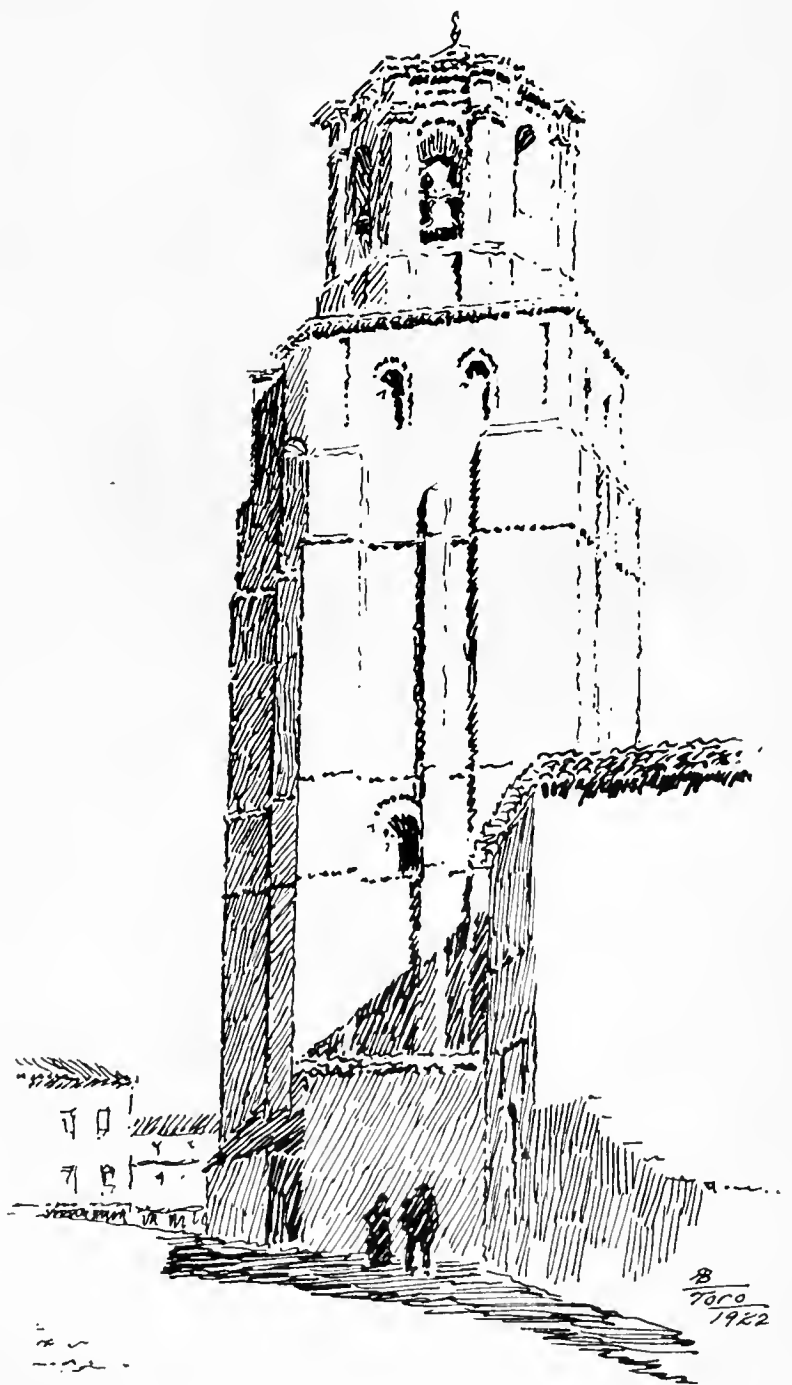

knee trousers, a broad sash, tight jacket and the small visorless cap so familiar in all of Northern Spain. An occasional farmer with his string of burros laden with produce, a drove of goats, a heavy slow-moving ox-cart and over it all a clear blue sky, local color and real.

A few short miles away lies Toledo with a Cathedral which is described by Street as one of the best churches he had visited in any part of Europe. To us it was more than a church; it was a veritable history in stone. Erected on the site of the mosque it displaced, a few bits of Moorish ornament with a Byzantine capital or two remain to tell of the Moor; an almost perfectly preserved Romanesque cloister of exquisite design and workmanship records the work of the Christian conquerors, and then follow in steady progression the Gothic of the nave and transepts, the fine brick tower in severe Renaissance and finally the numerous chapels in the tasteless style of the 18th century; practically a thousand years of history waiting there for one to stop and read. A rapid examination of the building, a long climb

to the belfry, a few rough notes, a measurement or two in which we were assisted by the sacristan and a priest, and we were gone.

Followed weeks of careless idling over the battlegrounds of old Castile, Burgos, Palencia, Toro, Zamora, Salamanca, Ciudad Rodrigo, all of interest and each in its way different. And of them all the small, to us nameless, towns that we passed along the way were the most interesting. Imagine a barren plateau, the soil of which is of a rather reddish color. A town huddled together, like lost sheep, built sometimes of a burnt brick or sometimes of adobe, made of the red soil. Cap it all with tile roofs of the same color and you will have a typical town in Old Castile. Studies in monotone, sometimes red, more often a drab yellow, with occasionally, when a stream is near, a few poplar trees to add a bright splash of color.

Segovia offers much, and to the seeker of compositions in line and mass is probably excelled by no other place in Europe. And to us was offered even more. Following

(Continued on Page 91)



*The Moorish Bridge - Londa-*



RESIDENCE OF GEO. A. BORN

BURLINGAME, CALIFORNIA.

## “Casa Ramona”

By CLARA FASSETT

**I**N THIS series of articles, featuring small Western homes of good design, and particularly of California, where it is said the bungalow first came into its own, the predominating theme is bound to be that type of dwelling which is native to the State. California has awakened to the beauty of its native architecture, evolved from the simple and characteristic dwellings of early colonists expressed in the old Spanish Mission and ranch house or hacienda. A few of these exist today, and show the development through Spanish influence, from a simple and primitive Indian “dobe” hut, to an impressive dwelling surrounding a patio with arched porticos, beautifully suited to the native landscape. And color—how they revel in it! There is little trace of it seen today in these old buildings as time has faded the hues of the plaster. The Indian builder, we know, mixed color into the plaster, which he obtained from pigment extracted from rocks. With the ad-

vent of the Spaniard, whose love of color is quite Oriental, still more brilliant effects were sought after; his doors and window-cases he painted bright blue—“Our Lady’s” color—or emerald green contrasting pleasantly with pinkish-salmon walls. Today in our little California home of Spanish or Mexican origin, we see this revival of color in architecture, an encouraging reaction from the preceding era of dull and somber hues.

The race that built of adobe has vanished; but treasured as relics of a romantic past are a few historic houses, reminders of departed days of huge ranches and careless abundance; of responsibility and protection of those who served the household; a kindly age with time for leisurely living and gracious hospitality.

The little house here portrayed derived its inspiration from the home of “Ramona,” that beloved heroine of the famous novel  
(Continued on Page 90)



## EDITORIAL

**F**EW people realize how great the responsibility banks must assume in connection with the building industry. Their work in financing large, business or semi-public buildings is taken for granted; but these constitute a small percentage of the total number of building operations, and in many cases the financing is privately managed.

On the other hand, the great bulk of building contracts is made up of small, individual housing propositions, and most of these must be financially. Building and loan and insurance companies take care of a comparatively small portion; it is upon the banks of the country that the responsibility mainly rests.

At present the banks have an abundance of money to invest, and it is not only a problem but a duty, to so lend their funds as to insure safe returns for the loan and a proper stimulation of business as developed in the building industry and its manifold ramifications.

Two things affect these objects most vitally; poor construction, resulting in early and undue depreciation, and the increase of costs, which naturally lowers the ultimate value of investment.

The work of bank appraisers therefore is now a most important and difficult one. Upon the impelling urge of keeping bank funds in circulation they must still assure themselves that each investment is safe and wise.

It is obviously to the permanent advantage of the building industry, including architects, labor, contractors, and manufacturers, and of the home-needing public, to co-operate with banks in these two fundamental matters; good construction and the reasonable control of costs. The temptation to seize a temporary opportunity to "get while the getting is good" is apt to blind men to the dangers affecting the future of the industry, like a fire-fly glittering over a marsh. And hurried, cheap construction, is the poorest kind of investment, for the owner as well as the financing interest.



~ PUENTE NUEVA ~

R. V. Blinn  
Londra





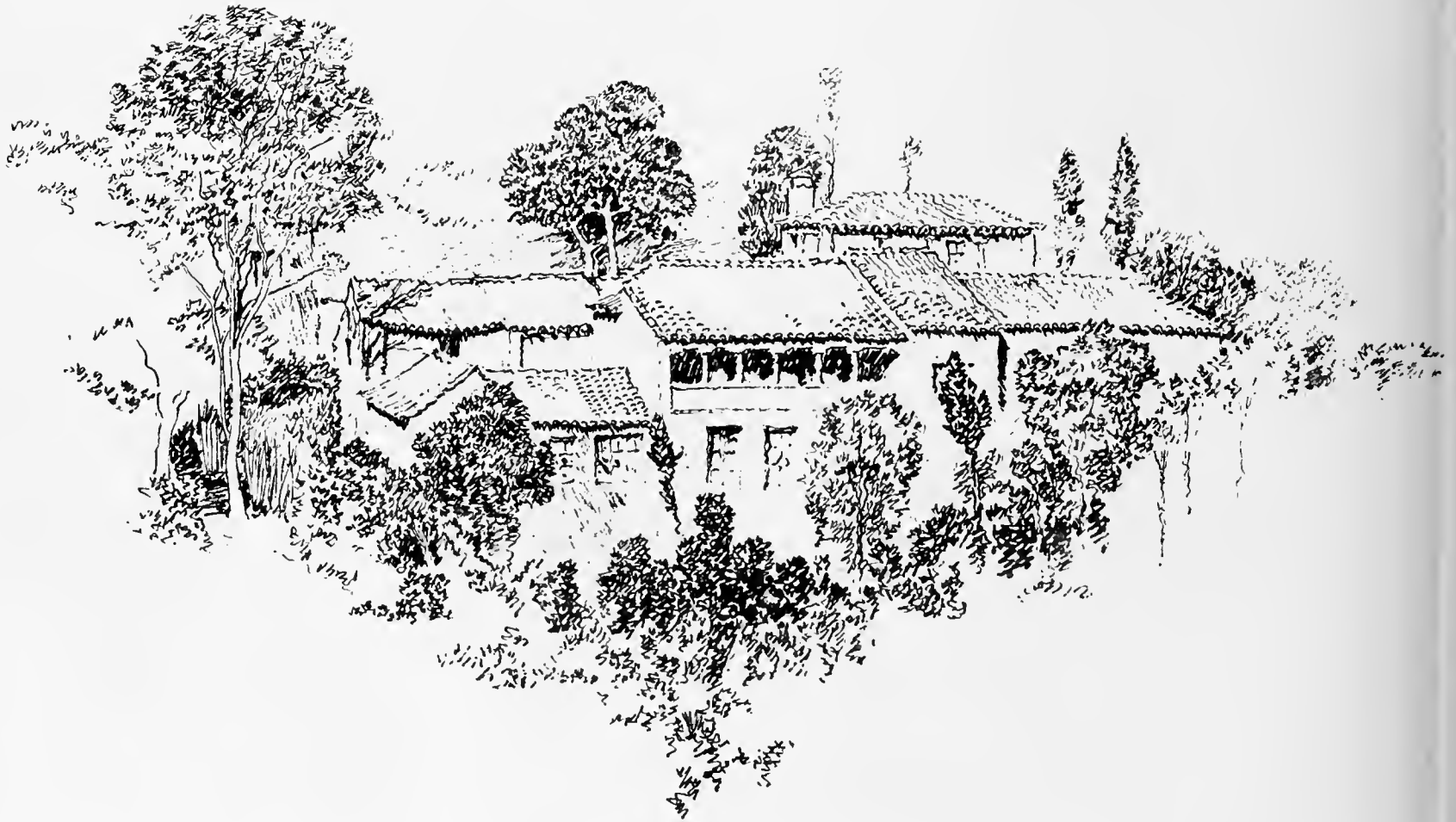

*B*  
*Gronada*  
1922





L. RANAVA



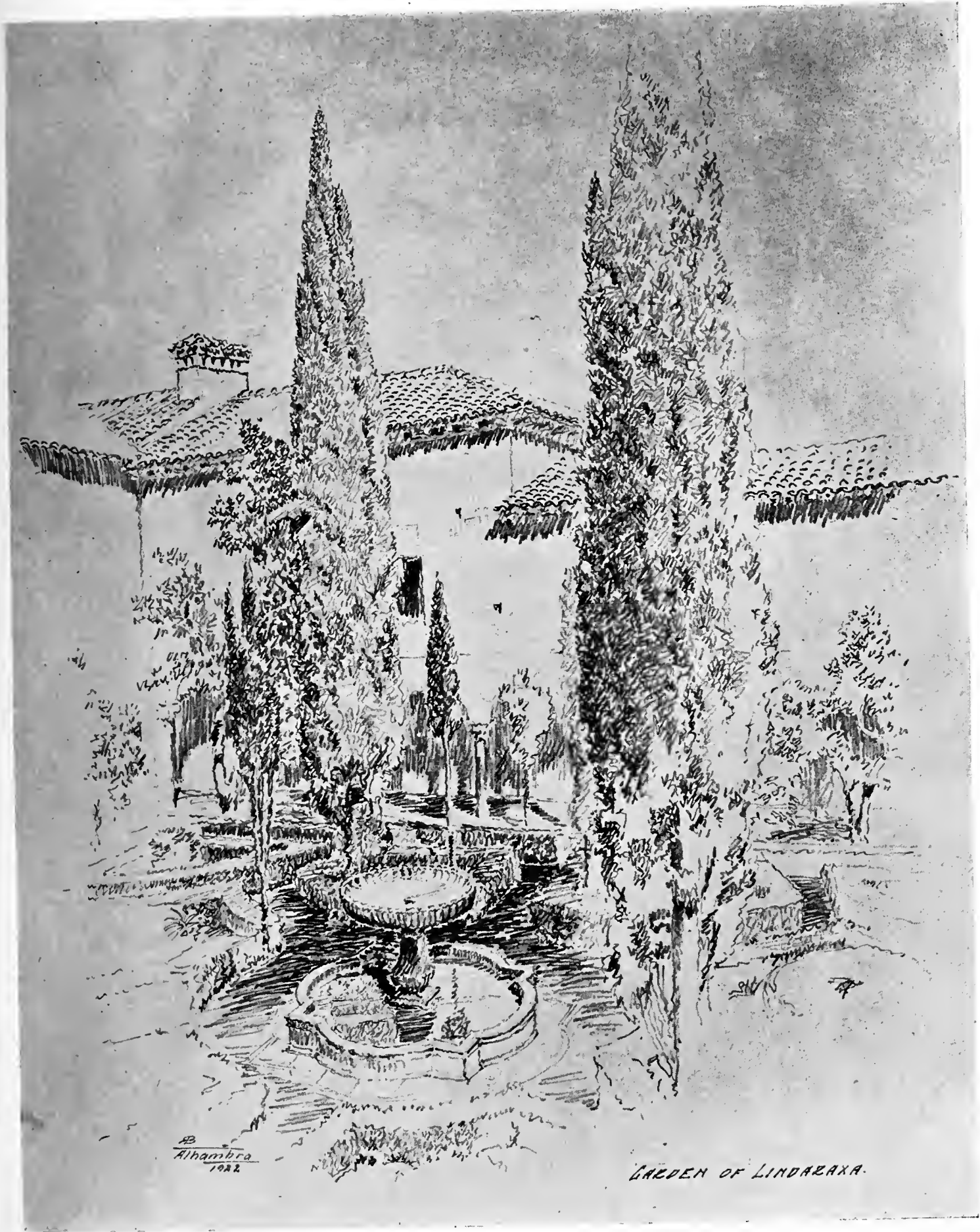



B  
Granada



*B.*  
*Vuedu*

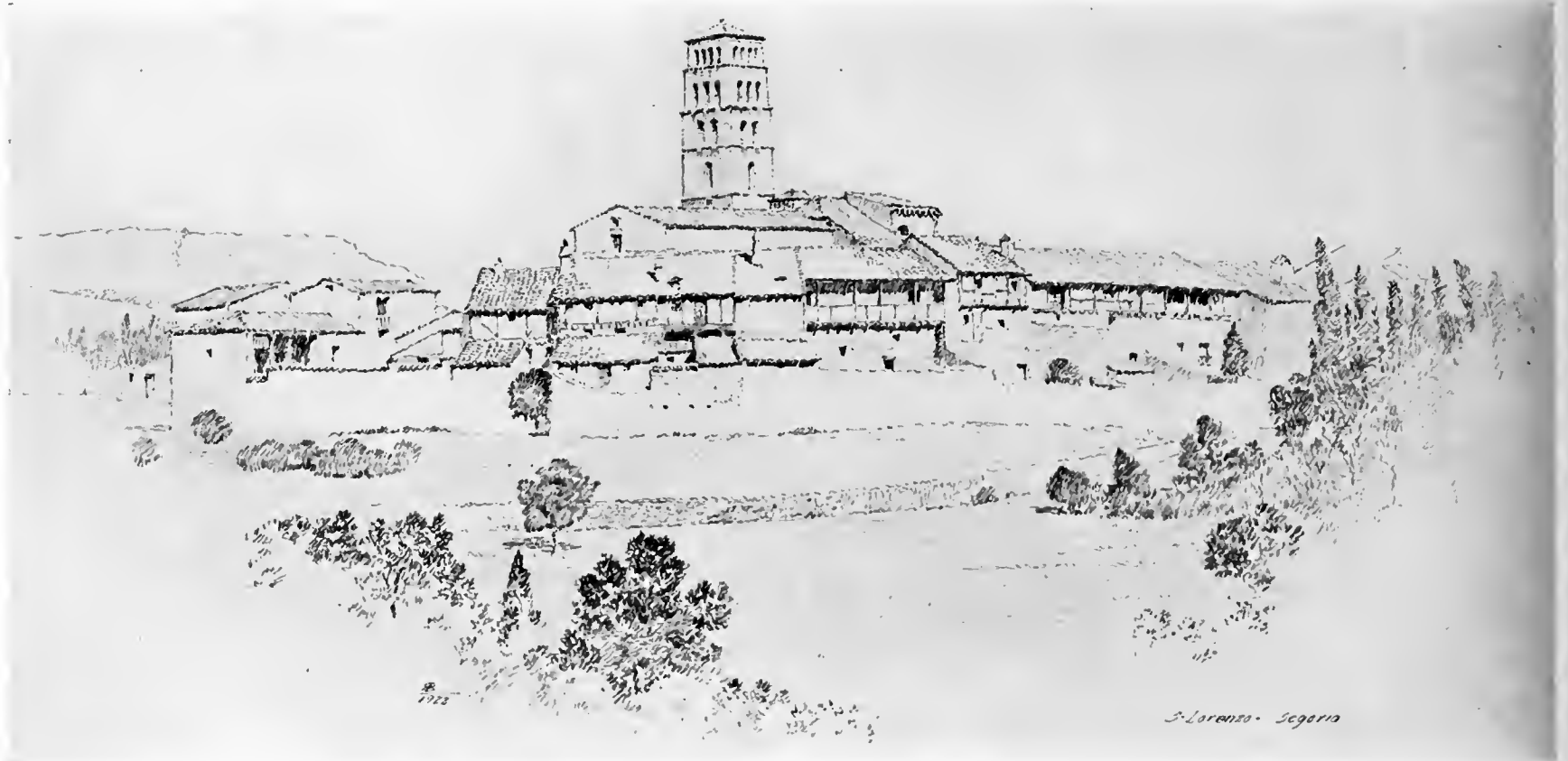









Northons  
123



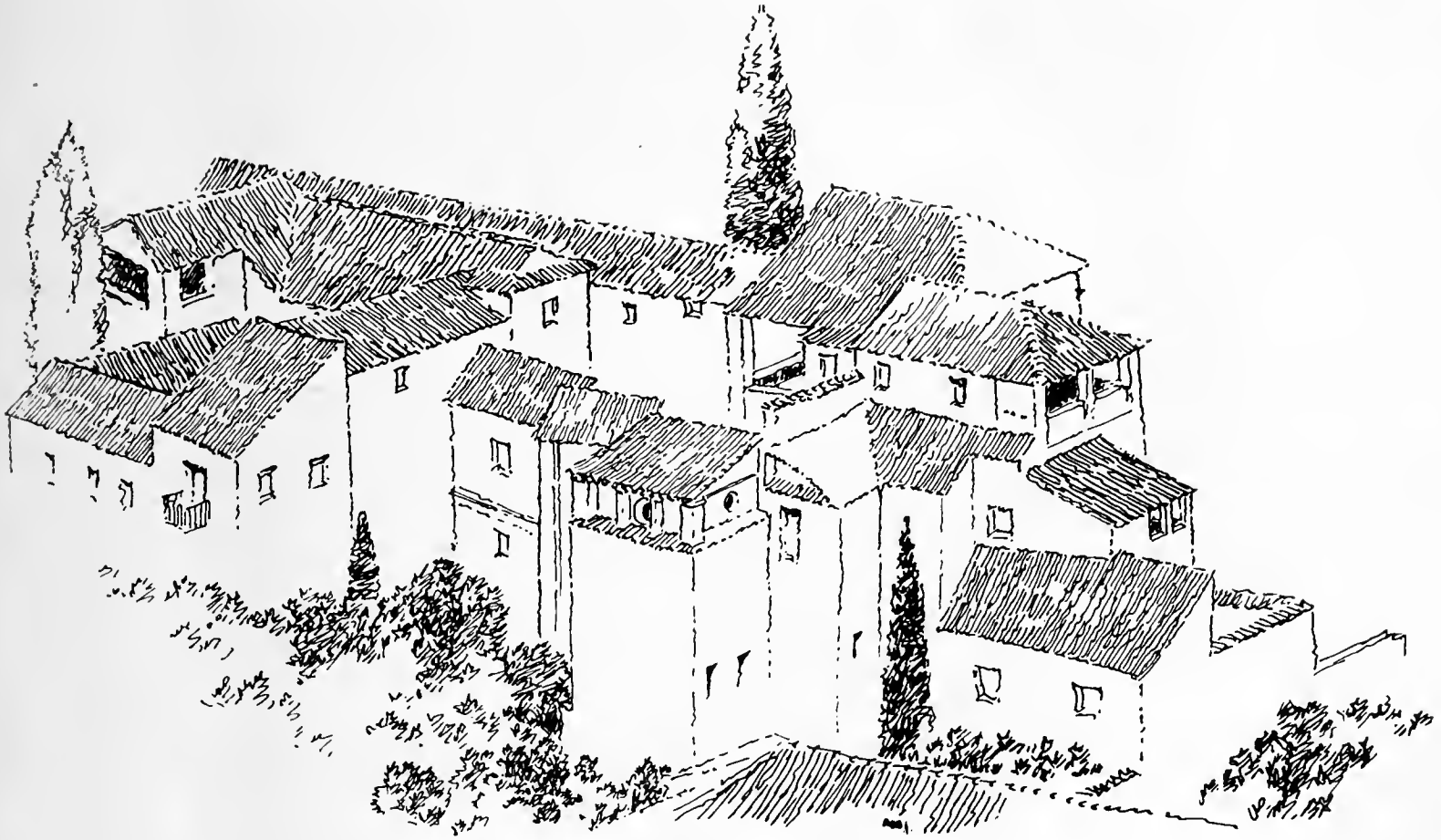

SKETCHES  
MADE AT  
GRANADA

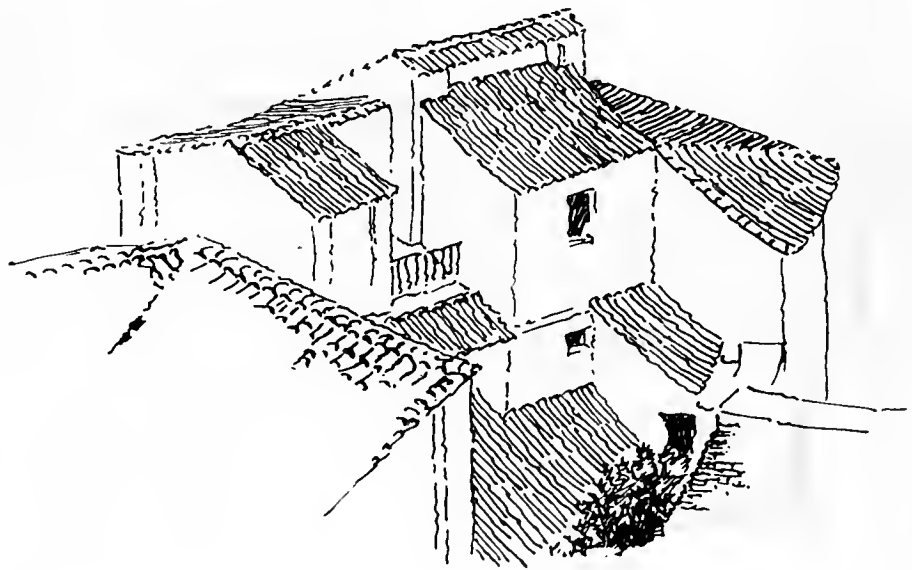





*Arabal*

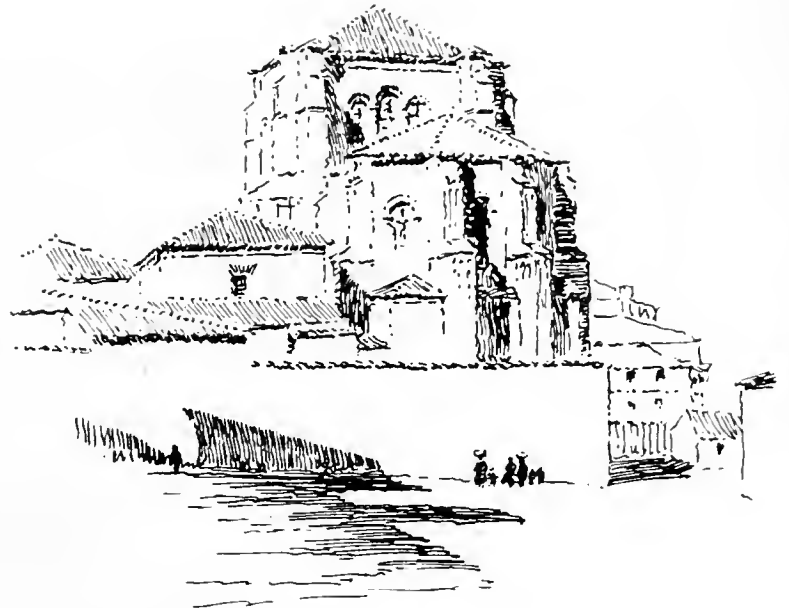

*San Esteban Salamanca*

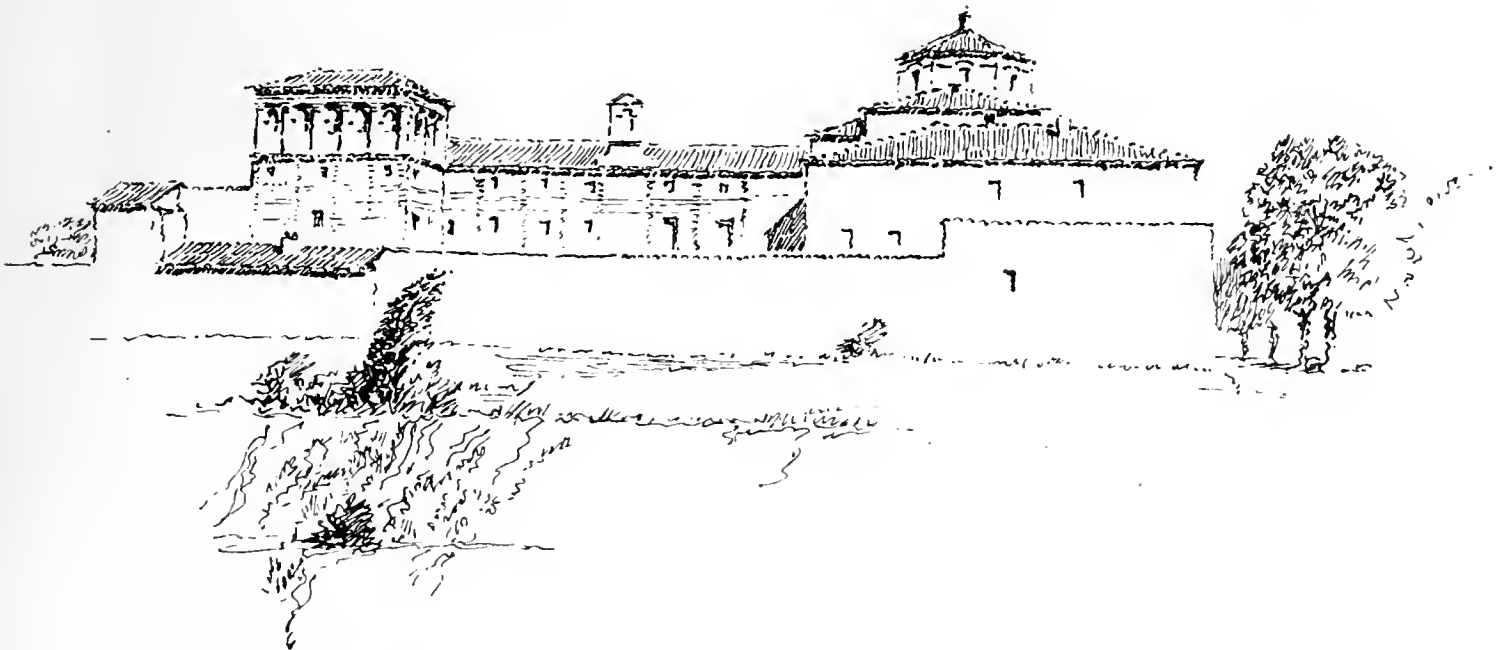
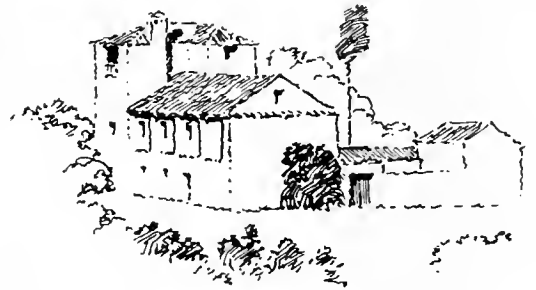

*Tudela*  
1922

(Continued from Page 87)

which is today more widely read than any other romance of California life. The "Home of Ramona" at Camulos in Ventura County, her "Marriage Place" at Old Town in San Diego are visited yearly by travelers from all over the world—shrines equal in interest to the Missions. Mr. Born desired to express, in his Burlingame home, in modified form the delightful features of the old Spanish hacienda, not too large but compact, conveniently arranged, to save steps and economize space. The result—after long working over of plans, looking up of data, sketches, and the few old houses which have been preserved in Southern California—is "Casa Ramona," a miniature or pocket edition of the ranch house described in the story. Mrs. Born stipulated that whatever else was to be changed or adapted, the patio should be reproduced as it exists in the restored "marriage place" in Mission Valley, San Diego. And that is the chief delight of the house. Facing the eucalyptus bordered highway, screened by a high wall, it has the privacy required for an out-of-door sitting room. In the center of the court is a small fountain set about



MAIN ENTRANCE.

with shrubs, a copy of the one at Camulos ranch. The Peninsula climate encourages out-door living, and this sheltered veranda with its pleasant outlook lures the dwellers out into the open for a greater part of the day and summer evenings.

The arrangement of rooms is convenient and simple. Dining room, kitchen, wash-room and maid's room are on one side of the long hall which extends from the front to the back of the house, dividing the service part from the living-room, veranda and bedrooms opposite. There is also provision for servant's quarters in the garage, which is easily accessible from the rear of the house.

The interior is strictly modern, designed for convenience both in point of layout and furnishings. The wall treatment deserves special mention. Of canvas finished with a wide molding, the whole antiqued, gives a soft and mellow atmosphere as of subdued sunshine.

Set as it is in almost an acre of ground, the landscaping plays no small part in perfecting the picture. With but two years' growth trees, shrubs and surrounding hedge



PATIO.

have already "taken root" as it were, they seem to have always been there. The supreme art which conceals itself has been employed in laying out this garden. Palms have been persuaded to grow in spite of gloomy predictions as to unsuitability of climate. And while the planting about the house is low in accordance with its structure, a few tall pines left in the background, with lower branches trimmed, do not take away from the tropical feeling.

The rose garden on the opposite—the hot house is in the center of the plot—borders a generous lawn which is the children's playground. Very jolly and informal it is with irregular graveled paths and cunning arbor.

"Casa Ramona" is altogether an interesting example of "native" architecture, charming in its carefully balanced proportions, set in appropriate surroundings—in color rather restrained—bringing out in pleasing contrast the variety of flowers and shrubs which surround it.

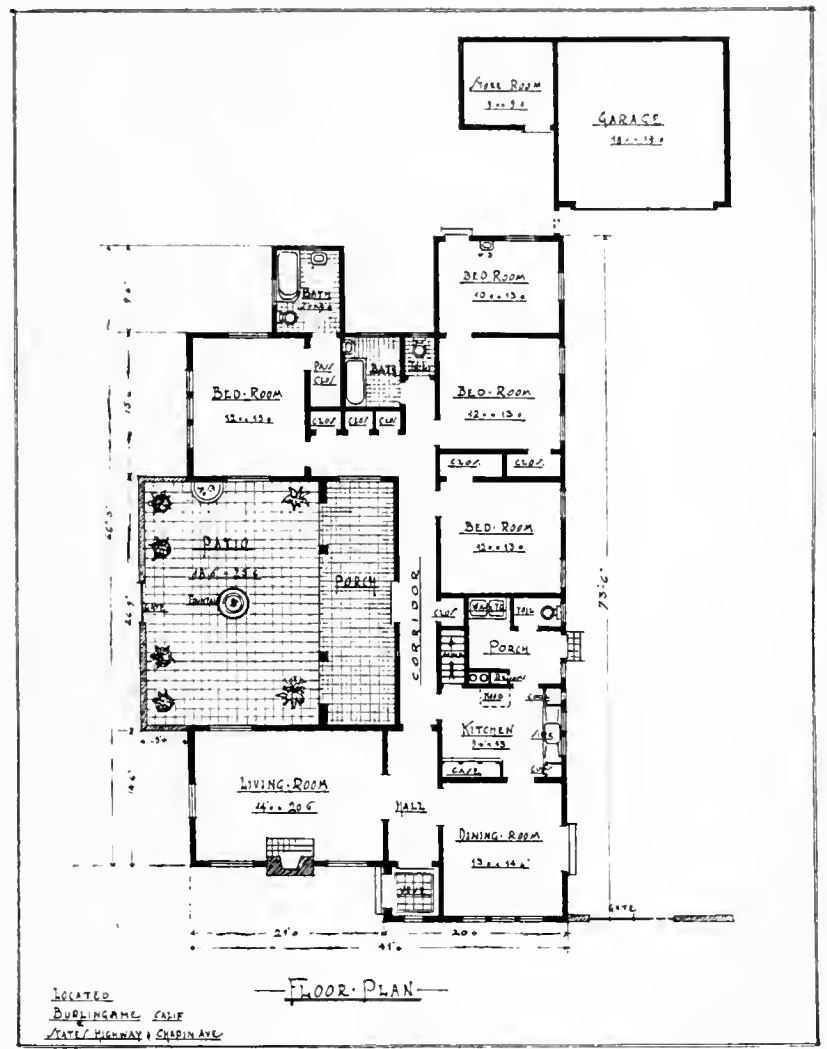

### While Sketching in Spain

(Continued from Page 86)

our usual program we had been devoting part of our time to "exploring" just to see what we could see, and in the course of events wandered into an old house which was undergoing repairs. Carelessly piled in the patio we found a marvelous old carved wooden ceiling, discarded and being sold as firewood. If we could have brought it back to America it would almost have been worth its weight in gold; we could only record it on paper.

On our way south, Avila, Escorial, Madrid and then Toledo, with an hour in the finest interior we saw, an old Synagogue. And then another discovery. Imagine a garage and repair shop with Fords, Dodges and a Studebaker or two, quartered in what was once a Moorish palace! Beautiful wood doors and ceilings, elaborately ornamented arches, all looking pathetically at the modern successors of the Arabian steeds of old. Times change.

A night of travel, and the finely situated towns of Baza and Ubeda gave us our first intimation of the treasures of Andalusia. Our own "California" architecture is that of the Spanish colonies. Now in Northern Spain we had found nothing resembling the hacienda or the churches of the New World,

and not until months later, in Seville, were we offered the answer to our puzzle. You can judge as well as we as to its logic. It seems that during the days of the Conquests the men from the north, Castile, Navarra and Aragon went on their adventure, made their fortune and returned home, while the Andalusian emigrated with family, language, customs and architecture. To those men does the New World owe much. The language of Andalusia is the language of Mexico; there, today, costumes like the Mexican costume appear on the streets, and in countless other ways does Southern Spain seem a country apart and foreign to the rest. To us the south was the Spain of our dreams and the Spain we wished to know.

Of the Moorish work we found in Granada much is in print, but not all. Houses without number in the little known but wonderfully effective "Mudejar" style, churches with the marvelous wooden ceilings of the period following the Conquest, all await the one who will hunt them out. Of the Palace of the Alhambra we will say nothing. Weeks of idling thru its halls or sketching in its gardens told us much, and little, of the art of the Arab. Much, in that we marveled at the beauty of its design and color, and little, if we were now to sit down and try to imitate or even adapt its simplest

motifs. Compared to the Bardo Palace in Tunis the Alhambra suffers much thru lack of furnishing, of divans and cushions, of fountains to fill its empty halls with music; in its heyday it must have been without a peer on this earth.

Usually, in speaking of the Alhambra, one thinks only of the Palace, but actually that part occupies but a small portion of the Alhambra proper. Taking its name from the material of which it is built (Medinat Alhambrâ, or the "Red Town"), the Alhambra occupies a magnificent situation on a ridge running out into the Vega or plain of Granada, with the city of Granada at its feet and on the hill across the Darro. Pictures rise on every side, black and deep for the etcher, little studies in water color, notes in pencil and huge canvases in oils. The red walls and towers of the Alhambra dominate it all, the whitewashed houses of the town with their brown tile roofs, the easy rolling hills, so similar to ours of California, backed by the snow-capped Sierras or stretching away across the brown plain of the Vega. The view from the "hill" is entrancing. Hours did we sit watching in our fancy the return of the raiding Moors or the advance of the conquering Christians, and on several memorable days we selected a village far out on the Vega, and after miles of trudging over the flat roads returned from it with our prizes on paper, compositions or bits of detail. All things must end; the longest road, or the most pleasant stay; and with a firm resolve to revisit Granada in the future, we left.

Ronda was architecturally a disappointment. This most "typical" of Southern Spanish towns falls far short of numerous others. Carmoma, Marchana or Moron all have as much or more to offer, but being off the main lines of travel are almost totally neglected. In Ronda, however, are two real prizes, the "New Bridge" and the Church of Santa Maria la Mayor. This last is another of the histories in stone, standing upon the foundations of a Roman temple and with the minaret and major portion of the mosque still structurally intact. A visit to the sacristan's room adjoining the tower will well repay those interested in wooden ceilings of the Moorish period. This one minaret so appealed to our fancies, that after some debate we decided to get the actual measurements, and it so happened that we undertook our task but shortly before high noon, just when the plaza below

was rapidly filling with interested watchers. Like most towers this one hadn't been designed with an eye to making life easy for ambitious architects armed with rules and tapes. Now your present day small town Spaniard is as yet unaccustomed to sky-writing aeronauts, or even to the gymnastics of the ordinary structural steel erector, so that the sight of a couple of "Americans" scaling their favorite tower was too much for their peace of mind. To quiet them we had to leave the job unfinished, and only after long persuasion aided by many "centimos," were we able to choose another and more appropriate hour to fill in the missing figures.

Cordova we found to be one of the most "Spanish" of towns. Of the Moorish Cordova, practically nothing is left except the great Mosque. Long and diligent search did unearth traces of Byzantine or Moorish motifs in a patio or two, but on the whole the town is the Spanish of the 17th and 18th centuries. Back on the edge of the hills a matter of some six or seven miles, lies the ruins of the palace of Abderrahmân III. Built about 950 A. D. as a summer palace for Az-Zahrâ, his favorite queen, it was on the scale of a town rather than a palace. Following the builder's death, it rapidly fell into decay, and having been used as a quarry for almost the last thousand years, only the general ground plan and the character of its ornamentation can be followed. However, we could note the almost total absence of anything resembling the more fully developed Moorish of later periods. The columns and capitals are of late Roman and Byzantine design, most of the ornament is Byzantine, and the only oriental feature is the slight "horseshoe" of the remaining arches in one of the galleries. It was in Cordova that our goddess of fortune smiled again. A chance meeting in a shop with one who spoke our own tongue, and we had added to our party another Californian, a Santa Barbaran bent on a similar quest.

It was he who ferreted out the route to Medînot az Zahrâ and he who carried on when an approaching storm augured ill for all who were out in the open. We journeyed on, following the traces of the Moorish highway with its two marvelously wrought stone bridges; Roman, apparently, in all except the slight horseshoe of the arches. Then the rain caught us, cameras and sketch books were buried under clothing for protection and we plodded on for



such shelter as we could find in the ruins. Not a good day for study, nor one for idle dreaming of past splendors. Cold facts were all about us, even dripping from our hats or occasionally trickling down our necks. Shelter of a sort we had, yes, but darkness was drawing on and the rain showed no signs of ceasing, so with a final last deep breath we plunged forth and started for town. A long six miles, open fields, soggy and muddy, a steady downpour, and it was a very wet and bedraggled pair who finally reached the shelter of the hotel and the warmth of the "brassero."

Seville and our last long stop. Quite different in color and atmosphere from Granada or Cordova. Pink and yellow walls replace the glaring whitewash. Colored tile abounds everywhere, and it is a poor patio indeed that does not have its marble colonnade. Moorish work, yes. Not the Moorish Gothic and Renaissance. "Mudejar," or, literally, "after the Moors."

Thru the efforts of the American Consul we were permitted to see a real Sevillian palace. Not the usual museum-like display of old walls and antique furniture, but the actual home of the descendants of its build-

ers. The Sanchez-Dalp house is as near the ancient perfection as is possible to imagine. True, restorations have been made, ceilings repainted, bits of tile work installed; but all carefully, lovingly and in perfect taste and harmony. Furniture that any museum in the world would be proud of, old tapestries, fine oriental rugs; garb the living occupants in the dress of the 16th century, and the picture would be complete. But no, that would spoil it; now it is just a home, a jewel of art; so why not think of it as such, and let the past be?

More weeks spent in exploring, ceilings measured, sketches made, and finally, farewells said. For us Seville was an ideal headquarters. Excursions to the country in search of a real hacienda, the successful termination of the search, the perfect hospitality of the owners; more excursions, to Jerez, Alcala de Guadaira, Marchena, Moron; ideal days and nights of wandering; and then the end came. Our Santa Barbaran on to Africa and Italy, the rest of us back to Paris and then home. Well, we are young yet, and some day, in the dim future, we'll return for another journey thru our land of delight, Spain.

## THE ANONYMOUS ARCHITECT

**I**N HIS address delivered before the Lincoln Memorial in honor of its architect, Henry Bacon, Royal Cortissoz used the phrase "unsigned buildings." To be literally accurate they are sometimes signed. But who ever turns to look at a cornerstone or read an inscription? The author's name on the title page of a book is certain to pass under the reader's eye. The architect of a great building, so far as the general public is concerned, dwells in a state of complete anonymity.

This is true not only in new America. It has been a habit of the ages, most completely and strikingly illustrated in the case of the great Gothic cathedrals. The historians have unearthed evidence as to the masters who designed Chartres, Rheims, Bourges, Amiens. But not one in a thousand of those who visit or worship at these shrines of beauty and religion could give the name of one. To an extraordinary degree these great churches of the Middle

Ages were community products. Yet there were unquestionably master minds to order so much soaring beauty, and fame has utterly passed them by.

An odd trick of the world, surely. So far as length of time goes, the architect outlives all his fellow artists. He builds in the most enduring of materials. Centuries are the unit of his influence and thousands of years often mark the beginning of his glory, as the fate of the Parthenon can testify. But the immortality is for his work, not for him or his name. He can die feeling that his labor may live for ages, perhaps meet its just praise among distant generations of alien races. Hope that his name will have an equal share of immortality is slight indeed.

Does the situation point to a law of compensation existing in nature, or a cynical distrust of good architects, or a tender heart toward the bad ones? It can be contended, in any event, that the world would be a more livable place if a similar state of modesty, of fame for the work and none for the artist, were enjoined upon all human creators.—From the New York Tribune.

# MONTHLY BULLETIN

## OFFICERS

Geo. W. Kelham, President.  
Henry H. Meyers, Vice-President.  
J. S. Fairweather, Secretary-Treasurer.



## DIRECTORS

A. J. Evers, two years.  
William Mooser, three years.  
J. H. Blohme, three years.  
Harris Allen, two years.  
S. Schnaittacher, one year.  
Morris M. Bruce, one year.

---

On account of Summer vacation there will be no meeting of the Chapter until September.

## MINUTES

The Directors' and Regular meeting of the San Francisco Chapter of the A. I. A. was held Thursday evening, May 17, 1923, in the Architectural Club Rooms, 77 O'Farrell Street. The meeting was called to order by President Geo. W. Kelham. The following members were present:

Geo. W. Kelham	Harris Allen
Wm. Mooser	H. E. Burnett
Stanton Willard	E. B. Hurt
Geo. Ashley	S. Schnaittacher
Morris M. Bruce	J. S. Fairweather

The minutes of the previous meeting were approved as published.

On account of the three months' vacation, which is customary with the Chapter, the subject of Exhibition was deferred until the September Meeting.

The following members were dropped for non-payment of dues:

Edward Glass, Walter O. Lewis, Louis Mastropasqua, Chapter Members. B. G. McDougall and Walter H. Parker, Institute Members.

It was reported that the State Housing bill was received favorably and would soon take the place of the 1917 Law.

There being no further business, the meeting adjourned.

J. S. FAIRWEATHER,

Secretary.

## DELEGATES REPORT OF THE FIFTY-SIXTH CONVENTION OF THE AMERICAN INSTITUTE OF ARCHITECTS

The Convention held in Washington on May 16th, 17th and 18th, we are glad to say, was presided over by W. B. Faville, the first Western Coast man to preside over a convention of the American Institute of Architects. It was attended by an almost complete delegation from all the Chapters, over two hundred being present at the sessions. Though it developed no political contest or great questions of policy, the meetings were nevertheless intensely interesting as an index of the growing power, usefulness and scope of the Institute. The co-operation of the Institute with the governmental boards and organized societies, as well as other branches of the building industry was brought home forcefully to those present and the broad field for united effort in the solution of large problems was made very clear indeed.

The first session of the Convention was marked by the reading of the reports of the President, the Secretary and the Treasurer, all of which were of much greater interest

than can be told in a limited space. Copies of these reports should be carefully perused and filed by all architects as an index of the intensely practical and useful service attempted by the Institute organization.

The afternoon was under the chairmanship of Past President R. Clipston Sturgis, whose scholarly wit, humor and comment was a treat in itself. The speakers of the day, Professors Edgell and Langfeld of Harvard University, Professor Baldwin of Columbia, and Mr. MacGregor Jenkins of the Atlantic Monthly, all spoke on the relation of architecture to the allied arts, to literature and psychology, and on bringing architecture to the knowledge of the layman.

In the evening our old friend, Mr. C. Howard Walker, took the opportunity to congratulate architects and architecture of the United States on notable achievements of recent years. His talk was illustrated with lantern slides selected to show the tendencies of American architecture.

Thursday morning was given over to routine, while on Thursday afternoon the speakers devoted themselves to explaining the work of the U. S. Bureau of Standards, the Structural Service Committee and the report of the Joint Construction Council. Danger of a collapse following the present rising costs was pointed out in this report and the curbing of unnecessary or speculative building was recommended.

The evening was principally devoted to a talk by Mr. J. M. Hewlett, on the architect's responsibility in the development of Industrial Art.

Mr. Hewlett made a plea for honest use and expression in the materials used by the architects and especially deplored the insistence on the part of architects that the manufacturers of terra cotta should imitate in texture and color other materials chiefly of more expensive textures; he emphasized that terra cotta as used in the renaissance period had a field of honest expression where the use of color was employed and which was infinitely more beautiful than the present degeneration of imitating expensive stone work.

The platform and back of the rostrum was hung with beautiful examples of materials on which color in design had been executed by stencils. Mr. Hewlett pointed out how a new field of decorative expression had been secured by stencil some of which he had used being from ten to fourteen feet in height. The stencils were used on burlap, canvas, silk, velvet, some in two tones and others in gorgeous riots of color; their use as indicated were wall coverings, theater curtains, background for settings, etc.

Following Mr. Hewlett's address, closing the evening exercises, was the Memorial of Bicentenary of the death of Sir Christopher Wren. Dr. C. Howard Walker presented a charming history of this noted and brilliant mathematician, engineer, astronomer and eminent architect, who erected one hundred and fifty churches including St. Paul's Cathedral in London, many hospitals and asylums, besides making the most comprehensive plan for the development

(Concluded on Page XIV)

Guaranteed  
for a  
lifetime of  
satisfactory  
service



TRADE MARK REGISTERED

*Specify*

**PACIFIC**  
PLUMBING FIXTURES

# Code of Ethics\*

Adopted by the National Association of Builders' Exchanges

## SECTION 1

We understand ethics to mean a declaration of principles, and that members of this Association shall regard themselves as being engaged in a profession in which there is a well-defined duty and obligation toward the public and themselves. The profession demands that the members use every honorable means to uphold the dignity and honor of the same, to exalt its standards and to extend its spirit of usefulness.

## SECTION 2

Every member should be mindful of the public welfare, and should participate in those movements for public betterments in which his training and experience qualify him to act. He should support all public officials and others who have charge of enforcing safety regulation in the rightful performance of their duty, and should carefully comply with all the laws and regulations touching their profession, and if any such appear to him unwise or unfair, he should endeavor to have them altered.

## SECTION 3

Members shall not falsely or maliciously injure, directly or indirectly, the business, reputation or prospects of a fellow-member, or in any other manner attempt to supplant him after definite steps have been taken toward his employment or toward the letting of a contract to him.

## SECTION 4

Members should work in harmony with each and every one interested in building construction work, and on each individual contract shall consider the far-reaching effort of fair dealing with the owner, the architect and others interested—striving to bring into general practice better co-operation and a better understanding of relations toward each other.

## SECTION 5

All Exchanges and Associations shall be scrupulously careful that their rules, regulations and articles for the government of members do not violate the provisions of National or State laws against combination; and members shall, in this sense, respect the rules and other articles of the Exchange or Association in any and all localities where they are competing for work or doing work.

## SECTION 6

Members shall infer that the owner or architect, or both, are competent to select the bidders from whom they desire bids on construction or repair projects, and that it would be unethical to submit a bid on any work unless invited to do so; forethought on the part of the owner or the bidder or his agent as to the competency and responsibility of the bidders invited enters into this question; consequently, no bidder's bond or certified check shall be required, and an award on the work shall be expected to be made to the lowest bidder.

## SECTION 7

Bids shall be offered only when a time and place have been designated, and they are to be opened in the presence of the bidders or their representatives, and shall be open to inspection by any one bidding on the work.

## SECTION 8

A general bidder having been awarded a contract involving sub-bids, shall award that particular portion of the work to the sub-contractor whose bid was used as a basis for the general bid.

## SECTION 9

General contractors and sub-contractors shall file true copies of their bids with their Exchange or Association before the time set for opening. Such copies shall be held unopened until one hour after the original bids are opened by the owner or architect, and shall then be opened and tabulated by the secretary, and be available for examination by those bidding.

## SECTION 10

Members shall discourage the practice on the part of the architect in asking for alternate bids, provided, however, that this section shall not be interpreted as prohibiting the specification and use of substitute materials or methods of construction, or methods and materials in every way equal to those which were specified for original bid.

## SECTION 11

Where specification requirements call for  
(Concluded on Page XV)

PHONE FRANKLIN 2492

**A. C. WOCKER**

INTERIOR DECORATOR

1370 SUTTER STREET

SAN FRANCISCO, CAL.

# Informative Advertising

## I. To the Architect:

**YOU** are the Owner's Purchasing Agent.

A manufacturer's product is more important to you than to the seller. To him it means only one part of his annual business—to you it may mean the success or failure of a building, and affect your whole practise.

If you are ignorant of materials, the owner must look elsewhere for information.

Organized agencies are now proceeding to make advertising a medium for conveying to architects authoritative information with respect to building material.

Your co-operation will be to the reciprocal advantage of all concerned. To mark an advertisement for filing takes but a moment.

(Concluded from Page 94)

# BALL BEARINGS

## SKF INDUSTRIES OF CALIFORNIA

Incorporated  
115 NEW MONTGOMERY ST.  
San Francisco, Calif.  
Phone Sutter 4196

DEEP GROOVE AND SELF-ALIGNING BEARINGS  
HANGER EQUIPMENT

# Clay Products

## Gladding, McBean & Co.

SAN FRANCISCO  
LINCOLN  
LOS ANGELES

PORTLAND                      LOS ANGELES                      SEATTLE

## R. N. NASON & CO.

PAINT MAKERS

151 Potrero Ave.--SAN FRANCISCO--436 Market St.

Makers of

### NASON'S OPAQUE FLAT FINISH

A flat oil paint made in soft Kalsomine Tints,  
that is washable; a practical article for  
walls, ceilings, etc., that is most  
economical and durable.

Agency for

Tamm & Nolan Varnish Works High  
Grade Varnishes and Finishes

Goods made on the Pacific Coast for the climate of this Coast

Del Monte                      - -                      Fan Shell Beach

# CLEAN WHITE SAND

Del Monte Properties Company

Sutter 6130 Crocker Building San Francisco

of London. A plan which now after a delay of two hundred years is about to be put into execution.

The evening session found Mr. Walker on the platform once more as the "pinch hitter" and held the interest of the delegates and guests with the remarkable story of the life and achievements of Sir Christopher Wren in memoriam of the bi-centenary of his death.

The Fine Arts Medal of the Institute was presented to Mr. Arthur F. Mathews of San Francisco for distinguished achievement in mural painting, and to Paul Manship for his work in sculpture. Awards of the craftsmanship medals were made to Mr. Frederick W. Gondy in typography, Henry C. Mercer in ceramics, and Samuel Yellin in iron work.

The business of the Convention of Friday morning was almost entirely routine business and was the concluding session.

The gift of \$5000 by the Allied Architects Bureau of Los Angeles to the Institute for the purpose of furnishing the board room of the Octagon House was one of the pleasant surprises of the Convention, and the large Los Angeles delegation was roundly cheered.

The climax of the Convention was the pageant on Friday evening to signalize the presentation of the Institute Gold Medal to Mr. Henry Bacon, architect of the Lincoln Memorial. The dinner was served in a marquee at the east end of the reflecting lagoon for over four hundred delegates and guests. After listening to several brilliant speakers, those present formed in procession on each side of the lagoon and towed the honored guests in at ceremonial barge to the foot of the Memorial. Beautiful banners from all the chapters of the Institute, and the architectural schools of the United States were carried by those in the procession, while all those who attended the dinner were clad in gowns of various colors. The lighting and scenic effects were tremendously impressive. President Harding presented the medal at the Memorial, making the ceremony unusually noteworthy in spite of a drizzling rain.

The increasing function of the Institute as an instrument in improving and safeguarding the best in our profession, and the growing idea of the great opportunity for community service by all architects must have impressed all those who were fortunate enough to attend the Convention.

Attending the Convention was a pleasant and constructive duty. Let us hope that future years will see our Chapter with a more complete representation.

The following were elected for the ensuing year:

President .....Wm. B. Faville, San Francisco  
First Vice-President.....N. Max Dunning, Chicago  
Second Vice-President.....W. S. Parker, Boston  
Secretary .....Edw. H. Brown, Minneapolis  
Treasurer .....D. E. Waid, New York City

### Board of Directors

For One Year, 1923-1924

Edwin Bergstrom (Ninth District).....Los Angeles, Calif.  
Chas. A. Favrot (Seventh District).....New Orleans, La.  
L. P. Wheat, Jr. (Fourth District).....Washington, D. C.

For Two Years, 1923-1925

Wm. Emerson (First District).....Boston, Mass.  
Benj. W. Morris (Second District).....New York City  
Wm. L. Steele (Sixth District).....Sioux City, Iowa

For Three Years, 1923-1926

Chas. H. Hammond (Fifth District).....Chicago, Ill.  
Arthur A. Fisher (Eighth District).....Denver, Colo.  
C. C. Zantzing (Fifth District).....Philadelphia, Pa.

Respectfully submitted,

A. J. EVERS,  
JAS. T. NARBETT.

## Stillwell PLAN BOOKS of CALIFORNIA STYLE <sup>All Climate</sup> HOMES

—show pictures, Floor Plans and Estimated Costs of Building over 200 Selected Designs.

"West Coast Bungalows"  
50 Houses—6 and 7 Rooms—\$1

"Little Bungalows"  
75 Houses—3-4-5 Rooms—\$1.

"Representative California Homes"  
50 Houses—7 to 10 Rooms—\$1.

"The New Colonials"  
60 Houses—6 to 10 Rooms—\$1.

SPECIAL OFFER: Send \$2.50 for any three of these books and get Garage Folder FREE.

Books and Blueprints sold with Money Back Guarantee

E. W. STILLWELL & CO., 790 California Building, Los Angeles



(Concluded from Page XII)

unit price, members, in bidding, shall declare that the unit price shall govern only where conditions of work and price remain the same as existing or known at the time of bidding.

#### SECTION 12

Competitive bids, submitted by invitation, shall be subject to compensation to each and every bidder from the owner, or the architect, or both, in the event of no award of the work made to those bidding.

#### SECTION 13

Members shall in no instance pay for the use of plans, excepting where a charge for plans is stipulated in bidding conditions.

#### SECTION 14

Members shall discourage the practice of making a deposit for the use of plans making estimates.

#### SECTION 15

Members shall be mindful of the interests of the architectural profession, and should in every way discourage the making of preliminary sketches and estimates for prospective builders.

#### SECTION 16

Members shall encourage the practice on the part of the architect of including in the specifications under each heading all of the work of each trade.

#### SECTION 17

Members shall make every effort to extend the use of the Standard Contract Documents of the American Institute of Architects, their third edition, without modification or change.

\*—National Builders Bulletin.

#### A CRAFTSMAN'S CREED

I hold with none who think not work a boon,  
Vouchsafed to man that he may aid his kind  
With offerings from his chisel, wheel or loom  
Fashioned with loving hand and loving mind.  
All of the fine traditions and the skill,  
Come from my elders through the long line down,  
Are mine to use, to raise our craft's renown,  
And mine to teach again with reverent will.  
Thus do I live to serve, tho' least for pay,  
With fingers which are masters of the tool,  
And eyes which light to see the pattern's play,  
As it unfolds, obedient to each rule  
Of our dear Art. So all my craft is praise  
To God—at once part homage and part song.  
My work's my prayer, I sing the whole day long,  
As Faith and Beauty shape the forms I raise.

JAMES PARTON HANEY.  
(Art Center Bulletin)

January 1, 1913.

# Advertising Efficiency

Is your advertising being read by the men who are specifying, buying, and selling the goods you handle?

## THE BUILDING REVIEW

Goes to Architects, Builders,  
Contractors and Home Owners

These are the men behind the  
guns in the Building Industry.

*Are you reaching them?*

*If not, let us show you how.*

*Address:*

THE BUILDING REVIEW

Chronicle Building, San Francisco

Phone Douglas 1956

# Why Contractors Encroach on Architect's Field

By J. C. EDWARDS,

President of the Southern California A. G. C.

**I** INTEND to be very frank and name a few of the real reasons why contractors, who feel themselves capable, encroach on the architect's field.

There has been a decided change in the personnel of the general contractors in the building industry during the past twenty years or even during the past ten years. Improved methods are definitely eliminating the rule-of-thumb contractor, and the contractor of today feels that he is entitled to and should receive the same recognition as the architect or engineer.

Your profession has permitted commercialism to gain such a foothold that, in many cases, completeness of plans and specifications are sacrificed in order that more of the fee may be retained as a net profit. Where this is done controversies arise, extras are claimed, and both owner and contractor are dissatisfied.

## Government Red Tape Offset

The thing that makes government red tape on construction work bearable is the wonderful completeness of the plans and specifications and the exactitude with which one can determine the volume and kind of work to be done.

The custom of calling for such a multitude of alternate bids is not looked on with favor by the contractor. He feels that it is part of your service to the owner to prede-

termine the volume of work to be done and the kind of materials to be used.

Contractors feel that in many cases bids are requested and their time consumed in preparing estimates on work, when the architect knows there is not even a remote possibility of the work going ahead; and it is a very common occurrence for a contractor to submit a proposal to be held for a month or more without being accepted or rejected, the contractor being unable to obtain any information regarding same. This is obviously unjust and should not be continued if it is your intention to recognize the service rendered to the industry by the contractor.

Draw your contracts so as to show fairness to both parties concerned, the owner and the contractor. Insert an arbitration clause in them so that honest differences may be settled out of court. This may be working a hardship on our friends, the attorneys, but nevertheless it is a most satisfactory way of adjusting disputes.

In your contracts and specifications avoid the shifting of responsibility. I have seen contracts based on specifications which provided that the contractor was to assume all responsibility for plans and specifications complying with city ordinances.

## Tit for Tat

Conditions such as I have mentioned have a tendency to create a desire in the contractor to undertake himself the architectural

## Pacific Manufacturing Company

Branches:

117 Stevenson St.  
SAN FRANCISCO

Manufacturers of and Dealers in

**Doors, Windows and Mouldings**

General Millwork

1001 Franklin St.  
OAKLAND

Branches:

908 Washington Bldg.  
LOS ANGELES

58 West Santa Clara St.  
SAN JOSE

Factory and Main Office: Santa Clara, Calif.



service necessary to a construction project, and it is with increasing frequency that you hear of it from the larger contracting firms.

Please do not think for one moment that I fail to appreciate the fact that in many instances contractors have, by their unsatisfactory methods, driven the architects to seek a method whereby they might be eliminated.

It is necessary, however, that we tell you our troubles and you tell us yours if anything is to be done to check this tendency to encroach on one another's field.

There never was a truer saying than this: "A man who is his own attorney has a fool for a client." The principle is applicable to construction. We each have a distinctive service to perform and I doubt very much the ability of either of us to successfully assume the other's position.

Our association will heartily endorse any effort on your part to eliminate the undesirable man in the business, because by so doing we both will be rendering a really honest service to the public. Unless such a service is rendered there is no jurisdiction for the existence of yours, ours, or any similar organization.—From National Builder.



Genuine Hyloplate Backboards  
 Moulthrop Movable Desks  
 Sheldon Manual Training Benches  
 Domestic Science and Laboratory Furniture

**C. F. WEBER & CO.**

Exclusive Agents

SAN FRANCISCO  
 RENO

LOS ANGELES  
 PHOENIX



SUMMIT APARTMENTS

## PITCHER'S Disappearing Doors Adjustable Hangers and Frames

MEET THE DEMAND FOR  
 APPEARANCE, QUIETNESS  
 AND DURABILITY

NO EXTRA WALL THICKNESS REQUIRED

*Manufactured by*

**National Mill and Lumber  
 Company**

318 MARKET STREET, SAN FRANCISCO, CAL.

# There is a difference of roofing tin—

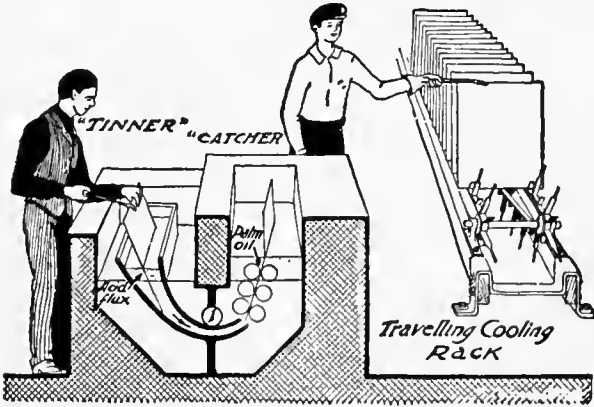

## Making "COMMON TERNES"

"Common Ternes" are those base plates carrying but eight pounds of coating to a box of 112 sheets, each sheet 20" x 28". They are the lowest grade of roofing tin made, and due to their extremely light coating are not recommended for roofing purposes of any kind.

Each sheet is coated by passing the base plate through an acid flux, then through molten metal and out through oil to the cooling racks. **The time required to coat each sheet is but fifteen (15) seconds.**

**T**HE lasting qualities of roofing tin depend on three things: First, the rust resistant quality of the base plate; second, the amount of coating; and third, and most important, the method of applying the coating.

Not only is the base plate of Target-and-Arrow the most rust resistant sheet obtainable, and not only is the coating heavier than standard practice, but this extra heavy coating is applied by the same Welsh process of hand dipping introduced into our plant when we started the manufacture of tin plate in this country thirty years ago; which has been strictly adhered to ever since.

We have often been asked the reason for the unusual wearing qualities of Target-and-Arrow. Here, then, is our answer—judge for yourself.

## Making "EXTRA COATED"

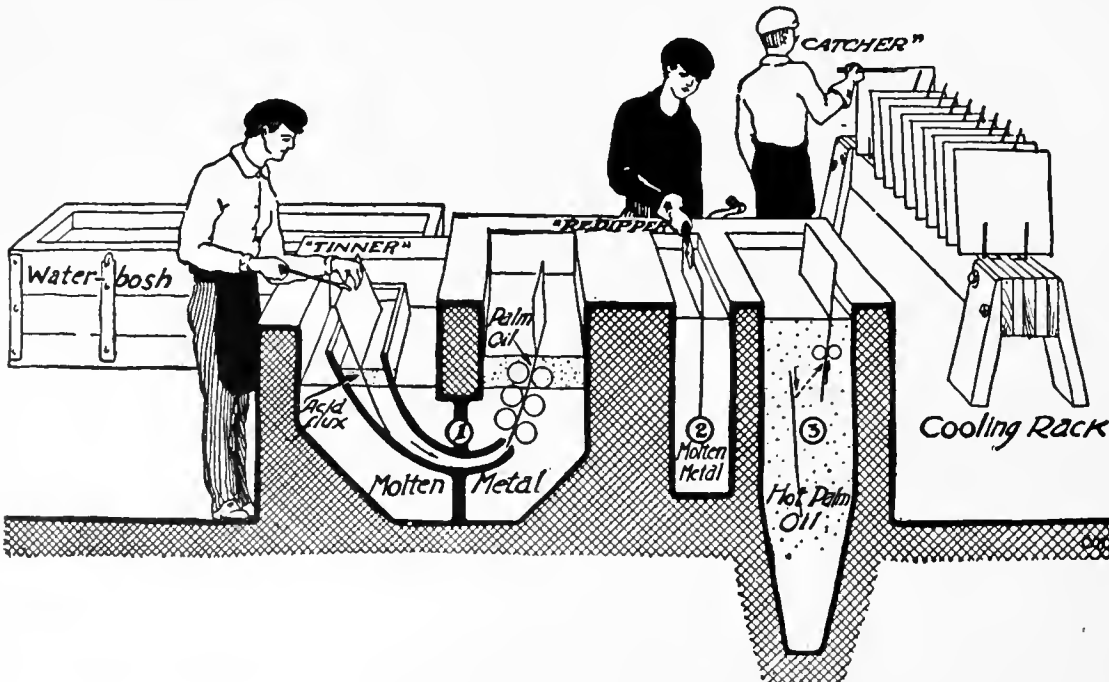

"Extra Coated" include all those roofing sheets carrying 12, 15, 20, 25, 30, 35 or 40 lb. of coating to the box. So called "Old Style," "Old Method," "Old Process," etc., roofing ternes come under the general classification of "Extra Coated." The best of them carries a 40-lb. coating.

Each sheet is coated by passing the base plate through an acid flux, then through molten metal and out through oil where it is grasped by the tongs of the "redipper," who gives it a single quick dip in another bath of molten metal and then runs it through hot palm oil, after which it is placed on the cooling rack. **The time required to coat each sheet is twenty (20) seconds.**

J. A. DRUMMOND, *Western Manager*

845 Seward Street  
Los Angeles, Cal.

1744 Folsom Street  
San Francisco, Cal.

2225 Fresno Street  
Fresno, Cal.

# in the manufacture

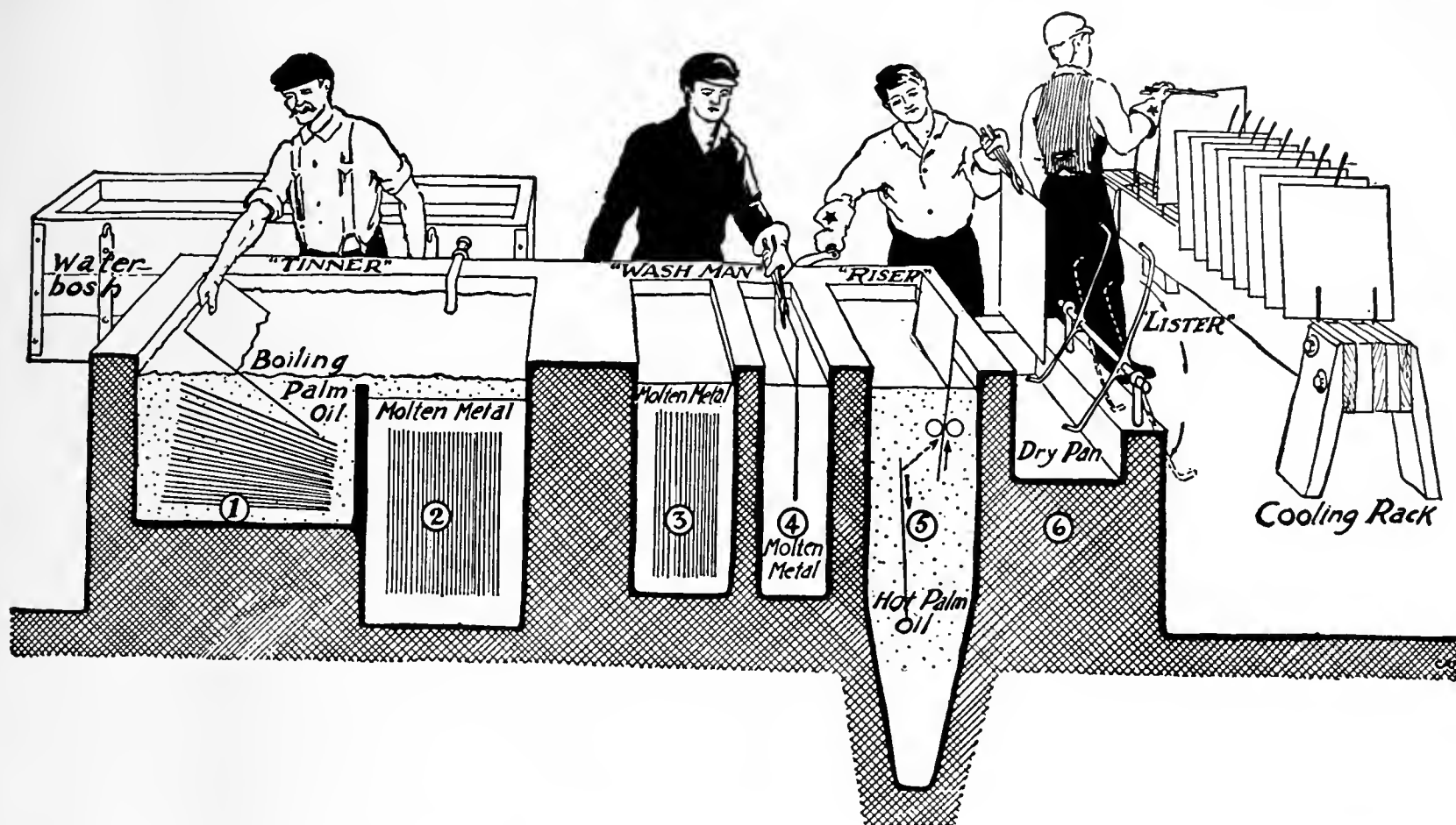

## Making "TARGET AND ARROW"

"TARGET AND ARROW" not only carries more than the standard 40 lb. coating to a box of 112 sheets, but "TARGET AND ARROW" is coated by a different process than the ordinary commercial plate previously described, for it is coated by an old Welsh process requiring the services of four experienced men. This process, used exclusively by us, is as follows:

A pack of about 120 black sheets is placed in a pot of boiling palm oil ("grease pot"), where they are allowed to soak for 15 minutes, thereby thoroughly preparing the base plate to receive and hold the coating composed of a mixture of tin and lead. The use of palm oil flux is a distinct advantage over the acid flux, for, it is more slow and thorough in its action on the base plate.

After soaking in palm oil, the sheets are lifted out and placed on edge in a pot of molten metal ("tin pot"), where they remain for 15 minutes, and the surface of the base plate becomes thoroughly impregnated with the lead-tin coating while the palm oil flux is completely expelled from the surface of the base plate. This complete expulsion of the flux is very necessary and can hardly be accomplished in the short length of time it takes to pass "common ternes" and "extra coateds" through their molten metal baths.

Next, about 20 sheets are lifted out and placed in a second pot of molten metal ("soak pot"), where they remain for about 4½ minutes and then, one at a time, they are lifted out and dipped into a third pot of molten metal ("wash pot") and then passed through a finishing bath of palm oil—"tumbled" (to insure even distribution of the coating) and lifted to the cooling racks.

**The time consumed to coat each sheet of Target and Arrow, as described above, averages 35 minutes for each sheet.**

This method not only assures an exceptionally heavy coating, but one that is thoroughly amalgamated with the base plate, assuring a more lasting coating than can possibly be produced by the usual method of coating.

**N. & G. TAYLOR CO., PHILADELPHIA, PENNA.**  
HEADQUARTERS FOR GOOD ROOFING TIN SINCE 1810

# Contractor and Architect\*

By ELMER GREY, Architect

AS I LOOK at the relation between the contractor and the architect it is simply this:

Planning and erecting a building are all one operation. The division between the planning end of it and the building end is purely a man-made distinction devised for convenience. I imagine that in the stone age the contractor was some big gun, and if the architect existed at all he was a sort of errand boy for the contractor and may have started out on his own by suggesting with considerable trepidation how many fig leaves might be spared from domestic use for ornamental building purposes.

The point is that it is merely because civilization has added so many duties to our curriculum that we have been forced to decide that one man shall take up one department of such work, and another man another. I see no reason why one kind is more dignified than another or why those operating in one department should have any more or any less credit than those in another.

The principal thing to remember is that it has been found absolutely necessary to separate the two owing to the complexity of modern life and activity, and that consequently it behooves those in each department to stay on their own side of the fence.

The reason we have contractors is because it is not humanly possible for one man to be well trained to plan modern buildings and at the same time be well trained to build them. Not only that but if it were humanly possible to do this it would still be impossible for one man to execute both departments efficiently. There wouldn't be time enough in a twenty-four hour day.

For a similar reason we have architects. Life and life's activities have become too complex for one man to know all about planning and still build and manage both efficiently.

All of which has led me to the firm conclusion that except in isolated cases the contractor can attend to his building business better when he does not attempt to run an architect's office at the same time; and conversely an architect can run his profession

better when he doesn't try to enter the field of the contractor by the segregated contract route.

As an illustration, I know of one architect who tried to do both and one day I attempted to get him on the telephone. His secretary informed me that he never came to his office until four in the afternoon, that previous to that time his work required him on his buildings!

I reflected how much efficient time such a man could probably give to design or to other office administration when he didn't get down to office business until four in the afternoon and had to quit at 5:30 or 6!

It seems to me that an architect, if he is worth anything as such, has his hands quite full with work of his own kind without attempting to manage the contractor's end of it; and conversely that no contractor who really gives his best to contracting is likely to have either the training or the time to dabble in architecture.

This is the reason I don't believe in the building company's methods—that is, from the owner's standpoint. When a building company is successful it is so because it is virtually a combination of a contractor with an architect, and in such a combination the two can play into each other's hands altogether too beautifully to suit me if I were an owner.

Also in the few cases where building companies seem to be permanently successful they are so because some talented architect is willing to play second fiddle to a contractor who scoops in the chips. That talented architects are not likely to be satisfied in doing this for long goes without saying, and so the permanency of any successful building company is problematical. When the architect wakes up and calls for his own it is apt to be all off with the platonic friendship. This is what has happened many times, and will happen many more I predict.

So I say let each fellow play his own game as best he knows how and it will be best for him in the long run and also best for the owner.

\*—Builders Exchange Bulletin, Los Angeles.

SAN FRANCISCO  
PUBLIC LIBRARY

# *THE BUILDING REVIEW*



Some Residential Work of  
**JOHNSON KAVEMANN & COATE**

**JULY 1923**

Published in San Francisco

Vol. XXIV No.1 Price 35c.

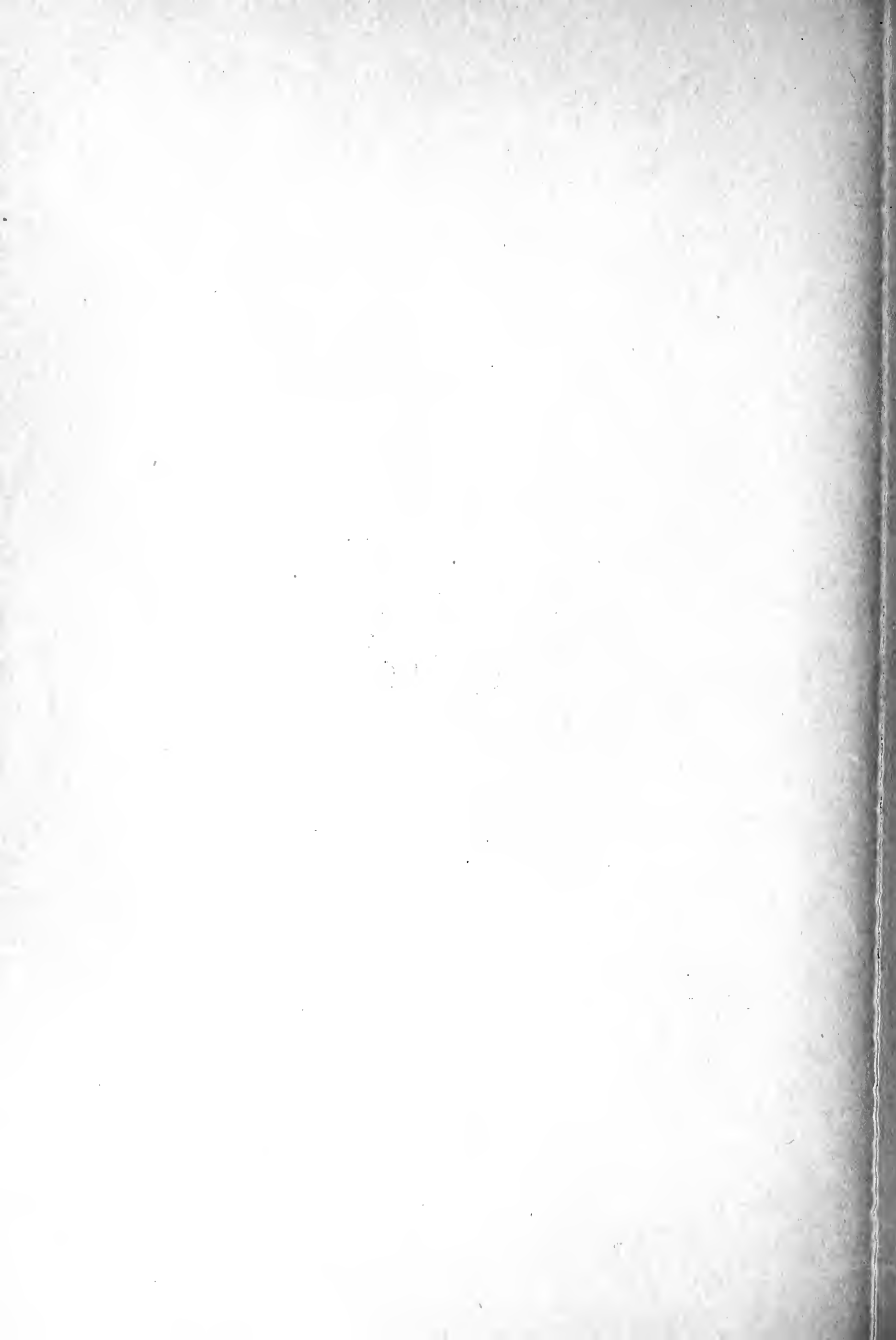

# THE BUILDING REVIEW

VOL. XXIV

JULY 1923

No. 1

## CONTENTS

COVER DESIGN .....By HOMER ANSLEY

### PLATE SECTION

ILLUSTRATING THE WORK OF JOHNSON, KAUFMANN & COATE.

### TEXT

	Page
RESIDENTIAL WORK OF JOHNSON, KAUFMANN & COATE, by Harris Allen .....	1
TWO STATELY GARDENS, by Esther Matson.....	5
SMALL HOUSE OF DELIGHTFUL FEATURES, by Charles Alma Byers	7
A MODEL PORTLAND HOME, by Ethel G. Peterson.....	9
NEW STATE HOUSING ACT, by Mark C. Cohn.....	12
MODERN FLOORS .....	11
NURSERIES FOR REDWOODS, by Frank Mulgrew.....	12

### DEPARTMENTS

EDITOR'S BOOK SHELF .....	VII
EDITORIAL .....	6

HARRIS ALLEN, Editor

HOWARD HOYT  
Industrial Editor  
And Business Manager.

NED BRYDONE-JACK  
Advertising Manager

Published Monthly by the Building Review Company,  
Chronicle Building, San Francisco, California

Address All Communications to No. 426 Chronicle Building, San Francisco, California

Yearly subscription—United States, \$2.50—foreign, \$3.00. Single copies, 25 cents.  
Entered as second-class matter in the San Francisco Postoffice under the Act of August 24, 1912. Previously entered as "The Architect."  
The editors will be pleased to consider contributions of interest to the Industry. When payment of same is desired, this fact should be stated.  
News stands and dealers supplied through San Francisco News Co., San Francisco, Calif., or American News Co., New York, N. Y.

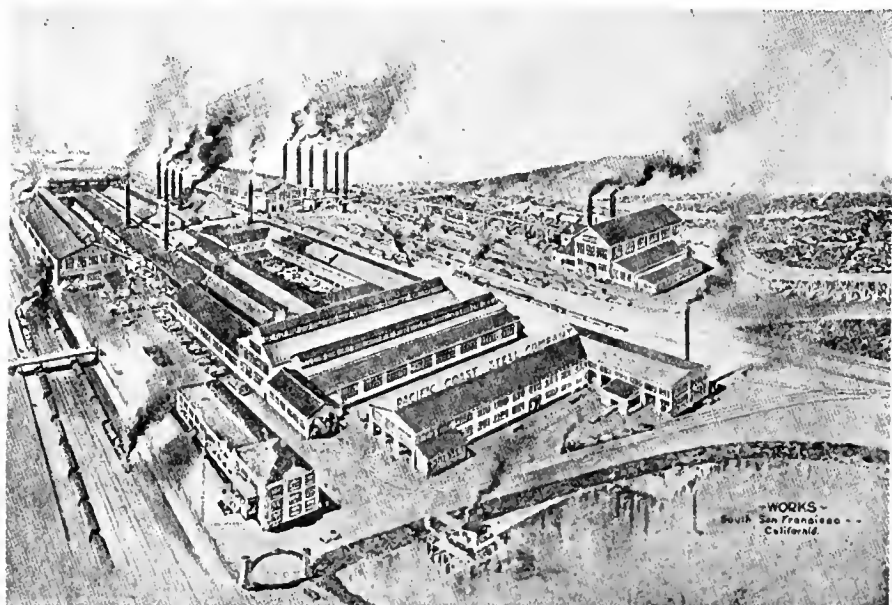

## SHAPES MANUFACTURED

Bolt Rods, Rivet Rods, Wire Rods, Bands, Flats,  
Billets for Forging, Plain Squares, Plain Rounds

Square and Round Corrugated Bars for Reinforcing  
Angles—Equal and Unequal Legs

Stock Lists will be Furnished Upon Request

## Pacific Coast Steel Company

OPEN HEARTH STEEL PRODUCTS

General Offices, Rialto Building, San Francisco



Interior View of Apartment House, 535 Geary Street, San Francisco. Walls done in Fuller Washable Wall Finish. E. E. Young, Architect, M. A. Little, Owner and Contractor.

## Specify FULLER WASHABLE WALL FINISHES

PEOPLE who appreciate artistic effects in their surroundings like the mellow tone produced by a flat oil paint. Such a paint is Fuller Washable Wall Finish. It provides a non-porous, washable surface that dries with a water-color effect. Because of the ease with which any desired tint may be secured, Fuller Washable Wall Finish offers an exceptionally wide range of usefulness.

### *How to Use Fuller Washable Wall Finish*

New plaster and cement walls should be prepared for painting by puttying all cracks and indentations with a stiff putty made by mixing plaster of Paris with Fuller Washable Wall Finish. When putty is thoroughly dry, apply, for a two-coat job, a coat of Washable Wall Finish reduced with Fuller Stopping Liquid in the proportion of three quarts of Washable Wall Finish to one quart of Stopping Liquid. For three-coat work, the first, or stopping coat should be mixed one-half each of Stopping Liquid and Washable Wall Finish. For second and third coats, use Fuller Washable Wall Finish as it is put up at the factory, or if desired, thin with a little turpentine.

Architects who desire specific information concerning Fuller Washable Wall Finish, and approved methods of application, should write for this information to the Fuller Service Department.

# FULLER

PAINTS  VARNISHES

W · P · FULLER & CO ·

San Francisco	Pasadena	Boise
Oakland	Long Beach	Salt Lake City
Sacramento	San Diego	Seattle
Stockton	Santa Monica	Tacoma
Fresno	San Bernardino	Spokane
Los Angeles	Santa Ana	Yakima
Hollywood	Portland	Walla Walla

**FIREPROOF**  
**Gates Hotel**  
**Los Angeles**  
**300 ROOMS**  
**250 BATHS**  
**OUR OWN CAFÉ**  
**RATES FROM \$1.50 PER DAY**  
**Holladay & Collins**  
**Owners.**

**Sixth**  
**at Figueroa**



## EDITOR'S BOOK SHELF

## THE PRINCIPLES OF INTERIOR DECORATION\*

**A**LTHOUGH it is stated frankly by the author (lecturer on interior decoration, University of California) that this book is intended for the beginner and for the reader desiring a general understanding of the subject, it contains much that is interesting and valuable to the architect. After introductory chapters on the general nature and method of interior decoration, the author takes up in detail the matters of line, form, color, texture, contrast, proportion and balance, light and shade, harmony, ornament, excellence in design, and period decoration. His treatment of these matters is intelligent and intelligible.

Especially interesting is the chapter "Fitness and Purpose." It expresses clearly and forcibly, principles which are basically sound but constantly ignored. "Good decoration is not absolute, but relative, being essentially a matter of correct relationships. A house can be considered to be properly furnished only when it meets all the real needs, both practical and esthetic, of all its occupants."

There is so much substantial merit in this book that it should and probably will obtain a permanent place in the study of decoration.

\*—The Principles of Interior Decoration, by Bernard C. Jakway. The Macmillan Company.

## THE BUNGALOW BOOK\*

**A**CCORDING to the preface, this is not a book of plans nor a dissertation on construction, but information as to what amateurs need to know about planning and building of bungalows. It contains many practical suggestions about fittings and accessories, about methods of construction, both fireproof and frame, about heating, plumbing and wiring, and even takes up decoration, furniture, and landscaping. It is written in a chatty informal manner, and while intended more especially for Eastern climate and methods, there is much that the Western bungalow builder can utilize profitably.

\*—The Bungalow Book, by Charles E. White, Jr. The Macmillan Company.

## UNITED STATES CIVIL SERVICE EXAMINATION

The United States Civil Service Commission announces the following open competitive examination:

## Design Draftsman (Structural)

Applications will be rated as received until August 31. The examination is to fill two vacancies at the Naval Operating Base, Pearl Harbor, Hawaii, one at an entrance salary of \$6.80 a day, and the other at an entrance salary of \$8.80 a day, and vacancies in positions requiring similar qualifications.

Applicants must have had experience in the designing and detailing of steel, concrete, reinforced concrete, and timber structures, and in the preparation of drawings for the various types of structures usually encountered at naval establishments, such as buildings, walls, foundations, wharves, piers, etc. They must be capable of assuming responsibility for the development of designs and the making of estimates and computations determining their sufficiency.

Competitors will not be required to report for examination, but will be rated on their education, training, and experience.

## BATCHELDER TILES



GARDEN POT No. 215

BATCHELDER-WILSON CO.  
2633 Artesian Street Los Angeles, Calif.

*No leaks,*  
**no roof troubles**  
*Specify*  
**PABCO**  
 10 & 20 year  
**ROOFS**

which require the use of  
**FLOATINE**

The improved roof asphalt  
 that will not soften  
 run, leak or slide.

one of  
 the  famous

TRADE MARK  
**PABCO**  
**PRODUCTS**

The PARAFFINE  
 COMPANIES, Inc.

SAN DIEGO  
 OAKLAND

LOS ANGELES  
 PORTLAND

SAN FRANCISCO  
 SEATTLE

# *The* BUILDING REVIEW

SAN FRANCISCO  
PUBLIC LIBRARY

VOL. XXIV

SAN FRANCISCO, JULY, 1923

No. 1



JOHNSON, KAUFMANN & COATE, Architects.

## Some Residential Work of the Firm of Johnson, Kaufmann & Coate

By HARRIS ALLEN

**T**O WRITE an article in appreciation of Johnson, Kaufmann and Coate's work is very much like gilding the lily. So much of it has been illustrated, and it has been so much admired and so ex-

haustively described, that apparently little remains to be said. But it is always interesting to try to determine, from different viewpoints, just what produces success. Not that one can lay down a hard and fast



HOUSE OF MR. WM. FLINT,  
FLINTRIDGE, CALIFORNIA.

rule for aspirants to follow; but guide-posts make it easier to keep from losing one's way.

Within a comparatively short time, a few years, this firm has built up a very large practise, has won many awards of merit, including the Medal of the American Institute of Architects, and has achieved nation-wide recognition. It is not luck, or chicanery, to which such progress is due. No prize-winning masterpiece brought publicity and clients to the firm; no special social or business favoritism singled them out. Sheer merit, of design and execution, has won its way.

Now just why is their work so good and so consistent? Of course it is easy enough to say that the delightful models found in Italian and Spanish hill towns have furnished a worthy inspiration, and that these originals have been cleverly adapted to our local conditions. That will not do. A lot of other well trained men who have had the same sources of inspiration, do not approach the distinction of this firm's work.

Moreover, the European "originals" are quite frankly, for the most part, farm houses; and no matter how simple in composition, these houses are distinctly not farm houses.

It seems to me that here we may be getting at the secret of their popularity. They have an air of distinction, of what the Southerners call "quality." It is not style, nor refinement, nor grandeur—not any of the accessories or trappings of rank; it is just the real thing, the evidence of gentle blood, the phrase "noblesse oblige" applied to architecture.

There is absolutely not a jarring element, not a single detail that is banal or vulgar. There are no forced effects. It would be absurd to say that picturesqueness of profile or balance of elements had occurred accidentally. Such things are the result of careful study—plus an inner conviction. The point is, the sureness of touch. There are no obviously unsuccessful experiments. How on earth do they avoid them? For of course they do experiment. It may be that in the dim recesses of their not very extensive past there are some skeletons which they hide from public recognition, in the shape of architectural aberrations (I use the more elegant word in this society) tried out and discarded; but somehow that doesn't seem plausible in the face of the succession

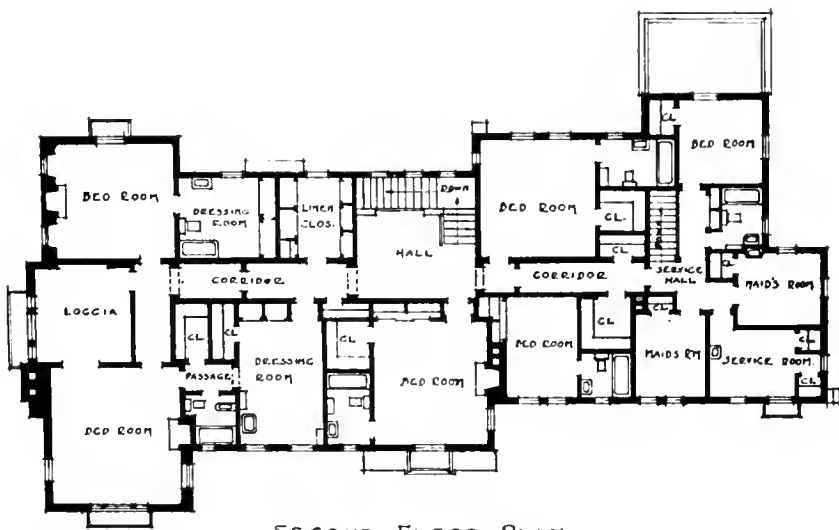

SECOND FLOOR PLAN

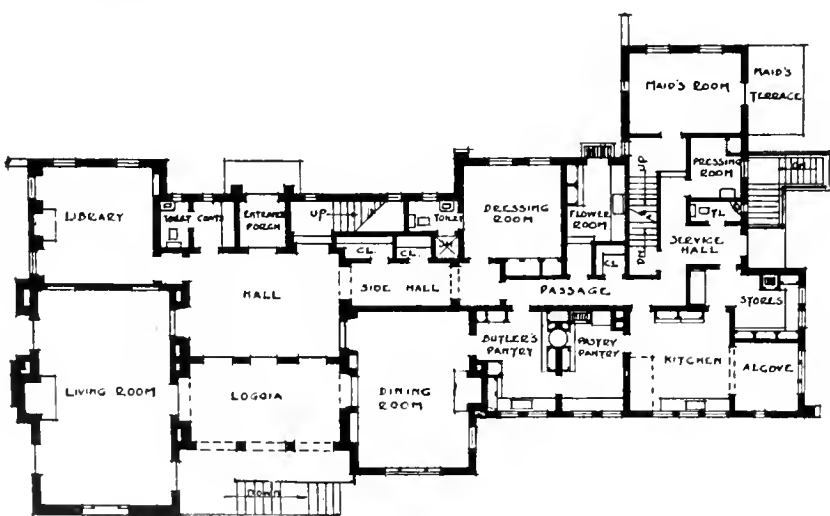

FIRST FLOOR PLAN

HOUSE FOR MR. EDWARD LOWE,  
MONTECITO, CALIFORNIA.

of successes we do see. Noblesse oblige again; you would as soon expect to hear a Prince Royal burst into Billingsgate, as to see on a Johnson design some exuberant outburst of imagination which was out of taste, out of balance, "out of the picture."

Good taste; that implies a trained palate, or mind, discriminating perceptions, sensitive nerves, and yet strength of conviction. You must convince others, if your taste is to be known as good. Using the broad, derived meaning of the term, it is far from easy to force everyone to accept your taste as good. And it is especially hard for an architect to persuade his clients to that belief, and to be allowed complete demonstration. A client is hypnotized, or bullied, or enthused, into giving his architect carte blanche, just often enough to bring it within the bounds of possibility, and to keep every architect dreaming that some day the miracle may happen to him. It is like making a hole in one, in golf.

Johnson, Kaufmann and Coate have been fortunate in their clients (and vice versa, it goes without saying) in that they have imposed their good taste successfully, or at least without obvious objection on the part of the owners. Moreover, one cannot but infer that the architects' taste has been so voracious as to consume everything, house, grounds, furnishings, et al. Allowing a certain amount of conference and co-ordination, it seems to be clear that all these elements have been included in the study and treatment which the architects gave the problem, and it is quite possible that they would now refuse to design a house under any other conditions.

It is not my intention to comment separately upon the recent examples of the firm's residential work which are illustrated in this issue. That a high standard of excellence is being maintained, no architect will question, and the number of laymen impressed thereby is sufficiently large to ensure continuing and increased activity for the firm. Their success ought not to be grudged, for it is based, as their recognition by the Institute shows, upon merit. To the innate qualities of good taste and judgment, combined with a fine sense of proportion and balance, have been added, as the result of study and practise, an acquired familiarity with certain styles and materials, the thorough knowledge of landscape effects, a facility in uniting elements into a congruous



HOUSE OF MR. E. V. ARMSTRONG, PASADENA, CALIFORNIA.

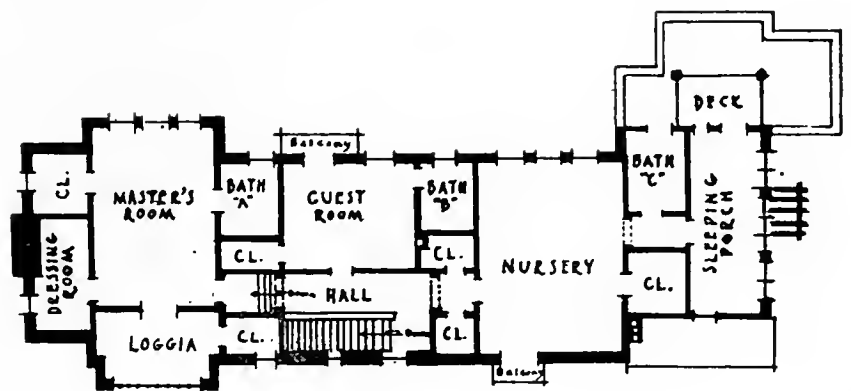

SECOND FLOOR PLAN

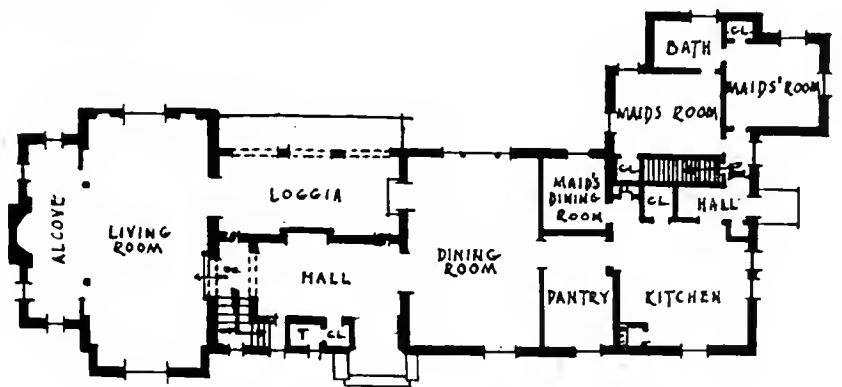

FIRST FLOOR PLAN

HOUSE FOR MR. E. V. ARMSTRONG, PASADENA, CALIFORNIA.



HOUSE OF MR. WM. FLINT,  
FLINTRIDGE, CALIFORNIA.

composition, and an intelligent control of ornament.

Much may be expected from Johnson, Kaufmann and Coate. It is reasonable to believe that a long career lies before them; and since already they have added materially to the charm of Southern California, we may count ourselves fortunate that the fullness of their powers is to be developed in this environment, of which they show such sympathetic understanding.

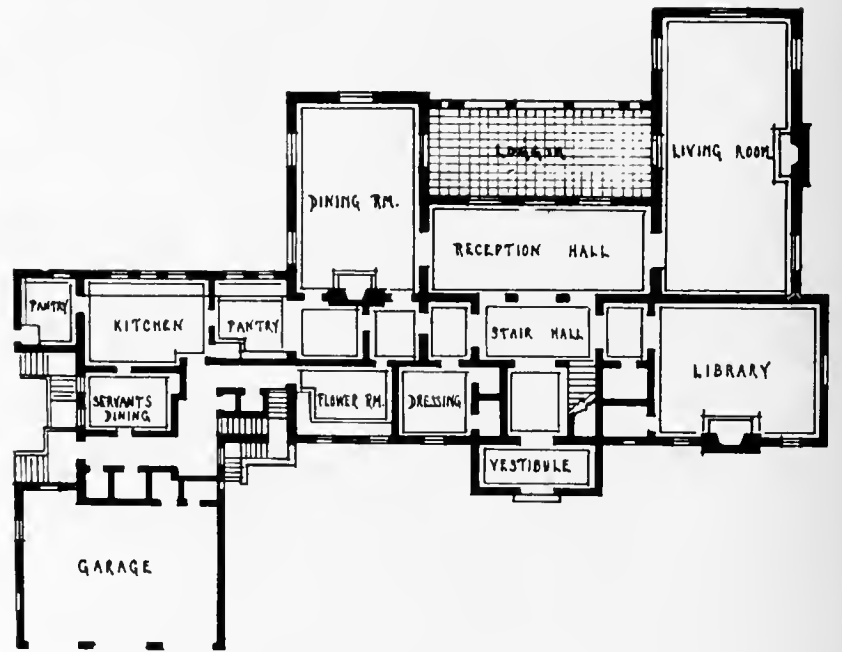

FIRST FLOOR PLAN

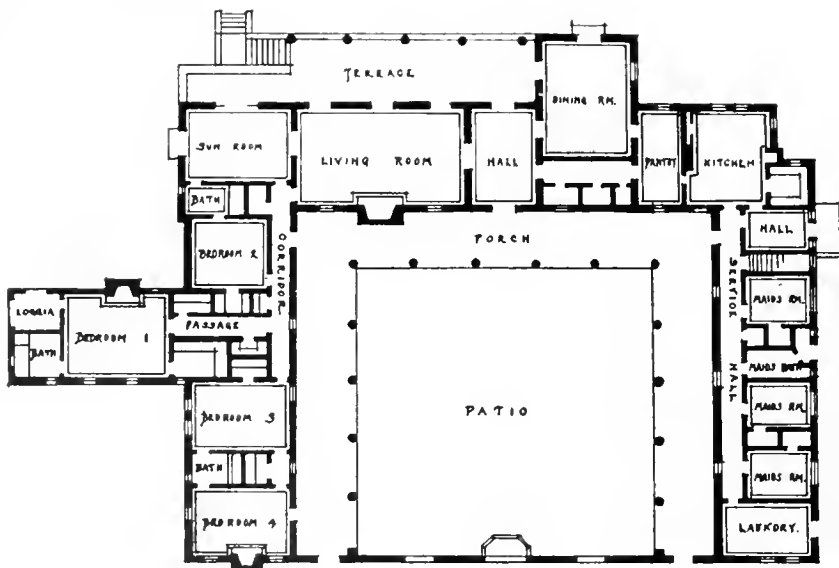

FLOOR PLAN

HOUSE FOR MR. E. M. GOULD,  
SANTA BARBARA, CALIFORNIA.

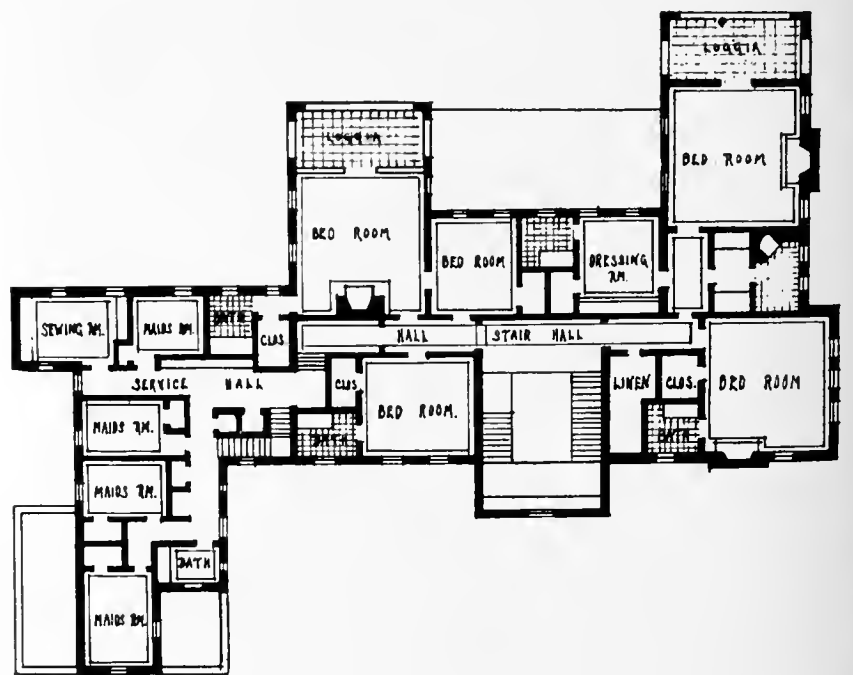

SECOND FLOOR PLAN

HOUSE FOR MR. TOD FORD, JR.,  
PASADENA, CALIFORNIA.

# Two Stately Gardens

By ESTHER MATSON

**I**T WAS the idea of Sir Francis Bacon that "Men come to build Stately sooner than to Garden Finely: as if Gardening were the Greater Perfection." We may not be quite ready to grant this implication in full, but we have come recently to realize how mutually dependent on one another are houses and gardens. The new viewpoint is shown in a very interesting manner by the way in which two large estates in Southern California are being developed.

For Mr. John Severance in Pasadena, and again for Mr. Ben Meyers in Beverly Hills, the architects, Messrs. Johnson, Kaufmann and Coate, are taking into their consideration the garden and its accessories not only in closest relation to the house, but actually before it.

This happy departure from the old custom of levelling a plot, cutting down all existing trees and plants, and beginning with a bald bare house, is highly significant of our new attitude toward the arts. In the case of the Pasadena estate there has been the advantage of a very delightful existing garden surrounding a spacious old frame mansion and here, too, a real "tone of time" and a utilization of centuries-old oaks has brought about a compelling and mysteriously subtle blend of lights and shades. As this garden tends to be naturalistic the task of the designers was to bring parts of it into more formal relation to the formality of the new casino and the new formal house which will replace the present informal one.

In Beverly the problem is different—this time the making of a wild hill-site into a pleasure with every conceivable appurtenance of luxury. The two tasks are brimful of possibilities and in both the water features are being emphasized—in one with

a reflection-pool, in the other with a pool for swimming.

Both are notable instances of gardening de luxe, but it is interesting to consider that in these just as truly as in respect to the small and intimate garden—are the words of the French historian, Guizot, hold. "A study of art," said Guizot, "possesses this great and peculiar charm, that it is absolutely unconnected with the struggles and contests of ordinary life. By private interests, by political questions, men are deeply divided and set at variance; but beyond and above all such party strife they are attracted and united by a taste for the beautiful in Art."

To garden "finely" is not necessarily to garden in the stately manner. But it is inevitably to apply certain of the same principles that underlie all the arts to the particular problem in hand. To ponder these principles—such as unity, as proportion, as balance—is to come into a greater enjoyment; not only of the elaborate and extremely art-ful landscape-gardens, but of natural scenes as well, and of the little intimate garths.

To have the privilege of seeing the two stately pleasancess here pictured, is to be given forceful illustration of the truth succinctly stated by Charles W. Eliot in his review of that recent and worth-while publication, "The Significance of the Fine Arts." In his summary of the chapter on Landscape Design he says: "The beauty of landscape is more complex than that developed in any other art; for it depends on texture, form, color, light and shade, detail and mass, outline and perspective. It is the latest of the fine arts; but it is likely to contribute to human health and happiness more than any other except music. . . ."

## EDITORIAL

THE policy of the Government in training a number of disabled veterans to be architectural draftsmen is a matter to which all architects should give consideration.

When the prescribed courses of these men are completed the directors of the Veteran's Bureau seek to place them in architect's offices. The value of their training is therefore important to their prospective employers, and certainly vital to the students. To them it must secure the means, first, to make a living wage, and second, if possible, to develop their ability so that they may advance to positions of responsibility and independence.

It is clear that in order to prevent economic waste, these courses should be so arranged as to determine at the earliest possible time the capacity of the student. Then if he is unfitted to earn a living as a draftsman, a change in course should be made, thereby saving the Government money, and what is far more important, saving the student time. These are not boys, but men, and to start again after wasting several years of training is a well nigh hopeless undertaking.

The course, therefore, should be flexible and stereotyped class instruction should be avoided. The greatest possible degree of individual contact with instructors should be provided, to determine the rate of each student's progress. Moreover, and this is

absolutely essential, the course should be confined to the essentials required in ordinary office practice.

At best it can extend but two or three years, and it is the height of folly to attempt covering in such a brief period the subjects which are included in collegiate architectural courses of from four to seven years, and after which there is required a year or more of office experience to make a draftsman of any practical value.

For some time to come men will be starting their training. The ideal course, as suggested by the local chapter of the A. I. A., would be in the nature of an atelier along very simple practical lines, which would enable a graduate to be of subsequent use in an architect's office; to eventually earn his living, and to forge ahead if he has the aptitude and application. This atelier could well run for a year and a half, to be followed by a year's apprenticeship under an architect with the student's expenses paid by the Bureau. If Government red tape will not permit this method, the course should be laid out, under the advice of architects to eliminate confusing and non-essential instruction and to include at least some familiarity with the working plans of modern buildings of the simpler types.

One encouraging sign is the fact that the Chapter has been asked for advice while there is still time to consider the best interests of the Vocational students.







RESIDENCE OF MR. JOHN SEVERANCE (SERVICE BUILDING),  
PASADENA, CALIFORNIA.  
JOHNSON, KAUFMANN & COATE, Architects.



RESIDENCE OF MR. JOHN SEVERENCE (GARDEN PAVILION),  
PASADENA, CALIFORNIA.  
JOHNSON, KAUFMANN & COATE, Architects.



RESIDENCE OF MR. JOHN SEVERANCE (GARDENS),  
PASADENA, CALIFORNIA.  
JOHNSON, KAUFMANN & COATE, Architects.



RESIDENCE OF MR. MAX C. FLEISCHMANN,  
EDGEWOOD RANCH,  
CARPENTERIA, CALIFORNIA.  
JOHNSON, KAUFMANN & COATE, Architects.



RESIDENCE OF MR. MAX C. FLEISCHMANN,  
EDGEWOOD RANCH,  
CARPENTERIA, CALIFORNIA.  
JOHNSON, KAUFMANN & COATE, Architects.



RESIDENCE OF MR. TOD FORD,  
PASADENA, CALIFORNIA.  
JOHNSON, KAUFMANN & COATE, Architects.



RESIDENCE OF MR. TOD FORD,  
PASADENA, CALIFORNIA.  
JOHNSON, KAUFMANN & COATE, Architects.



RESIDENCE OF MR. J. P. JEFFERSON,  
MONTICITO, CALIFORNIA.  
JOHNSON, KAUFMANN & COATE, Architects.





RESIDENCE OF MR. J. P. JEFFERSON,  
MONTECITO, CALIFORNIA.  
JOHNSON, KAUFMANN & COATE, Architects.



RESIDENCE OF MR. EDWARD LOWE,  
MONTECITO, CALIFORNIA.  
JOHNSON, KAUFMANN & COATE, Architects.

SAN FRANCISCO  
PUBLIC LIBRARY



RESIDENCE OF MR. EDWARD LOWE,  
MONTECITO, CALIFORNIA.  
JOHNSON, KAUFMANN & COATE, Architects.

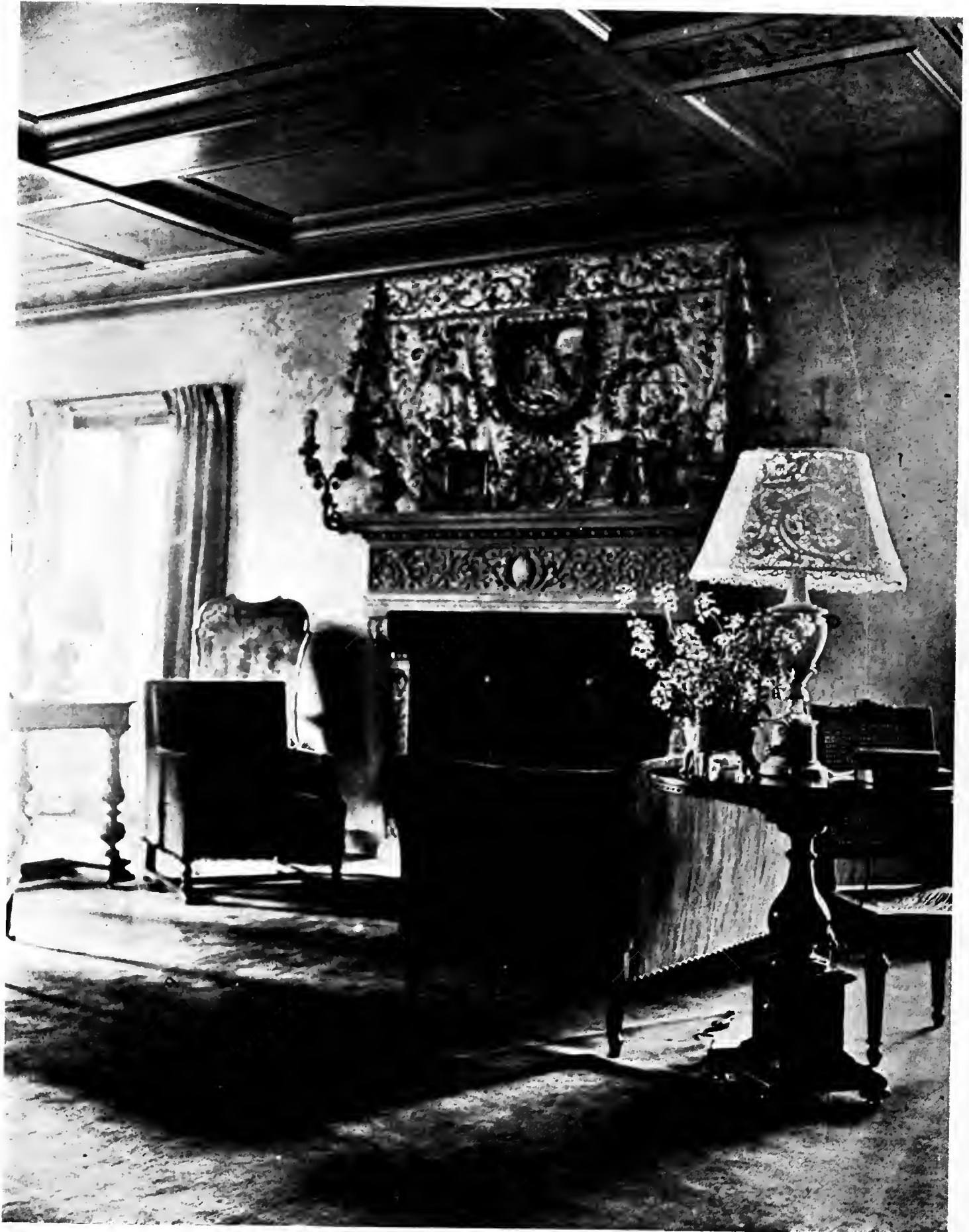

RESIDENCE OF MR. EDWARD LOWE,  
MONTECITO, CALIFORNIA.  
JOHNSON, KAUFMANN & COATE, Architects.



RESIDENCE OF MR. E. M. GOULD,  
ONTECITO, CALIFORNIA.  
JOHNSON, KAUFMANN & COATE, Architects.



SWIMMING POOL PAVILION,  
RESIDENCE OF MR. BEN MEYERS,  
BEVERLY HILLS, CALIFORNIA.  
JOHNSON, KAUFMANN & COATE, Architects.

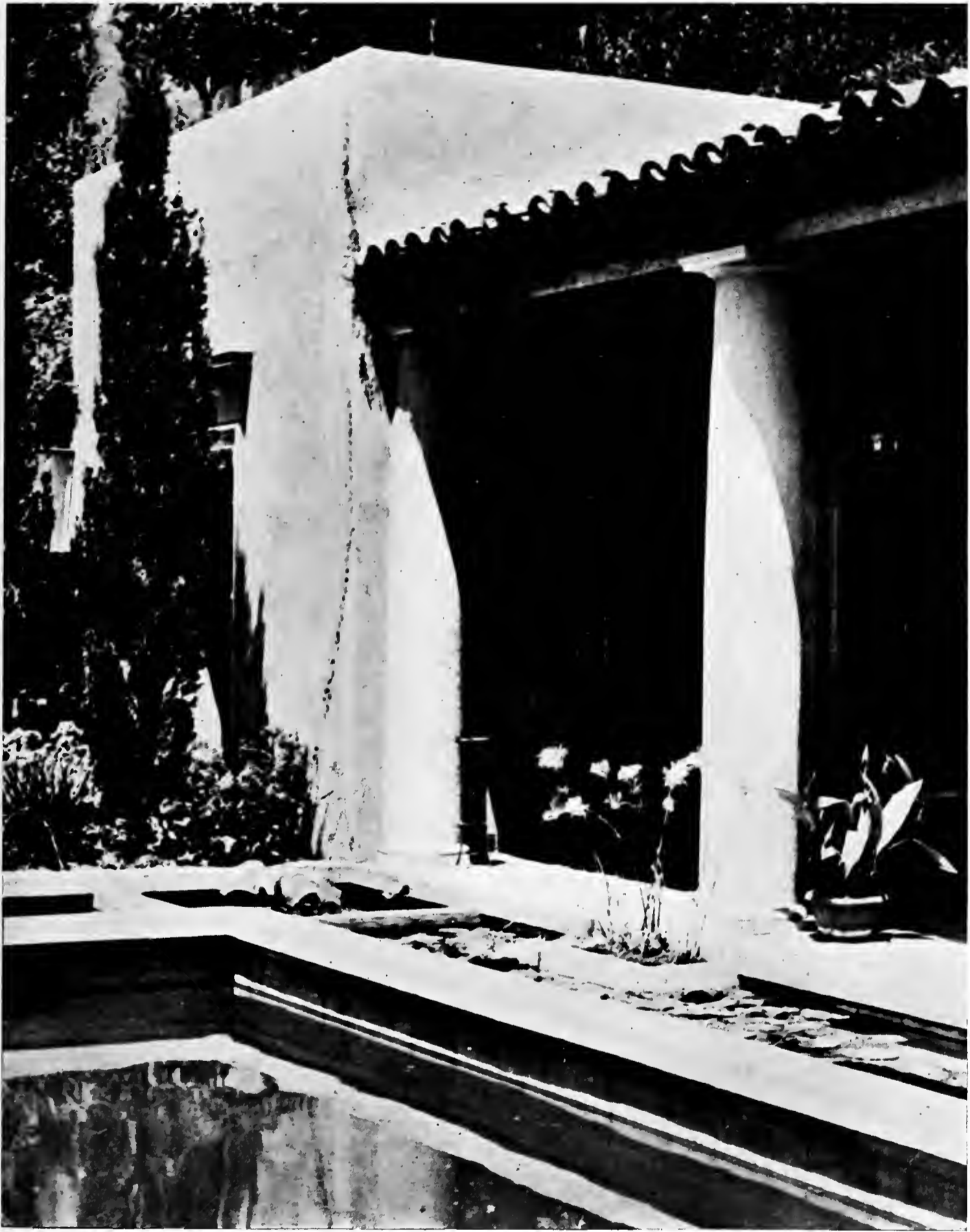

SWIMMING POOL PAVILION,  
RESIDENCE OF MR. BEN MEYERS,  
EVERLY HILLS, CALIFORNIA.  
JANSON, KAUFMANN & COATE, Architects.



GATE LODGE,  
RESIDENCE OF MR. BEN MEYERS,  
BEVERLY HILLS, CALIFORNIA.  
JOHNSON, KAUFMANN & COATE, Architects.





## A Small House of Many Delightful Features

By CHARLES ALMA BYERS

**T**HE small house illustrated herewith is deserving of far more than ordinary consideration. In the first place, while it is but a single story in height and possesses a width of only thirty-five feet, it contains the somewhat surprising number of seven rooms, as well as two bath rooms. Its plan, in view of its commodiousness, is therefore unusually well suited to a narrow building lot. Inspection of the plan also reveals it to be provided with a quite exceptional number and assortment of useful and enhancing built-in features, roomy closets and various other delightful conveniences. It is, in fact, in this latter respect that the designing of this house is made particularly noteworthy.

In general outside appearance, the house, it will be seen, is rather plain and unpretentious, but nevertheless neat and pleasingly attractive. The porch on a front corner is a most enjoyable feature, and also adds very

materially to the attractiveness of the street view of the little home. The long windows, one of which is rendered the most effective by shutters of special design, naturally further help to give charm to the front. Then, too, the color scheme is character-enhancing.

The house is of frame construction. Its exterior walls are finished with wide channel siding and painted light French gray. The usual wood trimming is in a lighter shade of gray, but the window sash are grayish green and the shutters are dull dark green. The roof consists of wooden shingles, painted grayish green like the window sash, and the chimney, as well as the edging of the cement floor of the front porch, is comprised of dark red brick. The foundation is of poured concrete.

Referring to the floor plan, it will be seen that the front door, which is of glass, opens off from one end of the porch to a

disproved the second notion, and according to the builders, has also refuted the charge of greater cost.

That everybody might enjoy its unique beauty, and see the very latest ideas in house-building, it was thrown open for some time to the public, and all who cared to do so were allowed to visit it at certain hours. The first Sunday that the Brick Home Beautiful was open, more than a thousand men, women and children visited it, and as many on succeeding Sundays, for as many weeks as it was on exhibition.

For the purpose of showing it at its best, and also to allow people the opportunity of feasting their eyes on a home completely and exquisitely furnished, it was fitted up to the last detail by local firms. A leading department store furnished the rugs, shades, drapes and furniture, as well as the lamps, and small articles of bric-a-brac. A music house put in a piano and a phonograph. An electrical company donated the modern electrical appliances and the kitchen range. So the house stood as a model, a real servantless home, with all the delights of home-making, and none of its disadvantages.

The Brick Home Beautiful is built according to the plan of those charming quaint old English cottages, with their steep roofs, low eaves, and leaded casement windows, and while dignified, has an intimate homey air that is most delightful.

The exterior is of Sylvan brick, made, by the way, in a plant only two miles outside of Portland, and has the richest variegated shades of coloring. There are half-timbered and paneled gable ends, great chimneys, and a roof of many-colored shingles. A garage is tucked on at an alluring angle, being an integral part of the house, yet entirely distinct.

There are six rooms in all—four rooms and a bath down, with two bedrooms and another bath upstairs. The walls of the living room are finished in rough plaster effect, like those of the other rooms, and it has a high domed ceiling, with a dark hardwood floor. The massive fireplace, set into a recess, is also of Sylvan brick in restful green, and over it is a quaint balcony, giving a sort of Old World effect.

Off the dining room is a conservatory, its walls and flower troughs of brick, and its floor of hand-made tiling. You can imagine the charming view it will afford from the

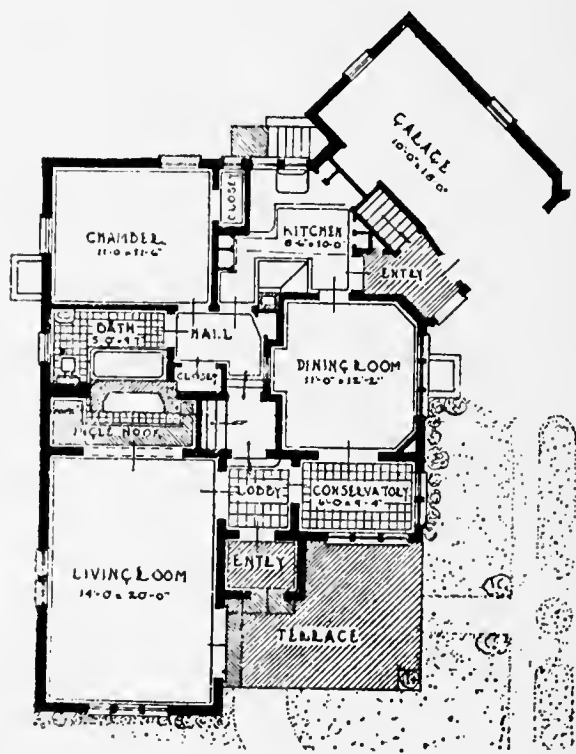
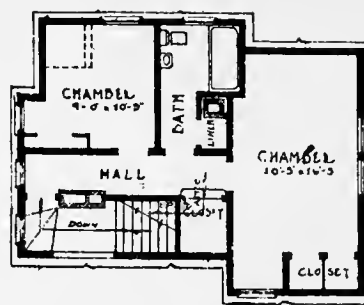

FLOOR PLANS.

dining room, when it is filled with blooming plants and ferns.

The dining room itself is of very convenient size, and an exquisite stained glass window, with a light glowing through it, enhances the recess designed for the buffet.

The kitchen would delight any modern housewife's heart, with its latest and most up-to-date appliances for relieving drudgery, and its compact arrangement of cupboards, sinks, and closets. The sink has a built-in dishwasher, so that the dishes are brought straight to it from the table, piled in it, and washed at once by the pushing of an electric button.

The shining bathrooms are the last word in plumbing, and conveniences for making cleanliness a joy, while the three bedrooms are personified daintiness, with their narrow woodwork in pink, blue, and green, respectively.

Not the least delightful thing about the Brick Home Beautiful is the fact that it is evenly heated by a gas furnace, the heat of which is automatically regulated.

## NEW STATE HOUSING ACT

By MARK COHN

**T**HE new Housing Act passed by the Legislature is of the utmost interest to realtors of California and all property owners. This act repeals all inconsistent building regulations including the State Tenement House Act, Hotel and Lodging House Act and State Dwelling House Act. The essential practical requirements of these laws, modified and simplified, are incorporated in one act.

Building activity will be materially augmented. Particularly in apartments, hotels, dwellings and institutional buildings. This will release millions of dollars for improvements. Many proposed projects held up or abandoned during the past three or more years because of impractical and costly requirements may now be revived and proceed unhampered by such theoretical requirements. Property owners are relieved of burdensome requirements in new and existing buildings that served no useful purpose but made for wasteful costs. Excessive provisions for unoccupied court areas and yards are materially modified, and it will be possible to design buildings more economically, and the productivity and use of properties is greatly enhanced. Height limits for semi-fireproof and wooden buildings are increased, and in the case of fireproof buildings local regulations alone govern rather than state laws. The requirements for two or more buildings on the same lot and changes in the definition of lot, make it possible to improve numerous properties practically outlawed by the existing housing acts.

Room sizes, porch requirements, interior design, fire escape and stairway provisions are rewritten and made practical. All of the highly desirable modifications in the new act are made possible without impairing essential requirements for safety and the public welfare.

The San Francisco Real Estate Board, in concert with other organizations throughout the state, and as a sustaining member of the California Housing and Building Institute, with headquarters in San Francisco but operating statewide, worked for more than three years to bring about the passage of the new Housing Act. All credit is due to Mr. Mark C. Cohn of San Francisco, expert consultant on building regulations and Executive Director of the California Housing and Building Institute. Mr.

(Continued on Page xii)

## MODERN FLOORS

**I**N THE good old days we solved the problem of floors by having them covered with carpets, stretched from wall to wall. The floors, once hidden, were forgotten, except at the semi-annual and turbulent house-cleanings, when the carpets were ripped up, the dingy newspapers burned, and the six-months' dust cleared away.

All that belongs to the good old days, but from it comes the realization that our grandfathers tried to use their floors as part of the decorative schemes of their rooms. In the hallowed Victorian parlor was found the floor, richly carpeted in green or red, or both. The dainty lady of hoop-skirt days often selected a thick, soft fabric in pink or blue for her boudoir.

But we, weary of keeping carpets clean, have discarded them, and contented ourselves, for the time being, with floors of hardwood, and turned our attentions to more beautiful walls, ceilings and soft tints and lovely distinctive furniture.

Now we are turning again to the floor, realizing that this is, after all, the foundation for the decorative scheme of the room, and we are borrowing from the Old World the idea of using linoleum in every room in the house. More and more, housewives, intent on making their homes more beautiful, are coming to use linoleum not only for the kitchen, where it has served a long and honorable apprenticeship for durability and cleanliness, but in the other rooms as well. This has been made possible largely by the new patterns which, although of the same material, bear no resemblance in coloring or design to the kitchen and bathroom patterns of five years ago.

For the bedroom one might select a beautiful creation which is made up of two shades of blue, in a striated effect. Against a background of this, well selected rugs and mahogany furniture take on a richer value. In your living-room you may achieve dignity by using a gray, either in this new two-tone effect, or in a solid color. For the hallway or sunroom there are tile patterns of unusual beauty, which make a cheerful, attractive floor, always refreshing to the eye.

With such tremendous strides in the making of linoleum and the creation of new and beautiful patterns, it has been necessary to devise, as well, a method of installing linoleum so as to make it in every sense a

(Continued on Page xii)

# Nurseries for Redwoods

By FRANK MULGREW

IF, IN the days of the overland stage and pony express, pioneers, felling giant trees on the fringe of redwood forests, had been told they would live to see redwood nurseries by the side of saw mills, they would have flouted the statement. At that time redwood seemed to be California's one inexhaustible resource, which would continue in their might long after the mineral lodes had yielded their hidden wealth.

These old woodmen might well look on forest tree nurseries as an absurd fancy. Redwoods interlocked boughs over spaces that a man on horseback might spend weeks in traversing. They emerged from forest fires with scorched bark when pitchy firs and pines became flaming torches. Unlike other cone-bearers, the redwoods refused to succumb to saw and axe, and sent forth a ring of vigorous suckers about their stumps. Such vitality would not die.

But redwood nurseries are now here. They supply evidence of a new spirit in America—a realization that the country has been playing the wanton spendthrift with its natural resources; that the present generation owes a duty to posterity; that the wasting of nature's gifts through ignorance or callousness is criminal.

The movement to replant the cut areas has been started by the redwood lumbermen—members of the California Redwood Association. They are actuated by a desire to perpetuate a valuable California industry. Deposits of oil and mineral can be exploited only once. Experiments show, however, that redwoods mature for commercial purposes at the relatively early age of 60 years; so that the soil and climate in which this unique species first found its home can continue to yield its valuable products for the use of mankind through the ages to come.

In the work of reforestation, the redwood companies of California have employed the services of Major David T. Mason, formerly an expert in the United States Forest Service. The Union Lumber Company of San Francisco started the first redwood nursery on land adjoining its sawmill at Fort Bragg, Mendocino County. There are now fully 800,000 young redwood trees growing there from the seed, a sufficient number to reforest 2800 acres a year. In the near future this nursery will furnish enough young redwood trees to plant 4600 acres annually, and, at the end of five years, this will be increased to 10,000 acres. The Pacific Lumber Company has a redwood nursery of 500,000 trees at Scotia, Humboldt County. Besides the nursery trees, about one-fifth additional second growth redwood will sprout from stumps of old trees. It was Mr. C. R. Johnson, president of the Union Lumber Company, who initiated this movement, which now includes most of the important redwood lumber companies of California. Altogether there are interested in reforestation, in vary degrees, 17 out of the 22 redwood companies in California. These companies produce about 87 per cent of the annual lumber cut of the redwood region.

The sponsors of redwood reforestation have definitely adopted the policy of cutting in such a manner that new growths of timber will be available for felling long before the original forests are exhausted. More than half the lumber production from the redwood area now comes from land that will be reforested and permanently guarded for timber production. The redwood companies, in starting the work of reforestation, are not only fulfilling their obligations to future generations, but are placing the redwood lumber industry of California on a protected and permanent basis.

The highest  
quality  
plumbing  
costs less in  
the long run



TRADE MARK REGISTERED

*Specify*

**PACIFIC**  
PLUMBING FIXTURES

(Concluded from Page 11)

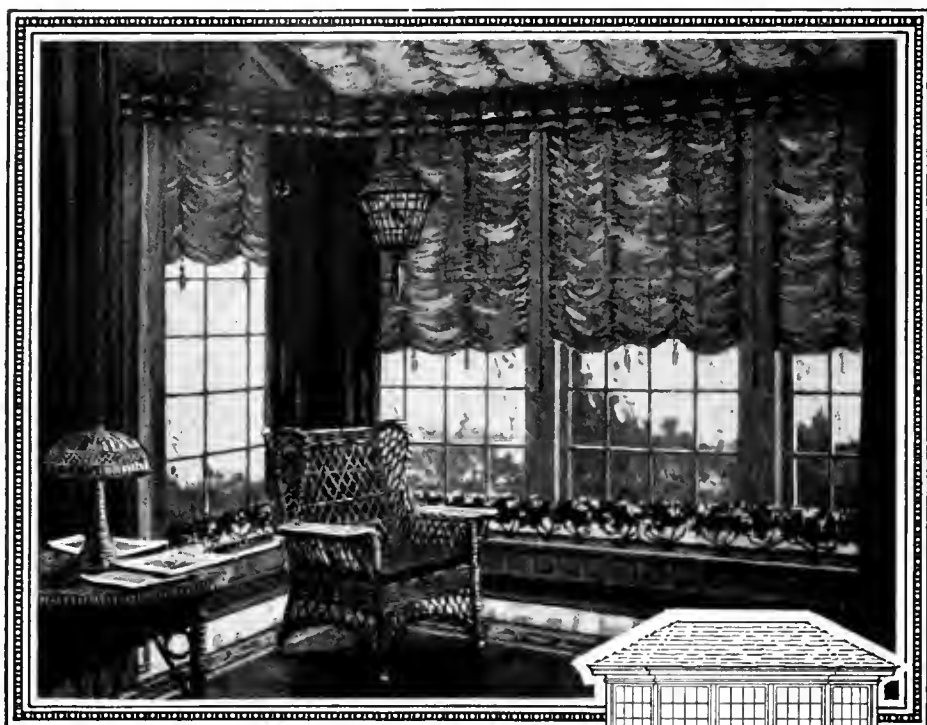

## ARCHITECTURAL HOME MAKING

**T**HE attractiveness of home life begins in the drafting room. Long after the fee is paid and forgotten, the thoughtfulness of the architect is remembered.

It is notable how many sun parlors are added to houses long after they have been built. It is but the addition of something which had been forgotten.

There is an ever-increasing trend "sunward", towards the enjoyment of sunshine and air made possible by the judicious but liberal use of better window glass. Cater to the "sunward" movement and reward will follow; principles of health, sanitation and human happiness will have been recognized.

### *The Mark on the Box*

The long ellipse that appears on every box of genuine American Window Glass is an assurance of quality.

Within the ellipse is the grade mark, A or B. The B glass is of as consistently high quality as the A grade of ordinary glass and our A grade is correspondingly superior. Demand the beauty, clarity, evenness and strength assured by this mark on every box.



**AMERICAN WINDOW GLASS CO.**  
GENERAL OFFICES: PITTSBURGH, PA. *The BEST Glass* BRANCHES IN PRINCIPAL CITIES

862 Mission Street

San Francisco, Calif.

permanent floor. After years of experiment, no better method has been devised than to cement the linoleum over a layer of builders' deadening felt. A mere description will prove the advantages of this method. The felt is first pasted to the floor with a specially prepared paste, and the linoleum is pasted over the felt. That is, the paste is used, except at the seams and edges, where waterproof cement holds the linoleum down firmly so that the seams are well nigh invisible. There is no danger then that when the linoleum is cleaned water will seep underneath. There is no danger, in case the under flooring expands or contracts, that the seams will open. There will be no bulges or buckles. When the linoleum is held firmly everywhere, it cannot stretch or contract.

Our interior decorators and architects, who compose a group of conservative artists, are beginning to recommend linoleum for various rooms in the house because they realize that it is a medium for greater beauty in the home, for cleanliness that is easily attained, and for durability that spells economy during the years to come.

(Concluded from Page 11)

Cohn worked out all the amendments supported by the San Francisco Real Estate Board, and because of his thorough knowledge and fidelity to the work there has been attained a Great Forward Achievement by the allied building and realty interests of California.

The new Housing Act will become effective August 17, 1923. Space here does not permit of enumerating many other changes contained in the act. However, in about thirty days, there will be issued a handbook, edited by Mr. Cohn, that will contain the text of the new law annotated, indexed, illustrated and with suggestions that will prove helpful to realtors and builders. This edition is under the direction of Pacific Coast Consulting Officials Conference.

PHONE FRANKLIN 2492

**A. C. WOCKER**

INTERIOR DECORATOR

1370 SUTTER STREET

SAN FRANCISCO, CAL.

# Informative Advertising

## II. To the Advertiser:

**S**INCE we have the competitive system of doing business, good advertising reduces the cost of distribution. Poor advertising is an economic waste.

The architectural profession is your most important market outlet. In 1922 \$3,400,000,000 was spent in the United States under the management of architects; \$720,000,000 was handled by general contractors without an architect, and \$380,000,000 without either.

It is your desire, and your problem, to present information about materials in such a form that it will be noticed and used. The architect is too busy and too cautious to waste time on advertising which does not clearly give him authoritative, specific information.

How will you solve this problem?

(To be continued)

# BALL BEARINGS

## SKF INDUSTRIES OF CALIFORNIA

Incorporated  
115 NEW MONTGOMERY ST.  
San Francisco, Calif.  
Phone Sutter 4196

DEEP GROOVE AND SELF-ALIGNING BEARINGS  
HANGER EQUIPMENT

# Clay Products

## Gladding, McBean & Co.

SAN FRANCISCO  
LINCOLN  
LOS ANGELES

PORTLAND                      LOS ANGELES                      SEATTLE

## R. N. NASON & CO.

PAINT MAKERS

151 Potrero Ave.--SAN FRANCISCO--436 Market St.

Makers of

NASON'S OPAQUE FLAT FINISH

A flat oil paint made in soft Kalsomine Tints,  
that is washable; a practical article for  
walls, ceilings, etc., that is most  
economical and durable.

Agency for

Tamm & Nolan Varnish Works High  
Grade Varnishes and Finishes

Goods made on the Pacific Coast for the climate of this Coast

Del Monte                      - -                      Fan Shell Beach

# CLEAN WHITE SAND

Del Monte Properties Company

Sutter 6130 Crocker Building San Francisco

## Hospital Association to Continue Floor Study

The American Hospital Association Committee on Floors is continuing its study on the subject of floors this year, and solicits samples being submitted for testing, these tests to be made the basis of a further report to the annual meeting of the Association. Particulars may be obtained by writing the chairman, Frank E. Chapman, 1800 E. 105th Street, Cleveland, Ohio. The committee consists of Doctor Thomas Howell, New York Hospital, New York City; Doctor Charles E. Young, Hospital of the Good Shepherd, Syracuse, New York; Mr. Charles F. Owsley, architect, Cleveland and Youngstown; Mr. J. W. McBurney, Engineer of Tests, Board of Education, Cleveland, Ohio, and the chairman.

The F. W. Woolworth Company will erect a modern business building in Stockton costing not less than \$100,000, according to a lease filed with the San Joaquin County Recorder.

The building will be constructed on a business property with frontages on Main and Sutter Streets. The lease begins January 1, 1924, and runs until December 1, 1973. The Woolworth Company will commence the construction of the new building before May 1, 1925.

Construction has started on a reinforced concrete garage to cost approximately \$88,000 in Stockton. The building, which will be erected by the Davis, Heller and Pearce Company, Architects and Contractors, has been leased to the L. S. Weeks Company. The structure will consist of two stories and basement, and it is planned to have it ready for occupancy by October 1st.

## Stillwell PLAN BOOKS of CALIFORNIA STYLE Climate HOMES

—show pictures, Floor Plans  
and Estimated Costs of Building  
over 200 Selected Designs.

"West Coast Bungalows"  
50 Houses—6 and 7 Rooms—\$1.  
"Little Bungalows"  
75 Houses—3-4-5 Rooms—\$1.

SPECIAL OFFER: Send \$2.50 for any three  
of these books and get Garage Folder FREE.

Books and Blueprints sold with Money Back Guarantee

E. W. STILLWELL & CO., 790 California Building, Los Angeles

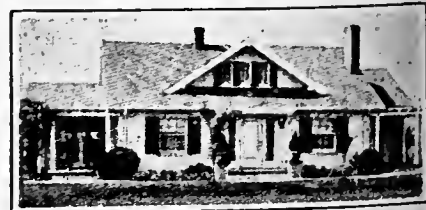

"Representative California Homes"  
50 Houses—7 to 10 Rooms—\$1.  
"The New Colonials"  
60 Houses—6 to 10 Rooms—\$1.



## OLDEST REDWOOD SHINGLE IN SANTA BARBARA COUNTY

The oldest sawn shingle in California has been found. It was 74 years old and came from an adobe dwelling, erected by the Arrellanes family in 1849 on the Guadalupe Rancho, near Santa Maria in Santa Barbara County. The building originally had a thatched roof of tule, but this was burned by General Fremont's soldiers, and then replaced by redwood sawn shingles.

This relic of the "Days of Gold" was submitted by W. L. Smith, manager of the Pacific Coast Coal Company of Santa Maria, who was awarded first prize in the state-wide contest conducted by Gus Russell of the Santa Fe Lumber Company. The contest grew out of the fight to "save the shingle" at the election last November. A. D. McKinnon, proprietor of the McKinnon Lumber Yard of Hollister, won second prize. He sent in a redwood shingle from the McMahon home in San Juan, San Benito County. The house was built in 1852.

Many other very old redwood shingles were in competition. Among these was one from the house of General Mariano G. Valjejo in Sonoma. It had been doing duty since 1836; but was disqualified by the judges because it was a split shingle.

## PARAFFINE CO. PURCHASES NEW PLANT

The Paraffine Companies, Inc., manufacturers of Pabco Products, today announce the purchase of the large plant of the Durable Roofing Co. of Portland, Oregon.

This makes the seventeenth plant of the Paraffine Companies, Inc., which is one of the West's largest industrial corporations, being a \$12,000,000 corporation, employing over 2000 people, and doing an international business in excess of \$15,000,000 annually.

This company is a Western company in every sense of the word, being entirely owned by 1780 Westerners.

This company operates large wood pulp, wall board and sulphite plants at Port Angeles; a board mill and fibre box plant at Sumner, Washington.

The Paraffine Companies, Inc., products include roofings, paints, floor coverings, wall board, paper boxes, shipping cases and allied products.

# Advertising Efficiency

Is your advertising being read by the men who are specifying, buying, and selling the goods you handle?

## THE BUILDING REVIEW

Goes to Architects, Builders,  
Contractors and Home Owners

These are the men behind the  
guns in the Building Industry.

*Are you reaching them?*

*If not, let us show you how.*

*Address:*

**THE BUILDING REVIEW**

Chronicle Building, San Francisco

Phone Douglas 1956

# GLADDING, McBEAN & CO. ABSORB THE TROPICO POTTERIES

For some time Gladding, McBean & Company have been considering establishing a factory in Los Angeles, and finally decided that their interests would best be served by obtaining control of Tropico Potteries, Inc.

Tropico Potteries, Inc., was incorporated in 1920 by Stephens & Company, investment bankers, who acquired all the assets of the Pacific Minerals & Chemical Company, located in South Glendale. Immediately upon the acquisition of these properties, the company started an extensive re-financing plan which provided the necessary capital for rapid development. Mr. F. B. Ortman, having had experience in the manufacture of clay products in the East and at the time Chief Ceramic Engineer of the Northwestern Terra Cotta Co., of Chicago, was engaged as vice-president and general manager of the properties, the other officers were Mr. B. M. Wotkyns, president; Mr. E. M. Davids, secretary; Mr. E. A. Jones, treasurer. The present shifting of control in no way affects the active management or operation of the plant, although Mr. Atholl McBean succeeds Mr. Wotkyns as president of the company, and Mr. Lee A. Phillips of Los Angeles becomes a vice-president.

The principal products of Tropico Potteries, Inc., are terra cotta, vitrified pipe and Faience tile. Terra cotta has been one of the principal departments of the business, and the company has been turning out a high grade material, having supplied their product for many of the large office buildings in Los Angeles, among the more notable of these being the Bank of Italy, for which the American Institute of Architects awarded the company a Medal of Honor on the excellence of the work.

All the earnings of the company during the past two and a half years have been put back into the plant in improvements so that the plant is now regarded as one of the most important institutions of its kind on the Pacific Coast. The new owners plan to continue this policy of expansion and development as rapidly as conditions warrant.

Gladding, McBean & Company have been the leading clay manufacturers on the Pacific Coast for forty-nine years, and with the passing of control of the southern plant into their hands, it is anticipated that they will be in a position to greatly enlarge their field of activity and render even better service to their many friends and customers in the South than has heretofore been possible.

## Pacific Manufacturing Company

Branches:

117 Stevenson St.  
SAN FRANCISCO

Manufacturers of and Dealers in

**Doors, Windows and Mouldings**

General Millwork

1001 Franklin St.  
OAKLAND

Branches:

908 Washington Bldg.  
LOS ANGELES

58 West Santa Clara St.  
SAN JOSE

Factory and Main Office: Santa Clara, Calif.

## NEW LOS ANGELES OFFICE FOR QUANDT

A. Quandt & Sons announce the opening of new headquarters at 3317 Central avenue, Los Angeles. They have been operating in Southern California for the past three years, and these enlarged quarters are the result of a phenomenal increase in business. Their main office is at 374 Guerrero street, San Francisco. It was in the year 1882 that Mr. A. Quandt, still the active head, founded the firm in the city of Los Angeles, but in 1884 he moved to San Francisco, where the firm has been in continuous operation.

Today associated with him are his three sons, trained to carry on with greater energy and efficiency the best practice and ideals of painting service. A solid foundation has been laid by its founder with the fixed policy of maintaining the highest standards in the painting and decorating field.

This organization is now engaged in painting and decorating buildings of all classes, from the largest office buildings down to the smallest dwellings, and in all parts of the State.



Genuine Hyloplate Backboards  
Moulthrop Movable Desks  
Sheldon Manual Training Benches  
Domestic Science and Laboratory Furniture

**C. F. WEBER & CO.**  
Exclusive Agents

SAN FRANCISCO      LOS ANGELES  
RENO                      PHOENIX

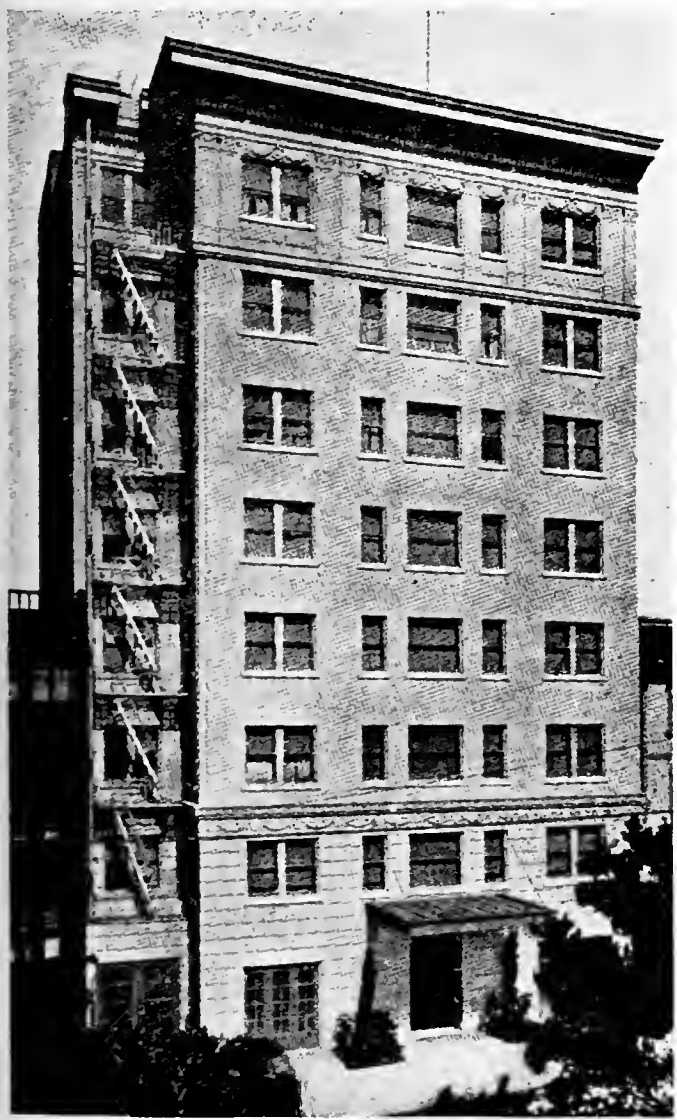

SUMMIT APARTMENTS

## PITCHER'S Disappearing Doors Adjustable Hangers and Frames

MEET THE DEMAND FOR  
APPEARANCE, QUIETNESS  
AND DURABILITY

NO EXTRA WALL THICKNESS REQUIRED

*Manufactured by*

**National Mill and Lumber  
Company**

318 MARKET STREET, SAN FRANCISCO, CAL.

# Los Angeles Building Activities

By I. C. TICHENOR

**L**OS ANGELES, continuing as the third city in the United States in point of building operations, is nearing the \$100,000,000 mark for 1923.

According to statistics compiled by the Chamber of Commerce, the total estimated value of buildings for which permits have been issued during the present year up to and including July 9, is \$96,515,229.

This compares with \$61,031,490 for the same period in 1922, or a gain of \$35,483,739.

During the six months period of 1923 there were issued 29,678 permits, with a total estimated valuation of \$93,889,185, as compared with 22,257 permits and a valuation of \$59,459,250 during the first half of 1922, or a gain of 7,421 in the number of permits and \$34,429,935 in cost over last year.

The figures for the first eight working days of July indicate a continued big increase over those of 1922. For the fraction of the month stated there were issued 951 permits having a total estimated valuation of \$2,626,044, as compared with 677 permits

and an estimated cost of \$1,572,240 during the corresponding period of 1922.

At this particular time, home-building is the principal feature of construction operations in Los Angeles. This is indicated, in part, by the fact that while the cost of construction in June was \$15,074,446, or a gain of \$5,622,181 over June of 1922, permits were issued for only three Class A buildings, the largest one of seven stories and costing \$350,000.

For the purpose of meeting the continued increase in the demand for housing facilities, permits were taken out in June for the construction of 1026 apartment houses, 1523 single dwelling, 953 double dwellings and 3 as flat buildings, or a total of 3838.

One of a number of assured construction projects is a twelve-story Class A store and office building to be erected by William M. Garland on the northwest corner of Ninth Street at the junction of Main and Spring streets. The excavation for this building is now in progress.

Another height-limit structure will be erected on the southeast corner of Eighth and Spring and extend to Main. The lower floor will be occupied by a banking institution.

Following the completion of a record job of excavating, the steel work now is in progress on the Mercantile Arcade building, being erected on the site of the old Mercantile Arcade at a cost of about \$2,500,000.

Figures recently compiled by the Chamber of Commerce show that Los Angeles is nearing the billion-dollar class in respect to manufacturing. A survey made by the Chamber for 1922 shows that the total cost of the manufactured products of the city last year was \$959,806,503.

In this production, motion pictures led with a total output valued at \$156,000,000. Petroleum products came next with \$135,271,000.

That Los Angeles is becoming an iron and steel center is shown by the fact that the machinery manufactured in 1922 was valued at approximately \$74,730,000, and was the third item on the list of the survey, followed by food products, with \$68,000,000; meat packing, \$56,271,000, and planing mill products, \$55,390,000.

The total amount of capital invested in manufacturing in 1922 was \$685,184,997, and the weekly payroll, \$5,325,234.

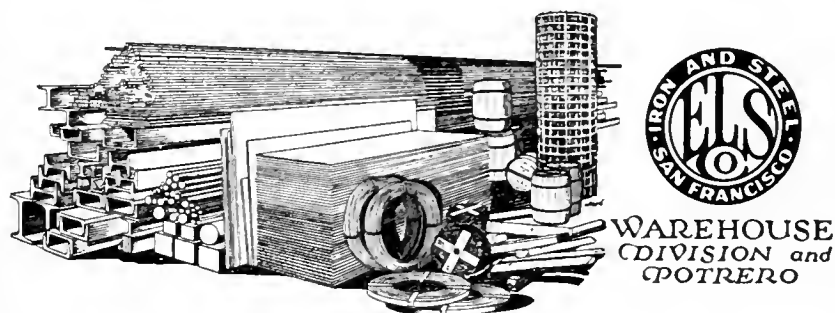

## STEEL

We carry in our warehouse a complete stock of Reinforcing Steel Bars, Merchant Bars, Galvanized Sheets, Nails, Pipe, Wire and Wire Fabric.

When speed in deliveries and bed rock prices count, you cannot afford to overlook Soule for steel.

**EDW. L. SOULE CO.**  
 RIALTO BUILDING  
 SAN FRANCISCO

# "A Bird in the Hand is worth two in the Bush"



STORMS come and go with unfailing certainty throughout the years, and, sooner or later, an inferior roofing, valley or gutter lining, will give out and let the elements in, with a resulting loss of furnishings, wall and floor finishes.

Awaiting your call are whole warehouses of

## TARGET AND ARROW

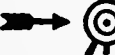
Look for this Trade  Mark on every Sheet

## ROOFING TIN

ready to do service for you for years to come, but "a box on the roof is worth two in the store." Then why delay or be misled by claims for new and untried roofings, valley and gutter linings, when *real roof insurance* can be so easily assured by requiring the use of time-tested Target and Arrow?



## N. & G. TAYLOR CO.

Offices: Philadelphia, Pa.

Mills: Cumberland, Md.

Established 1810



# New City Hall for Los Angeles

WITH the decision at the June election in Los Angeles to build a new City Hall, and to locate the City Hall so as to make it a unit in a comprehensive Administrative Center, the voters have cleared the way for a construction program of tremendous proportions.

The Administrative Center plans prepared by the City Planning Commission that formed the basis upon which the City Hall issue was decided, involves a program much larger than the City Hall alone. The Administrative Center plan makes provision for Federal, State and County as well as city buildings. Of the units that will ultimately constitute the complete group, the present Federal building and the Hall of Records exist. The New Hall of Justice is now under construction and the New City Hall is now authorized and the money appropriated.

Whether that will have to wait for the next legislature, two years hence, or whether it will be provided by private capital for the State, are matters soon to be determined.

The New City Hall, however, is the next large unit to materialize. Under the recent

bond issue, five million dollars has been made available for the building, and two and a half million dollars for the site. Under the plans, the City Hall is intended to occupy a spacious site consisting of practically everything between Temple and First Streets and between Main Street and the new straightened Spring Street—a large rectangle considerably larger than Pershing Square. The City Council, acting under the authority and the urge of the recent election has already ordered condemnation proceedings started to acquire this land. The City Engineer is actually engaged in the work incident to these proceedings.

The Federal building has long since been inadequate to the needs. Recently a Federal representative has been checking over the needs for added facilities and the question of location.

The report rendered has urged the necessity for a new building and the site in the Administrative Center just north of the present building as recommended by the City Planning Commission.

The State building is the only governmental unit not definitely under way.

# How to Prevent Oak Floors From Cupping or Buckling

By T. O. H. HERZOG

The purpose of this article is to give information as to how to prepare a house to receive a properly manufactured oak floor and keep it from cupping or buckling.

This is the condition which has given the builder in this territory the greatest amount of difficulty and by the layman has been attributed to faulty kiln-drying and manufacture, while the true cause has been completely overlooked; consequently, many owners of new homes are disappointed in the appearance of their floors.

It is well known that wet wood will give off moisture under ordinary atmospheric conditions and that dry wood will take on moisture in damp weather. In fact, thoroughly seasoned wood, under ordinary conditions, daily takes on or gives off moisture to accommodate itself to changing atmospheric conditions. This causes a corresponding shrinking and swelling commonly known as working.

There is a definite relation between the moisture content of wood and the humidity of the atmosphere when the wood has come into equilibrium. For example, wood exposed to a relative humidity of 78% (which would approximate the annual mean relative humidity in this vicinity) at 70° Fahrenheit, will finally attain a moisture content of 16%. This represents the average moisture content after flooring has been stored in this climate for a very short time and contains that proportion of moisture when delivered to the job.

Therefore, it is quite obvious that the swelling or cupping which takes place after the floor is laid must be due to some condition that increases the moisture content of the flooring. The Section of Timber Physics of the United States Forest Products Laboratory advise the shrinkage of quarter-sawed oak lumber in drying, from 25% moisture content to thorough oven dryness where it contains no moisture whatsoever, is from 3.7% to 8% of its width, depending upon species and individual characteristics. Plain-sawed boards will likewise shrink from about 8.3% to 10.8%.

This information will establish the fact that it is, therefore, better to use quarter-

sawed oak flooring instead of plain-sawed oak flooring, a point that should not be overlooked by the prospective builder. For ordinary purposes it is accurate enough to assume that 10% is the amount of shrinkage that takes place in drying from the 25% moisture stated above. Using these figures as a basis, it will be found an increase of 4° in moisture will cause one foot of oak flooring, very closely and tightly nailed together, to swell 3/16 of an inch. Therefore, do not insist on having floor driven up too close.

The reasons for the presence of moisture are many, but the most common are wet soil, improper ventilation under the house and green lumber supplied by the average dealer for subfloor.

To air-dry green lumber requires from six months to a year and then the moisture contents of the lumber would be in proportion to humidity of atmosphere which, in case of green lumber being placed a foot or eighteen inches above wet ground under a house without ventilation, when used as a subfloor for oak flooring, is too awful to contemplate. It is bad enough and has caused sufficient trouble, when used on the second floor.

The moisture from the green subfloor is absorbed by the lower portion of the oak, causing it to swell, resulting in the floor being cupped, often in a day or two after it is laid.

The builder will do well to place large ventilators under the house, eliminating the lattice work so generally used and insist on kiln-dried lumber for subfloor, which should cost but a trifle more.

Oak flooring will be found to open up and shrink during the winter months in houses where a basement and a furnace is placed. During the summer these cracks close and the floor will resume its original position. Therefore, if one cannot have a furnace under the house and may also be compelled to build over wet ground, it will at least be possible to have ventilation and a dry subfloor which will result in an oak floor as near perfect as it is possible to secure an article made of wood and subject to such varying conditions.—The Builders Exchange Bulletin.

SAN FRANCISCO  
PUBLIC LIBRARY

*THE  
BUILDING  
REVIEW*



*AUGUST, 1923*

*Vol. XXIV No. 2*

*Published in San Francisco*

*Price Twenty-five Cents*



W. H. RATCLIFF, Architect.

MISS HEAD'S SCHOOL,  
BERKELEY, CALIFORNIA.

E. E. JARVIS, Decorator.

Finished  
Throughout  
With

**Kyanize**  
KY-AN-IZE

White  
Enamel

Our new books "Recent Pacific Coast Architecture" and "Recent Eastern Architecture,"  
containing Practical Specifications, mailed on application

**Boston Varnish  
Company**

Office and Warehouse  
1551 MISSION STREET  
SAN FRANCISCO, CALIFORNIA  
A. L. GREENE, Local Manager

Distributors for Southern California  
SUNSET PAINT COMPANY  
627 SOUTH MAIN STREET  
LOS ANGELES, CALIFORNIA



# THE BUILDING REVIEW

VOL. XXIV

AUGUST, 1923

No. 2

## CONTENTS

COVER DESIGN—RESIDENCE OF MR. P. J. WALKER, PIEDMONT, CAL.

### PLATE SECTION

ILLUSTRATING THE WORK OF GEO. W. KELHAM

	Plates
RESIDENCE OF MR. P. J. WALKER, Piedmont, California.....	17 to 21
STANDARD OIL COMPANY, San Francisco, California .....	22 to 28

### TEXT

	Page
REMARKS ABOUT CALIFORNIA SCHOOL ARCHITECTURE, by John J. Donovan .....	13
ART IN THE SMALL SHOP, by Clara Fassett .....	16
MINIATURE MODELS OF CARDBOARD, by Jockemo Casassa.....	19
THE RELATION OF RADIUM TO ARCHITECTURE, by William H. Day .....	20
RESPONSIBILITIES OF THE ARCHITECT AND THE ENGINEER IN TIMBER CONSERVATION .....	21
TESTS POINT WAY TO SAFER ELEVATORS.....	24
LOS ANGELES BUILDING ACTIVITIES, by I. C. Tichenor.....	XVIII
QUICK-SETTING LIME BLOCKS DEVELOPED BY BUREAU OF STANDARDS .....	XX
ALUMINUM PAINT MAKES RADIATORS LESS EFFICIENT.....	XX
UNITED STATES CIVIL SERVICE EXAMINATION.....	XX

### DEPARTMENTS

EDITOR'S BOOK SHELF .....	VI
EDITORIAL PAGE .....	18

HARRIS ALLEN, Editor

HOWARD HOYT  
Industrial Editor  
And Business Manager.

NED BRYDONE-JACK  
Advertising Manager

Published Monthly by the Building Review Company,  
Chronicle Building, San Francisco, California

Address All Communications to No. 426 Chronicle Building, San Francisco, California

Yearly subscription—United States, \$2.50—foreign, \$3.00. Single copies, 25 cents.  
Entered as second-class matter in the San Francisco Postoffice under the Act of August  
24, 1912. Previously entered as "The Architect."  
The editors will be pleased to consider contributions of interest to the Industry. When  
payment of same is desired, this fact should be stated.  
News stands and dealers supplied through San Francisco News Co., San Francisco, Calif.,  
or American News Co., New York, N. Y.

### When You Specify

An Electrically Controlled Gas Fired

## McLAUGHLIN HEATING SYSTEM

You have insured the comfort of those who must live in the house, and

You have concentrated the responsibility for the installation of an efficient Heating System upon experts who are vitally interested in the satisfactory operation of each system.

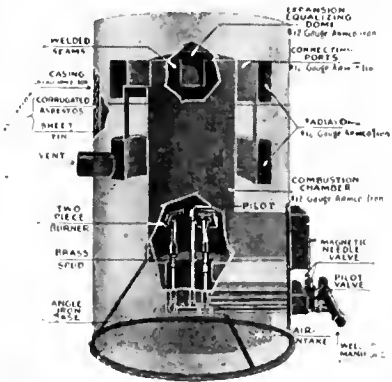

The temperature of the flue gases in the McLaughlin Furnace varies from 300°-430° Fahrenheit.

This gives a furnace efficiency of 88% without lowering the stack temperature to such an extent that moisture remains in the combustion chamber.

Write for information or ask our local agent

### McLAUGHLIN METAL WORKS

223 J St., Sacramento, Calif.

SAN FRANCISCO  
W. P. GOSS  
4640 GEARY ST.

STOCKTON  
WILLARD  
HARDWARE CO.

FRESNO  
EVANS  
HEATING CO.

CHICO: HALL SHEET METAL WORKS

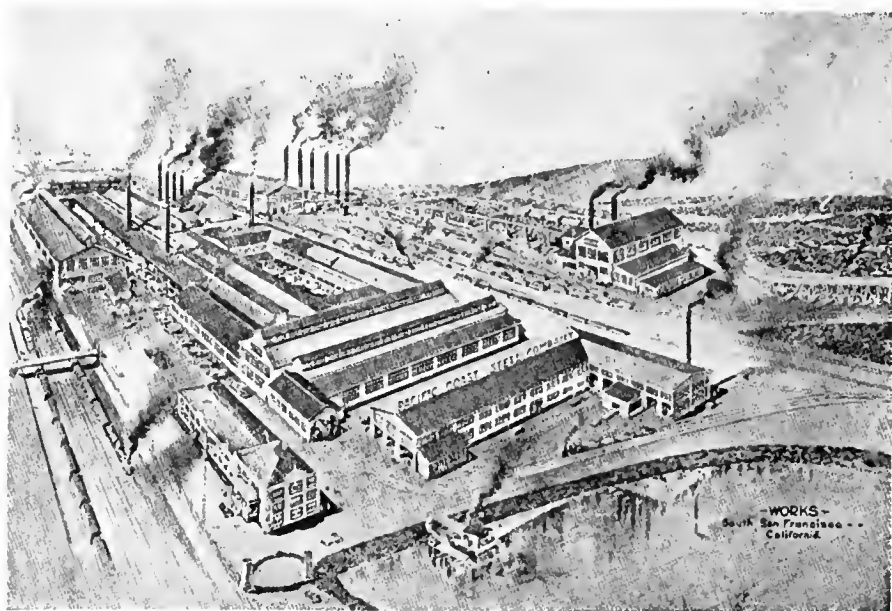

### SHAPES MANUFACTURED

Bolt Rods, Rivet Rods, Wire Rods, Bands, Flats, Billets for Forging, Plain Squares, Plain Rounds

Square and Round Corrugated Bars for Reinforcing Angles—Equal and Unequal Legs

Stock Lists will be Furnished Upon Request

## Pacific Coast Steel Company

OPEN HEARTH STEEL PRODUCTS

General Offices, Rialto Building, San Francisco

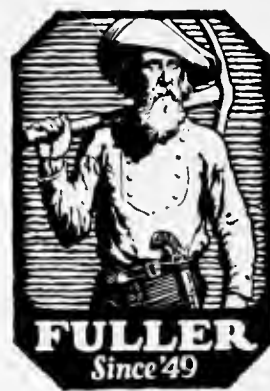

Specify

# FULLER PURE PAINTS

MANY architects specify Fuller Pure Paints because they know the results can be depended upon to redound to their credit. For when a house is well painted, the tough, elastic "film" of paint shields the surface like a rubber coat protects a man; satisfaction is given the owner, and the credit goes to the architect.

The high protective properties of Fuller Pure Paints are due to the proper proportioning and correct mixing of the pure ingredients—Pioneer White Lead, pure zinc, pure linseed oil, pure colors, and the right percentage of thinner and dryer.

This purity of materials is also responsible for the fact that Fuller Pure Paints last longer and are infinitely more economical than paints which may be purchased for a little less per gallon.

Specify Fuller Pure Paints on all your work. Detailed information on approved application methods will gladly be furnished upon receipt of a request addressed to the Fuller Service Department.

# FULLER PAINTS Since '49 VARNISHES

W. P. FULLER & CO.

San Francisco  
Oakland  
Sacramento  
Stockton  
Los Angeles  
Hollywood  
Pasadena

Long Beach  
San Diego  
Santa Monica  
San Bernardino  
Santa Ana  
Fresno  
Portland

Boise  
Walla Walla  
Salt Lake City  
Seattle  
Tacoma  
Spokane  
Yakima

EDITORS' BOOK SHELF

THE PLANNING OF APARTMENT HOUSES AND HOMES\*

THE title of this book is misleading. It would better be "Hygienic Principles in planning Dwellings." As regards planning, no requirements are considered except from a health standpoint — ventilation, light, sanitation. The plans chosen to illustrate these (very important) theories should not be taken as models.

The chapter on sanitary finish of rooms in dwelling houses presents in a methodical way much sensible and up-to-date information, or rather instruction. For this is really a text-book for the use of students, both of architecture and of public management and welfare. Part I is an historical summary of the development of human habitations, from prehistoric times to the present. Part II lays down elementary rules for planning country and city dwellings, apartment houses and tenements, to secure good hygienic and sanitary conditions.

\*—The Planning of Apartment Houses, Tenements and Country Homes, by Teunis J. Van der Bent. Brentaud's, 5th Ave. and 27th St., N. Y.

*Economical Heat*

—With a Hall Gas Furnace

*Hall Heat Is Economical Heat!*

You use gas only as you need it, saving the money and space ordinarily used in storing other fuels. You know in advance what your fuel will cost, for there is a fixed minimum rate on gas, which cannot fluctuate in price like other fuels.

With a Hall Gas Furnace you burn gas as you wish heat—and then only. You are freed from the necessity of stoking the furnace and feeding all-day fires to secure heat for a given time, for Hall heat is instant heat. Likewise you may have as much or as little heat as you desire at a time.

Finally, a Hall Gas Furnace burns gas efficiently and prevents radiation so that you obtain a maximum of heat from the fuel you use.

Make this economical heat *your* home heat. Install a Hall. There is a Hall product for every size home and public building. Consult our heating engineers about your requirements.

Write for our Illustrated Folder

Manufactured by

**D. H. McCORKLE MFG. CO.**

319 12th Street Oakland, Calif.

Dealers and distributors in principal Pacific Coast cities



OLD RELIABLE  
HYLOPLATE  
TRADE MARK  
BLACK BOARD



Genuine Hyloplate Backboards

Moulthrop Movable Desks

Sheldon Manual Training Benches

Domestic Science and Laboratory Furniture

**C. F. WEBER & CO.**

Exclusive Agents

SAN FRANCISCO  
RENO

LOS ANGELES  
PHOENIX

BATCHELDER TILES



A Mantel of Distinctive character  
built up entirely from stock materials.



BATCHELDER-WILSON CO.

2633 Artesian Street

Los Angeles, Calif.

*No leaks,*  
**no roof troubles**  
*Specify*

**PABCO**

10 & 20 year

**ROOFS**

which require the use of

**FLOATINE**

The improved roof asphalt  
 that will not soften  
 run, leak or slide.



TRADE MARK  
**PABCO**  
 PRODUCTS

The PARAFFINE  
 COMPANIES, Inc.

SAN DIEGO  
 OAKLAND

LOS ANGELES  
 PORTLAND

SAN FRANCISCO  
 SEATTLE

# The BUILDING REVIEW

VOL. XXIV

SAN FRANCISCO, AUGUST, 1923

No. 2



MAIN ENTRANCE, TECHNICAL HIGH SCHOOL, OAKLAND, CAL.  
JOHN J. DONOVAN, Architect.

## Remarks About California School Architecture

By JOHN J. DONOVAN, Architect, A. I. A.

[T WOULD require a volume of no mean size to chronicle the contributions of California to Education and to School Architecture, first as a State or a section of our country and secondly, by its

\*—Paper delivered at N. E. A. Convention, 1923.

people. Consequently, a paper of this length can touch only upon the higher and more prominent spots and leave the lure of pleasant discoveries to your wanderings and journeys through the State, which most

cordially welcomes and invites you to partake of its hospitality, for its

"Come in the evening or come in the morning,  
Come when looked for or come without warning  
Kisses and welcome await here before you, and  
The oftener you come the more we'll adore you."

An eminent divine of San Francisco on several occasions has stated that California is monumental in its resources, its trees, its mountains, its minerals, the productivity of its soil and, according to our far away friends and relatives, in its liars. So, if at times I should appear to be stretching the truth, kindly remember that I am only an adopted son and at one time I too was one of those far away relatives, and furthermore, a matter which may seem exceptional before you leave the Coast, I have no real estate for sale.

To me, some of California's most favorable contributions to school architecture reflect its climate, historical traditions and the occasional practical application of a clear understanding of the requisites of child welfare in acquiring sufficient land for school buildings and playgrounds. It is not so many years ago, and in spots prevalent today, that the architect and the school man were thinking, planning and building precisely as one might expect in a densely populated city section of states like Massachusetts, Pennsylvania or New York where the restricted yard, the roof and the basement are the only available play spaces and where the rigors of winter weather are determining influences toward compact types of school building plans.

Awakened vision, animated with conscious responsibility for the health and happiness of the child, visualized Arcadias as centers for practical education. Consequently, the boundaries of the school grounds expanded until the possibilities in the development of the school plant have become almost unlimited.

Naturally the architect, finding more land upon which to place his building, like a practical, sensible human, proceeded to take advantage of the opportunity. Hence the open type of plan, and from this the more healthful, useful, pleasing and attractive building.

Let us stop for a moment and analyze what this has meant to school architecture. In former days with the compact arrangement it was quite customary to plan for basement rooms. That is, about one-third of the first story was placed below grade. Instruction rooms thus located could not by

any means have adequate or proper lighting for notwithstanding the amount of glass area provided, the proximity of the windows to the ground precludes the admission of a sufficient volume of sky-blue light and, further, the relation of the pupil's eyes with the ground areas and adjacent buildings produce the maximum of injurious reflected light which enters the eyes whenever the pupil's head is in an upright position.

It is needless for me to take the time to dwell upon the many facts attendant to the unsanitariness of basement rooms for you all know it is only the rodent family that thrives under ground and in dark places. Elevating the building and spreading its area over more ground brought forth many interesting developments in plan of single units and groups of units which of course led to delightful exterior compositions of the modified Romanesque, Spanish, Italian, English and modern Renaissance. Thus it is that the school architecture of California has found a permanent spot in the sun.

The history of California is teeming with romance colored not only by the strong characters who were the actors but by Nature's own settings rich in mountain ruggedness and valley verdure. The early settlers, the founders of the Missions, the Padres with their small bands of pioneers, in planning and building their crude but well proportioned monasteries and Missions, chose desirable sites large in area and rich in colorful surroundings, and thereby were aided by Nature in the development of the landscape which naturally led to freedom in planning. Observe as you pass through the State and visit these early landmarks, the arrangement of the church, the cloisters, the patios and the gardens, and note the simplicity of treatment of detail and of the whole. Largeness in spirit and vision prevailed likewise with the ranch buildings or ranchos as they were called.

The story of Ramona, by Helen Hunt Jackson, with its beautiful rancho settings, vistas and simplicities of life is characteristic not only of one or two sections, but of all California. Is it any wonder then that as soon as the architect emerged from the ground and visualized what the Padres saw and allowed his imagination to flow, he reproduced only in greater splendor the "partes" of the early Missions in our later school work.

The magnificent and wonderful ecclesiastical edifices of Europe are unquestionably an expression of profound religious worship

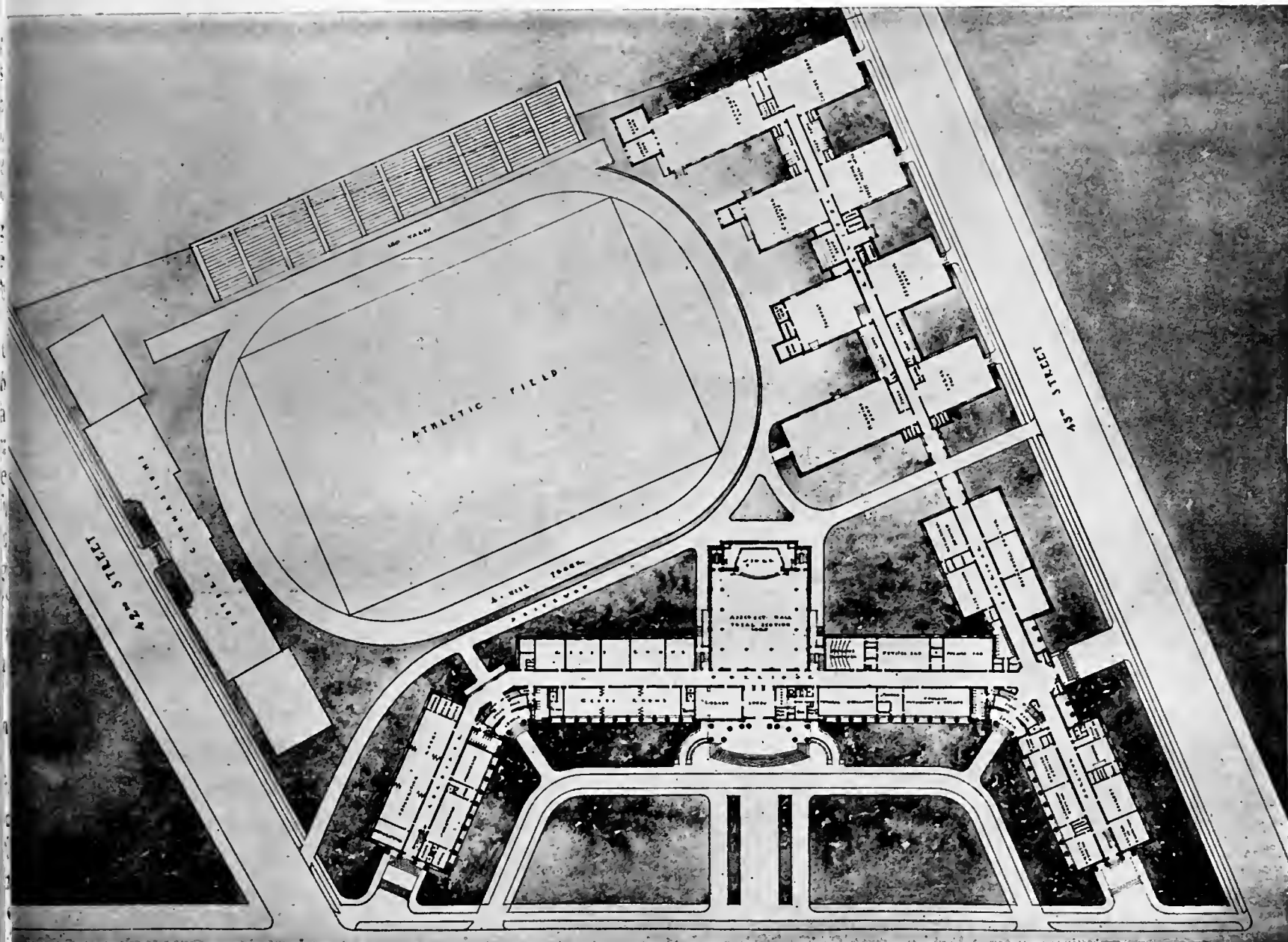

FIRST FLOOR PLAN, TECHNICAL HIGH SCHOOL, OAKLAND, CAL.  
JOHN J. DONOVAN, Architect.

and devotion of the people; and as you pass through California you can not fail to feel that the splendid architectural achievements in school buildings now found almost everywhere are a reflection of the people's devotion and generosity to education and to the child. Any great impulse for good prevailing with a race or nation extending over a long period of time is bound to be recorded in its architecture, music, literature and other fine arts.

When one weighs in contemplation the astonishing fact that of a population of 3,800,000 nearly one-quarter of that population or 916,000 are attending school and college in the State, when it is fully realized that the State is appropriating yearly by bond issues for just elementary and high schools close to \$35,000,000.00, is it any wonder that a responsive chord would be struck by the architects to give expression to such devotion. California has contributed the experiment of the one story school and it is pretty well known now just how far such a scheme should be carried so that administration may not become unwieldy,

and where the line of economy ends and extravagance begins with one story planning.

One of the greatest blessings to education and to the child has come through the awakening of appreciation in even the humblest of our citizens of the value of plenty of land for school and educational purposes. This has led to fine landscape developments of school grounds. No longer is the iron picket fence with its pad-locked gate and foreboding implication "keep off" to be found, except in some of the older structures soon to be abandoned. Instead we find the building set well back from the street and side boundaries, and delightful forms created by shrub-planted spots, lawns, walks and drives which, by their exuberance and color, invite us and make us feel the charm of welcome and sincere friendliness. Then we find that areas for play have not been forgotten nor have areas for floral cultivation and nature study been overlooked. It is so accepted that the layman and lay woman now insist that these must be a part of the building program.

(Continued on Page 22)



MR. LEMOS' HOUSE BEFORE ALTERATION.

## ART IN THE SMALL SHOP

By CLARA FASSETT

COMMERCE and Art have the name of being on very poor terms with each other. "Trade," "commerce," the "commercial spirit" is supposed to be quite indifferent to its surroundings.

Between the residence sections and show places of a city and the shopping district there is usually a distinct line drawn. Exceptions, of course, exist, as we wrote in our copybooks, "to prove the rule."

The feminine element entering trade is largely responsible for exceptions to the above rule. What of beauty in architecture and decorations we see in shops and stores is in tea-rooms and beauty parlors "salons de robes" and decorating studios, places catering to women.

The small shop of Fifth Avenue, of beautiful window effects, appeals first to the prospective buyer by reason of exterior charms. In a number of cities are being built rows of small shops, tiny "holes in the wall"—beautifully designed—all on the ground floor. The value of window advertising is so great to one starting in business that he is willing to pay the higher rent and save direct advertising expenses.

It is in the small town or city suburb that real architectural effects can be observed in the little shops selling commodities that require aesthetic surroundings to make the proper appeal.

The "Ramona Studios" at Palo Alto fur-

nish an example of what may be done in the way of attractive small shop design. Between the illustrations "Before" and "After" you must imagine a number of months elapsing, and if you have ever planned a building, or if you are an architect whose designs are a bit unusual, you will have no trouble in filling in this blank space with the numerous difficulties incidental to getting carpenters and plasterers to carry out your ideas. They do so hate to do anything that is not a repetition of what they have done before.

Here the point of departure was an ugly, commonplace two-story house of wood, whose only redeeming qualities were a well-built frame, simplicity of line and solid construction. Mr. Pedro J. Lemos is responsible for the translation of this uninteresting edifice to a building of beauty, Spanish in feeling, of terra cotta tinted plaster, with tiled roof, fence and gateway, all nicely balanced parts of the scheme. Mr. Lemos, besides being an artist and craftsman, editor of a magazine and curator of Stanford Museum, has also ideas on architecture and city planning which he is carrying out in his home town, Palo Alto.

The entrance to the art shop, which occupies the whole front of the studio, is at the side. You approach through a "Mission" gateway to a small portico. The door leading to the entrance hall is in itself a

Continued on Page xii)





MR. LEMOS' HOUSE AFTER ALTERATION.

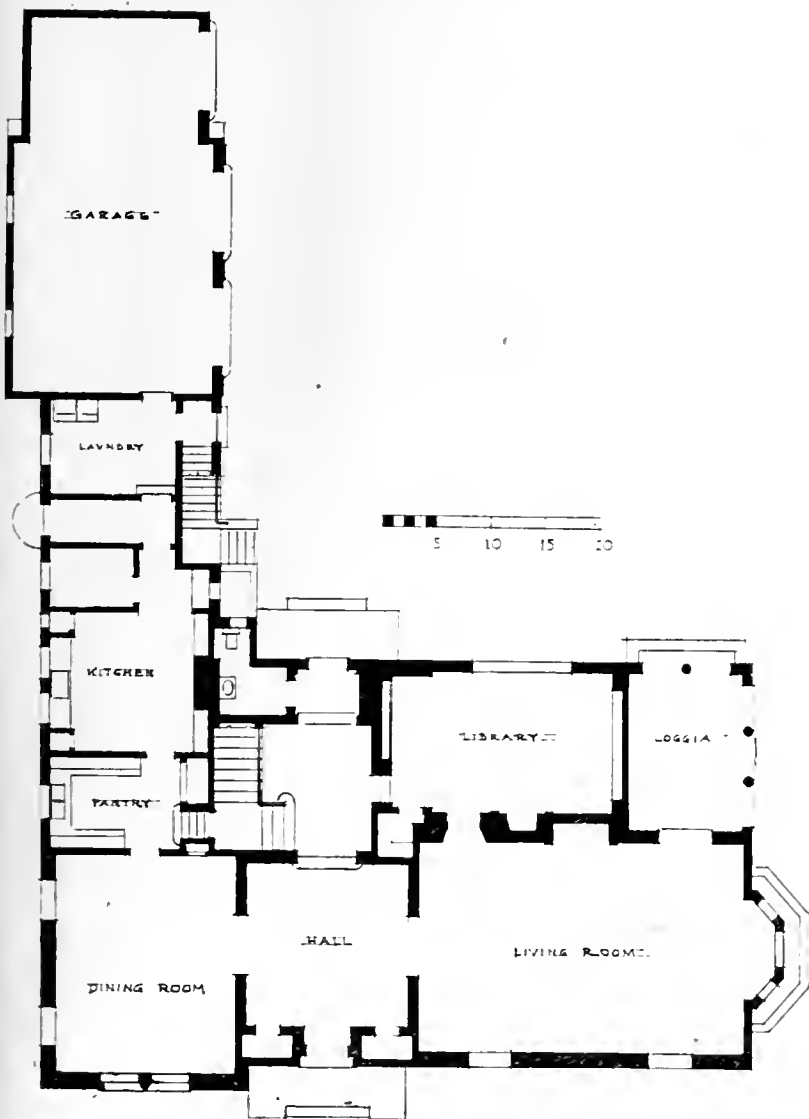

FIRST FLOOR PLAN.

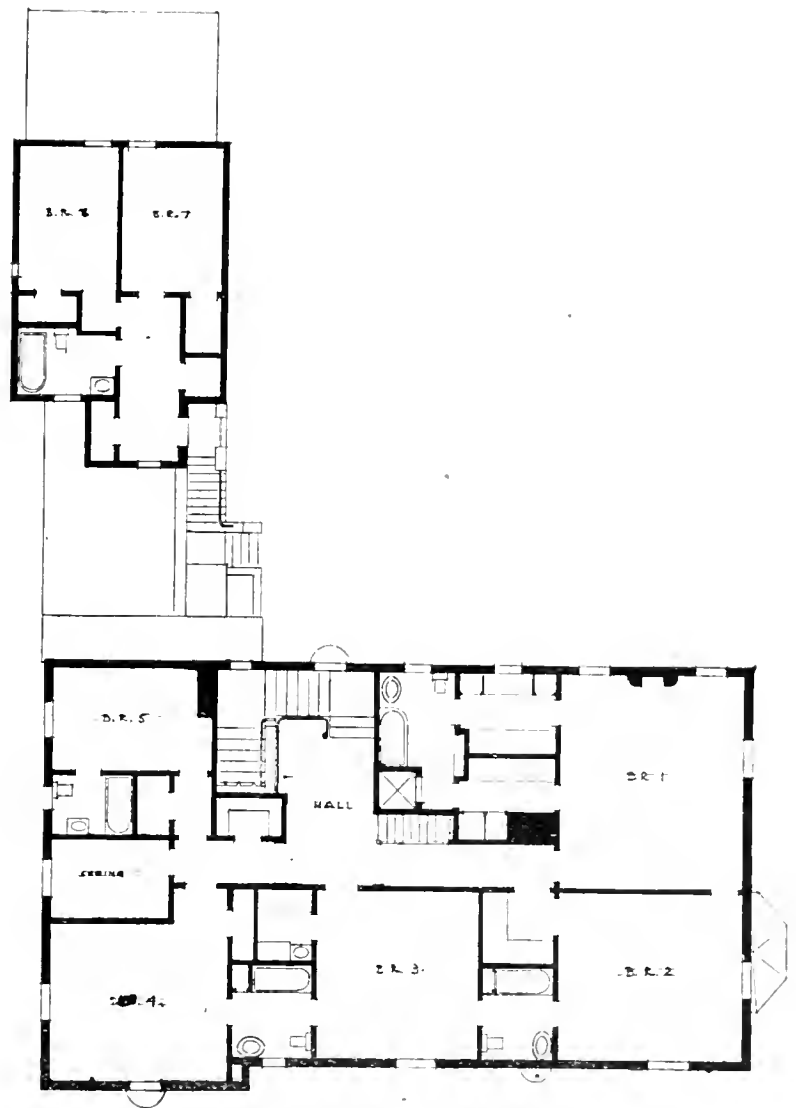

SECOND FLOOR PLAN.

RESIDENCE OF MR. P. J. WALKER, PIEDMONT, CAL.  
GEO. KELHAM, Architect.

## EDITORIAL

WHEN a man decides to put up a building, for whatever purpose, of whatever type, he wishes to have it up-to-date. If it is for revenue, it must compete with others of its kind for durability, for every attraction of modern conveniences. If for his own use, his pride and his comfort demand much the same conditions.

This statement is so obvious that it is almost a platitude.

For information as to the countless details of construction and equipment which are required, the owner investigates personally some few items, consulting with his architect for confirmation of his judgment; but for the most part, he must trust this architect to protect his interests. The amount of satisfaction and profit depends upon the extent to which this is accomplished. And the measure of success reacts inevitably upon the architect and his future practice.

It is clearly a vital necessity for architects to get as much as possible information about the thousands of materials, methods and devices now available, and to keep up with the constant changes and improvements.

The efforts of producers to give information to users have been most unsatisfactory. The economic waste has been appalling. Enormous sums of money have been spent in advertising and in salesmen's salaries. But busy architects can not wade through

masses of mail or listen to lengthy sales talks; they would have no time left for the drafting room and the regular business of their calling.

How, then, is this problem to be solved? How get information to users **when** they need it, and so **clear** and **compact** that no time is wasted?

This requires co-operation. The producer must reform his advertising methods, and the architect must reform his filing system.

It is safe to say that this reformation is under way. Following a conference about a year ago between the Structural Service Committee, A. I. A., and a number of prominent manufacturers, formed a "Producers' Section" of the A. I. A. Many subsequent conferences have resulted in definite progress; several reports have been printed and distributed to architects and producers; and a Standard Filing System has been adopted.

It remains for the spirit of co-operation to spread throughout these bodies. We may expect slow general progress for a time, but it is difficult to see how the mutual benefits can escape recognition. When an architect can keep in a compact file the addresses of manufacturers' agents for all products in which he is likely to be interested, and can send for complete data when the occasion arises, there will be saved all the vast quantity of indiscriminate mailed matter, and it will be comparatively easy to keep abreast of major improvements.



*Handwritten note:*  
P. J. Walker



RESIDENCE OF MR. P. J. WALKER,  
PIEDMONT, CALIFORNIA.  
GEO. W. KELHAM, Architect.



RESIDENCE OF MR. P. J. WALKER,  
PIEDMONT, CALIFORNIA.  
GEO. W. KELHAM, Architect.



RESIDENCE OF MR. P. J. WALKER,  
EDMONT, CALIFORNIA.  
D. W. KELHAM, Architect.



RESIDENCE OF MR. P. J. WALKER,  
PIEDMONT, CALIFORNIA.  
GEO. W. KELHAM, Architect.



RESIDENCE OF MR. P. J. WALKER,  
EDMONT, CALIFORNIA.  
O. W. KELHAM, Architect.

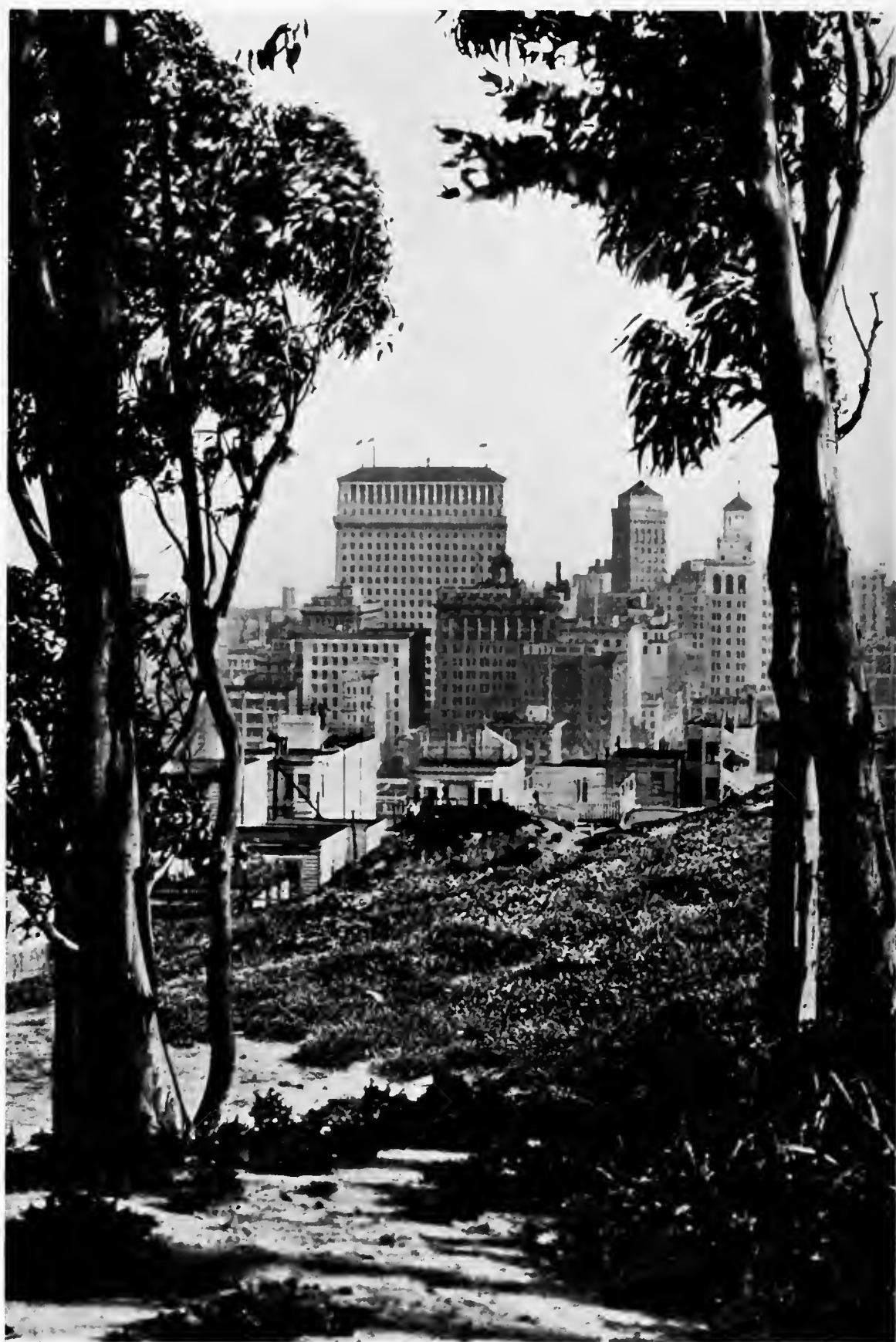

FROM TELEGRAPH HILL.

STANDARD OIL BUILDING,  
SAN FRANCISCO, CALIFORNIA.  
GEO. W. KELHAM, Architect.





STANDARD OIL BUILDING,  
SAN FRANCISCO, CALIFORNIA.  
Geo. W. Kelham, Architect.



COURT FACADE.

STANDARD OIL BUILDING,  
SAN FRANCISCO, CALIFORNIA.  
GEO. W. KELHAM, Architect.



DETAIL OF COURT ABOVE 18TH FLOOR.

STANDARD OIL BUILDING,  
SAN FRANCISCO, CALIFORNIA.  
O. W. KELHAM, Architect.



MAIN ENTRANCE.

STANDARD OIL BUILDING,  
SAN FRANCISCO, CALIFORNIA.  
GEO. W. KELHAM, Architect.



ROOF GARDEN, 22ND FLOOR.

STANDARD OIL BUILDING.  
SAN FRANCISCO, CALIFORNIA.  
GEO. W. KELHAM, Architect.

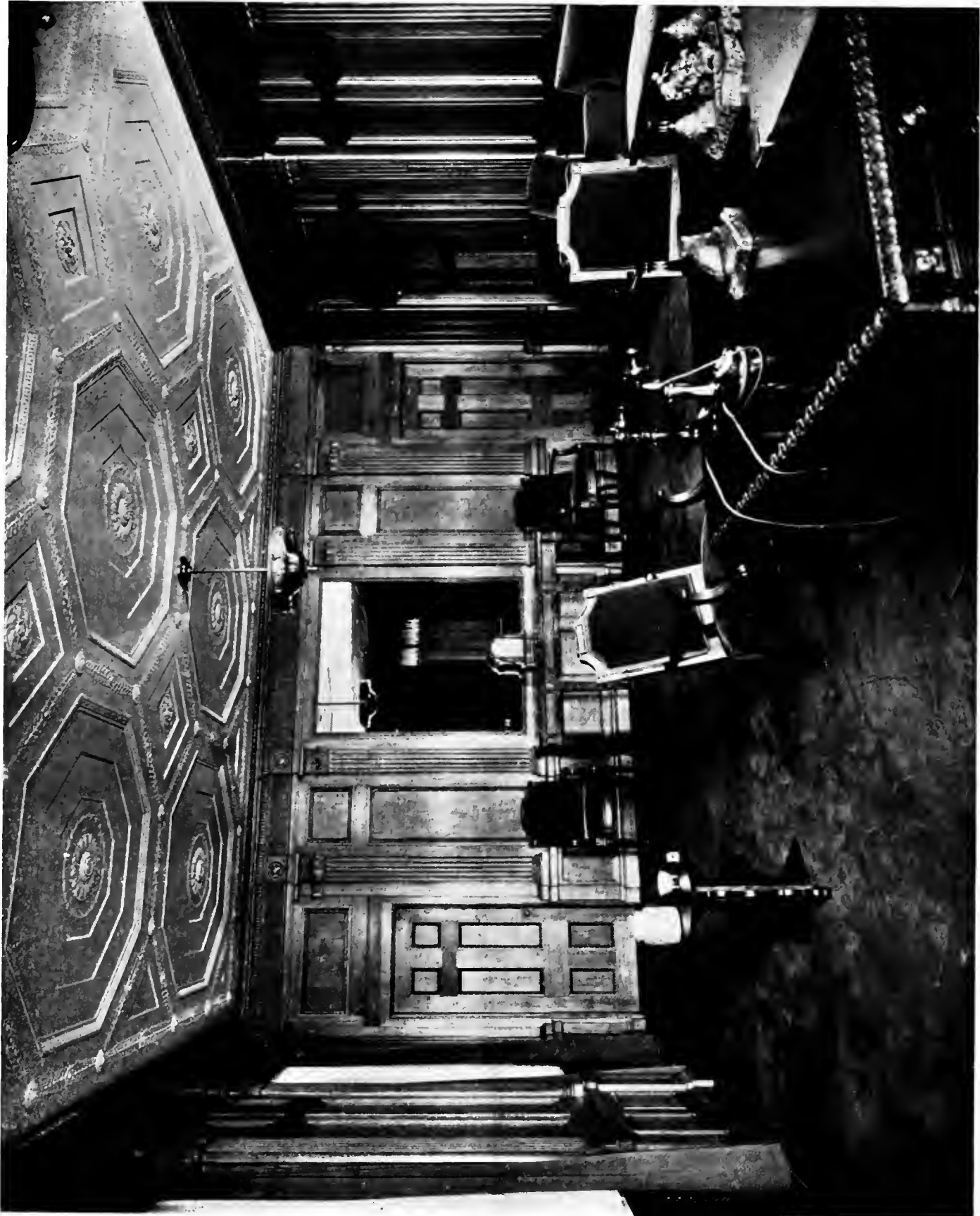

PRESIDENT'S OFFICE, 18TH FLOOR.

STANDARD OIL BUILDING,  
SAN FRANCISCO, CALIFORNIA.  
GEO. W. KELHAM, Architect.

SAN FRANCISCO  
JULY 15 1914

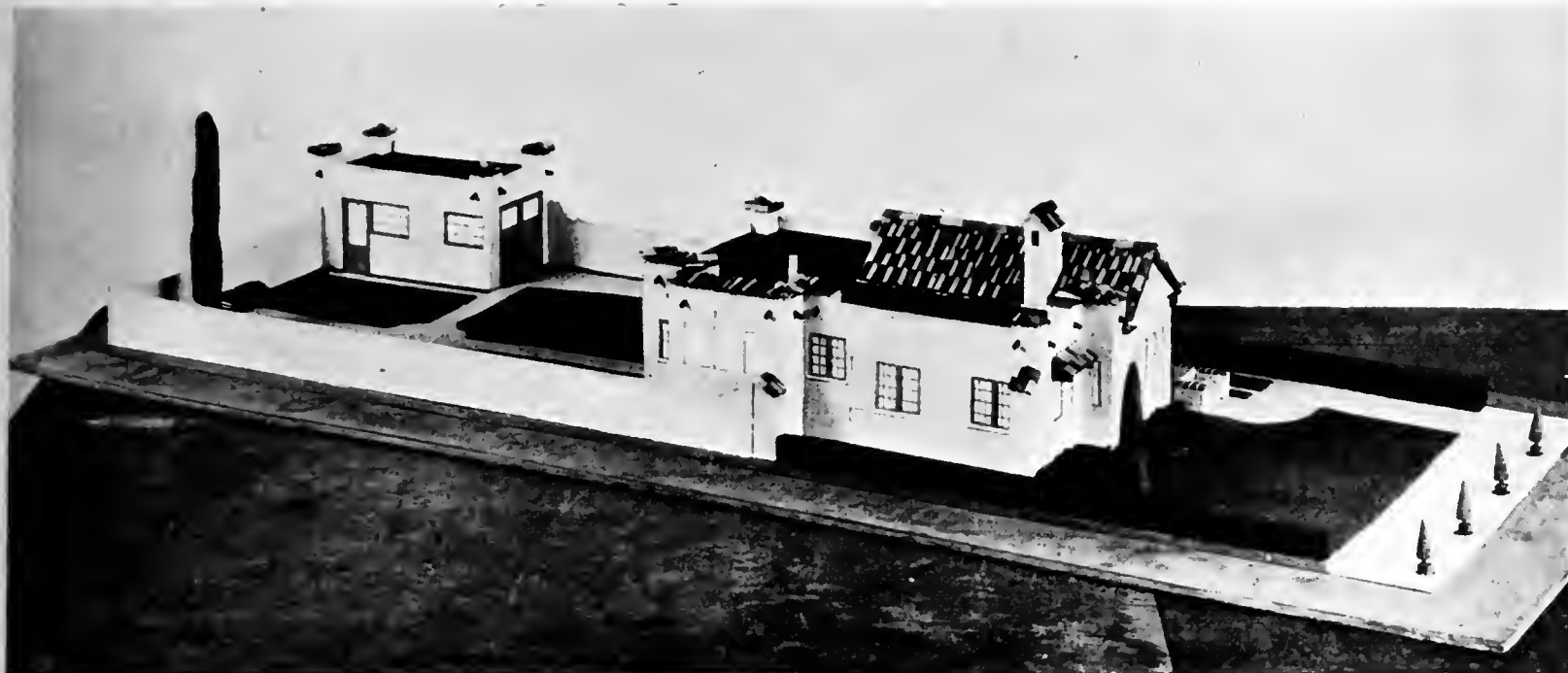

## Miniature Models of Cardboard

By JOCKEMO CASASSA,  
Of the Lewis Rothé Studios,  
San Francisco, Cal.

**M**ANY people find it difficult to visualize the completed structure from blue prints of plans and elevations. Architects have found a model, presented with the plans, the best way of insuring complete satisfaction. The model is the building in miniature, correct in every detail, for it is constructed from the architect's working drawings. The entire lot and as much more of the surroundings as desired, are embodied in the model. The building is placed to the best possible advantage on the lot, and gardens and other contemplated improvements on the property are also worked out to scale. The pro-

posed color scheme is accurately carried out, trees, flowers and shrubbery are also colored, giving the model a feeling of life. A carefully colored model is of value in obtaining painter's estimate.

A cardboard model can be made for approximately the price of a perspective drawing, which it replaces entirely. The drawing gives only an impression of the completed structure, and can give but two sides of the building. A model presents the building in any perspective or elevation. Any corrections or improvements desired can then be made in the plans before actual  
(Concluded on Page xx)

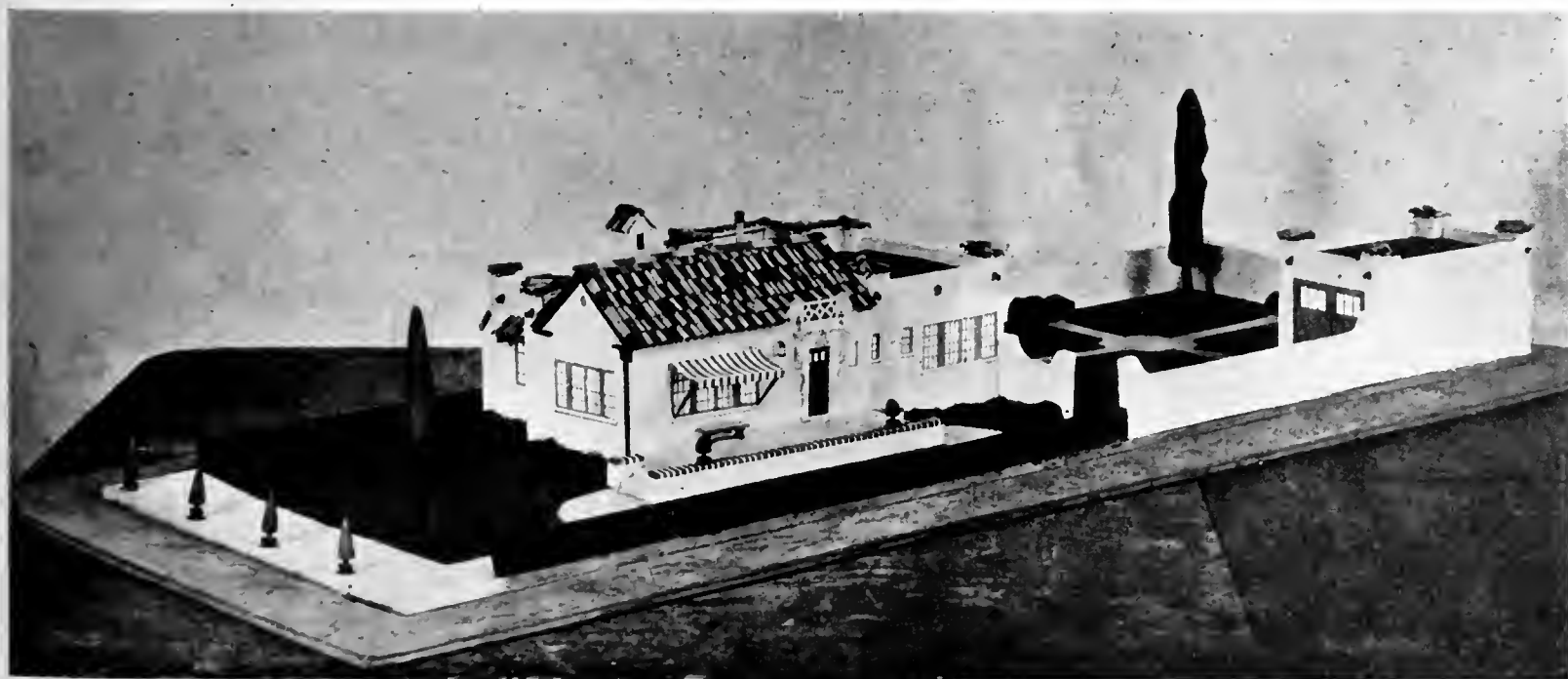

# The Relation of Radium to Architecture

By WILLIAM H. DEY,  
 Manager, Electrical Division,  
 United States Radium Corporation

**R**ADIUM may not commonly be looked upon as a building material, but nevertheless at the present time it is an important factor in architectural specifications, and it is important for the architect to be familiar, to some extent at least, with the facts concerning this unique material and the manner in which it is used.

Then tendency on the part of hospital boards to purchase radium as an essential part of their therapeutic equipment and to use it in the form of emanation, makes it necessary for the architect to be familiar with the provisions to be made to take care of the radium material and the accompanying apparatus.

A radium emanation plant must of necessity be designed by experts specializing on this subject, in which connection it might be mentioned that Dr. William Duane, professor of Bio-Physics at Harvard, is one of the men who have been very prominent in this work and has been responsible for the design of most of the large plants.

The provisions for room in which to install the apparatus must be made by the architect. It is well in this connection to observe that at least two rooms must be provided, since the sensitive instruments for measuring the emanation tubes must be located as far as possible from the supply of radium itself.

Noteworthy examples of planning in this respect are the work of Louis Allen Abramson of New York City in designing the Beth Israel Hospital, New York, and the work of Berlin & Swern of Chicago in their designs for the \$8,000,000 Herman Hospital in Houston, Texas.

In both cases lead lined rooms for the X-Ray and radium apparatus, and other special features have been provided which though expensive would cost considerably more to install if not arranged for in the original plans.

In addition to the above relation to the design of hospital and laboratory buildings, some of the indirect uses of radium are of interest to architects. Radium luminous

material, and its application to commercial products, forms the basis of the greater part of this interest.

Radium luminous material is a radioactive self luminous material and does not require connection with any outside source of energy or exposure to any source of light. The definition of a radioactive self luminous material as given by Dr. N. E. Dorsey, at that time in charge of the radium division of the U. S. Bureau of Standards, in a special report prepared for the National Advisory Committee for Aeronautics, is as follows:

"Self-luminous radioactive materials consist of mixtures of a responsive base, usually zinc sulphide, with small amounts of radioactive substances. Luminescence is caused and maintained by the bombardment of the responsive base by the alpha radiations accompanying the disintegration of the radioactive constituents of the material."

The question of length of useful life of this material is one of the questions most frequently asked the writer when discussing this subject with architects.

There are different combinations of radioactive materials and differences in the qualities of zinc sulphide used by the several manufacturers, but the standard luminous materials as made in this country all have a life estimated at from one to fifteen years. Foreign made materials are for the most part much shorter lived.

Radium luminous material has been manufactured in this country for about eight years, but the deterioration shown during this period has been in keeping with the life charts on which the above estimate was made and it is entirely probable that the estimate will be shown to be, if anything, conservative.

The problem of selecting a proper luminous material is one which the manufacturer using same is quite competent to solve, so that the architect can rely on the responsibility of the manufacturer in so far as this feature is concerned, the same as he does as

(Continued on Page xiv)



## Responsibilities of the Architect and the Engineer in Timber Conservation

LUMBER was used long before iron and steel and yet the general public, the architect and the engineer are more familiar with the mechanical properties of the metals than they are with those of the different species of wood. There is a reason for this condition. Engineers and architects have not studied the mechanical properties of woods as they have of the metals. Even lumbermen themselves have not studied the mechanical properties of the species of lumber they are manufacturing. As a matter of fact this information has largely not been available. Lumber has been merely lumber to most people and they have used it because it always has been used. Yet to use lumber intelligently one must consider the mechanical properties of each species, just as he considers the mechanical properties of the metals.

When the metal man came along and offered a substitute for wood he told the architect and engineer what the mechanical properties of his metal were, and we cannot blame the architect and the engineer for accepting the substitute, especially when they had no data on the properties of wood. Some of these substitutions have been advantageous and others have not.

The United States Forest Products Laboratory at Madison, Wisconsin, has been studying woods for many years. The war intensified these studies somewhat, but the Laboratory has been handicapped by insufficient appropriations and has not been able to do all it would like to do. However, the work that has been done has been highly satisfactory and very valuable to the lumber industry, and the Laboratory is endeavoring to disseminate the facts about wood to everyone interested.

Only a small percentage of architects and engineers are taking advantage of this information. A part of this lack of interest can be attributed to indifference, but most of it comes from their not knowing where to get the right kind of information on the different species of lumber.

This also accounts for the large variance in the specifications drawn up by architects

in different states and localities. Architects in one locality may be loath to consider the use of a certain species of wood even though that species has been specified, used and found entirely satisfactory for years by architects in another locality.

Why is it that the sticking on all the doors used in the state of California is always specified one of two styles, neither of which is standard with the large door manufacturer? If fir is good enough for the pulley stile of a window, why is it not used for the sills also?

The psychology of the carpenter in different localities has a great deal to do, too, with the uses of lumber. Why does he order 16 foot lumber and then cut most of it up into 8 foot lengths when he uses it? Why does he sometimes object to hanging a fir door because it cuts a little harder than white pine? Yet he uses fir for finish and cabinet work, and when he has to hang a hardwood door he accepts it and says nothing. California carpenters sometimes express themselves as not liking fir sash, yet they use fir in almost every other place in an house. Carpenters in Oregon, Washington, Louisiana, Tennessee, New York and Connecticut are using fir sash. Why not in California?

Lumber users do not seem to realize that, as the production of any species reaches its peak and begins to decline, it means smaller and smaller trees are being cut. The smaller the tree the greater the percentage of sap wood, and this is a great deal less durable for outside or exposed work, even though painted, than the heart wood. Some species of wood, too, run heavier to sap wood than others.

The millwork men in California have to pay the highest price for the fir lumber they use in order to get the long cuttings required for the stiles of the one panel doors which are popular there, and this price is reflected back to the builder, whereas if California were using fir sash the mill men could use a percentage of material with shorter cuttings as well as reduce the percentage of waste in the lumber he is now

\*—West Coast Forest Products Bureau.

buying and buy his raw material for less money.

The public looks to the architect and engineer to see that they get the best material possible at a reasonable cost in their construction work.

The architect who narrows his specification to one species of wood when other species have the same, and sometimes better, mechanical qualifications, is not only sometimes making the building cost more but is not helping to conserve timber resources.

With the necessary information put before architects and engineers, then, their recommendations can be based on the real qualifications of the woods that can best be used for any particular purpose or place.

We would then have true conservation of our natural resources.

Every lumber manufacturing district in the United States has had to go through the same experience with regard to waste in manufacturing a species of lumber. Each respective district has been nearly cut out before the waste was eliminated. In 1895 the mills in Northern Wisconsin would not saw a hemlock log, and if one slipped in by mistake and some of the lumber went out on a job, the carpenter would throw it out and would not use it. No one knew the mechanical properties of wood at that time, and prejudice on the part of the builder, the architect and the engineer was the force that threw it out. Today they are using practically none of the local woods but hemlock for building in that territory.

With the experience of earlier producing regions before it and the increasingly available knowledge of wood properties, the West Coast can practice better utilization and elimination of waste while it still has vast resources available.

The public depends on the advice of the architect and the engineer. If they know the mechanical properties of the different woods they can advise intelligently.

---

Mountjoy & Frewen, Architects, announce the removal of their offices on July 15, 1923, from the Chamber of Commerce Building to Suite 1000, Patterson Building, Denver, Colorado.

## Remarks about California School Architecture

(Continued from Page 15)

And to what does it all contribute — just this, that the school and the grounds attract the child, and, of course, that which attracts holds the interest.

We are far from the Utopian in man's relation to man, but it is certainly clear that these contributions to the child's welfare are deep foundations to fuller and more complete citizenship. And what is good citizenship, a phrase so often hauled forth to veil vacuity of thought or rambling in reason. To me it is simply an ingrained desire on the part of any member of a community first of all to do the right thing by himself and by his neighbor and then a desire to put into effect sound principles of progress for the maintenance and advancement of human health, prosperity and happiness. The object of the school is to train the child mentally and physically along prescribed lines and then, by environment, contact and observation, to give him the power to attain these desires and to employ them most effectively for the benefit of society in general.

Then is it not the function of the architect to interpret this purpose of the State in Education and so to plan, design and compose his projects that the environments of the institution are most conducive to harmonious assimilation of the ideals of citizenship with the other important elements of education as the child moves on in age.

The end is by no means in sight, but it is evident to those who seem to see and think most clearly on this great problem of school building, that the teaching and architectural professions are communing in a common language built on intimate knowledge of cause and effect, requirement and solution, and adaptation of building to curriculum.

And from this communion of minds and purposes there has come a serious effort to create an architecture delightful as well as practical. In spots there are evidences of stiffness and clumsiness in expression, but on the whole you will find a freedom in line and form guided by a sense of restraint and respect for good taste. Fortunately, slavish adherence to any particular style or period of architecture is generally absent. It seems that the members of the profession prefer to mould the native materials simply into the forms that come to mind in the solution of their problems. Academicians

in design we have few if any, and is it not fortunate that this is so, for, like the early writers of California, the architects are receiving their creative inspirations from the people, the times, the motives of purpose and the country itself, and the architecture is merely a reflection of the spirit of all these.

Grant me your indulgence to touch on the effects of climate again. I made a recent extended visit through the East where I returned to scenes of earlier life and at a time (February and March) when a great blazing log in the fireplace brought recollections of warmer climes. Then I realized that permanency in materials is a first consideration so that the structure of a building and its component parts shall withstand the rigors of frost and weather. I found places where that fine plastic material, terra cotta, so desired by us here, is in disfavor. Just what would happen to such materials as imitation stone, which is so frequently used here, is fearful to contemplate.

Rigorous winter sections of the country are building more permanently than we are in California and it may prove wiser and more profitable ultimately; but the next few years will be productive of many charming creations in California School Architecture because of the responsiveness of the materials to the touch of the creative power of the builders. In other words, because of climatic conditions, the architect here is held in less restraint both in form of plan and in use of material, which should enable him to contribute to the problem of school architecture many interesting and valuable solutions educationally and architecturally. May I say a good word here for my fellow architects in our mutual endeavors? It is this: they are sincere in their desires and ambitions to serve to the fullest extent and to accomplish creditable examples. That is an assurance of progress in achievement, and I am very happy indeed to be counted among them and to share their interest.

This brings to mind a matter which is well worth placing before this conference for reflection, and that is the attitude of the adverse critic of the public school and its architecture. Free and constructive criticism is good for the soul, humility of mind and for progress in human development, but criticism based on personal prejudices uninvestigated hear-say information not found on fact, and simply because the tax bill hurts is not productive of anything but de-

plorable decadence. Just because a man once attended school or once taught in a school or is a successful respectable citizen is no proof that he is a competent authority on education or on projects requiring special and extended training in the science of planning, engineering and artistic creativeness. The day worker is exempted from this charge, for as a rule he usually accepts conditions as they prevail with very little fault finding. But I do charge men who have risen to heights in their professions or trades with unfair and unwarranted criticism of the public school by decrying as lavish a well thought out plan to cope with the school requirements of the present day; and if the material of the structure is well chosen to express an excellent design, the criticism is extended to this—although the critic in ninety-nine times out of an hundred is unfamiliar with problems of education and child hygiene, to say nothing of building, engineering or architecture, and because of his position, social, professional, business or otherwise, his words carry weight and do endless harm. The "soap box" orator is harmless to any cause regardless of his rantings; but it is the unjustified complaints on baseless surmises from the substantial citizen that will retard the development of the country's greatest industry—the training of the future citizens.

No brief is held here for the incompetent or the sluggish minded architect who simply executes an honorable commission just for the financial returns. Nor is there any desire to spare the rod of just rebuke from the mountebank who sets himself up as a Moses ready to throw new light on this problem which actually requires self-effacement and realization that time an intimate acquaintance with school work is essential to successful solutions, nor is there any brief to hold for the absence of simplicity in plan and exterior in the architectural creation. Excrescence in useless, meaningless and misapplied ornament or decoration is to be abhorred by both professional and laymen alike, and this leads me again to pay tribute to the courage and fortitude of the architect who responds to the call of his ambition to do a work worthy of his calling both in plan, elevation, and choice of materials and workmanship. It is so easy to do the commonplace thing, to copy and repeat what has been done before by himself or by others, that when we find men first evolving the plant to its greatest usefulness and then

striking out to express this in clear, precise, harmonious architectural diction, those who understand are thrilled to exultation, realizing that the greatest profession of all—education—has received a progressive impetus.

If society has not yet learned where and how to place taxation, and evidently it has not, so that its burden is least felt by all, that is no reason why criticism should be levelled at the school and its plants, simply because it is the easiest and safest mark to hit. Has it ever occurred to you as peculiar that very little criticism has been levelled at the cost of jails, asylums and other penal and corrective institutions, compared with the criticisms aimed at the school and its operation? Do you know it cost Philadelphia about \$12.90 per capita last year to educate its children and about \$9.00 per capita for its corrective institutions, courts, and police department, and the ratio of the cost of education with correction in all cities and states is about this or worse? Do you ever stop to realize that more than 80% of the inmates of state penal institutions have received less than a sixth grade education? But enough of criticising the uninformed critic and his criticisms, but this is as favorable an opportunity as any to return his compliments of approbium in kind.

It takes years of association to understand the school building program for the fullest interpretation by the human mind and it takes years of intensive study, training and experience to attain proficiency in the architectural profession as it does in all professions and it is with a sense of respect for both achievements that I pay this simple tribute to my fellow architects, not only of California but throughout the United States for their efforts, skill, courage and intelligence in endeavoring to meet humanity's needs ambitiously for humanity's sake.

#### CEMENT MAKING FILMED

Much of the unusual equipment involved in making cement is interestingly illustrated in a two reel moving picture called "The Story of the Manufacture of Portland Cement," just released for general showing.

Starting with views of one of the large plants in which the country's cement is made, the film pictures in a non-technical way the essential steps in transforming thousands of tons of raw materials into portland cement. Scenes taken at a number of plants are included.

#### TESTS POINT WAY TO SAFER ELEVATORS

Seventy-five per cent of Fatal Accidents Preventable United States Bureau Finds

About three-fourths of all fatal elevator accidents are found to occur at the hoist-way door, either because of the door being opened when the elevator is not there or because of the elevator starting when the door is open. These accidents can be prevented by a reliable interlock, as when such a device is used the elevator must be stopped at the floor before the door can be opened, and the door must be closed before the car can be started again.

During the past year the Bureau of Standards has been conducting tests to determine the reliability of the various types now on the market. The devices have been given endurance tests under normal conditions, they have been tested in a corrosive atmosphere, in a dust laden atmosphere, without lubrication, and under conditions of misalignment likely to occur in practice.

#### INDUSTRIES EXPOSITION WILL OPEN IN NOVEMBER

The California Industries Exposition dates have been set. The exposition will be held in the Civic Auditorium, occupying the entire building, including all the halls, corridors and basement, from November 17 to December 2.

Angelo J. Rossi, president, has announced that Anthony A. Tresp, exposition director, has again been selected as general manager.

Offices with Mr. Tresp in charge have been opened on the fourth floor of the Civic Auditorium, and here manufacturers can make application for exhibit space.

In the past the exposition has shown its value as a business stimulator by interesting the consumer and acquainting him with the extent and variety of the many products manufactured in Central California. The exposition is an educational market builder.

Manufacturers are asked to take advantage of the opportunity to exhibit at the exposition, which is conducted by the Central Bureau and Program Committee of the San Francisco Organizations.

# Get the Best



TRADE MARK REGISTERED

*Specify*

**PACIFIC**  
PLUMBING FIXTURES



FIREPLACE IN MR. LEMOS' HOUSE.



## Art in the Small Shop (Continued from Page 16)

thing of beauty, inset with panels of polychromed wood carving, whose motifs are adapted from Alhambra tiles.

Opening from the entrance hall to the left, occupying the whole front of the building, in which are displayed objects of art and furniture, arranged as in a well furnished home. To the right, in a smaller room, is located the gift shop.

The lighting of the main room is worked out very successfully. The three windows of the original house were increased to six, making the whole front of glass. These windows are curtained in a khaki colored casement cloth, through which the sunlight streams a mellow golden glow.

Architecturally the feature of this living room shop is its fireplace of cement, built on lines of bold, almost primitive simplicity, with decorative insets of cement tiles in Aztec pattern. The tile inlay is typically Spanish, yet owing to the difficulty and expense in procuring the glazed tiles for building purposes, comparatively few builders use them. Mr. Lemos has overcome this difficulty by using cement tiles, designed to make this form of decoration popular by decreasing the expense, and at the same time meeting a demand for exterior ornament especially appropriate in this age of cement. These tiles are not glazed, but hardened in water, and have been used, both tinted and in natural color with gratifying results, as ventilators, decorative ornaments and for flooring.

Upstairs is the "Gown Shop Gay" in its painted and paneled walls, hung in orange and black, all accessories in perfect accord, just enough goods on display to whet the appetite creating an instant desire to buy clothes. Psychology is evident here. Contrary to the prevalent opinion, women who buy clothes at the most expensive stores do not like to spend hours shopping for the pleasure of the expedition. They like to make their selections at the "shop in time" where the element of personal service and painstaking interest is a special feature.

The living quarters are upstairs, reached by a separate entrance. At the back is the garage, a reformed coal shed, all dressed up in terra cotta plaster with a quaint green door and decorative panel ornamenting its front, almost too attractive for its utilitarian purpose; I do not doubt but that shortly it too will become a part of the studio.

# Informative Advertising

## II. To the Advertiser:

(Continued)

### In Connection with the Presentation of Printed Information

(From Bulletin issued by Structural Service Committee, A. I. A.)

#### 1. Substance of the Message

Does the document present the facts which architects are likely to demand?

Has a diagram or tabulation been omitted which would help; or has one been included which means nothing?

Is an example of the use of a material, or testimonial or report of test badly selected?

Has a vital question sure to arise in the architect's mind remained unanswered?

Has a claim been made which is likely to leave a bad impression?

Has a claim been made which is worthless without supporting evidence?

#### 2. Expression

Are the literary style and terminology employed appropriate to the subject and the audience?

Is the statement clear?

Is it general when it should be specific, or vice versa?

Is it flippant when it should be serious?

Are the thoughts expressed likely to arouse architects' hostility because they imply the assumption of unjustified knowledge or authority?

Does it indicate a knowledge of the architect's fiduciary relation to the client?

#### 3. Appearance

Is the periodical advertising or piece of printed matter attractive enough, measured by architects' standards, to capture their attention and obtain a reading?

Does a pictorial illustration offend good taste?

Has the printed matter color when it should not have?

Is it elaborate and garish when it should be simple and businesslike?

Does it convey the idea of cheapness when it should suggest quiet elegance?

## 14 Reasons for your Specification of "The BEST Glass"

THE answer of the architect to the ever increasing demand for more light in the home, school and office building is a provision for more windows and better window glass. Here are fourteen reasons why our window glass is not only better glass, but "The Best Glass."

1. Our melting furnaces are the largest in the world and produce uniformly melted batch.
2. Our improved mechanical process of drawing and blowing gives our glass greater tensile strength and higher modulus of rupture than any other window glass, plate glass, or rolled glass.
3. Our latest improvements in our blowing machines enable us to produce absolutely perfect cylinders, which makes it possible to secure the best flattening ever obtained.
4. Our new method of flattening gives our glass a wonderfully even surface, preserving meanwhile the brilliant lustre of the drawing process.
5. Our glass has less wave than other glass, and consequently shows less distortion.
6. Our glass is uniformly flat; it contains no reverse curves.
7. Our glass is uniform in thickness.
8. Our glass is perfectly annealed and therefore does not break as easily as poorly annealed glass.
9. Our glass is washed and thoroughly cleaned in an acid bath, which prevents discoloration and permits ready detection of defects.
10. Our glass cuts perfectly on both sides.
11. Our glass is graded to the highest standard of quality.
12. Our grading is the recognized standard for the United States, and is higher than the foreign standards.
13. Our glass does not break in shipment, on account of the uniformity of flatness, well made boxes, great care in packing, and skillful loading.
14. Our entire process is conducted on scientific principles.



Our elliptical trade-mark together with the grade markings stenciled on every box of the genuine guarantee the quality. Specify "The Best Glass" and be assured of strength, evenness and beauty.

**AMERICAN WINDOW GLASS CO.**  
 GENERAL OFFICES: PITTSBURGH, PA. *The BEST Glass* BRANCHES IN PRINCIPAL CITIES

## The Relation of Radium to Architecture

Continued from Page 20)

regards reliability of the other materials used in the same product.

Probably the next most important questions are the cost, the manner of specification, and the source of supply of this material. These questions will be answered throughout the article.

The following are amongst the most important uses of radium luminous material in so far as they relate to architectural specifications:

Luminous wall switches, including push buttons, tumbler and rotary switches, whether surface or flush.

Pull chain sockets and switches operated by a pull chain or cord.

Ceiling or wall switches operated by either pull cord or chain, or in the form of a pendant switch.

Fixture switches of the type frequently known as canopy switches.

Bell centers both of the flush and surface type.

Locks and other hardware items. (Luminous key holes are useful as well as humorous).

Luminous street door and room numbers. (The Pullman Company is, for example, using luminous berth curtain numbers.)

The methods of applying luminous material to these different devices vary considerably as manufacturing and design conditions necessitate.

Switches are usually treated by having a small luminous insert pressed or moulded into the handle by the manufacturer.

Sockets and pull cord or chain devices are taken care of by a luminous pendant spun in place by the manufacturer. The general idea of this pendant is quite familiar to the average man, as millions of them have been and are being sold over the counters of electrical and other retail stores with a slotted cap for attaching to sockets already in use.

House numbers are a complete item, and are made up by several manufacturers in various ways to afford protection to the luminous material from mechanical or chemical injury.

Bell centers in the surface type of bell buttons are made of transparent glass and filled with the luminous material, and this center substituted for the usual composition, porcelain or wood center. In the flush type of bell button, the manufacturer builds the luminous part into the button at the factory. The manufacturer of the surface



pe can supply the button with the luminous center, or it can be purchased separately.

In connection with certain kinds of ceiling switches or with certain uses of ceiling switches where the cord hangs down in such a way as to strike against walls or other objects, special pendants have been made of somewhat heavier construction. A notable installation of these is in the Filing Department of the John Hancock Building in Boston, which has been completely equipped with one of these to each filing case, and while the pendant strikes frequently against the steel filing cases it is so substantially made as to remain uninjured.

The use of the luminous pendant in this particular case is made with the object of saving electric current. It was found that the clerks usually after taking papers from the file draw left the light, which was a 100 watt bulb, burning, and the excuse was invariably made that inasmuch as they were going right back to replace the papers (which was not of necessity always the case), it was simpler to leave the light burning than to grope around for the switch cord. The use of the luminous pendant overcame the difficulty of locating the switch and made the enforcement of the rule that lights should be turned off promptly, practical.

This particular pendant, being made of a heavy glass and with a hermetically sealed top, appealed to the manufacturers of the generally manually operated hospital signal systems, and it has been adopted by them for the pull cord on the "calling" switch, both for the convenience of the patient in finding the cord and because of difficulty experienced with the usual composition or good pendants which failed to stand sterilizing in boiling water. This failure necessitated constant replacement, the expense of which very quickly exceeded the cost of the luminous pendant.

Luminous switches, etc., have many advantages. For example, on entering a house or room, the stranger can see exactly where the switch is located. The usual occupant of the house or room is of course familiar with this location, but no matter how familiar the person may be along these lines there is always that slight loss of time and feeling of helplessness that accompanies the groping around in the dark for something, saying to one's self—"I know just exactly where this is, I wonder where it has gone to. It ought to be right here." Some

## BALL BEARINGS

**SKF INDUSTRIES OF CALIFORNIA**

Incorporated  
115 NEW MONTGOMERY ST.

San Francisco, Calif.

Phone Sutter 4196

DEEP GROOVE AND SELF-ALIGNING BEARINGS  
HANGER EQUIPMENT

## Clay Products

Gladding, McBean & Co.

SAN FRANCISCO  
LINCOLN  
LOS ANGELES

PORTLAND

LOS ANGELES

SEATTLE

## R. N. NASON & CO.

PAINT MAKERS

151 Potrero Ave.--SAN FRANCISCO--436 Market St.

Makers of

NASON'S OPAQUE FLAT FINISH

A flat oil paint made in soft Kalsomine Tints, that is washable; a practical article for walls, ceilings, etc., that is most economical and durable.

Agency for

Tamm & Nolan Varnish Works High Grade Varnishes and Finishes

Goods made on the Pacific Coast for the climate of this Coast

Del Monte

--

Fan Shell Beach

## CLEAN WHITE SAND

Del Monte Properties Company

Sutter 6130 Crocker Building San Francisco

people very emphatically state that this is not a statement of fact so far as they personally are concerned, for **they** are able to place their finger directly on the switch button no matter how dark it is, but fingerprint evidence usually shows them to be wrong.

What is more unsightly than a switch plate or wall covered with finger prints? Even if the wall is kept constantly washed, the plate will show these prints and the constant washing of a wall will require frequent repainting or repapering, which means expense. Finger prints may be caused by dirty hands, and we all have them some time, and children have them nearly all the time. Dust on the wall and moist hands, or moist hands alone, will produce finger prints.

A prominent manufacturer of paints in a recent campaign featuring a washing wall paint, spent for one particular advertisement in one issue of a large magazine \$8500 to give his message to the public, and this was only one insertion in one particular magazine. Probably in all, that particular ad was shown to the public and the architect at a cost of \$30,000 or \$40,000, and in order to demonstrate the necessity for the use of a washable paint this manufacturer used a drawing in which the principal "horrible example" was a switch plate and its surrounding finger prints.

We have all had the experience of stumbling against various objects in the dark while looking for a switch, and possibly have experienced either or both personal and property damage as a result. This unpleasant experience is especially liable to occur in cellars, attics, garages, and places of that sort where one is less familiar with the location of other objects, thus making it particularly dangerous to grope around in such places in the dark.

A prominent architect in Rochester, N. Y., related a personal experience recently which demonstrates very well the above point. Coming home one night he miscalculated the location of the switch by possibly a foot and by mischance collided with a light card table in its usual place right near the switch in the room. Ordinarily there might have been no damage caused, but unfortunately his wife had been cleaning out the china closet and had placed on this light table the entire contents. The consequence was that the table collapsed, with results as might be expected. As he explained it, he did not mind so much the intrinsic loss of \$600 covering the broken articles, or even the sentimental value represented by the fact that many of the articles were wedding and anniversary gifts, but the thing he minded most was the lecture he received for his carelessness and the very strong probability that the initial lecture would not be the last on the subject.

When luminous switches are used, one never has occasion to strike matches to find them, and fire prevention engineers and insurance experts have stated to the writer that the lighting of matches to find switches has frequently caused fires. This is of course more particularly true where inflammables are kept, but in any case one of the worst features of such fires is the fact that usually they are of a smouldering nature and do not break out until some time later when they have gained sufficient headway to make them very stubborn to put out.

This point is well illustrated by the experience of an architect in St. Louis who stated that it had cost his client \$100,000 through not having luminous switches. The building in question was a very fine garage, but a careless chauffeur and a little oil soaked waste and a match carelessly thrown down after the switch was located caused a total loss.

## Pacific Manufacturing Company

Branches:

117 Stevenson St.  
SAN FRANCISCO

Manufacturers of and Dealers in

**Doors, Windows and Mouldings**

General Millwork

1001 Franklin St.  
OAKLAND

Branches:

908 Washington Bldg.  
LOS ANGELES

58 West Santa Clara  
SAN JOSE

Factory and Main Office: Santa Clara, Calif.

Luminous material is of great help in orienting one's self as regards the location of all other articles in the room. The single spot of light hanging from a pull chain socket, or visible on the switch button, will enable one to cross the room to reach the socket safely or to cross the room without turning on the light.

A further advantage in the use of radium luminous material is one that will appeal to the architect and the contractor alike; that is, the greater freedom permitted in the location of switches. The usual practice of placing a switch alongside the door frame is splendid if one has to feel for the switch, but often embarrassing for the contractor who has to install it. Many times a location could be found, which while eliminating the expense and difficulty found in the usual practice, will at the same time make the finding the switch through the use of luminous insert much simpler.

An example of this is seen where in an apartment hallway the door is located in the side of a hall with a wall directly opposite, and by placing the switch in the wall, even a few feet to one side of the door, one can walk directly to the switch and place the finger directly on the button, instead of turning around to feel for the switch, which if there were bundles or packages to be considered might be very inconvenient. At the same time the switch would not only be located in such a way as to avoid conflict with the door frame and other conditions, but there would be a considerable saving in B X, wire, etc., and less beams and uprights to cross between the switch and the outlet. It is not unusual for the saving on the installation of a single switch to be sufficient to pay for the luminous material for the entire job.

We are all familiar, if we have been around hotels very much, with the practice of having a sign on the door "Please turn off the lights," and we all know that if the switch is not convenient we are very prone to figure that we are paying for it anyway and to leave the lights burning. While the use of luminous switches will not guarantee the compliance with this rule, there is undoubtedly no deliberate waste of electric current on the part of the average citizen,

and by making it easy to locate the switches we remove the principal reason why this request is so frequently ignored.

Hotel lights in apartments and hotels are usually turned off or very low after a certain hour at night, and while some of the more modern hotels have ventilating transoms which do not permit light to enter, the average hotel room is frequently too light for sleeping, due to light from the hall, or even if the lights are turned low it is unpleasant to have them shining through the transom, or when the dimness is produced by turning off some of the lights it is very annoying to have a room opposite the light which is left burning. The general result of this dimming of light in hallways is that it is just light enough to cast shadows and makes traversing the hall more difficult than if there was no lights. Certainly it makes it very difficult to read the room numbers and a hallway with luminous room numbers on both sides is usually a better proposition completely dark than the average dimly lit hall, and the saving in current is complete instead of only partial, and the room numbers can be much more easily read.

Builders of apartment houses and houses put up for resale have frequently stated that in their estimation the use of Radium Luminous Material added very greatly to the rental or sales value of the properties by reason of the spectacular exemplification of the "every modern improvement" idea; the result being that the prospective tenant or purchaser will go away very much impressed with the extent to which conveniences have been provided "even switches which can be seen in the dark." In very cheap work, luminous pull chain sockets decidedly offset the disadvantage caused by the leaving out of switches.

In hotels luminous material tends to offset the disadvantage caused by the fact that one cannot have the switch near the door where it can be groped for and at the same time near the bed where it will be convenient for turning out the light when retiring, or turning on the light during the night. With the luminous tip the switch can be so located as to be seen from the door and at the same time be seen from the bed and be near the bed. Such a location is usually a more economical one for installing the switch.

(Concluded in September Issue)

# Los Angeles Building Activities

By IRA C. TICHENOR,  
Publicity Department,  
Los Angeles Chamber of Commerce

Contrary to general expectations, based upon the unbroken rule of past years, construction operations in Los Angeles actually increased, rather than diminished, during July.

In this month, the first of the new fiscal year and the height of the summer season, a slowing down in building work is anticipated by builders and contractors, architects and others directly or indirectly interested in the building industry.

This year, however, July has joined the record-breaking monthly column with a total estimated valuation of \$15,083,273, or a gain of \$7,019,255 over July of last year.

This record is considered especially remarkable in view of the fact that the permits for the month included only one height-limit Class A structure, the estimated cost of which was \$2,000,000.

Construction of dwellings continues to increase. Of the single variety the number of permits issued in July totalled 1,456, at a cost of \$3,038,870, and for double dwellings, 282 permits at a total estimated cost of \$1,409,960. Eighty flats and forty-five apartment houses were among the housing additions.

That Los Angeles is sustaining its reputation as an auto center is indicated by the fact that the July permits included 1,229 garages and 59 service stations, with a total estimated cost of \$512,000.

Los Angeles also is taking care of its increasing number of school children. The list of July permits included thirty-five school buildings having a total estimated cost of \$933,500.

The records of the building department show that during the first seven months of 1923 there were issued 34,400 permits with

a total valuation of \$108,972,458, as compared with 25,650 permits and \$67,523,268 in cost for the first seven months of 1922, or an increase of 8,750 permits and a gain of \$41,449,190 in valuation.

At this rate of increase the total for the year would be approximately \$185,000,000, as compared with the new record made in 1922 of something over \$121,000,000.

In view of the certainty of the beginning of construction of a dozen or more height-limit Class A buildings before the close of the year there is a strong probability that the total building operations for 1923 will approximate, if not exceed, \$200,000,000.

According to a statement made by the building inspector there are now on file in his department a number of plans for buildings that will cost several millions of dollars in the aggregate, and the prediction is made by the inspector that the August valuation of permits will be in excess of the July total of something above \$15,000,000.

While extensive construction operations have been planned for various sections of the retail business district, South Spring street, it would seem, has in prospect the greatest amount of big building work of any single district.

Architectural and engineering plans now are under way for a twelve-story Class A building on the southwest corner of Seventh and Spring. Alin, McCabe & Co. and Charles Shane have taken a 98-year lease on the frontage from Mildred Browning Green at a total rental of \$3,528,000.

Joe Toplitzky and associates will build a height-limit bank and office building on the northeast corner of Seventh and Spring at a cost of \$1,750,000.

The National City Bank of Los Angeles will build a twelve-story home on the

## WANTED DRAFTSMAN

Accurate in figures to make working drawings for marble work and to make lists for shop work.

AMERICAN MARBLE AND MOSAIC CO.

25 Columbia Square

San Francisco, Calif.

PHONE FRANKLIN 2492

A. C. WOCKER

INTERIOR DECORATOR

1370 SUTTER STREET

SAN FRANCISCO, CALIF.

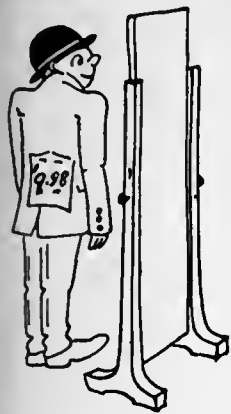

## "Penny Wise—Pound Foolish"

THE roof of a building stands the brunt of nature's onslaught and a few dollars saved by using unknown and unreliable roofings are soon spent in repairs and replacements due to roof leaks.



## TARGET AND ARROW Look for this Trade → Mark on every Sheet ROOFING TIN

may cost a little more in the beginning, but its ability to withstand the ravages of the weather soon proves its worth.

There are many records of Target and Arrow roofs which have given perfect protection, without any kind of repairs, for 50 years and more, and countless records of 30 years of service with the roof in shape to give many more years of wear.



## N. & G. TAYLOR CO.

Offices: Philadelphia, Pa.

Mills: Cumberland, Md.

Established 1810

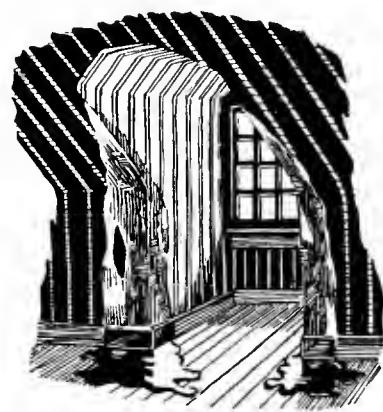

southwest corner of Eighth and Spring, to cost \$1,000,000, while another twelve-story building will be erected on the old armory site at the northwest corner of the same street intersection.

Construction already has begun on the thirteen-story Great Republic Life building on the northeast corner of Eighth and Spring, while operations have begun on a twelve-story building for William May Garland on the northeast corner of Ninth and Spring.

South Broadway also will have its share of big construction work. Among the assured projects is a thirteen-story Class A

building at 816-18 South Broadway at a cost of about \$1,500,000 for the Wurlitzer Music Company of Cincinnati. Construction operations will begin September 1.

On the west side of Broadway, between Ninth and Tenth, a nine-story building will be erected for the Western Costume Company at a cost of \$750,000. It will have a frontage of 100 feet.

Announcement has been made by E. M. Nutting, owner of the frontage on the northeast corner of Eleventh and Broadway, that he will soon begin the erection of a thirteen-story building.

At Twelfth and Broadway the basement has been excavated for the new home of the Los Angeles Chamber of Commerce. The building will be eight stories in height and will be a full block in length and half a block in width.

Excavating has just been started for the hall of justice and county jail to be erected at the northeast corner of Temple Street and North Broadway at a cost of \$3,500,000. This building will form a portion of the proposed civic center, favorably voted upon at the municipal election in May.

### Stillwell AN BOOKS

of  
CALIFORNIA STYLE All Climate HOMES  
New pictures, Floor Plans  
Estimated Costs of Build-  
over 200 Selected Designs.

"Coast Bungalows"  
Houses—6 and 7 Rooms—\$1.  
"The Bungalows"  
Houses—3-4-5 Rooms—\$1.



"Representative California Homes"  
50 Houses—7 to 10 Rooms—\$1.  
"The New Colonials"  
60 Houses—6 to 10 Rooms—\$1.

SPECIAL OFFER: Send \$2.50 for any three of these books and get Garage Folder FREE.

Books and Blueprints sold with Money Back Guarantee  
STILLWELL & CO., 790 California Building, Los Angeles

### Miniature Models of Cardboard

(Continued from Page 19)

construction work is begun, and the architect is assured of the client's approval of the finished work.

By the use of composite photography the relation of the building to the site it is to occupy can be determined.

Cardboard models have many advantages over the clay and plasticene models, cast into plaster paris. They are light in weight and easy to handle, but durable. Owing to difficulties of casting, clean sharp detail cannot be secured with a plaster model. It is also difficult to apply color to the plaster model. Working in cardboard takes much less time, there are no delays caused by casting, drying, etc. The interior of the building can also be constructed, as well as the exterior.

For the promotion and development of tracts of land, a model is of undisputed value. The base is made of papier mache, after the manner of a relief map, trees and shrubs of appropriate materials. Proposed improvements are constructed to scale, and this method of presentation has been found most practical and very valuable in encouraging sales.

### QUICK-SETTING LIME BLOCKS DEVELOPED BY BUREAU OF STANDARDS

A cast lime building tile for use in making partitions has been developed at the Bureau of Standards by the Fellow of the National Lime Association. The material of which it is made sets so that it can be removed from the mold at the end of ten minutes. After twenty minutes it can be handled, and after seven days it has a compressive strength of one hundred pounds per square inch. It can be sawed, and nails can be driven into it.

The material is composed of five parts by volume of ground quick lime, ten of hydrate or slaked lime, and one of wood fiber. It is found to cure best when outdoors exposed to the weather. The new tile is about twenty per cent heavier than gypsum tile of the same size, and experiments are being conducted to see if the core volume can be increased without too great a sacrifice of strength.

The quick setting lime of which the tile is made was developed several months ago by the Bureau of Standards, and can also be used for other purposes. Difficulty is found in shipping it, however.

### FINDS ALUMINUM PAINT MAKES RADIATORS LESS EFFICIENT

The aluminum or bronze paint generally applied to radiators greatly reduces their effectiveness and makes it necessary to have a larger surface for the same heating effect, according to experiments performed by Dr. W. W. Coblentz of the Bureau of Standards. Dr. Coblentz finds that the heat radiated from an aluminum painted radiator surface is less than a third of that emitted by a radiator of the same size painted with a non-metallic paint, enameled, or simply allowed to rust.

On the other hand he finds that aluminum paint is a very effective means of reducing the amount of heat transmitted through a thin material. Applied to the under side of a tent or awning it reduces by three-fourths the amount of heat from the sun which gets through the cloth, while if used on the cover of an automobile or ice wagon it cuts in half the heat let through and makes the temperature inside the vehicle more nearly that found in natural shade, thereby making it much more comfortable.

### UNITED STATES CIVIL SERVICE EXAMINATION

The United States Civil Service Commission announces the following open competitive examination:

#### ARCHITECTURAL DRAFTSMAN

The examination will be held throughout the country on September 5 and 6. It is to fill vacancies in the Departmental Service and in the field, at entrance salaries ranging from \$1500 to \$2000 a year, plus the increase of \$20 a month allowed by Congress.

Applicants must have graduated in architecture from a technical school of recognized standing, or have had at least five years' experience in progressive architectural office drafting work. If the applicant is not a graduate, but has had special training in architecture in a technical school of recognized standing, such training, according to its value, will be considered equivalent, year for year, to not more than two years of these five.

Full information and application blanks may be obtained from the United States Civil Service Commission, Washington, D. C., or the secretary of the board of U. S. civil service examiners at the postoffice or custom house in any city.

SAN FRANCISCO  
PUBLIC LIBRARY

# *THE BUILDING REVIEW*

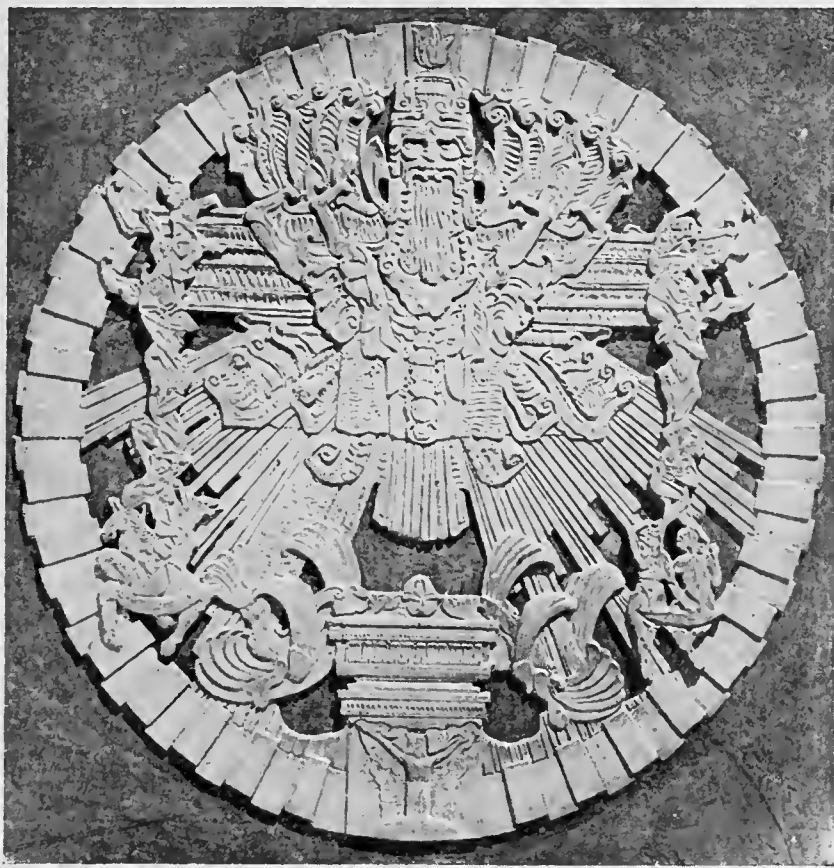

*SEPTEMBER, 1923*

*Vol. XXIV No. 3*

*Published in San Francisco*

*Price Twenty-five Cents*



BINDER & CURTIS, Architects,  
SAN JOSE, CALIFORNIA.

SANTA CLARA COUNTY HOSPITAL,  
SANTA CLARA, CALIFORNIA.

R. ZELENSKY, Decorator  
SAN FRANCISCO, CALIF.

Finished  
Throughout  
With

**Kyanize**  
KY-AN-IZE

White  
Enamel

Office and Warehouse  
1151 MISSION STREET  
SAN FRANCISCO, CALIFORNIA  
A. L. GREENE, Local Manager

**Boston Varnish Company**  
KY AN IZE

Distributors for Southern California  
SUNSET PAINT COMPANY  
627 SOUTH MAIN STREET  
LOS ANGELES, CALIFORNIA



# THE BUILDING REVIEW

Vol. XXIV

SEPTEMBER, 1923

No. 3

## CONTENTS

COVER DESIGN — MODEL OF "MR. GOD," PANEL, GRAUMAN'S METROPOLITAN THEATRE, LOS ANGELES, CALIFORNIA. MR. LEE WOOLLETT, Architect.

### PLATE SECTION

ILLUSTRATING THE WORK OF MR. LEE WOOLLETT, ARCHITECT, LOS ANGELES, CALIFORNIA.

Plates

GRAUMAN'S METROPOLITAN THEATRE, Los Angeles, California. Photographs by Albert J. Kopec...29 to 40

### TEXT

Page

PIONEERS, by Harris Allen .....	25
THE METROPOLITAN THEATRE, a Digest from the Local Press .....	27
A FARM IN THE FOOTHILLS, by Clara Fassett.....	29
INVITING DOORWAYS, by Mary Robinson Thomas.....	34
PAIN COMPANY OPENS SAN FRANCISCO OFFICE..	XVIII
THE RELATION OF RADIUM TO ARCHITECTURE, by William H. Day .....	XIV

### DEPARTMENTS

EDITORIAL PAGE .....	30
----------------------	----

HARRIS ALLEN, A. I. A., Editor

HOWARD HOYT  
Industrial Editor  
And Business Manager.

NED BRYDONE-JACK  
Advertising Manager

Published Monthly by the Building Review Company,  
Chronicle Building, San Francisco, California

Address All Communications to No. 426 Chronicle Building, San Francisco, California

Yearly subscription—United States, \$2.50—foreign, \$3.00. Single copies, 25 cents.

Entered as second-class matter in the San Francisco Postoffice under the Act of August 24, 1912. Previously entered as "The Architect."

The editors will be pleased to consider contributions of interest to the Industry. When payment of same is desired, this fact should be stated.

News stands and dealers supplied through San Francisco News Co., San Francisco, Calif., or American News Co., New York, N. Y.

## BATCHELDER TILES



GARDEN POT No. 215

BATCHELDER-WILSON CO.

2633 Artesian Street

Los Angeles, Calif.



# BUILDERS

KNOW THE VALUE OF

## SOULE STEEL SERVICE

In addition to carrying all kinds of

### WIRE NAILS

We carry a complete stock of  
Deformed Reinforcing Steel Bars  
Electrically Welded Wire Fabric  
Black and Galvanized Pipe  
Black and Galvanized Wire  
Galvanized Sheets



EDW. L. SOULE CO.

RIALTO BUILDING  
SAN FRANCISCO



## IN SPECIFYING VARNISHES

*Be Guided By Your  
Experience and the  
Maker's Reputation*

No chemical analysis or formula can solve the varnish maker's secrets. Oils and gums become so inextricably mixed when cooked together that their character is changed and they cannot be isolated by chemical analysis.

Generally speaking, the toughness, durability and water-and-weather-resistant qualities in a varnish are in direct proportion to the percentage of oil contained; also, the more oil, the slower the varnish will dry. In the Fuller process of varnish making, however, perfected methods of oil treatment make it possible to manufacture varnishes containing a maximum amount of oil which will still dry within fifteen to twenty hours.

Back of all Fuller varnishes is the Company's reputation founded upon seventy-four years of successful paint and varnish making experience. You may specify them with full confidence.

### "FULLERWEAR"

The Spar Varnish for Every Purpose. Resistant to hot and cold, fresh and salt water.

### "15 for FLOORS"

Tough, durable and water resistant; will not mar or scratch white. Dries over night.

### "40 for FINISHING"

For finest interior work. Unusual in brilliancy and depth as well as durability.

### "50 for FLATTING"

Produces a dull, rubbed effect on floors and interior woodwork. Saves expense of rubbing.

Sample pieces of wood showing the effects of varnishing with any of the above will gladly be furnished to architects on request.

# FULLER

PAINTS  VARNISHES

W. P. FULLER & CO.

San Francisco  
Oakland  
Sacramento  
Stockton  
Los Angeles  
Hollywood  
Pasadena

Long Beach  
San Diego  
Santa Monica  
San Bernardino  
Santa Ana  
Fresno  
Portland

Boise  
Walla Walla  
Salt Lake City  
Seattle  
Tacoma  
Spokane  
Yakima

# The BUILDING REVIEW

VOL. XXIV

SAN FRANCISCO, SEPTEMBER, 1923.

No. 3



PAUVE VELVET HANGING,  
GRAUMAN'S METROPOLITAN THEATRE.

## PIONEERS

By HARRIS ALLEN, A. I. A.

WHEN all histories and critical analysis of architecture are "boiled down," it is found that each new style has resulted from some violation of the existing architectural canons.

In this as in other professions, there has been, and there should be, reverence for time-honored customs and conditions, for forms and proportions that experience has found to be pleasing and right. And it is well that departure from precedent should be viewed with suspicion, considered with care, accepted slowly. For strange though it be, the further we advance in general civilization, the smaller appears to be the propor-

tion of us born with a natural discrimination aesthetically. In the present age of marvelous mechanical development, we need, as never before, education in the fine arts; knowledge of the Laws of Beauty (and there are laws of beauty just as surely as there are laws of Nature) enough to appreciate the beautiful. For education, definite standards, precedents, guide-posts, are necessary. If we could change these easily and frequently, a confusing and chaotic condition would result for the student and the layman.

But there has been recurrent revolt against precedent and custom. Many—most—of such movements are ineffective,

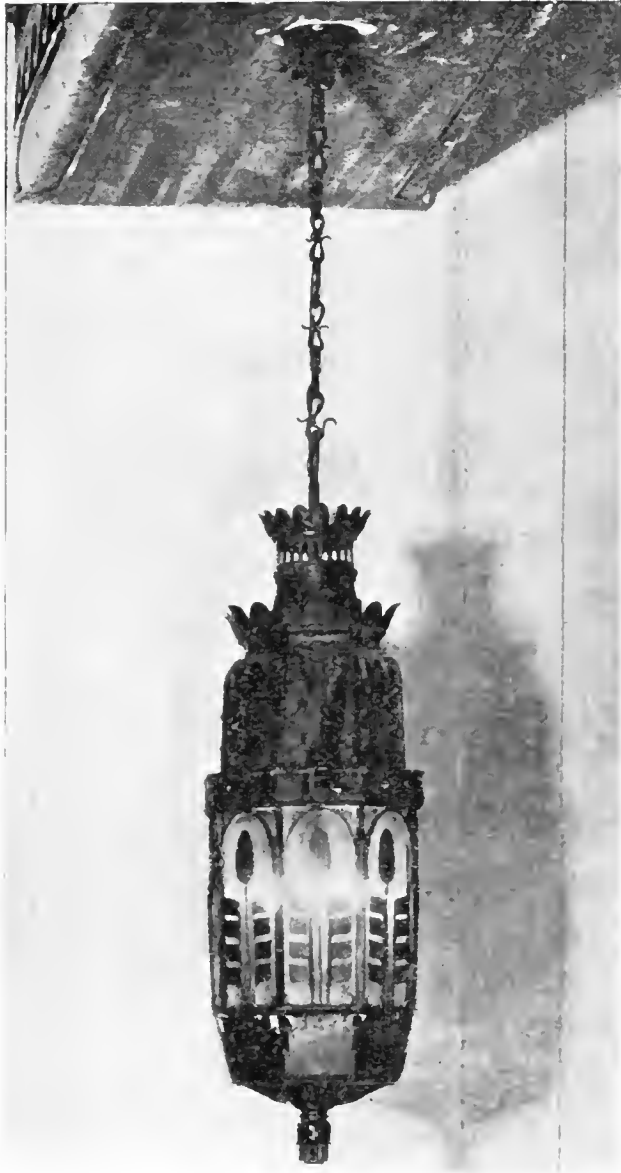

LANTERN IN MAIN LOBBY.

and, in fact, foolish; they are the futile efforts of inferiority. But the occasional Master does what had always been considered wrong, and a new style is born; new riches are added to the world's treasury of beauty.

It behooves us, therefore, while we exercise all caution to avoid the Scylla of blind enthusiasm over every freakish novelty, to shun equally the Charybdis of stubborn blindness to any possible enrichment of art. Who are we, to assert that architecture no longer lives and grows? That all true forms of beauty have already been discovered, all possible combinations of form already used?

To the inspection of such a building as the Metropolitan Theater, one must bring an open mind. To prejudice, that is to say, to the admirer of scholastic consistency, the treatment here will be shocking. All sorts of traditions are violated; many styles and forms are used and combined; new methods of decorations have been created, or at least used as never before.

Symbolism has been carried to an extreme. Few, if any, can grasp the meaning and application of all these motifs, but

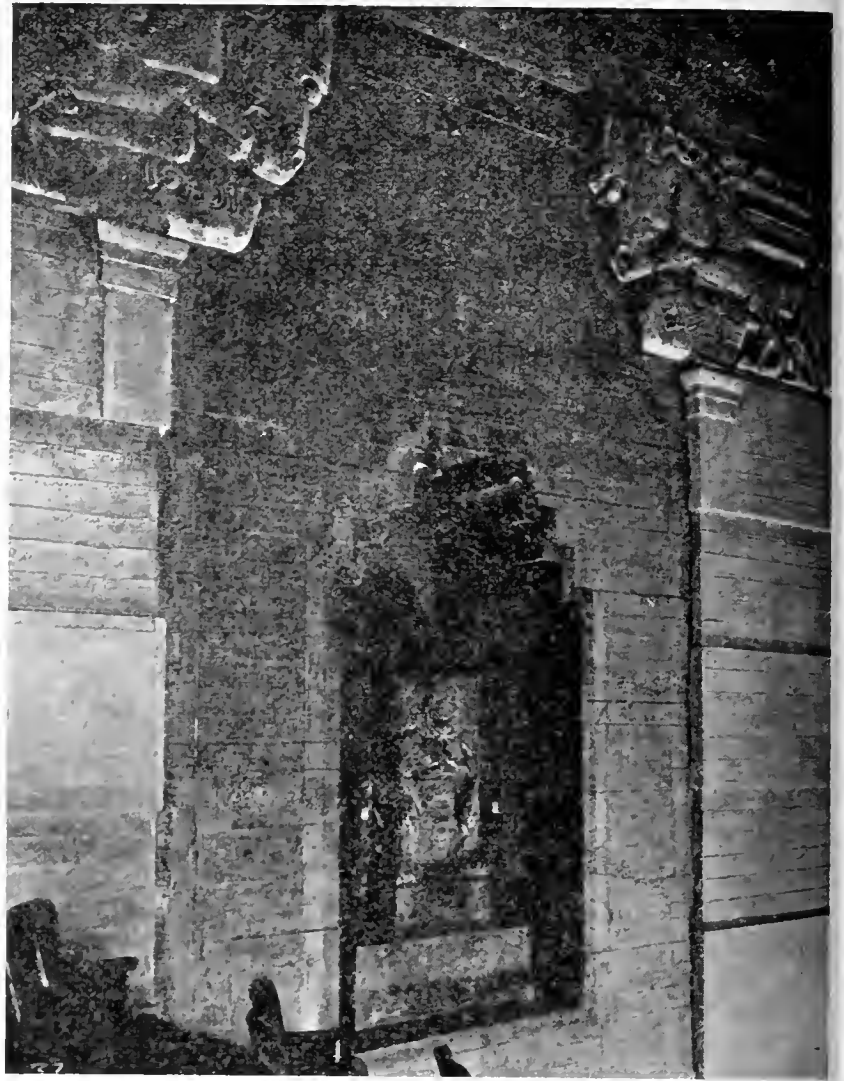

SIDE WALL OVER BALCONY.

the fact that they are symbolic, is plain, and is bound to awaken interest and attention.

The result of all this strangeness of design and shape and color, admitted by all unless it be the most conservative classicists, is—Beauty. There is a richness and sumptuousness that amounts to splendor; and withal, an effect of dignity, almost of simplicity. This is due partly to the bigness of scale, in which, certainly, consistency has been shown.

Of the details, dimensions, devices, I have nothing to say. They are shown or described elsewhere, sufficiently. But I wish to emphasize again the real beauty and dignity of the ensemble, for color and scale have much to do with the effect, and these, unfortunately, can not be conveyed by illustration, and can be but suggested by description.

One does not care to venture prophecy in these wild and hurried times. But it is safe to say that this theater is by way of being a torch light, making clearer some paths into a country little known and almost uncharted. As a company of brilliant actors, not all portraying characters to the audiences' liking, combine to produce an



OWL GRILLE OVER CEILING BEAMS.

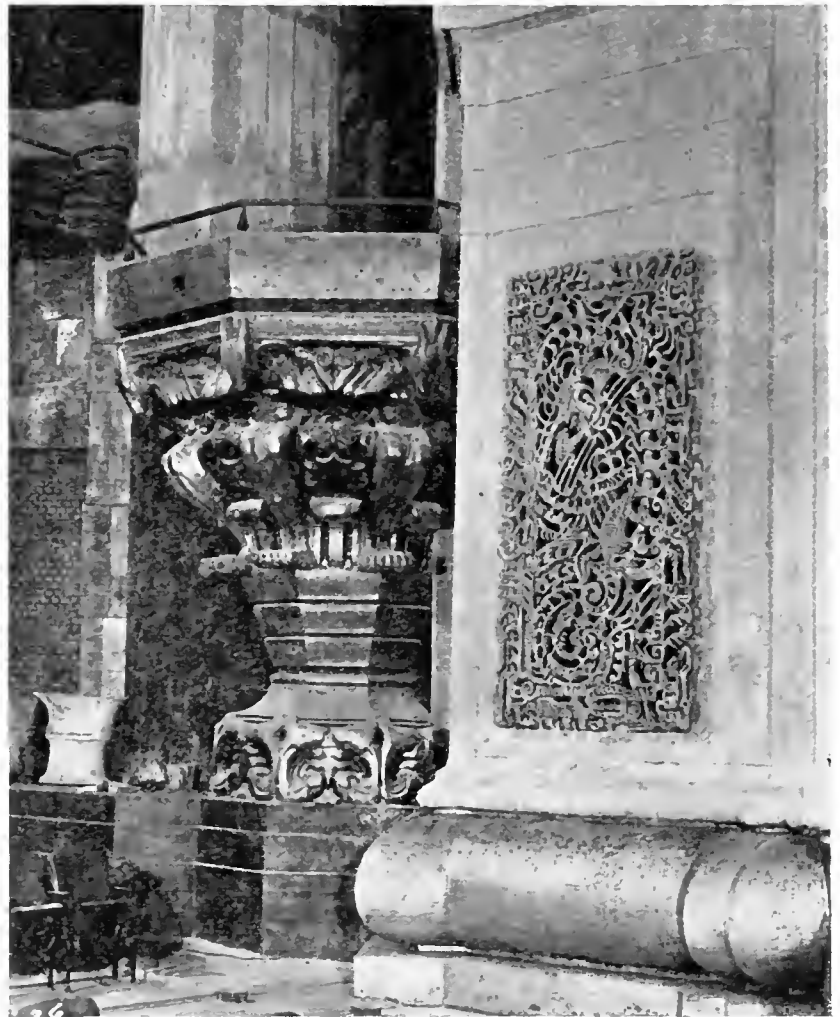

GRILLE IN PROSCENIUM ARCH.

interesting play, so here we have a company of able artists united to create an ensemble which must be recognized as an artistic success. And aside from their pay, disregarding all costliness of material and

method, one feels that with these artists their work has been largely a labor of love. This is not iconoclasm so much as it is the idea of a shrine to an unknown God. Pioneers, We salute thee!

## The Metropolitan Theater

A Digest From the Local Press

**S**PEND an hour in Sid Grauman's chromatic Metropolitan Theater and even in the glare of a gorgeous sunset the world will seem as drab as a patch of unlit winter clouds when you emerge from the spell of this unique playhouse—the center of the center of the motion picture universe. Jules Guerin, master colorist who tinted the Panama Pacific Exposition and color it after the manner of his own vivid Oriental prints, would himself yield his expert praises to the bendizened splendor of the palace. A million watts carry to the stage alone its tinctures of light; how many other millions of units of electrical energy provide the theater proper with its cascades, billows, splashes, inundations, undercurrents and tidal waves of

color, not even the chief electrician of the place can tell you offhand!

Infinite are the combinations of tone that spray the house; infinite are the contrasts of hue and shade that appeal from the proscenium arch of gray granite color, to the foyer that fairly drips color from walls, domes, ceilings and grotesque allegorical ornament.

It is impossible to describe the majestic volume of glowing pigments that enwrap the beholder in prismatic inundations.

Yet it were easier to body forth in words the effects of color than the effects or form. Architecturally, the Metropolitan eludes classification, defies analysis and repudiates every rule that architectural arts has developed from the days of Vitruvius to

Ruskin. A Grecian column whose hybrid capital supports no entablature but a grotesque griffin—a monster of decorative fascination. Thus the model is as much the Temple of Karnak as it is the Parthenon; the origins of the structure are just as likely to be found in the Temple of Nebuchadnezzar as in St. Paul's. If the Egyptians were the precursors of Greek architecture, it is a sign, says Mr. Grauman, that we can borrow where we want to. If Phidias went to the Orient, so may we.

If art is at once democracy and the aristocracy we can go to all people and, exercising our selective rights, we may honorably take what we will. And assuredly he did!

Yet, singular as it may sound, there is a sense of humor set up in this babel of tones and this cosmopolitan architecture. It is all held together in the immense spaces of the huge building uniting, I know not how, in the establishment of a sort of intimacy which brings the occupant of the farthest seat at the back of the area of balcony into relations neighborly with the patron in loge or downstairs orchestra seat—Anthony in "The Examiner."

\* \* \*

Gautier, the artist in color and in words, articulated an interesting principle, a variation of which is exhibited in Sid Grauman's stupendously successful experimentation in color and form. I cannot quote exactly, but this is the sense of it:

Beauty is harmony; harmony is an agreeable relation of parts to the whole: it is possible to achieve, in vast spaces, a sense of harmony though the parts composing the whole taken separately may seem mutually repellent. There is a type of woman, says Gautier, none of whose features is perfect but whose countenance in its totality of beauty is radiant with spiritual loveliness that transcends mere cold, classic symmetry. The truth of this lies deeper than the surface; just as the beauty of the woman is deeper than contour and more symmetrical than mere curves. The brain that conceived the interior of Grauman's utterly unique picture temple has caught just that beauty which defies analysis and escapes the prying fingers that play upon typewriter keys.

Musically expressed, there is the serenity of Beethoven's "Moonlight Sonata" in Sid Grauman's masterpiece of theater-building: there is the trumpet red of Wagner's

"Tannhauser," and the Sahara sun-lit yellow of David's "The Desert," the Bysantium mosaic of Mussorgski, the placid charm of Handel, the eternal sunshine of Mozart and—there's jazz in dizzy decorative lines that refuse to be catalogued or ignored!

It is without significance to say that there are 4400 seats in the house; that piece of statistics, important as it is in fact, leaves the informed one cold and unmoved. The non-slippable sidewalk, the stage accessories, the accommodations for guests, the innovation in box-office service, the ventilating equipment, the acoustics, the gorgeous, thousand-throated organ and all the rest of the theater's properties in their itemizing must be pale in the telling of them—like a catalogue. It is the co-ordination of all these, the bringing them together into a harmony of perfection and unity of appeal, it is the cementing of all these, so to speak, in their infinity of appeal through an all-embracing color that makes Sid Grauman's theater the world's unique show-house wherein the silences of pictures are destined to be made eloquent in the tones of a modern, splashing, gorgeous color symphony. —Walter Anthony in Los Angeles "Examiner."

\* \* \*

"The theater is an epitome of the time in which we live. The subtle meaning of its decorations serve to emphasize the truths uppermost in our minds today.

"The race movements of people of our own blood, forever moving eastward around the globe, are symbolized by the three service hats with an eagle coming out of the central one. The presence of the Red Cross heralds the advent of the impulse to universal service to which the best elements of the race now are dedicated."

The conventionalized flowers, buds and leaves used so profusely in many different phases in the architectural details, mural paintings and hangings symbolize the poppy fields of Flanders, the spirit of heroic self sacrifice.

The "Greek Dog" stands for the sea, the bluebird for happiness. The mural over the proscenium arch declares the right and power of individual thought. The Genii of the picture sits unmoved with all the untoward forces of the universe about him, touching the earth in token of loyalty to the genius of his own nature and the sword at

(Continued on Page 36)

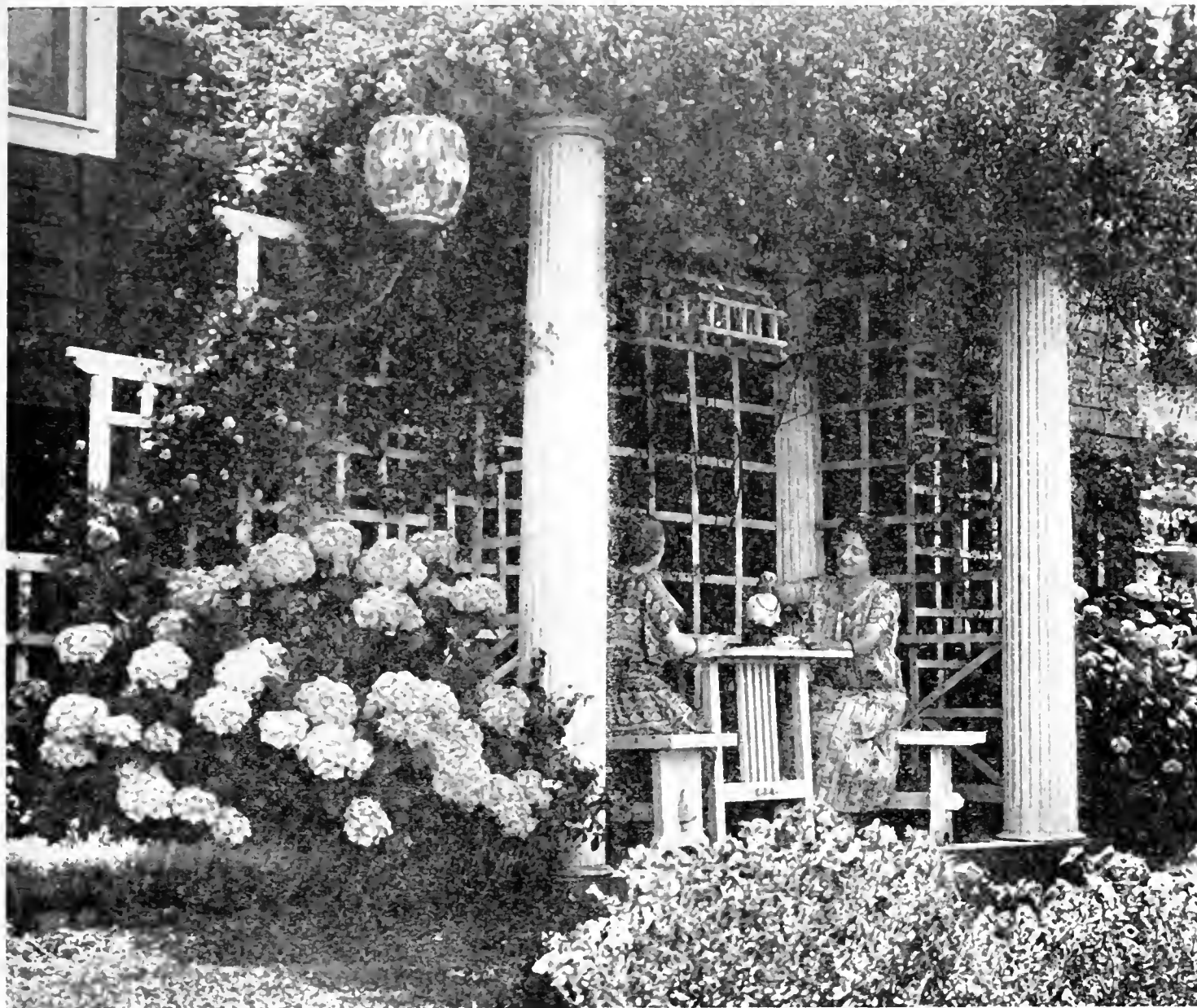

## A Farm in the Foothills

By CLARA FASSETT.

HOW to have a "country place" and enjoy the delights of a home with a garden and perhaps an orchard while one is young and has not yet accumulated enough of the necessary coin, is a dream which seems as far off as the end of the rainbow to most folks. But dreams have been converted into practical realities by those who combine a great desire with enough of hard work and just as important, systematic planning of their time.

Two young people who have lived long enough to know the wisdom of "doing it now" and who are courageous enough to look forward to a few economical years, who systematically conserve their spare time with this end in view, and find the very time thus used recreation, are finding it possible to enjoy home life amid the most pleasant and congenial surroundings. At the same time they are earning at their respective professions, in a city several

miles away, the necessary funds for its upkeep.

And this is but one instance which proves that at the present day one does not retire to a life of rest and seclusion: what we are aiming for mostly is to mix play and pleasure with work as we go along. The time to enjoy life is at that point when enthusiasm is at its highest, when one is doing his work with vim and vigor, and has a little energy to spare for the business of just living.

The dream which came true is a little three-room cottage tucked in between some hills, in a sheltered sunny valley, with an elevation which gives a view of lower hills and bay; and the story of this adventure in farming on one quarter of an acre of land, begins at the beginning of a life partnership, which of course is another story. Having had plenty of apartment-and-board-

(Continued on Page xvi)

# EDITORIAL

**G** RAUMAN'S Metropolitan Theater in Los Angeles, to which much space is devoted in this issue of the Building Review, has already received large publicity. We feel justified in its presentation, even though many of our reader's have no doubt seen previous illustrations, because it is too important, too significant, to be omitted from a publication which endeavors to show the general development of architecture on the Western Coast. Not such a storm center of discussion as the Imperial Hotel in Japan, still it is the object of violent criticism and of equally enthusiastic praise.

The free and daring use of architectural and decorative motifs can not but excite interest, and the structural treatment is also extremely interesting. We regret that

the architect responsible for construction has not been able to write an article descriptive of his work, which might have been included in this review.

Elsewhere in this issue is printed the program of a competition through which the Building Review hopes to secure a fitting cover design. With the first number of the next volume, January, 1924, we return to the original name under which this magazine was first published—"Pacific Coast Architect." We believe this name better expresses the aim and scope of the magazine; a review of recent buildings, to represent, as adequately as may be done, the development of good architecture on the Pacific Coast.

---

## THE FIFTY-SEVEN LAMPS OF ARCHITECTURE

When I had decided to build me a house  
 I felt just a little afraid  
 That plan and design were not quite in my line,  
 So I sought architectural aid.  
 And I said: "Show me, pray, something most  
 recherché,  
 For I'm weary of hanging my hat  
 In an Early Victorian,  
 Pre-Montessorian,  
 Plain two-by-fourian flat."

The architect puffed at his period pipe  
 As he sat in his Renaissance chair,  
 And he gave me a smile in the pure Gothic style.  
 Though he spoke with a Romanesque air.  
 Said he: "If your taste is not wholly debased,  
 The best you are certain to find,  
 Is the later colonial,  
 Pseudo baronial,  
 G. Washingtonian kind."

I thanked him politely and paid him his fee,  
 But sundry acquaintances cried,  
 "That stuff you should shun, for it hasn't been  
 done  
 Since Benjamin Harrison died!"  
 And they took me direct to a new architect,  
 Who argued with logic compelling  
 For a quasi Delsartean,  
 Post-Bonapartean,  
 Wholly Beaux-Artian dwelling.

My downfall had started; I grouped in a maze  
 Of traces, transitions and trends,  
 And I labored anew over prints that were blue,  
 With the aid of my numerous friends.  
 But I don't knit my brow about building plans  
 now,  
 For all of my money is spent—  
 And my home's an Arcadian,  
 Second-Crusadean,  
 Pink-lemonadean tent!

—STODDARD KING.







PROSCENIUM ARCH,  
GRAUMAN'S METROPOLITAN THEATRE,  
LOS ANGELES, CALIFORNIA.  
BY LEE WOOLLETT, Architect.

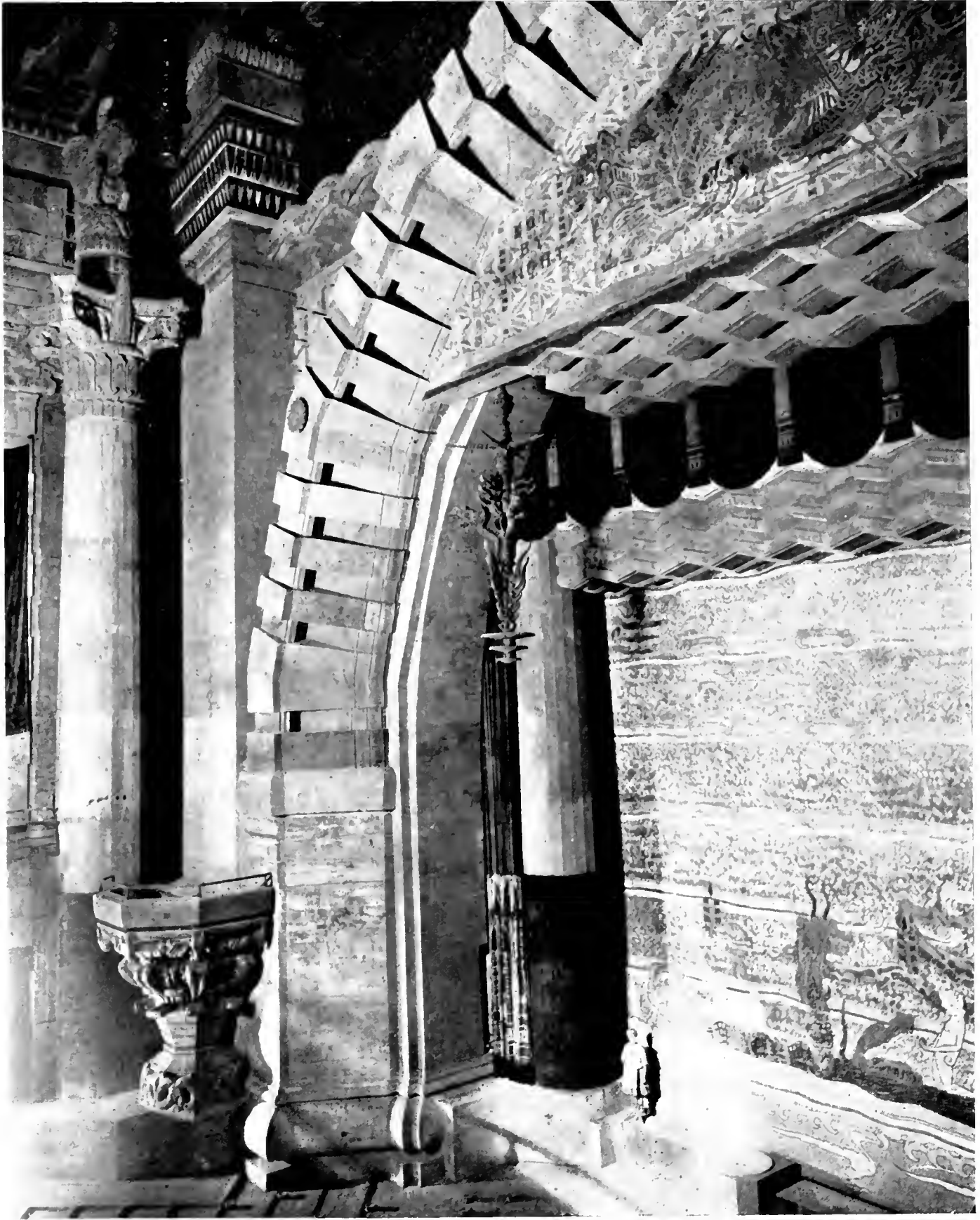

PROSCENIUM ARCH,  
GRAUMAN'S METROPOLITAN THEATRE,  
LOS ANGELES, CALIFORNIA.  
WM. LEE WOOLLETT, Architect.



SIDE WALL OVER BALCONY,  
SHUMAN'S METROPOLITAN THEATRE,  
LOS ANGELES, CALIFORNIA.  
W. LEE WOOLLETT, Architect.



PENDANT, CEILING,  
GRAUMAN'S METROPOLITAN THEATRE,  
LOS ANGELES, CALIFORNIA.  
WM. LEE WOOLLETT, Architect.

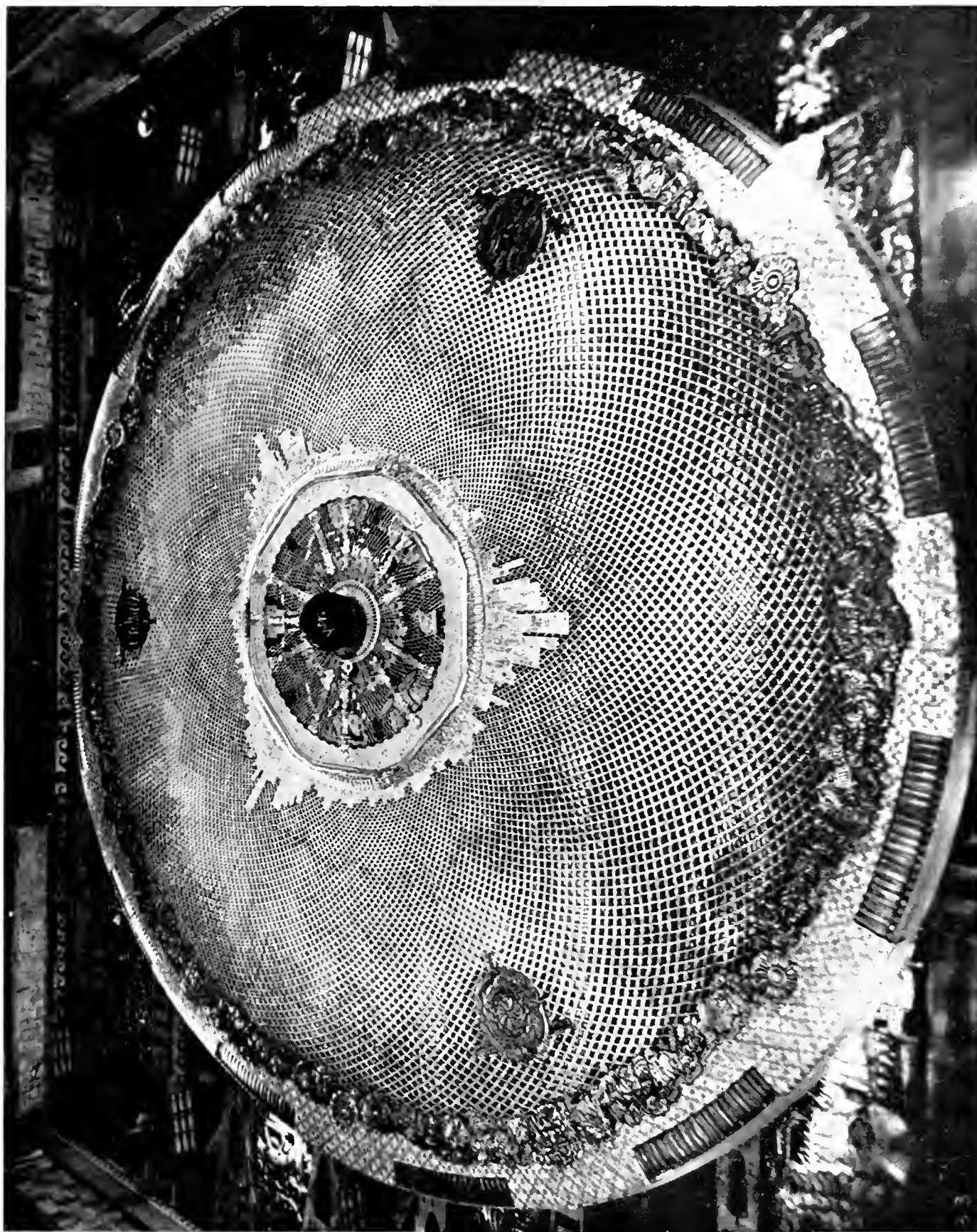

Y AND EXPOSED TRUSS WORK,  
EUMAN'S METROPOLITAN THEATRE,  
ANGELES, CALIFORNIA.  
LEE WOOLLETT, Architect.



VIEW IN MEZZANINE FLOOR,  
GRAUMAN'S METROPOLITAN THEATRE,  
LOS ANGELES, CALIFORNIA.  
WM. LEE WOOLLETT, Architect.



D H STREET LOBBY,  
ROMAN'S METROPOLITAN THEATRE,  
LOS ANGELES, CALIFORNIA.  
BY LEE WOOLLETT, Architect.



MAIN LOBBY,  
GRAUMAN'S METROPOLITAN THEATRE,  
LOS ANGELES, CALIFORNIA.  
WM. LEE WOOLLETT, Architect.





PASSAGE TO AUDITORIUM, MAIN LOBBY,  
WALKER'S METROPOLITAN THEATRE,  
LOS ANGELES, CALIFORNIA.  
FRANK LLOYD WOODS, Architect.



MAIN FLOOR FOYER, SHOWING MURALS  
GRAUMAN'S METROPOLITAN THEATRE,  
LOS ANGELES, CALIFORNIA.  
WM. LEE WOOLLETT, Architect.

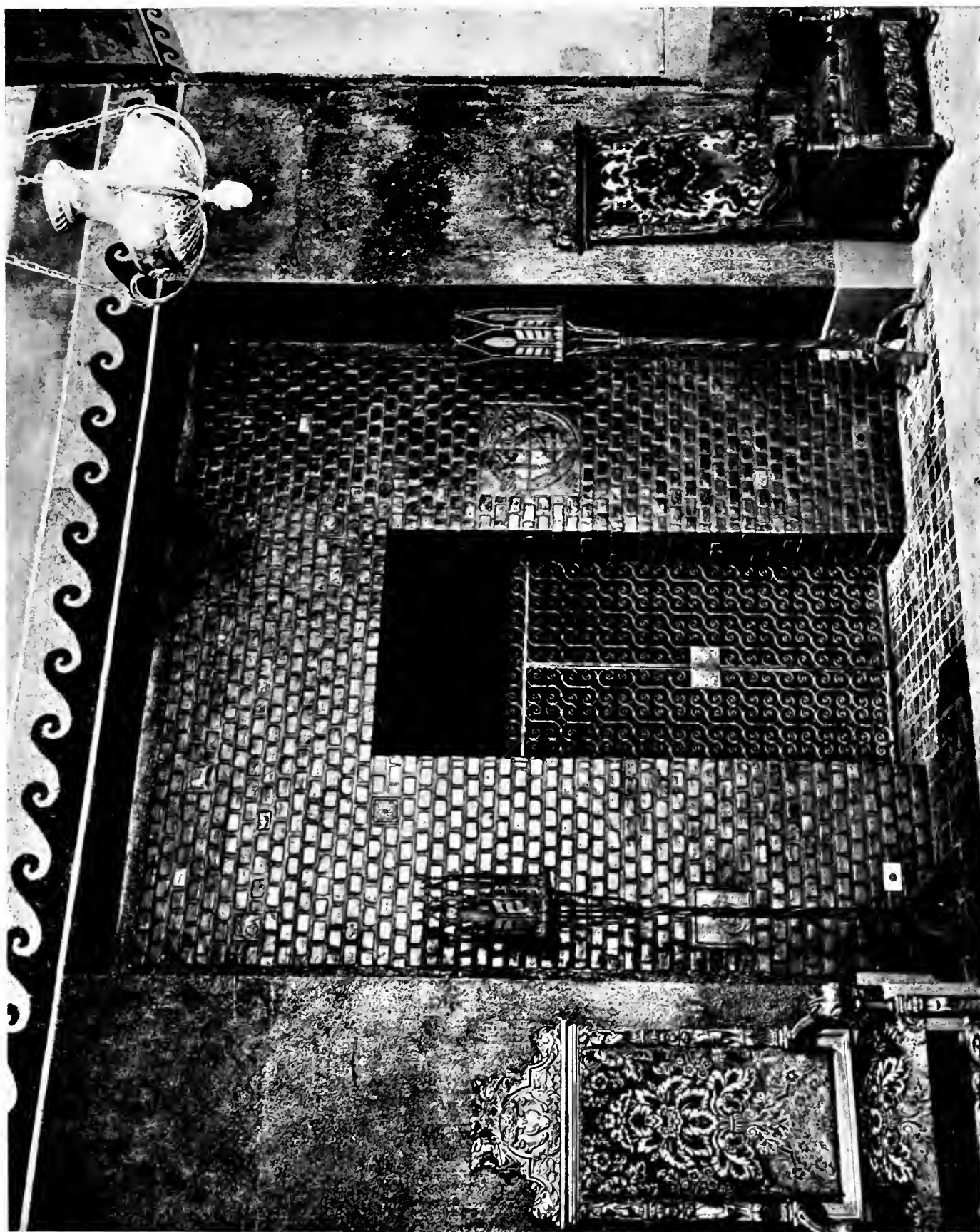

FRANCE TO MUSEUM, MAIN LOBBY,  
L'EMMAN'S METROPOLITAN THEATRE,  
ANGELES, CALIFORNIA.  
LEE WOOLLETT, Architect.

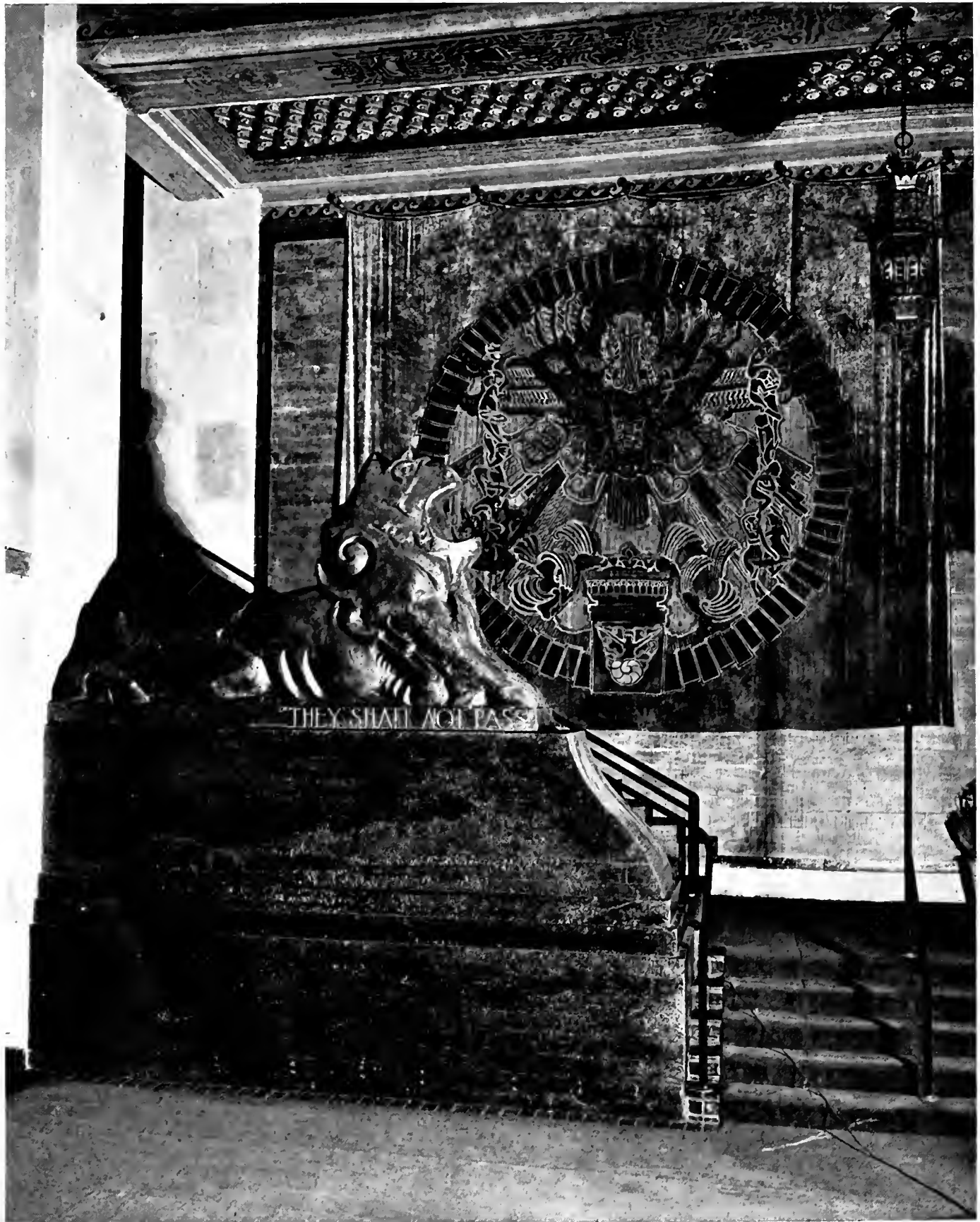

SCULPTURED FIGURE,  
GRAUMAN'S METROPOLITAN THEATRE,  
LOS ANGELES, CALIFORNIA.  
WM. LEE WOOLLETT, Architect.

THE BUILDING REVIEW

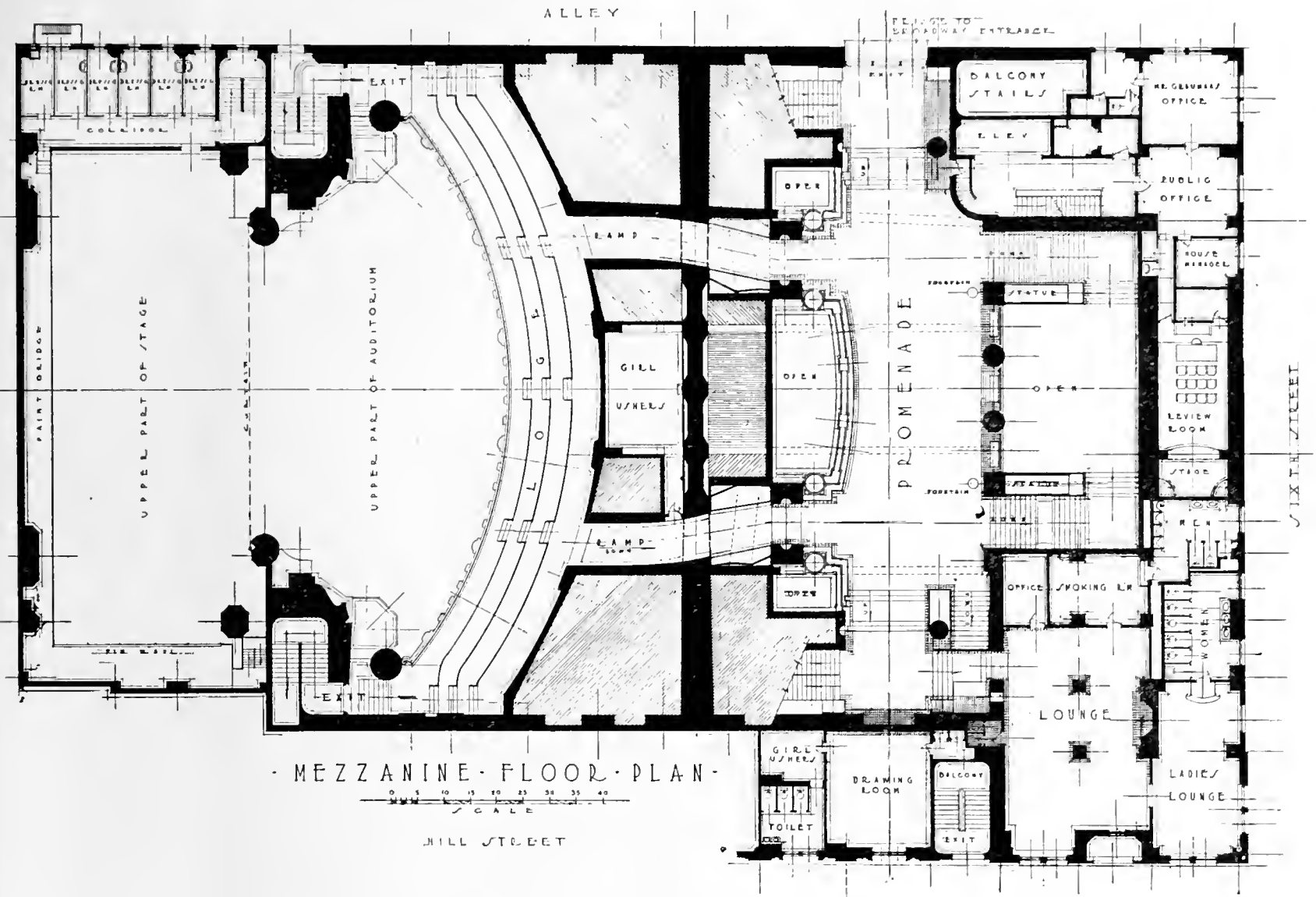

MEZZANINE FLOOR PLAN

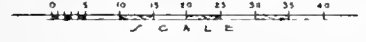

HILL STREET

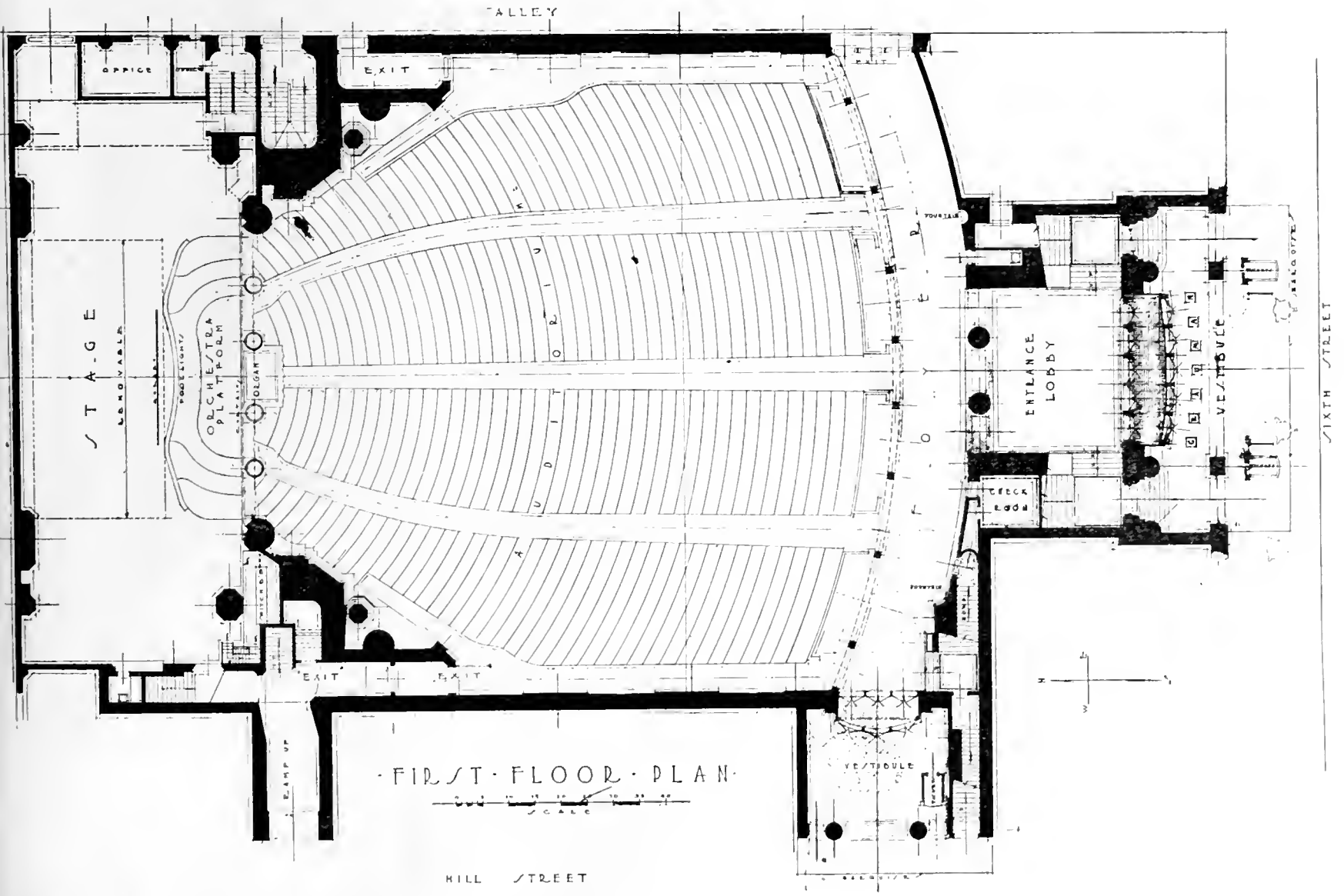

FIRST FLOOR PLAN



HILL STREET

BRAUMAN'S METROPOLITAN THEATRE,  
LOS ANGELES, CALIFORNIA.  
WM. LEE WOOLLETT, Architect.

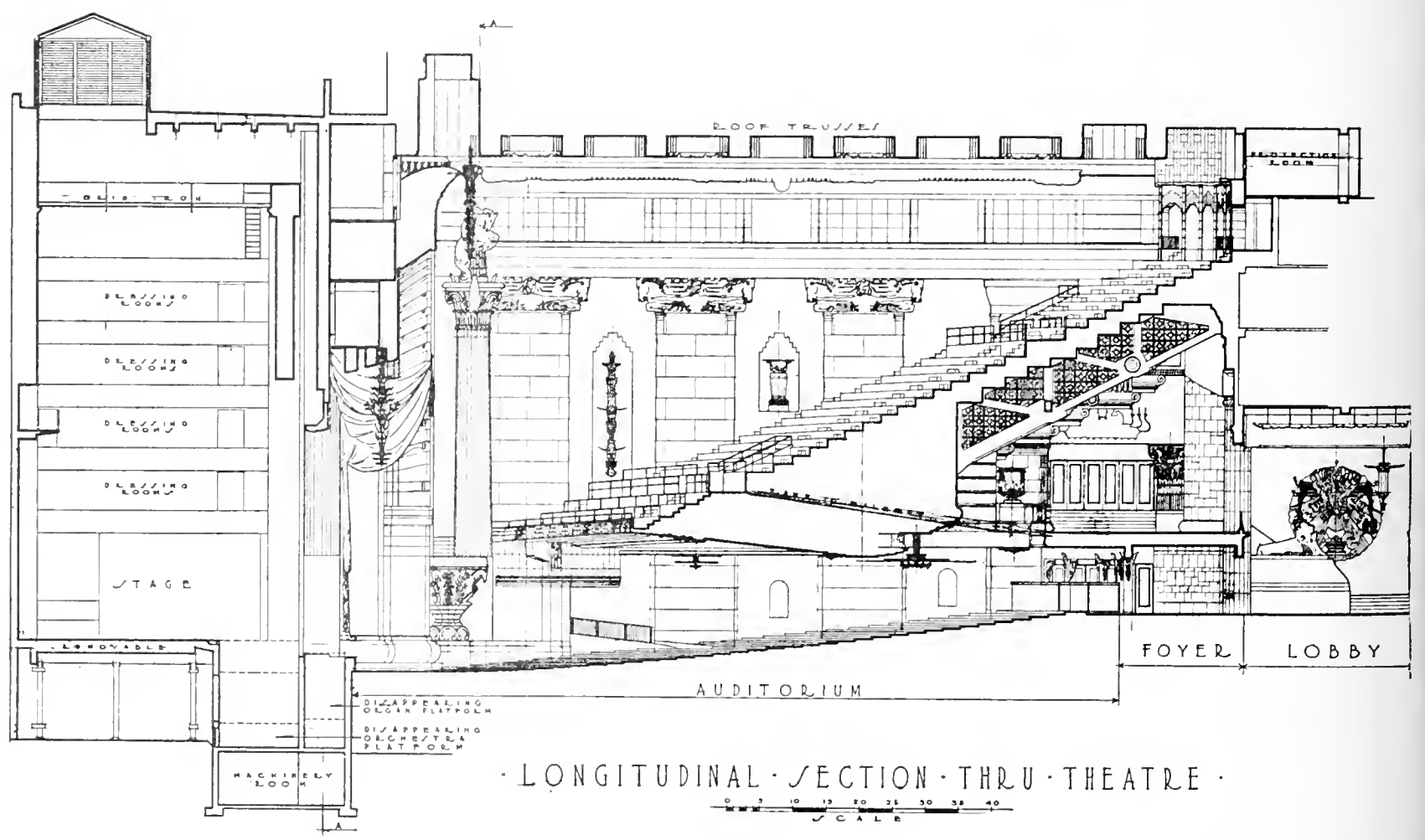
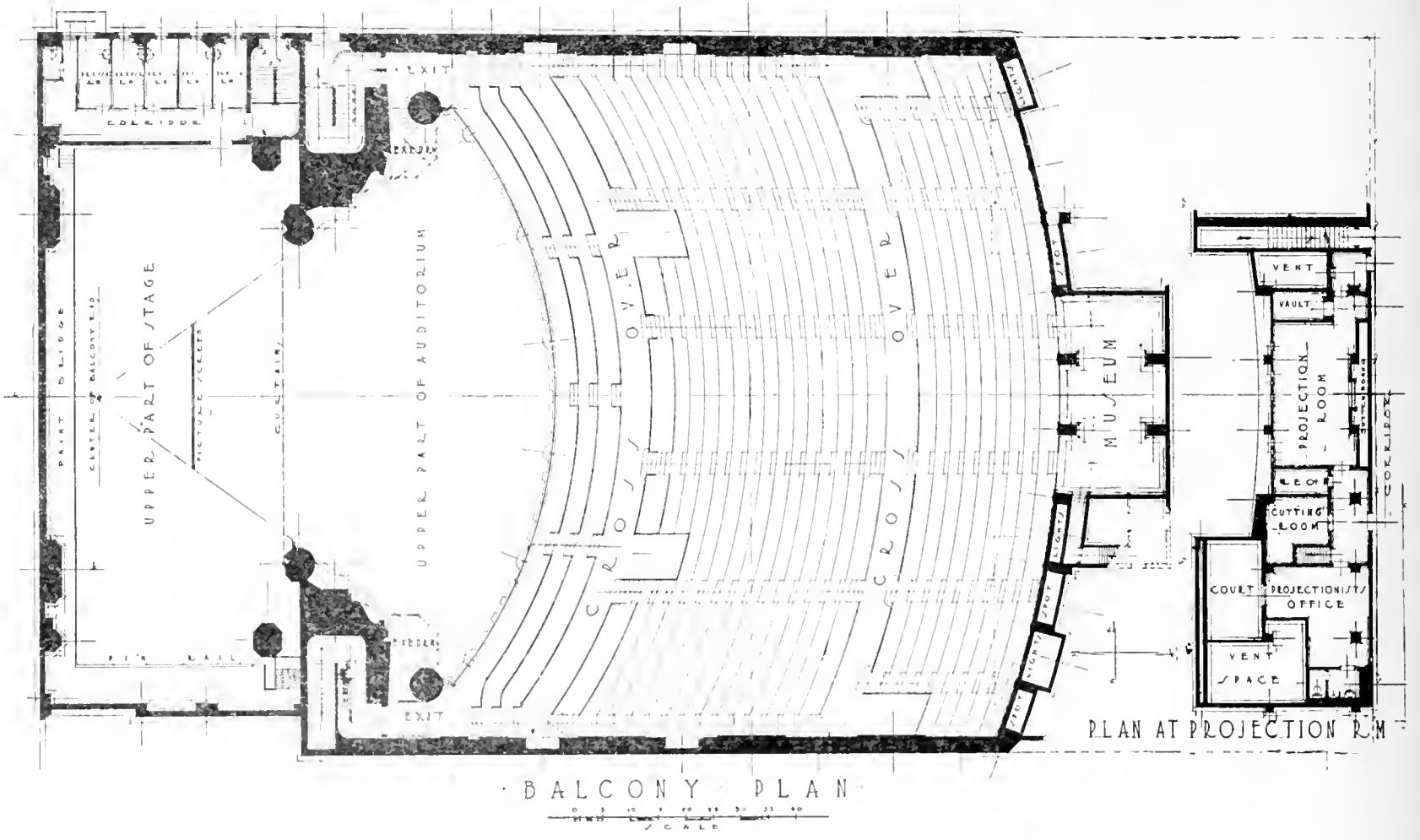

GRAUMAN'S METROPOLITAN THEATRE,  
LOS ANGELES, CALIFORNIA.  
W. J. WOOLLETT, Architect.

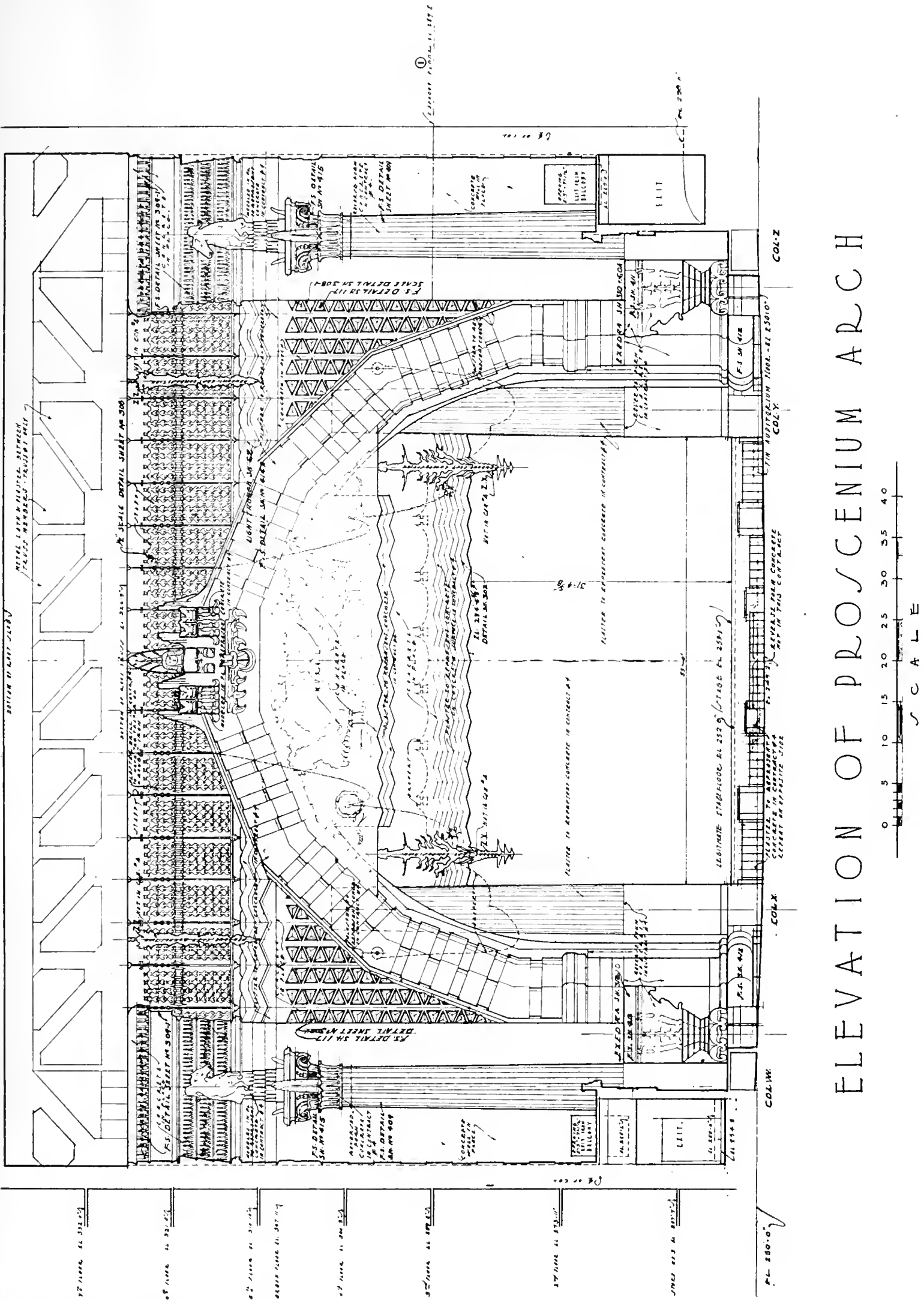

ELEVATION OF PROSCENIUM ARCH

GRAUMAN'S METROPOLITAN THEATRE.  
LOS ANGELES, CALIFORNIA.  
W. L. WOOLLETT, Architect.



**T**HE doorway has reason for being not only an entrance and exit but as an invitation; and for privacy and seclusion.

1. On a congested thoroughfare privacy and seclusion are rarely found; here the coveted aloofness is obtained by a side entrance, large trees, shrubs and vine-covered arches. The front entrance is reached by the winding path under the arch.

2. Such an approach makes one wish to loiter in the drapping shade. These steps lead to a living porch which is on a canyon's rim, and this in turn serves as a portico for the front door. Privacy and beauty are obtained without sacrificing the practical.

3. Even the roughest materials and the crudest design when complemented by Nature's attributes beckon and welcome.

4. This quaint doorway to the kitchen of a Dutch Colonial house is a gem and gems are rarely found at back doors.

5. A century-old oak dominates this picture as it does the structure of the house as it can be plainly seen that the house was built to fit the tree. Doesn't it add to the attractiveness of this back door?

6. These companion pictures show a charming doorway opening on to an equally charming terrace and the beauty of these is enhanced by the winding steps which lead both to the garden and street. The thatched roof, the gnarled oak and the

window are delightful features which arrest the attention.

7. The iron gate-way gives a finishing touch to this entrance. It adds dignity and gives a feeling of privacy. The stone steps are well done and the shrubs are well placed so that the ensemble is an addition to the landscape.







3



7



2



5



6



## The Metropolitan Theater

(Continued from Page 28)

rest as being unnecessary, since the power of right thought prevails.

The mural, "The Princess of the Flowery Kingdom," the chief decoration of the mezzanine, has to do with restoration. The Princess was thrown into the kettle of molten bronze, from which were to be poured the bells. The man with the magic whiskers (whose single horn and butterfly wings guard the head of the Princess) is the wizard. The friendship of the man with the magic whiskers and the golden pennies (which also guard the head of the Princess) are responsible, after many journeyings (also depicted in the mural) for the finding of the Princess.

In the main lobby the symbol of service is seen rising over the new earth. The great figure, whose wings seem to be aflame, seems to clasp the sign of the Red Cross.

In the small picture to the right, the devil is seen slinking in his hole, waiting for the thousand years of peace and good will on earth to pass.

On the left is a picture similar in size, which also compares with the central mural, in which are seen two figures: the rich and the poor at two alters—one meager in outline, the other affluent in architectural detail. The flame from the two alters join and form one flame.

The mural over the door to lounges on mezzanine: There is a legend of ancient India that the sand demon married the star and the Indian race is the issue of this union. In the picture the sand demon is seen riding the whirling sand and looking up to her lover in the sky. The rays from the star are seen in the picture.

The bas-relief on one of the large vases on the mezzanine is inspired by the story about a Prince who went in search of his future queen. He asked the Princess of each kingdom "What is a kiss?"

The Princess on the vase had a big book under her arm and answered his query in learned words from the book. The Prince kissed her on the forehead and passed on to search further for his queen.

On the other vase is shown a golden dragon and a carp from which all dragons grow. The eagle sitting in the clouds and the lion on the paw of a great dragon look out on a vision of the future. The two

great dragon's claws symbolize the all-pervading and eternal character of the east. Our particular division of the human race is typified by the eagle and a lion.—Los Angeles "Record."

\* \* \*

## THE CONSTRUCTION

From a structural standpoint, the new Metropolitan Theater Building is of unusual interest to contractors and builders throughout the country. Constructed entirely of concrete, the building possesses features which have been the subject of wide comment. The great balcony, which seats 2000 people, is supported by the longest concrete girder ever built, a girder ninety feet above the level of the foundations, and with a clear span of 127 feet.

Because of the fact that this was a new type of construction for buildings of this character, the balcony and the great supporting span was subjected to severe tests in the early stages of construction. Nearly 2,000,000 pounds of weight, or more than seven times the combined weight of all the people who will ever be seated in the balcony, were piled over the great span, in order to make certain of its safety.

Several novel features have also been incorporated in the design and construction of the stage, and through these unusual and interesting effects can be obtained. The entire front section of the stage, fourteen feet in depth, can be lowered out of sight by means of elevator machinery, operated by immense motors. This arrangement permits the lowering of the entire orchestra out of sight of the audience, and when the movable section is elevated, it increases the depth of the stage, making it one of the largest in the world. A similar plan has been followed for the organ console, which can be raised or lowered as desired.

Back of the stage there are forty dressing rooms for prologue and accompaniment performers, and underneath the stage are preview rooms, a large and well-equipped carpenter shop, electric-wiring systems, the ventilating system and the motors which control the elevators. The ventilating system, installed at a cost of \$115,000, requires fifty-one motors for its operation, and through this system circulation of cool air in summer and warm air in winter is provided.

Special consideration was given the pipe

# The World's best Made in the West

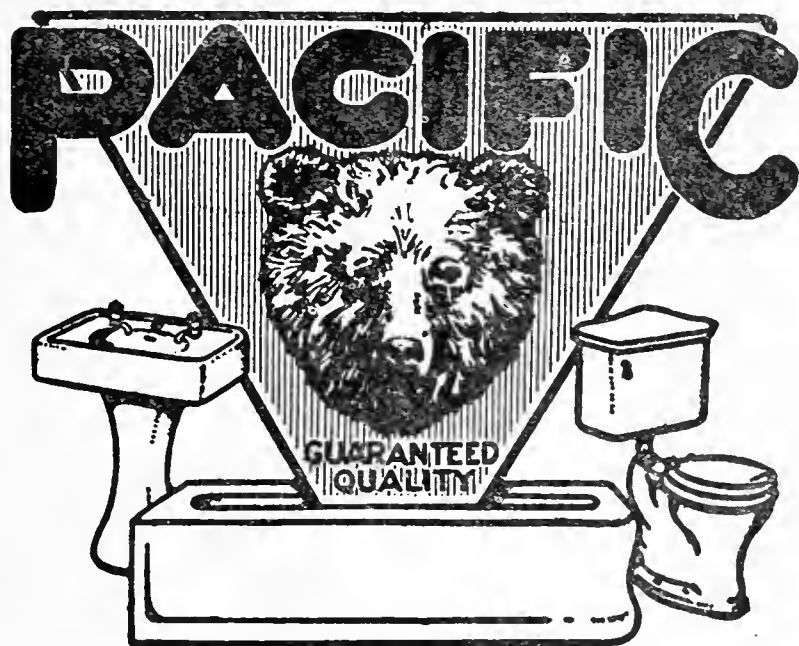

TRADE MARK REGISTERED

## **PACIFIC** PLUMBING FIXTURES

PACIFIC SANITARY MANUFACTURING CO.  
Main Office: 67 New Montgomery Street, San Francisco  
Factories: Richmond and San Pablo, California

W.R.C.

## A HOME, DESIGNED FOR CALIFORNIA'S VARIED CLIMATE, REQUIRES A HEATING SYSTEM

Which is always ready to supply heat quickly and Economically.

An Electrically Controlled-Gas Fired

# McLAUGHLIN FURNACE

responds instantly when the control button is pressed.

The temperature of the entire house may be raised to 70° Fahrenheit within a short time, and this temperature may be maintained by using one or two of the burners within the furnace.

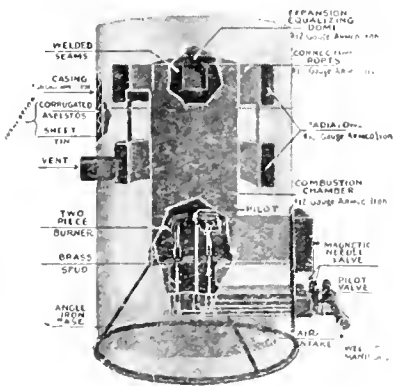

The combustion chamber and the double radiators are constructed of heavy Armco Iron. All seams are welded, preventing the escape of flue gases into the house.

Write for Information

**McLAUGHLIN METAL WORKS**  
223 J St., Sacramento, Cal.

organ, a specially built unit orchestra instrument, said to be the largest in the world and installed at a cost of \$80,000.

\* \* \*

### LIGHTING INNOVATIONS

The electric wiring system, installed by Holmes and Sanborn, electrical engineers under the supervision of William Lee Woollett, architect for the theater portion of the building, is of the most modern type, and the multi-colored light effects are controlled by a new style of switchboard, especially developed for the theater. This board, only thirteen feet in length, as compared with the old type of more than fifty feet, can be operated by one man, and will give the same degree of efficiency as the old style.

Special dimming apparatus allows the use of a wider range of lighting effects than any other system now in use. The electrical system enters the theater through a double system of transformers, six to each system. This arrangement makes two sources of current available. Either of which is sufficient to supply the needs of the theater.

The building proper was designed by Architect Edwin Bergstrom. Foundations were installed for a thirteen-story building, which will permit the addition of seven more stories at any time the owners wish. The building contains about 100 office rooms, a large number of which will be occupied by the various departments and officials of the theater business branch.

The building has a frontage of 155 feet on Sixth Street, and 247 on Hill. Both street frontages are occupied by shops, with the exception of the theater entrances. The Sixth-street side of the building has been set back ten feet from the building line, giving an unusually wide sidewalk, and eliminating congestion in front of the theater entrances and the shops.—Los Angeles "Times."

\* \* \*

### SOME REMARKS BY THE ARCHITECT

The problem given to me was to build a theater of a capacity approximating 4,000 without sacrificing the friendly, close-in atmosphere sometimes attainable in a smaller house. The sight lines were to be as good or better than such and such houses, and the acoustics perfect. In regard to the latter and in order to meet the specifications it was necessary for me to throw aside the rule of thumb methods which have characterized the solution of

# Informative Advertising

## II. To the Advertiser:

(Continued)

How are you going to educate the Architect?

(a) Attract his attention. Your advertisement should show at a glance that it contains information which may be useful to him.

(b) Give specific data; the exact uses and conditions to which your material is adapted.

(c) Give technical data; physical properties and tests (preferably such as the U. S. Bureau of Standards).

(d) Give references; buildings where used, names of architects, owners, contractors.

(e) Give nearest location where material can be obtained.

(f) Offer more complete data, suitable for filing, to be sent on request.

(g) Repeat your advertisement. Occasional, sporadic advertising is economic waste. A friend receives preference over a stranger.

(To be continued)

acoustic problems in theater construction for a half century in America, and to go my way alone.

Time is too short here, but suffice to say that an entirely new adaption of the laws of acoustics have been effected in this house. Naturally, the owner's interest in this problem was intense, and every facility was afforded by the owner in the way of expert advise and consultation with other architects. I am pleased to say we did agree, and that now one can actually hear in the theater, as one would in an out of door amphitheater.

Every seat in the house is in full view of the entire picture and the whole of the orchestra, and the organist, all of the time. The house has not been seated to capacity, that is to say, the city ordinances would allow a larger number of seats in the auditorium than have been installed there.

Certain rows of seats have been eliminated in order to provide more ample circulating spaces. Like the Hippodrome in New York City, this theater is provided with a platform for the orchestra which raises and lowers at the touch of an electric button. There is an additional raising platform for the organ console; these facilities are unique in so far as moving picture houses are concerned, when we consider that they are taken in conjunction.

I am pleased to be able to note that the delicate and precise mechanical equipment necessary to produce the desired results were achieved without going outside of our city for engineering advice, or for a mechanical plant to construct the work.

In regard to the lighting of this theater it is well within the bounds of truth to state that no theater has attempted to install such an elaborate system. From the first Mr. Grauman's idea appeared to be that the last resources of modern electrical science should be exhausted in order to perfect this plant. The unusual demands made upon the engineers have resulted in entirely new situations. For instance, in order to obtain mechanical efficiency and cheapness of overhead the remote control system for the dimmers and other stage equipment have been devised. The switchboards alone for these devices and other like items have meant a cost of \$65,000. These expenditures, however, figure out on the right side of the ledger when maintenance costs are compared with costs of other installations.

In regard to the architectural style of the theater I have merely to say that it is a serious attempt to conform practical

reinforced concrete construction of our time to the precedents of good architecture. Naturally, a new medium such as concrete cannot be used in the faithful representation or for copying of any historic style of architecture. A Greek temple or an Egyptian mosque built entirely of Monolithic concrete would not represent any style of architecture. In any type of architecture which is alive and full of meaning for the day in which it is built, it is necessary that the architectural forms be adapted sympathetically and intelligently to the materials of which they are made, just as the classic wood forms we find in Colonial architecture were adapted from forms which originated in the stone and marble buildings of antiquity. When these adaptations have been made unskillfully and immaturely we have a transient style in architecture; when they have been made skillfully and with sufficient intelligence the new forms and new materials merge into new style. When a new style of architecture satisfies the needs of both the practical and esthetic standpoint over a long period of time we have an architectural epoch. Back of a new style of architecture are the economic forces of the community. Is it cheaper to build this way or that in order to produce a given amount of utility, practical comfort, opulence or beauty?

Behind the stage is another story. The best stage for the theatrical producer is an absolutely clear floor area with plenty of rigging facilities aloft. The stage of the Grauman Theater, Sixth and Hill streets, is equipped with the latest counter-weighting device, so that all curtains, stage sets, flies, borders, etc., may be shifted with the minimum of expense in physical labor. Anything from a comedy to a hippodrome show can be put on this stage. The entire stage floor from one side of the stage to the other, and from the orchestra pit to the rear wall of the stage, may be eliminated, as the entire stage floor is made in sections and framed together in such a manner that any small part, or the entire area may be taken down and replaced without injury.—  
Los Angeles Examiner.

PHONE FRANKLIN 2492

**A. C. WOCKER**

INTERIOR DECORATOR

1370 SUTTER STREET

SAN FRANCISCO, CAL.



ROOFED WITH SIMONS  
LARGE SPANISH TILE.

MISSION CHURCH,  
KINGSBURG, CALIF.

ANTON JOHNSON,  
Architect.

Combining durability, economy and beauty in applied roofing material, Burned Clay Roofing Tile laid in variegated shades of five or six tones, using reds as a base color, produces a highly artistic design and color scheme.

Large Spanish Clay Roofing Tile is nailed directly on the Sheathing Boards, eliminating wood strips and requires lighter roof construction.

**SIMONS BRICK COMPANY**

Manufacturers

Walter R. Simons, President and Gen'l Manager  
11 West Third Street Los Angeles

1744 Folsom St.  
SAN FRANCISCO  
Phone Market 2273

**J. A. DRUMMOND**

Contractor and Distributor

225 Fresno St.  
FRESNO  
Phone 4073

845 Seward St.  
LOS ANGELES  
Phone 433929

## ORNAMENTAL FABRICS

The draperies in the Metropolitan Theater can safely be valued at \$200,000. Some are priceless. All are of first grade Japanese silk chiffon velvets and especially designed and dyed.

The large hanging in the main lobby required the steady efforts of three artists over a period of five months to complete. It is a masterpiece in drapery execution and alone is valued at \$50,000. The two large pieces in the balcony are each valued at \$20,000. All are original designs by William Lee Woollett, the architect.

## Especial Dyes

The dyes used were made especially for these draperies and alone constitute a tremendous investment. All dyes used are vegetable dyes and not the usual cheap commercial dyes.

The main stage curtain, also made of velvets, is the last word in dyeing and is valued at \$20,000. The shading of color in this curtain in an innovation.

## 12,000 Yards of Material

Altogether, over 12,000 yards of material were used for draperies and stage curtain and fifteen months' work were required to prepare these. All curtains were made in studios maintained especially to execute specially designed curtains for this theater. All are hand made and sewed.

The canopy, made of gold cloth and specially designed velvet straps with lisle and ornaments, is the most expensive and most gorgeous ever designed and represents a new idea in decoration.

All drapery work was executed under the supervision of R. J. Cosner, foreman of the drapery work room, who in turn was under the direction of Mr. Woollett. — Los Angeles Examiner.

## A Farm in the Foothills

(Continued from Page 29)

ing-house life, these two people decided to try the experiment of home owning at the start, and invested in the aforementioned ranch. This consisted of a lot 50 by 150 feet planted to about half a dozen varieties of fruit trees, and some flowers and berry vines, and a two-room shack, all purchased for a very modest sum in a little community of home-owners in the town of Larkspur, a little over an hours' ride from San Francisco.

In four years the garden plot has developed in luxuriance, rewarding the care which has been expended upon it with abundance of fruit and flowers. I am inclined to think that there is a sort of sympathetic response of gardens to owners who love them and take care of them. They seem to always reward labors of love and put forth their best efforts—the flowers are sweeter, the fruit grows larger and more abundant than that which results from paid labor.

Here grow ten varieties of fruit trees including apple, plum, peach, orange, lemon and fig, not more than two of a kind, just enough to supply two people with fresh fruit, fourteen grapevines, twenty-five logan berry vines and a hedge of blackberries; also a strawberry bed, which is not a bed but a barrel filled with earth and with holes punched in the sides, through which the plants grow. Imagine picking your strawberries vertically instead of horizontally! An idea for a small city garden plot.

From the front to the back of the place is a cement walk laid by the owner, which leads from the front entrance, a lattice gate ornamented by a trellis over which is trained a rambler rose—to the rear gate cut in a hedge. The front gate is flanked by shrubs in huge Chinese water jars, and as the front of the lot is higher than the house, it is a most delightful spot to view the whole garden, the valley below and the bay beyond the hills. But it is the rear garden that is the "motif" of the place, a colorful spot to delight the eye. Formal beds of petunias in their richest colors, velvety purple, wine and majenta, and the variegated kinds, striped with white in high relief against the darker masses. These are set in a series of formal beds bordered by graveled walks, and in the center of the middle bed is a fountain. Built against the house and overlooking this spot is a latticed pergola, covered with rose vines and

## Stillwell PLAN BOOKS

**CALIFORNIA STYLE** All **HOMES**  
Climate

—show pictures, Floor Plans and Estimated Costs of Building over 200 Selected Designs.

"West Coast Bungalows"

50 Houses—6 and 7 Rooms—\$1

"Little Bungalows"

75 Houses—3-4-5 Rooms—\$1.

**SPECIAL OFFER:** Send \$2.50 for any three of these books and get Garage Folder FREE.

Books and Blueprints sold with Money Back Guarantee

**E. W. STILLWELL & CO., 790 California Building, Los Angeles**



"Representative California Homes"

50 Houses—7 to 10 Rooms—\$1.

"The New Colonials"

60 Houses—6 to 10 Rooms—\$1.



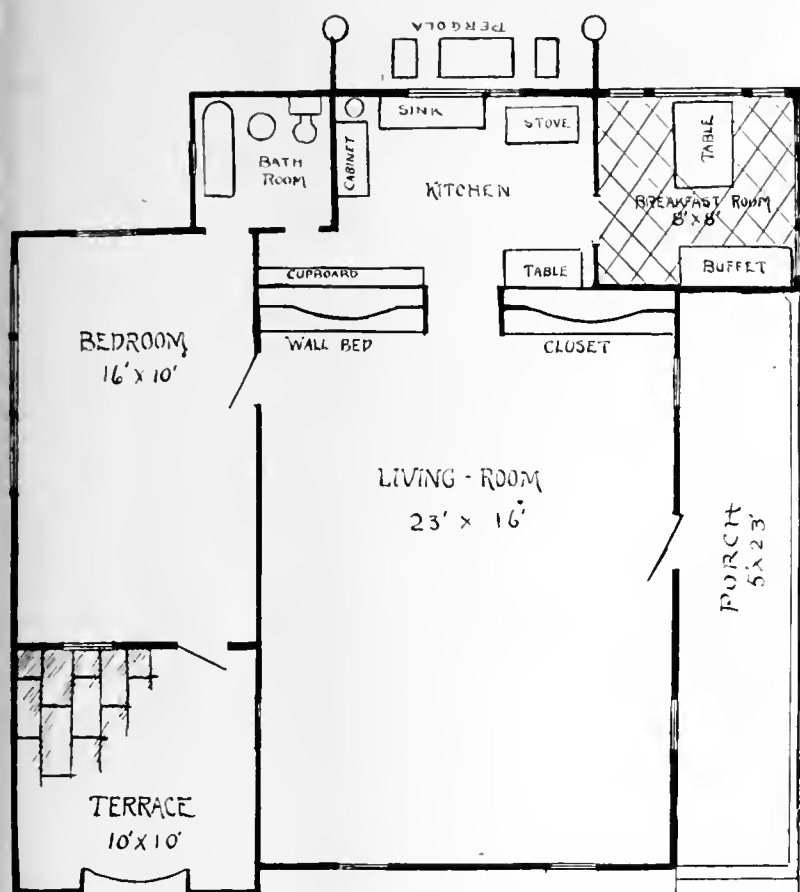

flanked with hydrangea whose deep blue color, caused by its contact with the iron drain pipe, contrasts vividly with purple and majenta petunias. A friendly little nook which invites a visitor to a cup of tea of an afternoon.

The cottage too has grown during four years to the dignity of a bungalow; a breakfast nook has been added, which was made by enclosing an end of the six-foot porch running along the side of the house, adjoining the kitchen from which it is separated by a doorway and half partition on one side. Although this breakfast room only measures eight by eight feet, it accommodates a buffet, drop leaf table and is decorated with orange flowers on a blue background, the work of the man of the house. Two sides of the nook are of glass, curtained with flowered chintz lined with orange giving a radiance to the morning atmosphere no matter whether the sun shines or not. The living-room, sixteen by

twenty-five feet has windows on three sides, and is furnished in wicker and hung with cretonne. Besides the dining table, cosy arm chair and couch, there is room for a piano, desk, work table and high-boy which serves the double purpose of linen press and chiffonier. This room may be also converted into a sleeping room; there is a cleverly built-in bed which looks like a cabinet with glass doors, at one side of the kitchen door, and on the other side a similar arrangement discloses a clothes-press. These cabinets were parts of discarded window fixtures from a department store; the chandelier shades, salvaged from the same source once figured in a window as flower receptacles!

Certain features of the house are especially interesting expressing as they do the personality of the owners in examples of clever handwork and craftsmanship; these people find great fun in converting material on hand to built-in conveniences.

The latest addition is the bed-room added on to the west side of the house in the space formerly occupied by a tent-house sleeping apartment. This measures ten by fifteen feet and opens upon a brick paved patio. Sheltered by a rustic roof over which vines are to be trained, this patio makes a cosy sun parlor. The whole was built, brick floor laid by the owner, with some outside help, and unites itself pleasingly with the simple lines and low roof of the original building.

Of course it is not yet finished. When it is complete to the last detail (as it won't be I hope, for years) then there will be nothing to plan for. "A home is never finished and that is one of the chief glories of a home. It is a living organism, growing as we grow, returning what we give to it." And there is a joy in "progressive building" that is forever lost on the day of completion.

## Pacific Manufacturing Company

Branches:

117 Stevenson St.  
SAN FRANCISCO

Manufacturers of and Dealers in

**Doors, Windows and Mouldings**

General Millwork

Branches:

908 Washington Bldg.  
LOS ANGELES

1001 Franklin St.  
OAKLAND

58 West Santa Clara St.  
SAN JOSE

Factory and Main Office: Santa Clara, Calif.

# Brininstool Company Opens New Office

The increase of building activities throughout Northern California has been



A. B. "Scotty" Campbell

the cause of the Brininstool Company, paint and varnish manufacturers, until this time operating from their Los Angeles office, to establish offices and warehouse

facilities in San Francisco, in charge of Mr. A. B. "Scotty" Campbell.

For the past 25 years Mr. Campbell has been actively engaged in the paint and varnish business. Seven years of this time were spent in China and the Far East, and over ten years in California. Mr. Campbell's host of friends are according him a hearty welcome in this new field.

The Brininstool Company state that on account of the vast number of large office buildings, schools, and other structures now arising in the northern part of the state on which their products are being specified that they have been compelled to open a local office here. This will enable them, they claim, to give a closer and better service to the architects and contracts.

All who are interested in the Brininstool Company's products, San-a-Cote and Velva-Cote are cordially invited to call at the local office, located at the Souther Warehouse, 2701 Sixteenth Street.



*"An Ounce of Prevention  
is Worth a Pound of Cure"*

THE place to make good roofing is in the factory—not on the roof. It is the amount of tin-lead coating *and the way it is applied* that determines the quality of roofing tin—in fact, an ounce of coating properly applied is worth a pound of patches.



**TARGET AND ARROW**  
*Look for this Trade → Ⓢ Mark on every Sheet*  
**ROOFING TIN**

is made by an old Welsh process in which each sheet is repeatedly dipped and soaked in pots of molten metal and boiling palm oil, consuming thirty-five minutes to coat each sheet and assuring an amalgamation of the extra heavy coating with the base plate that cannot be obtained in any other way. No wonder a Target and Arrow roof outlasts the building it covers!

**N. & G. TAYLOR CO.**

Offices: Philadelphia, Pa.

Mills: Cumberland, Md.

Established 1810

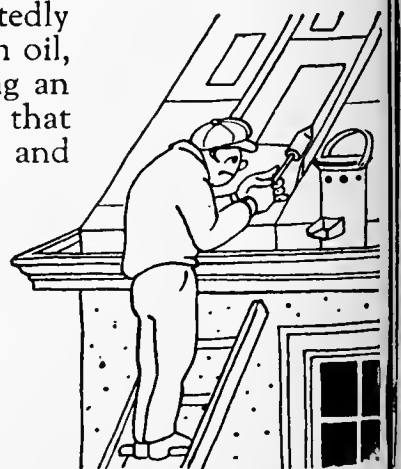
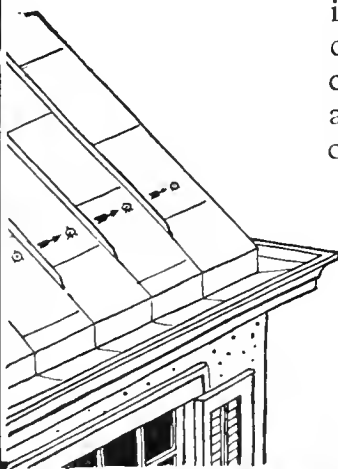

# The Relation of Radium to Architecture

By WILLIAM H. DEY,  
Manager, Electrical Division,  
United States Radium Corporation

(Concluded from August)

In bath rooms, and particularly hotel bath rooms, the use of a luminous pull chain socket on the mirror light is usually more advantageous than the use of a ceiling light and switch, since the switch either breaks up the tiling or it must be located more than ordinarily high. Furthermore there does not appear to be any standard location, which makes it noticeably difficult for the stranger to locate it, since the distance from the bath room door to the mirror light is short, and seldom anything between the door and the mirror, the saving of the ceiling light and the switch is a justifiable economy, besides the other method being more convenient.

In office buildings it can easily be checked up that cleaners usually work in cycles, doing one operation at a time in all of the rooms on a floor or several floors, with a result that the lights burn for hours instead of for the few minutes that it is necessary for them to burn. The excuse given by these people is that it is so difficult to find switches that they find it much easier to let the lights burn in between their several visits to the room. However, a certain office building owner in Louisville, Ky., determined to break up this practice of wasting current, and while it was not brought out in the report as to just how this was accomplished, it was found that in a very short time the walls around the switches became so soiled that it was necessary to call in a painter to make an estimate for repainting. When the building owner found that it would cost \$600 to fix up his walls, he immediately sent out an S. O. S. for information regarding luminous switches. It had not occurred to him that the cleaners, whose hands would be especially dirty, would ruin his walls in groping for the switches, but he found that he did not have to necessarily stand for a loss either way, since with the luminous switch he could continue to enforce the "lights out" rule and at the same time not have his walls soiled. No doubt the bad practice described here is the cause of many thousands of dollars of wasted light energy.

The extra cost of having radium luminous material applied on electrical devices is usually 25% additional to the list price of the device itself, the discount applying to this as well. This of course amounts to a very small sum on any job, even the largest, and even this small cost is usually offset or more than offset by savings in the installation costs as pointed out, to say nothing of the convenience value and the maintenance savings. The ordinary residence can be completely equipped with luminous material in every respect, including house numbers, for less than \$10.

In a ten-room house, twenty switches would be a large number for ordinary practice. The cost of luminous tips for this number of switches would be \$5 list. The net cost of these switches would probably be \$5 each. Thus it will be seen that in an extreme case where for any reason it is felt that the extra \$5 could not be spent, the elimination of one switch would permit the use of luminous material on the other nineteen, and a luminous pendant on the twentieth outlet for the same cost as the twenty non-luminous switches, and there can certainly be no question but that the electrical installation would be far more serviceable to the owner in the former case.

After all, switches themselves are only conveniences and not necessities, and where the owner can afford the switch he can easily afford the additional charge for the luminous material, and if he appreciates convenience to the extent of having switches throughout his house he will certainly appreciate the architect's interest in providing him with still further convenience.

The specification of luminous material is very simple, since all of the leading manufacturers of electrical devices are supplying this material on specification in their various types and styles of the particular devices wherein the use of luminous material is desirable. It is only necessary to insert a paragraph in the specification to the effect

that all of these devices should have luminous indicators, or to add the word "luminous" to the individual device specification.

The question of supply is a simple one, since these products being put out by established manufacturers in connection with standard devices are obtained through the usual channels. In carefully checking up on the matter, the writer has found very few instances where the jobber has not in stock a complete line of these devices with the luminous indicators, and in such cases it has been merely carelessness on the part of the jobber in failing to provide himself with a stock, which condition is easily remedied when the matter is called to his attention.

These same manufacturers are placing the luminous pendants in easily attached form on counter sale for use on sockets already installed, and one manufacturer is providing the luminous plate screw which enables one to equip switches already in place, since this screw is interchangeable with the regular plate screw in all makes of switches. Another manufacturer is threading his metal handle tumbler switch so that if this particular switch is installed without the luminous tip, a separate tip can be purchased complete with a lock washer to hold it in place, and this tip can be screwed on to the handle of the switch. This Glotip was designed by this particular manufacturer as a result of a number of cases coming to his attention wherein the architect found himself in difficulty with his client in his failure to provide for luminous material in his specifications, the client contending that the architect having been instructed to see that everything was as modern and up-to-date as possible, should have known about and specified "Luminous Switches, etc."

The writer came across an instance in Boston quite recently wherein these conditions obtained and the architect was able to entirely satisfy his client in this way and at the same time save himself the cost of having the switches changed, since of course he could not hold the contractor responsible.

There will of course be no necessity for this manufacturer to provide this tip for any great length of time, since the necessity for it will cease as the architect standardizes on luminous material and specifies the luminous switch in the original plans.

The necessity for special finishes and special products and unusual applications will of course come up from time to time, but

most of these have been foreseen and provided for and can be taken care of as the occasion arises.

In connection with a nearly completed one year's trip by the writer, covering 125 cities in 24 different states, visiting 2500 architects, some very interesting comments have been heard. As the trip has progressed through the year, an increasing percentage of architects have reported having specified luminous material and an increasing percentage have reported having intended to. One hundred per cent of the architects visited have reported being in favor of luminous material, 90% already knew something about luminous material, 50% were using luminous material in some form in their own home, 15% had already used it in at least one specification. Of the 85% who had never specified luminous material and of those of the 15% who had used it in some but not all cases, not one had any reason for his failure to specify it other than that he just hadn't done so. This is a perfectly human excuse, even though not a good one.

Wherever luminous material had been specified, complete satisfaction was reported; and since the above record shows that an item of this sort is so easily overlooked, with the consequent loss of opportunity to serve the client, it seems to be a good idea to suggest the including of a paragraph on the subject in the standard specification card file or folder. Since the use of radium luminous material is one of those important improvements that soon becomes considered as essential, a little foresight in specifying this material now will prevent current buildings from being at a disadvantage as compared to buildings built a few years from now when the use of this material will have become entirely standard.

After all, modern building practice has been pretty well standardized and modernness is expressed mainly in details. The architect thus has an opportunity to earn his fee for the client many times over, if by reason of good judgment in selecting details he is able to produce a finished job that is not only modern, insofar as current use is concerned, but which anticipates in such a way that the building will be commanding top prices for rents when the carelessly designed building has dropped into the second or third grade. We are all familiar with buildings which we know to be ten to fifteen years old and which we always think of as new.

*THE  
BUILDING  
REVIEW*



*OCTOBER, 1923*

*Vol. XXIV No. 4*

*Published in San Francisco*

*Price Twenty-five Cents*



J. J. McHUGH, Painters' Foreman,  
S. A. BORN BUILDING CO.

RESIDENCE OF MR. DUDLEY SALES,  
ST. FRANCIS WOOD, SAN FRANCISCO.

S. A. BORN BUILDING CO.,  
SAN FRANCISCO, CAL.

FINISHED THROUGHOUT WITH

*Kyanize*  
KY-AN-IZE

WHITE ENAMEL and VARNISHES

Office and Warehouse  
1151 MISSION STREET  
SAN FRANCISCO, CALIFORNIA  
A. L. GREENE, Local Manager

*Boston Varnish*  
Company  
KY-AN-IZE

Distributors for Southern California  
SUNSET PAINT COMPANY  
627 SOUTH MAIN STREET  
LOS ANGELES, CALIFORNIA

# THE BUILDING REVIEW

Vol. XXIV

OCTOBER, 1923

No. 4

## CONTENTS

COVER--ENTRANCE DETAIL, RESIDENCE OF MR. ROBERT WEBBER,  
HILLSBOROUGH, CALIFORNIA.

### PLATE SECTION

	Plates
RESIDENCES BUILT BY S. A. BORN BUILDING CO., Near San Francisco, California.....	41-56

### TEXT

	Page
GARDENING OF OUR COUNTRY HOMES, by Donald McLaren.....	37
CREDIT TO WHOM CREDIT IS DUE, by Harris Allen.....	41
MINUTES OF SAN FRANCISCO CHAPTER, AMERICAN INSTITUTE OF ARCHITECTS.....	42
DESCRIPTION OF THE MODEL RESIDENCE BEING BUILT IN GLAZENWOOD, CALIFORNIA, by Will H. Toepke, Architect.....	44
NOTES OF SAN FRANCISCO ARCHITECTURAL CLUB.....	46
JAPAN FACES GIGANTIC BUILDING PROGRAM.....	48

### INDUSTRIAL DEVELOPMENT

SAN DIEGO SEEKS NEW INDUSTRIES.....	XVI
THE USE OF DOUGLAS FIR FOR SASH AND FRAMES.....	XII
WESTERN PACIFIC BUILDS UP.....	XXI
NEW INDUSTRIES AID OAKLAND.....	XXI
NOBODY TO GUIDE THEM.....	XXII
SAN JOSE PROVES PROSPERITY.....	XXII
PREPARED ROOFING SIMPLIFIED .....	XXIII
SIMPLIFIED HOSPITAL BEDS .....	XXIV

HARRIS ALLEN, A. I. A., Editor

HOWARD HOYT  
Industrial Editor  
And Business Manager.

NED BRYDONE-JACK  
Advertising Manager

Published Monthly by the Building Review Company,  
Chronicle Building, San Francisco, California

Address All Communications to No. 426 Chronicle Building, San Francisco, California

Yearly subscription—United States, \$2.50—foreign, \$3.00. Single copies, 25 cents.

Entered as second-class matter in the San Francisco Postoffice under the Act of August 24, 1912. Previously entered as "The Architect."

The editors will be pleased to consider contributions of interest to the Industry. When payment of same is desired, this fact should be stated.

News stands and dealers supplied through San Francisco News Co., San Francisco, Calif., or American News Co., New York, N. Y.

## BATCHELDER TILES



GARDEN POT No. 215

BATCHELDER-WILSON CO.

2633 Artesian Street

Los Angeles, Calif.

## *Economical and Enduring Construction*

The Strength of the Welded Seam Is a Reason for the Superiority of the *Electrically Controlled--Gas Fired*

# McLaughlin Furnace

The escape of gas fumes into the interior of the home is absolutely prevented. The expansion and contraction stresses have no lap seams or cemented joints to fracture.

*Write for Information*

## McLAUGHLIN METAL WORKS

223 J STREET, SACRAMENTO, CALIF.

San Francisco  
W. P. GOSS

Stockton  
WILLARD HARDWARE CO.  
MILLER-HAYS CO.

Fresno  
EVANS HEATING CO.  
DEVLIN & DREW

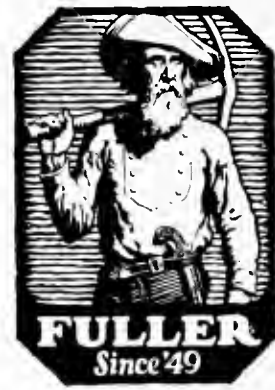

## *Silkenwhite Enamel*

produces superbly beautiful interior surfaces, on walls, doors and trimmings.

In addition to white, Silkenwhite is produced in varying shades of Ivory and Grey, thus offering ample opportunity for originality in decorative effects. The finishes are egg-shell and full gloss.

Many architects on the Pacific Coast are specifying "Silkenwhite Enamel or equal" because by setting this as the quality standard they are safe in the knowledge that results will be right.

Architects who desire specific information concerning Silkenwhite Enamel, samples of wood finished with the actual colors or other material, are invited to communicate with Fuller Service Department.

# FULLER

PAINTS  VARNISHES

W. P. FULLER & CO.

San Francisco  
Oakland  
Sacramento  
Stockton  
Los Angeles  
Hollywood  
Pasadena

Long Beach  
San Diego  
Santa Monica  
San Bernardino  
Santa Ana  
Fresno  
Portland

Boise  
Walla Walla  
Salt Lake City  
Seattle  
Tacoma  
Spokane  
Yakima

107-1023



THE USE OF DOUGLAS FIR FOR SASH AND FRAMES

THE following relative values are taken from Technical Note 173 of the Forest Products Laboratory of the U. S. Forest Service, at Madison, Wisconsin. In relation to Commercial White Oak at 100 per cent, the heart wood of these species shows the following comparison in decay resisting qualities:

White Oak, 100%; Northern White Pine, 70 to 90%, average 80%; Western White Pine, 65 to 80%, average 72½%; Western Yellow Pine, 35 to 50%, average 42½%; California Sugar Pine, 45 to 55%, average 50%; Douglas Fir, 75 to 85%, average 80%.

The sap wood of practically all species has a very low durability.

All the pines are very sappy, while Douglas Fir is comparatively free from sap.

Sappy Pine Sash rots out in a very few years, even though well painted.

The following figures are taken from the working stresses recommended by the Forest Products Laboratory at Madison, Wisconsin, for S1 grade.

Working stresses: for outside work, not in contact with soil (pounds per square inch).

	BENDING	COMPRESSION	
		Parallel to grain.	Perpendicular to grain.
Northern White Pine (Wis. and Mich.).....	930	875	175
Western White Pine .....	930	875	175
Western Yellow Pine .....	930	875	175
California Sugar Pine .....	930	875	175
Douglas Fir .....	1515	1165	260

Vertical Grain Douglas Fir for sub-sills in frames and for sash will give:

Over 60% greater strength in bending over the Pines.

Over 30% greater strength in compression parallel to grain.

Nearly 50% greater strength in compression perpendicular to grain.

In durability where all species are free from sap wood, the value of:

Douglas Fir is equal to Eastern White Pine.

Douglas Fir is over 10% higher than Western White Pine.

Douglas Fir is over 88% higher than Western Yellow Pine.

Douglas Fir is over 60% higher than California Sugar Pine.

Douglas Fir lumber is slightly harder than the Pines and requires a little more care in machining. On account of its straightness in grain, it should never be machined to a "feather edge." If the edge

is "nipped" or "slightly rounded," it will eliminate trouble from slivering on edges.

A folder containing the following circulars concerning the "Properties of West Coast Woods" will be sent to anyone requesting it:

1. Uses of Standard Grades of Douglas Fir.
2. Working Stresses for Standard Grades of Douglas Fir.
3. Working Loads for Douglas Fir Joists.
4. Sash and Frames. Douglas Fir and the Pines.
5. West Coast Hemlock.
6. Working Stresses for Standard Grades of West Coast Hemlock and Sitka Spruce.
7. Physical Properties of commonly used Species and Working Stresses for them.
8. Durability of West Coast Woods.
9. Text of Grading Rules referred to in above circulars.

From the moment that a great blast breaks loose a cliff of limestone in the quarry to the time when the finished cement goes into storage in big concrete bins, the process of manufacture is almost entirely mechanical—otherwise present day outputs would be impossible.

In addition to straight photography, animated drawings have been inserted to make clear what occurs inside the grinding mills, what goes on within the white-hot interior of the huge kilns, and how the cement sacks, suspended upside down, are filled after they have been tied.

This film can now be secured without charge by interested organizations through any office of the Portland Cement Association, or from Association headquarters at 111 W. Washington St., Chicago.

Gillis & Geoghegan, 558 West Broadway, New York, have just issued a new 24 page, 8½" x 11" two-color catalogue. It is fully illustrated with photographs of actual installations of G&G Telescopic Hoists, as used for handling ash cans, barrels, bales and other loads between floors. It also contains two forms of specification for each model, one a very short form and another, which describes in detail the construction and material used in the apparatus.

With the catalogue is included a special folder to fit a vertical filing cabinet for convenience in locating the data. Anyone interested may obtain a copy by writing to the above firm.

# BALL BEARINGS

**SKF INDUSTRIES OF CALIFORNIA**

Incorporated

115 NEW MONTGOMERY ST.

San Francisco, Calif.

Phone Sutter 4196

DEEP GROOVE AND SELF-ALIGNING BEARINGS  
HANGER EQUIPMENT

# Clay Products

Gladding, McBean & Co.

SAN FRANCISCO  
LINCOLN  
LOS ANGELES

PORTLAND                      LOS ANGELES                      SEATTLE

## R. N. NASON & CO.

PAINT MAKERS

151 Potrero Ave.--SAN FRANCISCO--436 Market St.

Makers of

**NASON'S OPAQUE FLAT FINISH**

A flat oil paint made in soft Kalsomine Tints, that is washable; a practical article for walls, ceilings, etc., that is most economical and durable.

Agency for

Tamm & Nolan Varnish Works High Grade Varnishes and Finishes

Goods made on the Pacific Coast for the climate of this Coast

Del Monte                      --                      Fan Shell Beach

# CLEAN WHITE SAND

Del Monte Properties Company

Sutter 6130 Crocker Building San Francisco

## "Winter Will Soon Be Here"

That is the warning carried by these brisk October days. Heed it! Think now of a Hall Gas Furnace to provide comfortable, healthful, warmth for winter.

Our heating engineers will call at any time and figure your requirements. Telephone Oakland 5528 for an appointment. Let them specify from the complete Hall line of gas-fired heating appliances.

Write for illustrated catalogue showing all the Hall equipment.

*Manufactured by*

**D. H. McCORKLE MFG. CO.**

319 12th St., Oakland, Calif.

*Dealers and distributors in principal Pacific Coast cities*



Genuine Hyloplate Backboards  
Moulthrop Movable Desks  
Sheldon Manual Training Benches  
Domestic Science and Laboratory Furniture

**C. F. WEBER & CO.**

Exclusive Agents

SAN FRANCISCO  
RENO

LOS ANGELES  
PHOENIX

# The BUILDING REVIEW

VOL. XXIV

SAN FRANCISCO, OCTOBER, 1923

No. 4

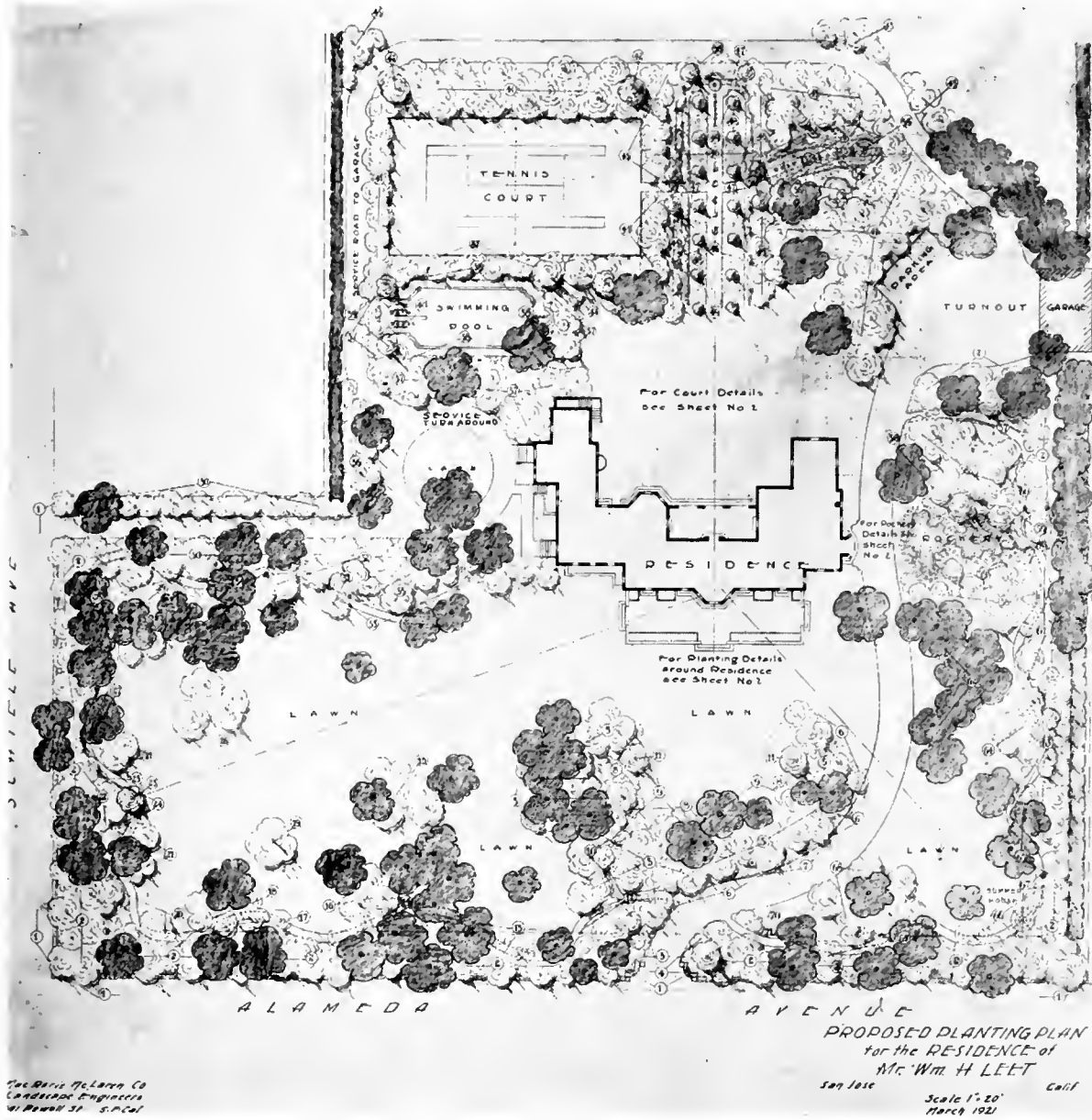

## Gardening of Our Country Homes

By DONALD McLAREN

THERE is no doubt but what there exists at the present time a great movement throughout our entire state towards life in the country, and people generally are beginning to learn the value and benefits of the outdoor country life. Much has been written recently with reference to landscape gardening in California due to the interest which has been developed on this subject within the last few years.

For the various conditions existing in California, it is absolutely impossible to outline or even suggest in a general way any special form of garden. In some portions of our state, shade should be the dominating feature so far as enjoyment of a garden is concerned, while in other sections it is possible to develop any form of garden which will agree with the house design, and right here is where the co-ope-

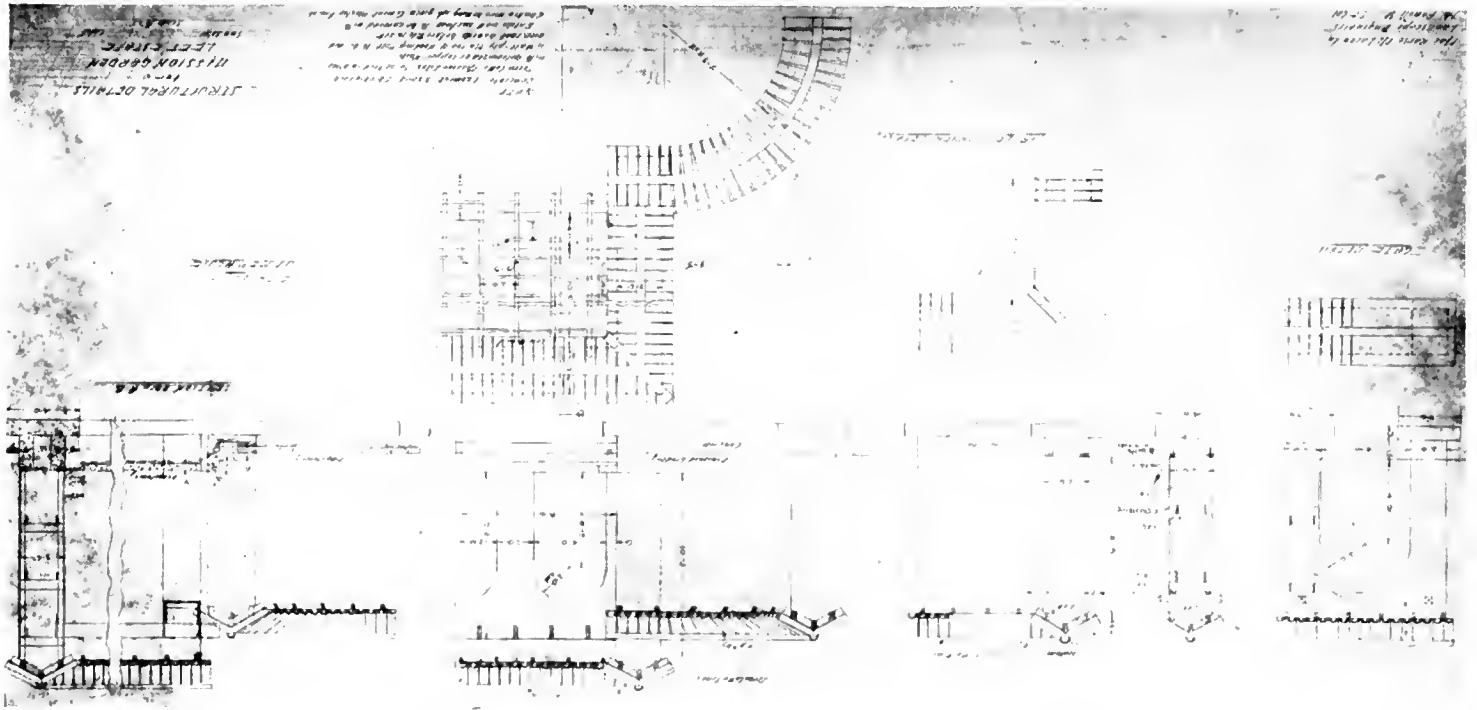

DETAILS FOR MISSION GARDEN, LEET ESTATE, SAN JOSE, CALIF.

ration of the architect and landscape man is most essential in order to obtain the best results, for it is an undoubted fact that the garden immediately surrounding the house should conform in design with the house itself. This is a feature which is too often lost sight of even in some of our large estates, and there is really no excuse for it whatsoever.

The accompanying illustrations of plans which were prepared for Mr. and Mrs. Wm. J. Leet of San Jose, tell in themselves a

very comprehensive story of the development of a general scheme and detailed features for a full and complete development of fair sized home grounds. While the various features embodied in the complete plan were evolved without a collaboration of the architect, nevertheless they were completed and executed in consultation with the owners at all times. As a matter of fact, before any work was considered consultations were held with the owners approximately two years before the building of the house was begun. A complete survey of the entire tract was made detailing all of the grades and a complete map made showing all existing trees and dominating features. It so happened that an old estate had existed on the property for a period of nearly fifty years, which meant that all of the trees and shrubs originally planted had reached to maturity. In order to obtain the best effects it was necessary to eliminate and cut down quite a large number of large trees and to move to other locations on the grounds quite a large number of matured specimen trees and shrubs in order to obtain the proper effect in the new development. After the house was located and its approximate size and ground plan established the detailed plans were prepared, and after being thoroughly discussed and considered by the owners certain changes were made and the plans remodeled, and finally adopted, after which detailed plans were made covering the swimming pool, natural lake effect and Mission Garden. The above illustrates the point which it is desired to make that full co-

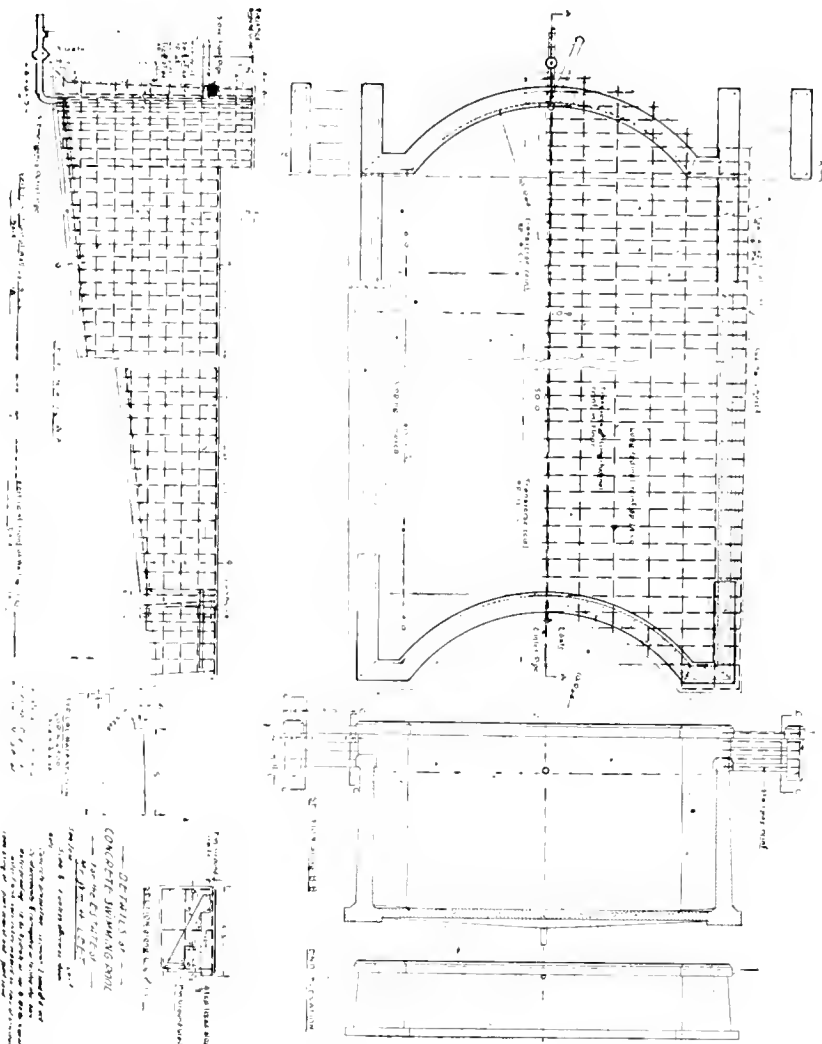

CONCRETE POOL FOR MR. W. H. LEET, SAN JOSE, CALIF.

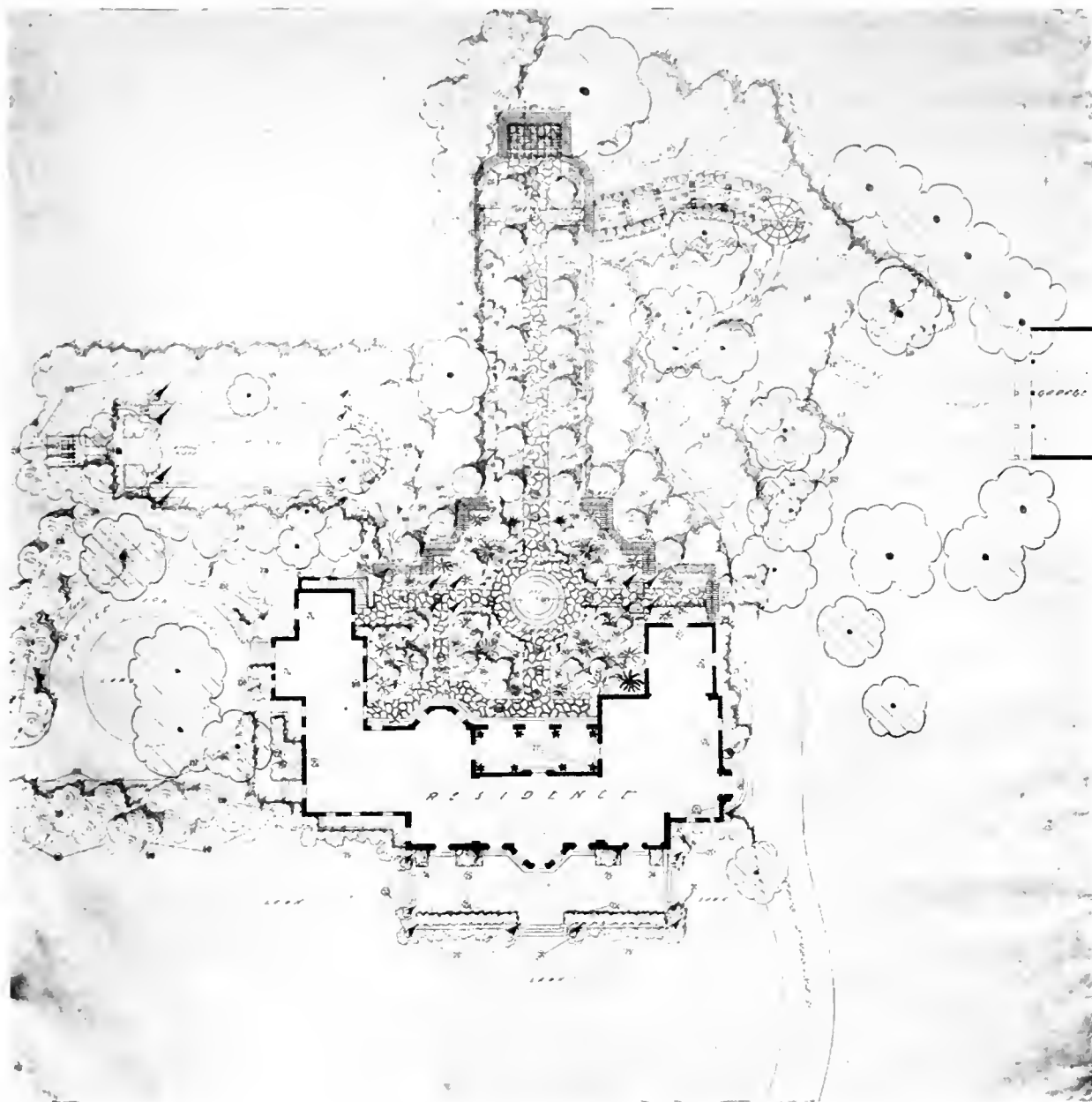

PLANTING PLAN FOR RESIDENCE OF MR. W. H. LEET, SAN JOSE, CALIF.  
Sheet No. 1.

operation should be had at all times between the owner and the landscape designer, and naturally it is far preferable that the architect be called in as well, for in the last analysis the immediate surroundings of the house are governed entirely by the type of architecture and by the ideas which the architect naturally has for the setting of his house. The careful preparation and consideration which was given the garden plans for the estate in question has resulted in a complete finished product and a satisfactory piece of work for all concerned, and I know that if more attention was given to the preliminary work that more of our gardens would prove sources of pleasure and enjoyment in future years.

We hear a great deal of discussion with reference to formal and informal design of gardens, but if the question is considered from a sensible point of view there should be no difference on this score. To my mind the design of the house should absolutely in all cases govern the style of garden to be created immediately adjacent to the house, after which the landscape treatment should be considered separately. I believe that we



LAKE ON SAN JOSE ESTATE—TWO WEEKS AFTER COMPLETION.

all prefer sweeping broad lawns wherever they are obtainable with natural groups of trees and shrubbery surrounding them, but this style of treatment demands large areas which are not always available, but it is always possible, given the proper house design, to create a natural effect, although much more expensive than to treat a small area in a formal manner. It will also be found that in many cases the success of the landscape plan will depend largely upon the use made of existing natural features, for instance, there may be a certain tree, as an example, which it is most important to preserve, and which must be utilized to the best advantage, which will determine the whole design in a small garden or in a certain portion of the garden.

As a matter of fact, a garden, no matter how large or how small, properly treated and laid out, will be found to give a very great deal of pleasure to the possessor and I firmly believe that there will be much more interest displayed with regard to this most important feature of home life within the next few years than ever before. Some of us prefer certain plants while others of us lean to certain other varieties of plant life, but the majority of hardy species do so well and grow so readily in California that there is abundant room for all to indulge their preferences.

As the writer has so frequently advocated, on account of the wonderfully equable and mild conditions of climate prevailing in the major portion of the state, we should utilize more and more evergreen plant materials in our garden work. There is such a wealth of various trees and shrubs which flourish so luxuriously and give such wonderful effects throughout the entire year that we should not neglect or overlook their use.

To the plant lover or enthusiast from our Eastern or Middle States, the first visit to California during the winter season is indeed a great revelation, leaving behind him as he does, a bleak bald landscape with its naked and leafless appearance and finding us with our wealth of evergreen foliage and our riot of color and bloom; for the very commonest and in many cases the most ordinary foliage which we use in such profusion will not grow in the section left behind; such for example as the Monterey Pine, the Monterey Cypress, the Acacia in its many forms, the Veronicas, the Heather

and a host of others. The Eucalyptus, the Redwood, the Date Palm and many more so extremely common and so generally used by us are only familiar to him from photographs or as puny greenhouse specimens, coddled and half alive. Imagine his enthusiasm over the Eucalyptus ficifolia, the Red flowering Gum, with its magnificent burst of color in November or the striking Acacia Baileyana with its tremendous bundles of lemon yellow trusses in full bloom during the month of January, or our hillsides clothed with the bright berried Redberry at Christmas time.

The Ericas or Heath family, many of which and in fact the most generally known and those varieties planted so profusely, form quite a study of their own and are fast becoming one of the most popular classes of plants we use. Their blooming season is ushered in by *Erica regerminans ovata*, very hardy out of doors, blooming during the latter part of November and carrying its blossoms until after the holiday season. It is of semi-drooping habit and bears its lovely pink blossoms out to the very tip of the branches, for which reason it is highly prized as a pot plant and in this form is shipped as far east as Detroit and Chicago. Probably, however, the best known and most generally used of all the Erica family is the pink variety *Melanthera*, which starts to bloom in December and carries the bloom right through the winter season until the month of April. The plants will attain in time a height of ten feet and often the sprays, covered with bloom to the very tips, are three or more feet in length and are very highly thought of and greatly used for decorations of all kinds. One great feature of this variety is its wonderful keeping qualities after cutting, for the branches last for many days and are shipped all over the United States, traveling in perfect condition as far as New York City. Naturally, this type of plant can only be grown under glass in the East and under this condition the flowers instead of being pink all turn white, which takes away practically all its Christmas value, for at the joyous Christmas tide we all want color.

Our violets are likewise a source of great pleasure to all of our visitors who are very greatly surprised at being able to obtain for the sum of twenty-five cents a quantity which would cost them at home several

(Continued on Page xx)

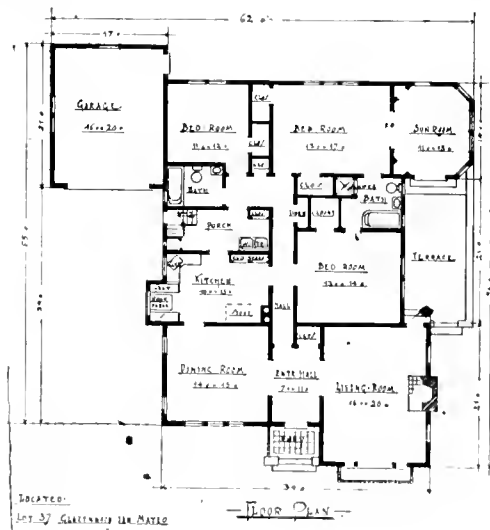

RESIDENCE,  
 SAN ANTONIO,  
 SAN ANTONIO, CALIFORNIA.  
 THE BORN BUILDING CO.  
 J. E. Petersen, Photographer.



RESIDENCE OF MRS. C. S. MALTBY,  
BURLINGAME, CALIFORNIA.  
S. A. BORN BUILDING CO.  
Albert Petersen, Photographer.



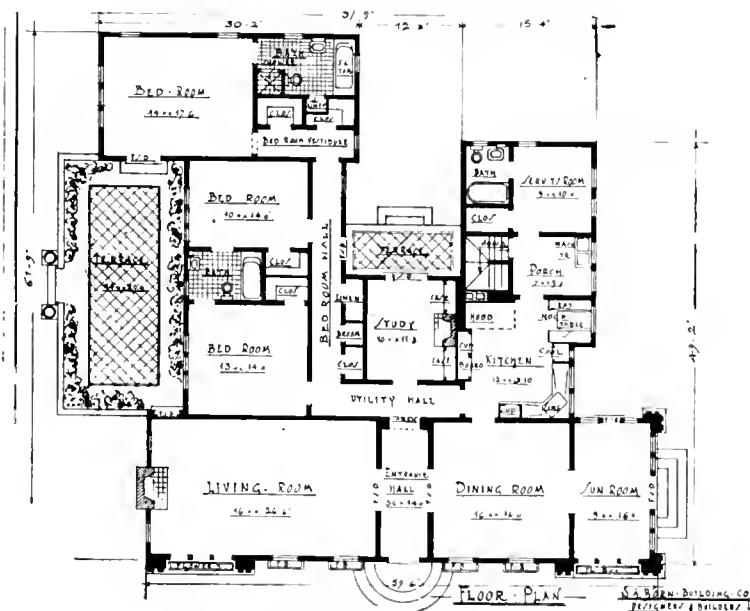

RESIDENCE OF MRS. C. S. MALTBY,  
 BULLINGAME, CALIFORNIA.  
 SABORN BUILDING CO.  
 H. T. Petersen, Photographer.



RESIDENCE OF MR. TIMOTHY SHEEHAN  
SAN MATEO, CALIFORNIA.  
S. A. BORN BUILDING CO.  
Albert Petersen, Photographer.

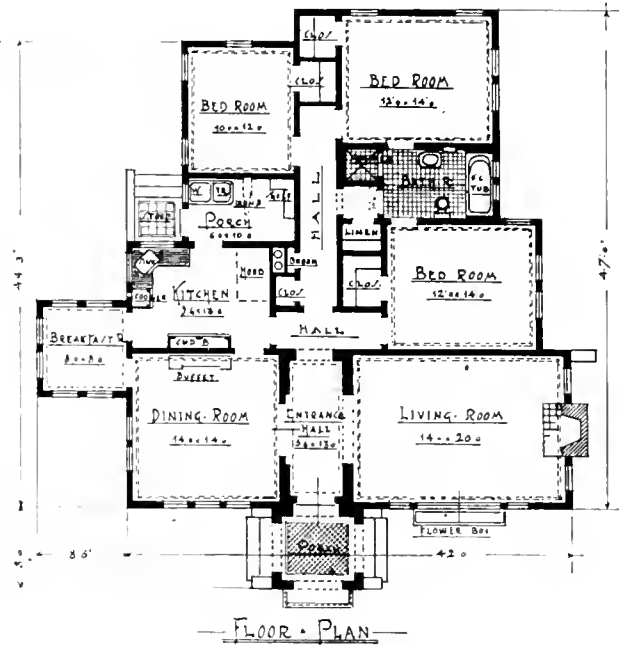

RESIDENCE OF MR. TIMOTHY SHEEHAN,  
 SAN MATEO, CALIFORNIA.  
 BORN BUILDING CO.  
 Bert Petersen, Photographer.

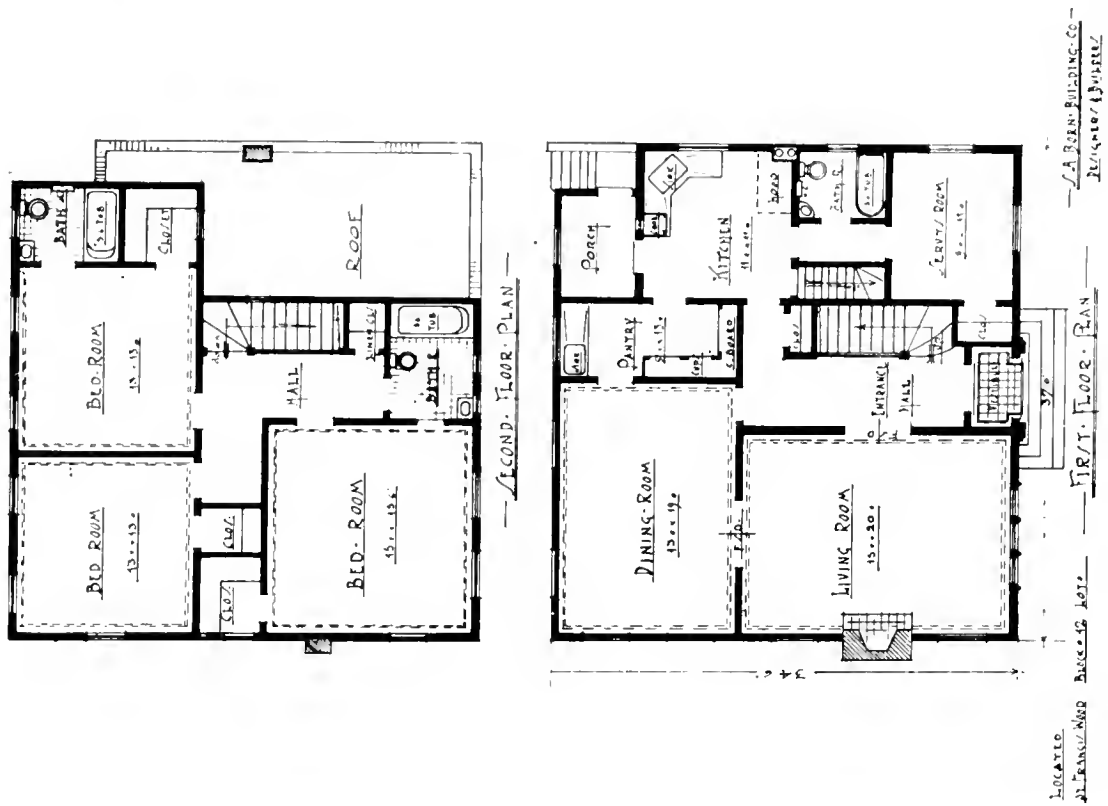

RESIDENCE OF MRS. L. SABINE,  
 ST. FRANCIS WOOD,  
 SAN FRANCISCO, CALIFORNIA.  
 S. A. BORN BUILDING CO.  
 Albert Petersen, Photographer.

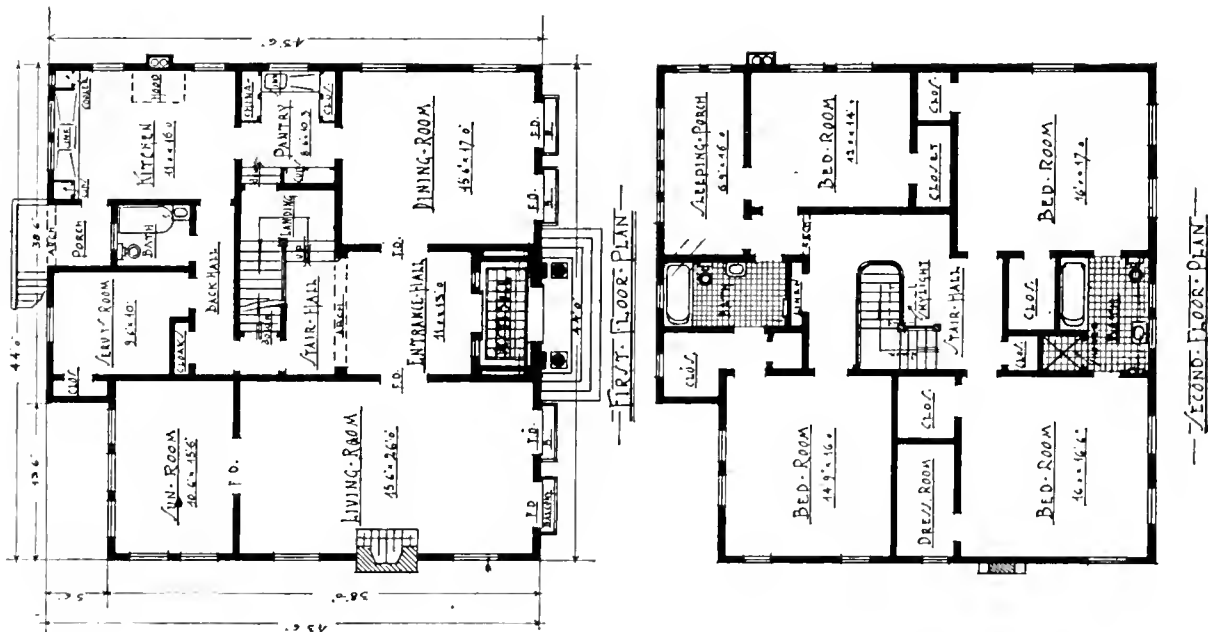

DENCE OF MR. DUDLEY SALES  
 FRANCIS WOOD,  
 FRANCISCO, CALIFORNIA.  
 BORN BUILDING CO.  
 t Petersen, Photographer.

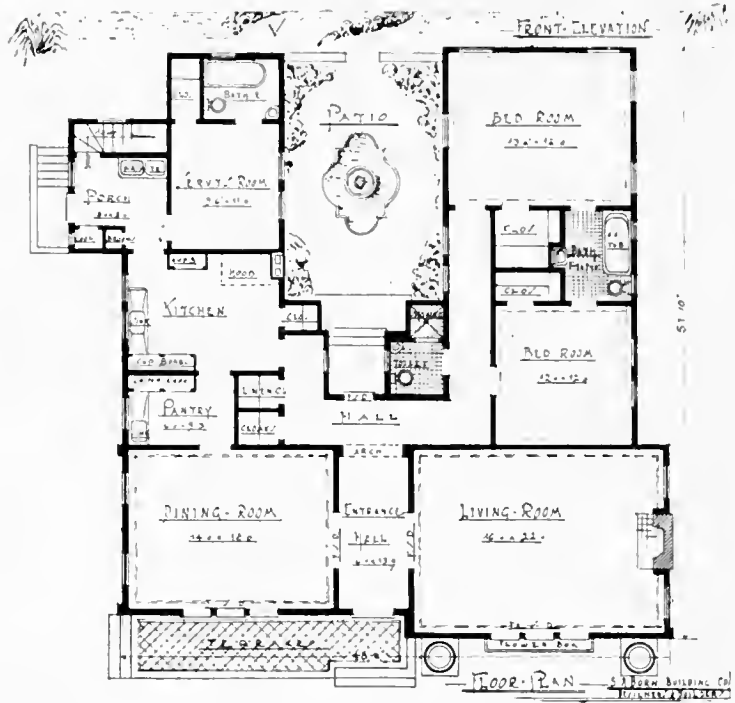

RESIDENCE OF MR. H. D. DIETRICH,  
 HILLSBOROUGH,  
 SAN MATEO, CALIFORNIA.  
 S. A. BORN BUILDING CO.  
 Albert Petersen, Photographer.

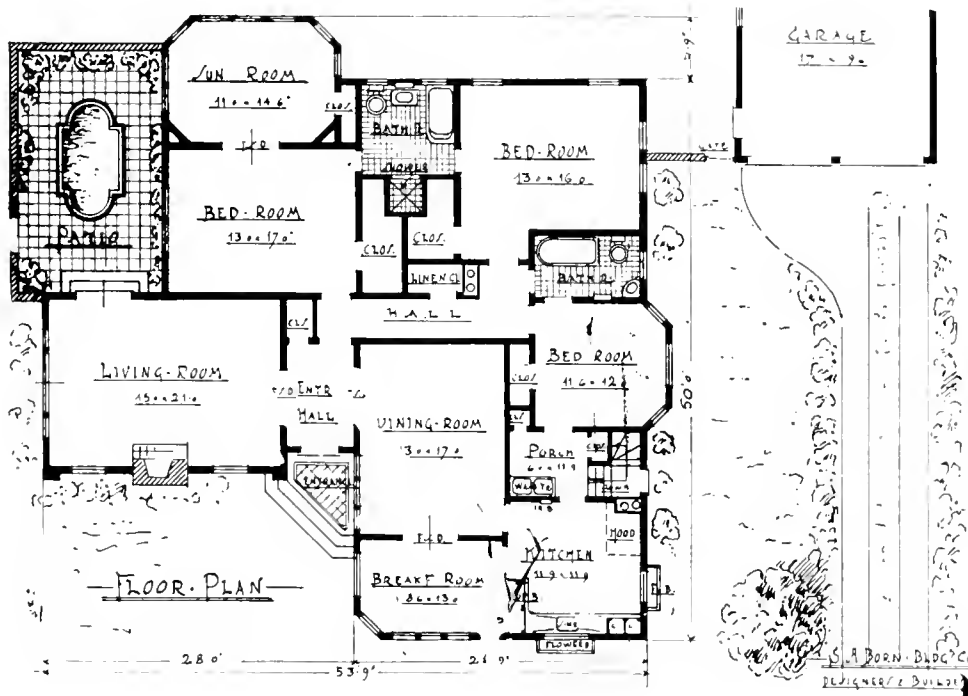

RESIDENCE OF MR. R. BONNER,  
 SAN ANTONIO,  
 SAN ANTONIO, CALIFORNIA.  
 S. A. BORN BUILDING CO.  
 J. C. Petersen, Photographer.

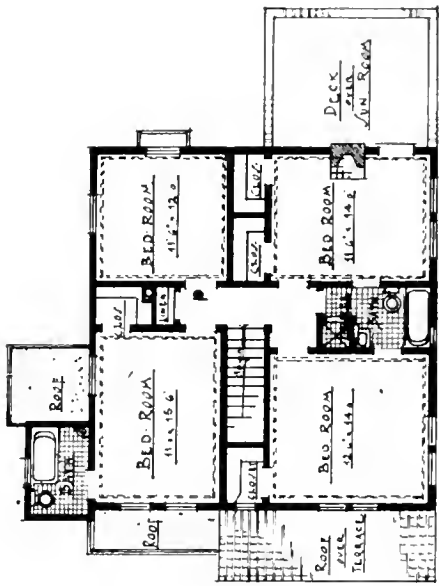

—SECOND FLOOR PLAN—

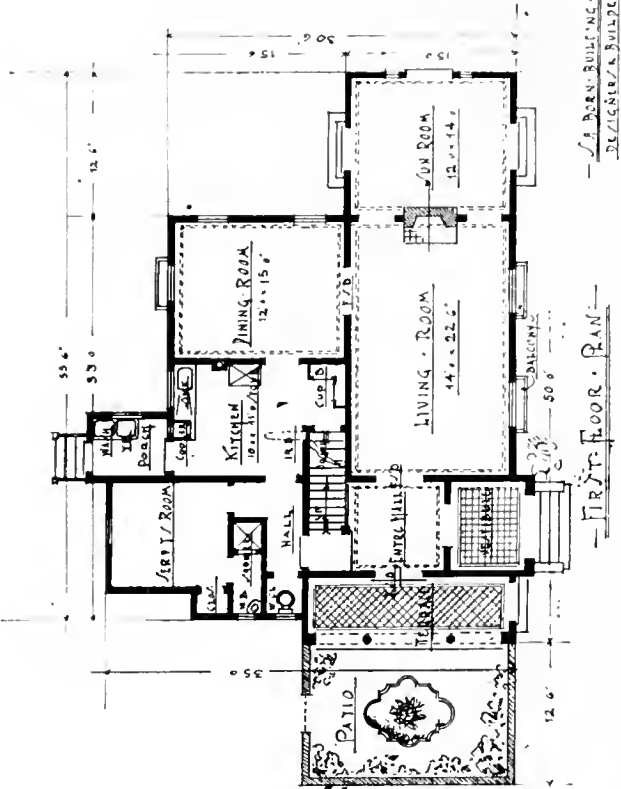

—S. A. BORN BUILDING CO.  
REGISTERED BUILDERS—

—FIRST FLOOR PLAN—

RESIDENCE OF MR. LEO McGUIRE,  
 HILLSBOROUGH,  
 SAN MATEO, CALIFORNIA.  
 S. A. BORN BUILDING CO.  
 Albert Petersen, Photographer.



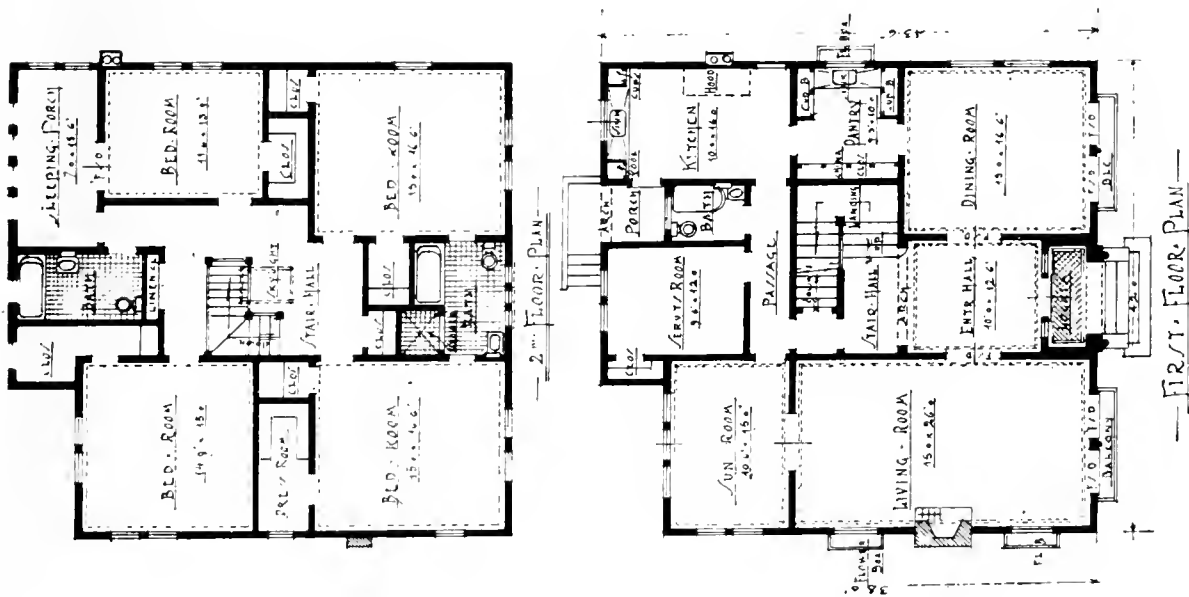

DESIGN BY MR. A. L. GREENE,  
 ARCHITECT,  
 SAN FRANCISCO, CALIFORNIA.  
 BUILT BY THE WOODBURN BUILDING CO.  
 PHOTOGRAPHED BY I. Scott, Photographer.

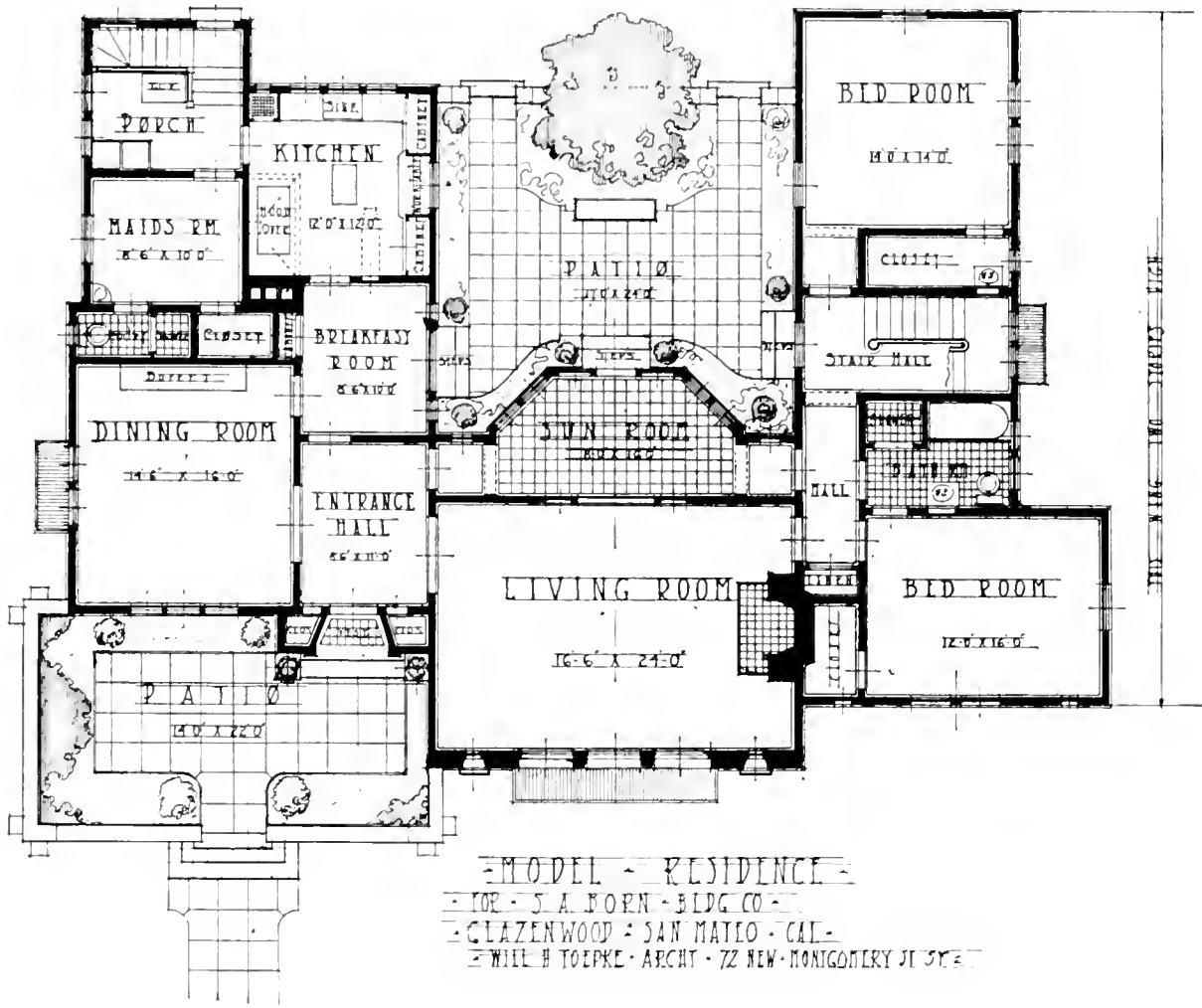

MODEL RESIDENCE,  
 GLAZENWOOD,  
 SAN MATEO, CALIFORNIA.  
 S. A. BORN BUILDING CO.  
 WILL H. TOEPKE, Architect.

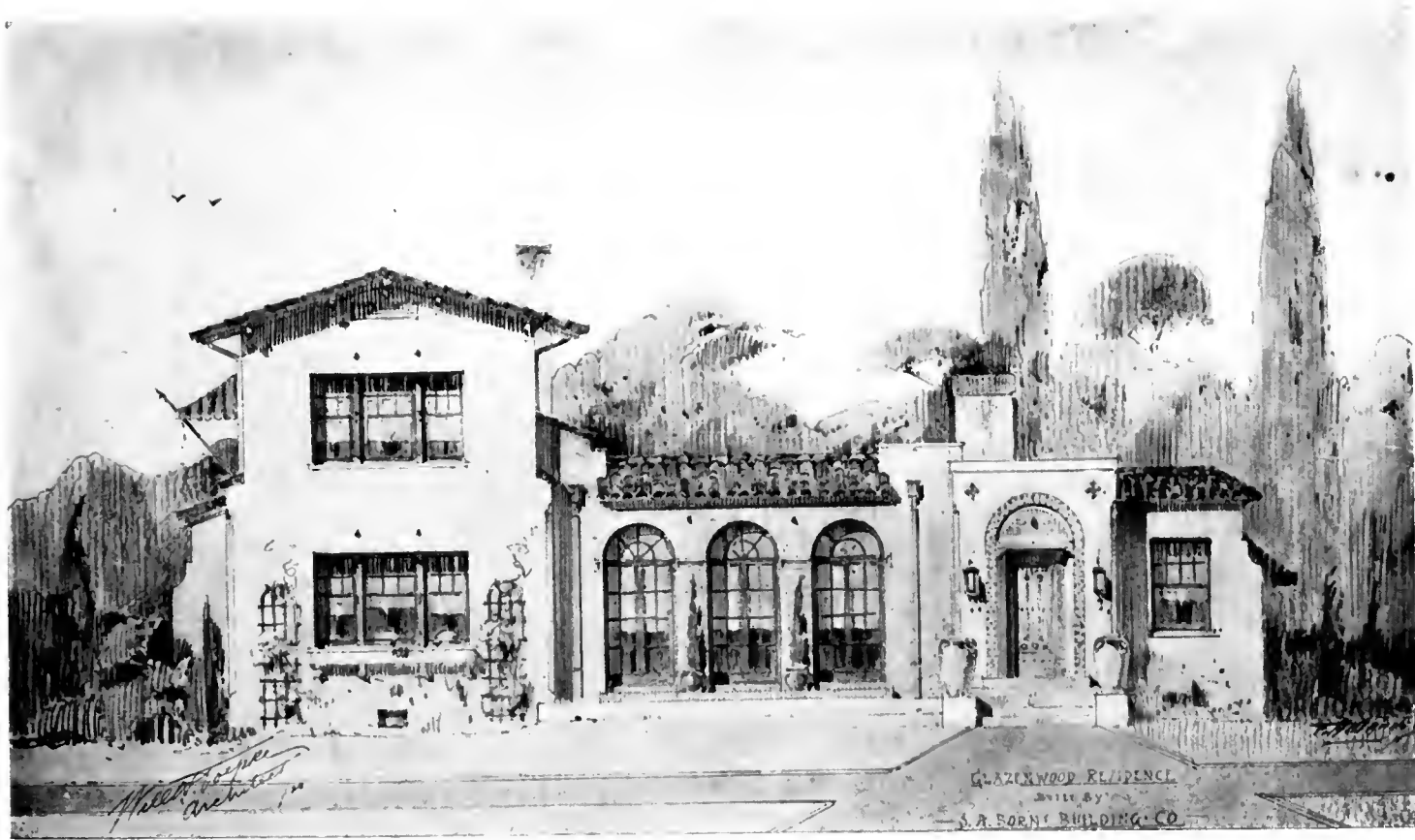
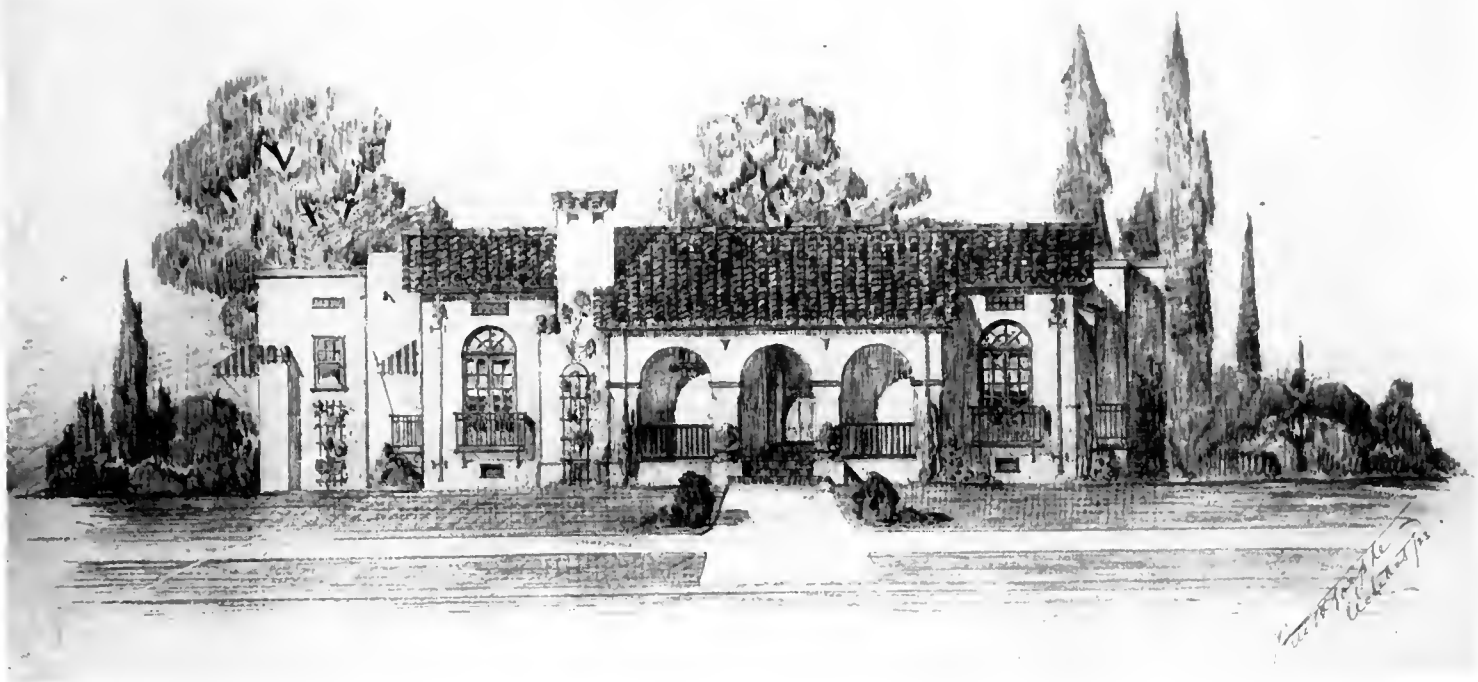

RESIDENCES,  
 GLAZIERWOOD,  
 SAN MATEO, CALIFORNIA.  
 S. A. BORN BUILDING CO.  
 W. H. TOEPKE, Architect.



RESIDENCES,  
ST. FRANCIS WOOD,  
SAN FRANCISCO, CALIFORNIA.  
S. A. BORN BUILDING CO.  
Albert Petersen, Photographer.

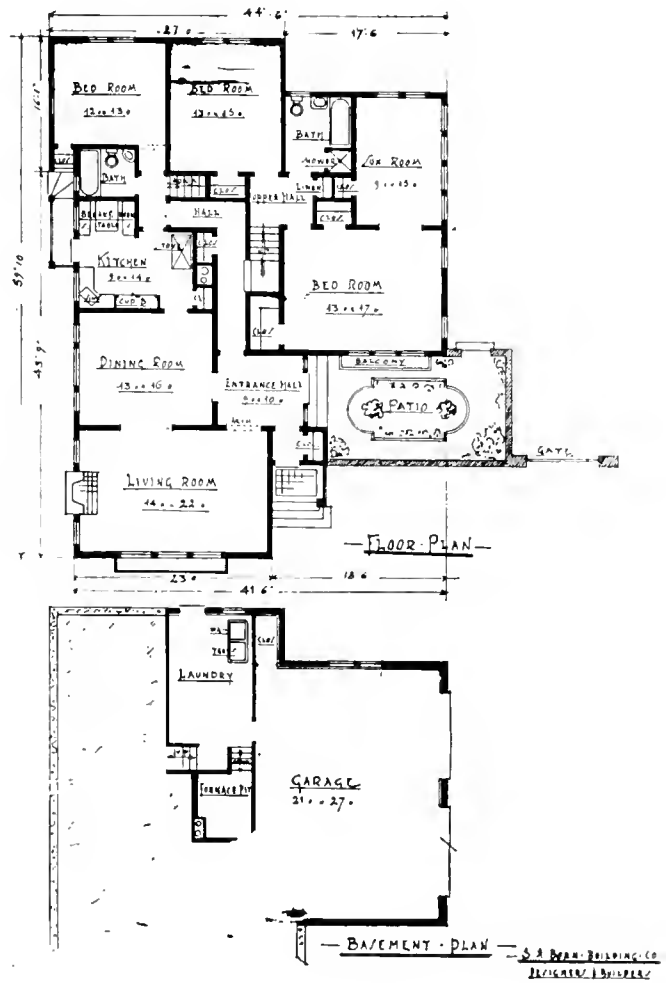

RESIDENCE OF MR. WM. RAPP,  
 SA MATEO, CALIFORNIA.  
 GLENWOOD,  
 S. BORN BUILDING CO.  
 Allt Petersen, Photographer.

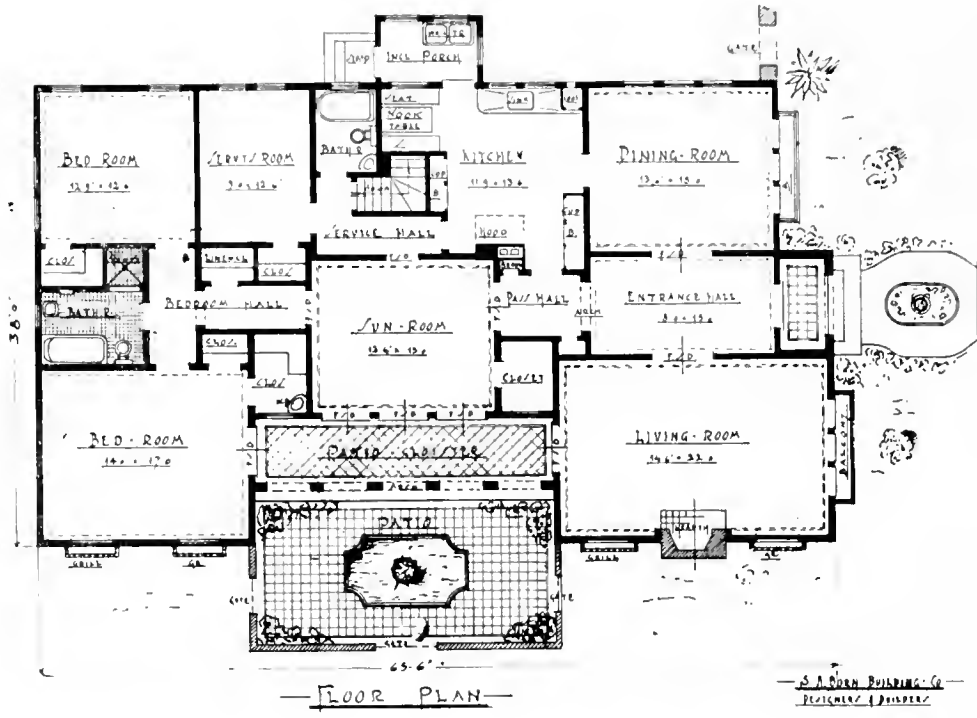

RESIDENCE OF MR. J. A. BERNHARD,  
GLAZENWOOD,  
SAN MATEO, CALIFORNIA.  
S. A. BORN BUILDING CO.  
Albert Petersen, Photographer.



RESIDENCE OF MR. J. A. BERNHARD, GLAZENWOOD, CALIF.

## CREDIT TO WHOM CREDIT IS DUE

By HARRIS ALLEN

During the last few years a number of houses have been built by a local building firm, the S. A. Born Building Co., in the Peninsula suburbs of San Francisco, which have excited much favorable attention. There is a consistent lack of pretentiousness, an attractive domestic quality, which runs through the entire output.

It is refreshing to find the work of a firm which is frankly designed for revenue, so free from the usual clap-trap of meretricious ornament and messy outline which usually is supposed to entrap the indiscriminating public, like a smear of honey to draw flies. On the contrary, there is, in general, a

feeling for quiet, restful lines and good proportions which is most creditable.

These houses are for the most part designed along Italian lines, although there are several of the attractive English cottage type. Stucco walls and tiled roofs predominate. They are fortunate in their settings of trees and lawns; the planting is uniformly good.

Since the work of such firms has a distinct place in the building industry, one which really does not invade the province of architecture as a profession, and yet bears a close relation, it is pleasant to be able to record the good points and the lack of glaring faults; this work constitutes a distinct advance in its line.



LIVING ROOM, RESIDENCE OF MR. A. L. GREENE, ST. FRANCIS WOOD, SAN FRANCISCO.





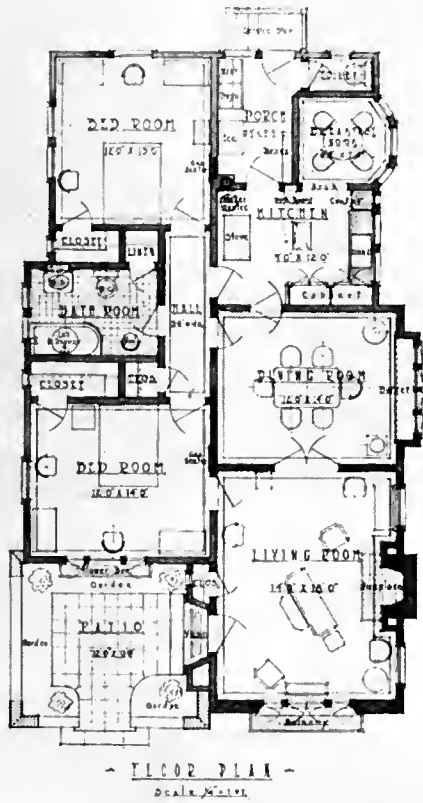
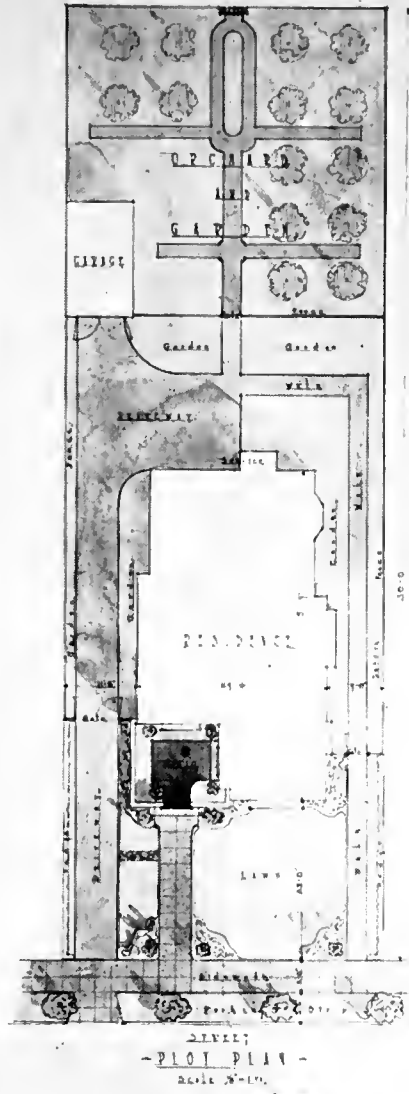

DESIGN SUBMITTED IN SANTA BARBARA  
SMALL HOUSE COMPETITION.  
WILL H. TOEPKE, Architect.

DESCRIPTION OF THE MODEL RESIDENCE BEING BUILT IN GLAZENWOOD, SAN MATEO, CALIF.

By WILL H. TOEPKE, Architect

The approach to the main entrance is through a gardened patio with a wrought iron gate and colored flagging, and upon entering the building to the left of the entrance hall we find the dining room, and to the rear, in the same wing is the servant's room, provided with tiled shower and toilet, service porch, kitchen and breakfast room. The breakfast room can be used as a serving room when the dining room is in use. The kitchen is provided with all modern conveniences with its tiled sink and drain-board, built-in cooler, ironing board, cabinet and work table and plastered hood over the range.

To the right of the entrance hall is a spacious living room with a large tile fire place. To the front of the living room is a triple sash leading to a metal balcony. To the rear of the living room is another patio, which is sheltered on three sides by the building and is approached from the living room through a sun room having a colored tile floor which also serves as a corridor from the entrance hall to the sleeping portion of the building. The rear patio will have tiled walks, stone benches, and will be attractively gardened. The open end of the patio will be closed by a garden wall and wrought iron gates, and in the center of the patio is a large camellia tree which has been on the property acquired for this model residence for years and will add considerable beauty to the place.

The sleeping portion of the building consists of two bedrooms and bath with tiled shower on the first floor, with a somewhat similar arrangement on the second floor, the only difference being that the front bedroom on the second floor has an open balcony, finished with a tiled floor.

The exterior of the building will be finished in cement stucco, blending three pastel colors. The entrance is to be ornamental cast stone and using cast cement ornaments throughout. The exterior is embellished in several places with wrought iron metal balconies and medium Cordova tile will be used on the roof.

Henry Weiss, president of the West Coast Porcelain Company, prior to leaving for the East recently, announced that this company, which has an investment of \$475,-

000 in its vitreous porcelain plant at Millbrae, on the peninsula south of San Francisco, has authorized expenditures for new machinery and equipment which will bring the total factory value up to approximately \$1,000,000.

The output under new conditions will be fully one car a day—a carload being equivalent to about 600 pieces of bathroom ware. Weiss states that the market developed for this product will fully absorb the increased output within the three coast states alone.

The directorate of the company includes Henry Weiss, president and manager; R. L. Dunn, president of the American Biscuit Company, vice-president and secretary; Moritz Thomsen, Seattle capitalist; and Henry Cartan, capitalist of Sausalito.

The Millbrae plant has been in operation five years, and has been largely instrumental in the development of the porcelain industry on this coast. Its plant is easily the most important of its kind in the West. The improvements have been compelled by the growth of demand for "West Coast" brand. The company will maintain its present high standard of output in the enlarged plant.

UNITED STATES CIVIL SERVICE EXAMINATION

The United States Civil Service Commission announces the following open competitive examination:

Architectural Draftsman

The examination will be held throughout the country on November 7 and 8. It is to fill vacancies in the Departmental Service, at entrance salaries ranging from \$1,500 to \$2,000 a year, plus the increase of \$20 a month granted by Congress, and vacancies in positions requiring similar qualifications.

Applicants must have been graduated in architecture from a technical school of recognized standing or have had at least five years' experience in progressive architectural office drafting work.

Competitors will be rated on the subjects of drawing and design; free-hand drawing, ornament, and projection; building materials and construction; and training and experience.

Full information and application blanks may be obtained from the United States Civil Service Commission, Washington, D. C., or the secretary of the board of U. S. civil service examiners at the postoffice or custom house in any city.

This  
label is our  
*guarantee*  
of quality



TRADE MARK REGISTERED

**PACIFIC**  
**PLUMBING FIXTURES**

PACIFIC SANITARY MANUFACTURING CO.  
Main Office: 67 New Montgomery Street, San Francisco  
Factories: Richmond and San Pablo, California

W.R.C.

NOTES OF SAN FRANCISCO ARCHITECTURAL CLUB

The San Francisco Architectural Club held a banquet at the Palais Royal on September 28th, to commemorate the 21st anniversary of the founding of the Club. All charter members and honorary members were invited as guests of the Club on this occasion, and the charter members at that time were presented with an appropriate token and a certificate of Honorary Membership.

The charter members of the Club are A. O. Johnson, August G. Headman, H. M. Smitten, George Wagner, H. G. Corwin, M. A. Sheldon, P. Brouchoud, H. E. Nye, F. J. Reinhardt, Wm. B. Betts, Arthur S. Bugbee, J. H. Ahnden, A. R. Johnson, F. A. Farnkopf, A. T. Ehrenpfort, E. G. Bolles, Fred C. Lebenbaum, T. Bearwald, and E. B. Scott. The two last named are deceased. Mr. August C. Headman acted as spokesman for the charter members, and gave an address on the early history and organization of the Club.

The honorary members of the club who were invited as special guests are Cass Gilbert, Irving K. Pond, Clarence R. Ward, John Reid, Jr., George W. Kelham, John Bakewell, Jr., Arthur Brown, Jr., and John Bauer. Messrs. Reid, Kelham, Bakewell, Brown and Bauer were all elected to Honorary Membership at a recent meeting of the Club.

This banquet was the biggest social event of the Club in recent years. A fitting and original entertainment was arranged, and speakers of ability responded to calls from the chair. Mark T. Jorgensen, president of the Club, presided.

\* \* \*

A very interesting excursion was made to the plants of the Paraffine Companies, Inc., at Emeryville on Saturday, September 15th, by members of the Club as guests of the company. Upon arrival at the plants a delightful luncheon was served, after which the guests were conducted through the plants where they learned much regarding the manufacture of paraffine products.

\* \* \*

Edward L. Frick is now patron of the Atelier and will continue as such during the ensuing year with the co-operation of Ernest Weiho. The students have done excellent work since Mr. Frick has had charge, and a good year is looked forward

to. The 1923-24 Atelier season opened Saturday, September 22nd, with an enrollment of about 15. In connection with this, a free-hand drawing class has been organized and Mr. Ralph Wilkins of the California School of Fine Arts has been secured to act as instructor. This class has started with a good enrollment, and it is intended to change to a Life Class, as soon as the present course is finished.

\* \* \*

The following members were elected at the last regular business meeting, September 5th: Clarence O. Peterson, Chris Mueller, Jr., Wilmoth D. Waterman, and Charles F. Cobblestick.

\* \* \*

An address by Supervisor Jas. B. McSheehy, of the Board of Supervisors of San Francisco, on the work recently completed by the city at Hetch Hetchy power site, was listened to with much interest by the Club members at a recent meeting. Mr. McSheehy, because of his position, was thoroughly familiar with his subject and its problems, and displayed great alacrity in dealing with pointed questions directed to him during the course of his remarks. It was learned during his talk that Mr. McSheehy was at one time a member of this Club, but he could not satisfactorily explain why he gave up his membership. A rising vote of thanks was tendered him at the conclusion.

\* \* \*

Important amendments to the Constitution and By-Laws were passed at the business meeting held August 1st. One of such amendments created a new class of membership to be known as "Student Members." Included in this class are any persons attending a school of architecture of recognized standing as a day student, such as the University of California, Stanford, etc. The dues are fixed at \$5.00 per year. This will enable many students of these schools to now join, who have heretofore found the dues for regular membership too high while they were trying to get their education. It is expected that a great number will take advantage of this new membership, so that they may have the privilege of joining the classes conducted by the Club.

Another amendment passed at the same meeting was one more definitely fixing the boundaries of the non-resident classification. Heretofore those living outside a radius of 50 miles of San Francisco were eligible for non-resident membership, but on account of the difficulty of determining

a 50-mile radius, it was changed to extend this privilege to anyone living outside of San Francisco, San Mateo, Alameda and Marin Counties. It is necessary that his place of business also be outside these counties.

One of the outstanding features of building construction in Utah this year is the erection of the new Continental National Bank Building at Second South and Main Streets. The building will be ready for occupancy about April 1st of next year.

Steel work is now completed. Concrete, granite and brick work is under way. The new building will be modern in every detail and will be particularly inviting because of the high airy rooms. The exterior will be of terra cotta with imitation granite finish and brick to match. The managers of construction, the P. J. Walker Company, have had charge of many of the large buildings erected on the Pacific Coast within the last few years and state that the Continental National Bank Building will compare favorably with any they have supervised. The exterior will be similar in design to the

Standard Oil Building in San Francisco, as far as materials are concerned.

The foundation extends into the ground thirty-four feet, and will house the safe deposit vaults of the bank. The main and mezzanine floors will contain the banking quarters and general offices of the bank. In the remaining stories there will be approximately 275 rooms for use as office space. Indications are that practically every room will be leased before the building is completed. The architect is George W. Kelham, with Fred A. Hale, associate.

The Continental National Bank as now constituted represents the consolidation of the National Bank of the Republic and the Continental National Bank. The consolidation became effective October 2, 1922, just as the dismantling of the National Bank of the Republic building was started. The effects of the National Bank of the Republic were moved to quarters of the Continental National Bank on East Second South and the consolidated business has been carried on in those quarters since, and will be continued until the completion of the new building.

---

# MACRORIE-McLAREN COMPANY

---

Landscape Engineers  
and  
General Nurserymen



Suite 301 Phelan Building  
Telephone Douglas 4442  
SAN FRANCISCO, CAL.

Nurseries at  
Beresford, San Mateo Co.  
Telephone San Mateo 1002

## JAPAN FACES GIGANTIC BUILDING PROGRAM

Half a Million Edifices, Mostly Homes, to Be Reconstructed. Will Create Great Demand for American Lumber, Already Very Popular in the Mikado's Empire.

HOUSING operations as America knows them even in war times, appear insignificant beside the scope of the building operations Japan now faces in reconstructing the great cities of Tokyo and Yokohama, says the Far Eastern Division of the Department of Commerce. The latest reports place the destruction of buildings in the devastated areas at 316,000 in Tokyo, or about 71 per cent of the total number in that city, while in Yokohama out of the 85,000 buildings standing before the disaster only 15,000 are left intact. The destruction in the outlying districts may bring the total of buildings destroyed up to the half million mark, the large majority of which are homes. This number, added to the housing shortage that existed in Japan before the earthquake, will necessitate the construction of dwelling houses on a large scale. Since Japan normally looks to the United States for about 60 per cent of its lumber requirements it is expected that the demand for American lumber during the reconstruction period will be very heavy.

The price of Japanese lumber delivered c. i. f. Yokohama or Tokyo has been approximately 20 per cent higher than that of similar qualities of American lumber, and American freight rates have been favorable. The American market also finds itself in a favorable position as regards delivery. It often happens that the Japanese importer can secure delivery from Pacific ports to Yokohama in less time than from Hokkaido, Karafuto, or even from the northern Provinces of Japan proper.

Japan's preference for American lumber, aside from the price consideration, is due, perhaps, more than anything else to the fact that our lumber is more nearly like that of Japan proper than the product of any other country from which it draws wood supplies. This similarity of wood makes it possible for Japanese builders to substitute American lumber for Japanese in all building projects. In fact, its use has become so universal that American lumber is now specified in many instances.

The principal lumber imports of Japan consist of fir, hemlock, pine, and cedar, about half of which is imported in large squares of from 12 to 24 inches and a lesser amount in small squares of 4½ by 4½ inches. The large squares are worked up in the local mills and carpenter shops into the different shapes required for general building, while the smaller squares are used as studs for holding up roofs and for supporting beams. The large squares are very popular among builders in Japan, and can only be obtained from America.

At the time of the disaster stocks of lumber in Japan were quite large, especially in Kobe, Osaka, and Tokyo. Assuming that all the stocks in Yokohama and Tokyo were destroyed, it is seen that there is still a fairly good supply on hand for immediate emergency purposes. The real demand will come when the permanent construction of the devastated areas commence. The requirements for home building will no doubt be satisfied first and will take the largest share of the lumber imports.

In rebuilding the residential sections of the cities which were visited by the disaster every economy will be practiced and the use of wood will be limited in every possible way. Despite these attempts to save, large quantities of lumber will be needed.

Piling will be required in large numbers for reconstructing the destroyed docks and waterside warehouses and sheds in Yokohama and Tokyo, as well as for building subfoundations for industrial buildings, bridges, and construction work in general. The city of Tokyo for some time has contemplated the widening and straightening of its narrow, crooked streets, and many have already been designated for this improvement. This plan will no doubt be carried out in the reconstruction program and the widening of the streets will require enormous quantities of paving blocks. Douglas fir has been used almost exclusively in the paving program of Tokyo.

It is reported that plans are being made to rebuild Tokyo and Yokohama along modern lines, conforming with the construction of the Western World as closely as possible. It is certain, however, that in a short time better and finer cities will rise from the ashes of Tokyo and Yokohama, and that they will regain the prominent positions in Japanese affairs that they enjoyed before the disaster.



THOUSAND OAKS SCHOOL,  
BERKELEY, CALIFORNIA.

AUDITORIUM ROOFED WITH  
SIMONS LARGE SPANISH BURNED CLAY ROOFING TILE.

Wm. C. HAYS, Architect.

**FIREPROOF AND PERMANENT**

# Burned Clay Roofing Tile

“THE EVERLASTING MATERIAL”

When you require a real  
**GOOD ROOF**

which also carries the qualifications of  
Strength, Durability, Beauty,  
*specify:*

**Red Interlocking Spanish Tile**

**SIMONS BRICK COMPANY**

Manufacturers

Walter R. Simons, President and Gen'l Manager  
West Third Street

Los Angeles

1744 Folsom St.  
SAN FRANCISCO  
Phone Market 2273

**J. A. DRUMMOND**  
Contractor and Distributor

2225 Fresno St.  
FRESNO  
Phone 4073

845 Seward St.  
LOS ANGELES  
Phone 433-929

When Writing to Advertisers Please Mention This Magazine.

## SAN DIEGO SEEKS NEW INDUSTRIES

San Diego's industrial and commercial outlook has been measurably brightened by the setting aside of approximately 1000 acres of land, which it is specifically stated is to be reserved exclusively for industrial purposes. This tract of land, acquired by popular subscription on the part of the San Diego business men, in co-operation with the Chamber of Commerce, borders the shores of San Diego Bay. The tract is served by two transcontinental railroads and is being held for sale to industries at prices far below its present market value. These industrial sites are proving very attractive to potential industries and have elicited many inquiries.

San Diego's steady growth as a shipping point is illustrated by the port statistics of the present year, when material increases in valuation of exports, imports and customs duties were recorded, despite the fact that pierage and storage facilities were inadequate, as a consequence of which a considerable amount of cargo, which otherwise would have been handled through this harbor, was diverted to other ports.

The problem of adequate pierage and storage facilities is now well towards solution through the construction of Municipal Pier No. 2, just north of Pier No. 1, at the foot of Broadway. The new pier will be 1000 feet long and 400 feet wide.

Building permits for 1922 exceeded \$10,000,000, the highest total recorded in nearly ten years. Permits for the first eight months of 1923 exceeded by nearly \$1,500,000 the value of permits issued during the same period of the previous year. It is predicted the year's total will be in excess of \$12,000,000.

A manufacturing survey made by the Chamber of Commerce early this year produced the following figures: Number of factories, 249; total capital invested, \$33,626,803; value of finished product, \$28,000,000.

### Stillwell PLAN BOOKS of CALIFORNIA STYLE All Climate HOMES

—show pictures, Floor Plans and Estimated Costs of Building over 200 Selected Designs.

"West Coast Bungalows"  
50 Houses—6 and 7 Rooms—\$1  
"Little Bungalows"  
75 Houses—3-4-5 Rooms—\$1.

SPECIAL OFFER: Send \$2.50 for any three of these books and get Garage Folder FREE.

Books and Blueprints sold with Money Back Guarantee

E. W. STILLWELL & CO., 790 California Building, Los Angeles



"Representative California Homes"  
50 Houses—7 to 10 Rooms—\$1.

"The New Colonials"  
60 Houses—6 to 10 Rooms—\$1.

# Boiler Plate Furnaces Don't Crack!



*All that remains of Prof. E. A. Lee's Home  
1562 Le Roy Ave., Berkeley, Cal.*

Telephone  
Thornwell 70

Building  
Designing  
Financing

## ROY O. LONG COMPANY

REAL ESTATE **ROY O. LONG** INVESTMENTS

PROPERTY MANAGEMENT

2114 Shattuck Avenue

Berkeley, Cal.

October 8th 1923.

M. F. Murray Co.,  
226 Webster Street,  
Oakland, Calif.

Gentlemen:-

This is to advise that the American Riveted Steel Furnace that was placed in Prof. E.A. Lee's home last year by you, went through the fire with very little damage.

Nearly all of the house fell in on the furnace burying it completely. When the property was finally cleaned off it was found that the riveted steel drum was in perfect condition, except for re-cementing the joints. The exterior casing was the only part that was really damaged. This will mean quite a saving to Prof. Lee in re-establishing his residence. We are authorizing you to get the furnace from the ruins, and proceed to get it ready for the new house.

This certainly speaks well for the American Furnace, when on close examination of other makes throughout the burned district showed them completely gone except for a pile of scrap iron.

It is a pleasure to know that we specified the American Furnace in Prof. Lee's home, and rest assured that we shall specify them in the future.

Prof. Lee's home was designed and built by this company, and we are to proceed re-building his home at once.

Yours very truly,

*William K. Partee*

W.K.B. H.K.

Architectural Designer.

## MURRAY & CO.

Heating Specialists

226-230 Webster St.

Oakland, Cal.

"We co-operate with the Architects"



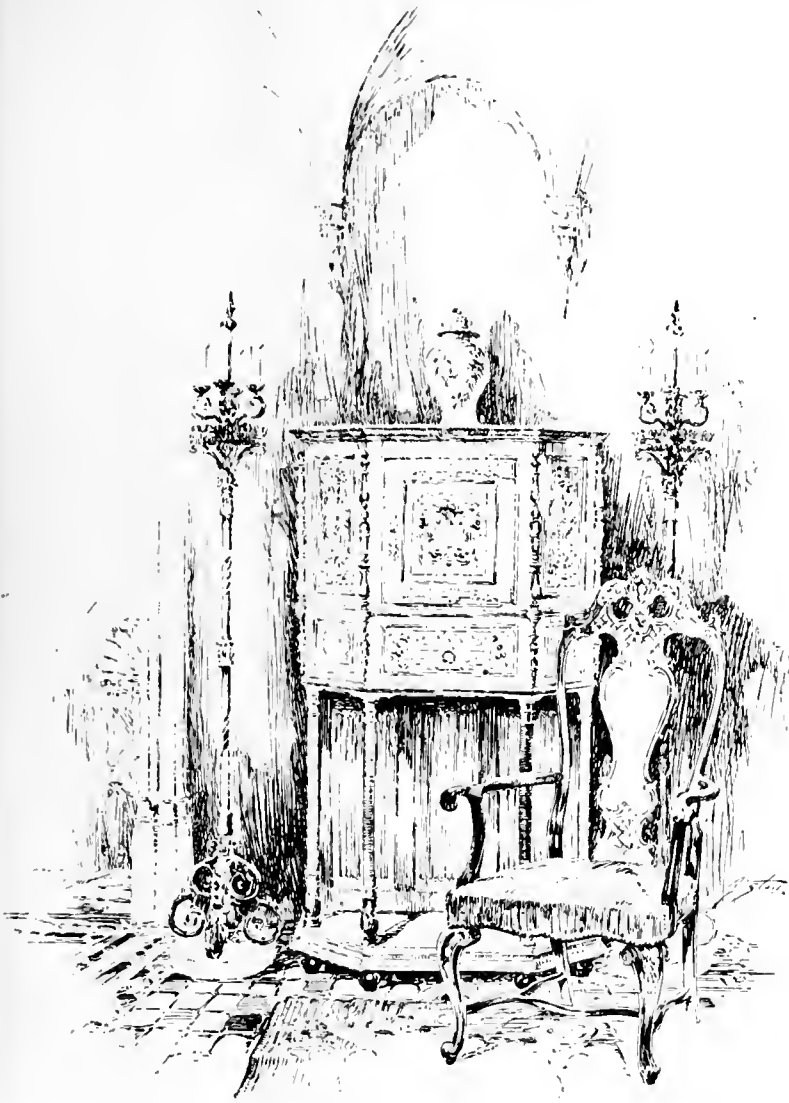

## Individuality

finds expression in all of the merchandise displayed by the John Brenner Co. of San Francisco.

—It is a fact that its unusual character is the result of fine judgment exercised by personal selection in a careful and persistent research in the great markets and exclusive cabinet shops of the east.

—The finest examples of Italian, French, Spanish and English Renaissance furniture combined with a moderate price range are outstanding characteristics of this store and its mammoth stock.

—The knowledge and genius of skilled colorists and decorators are available to solve your home-furnishing problems without cost. Window draperies and hangings you pay only for materials purchased and cost of making.

*John Brenner Co.*  
of *San Francisco*

GEARY ST., bet. Powell and Stockton

Furniture, Floor Coverings, Draperies, Decorators

All Hardware and Building Materials

Furnished By

WISNOM, BONNER HARDWARE CO.

San Mateo and Burlingame, California

# A. J. Ruhlman & Co.

## Wholesale and Retail

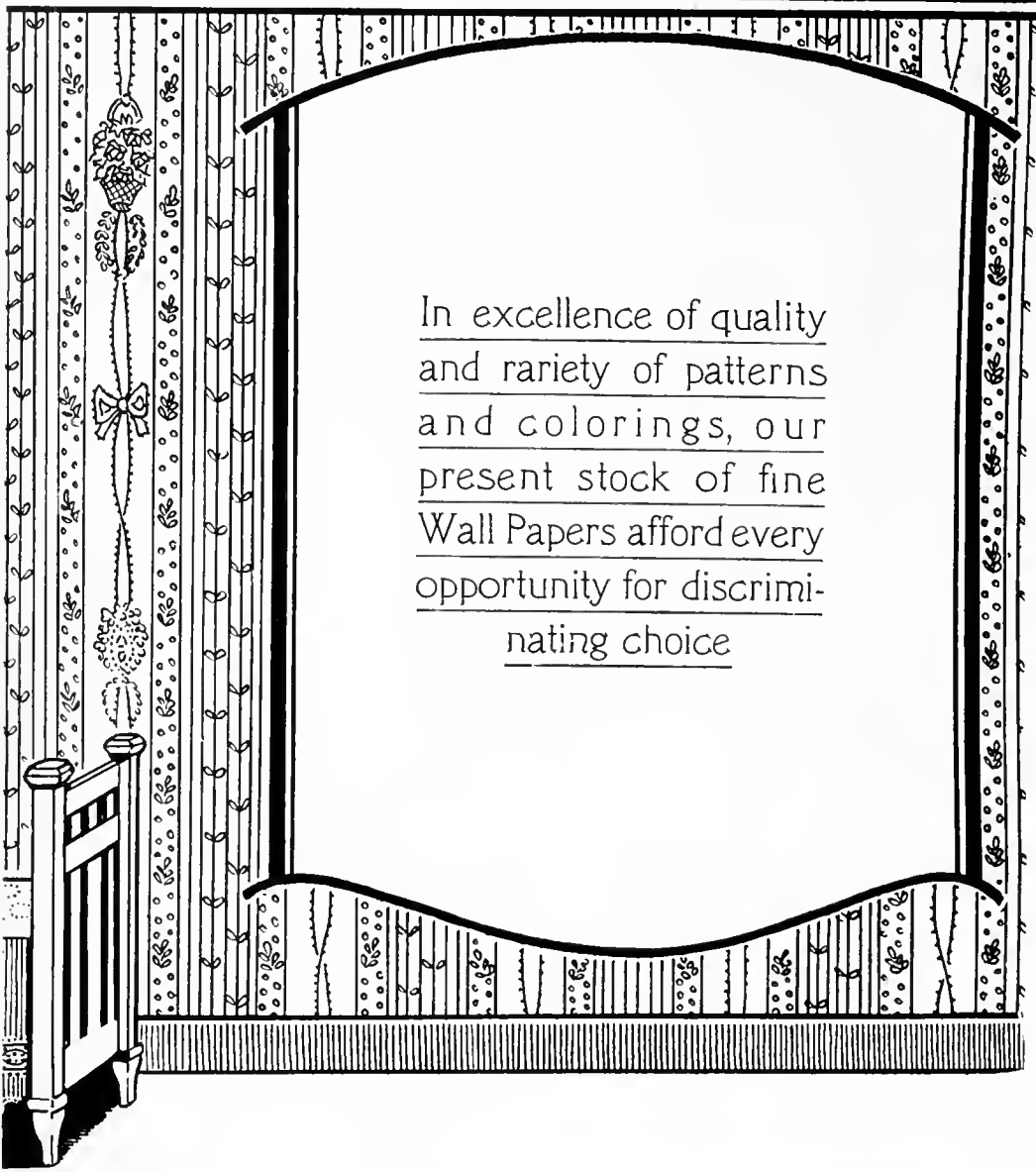

### Wall Paper

### Window Shades

## A. J. RUHLMAN & CO.

256 Sutter Street  
2nd Floor

San Francisco, Cal.  
Phone Kearny 2052

PHONE SAN MATEO 173 and 99

### San Mateo Planing Mill Co.

# LUMBER

MILLWORK  
DOORS  
WINDOWS  
SCREENS  
SHINGLES

WALL BOARD  
RUBEROID ROOFING  
LIME  
CEMENT

BRICK  
SAND  
GRAVEL  
ROCK  
LATH

SAN MATEO, CALIF.

### GARDENING OF OUR COUNTRY HOMES

(Continued from Page 40)

dollars. Our pansies and violas are in full bloom all winter long and we are able to have winter blooming sweet peas and stocks out of doors during all seasons, while the Crocus, the Daffodil and Hyacinth come in bloom during the month of January, if set out early in the Autumn.

The Japanese flowering Quince (*Cydonia Japonica*), both in pink and red, appears in bloom during the early part of January and continues during January and February. Both varieties are very striking and very handsome, and are especially useful as cut branches for vase work; the bright colored flowers showing off to most excellent advantage against the dark green foliage.

*Prunus pissardi*, the purple leave plum, is another very striking feature of our California landscape during the month of January. In this variety the flowers appear before the leaves, but the small white flowers, delicately tinged with pink, come in such profusion that the tree is a solid mass of beautiful blossoms so that the absence of foliage is not noticeable.

(To Be Continued)

## WESTERN PACIFIC BUILDS UP

Work on the new Stockton yard of the Western Pacific is progressing rapidly and by November 1st there will be laid ten miles of track, capable of accommodating 4000 freight cars. These facilities will make it one of the largest yards in California.

Along with this project goes an icing plant for refrigerator cars, constructed by the Valley Ice Company, with a production capacity of 150 tons a day and so arranged that it will be possible to ice 50 cars at a time. This represents an expenditure of \$1,500,000.

Testifying further to the Western Pacific's faith in Stockton is its expenditure of more than \$300,000 in tapping the north side of the Stockton waterfront with a spur track. In order to reach this section it was necessary to circle the northern part of the city. Constructing some six miles of track and requiring the purchase of an expensive right-of-way.

A new one-story business block has been started in Stockton at the corner of Channel and Sutter Streets to cost \$35,000. The building is being erected by Dr. Edward Cureton and the Architect is Glenn Allen. It is planned to make the structure five stories eventually.

John Galen Howard, architect, announces his association with E. Geoffrey Bangs, Henry C. Collins, Henry Temple Howard and Charles F. B. Roeth, architects, for the practice of architecture under the name of John Galen Howard & Associates, architects, First National Bank Building, San Francisco.

## NEW INDUSTRIES AID OAKLAND

With the addition of the California Body Building Company's plant, Oakland makes a further advance as the automobile center of the West.

Oakland now has the distinction of being the chief producer of automobiles on the Pacific Coast.

This Body Building Company has purchased a site. It will manufacture bus bodies to supply the needs of its huge fleet of passenger carrying coaches.

The building will have a total floor space of approximately one and one-half acres, with 43,750 square feet on the first floor.

In addition to manufacturing cars for its own use they will produce bodies for both pleasure and commercial vehicles.

In directing attention to the importance of the stage lines to Oakland, Mr. Travis, president of the company, points out that the two principal companies operating out of Oakland pay into this community \$900,000 a year in salaries and operating expenses. The plant will give employment to 160 additional men, adding materially to this already large figure. When completed, their building, machinery and equipment will represent an investment of approximately a quarter of a million dollars.

\* \* \*

The new home of Montgomery Ward & Company is now near completion and will be ready for occupancy before the end of the year. The building is eight stories in height, and is one of the most modern structures of its kind in the Bay district.

\* \* \*

The Pacific Spring Bed Company has purchased three acres on the east side of East Tenth Street and the Southern Pacific main line and on this property will begin manufacturing at an early date.

## Pacific Manufacturing Company

Branches:

117 Stevenson St.  
SAN FRANCISCO

Manufacturers of and Dealers in

### Doors, Windows and Mouldings

General Millwork

1001 Franklin St.  
OAKLAND

Branches:

908 Washington Bldg.  
LOS ANGELES

58 West Santa Clara St.  
SAN JOSE

Factory and Main Office: Santa Clara, Calif.

## SAN JOSE PROVES PROSPERITY

Building activity in San Jose and throughout Santa Clara County continues unabated and the city is steadily growing in population and business, as shown by the building permits, the increased attendance in the schools, the increasing postoffice receipts, the increasing street car traffic (in spite of the fact that there is one automobile to every five residents in the county), the numerous additional electric fixture placements by the local gas and electric company, and other evidences of growth. A close estimate of the present population of San Jose is 67,000. Up to October 1, the 1923 building permits exceed the aggregate for the entire year of 1922, being \$2,211,750 as against \$1,967,720 for all of 1922, in which year the construction cost exceeded the total for 1921 by more than half a million dollars. That local business is increasing at a corresponding rate is indicated by the fact that although the clearings for the six San Jose banks in 1922 were \$118,511,851, the largest in the history of the city, the clearings for 1923 up to October 4 inclusive of latter date were \$9,244,190 greater than the clearings up to the corresponding date in 1922.

## NOBODY TO GUIDE THEM

Julius H. Barnes has cited ten production records that have been recently broken. One of them was the largest residential construction in our history.

That thousands of these home builders know nothing of the comfort and convenience of oil heating is not surprising. Successful domestic oil burners are not old enough to have their merits universally known. Many—yes, most—architects' offices are a deep well of ignorance concerning home oil heating. Literally hundreds of home builders are asking these architects for advice about putting an oil burner in the new home. But they are asking for bread, and getting a stone.

"Yes," said an architect, "we're having a number of inquiries about oil burners now."

"How do you answer them?" we asked.

"Well we rather pass the burden of getting the information back to them." If the architect is satisfied with that kind of professional service, there seems but one sure means of getting the story of the oil burner to the home builder. It is through affiliated publicity on the part of the burner makers.

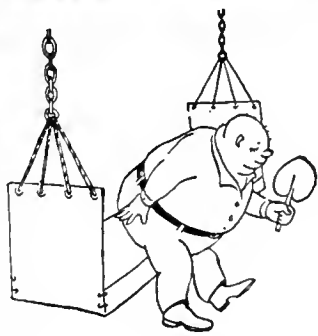

## "A Chain is as Strong as its Weakest Link"

THE material to be used for such small items as valleys, gutters and flashings, is too often given scant consideration, and yet, no matter what material is used for the roof proper, the complete roof will only be as strong as its valleys and gutters.

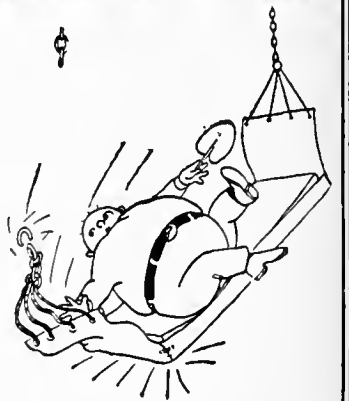

## TARGET AND ARROW

Look for this Trade  Mark on every Sheet

### ROOFING TIN

is the ideal valley, gutter and flashing material—light, strong, flexible, it can be finished in any desired color.

Do not be misled by unsupported claims and similar appearances, for although there are innumerable copies of Target and Arrow on the market today, the genuine is easily identified by the trade name and trade mark shown above.

## N. & G. TAYLOR CO.

Offices: Philadelphia, Pa.

Mills: Cumberland, Md.

Established 1810

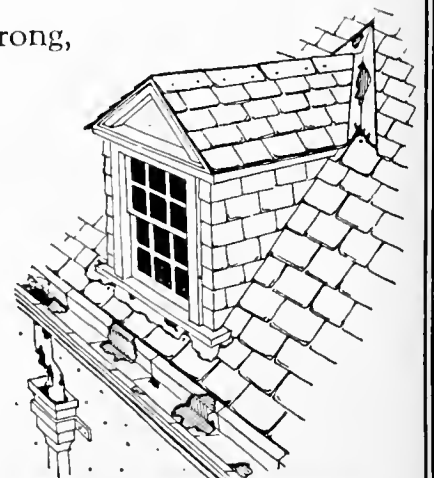
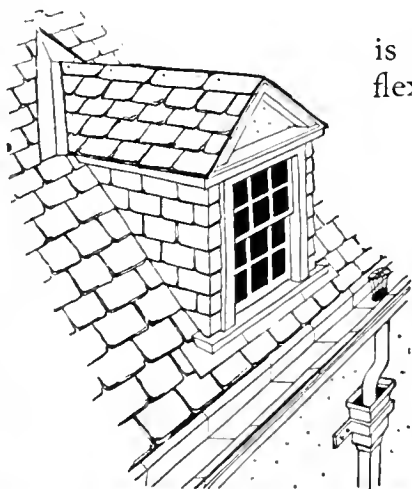

## PREPARED ROOFING SIMPLIFIED

At a meeting held at the Department of Commerce with representatives of the Division of Simplified Practice and the Chamber of Commerce of the United States, manufacturers, distributors and consumers of prepared roofing agreed to the following simplifications as being of benefit not only to the industry but also to the public at large:

1. To eliminate all grades or kinds of slate-surfaced and also stone-surfaced prepared roofing that do not measure up to the requirements of the "Class C Label" of the Underwriters Laboratories.

2. To reduce the varieties of smooth surface roofing to seven lines or grades—weights and qualities being considered.

This Simplified Practice Recommendation is to become effective January 1, 1924, and is to hold for one year.

According to Wm. A. Durgin, chief of the Commerce Department's Division of Simplified Practice, this is another step in the general program fostered by Secretary Hoover for the elimination of waste in industry. "The proposed eliminations," he said, "were strongly supported by the American Institute of Architects, the National Retail Hardware Association representing 21,000 retail hardware dealers throughout the United States, the National Retail Lumber Dealers' Association, the Southeastern Builders' Supply Association, and the Prepared Roofing Association."

Prepared roofing is a product used all over the world, not only as a roofing material, but in cane fields and elsewhere for keeping weeds down and retaining moisture and warmth.

It is believed this program will bring many economies to the manufacturers, such as decreased idle stocks, less idle investment, and ultimately lower production costs, and benefit the distributors by stimulating turnover and increasing sales. Consumers will also benefit in due time through better quality, better prices, and quicker service. Several other simplifications of building materials have been completed, notably common and face clay brick. Others in process of completion are lumber, hollow building tile, cement brick, block and tile, clay drain tile, etc. All of these simplifications are contributing to the general effort to reduce the needless wastes in the building field, and thus forward the achievement of the ideal now so prominently before the public—"Better Homes at Lower Cost."

## STATEMENT OF OWNERSHIP, MANAGEMENT, CIRCULATION, ETC., REQUIRED BY THE ACT OF CONGRESS OF AUGUST 24, 1912.

Of The Building Review, published monthly at San Francisco, Calif., for October 1st, 1923.

State of California, County of San Francisco—ss.

Before me, a Notary Public, in and for the State and County aforesaid, personally appeared Howard Hoyt, who, having been duly sworn according to law, deposes and says that he is the Business Manager of The Building Review, and that the following is, to the best of his knowledge and belief, a true statement of the ownership, management (and if a daily paper, the circulation), etc., of the aforesaid publication for the date shown in the above caption, required by the Act of August 24, 1912, embodied in section 443, Postal Laws and Regulations, printed on the reverse of this form, to-wit:

1. That the names and addresses of the publisher, editor, managing editor, and business managers are:

Publisher, The Building Review Publishing Company, San Francisco.

Editor, Harris Allen, 426 Chronicle Building, San Francisco.

Business Manager, Howard Hoyt, 426 Chronicle Building, San Francisco.

2. That the owner is: (If the publication is owned by an individual his name and address, or if owned by more than one individual the name and address of each, should be given below; if the publication is owned by a corporation the name of the corporation and the names and addresses of the stockholders owning or holding one per cent or more of the total amount of stock should be given.)

Harris Allen, 426 Chronicle Building, San Francisco.

A. Hoffman, 345 Battery Street, San Francisco.

3. That the known bondholders, mortgagees, and other security holders owning or holding 1 per cent or more of total amount of bonds, mortgages, or other securities are: (If there are none, so state.)

None.

4. That the two paragraphs next above, giving the names of the owners, stockholders, and security holders, if any, contain not only the list of stockholders and security holders as they appear upon the books of the company but also, in cases where the stockholder or security holder appears upon the books of the company as trustee or in any other fiduciary relation, the name of the person or corporation for whom such trustee is acting, is given; also that the said two paragraphs contain statements embracing affiant's full knowledge and belief as to the circumstances and conditions under which stockholders and security holders who do not appear upon the books of the company as trustees, hold stock and securities in a capacity other than that of a bona fide owner; and this affiant has no reason to believe that any other person, association, or corporation has any interest direct or indirect in the said stock, bonds, or other securities than as so stated by him.

5. That the average number of copies of each issue of this publication sold or distributed, through the mails or otherwise, to paid subscribers during the six months preceding the date shown above is (This information is required from daily publication only.)

HOWARD HOYT, Business Manager.

Sworn to and subscribed before me this 15th day of October, 1923.

(SEAL)

LOUISE BEARDEN.

(My commission expires May, 1925.)

## PROF. GREGG PREPARES PLANS FOR NEW TOWNSITE

Professor John William Gregg, Member of the American Society of Landscape Architects and Landscape Architect with the University of California, has recently prepared preliminary plans for the development of the new townsite of Ballico, for the California State Land Settlement Board.

Professor Gregg has recently returned to the University from a year's leave of absence, a part of which was spent in studying City and Town Planning in different European countries.

PHONE FRANKLIN 2492

A. C. WOCKER

INTERIOR DECORATOR

1370 SUTTER STREET

SAN FRANCISCO, CAL.

## SIMPLIFIED HOSPITAL BEDS

The hospitals of the United States and Canada spend over \$500,000,000 a year for supplies and equipment. The expenditure of this huge sum calls for considerable planning and forethought as to varieties, types, and kinds selected, for not only are many new hospitals being built, but many of the present ones are expanding their facilities to meet the needs of our growing population.

The American Hospital Association is especially interested in the economies its members might obtain through using the services of the Division of Simplified Practice of the United States Department of Commerce toward eliminating superfluous and non-essential varieties in the things they buy for hospital service. The Association through its executive secretary, Dr. A. R. Warner of Chicago, has asked the Department of Commerce to aid in its efforts to secure greater economy in purchasing hospital management by bringing before the manufacturers and distributors of hospital supplies and equipment the need for curtailing present variety in sizes and dimensions of many of these items. Beds in par-

ticular afford a very good example for simplification. Not only do lengths and widths vary greatly, but heights from floor are not at all standard, and this is an important item in the careful handling of patients.

Miss Margaret E. Rogers, superintendent of the Lafayette Home Hospital of Lafayette, Indiana, who is also chairman of the Committee on General Furnishings and Supplies for the American Hospital Association, has been appointed as Secretary Hoover's representative to make a survey of existing varieties in sizes and dimensions of hospital beds. Miss Rogers is canvassing the hospital superintendents as well as the manufacturers for the data necessary for the presentation of a complete report on this subject to the Secretary of Commerce. The report will provide the basis for the eliminations deemed advisable in the best interest of all concerned and thus aid materially in developing a simplified line of standard sizes which will be readily procurable in peace, or war, or in case of great disasters, and which, by reason of their production in greater quantities than present diversity now permits, can be obtained for relatively lower cost.

# The De Luxe Automatic Water Heater

EXTERIOR WHITE

INTERIOR RIGHT

"A Water Heater Masterpiece"

Specified and Used in the Homes Built by S. A. Born Building Co.

For years the discriminating Architect and Home Builder has been searching for an Automatic Water Heater which would not only be durable and perfect in operation, but which would be an ornament to the kitchen as well. This is now available to them in the **De Luxe Automatic**—a heater of dazzling beauty, encased in a smooth, glossy white enameled jacket insuring perfect insulation.

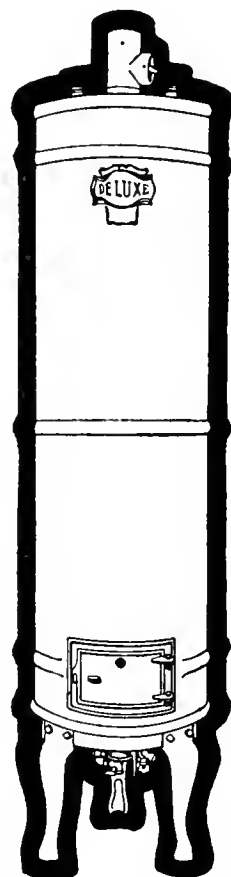

The simplest and most economical automatic water heater on the market. Highly efficient. Supplies Hot water at all fixtures for any purpose. Has no copper coils to be replaced. Burners will not rust nor corrode. **The De Luxe Automatic** is thermostatically controlled. Furnishes Hot water at the turn of the faucet at any time, night or day.

The **De Luxe** is moderately priced and backed with a first-class guarantee covering workmanship and material.

See it on Display and in Operation at

## General Water Heater Sales Co.

Exclusive Agents in the Bay Districts

77 O'Farrell Street

3rd Floor Phone Sutter 5333

SAN FRANCISCO, CAL.

Manufactured by  
**General Water Heater Corp.**

Sixteenth and Hooper Avenue

LOS ANGELES, CAL.

SAN FRANCISCO  
PUBLIC LIBRARY

# *THE BUILDING REVIEW*



*NOVEMBER, 1923*

*Vol. XXIV No. 5*

*Published in San Francisco*

*Price Twenty-five Cents*



APARTMENTS, 775 GEARY ST.,  
SAN FRANCISCO, CALIF.

J. E. HANSON,  
Painter and Decorator.

D. E. YOUNG, Architect,  
SAN FRANCISCO, CALIF.

FINISHED THROUGHOUT WITH

WHITE

*Kyanize*  
KY-AN-IZE

ENAMEL

Office and Warehouse  
1151 MISSION STREET  
SAN FRANCISCO, CALIFORNIA  
A. L. GREENE, Local Manager

*Boston Varnish*  
Company  
KY-AN-IZE

Distributors for Southern California  
SUNSET PAINT COMPANY  
627 SOUTH MAIN STREET  
LOS ANGELES, CALIFORNIA



# THE BUILDING REVIEW

Vol. XXIV

NOVEMBER, 1923

No. 5

## CONTENTS

COVER--ENTRANCE DETAIL "EL ZENZONTLE" APARTMENTS,  
BERKELEY, CALIFORNIA.

### PLATE SECTION

	Plates
"CASTLE REA VILLA" APARTMENTS, Berkeley, California. W. J. Wilkinson, Architect .....	57-59
RESIDENCE OF MR. R. H. HUBBELL, San Francisco, California. Ashley and Evers, Architects .....	60-64
"EL ZENZONTLE" APARTMENTS, Berkeley, California. A. M. Milwain, Architect.....	65-68

### TEXT

	Page
AERO-PHOTOGRAPHY, by George E. Russell.....	49
GARDENING OF OUR COUNTRY HOMES, by Donald McLaren. (Continued from the October issue).....	52
"EL ZENZONTLE APARTMENTS," a California Court, by Clara Fassett .....	55
MINUTES OF THE SAN FRANCISCO CHAPTER, AMERICAN INSTITUTE OF ARCHITECTS .....	56
SAN FRANCISCO ARCHITECTURAL CLUB NOTES.....	58
EVERY KNOB A POINT OF INTEREST, by Marjorie Spencer.....	60

### INDUSTRIAL DEVELOPMENT

NOTES ON LIGHTING .....	3
TESTS OF "COMPOSITION" FLOORS AND STUCCOS.....	13
SMALL BRICK HOUSE COMPETITION.....	14
UNITED STATES DEPARTMENT OF AGRICULTURAL FOREST SERVICE .....	58
PARAFFINE CO., INC., HAVE NEW MAIN OFFICE AND PLANT.....	59

HARRIS ALLEN, A. I. A., Editor

HOWARD HOYT  
Industrial Editor  
And Business Manager.

NED BRYDONE-JACK  
Advertising Manager

Published Monthly by the Building Review Company,  
Chronicle Building, San Francisco, California

Address All Communications to 345 Battery Street, San Francisco, California

Yearly subscription—United States, \$2.50—foreign, \$3.00. Single copies, 25 cents.

Entered as second-class matter in the San Francisco Postoffice under the Act of August 24, 1912. Previously entered as "The Architect."

The editors will be pleased to consider contributions of interest to the Industry. When payment of same is desired, this fact should be stated.

News stands and dealers supplied through San Francisco News Co., San Francisco, Calif., or American News Co., New York, N. Y.

## BATCHELDER TILES



A Mantel of Distinctive character built up entirely from stock materials.



BATCHELDER-WILSON CO.  
2633 Artesian Street Los Angeles, Calif.

## A HOME, DESIGNED FOR CALIFORNIA'S VARIED CLIMATE, REQUIRES A HEATING SYSTEM

Which is always ready to supply heat quickly and Economically.

An Electrically Controlled-Gas Fired

## McLAUGHLIN FURNACE

responds instantly when the control button is pressed.

The temperature of the entire house may be raised to 70° Fahrenheit within a short time, and this temperature may be maintained by using one or two of the burners within the furnace.

The combustion chamber and the double radiators are constructed of heavy Armco Iron. All seams are welded, preventing the escape of flue gases into the house.

Write for Information  
**McLAUGHLIN METAL WORKS**  
223 J St., Sacramento, Cal.

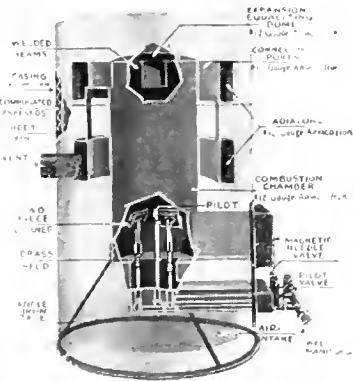

Interior view of Apartment House, 535 Geary Street, San Francisco. Walls done in Fuller Washable Wall Finish. E. E. Young, Architect. M. A. Little, Owner and Contractor

## FULLER Washable Wall Finishes

PEOPLE who appreciate artistic effects in their surroundings like the mellow tone produced by a flat oil paint. Such a paint is Fuller Washable Wall Finish. It provides a non-porous, washable surface that dries with a water-color effect. Because of the ease with which any desired tint may be secured, Fuller Washable Wall Finish offers an exceptionally wide range of usefulness.

### *How to Use Fuller Washable Wall Finish*

New plaster and cement walls should be prepared for painting by putting all cracks and indentations with a stiff putty made by mixing plaster of Paris with Fuller Washable Wall Finish. When putty is thoroughly dry, apply, for a two-coat job, a coat of Washable Wall Finish reduced with Fuller Stopping Liquid in the proportion of three quarts of Washable Wall Finish to one quart of Stopping Liquid. For three-coat work, the first, or stopping coat should be mixed one-half each of Stopping Liquid and Washable Wall Finish. For second and third coats, use Fuller Washable Wall Finish as it is put up at factory, or if desired, thin with a little turpentine.

Architects who desire specific information concerning Fuller Washable Wall Finish, and approved methods of application, should write for this information to the Fuller Service Department.

# FULLER

PAINTS  VARNISHES

W · P · FULLER & CO ·

San Francisco  
Oakland  
Sacramento  
Stockton  
Fresno  
Los Angeles  
Hollywood

Pasadena  
Long Beach  
San Diego  
Santa Monica  
San Bernardino  
Santa Ana  
Portland

Boise  
Salt Lake City  
Seattle  
Tacoma  
Spokane  
Yakima  
Walla Walla

104-723

## Notes on Lighting

**A**DEQUATE electric illumination for every home, shop, street and highway in the country is the aim of the electrical industry, as expressed by its representative committees at the forty-sixth convention of the National Electric Light Association, which is striving to set up standards for outdoor and indoor lighting to combine art with utility, and to preserve America's position as the best lighted nation on earth.

One committee has taken up the subject of home lighting and has devised a conservative ideal plan. A close study has been made of the expressiveness of light, or of the effect of lighting upon the expression or mood of a room. Special lighting equipment for living-rooms, libraries, dining-rooms and other chambers has been created, simplifying greatly the tasks of the interior decorator and giving character to the rooms created.

Removable electric attachments are now in use making it possible for unskilled householders to interchange or transfer them at will. It is suggested by the committee that apartment dwellers might carry about with them the proper lighting fixtures that suit their taste. Varicolored attachments may be kept on hand and brought into use for any special occasion or time.

### Outdoor Lighting Survey

A survey of outdoor lighting has revealed that there are over 250,000 electric signs in the country, illuminated by 15,005,000 amps. A single New York display contained 20,000 lamps—enough to light a small town. Electric signs as an advertising medium have come to be used almost universally. Over \$8,000,000 was invested in them in 1922 and the report estimates the investment will double in 1923.

Marked development has been shown in methods for lighting large buildings and auditoriums, also, and experimentation has produced street lighting systems that are considered unrivalled. In this respect the Bureau report: "Street lighting should not be looked upon as a political football threatening municipal ownership. It is a civic improvement affording the central station an opportunity for meeting municipal officials on common ground, and should be the means of developing cordial relations between the central station and the municipality."

(Continued on Page vi)



## Sunlit Basements

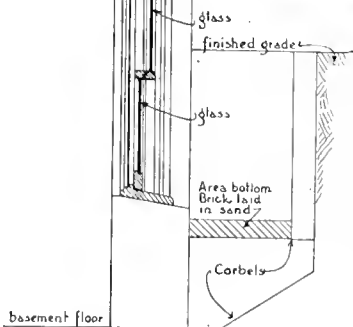

**R**AISE the basement out of the depths and darkness by providing windows of generous size. Make the home perfect in this respect and in other ways by (specifying) an abundance of good glazing.

Then specify "the best glass"—that of the American Window Glass Co. It is best because it is made from unvaryingly mixed batches, perfectly melted in the world's largest furnaces and of greater tensile strength, less wave and more luster by reason of improved methods of drawing and blowing. It is uniformly flat and of uniform thickness, acid washed before grading and then graded according to highest standards.

The contractor, the glazier, the frame manufacturer, the owner—all will thank you for specifying the glass of the American Window Glass Co. The elliptical mark on each box of the genuine means quality, the economy which goes with perfect packing and final results which can be obtained only by the use of "the best glass."



### Suggested Specifications for the Best Window Glass

"All the clear window glass glazed in this building shall be the AMERICAN WINDOW GLASS COMPANY'S make, or equal thereto."

Identification Label—Each light of single strength or double strength "AA" or first quality window glass, as well as 16 oz. first and second quality Picture Glass of AMERICAN WINDOW GLASS COMPANY'S manufacture is labelled as shown herewith. This label identifies the quality.

"A" and "B" grades of Window Glass are not labelled, but have a quantity brand stamped on each original box.



**AMERICAN WINDOW GLASS CO.**

GENERAL OFFICES: PITTSBURGH, PA.

*The BEST glass*

BRANCHES IN PRINCIPAL CITIES

# Fireproof and Everlasting

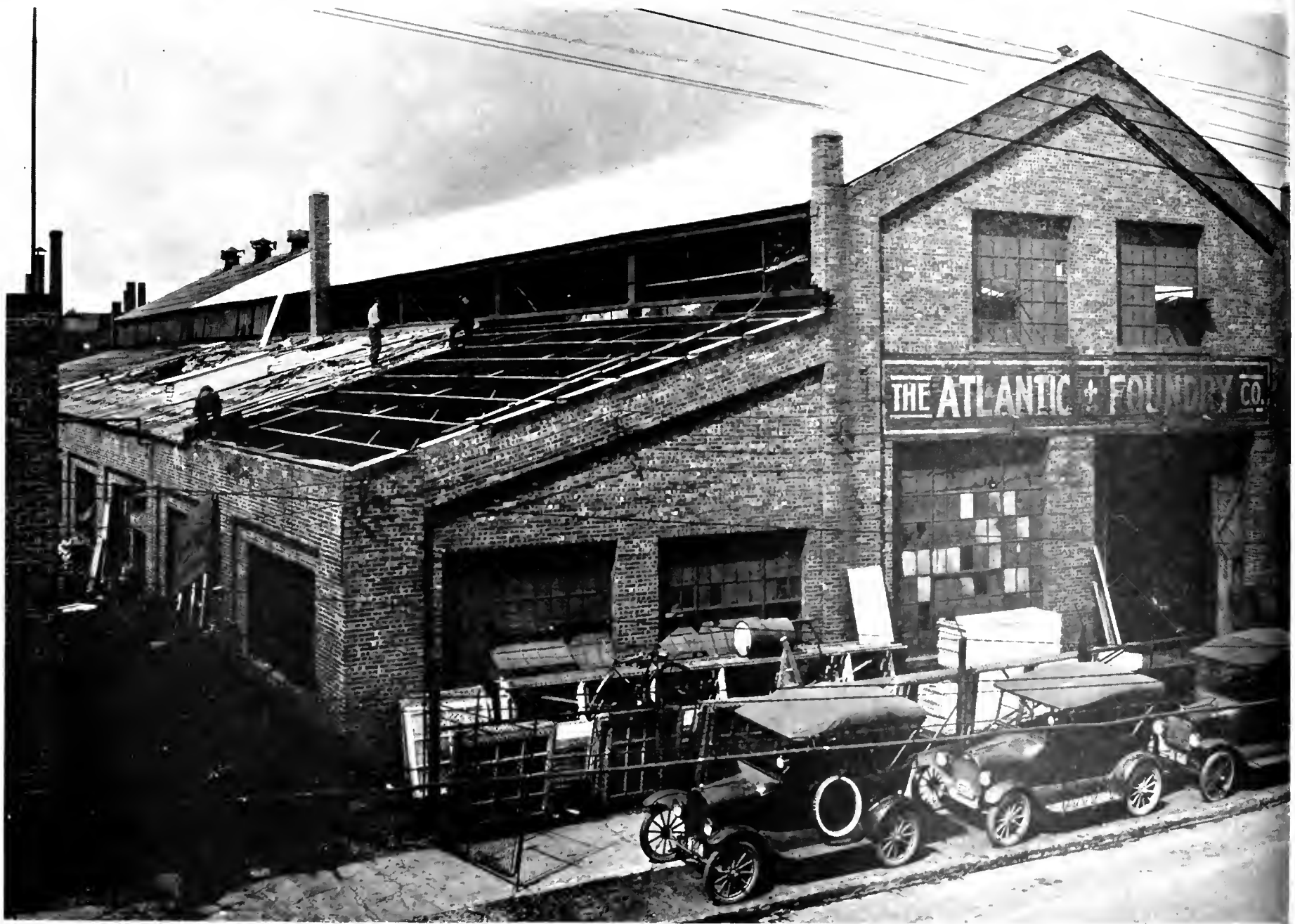

View of removal of Concrete Tile and application of

## AMBLER ASBESTOS CORRUGATED ROOFING

on the plant of the Atlantic Foundry Co.,  
Akron, Ohio.

Asbestos  
Shingle, Slate and Sheathing  
Company

AMBLER, PENNA.

Branch Offices: Baltimore, Boston, Buffalo, Chicago,  
Cincinnati, Detroit, Cleveland, Minneapolis, New York,  
Omaha, Philadelphia, Pittsburgh, Washington, Wilkes-  
Barre, Toronto, Canada.

Southwestern Distributors: R. V. Aycock Co., Kansas  
City, St. Louis, Tulsa, Houston.

Western Distributor:

**J. A. Drummond**

1744 Folsom St. 2225 Fresno St., Fresno 845 Seward St.  
San Francisco Los Angeles



View before removal of Concrete Tile

When Writing to Advertisers Please Mention This Magazine.

Other distributors throughout the country.

NOTES ON LIGHTING

(Continued from Page iii)

The recommendations for ideal street lighting for main business thoroughfares in cities of 100,000 population or larger are 10,000 to 50,000 lumens per cost, and for similar streets in cities of 20,000 to 100,000 population 10,000 to 25,000 lumens per cost.

**New Bowl Refractor**

A new type of bowl refractor for highway lighting which will direct the strength of its ray in any chosen direction has been perfected according to reports read before the convention. The construction of the refractor is such as to reflect the light ray laterally, while illuminating adequately the adjacent area. Experiments are being made in the design of a symmetrical refractor which will build up the light longitudinally while only allowing a small portion of the light to be directed across the street.

The Philadelphia Electric Company is carrying on some interesting experiments with 9.6 ampere series Mazda lamps, designed to take the place of the 9.6 ampere open arc lamps at present used in many parts of the City of Philadelphia. This latter type of street light has become antiquated and is rapidly being replaced by more modern designs of lighting fixtures.

The year just closed has seen more street lighting improvements made in the United States than in any previous annual period according to reports made to the convention. During the year the City of Chicago placed an order for 11,800 ornamental posts to complete a plan for placing the residence lighting distributing system underground. This is the largest individual order for ornamental posts ever placed at one time according to the association.

**Hydro-Electric Advances**

During the past year of unprecedented advancement in the electrical field generally hydro-electric turbines of new design and superlative power have been installed. The largest of these, according to reports given were three 70,000 horse-power hydraulic turbines placed at Niagara Falls. The output of this machinery swells the great "pool" of electric power now created at America's greatest falls by 210,000 horse-power. The turbines are the most powerful prime mover in the world. The year

was also marked by the resumption of construction by the United States Government on its plant at the Wilson Dam, or Muscle Shoals, and the completion of the turbines for this plant. These turbines will be of 30,000 horsepower capacity and will operate under a head of ninety-five feet.

New and ingenious systems for pre-determining the annual flow of water in streams available for waterpower development have been devised by research workers. Practical applications of these findings will result, it is estimated, in saving of millions of dollars in power plant and dam construction, and will be of indispensable assistance to designers of hydro-electric projects.

It has been found that forecasts may be arrived at from observations of ocean temperature, from snow surveys and seasonal run-offs, and from discharge records made over a period of years by the United States Geological Surveys or other research organization. Where the rapids to be harnessed are high in the mountains it has been found effective to forecast the minimum and maximum flow by measuring the snowfall over a watershed known acreage.

New officers of the Public Relations section elected were: Chairman, H. T. Sands, Boston; vice-chairman, Frank R. Coates, Toledo, O.; W. H. McGrath, Seattle, Wash.; Edward A. Barrows, Providence, R. I.; members-at-large of the executive committee, E. C. Keifer, San Antonio, Tex.; S. M. Kennedy, Los Angeles, Calif.; and M. S. Sloan, New York.—The Associated Contractor.

**Stillwell  
PLAN BOOKS**  
*of*  
**CALIFORNIA STYLE ALL CLIMATE HOMES**

—show pictures, Floor Plans and Estimated Costs of Building over 200 Selected Designs.

"West Coast Bungalows"  
50 Houses—6 and 7 Rooms—\$1  
"Little Bungalows"  
75 Houses—3-4-5 Rooms—\$1.

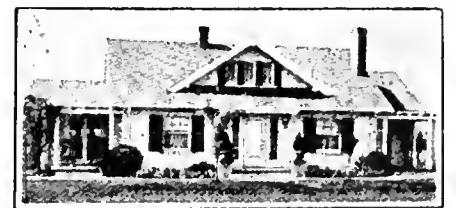

"Representative California Homes"  
50 Houses—7 to 10 Rooms—\$1.  
"The New Colonials"  
60 Houses—6 to 10 Rooms—\$1.

**SPECIAL OFFER:** Send \$2.50 for any three of these books and get Garage Folder FREE.

*Books and Blueprints sold with Money Back Guarantee*

**E. W. STILLWELL & CO., 790 California Building, Los Angeles**

PHONE FRANKLIN 2492

**A. C. WOCKER**

INTERIOR DECORATOR

1370 SUTTER STREET

SAN FRANCISCO, CAL.

# BALL BEARINGS

**SKF** INDUSTRIES OF CALIFORNIA

Incorporated

115 NEW MONTGOMERY ST.

San Francisco, Calif.

Phone Sutter 4196

DEEP GROOVE AND SELF-ALIGNING BEARINGS  
HANGER EQUIPMENT

# Clay Products

Gladding, McBean & Co.

SAN FRANCISCO  
LINCOLN  
LOS ANGELES

PORTLAND

LOS ANGELES

SEATTLE

## R. N. NASON & CO.

PAINT MAKERS

151 Potrero Ave.--SAN FRANCISCO--436 Market St.

Makers of

NASON'S OPAQUE FLAT FINISH

A flat oil paint made in soft Kalsomine Tints, that is washable; a practical article for walls, ceilings, etc., that is most economical and durable.

Agency for

Tamm & Nolan Varnish Works High Grade Varnishes and Finishes

Goods made on the Pacific Coast for the climate of this Coast

Del Monte -- Fan Shell Beach

# CLEAN WHITE SAND

Del Monte Properties Company

Sutter 6130 Crocker Building San Francisco

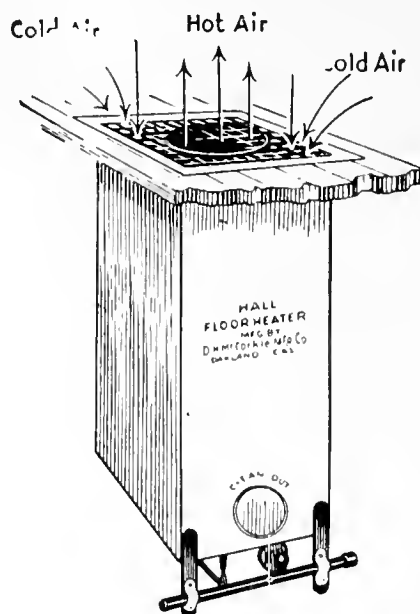

## Hall Floor Heaters

bring dryness, warmth, and coziness to single rooms, small suites of rooms, and bungalows. The adequate flow of warmth is healthful, inexpensive, and safe.

**Healthful** — because products of gas combustion are permanently separated from warmed air. **Inexpensive** — because

warmth is used only when you want it. No all-day fires. **Safe** — because all mechanism is thoroughly safeguarded, and a removable key (or electric button control) regulates the supply.

Write for our new, illustrated folder. You will find that the Floor Heater is but one of the many exceptional heating appliances in the complete Hall line—a line that includes furnaces built to satisfy every requirement of every size home or building.

Manufactured by

**D. H. McCORKLE MFG. CO.**  
319--12th St. Oakland, Calif.

Dealers and distributors in principal Pacific Coast Cities



Genuine Hyloplate Backboards  
Moulthrop Movable Desks  
Sheldon Manual Training Benches  
Domestic Science and Laboratory Furniture

**C. F. WEBER & CO.**  
Exclusive Agents

SAN FRANCISCO LOS ANGELES  
RENO PHOENIX

## THE GROWTH OF A FIRM THROUGH ITS PRODUCTS

MANY instances throughout the business world where firms or individuals, whether they be professional or laymen, prosper or fail with the rise or fall in the growth of their city.

In presenting this article to the "Building Review" it is necessary to draw a comparison of the growth of the industries of some of the Pacific Coast cities and communities with that of the manufacturing and industrial activities of these communities.

A great many of these cities have back of them organizations which hold as members the most active professional and business men who are citizens of that locality. By broadcasting propoganda in the way of advertising and boosting they have brought their communities to be recognized as prosperous cities throughout the world. Those citizens and buyers from long distances, hearing of this wonderful growth, not only are enthusiastic in reading each article proclaiming these wonders, but as time goes on are making all preparations that they can gather together their savings and dispose of what properties they have and immigrate, that they may become a part of and share in the prosperity of such a live commonwealth.

This also applies to "Industry." We will write of the building industry of the Pacific Coast; those alert to the possibilities of the wonderful growth. We find many of them represented in the columns of this magazine, many under the writing of architects. Architects bear a wonderful part in the construction and beautifying of our valleys and hills with beautiful homes and buildings, the dream of many of these immigrants who have heard of the wonders of our coast. Co-operating with the architects and the investors are the many factories making building materials that they can be woven together, that the plans and specifications of the builder may be realized.

Bearing in mind our progress of today, we would like to take you back thirty-five years on a side street in the City of Los Angeles, in a two-story frame, tumble-down building. A young man whose father, with very little capital, having a vision of the future

of the community in which they had located, put up a little plant and as this was the time when wagons, farm implements and vehicles of all kinds were consuming large quantities of axle grease, they started in the manufacture of this product. As time passed, demands were greater and it was realized by the investors of this small establishment that they would have to have larger quarters. So they bought a lot which had on it a larger frame building and in conjunction with axle grease, being alive to the requirements of the building progress in that community, added to their line the manufacture of shingle stains. Years have passed and the struggle of the early days almost forgotten. With time the father has passed, leaving the responsibility and the visions of the future for the creating of a manufacturing institution that would be a credit to the family name. The son decided, in keeping with the progress of that community, on a policy whereby he would have to discard many of the pet lines they had inaugurated, concentrate on one line of products, and enter into the business and proceed on a more sound and substantial basis of a more extensive line of painting materials. Today, standing with many other manufacturing institutions in the community where it is located, The Brininstool Co. of Los Angeles is recognized as one of the foremost institutions, in its lines, on the Pacific Coast.

In the last few weeks, The Brininstool Co. has branched into the Northern territory in their quiet way and are operating in the Bay district, represented by "Scotty" Archie B. Campbell, who has had a life experience, beginning as a boy in Scotland, working both the Western and Eastern coasts of the United States for large eastern paint and varnish manufacturers. Previous to an including the war time, up to the early part of 1923, he represented western manufacturers in China and the Orient. In the last few months Mr. Campbell has taken special representation of The Brininstool Co. with offices in San Francisco.

Non Leakable Roofs  
are assured by  
the use of~  
**FLOATINE**

The improved roof  
asphalt that will  
not soften, run,  
leak, or slide

*Specify~*

**PABCO**

*10 and 20 Year Roofs which  
require its use*



the,

famous

*The* **PARAFFINE COMPANIES, Inc.**

*17 Plants on the Coast*

TRADE MARK

**PABCO**  
PRODUCTS

SAN DIEGO  
OAKLAND

LOS ANGELES  
PORTLAND

SAN FRANCISCO  
SEATTLE



# The BUILDING REVIEW

VOL. XXIV

SAN FRANCISCO, NOVEMBER, 1923

No. 5

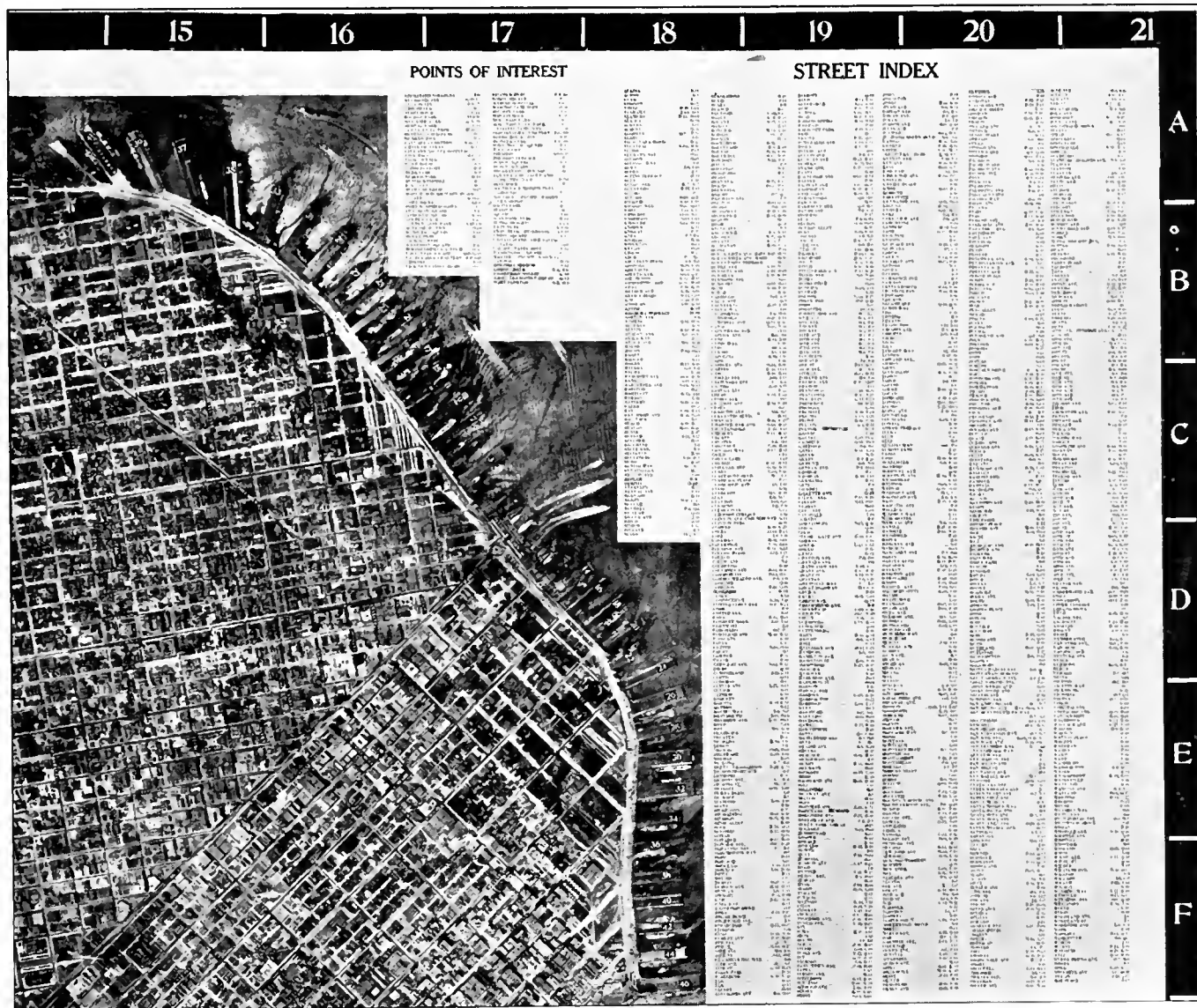

A MAP OF SAN FRANCISCO.  
(Copyright Aero-Photo by George E. Russell, S. F.)

## AERO-PHOTOGRAPHY

By GEORGE E. RUSSELL.

IN REVIEWING the many startling advancements in the development of aircraft, brought about during the World War and their latter application to commercial uses, probably one of the most remarkable and interesting is Aero-Photography and the number of different uses that have been found for it in numerous professions.

Prior to 1914 there were very few aerial photographs in existence except those taken

captive ballons and kites, very few of these were really satisfactory or of any particular value except as a novelty; whereas, today nearly every city of any importance has either been photographed from the air or contemplates having such work done in the near future.

The Germans were the first to realize the importance of using the camera as a recording device for the aerial observers and the Allies were not slow in following out this

method of obtaining absolutely accurate information. By the time the Armistice was signed aerial photography had reached a fairly advanced stage of development, but while it served all military purposes it was far from perfect, and did not reach up to the standards required by commercial enterprises; however, it seemed to have so many possibilities that through research and experimental work on the part of the army and civilian interests it is today one of the most important branches of the photographic profession and has found an unlimited field.

Realtors have found both the oblique Aero-Photo, which is simply a photographic birds eye view, and the Vertical or Aero-Photo-Map of utmost value; an oblique Aero-Photo, properly made is suitable for any advertising purpose. It shows the complete tract to natural advantage and surrounding, not just a close up of one particular spot as the ground photograph does; it pictures everything just as it is now and not as an artist may conceive it to look, either now or in twenty years, (this point has proved to be a real selling argument for the operator who really has a developed property to offer.) As with ground photography it is possible, by having a small amount of art work done, to bring out more effectively and vividly certain points and detail. Such a photograph is a very valuable asset in an advertising or sales campaign, as well as being a marked attraction in the office. The Aero-Photo-Map is just what the name implies, a photographic map made from the air, and showing everything in its exact location with every detail, such a map is made to any desired scale and with a remarkable degree of accuracy, its many



DURANT FACTORY, OAKLAND.  
(Copyright Aero-Photo by George E. Russell, S. F.)

uses and advantages over the drafted map are so apparent and well known that it is unnecessary to comment upon them in this article.

To the city planner, Aero-Photography has been a God-Send, both the obliques and the vertical are used extensively by at least 75 per cent of the planners throughout the country to the extent that where they are unable to obtain the services of an aerial photographer they are using the old observer's methods and flying over the area making notes and sketches; to those particularly interested in city planning and extensive landscape gardening, I suggest that they obtain a copy of the "Garden Cities and Town Planning Magazine" issue of April, 1920. This entire issue is devoted to Aero-Photography as applied to town planner. While this issue was published over three years ago and Aero-Photography has in that time advanced at a greater pace even than it did during the war, it is interesting to note the statement that "We think the time will soon come when a complete set of aerial photographs of an area to be planned will be recognized to be as essential to town-planning as a contour map or a geological survey." This prophecy has been more than fulfilled and for all preliminary work these Aero-Photos have been sufficient and the Aero-Photo-Map has replaced the Geological Survey. Guy Wilfrid Hayler, a city planner of note, has written an article on "The Aeroplane and City Planning" which I am sure would be of interest to every one interested in this line. I believe that he can be reached at Richmond, California.



THE HEART OF SAN FRANCISCO FROM THE AIR.  
(Copyright Aero-Photo by George E. Russell, S. F.)

As an example of planning I might add that most of the devastated area of France



SAN FRANCISCO FROM THE AIR: MARKET STREET FROM THE FERRY.  
(Copyright Aero-Photo by George E. Russell, S. F.)

was replanned from Aero-Photos taken by the French Air-Service and the matter of aerial photography was the subject of discussion at the sessions of the First Inter-Allied Town-Planning Conference, held in Paris several several months ago.

H. A. Lafler, an industrial expert of Oakland and, I believe, probably the largest operator, exclusively handling industrial property in the East Bay District, has employed Aero-Photos with great success for the last three years, and I believe it safe to say that many of the larger industries, which have recently located in that section, had their first glimpse of their location in the form of a vertical Aero-Photo.

To the builder and contractor, Aero-Photography has supplied a new method of keeping their records of progress, and many changes or alterations in the original plans have been determined by the use of the Aero-Photo.

The Architect has found many ways of using the aeroplane and camera for getting photographs of completed buildings, especially where it was impossible to obtain an elevation for a perspective view.

Several large ranches have been mapped by the aerial method and while, to date, no method of showing contours has been devised, many improvements, contemplated

are first worked out on these maps before going onto the ground, and in one case especially considerable of the operation of the ranch is handled by the Aero-Photo-Map at a considerable distance. I refer to the map of the Leano Secco Rancho of the Parrot Investment Co.

Most of the larger industrial and manufacturing concerns are proud of their plant and like to show their distributors that they have a real plant. To those that are fortunate enough to be near a high tank or tower, Aero-Photography has no advantages to offer, providing the tank or tower happens to be just the right place, but to these less fortunate, it provides the only means of obtaining a picture that will do justice to the entire plant and show the extensiveness. Here again the person interested sees the exact plant as it is and not as the architects or concern has intended it shall look when completed.

To the engineer or surveyor Aero-Photography has an unlimited field, and was the subject of a very interesting talk at a meeting of the American Society of Engineers in this city last November. Both the coast and geodetic and the Geological Surveys of the United States have adopted it and are using the aeroplane to considerable extent

(Continued on Page x)

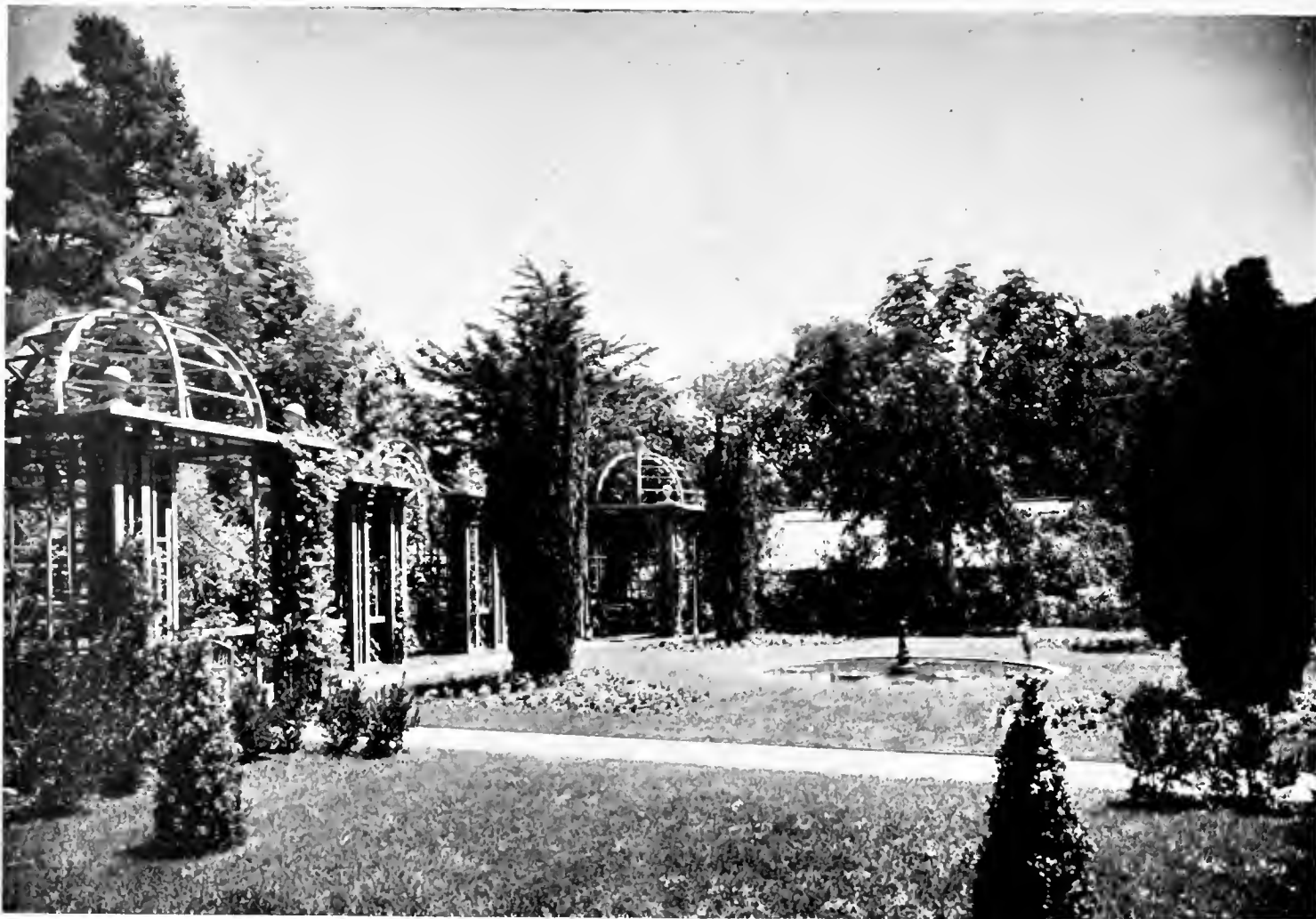

# Gardening of Our Country Homes

By DONALD McLAREN

(Continued from October Issue)

Of late years very few classes of plants have attracted such universal attention among plant lovers in California as have the berry bearing varieties. All of these plants bear their beautiful bundles of berries in great profusion during the winter months when flowers of other outdoor plants are exceedingly scarce, for which reason they are exceptionally valuable, not alone to the landscape out of doors, but they are equally useful to the florist and decorator as well. As a matter of fact, I do not know what these two latter would do without them.

Our common redberry, or Toyon (*Heteromeles arbutifolia*); is a native of our own State, and not hardy elsewhere in the United States, and is used in cut form tremendously during the Christmas and festive winter seasons. It has really become indispensable. The English Holly is likewise used very freely at this season of the year. This plant, while not a native, does exceedingly well in California, particularly in all of the coast regions, and should be used more generally than it is.

We should not forget when considering berried plants our native Madrone (*Arbutus Menzeisii*), which bears very attractive large redberries and whose bark is so greatly admired by everyone at all seasons of the year. The Snow-berry (*Symphoricarpus racemosus*) is also a native to our State and is very attractive with its clusters of large white berries which hang on the plant in great profusion all winter long.

There are, however, two classes of plants about which very little is known to the general public, outside of those who are especially interested in plant life. I refer to the Cotoneaster and Crataegi (or Thorn) families, the majority of whose branches bear wonderful bunches of brilliant berries during the winter months and the majority of which are evergreen. All of them are exceedingly hardy, and flourish in our ordinary climate, with the exception of the cold mountainous regions of our State. When we speak of the Thorn family of plants one naturally thinks of Hawthorn, which while bearing berries, is a deciduous tree, and we are apt to overlook the fact



that this family has numerous branches, many of them, as stated above, being evergreen.

Undoubtedly, the most striking variety is *Crataegus pyracantha lalandi* or Burning Bush, which with us bears from October to January a most wonderful crop of orange-red fruit, and which has attracted most marked attention of late years and is universally admired. This plant is evergreen, is very hardy, and attains a height of from 15 to 20 feet, forming a most gorgeous feature in the landscape.

Another Thorn which is also greatly admired, and which is becoming very generally used in California is *Crataegus pyracantha angustifolia*, which is also orange-berried, but which comes into a fruit just after the variety *lalandi* has finished its crop, the berries turning orange about the first of January and continuing during the months of January and February. It is also becoming extremely popular and is very generally used by florists and decorators whenever the branches are obtainable. The plant is also evergreen and reaches a height of only ten feet.

We also favor an evergreen redberried Thorn called *Crataegus pyracantha crenulata*, known as the Chinese evergreen Hawthorn. This plant grows to a height of ten

feet, and is very distinct from the preceding varieties, and is about the earliest red-berried bearing shrub, as the color of the berries is fully developed by August.

There has recently been introduced from North China a prostrate-growing Thorn, a plant discovered recently by Mr. Wilson of the Arnold Arboretum at Harvard University. This plant is called *Crataegus Yunnanensis*, named from the Province of Yunnan where it is native.

The cotoneasters form a most interesting group of plants for there is a great variety of them, all of them being berry-bearing and all adapted to use in our State. One of the most striking varieties is *Cotoneaster acuminata* or *Nepalense*, which bears bright red berries during the months of December and November. It is semi-deciduous, but at the same time is a very effective plant when planted in masses as its berries may be seen from quite a distance.

For landscape effects probably one of the best of this large group of plants, however, is *Cotoneaster pannosa*, a plant having a glaucous foliage, of semi-drooping habit attaining a height of only ten feet, but having its branches almost completely covered with brilliant red berries all during the

(Continued on Page x)

# THE BUILDING REVIEW

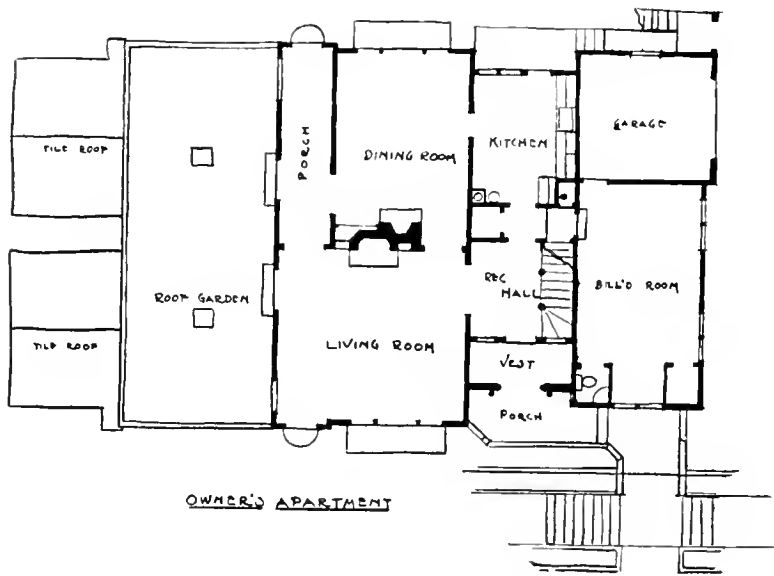

FOURTH FLOOR PLAN.

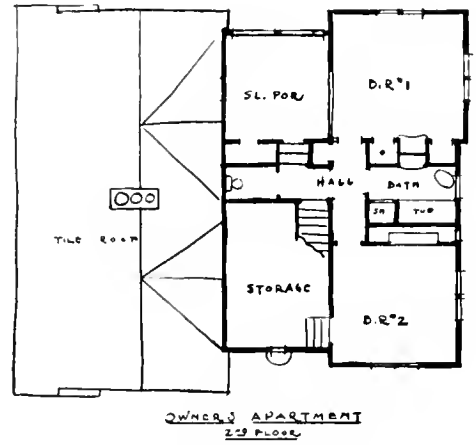

FIFTH FLOOR PLAN.

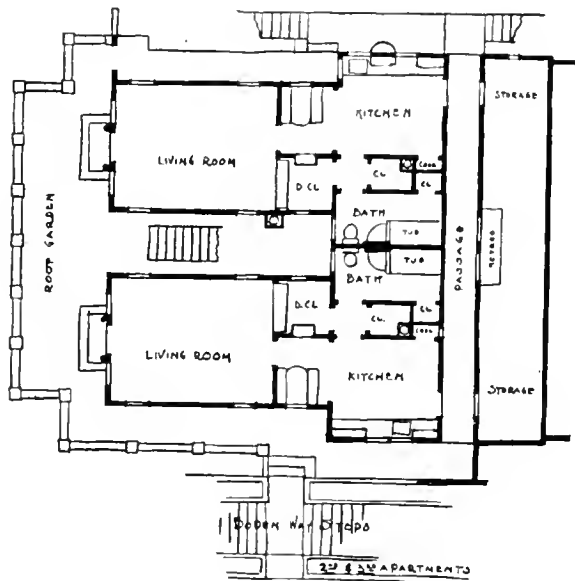

SECOND FLOOR PLAN.

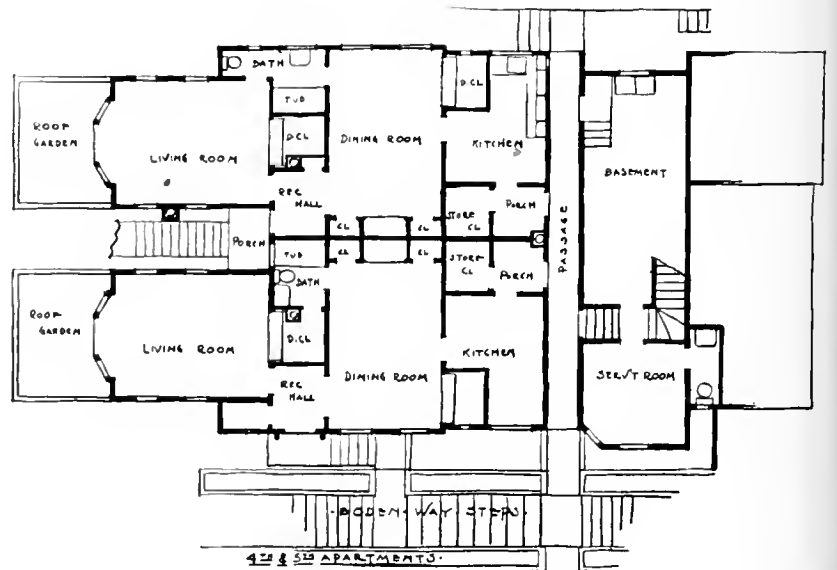

THIRD FLOOR PLAN.

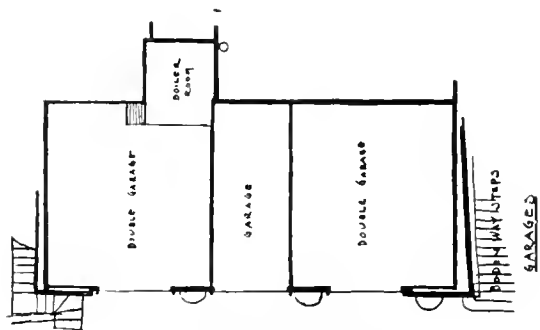

BASEMENT PLAN.

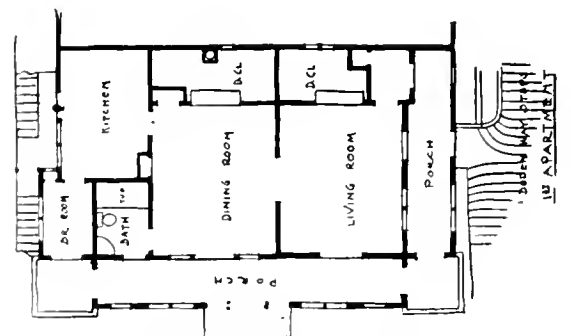

FIRST FLOOR PLAN.

FLOOR PLANS,  
 "CASTLE-REA VILLA" APARTMENTS,  
 OAKLAND, CALIFORNIA.  
 W. J. Wilkinson, Architect.



Photo by Com. & Photo View Co.

"PALE REA VILLA" APARTMENTS,  
SAND, CALIFORNIA.  
Wilkinson, Architect.

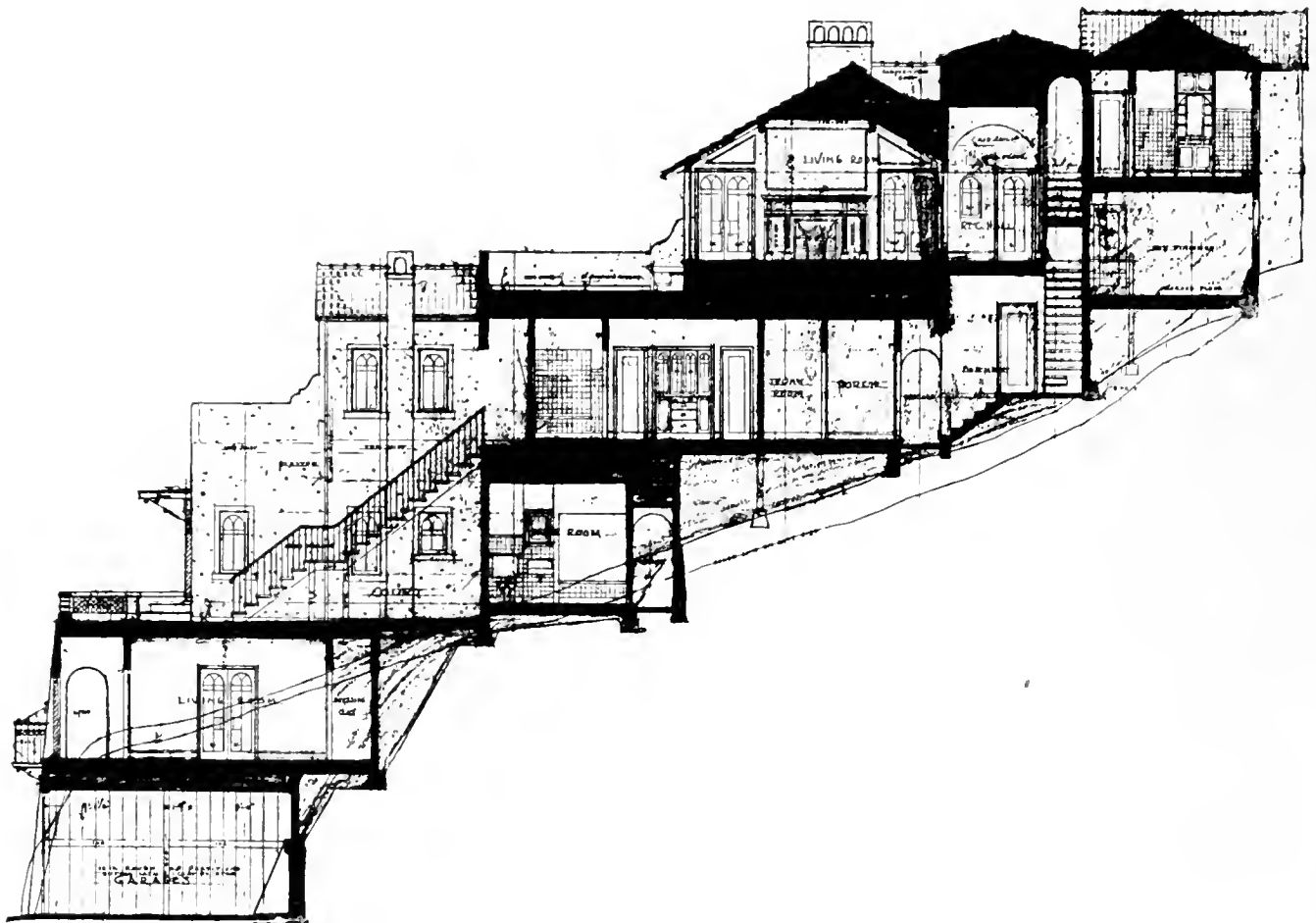
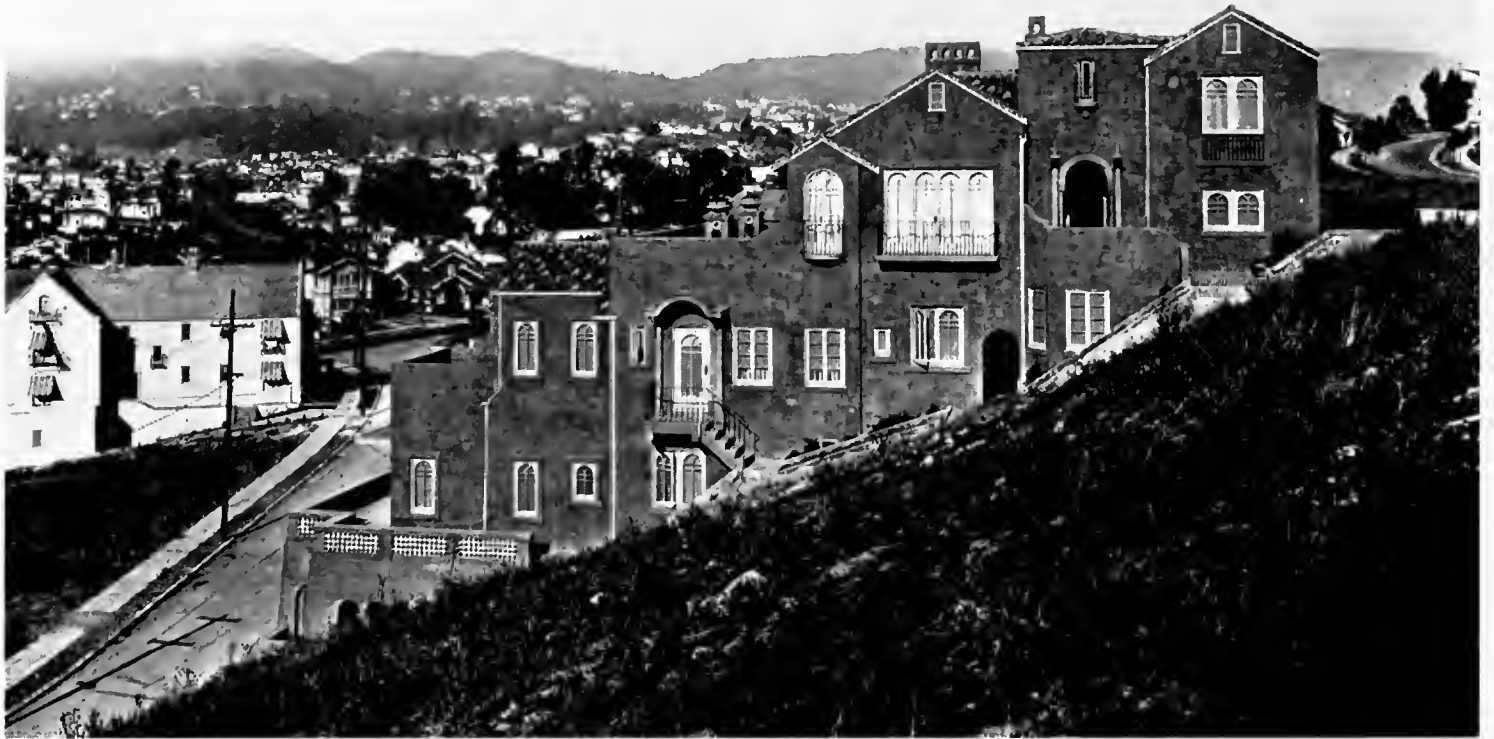

"CASTLE REA VILLA" APARTMENTS  
OAKLAND, CALIFORNIA.  
W. J. Wilkinson, Architect.





Photo by Com. & Photo View Co.

"STLE REA VILLA" APARTMENTS,  
LAND, CALIFORNIA.  
F. Wilkinson, Architect.



Photo by Gabriel Moulin.

RESIDENCE OF MR. R. H. HUBBELL  
SAN FRANCISCO, CALIFORNIA.  
Ashley and Evers, Architects.

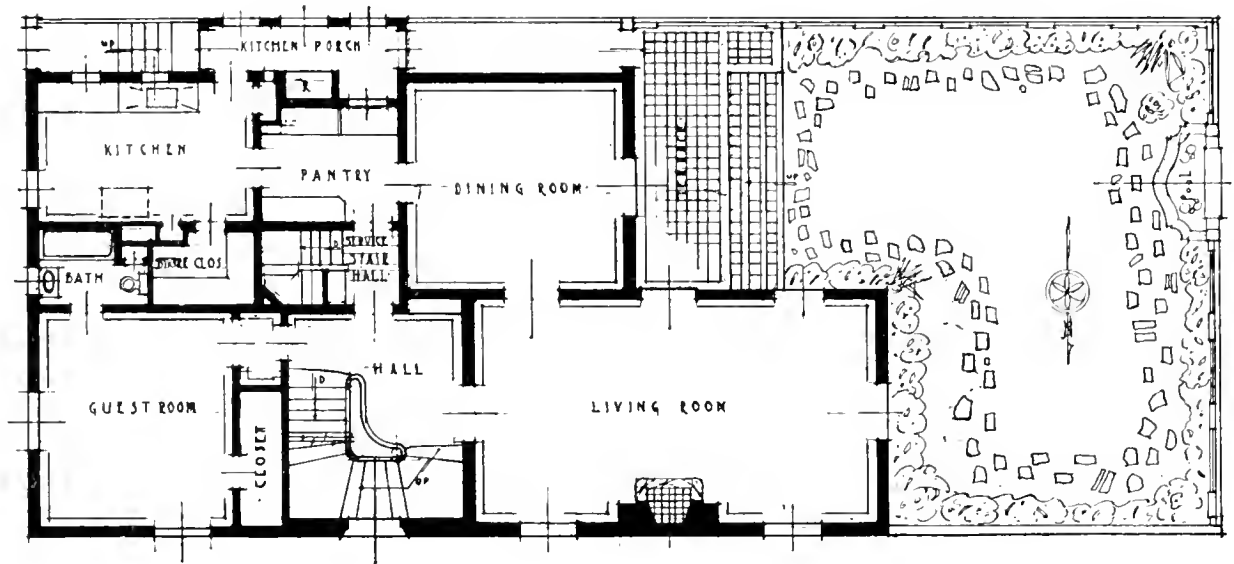

Photo by Gabriel Moulin.

RESIDENCE OF MR. R. H. HUBBELL,  
SAN FRANCISCO, CALIFORNIA.  
Hubbell and Evers, Architects.



Photo by Gabriel Moulin.



RESIDENCE OF MR. R. H. HUBBELL,  
SAN FRANCISCO, CALIFORNIA.  
Ashley and Evers, Architects.

SAN FRANCISCO  
PUBLIC LIBRARY



Photo by Gabriel Moulin.

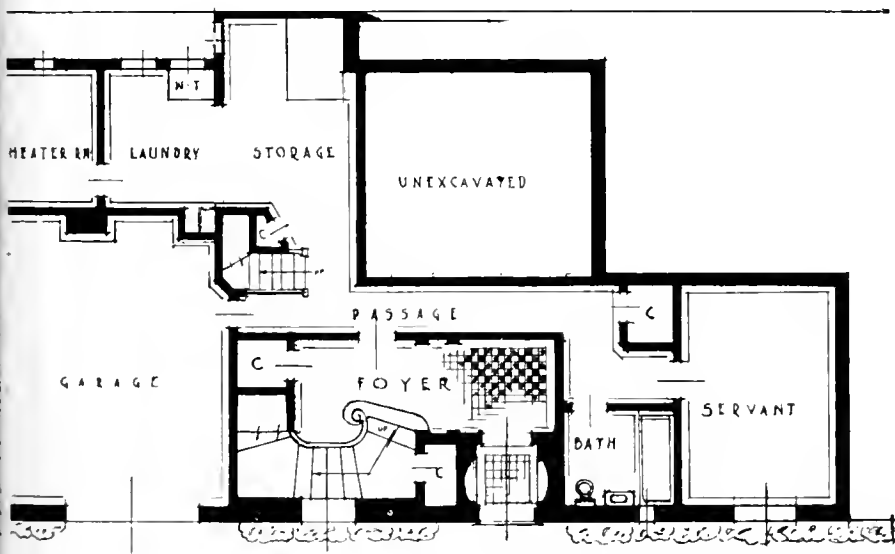

GROUND FLOOR PLAN  
SCALE 1/4" = 1'-0"

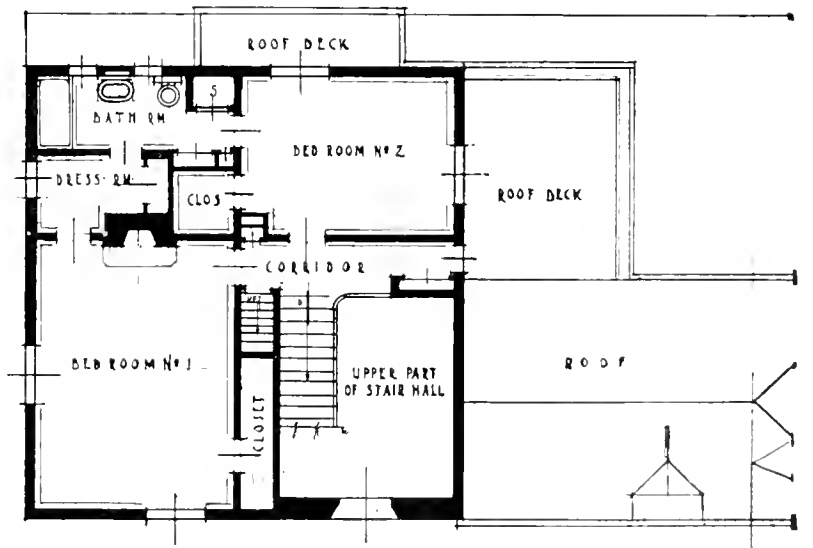

SECOND FLOOR PLAN  
SCALE 1/4" = 1'-0"

RESIDENCE OF MR. R. H. HUBBELL,  
SAN FRANCISCO, CALIFORNIA.  
Ashy and Evers, Architects.



RESIDENCE OF MR. R. H. HUBBELL,  
SAN FRANCISCO, CALIFORNIA.  
Ashley and Evers, Architects.

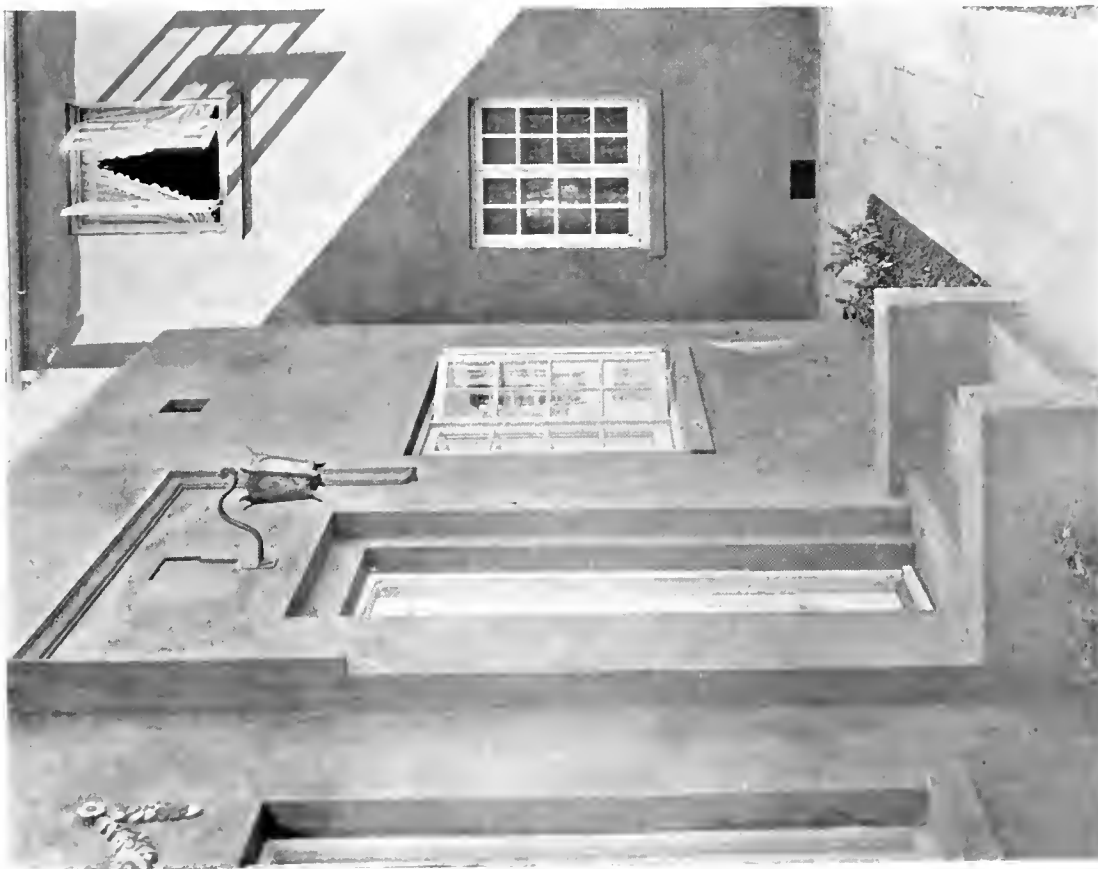

ENTRANCES—"EL ZENZONTLE" APARTMENTS,  
BERKELEY, CALIFORNIA.  
A. T. Milwain, Architect.  
J. F. MacTavish, Owner and Builder.



Photo by M. Taussig.

"EL ZENZONTLE" APARTMENTS,  
BERKELEY, CALIFORNIA.  
A. M. Milwain, Architect.  
J. P. MacTavish, Owner and Builder.





Photo by M. Taussig.

"SANTONILE" APARTMENTS,  
EUREKA, CALIFORNIA.  
J. Milwain, Architect.  
MacTavish, Owner and Builder.



Photo by M. Taussig.

"EL ZENZONTLE" APARTMENTS,  
BERKELEY, CALIFORNIA.  
A. M. Milwain, Architect.  
J. P. MacTavish, Owner and Builder.

# El Zenzontle---A California Court

By CLARA FASSETT

THE Bungalow Court as a type of community dwelling which is neither flat, apartment or bungalow, but which cleverly combines the good points of all three, is becoming immensely popular in California. Its advantages in a winter resort city are many and obvious. The average winter resorter must live in an apartment or flat, as the renting of a small house by the season, including the expense of upkeep is not practical; and too, there are few such places available in towns which must provide for a large winter population. The Bungalow Court, which is a group of attached cottages built around three sides of a grass plot, makes a strong appeal by providing for each tenant a bit of green to look out upon, with perhaps a tiny fountain or fish pool, all of which he may enjoy with no labor involved.

Many of these courts have no special design or group plan but are simply a series of plain little "dry goods box" cottages, relieved from the uniform ugliness of factory employees' homes by the open court of green, ornamented by flower beds and decorative shrubbery. Occasionally and even semi-occasionally one is found upon whose plan thought and artful design have not been spared; these look as though they were gradually assembled in that spot by people who have the same taste in houses, and whose individuality is given a chance to express itself in unexpected variations from the original plan. As a rule, however, in building these "Courts" it is more practical from the builder's standpoint to construct them as nearly alike as possible, depending upon an interior plan of convenience, built-in features and those apartment house arrangements for quick and simple house-keeping which so charm the "winter resorter" who desires to spend most of his time in the open.

And, too, there is something about the very word "Court" which implies friendliness, a spirit of interest and good-will which rarely manifests itself towards one's neighbor in a shut-in-apartment.

In days of Spanish dominion, family life centered about the court. The pleasant semi-seclusion of the "placita" offered a common meeting place for the family, friends, neighbors, servants, the wayfarer,

babies and household pets. Now, the court of Spanish Colonial days as adapted to the bungalow, the more pretentious house, the one-family or community dwelling is accepted as a satisfactory substitute for the "front porch and lawn" dear to the heart of the emigrant from the east.

"El Zenzontle" (the Mocking-Bird) strikes the arresting note of a gay little song architecturally expressed. Set on an elm bordered street in Berkeley, surrounded by conservative and dignified homes of the brown shingle, grey stucco variety of twenty years ago, it re-creates a bit of old California atmosphere. Of lively brown, almost terra cotta colored stucco, surrounding a velvet-green court, it is Southern California, Spanish, Mexican, Tropical.

The designers, J. P. and A. C. McTavish, with the help of A. M. Milwain, planned and built this most delightful of court dwellings. The theme is Spanish-Mexican, which is gradually taking its place as representative architecture of the Southwest. This style, known also as Spanish Colonial, seems to have been introduced to California at the time of the San Diego Exposition. Heretofore the native architecture of the west was generally known as "Mission." The designers of the exposition building went back to the days of Spanish glory in Mexico, and the result, derived from the original source was a group of buildings whose gaiety of color, wonderful wealth of exquisite ornament has proved an inspiration to the builders in California of houses, both large and small.

The "Court" is composed of eight units, three on each side facing each other, and two facing the court. Six of these are alike in floor plan which contains four rooms: living room with fireplace, kitchen containing a breakfast nook, dining room with cleverly concealed wallbed and built in china closet, bedroom and bath. The two rear units are a story and a half, and vary slightly in design. One has a tiny balcony projecting over a recessed doorway, whose striped awning supported by metal spears is very Spanish in effect. On either side of the court is a driveway leading to the garage, making a simple matter of rear delivery. At the back of the lot are the garages on

(Continued on Page xvii)

SAN FRANCISCO CHAPTER AMERICAN INSTITUTE OF ARCHITECTS  
**MONTHLY BULLETIN**

**OFFICERS**

J. S. Fairweather, President.  
 John Reid, Jr., Vice-President.  
 Albert J. Evers, Secretary-Treasurer.



**DIRECTORS**

George W. Kelham, three years.  
 Arthur Brown, three years.  
 Wm. Mooser, two years.  
 J. H. Blohme, two years.  
 Earle B. Bertz, one year.  
 Harris Allen, one year.

**NEXT MEETING**

The next meeting will be held on Thursday evening, November 15th, 1923, in the Architectural Club Rooms, 77 O'Farrell Street.

**OCTOBER MEETING**

The Annual Meeting of the San Francisco Chapter of the A. I. A. was held on Thursday evening, October 18th, 1923, in the Architectural Club Rooms, 77 O'Farrell Street. The meeting was called to order by Mr. Wm. Mooser.

The following members were present:

John Blakewell	Morris M. Bruce
Earle Bertz	H. E. Burnett
A. J. Evers	E. B. Hurt
P. J. Herold	Wm. Mooser
S. Schnaittacher	J. S. Fairweather

**MINUTES**

The minutes of the meeting held September 20, 1923, were approved as read.

**REPORT OF OFFICERS**

The Annual Report of the President was read, approved and ordered placed on file.

The Secretary read the annual report of the Board of Directors and of the Secretary-Treasurer, both of which was approved and ordered placed on file.

**STANDING COMMITTEES**

Mr. S. Schnaittacher, chairman of the committee on competitions, submitted a report which was read and placed on file; also a report on "Practice" was submitted by Mr. Schnaittacher, which was read and ordered placed on file.

It was moved and carried that the resignation of John D. Hatch be accepted.

**ELECTION OF OFFICERS**

The next in order of business being the election of officers for the ensuing year, the Secretary was directed to cast the ballot for the regular nominees, whereupon the chair announced that the following had been elected to serve the Chapter for the ensuing year:

President .....J. S. Fairweather  
 Vice-President .....John Reid, Jr.  
 Secretary and Treasurer.....Albert J. Evers

**Directors**

Three years.....Geo. W. Kelham and Arthur Brown

The following chairmen of committees have been appointed:

Architectural Relations and Publicity—Harris Allen.  
 Competition and Practice—Sylvain Schnaittacher.  
 Historic Monuments—E. E. Coxhead.  
 Registration, Laws and Building Relations—Wm. Mooser.  
 War Memorial—Arthur Brown.  
 Educational Fund—John Bakewell.

**NEW BUSINESS**

A letter from H. S. Stromach was read and placed on file.

A letter from Wm. George of the Builders Exchange was read and the Secretary ordered to draft a letter for Board of Directors' approval before being sent.

A letter from Edw. Bergstrom regarding an exhibit for the entire coast was read and Secretary ordered to answer same.

**ADJOURNMENT**

There being no further business before the Chapter, the meeting adjourned.

J. S. FAIRWEATHER,  
 Secretary.

**LIST OF MEMBERS OF THE SAN FRANCISCO CHAPTER, A. I. A.**

Allen, Harris, C., Central Bank Bldg., Oakland.  
 Applegarth, Geo. A., Claus Spreckles Bldg., S. F.  
 Ashley, George T., 58 Sutter St., San Francisco.  
 Bakewell, John, 251 Kearny Street, S. F.  
 Barth, Hermann, Phelan Building, San Francisco.  
 Baur, John A., 251 Kearny Street, S. F.  
 Binder, William, 257 So. First Street, San Jose.  
 Bertz, Earle B., 68 Post St., San Francisco.  
 Bliss, W. D., 1001 Balboa Building, San Francisco.  
 Bliss, W. M., 1001 Balboa Bldg., San Francisco.  
 Blohme, J. Harry, 454 California St., San Francisco.  
 Bolles, Edward G., 233 Post Street, San Francisco.  
 Brown, Arthur, 251 Kearny Street, San Francisco.  
 Bruce, Morris M., 859 Flood Building, San Francisco.  
 Burnett, H. E., 684 Haddon Road, Oakland.

## THE BUILDING REVIEW

- Cannon, Edward W., Central Bank Bldg., Oakland.  
 Cantin, A. A., 68 Post Street, San Francisco.  
 Cauldwell, Albert M., 251 Kearny St., San Francisco.  
 Cole, Chester, Waterland-Breslauer Bldg., Chico.  
 Corlett, Will G., Oakland Savings Bank Bldg., Oakland.  
 Coxhead, E. A., Hearst Building, San Francisco.  
 Clark, Arthur B., 4 Cabrillo Street, Palo Alto.  
 Crim, W. H. Jr., 425 Kearny Street, San Francisco.  
 Delongchamps, Fred J., 336 Gazette Bldg., Reno, Nev.  
 Devlin, Leo J., Pacific Bldg., San Francisco.  
 Dickey, Chas. W., City Hall, Oakland.  
 Dolliver, J. W., 114 Sansome Street, San Francisco.  
 Donovan, John J., 1916 Broadway, Oakland.  
 Ehrenpfort, Arthur T., Russ Bldg., San Francisco.  
 Emory, Walter L., 942 Fort St., Honolulu.  
 Evers, Albert J., Holbrook Bldg., San Francisco.  
 Farr, Albert, 68 Post St., San Francisco.  
 Faville, W. B., 1001 Balboa Bldg., San Francisco.  
 Falch, Walter C., Hearst Bldg., San Francisco.  
 Ferris, Geo. A., Box 363, Reno, Nevada.  
 Fairweather, J. S., 1001 Balboa Bldg., San Francisco.  
 Georgeson, F. T., Humboldt Nat. Bk. Bldg., Eureka, Cal.  
 Hayne, B. S., 604 Balboa Bldg., San Francisco.  
 Hays, Wm. C., 1st Nat. Bank Bldg., San Francisco.  
 Headman, August G., Call Bldg., San Francisco.  
 Hemmings, E. C., 1203 J St., Sacramento.  
 Herold, P. J., 718 Hearst Building, San Francisco.  
 Herold, R. A., Forum Bldg., Sacramento.  
 Hobart, Lewis P., Crocker Bldg., San Francisco.  
 Howard, John Galen, 1st Nat. Bank Bldg., S. F.  
 Hirschfeld, B. S., 1328 Hyde Street, San Francisco.  
 Heiman, Samuel, 57 Post St., San Francisco.  
 Hilderbrand, E. H., 110 Sutter St., San Francisco.  
 Hyman, Samuel L., 68 Post St., San Francisco.  
 Hurt, E. B., 1001 Balboa Bldg., San Francisco.  
 Howard, Geo. H., 35 Montgomery St., San Francisco.  
 Jacobs, Alfred H., 110 Sutter St., San Francisco.  
 Joseph, B. J., Call Bldg., San Francisco.  
 Johnson, A. R., 742 Market St., San Francisco.  
 Kelham, Geo. W., Sharon Bldg., San Francisco.  
 Kleeman, Otto, Woodstock, P. O. Box 11, Portland, Ore.  
 Knowles, Wm., Hearst Bldg., San Francisco.  
 Krafft, E. J., Phelan Bldg., San Francisco.  
 Lake, H. E., 522 Patterson Bldg., Fresno, Cal.  
 Lansburgh, G. A., 709 Mission St., San Francisco.  
 Lenzen, T. W., Humboldt Bank Bldg., San Francisco.  
 MacDonald, Kenneth, 234 Pine St., San Francisco.  
 Mathews, W. J., 927 Broadway, Oakland.  
 McCall, Chas. W., Central Bank Bldg., Oakland.  
 McDougall, Geo. B., Forum Bldg., Sacramento.  
 Meusdorffer, C. A., Humboldt Bk. Bldg., San Francisco.  
 Meyer, Fred H., 742 Market St., San Francisco.  
 Meyers, Henry H., Kohl Bldg., San Francisco.  
 Miller, C. H., 414 13th St., Oakland.  
 Miller, James R., Lick Bldg., San Francisco.  
 Morgan, Julia Miss, 1135 Merchants Exchange, S. F.  
 Mayo, Frank V., 207 Yosemite Bldg., Stockton.  
 Molera, E. J. (Hon.), 2025 Sacramento St., S. F.  
 Mooser, Wm., Nevada Bank Bldg., San Francisco.  
 Mullgardt, L. C., Honolulu, H. T.  
 Maybeck, Bernard R. (Hon.), Lick Bldg., San Francisco.  
 Narbett, Jas. T., 906 MacDonald Ave., Richmond.  
 Newman, Wm. A., 402 P. O. Bldg., San Francisco.  
 Newsom, Sidney B., Nevada Bank Bldg., S. F.  
 Newsom, Noble, Nevada Bank Bldg., San Francisco.  
 Nicholson, A. D., Chroniele Bldg., San Francisco.  
 Norberg, Ernest L., 604 Balboa Bldg., San Francisco.  
 Norberg, John E., 604 Balboa Bldg., San Francisco.  
 O'Brien, Matthew, 68 Post St., San Francisco.  
 O'Brien, Smith, 742 Market St., San Francisco.  
 Page, Geo. W., Santa Clara R-A, Box 14.  
 Politeo, M. V., 1st Nat. Bk. Bldg., San Francisco.  
 Plachek, James W., 2014 Shattuck Ave., Berkeley.  
 Perry, Chas. E., 514 Martin St., Vallejo.  
 Raignel, N. O., c/o Tropico Potteries Inc., Glendale, Cal.  
 Ratcliff, W. H., 1st Nat. Bk. Bldg., Berkeley.  
 Ray, Russel, 1530 Chapala St., Santa Barbara.  
 Reed, Walter D., Oakland Sav. Bk. Bldg., Oakland.  
 Reid, James W., Cal.-Pacific Bldg., San Francisco.  
 Reid, M. J., Cal.-Pacific Bldg., San Francisco.  
 Reid, John, 1st Nat. Bank Bldg., San Francisco.  
 Righetti, Perseo, 12 Geary Street, San Francisco.  
 Ross, T. Patterson, 310 California St., San Francisco.  
 Rushroth, Geo., 354 Pine St., San Francisco.  
 Sawyer, Houghton, Shreve Bldg., San Francisco.  
 Schmidt, Herbert, 45 Kearny St., San Francisco.  
 Schroepfer, Albert, Nevada Bank Bldg., San Francisco.  
 Schnaittacher, Sylvain, 233 Post St., San Francisco.  
 Schultz, Henry A. (Hon.), 1018 E. 17th St., Oakland.  
 Shea, Will D., Chroniele Bldg., San Francisco.  
 Sheldon, Martin A., Monadnock Bldg., San Francisco.  
 Smith, Thomas, 67 Elgin Park, San Francisco.  
 Simpson, Horace G., Call Bldg., San Francisco.  
 Skillings, Warren, Garden City Bk. Bldg., San Jose.  
 Scholz, Arthur G., Phelan Bldg., San Francisco.  
 Steilberg, Walter T., 908 Flatiron Bldg., San Francisco.  
 Symmes, Edwin J., 1700 Pearl St., Alameda.  
 Tantau, C. A., 251 Kearny St., San Francisco.  
 Thayer, O. R., 110 Sutter St., San Francisco.  
 Thomas, John H., 1st Nat. Bk. Bldg., Berkeley.  
 Traphagen, O. G., 244 California St., San Francisco.  
 Traver, Harrison B., 626 Rowell Bldg., Fresno, Calif.  
 Upton, Louis M., 454 Montgomery St., San Francisco.  
 Voorhees, Fred D., Central Bank Bldg., Oakland.  
 Ward, Clarence R., 454 California St., San Francisco.  
 Weeks, Chas. Peter, California Ins. Bldg., San Francisco.  
 Willard, S. D., 715 First Ave., San Mateo.  
 Wood, Hart, Castel & Cooke Bldg., Honolulu.  
 Wythe, W. J., Central Bank Bldg., Oakland.  
 Webb, Marshall H., James Campbell Bldg., Honolulu.  
 Wilkinson, W. J., 220 Howard Ave., Piedmont.  
 Yelland, W. R., 414 13th St., Oakland.

### *Fuller Service to Architects*

An invitation is extended to architects to make the fullest use of our well equipped laboratories and service department. A personal inspection of these departments and our extensive factories will prove interesting and profitable.

### W. P. FULLER & CO.

Manufacturers

High Grade Paints, Varnishes, Enamels and Stains

Since '49

301 MISSION STREET

SAN FRANCISCO

UNITED STATES DEPARTMENT OF  
AGRICULTURE  
FOREST SERVICE

Forest Products Laboratory  
Madison, Wisconsin.

To Architects and Engineers:

In these days of high-priced building materials everyone is interested in anything that will tend to cut down costs. There seems to be little possibility of a decrease in the price of lumber—but a saving can be made through intelligent use of this material. Investigations made at the Forest Products Laboratory have conclusively shown that in many cases builders are using larger sizes and better grades of timbers than are necessary to give the required strength and stiffness.

Here then is something to work on. Do you know safe working stresses for structural timbers? Are you informed in regard to the relative strength of different kinds of wood?

These and many other questions in regard to the use of wood in building construction have been answered by the investigators at the laboratory. The information gathered is to be made available in an instructional course to be given at the laboratory from December 10 to 15, inclusive. A synopsis of the course follows. A tuition fee of \$100 is charged to cover the cost of instruction.

Enrollments for the course are now being received. The class will be limited in size in order to provide for attention to individual problems. Make sure of a place by sending your name in now.

ARTHUR KOEHLER,

In Charge Instructional Service.

Synopsis of Course: Structure and composition of wood, moisture in wood, shrinking and swelling of wood, decay and durability of wood, strength of wood, grading rules and safe working stresses, seasoning of timber, defects in drying and how to prevent them, grading of lumber and significance of defects, lumber prices, glued wood products, protective coatings for woods, fire prevention in wood construction.

\$300,000 SAN FRANCISCO PLANT TO  
BE BUILT

A five-story warehouse to cost \$300,000 will be built at Ninth and Brannan Streets immediately by the Standard Sanitary Manufacturing Company. Architects Weeks & Day are in charge.

SAN FRANCISCO ARCHITECTURAL  
CLUB NOTES

After the banquet all effort is directed toward the success of the Annual Club Jinx to be held in December. Al Williams may be seen most any day in whispered consultation with other members of the Entertainment Committee, with a mysterious and knowing smile forcing itself upon his countenance. Wilton Smith closes up like a clam, and is apparently as much unconcerned, but we have always been told that appearances are deceiving with these quiet fellows. Discordant strains of guitars, banjos and ukeleles are heard emerging from the Atelier room every night, but still a trained ear can discern a remarkable improvement from a week ago. Rehearsals are the order of the day, and yet everything seems to be shrouded in mystery. This much only has gotten to the reporter's ears; that it is going to be SOME JINX, and this is all that he can testify to.

The Free Hand Drawing Class started in September has proved such a success, that it has been decided to continue the class for another 10 weeks, starting on November 27th, to draw from living models.

The following new members have been elected during the past month: H. W. Ruppe, Geo. W. Travis, M. Bernstein, Mark E. Manning, Theodore Vierro, Edward Cereghino, Bernard W. H. Scott, and James Edward Boden. The club is now aiming toward a goal of three hundred members, and at the present rate of increase, it will soon be reached.

The Architectural Department of the University of California has issued a sprightly sheet entitled "The University of California Architect" which deals with the "Ark" and its Alumni, of whom many interesting notes are given.

COMPETITION FOR HOUSE BEAUTIFUL  
COVERS

The success of the competition for cover designs held last year has led the House Beautiful to repeat this event, and again to offer two prizes, one of \$500 and one of \$250 to the successful contestants. The competition closes February 9th, 1924. Full particulars may be had on application from the Competition Committee, House Beautiful, Eight Arlington Street, Boston, Mass.



## New Main Offices of Paraffine Co. Inc.

Nearly forty years have passed since the first product was manufactured by The Paraffine Companies, Inc., at the then small factory at Emeryville, California. The products of this company have since developed and the sales have so expanded that enlarged conditions have called for a new, enlarged main office.

The new main office is situated at 475 Brannan Street, San Francisco, and comprises 205,000 square feet of floor space. The building is of the two story brick type. About twenty thousand square feet of space will be devoted to the use of the office force exclusively, while the board and paper division will use the remainder for manufacturing purposes. On the first floor is located the huge printing presses for the printing of cartons and shipping cases. Here also is located the machinery for the manufacture of fiber shipping cases. At the rear the warehouse will take care of the output from these machines and is equipped with a spur track for transportation.

On the second floor is the plant for the

manufacture of oyster and ice cream pails, cake plates and paper tile mah-jongg sets. A large part of the second floor, however, is devoted to the executive offices. The combining of light manufacturing facilities with the main office is considered a distinct advantage, and will do away with the Oakland Container plant, the Pacific Folding Box factory at San Francisco and one or two small warehouses.

The former location of The Paraffine Companies, Inc., at 34 First Street, San Francisco, has been used for the past eighteen years. At the time the company moved into the first street location, only two floors were used, but due to the rapid expansion of all departments, especially the new shipping case department, the entire building is now much too small to take care of the enlarged force.

The interior of the new offices have been finished with "Pabco" products wherever possible, so visitors can see "Pabco" paints, varnishes, floor coverings and wall boards in actual demonstration.

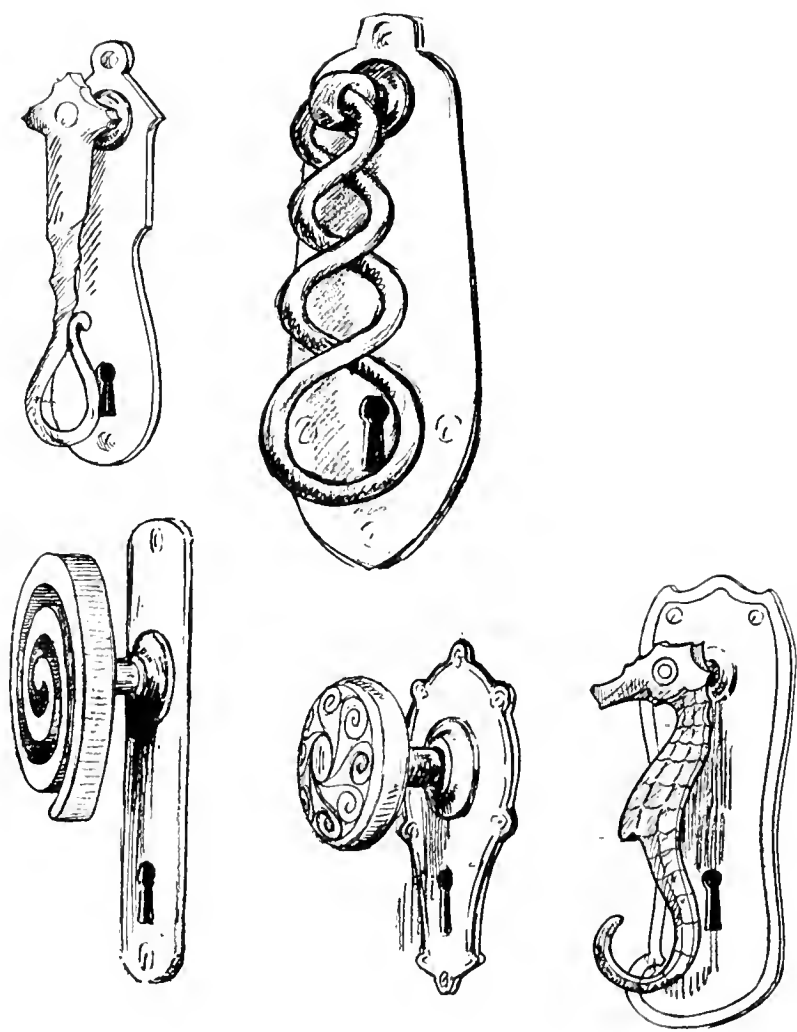

EVERY KNOB A POINT OF INTEREST

By MARJORIE SPENCER

GONE are the days when door knobs were regarded solely as a means of opening and closing doors, and in their place we have something of much greater interest, the time when every knob is taking a definite place in the scheme of decoration of a room, or the architecture of a building.

After the passing of nearly a century, the suggestion given in the account of Marco Polo's trip to the new world, in which he described the dwellings of the seven cities of Cibola, as being studded with turquoise, is being popularized. What the ancient adventurer said of the famed seven cities may yet be said of the homes of America.

Colored enamel and porcelain, wrought iron, hammered brass and copper, and carved ivory are vying with each other for first place in making beautiful a long neglected thing, the door knob. Tiny

latches for closets and cupboard doors are ornaments, instead of giving the impression of being made for mere utility.

Many people are now making their door knobs doubly interesting by having souvenirs of one kind or another made into knobs. Such a one is Mrs. Waldo Gibson of San Francisco, who collected pebbles, which she valued as souvenirs, from her property in Southern California. She had them set in brass and made into a door bell plate, and a unique handle. It holds the interest of the visitor from the first glance.

In another San Francisco home, the personality of the owner, a retired sea faring man, is manifest in a number of unexpected places, prominent among them being the doors and their intriguing knobs and handles. Swirling fish of oxidized copper, and colored enamel, a sea horse of cast bronze on the front door, sea shells, and treasures of the Orient are interestingly used.

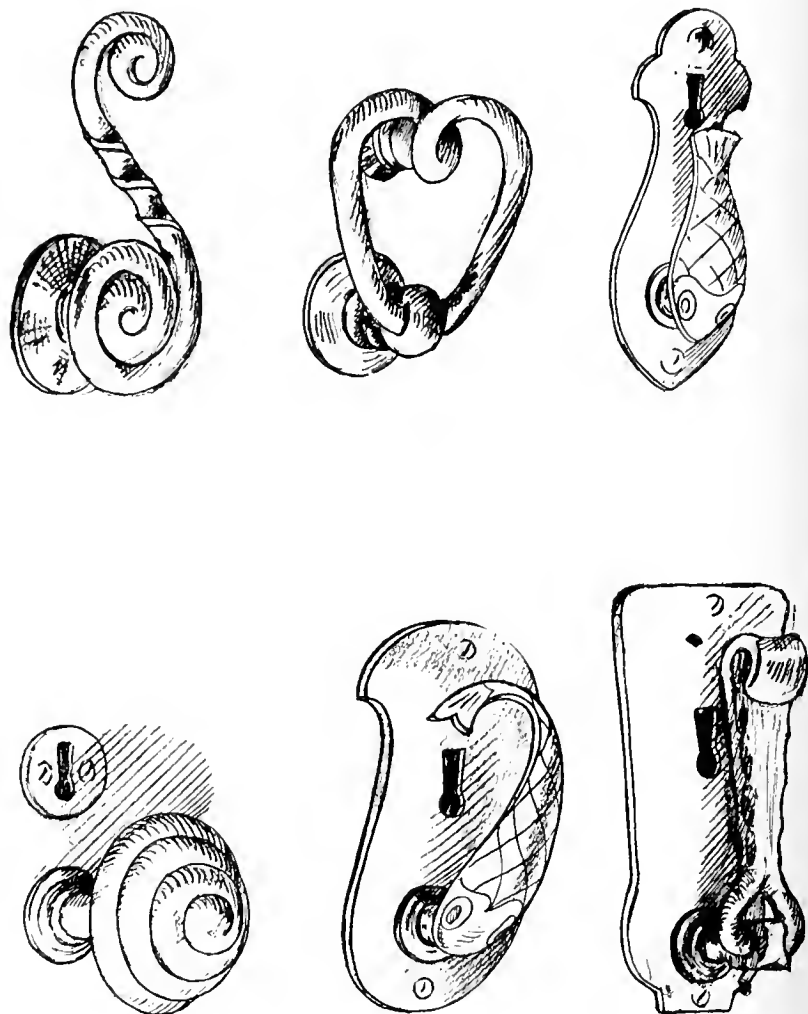



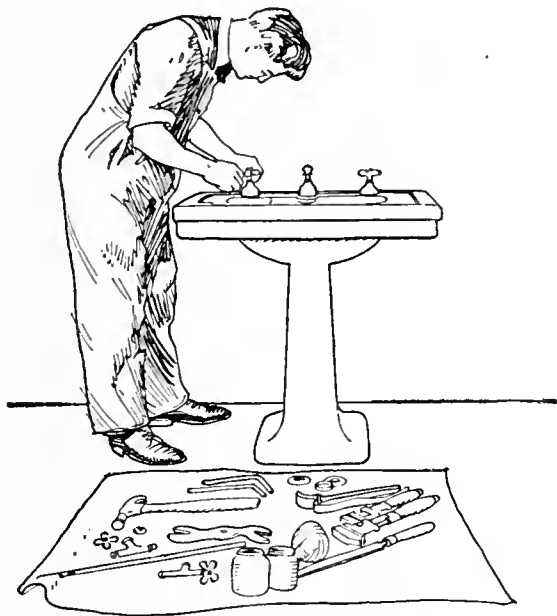

The Del Rey Lavatory

*Pacific  
quality  
is the  
highest*

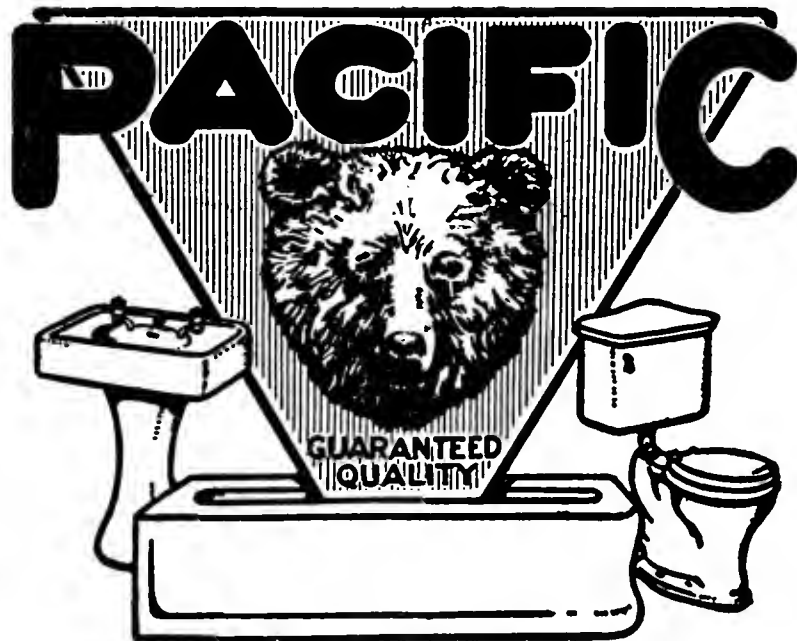

TRADE MARK REGISTERED

**PACIFIC**  
**PLUMBING FIXTURES**

PACIFIC SANITARY MANUFACTURING CO.  
Main Office: 67 New Montgomery Street, San Francisco  
Factories: Richmond and San Pablo, California  
Branches: Los Angeles, Portland, Seattle

## GARDENING OF OUR COUNTRY HOMES

(Continued from Page 53)

winter season. It is a very rapid grower and very hardy.

The prostrate forms of Cotoneasters are very greatly prized in our landscape work and are especially useful in any rock work effects, the most generally known varieties being *horizontalis* and *microphylla*. Both of these varieties bear berries in great profusion, horizontals having the more brilliant berries of the two. They are also very widely planted as ground covers over banks in particular and we often see *microphylla* planted to fall over walls and parapets to soften the harsh lines of concrete or stone work.

In conclusion, let me urge the necessity for careful study and preparation for our garden work, no matter how large or how small, for a small garden may be made equally as effective as a large one, provided, of course, that the plantings and effects be arranged in keeping. We have been endowed with such a wonderful climate in California that it seems a pity for us not to take full advantage of our opportunities.

# MacRorie-McLaren Company

LANDSCAPE ENGINEERS  
AND  
GENERAL NURSERYMAN

Suite 301 Phelan Building  
Telephone Douglas 4442  
San Francisco, Cal.

Nurseries at  
Beresford, San Mateo Co.  
Telephone San Mateo 1002

## AERO-PHOTOGRAPHY

(Continued from Page 51)

and have found it to be not only the quickest method of preliminary surveys, but also costing but a fraction of the amount that a similar ground survey would cost, in marshy sections or where the area is not easily accessible, the value of an aero-photo preliminary survey cannot be reckoned and with a very few ground controls to work from it is to make a far more accurate map than from the ground and at a fraction of the cost of the ground survey; meanders of streams and roads absolutely as they are, every detail is in the photo and if not assembled into a map, the photos make a supplement to the drafted map that is invaluable.

One thing that I wish to make clear is that Aero-Photography can not and will not ever take the place of engineering; without controls surveyed on the ground and the services of a civil engineer, or at least a knowledge of engineering, Aero-Photo-Maps are an impossibility, but there is no question but that Aero-Photography is the greatest aid and addition to civil engineering that has been brought forward for many years and I believe that in the next ten years will be as much a part of engineering as the transit and level are now.

Aero-Photography is still a baby in the commercial field and the possibilities seem unlimited and while it has long since passed the experimental and novelty stage, yet there are still many problems to be worked out, and while to the layman it may all seem very simple there is far more to it than simply holding a camera over the side of an aeroplane and making an exposure. Conditions in the air are far different than on the ground and it takes many hours of flying time to become accustomed to flying to the extent that one can absolutely become indifferent to the movement of the plane and the fact that he is several hundred or thousand feet above ground. To the one, who has arrived at that stage, and really tries to put composition into his photographs, Aero-Photography becomes very interesting. It requires quick work on the operator's part (the average speed of a plane is around 75 miles per hour) and perfect co-operation between him and the pilot of the plane. With a photographic pilot and a photographer that takes an interest in making photographs, not just pictures, Aero-Photography becomes a valuable asset to nearly every profession.

*"Don't be penny wise and fire foolish"*

**DEFY THE TWO DESTROYERS**  
*Fire and Decay*

**BUILD OF FACE BRICK**

Fire destroys non-permanent construction quickly; decay destroys it slowly, but relentlessly. Build of everlasting Face Brick - enjoy not only pride in its distinguished beauty, but also the peace of mind that comes with knowing your building is safe from fire and decay. The slightly higher first cost of Face Brick is quickly absorbed by year-in and year-out savings in repairs, painting, fuel and insurance costs.

Any of these four face brick manufacturers will gladly give you the facts:

RICHMOND PRESSED BRICK CO.      Sharon Building  
Telephone 3400      116 Natoma Street  
116 Natoma Street      Telephone 4644  
Crocket Building  
Telephone 2810

*"Conflagration Hurts Repairs Itself"*

**BUILD OF FACE BRICK**  
*Reduce these self-imposed Taxes*

HIGH upkeep and repair costs, recurrent expense for exterior repainting, high expense for heating, high fire insurance premiums - are *personal taxes* which the property owner imposes upon himself when he builds of non-permanent materials.

Cut them *way down* by building of fire-resistant, decay-proof Face Brick. Its first cost is slightly higher than frame - *its real cost is far less*. Prove this to your own satisfaction by *having your plans figured for Face Brick*.

Consult these Face Brick manufacturers:

RICHMOND PRESSED BRICK CO.      Sharon Building  
Telephone 3400      116 Natoma Street  
N. CLARK & SONS      Telephone 4644  
GLADDING, M. BEAN & CO.      Crocket Building  
Telephone 2810

*"An ounce of prevention is worth a gallon of fire extinguisher"*

Architectural beauty should be more than *paint deep*.

**BUILD OF FACE BRICK**

FACE BRICK is a surface material for buildings of common brick, hollow tile, reinforced concrete and frame. It is a material of everlasting beauty, mellowed, not defaced, by time and weather, preserving its strength and charm forever *without painting or other attention*.

The slightly higher cost of Face Brick over frame construction is the *best building investment that you can make*, since it brings large and never-ceasing dividends in the form of savings on repairs, upkeep, fire insurance and fuel.

Any one of these manufacturers will be glad to give you cost data on *fire-defying Face Brick*:

GLADDING, M. BEAN & CO.      Crocket Building  
Telephone 2810      116 Natoma Street  
LIVERMORE FIRE BRICK WORKS      Telephone 4644

*"Conflagration Hurts Repairs Itself"*

*Property Dollars Safe*

**BUILD OF FACE BRICK**

ed in non permanent concrete dollar If Fire doesn't rob me and Weather will steal

Face Brick construction is safe from Fire and Weather - thereby besting distinguished architectural savings in insurance costs.

Get data on the *modern* construction.

604 Mission Street  
Telephone 4113

*"It's never too late to mend with Face Brick"*

**REMODEL with FACE BRICK**

FRAME, stuccoed, or reinforced concrete buildings which show the effect of time and weather may be veneered with Face Brick at a surprisingly low cost.

A Face Brick veneer gives an old structure, all of the *beauty and artistic distinction* of a new Face Brick building. It is a good investment that means *higher rent and surer tenancy*.

Once applied, it requires *no painting or other attention* as long as the building stands.

Ask these manufacturers for data on building and remodeling with Face Brick:

LIVERMORE FIRE BRICK WORKS      604 Mission Street  
Telephone 4644      Telephone 4113  
RICHMOND PRESSED BRICK CO.      Sharon Building  
Telephone 3400      116 Natoma Street  
N. CLARK & SONS      Telephone 4644  
GLADDING, M. BEAN & CO.      Crocket Building  
Telephone 2810

*"A Burned City Dreads the Fire"*

**BUILD OF FACE BRICK**  
FOR FIRE PREVENTION  
AND ARCHITECTURAL BEAUTY

The fire safety of face brick is conceded, its endurance and artistic distinction are recognized. *But what of its cost!*

Its first cost is but *slightly higher than frame*, and the difference is soon absorbed by savings in repairs, painting, fuel and cost of fire insurance.

Get the facts from any of these Face Brick Manufacturers:

N. CLARK & SONS      116 Natoma Street  
Telephone 4644      Telephone 4113  
GLADDING, M. BEAN & CO.      Crocket Building  
Telephone 2810      Telephone 4644  
LIVERMORE FIRE BRICK WORKS      604 Mission Street  
Telephone 4644      Telephone 4113  
RICHMOND PRESSED BRICK CO.      Sharon Building  
Telephone 3400      Telephone 4644

*"A Burned City Dreads the Fire"*

-why not "Yearage"  
FACE BRICK

is on a mileage basis, why not on a "yearage" basis? And on no building material is so *early* the Brick.

never decays, it never cracks, needs painting or repairs of cost is its entire cost, and, besides, Face Brick affords the highest resistance.

Architectural beauty it is unequalled.

Get the facts from any of these Face Brick Manufacturers:

LIVERMORE FIRE BRICK WORKS      604 Mission Street  
Telephone 4644      Telephone 4113  
RICHMOND PRESSED BRICK CO.      Sharon Building  
Telephone 3400      Telephone 4644  
N. CLARK & SONS      116 Natoma Street  
Telephone 4644      Telephone 4113  
GLADDING, M. BEAN & CO.      Crocket Building  
Telephone 2810      Telephone 4644

*"An ounce of Prevention is worth a gallon of Fire Extinguisher"*

FIRE MAY COME  
AGE MUST COME

**BUILD OF FACE BRICK**

Face Brick affords not only *fire safety* but unequalled resistance to Time and Weather. The passing years do not deface it, but merely *mellow its beauty and heighten its charm*.

Its first cost is but slightly higher than frame, and savings in repairs, painting, fuel and cost of fire insurance soon bring down its *real cost to less than impermanent construction*.

Get the facts from any of these Face Brick Manufacturers:

GLADDING, M. BEAN & CO.      Crocket Building  
Telephone 2810      Telephone 4644  
LIVERMORE FIRE BRICK WORKS      604 Mission Street  
Telephone 4644      Telephone 4113  
RICHMOND PRESSED BRICK CO.      Sharon Building  
Telephone 3400      Telephone 4644  
N. CLARK & SONS      116 Natoma Street  
Telephone 4644      Telephone 4113

# The Renaissance of Brick

After a short period in which brick was, to a certain extent, superseded by other materials in the California field, present indications point to a marked revival in its use and, indeed, an extension of its employment to the home building field in which in the past brick has been little used.

This revival is being helped by the energetic work of the California Common Brick Association and by the Face Brick Manufacturers, of the bay cities, who are running dovetailed educational campaigns in the newspapers to emphasize in the property owners' and home builders' minds the beauties and advantages of brick construction.

Further, to promote the use of brick, both the above named associations are doing extensive research work in order to lay before architects and property owners, accurate cost data which will prove to them that brick construction is not unduly costly, but that, taking upkeep factors into consideration, it is the most economical type of construction.

It is, of course, well known that brick,

being a product of fire, is the most nearly fireproof material. Then, too, brick construction, once completed, requires a minimum of care. Other materials, due to weathering or molecular action, are chipped or cracked; other materials require frequent waterproofing or painting to preserve their sightliness. Age and weather merely heighten the charms and mellow the beauty of face brick construction. A thorough washing will give a face brick building the bright beauty of newness, saving thousands of dollars that, in the case of other materials, must be expended for periodical repainting.

And, finally, face brick has unequalled architectural possibilities. The range of delicate colorings and distinctive textures, the wide choice of bonds and mortar joints give unlimited scope to the architect's fancy in devising structures of distinction and charm.

Architects are viewing the brick educational campaign with approval since it is aiding them materially in persuading their clients to take this type of construction.



Not in an old-world pleasaunce, no nor even in one of our noted millionaire gardens, was this bit of scene discovered. It is virtually a "street-scape" overlooking a wee corner of one happy front yard and entrance path leading to a moderate-sized residence in a Southern California city.

The clipped cypress hedges make for grateful shadows and for a certain apparently contradictory charm compounded of homeliness and stateliness. The slim Italian cypress columns on the other hand give accent and intrigue us further by their vividness of contrast with the round-headed trees along the avenue's opposite side.

Add to these features a mountain background of ever-changing Sierra Madres and

in reality though not conspicuous in the black and white photograph a glimpse of colorful Cherokee roses behind the hedges and must we not confess that a veritable magic can result when members of a community "go to it" and seize their opportunities. Here instead of trying to out-do or out-wit each other they seem to have worked together in such wise that each "front yard" harmonizes not only with its neighbors to right and left but also with its near-by surroundings and with the character of the common scene. In such a wise it is proven possible not only to emphasize the sense of "Country in Town" but even—out of a mere street-scape to create a landscape.

EL ZENZONTLE—A CALIFORNIA  
COURT

(Continued from Page 55)

one side, on the other store rooms, accommodations for each unit. A much appreciated convenience where there are no basements. The building is of fire-proof tile, the walls eight inches thick, topped by a tiled roof.

The view of the ensemble is charming in color, design and variety of spaces, obtained by windows of different sizes, by doorways which are not all alike, but vary in pattern and arrangement of colored tiles. These are placed at intervals around the door frame. Over one doorway is a graceful garland of flowers of tinted plaster. Here and there a rectangular space is relieved by a set-in circular tile. The warm color of the plaster sets off the hues of blue, green and violet ornaments which attracts without striking one in the eye, so to speak. We are getting accustomed to color in architecture—we welcome it gladly when it is not too bizarre. And this is gay and spirited while not at all violent. A careful study of harmony carried out in ornament, shrubbery, in the bit of reflection which is obtained by the pool in the center, results in a fascinating play of color through the whole.

In the owner's opinion this type of dwelling is meeting a popular demand for small apartments on the ground floor, which has all the privacy of the detached house with the advantage of a community grass plot. Although but recently completed it was immediately rented and there is a waiting list. The building of a well constructed house which is pleasing to the eye, and affords material comforts as well, is apt to be a good investment, as it attracts people who make the most satisfactory tenants.

TESTS OF "COMPOSITION" FLOORS  
AND STUCCOS.

Comparatively very few people, who walk on oxy-chloride cement floors, or who live in houses having exterior walls of oxy-chloride cement stucco, are familiar with these materials. In fact, very often the architect or builder knows oxy-chloride cement products only in connection with trade names. The rapidly increasing demand for these materials is significant of certain desirable peculiarities, and has made it necessary to replace haphazard or "rule of thumb" methods, in the manufacture and use of this cement.

Caustic magnesia, the chief constituent of oxy-chloride cement, was made in the experimental cement plant by calcining magnesite ore. The temperature and other conditions were varied in order to study the effects on the properties of the product. An ore imported from Greece, one shipped from the State of Washington, and two from different mines in California were used, as these were representative of the chief sources of supply for this country. Cement mixtures, typical of those used by the trade, were then made and tested by laboratory methods, and in actual service. The service tests were conducted on panels of flooring and stucco exposed to actual service conditions. The results of this work add to the information necessary in producing the most satisfactory oxy-chloride cement products.

The results of these tests are published in Technologic Paper No. 239 of the Bureau of Standards entitled, "Tests of Caustic Magnesia Made From Magnesite From Several Sources." It can be obtained from the Superintendent of Documents, Government Printing Office, Washington, D. C. The price is 10 cents, cash.

**Pacific Manufacturing Company**

Branches:

117 Stevenson St.  
SAN FRANCISCO

Manufacturers of and Dealers in

**Doors, Windows and Mouldings**

General Millwork

Branches:

908 Washington Bldg.  
LOS ANGELES1001 Franklin St.  
OAKLAND58 West Santa Clara St.  
SAN JOSE

Factory and Main Office: Santa Clara, Calif.

## ANNOUNCING A SMALL BRICK HOUSE COMPETITION

Under the auspices of the Los Angeles and the San Francisco chapters of the American Institute of Architects and the Architectural Club of Los Angeles and San Francisco, and for which nine prizes totalling \$1000 are offered. Rules of the Competition.

Harwood Hewitt, A. I. A., professional advisor, 1130 Van Nuys Building, Los Angeles, California.

California Common Brick Manufacturers Association, 811 Sharon Bldg., San Francisco; 342 Douglas Bldg., Los Angeles.

### Rules of the Competition

#### I. Purpose

The purpose of this competition is to stimulate interest in the designing of small homes built of common brick, and through these designs to interest the public in the erection of brick houses.

#### II. Eligibility

No geographical limitation is placed on competitors.

#### III. Time

The competition opens at once.

#### IV. Registration

Every entrant should as early as possible advise the secretary of the Association of his intention to compete. In this way he will be certain to learn of any additional information regarding the contest which it may seem advisable to announce. See Paragraph on "communications."

#### V. Communications (Mandatory)

If any competitor desires information of any kind whatever in regard to the competition or the program he shall ask for this information by anonymous letter addressed to the architectural advisor, and in no other way. The reply thereto will be sent to every registered competitor. No communications, however, received after Dec. 1st will be answered.

#### VI. Anonymity and Transmission

No name or mark or sign shall be placed on the drawings or on the package containing them by which the author may be identified. (If the sender's name and address be required on the package, as in mail or express, a name of a representative may be substituted for that purpose.) No competitor shall reveal either directly or indirectly the identity of his design or hold any communication regarding the competition with any member of the jury. With each set of drawings, which shall be packed flat and adequately protected to prevent breaking,

creasing, or crushing, there shall be enclosed a plain, opaque sealed envelope, without any subscription or mark of any kind, containing the name and address of the competitor. These envelopes shall be opened by the architectural advisor after the selection has been made by the jury.

Drawings are at the owners' risk until returned, although reasonable care will be taken in their handling and keeping. Drawings not premiated by the jury or bought by the donor (see P. VIII) will be returned to their respective authors immediately after the jury has made its awards.

All drawings shall be addressed in plain lettering to Harwood Hewitt, Professional Advisor, Small House Competition, care California Common Brick Manufacturers' Association, 342 Douglas Building, Los Angeles.

They shall be delivered at this address or to the Post Office or Express Co. not later than 6 P. M. of Dec. 15, 1923.

#### VII. Jury of Award and Architectural Advisor

The jury shall consist of three architects to be selected by the Southern California Chapter, American Institute of Architects. Members of the jury shall not enter the competition. The names of the jury will be announced on the closing date of the competition. The jury will meet to consider the designs and will place in their order of merit, by secret ballot and majority vote the nine designs which appear to be most meritorious. In reaching its decisions, the jury will consider the merits of designs, the merits of the plans from the standpoint of economy in construction and accessibility of the various elements to one another, the integrity of the presentation, relationship of the house to its garden and such other points as they may deem best and award the prizes according to this program.

Harwood Hewitt, Architect, will act as professional adviser in the competition. He will not act as a juror. The competition will be conducted under Mr. Hewitt's personal direction and according to the competition requirements of the American Institute of Architects.

The award of the jury shall be final and binding to the California Common Brick Manufacturers' Association which agrees to award the prizes and honorable mention as follows

#### VIII. Award of Prizes

To each of the authors of the nine designs premiated by the Jury of Award, the

California Common Brick Manufacturers' Association agrees to pay respectively the following amounts:

First prize .....	\$400.00
Second prize .....	200.00
Third prize .....	100.00
Fourth prize .....	50.00
Fifth prize .....	50.00
Sixth prize .....	50.00
Seventh prize .....	50.00
Eighth prize .....	50.00
Ninth prize .....	50.00

Further the California Common Brick Manufacturers' Association will pay fifty dollars (\$50.00) each to the authors of designs, which (although not awarded prizes by the jury) seem in its judgment to be worthy of special recognition.

It is planned to make the awards so that the winners may be announced and checks mailed to them before Christmas.

#### IX. Ownership of Drawings

All designs awarded prizes by the jury and all those to the authors of which the California Common Brick Manufacturers' Association awards its special recognition by payment of \$50.00 (as in Paragraph VIII) shall become the property of the Association and may be published and exhibited by them.

#### X. Programme

##### (1) General Requirements—

##### (a) The Lot

The competitor shall select his own type and size of site. He shall, however, show on his plot plan the contour lines of his ground (with a contour taken every two feet) for an area of at least 7500 square feet, unless he selects an approximately flat lot.

##### (b) Type of House

The competitor is free to determine the number, character, and arrangement of rooms, always, however, bearing in mind the cost limit.

A single car garage shall be included in the cost given. This may or may not be an integral part of the house.

##### (c) Exposures

The house may be oriented at the discretion of the competitor, but the points of compass shall be shown on the plot plan and the arrangement of rooms studied from this point of view.

##### (d) Cost

Seventy-five hundred dollars or less (\$7500.00) shall be the cost for which

the house proper and garage can be constructed, at present prices of material and labor.

This shall not include the cost of the gardens, garden walls (where at least the same percentage of brick shall show) paving or architect's fee.

#### XI. Drawings Required

Perspective sketch. Elevation of two sides of the house not shown in the perspective. Scale  $\frac{1}{8}$  inch to the foot.

First Story plan. Scale  $\frac{1}{4}$  inch to the foot.

Second Story plan (if any). Scale,  $\frac{1}{8}$  inch to the foot.

Plot Plan. Showing the layout of the house, garage and grounds, to include an area of at least 7500 sq. ft. Scale,  $\frac{1}{8}$  inch to the foot.

Minor details in elevation or perspective may be added.

A roof plan or section should explain any roof or other structural form not entirely evident on other drawings.

#### XII. Presentation of Drawings

All plans are to be in dark ink, with walls shown in pochet. All letters in ink. A graphic scale and points of compass should be indicated. Give sizes of main rooms.

All of the drawings listed above are to be presented on one piece of illustration board, or on fairly heavy paper mounted on non-flexible board. The size of the board in either case is to be 30x40 inches and is to have a border  $\frac{3}{4}$  inch from each edge.

The title shall be at the bottom of the narrow side of the drawing so that the drawing may be shown vertically.

Drawings should be made to reproduce easily by either half tone or zinc etching. This will not eliminate proper use of sober color.

#### XII. Notes

(a) Competitors will remember that a considerable variety of both color and texture is available in common brick.

(b) The chief purpose of the California Common Brick Manufacturers' Association in giving this competition is to show the pleasing results to be obtained by the use of common brick, in exterior effects, as well as in solidity of construction. The use of a material of any nature to cover or supplant the exterior brick face is therefore prohibited for 80% of the surface of the exterior walls. Materials for the remaining 20% is at the discretion of the competitor. Within this 80%, however, the use of half timber work, where brick fills in between all

timbers, is permissible over a total area of not more than one-quarter of this 80% of the two wall faces which show in the perspective, if the competitor so desires.

(c) The perspective shall clearly suggest the effect of brick work, for the surfaces where it occurs; and the elevations shall indicate what surfaces, if any, are in other materials.

(d) While the area of the lot is not definitely limited, it is to be assumed that the average person spending not more than \$7500.00 for the house and garage will not have a very extensive plot of ground. Therefore well designed houses on average lots will be given fully as much consideration as those having larger plots.

e) Houses costing less than \$7500.00 are in every way desirable and will be given equal consideration by the jury.

November 1, 1923.

AWARDED PAINTING CONTRACTS

A. Quandt & Sons, of San Francisco and Los Angeles, have been awarded the painting contracts on the new building for the American Can Co., San Francisco. Lindgren & Swinerton, Builders; and for the new offices and main headquarters of the Paraffine Companies, Inc., at the then small S. Rosener, Engineer.

# Boiler Plate Furnaces Don't Crack!



*All that remains of Prof. E. A. Lee's Home  
1562 Le Roy Ave., Berkeley, Cal.*

Telephone  
Thornhill 70

Building  
Designing  
Financing

## ROY O. LONG COMPANY

REAL ESTATE **LONG** INVESTMENTS

PROPERTY MANAGEMENT

214 Shattuck Avenue  
Berkeley, Cal.

October 8th 1923.

M. F. Murray Co.,  
226 Webster Street.  
Oakland, Calif.

Gentlemen:-

This is to advise that the American Riveted Steel Furnace that was placed in Prof. E.A.Lee's home last year by you, went through the fire with very little damage.

Nearly all of the house fell in on the furnace burying it completely. When the property was finally cleaned off it was found that the riveted steel drum was in perfect condition, except for re-cementing the joints. The exterior casing was the only part that was really damaged. This will mean quite a saving to Prof. Lee in re-establishing his residence. We are authorizing you to get the furnace from the ruins, and proceed to get it ready for the new house.

This certainly speaks well for the American Furnace, when on close examination of other makes throughout the burned district showed them completely gone except for a pile of scrap iron.

It is a pleasure to know that we specified the American Furnace in Prof. Lee's home, and rest assured that we shall specify them in the future.

Prof. Lee's home was designed and built by this company, and we are to proceed re-building his home at once.

Yours very truly,

*William K. Bartleson.*

W.K.B. H.E.

Architectural Designer.

## MURRAY & CO.

Heating Specialists

226-230 Webster St.

Oakland, Cal.

*"We co-operate with the Architects"*

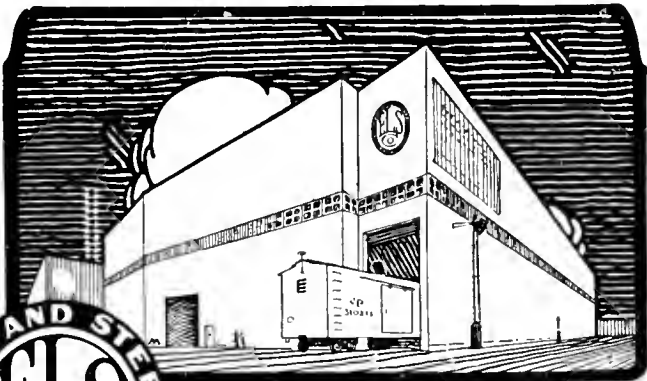

**STEEL**  
*Reinforcement*  
**BARS**

Steel Users Know Soule Service

Our warehouse is stocked and equipped to meet your requirements. Our mill connections are delivering the goods.

[Get a quotation  
from us.]

**EDW. L. SOULE' CO.**





*THE  
BUILDING  
REVIEW*



*DECEMBER, 1923*

*Vol. XXIV No. 6*

*Published in San Francisco*

*Price Twenty-five Cents*



LEWIS P. HOBART, Architect,  
SAN FRANCISCO, CALIF.

STEINHART AQUARIUM,  
GOLDEN GATE PARK, SAN FRANCISCO.

VINCENT DONOVAN, Painter,  
SAN FRANCISCO, CALIF.

*All Enamel Work*

*Finished  
With*

***Kyanize***  
KY-AN-IZE

*White  
Enamel*

Our new books "Recent Pacific Coast Architecture" and "Recent Eastern Architecture,"  
containing Practical Specifications, mailed on application

Office and Warehouse  
1151 MISSION STREET  
SAN FRANCISCO, CALIFORNIA  
A. L. GREENE, Local Manager

***Boston Varnish  
Company***  
KY-AN-IZE

Distributors for Southern California  
SUNSET PAINT COMPANY  
627 SOUTH MAIN STREET  
LOS ANGELES, CALIFORNIA

# THE BUILDING REVIEW

Vol. XXIV

DECEMBER, 1923

No. 6

## CONTENTS

COVER—RESIDENCE OF DR. J. W. CALKINS, OAKLAND, CALIFORNIA.

### PLATE SECTION

	Plates
GOUGH (ORAL DEAF) SCHOOL, San Francisco, California. John Reid, Jr., Architect .....	69-71
RESIDENCE OF DR. J. W. CALKINS, Oakland, California. Bernard Maybeck, Architect .....	72-74
PACIFIC COAST JOCKEY CLUB, San Bruno, California. George Applegarth, Architect .....	75-77
THE CALIFORNIA MEMORIAL STADIUM, Berkeley, California. John Galen Howard, Architect .....	78-80

### TEXT

	Page
THE CALIFORNIA MEMORIAL STADIUM, by Harris Allen.....	61
THE INTIMATE BEDROOM .....	64
PACIFIC COAST JOCKEY CLUB .....	65
THE GOUGH SCHOOL, by John Reid, Jr.....	65
EDITORIAL, by Harris Allen.....	66
SAN FRANCISCO ARCHITECTURAL CLUB NOTES.....	68
INDEX TO BUILDING REVIEW FOR THE YEAR 1923.....	71-72

### INDUSTRIAL DEVELOPMENT

AN AMERICAN SCOURGE .....	IV
LE BRUN TRAVELING SCHOLARSHIP COMPETITION YEAR 1924.....	VI
HOUSING AND CONSTRUCTION .....	67
HOW TO OWN YOUR OWN HOME.....	67
RESOLUTIONS PASSED BY AMERICAN CONSTRUCTION COUNCIL...	70
METAL LATH NOTES .....	70

HARRIS ALLEN, A. I. A., Editor

HOWARD HOYT  
Industrial Editor  
And Business Manager.

NED BRYDONE-JACK  
Advertising Manager

Published Monthly by the Building Review Company,  
Chronicle Building, San Francisco, California

Address All Communications to 345 Battery Street, San Francisco, California

Yearly subscription—United States, \$2.50—foreign, \$3.00. Single copies, 25 cents.

Entered as second-class matter in the San Francisco Postoffice under the Act of August 24, 1912. Previously entered as "The Architect."

The editors will be pleased to consider contributions of interest to the Industry. When payment of same is desired, this fact should be stated.

News stands and dealers supplied through San Francisco News Co., San Francisco, Calif., or American News Co., New York, N. Y.

## BATCHELDER TILES

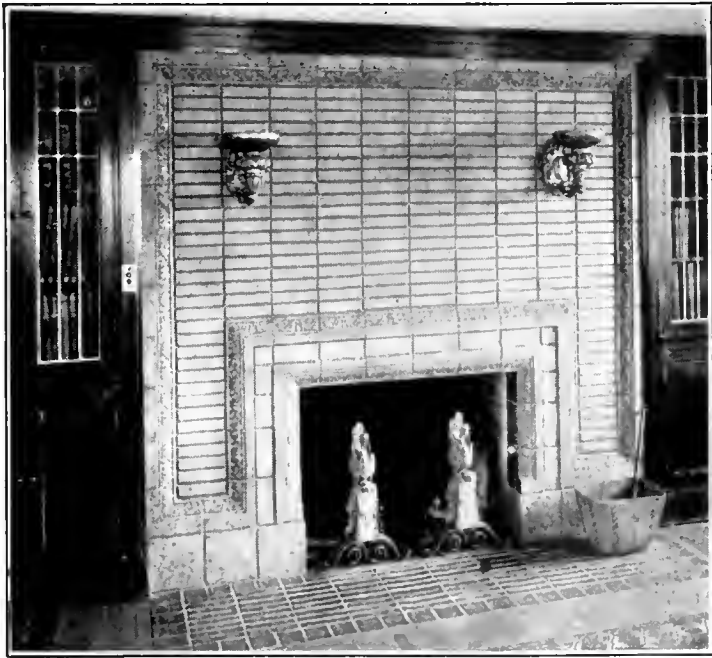

A Mantel of Distinctive character  
built up entirely from stock materials.



BATCHELDER-WILSON CO.  
2633 Artesian Street Los Angeles, Calif.

## THE ELECTRICALLY CONTROLLED—GAS FIRED McLAUGHLIN FURNACE

Responds to the touch of the finger upon the switch  
with a rush of warm pure air.

Magnetic valves raise and lower at the touch of  
the button supplying gas and relieving you from the  
annoyance of storing fuel and firing a furnace.



By installing a  
McLaughlin Furnace  
you enjoy the latest in  
"Home Comforts."

McLAUGHLIN SHEET METAL  
WORKS  
Sacramento, California

Agents in All the  
Largest Cities

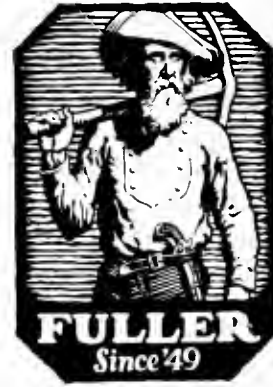
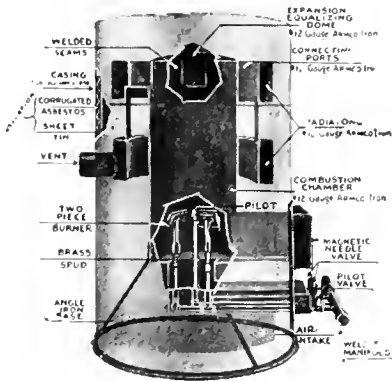

## In Specifying Varnishes

be guided by your  
experience and the  
maker's reputation

No chemical analysis or formula can solve the varnish maker's secrets. Oils and gums become so inextricably mixed when cooked together that their character is changed and they cannot be isolated by chemical analysis.

Generally speaking, the toughness, durability and water-and-weather-resistant qualities in a varnish are in direct proportion to the percentage of oil contained; also, the more oil, the slower the varnish will dry. In the "Fuller Process" of varnish making, however, perfected methods of oil treatment make it possible to manufacture varnishes containing a maximum amount of oil which will still dry within fifteen to twenty hours.

Back of all Fuller varnishes is the Company's reputation founded upon seventy-four years of successful paint and varnish making experience. You may specify them with full confidence.

### "FULLERWEAR"

The Spar Varnish for every purpose. Resistant to hot and cold, fresh and salt water.

### "15 for FLOORS"

Tough, durable and water resistant; will not mar or scratch white. Dries over night.

### "40 for FINISHING"

For finest interior work. Unusual in brilliancy and depth as well as durability.

### "50 for FLATTING"

Produces a dull, rubbed effect on floors and interior woodwork. Saves expense of rubbing.

Sample pieces of wood showing the effects of varnishing with any of the above will gladly be furnished to architects on request.

# FULLER

PAINTS  VARNISHES

W. P. FULLER & CO.

San Francisco  
Oakland  
Sacramento  
Stockton  
Los Angeles  
Hollywood  
Pasadena

Long Beach  
San Diego  
Santa Monica  
San Bernardino  
Santa Ana  
Fresno  
Portland

Boise  
Walla Walla  
Salt Lake City  
Seattle  
Tacoma  
Spokane  
Yakima

108-923



"I have specified 'The Best Glass' for you, Mr. Homeowner, because it is durable and increases your property value; for your wife because she will appreciate its beautiful lustre; and for the children because they will benefit by a generous supply of healthful sunlight.

"I have provided you, Mr. Glazier, with 'The Best Glass' because it permits easier glazing and because secure, expert packing means economy in its use."

## Why It's the Best Glass

Our melting furnaces are the **LARGEST IN THE WORLD**, permitting uniformly melted glass, while our improved mechanical process of drawing and blowing gives our glass greater tensile strength and higher modulus of rupture than any other window glass, plate glass or rolled glass.

Latest improvements in our blowing machines make possible the best flattening ever obtained. Our new method of flattening gives our glass a wonderfully even surface, preserving meanwhile the brilliant lustre produced in drawing. Our glass is **UNIFORMLY** flat, containing no reverse curves.

Our glass is **UNIFORM** in thickness, and, being perfectly annealed, does not break as easily as ordinary glass.

Our glass has less wave than other glass, and consequently shows less distortion.

Washing our glass in an acid bath prevents discoloration and permits ready detection of defects.

Our glass cuts perfectly on both sides.

Our glass is graded to a standard of quality now recognized as the national standard and distinctly higher than foreign standards.

Uniformity of flatness, well made boxes, careful packing and skillful loading prevents breakage of our glass in shipment.

Our scientifically accurate process produces a glass which is specified as "The Best Glass" and the quality of which is guaranteed by the elliptical trade mark on every box of the genuine. You will be interested in our Crystal Sheet, 34 and 39 oz. per sq. ft. Write for samples.



Practically alone of all nations, the United States faces the necessity of halting the depreciations of exposure fire; for this most destructive of fire causes is responsible for the conflagrations which have brought disaster upon so many of our cities and is a phenomenon that is all but unknown in Europe. Indeed, it is not an uncommon experience for some of the densest centers of population in England and France, Italy, Belgium and other old world countries to go through an entire year without having, at most, more than a dozen fires escape control and extend even to other floors of the building of origin. Much less are these cities accustomed to the sight of fire spreading to neighboring structures; in fact, the percentage of outbreaks that are confined to a single room is little short of miraculous.

This remarkable showing is not accomplished through the instrumentality of better fire-fighting facilities; for municipal fire defenses in America are—fortunately—superior, both in training and equipment, to most of those abroad. It is due, rather, to the interplay of several factors, the first of which is the fire-resistive nature of building materials employed in Europe. Thus, by reason of the scarcity of wood and the plentitude of brick and stone, the completed structure is invested with the initial virtue of fire-resistance.

It is, perhaps, hardly fair, in the absence of restraining laws, to criticize too severely American builders of an earlier day for utilizing those materials which were cheapest and most abundant. But conditions are fast changing. With her lumber resources by no means inexhaustible, America, in the not far distant future, will find herself driven, by the same inevitable necessity that marked their use centuries ago in olden lands, generally to adopt fire-resistive building materials.

There doubtless will come in time, too, a wider acceptance on the part of municipalities of the need for the close regulation of internal construction. It would be the queerest kind of reasoning that could discern real hardship in building laws designed to stop a waste which, from exposure alone, is running at the rate of a third of a billion dollars every five years.—Board of Fire Underwriters of the Pacific.

### Stillwell PLAN BOOKS of CALIFORNIA STYLE All Climate HOMES

—show pictures, Floor Plans and Estimated Costs of Building over 200 Selected Designs.

"West Coast Bungalows"  
50 Houses—6 and 7 Rooms—\$1  
"Little Bungalows"  
75 Houses—3-4-5 Rooms—\$1.



"Representative California Homes"  
50 Houses—7 to 10 Rooms—\$1.  
"The New Colonials"  
60 Houses—6 to 10 Rooms—\$1.

**SPECIAL OFFER:** Send \$2.50 for any three of these books and get Garage Folder FREE.

*Books and Blueprints sold with Money Back Guarantee*

**E. W. STILLWELL & CO., 790 California Building, Los Angeles**

PHONE FRANKLIN 2492

**A. C. WOCKER**  
INTERIOR DECORATOR

1370 SUTTER STREET

SAN FRANCISCO, CAL.

# BALL BEARINGS

**SKF INDUSTRIES OF CALIFORNIA**  
Incorporated

115 NEW MONTGOMERY ST.

San Francisco, Calif.

Phone Sutter 4196

DEEP GROOVE AND SELF-ALIGNING BEARINGS  
HANGER EQUIPMENT

# Clay Products

Gladding, McBean & Co.

SAN FRANCISCO  
LINCOLN  
LOS ANGELES

# Hall Furnace Comfort

Make your home warm and comfortable with a Hall Gas Furnace.

All our models supply fresh, warmed air, discharging the gas fumes outside the house.

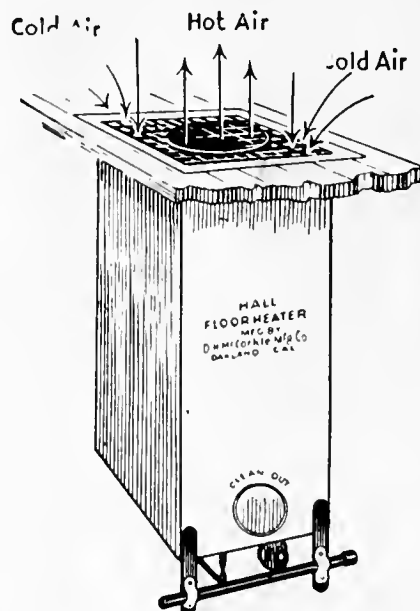

There is a Hall Gas Furnace to fit your needs. Telephone Oakland 5528 and arrange for one of our heating engineers to come out and figure your requirements.

Write for our illustrated folder.

Manufactured by

**D. H. McCORKLE MFG. CO.**  
319--12th St. Oakland, Calif.  
*Dealers and distributors in principal Pacific Coast Cities*

PORTLAND LOS ANGELES SEATTLE

# R. N. NASON & CO.

PAINT MAKERS

151 Potrero Ave.--SAN FRANCISCO--436 Market St.

Makers of

**NASON'S OPAQUE FLAT FINISH**

A flat oil paint made in soft Kalsomine Tints, that is washable; a practical article for walls, ceilings, etc., that is most economical and durable.

Agency for

Tamm & Nolan Varnish Works High Grade Varnishes and Finishes

Goods made on the Pacific Coast for the climate of this Coast

Del Monte -- Fan Shell Beach

# CLEAN WHITE SAND

**Del Monte Properties Company**

Sutter 6130 Crocker Building San Francisco



Genuine Hyloplate Backboards  
Moulthrop Movable Desks  
Sheldon Manual Training Benches  
Domestic Science and Laboratory Furniture

**C. F. WEBER & CO.**  
Exclusive Agents

SAN FRANCISCO LOS ANGELES  
RENO PHOENIX



G. A. Applegarth, Architect

TANFORAN RACE COURSE AND CLUBHOUSE—SAN BRUNO, CAL.

To complete the painting work of the Club House Grand Stand, and all other buildings, etc. of the Tanforan Race Course, over 5000 gallons of W. P. Fuller and Company's products were used.

To co-operate with the Architect in achieving the best results and to translate his vision of color and texture is always our paramount interest.

SAN FRANCISCO  
374 Guerrero Street  
PHONE MARKET 1709

**A. QUANDT & SONS**  
PAINTERS AND DECORATORS

SINCE 1885

LOS ANGELES  
3319 Central Ave.  
TELEPHONE 6514

### LE BRUN TRAVELING SCHOLARSHIP COMPETITION YEAR 1924

The Executive Committee of the New York Chapter of the American Institute of Architects, as Trustees of the Traveling Scholarship, founded by Pierre L. Le Brun, announces a competition for the selection of a beneficiary. The program will be issued about January 2, 1924, calling for drawings to be delivered about March 1, 1924.

The following excerpts from the Deed of Gift explain the award and conditions:

"Fourteen hundred dollars . . . is to be awarded, . . . to some deserving and meritorious architect or architectural draughtsman, resident anywhere in the United States, to aid him in paying the expenses of an European trip, lasting not less than six months."

"The selection of the beneficiary of the Scholarship is to be by means of a competition . . . and the drawings called for . . . are to be submitted for examination and judgment to a jury consisting of at least three practicing architects, no one of whom is to be connected with any school or atelier for the teaching of architecture. In making the award the jury is to give full and careful consideration to the records of qualification filed by the competitors as well as to the comparative excellence of the drawings submitted."

"Any architect or architectural draughtsman, a citizen and resident of the United States, not under twenty-three or over thirty years of age, who shall, for at least three years, have been either engaged in active practice, or employed as an architectural

draughtsman and who is not and has not been the beneficiary of any other traveling scholarship, shall be eligible to compete."

"Every competitor must be nominated by a member of the American Institute of Architects who shall certify in writing that the above conditions are fulfilled, and that in his opinion the competitor is deserving of the scholarship. No member of the Institute shall nominate more than one (1) candidate."

"Every competitor must engage to remain, if successful, at least six months abroad and to devote well and truly that length of time to travel and the study of architecture otherwise than by entering any school or atelier or attending lectures, it being intended that the benefit derived from this traveling scholarship shall supplement school or office experience."

"The successful competitor shall write from time to time, but not less than once every two months, to the New York Chapter of the American Institute of Architects, giving an account of the employment of his time."

All those wishing to enter the competition should arrange at once for nomination by a member of the American Institute of Architects. Nomination blanks can be had of the Secretary of any Chapter, A. I. A., or of the Le Brun Scholarship Committee, 215 West 57th Street, New York. Nominations should be sent, so as to be received before January 1, 1924.

To Le Brun Scholarship Committee, 215 West 57th Street, New York, Julian Clarence Levi, Chairman.

# Where Ambler Linabestos Wallboard Meets the need

It's permanent, fireproof, attractive, convenient. Saves plastering as well as painting.

Made entirely of two of the most indestructible materials — asbestos fiber and Portland cement—pressed out with pressure of 3000 pounds to the square inch, into a hard, non-warping, non-cracking wallboard of permanent buff color that can be worked with ordinary tools.

Made 48 by 48 and 48 by 96 to fit standard joists.

Plan to use fireproof Ambler Linabestos Wallboard for every interior lining use—partitions, wainscoting, hallways, libraries, game-rooms, attics, bathrooms, kitchens, etc.

For prices and samples, address

**Asbestos  
Shingle, Slate & Sheathing  
Company**

Dept. S

Ambler, Penna.

Branch Offices: — Baltimore, Boston, Buffalo, Chicago, Cincinnati, Detroit, Cleveland, Minneapolis, New York, Omaha, Philadelphia, Pittsburgh, Washington, Wilkes-Barre; Toronto, Canada.

Southwestern Distributors:—R. V. Aycock Co.,  
Kansas City, St. Louis, Tulsa, Houston.

Western Distributor:

**J. A. Drummond**

1744 Folsom Street  
San Francisco

2225 Fresno Street  
Fresno

845 Seward Street  
Los Angeles

Other distributors throughout the country



BATHROOMS

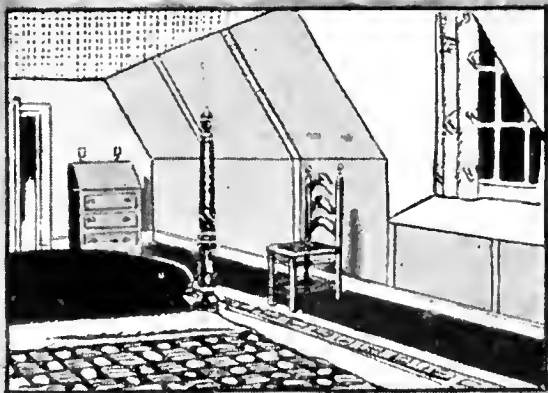

THIRD FLOOR ROOMS



KITCHENS



LIBRARIES

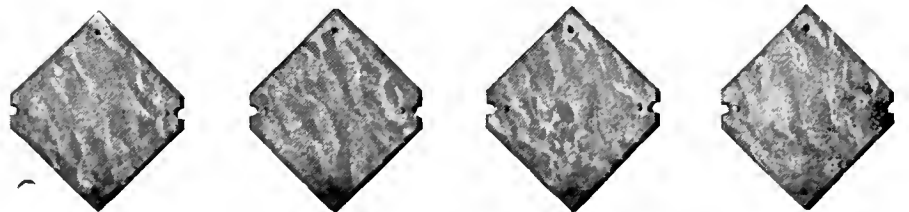

**AMBLER ASBESTOS SHINGLES**



# The BUILDING REVIEW

VOL. XXIV

SAN FRANCISCO, DECEMBER, 1923

No. 6

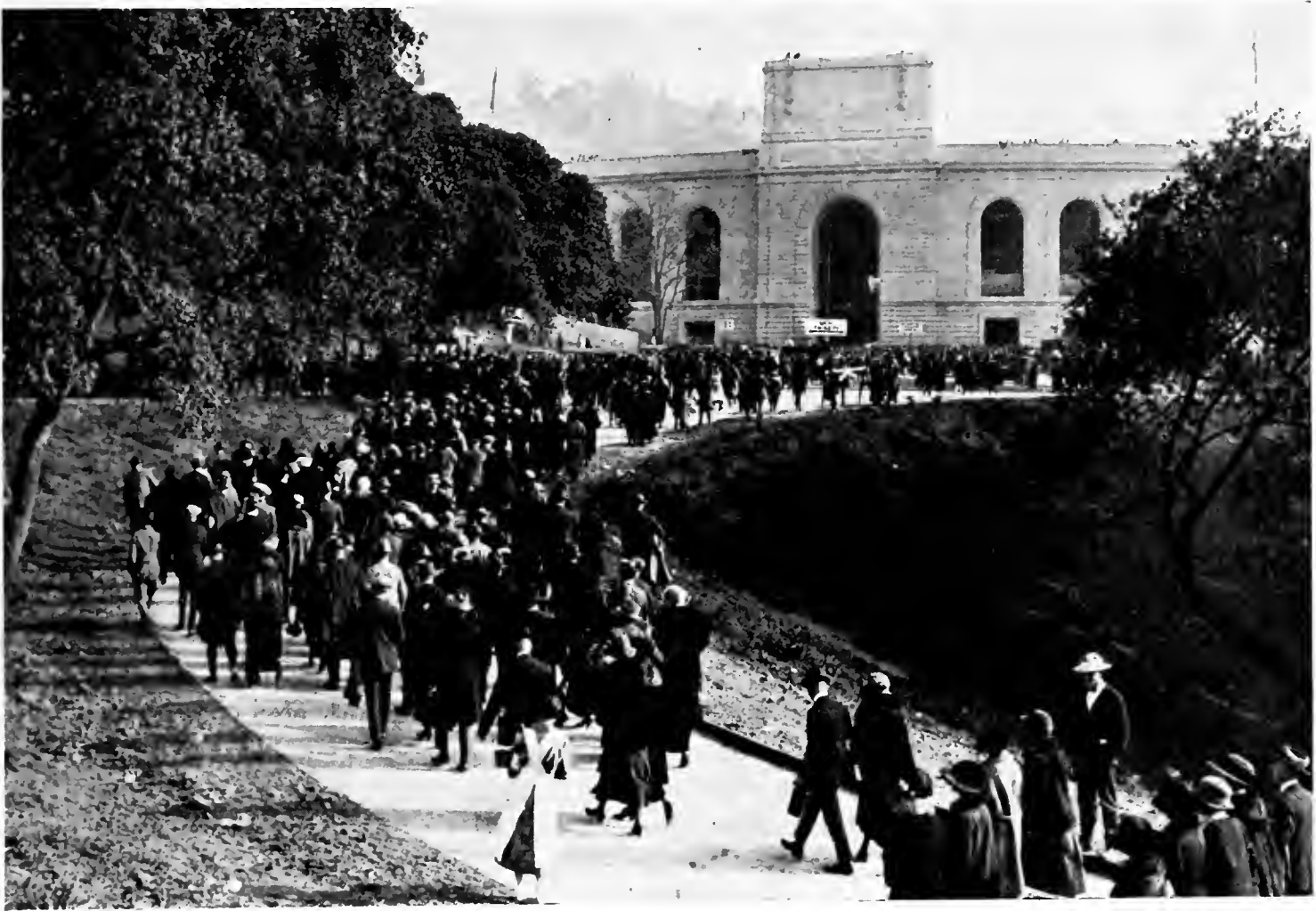

## The California Memorial Stadium

By HARRIS ALLEN.

THE stadium at the University of California, which was dedicated last month, first by an impressive memorial ceremony attended by 25,000 people, and the following day by an intercollegiate football game watched by probably 100,000 spectators (for the surrounding hills were black with people) has come into being through a process of evolution.

Its final site and form of construction was decided on, because and in spite of countless suggestions, criticisms and objections. No doubt there may be still found detrac-

tors; but the cachet of approval and admiration has been definitely bestowed by the throngs who attended its first function and who found no fault with the structure or the arrangements for handling the crowds.

The first studies were made for a concrete stadium of the bowl type. Next came the idea of a huge coliseum to include gymnasium, armory, athletic field and parade ground. This ambitious scheme took the project out of student control into the scheme of university development, making it purely a state enterprise. For this and

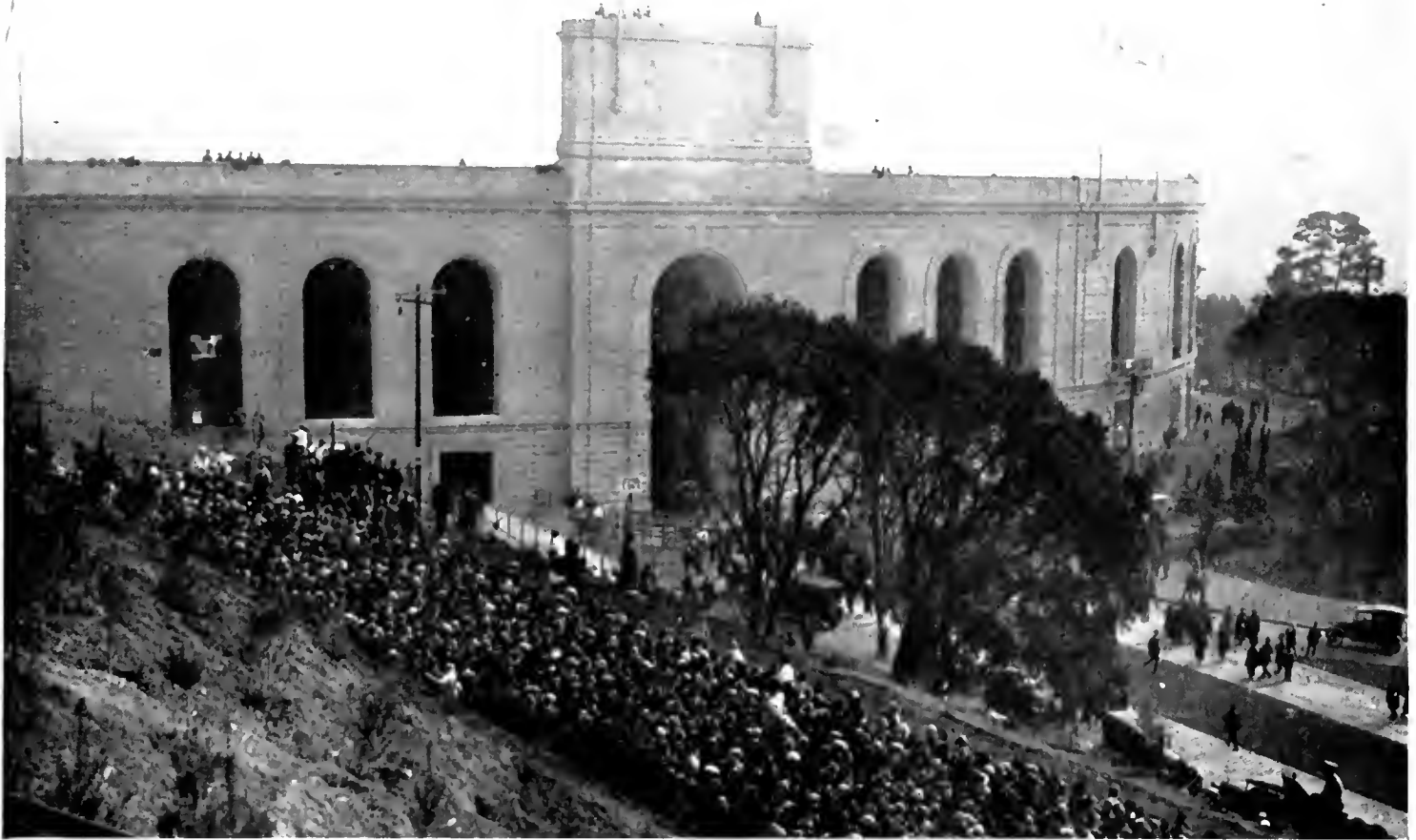

other reasons it was decided to be impractical.

In 1921 a block of land adjoining the lower, or southwest corner of the campus, was approved, and John Galen Howard, the university architect, prepared very complete studies for a double deck coliseum, a closed blunted ellipse with axes 730 and 560 feet, capacity 60,000, to be built of reinforced concrete. The exterior wall of this building would have risen about ninety feet above ground. It is somewhat appall-

ing to picture this enormous block in the very heart of a small city.

Advance of realty values made the purchase of this property a discouraging problem. At this time Baker and Carpenter, the construction engineers, who had built the Stanford bowl, presented plans for a cut and fill earth bowl in Strawberry Canyon near the final site. These plans, the results of private studies, were practical and reasonable.

A board of engineers was then appointed





(Copyright Aero-Photo by Geo. E. Russell)

to make tests and surveys, and developed a plan combining the features of an earth-fill bowl and a coliseum. This plan was adopted, and Messrs. Howard, Carpenter and Buckingham were appointed by the regents as the Stadium Commission.

The work of construction was begun in November, 1922, and was divided into two parts, the excavation, filling and foundations, and the building of the superstructure. Bates and Boiland received the first contract, the second being awarded to the Clinton Construction Company, which started work in May, 1923.

After careful study of the geologic formation, and the drainage requirements, the levels were established and about 280,000 cubic yards of material were removed, by hydraulicking and by steam shovels. It was an extremely interesting sight to see three giant streams of water eating away the strata of shale and sandstone. The excess of cut over fill was used to build up the approaches from below, and the rimway around the upper side, 75 feet wide.

A concrete culvert, 1,450 feet long, 4x4 feet cross section, was laid below the structure, with grades of 5 to 7 per cent, to carry drainage from the upper basin to Strawberry Creek.

The stadium is an ellipse with axes of  $759\frac{1}{2}$  feet and  $567\frac{2}{3}$  feet between walls. The axes of the inner ellipse, outlining the field, are 300 feet less than the overall di-

mensions. The west and most of the north and south sides are of concrete, extending two-thirds of the perimeter, and reaching a maximum height on the west side of 67 feet. There are 32 entrances leading to seating sections, including six tunnels to the playing field. The entrances are 10 to 12 feet wide, with a 20 feet entrance at the north ends.

(Continued on Page 69)



## THE INTIMATE BEDROOM

THE instant that a woman's foot touches the floor of her bedroom there should come to her the feeling of quiet relaxation, comfort and contentment. Her kitchen must be designed for efficiency, her dining-room for hospitality, her living-room for cordiality, but her bedroom is her own.

To make this one room, of all others, breathe a subtle restfulness and impart healthfulness, is engaging just now the minds of our best interior decorators and architects. However, let this not frighten the women who want to create from their own plans and ideas boudoirs that will reflect their own individuality, for the rules are few and simple enough.

In planning your bedroom it is necessary to realize that in it you will spend more hours than in any other single room. You will spend in it the hours most important to your health. It must, therefore, above all things, be conducive to physical and mental comfort.

In most rooms the furnishing scheme has its logical beginning with the floor. This, however, is not true in the bedroom. Select your bed with great discrimination and study of the various makes. Guard against irritations of any kind that will interfere with wholesome rest.

Having done this, the attention can be turned to carrying out ideas which make the bedroom a place of beauty—a fitting background for the woman, where she may spend a few leisure moments before her mirror, learning new lessons of beauty, where she may make or try on her new gown, or where she may find complete rest from her duties in other parts of the house.

It was in the bedroom that the old-fashioned carpet was longest used. Even after it had become a nuisance in other rooms in the house it was retained in the bedroom because it provided a quietness and lent color to the decorative scheme of the room. It has been finally discarded because it was neither durable nor clean, and above all, the floor of the bedroom should be clean and easy to clean. Hardwood took the place of the old-fashioned carpet, but at best it was

a mediocre background, relieved somewhat with beautiful rugs, but offering nothing that was distinctive from the other floors of the house. Nor was it especially easy to clean, for even a well constructed wood floor has tiny cracks where dust catches and lodges, and in which lint clings.

It is easy to understand, therefore, why modern interior decorators are more and more advocating the use of linoleum for the bedroom. Linoleum is now available in plain colors, such as blue, gray, green and brown. There are, too, the double tones in blue, gray, green and brown. This two-tone effect is known as jaspé, and it provides a lovely foundation for the color scheme of the whole room. When laid over a layer of builders' deadening felt, which is first pasted to the floor and the linoleum pasted over it, one may achieve a permanent linoleum floor in which the joints are practically invisible, a floor that will not bulge or buckle—a floor that is in every sense of the word permanent. A broom glides over it easily and quickly, removing every particle of dust. It provides a rich background for Orientals or for the popular rag and hooked rugs.

Bear in mind that the walls should be a trifle lighter than the floor, and the ceiling lighter than the walls. The floor may provide the color keynote which can be carried into the wallpaper and draperies at the windows. Refreshing effects, too, may be accomplished by using cretonnes or hand block linens on the dressing table and bed. Should you select a floor of blue jaspé linoleum you will find that your mahogany furniture will look more luxurious and enhanced. If you have a liking for the new painted furniture, a floor of gray linoleum will tone it down to a more quiet beauty.

Above all, your bedroom should be a place to rest. Have nothing in it that will prove distracting. Remember this when selecting pictures. Avoid using those that depict action. The bedroom is no place for Rosa Bonheur's "The Horse Fair"; better a few old prints or engravings of land scenes.

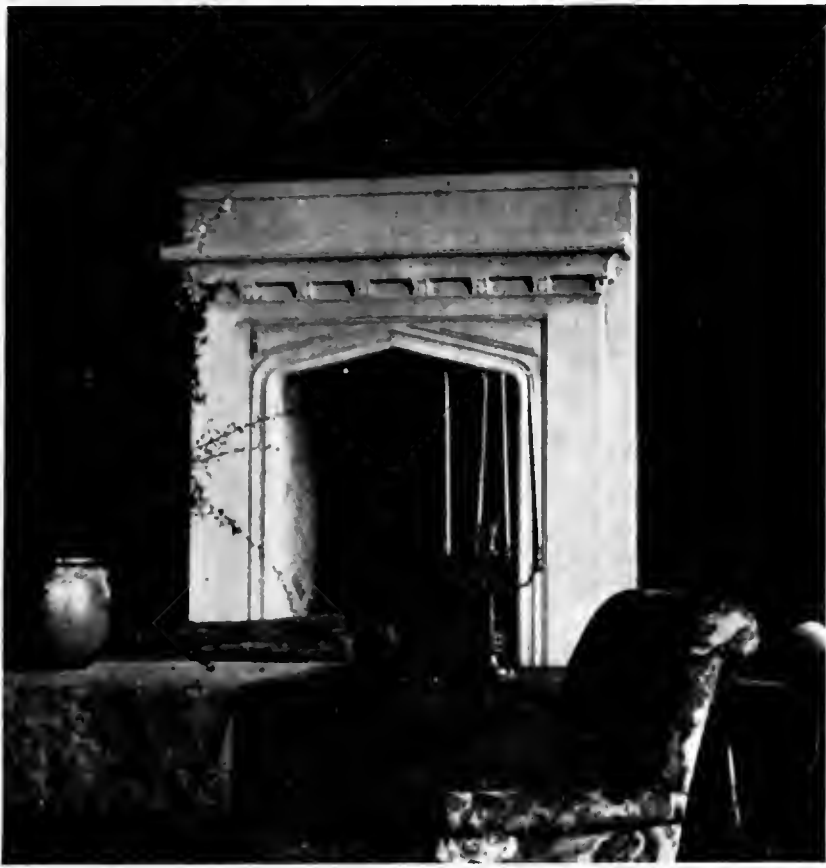

### Pacific Coast Jockey Club

The new club house for the Pacific Coast Jockey Club, at San Bruno near San Francisco, has been the Mecca for much of society during the short time it has been open.

It has amply demonstrated the arguments of the architect, Mr. Applegarth, that one large room could combine the functions of several small ones, and be "clubbier" and altogether more effective.

This room is 50 by 135 feet in size, about 40 feet high, and has been extremely successful for its joint purposes. It is inexpensively finished with gray-brown weathered oak stain. Permanent furniture has not yet been installed.

Attention may be called to the wide spacing of columns in the grandstand.

## The Gough School, San Francisco

By JOHN REID, Jr.

THE Gough School, which has just been completed under contract by the Board of Public Works for the Board of Education, is located on the south side of Washington Street between Franklin and Gough Streets. This building is for the so-called Oral Deaf School, where deaf children receive the instruction which meets their needs. Because of the special pedagogical requirements of this organization, every part of the building has been adapted to a specialized use.

It is estimated that the organization will never have enrolled more than seventy-five or eighty pupils. The difficulty of this type of teaching is such that the classes must be limited to ten children. This has determined the size of the class room units, which are sixteen by eighteen feet. There are eight of these class rooms. The desired size and shape were determined upon after a careful study of the seating requirements. Each class room consists of the class room proper with its blackboards, pinning rail, centrally controlled clock system and teacher's telephone, with hat and coat room containing lockers, shelving and wash basin.

Beside the eight class rooms, there are the Manual Training room, for woodworking and drawing, and the Domestic Science suite, consisting of dining room and a com-

binated cooking laboratory and sewing room. The Principal's office is adjoining the room where she conducts her individual class. Two of the class rooms are divided by a folding partition which can be removed when an assembly room is required.

The site is on a steep slope and this physical handicap added greatly to the cost and problem of planning. To accommodate itself to this slope, the floors of the building are arranged on four levels. This scheme permits of direct access to the outside at each floor. The building is the open "L"-shaped type and gives south or east exposures for all rooms.

The yard has been terraced and stepped to create the necessary level areas for play space.

The exterior of the building is finished in a warm brown plaster and the roof is covered with variegated Cordova terra cotta tile.

The heating is obtained by direct steam radiation, supplied from a low pressure, centrally located boiler.

The boys' and girls' toilets are so arranged that they have an abundance of outside ventilation and are directly accessible from the play yard.

The total cost of the building was \$56,705.00.

## EDITORIAL

**B**EGINNING with the January issue, Vol. XXV, No. 1, "The Building Review" will revert to its original title, "Pacific Coast Architect."

A change was made six or eight years ago, with the intention of broadening the scope of the magazine. The development, since that time, of a fairly typical "California" architecture has been so remarkable, and has attracted such wide-spread attention, that a journal which by cover and contents presents the best current architecture of the Pacific Coast, has a field amply broad enough to satisfy the needs of the profession and the public.

---

**T**HE wise man learns from the experience of others: the fool, from his own experience."

What is to be said for the man who does not learn, even from his own experience?

What must Europeans think of Americans when they read of our fire losses to the extent of hundreds of millions of dollars yearly?

When they look at their own buildings which have stood for centuries, with walls of masonry and roofs of tile or stone—each year adding its mellowing measure of

beauty—and contrast these with the flimsy clap-traps of inflammable construction which, alas! are so obtrusively evident throughout our modern, "civilized" America?

The latest local demonstration of our "civilization" is a referendum in Berkeley to rescind a recent ordinance, passed after Berkeley's disastrous fire, prohibiting the use of wooden shingles for roofs.

The basis for this movement is a claim that the ordinance permits patent roofings which are as dangerous as shingles, or worse.

So, going on the principle that two wrongs make a right, a petition was started—not to demand more fire-resisting roofs—but to restore the shingle to use!

We hold no brief for patent roofing. But we deplore the penny-wise, pound-foolish policy which protests against progress—especially when we are so far behind, that there are centuries of proof as to the value of this particular kind of progress.

Not alone all architects, but all true economists, will hope that Berkeley may eventually profit from her terrible and expensive experience, and guard against its repetition.



Photo by Gabriel Moulin.

GOUGH (ORAL DEAF) SCHOOL,  
SAN FRANCISCO, CALIFORNIA.  
John Reid, Jr., Architect.



Photos by Gabriel Moulin.

GOUGH (ORAL DEAF) SCHOOL,  
SAN FRANCISCO, CALIFORNIA.  
John Reid, Jr., Architect.



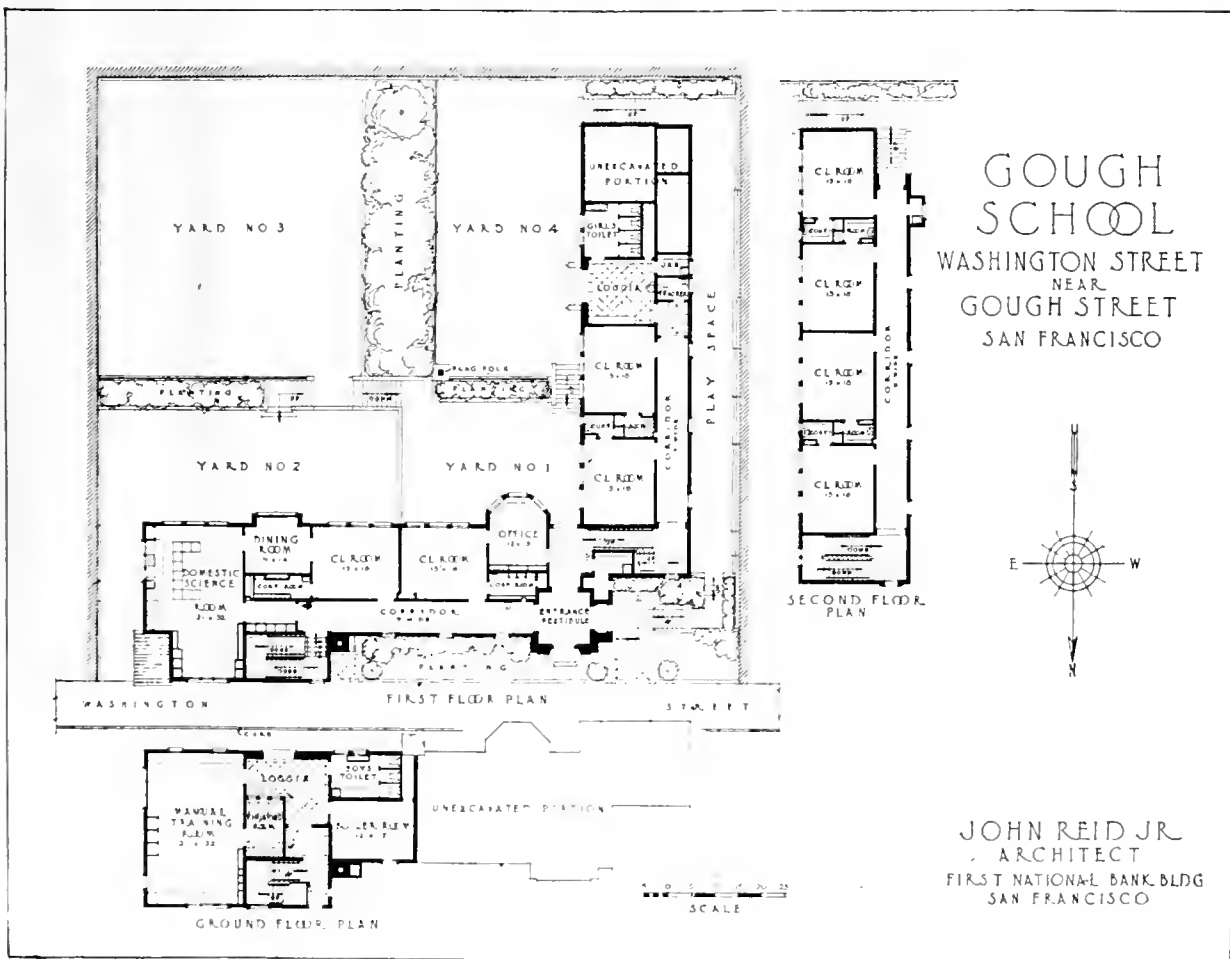

Photo by Gabriel Moulin.

GOUGH (ORAL DEAF) SCHOOL,  
SAN FRANCISCO, CALIFORNIA.  
John Reid, Jr., Architect.



Photos by W. E. Wold.

RESIDENCE OF DR. J. W. CALKINS,  
OAKLAND, CALIFORNIA,  
Bernard Maybeck, Architect.



Photos by W. E. Wold.



Photo by W. E. Wold.

RESIDENCE OF DR. J. W. CALKINS,  
OAKLAND, CALIFORNIA,  
Bernard Maybeck, Architect.

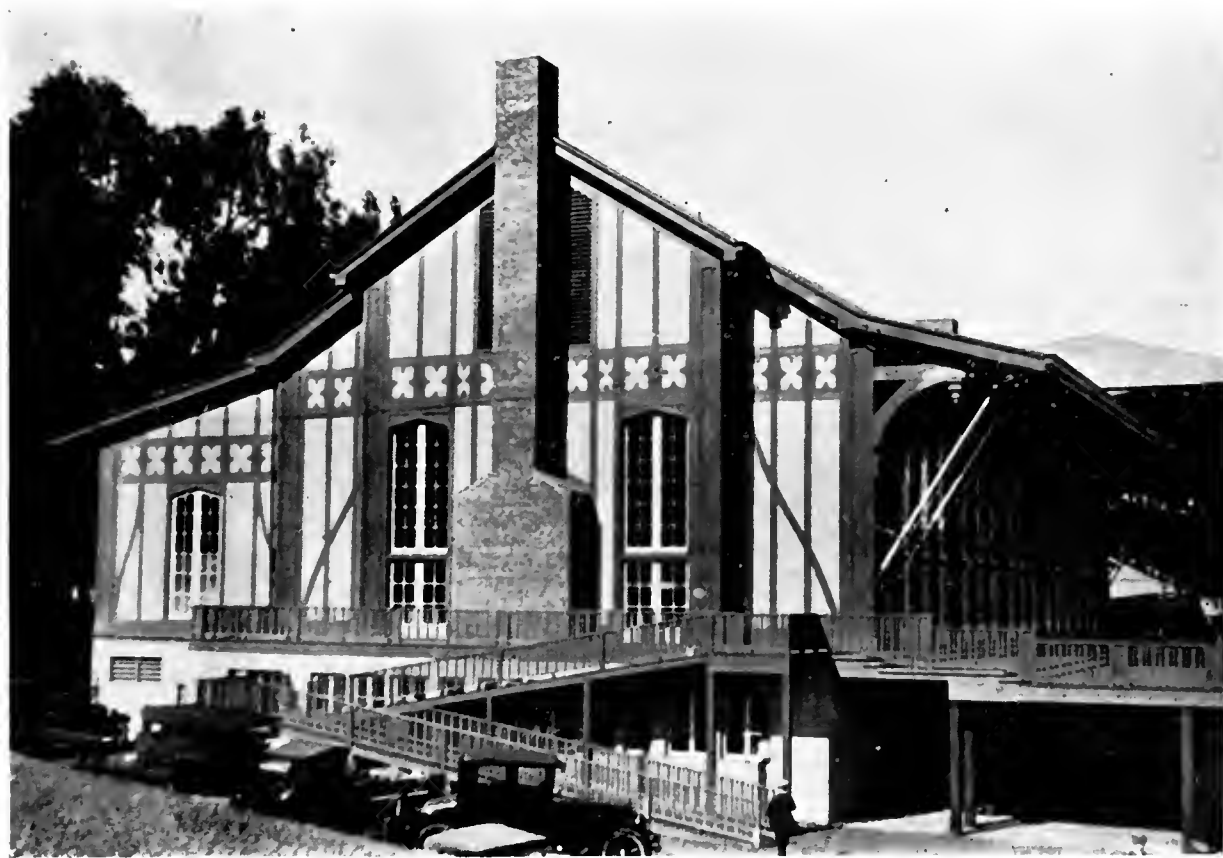

PACIFIC COAST JOCKEY CLUB,  
SAN FRANCISCO, CALIFORNIA.  
George A. Applegarth, Architect.



RACE TRACK

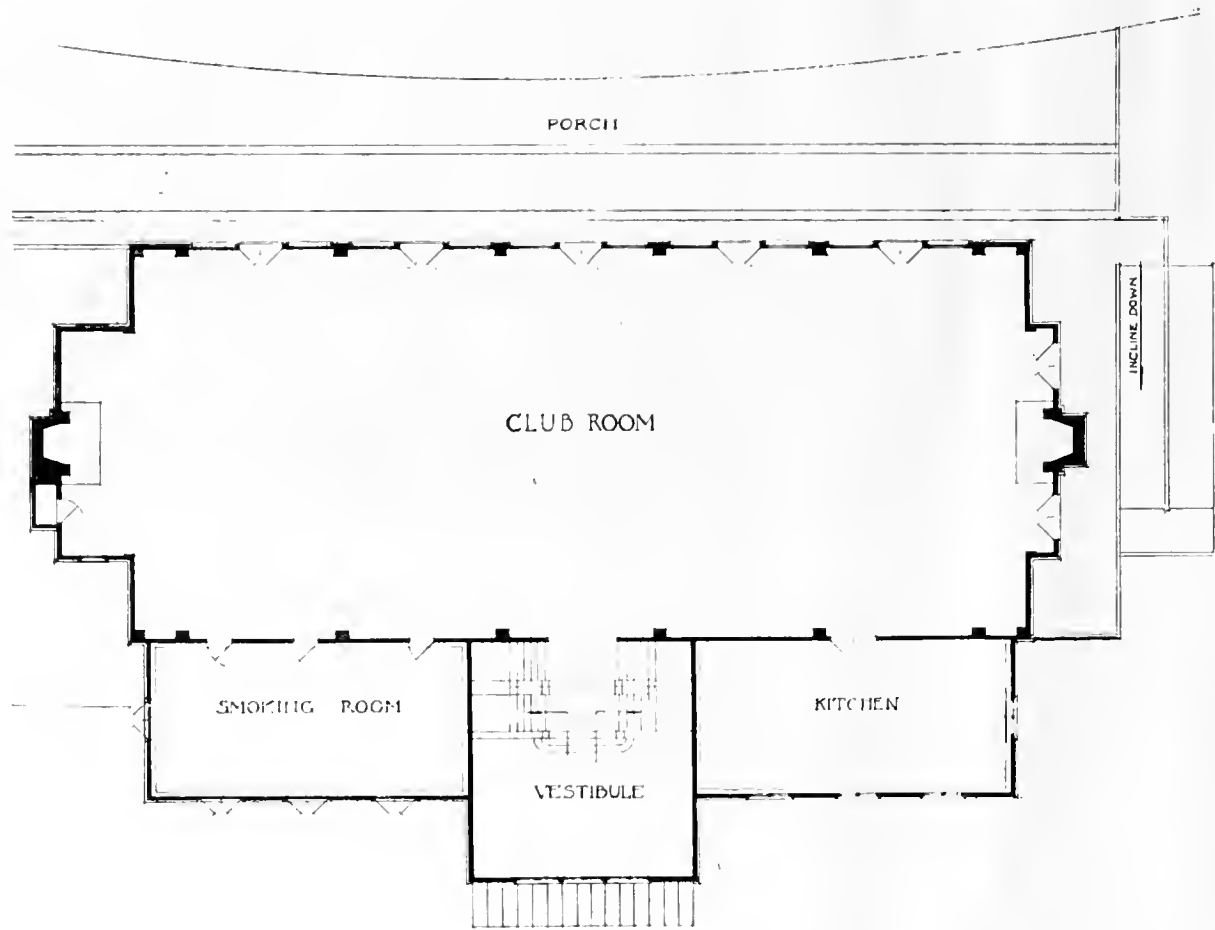



PACIFIC COAST JOCKEY CLUB.  
SAN FRANCISCO, CALIFORNIA.  
George A. Applegarth, Architect.



Photos by Gabriel Moulin.

CALIFORNIA MEMORIAL STADIUM,  
BERKELEY, CALIFORNIA.  
John Galen Howard, Architect.



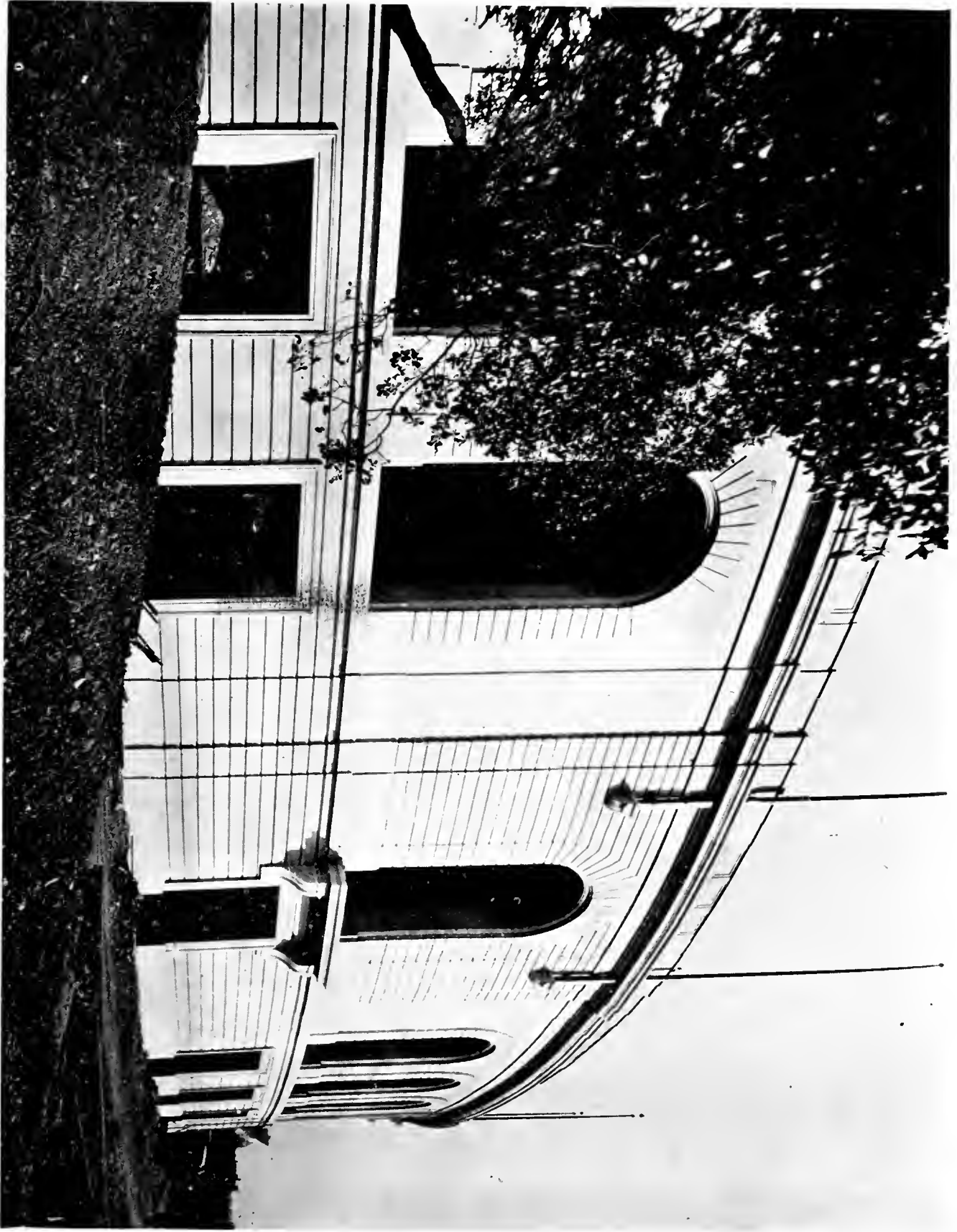

Photo by The Camera Shop.



Photo. by Gabriel Moulin.

Photo by Gabriel Moulin.

CALIFORNIA MEMORIAL STADIUM,  
BERKELEY, CALIFORNIA.  
John Galen Howard, Architect.

## HOUSING AND CONSTRUCTION

In connection with the disturbed housing conditions resulting from suspended construction during the war, I referred in my last annual report to a new division created in this department to assist and co-operate with voluntary bodies engaged in developing home ownership. The department, through this division, has during the fiscal year given active aid to a movement sponsoring demonstration houses that have been equipped and opened to the public in several hundred cities, usually by women's organizations in co-operation with business and civic groups. The result has been to encourage wiser expenditure for household purposes. Associated in the Better Homes movement, which you have headed, are Eight Federal Government officials, including two from the Department of Commerce, and representatives of the principal national organizations of women's clubs, business men, architects, and bodies interested in child welfare and public health.

Valuable educational work has also been carried on by the small house service bureaus, which have been encouraged by this department, in providing at cost small-house plans designed by competent architects.

At the request of many organizations interested in housing, a handbook for prospective home owners was prepared in the department during the year. Its value to the general public is well indicated by the fact that its sales by the Superintendent of Documents immediately ran into the hundreds of thousands.

During the period under review, the construction industry has been confronted with the problem of meeting the extraordinary demand for construction resulting from the suspension during the war and the postwar slump, without hurtful inflation of building costs. In March of this year the situation was such that, in response to an inquiry from the late President, I recommended that all but the most essential Government works and public buildings should be deferred for the time being, so as to give way to much needed private construction. Hundreds of manufacturers, labor organizations, contractors, and the public have concurred in this recommendation.

Increased interest has centered during the year on statistics of activity, production of building materials, and the building cost

indexes that the department has been distributing, but the inadequacy of the data available has been evident. The department has been unable, on account of lack of funds, to meet the demands on it for information that have come from many of the most important business groups.

The need for elimination of waste in construction has been recognized by practically every group concerned, and the members of the department's staff, and its funds, have been pressed to the limit by requests for co-operation in work on building codes, plumbing codes, simplification and elimination of dimensional varieties of building materials, research on the use of building materials, and studies of zoning and city planning problems.

## "HOW TO OWN YOUR HOME"

A guide book designed for the prospective small home owner has been issued by the United States Government, the Department of Commerce announcing the publication of a handbook setting forth details which assert the steps necessary to acquiring such property.

This aid to home builders is a publication entitled, "How to Own Your Home." It carries a foreword by Herbert Hoover, Secretary of Commerce, and was compiled by John M. Gries and James S. Taylor, of the Division of Building and Housing, in answer to the request of a large number of national civic organizations that the subject should be authoritatively covered to encourage home owning in the interest of good citizenship. The booklet, planned to give simple, common-sense information to the person of moderate means who would possess a home, is the result of collaboration and approval by more than fifty civic bodies and experts interested in developing a sound social and economic system through the home.

In declaring that the public recognizes the advantage of owning their own homes and that business groups, especially, are viewing this proposition in a new light, Secretary Hoover said in the foreword:

"They see that taking a neighborly interest in developing sound financing and other machinery for the use of home seekers and insisting on the observance of honest, straight-forward business methods by those who deal with home seekers is not paternalism but good business and good citizenship. It is the 'square deal'—and it is not only right but essential that the cards should not be stacked against the home seeker."

"Maintaining a high percentage of individual home owners is one of the searching tests that now challenge the people of the United States." Secretary Hoover asserted in urging "the own-your-home" idea. "The present large proportion of families that own their homes is both the foundation of a sound economic and social system and a guarantee that our society will continue to develop rationally as changing conditions demand."

(Continued on Page 69)

\*—Extract from Sec. Hoover's Annual Report.

# SAN FRANCISCO CHAPTER AMERICAN INSTITUTE OF ARCHITECTS

## MONTHLY BULLETIN

### OFFICERS

J. S. Fairweather, President.  
John Reid, Jr., Vice-President.  
Albert J. Evers, Secretary-Treasurer.



### DIRECTORS

George W. Kelham, three years.  
Arthur Brown, three years.  
Wm. Mooser, two years.  
J. H. Blohme, two years.  
Earle B. Bertz, one year.  
Harris Allen, one year.

### NEXT MEETING

The next meeting will be held December 20, 1923, in the Architectural Club Rooms, 77 O'Farrell Street.

### NOVEMBER MEETING

The monthly meeting of the San Francisco Chapter, American Institute of Architects, was held Thursday evening, November 15th, 1923, in the Architectural Club Rooms. The meeting was called to order by President J. S. Fairweather at 8 P. M.

The following members were present:

Morris Bruce	Earle B. Bertz
G. A. Applegarth	P. J. Herold
Geo. W. Kelham	W. M. Bliss
Harris Allen	J. S. Fairweather
Wm. Mooser	A. J. Evers

### MINUTES

The minutes of the meeting held October 18th were approved as read.

### UNFINISHED BUSINESS

The matter of co-operation with the Builders' Exchange in supporting the American Plan was again brought up

The letter from the Builders' Exchange was read and the reply thereto approved.

A motion was made and carried to send out a paragraph in the monthly circular urging members to incorporate the American Plan clause in their specifications.

A letter of appreciation from T. Patterson Ross was read and placed on file.

### NEW BUSINESS

A letter from Mr. Albert Kelsey, of Philadelphia, with an explanatory letter from Mr. L. C. Mullgardt was brought before the meeting for consideration of the Chapter. Mr. Kelsey proposed to be in San Francisco about January 25, 1924, and has offered to give an address on "Rome" before the Chapter.

It was moved and carried to accept Mr. Kelsey's kind offer and prepare to make the January meeting an especially large one, featuring Mr. Kelsey's address.

After some discussion it was moved and carried to inaugurate a membership drive and that a committee be appointed to take charge of this matter.

There being no further business the meeting adjourned.

Respectfully submitted,

A. J. EVERS,

Secretary.



Gough (Oral Deaf) School  
San Francisco, Cal.  
John Reid, Jr. Architect

A. QUANDT & SONS  
PAINTERS AND DECORATORS

## The California Memorial Stadium

(Continued from Page 63)

To prevent a pocket of "dead" air settling down, with discomfort to spectators and players, ample channels and passage-ways are provided to promote circulation on the north, west and south sides. The east side cares for itself, as the rimway offers no obstruction to air currents.

The seat banks are 150 feet wide horizontally, 162 feet on the slope, at an angle of 20 degrees. There are 48 sections, each with 72 rows, and 72,609 numbered seats of selected lumber, painted a pleasant tone of light grey. Both cement floor slabs and earth fill were thoroughly waterproofed with hot asphalt and coated with stone dust before sills and seats were installed.

Needless to say, the playing field was prepared and drained according to the best expert advice. Landscaping of the stadium, its approaches and parks, was done by the MacRorie McLaren Company of San Francisco, and all these terraces and slopes have been planted with lawns and shrubs and trees in such manner that already the barren aspect of new construction is hardly apparent, and, as the years pass, an ever-increasing richness of setting will enhance the impressive beauty of the stadium.

For it is beautiful. As a work of architecture it may be considered a masterpiece. However firmly established Mr. Howard's reputation was before, this accomplishment fixes his place among America's great architects beyond shadow of doubt.

In no other of his buildings are combined so perfectly the qualities of proportion, scale, restraint, dignity, beauty of form and line and texture and detail. Its simplicity of treatment is such that the illustrations need no comment as to architectural features. What photographs cannot show, however, is the harmony of site and structure; the essential "rightness" of this great monument wedded to the eternal hills. This is no academic essay in emulation of classic model; it is the living flesh expressing by its contours the sturdy framework of an organic creation. It is difficult to see how any improvement could be made, in mass or detail, in the expression of an heroic idea, the conception of a monument to American manhood.

## "How to Own Your Home"

(Continued from Page 67)

Secretary Hoover stated that the development of the automobile has given "a great impulse to suburban life and an increasing possibility of home ownership."

"A family that owns its own home takes pride in it, maintains it better, gets more pleasure out of it, and has a more wholesome, healthful, and happier atmosphere in which to bring up children. The home owner has a constructive aim in life. He works harder outside his home, he spends his leisure hours more profitably, and he and his family live a finer life and enjoy more of the comforts and cultivating influences of our modern civilization. A husband and wife who own their own home are more apt to save. They have an interest in the advancement of a social system that permits the individual to store up the fruits of his labor. As direct taxpayers they take a more active part in local government. Above all, the love of home is one of the finest instincts and the greatest of inspirations of our people."

One of the outstanding problems confronting the home seeker, the handbook points out, is that of financing the acquisition of property.

"The prospective home owner who uses his common sense in considering the real needs of his family and his ability to pay, and who checks his own judgment by consulting experienced persons, may go ahead with full confidence," it states. "He need not be frightened by the mistakes of heedless persons who have been carried away by some novel feature and coaxed into a bad bargain, or who have tried to buy beyond their means. While some risks are involved, as is usually the case in obtaining anything worth while, the danger of failure is relatively small when weighed against the advantages of an owned home."

What ratio of income may be safely devoted to the process of acquiring a home is explained in this vein: "If a certain family pays one-sixth of its income for rent, it may be able to devote one-fourth or more to buying and maintaining a house, for the amount thus used may include both rent and savings. Rent, or payments on a home, may require anywhere from one-eighth to one-third of the family income, depending on the special circumstances in each case."

Tables dealing with the ratio of income to home investment are given. The tables do not attempt to set up arbitrary standards, although they are stated to be fairly typical and may be used as a basis from which to start figuring.

Under the heading of "The Range of Safe Expenditure," the handbook does not approve of any effort to buy a home beyond a definite ratio to family resources and income, and carefully elaborates these ratios of expenditure in accordance with income.

Particular stress is placed by the handbook on the agreements which should be definitely entered into with regard to financing, building, and purchasing. The points which should be clearly defined are emphasized.

While conceding that the great majority of individuals and companies with which the home

## THE BUILDING REVIEW

seekers deal are honest and wish to do business honorably, the handbook insists that "no good business man should object to having his obligations, as he understands them, set down in writing and in accordance with legal procedure."

As for the financing of home building, the handbook gives sound information.

"Borrowing money to buy a home is no disgrace," it declares. "On the contrary, it is normal and in many ways desirable. Many families in meeting payments on a loan have learned the habit of saving, and have continued it as a step toward financial independence."

It is desirable, the book points out, for a family about to buy a home to possess a minimum of 20 per cent of the value of the house in cash, even though arrangements are often made for a purchase with a lesser amount. The advantage of a larger cash payment is found in the fact that it helps to insure a loan at a low rate of interest and one that can be paid off comfortably.

"How to Own Your Home" may be obtained for five cents from the Superintendent of Documents, Government Printing Office, Washington, D. C.

### RESOLUTIONS

Passed by the Board of Governors of the American Construction Council, Annual Meeting, New York City, September, 1923.

#### CONSTRUCTION CONGRESSES

Recognizing the need of promoting the organization of local building construction congresses throughout the various construction centers of the country where none already exist and with the desire to co-operate in every appropriate manner with such congresses as already exist and to assist in the establishment of others, the Board of Governors of the American Construction Council herewith authorizes the expenditure of such sum as may be available up to \$25,000, to be used in the promotion of this work; and the Board requests the officers of the Council to utilize its administrative resources in every way possible in the furtherance of this program.

#### APPRENTICESHIP

With the desire of furthering a sound and adequate program on apprentice training for the construction industry and of co-operating in every way possible with the present bodies who are directing their efforts in this field, and who are or in the future may be, inaugurating and conducting agencies for such training, the Board of Governors of the American Construction Council hereby requests the officers of the Council operating especially through its Committee on Apprenticeship, Vocational Guidance, and Craftsmanship, to co-operate with employees' and employers' organizations, building congresses, and all other elements in the construction industry, and

with the educational bodies, local and national, in providing for apprenticeship which will be attractive to young men and will afford the fullest means for the employment and training of efficient workers as apprentices, and will produce the skilled workmen needed in the construction industry; and the Board further authorizes as the first essential step in this program the making of a national survey on apprenticeship needs and conditions of labor supply throughout the construction industry and through the appropriate agencies of the Council co-operating with all organizations within the industry.

### METAL LATH NOTES

The Japanese earthquake is the fourth one on which we have reports showing the unusual value of expanded metal lath as a building material in an earthquake section. The resistance that metal lath gives in the presence of an earthquake is also to be counted upon in the everyday wind movement, uneven settlement, and hard usage that most buildings are subjected to.

The Engineering News Record of Nov. 1, 1923, has a very exhaustive report by Wilbur S. Sample of the Fuller Co., from which the following is quoted.

"Partitions—If impracticable to use reinforced-concrete partitions the next best in the order named are metal lath on steel studs, solid brick, hollow brick, hollow clay tile. Reinforced concrete, is, of course, recommended because of the additional stiffness thereby awarded to the structure as a whole, but if this seems to be impracticable then use metal lath.

"Interior columns and connecting girders should be entirely covered with concrete, thoroughly covered with concrete, thoroughly reinforced around and through the columns and longitudinally."

Mr. Sample's recommendations are particularly valuable, as he attended many of the meetings of architects and contractors after the San Francisco earthquake of 1906, and finds that the experience with materials in Japan was similar to the San Francisco experience. Metal lath in that earthquake was given a high rating, as discussed in our book, "Safety from Fire," pages 55, 59 and 64.

The experience at Inglewood, Calif., where a back-plastered stucco school house addition was intact and a brick section of the building cracked from cellar to garret is another illustration.

*Wain*  
B



