

E
51
U6X
CRLSSI

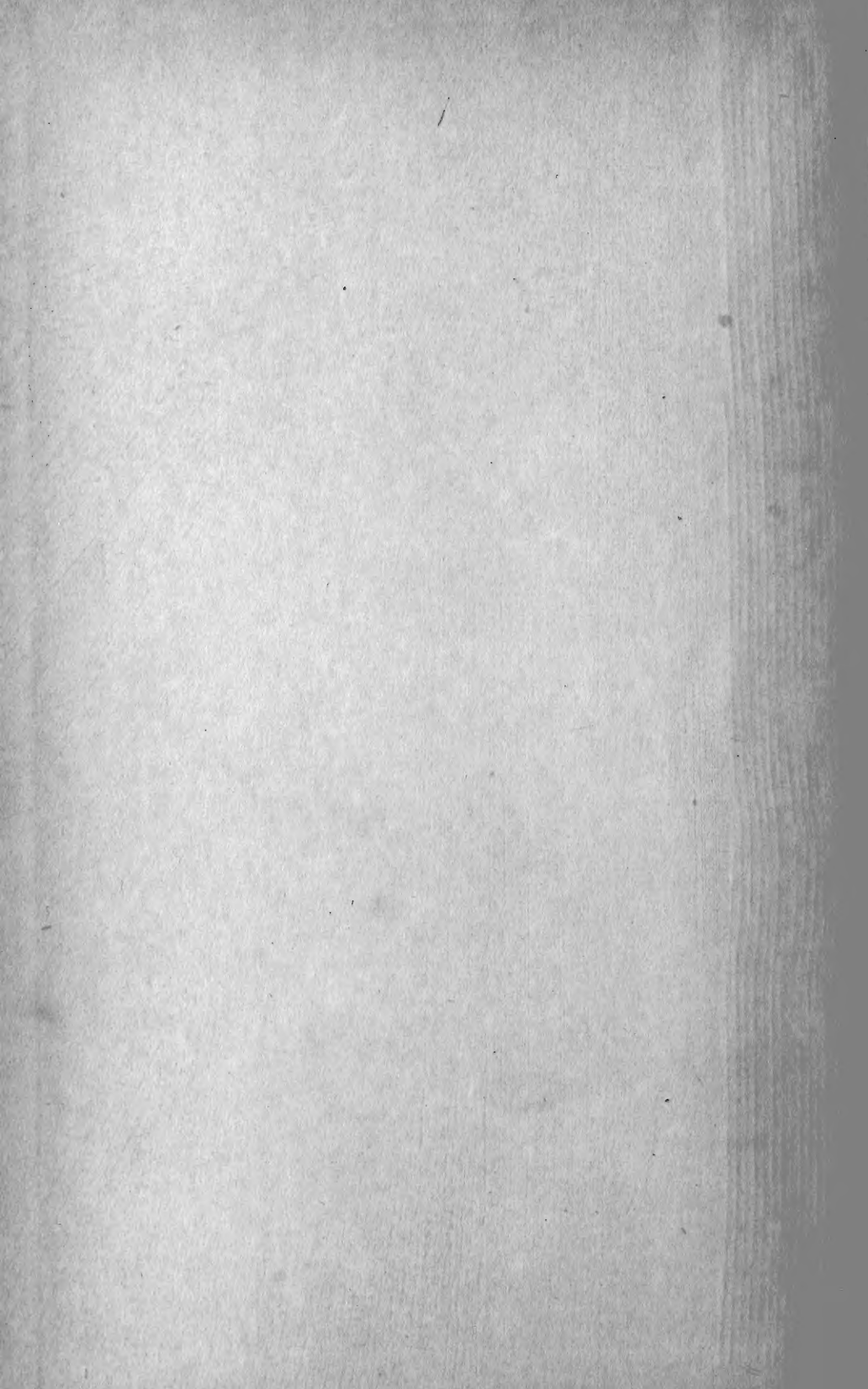

SMITHSONIAN INSTITUTION
BUREAU OF AMERICAN ETHNOLOGY
BULLETIN 91

ADDITIONAL STUDIES OF
THE ARTS, CRAFTS, AND CUSTOMS OF
THE GUIANA INDIANS

WITH SPECIAL REFERENCE TO THOSE OF
SOUTHERN BRITISH GUIANA

BY
WALTER E. ROTH

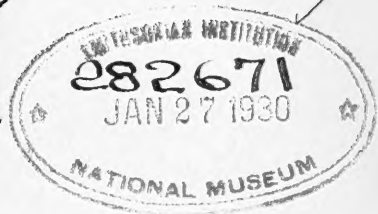

UNITED STATES
GOVERNMENT PRINTING OFFICE
WASHINGTON: 1929

LETTER OF TRANSMITTAL

SMITHSONIAN INSTITUTION,
BUREAU OF AMERICAN ETHNOLOGY,
Washington, D. C., March 1, 1927.

SIR: I have the honor to transmit the accompanying manuscript, entitled "Additional Studies of the Arts, Crafts, and Customs of the Guiana Indians, with Special Reference to those of Southern British Guiana," by Walter E. Roth, and to recommend its publication, subject to your approval, as a bulletin of this bureau.

Very respectfully,

J. WALTER FEWKES, *Chief.*

Dr. C. G. ABBOT,
Acting Secretary, Smithsonian Institution.

LETTER OF TRANSMITTAL

Washington, D. C., March 1, 1888.
Dear Sir: I have the honor to transmit the accompanying manuscript
entitled "Additional Studies of the Life, Customs, and Costumes of the
Guiana Indians, with Special Reference to those of Southern British
Guiana," by Walter B. Roth, and to recommend its publication
subject to your approval, as a bulletin of this Bureau.
Very respectfully,

J. WALTER BARNES, CMR.

Dr. G. G. Aschott,
Acting Secretary, Smithsonian Institution.

PREFACE

To confine my whole attention in the time at my disposal to the tribes of the southern area of British Guiana would have offered by itself too little material for original copy; to write a complete ethnographical history of them would have meant too much repetition of other people's labors besides my own, and, what is more, where I had expected to find at least 400 and more individuals, I met with barely 150. Of the two nations, the Taruma and Waiwai, that were believed to be occupying this portion of the colony, I could find less than a dozen representatives of the former and a little over a hundred of the latter. It accordingly seemed wisest, under these circumstances, to make the information gleaned on this expedition, extending from January to July, 1925, into a sort of appendix, as it were, to my main work on the Guiana natives,¹ and seize the opportunity of including in it the necessary corrections and additions that had been brought under notice since its publication. That the additions have not proved few may be gauged from the amount of literature which I have been able to peruse since learning to read Dutch, which up to five or six years ago had proved a sealed book to me. On the other hand, there still remained not a small list of books relative to the Indians along the Guianese-Brazilian borders which would have proved of great service had they been procurable. But to keep a special library up to date in these out-of-the-way parts is practically impossible.

On my return to civilization from the Brazilian border, I gave my friend, Dr. J. Walter Fewkes, a résumé of my experiences from notes as jotted down for subsequent publication in our local *Christmastide*. In acknowledging my letter this gentleman admitted that never before had it been brought home to him so strongly how much the bureau's field workers in the Tropics, especially in the inaccessible portions of South America, had to endure in securing their results. It is this very remark that has encouraged me to include here the résumé in its completed form.

It was on the 7th of January, 1925, that permission was granted me to leave my district with the object of making some ethnological observations, on behalf of the United States Government, concerning the Indians occupying the extreme southern area of our colony. To find a substitute to undertake magisterial duties, to buy a quantity of trade goods, to gather up suitable clothes and boots, and to have everything packed into as small a space as possible occupied the better part of the following 10 days. Owing to the paucity of information concerning the Indians I proposed visiting, the choice of suitable trade articles proved some-

¹Thirty-eighth Ann. Rept. Bur. Amer. Ethn. Washington, 1924.

what of a difficulty; as a matter of fact, though I took over half a ton with me, it subsequently transpired that I could have managed with but half that amount. Previous experience on the ranges and savannahs around Mount Roraima, where even hob-nailed boots get worn out within a couple of weeks, had taught me the necessity for suitable footwear, and I accordingly provided myself with a dozen of india-rubber soled ones. Food, beyond a little tinned stuff to last until I reached the outskirts of civilization, I did not bother about—what was good enough for the Indians would be good enough for me. The entire cargo was sent on ahead, some four days before my departure from Wismar.

Arrived at Potaro mouth on the 24th, Mr. Parker kindly made room for me in his motor boat. Next day we reached Waraputa and camped at the foot of the Falls, when I took the opportunity of visiting the huge boulder, some 15 or 16 feet high, on the flattened summit of which was still clearly visible what resembles the imprint of a huge human foot, a curiosity that Schomburgk first drew attention to; the rocks on which he discovered the petroglyphs were recognizable in the distance. The 29th found us at Kurupukarri, the crossing of the cattle trail over the Essequibo. From here I had a 60-mile walk before me to Annai village, where I hoped to find boat hands, and bring them across to Rupununi mouth in time for the arrival of my "trade" and other belongings. Fortunately I found a traveling companion in Major Walker, on his way to the Takutu, and notwithstanding a couple of wet nights with no shelter reached Wau-Weita, a Makusi settlement, where I found Sandy, an old Wapishana friend, with his Makusi wife. On learning that I was making for the Taruma and Waiwai country, which they had never visited, they attached themselves to me straightway as captain and cook, respectively. It is curious with what little compunction Indians will leave their home and provision field—in this case for a period of at least five months. Before reaching Annai I noticed a certain plant that was apparently thriving well along the roadside, but which was quite new to me; it turned out to be the so-called Venezuela grass, an excellent fodder grass that had been introduced into the district by the late commissioner.

At Annai I succeeded in enlisting the services of six of the least drunken and degenerate of the Makusi residents as boat hands, and with them returned downstream to Messrs. Garnett's landing at Rupununi mouth, where I found that my baggage and effects had just arrived. Within another week I was at the Yupukari Anglican Mission, only too glad to be rid of my boat hands, who were now paid off. They had given me no end of trouble; one had absconded with his advance, while all the others, Sandy excepted, had lost a day in getting drunk at an evening drinking party that they had visited without my permission or knowledge. At the mission the Reverend Mr. Hansford gave me a hearty welcome, and his charming wife a glorious jam pudding. It was here that I secured four new hands, three of them aged and trusty men who had worked with me not only 5, but 11 years before. These took me as far as Benjamin's landing, but with considerable difficulty, because, for the last three days the Essequibo had been falling rapidly, and it was a case of continually getting out of the boat and dragging it over sand bank or rock. Here a staging was built on the river bank, the stores piled up on top, the whole covered with a tarpaulin, the hands paid off, and the boat sent back. With loads on our backs, Sandy, myself, and the two women now had to foot it as best we could to Sand Creek village to engage carriers. With only cassava to eat, we kept a sharp lookout for turtle eggs along the 3 miles of sand bank in the river bed before reaching the forest trail, but no luck attended our efforts; although the season was late the creatures had not yet seen fit to lay. It is true that we could have secured a large specimen of mata-mata, perhaps the most hideous and ugliest of the chelonians, but as it was tabu to my companions, I had to let it go unmolested. Next day we

hit Wapishana, Manoel's farm, in the heart of the jungle, where I was glad to dip cassava into hot pepper water once more. It would seem that "peppers," in my case at least, must act as a stimulant after the fatigue consequent on hard physical labor, because it is only under such circumstances that I can partake of and enjoy them; they are food adjuncts to which I am particularly averse in ordinary home life.

Off early in the morning, we reached the edge of the forest about midday, when the placid savannah spread its green coverlet before me. Another few miles and I recognized at last the first of my old bearings that I had not seen for upward of 11 years—Mount Shiriri—notorious not only for the many legends connected with it, but also for the wild plantains said to be thriving at its summit, and for the salt deposits that are discoverable at its base. By midday we reached the Wapishana village of Sand Creek, but so changed that I hardly recognized it. I remembered a model garden city; I returned to find a miniature east-end slum. Instead of the houses being scattered over the savannah from 50 to a couple of hundred yards apart, an arrangement that afforded their occupants opportunity for privacy in their ablutions, etc., and so encouraged modesty and decency, that allowed them to spend their lives in the normal Indian secluded manner, and so helped each to mind his own business and prevent wrangling—the buildings are now all huddled together around a central modernized joss house, and form an excellent nidus for the dissemination of disease, filth, and scandal. What is worse, considering their position in life, everyone wears clothes; even the toddling infant has to be covered. And yet clothes are not worn for decency's sake, but for something akin to mimicry and swank, because underneath their European habiliments, the sexes sport the red-cloth lap and beaded apron, respectively. Talismans and charms continue to be employed and the filing of the incisor teeth is still in vogue. Arrangements were made here for carriers to fetch my cargo from Benjamin's landing and bring it to Wichabai, the balata depot, which I reached on the 21st of February. The carrying trade is a monopoly of the women here, and is at a fixed rate; so many yards of print for such and such a distance.

Wichabai is a comparatively new settlement about 4 miles north of Dadanawa, but on the opposite bank of the Rupununi. Mr. John Melville has a wonderful menagerie here. Leaving aside the dogs, pigs, and poultry, the number of tame pets certainly surprised me, and still more so, the unrestricted liberty they all enjoyed. The only exception was a specimen of the somewhat rare white-faced monkey that was still undergoing its probationary period on a waist cord. Otherwise the marmosets, parrots, powis, mocking birds, trumpeters, and macaw were as free to come and go as I was. The last-mentioned, a lovely full-grown example of the red variety, is worthy of special mention. Though trained by Mr. Turner, of Dadanawa, the bird spends his time between both places; if his master goes the rounds of his station for a few days, Master Robert will fly over to Wichaba and put in time there. The huge beak and claws made me fight somewhat shy of him at first, but in a couple of days we had become fast friends. I had only to call him and he would perch on my shoulder and accompany me for a bath in the lake; were I lying in my hammock, he would join me, turn on his back, and expect me to scratch his chest and armpits; were I taking a meal, he would want his share. When not eating, sleeping, or worrying me, his chief amusement seemed to consist in picking quarrels with the roosters, nipping the marmosets' and other monkeys' tails, or flying in a circle among a crowd of carrion crows and scattering them in all directions. In his habits he was as clean as a house dog, and I learned that these had been inculcated at a very early age by gently kicking him along the floor whenever he was guilty of misconduct.

While rummaging round one of the outbuildings at Wichabai station I found a woman in front of a huge frame, weaving a cotton hammock, and to my delight recognized it as of a rare Atorai type, one side smooth and the other rough, and further peculiar in that it is woven with six wefts and two heddles. (I might mention that a heddle is an apparatus for bringing the vertical warps forward into a position suitable for passing the horizontal wefts behind them.) I noted the special technical details, made sketches, and got a small model constructed. Sandy's wife and her friend were paid off and sent back home.

Early in March I reached Dadanawa, where a few days were very happily spent while awaiting the arrival of my carriers, and where I renewed acquaintance with Robert, who, in the meantime, had flown back to his home quarters. My trade having at last come to hand, I made tracks southward to Wawanawa village, where the social conditions were even worse than those at Sand Creek. The old saw that money is the root of all evil is well exemplified here. Owing to the comparatively large amount of pay received for balata, in which the majority of the residents are engaged, the provision fields are neglected and the wages squandered, mostly in clothes. I was told of a wedding recently celebrated in the neighborhood where the bridegroom turned up in collar, necktie, a tussore suit, and tanned boots. But clothes are far from implying cleanliness, because the use of soap, certainly at the time of my visit, seemed more or less unknown, and most of the villagers were verminous. To remedy this inconvenience, patent preparations have replaced good old crab oil; so much so that there had to be included among my trade articles 10 dozen bottles of solid and liquid brilliantine, not to mention 6 dozen assorted perfumes, all of which found ready sale here. Drink was the main curse here, and not a single female from adolescence to middle age was without a baby. The head man, who at the same time played the rôle of catechist, appeared to be the chief villain of the play, and I have every reason to know that he is exporting our Indian labor into the Brazils and making so much per capita on the transaction. Another source of mischief was the comparative prevalence of negroes, a difficult matter to cope with along the border, and without any police supervision or patrol whatever. I have seldom seen Indians so demoralized in so short a time.

Two days farther south we at last crossed the divide between the Essequibo and Rupununi, whence I enjoyed a glorious view over the Parabara savannah, and reached the landing on the upper Kuyuwini River on March 13. There were three corials here, two in fairly good condition, the third in urgent need of repairs, but all too small to carry me, much less my trade goods, of which I had to send back a large quantity to Wawanawa. I now dispatched Taruma George and William Akawai, a Wapishana, in the largest of the vessels, downstream with instructions to strike the Essequibo, pull up it as far as the Taruma Settlement, and procure the biggest corials available; they carried with them a case of fishhooks, knives, and cutlasses, and two tins of salt, as a sign of good faith that there was plenty to follow. For the next 10 days or so I had a good look around the district, saw a fair-sized camudi or two, almost stepped onto a large coral snake lying on the farther side of a cross log, and of an evening set fish traps. I likewise learned to make a new kind of spring hook that proved very successful with haimara, and got to know a new bait for pacu. Fishing one night below the steep river bank, I was suddenly confronted with an uncanny looking white object that turned out to be a huge spoonbill on the same quest as myself. Game was as plentiful here as the fish, and powis and maam quite common. The surrounding forest was, however, swampy and full of pimpler palm, so that on the whole walking was not so pleasant a pastime.

I now became daily more anxious at the nonreturn of George and William. What if they had been robbed and murdered for the sake of the knives and cut-

lasses? To distract these unpleasant thoughts I set about making a wood skin, but what with the nature of the forest there was no suitable timber available. We tried a locust tree, but this split just on the point of removal of the bark. A second attempt on a similar tree proved no more successful. We accordingly felled another piece of timber, cut it to shape and gauged it to make a corial, but on opening it out over a slow fire it also burst. A last attempt proved successful and within another week I was the proud possessor of a serviceable 18-foot-long canoe.

As day after day went by, and nothing was to be seen of the wanderers, I tried to forget all my moral responsibility in having sent them to what I now assured myself must be their death, by making working models and sketches of all the many temporary baskets that the Indians know how to weave so skillfully from the leaves of the ite, kokerit, pimpler, manicol, turu, and other palms. In the meantime, my poor old captain, Sandy, was daily getting worse with apparent lung mischief, and the spitting up of blood that took place each morning determined me in dispensing with his services; it was only with extreme reluctance that I paid him off. It was accordingly a great relief to me when on the 16th of April Taruma George with William showed up at the landing in company with three large vessels and the same number of Taruma boat hands. Leaving on the 19th, we pulled down the Kuyuwini, and struck the Essequibo on the 26th. Here I saw some remarkable shooting with the bow, two of the boys each bringing down a powis perching on a branch some 60 to 70 feet from the ground, with weapons upward of 8 feet in length—weapons that even I, and I am no strippling, had difficulty in drawing. Smaller bows are retained for shooting fish.

Another five days upstream, when on the 30th I got my first glimpse of the Taruma village of Wannawantuk. This settlement is situated on the summit of the hill of that name and consists of two huge houses built on a Wapishana model. The hill itself, some 300 feet high, fronts the right bank of the Essequibo, is flanked on either side by a creek, and slopes down behind into a swamp, an ideal spot protected by natural defenses to withstand any surprise attack. On arrival at the landing I was met by some 40 to 50 Waiwais of both sexes and greeted by each with a handshake—a form of salutation that must have been taught them by some previous European visitor. These good folk had come a five days' journey down the river from their own village at Duba-Kaiako to await my coming, word having been sent them that I had salt, fishhooks, and ax heads. Many were in holiday attire, or rather wore the decorations common to times of merrymaking; some of the men, for instance, having donned their feather head rings, while two of the women sported feather-bead corsets. The male fashion of doing up the hair in a queue and jamming its tip into a sugar-loaf leaf funnel decorated with paint and feathers produced quite a feminine appearance.

I was next led to an extraordinary structure at the foot of the hill, which was nothing less than a stepladder built up its steep declivity. It was formed of rungers with wooden rungs tied crosswise, the former running zigzag at a greater or less angle according to the conformation of the slope. Extra support was afforded by a double handrail formed of vine rope attached to gaudily painted stakes driven into the ground at distances about 10 to 12 feet apart. In my climb up it to the top plateau I counted over 260 rungs, and I have often pondered over the labor and skill entailed in their fixation and construction. The Taruma population of the village, apparently owing to influenza epidemics, has dwindled during the past decade from 60 or 70 individuals down to 8, all of them males, of whom 6 have taken Waiwai women to wife. I subsequently learned, on my return journey, that in the Wapishana village of Baidanau was still to be found a remnant of this once very powerful tribe (3 men, 6 women, and 3 children—1 boy and 2 girls). There would appear to be little room for doubt that these

Taruma are identical with the Saloema or Saluma of Surinam, known to the Bush negroes as Saluma-matti (mates, friends) and hence probably the Zurumata mentioned by Schomburgk. The former relations of the Taruma people with the Wapishana and their present ones with the Waiwai make their true ethnological study a somewhat complicated one.

Being ignorant of their language, trading was effected on very primitive lines. All I had to do was to open out my cases, spread the goods out before me on the ground, and then point to the various Indian objects of which I was in want. The sale was opened with an ax for a lovely feather-bead corset, and once started, business progressed. As soon as a lull came, I strolled into the houses and pointed to different articles that took my fancy. What I didn't see I asked for, by bringing out my drawing block and making a sketch of it. As a matter of fact, during the whole month spent with the Indians it was a case of sign language and pencil or water-color drawing. Some studies in the uses of signs among the North Queensland aboriginals, that I published 30 years ago, proved of great value here. All the same, it sometimes seemed quite uncanny to hear my own voice, which, for what reason I know not, I was almost afraid to use. I was absolutely and indeed alone with these people, but as usual quite content and happy. It was here that I first saw men making hammocks, but of peculiar mesh, out of ite, cotton, and kuraua, and all this meant further models and notes. Hunting dogs, for which the Taruma have been noted, were here galore, all on platforms ranged round the inside of the house walls some 4 feet from the ground. The creatures are well cared for, but neglected, like their aged parents, when their days of usefulness are over.

It is close to this village that a particular kind of rock is quarried from the bed of the river, when it is broken, flaked, and chipped up by the women to make teeth for their celebrated graters, which in the course of trade become very widely distributed. This quarry is of double interest in that it is the only one in the colony known to be worked. I am acquainted with another on the Brazilian side, and a third on the Orinoco, applied to similar purposes, but whether the rock is identical, there is not sufficient evidence to show.

After a very delightful 10 days' stay, I left in company with the Waiwai for their village up the Essequiibo. After five days' hard pulling, during the course of which we recognized one or two of the streams charted on the official map—e. g., the Kassikityu and Camoa—I finally reached their pretty little settlement at Duba-Kaiako Creek. On the way I noticed that their wood skins, by means of a very simple modification in the way of construction, were closed at both ends, rendering them as safe and as serviceable as any corial, and forming a strong contrast to those met elsewhere in the colony.

The Waiwai are a delightful and charming set of people—clean, industrious, and happy. It was the first occasion that I had come across Indians whistling while they work. The distance of their native haunts from centers of civilization has so far saved them from being interfered with by the missionary, rancher, and balata bleeder; at present they are moral, and during the whole of my month's stay among them, I saw no drinking. Smoking was unusual. With regard to looks, the girls are as pretty lassies as one could wish for, and their pale pink faces remind one of home. As a matter of fact, the comparatively light complexion of the tribe in general has given rise to its name—Waiwai being the Indian term for Tapioca. It was at this village that I saw a variation, new to me, of the large circular house, and by means of a model some 6 feet high that I induced one of the men to make, took careful notes of its method of construction. Another item of great interest was my initiation into the art of weaving a loin cloth, out of the finest cotton imaginable, to a width of some 6 inches and a length of as many feet. But to go into details of all the many wonderful things

I saw, learned, sketched, or photographed, would be pirating another manuscript that I am preparing on the scientific results of the expedition and which will occupy for its completion another six or eight months, perhaps more. Suffice it now, that on the return journey to the Demerara, where I arrived on July 29, I had a very rough time with jiggers and scarcity of food, often having to partake of monkey, iguana, mudfish, with occasionally an alligator tail thrown in as a special treat. How much nourishment was derivable from such a menu may be gauged by the fact that I lost 47 pounds in weight in the course of the trip.

These, however, were not my only troubles, for just four days from home, while streaking the Haiowa Falls, a wretch of a boat hand, with whom I had had some words on account of his refusal to work the day before, let go the warp, and down shot the boat, to be saved just in time by a tree trunk that had fortunately fallen athwart the stream. He subsequently got six months in the Georgetown Court for playing that trick. On the other hand, the gain in technical knowledge of certain primitive arts, the results of which will ultimately be published, has proved of incalculable value, and the lovely collections I brought back with me have combined to make me forget all the petty little worries and inconveniences that I experienced in gathering them. "Would I go out there again?" Of course I would, at the very first opportunity, but of course with a better equipment. The call of the wild can never be stilled in me, and thus it came to pass that on taking farewell of poor old Sandy, whom I never expect to see again in the flesh, we arranged to meet "some day" in the future and fish and hunt together in the happy hunting grounds beyond the Taruma and the Waiwai.

WALTER E. ROTH.

CHRISTIANBURG, DEMERARA RIVER, BRITISH GUIANA, *June 28, 1926.*

ILLUSTRATIONS

PLATES

	Page
1. <i>A</i> , Stone arrowheads (<i>a</i> , <i>c</i>) and perhaps a spearhead (<i>b</i>). <i>B</i> , Oyana dance clubs.....	10
2. Waiwai dance clubs.....	10
3. <i>a</i> , The Monta or Toekoesipan house of the Oyana. The structure on the right is probably a Maite house. (After Herderschee.) <i>b</i> , The Timakitti house of the Trio. (GOT, Pl. XXX).....	28
4. <i>A</i> , Position of the woman when making the stone-chip grater. <i>B</i> , Implements used in the manufacture of the stone-chip cassava grater. <i>C</i> , Stone-chip grater, showing the diagonal guiding pattern with the inserted chips, prior to being covered with the sap and red paint. (After Farabee).....	28
5. Patterns on the front and back of the Waiwai graters.....	28
6. Patterns on the front and back of the Waiwai graters.....	28
7. Various domestic articles, mostly from the Oyana. (After GOE, Pl. VIII).....	32
8. Waiwai sifter. <i>a</i> , From above. <i>b</i> , From below.....	32
9. <i>a</i> , Portable wooden mortar said to come from the Waiwai. (After Farabee.) <i>b</i> , Box made from strips of kokerit leaf.....	36
10. <i>a</i> , Wapishana pimpler-palm mat, having the rails on opposite sides, tied with fiber. <i>b</i> , Pepper carriers of the Waiwai and Taruma. <i>c</i> , Mat satchels of the Taruma and Waiwai.....	36
11. Trumpet-shaped carrying basket from the Orinoco mouth, Warrau. <i>a</i> , Front view. <i>b</i> , Back view.....	42
12. <i>a</i> , The Pakaruma basket of the Makusi. <i>b</i> , Twilled non-hourglass pattern pegall.....	42
13. <i>a</i> , Diagram of twilled non-hourglass pattern pegall. One quarter of top surface showing how the sides are built up with extra wefts. <i>b</i> , Pattern from side of Waiwai pegall. A central beetle and two deer facing each other.....	46
14. Pattern from side of Waiwai pegall. Two beetles and monkeys facing each other.....	46
15. <i>a</i> , Pimpler-palm (<i>Astrocaryum</i>) knapsack cover of Wapishana. <i>b</i> , Diagram explaining manufacture of the pimpler-palm knapsack cover.....	48
16. <i>a</i> , Vertically plaited single-leaf ite basket or satchel. <i>b</i> , The two split halves of an ite leaf prepared for subsequent manipulation into various receptacles.....	48
17. Ite leaf close-work knapsack. <i>a</i> , Front view. <i>b</i> , Back view.....	50
18. Stages in the manufacture of the ite-leaf close-work knapsack.....	50
19. <i>a</i> , A "freak" hanging basket of the Wapishana. <i>b</i> , An Arekuna carrier. <i>c</i> , The ite-leaf corn basket. <i>d</i> , The ite-leaf knapsack cover of the Waiwai and Taruma, etc.....	54
20. <i>a</i> , Waiwai making a hammock. <i>b</i> , Temporary bush basket, No. 2 on right and No. 3 on left.....	54

	Page
21. Shoulder baskets. <i>A</i> , Temporary basket of the Waiwai. <i>B</i> , Permanent basket of the Apalai (after Farabee). <i>C</i> , Waiwai women carrying permanent and temporary shoulder baskets, respectively-----	60
22. <i>a</i> , Waiwai cheek ornament. <i>b</i> , Waiwai nose ornament-----	70
23. <i>a</i> , Waiwai males using the nose and cheek and lower lip ornaments, respectively. <i>b</i> , Waiwai females. One showing the necklet and apron, the other the corselet and cotton cross cords. <i>c</i> , Waiwai method (male) of wearing the hair in a tube. <i>d</i> , Waiwai beaded bamboo hair tube-----	70
24. <i>A</i> , Various Waiwai ornaments and implements. (<i>a</i>) bush-hog scraper; (<i>b</i>) male cheek ornament; (<i>c</i>) nose ornament; (<i>d</i>) stage in making of a comb; (<i>e</i>) the compound brush cured for curare painting. <i>B</i> , Various Waiwai ornaments, etc. (<i>a</i>) three simple forms of hair tubes; (<i>b</i>) a feather fillet; (<i>c</i>) a necklet; (<i>d</i>) two ear ornaments; (<i>e</i> , <i>f</i>) hair comb in progress of construction-----	70
25. Waiwai hair tubes. <i>a</i> , Spiral sugar-loaf form; <i>b</i> , beaded bamboo form--	72
26. Compound vertical hats and back ornament from the Oyana and Trio. <i>a</i> , The Olok of the Oyana (GOE, Pl. III, fig. 1); <i>b</i> , The Walum of the Trio (GOE, Pl. II, fig. 11); <i>c</i> , The Harikete back ornament of the Oyana (GOE, Pl. II, fig. 9)-----	74
27. <i>A</i> , Macusi vertical feather crown. The bases of the macaw tail feathers are covered with powis plumage. <i>B</i> , Vertical and horizontal feather crown. <i>a</i> is feathered in an unusual fashion-----	76
28. Waiwai corselets-----	76
29. <i>a-e</i> , Waiwai corselet, showing details. <i>f</i> , Waiwai bush-hog tooth scraper-----	78
30. Trio and Waiwai armlets. <i>a</i> , Band made by Trio from a pimpler palm leaf. <i>b</i> , Made by Waiwai from bark and similar leaf. <i>c</i> , Made by Waiwai from beads-----	78
31. <i>A</i> , Waiwai bead and feather ornaments. (<i>a</i> , <i>b</i>) Two cotton cord belts with bead and feather hip covers, respectively; (<i>c</i>) Bead armlet; (<i>d</i>) Lower lip feather tuft; (<i>e</i>) Woman's bead and feather wristlet. <i>B</i> , Waiwai men's belts (after Farabee). (<i>a</i>) Probably of jaguar skin, showing feather hip covers; (<i>b</i>) shows bead hip covers-----	78
32. Hip cover belts of the Waiwai. <i>a</i> , Hip cover made of looped feathered strings; <i>b</i> , Made of a bead network foundation; <i>c</i> , Waiwai wristlet, showing the construction of the bead foundation-----	78
33. <i>A</i> , Waiwai loin cloth. <i>B</i> , Various body ornaments. <i>a</i> , Waiwai bark and leaf armlet surrounded by <i>b</i> , Makusi (?) tubular beaded belt, and <i>c</i> , two armlets with shell disks-----	82
34. Glass bead aprons of the Waiwai-----	82

TEXT FIGURES

1. Fire twirling apparatus, Taulipang (after Koch-Grünberg)-----	1
2. Clay-guard spindles for cotton spinning (Waiwai)-----	4
3. The Makusi farine sifter started with squares, the diagonals being subsequently added-----	6
4. An imbricate form of plaiting in the manufacture of a vertical feather crown-----	6
5. An imbricate form of plaiting adopted in the manufacture of the Waiwai sifter-----	7

	Page
6. Fixation of string onto bow, etc. Attached to upper end with a double loop (<i>a-e</i>), or with a single loop, a bowline (<i>f</i>); attached to lower end with a simpler form of bowline (<i>g, h</i>). Restoring a bent bow to its normal shape (<i>k</i>)-----	8
7. Fall-trap for armadillo, labba, etc., on upper Barima River-----	11
8. Fall trap for labba, etc., on the Demerara River-----	12
9. A "warning-bell" arrangement attached to a fishing line-----	14
10. Spring trap for haimara, etc-----	15
11. Spring-basket fish trap with movable door, from the upper Demerara River-----	16
12. Box trap for catching crab-----	17
13. Triangular banab (temporary shelter hut) of the Taruma, Atorai, and Waiwai-----	20
14. The simplest form of the lean-to banab-----	21
15. Rain shelters for protecting boat cargoes-----	22
16. The permanent lean-to (penthouse) of the Taruma, rectangular type-----	22
17. The permanent lean-to (penthouse) of the Taruma and Waiwai, half-hexagon type. View from back-----	23
18. Waiwai circular house-----	24
19. Waiwai circular house, showing progress of construction-----	25
20. Diagram of Oyana and Trio houses after GOE, Plate IX-----	26
21. Rectangular house of the Waiwai-----	26
22. Illustration of mauritia thatch to replace Figure 78, <i>c</i> (WER, vii), drawn incorrectly-----	27
23. Some methods of using manicol leaf for thatch-----	27
24. Typical Waiwai bench-----	28
25. Diagram to show variations in the commencing stages of the manufacture of a cassava squeezer-----	29
26. Commencing stage of Wapishana cassava squeezer-----	30
27. Commencing stage of Taruma cassava squeezer-----	31
28. Commencing stage of Waiwai cassava squeezer-----	32
29. Wapishana farine sifter with a central crossed quadrilateral pattern--	32
30. Diagram of manufacture of the Waiwai sifter-----	33
31. Diagram of manufacture of the Waiwai sifter-----	34
32. Roller press for squeezing sugar cane, upper Barama River-----	35
33. Manufacture of the kokerit leaf strip box-----	35
34. Manufacture of the kokerit leaf plaited box, with "two stars"-----	36
35. Manufacture of the mat illustrated in Plate 10, <i>a</i> -----	38
36. Manufacture of the mat illustrated in Plate 10, <i>a</i> , continued-----	39
37. Manufacture of the Taruma and Waiwai satchel-----	40
38. Square hanging tray of the Waiwai, etc-----	41
39. Wapishana circular tray, with two rails; another method of fixation--	41
40. Trumpet-shaped basket (Pl. 11) showing the original bundle of warp strands (<i>wa</i>) tied by the spiral weft (<i>we</i>)-----	42
41. A more advanced stage in the construction of the trumpet-shaped carrying basket-----	43
42. View of portions of the completed basket from the middle (A) and at the mouth (B), respectively-----	44
43. Diagram of basket shown in Plate 12, <i>a</i> -----	44
44. Manufacture of the checker rectangular flat-base basket of the Oyana, Waiwai, etc-----	45
45. Manufacture of the single-leaf ite basket or satchel-----	48
46. Diagram of split ite-leaf tray shown in Plate 121 A, C (WER, vii). Front view-----	49

	Page
47. Diagram of the same. Back view.....	50
48. Manufacture of the ite-leaf close-work knapsack.....	51
49. Manufacture of the ite-leaf close-work knapsack, continued.....	52
50. Manufacture of the ite-leaf close-work knapsack, continued.....	53
51. Manufacture of the ite-leaf throat-box basket.....	54
52. Manufacture of the ite-leaf throat-box basket, continued.....	54
53. Manufacture of the carrier illustrated in Plate 19, <i>b</i>	55
54. Manufacture of the ite-leaf corn basket.....	56
55. Manufacture of the pepper-pot basket.....	57
56. Manufacture of the pepper-pot basket, continued.....	58
57. Temporary bush basket, No. 1.....	59
58. Manufacture of temporary bush baskets.....	60
59. Manufacture of the Waiwai temporary pimpler-palm shoulder basket.....	61
60. Manufacture of the Waiwai temporary pimpler-palm shoulder basket, continued.....	62
61. Manufacture of a 6-weft Atorai hammock.....	63
62. Manufacture of a 6-weft Atorai hammock, continued.....	64
63. Manufacture of a 6-weft Atorai hammock, continued.....	65
64. Manufacture of a 6-weft Atorai hammock, continued.....	66
65. Back of the 6-weft Atorai hammock, showing the smooth surface as contrasted with the front.....	66
66. Manufacture of the Waiwai hammock.....	67
67. Manufacture of the Waiwai hammock, continued.....	68
68. Manufacture of the Waiwai hammock, continued.....	69
69. Manufacture of hair comb.....	73
70. Details of the macaw tail feather tips in Plate 27, <i>A</i>	75
71. Showing the two bars at the back of a vertical crown that support the macaw tail feathers.....	76
72. Construction of the feather head fillet of the Waiwai, etc.....	76
73. Diagram showing construction of the bead foundation of the Waiwai wristlet.....	79
74. Diagram to show construction of tubular beaded belt (after Koch- Grünberg).....	80
75. Diagram to show construction of the two-loop hollow cylindrical belt.....	80
76. Diagram to show construction of cotton-fringe apron belt (after Koch-Grünberg).....	81
77. Waiwai making a loin cloth.....	82
78. Manufacture of the Waiwai loin cloth.....	83
79. Manufacture of the Waiwai loin cloth, continued.....	84
80. Manufacture of the Waiwai loin cloth, continued. Making the main heddle.....	85
81. Manufacture of the Waiwai loin cloth, continued.....	86
82. Manufacture of the Waiwai loin cloth, continued.....	87
83. Bamboo flutes of the Oyana (after De Goeje). <i>a</i> , The taloeloepan. <i>b</i> , Nose flute.....	89
84. Method of playing the flageolet.....	89
85. Parishara dance headdress; method of fixing the horizontal into the vertical pinnules (after Koch-Grünberg).....	92
86. Wapishana method of shooting play arrows.....	93
87. Wapishana variations of the bowstring puzzle.....	94
88. Puzzle to lock and open two locked leaf strips.....	95
89. Canoe making on the upper Essequibo.....	97
90. Manufacture of the Waiwai woodskin.....	99

WORKS OF REFERENCE

[NOTE.—This list should be read with that given in the main work (Thirty-eighth Ann. Rept. Bur. Amer. Ethn.) to which it is additional.]

- AHL AHLBRINCK, W. Over de vlectmethoden gebruikelijk bij de *Kalina* (Suriname). *Anthropos*, 1925.
- BAK BAKHUIS, L. A. Verslag den Coppename expeditie Tijd. Kon. Ned. Aard. Gen. 1902.
- BES BENJAMINS, Dr. H. D. and JOH. F. SNELLEMAN. Encyclopaedie van Nederlansch West Indië. 's-Gravenhage, Leiden, 1914–1917.
- CAP VAN CAPELLE, H. De Binnenlanden van het Dist. Nickerie (Suriname). Baarn, 1903.
- CO COUDREAU, O. Voyage au Cumina. Paris, 1901.
COUDREAU, O. Voyage à la Mapuera. Paris, 1903.
- FAA } REFERENCE LETTERS OF FARABEE, Central Arawaks, and Central
FAC } Caribs, respectively, the latter published in Philadelphia, 1924.
- GOT GOEJE, C. H. DE. Verslag der Toemoek-hoemak expeditie. Tijd. Kon. Ned. Aard. Gen. 1908.
- HAA HAAN, EILERTS DE. Verslag van de Expeditie naar de Suriname Rivier (June–November, 1908). Tijd. Kon. Ned. Aard. Gen.
- HER HERDERSCHEE, A. FRANSSEN. Verslag van de Goninie Expeditie. Tijd. Kon. Ned. Aard. Gen. 1905.
- HER, I ———. Verslag van de Tapanahoni Expeditie. Tijd. Kon. Ned. Aard. Gen. 1905.
- KAY KÄYSER, C. C. Verslag der Corantijn Expeditie. Tijd. Kon. Ned. Aard. Gen. 1912.
- KGR KOCH-GRÜNBERG, THEODOR. Vom Roroima zum Orinoco. 5 vols. Berlin, 1916.
- LIN LINDBLOM, K. G. Über eine alte ethnographische Sammlung aus dem Nördlichsten Südamerika in Ethnog-Reichs Museum in Stockholm. Ymer, August, 1924.
- NC NIMUENDAJU, CURT. Die Palikur Indianer und ihre Nachbarn. Göteborg, 1926.
- NOS NORDENSKIÖLD, ERLAND. Comparative Ethnological Studies. Göteborg, 1923.
- NOT NORDENSKIÖLD, F. and E. Über Zwirnen und Spinnen bei den Indianern Südamerikas. Göteborg, 1918.
- SAC REFERENCE LETTER OF ALBERT VON SACK'S NARRATIVE, etc.
- SRR SCHOMBURGK, RICHARD. Reisen in British Guiana. 3 vols. Translation by W. E. Roth. Georgetown, B. G., 1922.
- STO VAN STOCKUM, A. J. Verslag van de Saramacca Expeditie. Tijd. Kon. Ned. Aard. Gen. 1904.
- VCO VAN COLL. Gegevens over Land en Volk van Suriname. Bijdragen tot de Taal-, Land- en Volkenkunde van Nederlandsch-Indië. 's-Gravenhage, 1903.
- WER, VII ROTH, WALTER E. An introductory study of the arts, crafts, and customs of the Guiana Indians. Washington, 1924.



ADDITIONAL STUDIES OF THE ARTS, CRAFTS, AND
CUSTOMS OF THE GUIANA INDIANS, WITH SPECIAL
REFERENCE TO THOSE OF SOUTHERN BRITISH GUIANA

By WALTER E. ROTH

[NOTE.—This work is an appendix to and should be used in conjunction with the original work in the Thirty-eighth Annual Report of the Bureau of American Ethnology. A few of the illustrations will be found in the original work. The section numbers refer to those in the original work. New sections are distinguished by an additional capital letter—A, B, etc.]

1. *At end of section add:*

The tinder (foengoe) used by certain Surinam bush negroes is derived from the nest of a black ant, *Cryptocercus atratus*. (HER, 11.)

The Taulipang use what may be called a compound twirling apparatus for catching fire. (Fig. 1.) Two or three pieces of arrow reed as long as one's hand are split in half along their length. The halves are placed on top of one another, pierced perpendicularly through by means of a little stick at both ends, and tied tightly together with string, after one has clinched cotton flock in between some of the pieces. On the flat of the

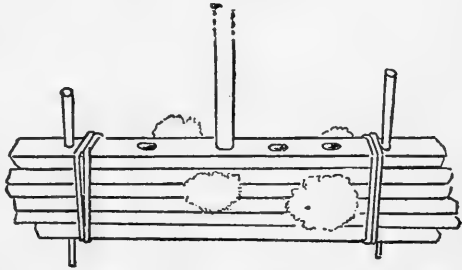

FIGURE 1.—Fire twirling apparatus, Taulipang (after Koch-Grünberg)

upper surface of the topmost piece of reed a few little pits are cut. The man who wants to kindle the fire squats on the ground, holds one end of the reed bundle between the great and second toes, and twirls a longer arrow reed perpendicularly in one of the little pits, while * * * at the same time he presses down strongly with the flats of both hands. The twirler gradually penetrates the individual layers of the arrow bundle and rubs away the fine dust, which inflames, begins to glow, and sets on fire the cotton upon which it falls. (KGR, III, 47.)

I can find no confirmation of the statement that among the Central Caribs fire is made by rubbing two sticks together in the form of a chisel and groove. (FAC, 38.)

3. *At end of section add:*

What we were particularly struck with in the (Oyana) village, says Herderschee, was a large dead tree trunk that had been set on fire and

was slowly smoldering away. The faggots that were required for preparing the food, and the torches with which they betook themselves of an evening to the sleeping huts, were kindled at this huge fire hearth. (HER, 124.)

5. *Page 72, after (BA, 231), second line from top, add:*

Candles are made from the fruit of the dalie [wild nutmeg]. The nut is pounded, boiled, and squeezed through a cassava press or jouri above water, whereupon the fat immediately congeals, from which, after being properly purified and melted, the candles are molded like yellow wax. (HRT, 72.)

At end of section add:

One finds there (in Surinam) a plant which the Spaniards call palo de luz—i. e., stok-kaars (stick candle), usually 2 feet high. It shoots from the root several stalks which are straight and smooth up to the top, where these give rise to small shoots provided with narrow leaves. When the stalks are cut off, and while still green, they burn like a candle and thus can be used as a torch or flambeau, provided that, from time to time, one knocks off the burning end. (HRT, 87.)

9. *Line 12, after Orinoco, add:*

In Surinam, at one spot on the Tapanahoni River, were to be seen certainly a few hundred whetting-grooves (*slijpgroeven*), spoon-shaped excavations that have been caused by the Indians grinding their stone axes and knives on the rocks. So also at several falls in the upper river were masses of these grooves, the characteristic signs of the former sojourn of Indians at those spots. (HER, I, 884, 924-925, 961.)

14. *At end of section add:*

Mention is made in one of the Arekuna myths of a wooden knife being made of *Astrocaryum tucuma*, a very hard wood. (KGR, II, 61.)

18. *Seventh line from top, after (JO), add:*

I have illustrated such a specimen (pls. 24, *A, a*; 29, *f*), which I obtained from the Waiwai who called it fakelioli. Like most of their implements, it is ornamented with feathers.

23. *Page 82, seventh line from bottom, after Indians, add:*

It would seem that the turara or turala (Wap.) is a tree distinct from the balata (*M. globosa*) which these Indians call iriari. They distinguish between the two which otherwise—in bark, size, and shape of leaf—are very similar by the under surface of the turara leaf being more “greyish” and lighter colored, and by the latex being less watery. Whereas the cut in a balata tree will start to “run milk” almost at once, the turala takes a day at least before exuding, and then only in smaller or larger drops, when it is picked off with the fingers or with a knife. In both trees the latex is equally white, and the bark is practically identical in appearance and conformation.

After being collected, the turara is wrapped up and pressed in leaves and dried in the sun, and like karamanni it is warmed over the fire before use. It is said to be better than karamanni in that it gives or yields, rather than cracks. It is hence commonly used for covering the attachment of fishhook to line. Like haiowa and balata, it is also employed for lighting a fire and as an illuminant, when it is fixed into a forked stick and allowed to burn from above down. Very common in the Taruma and Waiwai country, where it is largely bartered with the Wapishana.

Page 38, seventh line from bottom, after 357), add:

The bush negroes of Surinam use this resin as medicine; the women for sterility. (KAY, 480.)

At end of section add:

So also, I have not been able to determine the gum or resin (karimen of the Wapishana, arakú of the Waiwai) used for mixing with the annatto when painting the graters. It is derived from the bark of a tree with a large smooth spherical yellow fruit up to 2½ inches diameter containing eight flat melon-shaped light-brownish seeds, and large leaf. This karimen has, of course, nothing whatever to do with the well-known karamanni (*Moronobea*).

25. *At end of section add:*

Brazil nuts (*Bertholletia excelsa*) are pounded in a mortar to extract the oil, which is used on the hair and body * * * In extracting the oil a small press, like the one used for cassava, is employed. (FAC, 37.)

33. *At end of section add:*

The statement that the Wapishana learned the art of spinning and weaving cotton from the Makusi, who themselves learned it from the Arekuna (FAA, 26; FAC, 25), is as far-fetched as it is improbable, and I have never heard it mentioned by the Wapishana, even as a legend. (MEL.)

34. *At end of section add:*

The Waiwai make their guards (fig. 2) apparently of baked clay in the shape more or less of a spheroid. The single or double hooked tip is either part and parcel of the wooden shank or a separate piece of bone. The total length of these Waiwai articles is from 10 to 14 inches. The shape and material of the guard reminds us forcibly of those described from Bolivia, Paraguay, and Colombia. (NOS, figs. 17b, 36, 48b.)

52. *At end of section add:*

The Taulipang can evidently make bands with eight needles. These are used for covering the feather bands carrying the rows of feathers on the hats. (KGR, III, 39.)

72. *At end of section add:*

Sipo [sippi, etc.] is said to be the Brazilian word for any bush rope. Ropes for nets and hammocks are manufactured from the fiber underneath the bark of the white mangrove. (HRT, 78.)

75. *At end of section add:*

Among the Waiwai, on my recent trip, I saw fruit shells of fairly large size, up to seven-eighths inch greatest diameter, attached along the lower border of the women's aprons, etc., the tinkling of which was due not only to the one shell knocking against its neighbors, but also to artificial "clappers" introduced through a slit along the rounded edge. Whether the slit was a natural one or not I can not say, but at any rate it must have been through its means, before the hardening of the shell took place, that the clapper or clappers in the

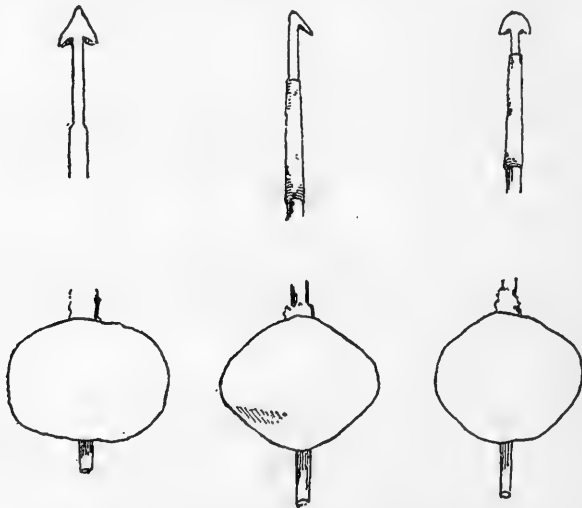

FIGURE 2.—Clay-guard spindles for cotton spinning (Waiwai).
(Sec. 34)

form of beads, gravel, stone chips, etc., were introduced. As a matter of fact, each fruit shell was the nearest approach imaginable to a "natural" form of a European child's folly-bell, and all the more remarkable in that for the first time, some 12 years ago, I had distributed many dozens of such folly-bells as trade among their neighbors (the Wapishana, and so through them), the Taruma. Two of the Waiwai girls were each wearing such a brummagem folly-bell. An illustration of such a clapper shell is given by De Goeje. (GOE, pl. 1, fig. 23.)

76. *At end of section add:*

Where the aperture of the bead is too small for even the fine korowa thread to pass, the latter is attached by means of a very fine blob of karamanni wax to an akuri hair which easily gets through.

Besides korowa, cotton, and occasionally its twine, the extremely thin and long woody stalk of the aroewepi was used for threading beads. (CAP, 181.)

78 A. There is no doubt that the method of connecting up the beads on the lines just described in the making of an apron lends itself to the formation of a compact, pliable, flat, and smooth surface—a sort of beaded cloth, if such a term is permissible. Similar effects, except perhaps that the result is not quite so compact, can, however, be produced by at least two other methods, e. g., by netting, as in the bead-and-feather hip covers of certain Waiwai belts (pl. 32, *b*) and by a hitherto undescribed procedure as in the bead foundation of the Waiwai women's wristlet (pl. 32, *c*; fig. 73). Beaded "cloth" of a much looser texture made of beaded strings connected up at their extremities, and likewise joined at various intervals in between, is met with in the Waiwai corselets (pl. 28), headband armlets (pl. 30, *c*), etc.

80. *At end of section add:*

As a rule, however, single small feathers are too soft and flexible to hang properly. They are accordingly laid one on top of another, face to back, two to four at a time, in bundles, every two bundles being then tied face to face by their quills onto the intervening string. (Pl. 22, *b*.) The feathers, fringes, and tassels around the Waiwai apron-belt, corselet, loin cloth, etc., the ear, cheek, and chin ornaments, and necklet are mostly constructed of smaller feathers attached after this fashion. (Pls. 22, 32.)

81. *At end of section add:*

Such a nose ornament is illustrated in Plate 22, *b*.

82 A. A feather lends itself to ornament and decoration in one of three ways. It may be sharply truncated at its terminal end or cut into various saw-edged shapes at both proximal and distal extremities. (Pl. 32.) Secondly, the point of the quill after being cleared of its pinnules may be attached to a bunch of smaller but similarly ornamented feathers as in the olok (sec. 518) or in the three or four upstanding plumes at the backs of the feather head-dresses (fig. 70), to a series of beaded strings bearing other feathers, as in the Waiwai nose ornaments (pl. 22, *b*), or even to a cotton overcast ring bearing beetles' wings (pl. 26, *a*). In the third case the decoration may be amplified by cementing pieces of other colored feathers along the midrib (sec. 81). And, finally, instead of being cut to shape, the base of the feather may be covered with bits of other plumage, as in the macaw tail feathers at the back of the head crown. (Pl. 27.)

On the other hand, feathers may be grouped into various thero-morphic or floral designs, as in the ant and wasp frames at certain ceremonials of the Oyana and Apalai, etc. (sec. 884), that un-

doubtedly constitute very striking representations of quadrupeds, fish, and birds. In speaking of floral designs, I have in mind a decorated fiber hammock in the Georgetown Museum of which little more is known than that it came "from the Brazils" some 30 years ago. Doubts may, however, be thrown on its alleged purely Indian origin because on more careful examination it will be found that while some of the prepared feathers have been attached direct to the material by means of some cementing substance, there are others that have been attached indirectly through the intermediary of a sheet of printed matter. Furthermore, the fringe to which the feathers are attached is of a type that I have not hitherto met among the Guiana Indians.

Independently of any particular design, feathers may be used for decorative purposes pure and simple; e. g., most of the red and yellow feathers or Waiwai implements, such as sifters, scrapers,

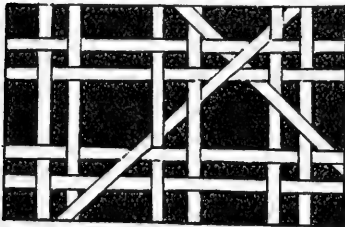

FIGURE 3.—The Makusi farine sifter started with squares, the diagonals being subsequently added. (Sec. 108)

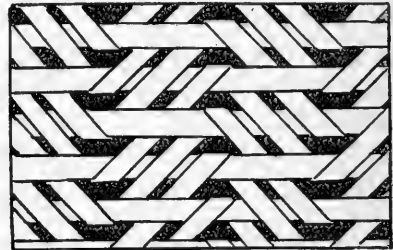

FIGURE 4.—An imbricate form of plaiting in the manufacture of a vertical feather crown. (Sec. 114)

boxes, etc., and the blue bits of feather along their hair tubes. (Pl. 25, a.)

85. *Line 25, after the Essequibo, add:*

What are believed to be remains of such diggings are still to be seen at Mount Kowatipu. In his map illustrating the route traversed by him from Holmia to Kaieteur Falls, Clementi marks the spot to the south of this mountain as "Excavations."

108. *At end of section add:*

It is only fair to state that what I presumed has turned out to be inaccurate. For during my last visit to these people I saw the Wapishana farine sifter, similar to the Makusi article, started with a series of squares, the diagonals being added subsequently. (Fig. 3.)

114. *At end of section add:*

For other kinds of imbricate plaiting (figs. 4, 5) see the construction of the vertical feather crown (fig. 4) and the Waiwai sifter (sec. 359). In the former case, as compared with Figure 41, c (WER, VII), three strands are locked at a time instead of two.

121. *At end of section add:*

More to the eastward the Trio possess the secret of curare preparation. The plant that supplies the main ingredient of the poison is a *Strychnos* (*S. Crevauxiana* Baill., *S. toxifera* Schomb.) which, according to the Indians, is present on the Paloemeu. The poison, that must work very swiftly, is smeared with a brush on loose arrow points about 10 centimeters long. When out hunting, these are carried along in a bamboo tube. For use, such a point is cut half-way through and stuck into the tubular proximal extremity of an ordinary long hunting arrow [from which its own point has been removed for the purpose]. The poisoned point then breaks off in the wound, and the shaft falls back. (HER, I, 943.) So again, blowguns are not known among the Trio, Waiwai, Pianocoto, etc., though these all employ curare-tipped arrow points.

122. *Page 150, last line, after 13) add:*

I came across such similarly constructed flat compound brushes among the Waiwai. (Pl. 24, A, e.)

123. *Page 151, line 19, after RO, 526, add:*

The [mainland] Indians make use of the markoeje or mancenielle [*Hippomane manicella* Linn. See Schomburgk's Travels, I, sec. 707] to poison their arrows. "This tree is remarkable on account of its poisonous property, which is dangerous even to rest or sojourn under, because the fluid that trickles down, after it has rained, makes the body swell just as if it had been burned with boiling water. If the fluid drops into the eyes, and one rubs it with a moist finger, one runs the risk of being blinded, because they first of all get red, afterwards blue, and finally full of pus. The principal venom, however, is contained in the fruit, and the antidote is, as a rule, oil. This tree, the shade of which even animals seem to avoid, grows to an uncommon height on the seacoast, resembling the pear tree very much, though the trunk is thicker. The bark is filled with a sharp astringent sap. The timber beneath the sapwood is gray, mixed through with small veins of various colors much more beautiful than the nut tree or roots of the olive tree. The fruit has much resemblance to a cannetje apple, and is dangerous to eat, being of a 'biting through' and poisonous material, as is said; so also is the bark, wood, and the leaves. So much so that a fish that has eaten it becomes a poisonous food for man. Yet man can discover such kinds by the blackness of their death." (HRT, 79, 80.)

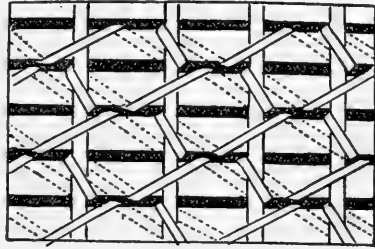

FIGURE 5.—An imbricate form of plaiting adopted in the manufacture of the Waiwai sifter. (Sec. 359)

Page 153, after line 5, add:

The Waiwai use plain bamboo tubes with deerskin cover-caps for their curare-tipped arrow points. Such quivers are from 9 to 10 inches long and $1\frac{3}{8}$ inches diameter; a septum of the cane being left to form the base. A good illustration of it is to be seen in FAC, plate xxxiii.

125. At end of section add:

The Oyana bow is of letterwood and is 2 meters long. (HER, 124.) Very long bows, judging from those met with among the Waiwai, up to 8 feet long, are used for shooting at vertical heights, e. g., birds, monkeys, etc., on branches of very high trees.

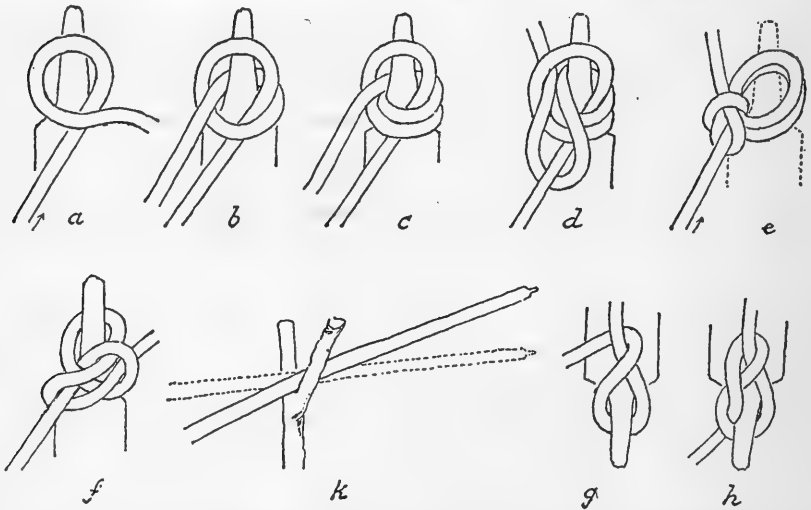

FIGURE 6.—Fixation of string onto bow, etc. (Sec. 127.) Attached to upper end with a double loop (a-e), or with a single loop, a bowline (f); attached to lower end with a simpler form of bowline (g, h). Restoring a bent bow to its normal shape (k)

127. At end of section add:

The Oyana are said to make the bowstring of cotton. (HER, I, 904.)

Some additional notes have been collected among the Wapishana, etc., concerning the fixation of bowstring onto bow. What is considered the best and most usual way is that shown in the illustration. (Fig. 6, a-e.) But instead of a double loop an ordinary bowline (single loop) may be constructed which has the advantage (f) over the single loop depicted in Figure 42, F (WER, VII) in that it can not possibly slip and accordingly does not require a knotted extremity. On turning the bow upside down, with the string loosely stretched, the Wapishana make a loop as depicted here (g, h). The proximal extremity of the bowstring is always attached to the upper end of the bow—i. e., as regards the position when the implement is being shot. The remainder of the string is then looped over the bow and finally

wound round it. To render the string taut prior to use, the loop is drawn off the upper end, the string twisted, and the loop replaced.

After use the bow is always unstrung; otherwise it develops too much curvature and loses pliability. Such curvature can only be remedied by heat. For this purpose it is well greased, warmed gradually over a fire, and then straightened by pulling it through a vertically planted forked stick (*k*), at the same time pressing it as required against the legs of the fork, one acting as fulcrum, the other as weight.

128 A. In section 147 I have mentioned certain prehistoric stone artifacts as spearheads. Of the two specimens illustrated in Plate 36, *A* (WER, VII), the larger measures $4\frac{1}{2}$ by $1\frac{1}{10}$ inches. The spatulate shape combined with the weight and size were among the more cogent of my reasons for believing them to be lance heads, rather than arrowheads, but having since found the Waiwai using a 2-ounce heavy iron barb almost 7 inches in length, on a bush-hog harpoon arrow, it is quite possible that I have been in error and that they are really arrowheads. In the meantime I have secured a specimen, illustrated in Plate 1, *c*, of comparatively large weight and size ($2\frac{5}{8}$ by $1\frac{1}{2}$ inches), which in shape is more or less an intermediate stage between the two artifacts above mentioned and the common North American type of arrowhead. This unique specimen was found in 1919 at Palikúa (Sparrow) Creek, about a mile to the north of Dadanawa head station on the upper Rupununi River. It was picked up in one of the bends of the creek where it had been washed down by a freshet, mixed with quartz gravel about 3 feet below the surface. On submitting the object for examination to Mr. E. E. Winter, the late geological surveyor of British Guiana, he wrote me that—

It seems to be agate, judging by the structure; the hardness (=7) agrees with this, but the specific gravity does not; it is too high for agate. This might be explained by a lot of impurities. * * * The specimen has the hardness of quartz and the structure of agate, and that is about all I can say.

129. Page 158, second line, after 44), *add*:

Koch-Grünberg found similar turtle-bone apparatus among the Schiriana and Waika. (KGR, III, pl. 46.) Among the Waiwai I saw the bones replaced by short sticks.

132. Page 160, line 13, after eagle, etc., *add*:

Tail feathers of the mahooka or horned screamer (*Palamedea cornuta*) are also used. (SR, II, ch. XI.)

136. At end of section *add*:

We might include here the loose curare arrow-points which are a sort of monopoly of the Trio; one seldom sees them among the Oyana. The point consists of a little stick of bamboo sharpened on both sides; the curare is streaked onto the one extremity with a brush made of howler-monkey hair; the points are carried about in a bamboo quiver

with a cover of tapir or howler-monkey hide. (GOE, 15.) These articles would seem to be traded long distances. I have seen points, quivers, and brushes among the Waiwai (sec. 123), who do not manufacture these articles for themselves. The brush is a composite one (sec. 122).

137. *Page 163, at end of paragraph, line 7, add:*

Some of the Trio possess an iron lanceolate-pointed spear (GOE, pl. v, 14) obtained by the intermediary Saluma from the Brazilians. This is sometimes used in hunting big game. (Cf. sec. 147.)

138. *At end of section add:*

So also, several of the Indian women (Arawak at Paramaribo) had light bows and soft cotton balls fastened on the points of the arrows for shooting those birds which they wished to preserve alive. When we made them understand our wish to see the effect of their bows they shot several little birds with great dexterity. (SAC, 122.)

139. *At end of section add:*

There is evidence that in these present-day composite arrows iron has replaced wood and a probability that what is now composite was originally simple. In Fahlberg's collection, made in 1786, and now located in the Ethnographisches Reichsmuseum at Stockholm, is a replica of Figure 53, *D, E* (WER, VII), in wood. (LIN, 164-165.) In Liljewalch's collection the similarly shaped tip and underlying barb are cut out of the same piece of timber.

143. *Page 168, line 1, after feathered, add:*

The Waiwai have a practically similar arrow employed for the same purpose, though the harpoon itself is perhaps a trifle heavier (up to 2 ounces). The connecting flat-braided cordage, not quite half an inch wide, is plaited from ite (?) fiber on a pattern of which I unfortunately neglected having a model made. The harpoon itself is decorated with feathers.

145. *Page 168, line 7, after classification, add:*

When the bow is very stiff Wapishana and other Indians will employ tertiary release.

147. *Page 170, line 10, after 107), add:*

At the present day up on the Wenamu, toward the Venezuelan border, the Akawai use a long spatulate-headed wooden spear for giving the coup de grace to the bush hog after being struck with the harpoon arrow.

152. *Page 173, line 4, after VI), add:*

As special war implements [they] are [alone] met with among the Trio. They are of a heavy dark-brown timber, broad and flat, and decorated with incised figures. (Pl. 1.) In order to render these more prominent a white material, probably a kind of clay, is smeared into the incisions. A small cotton tassel, sometimes with feathers, is at the base of the blade. With some, the blade is bored through for

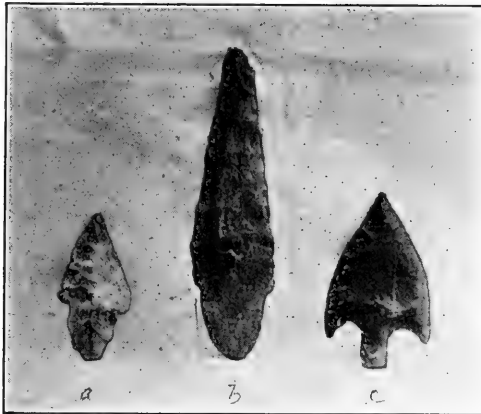

A, Stone arrowheads (a, c) and perhaps a spearhead (b)

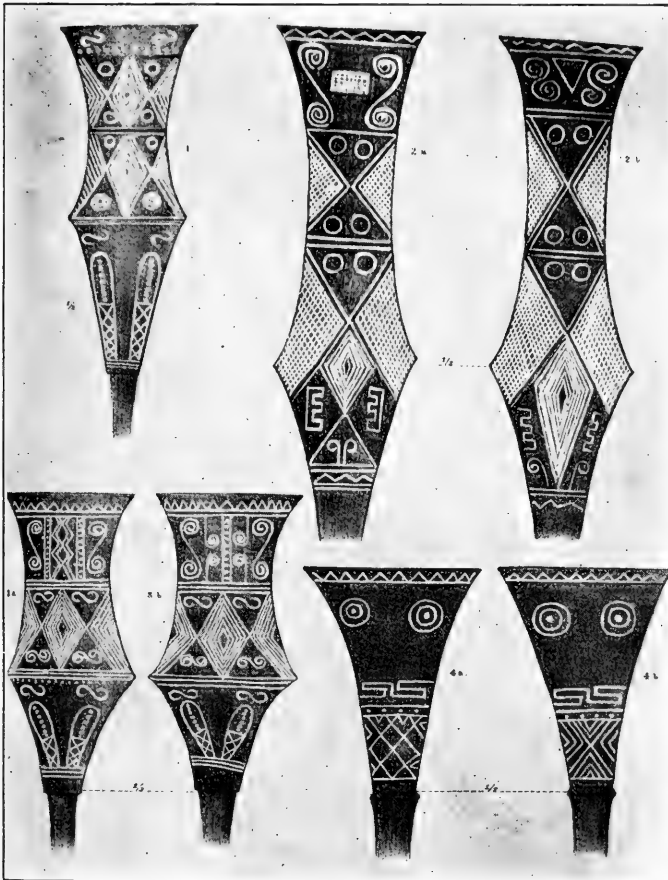

B, Oyana dance clubs

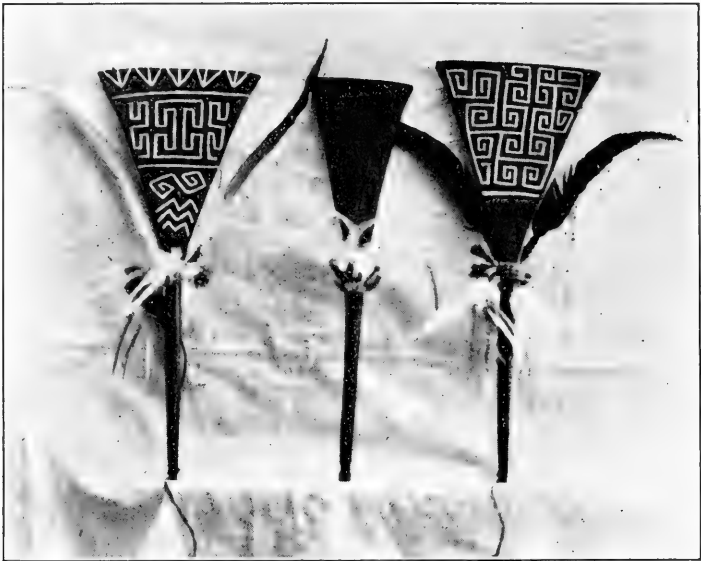

a



b

a small cord. The Trio frequently carry such a club in the hand when they have made themselves "pretty-pretty." It belongs somewhat to holiday attire. But they are still very serviceable war implements and in no cases degenerate into mere ornaments like the Oyana dance clubs (pl. 1, *B*). * * * The clubs met by O. Coudreau (CO, 180) among the Pianocoto are of the same type. (GOE, 16.)

At end of section add:

Thus among the Waiwai I collected an interesting series of dancing clubs, all more or less of the spatulate type, and the patterns either painted black or incised in white, upon a red (annatto) foundation. (Pl. 2.) In a few of the specimens the handle was enclosed in cover-basketry. Included in the plumage decorations (macaw, etc.) were

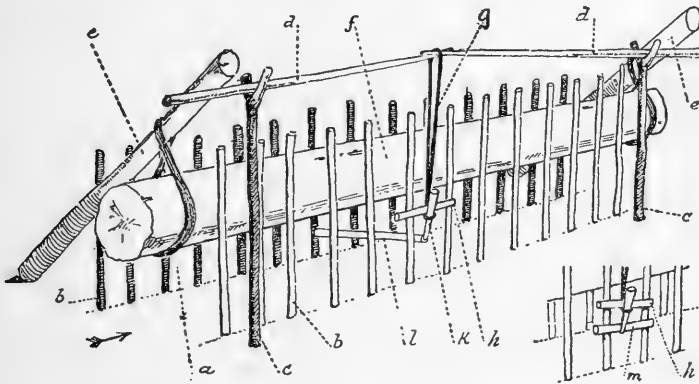

FIGURE 7.—Fall-trap for armadillo, labba, etc., on upper Barima River. (Sec. 161.)
a, track; *bb*, fence of vertical sticks; *cc*, forked staves, supporting the rods *dd*; *ee*, long laths; *f*, comparatively heavy log; *g*, looped string; *h*, crossbar; *k*, trigger; *l*, key pin; *m*, temporary crossbar

the long white feathers of the common barnyard fowl. The Waiwai name for a dancing club is shawaraha.

159. *Page 176, line 12, after 40), add:*

Among the Oyana, Herderschee reports that he saw in a high tree a sort of pigeon house made of palm leaves, and learned * * * that the Indians went to lie in wait there in the early mornings so as to shoot with bow and arrow the birds that alighted in the vicinity. (HER, 140.) De Goeje also saw such shelters made in trees, and once or twice on the solid ground, in the Trio country. (GOE, 16.) Koch-Grünberg also mentions them in the country of the Taulipang, where they are called muku. (KGR, III, 68, 69.)

161. *Add figures with legend:*

Compare this trap (fig. 7) with the armadillo trap of the Guarayú. (NOR, III, 69, fig. *a*.) (Fig. 8.)

163. *At end of section add:*

Kayser gives the following:

Hulk's medical knowledge continually gains more confidence among our fellow travelers [Trio], one of whom consults him for deafness. Two birds' eggs that the patient held in his hand the doctor had already regarded as the honorarium intended for him, but here he made a mistake. When the latter, by way of demonstration, held up his watch to the defective ear, the patient all of a sudden swallowed both eggs, shell and all, not without some difficulty, and at the same time mumbled a few unintelligible words. (KAY, 482.)

167. *Page 183, line 6, after JO), add:*

I have seen these same people use a detachable double-barbed iron-tipped arrow (sec. 143) for such game. The Akawai of the Wena-

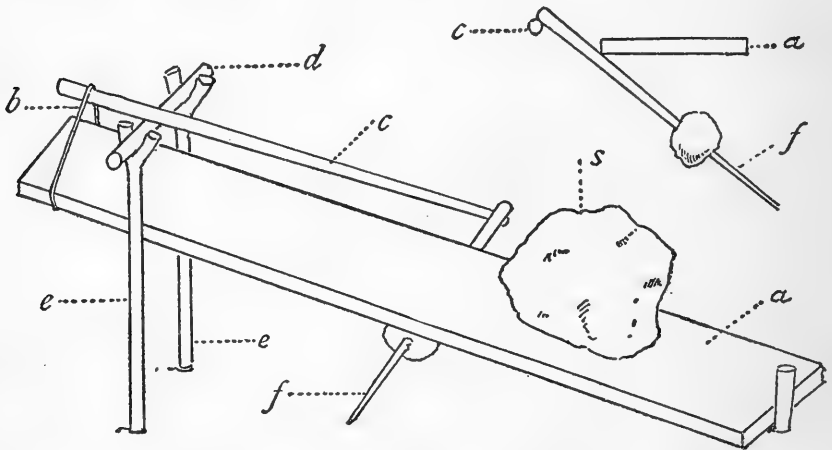

FIGURE 8.—Fall-trap for labba, etc., on the Demerara River. (Sec. 161.) *a*, Heavy plank, weighted with a stone; *b*, loop; *c*, catch stick; *d*, crossbar; *ee*, vertical forks; *f*, bait stick

mu, after sticking the animal in this way, complete the killing with a spatulate-tipped wooden spear (sec. 147).

At end of section add:

of which the legend, describing it as a trap, is somewhat misleading.

168. *At end of section add:*

Neither Melville nor I have ever seen or heard of deer being caught by stretching a net across the runway and setting fire to the grass in front. "The deer run into the net, and are killed by men who are hidden near by." (FAA, 53; FAC, 45.)

One must cut off the snout (or rather, cut out the lachrymal glands) of a stag or deer as soon as it is killed; otherwise it will stink within the next two or three hours, giving off such a nasty stench that it has to be thrown away at once. (BER, ch. XIX.) This is still done. The "hoof" glands are likewise immediately cut out.

170. *At end of section add:*

The Trio shoot couata monkey with poisoned arrows (GOT, 1040); the same is true of the Waiwai. The idea is that the dead beast becomes quite "limp" under the effects of the poison, and does not clutch onto a tree branch.

172. *At end of section add:*

This rat trap is practically identical with the snare for a large rodent from the Cavina (NOR, III, fig. 21, A, B, C) except that the leaf enclosure is replaced by vertical sticks against which the bait is jammed, and the bar is outside instead of inside.

174. *At end of section add:*

Taulipang catch the tapir, after the primitive style, in a deep pit which is dug in the course of its "pad," or else with a slip noose (*male*) made of strong cotton cord or tough Bromelia fiber, so set in its track that it runs into it. (KGR, III, 69.) Mention is made of pit-falls in the Arekuna myths and legends. (KGR, II, 112.) The Taulipang also use fall traps (*Schnell-fallen*) similar to those that have been figured and described from the Rio Negro. (KG, I, 227-228.)

181. *At end of section add:*

See section 176. Parrots are caught in a noose.

188. *At end of section add:*

Hartsinck speaks of cork-wood blossoms being used as bait for cartabak. (HRT, 82.) As often as not, however, the fish concerned may easily be recognized in the water, when of course there will be no necessity for bait, granted that the huntsman is a good arrow-shot. Take the case, for instance, of the *Sudis gigas* Cuv., the fresh-water giant of Guiana, the arapaima of the Makusi. "We gazed in astonishment," says Schomburgk, "at the huge monster that almost filled the whole of the corial, measured perhaps 8 feet and certainly ran up to 200 pounds in weight. * * * It is caught as well with the hook as killed with bow and arrow. In the latter case, its capture is undoubtedly one of the most interesting and liveliest of the fisher's art, for several corials generally take part in it and distribute themselves over the water. As the fish is recognized the signal is given. The corial with the best shots noiselessly makes its way up to within shooting distance, the arrow flies from the string, and both it and the fish disappear. Now they all join in the hunt and the arrow's feathered end hardly appears above the surface again before everybody's bow is on the stretch. The fish is seen and stuck with a new set of arrows, passes out of sight to allow itself to be recognized again within a shorter interval, and so receiving fresh charges at last falls a prey to the hunters. It is now floated to a shallow spot. The corial that has been filled with water and pushed underneath is then bailed out, and the monster brought in triumph to the settlement." (SRR, I, 284.)

190. *At end of section add:*

The following method of chopping practiced along the coast line seems to have been introduced by the Africans, but has been occasionally adopted by Indians: Queriman and other large fish are frequently caught by a single fisherman in the catamaran. This is a board 6 feet long and 10 or 12 inches broad, with a piece of wood 1½ inches thick nailed across it 10 inches from the end. The fisherman

goes in his corial to the edge of the mud flat, just as the falling water, receding from it, leaves it exposed. The catamaran is laid on the mud, and the man places himself on his knees on it with his left hand against the crosspiece to steady himself, and the cutlass in his right hand to chop the fish when he finds it. Looking over the mud flat, he sees the fish left in small pools by the tide, and at once starts off to it, paddling himself with one foot, at the rate of 6 or 8 miles an hour. (?DF.)

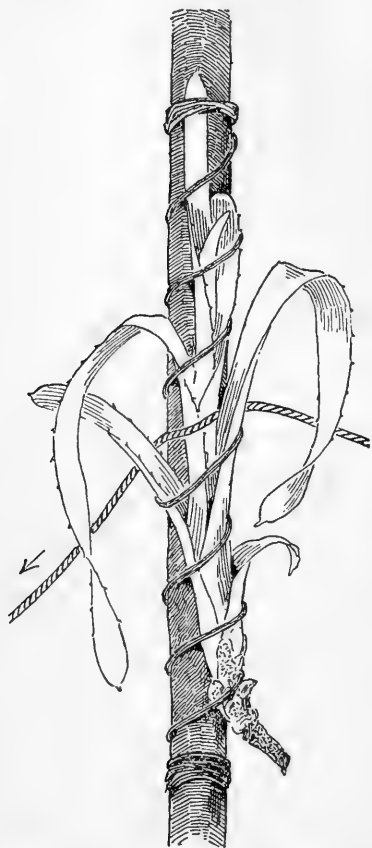

FIGURE 9.—A "warning-bell" arrangement attached to a fishing line. (Sec. 191)

191. *At end of section add:*

To save the labor of watching and waiting until the fish takes the hook, the line is passed in and over the leaves of a certain fibrous plant (that I have so far been unable to identify), just tied holusbolus onto a stick fastened upright into the ground. With a sudden pull a loud swishing sound is produced by the friction of the line over the serrated edges of the leaves. (Fig. 9.) The arrangement takes the place of a warning bell. Used by the Patamona of the upper Potaro.

192. *Page 193, after last line, add:*

cork-wood blossoms for cartabak (HRT, 82), big taparau, arikadaku, and

195. *Page 197, line 1, after 424), add:*

A very neat and easily constructed compound spring trap is that utilized on the upper reaches of the Essequibo by Wapishana, Taruma, and Waiwai, where the key pin in the form of a wooden pencil 5 or 6 inches long acts as its own trigger. (Fig. 10.) The slightest pull on

the hook releases the key pin, which in turn loosens the thread that holds down the rod.

At end of section add:

This, however, is probably a development of a natural form, because I saw Wapishana with such a trap for haimara on the Kuyuwini, utilizing for a rod the bent-over slender stem of a bush growing alongside the river bank, and for a block to which to attach the lock, an old stump projecting about a foot above the water. The lock was none other than an 8 or 10 inch long piece of branch, fairly thick, cut away from the tree with a projecting offshoot, the stump of which now acted as the leg of the inverted L.

200. *Line 11, after door, add:*

In the upper Demerara River, among the Akawai, Bovianders, and others, the spring basket likewise has a movable door (fig. 11) attached by a string to the handle, the length of the string being such as to allow of its having plenty of play; the bait cord is fixed direct to the

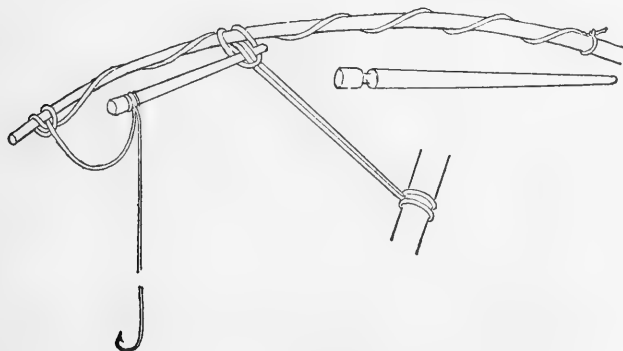

FIGURE 10.—Spring trap for haimara, etc.

key pin which keeps the trigger in position up against a split vine loop that replaces the square frame. The pull on the bait releases the trigger which thus frees the key pin, the bent handle shoots upward, pulling with it the string (now taut) tied to the door, and the latter remains tightly closed. The basket is made of split strips from the paré palm (one that grows to a height of 12 or 15 feet and becomes hollow with age); these are kept in position with split vine around a curved and strong but pliable handle reaching to the opening of the basket. The lid or door is made of a series of parallel strips tied to a circular frame.

209. *At end of section add:*

Other unidentified poison plants are:

Inyak (Wap.). A smooth-barked savanna tree, mostly on sandy rises, with a short (1½-inch) smooth brittle leaf. Pounded when green (it does not go into a pulp), it is stuffed into a basket and the

basket swished in the water. For smooth shallow pools, slow action, taking about 2 hours before showing effects. The small fish come to the surface and are caught, the large ones becoming sluggish, but the effects are only temporary.

Kowari (Wap.). Leaf, as well as the fruit, are used in similar fashion.

Puraunun (Wap.). An agave, the bulbs of which are reduced to pulp in a mortar, and then used in small pools.

210. *After line 3 add:*

as ai-shal to the Wapishana.

211. *Line 4, after kunalli, add:*

The Wapishana name is kunana.

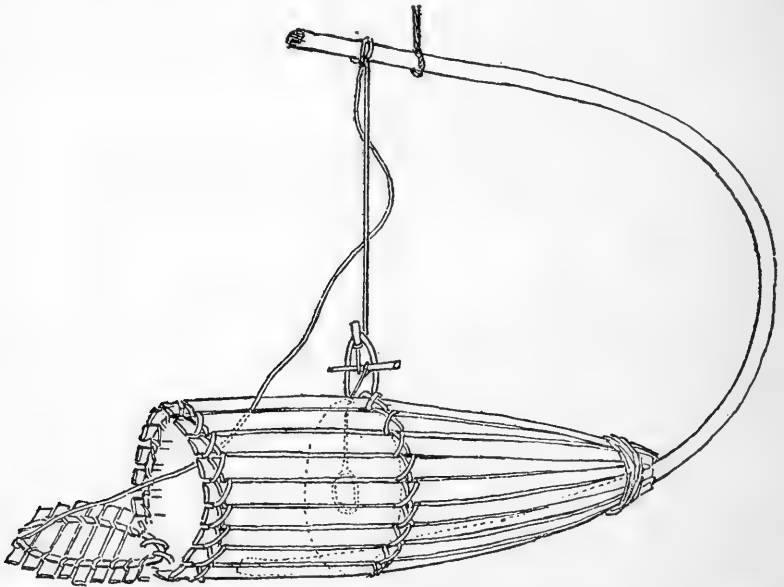

FIGURE 11.—Spring-basket fish trap with movable door, from the upper Demerara River.
(Sec. 200)

216. *At end of section add:*

On the Tapanahoni iguana eggs were searched for in the sandy places by (negroes and) Oyana as follows: They drive a pointed stick into the sand until they find a place that is looser and thus presumably a passage dug by the iguanas. If now the nest with eggs happens to be in the vicinity of such a spot, and the stick be driven in the sand there, one will most probably, if eggs be present, knock into one of them, and that is recognizable at once on the lower end of the stick through the viscous yellow musk of the yolk that gets stuck on it. The exact spot is then found, the sand is cleared away with the hands, and the eggs quickly come to light. (HER, I, 921.)

220. *At end of section add:*

There is a box trap for catching crab on the Pomeroon, where I first saw it, which was certainly originally introduced into the colony by Africans, though it is now often set by Indians. (Fig. 12.) The cover, which works on a pivot far behind and is weighted with a heavy stone, is held up by a cord passing over the back wall of the box onto the projecting key pin, under which it is held by a small crosspiece or loop at its extremity. Inside the apparatus is the key pin onto which the bait, a lump of meat, etc., is tied. When the crab steps in and pulls at the bait, it drags with it the key pin, the crosspiece or loop outside loses its support, the cord is released, and the lid falls.

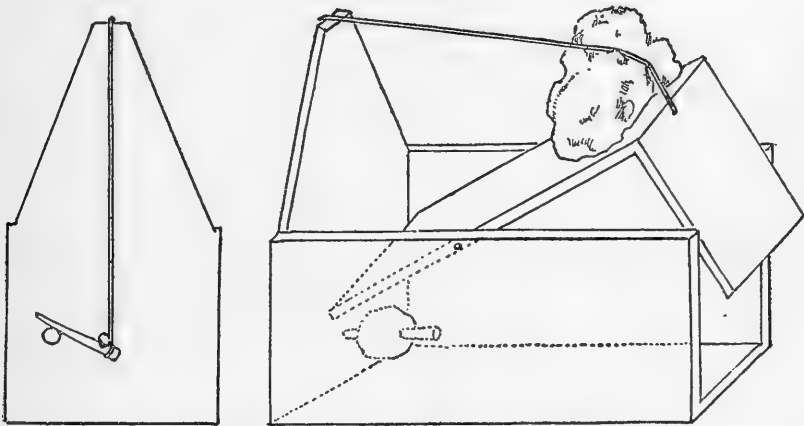

FIGURE 12.—Box trap for catching crab. (Sec. 220)

221. *At end of section add:*

Various other species of fresh-water mussel are eaten, known collectively as mo-kót (Wap.) or puä-puä (Mak.).

225. *At end of page 211 add:*

Among the Oyana Herderschee speaks of seeing a whole scaffolding of wood above an ant's nest, presumably to catch the flying kind, which are regarded as a delicacy. (HER, I, 903.)

226. *Line 4, after 104, add:*

When a black (stinging) bee's nest is found, and the tree felled, one Indian cuts open the hollow while a couple of others keep on beating the opening formed with a bundle of palm leaves; the Trio call these stinging bees mato-oeani (=fire-honey). (HER, I, 955.) Of the nonstinging brown variety, the same people eat the larvae with relish. Their honey is an almost colorless thin-flowing liquid of a very choice fragrance. (HER, I, 935.) There are other nonstinging black bees, but their honey is not so tasty. (HER, I, 952.)

236. *At end of section add:*

With the Makusi, and occasionally among the Wapishana, cassava may be mixed with red potato, giving the bread a light reddish-purple color.

Line 13, after grid, add or ground dish. (NC, 47.)

244. *After line 14 add:*

"Breads" are also made from maize meal with a little sugar. These are wrapped in leaves and set on the fire in a pot full of water to cook. The name canti or makinde is given to them. (HRT, 60.)

246. *At end of section add:*

Colocasia esculenta. Tannier.

247. *After Caria seeds add:*

Caria palm = sea coconut of the Creoles (ScO, 48) = *Astrocaryum murumura* Mart. = Muro-muro of the Caribs. (ScO, 204.)

Passion fruit (run wild) = kakaruma (Mak.), dadamal (Wap.).

Bauwau, makkamkari ("whitey"), turár (tonka bean) karalidwa, ilim, etc., are fruits eaten by Wapishana.

253. *At end of section add:*

In Surinam De Goeje speaks of a hungry Trio widow eating clay. (GOT, 1049.)

258. *At end of section add:*

Chacola or sjakola of the Oyana (Roucouyenne) is prepared in the same way as the cachiri, but remains standing for one night only after manufacture, while the cachiri undergoes a long fermentation process. (HER, 137.)

261. *At end of section add:*

I have, however, since come to the conclusion that it is more probably the "basha," a stage in the preparation of paiwarri (sec. 257).

262. *Line 11, after drunk, add:*

Omani is the fermented cassava drink of the Trio (GOT, 1088), but no description is given of its manufacture.

274. *At end of section add:*

Among the Oyana, the women serve the food, and take away what is left, out of which they make their meal. Among the Trio De Goeje likewise saw men and women eating together. (GOE, 14.)

275. *At end of section add:*

As to the table manners of the Trio [which practically hold good for Indians everywhere], they all grab with their hands out of one pot. After finishing their repast, however, they carefully wash their hands, in which they use their mouth as a fountain by filling it full of water and then letting it flow slowly over their hands. (KAY, 482.)

285. *At end of section add:*

Rather than smoke tobacco, the bush negroes, for instance, are more fond of making snuff of it. This they do, however, in a peculiar

way. In the tin which they always have by them the tobacco is bruised with a little water, and afterwards squeezed, the juice is caught in the palm of the hand, and then sniffed up. (BAK, 799.)

290. *At end of section add:*

An Indian village in these parts (Tumac-Humac ranges) does not last as a rule longer than from 5 to 10 years. If there is no death or discord causing the residents to disperse, it is nevertheless customary, after some years, to build a new village, sometimes near the old one, sometimes at a considerable distance away. (GOT, 1120.) On the other hand, villages are known that have occupied practically the same area for upward of 80 years at least; e. g., Paripu village, situated between the Barima and Barama Rivers, that was visited by Schomburgk, is still in existence. Indians (Oyana and Trio) frequently designate the village by the name of the head man. (GOT, 1121; HER, 120, 127; HER, I, 897.) Kanaimapu, an Akawai settlement on the upper Demerara River near the Great Falls, is said to have been so named after a head man.

291. *Page 250, line 4, after 368) add:*

A palisade is mentioned among the Auake, on the Uraricuera, etc. (KGR, III, 12.)

292. *At end of section add:*

Among the Oyana the village is abandoned only when the Tamoესji (head man) dies, but not for any other resident. (HER, I, 907.)

294. *At end of section add:*

The triangular banab. of the Taruma, Atorai, and Waiwai, and sometimes of the Wapishana (fig. 13), is somewhat different from what has been observed elsewhere in that the triangular framework is so constructed as to form a more or less rectangular thatch. Having chosen his tree or sapling for the apex post (*a*) the Indian selects two others for the base posts (*b*). If none are convenient he will make forked ones by means of crossed saplings and then jam his base post firmly into position. To get a post into the ground it is tapered off with a knife, stuck in where required, worked backward and forward, jammed in again, and the process repeated until the necessary depth is reached. The base stick or wall plate (*c*) is fixed about $4\frac{1}{2}$ or 5 feet from the ground. Two much longer pieces or side sticks (*d*) are next cut to make the sides of the triangular roof. The one is tied below on the base stick outside of its support, its thinner end being (laid in the fork if present, or) tied with vine rope to the apex post about 10 to 12 feet from the ground. To reach this height and manipulate the tying, the Indian will bind a sapling, etc., to the post at an angle with the ground, and so climb it. The other sidepiece is next raised in place, and similarly tied to the base stick outside of its support. Its upper and thinner extremity rests on the projecting end of its fellow sidepiece, to which it is tied. For

extra strength it may also be tied to the supporting post. The rafters (*e*), of a fairly even length, are now laid on the wall plate and sidepieces parallel with one another. They are looped to the wall plate with vine rope and kept in position by being again looped to a runner (*f*) parallel with the base stick and about 3 feet above it. This crosspiece is invariably looped under the sidepieces, but whether this is done for convenience of tying, I can not say.

The leaves for the thatch (туру, pimpler palm, etc.) are generally collected in threes or fours, placed on top of one another, face downward, and tied together in two or three places with their own pinnules.

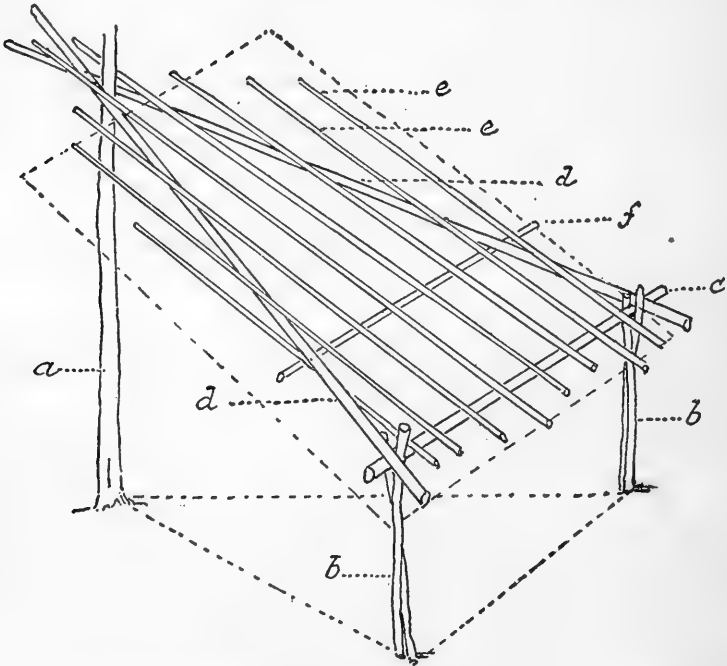

FIGURE 13.—Triangular banab (temporary shelter hut) of the Taruma, Atorai, and Waiwai. (Sec. 294)

They are thus hauled out of the forest and carried (over the Indian's head, shoulder, and back) to where required, and then thrown up over the wall plate to the Indian standing on the apex ready to receive and place them in proper position lengthwise—i. e., at right angles to the wall plate. To prevent them from slipping down again, their proximal ends are tied by their pinnules to the apex post. As the leaves referred to are from 16 to 18 feet long and upward, the thatch is soon completed. But when wild plantain leaves are employed for thatch they are placed horizontally with the wall plate, and set up tilewise until the apex is reached. They are set face downward with tip and base on alternate sides. When one thickness

from bottom to top has been completed a start is made from the wall plate with another layer. There may be three or four of such layers. As a rule, before the horizontal series is commenced, a few leaves are laid lengthwise on the rafters with their faces turned up to insure that any rain that may have leaked through the "tiles" does not fall within the precincts of the structure. The whole thatch, in all cases, is finally kept in position by being pressed down with the weight of two heavy rods lying on top, on either side of the apex post. The following are the Taruma, Waiwai, and Wapishana names for the different parts of this triangular banab:

	Taruma	Waiwai	Wapishana
Apex post.....	Jesada.....	Iretiri.....	Takoraí.
Framing post.....	Dobír.....	Aporowa.....	Toro.
Wall plate.....	Katamma.....	Makwanan.....	Taramír.
Runner.....	Assaga.....	Hereatarino.....	Kawannap.
Sidepiece.....	Chechamba.....	Fanashiri.....	Atámwin.
Rafter.....	Kobir.....	Iwishkon or Kamru..	Kabarimed.

It should be pointed out that the turu and pimpler palm thatched triangular banabs may be used as permanent houses. Herderschee also speaks of five open huts with triangular roofs in an Oyana forest village, but gives no further description. (HER, I, 904.)

295. *At end of section add:*

See Figure 14.

296. *At end of section add:*

Rain shelters may likewise be made for protecting boat cargoes. Thus the boat cover of the Wapishana, Taruma, and Waiwai is made to a length of 6, 8, or 10 feet, or even more, according to the size of vessel it has to shelter. It is kept in position by laying lengthwise on top of it a thin withe or two which is tied



FIGURE 14.—The simplest form of the lean-to banab. (Sec. 295)

down to the boat, or placing some heavy article on it at each extremity. There are two varieties of this boat cover, but both have dallibanna leaves as their essential, these being put on in pairs in both cases. In the one (fig. 15, A) the leaf stalks are placed between two laths or rails, e. g., the midrib of the turu palm, over the lower one and under the upper, over which they are bent and then looped below onto the lower rail by means of a long vine rope. That is how the Wapishana and Taruma make it. In the second variety

(B), made by Taruma and Waiwai, use is made of the large "pimpler palm" leaf, with the pinnules of the one half "broken"—i. e., bent over each preceding one and passed over the midrib, under

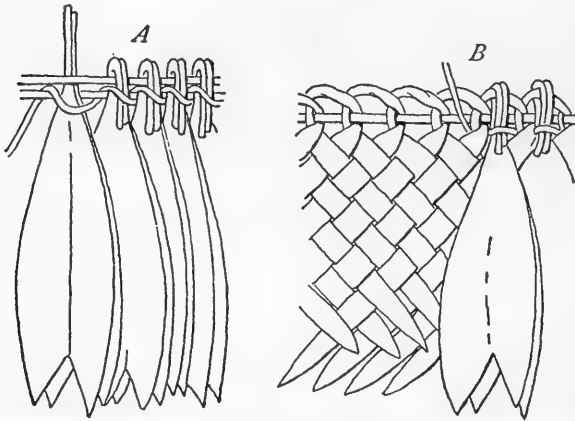

FIGURE 15.—Rain shelters for protecting boat cargoes. (Sec. 296.)
A, Dalibanna leaves on two turu-palm laths (Wapishana, Taruma).
B, Dalibanna leaves on plaited spinous-palm leaves (Taruma, Waiwai)

their corresponding pinnules, where they are plaited into those of the other half. The pinnules that have been broken are twisted so as to have their undersurfaces up. The midrib represents the lower rail of the first variety and the "broken" twisted portions the upper one. And it is on these that the dalibanna leaves are

fixed as before, save that the vine rope, instead of being looped over the midrib, is looped in between the interpinnular spaces just below it.

298. *At end of section add:*

The lean-to (pent-house) type of permanent house was subsequently observed by me among the Taruma of the upper Essequibo, who speak of it as *du-ya*. In one variety of it (fig. 16) there was little to distinguish it from that just mentioned, save that the top ends of the rafters rested on a runner supported by two framing posts and there was no inside staging. The Taruma names are

diwiju (rafters), *do'-bir* (the four framing posts), *dallakakan* (lower wall plate), and *jebedomagi* (upper wall plate). In the other variety (fig. 17) the ground plan formed practically half a hexagon instead of a rectangle. The ends of the rafters were attached to run-

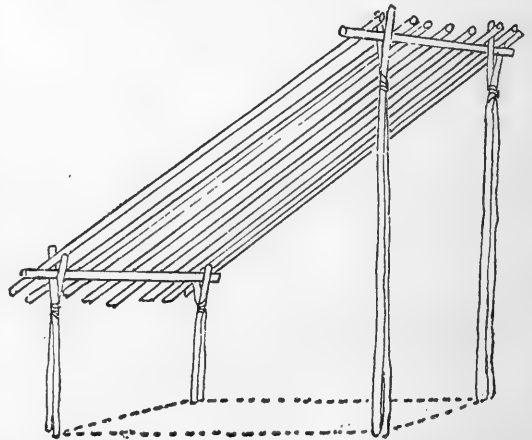

FIGURE 16.—The permanent lean-to (penthouse) of the Taruma, rectangular type. (Sec. 298)

ners resting on a series of vertical sticks. Such structures, which would seem to be likewise made by Waiwai, are practically a compound of three Taruma triangular banabs (sec. 294) and built up on identical lines. The thatch in both varieties was made of dallibanna leaves by themselves, or of dallibanna leaves plaited into pimpler-palm fronds, the same as with the rain shelters for boats. (Fig. 15.)

300. Page 254, last line after B), add:

Waiwai, Parikuta, Maopidian, Oyana, Taruma (up to Coudreau's time).

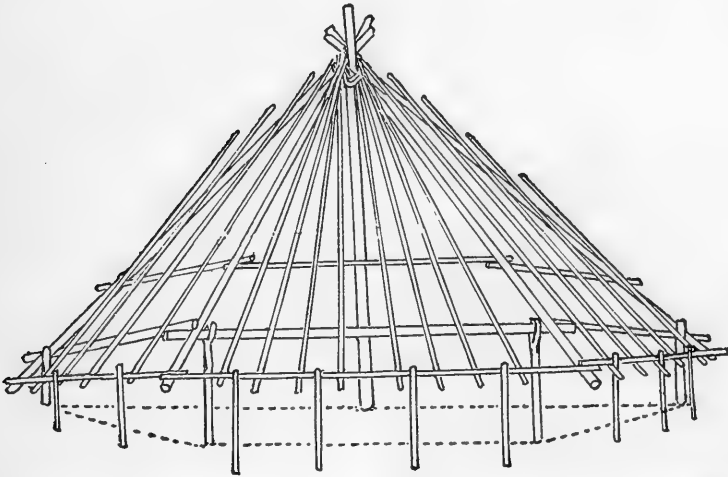

FIGURE 17.—The permanent lean-to (penthouse) of the Taruma and Waiwai. Half-hexagon type. View from back. (Sec. 298)

301. At end of section add:

The circular house of the Waiwai, the mirimö or mirimor, is built in the following order (fig. 18):

1. Main central post, iretiri.
2. Inner four supports, aporowan.
3. Main purlin, makwanan.
4. Primary rafters, kamru.
5. Upper inner purlin, chifrimato.
6. Secondary rafters, kamru.
7. Lower purlin, makwanan.
8. Outside posts or supports, maiyahorowan.
9. Intermediate double purlin, iwishkon-man.
10. Crosspieces, tarai-i.
11. Doors: Front, mitata; back, machá.
12. Double halfway purlin on the outside posts, mahokono.
13. Upper outer purlin, iwishkon.
14. Tertiary rafters, kamru.

The specimen I watched being built (fig. 19) was subsequently thatched with spinous palm leaf.

301 A. As compared with the circular houses already described, those of the Oyana are more dome shaped [than conical, but unfortunately no illustrations or descriptions of their frames are available]. The *monta* or *toekoesjipan* (pl. 3, *a*) at the Oyana village of Intelewa (GOT, 1016) was a large round house with a diameter of about 10 m. and a height of 15 m. The thatch, manufactured from the leaves of the *tas* palm (*Geonoma*), reached to 1.75 m. from the ground. This building, like the Tamoesti's elliptical house, had a story with a floor that was made of palm laths. A

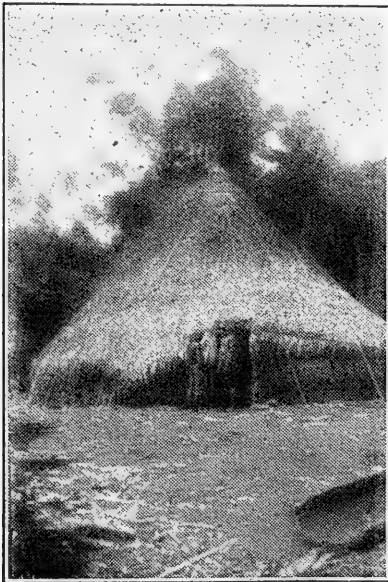

FIGURE 18.—Waiwai circular house. (Sec. 301)

ladder gave access through a meter-square opening to the upper portion. It formed the real sleeping quarters and storeroom of the family, while the open ground-floor portion served as day room. (HER, I, 898.) At Jamaiké village (Oyana) the roof * * * rested on ten posts to which it was fastened by strong vine ropes * * * Each male resident appeared to have his own compartment there, where the articles belonging to him were slung, while in the vicinity of the ridge a neutral compartment was divided off where the dance ornaments that comprised the common property of the village were hung. (HER, 121.) The Trio *timakitti* (pl. 3, *b*) is something like the Oyana *monta*, but no Trio houses have an

upper story. The *maite* of the Oyana is a round hut with roof reaching to the ground, and one door opening. The Trio *moeineu* is something like it, but is larger, and has door openings at opposite ends. (GOE, 12.)

307. *At end of section add:*

At the Oyana village of Intelewa, so named after the headman, the dwelling of the Tamoesti was called *otomane*, was elliptical, about 9 m. long, 5 m. wide, and 5 m. high. (HER, I, 898.) According to Coudreau the *otomane* is the house for guests. De Goeje came across this type of habitation only at Intelewa, he living down below while the Indians slept at night on the upper floor. The *tialetakim* is the same type of building but somewhat smaller. The *itoeta* is the half-elliptical sleeping hut in the provision field, thatched to the

ground (GOE, 12), but the thatch of the Trio half-elliptical tempatalakai does not reach to it. (Fig. 20.)

311. *At end of section add:*

Such rectangular houses are likewise met with among the Trio, Oyana, Waiwai, and others. The tilaka of the Oyana is a simple rectangular hut with roof hanging down low on the two sides and

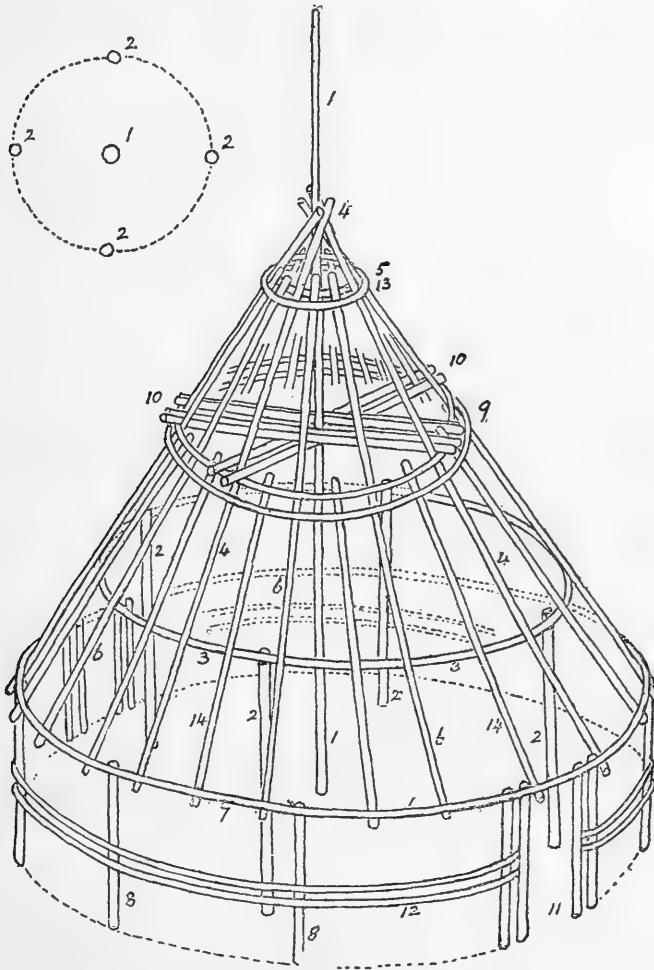

FIGURE 19.—Waiwai circular house, showing progress of construction. (Sec. 301)

open at the ends. (GOT, 1020.) It is apparently identical with the pakolo open hut of the Roucouyenne (HER, 121), where the daily chores are done. The tilaka of the Trio has sometimes a thatch that is continued to the ground. The rectangular two-post permanent house of the Waiwai, shown in diagram in Figure 21, differs from the Arawak type (sec. 311) only in the absence of a runner over the wall

plate and the addition of a support for the ends of the rafters. These latter rest on a runner tied onto the mortised extremities of a series of upstanding sticks. One such building was constructed for my special use by the Waiwai while waiting for me at the Taruma village of Wannawantuk. It was thatched with two rows of turu leaf.

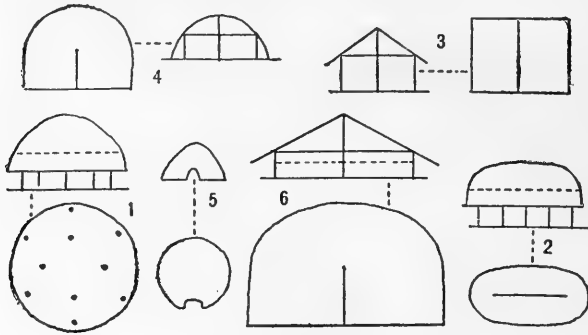

FIGURE 20.—Diagram of Oyana and Trio houses after GOE, Plate IX. (Secs. 301 A, 307.) 1, Monta, O; Timakitti, T. 2, Otomane (larger), Tialetakim (smaller), O. 3, Tilaka, O. 4, Lomonoka, O. 5, Maite, O. 6, Tempatalakai, T. (O=Oyana. T= Trio)

Each leaf before being put in place was prepared by bending the pinnules of one half over, one by one, and backward. When the ridgepole was finally covered along its length with a thickness of leaves their pinnules were kept in place by means of two outside laths which were each sewn in two or three places to the rafters below. A

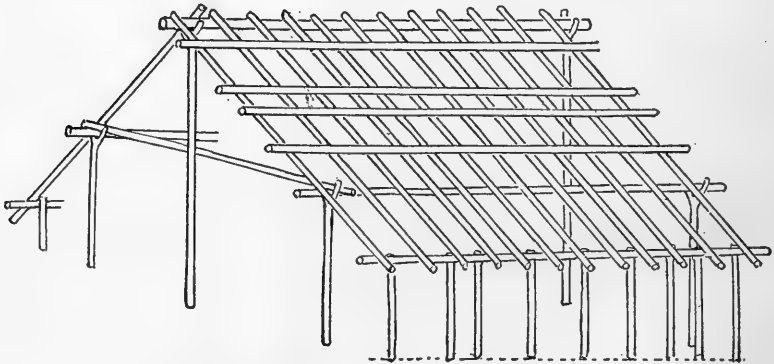

FIGURE 21.—Rectangular house of the Waiwai. (Sec. 311)

huge 3-foot long wooden pen with vine rope attached was pierced through the whole thickness of thatch by one man sitting astride the house ridge, and another standing inside and underneath on some support or other; the loop of vine rope was thus made to enclose outside lath and rafter.

313. *At end of section add:*

The Waiwai names for the components of a corresponding building are: Yakotono (ridgepole), iretiri (main posts), kamru (rafter), makwanan (wall plate), aiyaritechu (tie beam), aforowan (side framing posts), iwishkon (thatch rods), maiyahorowani (vertical sticks supporting the ends of the rafters).

319. *Line 3, after lands, add:* where it alone grows and hence is not met with among the Wapishana (FAA, 18) or other hinterland tribes.

320. *Redrawing of Figure 78, C.*

Figure 78, C (WER, VII), is drawn incorrectly. It is therefore replaced by Fig. 22.

321. *At end of section add:*

The Taruma, Waiwai, Maopidyan, etc., use a mixed thatch of dallibanna and pimpler palm leaves, after the style of the second variety of rain shelter for protecting a ship's cargo described in

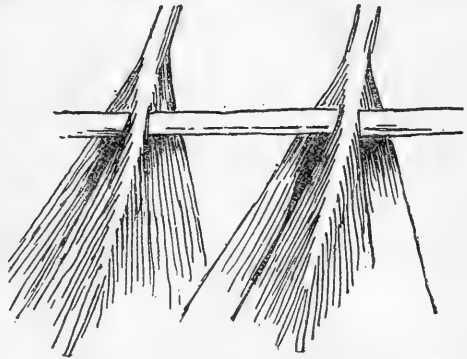

FIGURE 22.—Illustration of mauritia thatch to replace Figure 78, c (WER, VII), drawn incorrectly

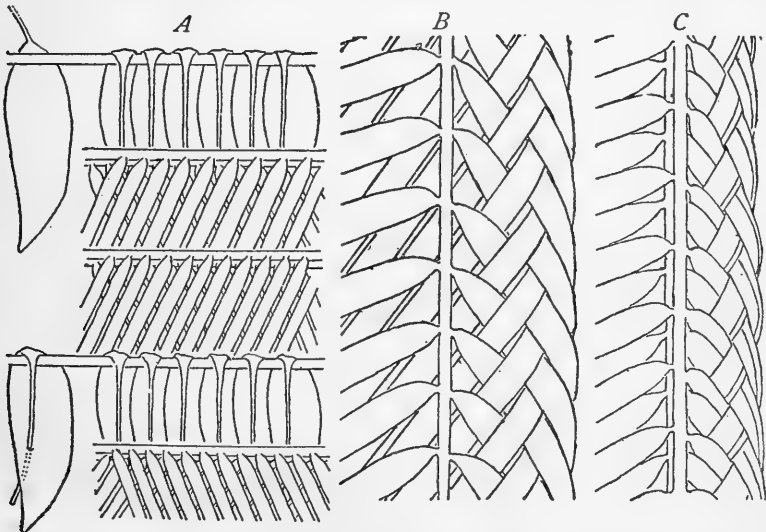

FIGURE 23.—Some methods of using manicol leaf for thatch. (Sec. 323.) A, Manicol and itiriti leaf, Carib, Barima River. B, C, The half-blade of the manicol leaf is plaited into itself with a single or double plait, respectively, Wapishana, Rupununi watershed

section 296 (this volume). The plaited pimpler palm leaves are on the inside. Farabee has a good illustration of such a thatch on a Maopidyan house. (FAA, pl. XXIII.)

323. *Line 8 after leaves add* (fig. 23, A).

At end of section add:

The thatch of certain Wapishana houses toward the head of the Kuyuwini may be of manicol, but is employed in yet a third way. The half blade of each leaf is plaited into itself with a single or double plait up to about three-fourths of its length, when the plait is tied. The plaiting has, of course, commenced at the base of the leaf. Each plaited leaf is fixed vertically, top and bottom, to the laths on the rafters. Starting from right to left, the unplaited half of one leaf is hidden by the plaited half of the one immediately succeeding it. I

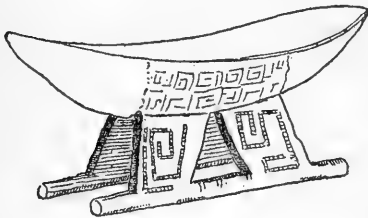

saw this form of thatch, illustrated in Figure 23, B, C, at Wappu (manicol) -Wau (creek) settlement.

324. *At end of section add:*

Also the *Astrocaryum murumura* Mart., one of the pimpler palms used by the Trio (GOT, 103), Taruma, Waiwai, and others.

328. *At end of section add:*

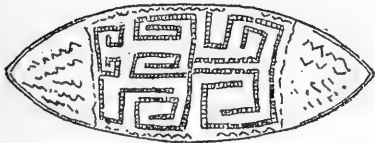

FIGURE 24.—Typical Waiwai bench

The Waiwai type of bench is illustrated in Figure 24. The seat is somewhat concave spindle-shaped, while the supports, wider below than above, are in closer apposition at their fixed than at their free

ends which project in front and behind. The supports have a triangular opening. The whole is covered with black patterns on a red (annatto) foundation. The ends of the seat above and below (like that of the Waiwai paddle blades) are always painted black, which may be in turn decorated with wavy lines, etc., formed with the finger tip before the black paint has set and through which the red pigment shows.

330. *At end of section add:*

The Taulipang also appear to have three-legged stools that with little alteration of their natural growths have been cut out of a root or branch fork. (KGR, III, 79.)

337. *Line 3, for* (one of the Simarukas?), *read:*

(a species of *Aspidosperma*, the paddle wood of the Creoles).

340. *At end of section add:*

It should be noted that the holes for the insertion of the chips are really longitudinal incisions, i. e., longitudinal with the length of the board. A flat piece of iron with a rounded extremity set in a wooden handle wrapped in fiber acts perhaps better than the couata bone for making the cuts. Both iron plug and couata bone are struck with the flat of the piece of cutlass. (Pl. 4.)



a, The Monta or Toekoesipan house of the Oyana. The structure on the right is probably a Maite house. (After Herderschee.) (Secs. 301 A)



b, The Timakitti house of the Trio. (GOT, Pl. XXX.) (Secs. 301 A, 307)

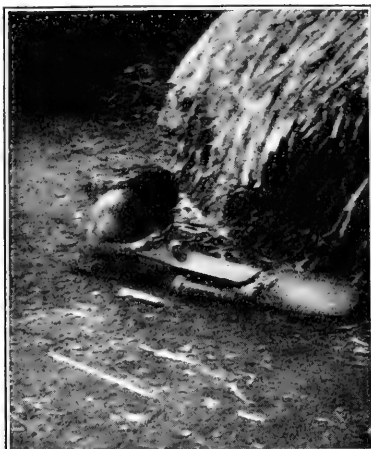

A, Position of the woman when making the stone-chip grater. (Sec. 339)

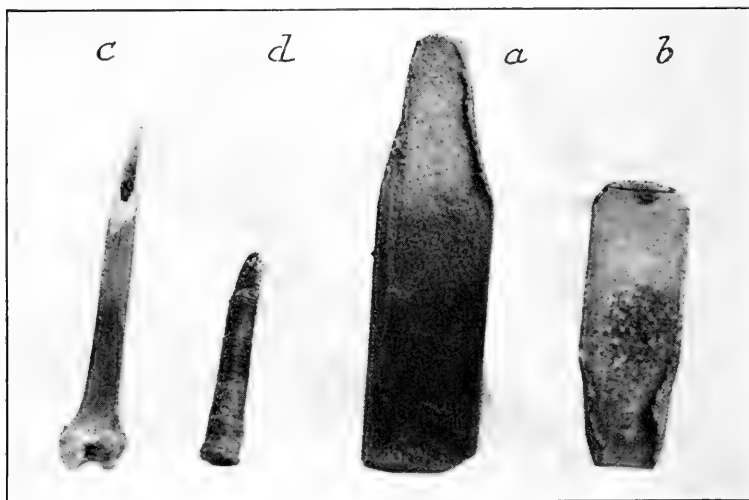

B, Implements used in the manufacture of the stone-chip cassava grater. (Secs. 339, 340.)
a, b, Pieces of cutlass with their edges worn down by the flaking and chipping. *c*, Couteau-bone for making the slot into which the chip is stuck; this may be replaced nowadays with a piece of flat rounded iron

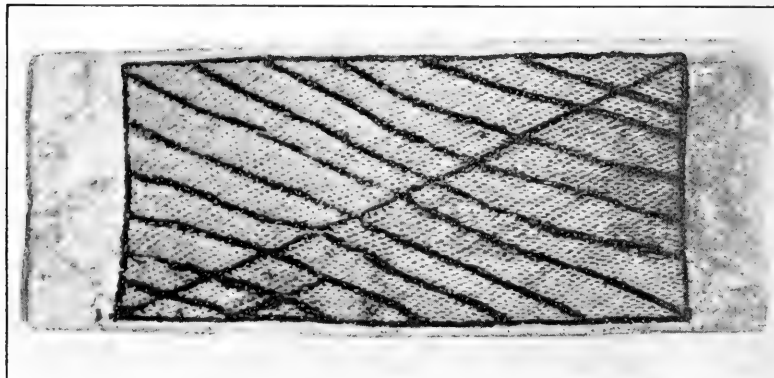

C, Stone-chip grater, showing the diagonal guiding pattern with the inserted chips, prior to being covered with the sap and red paint. (After Farabee.) (Sec. 336)

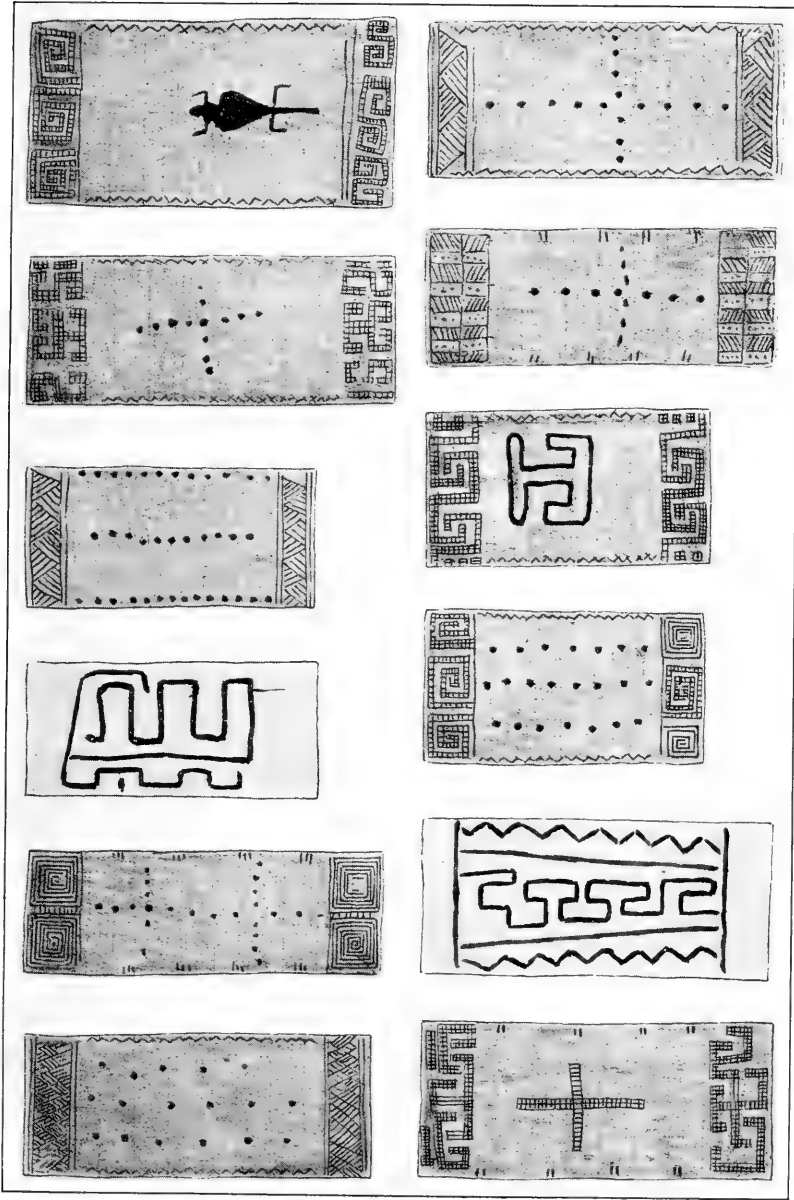

PATTERNS ON THE FRONT AND BACK OF THE WAIWAI GRATERS. (SEC. 341)

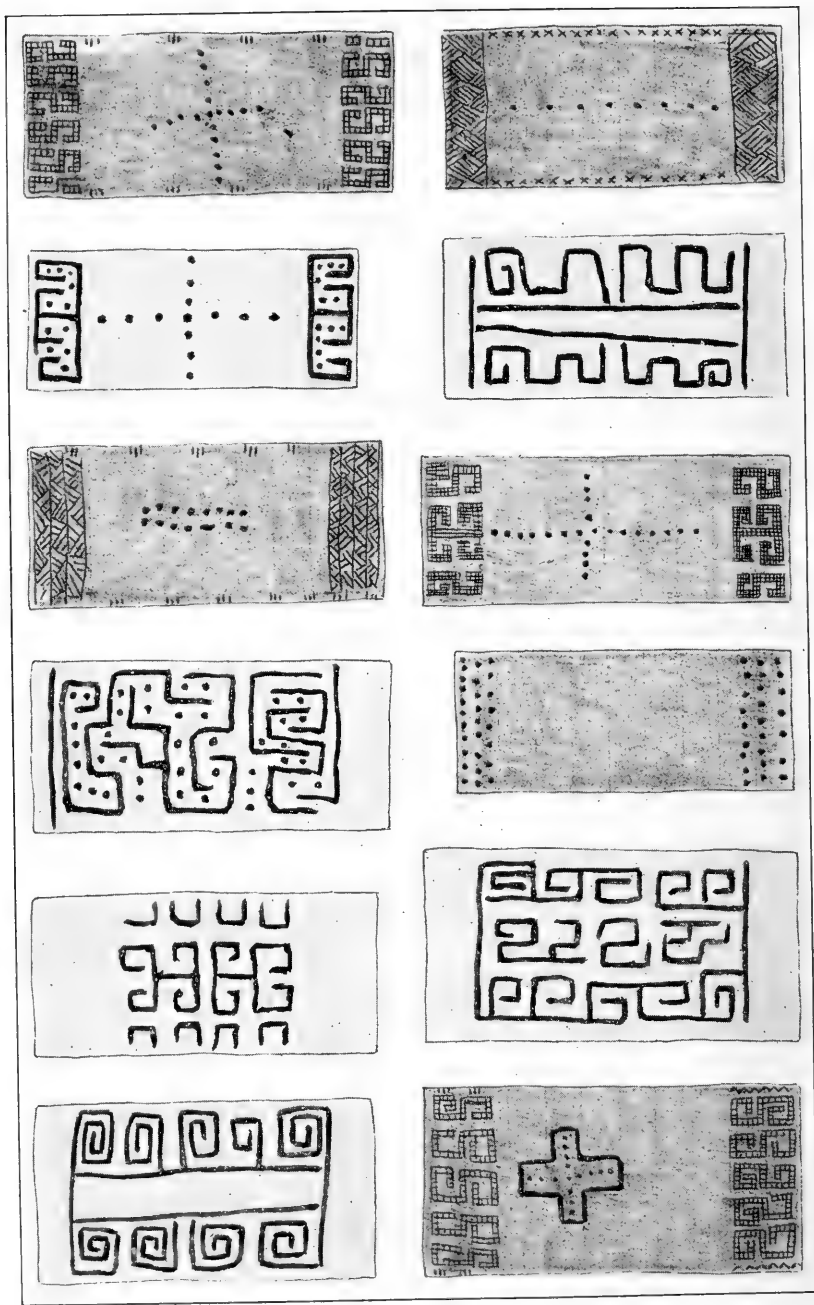

PATTERNS ON THE FRONT AND BACK OF THE WAIWAI GRATERS. (SEC. 341)

341. *At end of section add:*

Some mistakes have crept in here. So far as my own experience goes it was the women alone (certainly among the Waiwai) who poured the mixture over and rubbed it into the board, which thus became entirely covered with a bright, shiny scarlet. The sap that is mixed with the annatto in an earthen bowl is known as karimen (nothing to do with karamanni) to the Wapishana, and asakú to the Waiwai. It is derived from a tree, with a broad leaf and large fruit, the leaf seeming to come off in threes (sec. 23). The black designs put on by the men by means of a stick with a more or less frayed

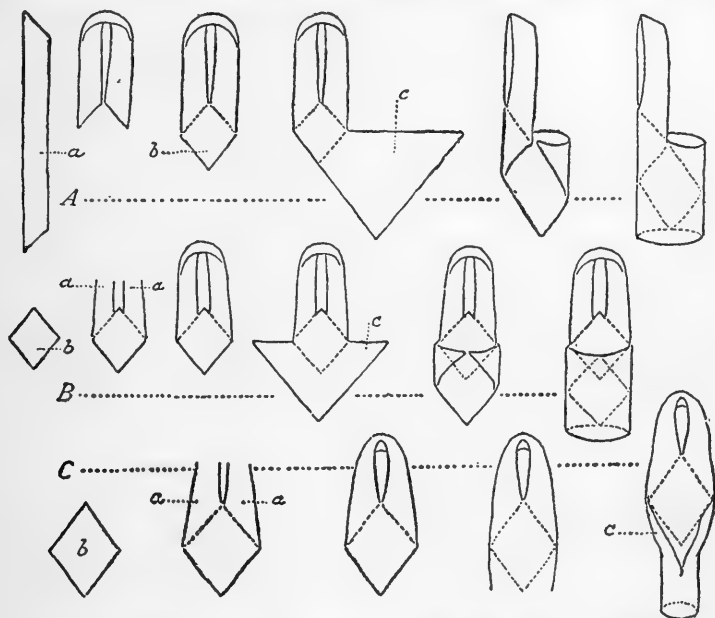

FIGURE 25.—Diagram to show variations in the commencing stages of the manufacture of a cassava squeezer. (Sec. 354 A.) A, Arawak; B, Wapishana; C, Taruma, Waiwai. a, Collar; b, neck; c, shoulder

end may occupy the back, the edges, the free surface of the front, sometimes even that portion on which the chips are secured. Certain of these designs are illustrated in Plates 5 and 6. The black pattern may occasionally be painted on the back before any action is taken in the way of inserting the stone chips on the front. On the front there is a tendency to symmetry in the designs on the two ends, and occasionally there may be a central figure.

343. *Line 5, after waist, add:*

It is only a question of size, comparative convenience, a restful change of position, etc., whether the grater is put to use vertically or horizontally. It is not a case of this tribe using it one way and that another. (FAC, 21.)

345. *Line 4 after Negro. add:*

It is usually made from split itiriti or calathea strands. To manufacture it as one author (FAC, 21) has alleged from the kokerit palm (*Maximiliana regia*) would be a physical impossibility.

At end of section add:

Among the Schiriana at Motomoto the press-tubes of the higher advanced tribes are replaced by small flattened round basket trays that are rolled up and squeezed with both hands so as to press out the contained grated cassava mass. (KGR, III, 308.)

354 A. The Wapishana matapi is manufactured on somewhat simpler and apparently more symmetrical lines than that of the Arawak. The neck (figs. 25, B, b; 26, b) is the first part to be completed, then the two bases of the collar along the lower three-fourths or so of its upper borders, and finally the (shoulder with) shoulder girdle (sec. 350) by means of additional strands along its lower borders. In the example illustrated the collar was made of 22 by 22 strands and the shoulder girdle of 10 additional strands on either side. It is only when the girdle is completed, and the top portion of the cylindrical body firmly set, that an attempt

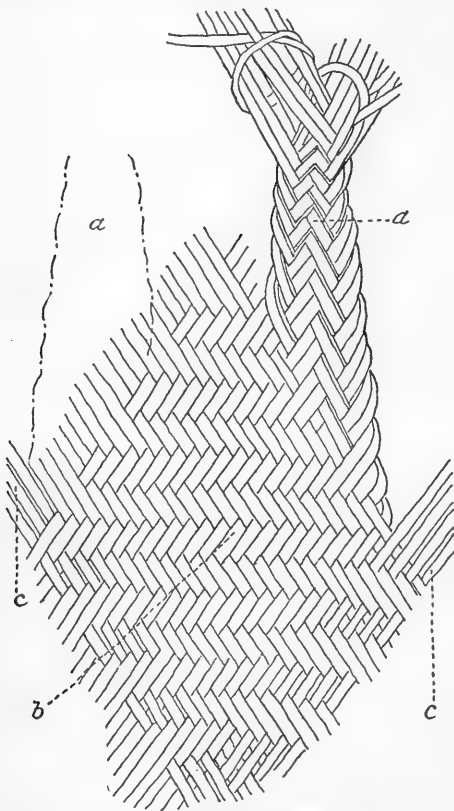

FIGURE 26.—Commencing stage of Wapishana cassava squeezer. (Sec. 354 A)

is made to complete the collar, though this would appear to be left often to the very last. The apex of the neck is "broken" (bent) and turned inward. The strength of the collar (fig. 26) is noticeably assured by being plaited of one composite (i. e., formed of two superposed) strand, passing under and over two similar composite ones. The arch joining the two bases is completed by plaiting the extremities together and finishing off on identical lines as the ankle ring (sec. 354), the four groups of projecting strands being worked off in themselves. On the other hand, the arch may be completed

by plaiting the ends together, direct into one another without any projecting strands having to be dealt with.

The Taruma matapi is likewise differentiated from the Arawak type. The neck (figs. 25, *C*, *b*; 27, *b*) is the first part to be completed, but the whole length of its upper borders goes to form the bases of the collar which is plaited of one composite strand (i. e., one formed of three superposed) passing under and over two similarly composite ones. More than this, there is an absence of shoulder, and so, an absence of additional strands, the width of the neck limiting the circumference of the body. There is also an absence of hip girdle, the pattern of the body proper running direct into the leg.

The Waiwai matapi, in the commencement of collar and neck (fig. 25, *C*), is identical with the Taruma type, and, like it, there is an absence of hip girdle. The collar, however, is finished up in four tassels that are tucked inside out of sight. Its distinctive characteristic is in the pattern of plait (fig. 28) which differs from all the other kinds, and allows of more elasticity on being filled and emptied.

To recapitulate: In the Arawak type of matapi (fig. 25, *A*) a commencement is made with collar, neck, and asymmetrical shoulder successively; in the Wapishana (fig. 25, *B*) it is started with neck, collar, and symmetrical shoulder; in the Taruma and Waiwai (fig. 25, *C*) the sequence of technique is a neck, collar, and absence of any special shoulder, this being replaced by the sides of the enlarged neck, and a difference of plaitwork.

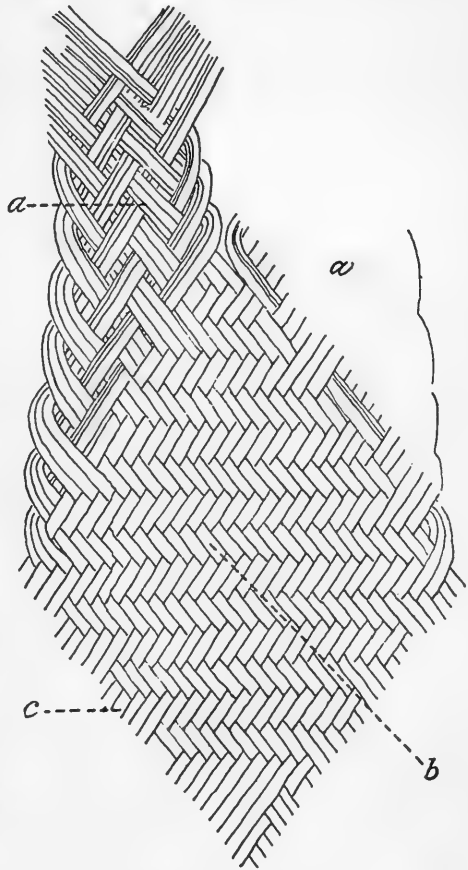

FIGURE 27.—Commencing stage of Taruma cassava squeezer. (Sec. 354 A)

355. *Fourth line from end, after 25). add:*

from Brazil nuts in the manufacture of hair and body oil (sec. 25), from Dalie fruit in the making of candles, etc. (sec. 5).

358. *At end of section add:*

The Wapishana can also plait the central portion in a crossed quadrilateral pattern. (Fig. 29.) The "Austrian cane-seat" pattern referred to above is illustrated in Figure 38, *H* (WER, VII).

359. *At end of section add:*

in the former case, and so the next best thing I can do is to give a copy of his illustration. (Pl. 7.) Fortunately, I have recently seen the Waiwai making theirs.



FIGURE 28.—Commencing stage of Waiwai cassava squeezer. (Sec. 354 A)

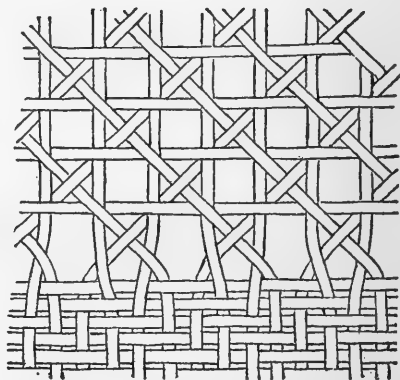

FIGURE 29.—Wapishana farine sifter with a central crossed quadrilateral pattern. (Sec. 358)

The Waiwai and Taruma sifter, also known as *manari* to these people, consists of a sifter proper intimately attached to a circular supporting framework about 6 or 7 inches deep (pl. 8) made of *itiriti*. The body of the sifter proper is divided into four or more squares limited by treble sets of strands varying in arrangement according as the general plait is a two-over-two or a three-over-three one. To insure larger apertures between the meshwork, the strands, before being plaited together, are shaved down for about a third of their length at their centers. On completion of the sifter proper, which is on similar lines with that described in section 357, Figure 87 (WER, VII), three strands (in the larger articles, or two in the smaller ones) are taken up at a time, and, starting from left to right, rolled as one over the rail (fig. 30). The rolling, however, is not a single turn, but



VARIOUS DOMESTIC ARTICLES, MOSTLY FROM THE
OYANA. (AFTER GOE, PL. VIII)

1, Pegall for preserving feathers (sec. 430). 3, Basin-tray made of palm leaf for holding the cotton (sec. 411 A). 7, Pegall for holding comb, mirror, etc. (sec. 430). 8, Twilled pegall, wound round with leaf and decorated with feathers, toucan beaks, etc., from Saluma, Trio (sec. 441)

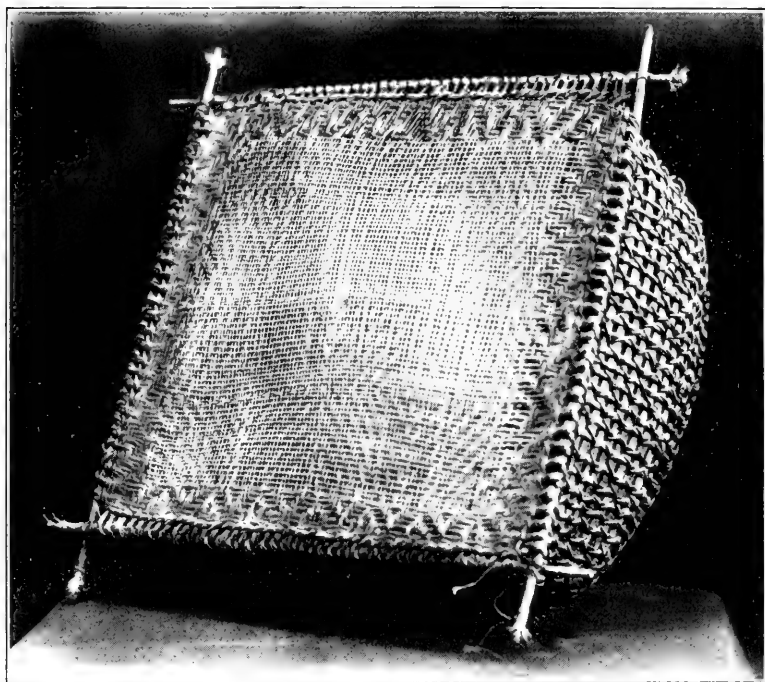

a, Waiwai sifter, from above

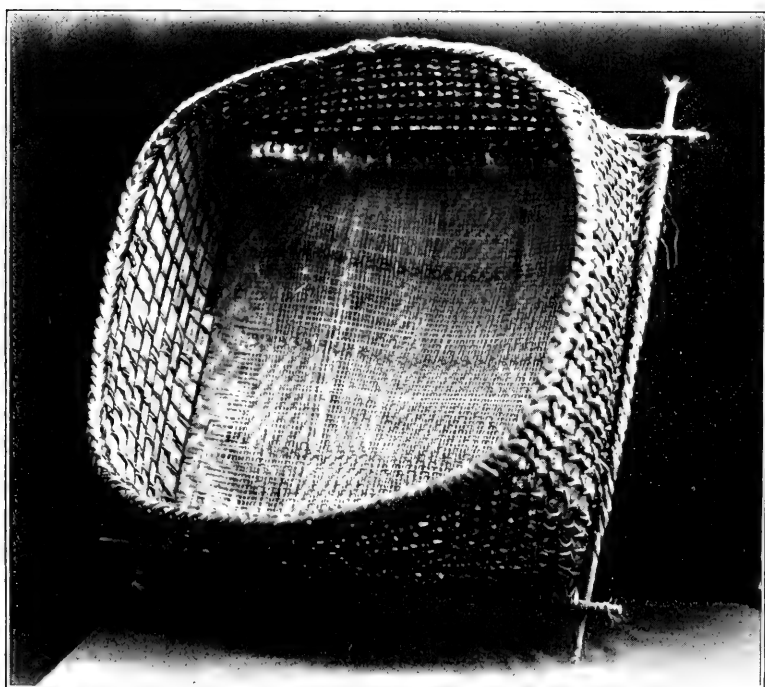

b, Waiwai sifter, from below. (Sec. 359)

a double one, inclosing on the first part of its return journey the fourth and fifth strand triplet, and on its latter part winding around its own base to pass upward behind the rail. This manipulation is carried out on all four sides, all the way round, and the extremities of the rails tied together. Each triplet of strands passing behind the rails constitutes one of the warps of the circular supporting framework (fig. 31). To build this up, the single continuous weft that is now introduced is fixed on the inner side of the series of triplets, derived from the sifter proper, that now constitute warps. On its passage round and round it is locked onto each warp with a vine-ropé strand, an example of intricate weaving. When the circular supporting frame has reached the depth required, the warps are finished off in an edging on lines similar to those followed on the rails.

364. *Line 9, after 350). add:*

According to an illustration furnished by Farabee (FAA, pl. XIX) the Maopidians still use similar clay cylinders.

376. *At end of section add:*

The description of the manufacture of the Akawai fan was given me by the Arawak medicine man Bariki, the Dr. "Knows-all," of whom mention has already been made. (WER, VI, p. 343.) Until quite recently I have never had the opportunity of confirming it, and now find that this gentleman must have worked it out "on his own." As a matter of fact the proper orthodox Akawai method is to start the manufacture with a central square and so build outward.

378. *At end of section add:*

The illustrations Figure 337, *E, F* (WER, VII), are really types of stirring paddle among the Oyana and Trio. (GOE, 14.) An example of the decoration of the former is shown in GOE, pl. XI, fig. 20.

380. *At end of section add:*

Unfortunately there is no description given of the portable wooden mortar said to come from the Waiwai (FAC, pl. XXXVII), of which a copy is given in Plate 9, *a*. I came across a portable one, neither constricted nor decorated, in a Taruma camp.

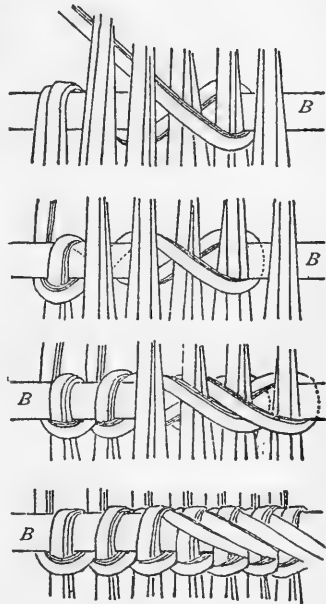

FIGURE 30.—Diagram of manufacture of the Waiwai sifter. (Sec. 359.) To show how the strands from the sifter proper are rolled around the rail (*B*) before they act as warps for the circular supporting framework

383. *At end of section add:*

In connection with the sugar mill of Brett's day, mentioned above, it is interesting to note that so late as 1920 in a Carib village at the head of Yakibiari Creek, on the right bank of the upper Barama, I came across a roller press for squeezing sugar cane, apparently of mixed African and Indian origin. (Fig. 32.) It was formed of two sturdy upright posts (*a, a*) about 6 feet high, each with a longitudinal

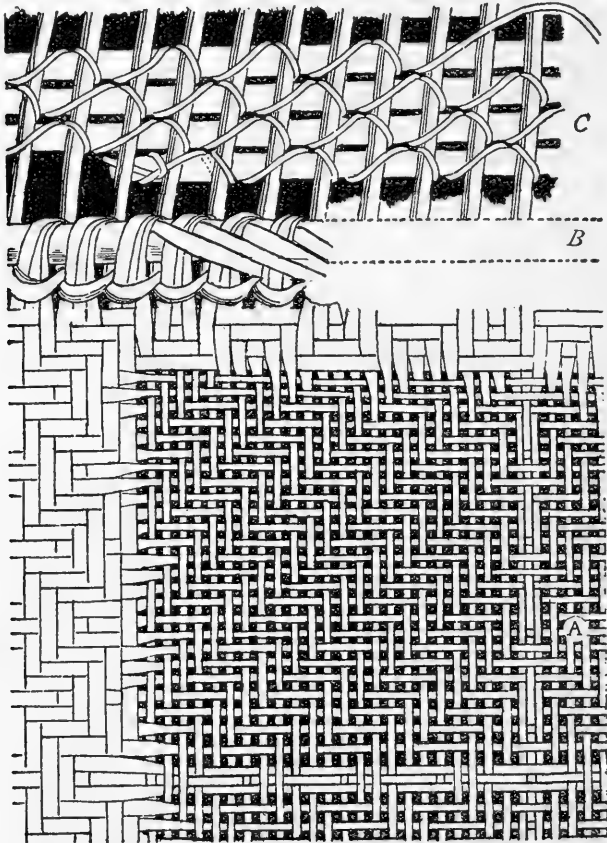

FIGURE 31.—Diagram of manufacture of the Waiwai sifter. (Sec. 359.)

A, The sifter proper, the projecting strands of which are wound over the rail *B* to form the circular supporting framework *C*

slit in which the two rollers (*b, b*) rested, one above the other. Each roller, some feet long, was provided with a round neck, a flattened enlarged head, and a round tail. The neck and tail, which were abruptly demarcated from the body, constituted the axis around which the roller turned. The rollers were fixed in opposite directions, the necessary pressure on the head and tail being obtained by means of two long saplings (*c, c*) fixed behind under the spur of a big tree stump, in front of two vertical sticks firmly planted in the ground.

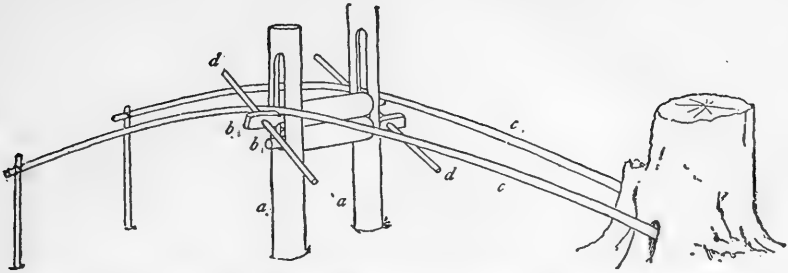

FIGURE 32.—Roller press for squeezing sugar cane, upper Barama River. (Sec. 383.) *a, a*, Upright posts with slits in which to rest the two rollers *b, b*. These are pressed together by the saplings *c, c*, and turned in opposite directions by the handles *d, d*

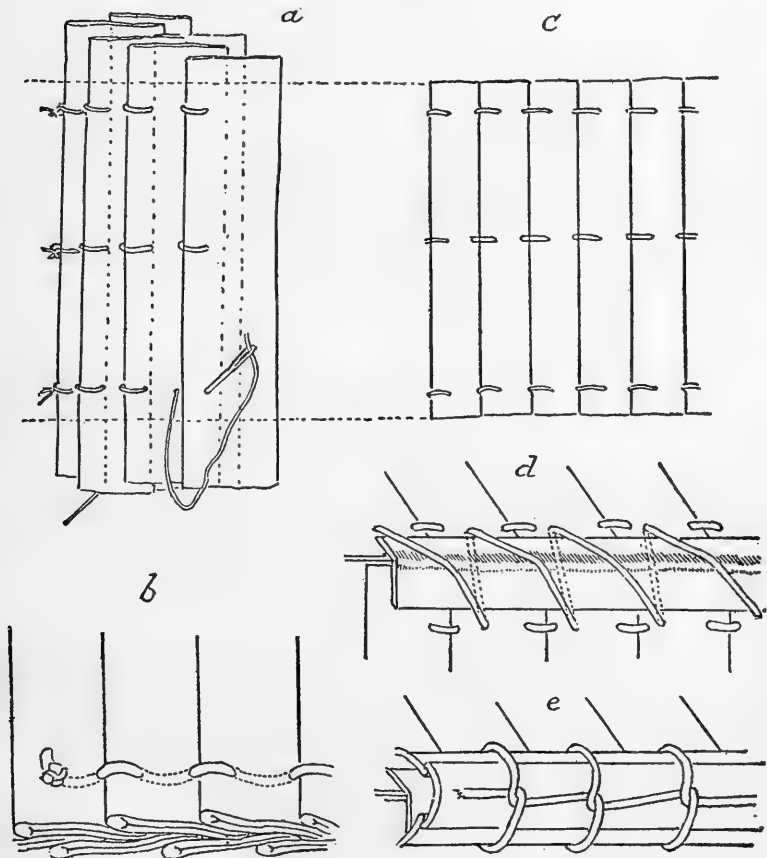

FIGURE 33.—Manufacture of the kokerit leaf strip box. (Sec. 386)

To feed the machine, handles (*d*, *d*) were inserted through a hole bored in each head, and turned in opposite directions.

386. *At end of section add:*

These Waiwai boxes are made from strips of the kokerit leaf. (Pl. 9, *b*.) The following description is of one that I saw made from start to finish (fig. 33): The folded pinnules are cut off into fairly equal lengths, dependent upon the width of the box, and sewn onto each other side by side by means of three threads of korowa fiber,

one at each end and one at the center, each strip being threaded in its three places before its successor is put in place (*a*). More than this, the component strips are placed in such close apposition that each needle passes through three at a time, and great care is taken that the threading is in as straight a line as possible (*b*). When a sufficient length has been completed, the uneven sides are trimmed into shape and the cover of the box finished (*c*). The sidepiece is next completed on similar lines, but only with two threads, a top and bottom, to a length corresponding with the circumference of the cover to which, after trimming, its upper edge is roughly sewn. This sewing is not direct, but over a half strip of kokerit pinnule, folded along its length, and so enclosing and hiding the free edges of cover and side (*d*).

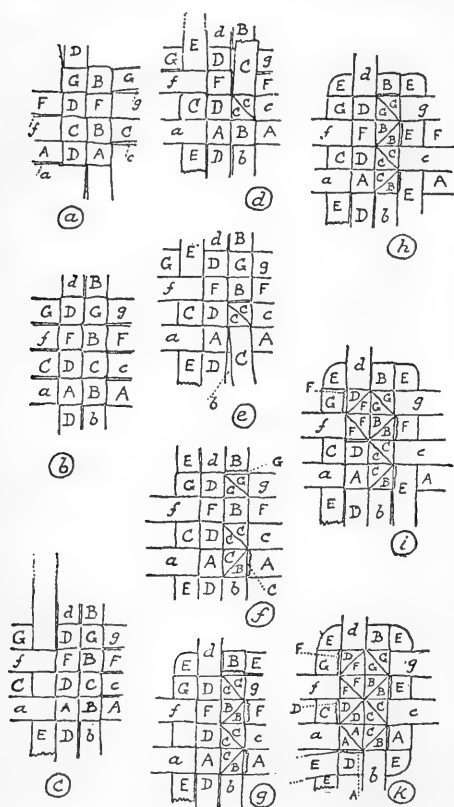
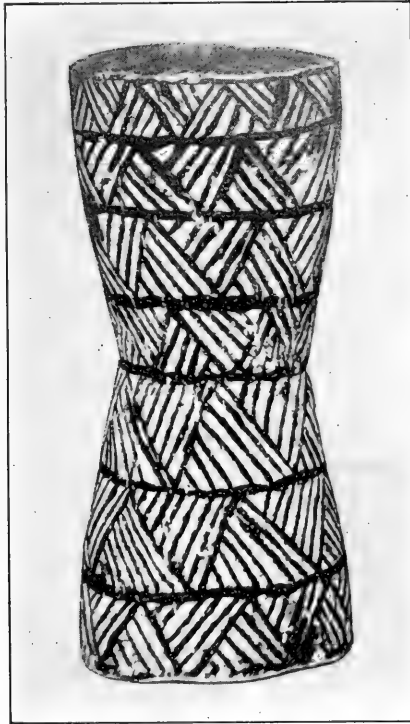
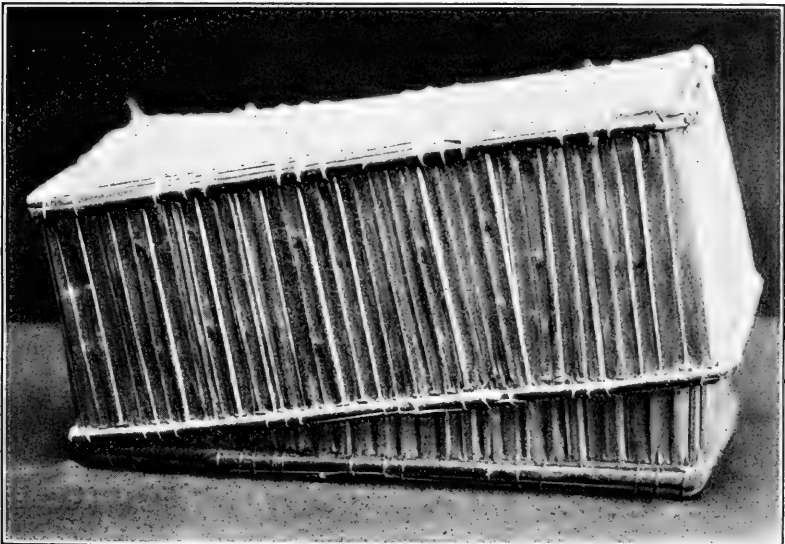

FIGURE 34.—Manufacture of the kokerit leaf plaited box, with "two stars." (Sec. 387)

The sewing itself is a form of overcasting, one unit of the cover being threaded with one unit from the side in regular sequence. On completion of this process, i. e., on the junction of the edge of the sidepiece with that of the cover, the folded strip of kokerit leaf is in its turn covered with three long slips of cane that are kept in position by a string of simple loops, a little distance apart, all round the circumference (*e*). Such loops at the same time inclose a single turu slip on the inside. The free edges of the cover are protected with three cane slips as before, but without any folded leaf strip. For increased



a, Portable wooden mortar said to come from the Waiwai. (After Farabee.) (Sec. 380)



b, Box made from strips of kokerit leaf. (Sec. 386)

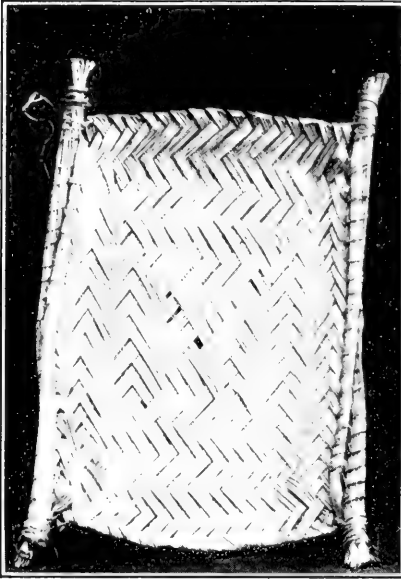

a, Wapishana pimpler-palm mat, having the rails on opposite sides, tied with fiber. (Sec. 396)

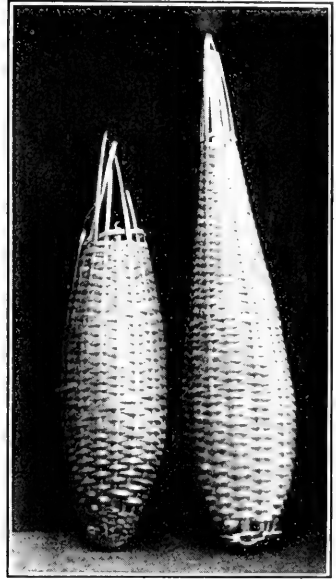

b, Pepper carriers of the Waiwai and Taruma. (Sec. 416)

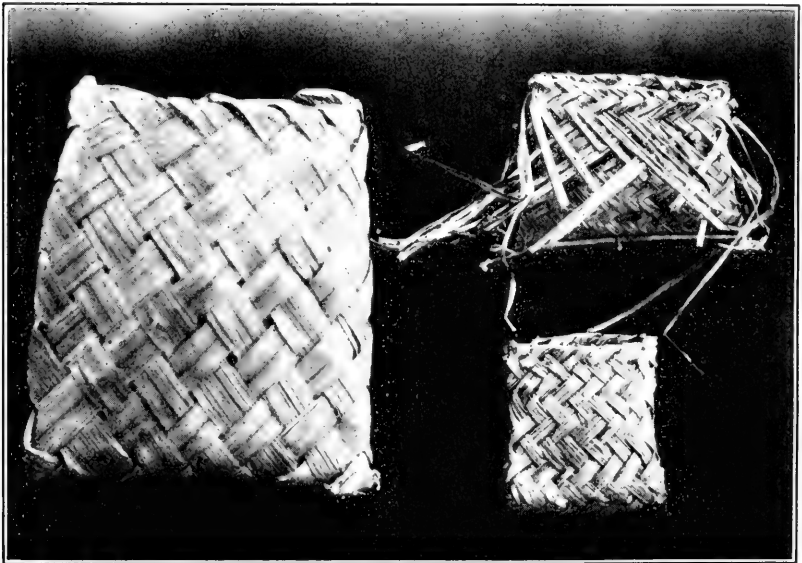

c, Mat satchels of the Taruma and Waiwai. (Sec. 400)

strength, instead of a single half strip of pinnule along edge of cover and side, there may be two of them, one overlying the other. The body proper of the box is next made on exactly identical lines.

387. *At end of section add:*

Such kokerit, etc., leaf-boxes, instead of being made of one "star" can also be manufactured of two or four. (Pl. 84, C, WER, VII.) The construction of the former is as follows (fig. 34):

- a. Double six strands upon themselves as in attached figure.
- b. Fold *A* over *D*; fold *B* over *A*; fold *C* over *B*; fold *F* under *B*; fold *G* over *B* through loop of *F*, over *C*, and through loop of *A*.
- c. Introduce a new strip *E* (to form the side walls of the basket ultimately) under *f* and *a*, but over *G* and *C*.
- d. Fold *C* over *E* and under *D*; as it emerges, bend down at a right angle to form a triangle.
- e. Fold *C* backward and downward on itself and pull the free end between itself and *B* until the folding crease reaches the upper angle of the triangular fold *C*.
- f. Bend the free end upward at a right angle to the left; double it back under *B* and cut it as it emerges. Fold *G* over *E* and under *D*; bend it down at right angles, tuck the free end back again under *G* and cut it as it emerges.
- g. Bend *E* round the corner and pass it under *d* and over *B*. Fold *B* downward, pass it under *G*, and as it emerges on *B*, bend it at right angles to the left, pass it back again to the right under *B*, and cut it as it emerges.
- h. Curl *E* round again at second corner; pass it under *g* and *c*, but over *F* and *A*.
- i. Fold *F* over *E* and under *BB*, and as it emerges on *F*, bend it upward into a right angle, pass it downward between *F* and *D*. Fold *F* downward and backward on itself under *F* and pull the free end up onto *D* until the folding crease reaches the level of the lower angle of the triangle *F*. Turn it up at right angles to the right, pass it back to the left under *D*, and cut it as it emerges on *G*.
- k. Fold *A* over *E*, pass under *CB* and as it emerges fold into a right angle upward, and pass it down again between *D* and *A*, cutting it as it emerges. Curl *E* round the third corner under *b* and over *D*. Fold *D* forward and pass its free end upward behind the cut end of *A*, and after emerging on *D*, turn it at right angles to the right, tuck back again under *D*, and cut it as it emerges on *C*. The article is now turned over, and the remaining strips *f*, *a*, *c*, *g* bent over the strip *E* (which has been manipulated to stand up in proper position), passed under the first available strip and cut as they emerge.

l. In the case of the four-star boxes, a commencement is apparently made with the doubling of eight strips on themselves as in attached sketch, but I have never seen one in the course of manufacture.

393. *At end of section add:*

These may be what Van Sack had in mind when speaking of the large floor mats in a Surinam Arawak house; they were plaited in the same manner as the packall baskets. (SAC, 90.) Elsewhere in Surinam the Oyana and Trio had square floor mats made from the komboe (*Oenocarpus*) palm. (GOE, 20.)

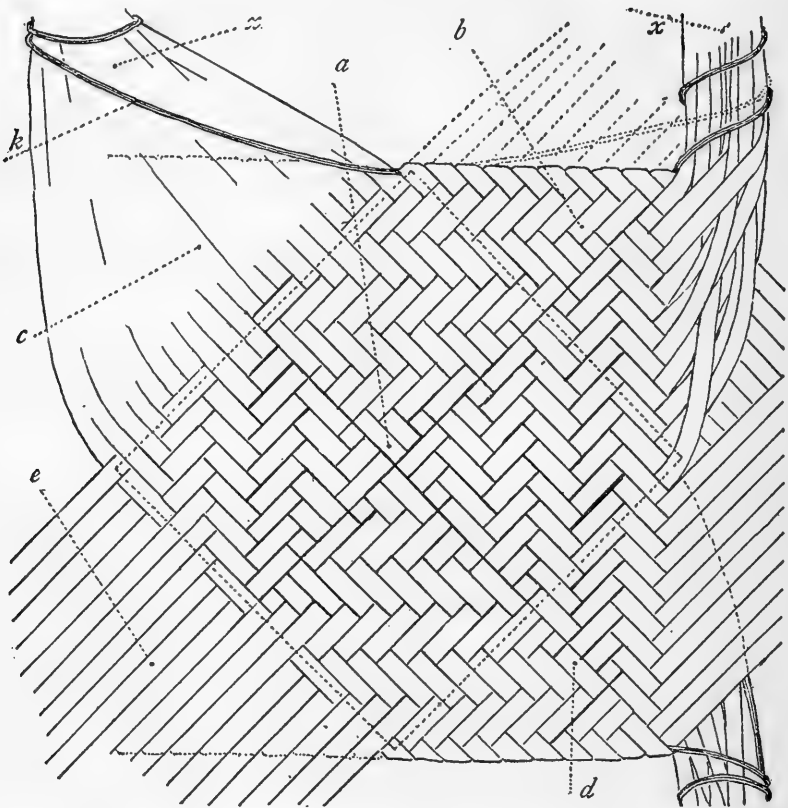

FIGURE 35.—Manufacture of the mat illustrated in Plate 10, *a*. (Sec. 396)

395. *Line 5, after pattern, add:*

Checker floor mats for the babies to lie and roll on were observed in some of the Wapishana houses. They were said to have been made from the wild plantain leaf.

396. *At end of section add:*

The manufacture of a Wapishana pimpler-palm mat (pl. 10, *a*) having the rails tied with fiber may be described as follows: With the divided pinnules of an as yet unopened leaf of the pimpler palm (*Wap. wiréssi*) make a diamond on an hourglass foundation (sec. 433), taking in this case 20 by 20 strands for the purpose (fig. 35, *a*). Tie the upper projecting strands into their respective bundles (*x*)

loosely by means of a connecting cord *k*, and over this cord "break" (bend) and plait the right-hand strands so as to form the top right-hand corner (*b*). Turn the article over, and in a similar manner complete the left-hand corner (*c*); and, lastly, the two lower ones (*d*, *e*). The right half of the mat so far completed is shown in the figure where it will be noticed how the projecting strands run in two layers, a front and back, the former directed up, the latter down.

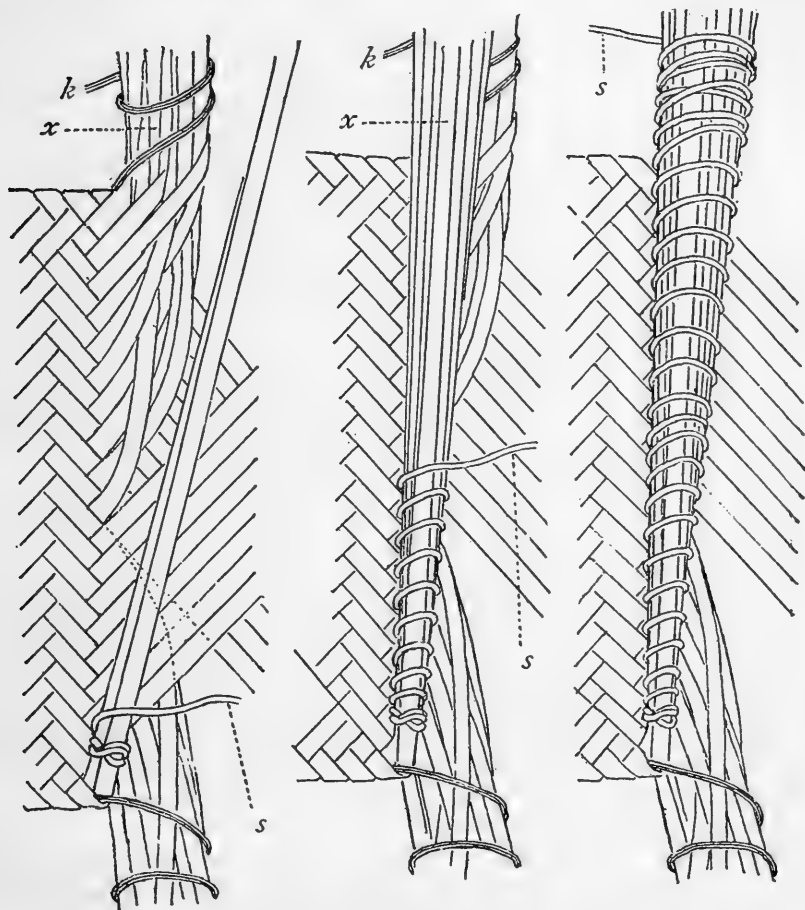

FIGURE 36.—Manufacture of the mat illustrated in Plate 10, *a*, continued. (Sec. 396)

Starting with the two lowermost projecting front strands, tie them together with a specially strong cord, bark strip, etc. (Fig. 36, *s*.) Continue winding this cord, taking care at each turn to pick up another and another strand, and when halfway undo the connecting string, pick up strand by strand again, and tie tightly. Do not, however, lose sight of the connecting string but fix it taut now because it helps to strengthen and render stable the top edge of the mat.

Turning the article over, a similar tapering bundle is now made of the back layer of projecting strands. The left-hand edge of the mat is completed on identical lines.

400. *At end of section add:*

The Taruma and Waiwai mat satchels (pl. 10, *c*) are made of pimpler-palm pinnules. The latter are used whole with a one-over-one (checker) plait in the larger articles, but are split and plaited with a two-over-two plait in the smaller ones. In the smaller satchels (fig. 37, *a, b, c*) the base is more or less lozenge shaped, and, to prevent

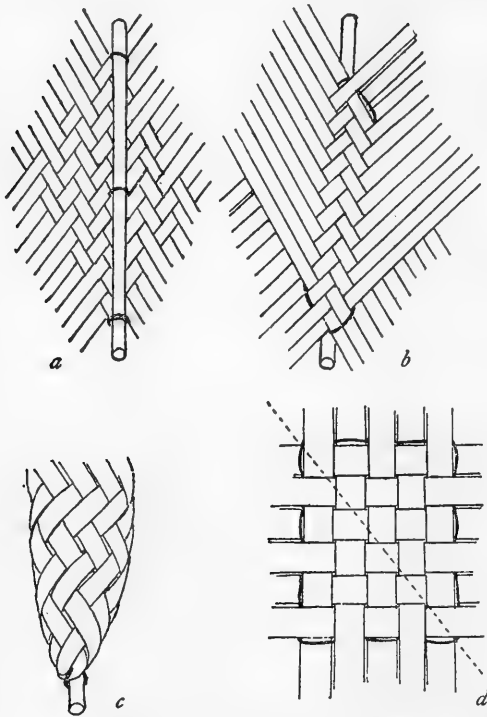

FIGURE 37.—Manufacture of the Taruma and Waiwai satchel. (Sec. 400.) *a, b, c*, The smaller kind with a two-over-two plait; *d*, the larger with a one-over-one plait

its strands slipping out of place, is attached by string to a small wooden pencil on the outside running along its greater diameter. It will be noted that the sides of this figure are not completed until the string and pencil have been placed in position. In the larger articles (*d*) the base is a rectangle, likewise held in situ by tying round it a double string, but no pencil. In both cases an uneven number of strands have to be used—this is essential—and the edges of the bases finally plaited together, the lower edge of the completed satchel running along the diagonal of the rectangle, or the long diameter of the diamond, according to the article that is being made.

There is nothing difficult to understand with regard to the “breaking” of the ends of the strands to form the edges of the mouth of the basket.

407. *At end of section add:*

Among the Waiwai and Taruma I found a somewhat unusual form of hanging tray (fig. 38) with two movable raised sides, all formed of a series of bars chained together with vine rope.

410. *At end of section add:*

I have since discovered another method of finishing the strands off with two rails. Each strand passes behind the lower rail, over and around the upper, back upon itself to the right, behind the bunch of

terminal strands already there, then over the lower rail, behind it to the left, and over itself to join in the bundle. (Fig. 39.)

411 A. A circular close-work basin-tray has been described from the Oyana and Apalai (pl. 7) where it is employed by women for keeping their flocks of cotton when spinning. From De Goeje's description it would appear that the base is made of makka palm (*Astrocaryum* sp.), seemingly twilled, with a wickerwork upstanding edge. The accompanying sketch (GOE, pl. VIII, fig. 3) unfortunately does not permit of further detail.

416. *At end of section add:*

The elongate baskets for carrying peppers, as made by the Waiwai, are constructed on this same type of circular-base radiate pattern. (Pl. 10, b.)

416 A. Most interesting of all these, however, is a trumpet-shaped basket (pl. 11) coming from the mouth of the Orinoco, made by the

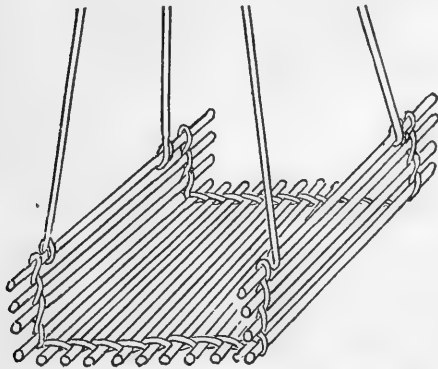

FIGURE 38.—Square hanging tray of the Waiwai, etc. (Sec. 407)

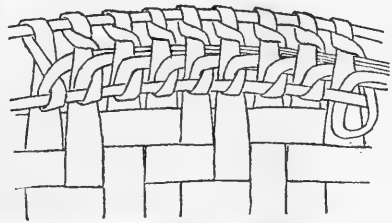

FIGURE 39.—Wapishana circular tray, with two rails; another method of fixation. (Sec. 410)

Warrau, and used by their women. It is supported by a wide fibrous bark band (that goes over the forehead) tucked at each end into the meshwork. The specimen here described is about 23 inches high, 14 inches wide at its mouth, 9 inches diameter at its middle, and apparently made of split itiriti. In construction it belongs to the series of baskets with a circular base on a radiate foundation, so arranged that the warp strands from the original bundle (fig. 40) form an outside and an inside layer, these overlapping to form quadrilaterals that are locked by a single spiral (fibrous) weft to form pentagons. The weaving only differs from the orthodox pentagonal form (fig. 39, H, WER, VII) in that the weft does not join up directly succeeding rows of quadrilaterals. Thus, some five or more rows of quadrilaterals intervene between the weft spirals in the basal and middle portion of the basket (fig. 42, A), these being reduced to three and two (B) to form the gradually

enlarging mouth, the reduction in the number of rows being proportionate with the increased size of the quadrilaterals. Another noteworthy feature of the construction—with the object of covering over the increased area consequent on the semiglobular shape of the base—is the insertion of extra warp strands (fig. 40, *ewa*) around the first spiral: such extra strands being more than double the

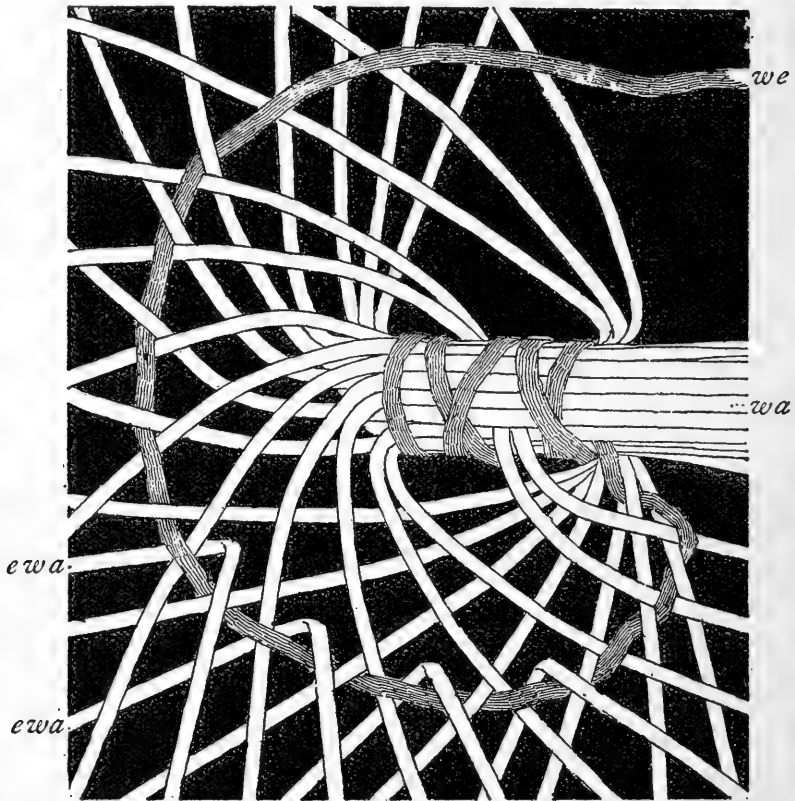
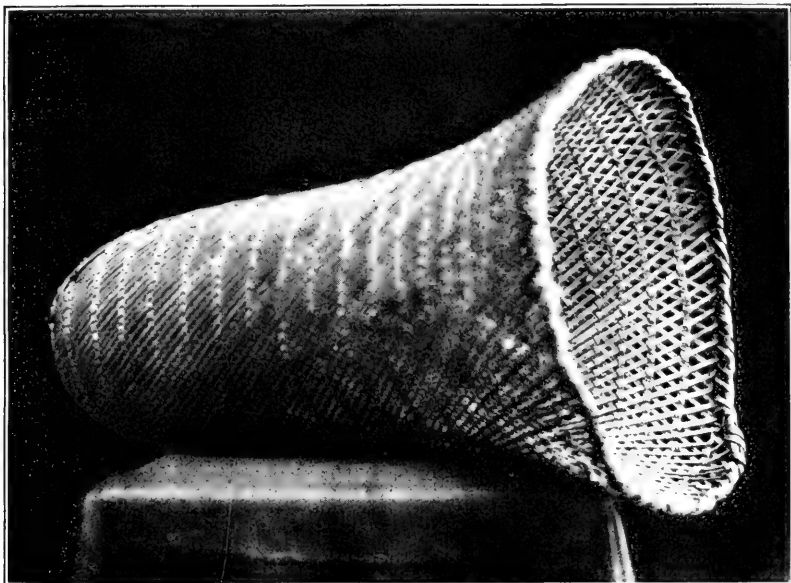

FIGURE 40.—Trumpet-shaped basket (pl. 11), showing the original bundle of warp strands (*wa*) tied by the spiral weft (*we*). The warps at one extremity of the bundle are curved into position into two series of overlapping layers, an outside and inside, and are locked by the commencing spiral of the weft, over which extra warp strands (*ewa*) are sharply bent at their middle. (Sec. 416 A)

height of the basket and bent at their middle over the spiral, the respective halves forming inside and outside warp strands. Subsequently, introduced warp strands are inserted in position singly and independent of the weft. (Fig. 41, *eww*). The free extremities of the constituents of the two layers (outside and inside) are bundled and tied in the usual way to form the edging. (Fig. 42, *B*.)



a, Front view



b, Back view

TRUMPET-SHAPED CARRYING BASKET FROM THE ORINOCO
MOUTH, WARRAU. (SEC. 416 A)

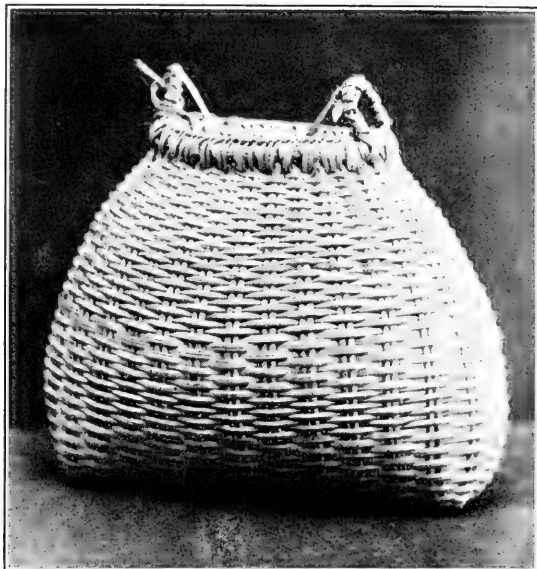

a, The Pakaruma basket of the Makusi. (Sec. 417)

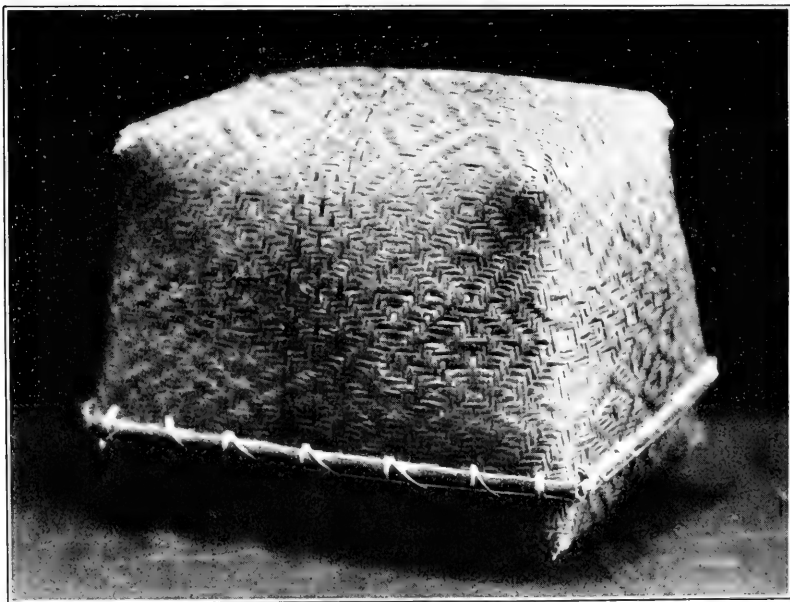

b, Twilled non-hourglass pattern pegall. (Sec. 432 A)

417. *At end of section add:*

In these cases the vertebra, instead of being single, is formed of several strands, as many as six (pl. 12, *a*; fig. 43), even seven being utilized for the purpose. (Compare this with fig. 151, WER, VII.)

430. *At end of section add:*

With the Oyana and Waiwai these checker rectangular flat-base baskets are more oblong, and employed for preserving the feathers

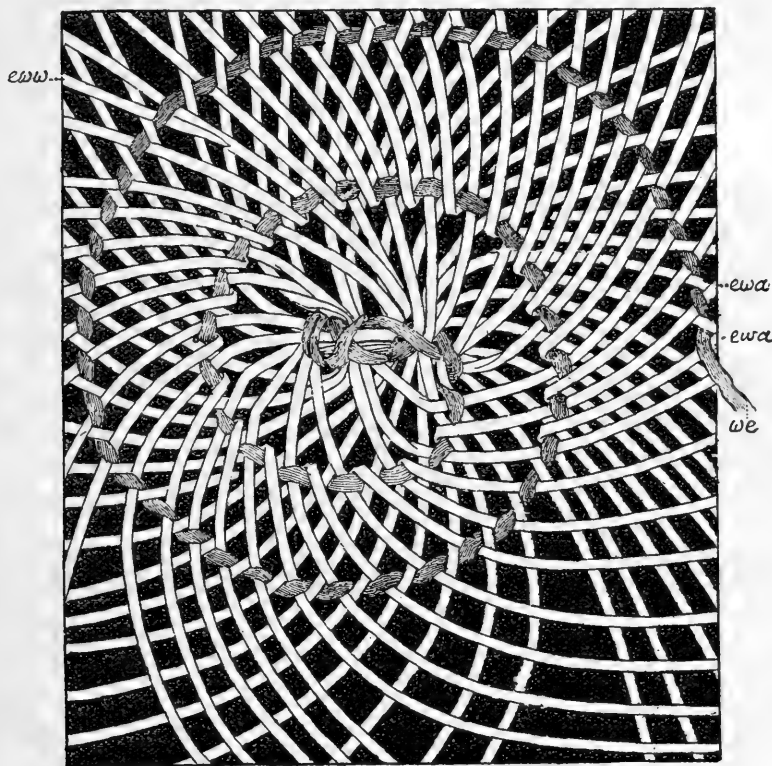
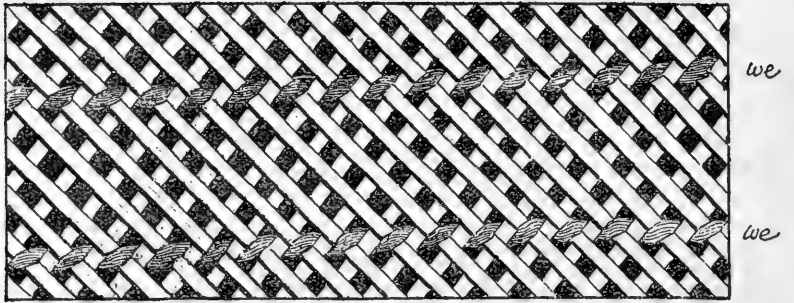
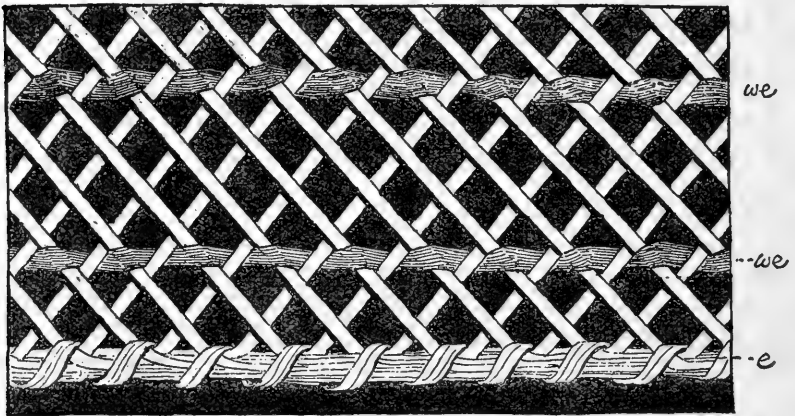

FIGURE 41.—A more advanced stage in the construction of the trumpet-shaped carrying basket. The first and last extra warp strands (*ewa*) around the first spiral are indicated above the projecting weft (*we*). A single independent extra warp is likewise shown (*eww*). (Sec. 416 A)

required at the various dances, etc. I saw them manufactured by the Waiwai on the following lines. (Fig. 44.) The pinnule of the kokerit leaf is split, the midrib and tapering ends removed, and the sides shaved away, so as to get a series of leaf strips of fairly uniform size. These are plaited checkerwise to form a rectangle of the length and width required (*A*). To keep the plait in position and prevent it from fraying, as well as to stiffen it, the circumference is tied around with a double thread of korowa fiber and turu strips attached along



A



B

FIGURE 42.—View of portions of the completed basket from the middle (A) and at the mouth (B), respectively. (Sec. 416 A)

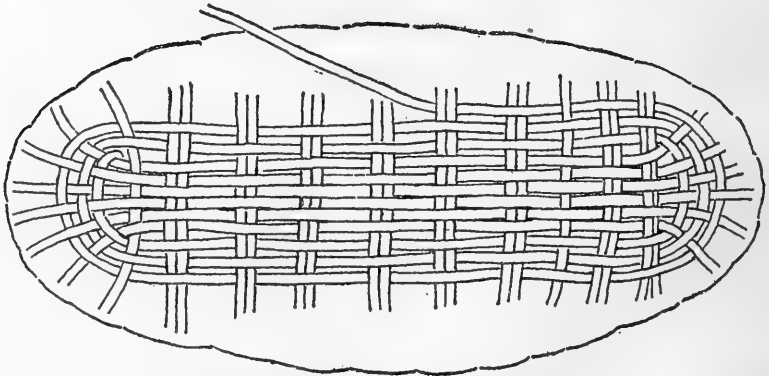

FIGURE 43.—Diagram of basket shown in Plate 12, a

the diagonals (*B*). As already mentioned above, the projecting ends (warps) are next turned up, and maintained in position by the multiple wefts of the same material that are now introduced until the final cane strip is reached, etc. The half-basket, so to speak, in its present condition, is quite soft and pliable. To remedy this, fine strips of turu palm are carefully slipped in lengthwise under and over the plaits (alternately with each row) to the full extent and width of the article (*C*), to be covered again by another series of kokerit strips carefully passed over and along them, which hide them from view.

For keeping their toilet requisites or small kickshaws (pen-knife, cotton clew, mani resin, beads, fishhooks, etc.) the Trio employ a small pegall of apparently somewhat similar construction, save that the direction of the strands, instead of being parallel with, run at an angle of 45 degrees with the frame. (Pl. 7, 7.) Otherwise, it is a checker of the same material, but I can say nothing more. DeGoeje's description of the technique is none too clear:

Bent back at the edges and again further interlaced so that the box (and cover) consists only of a single strand; where the strand ends, it is lengthened by a new one, the breaks disappearing in the various layers. (GOE, 20.)

432 A. Among the Carib stock certain of these wicker armadillo pattern pegalls (i. e., baskets with covers) the covering may be double, inclosing between its layers the itiriti leaves that will render the contents waterproof. This outer covering, unlike that of the hourglass pattern pegalls to be subsequently described (sec. 433, etc.), is built up on a twilled pattern (pl. 12, *b*) to a size equal to that of the surface it is intended to cover, when the warps and wefts are bent down at a right angle to form warps collec-

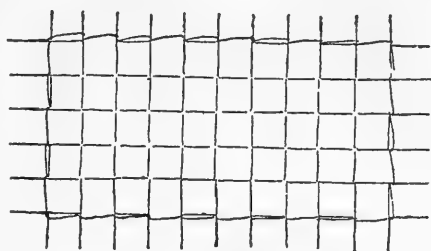

A

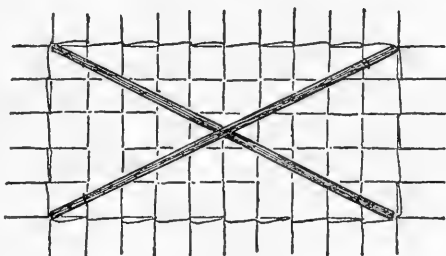

B

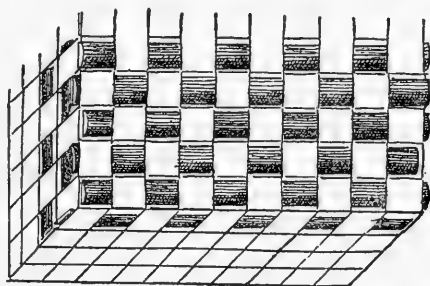

C

FIGURE 44.—Manufacture of the checker rectangular flat-base basket of the Oyana, Waiwai, etc. (Sec. 430)

tively and solely (pl. 13, *a*). It is out of these collective warps that the sides and ends of the outer covering are now built by running into them extra independent wefts, strand by strand, over and under in furtherance of the original design, the ends of each extra weft being tucked under one another (*ew*). In other words, unlike the hourglass pattern pegalls (fig. 157, *A*, WER, VII), the sides are not built up solely from the continuations of the warp and weft strands constituting the cover. Furthermore, these boxes never look so neat, there being always bulges and kinks to be seen at the lines of junction of the four sides. From the Caribs on the Barima River, and apparently in the old days from Cayenne. (Pl. 117, *C*, WER, VII, lower right-hand figures.)

433. *Line 9 instead of all read most.*

Page 346, line 2, after 108) add:

All other remaining pegalls, though nonhourglass, are twilled into various symmetrical patterns. (Sec. 447 A.)

441. *At end of section add:*

As compared with the Arawak ones of the Pomeroon, etc., those of the Waiwai, Taruma, Trio, etc., are more compressed, narrower, and made of strands more finely split. Probably for the protection of the pretty pattern of plait, or because it has not been properly colored, etc., the cover may be wound round with leaf. (Pl. 7, 8.)

445. *At end of section add:*

In the comparatively compressed pegalls of the Waiwai, Trio, Taruma, and Saloema there is a distinct advance in the artistic design of the pattern, in that there is a tendency toward a symmetrical picture, e. g., two stags (pl. 13, *b*), two monkeys facing one another (pl. 14).

447 A. The twilled (non-hourglass) pattern of pegall (pl. 12, *b*) is of comparatively simple construction. On completion of the rectangular top, which can be of any pattern except hourglass, the ends are bent down as warps and kept in position by extra wefts to form the sides, the lower edges being finally strengthened with split strips, etc., in the usual way. This arrangement is shown in Plate 13, *a*.

448. *Page 371, after last line in table add:*

Twilled (non-hourglass)----- Sec. 447 A.

449. *At end of section add:*

Since the above was written I have found cover basketry on the Waiwai ceremonial clubs. Lindblom describes it on certain old-time bows. (LIN, 164.)

450. *Last line, after hotte; add:*

in Surinam katali, when made of palm leaf, or moetetei, if made of split tough vine (GOT, 1043); cotari among the Oyana (HER, 137).

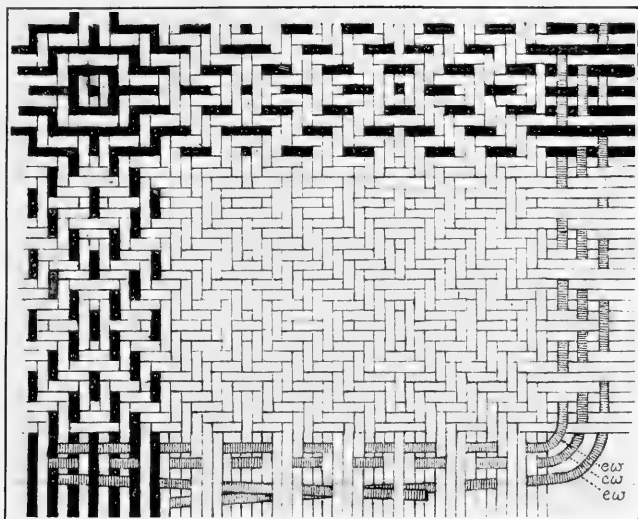

a, Diagram of twilled non-hourglass pattern pegall. One quarter of top surface showing how the sides are built up with extra wefts. (Sec. 432 A)

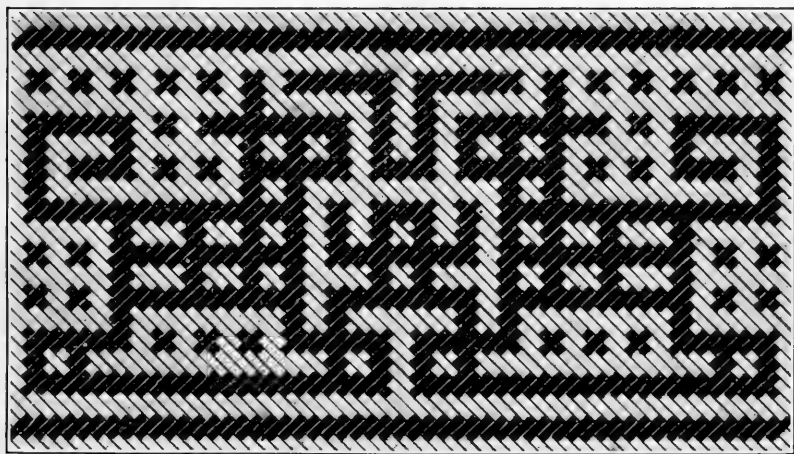

b, Pattern from side of Waiwai pegall. A central beetle and two deer facing each other. (Sec. 445)

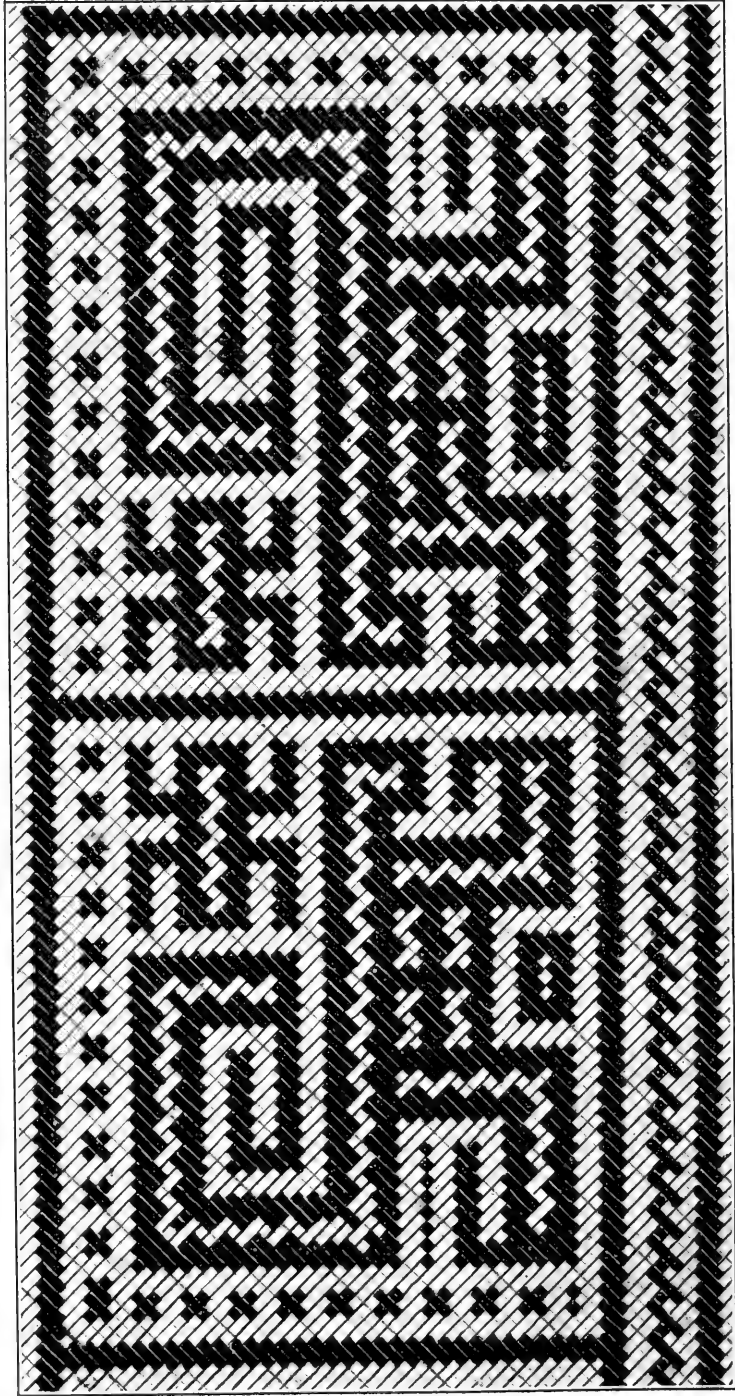

PATTERN FROM SIDE OF WAIWAI PEGALL. TWO BEETLES AND MONKEYS FACING EACH OTHER. (SEC. 445)

452. *At end of section add:*

The pimpler palm (*Astrocaryum*) knapsack cover (pl. 15, *a*) mentioned at the commencement of this section is manufactured by Wapishana, Taruma, and Waiwai thus (pl. 15, *b*): Train the pinnules before you begin splitting off the harder and stiffer edge so that they will bend easily. Loop together loosely with a cord a number of crossed pairs—the number depending on the size of cover required—at about one-fifth of their length from their base (*A*). Now spread them out on the flat (*B*) and tie the end of the string. To facilitate the plaiting, insert temporarily a cane-strip between the two series of septa; one series is sloping to the right, the other to the left. Plait in the present case in the two-over-two style and “break” at the side edges until these are completed. There now project from the base of the cover a front series of strands sloping to the right and a back series sloping to the left. These are worked off (*C*) by starting from the left, “breaking” the first one under the next, then passing it over and under one, and finally over the fourth and back again to be tucked under itself. This process is continued from left to right (*D*) until each has been picked off, the remaining four strands being finished off into a plait and tied. Turn over, and do the same with the other side, then cut off the projecting terminals.

The Waiwai and Taruma ite-palm knapsack cover is built up of two halves of a leaf in a one-under-and-over-three pattern with concentric rectangular figures. (Sec. 455 G.)

454. *At end of section add:*

How to make the single-leaf ite basket or satchel. (Pl. 120, *B*, WER, VII.) Prepare the leaf by splitting the septa (strands) down to their origins, so as to be all separated at the one level, and see that the number of strands is even. Start at the center at the back with, in the present case under consideration, a one-over-and-under-two plait. (Fig. 45, *A*.) Carry the plait work over each side up to the very edge in front, at the same time building up a triangular wing by “bending.” This wing may or may not be strengthened by plaiting it over the outermost strand (compare the wing in the ite-leaf close-work knapsacks illustrated in fig. 48, *C*, *D*). On each side of the future basket there are now, on completion of the plait, an outer series of strands sloping upward and an inner one sloping downward. (Fig. 45, *B*.) Starting from above, plait the two inner series one by one into a three-ply, and on completion tie it (*C*). Bend the terminal portion of this ply upward and cover it by plaiting over it in the same way the two outer series from below up into a three-ply (*D*). Compare Plate 120, *B* (WER, VII), where the lower knob represents the bend in the three-ply made up of the inner series and the upper tail indicates the extremity of the three-

ply made up of the outer series. In this case the leaf stalk has been turned inward. It is to be noted that this method of finishing off the article is identical with that employed in completing the close-work ite-leaf knapsack (sec. 455 C). Furthermore, the basket under manufacture, here described, is plaited on a horizontal pattern, but it can just as easily be plaited on a vertical one. (Pls. 16, *a*;

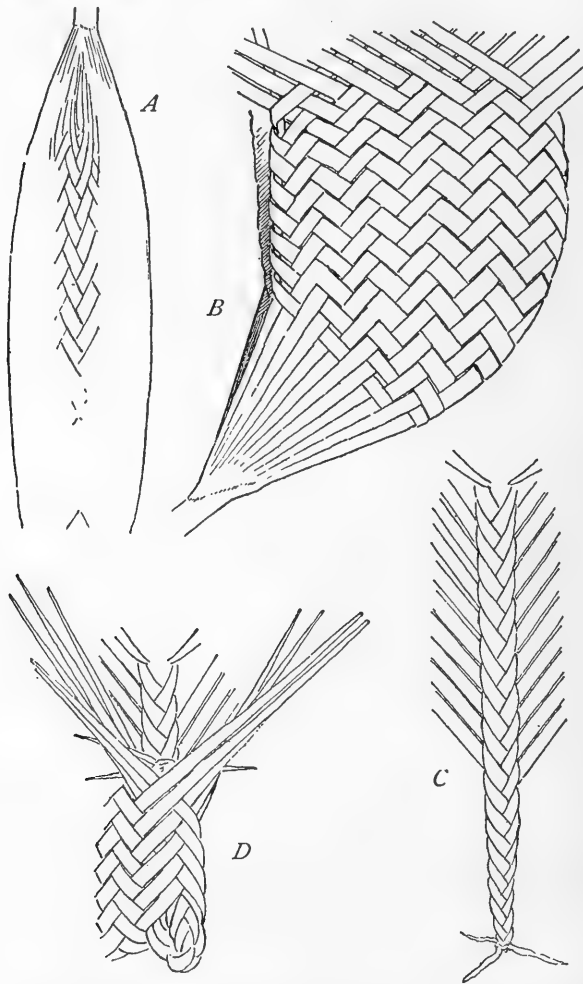
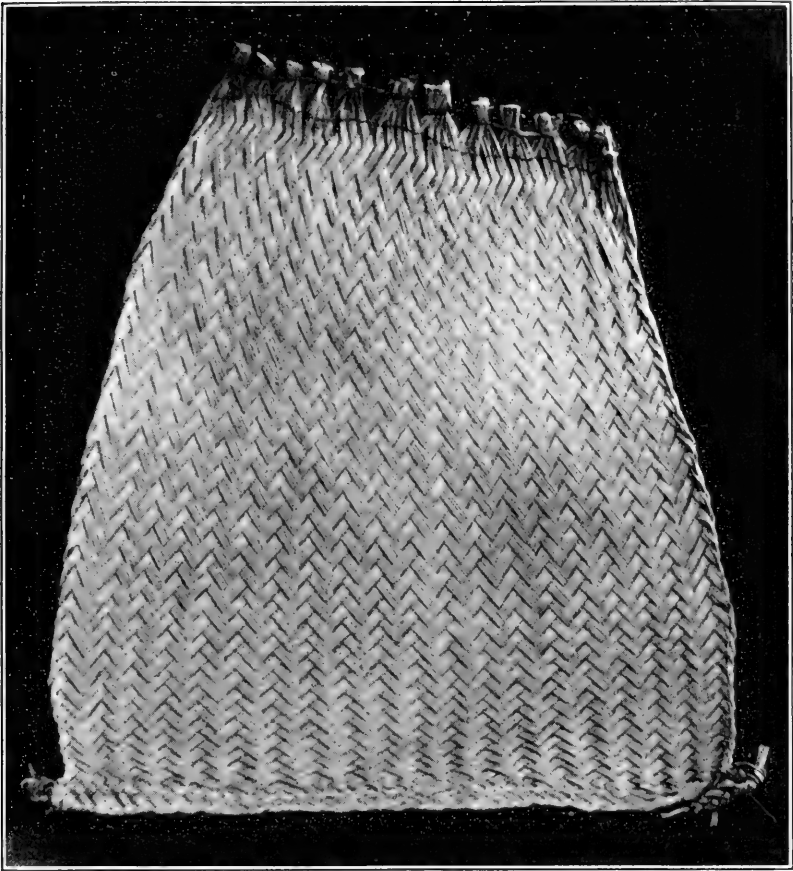

FIGURE 45.—Manufacture of the single-leaf ite basket or satchel. (Sec. 454)

120, *C*, WER, VII.) On occasion the plait may be of a one-over-and-under-three variety.

455 *A*. Where the basket, etc., is made of the two halves of a split ite leaf, these may be plaited into each other straight away, or each half may be subject to a previously plaited preparation. Where the leaf is split, the corresponding surfaces of the pedicle will



a, Pimpler-palm (*Astrocaryum*) knapsack cover of Wapishana. (Sec. 452)

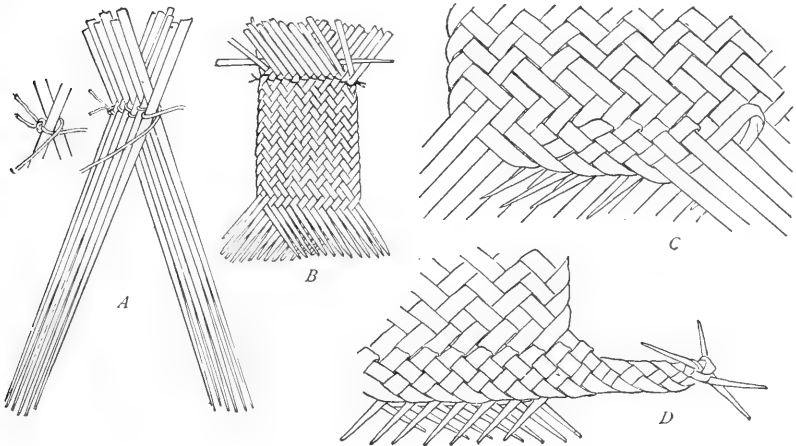

b, Diagram explaining manufacture of the pimpler-palm knapsack cover. (Sec. 452)

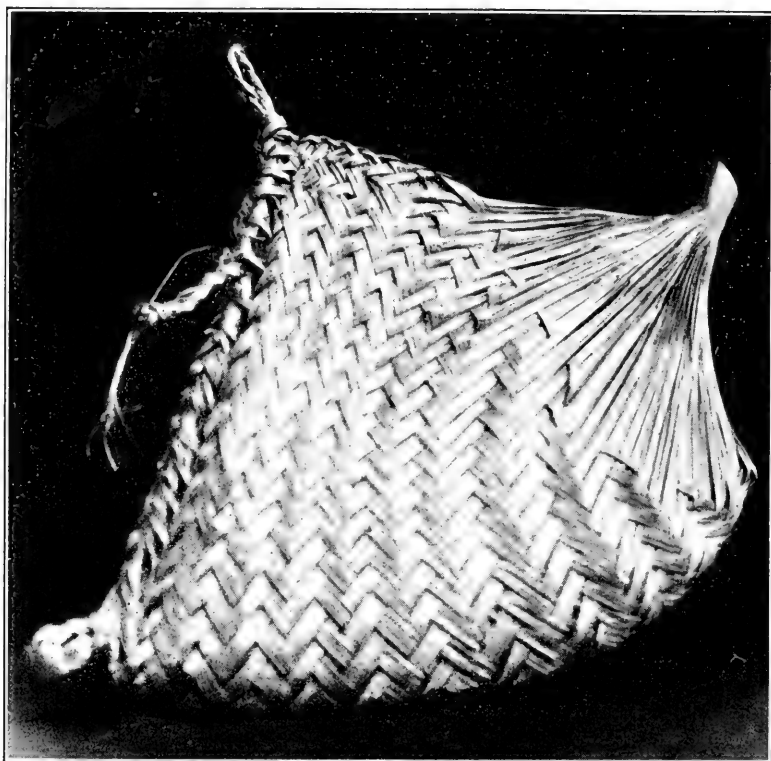

a, Vertically plaited single-leaf ite basket or satchel. (Sec. 454)

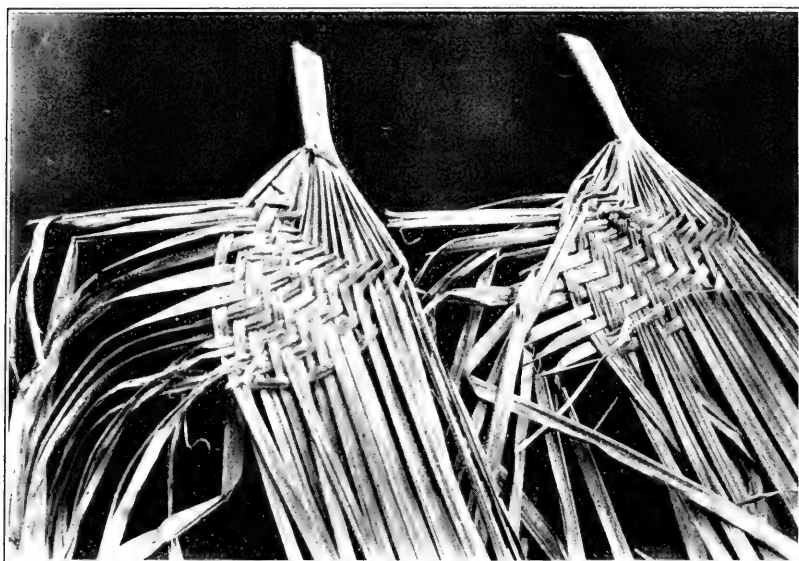

b, The two split halves of an ite leaf prepared for subsequent manipulation into various receptacles. (Sec. 455 A)

be "rough," the outer free surfaces remaining "smooth." After the leaf has been split in two the septa have to be sliced down to their origins and care taken that each half has the same number of septa. Such as may not be necessary must be removed. In cases where each half requires previous preparation a commencement is made on the "smooth" half by starting from the second septum (strand) on the right and "breaking" (bending) every succeeding second strand or septum over two. To prepare the "rough"

half, a start is made with the second strand from the left, again bending every succeeding second strand over two. Of course, if the article is to be made with a three plait it will be a case of breaking every third strand over three. The resultant figure is more or less heart shaped, and may therefore be conveniently described as a cardium. (Pl. 16, *b.*) Each cardium, according to its pedicle, will have a smooth and a rough side, these corresponding, respectively, with the outside or back and

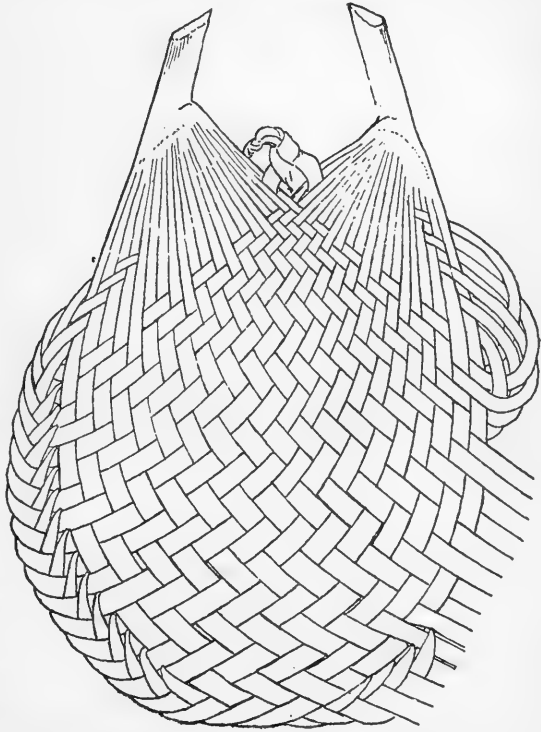

FIGURE 46.—Diagram of split ite-leaf tray shown in Plate 121 A, C (WER, VII). Front view. (Sec. 455 B)

inside or front of the leaf. The Indian speaks of the smooth side as the "top" and the rough side as the "bottom" of the leaf.

I propose now describing the manufacture of various articles made from the two halves of an ite leaf. First will be considered those where the two halves are just laid across each other and plaited, e. g., the tray or plate (sec. 455 B), the close-work knapsack (sec. 455 C, of which I had lost a type specimen on a previous journey 12 years ago), the throat box basket (sec. 455 D), and the Arekuna carrier (sec. 455 E). Secondly, descriptions will be given of the technique where the two halves undergo previous

manipulation into cardiums, e. g., the corn basket (sec. 455 F), the knapsack cover (sec. 455 G), and the pepper-pot carrier (sec. 455 H).
455 B. To make the Wapishana ite-leaf plate or tray, place the two halves side by side, with the smooth surfaces up, and plait together. In this case (fig. 46), a one-under-and-over-two pattern, this becomes the front of the plate. Starting from the center of the distal extremity, where the last of the septa cross, "break" on each side one strand over two, and pass it through the interspace beyond the second succeeding one onto the back of the plate.

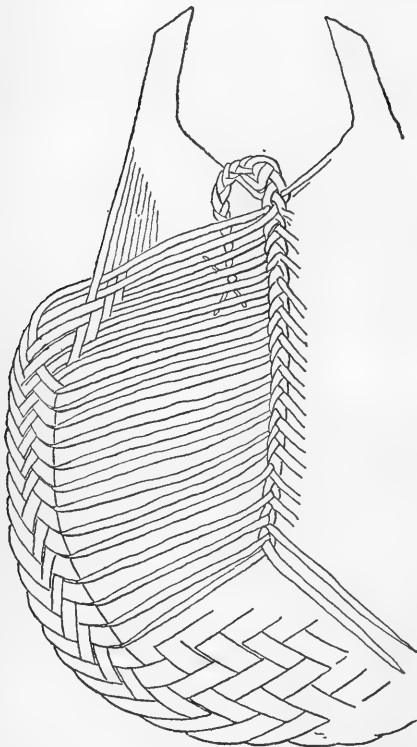
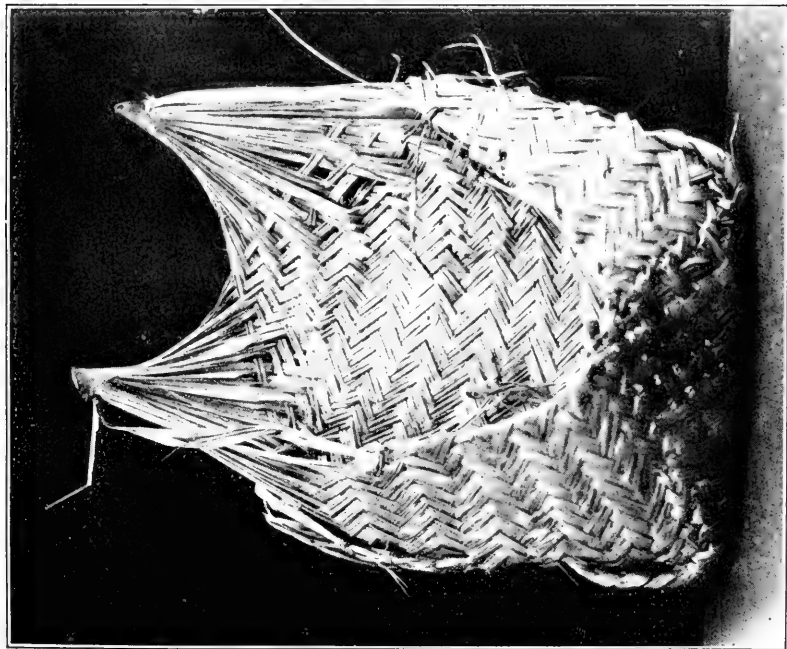

FIGURE 47.—Diagram of the same. Back view. (Sec. 455 B)

When all of these have been passed through, turn the article over and join them up in a central vertical three-ply. (Fig. 47.)

455 C. To make the ite-leaf close-work knapsack (pl. 17), place the two halves side by side (fig. 48, A), both with their smooth surfaces up, and plait them together (in this case likewise one-under-and-over-two) so as to get the article illustrated in Figure 48, B. The "wings" are next plaited. Each is made by "breaking" strand over strand from above down, but in order to strengthen their edges the strands are "broken" (bent) over a rail formed by the uppermost one (C). Now turn the article on its back and, starting from right to left, break the overlying layer of projecting strands, one at a time, under the next, across

the whole base (D). Turn the article to the front again and join the lower borders of the two wings (E) by pulling down on each border the strands that have just been "broken," superposing them on the corresponding strands below and plaiting each as a single strand with the correspondingly treated strands from the other lower border, the plait being a checker type—i. e., a simple one-over-one. (Pl. 18.) This triangular front is then completed below. Starting at the base of this triangle from left to right, break the upper layer of strands projecting from it one-under-one. (Fig. 49.) It will now



a, Front view

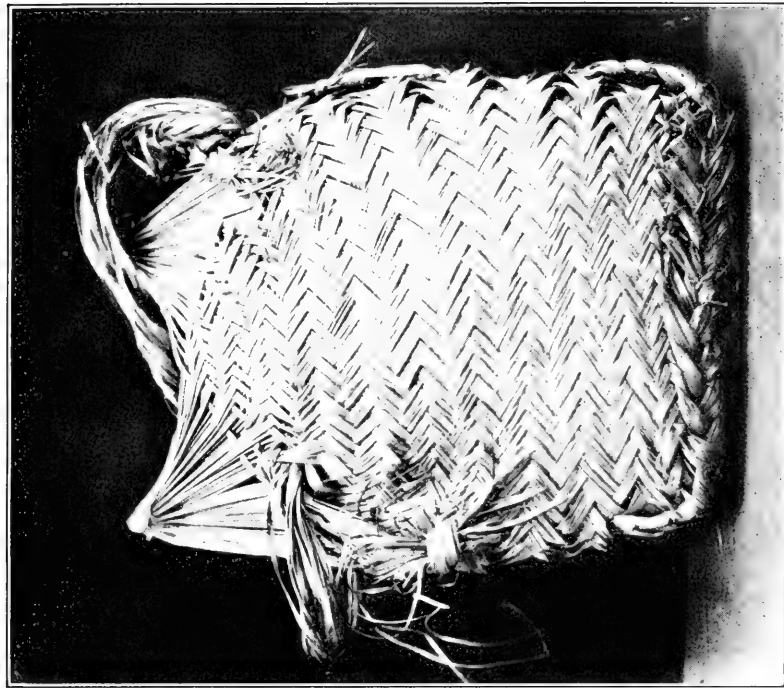

b, Back view

ITE-LEAF CLOSE-WORK KNAPSACK. (SEC. 455 C)

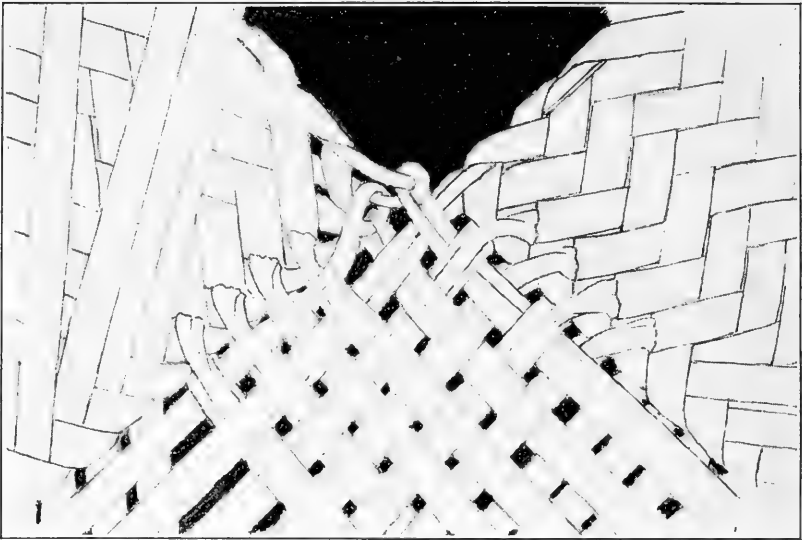

a

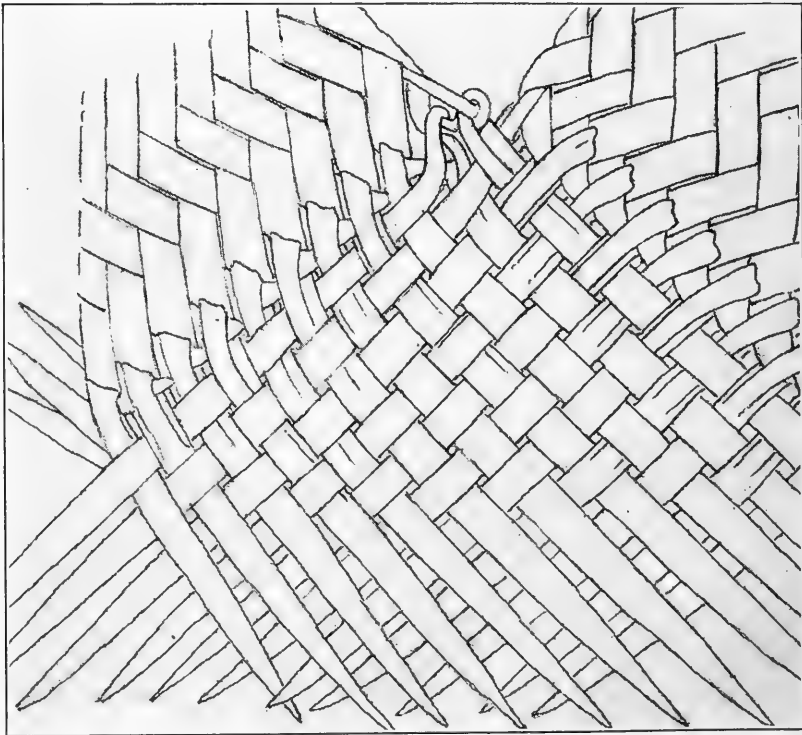

b

STAGES IN THE MANUFACTURE OF THE ITE-LEAF CLOSE-WORK KNAPSACK. (SEC. 455 C)

be remembered that when turned on its back (fig. 48, *D*) the upper layer of basal projecting strands were "broken" one at a time from right to left across the whole base; the lower portion of the back of the article will therefore be represented as in Figure 49, *K*. The resultant effect of all this manipulation is that there is now on front and back an upper and lower layer of strands, the strands of each

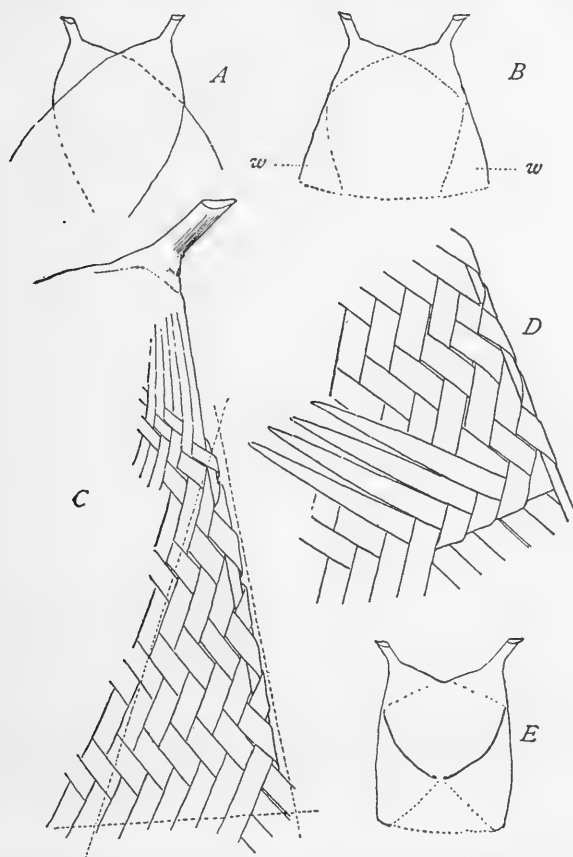

FIGURE 48.—Manufacture of the ite-leaf close-work knapsack. (Sec. 455 C.) *A*, The two split halves, with smooth surfaces up, are placed in position and plaited together to form a rectangular figure, *B*, with wings (*w*). *C*, *D*, show the manufacture of a wing in detail. *E*, The apices of the two wings are approximated

layer, front and back, sloping in the same direction when viewed from either surface. Plait the strands of the lower layer one by one from opposite faces in the direction they are lying, into a three-ply, and finish by tying into a knotted tail. (Fig. 50, *L*.) In a similar manner plait the strands of the upper layer from face to face in the direction they are lying (which is of course opposite to that

of the lower layer) over the lower just-plaited layer, and finish up with a similar tail (*M*).

455 D. To make the ite-leaf throat-box basket (pl. 123, *A*, WER, VII): With the smooth sides of the two halves of the leaf up, plait them together, in the case under consideration in a one-over-and-under-two plait, which will ultimately form the back of the basket. To start the concavity of the base, two or more of the pinnules on either side have generally to be more or less twisted upward and downward.

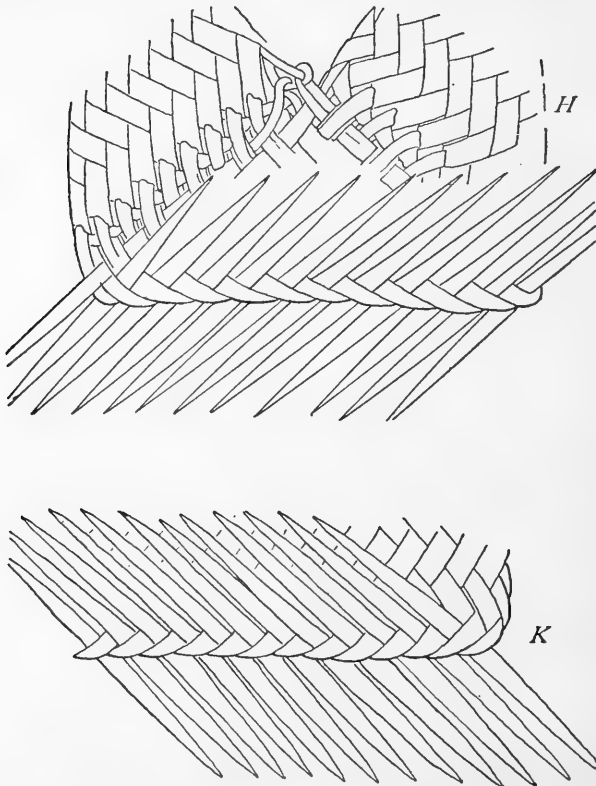

FIGURE 49.—Manufacture of the ite-leaf close-work knapsack, continued. (Sec. 455 C.) *H*, Starting at the base of the triangle from left to right break the upper layer of projecting strands one-under-one. *K*, View of the lower portion of the back of the article

(Fig. 51, *A*.) The article is now turned on its back and the plaiting loosely continued across the sides (*B*) and then along the front (*C*). Projecting from the front will be a series of strands, one set (the outer) sloping to the right and another (the inner) to the left. To form the free edge of the mouth of the basket, a start is made from left to right with the outer set, each strand being “broken” (bent), passed under the next succeeding one, and carefully superposed over the corresponding plaited strand sloping downward to

the right. Starting from right to left, similar treatment is given to the inner set of projecting strands. (Fig. 52, *D*.) But on either side of the free edge of the mouth at its junction with the back a certain number of the upward-sloping projecting strands will be left over—i. e., there is no more space available for dealing with them like the others. They are therefore tucked in and out between the

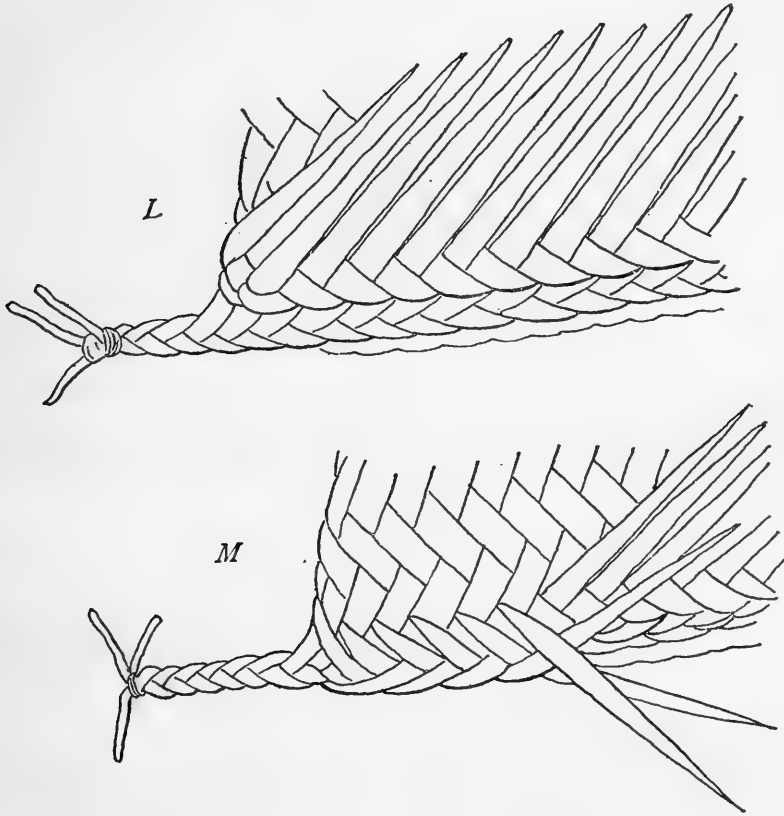

FIGURE 50.—Manufacture of the ite-leaf close-work knapsack, continued. (Sec. 455 C.) *L*, Strands of the lower layer, from opposite faces, are plaited one by one in the direction in which they lie, into a 3-ply. *M*, Strands plaited in similar manner over the lower layers just plaited, so as to inclose them

proximal extremities of the septa in close proximity to the petiole and then plaited into a three-ply (*E*). The extremities of the strands that are left exposed on the downward slope are cut off with a knife. The hanging basket represented in Plate 19, *a*, is judged to be a “freak.” A few Wapishana can make it, but it is not regarded as orthodox or of everyday use. Neither have I ever seen it put to use in any of their houses.

455 E. The Arekuna carrier. (Pl. 19, *b*.) I have named it thus because it has hitherto been observed only among that tribe. It is made of the two split halves of an ite leaf, their smooth sides up,

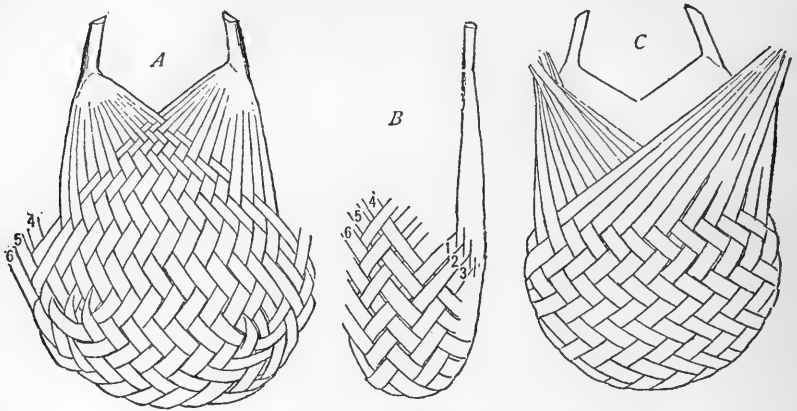

FIGURE 51.—Manufacture of the ite-leaf throat-box basket. (Sec. 455 D)

with the stalks outward, and then plaited together in a two-over-and-under-two pattern. (Fig. 53.) The article is then turned on its back and the free ends of the strands worked off into two-plait handles.

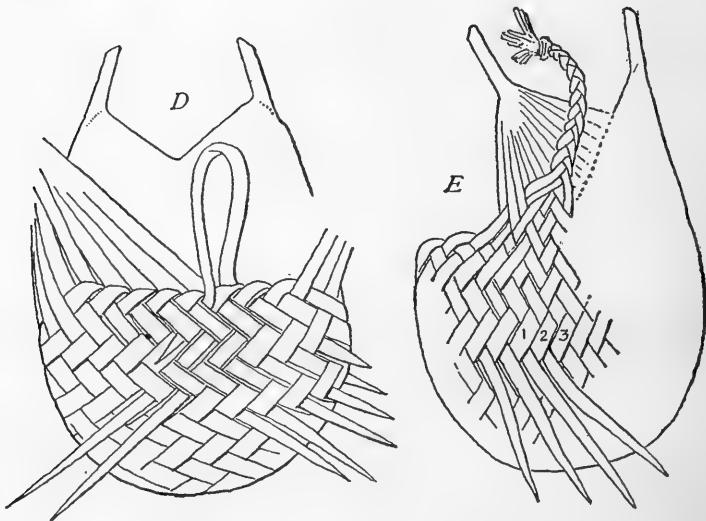
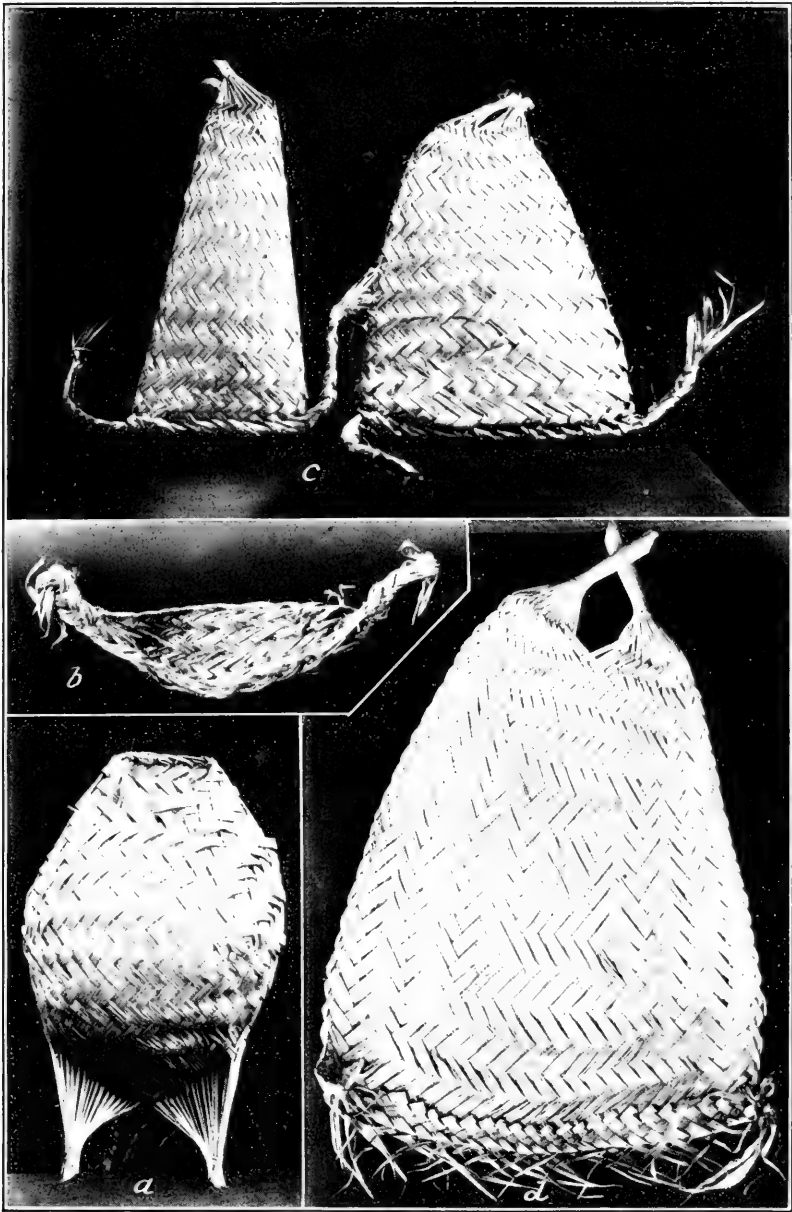

FIGURE 52.—Manufacture of the ite-leaf throat-box basket, continued. (Sec. 455 D)

455 F. To make the corn basket for preserving corn from season to season for planting (pl. 19, *c*), make your cardiums, place them back to back so that one rough side faces a smooth, and plait them



a, A "freak" hanging basket of the Wapishana. (Sec. 455 D.) *b*, An Arekuna carrier. (Sec. 455 E.)
c, The ite-leaf corn basket. (Sec. 455 F.) *d*, The ite-leaf knapsack cover of the Waiwai and
 Taruma, etc. (Sec. 455 G)



a, Waiwai making a hammock. (Sec. 477 A)



b, Temporary bush basket, No. 2 on right and No. 3 on left. (Sec. 456 A)

together, thus forming a gradually enlarging cylinder. When arrived at a suitable length, flatten the cylinder in the plane of the two pedicles, so as to get two faces and two edges. Start at the bottom from left to right and "break" the outer series of strands one at a time under the next. (Fig. 54.)

Turn the article over and do the same with the outer series, but on this occasion from right to left. On each face there will now be remaining an inner series of strands running in the same direction. Plait these together from face to face in the direction they are lying into a three-ply and tie into tail, as in the close-work knapsack. (Fig. 50.) So also in a similar manner plait the outer series together from face to face in a three-ply in the direction they are lying, which will be opposite to that of the inner series (that will now be covered over) and finish with a tail.

455 G. The Waiwai and Taruma ite-leaf knapsack cover (pl. 19, *d*) is built up of the two halves of a leaf, made into cardiums (sec. 455 A) with both the smooth sides up. They are made of a one-under-and-over-three pattern with concentric rectangular figures, and are finished off at the base symmetrically in the same manner as the pimpler palm knapsack cover. (Sec. 452.)

455 H. To make the baskets for carrying the pepper pot (pl. 122, WER, VII) plait your two cardiums (sec. 455 A), place them in the position indicated in diagram, with smooth and rough sides up, respectively. Plait these together, in this case one-over-and-under-two in correspondence with the cardium, and you will get a more or less diamond-shaped figure. (Fig. 55, *A*.) Starting at the top center, "break" one-under-one from left to right, and complete the plait. Turn the article over and starting at the top center work similarly and complete it. Finish lower edge by similar manipulation, the whole now forming a figure (*B*) with contracted center to which the sloping sides converge. Four groups of strands project at right angles from these sloping sides, above and below the center

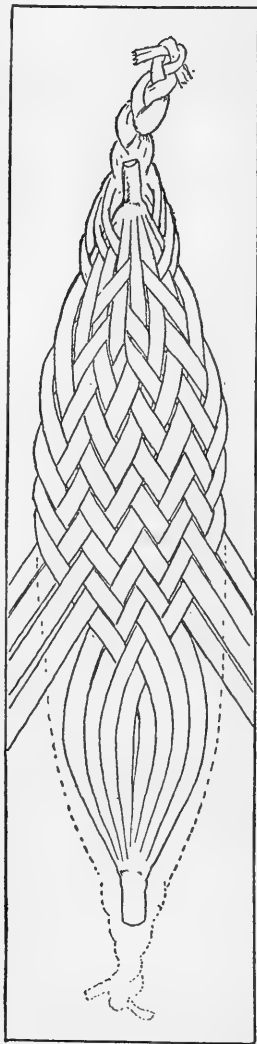

FIGURE 53.—Manufacture of the carrier illustrated in Plate 19, *b*. (Sec. 455 E)

portion; call those of one side ab and those of the other cd . The two groups of strands on each side have now to be plaited together over their respective cardiums. To do this turn the article over on its upper and lower edge with the end toward you and approximate the apices of a and b , taking care to keep the cardium beneath—i. e., inside—the basket when completed. A triangular space, hidden with projecting strands, results. (Fig. 56, *C*.) Cover in this space (and the cardium) by plaiting these strands projecting from a and b , continuing the same pattern of plait. This will end in two series of strands, one sloping to the right, the other to the left (*D*), which are now divided into groups of twos or threes and so worked up into two, three, or four plait tails or tassels (*E*). Do the same with the sides c , d . The two tassels at each end of the

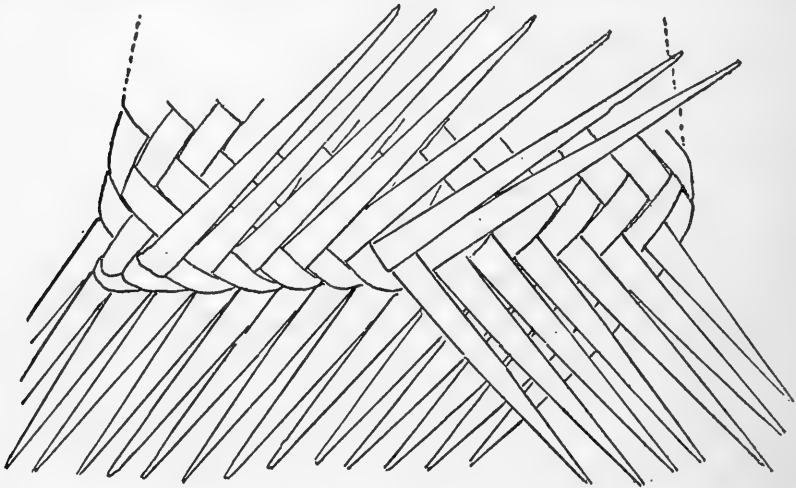

FIGURE 54.—Manufacture of the ito-leaf corn basket. (Sec. 455 F)

basket are either knotted to the corresponding ones at the opposite extremity or tucked into themselves to form knobs. (Pl. 122, *C*, WER, VII.) The strands projecting from the apices of the sides ab , cd are similarly plaited and then tied to their corresponding fellows to form a handle.

456 A. The Wapishana can make two baskets similarly shaped to that in Plate 124, *E* (WER, VII), but in a somewhat different manner.

Bush basket No. 1.—This particular one on the Kuyuini was plaited out of lu palm. To make it, cut away about a 30-inch length of leaf, not from the tip, but about a couple of feet below it. Divide the midrib into three sections. Bend the proximal (thicker) end one (fig. 57, *A*) at right angles and on each face plait together the horizontal pinnules (of the central section of the

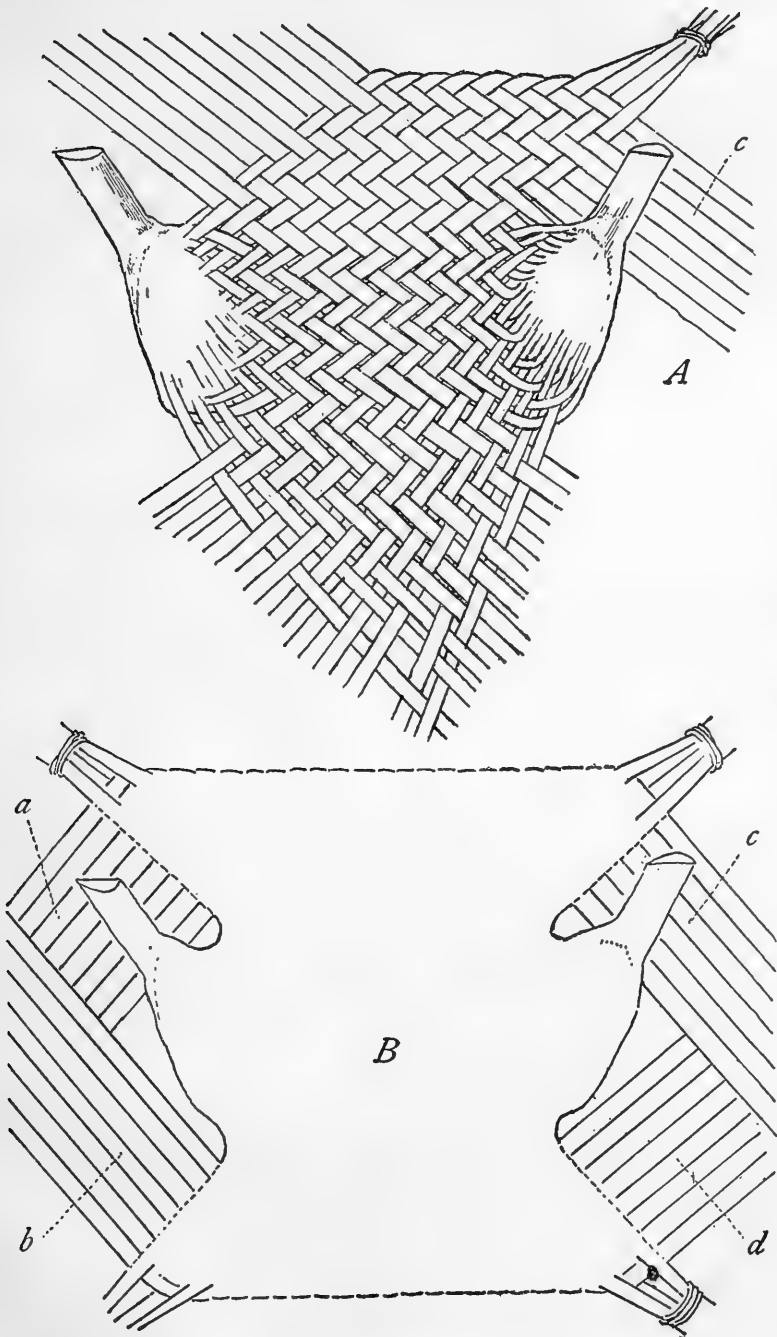

FIGURE 55.—Manufacture of the pepper-pot basket. (Sec. 455 H)

midrib) with the vertical ones (of the proximal section). Starting below from the midrib plait the free ends of the vertical ones from both faces into a three-ply, by picking up one at a time. Bend the distal portion of midrib up onto the central and tie (*B*). Pass its pinnules over those already plaited and from below up work them together with the free ends of the horizontal pinnules from both

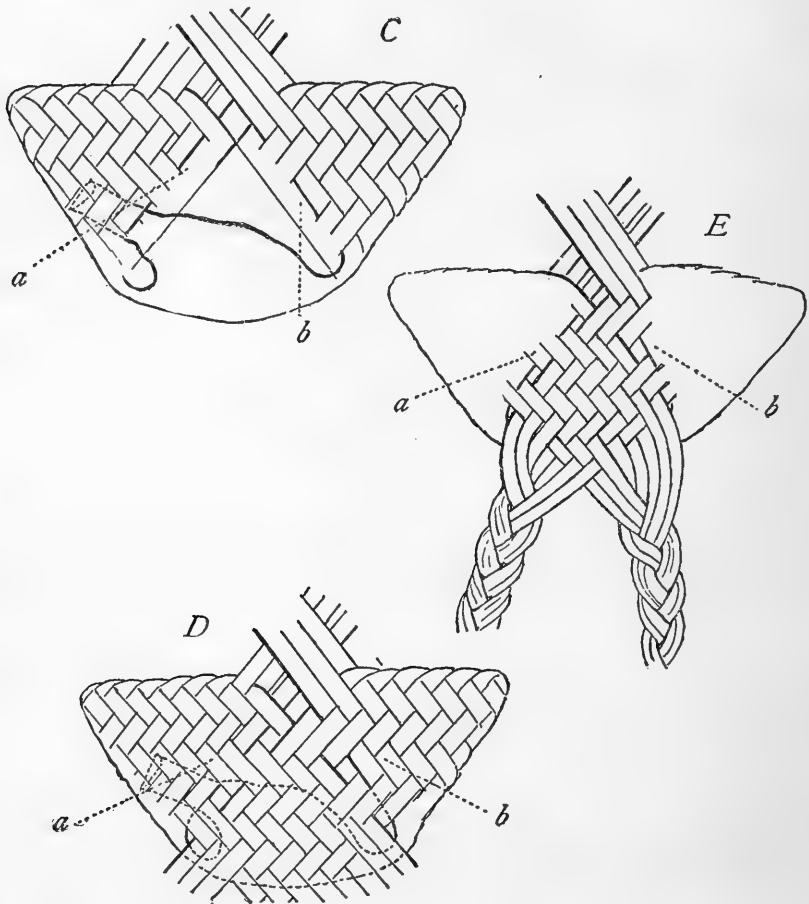

FIGURE 56.—Manufacture of the pepper-pot basket, continued. (Sec. 455 H)

faces into a three-ply. Split the horizontal portion (distal section) of midrib, the two halves of which constitute the edges of the mouth.

Bush basket No. 2.—The second kind (pl. 20, *b*) is made of manicol with the midrib similarly bent in two places. Bend the middle section (fig. 58, *A*) backward over the proximal and the distal or terminal one at right angles to it. Plait the two faces each from

below up, leaving the sides free, but plait them together over the base. The effect will be that on each face there are now three sets of free pinnules, one sloping downward, another passing upward from the side edge, and a third also sloping upward but from the base. From above down, plait the downward-sloping series of pinnules from both faces, one at a time, into a 3-ply (*B*). Bend this 3-ply upward and cover it up with another 3-ply made by including the upward-sloping pinnules one after another from below up (*C*).

Bush basket No. 3.—The Wapishana make yet another kind, of a rectangular shape, out of manicol. (Pl. 20, *b*.) The piece of midrib is again bent into three sections, the central forming the base, the proximal and distal the two lateral edges of the article. (Fig. 58, *D*.) Start plaiting from the center of the base up, and on completion of each face, plait together from below up, picking one at a time, the free ends of the pinnules sloping up on each side.

456 B. The Waiwai manufacture a very strong shoulder basket (knapsack) from the pimpler palm. (Pl. 21, *A*.) Take two of the unopened leaves, and, beginning at the base, open up and twist the pinnules outward one by one; on reaching the upper extremity pick off altogether the last few very small and fine ones. (Fig. 59, *A*.) After bending each midrib sharply in two places and so dividing it into what will ultimately be the side and base supports

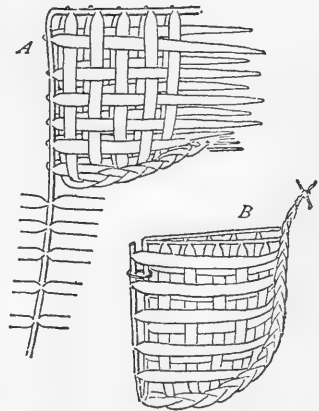

FIGURE 57.—Temporary bush basket, No. 1. (Sec. 456 A)

of the future knapsack, tie opposite ends together in two places (*B*). The idea of tying opposite ends together is to insure the slope of the pinnules on the one leaf lying in a direction opposite to that of the other, and so allowing of their being plaited together. Remove all superfluous pinnules, i. e., those that may interfere with the regularity of the plait, and tie on additional ones where necessary to maintain it. Trim off the top and tie on a crosspiece. Now start plaiting the pinnules across from side to side in a checker pattern, commencing from below up, and so closing in what will ultimately be the back of the knapsack (*C*). Having reached the top, "break" one-over-one, so as to get two wings. Holding the article sidewise toward you, start from below up and plait together the two leaves along the side edge (and over the side supports); on reaching the wing, run it into the plait to form a sidepiece. Do the same with the other side edge (*D*). Put the article on its

back, plait together the pinnules of both leaves as they rise from the base supports and run them into the sidepieces (*E*). The central longitudinal unplaited space (hidden at present by the free strands of the sidepieces) will ultimately form the mouth of the knapsack, and the next manipulation will be to limit and strengthen

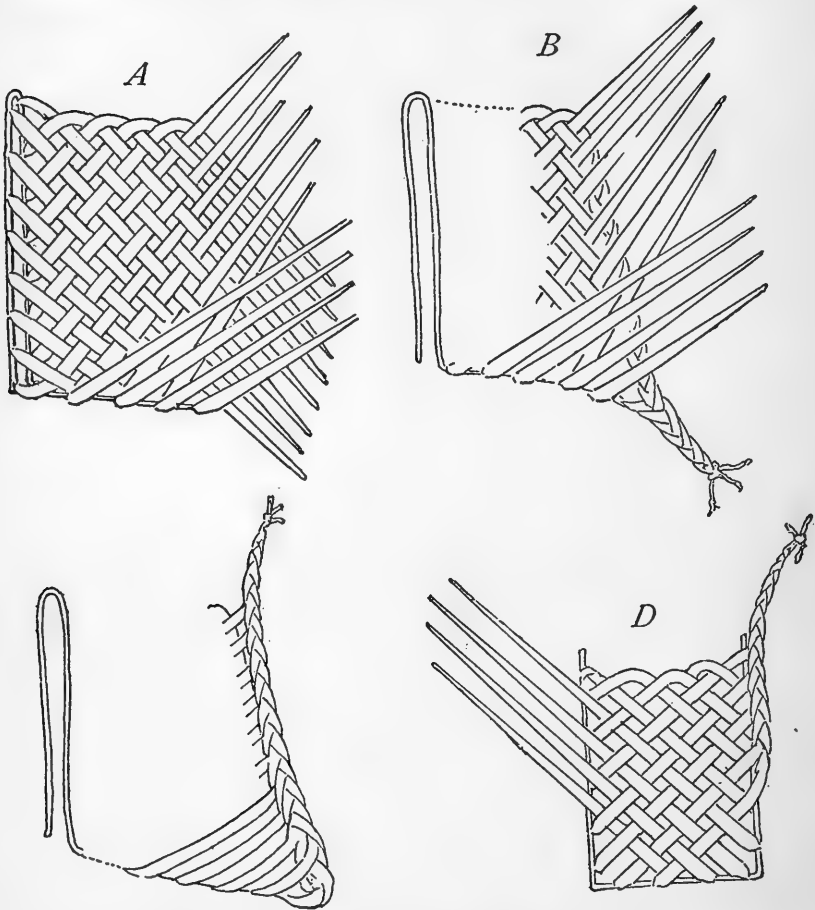

FIGURE 58.—Manufacture of temporary bush baskets. *A, B, C*, Stages in basket No. 2; *D*, stage in basket No. 3. (Sec. 456 A)

its borders (*a, b*). On each side of this space the free strands will be lying in two series, an outer and an inner layer.

Starting from the left-hand corner of the top of this prospective mouth (fig. 60, *F, a*) break one-over-one of the outer series all the way round to the top right-hand corner and return; but on the return journey break one-over-one of the inner series, and tie when arriving at the starting point. As an alternative method the



C, Waiwai women carrying permanent and temporary shoulder baskets, respectively

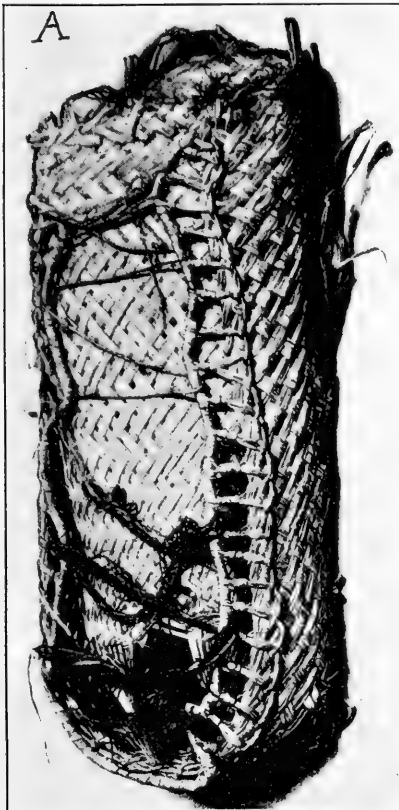

A, Temporary basket of the Waiwai.
(Sec. 456 B)

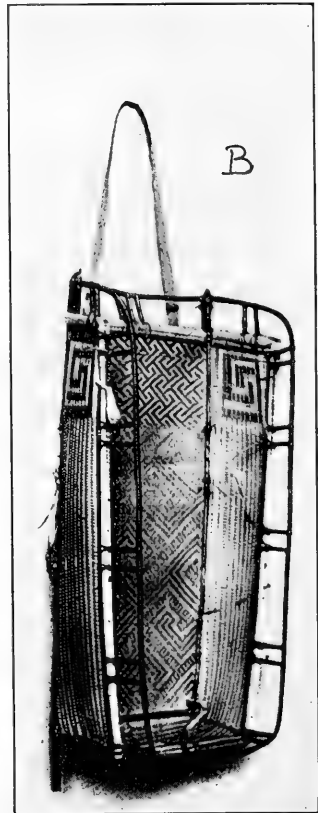

B, Permanent basket' of the Apalai
(after Farabee)

SHOULDER BASKETS



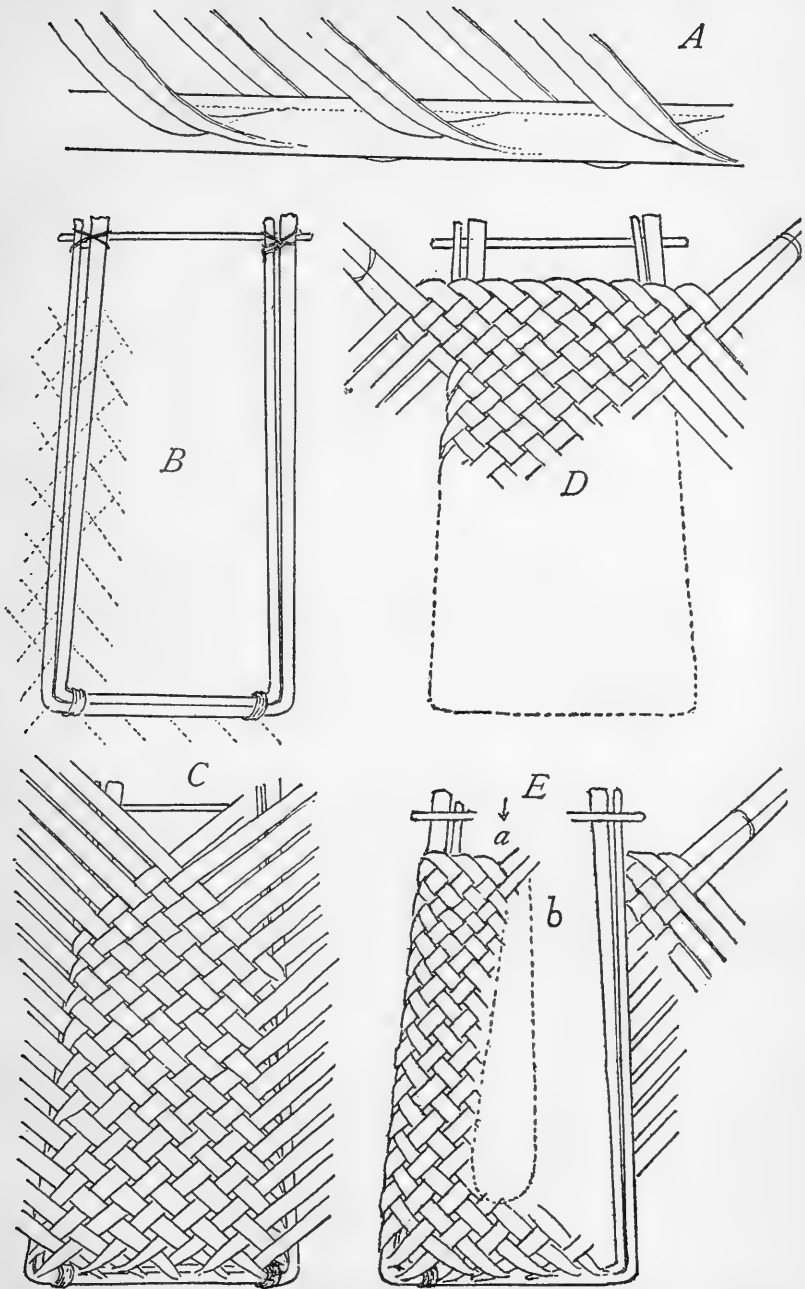

FIGURE 59.—Manufacture of the Waiwai temporary pimpler-palm shoulder basket. (Sec. 456 B)

“break” may be similar but the free end further plaited (*G*). Thus along and around the whole edge of the mouth there is again an outer and inner series of free pinnules. Commencing from the top left-hand corner of the mouth, each of the outer pinnules is twisted some three or four times at its base and tucked under and up behind the next succeeding one. This process is continued all the way round. Again making a start from the top left-hand corner, the first of the series of free outer pinnules is taken up with its corresponding inside one, and together with the extremity of the wing rolled into a twist (*H*). This same twist is next rolled twice around the base of the second outer pinnule, together with its corresponding inside one; the distal ends of which (i. e., second outer and corresponding inner pinnule) are similarly rolled over its free extremity. And so the process is repeated (*K*) all the way round and the edge of the mouth so completed. (Pl. 21, *A*.)

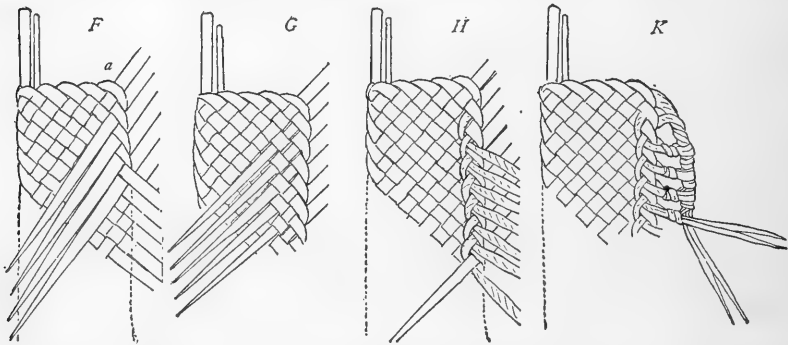

FIGURE 60.—Manufacture of the Waiwai temporary pimpler-palm shoulder basket, continued.
(Sec. 456 B)

Such a shoulder basket will last a considerable period, provided it does not get wet. At the same time, besides the usual twilled itiriti-strand article, which is made comparatively long, the Waiwai can construct a very temporary knapsack out of turu (?) leaf, somewhat on the lines figured in Plate 124, *B*. (WER, VII.)

458. Page 381, third line from bottom, after 157) add:

The hammocks of the Schiriana are quite peculiar and very primitive. A bundle of hard yellow fairly broad bast strips [probably of a species of *Philodendron*] is tied up at both ends and from four to five wefts plaited in a double thread of red-colored cotton drawn through them. In the hammocks from Motomoto even every weft was missing . . . Among the extremely primitive hammocks, but yet answering the purpose, which are used by the Ipurina (on the Rio Purus) in cases of necessity, on journeys, hunting expeditions, etc., four or five bast strips (*Embira*: *Malvaceae* species) 2 meters in length and 3 to 4 cm. in breadth are loosened from the tree and tied

together at both ends, sometimes also furthermore connected with one another by one or two shorter cross-strips. (KGR, III, 314.)

459. *After first paragraph add:*

Mauritia fiber is used for hammocks by the Frog Indians (SR, II, 472), Taruma and Waiwai.

After third paragraph add:

Bromelia (korowa) hammocks are also made by the Trio (HER, I, 943), Taruma and Waiwai.

460. *At end of section add:*

The Oyana cotton hammock is of this type, each bar being formed of two wefts, but only a single warp is taken up at a time. (GOE, 21; pl. IX, fig. 10.)

463. *At end of section add:*

The Saloema have in addition a cotton hammock constructed on this type, each bar being formed of four wefts, but with a single warp taken up at a time. (GOE, 21; pl. IX, fig. 11.)

464 A. It will have been noticed that in all the hammocks just described the warp is wound as a whole around the posts before any action is taken with the wefts. On the Caiary-Uaupes, however, each warp is taken off from the cotton-ball separately, one at a time, and each fixed in place with the wefts, before the next warp is put in position. (KG, II, 210, 211.)

473 A. I have since had an opportunity of watching such an Atorai six-weft hammock through the whole course of manufacture. What I saw may be described as follows:

After the cotton has been rolled onto the hammock frame and over the head-stick to allow of its ultimate removal (fig. 61, A), two wooden slips (*ps*, *ts*) are inserted from left to right in the front layer of warps in such a way as to pick up alternate strings as they are passed along. (In this case the alternate warps picked up are Nos. 2, 4, 6, 8, 10, etc., above and Nos. 1, 3, 5, 7, 9, etc., below.)

A second set of sticks (*B*) is similarly introduced (*ts I*, *ts II*) below the previous ones but in a different way as regards the number and

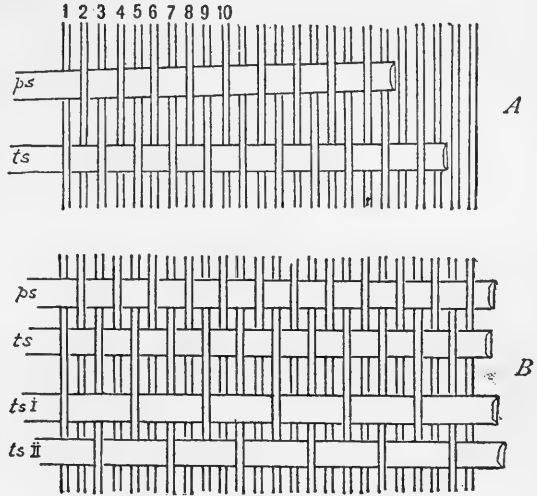

FIGURE 61.—Manufacture of a 6-weft Atorai hammock. (Sec. 473 A.) *A*, The first two wooden slips (*ps*, *ts*) picking up strings 2, 4, 6, 8, 10, etc., and 1, 3, 5, 7, 9, etc., respectively. *B*, The second two wooden slips (*ts I*, *ts II*) picking up strings 1, 5, 9, 13, 17, etc., and 3, 7, 11, 15, 19, etc., respectively

position of the warps of the latter; the upper slip (*ts* I) is placed behind warps 1, 5, 9, 13, 17, etc., the lower one (*ts* II) behind warps 3, 7, 11, 15, 19, etc.

A heddle or raiser, etc. (*r* I) is introduced around the first and each alternate warp passing over the second wooden slip. (Fig. 62.) A second heddle (*r* II) is introduced below the fourth stick around every warp passing over it.

It will be noticed that, between the two of them, both heddles can raise all the uneven numbered warps, commencing with the first on the left; i. e., the upper heddle controls warp strings Nos. 1, 5, 9, 13, 17, etc., while the lower controls Nos. 3, 7, 11, 15, etc.

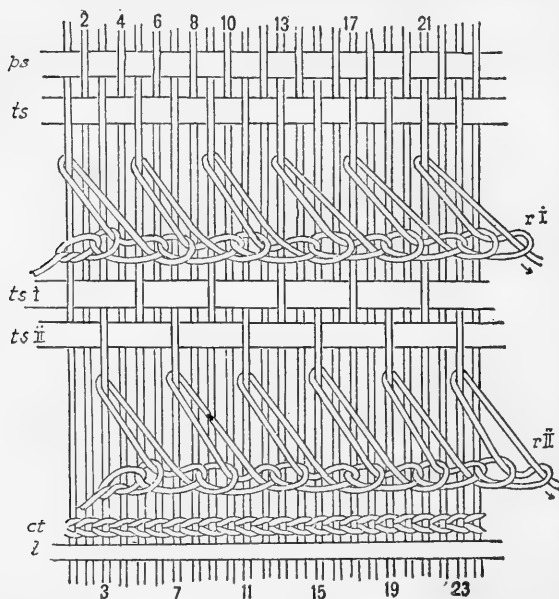

FIGURE 62.—Manufacture of a 6-weft Atoral hammock, continued (sec. 473 A), showing insertion of the level (*l*) and the commencing chain twist (*ct*). In actual practice the lower three slips (*ts*, *ts* I, *ts* II) are, however, previously removed

Remove the lower three slips (*ts*, *ts* I, *ts* II), retaining the top one as the permanent separator (*ps*) that divides the front set of warps into an anterior and posterior layer, the former consisting of even-numbered warps—i. e., Nos. 2, 4, 6, 8, etc.—the latter of uneven-numbered ones.

Note that the anterior layer of the front set of warps is not controlled by heddles, but can be raised by passing behind it the flat of the hand (facing you), the back of the hand sliding

along the front of the top slip or permanent separator (*ps*).

To make a commencement, insert your level (*l*) and fix the usual initial row of chain twist (*ct*) as in Figure 204 (WER, VII).

Raise the anterior layer of warps (fig. 63, *D*) as just indicated (i. e., Nos. 2, 4, 6, etc.), insert your presser or beater (*ts*), turn it at right angles to make space and pass in your first weft (*we* I), which is wound on a fairly long and proportionately thin shuttle.

When through, beat it down nice and straight with the edge of the presser (*EF*). Remove the presser. (See diagram, fig. 64.)

Now pull on the upper heddle so as to draw forward warps Nos. 1, 5, 9, 13, 17, etc., insert your presser and make space for the

second weft (*we II*), which is now inserted, and pressed down; remove the beater.

Pull on the lower heddle, so as to raise warps Nos. 3, 7, 11, 15,

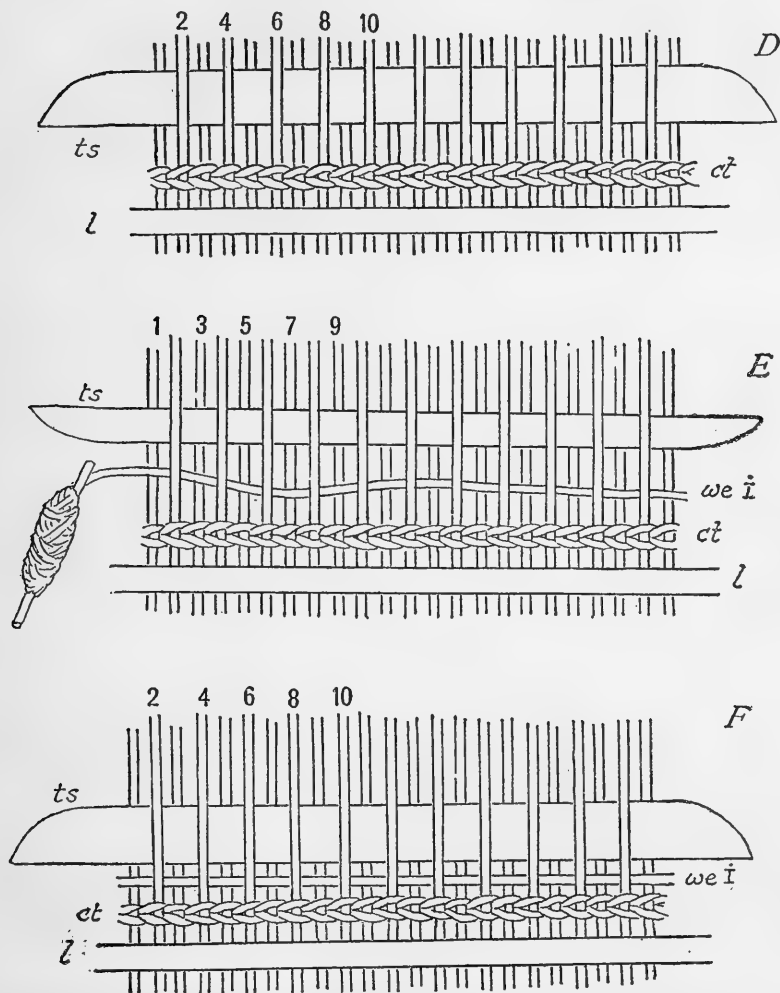

FIGURE 63.—Manufacture of a 6-weft Aorai hammock, continued (sec. 473 A), showing how the first weft (*we i*) is placed and fixed in position

19, etc., and observing the same details as just mentioned, insert the third weft (*we III*).

Similarly, raise the upper heddle for the fourth weft (*we IV*), the lower one for the fifth (*we V*), and the upper one again for the sixth (*we VI*).

Having thus reached the left extremity of the warp series, the wefts are reinserted from left to right in the following manner:

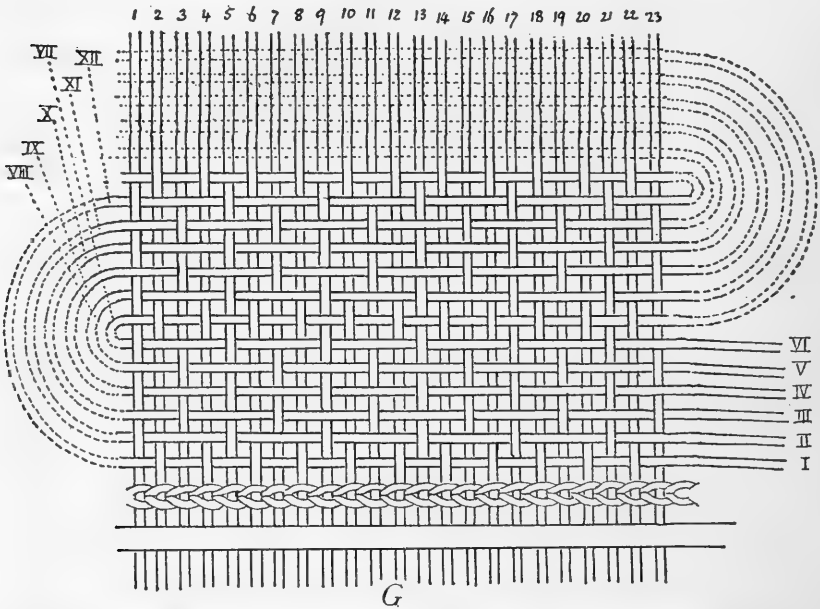

FIGURE 64.—Manufacture of a 6-weft Atorai hammock, continued (sec. 473 A), showing how wefts i, ii, iii, iv, v, vi in the first series become, respectively, wefts xii, xi, x, ix, viii, vii in the second series

Raise the anterior layer of the front row of warps (by inserting the hand along the front of the permanent separator), and after

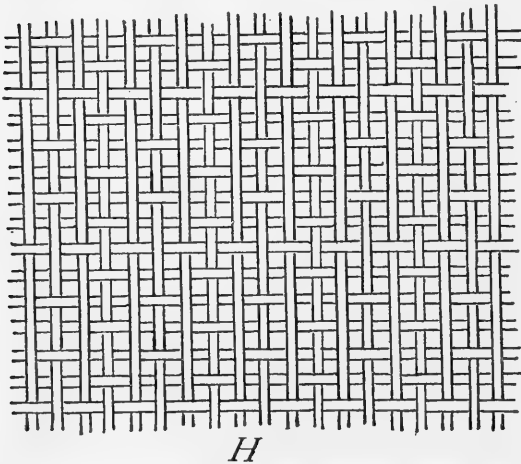

FIGURE 65.—Back of the 6-weft Atorai hammock, showing the smooth surface as contrasted with the front. (Sec. 473 A)

inserting the presser behind the warps so raised (Nos. 2, 4, 6, etc.) pass your sixth weft back again from left to right. This weft now becomes the seventh. Now pull on the upper heddle so as to draw forward warps Nos. 1, 5, 9, 13, etc., and insert, on similar lines as already followed, the continuation of the fifth weft, which now becomes the eighth.

So in the same way take up in turn the fourth, third, second, and first wefts, which become now, respectively, the ninth, tenth,

eleventh, and twelfth. In the same manner repeat the whole process back again from right to left, left to right, until the hammock is completed.

It is as well to note that the appearance of the back of the finished article (fig. 65) is quite different from that of the front; the even-numbered warps practically cover the intermediate ones, and so render the undersurface comparatively smooth in contrast with the rough upper surface—the main object underlying this method of manufacture.

Furthermore, whereas in the diagram the wefts when about to return on their crosswise journey are represented more or less concentrically, the arrangement is really such that each weft loop

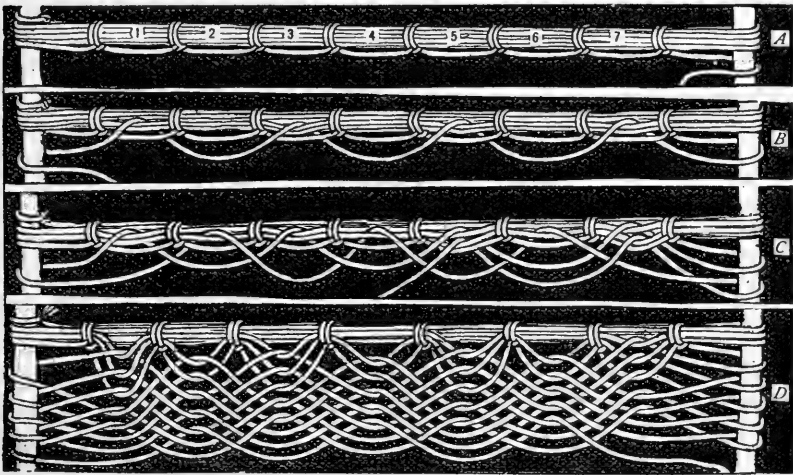

FIGURE 66.—Manufacture of the Waiwai hammock. (Sec. 477 A)

projects quite 6 inches or so from each side, all six loops being rolled into one another to form a sort of tassel.

Such a hammock may be of great size and occupy the attention of two women at a time. This, combined with the skill displayed and the labor entailed, causes it to be rarely made, and, when made, to command a high price.

477 A. The cotton, etc., or korowa (either of these materials may be used) hammock of the Taruma (Saloema), Trio and Waiwai is woven on a frame of two lengths of turu midrib joined by two smaller crossbars fixed in holes. This frame is set in a horizontal position. (Pl. 20, *a.*) Starting from left to right, a thread is passed across the top length between the bars forward and backward at least three times; this forms the top string. (Fig. 66, *A.*) On the fourth occasion the thread divides this top string into a

series of segments (I, II, III, IV, etc.) by means of clove hitches and terminates behind, around, and in front of the right-hand vertical bar. The thread now continues from right to left behind and over three strands of the seventh, fifth, third, and first segment, to end behind, around, and in front of the left-hand vertical bar (*B*). It next passes back again under and over three strands of the second, fourth, and sixth segments to end behind, around, and in front of the right-hand vertical bar (*C*). It again returns from right to left under and over three strands of the seventh, fifth, etc., segments, and so on. All one has to remember is that in each successive passage of the thread from bar to bar it deals with segments alternating with the preceding, and has always to pass under and over three strands in connection with the segment dealt with (*D*). While in reality the thread is kept quite taut and in close apposition on either bar, it is represented

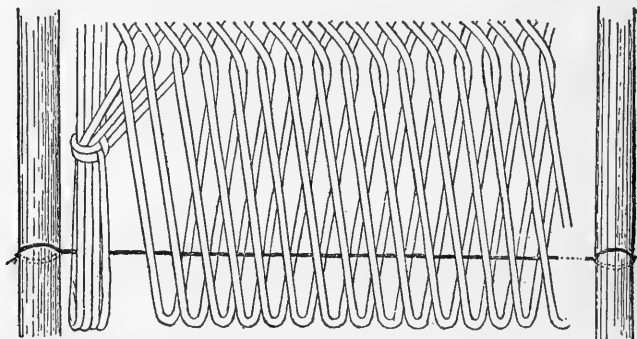

FIGURE 67.—Manufacture of the Waiwai hammock, continued. (Sec. 477 A.)
The frame is turned on its long axis prior to making the scale lines

in the diagram as quite loose to show the technique. After the weaving has been completed, the frame is turned on its long axis, the (now) lower bar being shifted into another pair of holes 8 or 10 inches farther down, its place in between the lowermost loops being substituted by a string that is tied across the bars. (Fig. 67.) The scale lines are now made. This is worked with a make-shift shuttle upon which the thread is wound; the end of the latter is secured to the extremity of the original compound crosstie with which operations were commenced, and passed over and under the lower bar. In the meantime, the operator, working from left to right, picks up the first three of the lowermost set of loops, into which he passes the second three, the two sets being hitched together by the scale line in the manner indicated in the illustration. (Fig. 68.) Next, the fourth set of triplets is inserted into the third, and hitched up again with the scale line, and so on until the whole lower edge of loops is done with. Taking the hammock

off the frame, and replacing it in the position required, the scale line on the opposite edging is completed.

478. *At end of section add:*

Among the Taulipang the cotton threads are occasionally colored black, yellow, or reddish brown with vegetable substances. To

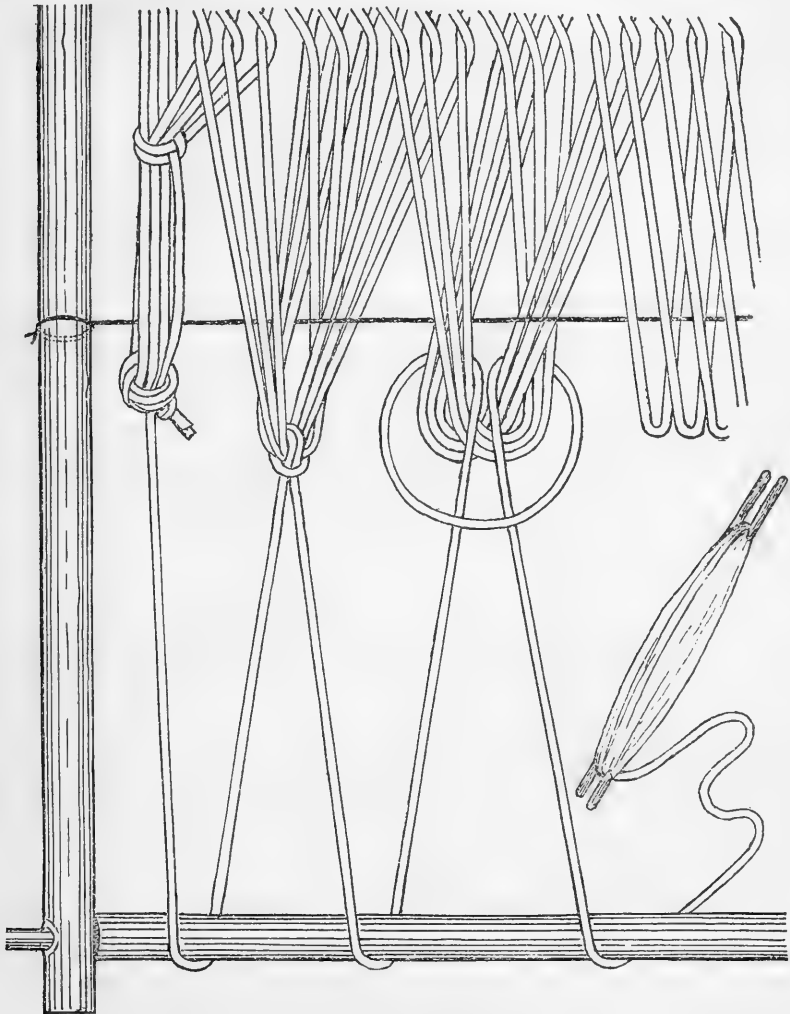

FIGURE 68.—Manufacture of the Waiwai hammock, continued. (Sec. 477 A.) The making of the scale lines

produce the red color the thread is put for a night in a lye formed of the bark soaked in water of a low savanna foliage tree which the Makusi call *molipode*, and the Brazilians *miriti*. This must not be mistaken for the similarly named palm *Mauritia flexuosa*. A yellow

and a blue-black color are obtained from the bark of other savanna trees. (KGR, III, 86.)

483. *Line 8, after extremities, add:*

For carrying their children the Oyana have an endless cotton band. This may be of the same construction as the Saloema bar hammock, each bar with four wefts and a single warp being taken up at a time. (GOE, Pl. VII, fig. 19.) For the same purpose Waiwai women use a piece of pliable bark with its ends joined.

503. *At end of section add:*

Both sexes of the Trio have the under lip pierced; on ordinary occasions, provided with a thorn or fine wooden splinter, on festive ones, with feathers attached to a little stick. (HER, I, 941, 942.) The same is true of the Waiwai, who call the feather ornament itach-horoku. (Pls. 23, a; 31, A, d.)

504. *At end of section add:*

Some of the Waiwai males also have a hole behind the outer corners of the mouth for the insertion of sticks to which specially prepared feathers are attached. (Pls. 22, a; 23, a; 24, A, b.) Such a cheek ornament they call wánatu.

505. *Line 9 from bottom, after say, add:*

This piercing of the nasal septum and the wearing of a pin to which a piece of metal is attached was mentioned by Coudreau. (Cou, II, 313.)

At end of section add:

The Waiwai and Taruma males may have the nasal septum bored, through which, on occasions of merrymaking, feathers are stuck from either side to form an ornament known to the Waiwai as i-yunarakka. (Pls. 22, b; 23, a; 24, A, c.) These feathers are specially prepared and "doctored." One of them carries in its quill a fine wooden pencil which fits into the empty quill of the other. (Pl. 22, b, 1.) It is a method of fixation likewise adopted by the Trio.

506. *Page 416, line 5 from top, after 2), add:*

Among the Oyana and Trio the ear lobes which are bored in youth with a glowing hot needle serve for the attachment of various decorations; with the Oyana, tassels of beads, etc., or at festivals, feathers; among the Trio, pieces of arrow reed with incisor teeth of the water haas, or little shells linked by a small band of beads which hangs under the chin. As a rule, the Trio replace this inconvenient decoration with short pieces of arrow reed that serve to keep the apertures open. (GOE, 8, 9.) The Waiwai, in both sexes, wear bunches of ear feathers (panatari) or water-haas teeth or pieces of iridescent shell (pl. 24, B, d), fixed with cement to small wooden pencils, maintained in position, as with the Trio, by means of a beaded thread or band passing under the chin like a strap. (GOE, pl. I, 4, and FAC, pl. XXXII.) The Pianocoto have their ears pierced. Some do not



a, Waiwai cheek ornament. (Sec. 504)

b, Waiwai nose ornament. (Sec. 505)



c



a



b



d

a, Waiwai males using the nose and cheek, and lower lip ornaments, respectively. (Secs. 503, 504.)
b, Waiwai females, one showing the necklet (sec. 531) and apron, the other the corselet (sec. 537) and cotton cross cords. *c*, Waiwai method (male) of wearing the hair in a tube. (Sec. 515.) *d*, Waiwai beaded bamboo hair tube. (Sec. 515)

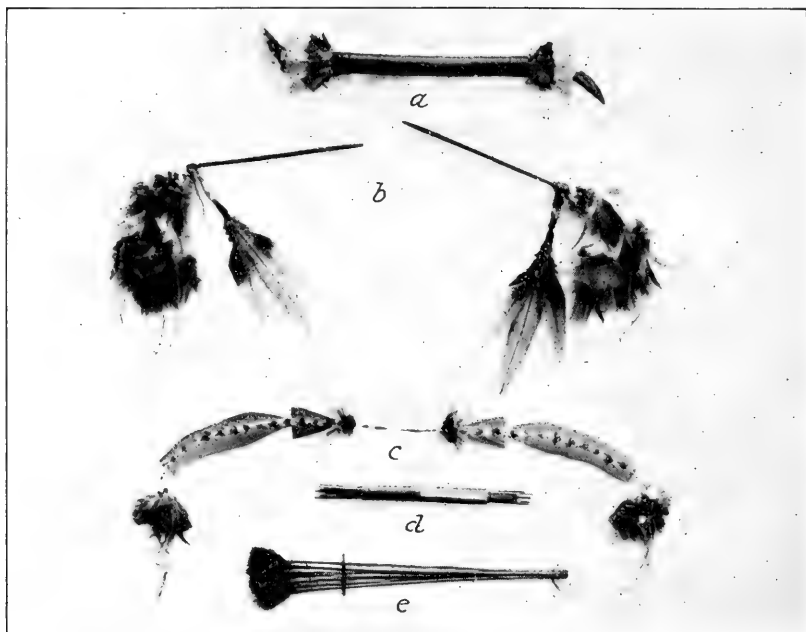

A, Various Waiwai ornaments and implements. *a*, Bush-hog scraper. (Sec. 18.) *b*, Male cheek ornament. (Sec. 504.) *c*, Nose ornament. (Sec. 505.) *d*, Stage in the making of a comb. (Sec. 517 A.) *e*, The compound brush cured for curare painting. (Sec. 122)

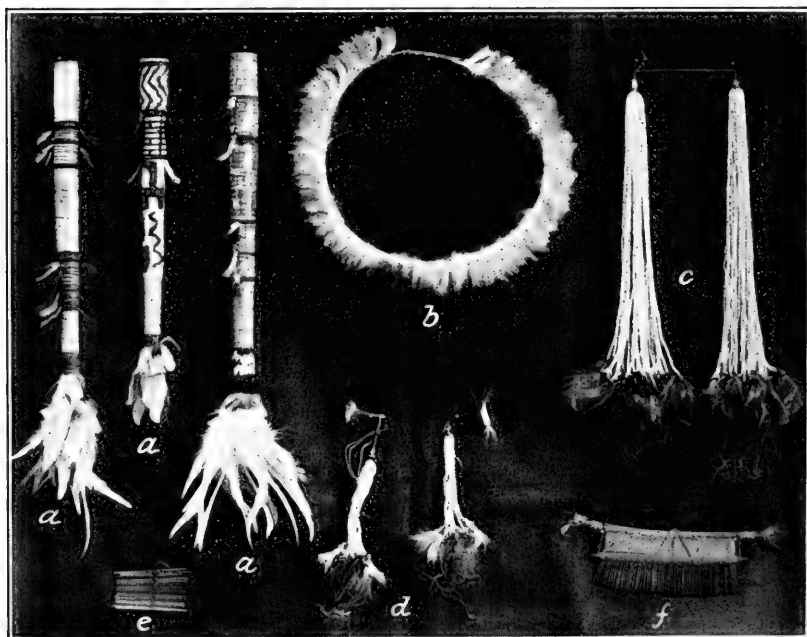

B, Various Waiwai ornaments, etc. *a*, Three simple forms of hair tubes. (Sec. 515.) *b*, A feather fillet. (Sec. 530.) *c*, A necklet. (Sec. 531.) *d*, Two ear ornaments. (Sec. 506.) *e, f*, Hair comb in progress of construction. (Sec. 517 A)

wear anything at all; some carry an agouti tooth with a blue bead; others deck them with two round disks that hide the whole of the ear lobe. (CO, 162.)

508. *Line 19, after 365), add:*

Moustache and beard are objected to by the Trio. (GOT, 1031.)

510. *After line 11, deleting This in line 12, add:*

At the beginning of the present century no trace of tattoo was present among the Trio, Herderschee suggesting that Schomburgk may have meant painting of the skin. (HER, I, 941.) But if a real tattoo was intended by the illustrious traveler this

510 A. Among the Pianocoto there is apparently a reference to scarification as a decorative agent—some scars on the arms. These are made with a tiger claw and are only favored by dandies who wish to appear attractive. (CO, 162.)

512. *Page 423, line 10, after 124), add:*

Like many other tribes, the Atorai have stamps for painting designs on the body. (FAA, pl. xxv.)

513. *Page 424, last line, add:*

The Pianocoto simply have a longitudinal line of genipa running from the forehead to the point of the nose, and another transverse one above the eyebrows. (CO, 162.)

514. *At end of section add:*

Feather down may decorate the hair as among the Trio (where the feather head crowns are reserved for dance parties). They had only painted their faces afresh, oiled their hair, combed it neatly and plastered it with maliti, specks of white eagle down. (GOT, 1033.)

515. *Page 426, line 26, after 74), add:*

A similar tonsure is described by Koch-Grünberg among the present-day Schiriana on the Rio Uraricuera. (KGR, III, pl. 44.) I am informed by an old Akawai female that in old times it was customary with her tribe on the Demerara River to "ring" their children's hair in this manner to make them grow in height and strength.

Page 426, line 8 from bottom, after 307), add:

Among the Oyana the hair is worn parted in the middle, and long, in both sexes. (HER, 112.)

Page 427, line 10 from top, after 278), add:

While the hair was cut away close to the ears (distinctive of the Trio), on special festival occasions, the hair was blobbed with eagle down in regular rows, and held behind in a tube of palm leaf or jaguar skin, with dependent red and green feathers. (HER, I, 941.)

Line 6 from end of section, after tube, add:

For everyday wear this tube consists of a couple of pimpler-palm pinnules spirally rolled to form a sort of elongate sugar loaf which is subsequently daintily painted and feathered. (Pls. 23, c; 24, B, a, a,

a; 25, *a*.) A great deal of artistic taste is displayed in the decoration of these articles. For high days and holidays this spiral tube is replaced by a piece of bamboo, covered with pretty designs in beads (pls. 23, *d*; 25, *b*; FAA, pl. xxv) to which are attached various gaily colored bird skins, beetle wings, cotton streamers, toucan beaks, etc., which dingle-dangle down the back. The simpler form of tube is known as *yammi*, the bamboo variety as *kirijiti*. I have ventured the manufacture of such beadwork on the tube in section 544.

At end of section add:

It frequently happens that an Indian keeps the hair short in order to be the better able to keep the head clean. De Goeje reports seeing on an expedition through the forest how a pair of Trio washed their hair with a sort of soap which they obtained by bruising and squeezing the bark of a bush rope. (GOE, 8.) The Oyana (the man, namely) frequently carries his toilet necessaries round his neck. This consists of a home-framed square piece of looking-glass, a wooden comb, a calabash with red pigment (*ruku*) and one or two bamboo tubes filled with a black color, rendered sweet scented by mixing with the resin of the "tingi-moni" tree (*Protium heptaphyllum* March) wherein are stuck two wooden needles. (GOE, pl. i, fig. 18.) The Trio fixes his toilet necessaries in a different way. The paint is kept in a little calabash, just like the crab oil with which he anoints his hair, sometimes also his face. (GOE, pl. ii, fig. 1.) In a small basket (pl. viii, fig. 7) he puts his looking-glass, comb, and small sticks for painting with.

517 A. The manufacture of the last-mentioned comb is carried out as follows (fig. 69): Splitting a convenient length from the midrib of a *turu* palm leaf, the Waiwai slices off a small piece from the outer cortex, cuts off a length according to scale, whittles it into a more or less flattened shape with a somewhat attenuated business end; it is the first tooth of the comb about to be made.

The scale that he measures the length with is the flat shaved-off portion of a piece of arrow reed. This has a soft pith, and the completed tooth is stuck into one of its extremities, the soft material acting as a pincushion for it. (Pl. 24, *A, d.*) Instead of the original *turu* strip being cut into a number of the requisite length and then completed, each tooth is finished before the next is commenced, each in its turn being stuck into the pincushion at either end of the pencil. The necessary number being obtained, they are attached to each other centrally one by one, with their proper ends together, by means of a *korowa* thread which is looped regularly over two and under two, over three (as a new tooth is added), and under two, and so repeated until all the teeth are connected. (Fig. 69, *B.*)

The ends on both sides are now trimmed and cut if necessary, so as to get straight edges.

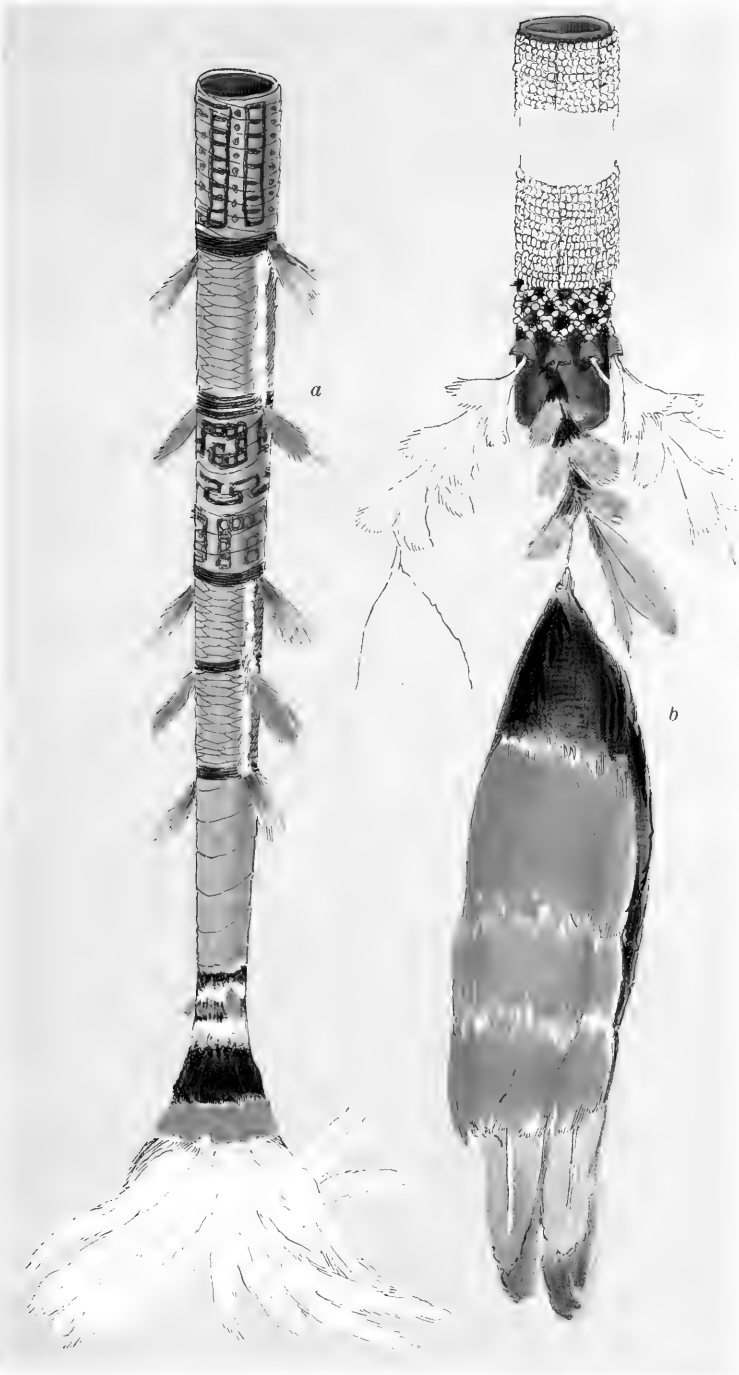

WAIWAI HAIR TUBES
(Sec. 515)

a, Spiral sugar-loaf form.

b, Beaded bamboo form.

Two fine strips of turu are now laid over the korowa chain, which they hide, and are tied at one extremity with korowa thread. This thread is continued in a spiral over both strips and in between the teeth, to be tied again at the other extremity (*C*).

The two turu strips are next covered with a crosshatching of cotton work that has a very pretty effect and which would appear to vary with the taste of the maker. From one end of the comb to the other the cotton thread passes in regular sequence from the top on the one half of the comb to the next seventh or eighth interspaces

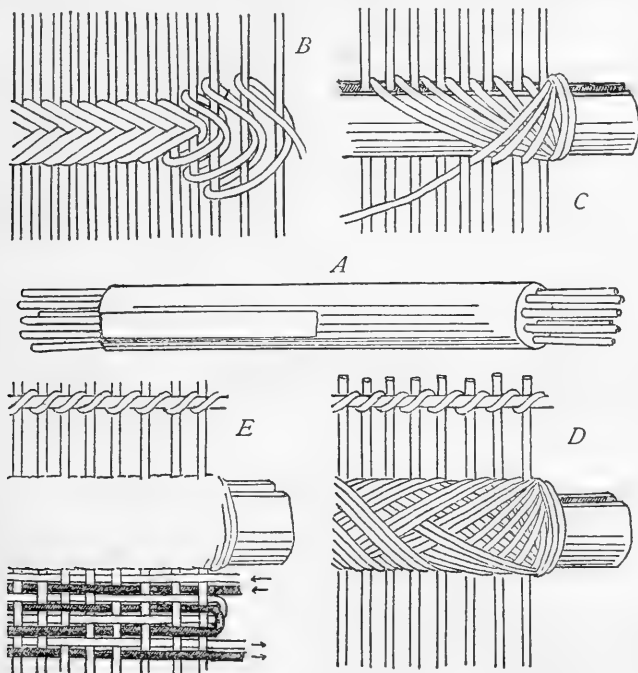

FIGURE 69.—Manufacture of hair comb. (Sec. 517 A.) *A*, Arrow reed on which each tooth, after being cut to measure, is stuck. *B*, The teeth are looped together at their centers by means of a korowa string. *C*, This central looping is now covered over with two flat palm strips, and then overcast in a decorative manner with a cotton thread passing in between the teeth to form a crosshatch. *D*, The front edge of the future comb is aligned, by means of a thin strip, and cut. *E*, The plaitwork is next taken in hand

on the other, back again to the top on the other half, and so on again, starting from the first interspace on the original half he started from back to the eighth or ninth interspace on the other half, etc. Every interspace has its own quota of cotton thread (*D*).

On completion of this cotton-tying and decorative work, a fine slip of turu is laid along and close to the edge of what will ultimately form the front of the comb. This is to give the proper regularity and alignment; it is affixed with a fine korowa thread wound spirally over every tooth in turn.

The plaitwork is next taken in hand, the teeth constituting the warps over which the wefts of ite and korowa fiber (rubbed with karamanin) are plaited. First comes the ite thread passing over and under three, and then the korowa one which passes under and over the same three (*E*). The first two rows completed, the threads are twisted and the return journey commenced again with the ite, the korowa following on the same warps again and so backward and forward from end to end until at about one-fourth inch from the tips of the teeth the plaitwork is complete. This plaitwork (pl. 136, *c*, WER, VII) may take on various patterns (FAC, pl. XXIX), but if the individual is lazy or in a hurry he will make a covering with bark-strip in place of plaitwork. (Pl. 24, *B, f.*)

The article is now jammed into a slot made to receive it in what I was told was one of the forearm bones of a howler monkey and fixed in position by means of a strong korowa thread tied round both extremities of the central cotton-covered turu slips. No opportunity of seeing how the slot was made offered itself, the Indian under observation taking out of his pegall an old one that he now utilized afresh.

After tying on a few scarlet feathers (macaw) at each end of the bone, and removing the spirally wound turu slip from the front of the article, the comb was completed. It took the better part of a day to make, the manufacture of the teeth absorbing the greater part of the time.

518. *At end of section add:*

These are the waluma (pl. 26, *b*), a high basket-work crown trimmed with feathers, of the Trio, and the olok (*a*), a huge 3-story frame of plaitwork covered with variegated feathers, decorated above with a radiating garland of long fiery-red macaw feathers, in vogue with the Oyana. (HER, I, 967; GOE, 10; GOT, 1088-1089.) Around the body of the olok crown are tied feathers that are attached by cotton bands. A fixed order is followed here. Below is a little band of mat work whereon tiny bits of horny material are sewn. The outermost of the large red and blue macaw feathers carry other feathers or wing-cases of the Buprestis beetle. The various component parts are put away in a pegall, the apparatus being only set up when it is about to be used. (GOE, 10.) And when it is put to use these long feathers are evidently kept in position by some sort of a hoop arrangement. (GOT, pl. xxxv, fig. 34.) I can find no confirmatory evidence for the statement (FAC, 221) of this head-dress being specially used by the medicine man, or ever worn in conjunction with any bark-strip cloak, or by the war chief in any dance preparatory to setting out on a raid, or in the celebration of a victory. As a matter of fact, the bark-strip cloak represented in

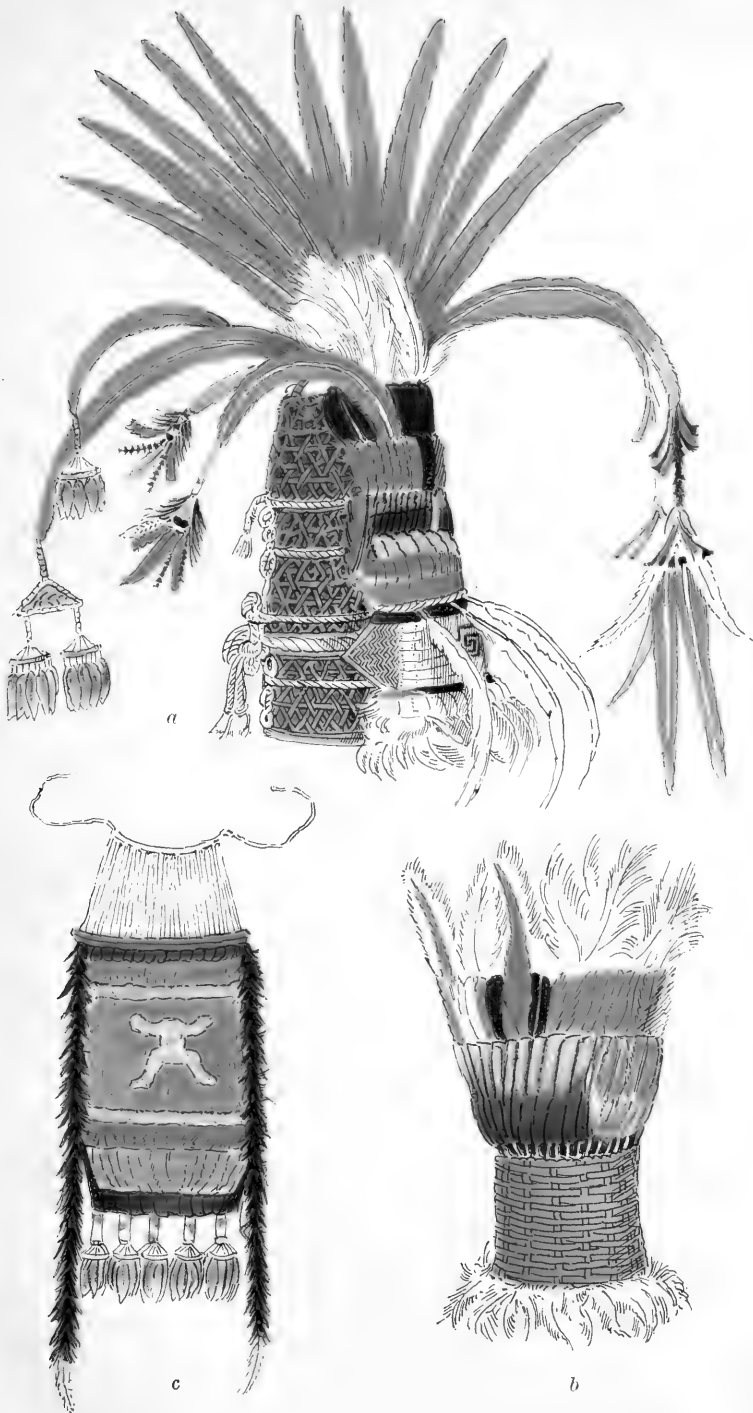

COMPOUND VERTICAL HATS FROM THE OYANA AND TRIO
(Sec. 518)

a, The Olok of the Oyana (GOE, Pl. III, fig. 1)

b, The Walum of the Trio (GOE, Pl. II, fig. 11)

c, The Hariketete back ornament of the Oyana (GOE, Pl. II, fig. 9)

the figure accompanying the above statement (FAC, pl. XIX) is strikingly like that employed in the Pono dance of the Oyana (secs. 840, 865). Both waluma and olók are dancing ornaments. Besides the olók, the Oyana sometimes wear the tamojetpé, a hat somewhat like the olók which is fastened to a small board. There was an article of this kind at Jamaiké; in a particular dance the one lays his hand on the shoulder of the one in front when the foremost man in the row then carries the tamojetpé. The people would not part with it because it could not be done without at the approaching festivities. (GOE, 11.)

520. *At end of section add:*

A specimen of the latter type is to be seen in the ledge of the crown in Figure 71.

524. *At end of section add:*

The long tail feathers of the macaw, as above mentioned, if fixed in the orthodox style, rest in holes bored through two bars attached to the back of the crown. (Fig. 71.) It is not unusual for the bases of such feathers, so utilized, to be covered with the glossy black crest plumage of the powis. (Pl. 27, A.) The tips of these long feathers are also often decorated. (Fig. 70.)



FIGURE 70.—Details of the macaw tail feather tips in Plate 27, A

In the Georgetown Museum is a vertical crown that is decorated in an unusual fashion by means of a string, to which comparatively large and evenly stumped feathers are attached, wound round and round it. (Pl. 27, B, a.) Unfortunately there is no reliable information as to its origin; it may be a freak and yet it somewhat resembles the headdress of the Paravilhano Indian figured in Richard Schomburgk's Travels, volume I, chapter VII.

526. *At end of section add:*

The Hamiré head ornament (GOE, pl. II, fig. 8), a plaitwork crown, trimmed with feathers, used by the Oyana when dancing, etc., belongs to the horizontal type of headdress. Strings of white cotton are attached to it. The basketry portion is of the locked or imbricate type. (Fig. 41, G, WER, VII.)

530. *At end of section add:*

To look smart, Taruma, Waiwai, Trio, and Oyana males will wear head fillets of red and yellow, or wholly one-color feathers. They call them apomali. Their construction is simple: Taking the various colored feathers out of the different boxes into which they have been sorted, they are fixed, faces down, onto a very thin palm-strip by overcasting their quills with a strong thread. (Fig. 72.)

531. *At end of section add:*

What may be called a necklet (pl. 24, *B, c*) I found used among the Waiwai females. It is composed of two tassels joined by a string, the latter resting on the nape, the former along the sides of the neck down over the chest. (Pl. 23, *b*.) The tassel is composed of strings of white beads terminating in the usual feather tufts (sec. 80). Panahoraku is the name of this ornament.

Bandoliers made of many loosely spun cotton cords, stained with annatto, are used by Waiwai men and women. Where these ornaments cross, both back and front, they may be tied or hitched together. The Waiwai women may also have them made of beads. The Trio similarly wear, crosswise, broad sashes of wiri which are decorated with little feathers, toucan beaks, etc. Worn between the bead sash on the breast or stuck through the bead band around the upper arm is the ipasikile (both Trio and Oyana), a little stick decorated with feathers, small monkey tail, etc. (GOE, 9, 10, 11.)

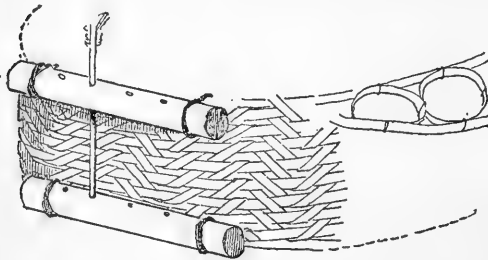

FIGURE 71.—Showing the two bars at the back of a vertical crown that support the macaw tail feathers. (Sec. 524)

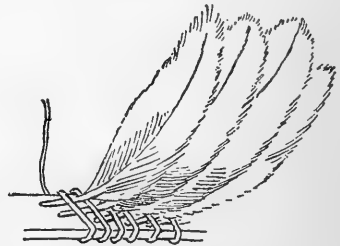

FIGURE 72.—Construction of the feather head fillet of the Waiwai, etc.

535. *Page 434, line 10, after white, add:*

the Trio, purple (GOT, 1036); the Emerillons, green (HER, I, 979).

Line 14 from bottom, after 540), add:

On the other hand, this arowepi may be the thread on which the beads are hung, of which Van Capelle writes as follows:

Below up a thick trunk creep the extremely thin and long woody stalks of a little plant that the Indians (?Warrau) call arowepi, and is so tough and flexible that they thread their beads on it for the pretty neck ornaments of their own women. (CAP, 181.)

Line 4 from bottom, after 285), add:

Thick threads of black seeds, instead of bead necklaces, would seem to be favored by the Trio for everyday costume. (HER, I, 938.) These are almost exclusively the black cylindrical (perhaps ground-down) threaded seeds (GOE, pl. I, fig. 10) which they call wiri, and the Oyana sara. On the coast they are named safroe (GOE, 9).

537. *Delete last paragraph and replace it by:*

Dancing ornaments of the Oyana include the harikete (pl. 26, *c*) and a little board with feather-like tails worn on the back. In the



A, Macusi vertical feather crown. (Secs. 82 A, 524.) The bases of the macaw tail feathers are covered with powis plumage



B, Vertical and horizontal feather crowns. a is feathered in an unusual manner

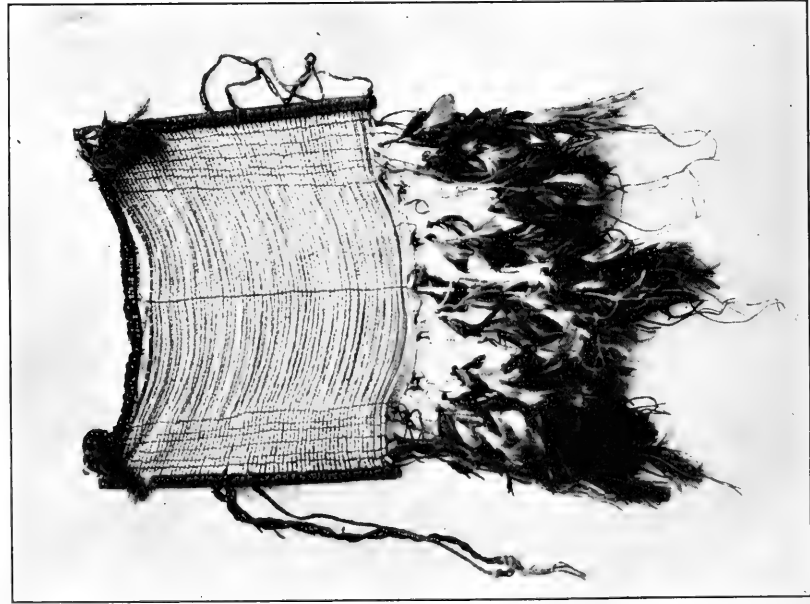

a

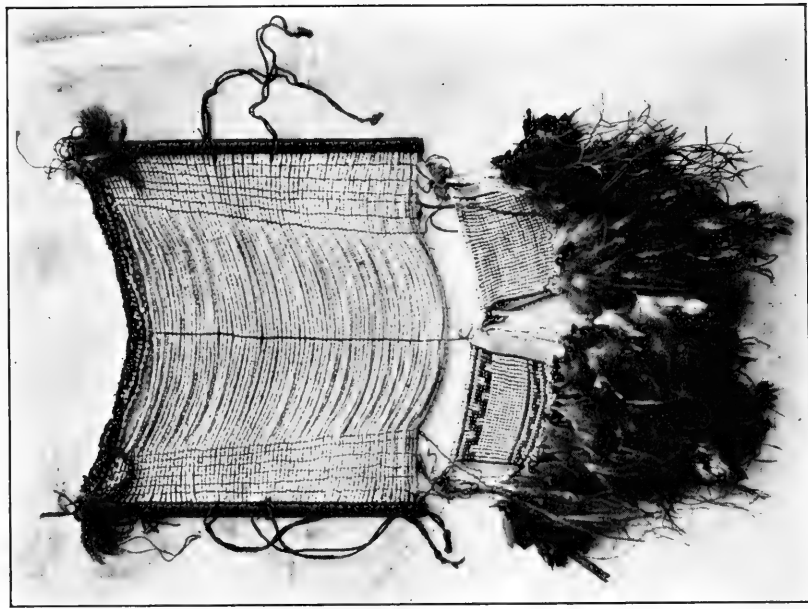

b

WAIWAI CORSELETS. (SEC. 537)

example figured the little board is decorated with a stuffed kingfisher, but in others it may be painted. (GOE, 10.) The harikete is a piece of cotton cloth upon which feathers are attached and decorated below with beetles' wings. It is worn on the back, hanging on a cord round the neck. (GOE, 10.) The manamu is a Trio corselet used in times of merrymaking. It consists of two small bars tied with strings of wiri, worn by women on the back, just above the waist, with the sticks vertical and tied in front. (GOE, 11.) The katami is the corresponding Waiwai similarly worn female ornament (which has been wrongly described as a beaded apron by Farabee, FAA, pl. xxix). The latter, however, instead of being uniformly black is made wholly of white beads (pl. 28), the separate strings being held together by central and lateral wefts, the technique being very like that of the beaded armlet found among the same people. (Pl. 30, c). The lower border may be free as in the Trio article, but may be still further decorated with buttock covers consisting of beaded strings with attached feathers (pl. 28, a) or a beaded fringe (pl. 29, a, b) or beaded band (pls. 28, b; 29, c), manufactured like a queyu, from which feathered strings are dependent. Where such covers are present there is usually to be seen a peculiar circular button made up of two halves, bored and tied together (pl. 29, d, e) from which feathered strings likewise hang. The button is attached close to the vicinity of the lower end of the central weft.

As typical of the variety of back ornaments may be taken the case of the Taulipang where, hanging down the back from the necklaces, a number of the following articles may be met with: Long thick cotton strands onto which tufts of feather down are tied, wings of the white heron and other birds, the neck skin of a maguary stork, bird skins (stuffed with cotton or silk-cotton) of toucan, green woodpecker, white gull, a whole duck skin, besides pelts of little mammals, a piece of pelt of a black ape, animals' tails (deer), bird beaks, filled up with black pitch into which white glass beads are stuck, even a bundle of three armadillo heads with their long ears and tails. Among the Taulipang at Roraima there was repeatedly seen a beautiful back ornament made out of the skins of seven-color tangerers (*Tangara paradisea* Sw.), humming birds, and other small gay-colored birds that hung from a ring overcast with cotton thread. The wing covers of the large Buprestis beetle are worn in the same way. (KGR, III, 37.)

538. *At end of section add:*

The sulu of the Oyana (GOE, pl. II, fig. 10) employed for dancing purposes, etc., is a kind of feather mantle which is worn on the back and tied to the upper arms. In the figure illustrated the method of construction reminds one of the first series of Im Thurn's shoulder ruffs mentioned above. A sort of cloak, manufactured of small strips

of tree bark, which covered the whole face is worn by the Oyana at the Pono dance. (GOE, pl. VII, fig. 16.) The Trio also appear to use such cloaks (okola). For another illustration of such a bark-strip cloth, see Plate 183 (WER, VII).

540. *Line 11, delete the sentence commencing The Oyana and replace by:*

The Trio wear bands of makka (pimpler palm) leaf tied round upper arm and above ankle. Occasionally a band of black seed (wiri) around upper arm. (HER, I, 941.) The leaf bands on the arms have markings on them (GOE, pl. I, fig. 17); those above the ankle are without (GOE, 9). Such bands are about 2 feet long with more or less attenuated extremities. (Pl. 30, a.)

After line 12 add:

At the present time these people wear armlets made of bark and leaf and of beads. The former, really a ring of bark about 3 inches wide for foundation, is covered or rather wound around with pimpler-palm pinnule, upon which a so-called Greek pattern is painted in black. From the lower edge hang a series of feather decorations, suspended by beads, etc. (Pls. 30, b; 33, B, a.) Such rings, drawn over the hand, wrist, and forearm, are just of the size to be held in place on the upper arm where they are worn (by men). Macaw feathers may be stuck upright inside these armlet rings, which are known as ahómi. The bead armlet of the Waiwai is of two varieties. The simpler consists of a single length, sometimes many feet long, of string beaded at the extremities with white beads, but its main portion with dark blue ones, or the colors may be reversed. When wound round and round into position over the upper arm its appearance at a distance is like a dark blue (or white) band with an upper and lower white (blue) border. The more complicated bead armlet of the Waiwai (pls. 30, c; 31, A, c) is made of a series of beaded strings lying horizontally one below the other, and each attached at its extremities to two vertical wooden slips about 3½ inches long. These bars have attached to them a cord above and below, and it is these cords that tie the armlet and keep it where required. Some half a dozen strands of thread running vertically lock the extremities of the horizontal beaded strings into position. The beading in the example referred to is blue and white, so arranged that a definite pattern results.

At end of section add:

Among the Pianocoto, men wear cotton bands, one over the right forearm, the other over the left wrist. (CO, 162.)

541. *At end of section add:*

Around the wrist the Trio wear beads or copper ring bracelets like the bush negroes. (GOE, 9.) At times of merrymaking I have seen Waiwai women wearing a wristlet made of a bead foundation with attached feathers. (Pl. 31, A, e.) The foundation is built up on

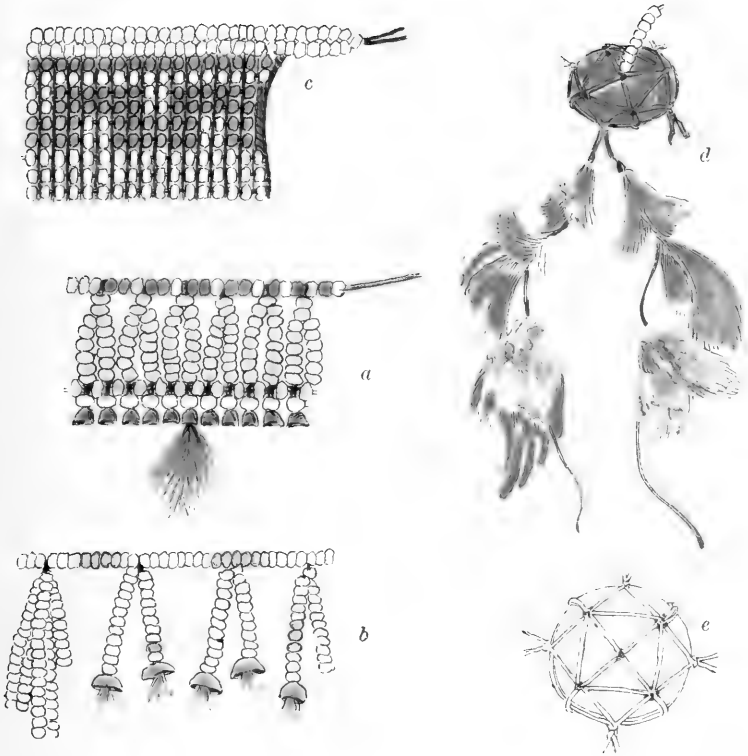

a-e, Waiwai corselet, showing details.
(Sec. 537)

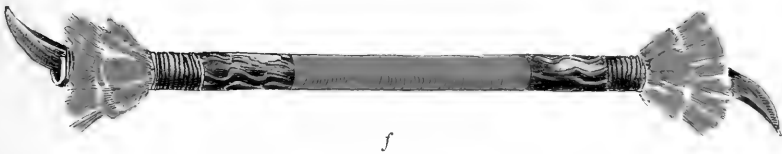

f, Waiwai bush-hog tooth scraper.
(Sec. 18)

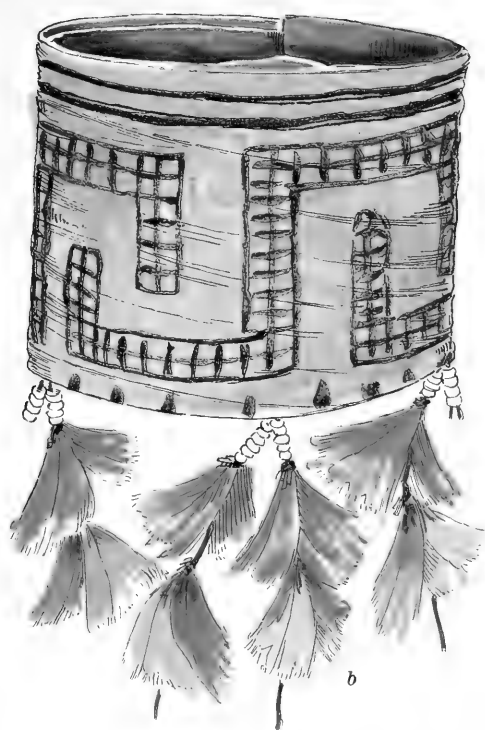

a

b

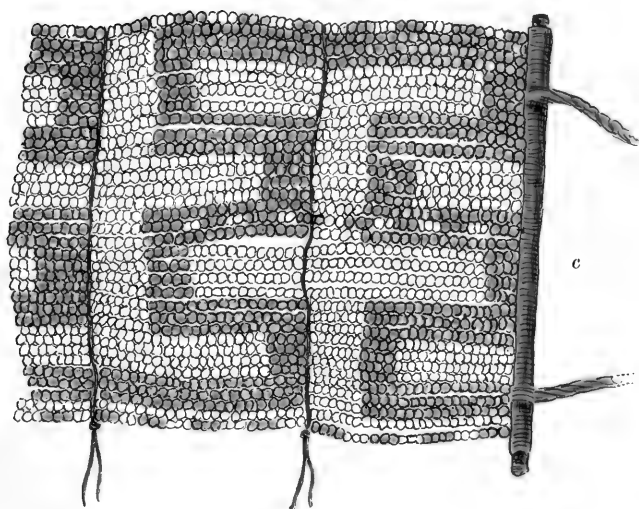
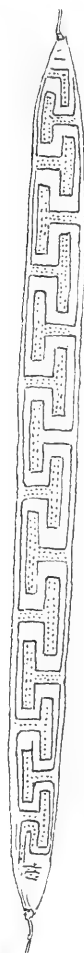

c

TRIO AND WAIWAI ARMLETS
(Sec. 540)

- a*, Band made by Trio from a pimpler-palm leaf.
b, Made by Waiwai from bark and similar leaf.
c, Made by Waiwai from beads.

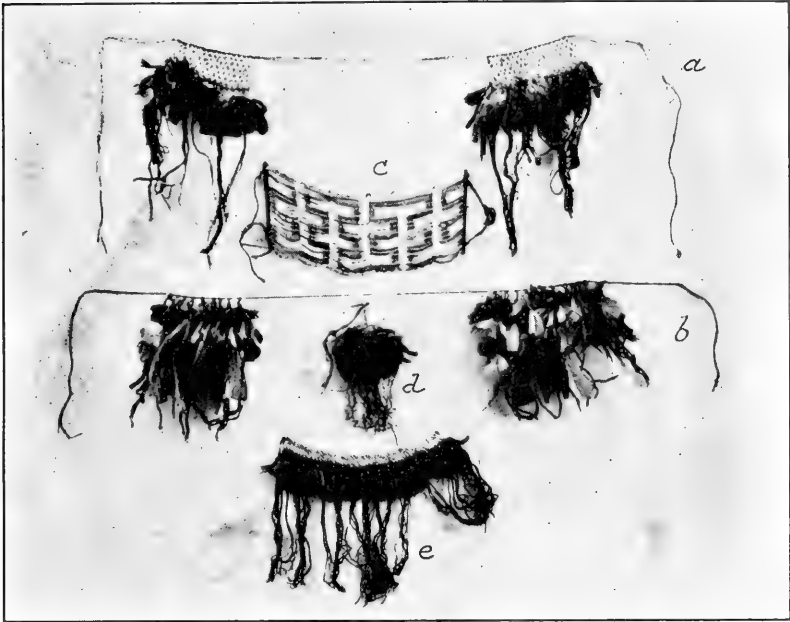

A, Waiwai bead and feather ornaments. *a, b*, Two cotton cord belts with bead and feather hip covers, respectively. (Sec. 543.) *c*, Bead armlet. (Sec. 540.) *d*, Lower lip feather tuft. (Sec. 503.) *e*, Woman's bead and feather wristlet. (Sec. 541)

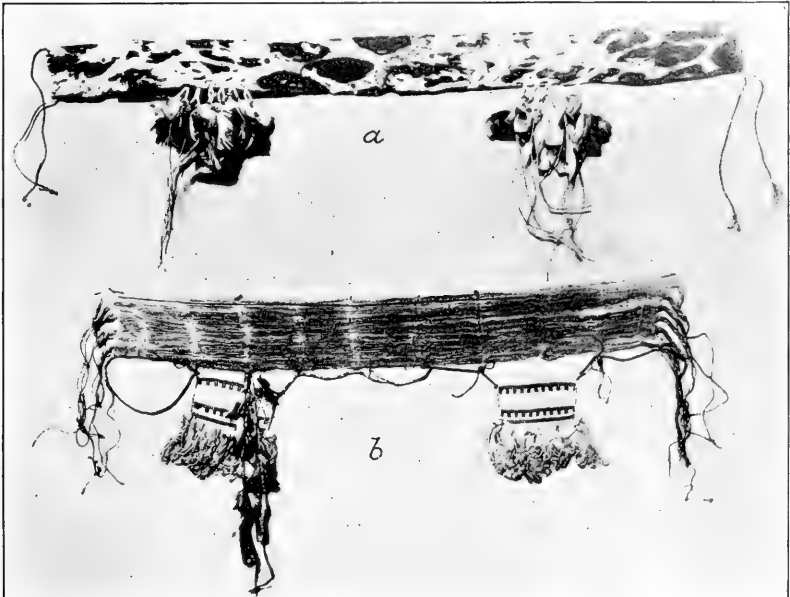

B, Waiwai men's belts (after Farabee). *a*, Probably of jaguar skin, showing feather hip covers; *b*, Shows bead hip covers. (Sec. 543)

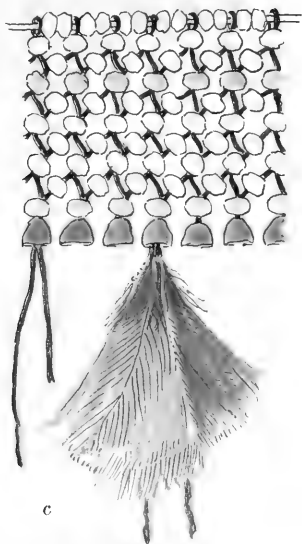

c



a

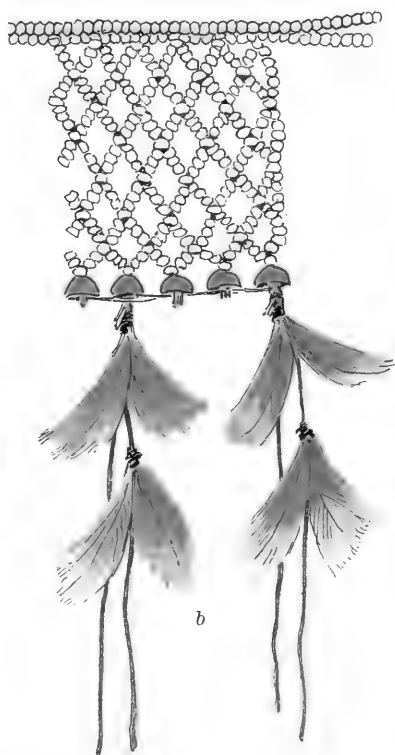

b

HIP-COVER BELTS OF THE WAIWAI
(Sec. 543)

- a, Hip cover made of looped, feathered strings.
 b, Made of bead network foundation.
 c, Waiwai wristlet. (Sec. 541.) Showing construction of bead foundation.

the flat in a somewhat unusual fashion, in fact along lines that I believe have not hitherto been recorded. (Pl. 32, c.) Although I have not observed the actual manufacture of the article, investigation shows that it is very probably as shown in the diagram (fig. 73); i. e., the beads are threaded on a series of strings looped over a top cord, one leg of each loop not lying parallel with the other but at an acute angle to it. We thus get a series of sloping strings and a series of vertical ones, their relative position being retained by the beads on the latter. Over and above this a bead is threaded on each sloping string between every two vertical ones. The terminals are threaded through a seed capsule and finally decorated with feathers.

542. *At end of section add:*

The Trio wear copper finger rings, obtained in barter from the bush negroes. (HER, 1, 941.) I also noticed the Waiwai with copper rings and copper-wire bracelets. They had been obtained by way of trade.

543. *Page 440, line 2 from top, after 11, add:*

and called it akoewali. (GOT, 1017.) The Waiwai as well as the

Page 440, line 19 from top, after 307, add:

The Trio use girdles of cotton as well as of wiri, decorated with feathers. (GOE, 11.) Unfortunately no description is given of the Waiwai men's belts (fig. 31, B) figured by

Farabee (FAC, pl. xxx) but those that I found among these people (pl. 31, A, a, b) are typical of a characteristic peculiar to the girdles of the Trio, Waiwai, and perhaps the Galibi, Caribs of the Marowijne, etc., in possessing what, for want of a better name and from the portion of body that they cover, I am calling "hip covers." These may be formed of a bundle of cotton strings, each looped over the girdle itself and decorated in the usual way with feathers (pl. 32, a), or of a bead foundation in the form of an ordinary network (b), the construction of which calls for no further description. The Waiwai call the men's bead hip-cover girdles akonhoraku.

544. *At end of section add:*

Since the above was written I have seen Wapishana boys with hollow cylindrical belts made of split kamwarri strand, differing from the above mentioned in that its manufacture entails only two loops

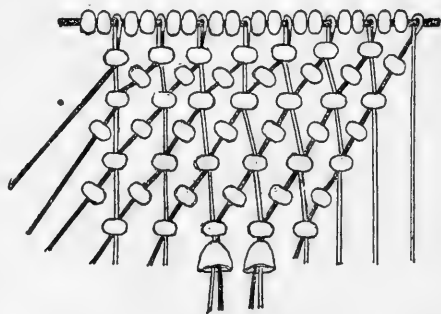

FIGURE 73.—Diagram showing construction of the bead foundation of the Waiwai wristlet

around the central wooden pencil. In diagram its technique can be represented somewhat as in Figure 75.

Among the Taulipang, and with the boys only, Koch-Grünberg saw bead girdles made by the women in pretty patterns woven out of European glass beads of different colors. The technique is the same as that of the bead aprons of the women. The woman takes a thickish bundle of cotton threads of a length equal to that of the future girdle. She holds one end of the bundle between the big and second toes of one foot and clinches the other in her armpit and in this way stretches the warp as in a frame. The weft consists of two very fine threads which are entwined crosswise around the outer

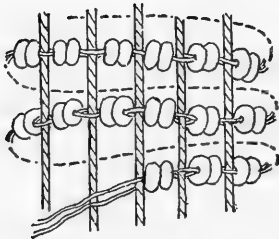

FIGURE 74.—Diagram to show construction of tubular beaded belt. (Sec. 544.) After Koch-Grünberg

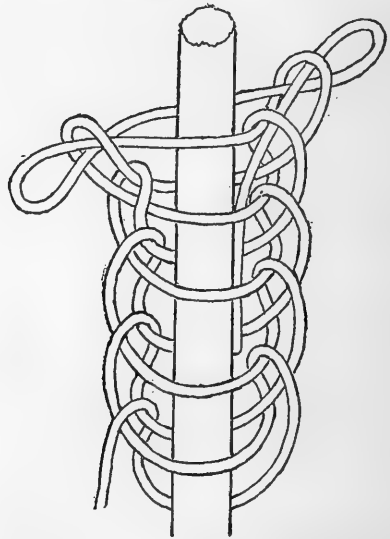

FIGURE 75.—Diagram to show construction of the 2-loop hollow cylindrical belt. (Sec. 544)

threads of the bundle, while the inner ones only serve as "filling." Two beads are threaded between every two warp threads. (Fig. 74.) While the weft is thus woven in spirals round and round the bundle close to one another, this becomes gradually entirely covered with bead patterns. (KGR, III, 32.)

Though I have never had the opportunity of watching the manufacture of the beaded bamboo type of hair tube, the kirijiti of the Waiwai (sec. 515), an examination of the specimens that have passed through my hands shows that the beaded covering could be made on lines similar to those followed in the making of the Taulipang belt just described.

There is a tubular bead girdle, believed to be of Makusi make, in the Georgetown Museum (pl. 33, *B, b*) which at first sight might be mistaken for the 'Taulipang boys' article, but closer examination shows that it is made of a long bead band with its lengths sewn together over the inclosed bundle of cotton.

548. Page 444, line 3 from top, after 49), *add*:

In the ordinary everyday costume of the Trio, European cotton is used, a kamisa supported by a cotton belt for the males, an apron for the women. On occasions of merrymaking, etc., the kamisa is replaced by an exquisitely finished (cotton) cloth from the Saloema and the linen apron by a bead kwejoe. (HER, I, 941.) The commonest method of wearing a short breechcloth with most of the men

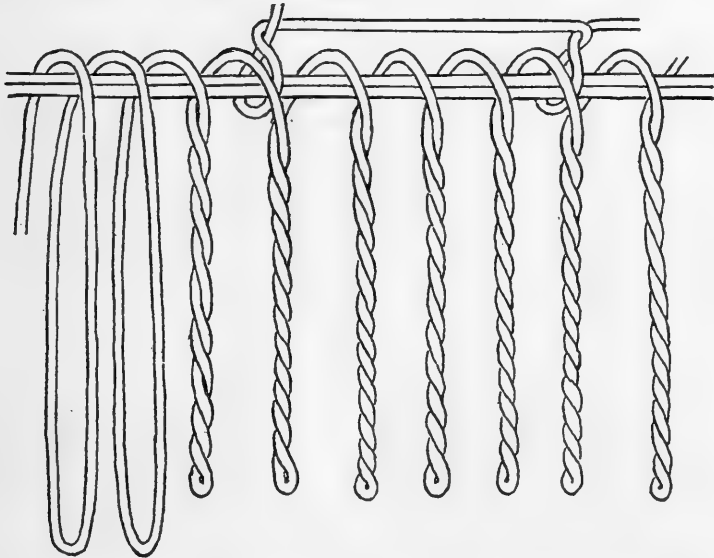

FIGURE 76.—Diagram to show construction of cotton-fringe apron belt (after Koch-Grünberg). (Sec. 548)

is to pass it under the fork and support it back and front over a belt. The Pianocoto cloth consists of a small piece of cotton material woven at the maloka and fastened behind [to the cord] by a knot, passed between the two buttocks, and [passing up under the cord] falls down in front. (CO, 162.) The Waiwai may wear a comparatively longer cloth, serving as a belt as well, and don it as follows: The man holds one end under his chin, passes the other back between his legs, around in front over his right hip, back over the left, and fastens it behind with a regular timber hitch, leaving 8 or 10 inches free to fall down over the left hip. The front is then folded down near to the knees and attached by the tassels, which are allowed to hang down in front on either side of the cloth. (FAC, 26.)

Page 445, line 8 from top, after 472), add:

Makusi and others. Koch-Grünberg (KGR, III, pl. 48, fig. 5) gives a diagram showing the construction of such a fringed cotton apron. (Fig. 76.)

548 A. The Waiwai loin cloth, breechcloth, lap, or kamisa as they themselves call it, is made of cotton. It is from 5 to 6 inches wide and up to 6 feet long, the width being uniform. (Pl. 33, A.) Its manufacture, which almost deserves a chapter to itself, reminds one of that of a hammock of the Ab3 series as laid down in my classification of those articles (WER, VII, sec. 479), e. g., the warp and weft are distinct and separate. The weft consists of a series of threads, each series constituting a bar. The frame on which it is woven is made of two horizontal timbers [canes in this case]. The warp is vertical, the weft horizontal, and the front set of warps are "interwoven" after division into anterior and posterior layers.

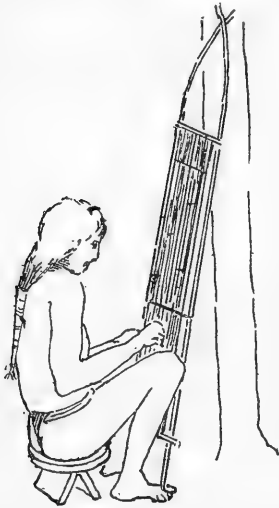

FIGURE 77.—Waiwai making a loin cloth. (Sec. 548 A)

The narrow frame on which it is woven (fig. 77) consists of two long canes, turu-leaf midrib, etc., bent, crossed, and tied above, and firmly bound with vine rope, etc., to upper and lower crossbars below. The distance between upper and lower crossbar must of necessity be more than double the half of the kamisa to be manufactured, and hence this alone may run to upward of $4\frac{1}{2}$ to 5 feet. The frame is steadied in position above, up against a house post, sapling, etc., where it may be tied, and below in between each big toe and digit of the Indian seated in front of it.

As in the hammock above referred to, the fine cotton of which it is woven is wound, not direct from upper to lower horizontal bar, but indirectly (fig. 78) over a strong cotton attached to both vertical bars, and at the same time in front of, and behind, a thin strip of vine rope, similarly attached to both vertical bars. The strong cotton acts as a headpiece (*h*) and is the starting point of the kamisa about to be woven; the vine rope, as permanent separator (*ps*) of the anterior and posterior series of the front set of warps, is fixed above the headpiece.

The cotton so wound over both bars constitutes the warps. These warps are now divided into three groups (fig. 79) from the headpiece up, to form the main width of the article and its two edges. Each of the latter consists of six strands only.



A, Waiwai loin cloth. (Sec. 548 A)

b

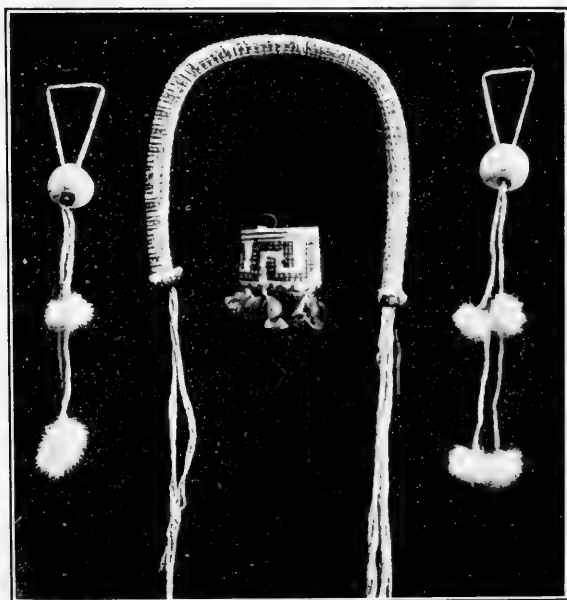

B, Various body ornaments. *a*, Waiwai bark and leaf armlet (sec. 540) surrounded by *b*, Makusi (?) tubular beaded belt (sec. 544), and *c*, two armlets with shell disks (sec. 540)



a



b

GLASS BEAD APRONS OF THE WAIWAI. (SEC. 549)

A raiser or heddle (*r*) is made now for the body of the article (fig. 80) so as to raise, bring forward, the warps of the posterior layer and thus admit of the passage of the weft behind them. The Waiwai speak of it as *yarúno*, and build it as follows: A temporary separator, presser, etc. (*ts*), is inserted behind all the posterior layer warps of the body by catching them up just above the

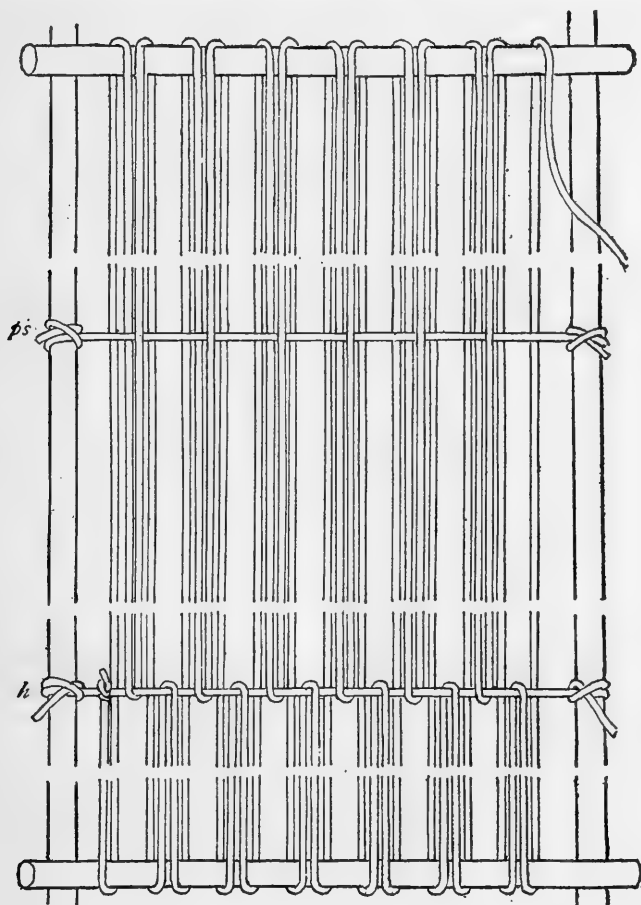

FIGURE 78.—Manufacture of the Waiwai loin cloth. (Sec. 548 A.) The cotton warp is wound indirectly from upper to lower bar in front and behind the vine rope, the permanent separator (*ps*), and over the headpiece (*h*)

headpiece—i. e., where they approach nearest the surface. It is then pushed up toward the permanent separator, and now turned on its axis to make space. In the case under observation the presser was a spatulate arrow tip, and called *waiyahú*. Into the space thus formed there is next introduced from right to left the extremity of a cotton string unwound from a ball. On emerging from the left the cotton end is tied tightly around the one extremity

of a short piece of arrow-reed pencil that has been split into two halves. A loop of the same cotton string is picked up from in between the first interspace of body warps, by means of a pointer, and fixed from behind forward into the split (inserted in the pencil's distal extremity), round the pencil, and into the split again. Another loop is picked up from the second interspace and the process

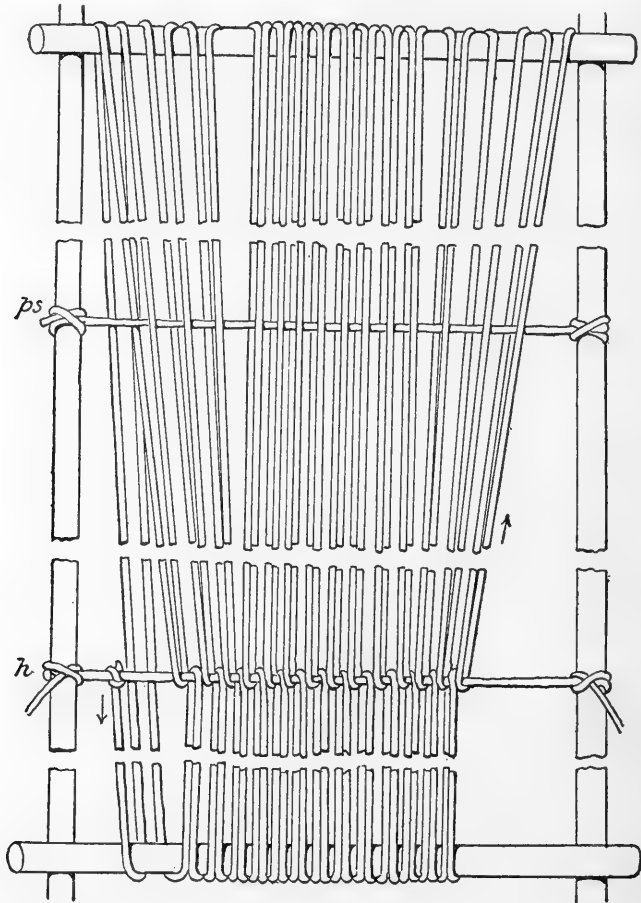

FIGURE 79.—Manufacture of the Waiwai loin cloth, continued. (Sec. 548 A.)
From the headpiece up, the warps are now divided into three groups, one central to form the main width of the article, and two lateral to form the thickened edges

repeated again and again until the whole series of loops (and with them, of course, all the posterior layer warps) have been caught up. The distal end of the pencil is next tightly secured around its two split halves. Great care seems to be taken in the manufacture of this heddle to see that all the loops are of equal length, and likewise approximated as closely as possible.

Secondary heddles (fig. 81) are now made for the edges, but in these cases without any pencil, the three loops in each case being tied together into a tail. Two of these secondary heddles are fixed onto the three front warps above the permanent separator, and two onto the three back warps below it.

A second presser (fig. 82), in this case also an arrow tip, is passed behind the front layer of warps above the permanent separator and retained there.

All the warps are now under control and a commencement is made by inserting three single and separate strong cotton wefts

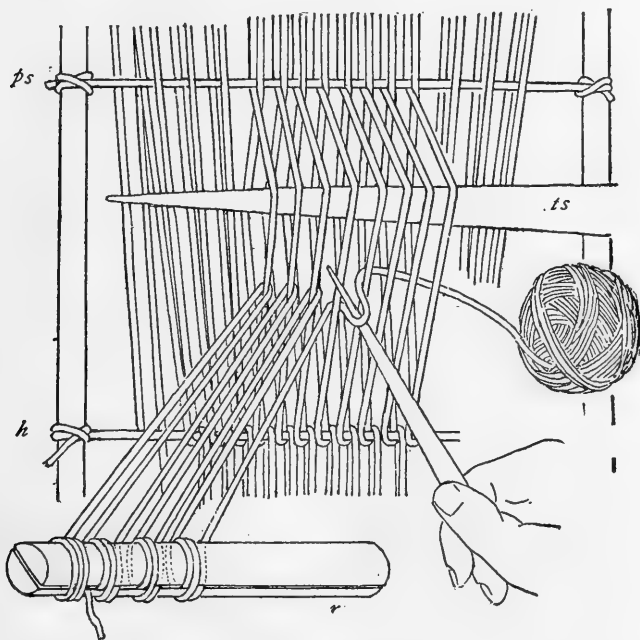

FIGURE 80.—Manufacture of the Waiwai loin cloth, continued (sec. 548 A), to show how the main heddle (*r*) is made for the body of the article

right across the body and edges, about which there is no difficulty. [These three cottons act the part of a chain twist, with which most of the hammocks start, and are strongly tied together at their ends before the headpiece is removed from the frame, and ultimately prevent the threads of the kamisa from becoming undone.]

The cotton for the weft is wound onto a shuttle; in the case under observation a flat slip of turu palm deeply notched at each end. While the cotton for the warp is very fine, that for the weft is still finer—the finest that can be made, and for which the Waiwai women are particularly noted.

To commence the actual weaving of the cloth, pull the main heddle forward, turn the presser horizontally, pass in your shuttle with weft from right to left, and press it down into position.

To deal with the edging, push the lower presser up out of the way, pull the left lower secondary heddle forward, pass your shuttle behind the three warps so raised, return it behind the edging;

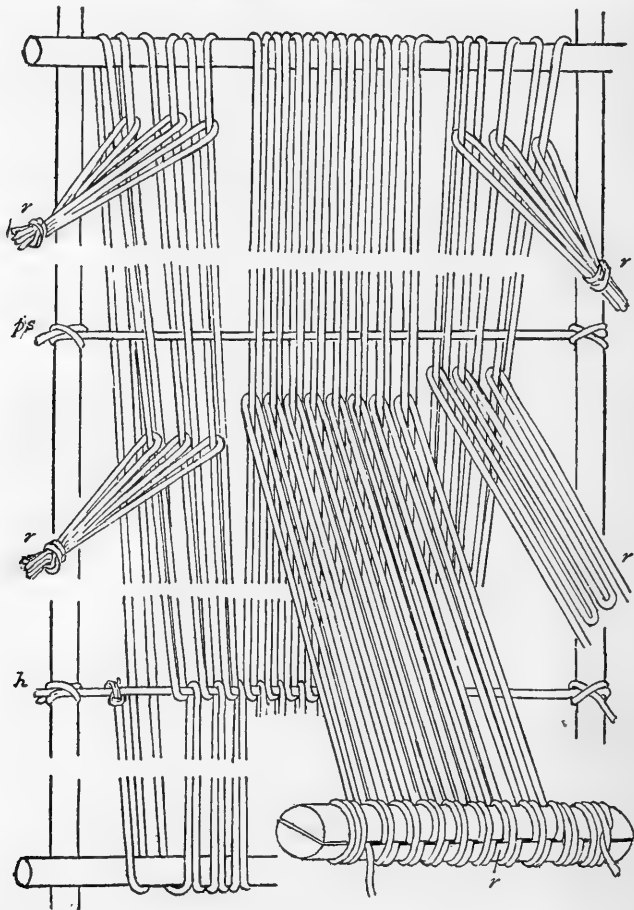

FIGURE 81.—Manufacture of the Waiwai loin cloth, continued. (Sec. 548 A.)
Secondary heddles above and below the permanent separator are next made for the thickened edges of the article

pull the left upper secondary heddle forward, pass your shuttle behind the warps so raised and return it, behind the edging, and back to the body. Press down.

Turn the upper presser forward, pass your shuttle behind the warps so raised from left to right, and with it the weft which is now behind the front layer of warps. Press down.

Pull the right lower secondary heddle forward, pass your shuttle behind the warps so raised, return it behind the edging; pull the right upper secondary heddle forward, pass your shuttle behind the

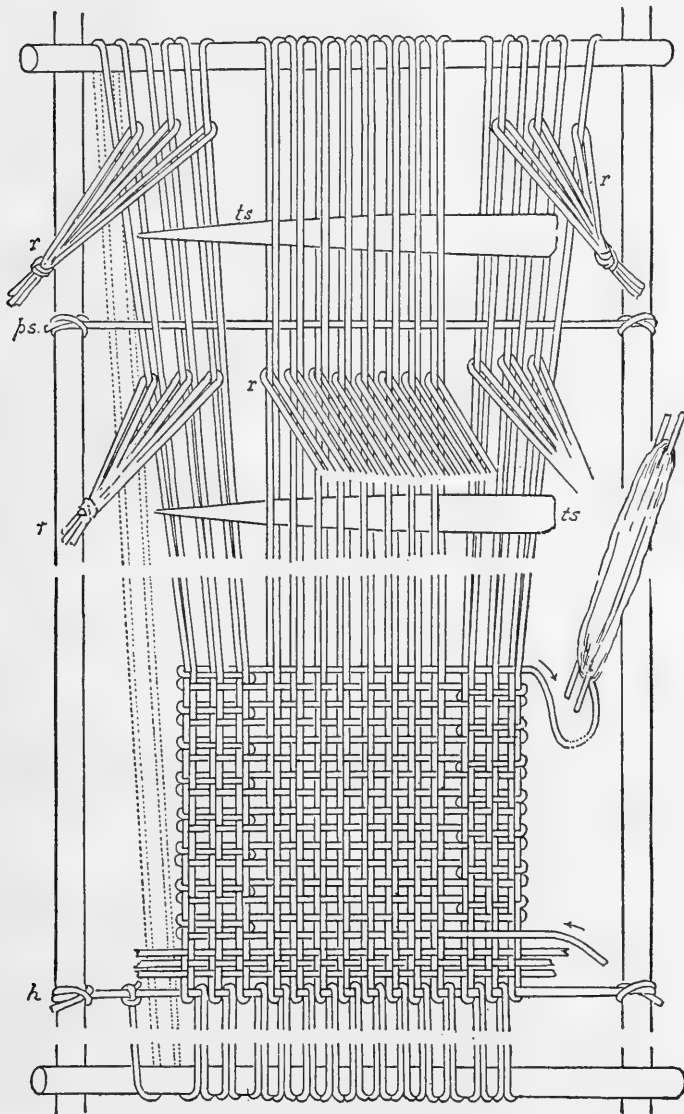

FIGURE 82.—Manufacture of the Waiwai loin cloth, continued. (Sec. 548 A)

warps so raised, and return it behind the edging again, so as to get back to the body. Press down.

So fine is this weft cotton that notwithstanding the double looping around the edging, which helps to "thicken" it, the wefts are

apparently in the most intimate apposition. Of course, in the diagram they have had to be represented as widely separated.

The weaving is thus continued backward and forward—left edging, body, and right edging each has an independent entity—until the whole length is completed as in the hammock originally referred to.

When completed, I was told that it was finished off with another three strong cotton cords (as at the commencement), and their ends tied, prior to removal of the headpiece. It is subsequently stained with annatto. and titivated with feathers, jingling seeds, etc.

549. *At end of section add:*

Waiwai women's glass-bead aprons are shown in Plate 34.

552. *Line 18, after Wapishana, add:*

With the Trio, as with the Oyana, cotton calf bands are woven around the leg below the knee; the men with, the women generally without, a fringe, but the habit of tying it so tightly as among the Galibi does not obtain here. (GOE, 9.) The Pianocoto wear cotton garters, with fringes hanging down to the middle of the leg. (CO, 162.) The Trio wear bands of plain makka leaf for anklets. (GOE, 9.)

558. *At end of section add:*

These trumpets were made of the inner bark of the kakaralli tree (*Lecythis ollaria*) by winding a band of bark in a coil 3 feet long, 1 inch in diameter at the mouth and 4 inches at the bottom. The band was held from uncoiling by tying four ribs of palm fronds lengthwise. (FAC, 160.)

560. *At end of section add:*

Such instruments having both ends closed (fig. 83, *a*) but with two vent holes placed near each extremity like the Taruma flutes illustrated in Figure 234 (WER, VII).

561. *At end of section add:*

The taloeloepan (fig. 83, *b*) is the large bamboo flute of the Oyana. At one extremity is a little hole into which a piece of feather quill is inserted and close to this end a rectangular mouth slot. The other end is open, but the bamboo projects a little for half its circumference for the support of the fingers. The blowing of this flute requires a fair amount of strength. (GOE, 24.) [I can not help thinking that some error has crept into this description.—W. E. R.]

563. *Page 457, after (AB) in top line, delete the whole remainder of the section and replace by:*

i. e., the distal end is closed, the closure being a natural one, a septum, or open. In the former case the air escapes through two longitudinal slits close to the extremity placed opposite each other, on a level at right angles to the line of the ventholes. It contains no perforated segment, etc., throughout its entire length. In the latter the air has,

of course, free room for escape, too much, in fact, whence it is accordingly limited by a segment left in situ or by the insertion of an artificial wax diaphragm, the three ventholes being perforated below such segment or diaphragm. This diaphragm has either a single large central perforation or (JO) occasionally (Taruma) a small central one

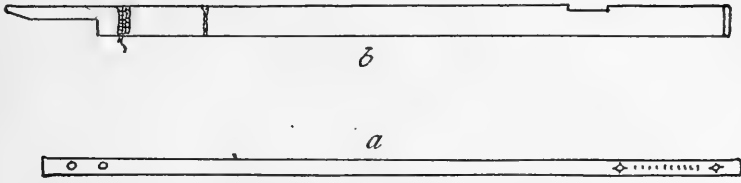

FIGURE 83.—Bamboo flutes of the Oyana (after De Goeje). (Sec. 560.) *a*, The taloelopan. *b*, Nose flute

surrounded by four others. In both cases there is the usual nick on the upper edge of the mouthpiece. The scarifying of the pattern is far from being an easy undertaking, the operator having to place his mouth in close proximity to the glowing end of vine rope over that particular portion of surface that he wishes to char. Bamboo flageolets also come from the Trio and Oyana. (GOE, pl. VII, fig. 9.) The three ventholes of the open or tail variety are operated by the left

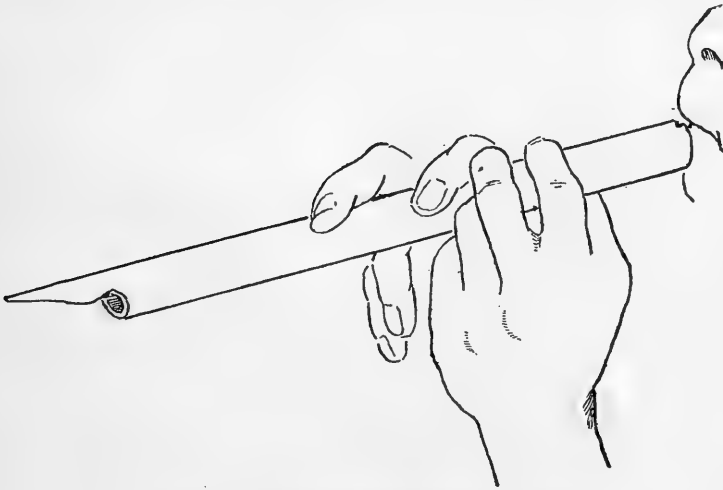

FIGURE 84.—Method of playing the flageolet. (Sec. 563)

index, right index, and middle fingers. (Fig. 84.) The distally closed variety has four ventholes.

564. *At end of section add:*

The lower end is always open.

566. *At end of section add:*

With the Oyana and Trio panpipes are used in conjunction with a tortoise shell. (Sec. 582.) The latter is smeared with balata over the

posterior of the belly plate. The player holds it under the left arm and strikes it with the right hand, when it produces the single note. With the left hand he holds the little panpipe in front of his mouth. He dances at the same time. (GOE, 24.)

567. *At end of section add:*

On my visit to the Waiwai country (May-June, 1925) I came across these half-moon shaped whistles, one of which had the sounding box made of a large seed capsule. The other half dozen or so were without this arrangement. Considering that I saw certain of these articles made from start to finish, and most of them played on, I am at a loss to understand the statement that it is no longer in use, and no one knows how to play it. (FAC, 176.) They are painted with a red foundation of annatto, upon which are drawn black figures, similar to those on the stone graters. The Waiwai call them ya-mo.

574. *Line 8, after Juss. add:*

The Trio call these seeds as well as the band made from them koe-ai. (GOT, 1089.)

581. *Page 469, line 4 from top, include in the parentheses:*

GOT, 1091.

582. *At end of section add:*

Farabee thus describes the Waiwai tortoise-shell resonator (sec. 566): The underlip of the shell was coated with black pitch, which, when struck a glancing blow with the heel of the right hand, adhered sufficiently to cause the lip to vibrate and to produce a loud, chirping sound. (FAC, 159.)

583. *Page 471, line 2, after 197). add:*

Schomburgk mentions the shouting after the dance among the Akawai. (ScO, 216.)

At end of section add:

Try as I could, I have been unable to obtain confirmation of the statement (FAC, 67) that often the drink gives the name to the dance. What has happened is that there has been a muddle over the names, e. g., the greatest dance is not the paricari (FAC, 39) but the parishara, and the name (Makusi) of the drink is parakari.

584 A. Though happening to take place on the occasion of the death of a Trio female, what is probably a special male puberty initiation dance is the tapsem of the Trio, of which a comparatively full description is given by De Goeje and is here curtailed. It was at this dance that the extraordinary olok headdress (sec. 519) was brought into requisition. He says:

As darkness came on, drums and pegalls were brought out and several men began to decorate themselves with feathers, strings of cotton, etc. At 8.30 a start was made. (GOT, fig. 32.) In the middle stood a man who held in his hand the tapsem, an old olok attached to a board. In the other he held

an arrow and tripping it on the spot, sang in a monotonous minor key. Seven prettily decorated men ran stamping round him, one behind the other, each with a hand on the shoulder of the man in front and in the free hand a green twig. At a little fire sat the headmen and some others who, looking on, did not take part in the dance. They were repeatedly brought calabashes with omani, the fermented cassava drink * * *. And so the festivities proceeded all night through * * * and at daybreak there still only resounded the monotonous song and the swishing of the koelai, bands of jingling seeds which the dancers wore around the leg below the knee. When it was quite light the women got some food ready and the men ate, but a couple of the dancers remained continuously on the go. And also after the sun began to get too strong to be able to keep it up outside it was continued inside one of the houses. In the meantime the pegalls in which the costly feathers were preserved were pulled open and some of the men started rigging themselves up in a three-story olok (sec. 519). A small koenana mat (sec. 884) was furnished with ants (GOT, fig. 33), and the headman Pontoetoe stuck with it various children of from 6 to 12 years of age, who were brought to him * * *. Three young men, Makot, Sili, and Ololi, already filled, since the evening before, the rôle of masters of ceremony. They each had a small piece of arrow reed in their hand, and wore no decorations whatever. Toward the end of the afternoon the tapsem ended and three of the dancers were fixed up with the oloks. Each received a large decorated flute in one hand, and a specially fashioned arrow in the other,² and so betook themselves away dancing and playing the flute. Others seized palm leaves and canes with which they tried to cut them off, to force them back, and finally to surround them. In the meantime several children were again treated with the koenana * * *

Toward dark everything ended * * *. But in the latter part of the night it began again and at dawn was in full swing. The men sat now all in a row. A couple of youngsters about 12 years of age, who had been stung the day before, were led up by the masters of ceremonies and took their places with the men * * *. Everybody drank until he was full, found space by the reverse operation, and again drank anew and so on till the ground in front of him was like a whitish muddy slough * * *. This lasted for an hour * * *. The ornaments were discarded and all went away * * * to secure wasps in their new koenanas * * *. Toward midday they came back with them * * *. Later there was another performance. Five men brought a board which they held above their heads. Each of the three masters of ceremonies went in rotation to stand under it, and received from Pontoetoe some blows on the calves with a bundle of young palm sprouts. Afterwards Makot and his two colleagues dug a hole which they filled with palm leaves and covered with the plant, whereby a hollow sounding dancing floor was obtained. Toward the end of the afternoon the same game of the previous day was repeated. The masters of ceremonies afterwards bathed and were now fixed up for the main festival. All the men donned beads so as to make them look all the more radiantly decorated. The head of each was invested with an olok; on the back an uncommonly pretty feather was placed; strings of cotton were attached to the arms and neck; round the hips a petticoat of new colored cloth; jingling seeds on the legs.

It was already dusk before it was ready. Each of the dancers now received in his right hand the great festival flute, in his left hand one of the koenanas attached to a stick, and all of a sudden small fires were simultaneously lighted at various points. Illumined in front by a couple of men with burning chips,

² Illustrations of these are given in GO, pl. 1, figs. 2, 3.

the dancing now made good progress—an uncommonly pretty sight. They soon reached the dancing floor. The koenanas were taken from the dancers, and in their place a dance arrow fastened to the left wrist, and with a spring they stepped onto the dancing floor and started stamping straddle-legged there, all the time blowing on their flutes.

The people rammed posts in the ground here and there onto which they slung their hammocks, so as not to lose anything of the show, and yet be able to have a rest.

The three danced like this all the night through. Only now and again did one leave his place. The heavy olok was taken off him, and, seated on a bench, he refreshed himself with omani. At break of day, however, their gorgeousness and magnificence came to an end. Makot was the first to stop dancing, and betook himself to the spot where they had dressed him the night before. They now stripped him of all his ornaments, and he was then led to the dancing floor.

Pontoetoe now took one of the koenanas and commenced pressing it on all sorts of spots on the unfortunate man's body.

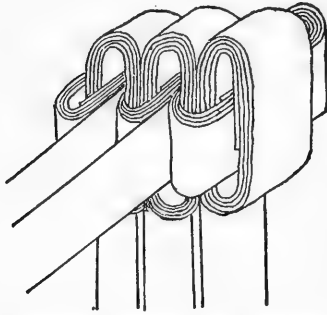

FIGURE 85.—Parishara dance headdress; method of fixing the horizontal into the vertical pinnules (after Koch-Grünberg). (Sec. 539)

* * * *

The sufferers have now to keep a strict fast for the next six days, when they are only allowed to use dry cassava. The omani was not yet ripe and the other young men spent the rest of the morning in various games. One of the funniest of those games was when some men imitated a troop of couatta monkeys who went to disturb the repose of the sufferers by climbing onto the tiebeams of the ornament house. The others formed a complete hunting party, tracked the monkeys up and finally overpowered them. (GOT, 1089-1093.)

589. *Line 10, after C). add:*

How the Taulipang manage to join the horizontal onto the vertical pinnules in making the crowns, etc., is shown in Figure 85, which I have taken from Koch-Grünberg. (KGR, III, pl. 8, fig. 4.)

610. *At end of section add:*

Wapishana youngsters are also adept at shooting play arrows—any round wooden splinter or pencil—a considerable distance with the fingers alone. Shot from the bent left forefinger acting as a bowstring, the arrow, resting over the left wrist, is held between right thumb and forefinger in the usual manner. (Fig. 86.)

651. *Line 8, for on ul side read on distal side.*

655. *Line 4, for R ul l read R ra l.*

658. *Line 23, for i read m.*

661. *Page 520, line 5 from top, add and draw out.*

671. *At end of section add:*

After repeated manipulation I find that my description must be incorrect. Lutz, however, gives the same figure as "Pis or river" [really intended for "Fish in river" by his Indian interpreter], which he makes as follows:

Put each hand in the string, having it run back of the wrists. Bring the left ulnar string to the radial side and proximal of the radial string, then distal of it and place it on the little finger without twisting it. The strings to the right hand will, however, be twisted near the middle. Run the right little finger from the radial side under the upright string, which runs between the left ring and little finger, taking this string up on the dorsum of the finger and separate the hands. Place each wrist loop on the corresponding index finger without twisting. Passing each thumb on the distal side of the index loops, take up on its dorsum from the proximal side the strings between the ring and little fingers. Return the thumbs to position and place on their distal ends that part of the index loop which is between the index fingers and the thumb. Release the first loop put on the thumbs by pulling it over the second and the end of the thumb. There will be a triangle formed between each thumb and index finger. Place each index finger in its triangle from the distal side and continue the twisting of the hands



FIGURE 86.—Wapishana method of shooting play arrows. (Sec. 610)

(toward the body, then down, then out), at the same time releasing the little fingers. If the thumbs and index fingers are not kept well apart the figure will be narrow. (FEL, 11.)

687. *Line 3, after each the add distal.*

Line 10, add as far as (C).

689. *Line 3, add as far as (C).*

Line 12, for i read t.

693. *Page 538, line 4, for M read m.*

Page 538, line 10, for t and l read all the fingers.

Page 538. In the illustration Figure 309 alter (B) into (C) and alter (C) into (B).

694. *Page 539, line 12, add (C).*

Page 539, line 26, omit (C).

696. *Line 7, delete the whole and replace by:*

Now follow the last four paragraphs of section 671.

699. *Line 18, add: replacing i and m by t and l.*

713. *At end of section add:*

A variation of this puzzle is met also among Wapishana where two loops, with shoulders too large for them to pass through, have to be unloosed. The material from which the toy was cut was wild plantain leaf. (Fig. 87.)

715. *At end of section add:*

To open two locked leaf strips constitutes a third means at the disposal of the Indians for circumventing the bush spirit who has caused them to miss the track. I had noticed an example of the puzzle among Makusi some years ago but had ignored its significance and only recently resumed its acquaintance among the Wapishana and Taruma, where it was made of two long strips of wild plantain leaf with a varying number of slits from three to six in each, it being immaterial whether the two strips have an equal number of slits or not. In the illustration shown (fig. 88), one has five and the other (*a*) four. These have been locked by superposing them, inserting the cut segments of the one in regular sequence into the other over the

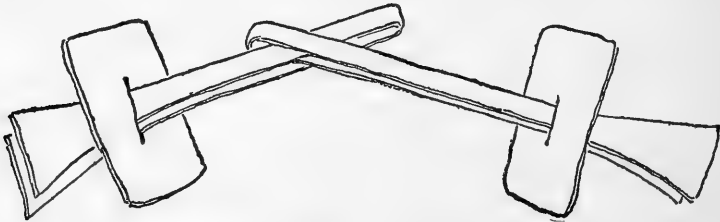

FIGURE 87.—Wapishana variations of the bowstring puzzle. (Sec. 713)

left forefinger (*b*) which is then replaced by the two lower tucked-up ends (*c*) that are now pulled through and carefully manipulated until arrived at its final position (*d*). To open it, the bush-spirit will take considerable time.

719. *At end of section add:*

If an Indian (Trio, Oyana, etc.) is giving an account of his family he begins by telling how many women and children he has, but all in a breath is added, a hunting dog that is suitable for chasing tapir, another that is specially trained for hunting bush hog, etc. (HER, I, 902.)

720. *At end of section add:*

The women have most care of the dogs. They take them from their platforms and carry them under their arms to the creek each day for a bath. Morning and evening they carry them away from the house and turn them loose for a run, but gather them under their arms again to carry them back to their platforms * * * The short rope with which the dog is tied has a stick in the middle part to prevent the dog chewing it. (FAC, 43.) At the Taruma village

of Wannawantuk the dog benches were ranged right round the inside of one of the houses and accommodated more animals than there

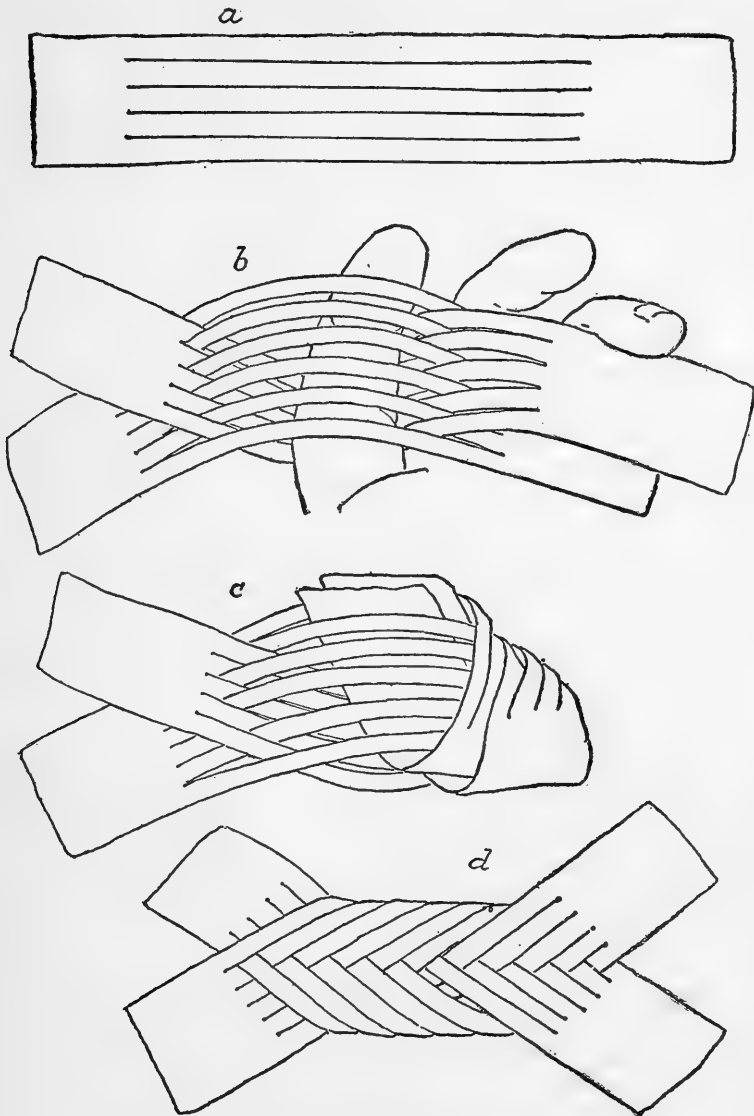

FIGURE 88.—Puzzle to lock and open two locked leaf strips. (Sec. 715)

were residents. The animals are apparently of mixed breed and well cared for, but neglected and cast out when their days of usefulness are over. In these circumstances, they are not directly killed but

left to die by being forcibly driven out of the camp, or stranded on the farther side of a crocodile-infested stream.

724. *Page 556, line 13, after 183). add:*

So again, the Oyana, etc., breed white poultry (HER, I, 904, 907) chiefly for the feathers for dance ornaments (HER, 122). At night they are kept in a pyramid-shaped coop 2 meters high made of sticks stuck into the ground and tied together at their upper ends (HER, I, 898), a structure common to many other parts of the Guianas.

725. *Line 5, after were, add:* (BER, ch. xxiv).

740. *Line 7, after 257). add:*

Tojepotori to the Makusi (ScO, 358), iapotoli to the Trio (HER, I, 957).

Line 9, after 241) add:

and who is subordinate to the headman. (GOT, 1035.)

770. *At end of section add:*

In the eastern Guianas the Oyampi, Aparai, and other Carib stock were apparently addicted to the practice. (HER, I, 937.)

778. *At end of section add:*

The following is reported by Herderschee from Surinam:

I carve my name and date on a tree and, according to Indian custom, the Trio decorate the spot by hanging up on the sticks and branches old katalis (shoulder baskets), wreaths of palm leaf, couatta bones, etc. (HER, I, 954-955.)

It is quite possible, however, that other reasons may have prompted the Indian to such action, e. g., the propitiation of the medicine men, spirits, etc., to insure a safe return. (WER, VI, 229.)

784. *At end of section add:*

The descriptions given De Goeje by Indians of the route up the Tapanahoni with the help of a sand tracing (HER, I, 899) and of the track from the Paloemeu to the Paroe by word of mouth alone (HER, I, 965) likewise constitute interesting examples of their sense of locality. Koch-Grünberg gives some remarkable examples of maps drawn by Indians. (KGR, III, 90, 350.)

787. *At end of section add:*

The Taruma village of Wannawantuk is situated on a hill of that name about 300 feet high fronting the right bank of the upper Essequibo a little above the mouth of the Kuassikityu. On my arrival at the landing there in April, 1925, I was led to an extraordinary structure at the foot of the hill which was nothing less than a stepladder built up its steep declivity. It was formed of runners with wooden rungs tied crosswise, the former running zigzag at a greater or less angle according to the conformation of the slope. Extra support was afforded by a double handrail formed of vine rope attached to gaudily painted stakes driven into the ground at distances about 10 to 12 feet apart. In my climb up to the top plateau I counted over

260 rungs and I have often pondered over the labor and skill entailed in the fixation and construction.

Of other methods employed in climbing, there is the type of a single log with successive steps cut in it, often to be seen on the banks of various streams, or sometimes doing duty as a doorstep. For mounting from the ground floor to the upper story in Makusi, etc., houses I have noticed a pole with rungs tied more or less at their centers across it at regular intervals. A more advanced development consists of two posts with notches into which the rungs are attached and employed for similar purposes. (GOE, 11.)

790. *At end of section add:*

On the other hand, a sturdy vine rope can be utilized for climbing the tree from which it is dependent. (HER, 40.) But trees may be climbed without any apparatus at all * * * now, most of the young Indians [Arawaks at Paramaribo] began a general attack by climbing the trees with great agility but not, as Europeans do, with the help of the knees. These Indians put the soles of their feet against the

trees, and in this manner walked up, holding fast with the hands, which certainly must require a great deal more strength. (SAC, 122.)

793 A. Canoe making on the Kuyuwini, a branch of the upper Essequibo, has some interesting features about it. (Fig. 89.) After felling and trimming the log, the Wapishana flatten the top surface,

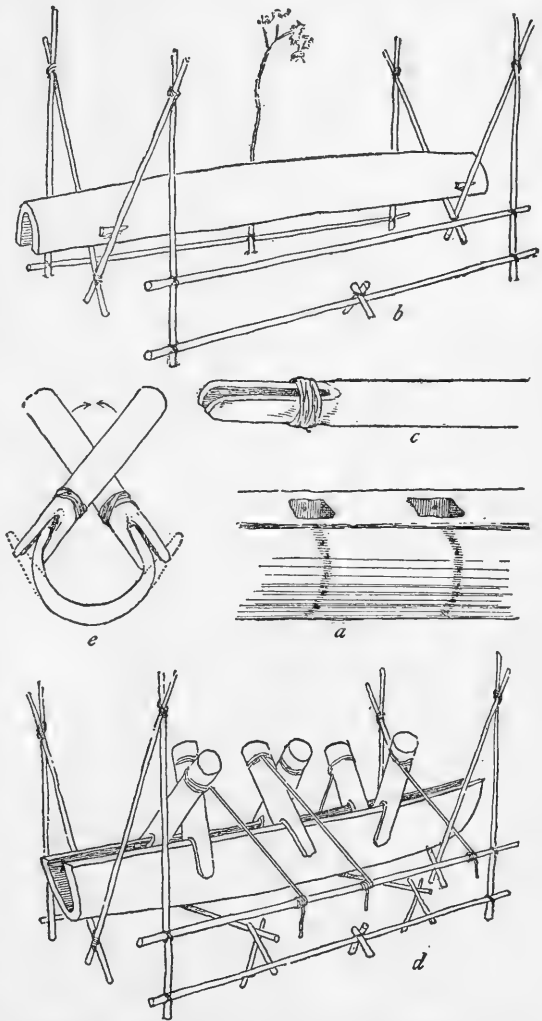

FIGURE 89.—Canoe making on the upper Essequibo. (Sec. 793 A)

and mark out the area to be excavated and roll it over. It is then lined out with a charcoaled string and roughly divided into three parts to represent the bow, body, and stern, the first and last being tapered from above down, as well as laterally toward their respective extremities. At about every foot distant, from end to end, the blackened line is run across the log, and at 3 or 4 inches interval along each, holes are made with a brad awl. These holes are about 2 inches deep, perhaps a little more, and are regulated by tying a string around the brad, beyond which it must not pierce the timber. The log is next turned on its back and the excavation started about the center by means of a carpenter's large chisel fixed into a long stick so as to be worked with both hands like a shovel. The gouging takes place along the area of one of the black crosslines (*a*) and as soon as the brad-awl holes are reached the canoe maker knows he has gouged sufficiently deep. He then starts along the area of the next black crossline, and when that is gouged out, he cuts and picks away the intervening timber with an ax. This process is continued all the way through until the whole body of the canoe is gouged out, the two ends being left to the last, and are only opened when the vessel is placed downward on a scaffolding specially prepared to receive it. (Of course, if a corial were being made, the ends would be left as they are.)

The scaffolding consists of two sets of crosspieces supported by four posts (*b*). If any trees are conveniently situated they are utilized; otherwise, posts are cut and fixed where required. The length of such a structure varies in proportion with that of the vessel to be supported; the width is about 9 feet. Two rails are attached to the sides, the lower about 6 inches and the upper some 3 feet from the ground. At the same time that the scaffold is being fitted up, some four to six forked logs are made ready. Those that I saw were cut from the lu palm (*Oenocarpus* sp.) to a length of about 4 feet, the fork being about a foot, and strengthened with a vine rope to prevent its splitting when put to use (*c*). This implement seems to have no special name. When I inquired, they called it mapurr, the name of the palm from which it had been cut.

All being ready, the vessel is made to rest on the angles of the two crosspieces into which it is wedged, and a slow fire set going below along its whole length, but started first of all at either end, then in the middle, and finally in the spaces intervening. Particular timber for fuel is chosen and the fire kept up for some three to four hours, until the outer (upper) surface becomes sufficiently hot for the hand to touch. Two extra supports on trestles that in the meantime have been prepared are quickly fixed in position, and the vessel turned over onto its back, when it is made to rest, the ends

on the higher crosspieces and the body on the somewhat lower props.

The forked logs are at last placed in position, jammed into the excavated sides, and drawn outward and downward, both by hand and by vine-ropes straps that are tightened up on the rails (*d*). The sides are thus gradually opened (*e*) and kept in their new position by strong crossbars. As often as not the canoe maker will jump inside, and standing on a piece of bark to protect his feet

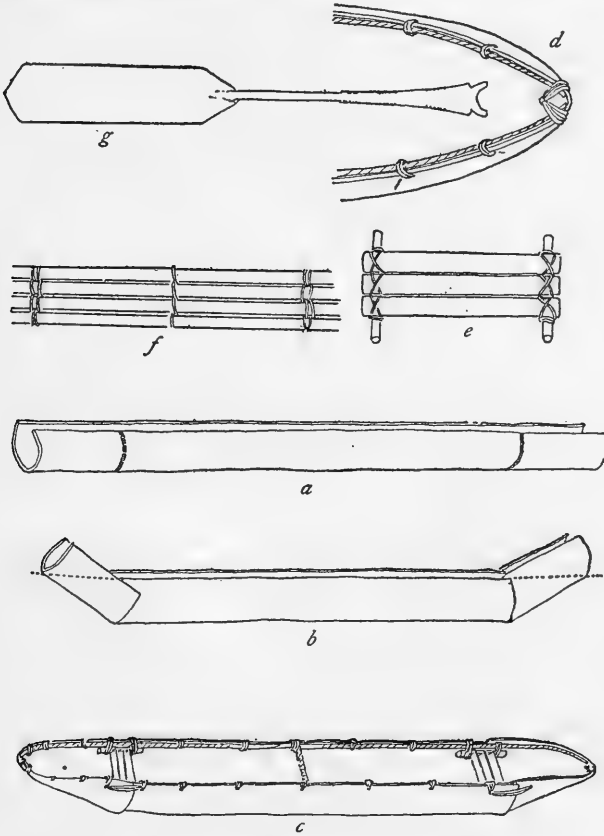

FIGURE 90.—Manufacture of the Waiwai woodskin. (Sec. 798 A)

from being burned arrange or alter the position of the forks. The ends are finally closed with the thick heavy triangular plates.

798 A. The Waiwai and Taruma woodskin (fig. 90, *c*) is made of locust tree (*simiri*), and would seem to upset the opinion previously expressed and endorsed by reliable observers (sec. 798) that it will accordingly curl up in a few weeks' time and prove useless. Investigation, however, has shown that the locust tree of the higher reaches of the Essequibo is not identical with that known as such

in other parts of the colony. The method of construction, which is peculiar, may also prove to be a prime factor in its permanency.

After removal from the tree in the usual way the bark is measured off for bow and stern, the respective incisions being carried down from the edge to almost the very base. As a matter of fact less than 2 inches separate the cuts on one side from those on the other (*a*). The result is that both extremities of the future vessel can be tilted far higher than is possible with the very much smaller incisions as practiced by other tribes. Where their edges overlap they are pierced and sewn with bush rope. The raised ends are then pared down to the same level as the body of the craft (*b*). Bow and stern are thus closed in. Holes are now pierced along the whole edge right round the vessel and the strengthening rods prepared. There are four of these, tapering from base to tip, each a little more than half the length of the vessel, and covered from above down with a spiral of split mamuri strand. Two of these with their bases spliced are strung with vine rope to the holes along the inner edge on either side. Each pair touches the other at bow and stern (*c*, *d*). Seats (*e*) that act as spreaders are inserted fore and aft. These are composed of three or four flattened slabs tied to crosspieces which in their turn are fixed at their extremities with vine rope to the strengthening rods. Last of all, a wooden tie is fixed to the rods at the center of the craft. A roll-up split manicol mat (*f*) is generally to be seen in a woodskin, for the dogs and other impedimenta.

The following are Waiwai names for a woodskin and its parts: The craft itself, *yikchibitiri*; bow, *yiktawiri*; stern, *mai-iri*; strengthening rod, *echehókono*; tie, *yakotono*; seat, *afón*; manicol mat, *safaliyofóni*.

The cargo of the corial or woodskin may be covered by *truli* and other large leaves convenient to hand, or by specially constructed rain shelters (sec. 296).

799. *Line 7, after 329), add:*

Paddles can likewise be made from a soft white wood, a species of cork wood, the *pitorro* of the Wapishana.

Page 618, top line, after flood, add:

The Taruma and Waiwai paddle (fig. 90, *g*) is of the intermediate type, with the blade angular above and below, and the proximal end of the handle flattened and chipped along the sides. Its extreme tip is carved into a horn. The blade is usually covered with black over the upper and lower quarter, the intermediate portion painted with red. The handle is sometimes similarly decorated. The paddle itself is of fairly large size. One that I brought back with me measures 4 feet 4 inches.

At end of section add:

An error has crept into Figure 337 (WER, VII): *F* and *E* are not rowing paddles but stirring paddles for food, etc.

801. *At end of section add:*

When not in use, boats, woodskins, etc., are usually sunk under water. This practice is pursued for one or other of three reasons—to preserve the vessel, to prevent it being stolen, to hide the location of the owner.

802 A. *At end of section add:*

Schomburgk speaks of Indians shouting to find dry land [at night] (ScO, 244). I have noticed this myself with the Indians when crossing Tapakuma Lake on a dark night with no stars to guide the direction taken.

803. *Line 3 from bottom of page, after 158), add:*

Trio also play the flute on entering a village. (GOT, 1072, 1085.)

804. *At end of section add:*

On the other hand, visitors may not be wanted. The Trio have a strong dread of and objection to strangers. (GOT, 1027, 1062, 1064.)

808. *Line 10, for Kalirya read Kalinya.*

After Guanero add Trio. (GOT, 1073.)

813. *At end of section add:*

Herderschee was specially warned that none of his party must have a cold when he put in an appearance among the Trio, because that could give rise to all of them taking to flight. This indication was presumably connected with the influenza epidemics that had raged among them and the bush negroes, and to which several had fallen victims. (HER, I, 864.)

815. *At end of section add:*

The same is true among other tribes, e. g., the Trio and Oyana. Intelewa's son and stepson, reports Herderschee, proceed ahead in a corial to pilot us down the fall. When we are down it, one of them says in a dry style, "I go away," and both turn their backs on us. The Indian manner of farewell is like that. (HER, I, 968.)

817. *At end of section add:*

Similar experiences have been recorded in plenty; e. g., among the Oyana and the Trio. (HER, I, 939.) In the former case we notice, says Herderschee, during the trading, how peculiar the taste of the Indian is, and from what an entirely different standpoint he regards the worth of an article to what we do. A beautiful feather article, e. g., for which we offered a few penknives and a scissors, was not handed over, but they were willing to exchange it for a little mouth harmonica that was worth much less. (HER, I, 901-902.)

818. *At end of section add:*

It seems probable that in the olden days trade was not run on the lines [present for present], article for article. Perhaps they learned

such a thing from the bush negroes. They have, however, made that method quite their own, and I saw bartering take place between an Oyana and a Trio in exactly the same way [i. e., article for article]. Besides that, the least greedy likewise practice the old style; a present whether all or nothing is asked for it. The other party must, in his turn, occasionally give something, but he is not bound to time and a fixed rate. (HER, I, 958.)

821. *At end of section add:*

The middleman, however, will often take measures to prevent direct trade between buyer and seller. Thus from Surinam come some very interesting records showing the means adopted to obtain such an end, followed by bush negroes and Trio. The Indians in the interior obtain what they want in the way of products of European industry in large measure through the intervention of the bush negroes. As the latter do very well in that trade it is of great importance to them to take care that the Indians never come into direct touch with the whites. At the beginning the Joeka (bush negroes) told them that they had a village somewhere near the sea where they themselves made axes, beads, cotton, etc. They further once upon a time took Indians with them to Poeloegoedoe and then told them it was still a formidably long distance from there to the sea. Besides that, the tempestuous water would perhaps capsize the boats and the whites stood on shore ready to murder every Indian whom they saw. * * * When the expedition went up the Tapanahoni Captain Arabi [bush negro] sent on a message that all the Indians must make their escape as quick as possible, as the whites were coming with a large force to plunder the villages and kill the populace. The Trios then abandoned their village and kept themselves hidden in the forest until news came from Arabi that there was nothing to fear. * * * The Joeka likewise tried to work on the whites. They several times reported on the coast that such dangerous Indians were still living up yonder * * * It was the same bush negroes again who in 1878 made the Trio fly before Crevaux by circulating the story that he was bringing a serious disease with him, and that he had some evil-minded negroes in his following. The Oyana who accompanied Crevaux in order to prevent their own trade being harmed considered it profitable to leave the Trio in that erroneous opinion. (HER, I, 944-945.) So again Herderschee was himself tricked by having withheld from him by the Trio and Oyana the existence of a second trail leading from the Arakoepina to the Wana or Wanama (presumably the Wanamu of Schomburgk). The reason of this secrecy was also not far to seek: they prefer the white man not to bring his wares direct to their fellow-tribesmen. The billet of middleman yields a profit not to be despised. (HER, I, 966.)

822. *Line 7, after 26), add:*

In the same way, Koch-Grünberg tells a story—a satire on the Indians who, after temporarily working in British Guiana, return home and report all possible exaggerations—where guns, shot, powder, etc., grow on trees which have only to be shaken for the ripe guns, etc., to drop. (KGR, II, 150.)

823. *At end of section add:*

In Surinam the lines of communication of the Joeka bush negroes, the Oyana (who with the Oepoeroei total some 1,000) and Trio (about 800) have all been recorded. The Oyana are in direct communication with the Joeka and Boni negroes, the Oyampi [on the Oyapok], Emerillon, Aparai, and Trio. The Trio are in direct intercourse with Joeka, Oyana, Okomajana, the Eastern Trio also with the Aparai. The Western Trio keep up a lively trade with the Saloema and on that account are called Saloema matti, i. e., Saloema friends [= ?Zurumatta]. They are furthermore in connection with the Sikijana, Toenajana, and probably other tribes living more to the westward. (GOT, 1119.) The trade of the Pianocoto is carried on exclusively with the Roucouyenne of the Paru. The Roucouyenne receive their merchandise from the Mécoras (Boni negroes) of the Maroni. Either the Boni come to the Oyana of the Yary or the Oyana go to Cottua on the Maroni. The Oyana of the Yary sell to the Roucouyenne of the Paru, the Roucouyenne to the Pianocoto, and the Pianocoto to the Indians of the Poanna. One can imagine what the cost of an ax or a cutlass must be when, already tariffed at 100 per cent profit by the Boni, these articles reach the hands of the Pianocoto of the Poanna. (CO, 164.)

825. *At end of section add:*

In the more eastern Guianas curare is traded to the Waiwai, Parikutu, etc., who use it for shooting howler and other monkey. It probably comes from the Trio who manufacture it. (HER, I, 943.)

827. *At end of section add:*

Hunting dogs constitute the most important trade product of the Trio. They breed these animals with great care and supply them not only to their nearest neighbors, the Joeka, but also via the Parou and Yari to the Boni bush negroes. (HER, I, 942.)

829. *At end of section add:*

Among present-day articles of trade from the Dutch particularly favored by the Trio are: White buttons on cards, purple beads (Silirman, GOT, 1036), and especially balsam of Peru (GOT, 1048). The Oyana seemed very keen on salt (HER, 141), as also I found the Waiwai and Taruma were.

830. *At end of section add:*

De Goeje relates the following from the Trio Indians, but whether it has anything to do with mourning I can not say: About 4 o'clock the Indians woke, raked the fires under their hammock a bit and then took another forty winks. An hour later the night's rest was ended for good, which was mostly notified by one of their number imitating the note of the tokro [partridge, *Odontophorus* sp.], which the birds in the forest answered. (GOT, 1044.)

835. *Line 4, after hut, add:*

The Waiwai and neighboring forest tribes also practiced cremation (sec. 867 B).

867 A. Mourning at a Trio female's death has been noted by De Goeje. At Popokai village, sitting in the shade of the house were a number of men, Pontoetoe among them, in a row, busy with a sort of song of lamentation during which, every now and again, a couple of singers went to sit beside each other, and embraced each other as they wailed. They were for the most part painted with genipa juice, feet, knees, and hands quite black, the rest of the body with black rectilinear figures. On the head a garland of white chicken feathers covered with an apomali (circlet of short red, yellow, and black feathers) and in the bead band around the right arm a plume of ara feathers. * * * Aponhawa had died this morning * * * and they had immediately buried her in the old village of Intelewa. (GOT, 1087.)

867 B. Waiwai. The Waiwai and other forest tribes cremate the dead. When anyone dies the relatives and friends take the body in its hammock (hung on a pole), carry it away into the forest, build a heap of logs and brush, lay the body on top, and set fire to the heap. When the fire has burned out they gather up the ashes and fragments of bones in a large drink pot, cover it with a bowl, and leave it on the site without other covering; or a hole is dug in the center of the heap of ashes, the fragments of bones thrown in, and a large pot turned upside down over them. Sometimes palm leaves are thrown over the heap of ashes and a pot inverted over the charred bones. Personal things are burned with the dead; a man's ornaments, necklaces, shoulder basket, containing comb, paint, knife, and arrow-making implements; his breech-cloth and hammock are all placed with the body, but his bows and arrows are broken and thrown away in the forest. A woman's ornaments, her workbasket, containing spindle whorls and implements for making pottery, her aprons, and hammock are burned with her, but her cooking pots, food bowls, water jars, and calabashes are broken and the fragments scattered. (FAC, 171-172.)

868. *Page 667, line 16, after 136), add:*

A Wapishana girl would say, "Do you think you are a vampire bat that's going to suck me?"

884. *Line 11, after 250). add:*

Among the Trio, these koenana mats are provided with ants and wasps for children and adults, respectively, at the tapsem dance. The wasps are caught with a kind of glue, then benumbed with water, and quickly fastened in between the plait work, during which operation one occasionally gets stung. (GOT, 1089-1091, pl. xxxiv, fig. 33; GO, pl. II, figs. 1-4.)

Page 680, line 6, after 307), add:

The flogging of the boys with a bundle of young palm shoots at the tapsem dance of the Trio (GOT, 1091) is probably a puberty initiation.

892. *Last line, after 369), add:*

Oyana and Trio. (HER, I, 960.)

899. *Page 690, line 24, after 398). add:*

Von Sack speaks of Indian women at Paramaribo shooting birds with cotton-ball tipped arrows (sec. 138).

Page 690, line 28, after 235), add:

With the Trio, the man and woman are said to look after the cultivation of the provision field together. (HER, I, 957.)

At end of section add:

Pottery, cotton spinning, and hammock making is mostly woman's work. The Trio men make the dancing ornaments and most of the articles for household use. Herderschee seems to have had some interesting conversations with these people relative to the question of division of labor. He says they take a great deal of interest in everything. Why those gaiters? Whether I made them? And as the answer is in the negative, whether I made my coat? Great surprise when it is found that nothing that I have on is self-manufactured. I then explain to them as well as I can how the whites make everything; how the one does nothing but forge knives, how another exclusively makes beads. (HER, I, 957.)

901. *Line 19, after 478). add:*

At the present day the Taruma and Waiwai males certainly manufacture the korowa hammock in its entirety. Among the Yekuana and Guinau cotton hammocks are woven only by the men. (KGR, III, 346.)

907. *Line 15, after 81), add:*

(HER, I, 957.)

918. *Line 8 from bottom, after 15), add:*

(HER, I, 864.)

926. *At end of section add:*

The following account of the application of such an irritant comes from the Oyana. After the hollow branch has been cut through, etc., the contents (ants and larvae) are shaken out onto a blob of cotton. The ants try to carry their larvae away, but are prevented by the cotton fibers. Pontoetoe then takes the tuft and presses it on the patient's skin a couple of times under the armpits and then on the calves. The ants bite with all their might, as is evident from the pitiful screaming of the youngster. (HER, I, 967.)

931. *Line 5, after 238), add:*

With the Otomac, the first thing in the morning was the bewailing of the dead (sec. 830). With the Trio, the night's rest is ended by "calling" the tokro partridge, *Odontophorus guianensis* Gm. (GOT, 1044.)

933. *At end of section add:*

The Surinam, Oyana, etc., have apparently reached the stage of using European mosquito curtains. (HER, 124; HER, I, 903.)

934. *Page 720, line 1, after 299), add:*

The Oyana clip the hair short when troubled with lice. (HER, 124.)

INDEX AND GLOSSARY

[To be read with index of the main work. The figures indicate section numbers]

- AHOMI, Waiwai bark armband, 540.
AKOERI. *See* Trio.
AKULI-JU. *See* Trio.
AMALISANA TRIBE. *See* HER, I, 978.
ANKLET, 552.
APARAI=APALAI. Besides being on the Parou (Paroe) they are said to occupy the Citare, Mekoe Creek (a right branch of the Paroe), as well as the Peikoele (a right-hand tributary of the Koeroeni). (HER, I, 977.)
APOMALI, feather garland, 527.
ARIKIANA, mentioned by FAC, 251; perhaps intended for the Alukujana Indians.
ARROW HEAD, stone, 128 A.
AZUMARA, mentioned by FAC, 242. No confirmation obtainable of such a people.
BARRICADE. *See* Palisade.
BASSIA, a cassava drink, 251.
BERTHOLLETIA EXCELSA HUMB. *See* Bertholletia.
BREECHCLOTH. *See* Apron, etc., 548 A.
CAMISARO or HIATO, a loin cloth. *See* ScO, 291.
CASIPAN. *See* Turtle.
CECROPIA sp. Also known as forest papaja. (GOT, 1082.)
CHACOLA, Sjakola drink. *See* Cassiri.
CHERUVICHAHENA INDIANS. *See* ScO, 476.
CHIKENA, mentioned by FAC, 194; no confirmation of such Indians.
CRESCENTIA CUJETE. *See* Calabash.
CREVAUX should be written without an accent on the e.
DANCE FLOOR, 581.
DIAMOND, Marawuni. *See* ScO, 29 (typed translation).
DONKÉ POISON, 734.
DRINK, *after* xiv *add* 254, etc.
FLOOR MAT, 393.
GUIANA, origin of name. *See* HER, 114.
HAMIRE, feather crown of the Oyana, 526.
HARIKETE, back ornament of the Oyana, 537.
IPAVAQUENA INDIANS. (ScO, 464.)
ITOTO, Trio name (=my enemy) for Joeke bush negroes. (HER, I, 975.)
JURUBA, YURABA, for encasing tube of blowgun, 117.
KAIKOESIANA, alleged cannibals. *See* HER, I, 937. Compare Kaikusi, tiger, crocodile.
KAIKUTCIANA (FAC, 25). *See* Kaikoesia.
KALAIWA is the name by which the Brazilians of the Amazon are known to the Indians as distinct from the Paranakiri, seamen, or men from the north. The word, according to what is supposed, is the same as karaib, and means strangers. (HER, I, 936-937.)
KALIPINI=GALIBI. *See* HER, I, 974.

- KANAIMA, KENAIMA, Evil Spirit, Spirit of Revenge, probably a form of Kalaiwa.
 KARAIB. *See* Kalaiwa.
 KARIMEN, resin of the Wapishana, 23.
 KATAPOLITANI. *For* cana, *read* Içana.
 KATAWIAN (FAC, 197). No confirmation of any such people.
 KIBIHI. *For* 717, *read* 723.
 KIRISHANA. *Add see* Guaharibo.
 KOELA, punting pole for boats. Bush negro. *See* HER, 21.
 KOENANA MAT, for ants and wasps, 584 A, 884, 926.
 KOKERIT. *Add* darts for blow gun, 120.
 KOKOJANA (koko=night) INDIANS. *See* HER, I, 978.
 KOMAJANA. *See* Okomajana.
 KUARI, black dye, 30.
 KUMAYENA (FAC, 214). *See* Okomajana.
 KUTCIFIANA. *See* Waiwe.
 LAULAO. *Read* Laulau.
 LUKU-LUKU. *For* caught *read* bait.
 MAIPOERIANA (Maipoeri=tapir) INDIANS. *See* HER, I, 978.
 MALELEANA, alleged cannibals. *See* HER, 937.
 MALITI, eagle-down decoration of hair, 515.
 MANICOL. *For* 454 *read* 456. *At end of paragraph add* 316.
 MANITIVITANO. *See* ScO, 480.
 MARAI=Penelope.
 MARAWUNI DIAMOND. *See* ScO, 29 (typed translation).
 MAWAJANA (Mawa=frog) INDIANS. *See* HER, I, 978.
 MEKOJANA (Meko=Capuchin monkey) INDIANS. *See* HER, I, 978.
 MONTA or TOEKOESJIPAN, Oyana house, 308.
 MUKU. A hiding shelter on trees from which to shoot birds, 159.
 NAMES OF VILLAGES, 290.
 NOOSE BIRD (Stropvogel of the Dutch), 176.
 ODONTOPHORUS GUIANENSIS Gm. The tokro partridge, 931.
 OEPOEROEI. *See* Oyana.
 OEWAKU TRIBE. *See* ScO, 402.
 OJAMPI. *See* Oyampi.
 OJANA. *See* Oyana.
 OJAPI (FAC, 251), presumably intended for Oyampi.
 OJARIKOELÉ INDIANS, on Loë Creek and Oelmarie; formerly also on the Litani but driven from there by the Boni negroes. (HER, I, 937, 977.) Perhaps identical with the Comajana, Okomajana. (HER, 116.)
 OKOMAJANA, KOMAJANA (Okoma=wasp) INDIANS. On the Koeroeni, Sipaliwini, and Saramacca. Before the arrival of the bush negroes they lived on the Paloemeu and carried on sanguinary wars with the Trio. (HER, I, 977.)
See Ojarikoelé.
 OLISIANA (Oli=woman) INDIANS. Consist of a few women. On the Akalapi Creek. (HER, I, 978.)
 OLOK, headdress of the Oyana used at the tapsem dance, 519, 584.
 OMANI DRINK, 262.
 OREWEEBBE ORNAMENTS, 535.
 OYANA, AJANA, etc.:
 In line 2, *for* (GOE, 33) *read* (GOE, 2).
 In line 7, *for* Trio of Surinam *read* bush negroes.
 In line 8, *for* (GO, 27) *read* (HER, I, 975).
At end of paragraph add: They occupy the Marowini, Litani, upper Yari, Citare (right-hand branch of Paroe), Tapanahoni, Paloemeu (HER, I, 976). 823.

PAKASSE, bark canoe. *See* ScO, 308.

PALM, PIMPLER. Wiressi of the Wapishana. Probably a species of *Astrocaryum*. 396.

PALO DE LUZ, 5.

PANNIER. *See* Knapsack.

PAPAYA, Forest. *See* Cecropia.

PARAKUTU (FAC, 183). *See* Parukutu.

PARANAKIRI (seamen), the whites who come from the north, or Parasjensi (presumably a corruption of FRANÇAIS) as opposed to the Kalaiwa, which see.

PARAWAJANA (Palawa=Amazon parrot) INDIANS (HER, I, 978).

PARIA or PARIAGOTO tribe on coasts of Berbice and Essequibo, ScO, 172 (of typed translation).

PARICARI (FAC, 39, 67)=Parishara.

PARIKUTA, PARICONTE, etc.:

Delete lines 2 and 3 and read: watershed between the Mapura and upper Trombetas (Coudreau).

PARIPI, etc. Line 1, for 116, 117 read 246, 247.

PARUKUTU (FAC). *See* Parikuta.

PENEOJA, Peneoje of Surinam. *See* HER, I, 936-937, 978.

PENTARI FRUIT. *See* ScO, 47.

PERNOU, cassava drink, 261.

PEUNAMA INDIANS on the Koetari. *See* HER, I, 978.

PIANACOTO (Piana=eagle) INDIANS=Pianoghotto. At present they are on the Rio Paru of the Cumina (a branch of the Trombetas), the Igarape Imarara (branch of the Paru), and Igarape Poanna (branch of the Cumina). *See* CO, 169.

PIANAJE (Piana=eagle) INDIANS. *See* HER, I, 978.

PIMBA=white clay of the Surinam Indians.

POLUYO, a *salicornia* sp. for staining timbers. *See* ScO, 167 (typed translation).

POULTRY, WHITE, 724.

SALOEMA. *See* Saluma.

SALUMA, in Surinam, etc., on the Kapoe, Koetari, and Wanama. Make some beautiful basketry and dance decorations. The bush negroes call them Saloema-matti; perhaps they are the Zurumata of Schomburgk. (GOT, 1119; HER, I, 977.) The identity of the Saluma and Taruma is, however, denied by De Goeje, who maintains that they speak quite different languages. (BES, under "Bovenlandsche Indianen," p. 175.)

SHOULDER BASKET. *See* knapsack.

SIKA, sand flea. (GOT, 1078.)

SIKALESANA INDIANS. (HER, I, 978.)

SIKIJANA, on the Kapoe, with the Saloema must be in direct intercourse with the Kalaiwa (Brazilians), possibly with the Mucambairo runaway slaves of the Trombetas. (HER, I, 977.)

SILIRMAN, purple beads, 829.

SIROJANA INDIANS. *See* HER, I, 978.

SJAKOLA. *See* Chacola.

SPEARHEADS, stone, 128 A.

STAGING, from which to watch and hunt birds, jaguars, 159.

STRANGERS, not wanted, 804.

STROPVOGEL. *See* Moose bird.

TABUSEBA, for : read Tabureba.

TALULUPAN, musical instrument, Oyana flute, 561.

TAMoesJI=Tamuchi.

TAMOJETPE, headdress of Oyana, 519.

TAPSEM DANCE, 584 A.

TARUMA. *See* Saluma.

TAS PALM=Geonoma sp.

TIRIJO (FAC, 251). Trio is presumably intended.

TOEKOESJIPAN. *See* Monta.

TOELOELOEPAN. *See* Talulupan.

TOJEPOTORI, 740.

TONAYENA (FAC, 198). *See* Tunayana.

TONSURE OF HAIR, 515.

TRIO. *At end of paragraph add:* Identical with the former Akuliju (living on the Corantijn) and Akoeri. For present locality of Trio *see* HER, I, 973, 974.

TUNAYANA, TOENAJANA, or PATAKASJIANA who, according to legend, sleep under water at night (Tuna=water). *See* HER, I, 978.

UPURUI. *See* Oepoeroeri.

URUKUENA (FAC, 217). *See* Orokoyana.

VILLAGE. *See* Houses.

WAINAMPU TRIBE. *See* ScO, 245 (typed translation).

WAIWE or KUTCIFIANA (FAC, 182); no confirmatory evidence of such Indians.

WAKERA (FAC, 212); no confirmation obtainable.

WALUMA, headdress of the Trio, 519.

WIRI SEEDS, 535.

YAPOTOLI (HER, 141) or Iapotoli (HER, I, 957) is the headman, chief, etc., to the Oyana: but he is known as Tojeputori to the Makusi. (ScO, 175, typed translation.)





SMITHSONIAN INSTITUTION LIBRARIES



3 9088 01421 8366