



SBM

1015





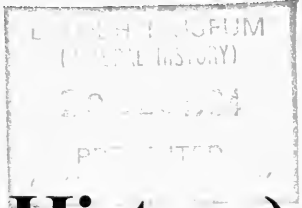

# **Bulletin of the British Museum (Natural History)**

Entomology series    Vol 49    1984

British Museum (Natural History)  
London 1984



**Contents**  
**Entomology Volume 49**

No 1	Afrotropical jumping plant lice of the family Triozidae (Homoptera: Psylloidea) By David Hollis . . . . .	1
No 2	The taxonomy of the western European grasshoppers of the genus <i>Euchorthippus</i> , with special reference to their songs (Orthoptera: Acrididae) By D. R. Ragge & W. J. Reynolds . . . . .	103
No 3	An historical review of the higher classification of the Noctuidae (Lepidoptera) By Ian J. Kitching . . . . .	153
No 4	The Pimplinae, Xoridinae, Acaenitinae and Lycorininae (Hymenoptera: Ichneumonidae) of Australia By I. D. Gauld. . . . .	235
No 5	The Palaearctic species of <i>Ascogaster</i> (Hymenoptera: Braconidae) By T. Huddleston . . . . .	341







# Bulletin of the British Museum (Natural History)

Afrotropical jumping plant lice  
of the family Triozidae  
(Homoptera: Psylloidea)

David Hollis

The *Bulletin of the British Museum (Natural History)*, instituted in 1949, is issued in four scientific series, Botany, Entomology, Geology (incorporating Mineralogy) and Zoology, and an Historical series.

Papers in the *Bulletin* are primarily the results of research carried out on the unique and ever-growing collections of the Museum, both by the scientific staff of the Museum and by specialists from elsewhere who make use of the Museum's resources. Many of the papers are works of reference that will remain indispensable for years to come.

Parts are published at irregular intervals as they become ready, each is complete in itself, available separately, and individually priced. Volumes contain about 300 pages and several volumes may appear within a calendar year. Subscriptions may be placed for one or more of the series on either an Annual or Per Volume basis. Prices vary according to the contents of the individual parts. Orders and enquiries should be sent to:

Publications Sales,  
British Museum (Natural History),  
Cromwell Road,  
London SW7 5BD,  
England.



*World List* abbreviation: *Bull. Br. Mus. nat. Hist. (Ent.)*

© Trustees of the British Museum (Natural History), 1984

The Entomology series is produced under the general editorship of the  
Keeper of Entomology: Laurence A. Mound  
Assistant Editor: W. Gerald Tremewan

ISBN 0 565 06003 1

ISSN 0524-6431

British Museum (Natural History)  
Cromwell Road  
London SW7 5BD

Entomology series  
Vol 49 No 1 pp 1-102

Issued 28 June 1984

# Afrotropical jumping plant lice of the family Triozidae (Homoptera: Psylloidea)

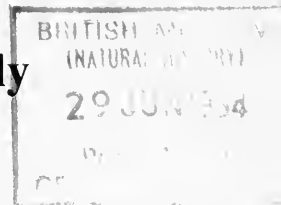

David Hollis

Department of Entomology, British Museum (Natural History), Cromwell Road, London SW7 5BD

## Contents

Synopsis.....	1
Introduction .....	2
Checklist, host plants and distribution of Afrotropical Triozidae.....	4
Material, methods and terminology .....	7
Acknowledgements .....	8
Triozidae Löw .....	8
Characters and their polarity .....	9
Identification .....	18
Key to species of Afrotropical Triozidae .....	18
<i>Triozamia</i> Vondráček .....	22
<i>Afrotrioza</i> gen. n. ....	25
<i>Trichohermes</i> Kirkaldy .....	26
<i>Pauropsylla</i> Rübsaamen .....	27
The <i>willcocksii</i> -group.....	29
The <i>trigemma</i> -group .....	31
The <i>septima</i> -group.....	32
Ungrouped species .....	33
<i>Trioza</i> Foerster.....	35
The <i>erytreae</i> -group .....	36
The <i>litseae</i> -group.....	43
The <i>anomalicornis</i> -group .....	44
The <i>neoboutonia</i> -group .....	46
The <i>hargreavesi</i> -group.....	50
The <i>obsoleta</i> -group.....	51
The <i>cockerelli</i> -group .....	55
The <i>etiennei</i> -group.....	56
The <i>glabea</i> -group .....	59
Ungrouped species .....	60
Doubtful species .....	69
References .....	69
Index to host plants .....	101
Index .....	101

## Synopsis

The family Triozidae is defined within the context of the superfamily Psylloidea. A list is given of the genera included in the family, on a world basis, with type-species and a summary of numbers of species, their distribution and host plant data. The family-group name Pauropsyllinae is placed within the Triozidae, necessitating the transfer of *Paurocephala* back to the Aphalaridae and *Microceropsylla* and *Pelmato-brachia* to the Calophyidae, and seven new combinations. The genus-group name *Sympauropsylla* is synonymised with *Pauropsylla*. A checklist of Afrotropical taxa is given, with host plant and distribution data, and a key is provided for the identification of the 69 recognisable species. Two of the eight previously described species are treated as doubtful because their types are lost or untraced and the species cannot be recognised from their original descriptions; *Trioza eastopi* Orian is synonymised with *T. litseae* Bordage; one new genus and 63 new species are described.

## Introduction

Throughout the world, species of the family Triozidae display a wide range of body form and host plant preferences. Currently 48 genera are recognised but many of these are poorly defined and have no clear diagnostic features. Members of the family may be recognised easily, in the adult stage, by the unique venation and structure of the forewing (pp. 8–10, and Figs 40, 43). Fifth instar larvae of most species are also characteristic as the head and body margins normally have a complete fringe of specialised wax-producing setae called sectasetae (Figs 280, 289, 315). Table 1 gives, for each genus of Triozidae, a summary of the type-species, numbers of species included, distribution and host plant preferences.

**Table 1** Genera of Triozidae with type-species, numbers of species, distribution and host plant data. Numbers of species recorded in parenthesis under one zoogeographical region also occur in another region. For the purposes of this table species previously included under the generic names *Megatrioza*, *Heterotrioza* and *Smirnovia* are here included under *Trioza*. (*Heterotrioza* Dobreanu & Manolache, 1962: 258; type-species *Trioza obliqua* Thomson. *Megatrioza* Crawford, 1915: 264; type-species *M. armata* Crawford. *Smirnovia* Klimaszewski, 1968: 13; type-species *Trioza femoralis* Foerster.)

GENUS	TYPE-SPECIES	DISTRIBUTION								NUMBERS OF SPECIES	HOST PLANT FAMILIES					
		PALAEARCTIC	AFROTROPICAL	ORIENTAL	AUSTRALO-ORIENTAL	AUSTRALASIAN	POLYNESIAN	NEARCTIC	NEOTROPICAL							
<i>Acanthocnema</i> Tuthill & Taylor, 1955: 252	<i>Trioza casuarina</i> Froggatt, original designation					3				3	Casuarinaceae, Proteaceae, Myrtaceae					
<i>Anomocephala</i> Tuthill, 1943: 75	<i>Anomocephala unica</i> Tuthill, original designation								1	1	unknown					
<i>Bactericera</i> Puton, 1876: 286	<i>Bactericera perrisii</i> Puton, by monotypy		5							5	Compositae (one on <i>Allium</i> )					
<i>Calinda</i> Blanchard, 1852: 309	Type-species not designated									8	unknown					
<i>Cecidotrioza</i> Kieffer, 1908: 159	<i>Cecidotrioza baccarum</i> Kieffer, by monotypy				2					1	3	Symplocaceae, Compositae				
<i>Ceropsylla</i> Riley, 1885: 76	<i>Ceropsylla sideroxyli</i> Riley, by monotypy				3					1	4 + (1)	8	various			
<i>Cerotrioza</i> Crawford, 1918: 454	<i>Cerotrioza bivittata</i> Crawford, original designation					1			2			3	Flacourtaceae			
<i>Crawforda</i> Caldwell, 1940: 397	<i>Crawforda triopsyllina</i> Caldwell, original designation								1			1	Araliaceae			
<i>Dasymastix</i> Enderlein, 1921: 122	<i>Trioza gigantea</i> Crawford, original designation											1	unknown			
<i>Egeirotrioza</i> Boselli, 1931: 268	<i>Trioza ceardi</i> de Bergevin, original designation		11									11	Salicaceae ( <i>Populus</i> )			
<i>Engyatoneura</i> Loginova, 1972b: 33	<i>Engyatoneura lindbergi</i> Loginova, original designation									1		1	unknown			
<i>Epitrioza</i> Kuwayama, 1910: 55	<i>Epitrioza mizuhonica</i> Kuwayama, original designation									11		11	Eleagnaceae			
<i>Eryngiofaga</i> Klimaszewski, 1968: 10	<i>Trioza mesomela</i> Flor, original designation											13	Umbelliferae			
<i>Eutrioza</i> Loginova, 1964: 473	<i>Eutrioza opima</i> Loginova, by monotypy											1	unknown			
<i>Hemischizocranium</i> Tuthill, 1956: 158	<i>Hemischizocranium bessii</i> Tuthill, original designation											2	Rutaceae			
<i>Hemitrioza</i> Crawford, 1914: 104	<i>Hemitrioza sonchi</i> Crawford, original designation											1	Compositae			
<i>Hevaheva</i> Kirkaldy, 1902: 113	<i>Hevaheva perkinsi</i> Kirkaldy, by monotypy											8	Rutaceae, Xanthophyllaceae			
<i>Izpania</i> Klimaszewski, 1962: 254	<i>Izpania acona</i> Klimaszewski, original designation											1	unknown			
<i>Kuwayama</i> Crawford, 1911: 503	<i>Paratrioza medicaginis</i> Crawford, original designation											5	1 + (1)	11	17	various
<i>Leptotrioza</i> Miyatake, 1972: 29	<i>Neotrioza bicolor</i> Crawford, original designation											1	1	? Annonaceae		

GENUS	TYPE-SPECIES	DISTRIBUTION								NUMBERS OF SPECIES	HOST PLANT FAMILIES					
		PALAEARCTIC	AFROTROPICAL	ORIENTAL	AUSTRALO-ORIENTAL	AUSTRALASIAN	POLYNESIAN	NEARCTIC	NEOTROPICAL							
<i>Leptynoptera</i>	<i>Leptynoptera sulfurea</i>															
Crawford, 1919: 147	Crawford, original designation			(1)	1 + (1)		1 + (1)			2	Guttiferae ( <i>Calophyllum</i> )					
<i>Leuronota</i>	<i>Trioza maculata</i> Crawford,			1	3		1	2	6 + (1)	13	various					
Crawford, 1914: 67	original designation															
<i>Levidea</i> Tuthill,	<i>Levidea lineata</i> Tuthill,							1		1	Compositae					
1938: 245	original designation							2		2	unknown					
<i>Metatrioza</i> Tuthill,	<i>Metatrioza pubescens</i> Tuthill,									2	unknown					
1939: 53	original designation									1	unknown					
<i>Myrmecephala</i>	<i>Myrmecephala prima</i> Tuthill,									2	unknown					
Tuthill, 1945: 22	original designation									1	Euphorbiaceae ( <i>Sapium</i> )					
<i>Neolithus</i> Scott,	<i>Neolithus fasciatus</i> Scott, by									1	1	Euphorbiaceae ( <i>Sapium</i> )				
1882a: 445	monotypy									1	1	Lauraceae				
<i>Neotrioza</i> Kieffer,	<i>Neotrioza machili</i> Kieffer, by			1						1	2	Lauraceae				
1905: 175	monotypy									4	4	? Rosaceae				
<i>Neotriozella</i>	<i>Trioza immaculata</i> Crawford,									4	4	? Rosaceae				
Crawford, 1911: 503	original designation															
<i>Optomopsylla</i>	<i>Optomopsylla formiciformis</i>										1	1	? Salicaceae			
Caldwell, 1944: 338	Caldwell, original designation										1	1	? Salicaceae			
<i>Ozotrioza</i> Kieffer,	Type-species not designated											2	2	Styracaceae, Lauraceae		
1905: 178				2												
<i>Paracomeca</i> Laing,	<i>Paracomeca fuscata</i> Laing,										1	1	? Ulmaceae			
1923: 702	original designation															
<i>Paratrioza</i>	<i>Paratrioza ocellata</i> Crawford,															
Crawford, 1910: 228	subsequent designation by Crawford, 1911: 446	4								6	(2)	10	Mainly Solanaceae			
<i>Pariaconus</i>	<i>Kuwayama nigricapita</i> [as											1	1	Myrtaceae		
Enderlein, 1926: 401	<i>nigricapatus</i> ] Crawford, original designation									1		1	1	Myrtaceae		
<i>Pauropsylla</i>	<i>Pauropsylla udei</i> Rübssaamen,															
Rübssaamen, 1899: 262	by monotypy	2	13	5	2 + (1)								22	Moraceae ( <i>Ficus</i> ), ? Rubiaceae		
<i>Paurotirozana</i>	<i>Paurotirozana adaptata</i>															
Caldwell, 1940: 396	Caldwell, original designation									1		1	1	Lauraceae		
<i>Petalolyma</i> Scott,	<i>Psylla basalis</i> Walker, by															
1882b: 359	monotypy			1									1	Fagaceae		
<i>Pseudotrioza</i>	<i>Pseudotrioza hiurai</i>															
Miyatake, 1972: 27	Miyatake, original designation					1							1	Anacardiaceae		
<i>Rhegmoza</i>	<i>Rhegmoza tinctoria</i>															
Enderlein, 1918: 480	Enderlein, original designation												1	1	unknown	
<i>Rhinopsylla</i> Riley,	<i>Rhinopsylla schwarzi</i> Riley,															
1885: 77	by monotypy	1		2	1					4	(1)	8	8	unknown		
<i>Schedoneolithus</i>	<i>Schedoneolithus dunaliae</i>															
Tuthill, 1959: 26	Tuthill, original designation												1	1	Solanaceae	
<i>Schedotrioza</i> Tuthill	<i>Trioza eucalypti</i> Froggatt,															
& Taylor, 1955: 251	original designation						4						4	4	Myrtaceae	
<i>Stenopsylla</i>	<i>Stenopsylla nigricornis</i>															
Kuwayama, 1910: 53	Kuwayama, original designation				2	3							5	5	Symplocaceae, Myrsinaceae, Ericaceae	
<i>Swezeyana</i>	<i>Swezeyana elongagena</i>															
Caldwell, 1940: 389	Caldwell, original designation									2			2	2	Sapotaceae	
<i>Trichoermes</i>	<i>Trioza walkeri</i> Foerster, by															
Kirkaldy, 1904: 280	monotypy	4	1	2									7	7	Mainly Rhamnaceae	
<i>Trioza</i> Foerster,	<i>Chermes urticae</i> Linnaeus, by															
1848: 82	subsequent designation, Oshanin, 1912: 128	133	53	24 + (3)	28 + (2)	3	61 + (2)	43 + (3)	44 + (9)	389			389	various		
<i>Triozamia</i>	<i>Rhinopsylla lamborni</i>															
Vondracek, 1963: 266	Newstead, original designation				3								3	3	Moraceae ( <i>Antiaris</i> )	
<i>Triozioida</i> Crawford,	<i>Triozioida johnsonii</i>															
1911: 491	Crawford, original designation												5	5	various	
<i>Afrotrioza</i> gen. n.	<i>Afrotrioza bersama</i> sp. n., here designated													1	1	Melanthaceae
			1													
Numbers of species		186	71	46	41	10	86	65	88	593						

Like most Psylloidea, trioqid species have very restricted trophic requirements, at least in their larval stages. They are associated with dicotyledonous plants, and the host range of trioqids, as a whole, is greater than any other family of psyllids. It is worthy of note that the family does not colonise the Fabaceae (= Leguminosae), a plant family greatly exploited by the Aryaninae/Euphalerinae complex of the Psyllidae. Two *Trioza* species in New Zealand, *T. colorata* (Ferris & Klyver) and *T. dacrydii* Tuthill, are known to develop on *Dacrydium*, a gymnosperm (Podocarpaceae); and one species in Hawaii, *Megatrioza palmicola* Crawford, develops on *Pritchardia* spp. (Palmae). One Palaearctic species, *Trioza nigricornis* Foerster, is apparently polyphagous and has been recorded from *Brassica* (Cruciferae), *Daucus* (Apiaceae), *Solanum* (Solanaceae) and *Beta* (Chenopodiaceae), but recent work (Hodkinson, 1981) suggests a species complex may be involved.

Several other trioqid species are associated with plants of economic importance. *Trioza alacris* Flor causes leaf-rolling in bay laurel (*Laurus nobilis*, Lauraceae) and has been introduced to various parts of the world, along with its host plant. In the New World *Paratrioza cockerelli* (Sulc) causes 'psyllid yellows' on potato (*Solanum tuberosum*, Solanaceae); *T. anceps* Tuthill, *T. magnoliae* Ashmead and *T. perseae* Tuthill feed on avocado pear (*Persea americana*, Lauraceae) in Central and South America. In the Oriental Region *Trioza vitiensis* Kirkaldy causes gall formation on the leaves of Malay apple (*Eugenia malaccensis*, Myrtaceae), and *T. cinnamomi* (Boselli) larvae form pit-galls on the leaves of *Cinnamomum* spp. (Lauraceae). In North Africa and the eastern Mediterranean basin *Pauropsylla willcocksii* Dębski causes pit-gall formation on the leaves of fig trees (*Ficus sycomorus*, Moraceae). *T. litseae* Bordage develops on *Litsea glutinosa* (Lauraceae) and feeds as an adult on *Vanilla planifolia* (Orchidaceae) on Réunion and Mauritius, and *T. erythrae* (Del Guercio) is a serious pest of citrus (Rutaceae) in eastern and southern Africa where it is the principal vector of 'citrus greening disease'.

Because of its pest status, *T. erythrae* has received considerable attention from biologists. Information on its life-cycle, bionomics, control, and further references may be found in Catling (1969a; 1969b; 1969c; 1970; 1971; 1972; 1973); Moran (1968a; 1968b); Moran & Blowers (1967); Moran & Brown (1973); and Moran & Buchan (1975). This species is of considerable taxonomic interest as it is part of a complex of species, all of which are difficult to define morphologically, but which have discrete host plant preferences (see pp. 36–42).

Five other trioqid species are recorded from the Afrotropical Region and the present paper adds a further 63 hitherto undescribed species to this list. A species and host plant checklist is given below.

### Checklist, host plants and distribution of Afrotropical Triozidae

SPECIES	HOST PLANTS		DISTRIBUTION
	family	species	
<i>Afrotrioza bersama</i> sp. n.	Melanthaceae	<i>Bersama</i> sp.	Tanzania
<i>Pauropsylla angolensis</i> sp. n.		Not known	Angola
<i>P. brevantennata</i> sp. n.		Not known	Ghana, Nigeria
<i>P. eastopi</i> sp. n.		Not known	Cameroun
<i>P. longipes</i> sp. n.	Moraceae	<i>Ficus</i> sp.	Ghana, Nigeria, Cameroun, Tanzania
<i>P. mistura</i> sp. n.		Not known	Ghana, Nigeria, Cameroun
<i>P. ngongae</i> sp. n.		Not known	Kenya
<i>P. proxima</i> sp. n.	Moraceae	<i>Ficus thonningii</i> Blume; <i>Ficus</i> sp.	Nigeria, Cameroun, Angola

SPECIES	HOST PLANTS		DISTRIBUTION
	family	species	
<i>P. senegalensis</i> sp. n.	Moraceae	<i>Ficus</i> sp.	Senegal
<i>P. septima</i> sp. n.		Not known	Cameroun
<i>P. tatricea</i> sp. n.		Not known	Ivory Coast, Cameroun
<i>P. trichaeta</i> Pettey	Moraceae	<i>Ficus sur</i> Forskål; <i>Ficus</i> sp.	Pan-African
<i>P. trigemma</i> sp. n.		Not known	Angola, Tanzania
<i>P. willcocksii</i> Dębski	Moraceae	<i>Ficus sycomorus</i> Linn.; <i>F. gnaphalocarpa</i> A. Rich; <i>Ficus</i> sp.	Cape Verde Is., Senegal, Sudan, Egypt, Saudi Arabia
<i>Trichohermes insleyi</i> Capener	Rhamnaceae	<i>Ziziphus mucronata</i> Willd.	South Africa (Transvaal)
<i>Trioza afroboleta</i> sp. n.	Ebenaceae	<i>Diospyros mespiliformis</i> Hochst. ex A. DC	Ivory Coast, Ghana, Nigeria, Sudan, Angola, Tanzania
<i>T. afrosersalisia</i> sp. n.	Sapotaceae	<i>Afrosersalisia</i> sp.	Tanzania, South Africa (Cape Province)
<i>T. anomalicornis</i> sp. n.		Not known	Nigeria, Cameroun
<i>T. ata</i> sp. n.	Salicaceae	<i>Salix safsaf</i> Forssk.	Angola, Tanzania
<i>T. bamendae</i> sp. n.		Not known	Cameroun
<i>T. boxi</i> sp. n.	Ebenaceae	<i>Diospyros canaliculata</i> De Wild	Ghana
<i>T. bussei</i> Zacher	?Apocynaceae	<i>Kickxia</i> sp.	Cameroun
<i>T. camerounensis</i> sp. n.		Not known	Cameroun
<i>T. capeneri</i> sp. n.	Araliaceae	<i>Seemannaralia gerrardii</i> (Seeman.) Vig.	South Africa (Natal)
<i>T. capensis</i> sp. n.	Solanaceae	<i>Lycium salinicola</i> Verdoorn; <i>L.</i> <i>?tetrandrum</i> Thunb.	South Africa (Cape Province and Orange Free State)
<i>T. carvalhoi</i> sp. n.	Araliaceae	<i>Cussonia angolensis</i> Hiern; <i>C. paniculata</i> Ecklon.; <i>C.</i> <i>spicata</i> Thunb. & Zeyher	Kenya, Angola, South Africa (Transvaal and Natal), Swaziland
<i>T. catlingi</i> sp. n.	Menispermaceae	<i>Cissampelos torulosa</i> E. Mey. ex Harv. & Sond.; <i>Cissampelos</i> sp.; <i>Stephania abyssinica</i> (Dill. & Rich.) Walp	Kenya, Tanzania, South Africa (Transvaal)
<i>T. chiangae</i> sp. n.	Uapacaceae	<i>Uapaca nitida</i> Muell. Arg.	Angola
<i>T. dinaba</i> sp. n.		Not known	Ghana, Nigeria
<i>T. eafra</i> sp. n.	Araliaceae	<i>Cussonia spicata</i> Thunb.	Kenya, Tanzania
<i>T. erytreae</i> (Del Guercio)	Rutaceae	<i>Clausena anisata</i> (Willd.) Oliv.; <i>Citrus</i> spp.; <i>Fagara</i>	Tropical and South Africa, São Tomé, St Helena,

SPECIES	HOST PLANTS		DISTRIBUTION
	family	species	
		<i>capensis</i> Thunb.; <i>Vepris undulata</i> (Thunb.) Verdoorn & C. A. Smith	Réunion, Madagascar
<i>T. etiennei</i> sp. n.	Sapotaceae	<i>Malacantha alnifolia</i> (Baker) Pierre	Senegal, Ghana, Nigeria
<i>T. ficicola</i> sp. n.	Moraceae	<i>Ficus</i> sp.	Mozambique
<i>T. fuscivena</i> sp. n.		Not known	Cameroun
<i>T. ghanaensis</i> sp. n.	Sapotaceae	<i>Malacantha</i> sp.	Ghana, Zaire
<i>T. glabea</i> sp. n.		Not known	Angola
<i>T. gonjae</i> sp. n.	Ebenaceae	<i>Diospyros squarrosus</i> Klotzch	Tanzania
<i>T. gregoryi</i> sp. n.		Not known	Nigeria, Burundi, Tanzania
<i>T. guiera</i> sp. n.	Combretaceae	<i>Guiera senegalensis</i> J. F. Gmel.	Senegal, Gambia, Chad, Sudan
<i>T. hargreavesi</i> sp. n.		Not known	Nigeria, Uganda
<i>T. harteni</i> sp. n.	Uapacaceae	<i>Uapaca nitida</i> Muell. Agr.	Angola
<i>T. kakamegae</i> sp. n.	Icacinaceae	<i>Apodytes dimidiata</i> E. Mey.	Kenya
<i>T. karroo</i> sp. n.		Not known	South Africa (Cape Province)
<i>T. kilimanjarica</i> sp. n.		Not known	Tanzania
<i>T. laingi</i> sp. n.	?Scrophulariaceae	? <i>Bartsia longiflora</i> Benth.	Ethiopia, Kenya
<i>T. litseae</i> Bordage	Lauraceae	<i>Litsea glutinosa</i> (Lour.) C. B. Rob.	Réunion, Mauritius
<i>T. luvandata</i> sp. n.		Not known	Angola
<i>T. medleri</i> sp. n.		Not known	Nigeria, ?Zaire
<i>T. menispermicola</i> sp. n.	Menispermaceae	<i>Cissampelos owariensis</i> P. Beauv. ex A. DC; <i>Triclisia macrophylla</i> Oliv.; <i>T. patens</i> Oliv.	Ghana, Nigeria
<i>T. messaratina</i> sp. n.		Not known	Tanzania
<i>T. mimusops</i> sp. n.	Sapotaceae	<i>Mimusops caffra</i> E. Mey. ex A. DC; <i>M. obovata</i> Sonder; <i>M. zeyheri</i> Sonder	South Africa (Transvaal, Natal, Cape Province)
<i>T. mirificornis</i> sp. n.		Not known	Cameroun, Uganda
<i>T. nachingweae</i> sp. n.		Not known	Tanzania
<i>T. neoboutonia</i> sp. n.	Euphorbiaceae	<i>Neoboutonia</i> sp.	Tanzania



SPECIES	HOST PLANTS		DISTRIBUTION
	family	species	
<i>T. nestasimara</i> sp. n.		Not known	Tanzania
<i>T. pitkini</i> sp. n.	Sapotaceae	<i>Chrysophyllum viridifolium</i> Wood & Franks or <i>C.</i> <i>pruiniforme</i> Engl.	Kenya
<i>T. schroederi</i> sp. n.		Not known	Tanzania, Zimbabwe
<i>T. seranistama</i> sp. n.		Not known	Tanzania
<i>T. similis</i> Heslop-Harrison		Not known	South Africa (Cape Province)
<i>T. tangae</i> sp. n.		Not known	Tanzania
<i>T. tavandula</i> sp. n.		Not known	Angola
<i>T. tenuis</i> sp. n.	Sapindaceae	<i>Haplocoelum foliolosum</i> (Hiern) Bullock	Angola
<i>T. theroni</i> sp. n.		Not known	South Africa (Natal, Cape Province)
<i>T. thibae</i> sp. n.	Icacinaceae	<i>Apodytes dimidiata</i> E. Mey.	Kenya
<i>T. tiliacora</i> sp. n.	Menispermaceae	<i>Tiliacora</i> sp.	Tanzania
<i>T. tundavalaе</i> sp. n.	Myrtaceae	<i>Syzygium benguelense</i> (Welw. ex Hiern)	Angola
<i>T. usambarica</i> sp. n.		Not known	Tanzania
<i>T. xylopiа</i> sp. n.	Annonaceae	<i>Xylopiа</i> sp.	Tanzania
<i>Triozamia lamborni</i> (Newstead)	Moraceae	<i>Antiaris toxicaria</i> Lesch. subsp. <i>africana</i> (Engl.) C. C. Berg var. <i>africana</i>	Senegal, Ivory Coast, Ghana, Nigeria, Zaire, Tanzania
<i>T. usambarensis</i> sp. n.	Moraceae	<i>Antiaris toxicaria</i> Lesch. subsp. <i>africana</i> (Engl.) C. C. Berg var. <i>usambarensis</i> (Engl.) C. C. Berg	Tanzania
<i>T. vondraceki</i> sp. n.	Moraceae	<i>Antiaris toxicaria</i> Lesch. subsp. <i>africana</i> (Engl.) C. C. Berg var.?	Central African Republic, Uganda

### Material, methods and terminology

The bulk of the material studied is deposited in the British Museum (Natural History) (BMNH), with additional material from the Museum für Naturkunde der Humboldt Universität, Berlin (MNHU); Musée Royal de l'Afrique Centrale, Tervuren (MRAC); and the [National Collection of Insects] Plant Protection Research Institute, Pretoria (NCI). Holotypes and paratypes of the species treated below are deposited in BMNH, MNHU, NCI, Muséum National d'Histoire Naturelle, Paris (MNHN); the National Museums of Kenya (NMK); South African Museum, Cape Town (SAM); and the National Museum of Natural History, Washington (USNM).

All measurements are quoted in millimetres and were taken from slide-mounted material. Reference points, within which measurements were taken of the various structures, are given in Hollis (1976), with additional information in Fig. 43. The length of the antennal flagellum is a summation of the lengths of individual flagellomeres.

Unless otherwise stated all figures were drawn from slide-mounted material; scale lines represent 0.1 mm unless labelled otherwise. On the forewing figures the outer limits of patches of spinules are indicated by pecked lines, as is the claval suture. Each paramere figure shows the inner surface of the right paramere. The figures of the larvae show the dorsal surface outline, left side only; details are shown of the marginal setae, representing 0.1 mm, of the head, forewing bud and caudal plate. The detail of the anal pore area is shown from a ventral view, right side only.

Structural terminology follows that of Vondráček (1957) and Hollis (1976). Wing venation terminology is explained in Figs 40, 43. The  $m_1$  cell value is an expression of shape calculated by dividing the length of  $M_{1+2}$  by the distance between the apices of  $M_{1+2}$  and  $M_{3+4}$ . Similarly the  $cu_1$  cell value is the distance between the apices of  $Cu_{1a}$  and  $Cu_{1b}$  divided by the length of  $Cu_{1b}$ . The  $Rs-Cu_{1a}$  line is an imaginary line connecting the apices of  $Rs$  and  $Cu_{1a}$ .

### Acknowledgements

I thank Dr L. A. Mound, BMNH, and Dr M. R. Wilson, Commonwealth Institute of Entomology, London, for offering constructive criticism of early drafts of the manuscript. The following colleagues provided valuable loans and gifts of material: A. L. Capener, formerly of NCI; José Passos de Carvalho, presently with Departamento de Entomologia, Estação Agronómica Nacional, Portugal; J. Etienne, Institut Sénégalais Recherches Agricoles, Ziguinchor; Dr U. Göllner-Scheiding, MNHU; A. van Harten, presently with Projecto Luta Integrada, Praia, Cape Verde Is; and Dr G. Schmitz, MRAC.

### TRIOZIDAE Löw

Triozinae Löw, 1879: 605, 609; Maskell, 1890: 164; Froggatt, 1901: 272; Crawford, 1914: 64; 1919: 184; Pflugfelder, 1941: 78; Tuthill, 1943: 545; 1944: 144; 1952: 97; Zimmermann, 1948: 14; Heslop-Harrison, 1958: 562; 1961: 529; Ramirez-Gomez, 1960: 15; Mathur, 1975: 299. Type-genus: *Triozia* Foerster.

Triozina Löw; Löw, 1886: 163.

Triozaria Löw; Puton, 1886: 93.

Triozidae Löw; Edwards, 1896: 251; Vondráček, 1957: 297; Dobreanu & Manolache, 1962: 253; Loginova, 1964: 473; Klimaszewski, 1973: 231; 1975: 201; Bekker-Migdisova, 1973: 113.

Siphonaleyrodinae Takahashi, 1932: 48. Type-genus: *Siphonaleyrodes* Takahashi. [Synonymised by Mound & Halsey, 1978: 252.]

DIFFERENTIATING DIAGNOSIS. Forewing (Fig. 40) without a costal break;  $R_1$  unbranched and pterostigma absent;  $M+Cu$  stem absent or very short so that  $R+M+Cu$  stem branches into its component veins at approximately one point;  $R_s$  not fused to  $M$  stem at any point.

COMMENTS. This suite of characters separates the Triozidae from all other psyllid groups and I regard it as autapomorphic for the family. Furthermore I believe the morphology of the trioqid forewing has evolved to produce a wing movement which is fundamentally different to that of other psyllids: there being no nodal line, from the costal break through to the break on the hind margin at the apex of the claval suture, for the wing to flex.

Many other groups of psyllids have some, but not all, of the trioqid wing features. The costal break is lost in the Macrohomotomini, the Carsidarini and many members of the Arytainini; in *Epipsylla* the pterostigma is lost; and in many members of the Calophyidae  $M+Cu$  stem is reduced. In the Central and South American genus *Synoza* the trioqid wing condition is achieved in an entirely different way.  $Rs$  is fused to  $M$  stem along its proximal two-thirds, the costal break is absent but  $C+Sc$  is only very weakly sclerotised in the break area. The venation of this genus can be derived easily from that of some South East Asian members of the Homotominae to which *Synoza* is most closely related.

As yet I have been unable to find synapomorphies linking the Triozidae with any one other group of psyllids to the exclusion of all others. Therefore I am regarding the rest of the Psylloidea as a paraphyletic group with respect to the Triozidae.

The systematic scope of the Triozidae, as considered here, is similar to that of most recent authors but with the addition of the genera *Pauropsylla* and *Leptynoptera*. This is a relatively radical change as all previous authors, apart from White (1980), regarded *Pauropsylla* as a member of the Pauropsyllinae (or Pauropsyllini) within either the Carsidaridae or the Aphalaridae (see p. 27).

Some attempt has been made by previous authors to provide a subfamilial or tribal classification for the Triozidae. Vondráček (1963) placed *Triozamia* in the Bactericerinae but retained the subfamily within the Ciriacreminidae (sensu Heslop-Harrison, 1958; nec Hollis, 1976). Klimaszewski (1964: fig. 7) divided the group into two subfamilies, the Bactericerinae and the Triozinae. Bekker-Migdisova (1973) retained these two subfamilies and divided the Bactericerinae into two tribes, the monotypic Triozamini (*Triozamia*) and the Bactericerini (*Bactericera*, *Rhinopsylla*, *Levidea* and one unnamed genus). She divided the Triozinae into the Hemischizocraniini (*Hemischizocranium*), the Paracomecini (*Paracomeca*) and the Eutrioziini (*Eutrioza*). Presumably she regarded the remaining 40 or so genera as members of a fourth tribe, the Triozini. Kwon (1983), in a review of the Korean psyllid fauna, erected the monobasic tribes Epitrioziini (*Epitrioza*) and Trichohermini (*Trichohermes*), apparently without reference to the remaining world fauna.

Most of the 47 previously described triozid genera are poorly defined and often based on inadequate or primitive characters. Species have been added to various genera without comparison with relevant type-species, thus stretching generic limits beyond usefulness and logic. The resulting network of genera is impossible to unravel without an overall examination of original material. No attempt is made here to 'fit' species into existing genera other than *Trioza*, only one new genus is erected and the bulk of the Afrotropical species are placed in *Trioza* on a temporary basis. Where species-groups are recognisable these are defined, and if relationships with the triozid fauna outside Africa are apparent then these are noted.

The characters used to differentiate taxa in this paper are discussed, together with their likely polarity. When other faunas are examined in the light of these, and probably other characters not considered here, we may be able to produce a reasonably natural and predictive higher classification for the Triozidae and offer useful biogeographical comment on the group.

### Characters and their polarity

The *integument* has a general covering of setae of varying density which can be of use in distinguishing between closely related species. Often the density of pilosity on the vertex and thoracic dorsum is different to that of the genal cones and legs. Illustrations of dense, sparse, long and short pilosity are given in Figs 35, 38, 39.

The *head*, in its primitive condition, is adpressed to the thorax and not declined from the longitudinal axis of the body (Figs 32, 33). The occipital margin is sharply defined, the median suture of the vertex is well developed and the median ocellus is visible from above. Frontal lobes on the vertex tend to be better developed in the primitive head condition. Genal cones are normally well developed in the group and cover the frons. Generally, in psyllids, it is thought that the absence of genal cones is a primitive condition but their absence may be a reversal in Triozidae. The more derived head condition shows it declined towards 90° from the longitudinal axis of the body (Fig. 34), with a rounded occipital margin. The vertex becomes rounded downwards and lacks frontal lobes. In some species, especially in the genus *Pauropsylla*, the median suture of the vertex is lost.

The *antenna* (Figs 9–29) shows many useful characters. In the primitive condition it has a scape, pedicel and a flagellum which has eight flagellomeres, with a single rhinarium present subapically on each of flagellomeres 2, 4, 6 and 7. Several species have developed supplementary rhinaria, particularly on the first flagellomere (*Triozamia lamborni*, *Trioza theroni* and the *T. hargreavesi*-group). I suspect this feature is not uniquely derived. The rhinaria are normally

disc-shaped, with a convex centre, but may have complicated associated sensilla (Figs 22–28). Flagellomere 8 bears two terminal setae, which are subequal in length in the primitive condition. Throughout the group there is a tendency for one of the pair to become shortened and truncate apically, and this condition reaches its greatest development in *Trioza anomalicornis* where one of the setae is reduced to a flat, circular sense organ (Fig. 17). The overall length of the flagellum compared to head width is of use in distinguishing between species, and the relative lengths of individual flagellomeres can also be useful. Reduction in the number of flagellomeres is rare but does occur in some *Pauropsylla* species, with 3 and 5, which do not normally bear rhinaria, being lost.

The *mouthparts* are relatively standard throughout the group. The clypeus most commonly has a pair of setae but in some species, notably those displaying primitive character states, several setae are present (Figs 5, 7). The ultimate rostral segment always bears a pair of basal setae and one or more pairs of setae along its length. It is rarely devoid of setae supplementary to the basal pair (Figs 6, 8).

The *thorax*, in the primitive state, is relatively flat, the pronotum is clearly visible from above and rounded down anteriorly behind the occiput (Figs 30, 31). The propleural suture is diagonal, with the episternum somewhat larger than the epimeron, but the latter is in contact with the posterolateral corner of the pronotum. The mesopraescutum is wider than long, with a broadly arcuate anterior margin which is gently rounded down to the pronotum. In the derived state the pronotum becomes strongly rounded down behind the occiput and is scarcely visible from above. The episternum becomes greatly enlarged and its posterior margin expanded laterally and curved forward behind the eye; the epimeron being reduced and displaced ventrally. The mesopraescutum is elongated and produced forward, with a strongly arcuate anterior margin which is strongly rounded or angled down to the pronotum (Figs 36, 37).

The *forewing* displays a number of distinct trends. The general shape varies from being ovate with a rounded apex to elongate oval with an angular apex, but the obovate condition in *Pauropsylla* is probably secondarily derived. The membrane may be heavily spinuled (Fig. 241) through to being devoid of spinules apart from the radular areas. The latter are normally present at the margin of the wing in cells  $m_1$ ,  $m_2$  and  $cu_1$ , although more primitively they also occur in  $r_2$  (Fig. 65). They may be diffuse and broad or sharply defined and narrow triangular (Figs 249, 178). The wing veins are usually sparsely clothed with short setae (Fig. 126) but may bear long setae (Figs 183, 254); the latter condition is not always associated with a dense pilosity on the integument. In the most primitive form of venation (Fig. 268)  $R_s$  is long,  $M$  branches proximally to the  $R_s-Cu_{1a}$  line (see p. 16) with a consequently high  $m_1$  cell value,  $Cu$  is short with a consequently low  $cu_1$  cell value, and the claval suture reaches the wing margin close to the distal apex of  $Cu_{1b}$ . In the most derived condition (Fig. 126)  $R_s$  is short,  $M$  branches distal to the  $R_s-Cu_{1a}$  line with a consequently low  $m_1$  cell value,  $Cu$  is long with a consequently high  $cu_1$  cell value and the claval suture reaches the hind margin distant from the apex of  $Cu_{1b}$  and more proximal to the base of the wing. These trends are not always associated and there are many combinations.

The *hindwing*, in the primitive state, is two-thirds or more as long as the forewing. The costal margin is more densely setose, with the setae distal to the costal break not clearly divided into two groups (Fig. 44). In the derived state the hindwing is much shorter than the forewing and, in the *Trioza obsoleta* group, it can be completely reduced and scale-like (Figs 179, 184, 189). Reduction in length is congruent with the displacement of the apex of the claval suture of the forewing towards the base of the wing. The costal margin is sparsely setose, with the setae distal to the costal break clearly divided into two groups (Fig. 42).

The *fore* and *mid legs* offer few characters of taxonomic significance, although the *Pauropsylla willcocksii*-group has the extraordinary development of a ventroapical spur on the fore coxa (Fig. 45). One or other of the tarsal segments may be elongated.

The *hind leg* bears several useful characters. The coxa usually bears a well-developed meracanthus, although this is weak in *Triozamia lamborni* and in the *Trioza etiennei*-group, and there is often an anterior lobe developed (Figs 46, 47). The latter structure has, in the past, been

used to group species but the feature has probably evolved several times. The three ventral sense organs on the femur, which are probably stretch receptors, are usually in a medial position (Fig. 49) but in *Triozamia lamborni* they are in the more primitive basal position (Fig. 48). The tibia has a basal spine or tubercle, or a raised area bearing one or more small spines. The presence of a large basal spine has been used in generic diagnoses, but I consider this to be the primitive state. Apical tibial spurs (Figs 52, 53) are normally present and are divided into an outer group of one spur and an inner group of up to four spurs. In *Triozamia lamborni* the outer spur is lost and the inner group consists of up to five spurs. There is a tendency towards reduction of the number of inner spurs and there can be some variation within a species, e.g. some species which normally have three inner spurs occasionally have only two on one or other leg. Few species have these spurs completely lacking but again I think this is a feature which has arisen more than once. Spurs at the apex of the basitarsus, a common feature in the rest of the Psylloidea, are, with the exception of *Afrotioza*, absent in the family.

The *abdomen*, in psyllids generally, has setae on all visible abdominal tergites but this condition occurs in very few triozids (four species in the Afrotropical Region). The usual condition in this family is for setae to be present only on the first, or the first two, visible tergites, i.e. tergites 2 and 3 in males and 3 and 4 in females. *Trichohermes insleyi*, some of the *Triozia obsoleta*-group and *T. guiera*, have setae on all tergites except the pregenital; *T. mimusops* has setae only on tergites 6 to 8; *T. chiangae* has setae on tergites 3 to 5; and the abdominal tergites of *T. afrosersalisia* are apparently devoid of setae. This character is not directly associated with general body pilosity because *T. medleri*, probably the most setose Afrotropical species, has only the first visible abdominal tergite setose.

The *male genitalia* provides the most useful character suite for defining species. As in most psyllids, the proctiger is normally unsegmented (unipartite), but a bipartite proctiger occurs in *Triozamia* species and is almost developed in the *Triozia etiennei*-group. I consider a bipartite proctiger to be the derived condition (Fig. 59). The unipartite proctiger can be a simple, almost cylindrical tube (Fig. 242) but more commonly the basal part is swollen and often bears lateral expansions which sometimes have modified setae on their inner surfaces (Figs 76, 97, 135). The shape of the paramere and its chaetotaxy is usually definitive for a species. The aedeagus is composed of two articulated segments, as in most psyllids, but the apical segment is subdivided into two parts in *Triozamia lamborni* and in the *Triozia etiennei*-group (Figs 64, 200). The apical part of the aedeagus is usually definitive for each species, and in some cases is quite complex (Figs 88, 91, 136).

The *female genital complex* is usually conoid, with a subacute posterior apex (Fig. 127). The anal pore ring usually consists of a double ring of wax-producing cells and is rarely modified; in *Triozamia* species it is very convoluted (Fig. 62), in the *litseae*-group and some species of the *neoboutonia*-group of *Triozia* it is reduced to a single ring, and in *Triozia tundavala* it is incomplete anteriorly and forms multiple rows posteriorly (Fig. 274). The base of the proctiger is much less sclerotised than in other groups of psyllids, and is sometimes membranous around the anterior arch of the anal pore ring. The apical part of the proctiger is usually narrowed to a subacute apex but may be modified in various ways (Figs 138, 253, 274). The subgenital plate is triangular in profile and usually has a narrowly arcuate or subacute posterior margin. Occasionally the posterior margin is truncate or emarginate (Figs 89, 138). The lower valves of the ovipositor sometimes have teeth or ridges developed (Figs 128, 138, 273) which can be useful in species diagnosis.

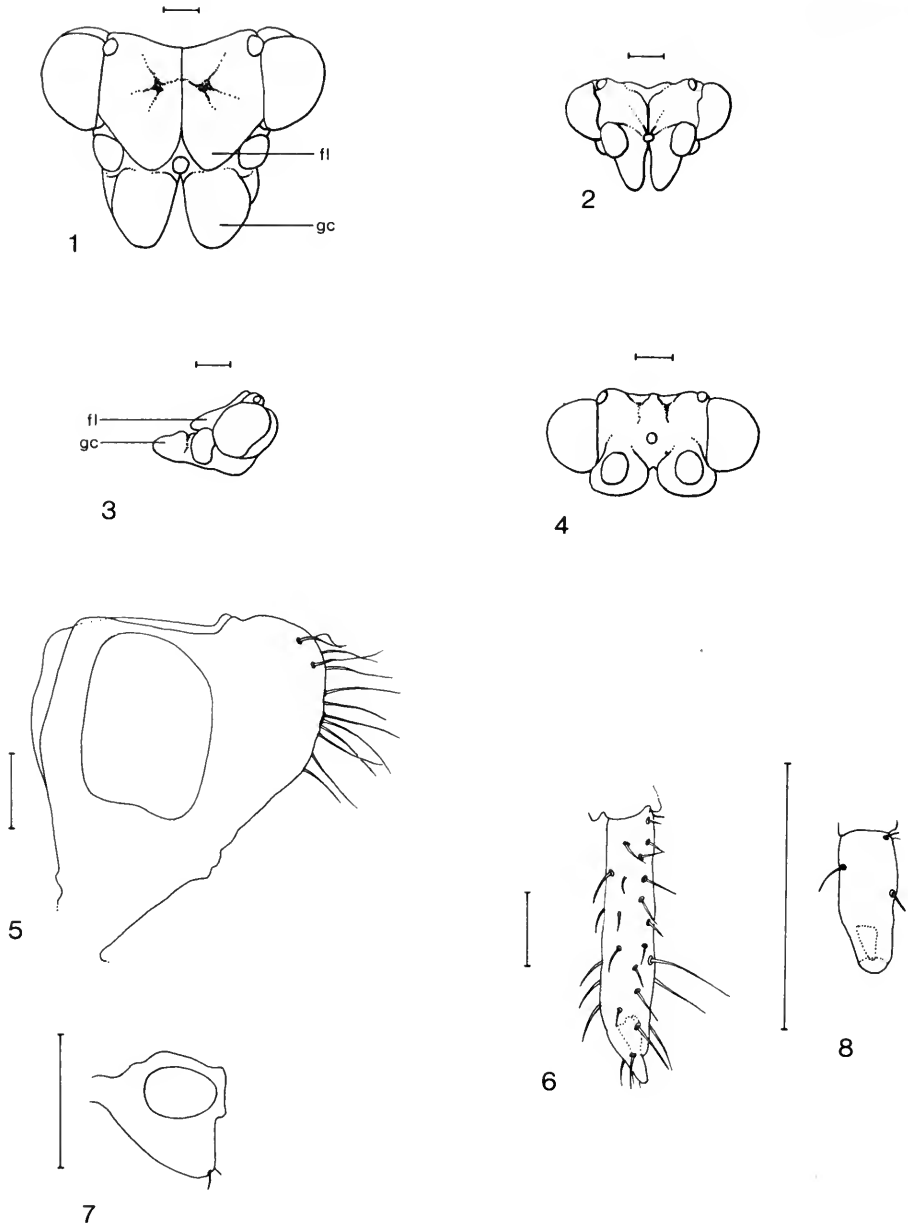

**Figs 1–8** Afrotropical Triozidae, head and mouthparts structure. 1, *Afrotrioza bersama*, head, antero-dorsal view. 2, 7, 8, *Trioza erytreae*; 2, head, anterior view; 7, clypeus, lateral view; 8, ultimate rostral segment. 3, *Trichohermes insleyi*, head, lateral view. 4, *Pauropsylla trichaeta*, head, anterior view. 5, 6, *Triozamia lamborni*; 5, clypeus, lateral view; 6, ultimate rostral segment. (fl – frontal lobe; gc – genal cone.) Figs 1–4 drawn from dry mounted specimens.

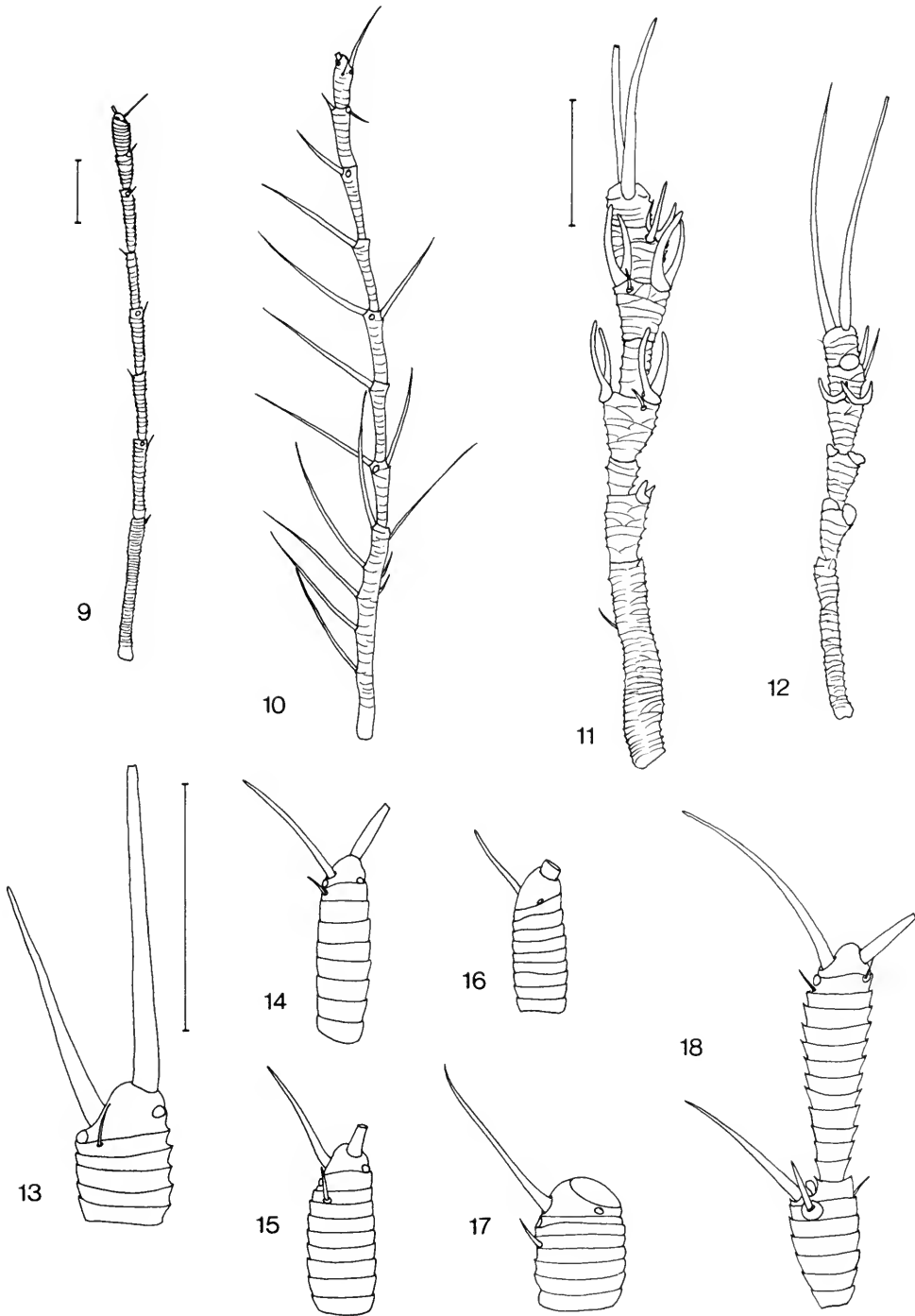

**Figs 9–18** Afrotropical Triozidae, antennal structure. 9, *Trioza erythrae*, flagellum. 10, *T. medleri*, flagellum. 11, *Pauropsylla trigemma*, flagellum. 12, *P. breviantennata*, flagellum. 13, *Trioza afroboleta*, apical flagellomere. 14, *T. neoboutonia*, apical flagellomere. 15, *T. kakamegae*, apical flagellomere. 16, *T. dinaba*, apical flagellomere. 17, *T. anomalicornis*, apical flagellomere. 18, *T. tangae*, subapical and apical flagellomeres.

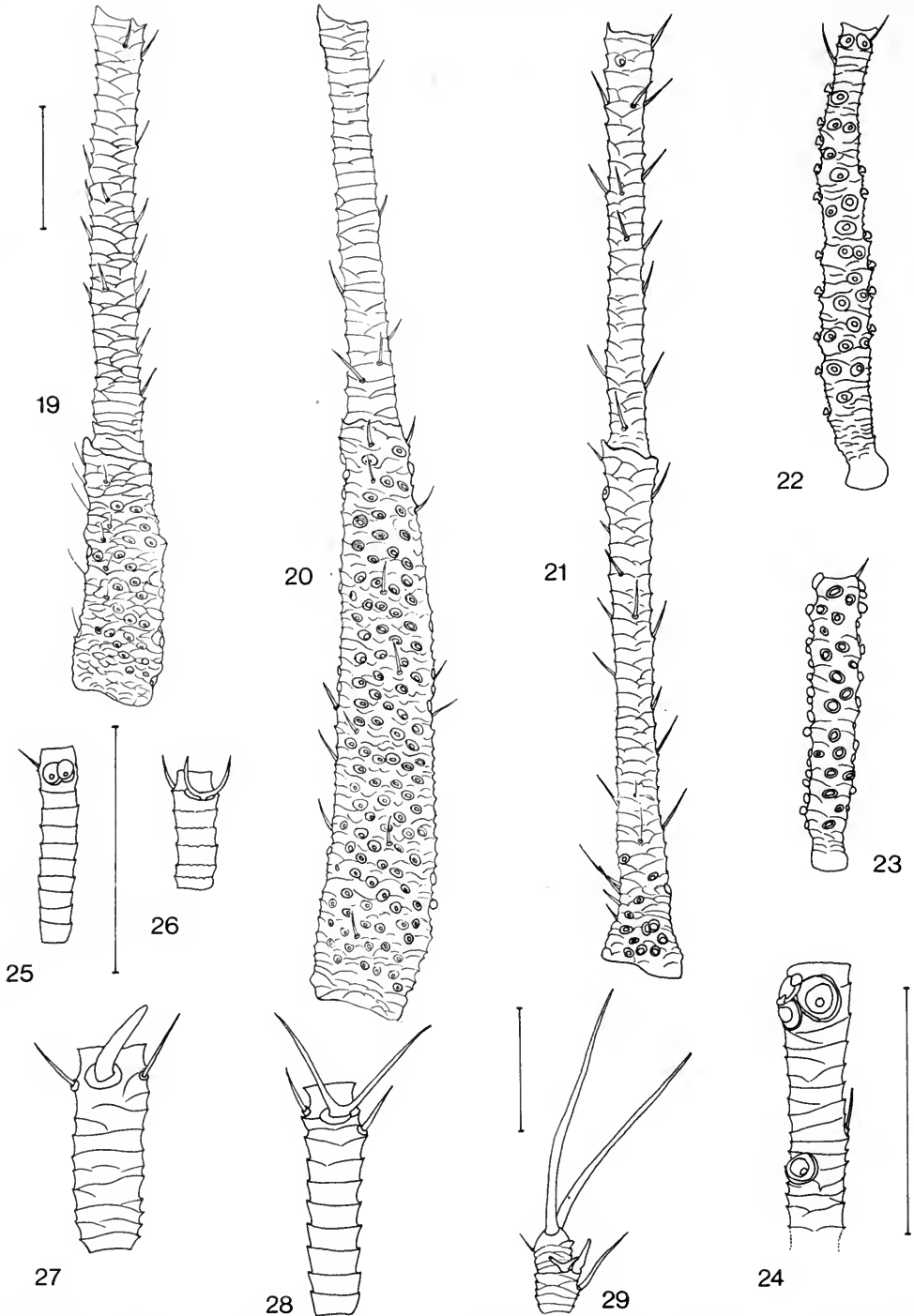

**Figs 19–29** Afrotropical Triozidae, antennal structure. 19, *Triozamia lamborni*, 1st and 2nd flagellomeres. 20, *T. vondraceki*, 1st and 2nd flagellomeres. 21, *T. usambarensis*, 1st and 2nd flagellomeres. 22, *Trioza hargreavesi*, 1st flagellomere. 23, *T. mirificornis*, 1st flagellomere. 24, *T. theroni*, apical third of 1st flagellomere. 25, *T. dinaba*, 2nd flagellomere. 26, *T. pitkini*, 2nd flagellomere. 27, *T. capensis*, 2nd flagellomere. 28, *T. ghanaensis*, 4th flagellomere. 29, *Pauropsylla ngongae*, subapical and apical flagellomeres.



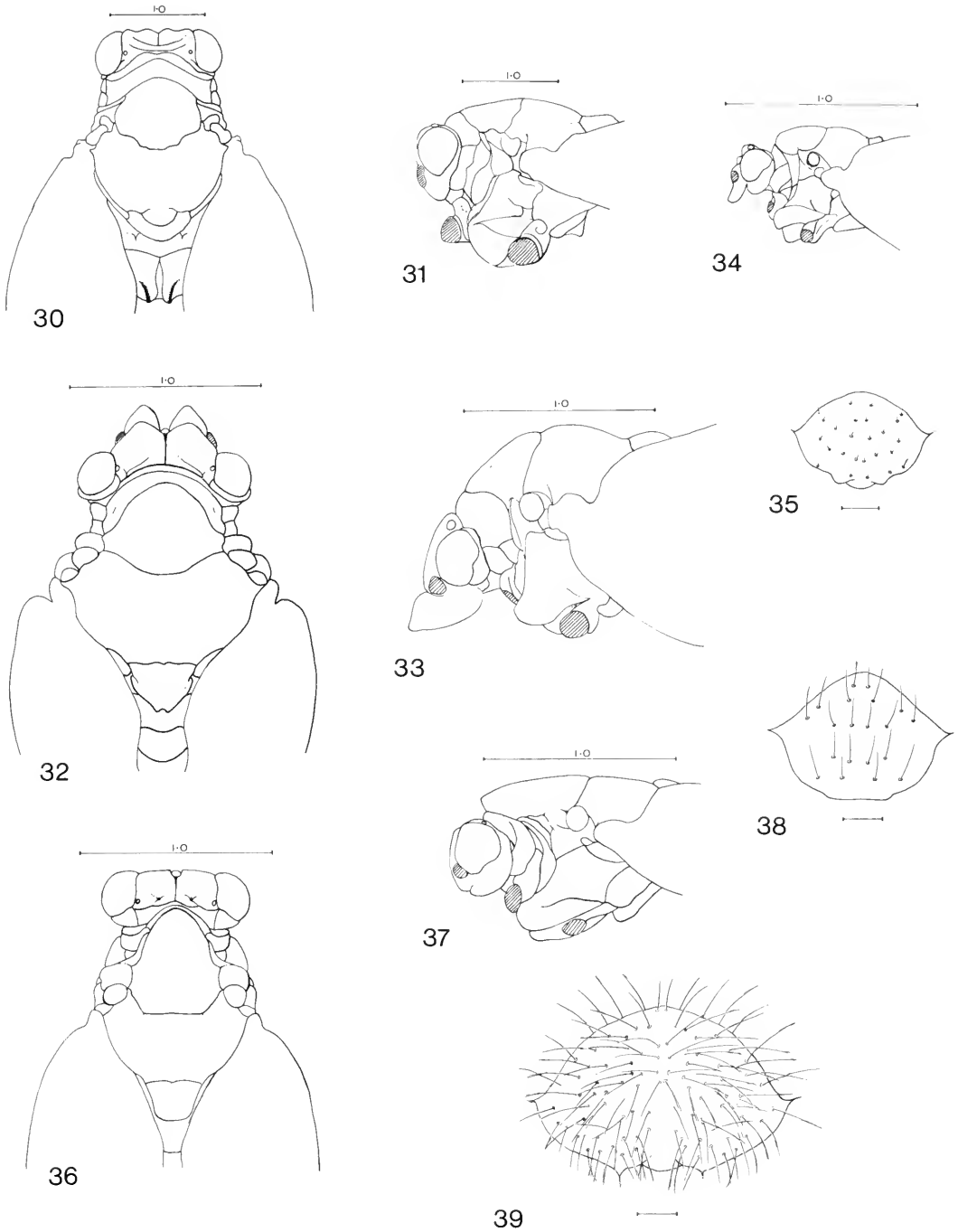

**Figs 30–39** Afrotropical Triozidae, head and thorax structure. 30, 31, *Triozamia vondraceki*; 30, head and thorax, dorsal view; 31, same, lateral view. 32, 33, *Afrotrioza bersama*; 32, head and thorax, dorsal view; 33, same, lateral view. 34, 35, *Triozia erytreae*; 34, head and thorax, lateral view; 35, mesopraescutum, dorsal view. 36, 37, *T. tenuis*; 36, head and thorax, dorsal view; 37, same, lateral view. 38, *T. gonjae*, mesopraescutum, dorsal view. 39, *T. medleri*, mesopraescutum, dorsal view. Figs 30–34, 36, 37 drawn from dry mounted specimens.

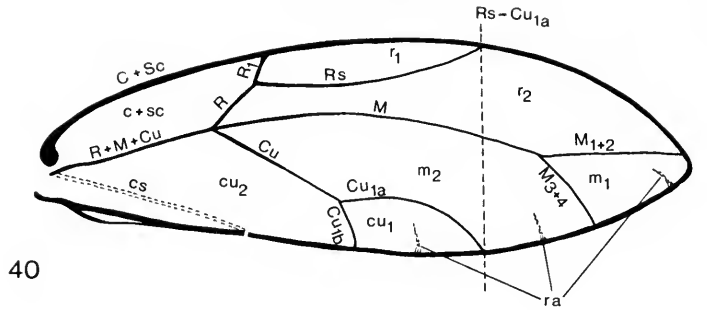

40

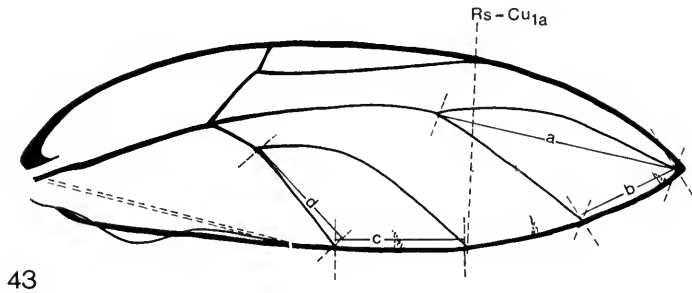

43

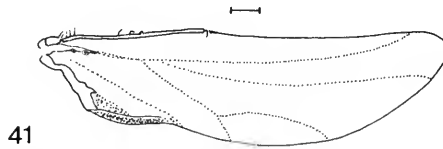

41



44



42

**Figs 40–44** Afrotropical Triozidae, wing structure. 40–42, *Trioza erytraea*; 40, forewing, showing vein and cell nomenclature; 41, hindwing; 42, costal setae of hindwing. 43, *T. tenuis*, forewing ( $a/b = m_1$  cell value,  $c/d = cu_1$  cell value). 44, *Afrotrioza bersama*, costal setae of hindwing. (ra – radular areas, cs – claval suture.)

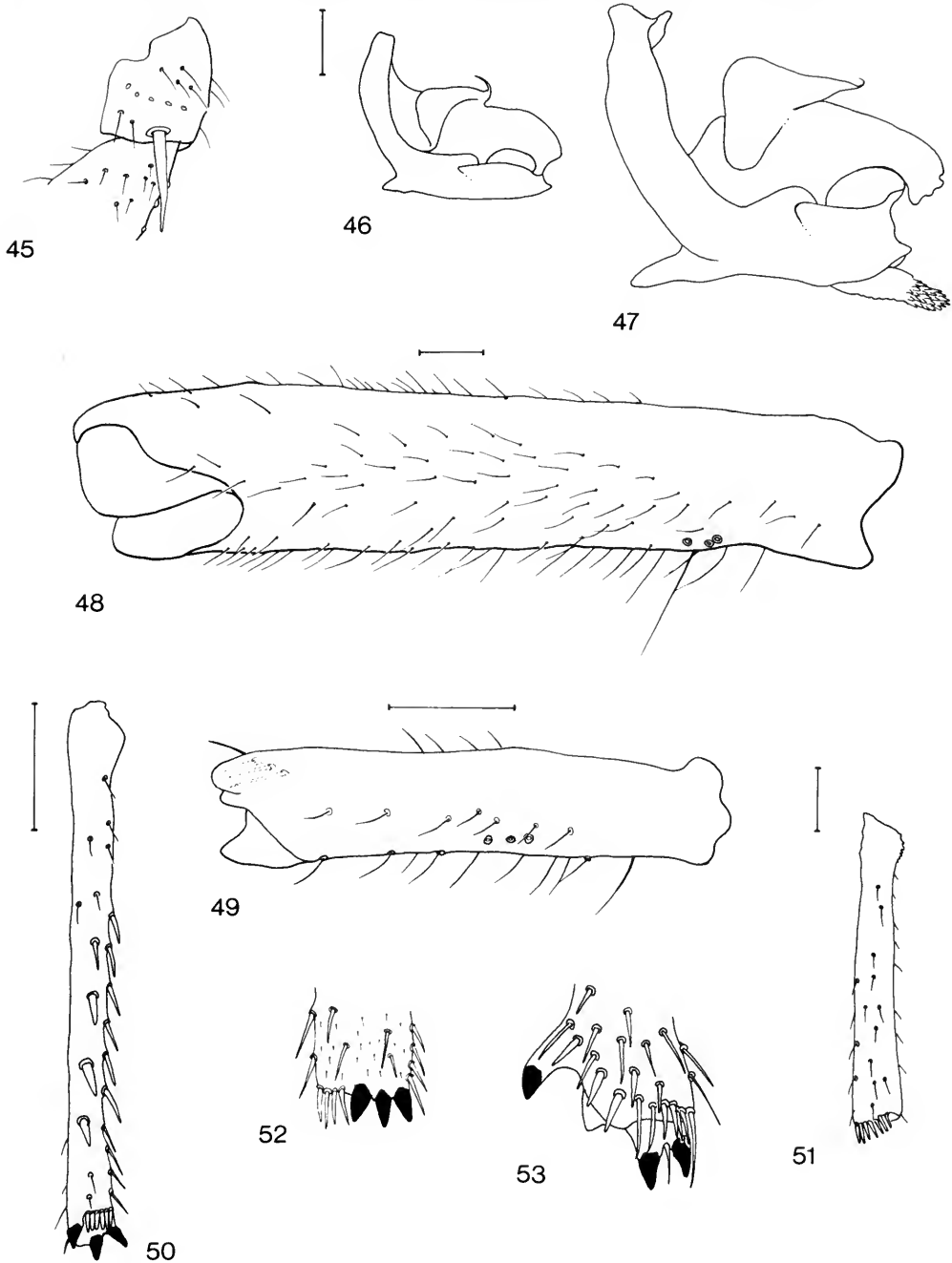

**Figs 45–53** Afrotropical Triozidae, leg structure. 45, *Pauropsylla trichaeta*, fore coxa, anteroventral view. 46, 50, *Trioza etiennei*; 46, hind coxa, lateral view; 50, hind tibia, anterodorsal view. 47, *T. gonjae*, hind coxa, lateral view. 48, *Triozamia lamborni*, hind femur, posteroventral view. 49, 52, *Trioza erythrae*; 49, hind femur, posteroventral view; 52, apex of hind tibia, posteroventral view. 51, *T. karroo*, hind tibia, anterodorsal view. 53, *T. capensis*, apex of hind tibia, posterodorsal view.

## Identification

The key presented below is intended to facilitate identification of Afrotropical trioqid species; it does not reflect phylogenetic relationships. The concept of the 'genus' *Trioza*, used here, is admittedly artificial, hence *Trioza* species key out both before and after the other included genera.

Undoubtedly the user will have difficulty identifying species in the *erytraea*- and *anomalicornis*-groups of *Trioza* (couplets 57–65) because of their morphological homogeneity. As *T. erytraea* is of economic importance a summary of characters used to identify species of the *erytraea*-group is given in Table 4. Apart from *anomalicornis*, which has distinctive antennal characters, the other four species in this group can be separated on the basis of the shape of the male paramere and the apical segment of the aedeagus (see quadruplet 61, p. 22). No reliable characters were found which would discriminate between females of this group.

*T. bussei* and *T. similis* are excluded from the key because of insufficient data (see p. 69).

## Key to species of Afrotropical Triozidae

- 1 Forewing with extensive brown-pigmented area either as a speckled pattern over most of wing, or as an infuscation along the medial vein and extending over posterior half of wing (Figs 69, 216, 245, 249) ..... 2
- Forewing hyaline, if brown-pigmented areas are present they are restricted to the very base of wing (Fig. 188), or along course of *R* and *R*<sub>1</sub> veins (Figs 169, 194, 233, 272), or at points where veins meet wing margin (Fig. 202) ..... 5
- 2 Forewing with brown speckled pattern over most of surface (Fig. 69); long and narrow, more than 3.5 times longer than wide; *Rs* strongly curved towards *M*<sub>1</sub> before reaching margin  
*Trichohermes insleyi* Capener (p. 26)
- Forewing with brown infuscation along *M* stem and across posterior half of wing; broader, at most slightly more than 3 times longer than wide; *Rs* continuously divergent from *M* stem (Figs 216, 245, 249) ..... 3
- 3 Small species, forewing not more than 1.8 mm long; antennal flagellum short, about as long as head width; genal cones absent ..... *Trioza pitkini* sp. n. (p. 59)
- Larger species, forewing more than 2 mm long; antennal flagellum more than 1.5 times longer than head width; genal cones well developed ..... 4
- 4 Hind tibia with well-developed apical spurs; *cu* cell value 1.07–1.40; ♀ proctiger blunt, rounded apically in profile ..... *Trioza laingi* sp. n. (p. 64)
- Hind tibia without apical spurs but with a crown of stout setae; *cu* cell value 1.48–1.79; ♀ proctiger acute, extended apically in profile ..... *Trioza karroo* sp. n. (p. 63)
- 5 Forewing with a radular area present in cell *r*<sub>2</sub> as well as in cells *m*<sub>1</sub>, *m*<sub>2</sub> and *cu*<sub>2</sub>, but if absent then apex of claval suture in close proximity to apex of *Cu*<sub>1b</sub> (Figs 56, 65); *C+Sc* greatly thickened along its whole length and more than twice as thick as *R* stem ..... 6
- Forewing with radular area absent from cell *r*<sub>2</sub> and apex of claval suture distant from apex of *Cu*<sub>1b</sub>; *C+Sc* not or hardly thickened and at most slightly thicker than *R* stem ..... 9
- 6 Metabasitarsus with a single apical spur; antenna short, flagellum 0.91–0.98 times as long as head width, 1st flagellomere without rhinaria; aedeagus 2-segmented  
*Afrotrioza bersama* sp. n. (p. 25)
- Metabasitarsus without apical spurs; antennal flagellum 1.5–2.0 times longer than head width, 1st flagellomere bearing several rhinaria and often thickened (Figs 19–21); aedeagus 3-segmented (*Triozamia* spp.) ..... 7
- 7 First flagellomere not at all thickened and bearing only 4–8 rhinaria basally; ♀ proctiger relatively short, 0.97–1.01 times as long as head width ..... *Triozamia usambarensis* sp. n. (p. 24)
- First flagellomere thickened and almost completely covered with rhinaria; ♀ proctiger longer, 1.2–1.54 times longer than head width ..... 8
- 8 First flagellomere 1.39–1.47 times longer than 2nd flagellomere; apical aedeagal segment 0.52–0.56 times as long as medial aedeagal segment ..... *Triozamia vondraceki* sp. n. (p. 24)
- First flagellomere 0.63–0.76 times as long as 2nd flagellomere; apical aedeagal segment longer than medial aedeagal segment ..... *Triozamia lamborni* (Newstead) (p. 23)
- 9 Vertex dish-like, evenly and roundly concave, not at all raised or interrupted along median suture, margin of 'dish' complete, sharp, finely serrate ..... *Trioza afrosersalisia* sp. n. (p. 54)

- Vertex convex, flat, or at most weakly concave on either side of median suture which clearly divides vertex into two halves; if median suture absent then forewing, at most, 2·3 times longer than wide ..... 10
- 10 *M* branching proximal to *Rs*-*Cu*<sub>1a</sub> line ..... 11
- *M* branching distal to *Rs*-*Cu*<sub>1a</sub> line ..... 26
- 11 Hindwing very reduced and scale-like ..... 12
- Hindwing not less than one-third the length of forewing ..... 14
- 12 Angle at which *R*<sub>1</sub> branches from *Rs* greater than 90° (Fig. 178); genal cones short; terminal setae of apical flagellomere subequal ..... *Trioza afroboleta* sp. n. (p. 52)
- Angle at which *R*<sub>1</sub> branches from *Rs* 90° or less; genal cones long; apical flagellomere with one long and one short terminal seta ..... 13
- 13 *m*<sub>1</sub> cell value 1·72-1·74, *cu*<sub>1</sub> cell value 2·9-3·0; hindwing with broad, almost truncate apex (Fig. 189) ..... *Trioza boxi* sp. n. (p. 53)
- *m*<sub>1</sub> cell value 1·91-2·08, *cu*<sub>1</sub> cell value 1·96-2·63; hindwing with narrow, subacute apex (Fig. 184) ..... *Trioza gonjae* sp. n. (p. 53)
- 14 *Cu* stem not more than half (0·45) the length of *Cu*<sub>1b</sub> ..... 15
- *Cu* stem not less than half (0·6) the length of *Cu*<sub>1b</sub> ..... 17
- 15 Densely pubescent species; genal cones long, well developed; forewing rounded apically (Fig. 254) ..... *Trioza medleri* sp. n. (p. 65)
- Weakly pubescent species; genae rounded, cones not developed; forewing subacute apically (Figs 237, 265) ..... 16
- 16 Forewing more than 3 times longer than wide; 1st flagellomere about twice as long as 2nd; *R*<sub>1</sub> short, about half as long as *R* stem; inner apical spurs of both hind tibiae together numbering 5 or 6; paramere as in Fig. 266; dorsal valve of ovipositor smooth apically ..... *Trioza tenuis* sp. n. (p. 67)
- Forewing about 2·5 times longer than wide; 1st flagellomere about 3 times as long as 2nd; *R*<sub>1</sub> about as long as *R* stem; inner apical spurs of both hind tibiae together numbering 4; paramere as in Fig. 239; dorsal valve of ovipositor serrate apically ..... *Trioza ghanaensis* sp. n. (p. 62)
- 17 Antennal flagellum not less than 1·5 times longer than head width ..... 18
- Antennal flagellum not more than 1·3 times longer than head width ..... 19
- 18 Distal segment of aedeagus with a large basal expansion (Fig. 222); cell *r*<sub>2</sub> of forewing with spinules apically (Fig. 219) ..... *Trioza glabea* sp. n. (p. 59)
- Distal segment of aedeagus with a small basal expansion (Fig. 224); cell *r*<sub>2</sub> of forewing devoid of spinules ..... *Trioza usambarica* sp. n. (p. 60)
- 19 First flagellomere with at least one rhinarium apically and usually two or three ..... *Trioza theroni* sp. n. (p. 67)
- First flagellomere without rhinaria ..... 20
- 20 Larger species, forewing 2·75-6·00 mm long; antennal flagellum more than twice as long as head width ..... 21
- Smaller species, forewing less than 2 mm long; antennal flagellum about as long as head width ..... 22
- 21 Forewing about 6 mm long, less than 2·5 times longer than wide; course of *R* stem and *R*<sub>1</sub> brown-pigmented (Fig. 272) ..... *Trioza tundavalaе* sp. n. (p. 68)
- Forewing about 3 mm long and about 2·8 times longer than wide and unpigmented (Fig. 256) ..... *Trioza schroederi* sp. n. (p. 65)
- 22 Pronotum with a median and two lateral raised tubercles (Fig. 203) ..... 23
- Pronotum without raised tubercles ..... 24
- 23 Antennal flagellum 0·7 times as long as head width; *m*<sub>1</sub> cell value 1·62, *cu*<sub>1</sub> cell value 2·9; brown-pigmented areas present where veins reach wing margin (Fig. 202) ..... *Trioza messaratina* sp. n. (p. 57)
- Antennal flagellum 1·06-1·23 times longer than head width; *m*<sub>1</sub> cell value 1·25-1·45, *cu*<sub>1</sub> cell value 1·07-1·38; forewing hyaline (Fig. 198) ..... *Trioza etiennei* sp. n. (p. 56)
- 24 Wing veins with short setae, *m*<sub>1</sub> cell without spinules; antennal flagellum 1·11-1·23 times longer than head width; ♂ paramere long and slender, with a pair of teeth apically (Fig. 215) ..... *Trioza camerounensis* sp. n. (p. 58)
- Wing veins with long setae; *m*<sub>1</sub> cell with spinules apically; antennal flagellum not more than 0·91 times as long as head width; ♂ paramere 'thumb-shaped' with a transverse ridge in apical third (Figs 210, 213) ..... 25
- 25 Rhinaria on flagellomeres 2, 4, 6 and 7 each with a short bifid sensillum; ♂ paramere with a

- transverse ridge one-third below apex (Fig. 210) ..... *Trioza seranistama* sp. n. (p. 58)
- Rhinarium of flagellomere 2 with a long bifid sensillum; inner transverse ridge of ♂ paramere apical (Fig. 213) ..... *Trioza nestasimara* sp. n. (p. 58)
- 26 Forewing with course of *R* stem and *R*<sub>1</sub> marked with brown pigment (Figs 169, 194, 233) ..... 27
- Course of *R* stem and *R*<sub>1</sub> unpigmented ..... 29
- 27 *m*<sub>1</sub> cell value more than 1.8; forewing about twice as long as hindwing; abdomen with setae on tergites 6–8 ..... *Trioza mimusops* sp. n. (p. 54)
- *m*<sub>1</sub> cell value less than 1.3; forewing at most 1.8 times longer than hindwing; abdomen with setae on first two visible tergites at most ..... 28
- 28 Antennal flagellum about twice as long as head width; ultimate rostral segment shorter than apical flagellomere ..... *Trioza fuscivena* sp. n. (p. 61)
- Antennal flagellum about as long as head width; ultimate rostral segment about twice as long as apical flagellomere ..... *Trioza nachingweae* sp. n. (p. 49)
- 29 Angle of *R*<sub>1</sub> and *R*<sub>s</sub> branch obtuse (Fig. 178) ..... *Trioza afroboleta* sp. n. (p. 52)
- Angle of *R*<sub>1</sub> and *R*<sub>s</sub> branch 90° or less ..... 30
- 30 First flagellomere thickened and bearing about 40 rhinaria ..... 31
- First flagellomere not or hardly thickened, devoid of rhinaria ..... 32
- 31 Larger species, forewing length of ♂ 4.4–5.0, of ♀ 5.0–5.4; *m*<sub>1</sub> cell value 1.32–1.6; 3rd flagellomere without rhinaria; lower valves of ovipositor saw-like apically  
*Trioza hargreavesi* sp. n. (p. 50)
- Smaller species, forewing length 3.2–3.9 in ♂ and 4.1–4.6 in ♀; *m*<sub>1</sub> cell value 1.13–1.29; 3rd flagellomere bearing several rhinaria; lower valves of ovipositor smooth  
*Trioza mirificornis* sp. n. (p. 51)
- 32 Forewing membrane with spinules in addition to radular areas ..... 33
- Forewing membrane devoid of spinules apart from radular areas ..... 35
- 33 Forewing short and broad, 2.25–2.57 times longer than wide, with rounded apex (Fig. 241); antennal flagellum about as long as head width; apex of hind tibia without spurs  
*Trioza guiera* sp. n. (p. 62)
- Forewing more than 2.5 times longer than wide, with subacute apex; antennal flagellum more than 1.5 times longer than head width; apex of hind tibia with well-developed spurs ..... 34
- 34 Apex of hind tibia with two inner apical spurs; forewing 2.71–3.43 times longer than wide; antennal flagellum 1.94–2.53 times longer than head width; ultimate rostral segment 1.0–1.4 times longer than apical flagellomere  
*Trioza litseae* Bordage (p. 43) and *T. xylopi*a sp. n. (p. 43)
- Apex of hind tibia with three inner apical spurs; forewing 2.60–2.89 times longer than wide; antennal flagellum 1.62–1.97 times longer than head width; ultimate rostral segment 1.3–2.0 times longer than apical flagellomere ..... *Trioza eafra* sp. n. (p. 42)
- 35 Hind tibia shorter than width of head, apex expanded, basal spine well developed, outer apical spur enlarged and displaced to a subapical position (Fig. 53); male genitalia as in Figs 226–228 ..... *Trioza capensis* sp. n. (p. 55)
- Hind tibia longer than width of head, apex not expanded, basal tubercles small and poorly developed, outer apical spur not enlarged or displaced; male genitalia another shape ..... 36
- 36 Forewing narrow, not less than 2.5 times longer than wide, with angular or subangular apex, *m*<sub>1</sub> cell value greater than 1.1 ..... 37
- Forewing broadly rounded apically (Figs 75, 80, 83, 84, 86), not more than 2.3 times longer than wide, *m*<sub>1</sub> cell value not more than 1.05 (*Pauropsylla* species) ..... 39
- 37 Second flagellomere with a double rhinarium (Fig. 25) ..... 38
- Second flagellomere with a single rhinarium ..... 51
- 38 *Cu* stem long, more than 2.8 times longer than *Cu*<sub>1b</sub>, branching from *R+M+Cu* proximally to *R* branch (Fig. 165); ♂ paramere and aedeagus as in Figs 166–168 ..... *Trioza dinaba* sp. n. (p. 49)
- *Cu* stem not more than 2.6 times longer than *Cu*<sub>1b</sub>, branching from *R+M+Cu* at or slightly distal to *R* branch; ♂ paramere and aedeagus as in Figs 162–164 ..... *Trioza bamendae* sp. n. (p. 48)
- 39 Fore trochanter with a well-developed ventroapical spur (Fig. 45) ..... 40
- Fore trochanter without a ventroapical spur ..... 42
- 40 Clypeus with a pair of setae; ultimate rostral segment with a pair of short setae; ♀ genital segment rounded triangular in profile, subgenital plate without a ventral transverse groove  
*Pauropsylla tatricea* sp. n. (p. 30)
- Clypeus with several short setae, ultimate rostral segment with a pair of long setae and a pair of

- short setae; ♀ genital segment angular in profile, subgenital plate with a ventral transverse groove ..... 41
- 41 In final instar larva sectasetae present on dorsum, marginal sectasetae widely spaced and of uneven length (Fig. 280) ..... *Pauropsylla willcocksii* Dębski (p. 29)
- Final instar larva without sectasetae on dorsum, marginal sectasetae closely spaced and of even length (Fig. 282) ..... *Pauropsylla trichaeta* Pettey (p. 30)
- 42 Antenna with 6 flagellomeres (Fig. 12) ..... *Pauropsylla brevientennata* sp. n. (p. 31)
- Antenna with 8 flagellomeres ..... 43
- 43 Basitarsus of each leg 1.5–2.0 times longer than corresponding apical tarsal segment; median suture of vertex absent ..... *Pauropsylla longipes* sp. n. (p. 33)
- Basitarsus of each leg short, hardly longer than corresponding apical segment; median suture of vertex present although sometimes incomplete posteriorly ..... 44
- 44 ♂ proctiger with greatly expanded lateral lobes (Fig. 97); ♀ abdomen with sternite 6 much less sclerotised than other segments and membranous ventrally ..... *Pauropsylla eastopi* sp. n. (p. 33)
- ♂ proctiger flask-shaped, without expanded lateral lobes; ♀ abdomen with evenly sclerotised sternites ..... 45
- 45 Antennal flagellomeres 4 and 6 each bearing two apical rhinaria and each of these with a bifid sensillum (Fig. 11) ..... 46
- Antennal flagellomeres 4 and 6 each with a single apical rhinarium which does not bear a bifid sensillum ..... 47
- 46 Forewing broader, about 1.8 times longer than wide, veins bearing long setae, at least in proximal half of wing (Fig. 83) ..... *Pauropsylla ngongae* sp. n. (p. 31)
- Forewing narrower, about 2.25 times longer than wide, veins bearing short setae (Fig. 80) ..... *Pauropsylla trigemina* sp. n. (p. 31)
- 47 ♂ aedeagus with a complex apical segment (Figs 88, 91); ♀ subgenital plate with a ventroapical notch (Figs 89, 92) ..... 48
- ♂ aedeagus with a simple apical segment (Figs 94, 103, 106); ♀ subgenital plate with a smoothly rounded or straight posterior margin ..... 49
- 48 ♂ paramere broadening towards apex and with a transverse inner apical ridge (Fig. 87); posterior margin of ♀ subgenital plate weakly notched and bordered with short setae (Fig. 89) ..... *Pauropsylla septima* sp. n. (p. 32)
- ♂ paramere narrowing towards apex which is twisted and abcurved (Fig. 90); posterior margin of ♀ subgenital plate deeply notched and bordered with long setae (Fig. 92) ..... *Pauropsylla proxima* sp. n. (p. 32)
- 49 Smaller species, forewing less than 1.9 mm long in ♂ and 2.1 in ♀; hind tibia less than 0.57 mm long; median suture of vertex incomplete and evanescent towards occiput; ♂ paramere as in Fig. 105; ♀ genital segment subrectangular in profile ..... *Pauropsylla senegalensis* sp. n. (p. 34)
- Larger species, forewing more than 2.4 mm long; hind tibia more than 0.58 mm long; median suture of vertex complete to occiput; ♂ paramere as in Figs 93, 102; ♀ genital segment rounded triangular in profile ..... 50
- 50 Larger species, hind tibia more than 0.75 mm long; ♂ paramere clavate, with an inner apical transverse ridge (Fig. 93); posterior margin of ♀ subgenital plate truncate ..... *Pauropsylla angolensis* sp. n. (p. 33)
- Smaller species, hind tibia not more than 0.7 mm long; ♂ paramere conical with an apical pair of spines (Fig. 102); posterior margin of ♀ subgenital plate rounded ..... *Pauropsylla mistura* sp. n. (p. 34)
- 51 *Cu* stem relatively short, not more than 1.5 times longer than *Cu*<sub>1b</sub> ..... 52
- *Cu* stem longer, not less than 1.6 times longer than *Cu*<sub>1b</sub> ..... 53
- 52 Hind tibia with one outer and three inner apical spurs; ultimate rostral segment narrow, almost twice as long as wide; ♂ paramere with a long abcurved anteroapical process (Fig. 231) ..... *Trioza ficicola* sp. n. (p. 60)
- Hind tibia with one outer and two inner apical spurs; ultimate rostral segment broad, not more than 1.5 times longer than wide; ♂ paramere with a simple rounded and notched apex (Fig. 157) ..... *Trioza harteni* sp. n. (p. 47)
- 53 Apical flagellomere twice as long as flagellomere 7 ..... *Trioza tangae* sp. n. (p. 66)
- Apical flagellomere at most slightly longer than flagellomere 7 ..... 54
- 54 Flagellomeres bearing long subapical setae, apical flagellomere with one apical seta and a flat discoid sense organ (Fig. 17) ..... *Trioza anomalicornis* sp. n. (p. 44)

- Flagellomeres with short subapical setae, apical flagellomere with one long and one short terminal seta ..... 55
- 55 Second flagellomere 1.76–2.35 times longer than 3rd; inner apical spurs of both hind tibiae together numbering at most 4 ..... 56
- Second flagellomere about as long as 3rd; inner apical spurs of both hind tibiae together numbering 6 or rarely 5 ..... 57
- 56  $m_1$  cell value 1.10–1.23,  $cu_1$  cell value 1.6–1.9 ..... *Trioza neoboutonia* sp. n. (p. 46)
- $m_1$  cell value 1.40–1.65,  $cu_1$  cell value 2.00–2.82 ..... *Trioza chiangae* sp. n. (p. 48)
- 57 All visible abdominal tergites with a transverse row of setae; setae on wing veins twice as long as width of veins ..... *Trioza tiliacora* sp. n. (p. 41)
- Transverse row of setae present only on first two visible abdominal tergites; setae on wing veins shorter than width of veins ..... 58
- 58 Ratio of head width to length of ultimate rostral segment 4.6:1 or more ..... 59
- Ratio of head width to length of ultimate rostral segment 4.5:1 or less ..... 60
- 59 Smaller species, forewing length less than 2.6 in ♂ and 2.9 in ♀; ♂ paramere broadening towards apex which is truncate (Fig. 118) ..... *Trioza kilimanjarica* sp. n. (p. 40)
- Larger species, forewing length more than 3.0 in ♂ and 3.3 in ♀; paramere broad medially but narrowing to subacute apex ..... *Trioza ata* sp. n. (p. 40)
- 60 Ventral valves of ovipositor with strong transverse ridges, giving the valves a saw-like appearance (Fig. 138); paramere as in Figs 141, 144, 147, 150 ..... 61
- Ventral valves of ovipositor smooth or with a few weak serrations apically; paramere as in Figs 110, 112, 114, 123 ..... 62
- 61 Paramere as in Fig. 141 ..... *Trioza kakamegae* sp. n. (p. 45)
- Paramere as in Fig. 144 ..... *Trioza thibae* sp. n. (p. 45)
- Paramere as in Fig. 147 ..... *Trioza tavandula* sp. n. (p. 46)
- Paramere as in Fig. 150 ..... *Trioza luvandata* sp. n. (p. 46)
- 62  $cu_1$  cell value not more than 2.4 in ♂ and 2.45 in ♀; forewing, at most, 1.58 times longer than hindwing ..... 63
- $cu_1$  cell value not less than 2.55; forewing, at least 1.59 times longer than hindwing ..... 64
- 63 ♂ paramere conical, in profile narrowing towards apex which is abcurved (Fig. 123); ♂ proctiger broader than long due to strong lateral expansions (Fig. 122) ..... *Trioza carvalhoi* sp. n. (p. 41)
- ♂ paramere ovoid, in profile broadening medially then narrowing towards apex (as in Fig. 110); ♂ proctiger narrower with less well-developed lateral lobes (as in Fig. 109) ..... *Trioza capeneri* sp. n. (p. 42)
- 64 ♂ paramere and aedeagus as in Figs 114, 115 ..... *Trioza gregoryi* sp. n. (p. 40)
- ♂ paramere and aedeagus as in Figs 110–113 ..... 65
- 65 Ratio of head width to length of 1st flagellomere not more than 1.25:1 ... *Trioza catlingi* sp. n. (p. 39)
- Ratio of head width to length of 1st flagellomere not less than 1.26:1  
*Trioza erytrae* (Del Guercio) (p. 36) and *T. menispermicola* sp. n. (p. 40)

### TRIOZAMIA Vondráček

*Triozamia* Vondráček, 1963: 266. Type-species: *Rhinopsylla lamborni* Newstead, by original designation and monotypy.

DESCRIPTION. Head, from above, slightly narrower than mesoscutum, in profile at 90° to longitudinal axis of body; occipital margin angular, occiput concave; vertex with a median suture, without frontal lobes; median ocellus not visible from above, frons just visible in anterior view; genae slightly swollen ventrally; 1st flagellomere bearing several rhinaria, flagellomeres 4, 6 and 7 bearing a single subapical rhinarium; clypeus prominent, densely setose. Thorax, in profile, weakly arched; pronotum clearly visible from above and strongly rounded down anteriorly behind occiput; propleural suture diagonal but both pleurites in contact with lateral margin of pronotum; forewing elongate oval with a subangular apex, C+Sc strongly thickened, M branching proximally to Rs–Cu<sub>1a</sub> line, claval suture reaching hind margin of wing at same point as apex of Cu<sub>1b</sub>, radular spines present in cells  $r_2$  (sometimes weak or absent),  $m_1$ ,  $m_2$  and  $cu_1$ ; hindwing well developed, costal margin densely setose both proximally and immediately distal to the costal break. Hind coxa with a weakly developed meracanthus and without anterior lobe; hind femur not thickened medially, ventral sense organs basally positioned with the most distal organ slightly separated from the proximal pair; hind tibia with well-developed basal spine, and an inner apical group of



well-developed spurs. Abdomen with setae on all tergites; ♂ proctiger bipartite; aedeagus 3-segmented; anal pore of ♀ proctiger with a double, convoluted ring of wax-producing cells.

COMMENTS. When Vondráček described this genus he placed it in the Bactericerinae of the Ciriacreminidae (sensu Heslop-Harrison, 1958; nec Hollis, 1976). Klimaszewski (1964) rightly removed the Bactericerinae to the Triozidae, recognising the true relationships of the group, and Bekker-Migdisova (1973) separated *Triozamia* from the other Bactericerinae on a suite of both derived (bipartite ♂ proctiger, 3-segmented aedeagus) and primitive (proximity of apex of claval suture to apex of  $Cu_{1b}$ , radulae area in  $r_1$ ) characters. The genus has retained many primitive features in addition to those mentioned by Bekker-Migdisova, notably the flattened thorax and unmodified prosternum, the basal position of the ventral sense organs on the hind femur and the presence of setae on all abdominal tergites. Her statement of a 'distinct sclerotisation of the pterostigma' is probably a misinterpretation of the thickening of  $C+Sc$ , a true pterostigma being absent. Other derived features of the genus include the large number of rhinaria on the first flagellomere and the usual absence of a rhinarium on flagellomere 2, but these offer no indication of the relationships of the genus to the rest of the Triozidae.

Three included species are treated below.

*Triozamia lamborni* (Newstead)

(Figs 5, 6, 19, 48, 63, 64, 275, 276)

*Rhinopsylla lamborni* Newstead, 1914: 520; Eastop, 1961: 168. Holotype ♂, NIGERIA: 'Lagos, 70 m. E. nr Oni clearing' [not traced].

*Triozamia lamborni* (Newstead); Vondráček, 1963: 266, partim; Akanbi, 1981: 113.

*Triozamia lambourni* [sic] (Newstead); Roberts, 1969: 78.

DESCRIPTION. Adult. Having generic characters stated above. Integument of thoracic dorsum sparsely short-haired but mesoscutellum and metascutum more densely haired. Vertex pentagonal, steeply sloping downwards, slightly concave; ultimate rostral segment 4–5 times longer than apical flagellomere, densely haired; antennal flagellum 1.71–2.04 times longer than head width, 1st flagellomere 0.63–0.76 times as long as 2nd flagellomere, thickened and with a large number of rhinaria, 2nd flagellomere without a rhinarium, flagellomeres 4, 6 and 7 each with a single subapical rhinarium, apical flagellomere with one moderately long and pointed seta and one shorter and truncate seta terminally. Mesopraescutum, from above, rounded rhomboidal, wider than long and with a broadly arcuate anterior margin; forewing 2.66–2.81 times longer than wide, apart from radular areas there is a patch of spinules in  $c+sc$ , veins moderately densely setose,  $R_s$  long,  $M$  branching proximal to  $R_s-Cu_{1a}$  line,  $m_1$  cell value 4.9–6.0,  $cu_1$  cell ratio 0.4–0.5; costal setae of hindwing, distal to costal break, divided into two groups; hind tibia with an inner apical group of 5–6 strongly developed spurs and an outer apical group of about 10 thickened setae; hind basitarsus elongate. Abdomen with a pair of lateral eversible sacs on segment 4; ♂ proctiger and genitalia as in Figs 59, 63, 64, apical segment of aedeagus 1.12–1.23 times longer than medial segment; ♀ genital segment with proctiger 1.20–1.27 times longer than head width, ovipositor valves smooth.

Measurements (7 ♂, 5 ♀). Maximum width of head, ♂ 1.23–1.30, ♀ 1.30–1.35; length of antennal flagellum, ♂ 2.22–2.51, ♀ 2.31–2.51; length of ultimate rostral segment, ♂ 0.41–0.46, ♀ 0.45–0.50; length of forewing, ♂ 4.05–4.33, ♀ 4.21–4.58; length of hind tibia, ♂ 0.90–1.00, ♀ 0.95–1.05.

Fifth instar larva (Figs 275–277). Body clearly divided into head, thorax and abdomen, about 1.1 times longer than wide. Antenna with 8 flagellomeres. Small prothoracic sclerites present behind cephalo-prothorax, meso- and metathoracic sclerites separated. Forewing bud about 0.92 mm long, humeral lobes not at all developed. Caudal plate about half as long as wide and does not include first 4 abdominal segments; anus terminal or terminodorsal, anus and pore ring as in Fig. 277, caudal plate with a complicated arrangement of wax pores on dorsal and ventral surfaces (Fig. 276). No sectasetae present but caudal plate bears 8 small dorsomarginal lanceolate setae positioned as in Fig. 276.

HOST PLANT. Larvae and adults collected from *Antiaris toxicaria africana* var. *africana* (Moraceae). The larvae are free-living and produce copious wax strands.

DISTRIBUTION. Senegal, Ivory Coast, Ghana, Nigeria, Zaire and Tanzania.

COMMENTS. *T. lamborni* may be distinguished from the other two known species in the genus by the characters given in Table 2.

**Table 2** Characters for the separation of the three African species of *Triozamia*.

	$\frac{\text{length of flagellomere 1}}{\text{length of flagellomere 2}}$	$\frac{\text{length of apical aedeagal segment}}{\text{length of medial aedeagal segment}}$	paramere	$\frac{\text{length of } \text{♀} \text{ proctiger}}{\text{head width}}$
<i>lamborni</i>	0.63–0.76	1.12–1.23	Fig. 63	1.20–1.27
<i>usambarensis</i>	1.1–1.26	0.96–0.97	Fig. 57	0.97–1.01
<i>vondraceki</i>	1.39–1.47	0.52–0.56	Fig. 60	1.52–1.54

The material upon which Vondráček based his redescription of this species was a mixed series, the Ugandan specimens and his figs 18 and 26 being *vondraceki*.

The presence of three clearly recognisable species of *Triozamia* in Africa raises some interesting questions on the taxonomy of the host plant genus *Antiaris*. In a recent review of African Moraceae Berg (1977) recognises one African species, *Antiaris toxicaria*, which also occurs in Asia and Australia. Berg refers the African populations to the subspecies *africana* and further recognises three varieties, *africana*, *welwitschii* and *usambarensis*, all with partially overlapping distributions (Berg, 1977: fig. 8).

Of the three *Triozamia* species on *Antiaris*, *lamborni* is known from Senegal, Ivory Coast, Ghana, Nigeria, northern Zaire and Tanzania (Pare Mountains and Uluguru Mountains); *vondraceki* is described from Uganda and the Central African Republic; and *usambarensis* is described from Tanzania (Usambara Mountains). It seems likely that the three psyllid species maintain their genetic independence each on one of three 'varieties' of *Antiaris toxicaria africana*.

#### *Triozamia usambarensis* sp. n.

(Figs 21, 56–58)

DESCRIPTION. Adult. Very similar to *T. lamborni* but slightly larger. First flagellomere 1.10–1.26 times longer than 2nd flagellomere, not thickened and bearing only 4–12 rhinaria on basal half, a subapical rhinarium rarely present on 2nd flagellomere. Apical segment of aedeagus 0.96–0.97 times as long as medial aedeagal segment, paramere as in Fig. 57; ♀ proctiger short, 0.97–1.01 times as long as head width.

Measurements (2 ♂, 2 ♀). Maximum width of head, ♂ 1.41–1.43, ♀ 1.48–1.51; length of antennal flagellum, ♂ 2.4, ♀ antennae incomplete; length of ultimate rostral segment, ♂ 0.37–0.39, ♀ 0.40; length of forewing, ♂ 5.51–5.57, ♀ 6.10–6.12; length of hind tibia, ♂ 1.11 ♀ 1.17–1.20.

Larva. Unknown.

HOST PLANT. Adults collected from *Antiaris toxicaria africana* var. *usambarensis* (Moraceae).

Holotype ♂, Tanzania: Lushoto, 23.vi.1977, *Antiaris usambarensis* (*Wadudu Msituni*) (BMNH; slide mounted).

Paratypes. Tanzania: 1 ♂, 1 ♀, same data as holotype; 1 ♂, 1 ♀, Lushoto, 22.ix.1977, 'ex scales on *Hirus*' [probably an error of transliteration from a handwritten label]; 1 ♂, 1 ♀, Lushoto Silv. Arb. 22.ix.1980, *Antiaris usambarensis* (*Wadudu Msituni*) (BMNH; slide and dry mounted).

COMMENTS (see also under *T. lamborni*). This species is described from seven rather poorly preserved specimens, all from approximately the same locality. However, they were collected on three separate occasions over a period of three years and the population is clearly maintaining its morphological identity from the other two species of the genus. The type-locality is close to that of *Antiaris usambarensis* (see Berg, 1977: 318).

#### *Triozamia vondraceki* sp. n.

(Figs 20, 30, 31, 59–62)

[*Triozamia lamborni* Newstead; Vondráček, 1963: 268, partim (figs 18, 26). Misidentification.]

DESCRIPTION. Adult. Very similar to *T. lamborni* and *T. usambarensis* but larger. First flagellomere

1.39–1.47 times longer than 2nd flagellomere, swollen and almost completely covered with rhinaria, 2nd flagellomere without a subapical rhinarium. Apical aedeagal segment short, 0.52–0.56 times as long as medial aedeagal segment; paramere as in Fig. 60; ♀ proctiger long, 1.52–1.54 times longer than head width.

Measurements (3 ♂, 2 ♀). Maximum width of head, ♂ 1.53–1.63, ♀ 1.81–1.83; length of antennal flagellum, ♂ 2.64–2.77, ♀ 2.87–2.96; length of ultimate rostral segment, ♂ 0.47–0.50, ♀ 0.52; length of forewing, ♂ 5.69–6.16, ♀ 6.96–7.26; length of hind tibia, ♂ 1.26–1.38, ♀ 1.45–1.57.

Larva. Unknown.

HOST PLANT. Adults collected from *Antiaris toxicaria africana* var. ?.

Holotype ♂, Uganda: Kampala, 8.x.1915 (C. C. Gowdey) (BMNH; dry mounted).

Paratypes. Uganda: 1 ♂, 1 ♀, same data as holotype; 5 ♂, 6 ♀, 17.xi.1915 (C. C. Gowdey); 2 ♂, 20.ii.1923 (H. Hargreaves); 2 ♂, 27.ii.1925, 'Kirundo' (*Antiaris africana*) (J. L. R. Hanwer). Central African Republic: 1 ♂, Route Mbalé, P.L., 12.ii.1969 (M. Boulard) (BMNH; slide and dry mounted).

COMMENT. See under *T. lamborni*.

### AFROTRIOZA gen. n.

Type-species: *Afrotrioza bersama* sp. n.

DESCRIPTION. Head, from above, narrower than mesoscutum, in profile continuing axis of anterior part of thorax; occipital margin sharp; median suture of vertex moderately developed, frontal lobes well developed; median ocellus visible from above, frons completely covered by genal cones; latter large and well developed, constricted basally and in parallel plane to vertex; antenna with a single subapical rhinarium on each of flagellomeres 2, 4, 6 and 7; clypeus not prominent, with several short setae. Thorax, in profile, strongly arched; pronotum clearly visible from above and scarcely rounded down behind occiput, prothoracic suture diagonal with both pleurites in contact with lateral margin of pronotum; forewing elongate oval, narrowing to subangular apex, radular areas present in cells  $r_2$ ,  $m_1$ ,  $m_2$  and  $cu_1$ , C+Sc strongly thickened, M branching proximal to  $Rs-Cu_{1a}$  line, claval suture reaching hind margin a short distance proximal to apex of  $Cu_{1b}$ ; hindwing well developed, costal margin densely setose proximal to costal break, costal setae distal to costal break not clearly grouped; hind coxa with a well-developed meracanthus, anterior lobe absent; ventral sense organs of hind femur medially placed; hind tibia with a small basal spine, with one outer and four inner apical spurs; hind basitarsus with an outer apical spur. Abdomen with setae on all tergites; ♂ proctiger unipartite, aedeagus 2-segmented.

COMMENTS. This monotypic genus shows a mixture of both primitive and derived character states and is clearly defined from all other described triozids by the presence of an apical spur on the hind basitarsus. The shape of the genal cones is similar to that of *Trichohermes* but the thorax is strongly arched. It shares such primitive character states with *Triozamia* as the presence of a radular area in  $r_1$  and an unmodified prothorax.

### *Afrotrioza bersama* sp. n.

(Figs 1, 32, 33, 44, 65–68, 278, 279)

DESCRIPTION. Adult. Having generic characters stated above. Large species, head width 0.91–0.97 mm. Integument of thoracic dorsum almost devoid of setae but genal cones, legs and abdomen densely setose. Vertex pentagonal, with a deep concavity on either side of median suture; antennal flagellum short, 0.91–0.98 times as long as head width, apical flagellomere with one moderately long pointed seta and one very short truncate seta terminally; ultimate rostral segment about twice as long as apical flagellomere, sparsely haired. Mesopraescutum, from above, rounded rhomboidal and almost as long as wide, with an arcuate anterior margin; forewing 2.27–2.40 times longer than wide, membrane moderately densely covered with spinules, veins densely short haired,  $Rs$  long,  $m_1$  cell value 2.73–3.07,  $cu_1$  cell value 0.73–0.83; hind tibia with one outer and four inner apical spurs; hind basitarsus short. ♂ genitalia and proctiger as in Figs 66–68; ♀ genital segment conical, proctiger slightly attenuate apically, anal pore with a double ring of wax-producing cells, ovipositor valves smooth.

Measurements (6 ♂, 3 ♀). Maximum width of head, ♂ 0.91–0.95, ♀ 0.91–0.97; length of antennal flagellum, ♂ 0.86–0.91, ♀ 0.87–0.89; length of ultimate rostral segment, ♂ 0.16–0.17, ♀ 0.16–0.18; length of forewing, ♂ 4.13–4.37, ♀ 4.48–4.64; length of hind tibia, ♂ 0.74–0.80, ♀ 0.76–0.78.

Fifth instar larva (Figs 278, 279). Dorsal surface outline broadly oval, about 1.1 times longer than wide. Antenna with two flagellomeres. Forewing pad 2.2 mm long; narrow prothoracic sclerites present between cephaloprothorax and mesothorax, meso- and metathoracic sclerites as in Fig. 278; humeral lobe strongly extended forward and reaching beyond anterior margin of cephaloprothorax. Caudal plate about 0.6 times as long as wide; anus ventral, a short distance from posterior margin of abdomen, anus and pore ring as in Fig. 279. Pointed setasetae forming a dense fringe along anterior margin of cephaloprothorax and caudal plate, wing buds with a sparse fringe of very short simple setae; setasetae absent from dorsum.

HOST PLANT. Larvae and adults collected from *Bersama* sp. (Melianthaceae); the larvae cause severe leaf-rolling and distortion.

Holotype ♂, **Tanzania**: E. Usambara mts, Amani Res. Sta. 19–27.vi.1974, c. 3,000' *Bersama* sp. (*D. Hollis*) (BMNH; dry mounted).

Paratypes. 56 ♂, 33 ♀, larvae, same data as holotype. (BMNH; slide and dry mounted, and stored in 80% ethanol).

### *TRICHOCHERMES* Kirkaldy

*Trichopsylla* Thomson, 1877: 823. Type-species: *Trioza walkeri* Förster, by monotypy. [Homonym of *Trichopsylla* Kolenati, 1863.]

*Trichohermes* Kirkaldy, 1904: 280; Kuwayama, 1910: 54; Loginova, 1964: 473. [Replacement name for *Trichopsylla* Thomson.]

DESCRIPTION. Head, from above, narrower than mesoscutum, in profile in same plane as longitudinal axis of thorax; occipital margin sharp, occiput concave; frontal lobes of vertex well developed, median suture well defined; median ocellus visible from above, frons completely covered by genal cones; latter well developed, in parallel plane to vertex, clavate and constricted basally; antenna with a single subapical rhinarium on each of flagellomeres 2, 4, 6 and 7. Thorax, in profile, very weakly arched; pronotum clearly visible from above and not rounded down behind occiput, prothoracic suture diagonal, episternum greatly enlarged, epimeron reduced and not in contact with lateral margin of pronotum; forewing narrow elongate oval, with subacute apex, membrane with extensive brown pattern, C+Sc not thickened, Rs sinuous or arched strongly toward M stem, M branching distal to Rs—Cu<sub>1a</sub> line, claval suture reaching hind margin a long distance proximal to apex of Cu<sub>1b</sub>; hindwing well developed, costal setae separated into groups distal to costal break; hind femur with ventral sense organs medially placed, hind tibia with apical spurs separated into two groups, hind basitarsus without spurs. Abdomen with setae on tergites 2–7 in ♂, and 3–7 in ♀; ♂ proctiger unipartite, aedeagus 2-segmented; anal pore of ♀ with a double ring of wax-producing cells.

COMMENTS. *Trichohermes* may be distinguished from other trioizids by the shape of the genal cones, the flattened thorax, the patterned forewing and the sinuous or displaced Rs vein. The genus is similar in appearance to *Leuronota* but the latter has simple genal cones and a relatively straight Rs.

Four Palearctic species, all apparently developing on different species of *Rhamnus*, and one Afrotropical species are recognised. It is doubtful if either of the two Japanese species, described by Kuwayama (1910), are true *Trichohermes* and Crawford (1919: 185) regarded them both as *Trioza* species. From Kuwayama's original description it seems that *Trichohermes bicolor* Kuwayama, 1910: 54 is identical with *Petalolyta basalis* (Walker, 1858: 275), from India, but formal synonymy cannot be established until Kuwayama's type-material has been examined.

### *Trichohermes insleyi* Capener

(Figs 3, 69–71)

*Trichohermes insleyi* Capener, 1973: 59. Holotype ♀, SOUTH AFRICA: 'Rustenburg, Tvl, 15 Sept. 1971' (NCI) [not examined].

DESCRIPTION. Adult. Having generic characters given above. Medium size, head width 0.50. Integument of head, body and legs sparsely covered with long setae. Vertex pentagonal with a well-developed concavity on either side of median suture; genal cones well developed; antennal flagellum 1.22 times longer than head width; clypeus not prominent, bearing two setae. Anterior margin of pronotum angular medially; mesopraescutum about as long as wide, with arcuate anterior margin. Forewing (Fig. 69) 3.72 times longer

than wide, with mottled brown pigmentation over whole membrane, veins densely long-haired, *Rs* arched strongly toward *M*,  $m_1$  cell value 1.31,  $cu_1$  cell value 0.45; hindwing with five setae on *C+Sc* proximal to costal break, setae distal to costal break divided into two groups; hind coxa with a well-developed meracanthus and incipient anterior lobe; hind tibia with a well-developed basal spine, with one outer and two inner apical spurs. ♂ proctiger narrow, lateral margins not expanded, genitalia as in Figs 70, 71; ♀ genital segment short, conical, ventral valves of ovipositor serrate at extreme apices.

Measurements (1 ♀). Maximum width of head, 0.5; length of antennal flagellum, 0.61; length of ultimate rostral segment, 0.11; length of forewing, 2.97; length of hind tibia, 0.56.

Fifth instar larva. See Capener, 1973: 60, figs 122, 123.

HOST PLANT. Larvae and adults collected from *Ziziphus mucronata* (Rhamnaceae).

DISTRIBUTION AND MATERIAL EXAMINED. Known only from the type-series of which 1 ♂ and 2 ♀ paratypes (BMNH) have been examined.

### PAUROPSYLLA Rübsaamen

*Pauropsylla* Rübsaamen, 1899: 262; Kieffer, 1905: 167; Crawford, 1915: 258, partim; Crawford, 1919: 142, partim; Enderlein, 1921: 115, partim; Loginova, 1972a: 839; Mathur, 1975: 72 partim. Type-species: *Pauropsylla udei* Rübsaamen, by monotypy.

*Sympauropsylla* Enderlein, 1921: 116. Type-species: *Pauropsylla triozyptera* Crawford, by original designation. **Syn. n.**

DESCRIPTION. Head, from above, as wide as mesoscutum, in profile inclined almost at 90° to longitudinal axis of body; vertex pentagonal, with sharp occipital margin medially, rounded down anteriorly to genae, median suture weak or absent, dorsal depressions well developed, lateral ocelli placed on outer surfaces of raised tubercles, median ocellus visible from above; frons visible from anterior view; genae rounded, sometimes weakly expanded laterally below eyes; latter prominent, rounded; antenna short, with 8 or, more rarely, 6 flagellomeres. Thorax strongly arched dorsally; pronotum just visible from above, strongly rounded down below anterior margin of mesopraescutum and behind occiput, propleural suture diagonal with epimeron reduced and not in contact with lateral margin of pronotum; mesopraescutum, from above, with broadly arcuate anterior margin, in profile anterior margin sharply rounded down to pronotum; forewing obovate with narrow proximal part, not more than 2.3 times longer than wide, a very short *M+Cu* stem often present, *M* branches distally to *Rs-Cu<sub>1a</sub>* line,  $m_1$  cell value less than 1, *Cu* stem always more than twice as long as *Cu<sub>1b</sub>*, wing membrane devoid of spinules except for radular areas; hindwing at least two-thirds as long as forewing; legs slightly elongate, meracanthus present on hind coxa, hind femur narrow with ventral sense organs medial, hind tibia elongate with a group of small weak spines basally and one outer and two inner spurs apically (2 + 2 in *P. udei*), hind basitarsus without apical spurs. Abdomen with setae on tergites 2 and 3 in ♂, and 3 and 4 in ♀; ♂ proctiger unipartite, mostly simple, flask-shaped, basal part rarely expanded; anal pore of ♀ normally with a double ring of wax-producing cells.

COMMENTS. *Pauropsylla* may be distinguished from other trioizid genera by the shape and venation of the forewing (Figs 75, 80, 83, 84, 86).

The most recent and comprehensive review of psyllid systematics (Bekker-Migdisova, 1973) places *Pauropsylla* in the tribe Pauropsyllini, together with the Microceropsyllini, in the subfamily Pauropsyllinae and in the family Carsidaridae. This largely follows Klimaszewski (1964) rather than Heslop-Harrison (1958) who placed the genus within his diffuse group the Ciriacreminae (see Hollis, 1976).

In a recent revision of the Pauropsyllini, Loginova (1972a) concludes that the group is closely related to the Phacopterionini and contains the genera *Pauropsylla*, *Sympauropsylla*, *Leptynoptera*, *Microceropsylla*, *Pelmatobrachia* and *Paurocephala*. Including *Paurocephala* in this group is consistent with Crawford's (1915; 1919) interpretation, but other workers (Vondráček, 1957; Heslop-Harrison, 1958; Klimaszewski, 1964) disagreed with this and placed *Paurocephala* in the Aphalaridae. After examining several species of *Paurocephala*, including the type-species, *P. psylloptera* Crawford, the structure of the adult head, thorax and wing venation, and the 5th instar larva (Table 3) suggest this genus should be placed in the Aphalaridae close to the genera *Haplaphalara* and *Moraniella*. Of the five remaining genera in Loginova's (1972a) Pauropsyllini, *Microceropsylla* and *Pelmatobrachia* (Bekker-Migdisova's 1973 Microceropsyllini) are transferred to the Calophyinae; *Sympauropsylla* is synonymised with *Pauropsylla* which, together with

*Leptynoptera*, is transferred to the Triozidae. Following Klimaszewski (1964) the Phacopteronini is placed in the Aphalaridae.

Mathur (1975), in his account of Indian psyllids, reviews the Pauropsyllinae (auctt.) and includes four genera, *Apsylla*, *Paurocephala*, *Pauropsylla* and *Phacopteron*. *Apsylla* was placed in the Anomalopsyllini by Vondráček (1963) and into the Aphalaridae by Klimaszewski (1964). Of the species Mathur included in *Paurocephala* only *minuta* Crawford, *psylloptera* Crawford, *phalaki* Mathur and *russellae* Mathur should remain in that genus. *P. menoni* Mathur and *trimaculata* Mathur are here transferred to *Haplaphalara* as *H. menoni* (Mathur, 1975) **comb. n.**, and *H. trimaculata* (Mathur, 1975) **comb. n.** Of the 14 species Mathur placed in *Pauropsylla*, *depressa* Crawford, *ficicola* Kieffer, *globuli* Kieffer, *purpurescens* Mathur and *reticulata* Mathur should remain. *P. brevicornis* (Crawford) and *nigra* (Crawford) were placed in *Microceropsylla* by Boselli (1930a); *longispiculata* Mathur, *maculata* Mathur and *verrucosa* Mathur are here transferred to *Microceropsylla* as *M. longispiculata* (Mathur, 1975) **comb. n.** *M. maculata* (Mathur, 1975) **comb. n.** and *M. verrucosa* (Mathur, 1975) **comb. n.** *P. spondiasae* (Crawford) was placed in *Pematobrachia* by Enderlein (1921), and *tuberculata* (Crawford) was placed in *Pseudophacopteron*, also by Enderlein (1921). *P. beelsoni* Laing is here transferred to *Trioza* as *T. beelsoni* (Laing, 1930) **comb. n.** *P. stevensi* Laing is here transferred to the genus *Diceraeopsylla* as *D. stevensi* (Laing, 1930) **comb. n.**, and the genus is referred to the Aphalaridae.

The description and figures of *Pauropsylla shiwapuriensis* Miyatake (1981: 53) show that this species is wrongly assigned and, more likely, belongs in the Aphalaridae near the *Haplaphalara/Diclidophlebia*-group.

Most *Pauropsylla* species are recorded from species of *Ficus* (Moraceae) although *udei*, the type-species, was described from a member of the Rubiaceae. Uichanco (1921: 265) regards this host record as a misidentification but Mathur (1975: 105) has described *reticulata* from *Anthocephalus indicus* (Rubiaceae). I have examined specimens from the same sample as the type-series of *reticulata* and suspect that this species is synonymous with *udei*. Further material, including larvae, from *Anthocephalus indicus* will be needed before this synonymy and host plant record can be confirmed.

Eleven described species are regarded here as congeneric in *Pauropsylla*, mainly from the

**Table 3** Comparison of morphological features and host plant preferences of *Paurocephala* species and *Pauropsylla* species.

	<i>Paurocephala</i>	<i>Pauropsylla</i>
Adults	In profile, head inserted at or below anterior margin of pronotum.	Pronotum strongly rounded down behind occiput so that, in profile, it is below dorsal margin of head.
	From above, dorsum of thorax broad.	From above, dorsum of thorax narrow.
	Forewing with costal break, pterostigma clearly defined, long <i>M+Cu</i> stem present, apex of claval suture adjacent to apex of <i>Cu</i> <sub>1b</sub> .	Forewing without costal break and pterostigma, <i>M+Cu</i> stem very short or absent, apex of claval suture distant from apex of <i>Cu</i> <sub>1b</sub> .
Larvae	Free-living; dorsal sclerites of thorax separate; sectasetae present on antenna.	Gall-forming; dorsal thoracic sclerites fused to form a single plate (except in <i>proxima</i> sp.n.) sectasetae absent from antenna.
Host plants	Malvales and Urticales (Moraceae, Ulmaceae, Tiliaceae, Malvaceae and Sterculiaceae).	<i>Ficus</i> spp. (Moraceae), and possibly Rubiaceae.

Oriental region, but two species of doubtful validity, *nussex* Carmin and *biki* Carmin, occur in the Palaearctic Region. *P. willcocksii* and *trichaeta* occur in Africa and a further eleven Afrotropical species are described below. They may be identified using couplets 39–50 in the key (p. 20).

### The *willcocksii*-group

Defined by the presence of a strong ventroapical spur on the fore coxa. Three species with an Afrotropical distribution belong in this group, *willcocksii*, *trichaeta* and *tatrichaeta*. Two poorly described species from Palestine also belong here (see comment under *willcocksii*).

#### *Pauropsylla willcocksii* Dębski

(Figs 72–74, 280, 281)

*Pauropsylla willcocksii* Dębski, 1918 [?1923]: 14; Willcocks, 1922: 275; Samy, 1972: 458. Syntypes, ♂s, ♀s, larvae, EGYPT [not traced].

[*Pauropsylla trichaeta* Petthey; Awadallah & Swailem, 1971: 193;? Loginova, 1972a: figs 40, 41. Misidentifications.]

**DESCRIPTION.** Adult. Having generic characters given above. Integument shiny, sparsely covered with very short setae. Median suture of vertex absent; antenna with eight flagellomeres, flagellum 1.34–1.61 times longer than head width, apical flagellomere with one long and one moderately long and truncate terminal seta; clypeus bearing several hairs, ultimate rostral segment bearing a long basal pair and a short subapical pair of setae. Forewing 1.92–2.06 times longer than wide, veins very sparsely clothed with very short setae,  $m_1$  cell value 0.79–0.99,  $cu_1$  cell value 1.15–1.69; costal margin of hindwing with 1–2 setae proximal to costal break, setae distal to costal break clearly divided into two groups; forecoxa with a well-developed ventroapical spur; tarsal segments subequal. ♂ proctiger flask-shaped with weak basal expansions, the inner surface of each expansion bearing up to 22 thickened peg-like setae (Fig. 72); paramere and aedeagus as in Figs 73, 77 (*trichaeta*); ♀ genital segment short, triangular in profile, subgenital plate with a ventral transverse groove in apical third.

Measurements (10 ♂, 10 ♀). Maximum width of head, ♂ 0.44–0.51, ♀ 0.46–0.57; length of antennal flagellum, ♂ and ♀, 0.65–0.80; length of ultimate rostral segment, ♂ 0.07–0.10, ♀ 0.09–0.11; length of forewing, ♂ 1.75–2.15, ♀ 2.07–2.55; length of hind tibia, ♂ 0.51–0.67, ♀ 0.56–0.71.

Fifth instar larva (Figs 280, 281). Dorsal surface outline broadly oval, about 1.3 times longer than wide. Antennal flagellum unsegmented. Cephalothorax entire. Forewing pad about 0.47 mm long, humeral lobe extending forward but not as far as anterior margin of eye. Caudal plate about 0.6 times as long as wide, anus ventral and distant from posterior margin of abdomen, anus and pore ring as in Fig. 281. Marginal fringe consisting of moderately dense truncate setae of varying lengths; postocular truncate setae present; dorsum sparsely covered with truncate setae.

**HOST PLANTS.** Adults and larvae collected from *Ficus ?gnaphalocarpa* and *Ficus* sp. in Senegal, and *Ficus sycamorus* in Egypt (Moraceae). The larvae live in pit-galls on the undersides of the leaves.

**DISTRIBUTION.** Material has been examined from Cape Verde Is., Senegal, Egypt, Sudan and Saudi Arabia.

**COMMENTS.** *Pauropsylla willcocksii* is very close to *P. trichaeta*. Adults of the two species appear to be almost indistinguishable, but males of *trichaeta* tend to have more peg-like setae on the inner surface of the lateral expansions of the proctiger (25–30 on each side as opposed to a maximum of 22 on each side in *willcocksii*). However, the larvae of the two species appear to be quite distinct (see Figs 280, 282).

Carmin (1951: 1–3) described two species, *P. nussex* and *P. bikii*, from Palestine, but the descriptions are not diagnostic from one another or from *willcocksii* and the type-material is apparently lost. In the BMNH collection are several adult specimens labelled 'Palestine, Drs. D. Scheinkin and J. Carmin, on *Ficus sycamorus*', some bear the number S.108, others S.109. If these specimens are not part of the original syntypic series of *nussex* and *bikii* they certainly represent Carmin's two species. This material is indistinguishable from *willcocksii*. Recently

collected *Pauropsylla* specimens from Israel (Bet Dagan) on *Ficus sycomorus*, consisting of adults and larvae, do not resolve the problem. The adults are not distinguishable from *willcocksii* but the larvae are distinct from both *willcocksii* and *trichaeta*. They have the narrower dorsal surface outline and uneven marginal fringe of *willcocksii*, but lack sectasetae on the dorsal surface, as in *trichaeta*.

Thus we have a series of populations of *Pauropsylla* species from South Africa, throughout Africa and extending into the Middle East. The adults of these populations are morphologically very similar but three distinct forms of larvae can be identified, and names are available for these three larval types. I have therefore decided to name those populations from Africa, south of the Sahara, on *Ficus sur* (= *F. capensis*) and *Ficus* spp. as *P. trichaeta*; those populations from Senegal, North Africa, Saudi Arabia and Cape Verde Is. on *Ficus sycomorus* and *F. gnaphalocarpa* (H. C. D. de Wit in a personal communication, suggests these two species may be synonymous) as *P. willcocksii*; and the Palestinian populations on *F. sycomorus*, as either *P. nussex* or *bikii* or both.

### *Pauropsylla trichaeta* Pettey

(Figs 4, 45, 75–78, 282)

*Pauropsylla trichaeta* Pettey, 1924: 29; 1925: 137; Capener, 1970: 199. Holotype (? sex), SOUTH AFRICA: 'Tanzeen, Transvaal, on a native fig tree, associated with galls' (SAM) [not examined].

DESCRIPTION. Adult. Similar in most features to *P. willcocksii*. Differs in that 25–30 peg-like setae are present on inner surface of each lateral expansion of the ♂ proctiger (Fig. 76).

Measurements (10 ♂, 10 ♀). Maximum width of head, ♂ 0.40–0.51, ♀ 0.44–0.56; length of antennal flagellum, ♂ 0.67–0.80, ♀ 0.63–0.80; length of ultimate rostral segment, ♂ 0.07–0.09, ♀ 0.08–0.11; length of forewing, ♂ 1.83–2.31, ♀ 2.12–2.77; length of hind tibia, ♂ 0.50–0.67, ♀ 0.53–0.69.

Fifth instar larva (Fig. 282). Dorsal surface outline almost circular, about 1.2 times longer than wide. Antennal flagellum unsegmented. Cephalothorax entire. Forewing pad 0.64 mm long, humeral lobe extending forward but not reaching anterior margin of eye. Caudal plate about half as long as wide, anus ventral and distant from posterior margin of abdomen, anus and pore ring as in *willcocksii* (Fig. 281). Truncate tubular sectasetae forming an even dense marginal fringe, postocular tubular sectaseta present, sectasetae absent from dorsum.

HOST PLANTS. Adults and larvae collected from *Ficus sur* (= *F. capensis*), *Ficus* spp. (Moraceae). The larvae from pit-galls on the undersides of the leaves.

DISTRIBUTION. Material has been examined from South Africa, Mozambique, Zimbabwe, Angola, Tanzania, Kenya, Uganda, Sudan, Cameroun, Nigeria, Ghana, Ivory Coast, Sierra Leone and Senegal.

COMMENT. See under *P. willcocksii*.

### *Pauropsylla tatricea* sp. n.

(Fig. 79)

DESCRIPTION. Adult. Very similar to *P. willcocksii* but larger. Clypeus with a pair of setae, ultimate rostral segment with a pair of small setae subapically. Costal margin of hindwing with 3–4 setae proximal to costal break. ♀ genital segment (Fig. 79) rounded triangular in profile, subgenital plate without ventral transverse groove. ♂ unknown.

Measurements (3 ♀). Maximum width of head, ♀ 0.55–0.57; length of antennal flagellum, ♀ 0.79–0.88; length of ultimate rostral segment, ♀ 0.09; length of forewing, ♀ 2.77–3.08; length of hind tibia, ♀ 0.65–0.70.

Larva and host plant unknown.

Holotype ♀, Cameroun: Bamenda, 6.ii.1957, yellow tray (*V. F. Eastop*) (BMNH; slide mounted).

Paratypes. Cameroun: 1 ♀, same data as holotype. Ivory Coast: 1 ♀, 24.iv.1969 (*A. Poller*). (BMNH; slide mounted.)



**The *trigemma*-group**

Defined by having highly modified antennae which are reduced in length, some of the flagellomeres bearing double rhinaria with bifid sensilla; anal pore of ♀ with an incomplete outer ring of wax-producing cells. Three species are included: *trigemma*, *ngongae* and *breviantennata*.

***Pauropsylla trigemma* sp. n.**

(Figs 11, 80–82)

**DESCRIPTION.** Adult. Integument with a dense covering of short setae. Median suture of vertex present and complete; antennal flagellum (Fig. 11) very short, 0.84–0.88 times as long as head width, flagellomere 2 with a single rhinarium bearing a very short bifid sensillum, flagellomeres 4 and 6 each with a pair of rhinaria and each of these bears a long bifid sensillum, flagellomere 7 with a single rhinarium which bears a bifid sensillum of moderate length, both terminal setae on apical flagellomere long; clypeus with a pair of setae, ultimate rostral segment without setae. Forewing (Fig. 80) 2.24–2.26 times longer than wide, veins bearing short setae,  $m_1$  cell value 0.94–1.04; fore coxa without a ventroapical spur; tarsal segments subequal. ♂ proctiger narrow tubular, without lateral expansions or thickened setae, paramere and aedeagus as in Figs 81, 82; ♀ unknown.

Measurements (2 ♂). Maximum width of head, 0.48–0.55; length of antennal flagellum, 0.42–0.46; length of ultimate rostral segment, 0.06–0.08; length of forewing, 1.82–1.91; length of hind tibia, 0.32–0.39.

Larva and host plant unknown.

Holotype ♂, **Angola**: Bruco, 26.ii.–2.iii.1972, at light (*D. Hollis*) (BMNH; slide mounted).

Paratype. **Tanzania**: 1 ♂, Kilimanjaro, Bismark Hut, 2,500–3,000 m, S. Mawenzi, at foot of high pasture, ii.1912 (*Chr. Schröder*) (MNHU; slide mounted).

**COMMENTS.** *P. trigemma* and *ngongae* are regarded as sister-species. They may be separated from one another by the shape of the forewing and the chaetotaxy of the forewing veins. Both species form the sister-group of *breviantennata*.

***Pauropsylla ngongae* sp. n.**

(Figs 29, 83)

**DESCRIPTION.** Adult. Very similar to *trigemma*. Integument covered with long setae. Antennal flagellum 0.77 times as long as head width, flagellomere 7 (Fig. 29) with a supplementary long conical sensillum adjacent to rhinarium. Forewing (Fig. 83) 1.79 times longer than wide, veins bearing long setae in proximal two-thirds of wing. ♂ unknown. ♀ genital segment short, triangular in profile; subgenital plate with a truncate posterior margin which bears long setae, inner fold connecting ventral ovipositor valve sclerotised and extended as a triangular projection beyond posterior margin of subgenital plate.

Measurements (1 ♀). Maximum width of head, 0.48; length of antennal flagellum, 0.37; length of ultimate rostral segment, 0.05; length of forewing, 1.75; length of hind tibia, 0.46.

Larva and host plant unknown.

Holotype ♀, **Kenya**: Nairobi, junc. Magadi-Langata Rd, c. 5,400', 26.vii.1974 (*D. Hollis*) (BMNH; dry mounted).

Paratypes. 2 ♀, same data as holotype (BMNH; slide and dry mounted).

**COMMENT.** See under *P. trigemma*.

***Pauropsylla breviantennata* sp. n.**

(Figs 12, 84, 85)

**DESCRIPTION.** Adult. Similar to *P. trigemma*. Integument covered with short setae. Median suture of vertex weak and incomplete towards occipital margin; antennal flagellum (Fig. 12) 6-segmented, 0.76–0.84, times as long as head width, two rhinaria present apically on flagellomeres 2, 3 and 4, a single rhinarium present on flagellomere 5, rhinaria of flagellomeres 2, 3 and 5 bear large bulbous sensillae, rhinaria of flagellomere 4 bear bifid sensillae, rhinarium of flagellomere 5 with an associated conical sensillum, terminal setae of apical flagellomere of equal length, very long, about 0.75 times as long as whole flagellum. ♂ proctiger,

paramere and aedeagus as in Fig. 85; ♀ genital segment damaged in specimen available, posterior margins of both proctiger and subgenital plate densely clothed with long setae.

Measurements (1 ♂, 1 ♀). Maximum width of head, ♂ 0.37, ♀ 0.42; length of antennal flagellum, ♂ 0.31, ♀ 0.32; length of ultimate rostral segment, ♀ 0.04; length of forewing, ♂ 1.13, ♀ 1.32; length of hind tibia, ♂ 0.36, ♀ 0.34.

Larva and host plant unknown.

Holotype, ♂ **Ghana**: Tafo, 29.v.1957 (*V. F. Eastop*) (BMNH; slide mounted).

Paratype, **Nigeria**: 1 ♀, Mokwa, 6–12.ix.1964, Moericke bowl (*J. A'Brook*) (BMNH; slide mounted).

COMMENTS. *P. breviantennata* is regarded as the sister-species of both *trigemma* and *ngongae*. It differs from both of these in that the antennal flagellum is even more reduced with the loss of flagellomeres 3 and 5, these being the non-rhinarium-bearing flagellomeres of the primitive antenna. In all three species, congruent with the reduction in length of the antenna, is the development of complex rhinaria and lengthening of the terminal setae.

### The *septima*-group

Defined by the complex form of the apical segment of the aedeagus and the emarginate posterior margin of the female subgenital plate. Two species are included: *P. septima* and *P. proxima*.

#### *Pauropsylla septima* sp. n.

(Figs 86–89)

DESCRIPTION. Adult. Integument sparsely covered with short setae. Median suture of vertex present; antennal flagellum 1.14–1.40 times longer than head width, rhinaria simple, apical flagellomere with one long and one short and truncate terminal seta; clypeus with a pair of setae, ultimate rostral segment with a pair of short setae. Forewing (Fig. 86) 2.00–2.25 times longer than wide, veins very sparsely clothed with short setae; forecoxa without ventroapical spur; tarsal segments subequal. ♂ proctiger flask-shaped, with patches of fine setae on inner surfaces of lateral expansions; paramere and aedeagus as in Figs 87, 88, latter with complex apical segment; ♀ genital segment rounded triangular in profile, posterior margin of subgenital plate with a small emargination and bordered with short setae (Fig. 89).

Measurements (8 ♂, 7 ♀). Maximum width of head, ♂ 0.42–0.47, ♀ 0.43–0.49; length of antennal flagellum, ♂ 0.54–0.61, ♀ 0.55–0.61; length of ultimate rostral segment, ♂ and ♀, 0.06–0.07; length of forewing, ♂ 1.87–2.13, ♀ 2.16–2.49; length of hind tibia, ♂ 0.48–0.58, ♀ 0.52–0.58.

Larva and host plant unknown.

Holotype ♂, **Cameroun**: Bamenda, 20–24.i.1957, yellow tray (*V. F. Eastop*) (BMNH; slide mounted).

Paratypes. **Cameroun**: 3 ♂, 2 ♀, same data as holotype; 17 ♂, 11 ♀, 25.i.–6.ii.1957 (*V. F. Eastop*) (BMNH; slide mounted and stored in Berlese fluid).

COMMENT. *P. septima* and *proxima* are regarded as sister species and may be distinguished from one another by the form of the male paramere (Figs 87, 90) and the female subgenital plate (Figs 89, 92).

#### *Pauropsylla proxima* sp. n.

(Figs 90–92, 283, 284)

DESCRIPTION. Adult. Very similar to *septima*. Differs in the shape of the ♂ paramere (Fig. 90), and the deeply emarginate and long-haired posterior margin of the ♀ subgenital plate (Fig. 92).

Measurements (10 ♂, 10 ♀). Maximum width of head, ♂ 0.46–0.53, ♀ 0.50–0.53; length of antennal flagellum, ♂ 0.59–0.73, ♀ 0.63–0.72; length of ultimate rostral segment, ♂ 0.07, ♀ 0.07–0.08; length of forewing, ♂ 2.09–2.24, ♀ 2.32–2.49; length of hind tibia, ♂ 0.53–0.59, ♀ 0.54–0.61.

Fourth instar larva (Figs 283, 284). No 5th instar larvae available for study. Dorsal surface outline oval with clearly defined head, thorax and abdomen, about 1.5 times longer than wide. Small prothoracic sclerites present behind cephaloprothorax, arrangement of sclerites of rest of thorax as in Fig. 283; humeral lobe of forewing bud not developed. Caudal plate excludes first four abdominal segments; anus ventral, pore ring complex (Fig. 284). Sectasetae absent from margin of cephaloprothorax, pointed sectasetae present on margins of wing buds and abdomen, dorsal surface of abdomen with a dense covering of lanceolate setae.

HOST PLANT. Adults and larvae collected from *Ficus* sp., and adults only collected from *Ficus thonningii* (Moraceae).

Holotype ♂, **Cameroun**: Bamenda, 25–31.i.1957, yellow tray (*V. F. Eastop*) (BMNH; slide mounted).

Paratypes. **Cameroun**: 6 ♂, 15 ♀, same data as holotype; numerous ♂ and ♀, 20–24.i.1957 and 1–6.ii.1957. **Angola**: 3 ♂, 7 ♀, larvae, Chianga, 10.x.1970, *Ficus* sp.; 4 ♂, 3 ♀, 7.x.1971, *Ficus thonningii* (*A. van Harten*). **Nigeria**: 4 ♂, Zaria, 28.ii.1956, yellow tray (*V. F. Eastop*). (BMNH; slide and dry mounted, and stored in Berlese fluid.)

COMMENT. See under *P. septima*.

### Ungrouped species

#### *Pauropsylla angolensis* sp. n.

(Figs 93, 94)

DESCRIPTION. Adult. Similar to *senegalensis* (p. 34) but larger. Median suture of vertex weak but complete; antennal flagellum 1.13–1.17 times longer than head width; clypeus with two pairs of setae. Forewing 1.99–2.09 times longer than wide. ♂ proctiger with very weakly expanded lateral lobes; paramere and aedeagus as in Figs 93, 94; ♀ genital segment short, rounded triangular in profile; posterior margin of subgenital plate truncate.

Measurements (2 ♂, 1 ♀). Maximum width of head, ♂ 0.60–0.64, ♀ 0.63; length of antennal flagellum, ♂ 0.72, ♀ 0.74; length of ultimate rostral segment, ♂ 0.07, ♀ 0.08; length of forewing, ♂ 2.80, ♀ 3.03; length of hind tibia, ♂ 0.78–0.79, ♀ 0.88.

Larva and host plant unknown.

Holotype ♂, **Angola**: 3 mls SW. Salazar, 15.iii.1972, at light (*D Hollis*) (BMNH; dry mounted).

Paratypes. 4 ♂, 1 ♀, same data as holotype (BMNH; slide and dry mounted).

#### *Pauropsylla eastopi* sp. n.

(Figs 95–97)

DESCRIPTION. Adult. Integument shiny, sparsely covered with short setae. Median suture of vertex present; antennal flagellum 1.24–1.45 times longer than head width, rhinaria simple, apical flagellomere with subequal terminal setae; clypeus with several short setae; ultimate rostral segment without setae. Forewing 2.08–2.26 times longer than wide, veins very sparsely clothed with short setae,  $m_1$  cell value 0.86–0.98; forecoxa without ventroapical spur; tarsal segments subequal. ♂ proctiger (Fig. 97) with greatly enlarged lateral expansions which do not bear peg-like setae, paramere and aedeagus as in Figs 95, 96; ♀ genital segment very short triangular in profile, sternite 6 of abdomen very weakly sclerotised ventrally, membrane between tergite 8 and proctiger with lateral glandular areas.

Measurements (7 ♂, 7 ♀). Maximum width of head, ♂ 0.47–0.50, ♀ 0.49–0.51; length of antennal flagellum, ♂ 0.65–0.71, ♀ 0.62–0.65; length of ultimate rostral segment, ♂ and ♀ 0.06–0.07; length of forewing, ♂ 2.25–2.40, ♀ 2.43–2.61; length of hind tibia, ♂ 0.55–0.60, ♀ 0.57–0.60.

Larva and host plant unknown.

Holotype ♂, **Cameroun**: Bamenda, 1–5.ii.1957, yellow tray (*V. F. Eastop*) (BMNH; slide mounted).

Paratypes. **Cameroun**: numerous ♂ and ♀, same data as holotype; numerous ♂ and ♀, 20–31.i.1957 and 6.ii.1957 (*V. F. Eastop*) (BMNH; slide and dry mounted, and stored in Berlese fluid).

COMMENTS. This species is easily distinguished from all other known *Pauropsylla* species by the form of the male proctiger and genitalia (Figs 95–97), and the lack of sclerotisation of the female abdominal sternite 6. I can find no other characters which will relate it more closely to other species-groups within the genus.

#### *Pauropsylla longipes* sp. n.

(Figs 98–101, 287, 288)

DESCRIPTION. Adult. Integument granular, sparsely covered with short setae. Median suture of vertex absent; antennal flagellum 1.41–1.78 times longer than head width, rhinaria simple, apical flagellomere with one long and one moderately long truncate seta terminally; clypeus with a pair of setae, ultimate

rostral segment with 2–4 pairs of setae. Forewing 2.05–2.26 times longer than wide, veins very sparsely clothed with short setae,  $m_1$  cell value 0.77–1.05; costal margin of hindwing with 2–4 setae proximal to costal break; forecoxa without ventroapical spur; basitarsal segments 1.5 times as long as apical segments of tarsi. ♂ proctiger with a small group of up to 12 peg-like setae on the inner surface of each lateral expansion (Fig. 100), paramere and aedeagus as in Figs 98, 99; ♀ genital segment (Fig. 101) elongate triangular in profile, subgenital plate without ventral transverse groove.

Measurements (9 ♂, 7 ♀). Maximum width of head, ♂ 0.43–0.50, ♀ 0.43–0.52; length of antennal flagellum, ♂ 0.68–0.94, ♀ 0.66–0.80; length of ultimate rostral segment, ♂ 0.08–0.10, ♀ 0.09–0.10; length of forewing, ♂ 1.94–2.24, ♀ 1.91–2.47; length of hind tibia, ♂ 0.63–0.78, ♀ 0.67–0.81.

Fifth instar larva (Figs 287, 288). Dorsal surface outline elongate oval with a clear indentation on either side at base of abdomen, and a posteromedian prolongation, about twice as long as wide (including prolongation). Antenna with three flagellomeres. Cephalothorax entire, posterior margin serrate; forewing pad 0.52 mm long, humeral lobes weakly produced forward but not reaching hind margin of eye. Caudal plate about 1.3 times longer than wide (including prolongation); anus ventral and distant from posterior margin of abdomen, anus and pore ring as in Fig. 288. Small narrow tubular sectasetae form a sparse fringe on head and wing buds; both large and small tubular sectasetae form an uneven fringe around abdomen; a simple postocular seta present; sectasetae on dorsum as in Fig. 287.

HOST PLANT. Adults and larvae collected from *Ficus* sp. (Moraceae).

Holotype ♂, **Tanzania**: S. Pare mtns, hillside above Gonja, c. 3,000', 12–16.vi.1974, *Ficus* sp. (*D. Hollis*) (BMNH; dry mounted).

Paratypes. **Tanzania**: 18 ♂, 7 ♀, same data as holotype; 21 ♂, 19 ♀, larvae, E. Usambara mtns, Amani-Muheza Rd, below Kiswani, c. 2,000', 21–24.vi.1974, *Ficus* sp. (*D. Hollis*). **Cameroun**: 5 ♂, 6 ♀, Bamenda, 24.i.–6.ii.1957, yellow tray (*V. F. Eastop*). **Nigeria**: 1 ♀, W. State, Ile-Ife, 6.ix.1971 (*J. T. Medler*). **Ghana**: 2 ♂, Tafo (*B. N. Gerrard*); 7 ♂, 12 ♀, 15.v.1957; 15 ♂, 15 ♀, vi.1957 (*V. F. Eastop*). (BMNH; slide and dry mounted, and stored in Berlese fluid.)

COMMENTS. This species resembles those of the *willcocksii*-group in lacking a median suture on the vertex and having peg-like setae on the inner surfaces of the lateral expansions of the male proctiger, but differs in lacking a ventroapical spur on the forecoxa. It is readily distinguished from other Afrotropical *Pauropsylla* species by the proportions of the tarsal segments.

### *Pauropsylla mistura* sp. n.

(Figs 102–104)

DESCRIPTION. Adult. Very similar to *senegalensis* (p. 34) but larger. Median suture of vertex present and complete; antennal flagellum 1.15–1.31 times longer than head width. Forewing 2.21–2.30 times longer than wide. ♂ proctiger with very weak lateral expansions, paramere and aedeagus as in Figs 102, 103; ♀ genital segment short, rounded triangular in profile (Fig. 104), ventral margin of subgenital plate rounded in profile.

Measurements (3 ♂, 6 ♀). Maximum width of head, ♂ 0.50–0.51, ♀ 0.51–0.53; length of antennal flagellum, ♂ 0.62–0.64, ♀ 0.61–0.67; length of ultimate rostral segment, ♂ 0.07, ♀ 0.07–0.08; length of forewing, ♂ 2.49–2.64, ♀ 2.58–2.78; length of hind tibia, ♂ 0.58–0.60, ♀ 0.59–0.66.

Larva and host plant unknown.

Holotype ♂, **Cameroun**: Bamenda, 20–24.i.1957, yellow tray (*V. F. Eastop*) (BMNH; slide mounted).

Paratypes. **Cameroun**: 1 ♀, same data as holotype; 1 ♂, 3 ♀, 25.i.–5.ii.1957. **Nigeria**: 1 ♂, 1 ♀, Samaru, viii.1956; 1 ♀, Jos, 25–26.xi.1956, yellow tray (*V. F. Eastop*). **Ghana**: 1 ♀, Tafo, v.1957 (*V. F. Eastop*). (BMNH; slide mounted.)

COMMENTS. *P. mistura* is larger than *senegalensis*, has the male paramere and aedeagus of a different shape, and a rounded conical female genital segment. It may be separated from *angolensis* on the form of the male genitalia.

### *Pauropsylla senegalensis* sp. n.

(Figs 105–108, 285, 286)

DESCRIPTION. Adult. Integument granular, sparsely covered with very short setae. Median suture of vertex weak, evanescent before reaching occiput; antennal flagellum 1.06–1.27 times longer than head width,

rhinaria simple, apical flagellomere with one long and one short and truncate seta; clypeus with a pair of setae, ultimate rostral segment without setae. Forewing 1.91–2.03 times longer than wide, veins very sparsely clothed with short setae,  $m_1$  cell value 0.69–0.91. Forecoxa without ventroapical spur; tarsal segments subequal. ♂ proctiger (Fig. 107) flask-shaped, with weak lateral expansions which bear simple setae on their inner surfaces, paramere and aedeagus as in Figs 105, 106; ♀ genital segment (Fig. 108) short, subrectangular in profile, proctiger with a weak transverse groove posterior to anal pore, subgenital plate with a narrowly arcuate posterior margin, ventral margin subangular in profile.

Measurements (7 ♂, 4 ♀). Maximum width of head, ♂ 0.45–0.48, ♀ 0.48–0.50; length of antennal flagellum, ♂ 0.54–0.61, ♀ 0.51–0.58; length of ultimate rostral segment, ♂ and ♀ 0.06–0.07; length of forewing, ♂ 1.75–1.87, ♀ 1.93–2.09; length of hind tibia, ♂ 0.50–0.54, ♀ 0.54–0.56.

Fifth instar larva (Figs 285, 286). Dorsal surface outline broadly oval, about 1.2 times longer than wide. Antenna with two flagellomeres. Cephalothorax entire; forewing pad 0.65 mm long, humeral lobe extending forward as far as anterior margin of eye. Caudal plate about 0.6 times as long as wide, anus ventral and distant from posterior margin of abdomen, anus and pore ring as in Fig. 286. Truncate tubular setae forming an even dense fringe; postocular seta absent, setae absent from dorsum.

HOST PLANT. Adults and larvae collected from *Ficus* sp. (Moraceae).

Holotype ♂, Senegal: Simbandi-Balante, 18.vi.1981, *Ficus* sp. (*J. Etienne*) (BMNH; dry mounted).

Paratypes. Numerous adults and larvae, same data as holotype (BMNH; MNHN; slide and dry mounted, and stored in 80% ethanol).

COMMENTS. This species is very similar to *mistura* and *angolensis*, but it may be distinguished from these by its smaller size, the incomplete median suture of the vertex and the form of the male and female genitalia (Figs 105–108).

### TRIOZA Foerster

*Triozia* Foerster, 1848: 67. Type-species: *Chermes urticae* Linnaeus, by subsequent designation of Oshanin, 1912: 128.

*Powellia* Maskell, 1879: 223. Type-species: *Powellia vitreoradiata* Maskell, by monotypy. [Synonymised by Maskell, 1890: 167.]

*Phyllopecta* Riley, 1884: 319. Type-species: *Psylla tripunctata* Fitch, by monotypy. [Synonymised by Tuthill, 1943: 546.]

*Phyllopecta* Ferris, 1926: 16. [Misspelling of *Phyllopecta* Riley; Tuthill, 1943: 546.]

*Spanioza* Enderlein, 1926: 400. Type-species: *Triozia galii* Foerster, by original designation. [Synonymised by Tuthill, 1943: 546.]

*Colopelma* Enderlein, 1926: 400. Type-species: *Triozia thomasii* Löw, by original designation. [Synonymised by Tuthill, 1943: 546.]

*Siphonaleyrodes* Takahashi, 1932: 48. Type-species: *Siphonaleyrodes formosanus* Takahashi, by original designation. [Synonymised by Mound & Halsey, 1978: 252.]

Only established synonymy is stated above but the following references, given under the synonymy of the family Triozidae (p. 8), contain regional revisions of *Triozia*: Vondráček, 1957 (Czechoslovakia); Ramirez-Gomez, 1960 (Spain); Dobreanu & Manolache, 1962 (Rumania); Loginova, 1964 (European U.S.S.R.); Klimaszewski, 1973 (Palaeartic check-list); 1975 (Poland); Sulc, 1910; 1911; 1912; 1913 (revision of Palaeartic species); Crawford, 1919 (Oriental, Australo-oriental and Pacific); Mathur, 1975 (India); Froggatt, 1901 (Australia); Tuthill, 1952 (New Zealand); Zimmermann, 1948 (Hawaii); Crawford, 1914 (New World); Tuthill, 1943 (N. America); 1944 (Mexico); 1959; 1964 (Peru).

Tuthill's argument (1943: 547) that *Phyllopecta* Riley is a nomen nudum is not accepted here as Riley's statement '*Phyllopecta tripunctata*, which crumbles the tips of blackberry' makes clear he is referring to *Psylla tripunctata* and validates *Phyllopecta* Riley, 1884 under Article 16(v) of the *International Code of Zoological Nomenclature*.

As the following species are here placed in *Triozia* on a temporary basis, a detailed description of the genus is of no systematic value. These species differ from Afrotropical species placed in other trioziid genera as follows.

Median suture of vertex present and normally complete; genal cones, when present, not constricted basally. Propleural suture diagonal, episternum enlarged, epimeron reduced,

displaced ventrally and not in contact with lateral margin of pronotum. Forewing shape mostly elongate elipsoid and narrowing to a subangular apex, if with rounded apex then more than 2.3 times longer than wide (exception *T. guiera*, p. 62); radular areas present only in cells  $m_1$ ,  $m_2$  and  $cu_1$ ; claval suture reaching hind margin of wing some distance from apex of  $Cu_{1b}$ . Ventral sense organs of hind femur in median position; basal tarsal segment of hind leg without apical spurs. Male proctiger unipartite.

For the species treated below the grouped species are considered before those not placed in groups. The *erytreae*-group is dealt with first as it contains the major pest species and, probably, is most closely related to the type-species. Other species-groups are treated in descending order of apparent relationship to the *erytreae*-group. The ungrouped species are treated in alphabetical order.

### The *erytreae*-group

A difficult group to define, the 10 species included having no single character which will delimit them from other *Trioza* species, and therefore the grouping may be artificial. The description of *erytreae* serves to define the group. The species included are: *erytreae*, *catlingi*, *menispermicola*, *gregoryi*, *ata*, *kilimanjarica*, *tiliacora*, *carvalhoi*, *capeneri* and *eafra*.

Known host plant families are Rutaceae, Menispermaceae, Araliaceae and possibly Salicaceae. This is a rather wide range but there may be chemical similarities within these families (Thorne, 1976: 85; Dahlgren, 1977: 260).

### *Trioza erytreae* (Del Guercio)

(Figs 2, 7–9, 34, 35, 40–42, 49, 52, 54, 55, 109–111, 126, 127, 289, 290)

Citrus Psylla (*Trioza*); Lounsbury, 1897: 116.

'Psyllidengalle'; *Citrus aurantium*; Rübsaamen, 1899: 266.

*Aleurodes erytreae* Del Guercio, 1918: 167. Syntypes, larvae, ETHIOPIA 'Eritrea' [not traced].

*Trioza citri* Laing; Waterston, 1922: 49, 55. [Nomen nudum.]

*Trioza merwei* Pettey, 1923: 30. Syntypes SOUTH AFRICA 'Natal, Durban, on orange and *Toddalia lanceolata*' (SAM; USNM) [not examined]. [Synonymised by Pettey, 1933: 19.]

*Spanioza merwei* (Pettey); Enderlein, 1926: 400.

*Spanioza erythrae* (Del Guercio); Boselli, 1930b: 228; Pettey, 1933: 19; Harris, 1936: 498.

Citrus Psylla (*Spanioza erytreae*) Del Guercio; Van der Merwe, 1941: 5.

*Trioza erytreae* (Del Guercio); Capener, 1970: 200.

Only primary taxonomic references are quoted above. Further references on the biology and economic aspects of this species are given in the introduction (p. 4).

DESCRIPTION. Adult. Integument sparsely covered with short setae. Head, in profile, almost at 90° to longitudinal axis of body, from above almost as wide as mesoscutum; occipital margin rounded; vertex pentagonal with anterior margin deeply incised by median suture, rounded down to frons, lateral ocelli on outer sides of raised tubercles, a shallow concavity present on either side of median suture; median ocellus not visible in dorsal view; frons completely covered by genae in anterior view; genal cones well developed, elongate conical with rounded apices; antennal flagellum 2.08–2.81 times longer than head width, head width to length of 1st flagellum in ♂ 1.26–1.70, in ♀ 1.30–1.82; a single rhinarium present subapically on flagellomeres 2, 4, 6 and 7, apical flagellomere with a long pointed seta and a short truncate seta apically; clypeus with a pair of setae, ultimate rostral segment with two pairs of setae. Thorax strongly arched; pronotum just visible from above, in profile strongly rounded down behind occiput. Mesopraescutum about as wide as long, its anterior margin strongly arcuate in dorsal view, in profile strongly downcurved to pronotum; forewing hyaline, elongate oval and narrowing to a rounded rectangular apex, 2.79–3.09 times longer than wide, radular areas elongate triangular, remainder of membrane devoid of spinules; veins bearing short setae, *R* branch acutangular, *M* branch distal to *Rs*–*Cu*<sub>1a</sub> line, *Cu* stem 2.75–4.20 times longer than *Cu*<sub>1b</sub>,  $m_1$  cell value 1.10–1.38,  $cu_1$  cell value 2.56–3.71; forewing 1.59–1.82 times longer than hindwing, costal margin of hindwing with up to two setae proximal to costal break, setae distal to costal break clearly divided into two groups; hind coxa with a well-defined meracanthus and without anterior lobe; hind tibia with a moderately developed basal spine, with one outer and three (rarely two) inner apical

spurs. Abdomen with setae on tergites 2 and 3 in ♂, and 3 and 4 in ♀; ♂ proctiger (Fig. 109) with a laterally expanded basal part and a very short and narrow apical part; paramere as in Fig. 110; apical segment of aedeagus simple (Fig. 111); ♀ genital segment (Fig. 127) short, conical, subgenital plate with a ventral bulge, ventral valves of ovipositor weakly serrate apically.

Measurements (19 ♂, 21 ♀). Maximum width of head, ♂ 0.37–0.40, ♀ 0.38–0.46; length of antennal flagellum, ♂ 0.85–1.10, ♀ 0.83–1.10; length of ultimate rostral segment, ♂ 0.09–0.10, ♀ 0.09–0.11; length of forewing, ♂ 2.40–2.96, ♀ 2.61–3.46; length of hind tibia, ♂ 0.50–0.62, ♀ 0.48–0.62.

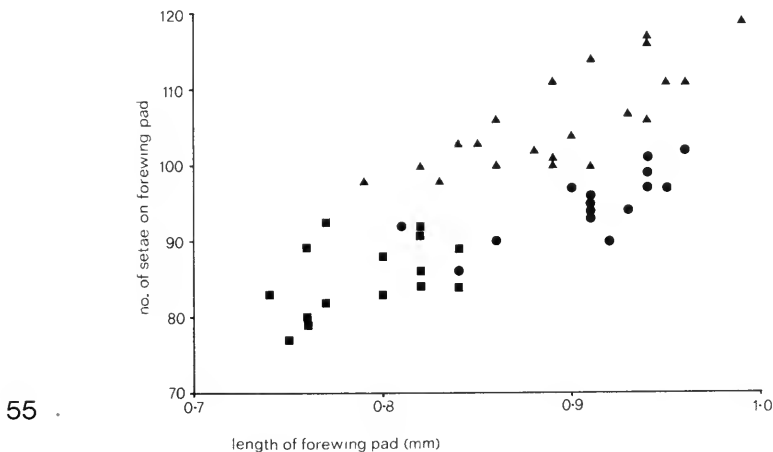
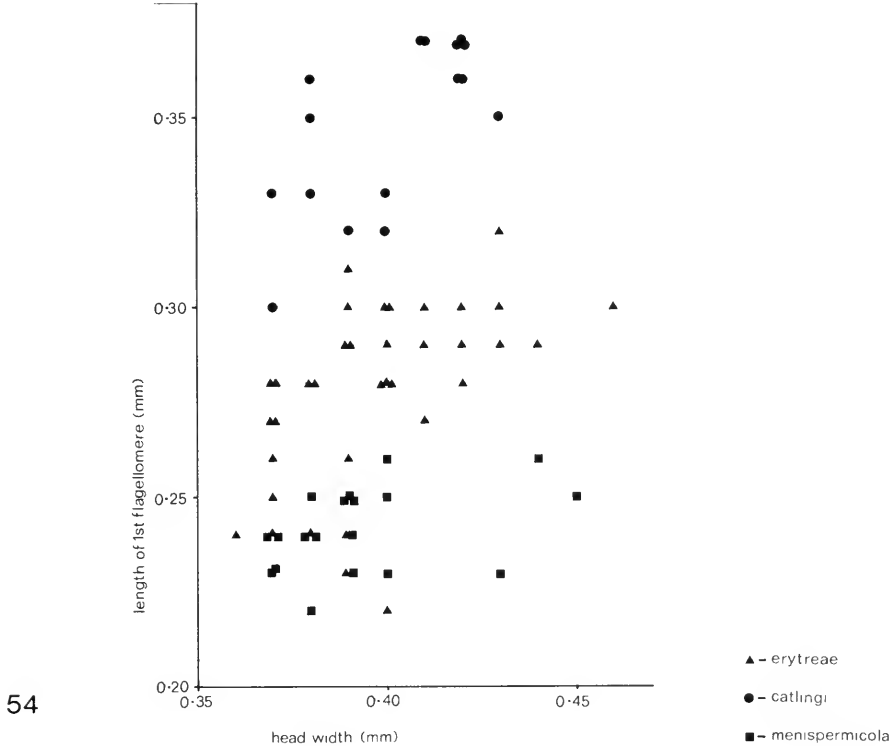

**Figs 54, 55** Scatter diagrams comparing characters of *Trioza erytrae*, *T. catlingi* and *T. menispermicola*. 54, adults, length of 1st flagellomere against head width. 55, larvae, number of setae on forewing pad against length of forewing pad.

**Table 4** Character matrix for the *erytrae*-group. Values and character states edged in heavy lines are diagnostic for each species.

SPECIES	CHARACTERS												
	sex	abdominal tergites bearing setae	forewing length	Paramere	apex of aedeagus	forewing hindwing length	<i>cu<sub>1</sub></i> cell value	spinules on forewing membrane	head width ultimate rostral segment	head width	head length of 1st flagellar segment	density of setae on forewing pad of 5th instar larva	position of anus of 5th instar larva
<i>tiliadora</i>	♂	2-7	2.55-2.67	Fig. 120	Fig. 121	1.68-1.74	2.37-2.69	absent	3.73-4.00	0.40-0.42	1.31-1.40	Fig. 293	Fig. 294
	♀	3-8	2.46-2.61			1.68-1.71	2.51-2.82		3.58-4.00	0.41-0.44	1.32-1.65		
<i>gregoryi</i>	♂	2-3	2.80-2.99	Fig. 114	Fig. 115	1.58-1.77	2.60-3.22	absent	3.45-4.00	0.35-0.38	1.46-1.71		
	♀	3-4	2.72-2.81			1.69-1.75	2.28-3.00		3.25-4.11	0.36-0.39	1.48-1.76		
<i>capeneri</i>	♂	2-3	2.77-3.00			1.46-1.52	1.91-2.40	absent	3.80-4.44	0.38-0.41	1.60-1.86		Fig. 297
	♀	3-4	2.84-3.03			1.48-1.58	2.09-2.45		3.91-4.30	0.41-0.43	1.64-1.83		
<i>carvalhoi</i>	♂	2-3	2.74-2.98	Fig. 123	Fig. 124	1.42-1.52	1.60-2.25	absent	3.80-4.55	0.36-0.41	1.44-1.90	Fig. 295	Fig. 296
	♀	3-4	2.69-2.90			1.47-1.54	1.67-2.26		4.00-4.42	0.40-0.43	1.48-1.87		
<i>eafra</i>	♂	2-3	2.69-2.89	Fig. 125		1.38-1.43	1.61-2.45	present	4.00-4.75	0.35-0.40	1.90-2.25		
	♀	3-4	2.60-2.85			1.37-1.56	1.72-2.10		4.22-4.75	0.35-0.42	1.74-2.29		
<i>kilimanjarica</i>	♂	2-3	2.90-3.14	Fig. 118		1.54-1.60	2.12-2.73	absent	5.29-5.43	0.37-0.38	1.61-1.90		
	♀	3-4	2.75-2.92			1.57-1.64	2.19-2.55		5.43-5.71	0.38-0.40	1.60-1.81		
<i>ata</i>	♂	2-3	2.76-3.14	Fig. 116	Fig. 117	1.54-1.68	2.56-3.43	absent	4.60-5.22	0.43-0.49	1.35-1.69		
	♀	3-4	2.96-3.13			1.59-1.65	2.38-3.06		4.60-5.11	0.46-0.50	1.47-1.53		
<i>callingi</i>	♂	2-3	2.73-3.05	Fig. 112	Fig. 113	1.63-1.71	2.93-4.18	absent	3.73-4.33	0.37-0.41	1.06-1.23	Fig. 292	
	♀	3-4	2.62-2.92			1.61-1.80	2.55-3.87		3.82-4.20	0.40-0.43	1.11-1.25		
<i>menispermicola</i>	♂	2-3	2.76-2.93			1.65-1.79	2.85-3.33	absent	3.36-4.30	0.37-0.43	1.54-1.87	Fig. 55	
	♀	3-4	2.69-2.86			1.64-1.77	2.65-3.83		3.45-4.40	0.38-0.45	1.52-1.80		
<i>erytrae</i>	♂	2-3	2.88-3.09	Fig. 110	Fig. 111	1.59-1.67	2.60-3.71	absent	4.00-4.44	0.37-0.40	1.26-1.70	Fig. 55, 289	Fig. 290
	♀	3-4	2.79-3.05			1.62-1.82	2.56-3.67		3.82-4.44	0.38-0.46	1.30-1.82		



Fifth instar larva (Figs 289, 290). Dorsal surface outline oval, about 1.5 times longer than wide. Antenna with 4–5 flagellomeres. Cephaloprothorax separate from rest of thorax which is entire. Forewing pad about 0.8 mm long, humeral lobe extending forward beyond anterior margin of eye. Caudal plate about 0.65 times as long as wide, anus ventral and distant from posterior margin of abdomen, anus and pore ring as in Fig. 290. Truncate tubular sectasetae forming a dense, entire marginal fringe, postocular seta absent, sectasetae absent from dorsum.

**HOST PLANTS.** Larvae, which form pit-galls on the lower surfaces of the leaves, and adults have been collected from *Clausena anisata*, *Fagara capensis*, *Vepris undulata* and *Citrus* spp.

**DISTRIBUTION.** Widely distributed in the Afrotropical Region and specimens have been examined from Cameroun, Zaire, Angola, Ethiopia, Ruanda, Uganda, Kenya, Tanzania, Malawi, Zimbabwe, South Africa, São Tomé, St Helena, Réunion and Madagascar.

**COMMENTS.** *T. erythrae* is the only member of this group known to develop on members of the Rutaceae. Apart from citrus I have collected adults and larvae from *Clausena anisata* in East Africa but Van Der Merwe (1941) records the insect from *Vepris undulata* (as *Toddalia lanceolata*), *Fagara capensis* and *Clausena anisata* (as *C. inaequalis*) in South Africa, stating that the last seemed to be the preferred host. Moran (1968a) concludes that *V. undulata* and/or *C. anisata* were probably the indigenous host plants in South Africa.

Members of the *erythrae*-group are morphologically homogeneous and male genitalia characters are not always species diagnostic. These characters can be used to separate *erythrae* from *gregoryi* (Figs 114, 115), *kilimanjarica* (Fig. 118), *carvalhoi* (Figs 122–124) and *eafra* (Fig. 125) but not the rest of the group. *T. tiliacora* is easily separated as it has setae on all abdominal tergites and a relatively broader forewing; *capeneri* has a lower  $cu_1$  cell value and a relatively longer hindwing; in *ata* the clypeus has two pairs of setae and a relatively shorter ultimate rostral segment. It is extremely difficult to separate *catlingi* and *menispermicola* from *erythrae*: in *catlingi* the first flagellomere is longer (head width to length of 1st flagellomere 1.06–1.23) and the marginal sectasetae of the 5th instar larva are less dense (Fig. 54); in *menispermicola* the adults appear identical to *erythrae* but the marginal sectasetae are less dense (Fig. 55). A summary of the characters used to separate members of the *erythrae*-group is given in Table 4.

### *Trioza catlingi* sp. n.

(Figs 54, 55, 112, 113, 291, 292)

*Trioza* sp.; Catling, 1969b: 220; McDaniel & Moran, 1972: 299.

**DESCRIPTION.** Very similar to *T. erythrae*. First flagellomere longer, head width to length of 1st flagellomere ratio in ♂ 1.06–1.23 and 1.11–1.25 in ♀. Marginal sectasetae of 5th instar larva less dense (Figs 55, 291).

Measurements (10 ♂, 8 ♀). Maximum width of head, ♂ 0.37–0.41, ♀ 0.40–0.43; length of antennal flagellum, ♂ 1.01–1.16, ♀ 1.05–1.22; length of ultimate rostral segment, ♂ 0.09–0.11, ♀ 0.10–0.11; length of forewing, ♂ 2.61–3.12, ♀ 2.74–3.24; length of hind tibia, ♂ 0.58–0.65, ♀ 0.57–0.68.

**HOST PLANTS.** Larvae, which form pit galls, and adults have been collected from *Stephania abyssinica* and *Cissampelos* sp. (Menispermaceae).

Holotype ♂, Kenya: Kakamega For. sta., c. 5,000', 18–19.vii.1974, *Stephania abyssinica* (D. Hollis) (BMNH; dry mounted).

Paratypes. Kenya: 10 ♂, 6 ♀, larvae, same data as holotype; 5 ♂, 12 ♀, larvae, S. slope Mt Kenya, Thiba camp, c. 6,000', 9–10.vii.1974, *Cissampelos* sp.; 2 ♂, 2 ♀, Tinderet For., 5 km along Lessos rd, c. 8,000', 20.vii.1974, *Stephania abyssinica*. Tanzania: 5 ♂, larvae, Arusha NP, track to Ngurdoto, c. 5,000', 7.vi.1974, *Stephania abyssinica*; 11 ♂, 9 ♀, Ngurdoto Crater rim, c. 5,000', 8.vi.1974; 9 ♂, 12 ♀, larvae, *Stephania abyssinica*; 6 ♂, 1 ♀, Meru FR, track to crater, 6,000–9,000', 9.vi.1974, *Stephania abyssinica* (D. Hollis). South Africa: 1 ♀, N. Tvl, Letaba, ix.1966, *Cissampelos torulosa* (A. P. D. McClean). (BMNH; NMK; slide and dry mounted and stored in 80% ethanol.)

*Trioza menispermicola* sp. n.

(Figs 54, 55)

DESCRIPTION. Very similar to *erytreae* and *catlingi*. Differs from *catlingi* in that ratio of head width to length of 1st flagellomere is 1.54–1.87 in ♂ and 1.52–1.80 in ♀. ♀ subgenital plate without ventral bulge. Differs from *erytreae* in the density of marginal setae of the 5th instar larva (Fig. 55).

Measurements (9 ♂, 10 ♀). Maximum width of head, ♂ 0.37–0.43, ♀ 0.38–0.45; length of antennal flagellum, ♂ 0.83–0.89, ♀ 0.84–0.93; length of ultimate rostral segment, ♂ and ♀ 0.10–0.11; length of forewing, ♂ 2.27–2.64, ♀ 2.49–3.08; length of hind tibia, ♂ 0.47–0.53, ♀ 0.49–0.56.

HOST PLANTS. Larvae, which form pit galls, and adults have been collected from *Triclisia macrophylla*, *T. patens* and *Cissampelos owariensis* (Menispermaceae).

Holotype ♂, Ghana: 'Gold Coast; Bunsu, Jan. 1943, *Triclisia macrophylla*' (H. E. Box) (BMNH; dry mounted).

Paratypes. Ghana: 1 ♂, 5 ♀, larvae, same data as holotype. Nigeria: 100 ♂, 100 ♀, larvae, Ibadan, Moor pln, 7.iv.1956, 'Pseudogalls on creeper' (R. Donald); 4 ♂, 2 ♀, larvae, Ilesha, 30.xii.1943, *Cissampelos owariensis* (H. E. Box). No locality data: 3 ♂, 2 ♀, larvae, 22.xii.1942, *Triclisia patens* (H. E. Box). (BMNH; slide and dry mounted and stored in 80% ethanol.)

*Trioza gregoryi* sp. n.

(Figs 114, 115)

DESCRIPTION. Adult. Very similar to *erytreae*. Differs in shape of ♂ paramere (Fig. 114) and apical segment of aedeagus (Fig. 115). ♀ subgenital plate smoothly rounded and without ventral bulge.

Measurements (9 ♂, 8 ♀). Maximum width of head, ♂ 0.35–0.38, ♀ 0.36–0.39; length of antennal flagellum, ♂ 0.72–0.86, ♀ 0.75–0.82; length of ultimate rostral segment, ♂ 0.09–0.11, ♀ 0.09–0.12; length of forewing, ♂ 2.30–2.74, ♀ 2.55–2.94; length of hind tibia, ♂ 0.44–0.57, ♀ 0.47–0.56.

Larva and host plant unknown.

Holotype ♂, Nigeria: Umuahia, Umudike, 28.viii.1958, yellow tray (J. L. Gregory) (BMNH; slide mounted).

Paratypes. Nigeria: 6 ♂, 7 ♀, same data as holotype. Burundi: 1 ♂, 1 ♀, Gitega, 20.x.1980 (Pointel). Tanzania: 2 ♂, 1 ♀, E. Usambara mtns, Amani Res. sta., 19–27.vi.1974 (D. Hollis). (BMNH; MNHN; slide mounted.)

*Trioza ata* sp. n.

(Figs 116, 117, 128)

DESCRIPTION. Adult. Very similar to *erytreae* but relatively larger (see measurements below). Clypeus with two pairs of setae; ultimate rostral segment relatively shorter, head width to ultimate rostral segment length ratio 4.6–5.22. ♂ proctiger less expanded laterally, paramere and apical segment of aedeagus as in Figs 116, 117. Ventral valves of ovipositor with more serrations along apical part (Fig. 128).

Measurements (13 ♂, 6 ♀). Maximum width of head, ♂ 0.43–0.49, ♀ 0.46–0.50; length of antennal flagellum, ♂ 1.04–1.20, ♀ 1.13; length of ultimate rostral segment, ♂ and ♀ 0.09–0.10; length of forewing, ♂ 3.11–3.51, ♀ 3.41–3.61; length of hind tibia, ♂ 0.53–0.60, ♀ 0.55–0.57.

Larva unknown.

HOST PLANT. Adults collected from *Salix safsaf* (Salicaceae).

Holotype ♂, Angola: 12 mls SW. Luimbale, c. 5,500', 20–21.iii.1972, *Salix safsaf* (D. Hollis) (BMNH; dry mounted).

Paratypes. Angola: 19 ♂, 9 ♀, same data as holotype; 7 ♂, 3 ♀, Tundavala, 8–10 mls NW. Sa da Bandeira, 27–29.iii.1972, *Salix safsaf* (D. Hollis). Tanzania: 2 ♂, Kilimanjaro, Bismark Hut, 2,500–3,000 m, S. Mawenzi, at foot of high pasture, ii.1912 (Chr. Schröder). (BMNH; MNHU; slide and dry mounted.)

*Trioza kilimanjarica* sp. n.

(Fig. 118)

DESCRIPTION. Adult. Similar to *ata*. Distinguished by its smaller size (see measurements below); head width

to ultimate rostral segment length ratio 5.29–5.71. ♂ paramere as in Fig. 118. ♀ subgenital plate without ventral bulge, ventral valves of ovipositor serrate only at extreme apex.

Measurements (7 ♂, 4 ♀). Maximum width of head, ♂ 0.37–0.38, ♀ 0.38–0.40; length of antennal flagellum, ♂ 0.73–0.80, ♀ 0.82; length of ultimate rostral segment, ♂ and ♀, 0.07; length of forewing, ♂ 2.37–2.52, ♀ 2.64–2.87; length of hind tibia, ♂ 0.40–0.45, ♀ 0.42–0.45.

Larva and host plant unknown.

Holotype ♂, **Tanzania**: Kilimanjaro, Bismark Hut, 2,500–3,000 m, S. Mawenzi, at foot of high pasture, ii.1912 (*Chr. Schröder*) (MNHU; slide mounted).

Paratypes. 6 ♂, 4 ♀, same data as holotype (MNHU; BMNH; slide mounted).

### *Trioza tiliacora* sp. n.

(Figs 119–121, 129, 293, 294)

DESCRIPTION. Adult. Of similar general appearance to *erytrae* and *catlingi*. Integument slightly more densely haired. Genal cones less elongate; antennal flagellum 2.05–2.41 times longer than head width. Forewing with an even yellowish infuscation in mature specimens, 2.46–2.61 times longer than wide; veins with slightly longer setae; *Cu* stem 2.35–3.10 times longer than *Cu*<sub>1b</sub>; *m*<sub>1</sub> cell value 1.08–1.26, *cu*<sub>1</sub> cell value 2.37–2.82. Abdomen with setae present on all visible tergites; ♂ genitalia as in Figs 119–121; ♀ proctiger slightly less elongate apically than in *erytrae* and subgenital plate with less pronounced ventral bulge.

Measurements (4 ♂, 7 ♀). Maximum width of head, ♂ 0.40–0.42, ♀ 0.41–0.44; length of antennal flagellum, ♂ 0.92–1.0, ♀ 0.88–1.01; length of ultimate rostral segment, ♂ 0.10–0.11, ♀ 0.11–0.12; length of forewing, ♂ 2.46–2.81, ♀ 2.61–3.09; length of hind tibia, ♂ 0.56–0.62, ♀ 0.54–0.62.

Fifth instar larva (Figs 293, 294). Dorsal surface outline broadly oval, slightly emarginate posteriorly, about 1.4 times longer than wide. Antenna with 5–6 flagellomeres. Cephaloprothorax separated from rest of thorax which is entire. Forewing pad about 0.8 mm long, extending forward anterior to anterior margin of eye. Caudal plate about 0.56 times as long as wide, anus posteroventral (Fig. 294). Truncate tubular sectasetae forming a moderately dense marginal fringe but absent on posteromedial margin, postocular setae absent, sectasetae absent from dorsum.

HOST PLANT. Adults and larvae collected from *Tiliacora* sp. (Menispermaceae) in association with ants of the genus *Technomyrmex*. The larvae were causing severe leaf curl.

Holotype ♂, **Tanzania**: E. Usambara Mtns, Amani Res. sta., 19–27.vi.1974, c. 3,000', *Tiliacora* sp., in association with *Technomyrmex* sp. (*D. Hollis*) (BMNH; dry mounted).

Paratypes. 5 ♂, 13 ♀, larvae, same data as holotype (BMNH; slide and dry mounted).

COMMENTS. Unlike other species in the *erytrae*-group, *tiliacora* has the chaetotaxy of the abdominal tergites in the primitive condition. Furthermore the anus of the 5th instar larva is in a posteroventral position which is normally regarded as a primitive state. However, in this case I believe it to be secondarily derived and associated with ant-tending.

### *Trioza carvalhoi* sp. n.

(Figs 122–124, 130, 295, 296)

DESCRIPTION. Adult. In general appearance very similar to *erytrae*. Antennal flagellum slightly shorter, 1.95–2.27 times longer than head width. *Cu* stem 2.19–3.06 times longer than *Cu*<sub>1b</sub>, *cu*<sub>1</sub> cell value 1.6–2.26; hindwing relatively longer, ratio of length of forewing to length of hindwing 1.42–1.54. ♂ genitalia as in Figs 122–124; ♀ subgenital plate without ventral bulge.

Measurements (13 ♂, 19 ♀). Maximum width of head, ♂ 0.36–0.41, ♀ 0.40–0.43; length of antennal flagellum, ♂ 0.79–0.86, ♀ 0.81–0.96; length of ultimate rostral segment, ♂ and ♀, 0.09–0.10; length of forewing, ♂ 2.40–2.55, ♀ 2.66–2.92; length of hind tibia, ♂ 0.48–0.52, ♀ 0.48–0.55.

Fifth instar larva (Figs 295, 296). Very similar to *erytrae*. Antenna with 5–6 flagellomeres. Forewing pad about 0.66 mm long, humeral lobe extending forward to anterior margin of eye. Anus and pore ring as in Fig. 296.

HOST PLANTS. Adults and larvae collected from *Cussonia spicata*, *C. angolensis* and *C. paniculata*. The larvae form pit galls on the lower surfaces of the leaves and cause severe leaf distortion.

Holotype ♂, **Kenya**: N. slope Mt Kenya, Naro Moru lodge area, c. 6,000', 11–14.vii.1974, *Cussonia spicata* (*D. Hollis*) (BMNH; dry mounted).

Paratypes. **Kenya**: 15 ♂, 13 ♀, same data as holotype; 1 ♀, Thomson's Falls, path into gorge, c. 7,800', 15–16.vii.1974; 1 ♀, Marmanet FR, 5–15 km N. Thomson's Falls, c. 8,000', 16.vii.1974. **Angola**: 1 ♂, 12 mls SW. Luimbale, c. 5,500', 20–21.iii.1972; 11 ♂, 23 ♀, larvae, Chianga, 21–24.iii.1972, *Cussonia angolensis* (*D. Hollis*); 7 ♂, 7 ♀, larvae, 29.x.1970, *Cussonia angolensis*; 1 ♂, 4 ♀, i.1971, vagrants (*A. van Harten*); 3 ♂, 5 ♀, 8.i.1973, *Cussonia angolensis* (*L. Amorim*). **South Africa**: 3 ♂, 3 ♀, larvae, N. Tvl, *Cussonia spicata* (*C. Malan*); 2 ♂, 3 ♀, Natal, Cathedral Peak, 18.i.1964, *Cussonia paniculata* (*A. L. Capener*); 1 ♂, 1 ♀, Swaziland, M.R.S., iv.1966, *Cussonia* sp. (*R.C.H. Sweeney*). (BMNH, NCI; NMK; slide and dry mounted, and stored in 80% ethanol.)

### *Trioza capeneri* sp. n.

(Fig. 297)

DESCRIPTION. Adult. Very similar to *erytrae* and *carvalhoi*. Antennal flagellum 1.95–2.28 times longer than head width. *Cu* stem 2.27–3.40 times longer than *Cu*<sub>1b</sub>; *m*<sub>1</sub> cell value 1.26–1.55, *cu*<sub>1</sub> cell value 1.91–2.45. Forewing 1.46–1.58 times longer than hindwing. ♂ genitalia not distinguishable from *erytrae*.

Measurements (6 ♂, 6 ♀). Maximum width of head, ♂ 0.38–0.41, ♀ 0.41–0.43; length of antennal flagellum, ♂ 0.79–0.91, ♀ 0.84–0.89; length of ultimate rostral segment, ♂ 0.09–0.10, ♀ 0.10–0.11; length of forewing, ♂ 2.54–2.80, ♀ 2.93–3.12; length of hind tibia, ♂ 0.48–0.51, ♀ 0.50–0.53.

Fifth instar larva. Very similar to *carvalhoi*, anal pore area as in Fig. 297.

HOST PLANT. One sample of adults and larvae collected from *Seemannaralia gerrardii* (Araliaceae). The larvae were forming pit galls on the fruit.

Holotype ♂, **South Africa**: Natal, vii.1972, from pit galls on fruits of *Seemannaralia gerrardii* (*A. L. Capener*) (NCI; slide mounted).

Paratypes. 13 ♂, 18 ♀, larvae, same data as holotype (NCI; BMNH; slide mounted and stored in 80% ethanol).

COMMENTS. The male genitalia of this species are very similar to *erytrae* but the *cu*<sub>1</sub> cell value and relatively longer hindwing are similar to *carvalhoi*. Its host plant is a member of the Araliaceae and I am regarding it as the sister species of *carvalhoi*.

### *Trioza eafra* sp. n.

(Fig. 125)

DESCRIPTION. Adult. Very similar to *carvalhoi*. Differs in having shorter antennae, antennal flagellum 1.62–1.97 times longer than head width. Forewing membrane covered with spinules except for narrow areas bordering wing veins; *cu*<sub>1</sub> cell value 1.61–2.45; forewing 1.37–1.56 times longer than hindwing. ♂ paramere as in Fig. 125.

Measurements (11 ♂, 10 ♀). Maximum width of head, ♂ 0.35–0.40, ♀ 0.35–0.42; length of antennal flagellum, ♂ 0.59–0.71, ♀ 0.60–0.80; length of ultimate rostral segment, ♂ and ♀, 0.08–0.09; length of forewing, ♂ 1.87–2.41, ♀ 1.99–2.70; length of hind tibia, ♂ 0.36–0.43, ♀ 0.36–0.47.

Larva unknown.

HOST PLANT. Adults collected from *Cussonia spicata* (Araliaceae). The leaves of the host trees were heavily pitted but no larvae were found.

Holotype ♂, **Kenya**: L. Naivasha, W. shore rd, c. 6,200', 21–22.vi.1974, *Cussonia spicata* (*D. Hollis*) (BMNH; dry mounted).

Paratypes. **Kenya**: 9 ♂, 16 ♀, same data as holotype; 5 ♂, 8 ♀, Thomson's Falls, path into gorge, c. 7,800', 15–16.vii.1974, *Cussonia* sp.; 1 ♀, Mt Londiani For., 57 km W. Nakaru, c. 8,500', 20.vii.1974 (*D. Hollis*); 2 ♂, 2 ♀, Muguga, vi.1953, trapped. **Tanzania**: 5 ♂, 6 ♀, Nachingwea, xi.1953–iii.1954, trapped (*V. F. Eastop*); 3 ♂, 6 ♀, E. Usambara Mtns, Amani-Muheza rd, below Kiswani, c. 2,000', 21–24.vi.1974, *Cussonia* sp. (*D. Hollis*). (BMNH; NMK; slide and dry mounted.)

COMMENTS. This species is the only member of the *erytrae*-group to have retained (or reverted to) the primitive condition of having spinules on the forewing membrane. It has the relatively longer hindwing and low *cu*<sub>1</sub> cell value of *carvalhoi* and *capeneri* and I regard it as the sister-species of this pair.

### The *litseae*-group

Very similar to the *erytreae*-group but body form and forewings narrower, the hind tibia has two inner apical spurs and the female anal pore has a single ring of wax-producing cells. Two very closely related species are included: *litseae* and *xylopi*a. Host plants of both are in the Annonales.

#### *Trioza xylopi*a sp. n.

(Figs 131–134, 298, 299)

**DESCRIPTION.** Adult. Integument sparsely covered with very short setae. Head, in profile, almost at 90° to longitudinal axis of body, in dorsal view about as wide as mesoscutum; occipital margin rounded; vertex rounded pentagonal, strongly rounded downwards, with a deep median suture on either side of which is an irregular concavity, lateral ocelli on outer sides of raised humps; median ocellus not visible from above, in anterior view from completely covered by genae; genal cones well developed, downward pointing, conical with rounded apices; antennal flagellum 1.97–2.53 times longer than head width, a single rhinarium present subapically on flagellomeres 2, 4, 6, and 7, apical flagellomere bearing one long pointed and one short truncate seta terminally; clypeus with a pair of short setae, ultimate rostral segment with a pair of setae. Thorax strongly arched; pronotum visible from above, strongly rounded down behind occiput; mesopraescutum, in profile, angled down to pronotum, in dorsal view anterior margin strongly arcuate; forewing elongate oval, narrowing to a subacutangular apex, 2.94–3.43 times longer than wide, membrane with spinules in all cells apart from *c+sc* and *r*<sub>1</sub>, radular areas narrow, veins bearing very short setae, *R* branch acutangular, *M* branching distal to *Rs-Cu*<sub>1a</sub> line, *Cu* stem 1.78–2.17 times longer than *Cu*<sub>1b</sub>, *m*<sub>1</sub> cell value 1.09–1.38, *cu*<sub>1</sub> cell value 1.73–2.19; forewing 1.54 times longer than hindwing, costal margin of hindwing without setae proximal to costal break, setae distal to costal break clearly divided into two groups. Hind coxa with a well-developed meracanthus, without anterior lobe; hind tibia with 1–2 small basal spines and one outer and two inner apical spurs. Abdomen with setae on tergites 2–3 in ♂ and 3–4 in ♀; ♂ proctiger (Fig. 132) roundly expanded laterally, paramere and apical segment of aedeagus as in Figs 133, 134; ♀ genital segment short, conical, ventral surface of ventral valve of ovipositor smooth.

Measurements (7 ♂, 6 ♀). Maximum width of head, ♂ 0.34–0.38, ♀ 0.36–0.41; length of antennal flagellum, ♂ 0.76–0.86, ♀ 0.75–0.84; length of ultimate rostral segment, ♂ 0.06–0.07, ♀ 0.07; length of forewing, ♂ 1.94–2.22, ♀ 2.34–2.59; length of hind tibia, ♂ 0.34–0.43, ♀ 0.41–0.44.

Fifth instar larva (Figs 298, 299). Dorsal surface outline oval but with clear indentations at posterior margin of eye and at base of abdomen, about 1.75 times longer than wide. Antenna with four flagellomeres. Cephaloprothorax separate from rest of thorax which is entire. Forewing pad about 0.6 mm long, humeral lobe weakly extended forward to just beyond posterior margin of eye. Caudal plate about 0.7 times as long as wide; anus ventral, a short distance from posterior margin of caudal plate, anal pore area as in Fig. 299. Narrow tubular sectasetae forming an even and moderately dense marginal fringe, postocular tubular sectaseta present, sectasetae absent from dorsum.

**HOST PLANT.** Larvae and adults swept from *Xylopi*a sp. (Annonaceae); the larvae are apparently free-living as no evidence of galls was observed.

**Holotype** ♂, **Tanzania:** E. Usambara Mtns, Amani Res. sta., c. 3,000', 19–27.vi.1974, *Xylopi*a sp. (*D. Hollis*) (BMNH; dry mounted).

**Paratypes.** **Tanzania:** 14 ♂, 17 ♀, same data as holotype. **Kenya:** 1 ♂, W. slope Mt Kenya, Naro Moru lodge area, c. 6,500', 11–14.vii.1974, *Cussonia spicata* (*D. Hollis*). (BMNH; slide and dry mounted.)

**COMMENTS.** *T. xylopi*a is very closely related to *litseae* and the two species can be separated only by the form of the 5th instar larvae (Figs 298–301). Both are similar to *ea*fra (p. 42), in the *erytreae*-group, but have only two inner apical spurs on the hind tibia.

#### *Trioza litseae* Bordage

(Figs 300, 301)

*Trioza litseae* Bordage, 1898: 524; 1914: 409. Syntype[s] [? sex], RÉUNION: *Litsea (Tetranthera) laurifolia* [not traced].

*Trioza eastopi* Orian, 1972: 4. Holotype ♂, MAURITIUS: *Litsea glutinosa* (BMNH) [examined]. **Syn. n.**

**DESCRIPTION.** Adult. Very similar to *xylopi*a and, apart from its smaller size, not morphologically distinct from that species.

Measurements (5 ♂, 8 ♀). Maximum width of head, ♂ 0.28–0.32, ♀ 0.30–0.34; length of antennal flagellum, ♂ 0.66–0.73, ♀ 0.61–0.70; length of ultimate rostral segment, ♂ 0.06–0.07, ♀ 0.07–0.08; length of forewing, ♂ 1.39–1.79, ♀ 1.78–2.06; length of hind tibia, ♂ 0.29–0.35, ♀ 0.31–0.36.

Fifth instar larva (Figs 300, 301). Similar to *xylopi*a but broader, about 1.5 times longer than wide in dorsal view. Forewing pad about 0.5 mm long. Anus ventral and distant from posterior margin of caudal plate, anal pore area as in Fig. 301. Marginal setae consisting of a moderately dense fringe of broad tubular setasetae of varying lengths; postocular tubular setaseta present; dorsum with a sparse covering of setasetae.

HOST PLANT. Larvae and adults collected from *Litsea glutinosa* [= *L. laurifolia*]; the larvae damage the flower buds and flowers of the host; adults are also known to damage *Vanilla*.

MATERIAL EXAMINED. Réunion (*Litsea glutinosa*); Mauritius (*L. glutinosa* and 'citrus'). Bordage's type-series was not traced and may have never been preserved. Orian's holotype and some of the paratypes, which are slide-mounted, are damaged in that the gum mountant has become opaque.

COMMENTS (see also p. 43). Orian (1972) regarded *Trioza litseae* Gd as a nomen dubium and I have not been able to trace this description. However, Bordage (1898) described the work of this insect so the name *Trioza litseae* Bordage, 1898, becomes available under Article 16 (a)(viii) of the Code.

### The *anomalicornis*-group

Defined by the form of the ovipositor (Fig. 138), otherwise the five included species, *anomalicornis*, *kakamegae*, *thibae*, *tavandula* and *luvandata*, are similar to those of the *erytreae*-group. Two species are known to develop on *Apodytes dimidiata* (Icacinaceae).

### *Trioza anomalicornis* sp. n.

(Figs 17, 135–138)

DESCRIPTION. Adult. Integument sparsely covered with long setae. In profile, head moderately depressed from longitudinal axis of body, in dorsal view almost as wide as mesoscutum; occipital margins rounded; vertex pentagonal, gently rounded downwards, median suture clearly defined, lateral concavities weak, lateral ocelli on outer sides of strongly raised humps, frontal lobes absent; median ocellus visible from above, frons completely covered by genae in anterior view; genal cones elongate conical, slender, with narrowly rounded apices; antennal flagellum 1.84–2.0 times longer than head width, each flagellomere with a pair of long setae apically, apart from apical flagellomere which bears one long pointed seta and one large campaniform sensillum apically (Fig. 17), a single rhinarium present subapically on flagellomeres 2, 4, 6 and 7; clypeus with one pair of setae, ultimate rostral segment densely setose. Thorax strongly arched; pronotum just visible from above, in profile strongly downcurved behind occiput and well below plane of vertex and mesopraescutum; mesopraescutum, in profile, strongly rounded down to pronotum, in dorsal view its anterior margin narrowly arcuate; forewing elongate oval and narrowing to rounded acutangular apex, 2.88–3.12 times longer than wide, radular areas narrow elongate, remainder of membrane devoid of spinules; veins bearing very short setae, *R* branch acutangular; *M* branching distal to *Rs*–*Cu*<sub>1a</sub> line, *Cu* stem 2.81–3.94 times longer than *Cu*<sub>1b</sub>, *m*<sub>1</sub> cell value 1.08–1.17, *cu*<sub>1</sub> cell value 2.14–3.00; forewing 1.88–1.98 times longer than hindwing, costal margin of hindwing with 1–2 setae proximal to costal break, setae distal to costal break clearly divided into two groups. Hind coxa with a well-developed meracanthus and without anterior lobe; hind tibia relatively long, 1.49–1.69 times longer than head width, with a pair of small spines basally and one outer and three inner apical spurs, the middle spur of the inner trio being less developed than the remaining two. Abdomen with setae on tergite 3 in ♂, and 4 in ♀; ♂ proctiger with a greatly expanded basal part (Fig. 135), paramere and apical segment of aedeagus as in Figs 136, 137; ♀ genital segment (Fig. 138) short, truncate, ventral valve of ovipositor with saw-like teeth on ventral and lateral surfaces, posterior margin of subgenital plate deeply incised ventrally.

Measurements (1 ♂, 3 ♀). Maximum width of head, ♂ 0.38, ♀ 0.35–0.40; length of antennal flagellum, ♂ 0.70, ♀ 0.70–0.76; length of ultimate rostral segment, ♂ and ♀ 0.09; length of forewing, ♂ 2.72, ♀ 2.94–3.05; length of hind tibia, ♂ 0.59, ♀ 0.59–0.60.

Larva and host plant unknown.

Holotype ♂, **Nigeria**: Ibadan, Moor pltn, 25–26.xi.1957, yellow tray (*V. F. Eastop*) (BMNH; slide mounted).

Paratypes. **Nigeria**: 1 ♀, vi.1956 (*V. F. Eastop*); 1 ♀, v.1959; 1 ♀, 2.vi.1961 (*F. A. Squire*). **Cameroun**: 1 ♀, Bamenda, 1.ii.1957, yellow tray (*V. F. Eastop*). (BMNH; slide and dry mounted.)

COMMENT. *T. anomalicornis* and the following four species described below seem to form a natural group, having a similarly derived ovipositor and a slightly thickened antennal flagellum. In other respects they resemble the *erytreae*-group. *T. anomalicornis* is easily distinguished by its antennal structure, the relatively short hindwing, the elongate hind tibia, the form of the ♂ proctiger, paramere and apical aedeagal segment, and the deeply emarginate ♀ subgenital plate. The remaining four species in the group can only be separated from one another on ♂ genital characters.

### *Trioza kakamegae* sp. n.

(Figs 139–141, 302, 303)

DESCRIPTION. Adult. Integument sparsely covered with moderately long setae. In profile, head depressed from longitudinal axis of body, in dorsal view as wide as mesoscutum; occipital margins rounded; vertex pentagonal, rounded downwards, without frontal lobes, median suture clearly defined, lateral ocelli on outer sides of raised humps; median ocellus visible from above, frons completely covered by genae in anterior view; genal cones elongate conical, broad, with broadly rounded apices; antennal flagellum 2.05–2.47 times longer than head width, each flagellomere with a pair of short setae apically apart from apical flagellomere which bears a long pointed seta and a short truncate seta, a single rhinarium present subapically on flagellomeres 2, 4, 6 and 7; clypeus with a pair of setae, ultimate rostral segment with a pair of setae. Thorax strongly arched; pronotum just visible from above, in profile strongly rounded down behind occiput and well below plane of vertex and mesopraescutum; mesopraescutum with anterior margin narrowly arcuate in dorsal view and strongly rounded down to pronotum in lateral view; forewing elongate oval, narrowing to rounded acutangular apex, 2.69–2.86 times longer than wide; *Cu* stem 2.89–3.51 times longer than *Cu*<sub>1b</sub>, *m*<sub>1</sub> cell value 1.18–1.29, *cu*<sub>1</sub> cell value 1.74–2.48; forewing 1.55–1.65 times longer than hindwing, costal margin of hindwing with 0–1 seta proximal to costal break, setae distal to costal break clearly divided into two groups; hind coxa with a well-developed meracanthus and without anterior lobe; hind tibia 1.16–1.36 times longer than head width, with a pair of small basal spines, with one outer and three inner apical spurs, latter of equal development. Abdomen with setae on tergite 3 in ♂ and 4 in ♀; basal part of ♂ proctiger (Fig. 139) weakly expanded, apical segment of aedeagus and paramere as in Figs 140, 141; ♀ genital segment short, truncate, posterior margin of subgenital plate truncate.

Measurements (6 ♂, 5 ♀). Maximum width of head, ♂ 0.34–0.42, ♀ 0.37–0.41; length of antennal flagellum, ♂ 0.83–0.99, ♀ 0.82–0.96; length of ultimate rostral segment, ♂ 0.09–0.10, ♀ 0.09–0.11; length of forewing, ♂ 2.46–2.95, ♀ 2.78–3.18; length of hind tibia, ♂ 0.46–0.53, ♀ 0.45–0.51.

Fifth instar larva (Figs 302, 303). Dorsal surface outline broadly oval, about 1.4 times longer than wide. Antenna with four flagellomeres. Cephaloprothorax separate from rest of thorax which is entire. Forewing pad about 0.75 mm long; humeral lobe extending forward in front of anterior margin of eye. Caudal plate about 0.65 times as long as wide; anus ventral and distant from posterior margin of abdomen, anus and pore ring as in Fig. 303. Truncate tubular sectasetae forming an even dense marginal fringe; postocular seta absent; sectasetae absent from dorsum.

HOST PLANT. Larvae and adults swept from *Apodytes dimidiata* (Icacinaceae).

Holotype ♂, **Kenya**: Kakamega For. sta., c. 5,000', 18–19.vii.1974, *Apodytes dimidiata* (*D. Hollis*) (BMNH; dry mounted).

Paratypes. **Kenya**: 6 ♂, 5 ♀, larvae, same data as holotype; 1 ♀, 4.viii.1980 (*Min. of Ag.*); 3 ♂, 6 ♀, Muguga, vi.1953; 1 ♂, 1 ♀, vii.1954 (*V. F. Eastop*) (BMNH; slide and dry mounted.)

### *Trioza thibae* sp. n.

(Figs 142–144)

DESCRIPTION. Adult. Very similar to *kakamegae*. Differs in the shape of the ♂ proctiger, paramere and aedeagus (Figs 142–144).

Measurements (3 ♂, 3 ♀). Maximum width of head, ♂ 0.40–0.44, ♀ 0.41–0.44; length of antennal

flagellum, ♂ 0.94–1.05, ♀ 0.93–0.98; length of ultimate rostral segment, ♂ and ♀ 0.10; length of forewing, ♂ 2.89–2.99, ♀ 3.11–3.28; length of hind tibia, ♂ 0.49–0.53, ♀ 0.50–0.52.

Fifth instar larva. Very similar to *kakamegae*. Dorsal outline about 1.3 times longer than wide, forewing pad about 0.8 mm long, caudal plate about 0.6 times as long as wide.

HOST PLANT. Larvae and adults swept from *Apodytes dimidiata* (Icacinaceae).

Holotype ♂, Kenya, S. slope of Mt Kenya, Thiba camp, c. 6,000', 9–10.vii.1974, *Apodytes dimidiata* (*D. Hollis*) (BMNH; slide mounted).

Paratypes. 2 ♂, 4 ♀, larvae, same data as holotype (BMNH; slide and dry mounted).

### *Trioza tavandula* sp. n.

(Figs 145–147)

DESCRIPTION. Adult. Very similar to *kakamegae* and *thibae*. Integument bearing much shorter hairs. Antennal flagellum 1.90–2.32 times longer than head width. Thorax less strongly arched, pronotum more clearly visible from above, anterior margin of mesopraescutum less narrowly arcuate. Forewing 2.83–3.16 times longer than wide; hind tibia 1.07–1.16 times longer than head width. ♂ proctiger, paramere and aedeagus as in Figs 145–147; ♀ subgenital plate with obtusangular posterior margin.

Measurements (6 ♂, 3 ♀). Maximum width of head, ♂ 0.38–0.40, ♀ 0.40–0.42; length of antennal flagellum, ♂ 0.76–0.88, ♀ 0.83–0.92; length of ultimate rostral segment, ♂ and ♀ 0.09–0.10; length of forewing, ♂ 2.53–2.59, ♀ 2.77–3.03; length of hind tibia, ♂ 0.43–0.44, ♀ 0.44–0.48.

Larva and host plant unknown.

Holotype ♂, Angola: Tundavala, 8–10 mls NW. Sa da Bandeira, 27–29.iii.1972, general sweeping (*D. Hollis*) (BMNH; dry mounted).

Paratypes. Angola: 4 ♂, same data as holotype; 7 ♂, 6 ♀, 5.iii.1972 (BMNH; slide and dry mounted).

### *Trioza luvandata* sp. n.

(Figs 148–150)

DESCRIPTION. Adult. Very similar to *kakamegae* and *thibae*. Differs in shape of ♂ paramere and aedeagus (Figs 148–150).

Measurements (3 ♂, 1 ♀). Maximum width of head, ♂ 0.40–0.41, ♀ 0.40; length of antennal flagellum, ♂ (incomplete), ♀ 0.85; length of ultimate rostral segment, ♂ 0.08–0.10, ♀ 0.09; length of forewing, ♂ 2.83–2.86, ♀ 2.75; length of hind tibia, ♂ 0.44–0.48, ♀ 0.44.

Larva and host plant unknown.

Holotype ♂, Angola: Tundavala, 9 mls NW. Sa da Bandeira, 5.iii.1972, swept (*D. Hollis*) (BMNH; slide mounted).

Paratypes. 2 ♂, 1 ♀, same data as holotype (BMNH; slide mounted).

### The *neoboutonia*-group

Defined by the relatively short 3rd flagellomere and the presence of only two inner apical spurs on the hind tibia. Females of this group show a tendency towards a reduction of the outer ring of wax-producing cells around the anal pore. Six species are included: *neoboutonia*, *harteni*, *chiangae*, *bamendae*, *dinaba* and *nachingweae*. Known host plants are in the Euphorbiaceae and Uapaceae.

### *Trioza neoboutonia* sp. n.

(Figs 14, 151–155, 304, 305)

DESCRIPTION. Adult. Integument sparsely covered with short setae. Head, in profile, moderately depressed from longitudinal axis of body, in dorsal view narrower than mesoscutum; occipital margin subangular dorsomedially, rounded dorsolaterally and laterally; vertex pentangular, with an irregular concavity on either side of median suture, latter more strongly developed anteriorly, frontal lobes weakly developed; median ocellus just visible from above; frons completely covered by genae in anterior view; genal cones short, conical, in lateral view their longitudinal axis slightly depressed from plane of vertex; clypeus with



one pair of setae, ultimate rostral segment with two pairs of setae; antennal flagellum 1.95–2.12 times longer than head width, 3rd flagellomere very short, ratio of length of 2nd flagellomere to 3rd 1.76–2.35, a single rhinarium is present subapically on flagellomeres 2, 4, 6 and 7, apical flagellomere bearing one long pointed seta and one short truncate seta apically. Thorax moderately arched; pronotum clearly visible from above, its anterior margin strongly rounded down behind occiput; mesopraescutum about as long as wide, its anterior margin rounded; forewing elongate oval, narrowing to a rounded obtusangular apex, 2.7–2.91 times longer than wide; radular areas narrow elongate triangular, remainder of membrane devoid of spinules apart from a short narrow band at base of claval suture; veins bearing short setae, *R* branch acutangular, *M* branching distal to *Rs*–*Cu*<sub>1a</sub> line, *Cu* stem 1.63–1.84 times longer than *Cu*<sub>1b</sub>, *m*<sub>1</sub> cell value 1.13–1.23, *cu*<sub>1</sub> cell value 1.61–1.91; forewing 1.5–1.62 times longer than hindwing, costal margin of hindwing with 2–4 straight setae proximal to costal break, setae immediately distal to costal break absent, 2–3 curved setae present immediately proximal to retinaculum; hind coxa with a well-developed meracanthus, without anterior lobe; hind tibia relatively long, 1.37–1.48 times longer than head width, with a well-developed basal spine, with one outer and two inner spurs apically. Abdomen with setae on tergite 3 in ♂ and tergite 4 in ♀; ♂ proctiger, paramere and aedeagus as in Figs 152–154; ♀ genital segment (Fig. 155) short, triangular in profile, ovipositor valves smooth, apex of proctiger upcurved, subgenital plate weakly serrate apicoventrally, anus with a single ring of wax-producing cells.

Measurements (5 ♂, 7 ♀). Maximum width of head, ♂ 0.40–0.42, ♀ 0.42–0.44; length of antennal flagellum, ♂ 0.83–0.87, ♀ 0.82–0.88; length of ultimate rostral segment, ♂ and ♀ 0.09–0.10; length of forewing, ♂ 2.53–2.75, ♀ 2.75–2.96; length of hind tibia, ♂ 0.56–0.62, ♀ 0.59–0.63.

Fifth instar larva (Figs 304, 305). Dorsal surface outline oval, about 1.5 times longer than wide. Antenna with 5–6 flagellomeres. Cephaloprothorax separate from rest of thorax which is entire. Forewing pad about 0.65 mm long, humeral lobe extending forward to just behind anterior margin of eye. Caudal plate about 0.65 times as long as wide, anus ventral and distant from posterior margin of abdomen, anal pore area as in Fig. 305. Short, truncate, tubular sectasetae forming an even, dense marginal fringe; postocular seta absent; sectasetae absent from dorsum.

**HOST PLANT.** Larvae, which form pit galls on the lower surfaces of the leaves, and adults swept from *Neoboutonia* sp. (Euphorbiaceae).

**Holotype** ♂, **Tanzania:** E. Usambara Mtns, Amani Res. sta., c. 3,000', 19–27.vi.1974, *Neoboutonia* sp. (*D. Hollis*) (BMNH; dry mounted).

**Paratypes.** **Tanzania:** 10 ♂, 8 ♀, larvae, same data as holotype; 1 ♀, yellow tray (BMNH; slide and dry mounted).

**COMMENTS.** Within this species-group *neoboutonia* displays the most derived condition of head and thorax structure, wing venation and abdominal chaetotaxy. Of the three known larvae in the group, that of *neoboutonia* is the most highly evolved and adapted to living in a pit gall.

### *Trioza harteni* sp. n.

(Figs 156–158, 306, 307)

**DESCRIPTION** (only slide-mounted material available for study). Adult. Integument sparsely covered with short setae. Head, from above, narrower than mesoscutum; frons not visible in anterior view; genae short, broadly rounded; antennal flagellum 2.07–2.72 times longer than head width, 3rd flagellomere short, ratio of length of 2nd flagellomere to 3rd 1.45–1.97, a single rhinarium present subapically on flagellomeres 2, 4, 6, and 7, apical flagellomere bearing one long pointed seta and one short truncate seta apically; clypeus with one pair of setae, ultimate rostral segment with one pair of setae. Pronotum strongly rounded down behind occiput; mesopraescutum, from above, wider than long, its anterior margin broadly arcuate; forewing elongate oval, strongly narrowing to subangular apex, 2.62–2.84 times longer than wide, radular areas narrow elongate, remainder of membrane devoid of spinules; veins bearing short setae, *R* branch acutangular, *M* branching distal to *Rs*–*Cu*<sub>1a</sub> line, *Cu* stem 1.13–1.48 times longer than *Cu*<sub>1b</sub>, *m*<sub>1</sub> cell value 1.37–1.46, *cu*<sub>1</sub> cell value 1.48–1.91; forewing 1.75–1.86 times longer than hindwing, costal margin of hindwing with up to four straight setae proximal to costal break, setae distal to costal break clearly divided into two groups; hind coxa with a well-developed meracanthus and without anterior lobe; hind tibia relatively short, 1.19–1.25 times longer than head width, with a group of small spines basally, with 0–1 outer and 1–2 (rarely 3) inner spurs apically. Abdomen with setae on tergites 3–8 in ♂ and 4–8 in ♀; ♂ proctiger with a moderately swollen basal part and a very short and narrow apical part, paramere as in Fig.

157, apical part of aedeagus simple; ♀ genital segment as in Fig. 158, ventral surface of ventral valve of ovipositor weakly serrate, outer ring of wax-producing cells around anus incomplete.

Measurements (2 ♂, 3 ♀). Maximum width of head, ♂ 0.57–0.59, ♀ 0.59–0.62; length of antennal flagellum, ♂ 1.48–1.55, ♀ 1.22–1.40; length of ultimate rostral segment, ♂ 0.10, ♀ 0.10–0.11; length of forewing, ♂ 3.99–4.07; ♀ 4.63–4.73; length of hind tibia, ♂ 0.71–0.72, ♀ 0.70–0.75.

Fifth instar larva (Figs 306, 307). Dorsal surface outline showing head, thorax and abdomen clearly defined, about 1.6 times longer than wide. Antenna with seven flagellomeres. Cephaloprothorax, mesothorax and metathorax clearly defined. Forewing pad about 1.3 mm long, humeral lobe very weakly developed and anterior margin of forewing pad reaching barely anterior to posterior margin of cephaloprothorax. Basal two-thirds of abdomen not sclerotised, caudal plate about half as long as wide. Anus ventral but close to posterior margin of abdomen, anal pore area as in Fig. 307. Marginal setae simple with sparsely scattered pointed sectasetae, anterior margin of cephaloprothorax between eyes without sectasetae but with scattered lanceolate setae, four postocular pointed sectasetae present, sectasetae absent from dorsum.

HOST PLANT. Larvae taken from large, enclosed galls on *Uapaca nitida* (Uapacaceae); adults reared from these larvae (van Harten, pers. comm.).

Holotype ♂, **Angola**: Chinaga, 19.x.1970, galls of *Uapaca nitida* (A. van Harten) (BMNH; slide mounted).

Paratypes. 1 ♂, 3 ♀, larvae, same data as holotype (BMNH; slide mounted).

COMMENT. *T. harteni* displays primitive character states for the *Cu* stem and, therefore, a low  $cu_1$  cell value, and abdominal chaetotaxy. The larva is very non-triozid in general appearance but this is almost certainly due to the fact that it develops in an enclosed gall.

### *Trioza chiangae* sp. n.

(Figs 159–161, 308)

DESCRIPTION (only slide-mounted material available for study). Adult. Very similar to *harteni* but smaller. Clypeus with a pair of short setae, ultimate rostral segment without setae. Forewing more elongate, 2.87–3.18 times longer than wide, *Cu* stem 2.11–2.52 times longer than  $Cu_{1b}$ ,  $m_1$  cell value 1.41–1.65,  $cu_1$  cell value 2.0–2.82; hind tibia relatively short, 1.07–1.21 times longer than head width. Abdomen with setae on tergites 3–5 in ♂ and ♀; ♀ paramere as in Fig. 160; ♀ genital segment (Fig. 161) with ovipositor valves smooth apically, anal pore with a double ring of wax-producing cells.

Measurements (6 ♂, 6 ♀). Maximum width of head, ♂ 0.37–0.39, ♀ 0.40–0.44; length of antennal flagellum, ♂ 0.86–0.93, ♀ 0.85–0.92; length of ultimate rostral segment, ♂ and ♀ 0.06–0.07; length of forewing, ♂ 2.41–2.56, ♀ 2.93–3.08; length of hind tibia, ♂ 0.41–0.46, ♀ 0.45–0.48.

Fifth instar larva (Fig. 308). Very similar to *harteni*. About 1.8 times longer than wide; forewing pad about 0.7 mm long; caudal plate not at all developed; anal pore area damaged in specimens available but similar in shape and structure to *harteni*. Long and short, narrow conical sectasetae with truncate apices forming a sparse marginal fringe, including anterior margin of cephaloprothorax; five postocular sectasetae present; sectasetae absent from dorsum.

HOST PLANT. Larvae and adults collected from *Uapaca nitida* (Uapacaceae); the larvae are free-living among unfolded leaves on the growing points (A. van Harten, pers. comm.).

Holotype ♂, **Angola**: Chianga, 12.ix.1973, *Uapaca nitida* (A. van Harten) (BMNH; slide mounted).

Paratypes. 5 ♂, 6 ♀, larvae, same data as holotype (BMNH; slide mounted).

COMMENT. *T. chiangae* has a relatively long *Cu* stem and, therefore, a relatively higher  $cu_1$  cell value than *harteni*, but the chaetotaxy of the abdominal tergites is intermediate between *harteni* and *neoboutonia*. The free-living larva is relatively unmodified for a triozid.

### *Trioza bamendae* sp. n.

(Figs 162–164)

DESCRIPTION. Adult. Integument very sparsely covered with short setae. Head, in profile, very slightly depressed from longitudinal axis of body, from above at least as wide as mesoscutum; occipital margin deeply notched medially; vertex in same plane as thorax, median suture shallow, with a secondary furrow on either side originating from a point just above median ocellus and extending back diagonally to occipital

margin, frontal lobes well developed, their anterior margins arcuate; median ocellus visible from above, frons not visible in anterior view; genal cones well developed, broadly conoid, in profile slightly depressed from plane of vertex; antennal flagellum 1.22–1.40 times longer than head width, ratio of length of 2nd flagellomere to 3rd 2.18–3.39, a double rhinarium present subapically on 2nd flagellomere and a single rhinarium present subapically on flagellomeres 4, 6, and 7, apical flagellomere with one long seta and a very short truncate seta apically; clypeus with a pair of setae, ultimate rostral segment with a pair of setae. Thorax flattened; pronotum mostly flat with only anterior margin sharply downcurved behind occiput; mesopraescutum, from above, longer than wide, with broadly rounded anterior margin; forewing elongate ellipsoid, strongly narrowing distally to rounded acutangular apex, 3.12–3.50 times longer than wide, membrane devoid of spinules apart from narrow radular areas; veins almost devoid of setae, *R* branch acutangular, *M* branching distal to *Rs*–*Cu*<sub>1a</sub> line, *Cu* stem 1.42–2.58 times longer than *Cu*<sub>1b</sub>, *m*<sub>1</sub> cell value 1.00–1.27, *cu*<sub>1</sub> cell value 2.03–3.22; forewing 1.73–1.93 times longer than hindwing, costal margin of hindwing with up to two setae proximal to costal break and with at most one seta distal to costal break; hind coxa with a well-developed meracanthus and without anterior lobe; hind tibia with 1–2 small conoid spines basally, and one outer and two inner apical spurs. Abdomen with setae on tergite 3 in ♂ and 4 in ♀; ♂ proctiger, paramere and aedeagus as in Figs 162–164; ♀ genital segment short, conoid, anus with a single ring of wax-producing cells, ventral valve of ovipositor with three transverse ridges on ventrolateral surface.

Measurements (6 ♂, 7 ♀). Maximum width of head, ♂ 0.30–0.34, ♀ 0.31–0.34; length of antennal flagellum, ♂ 0.39–0.44, ♀ 0.39–0.46; length of ultimate rostral segment, ♂ 0.05, ♀ 0.05–0.06; length of forewing, ♂ 1.84–2.08, ♀ 2.12–2.35; length of hind tibia, ♂ 0.45–0.50, ♀ 0.43–0.50.

Larva and host plant unknown.

Holotype ♂, **Cameroun**: Bamenda, 20–24.i.1957, yellow tray (*V. F. Eastop*) (BMNH; slide mounted).

Paratypes. **Cameroun**: 3 ♂, 7 ♀, same data as holotype; 2 ♂, 2 ♀, 25–31.i.1957; 1 ♂, 1 ♀, 1.ii.1957; 1 ♀, 6.ii.1957 (BMNH; slide and dry mounted).

COMMENT. *T. bamendae* and the following species are regarded as sister-species as both share the unique character of the double rhinarium on the 2nd flagellomere (Fig. 25).

### *Trioza dinaba* sp. n.

(Figs 16, 25, 165–168)

DESCRIPTION. Adult. Very similar to *bamendae*. Secondary diagonal furrows on vertex much less well defined, frontal lobes broad; antennal flagellum 1.22–1.59 times longer than head width, ratio of length of 2nd flagellomere to 3rd 1.61–3.5, 2nd flagellomere as in Fig. 25. Forewing 2.93–3.38 times longer than wide; *Cu* stem branching from *R*+*M*+*Cu* proximally to branch of *R* stem, 2.81–4.67 times longer than *Cu*<sub>1b</sub>, *m*<sub>1</sub> cell value 1.06–1.29, *cu*<sub>1</sub> cell value 2.31–4.0. ♂ proctiger, paramere and aedeagus as in Figs 166–168; anus of ♀ with an incomplete double ring of wax-producing cells.

Measurements (10 ♂, 10 ♀). Maximum width of head, ♂ 0.32–0.34, ♀ 0.32–0.36; length of antennal flagellum, ♂ 0.46–0.51, ♀ 0.43–0.50; length of ultimate rostral segment, ♂ and ♀ 0.06–0.07; length of forewing, ♂ 2.08–2.32, ♀ 2.30–2.70; length of hind tibia, ♂ 0.45–0.50, ♀ 0.44–0.51.

Larva and host plant unknown.

Holotype ♂, **Nigeria**: Ibadan, Moor plntn, 11.viii.1956, yellow tray (*V. F. Eastop*) (BMNH; slide mounted).

Paratypes. **Nigeria**: 9 ♂, 11 ♀, same data as holotype; 1 ♂, vi.1956; 1 ♂, Umuahia, Umudike, 28.viii.1958. **Ghana**: 2 ♂, 2 ♀, Tafo, 15.v.1956, yellow tray (*V. F. Eastop*). **Zaire** ['Congo Belge']: 1 ♀, P.N.G., Miss. de Saeger, II/fd/5, 10.ix.1951; 1 ♂ II/fd/17, 9.vii.1952 (*H. de Saeger*). (BMNH; MRAC; slide and dry mounted.)

Non-paratypic material. **Uganda**: 1 ♀, Jinja, xii.1954–ii.1955, U.V. lamp (*P. S. Corbett*) (BMNH); slide mounted. This specimen differs from the type-series in having a triple rhinarium present apically on the 2nd flagellomere.

### *Trioza nachingweae* sp. n.

(Figs 169–172)

DESCRIPTION (only slide-mounted material available for study). Adult. Very similar in general appearance to *fuscivena* (p. 61) but smaller. Antennal flagellum shorter, 1.03–1.40 times longer than head width, ratio

of length of 2nd flagellomere to 3rd 1.82–2.67; ultimate rostral segment relatively longer. Forewing (Fig. 169) 2.74–3.12 times longer than wide, veins sparsely clothed with very short setae, *Cu* stem 1.59–2.65 times longer than *Cu*<sub>1b</sub>, *m*<sub>1</sub> cell value 1.10–1.28, *cu*<sub>1</sub> cell value 1.59–2.50; forewing 1.54–1.58 times longer than hindwing; hind tibia with one outer and two inner apical spurs, of which the second inner spur is weak and difficult to see. ♂ proctiger narrow, tubular, paramere and aedeagus as in Figs 170, 171; ♀ genital segment (Fig. 172) elongate triangular in profile, anus with a single ring of wax-producing cells, subgenital plate with acutangular posterior margin.

Measurements (6 ♂, 3 ♀). Maximum width of head, ♂ 0.34–0.36, ♀ 0.37–0.40; length of antennal flagellum, ♂ 0.42–0.49, ♀ 0.38; length of ultimate rostral segment, ♂ 0.08–0.09, ♀ 0.09–0.10; length of forewing, ♂ 1.78–1.92, ♀ 2.18–2.30; length of hind tibia, ♂ 0.47–0.50, ♀ 0.51–0.53.

Larva and host plant unknown.

Holotype ♂, **Tanzania**: Nachingwea, xi.1953–iii.1954, trapped (*V. F. Eastop*) (BMNH; slide mounted).

Paratypes. **Tanzania**: 6 ♂, 3 ♀, same data as holotype; 1 ♂, 1 ♀, x.1953–ii.1954. (BMNH; slide mounted.)

COMMENTS. *T. nachingweae* is distinguished from other members of the *neuboutonia*-group by the presence of brown pigmentation along the course of *R* and *R*<sub>1</sub> and at the bases of *M* and *Cu* on the forewing. This feature has apparently arisen independently in many groups of triozids.

### The *hargreavesi*-group

Defined by the extraordinary development of supplementary antennal rhinaria which have associated bulbous or mushroom-shaped sensilla (Figs 22, 23). Two species, *hargreavesi* and *mirificornis*, are included. Larvae and host plants are not known but original collection data suggest that the larvae of both species form pit galls on a forest climbing plant.

### *Trioza hargreavesi* sp. n.

(Figs 22, 173–175)

DESCRIPTION. Adult. Integument densely covered with short setae. Head, in profile, almost at 90° to longitudinal axis of body, in dorsal view slightly narrower than mesoscutum; occipital margin sharp dorsomedially; vertex pentagonal, rounded downwards, with a deep irregular concavity on either side of median suture which is deep and well defined, frontal lobes not developed; median ocellus visible from above, frons just visible between genae in anterior view; genal cones small, rounded; antennal flagellum approximately 1.8 times longer than head width (no complete antennae in type-series), with a single rhinarium subapically on flagellomeres 2, 4, 6 and 7, 1st flagellomere with 30–35 rhinaria along its length (Fig. 22), each bearing a small mushroom-shaped sensillum; clypeus with a pair of setae, ultimate rostral segment with at least four pairs of setae. Thorax, in profile, strongly arched; pronotum, from above, hardly visible, in profile strongly rounded down behind occiput; mesopraescutum, from above, longer than wide, its anterior margin strongly arcuate and, in profile, strongly angled down to pronotum; forewing elongate oval, narrowing to rounded obtusangular apex, 2.36–2.45 times longer than wide, radular areas narrow and elongate, remainder of membrane devoid of spinules; veins bearing short setae, *R* branch acutangular, *M* branching distal to *Rs*–*Cu*<sub>1a</sub> line, *Cu* stem 1.24–1.72 times longer than *Cu*<sub>1b</sub>, *m*<sub>1</sub> cell value 1.32–1.6, *cu*<sub>1</sub> cell value 1.78–1.98; forewing 1.66–1.77 times longer than hindwing, costal margin of hindwing with 0–2 setae proximal to costal break, setae distal to costal break clearly divided into two groups; hind coxa with a well-developed meracanthus and without anterior lobe; hind tibia with 2–4 small spines basally and with one outer and two inner apical spurs. Abdomen with setae on tergite 3 or 3 and 4 in ♂, and on 4 or 4 and 5 in ♀; ♂ proctiger with weak lateral expansions, paramere and aedeagus as in Figs 174, 175; ♀ genital segment short, conical, ventral valves of ovipositor regularly saw-toothed on ventral and lateral surfaces in apical half, subgenital plate short and with truncate posterior margin.

Measurements (5 ♂, 5 ♀). Maximum width of head, ♂ 0.65–0.74, ♀ 0.69–0.76; length of antennal flagellum, ♀ 1.25 (approx.); length of ultimate rostral segment, ♂ and ♀ 0.13–0.16; length of forewing, ♂ 4.45–5.02, ♀ 5.02–5.42; length of hind tibia, ♂ 0.72–0.81, ♀ 0.81–0.84.

Larva and host plant unknown. (A label in the original tube containing the type-series from Uganda stated 'nymphs in pits in leaf of forest climber' but no larvae were present.)

Holotype ♂, **Uganda**: F. Kawanda, 14.ii.1940, nymphs in pits in leaf of forest climber (*H. Hargreaves*) (BMNH; slide mounted).

Paratypes. **Uganda**: 8 ♂, 6 ♀, same data as holotype. **Nigeria**: 1 ♀, NE. State, Ngel Nyaki, 31.iii.1970, 5,000'; 1 ♀, K[wara] State, 20 mls W. Lokaja, 21.iii.1970; 1 ♀, SE. State, Obudu CR, 21.iii.1971 (*J. T. Medler*). (BMNH; slide and dry mounted, and stored in 80% ethanol.)

COMMENTS. *T. hargreavesi* and *mirificornis* are grouped together as sister-species because they both share the extraordinary development of multiple supplementary rhinaria on the antennal flagellum. At present I can find no further derived characters relating this group with other species in the genus.

### *Trioza mirificornis* sp. n.

(Figs 23, 176, 177)

DESCRIPTION. Adult. Very similar to *hargreavesi* but smaller. Flagellomeres 1–7 bearing many rhinaria, each rhinarium bearing a bulbous sensillum (Fig. 23), 1st flagellomere with about 60 rhinaria, 2nd with 18–25, 3rd with 7–15, 4th with 5–20, 5th with about 11, 6th with about seven, and 7th with one, apical flagellomere with a long pointed seta and a short truncate seta apically; ultimate rostral segment with a pair of setae. Pronotum more clearly visible from above, anterior margin of mesopraescutum less strongly arcuate and less pushed forward, rounded down to pronotum; forewing narrower, 2.51–2.7 times longer than wide, *Cu* stem 1.70–2.32 times longer than *Cu*<sub>1b</sub>, *m*<sub>1</sub> cell value 1.13–1.29, *cu*<sub>1</sub> cell value 1.75–2.36; forewing 1.56–1.64 times longer than hindwing. ♂ paramere and aedeagus as in Figs 176, 177; ♀ subgenital plate with acutangular posterior margin, ventral valves of ovipositor smooth.

Measurements (7 ♂, 4 ♀). Maximum width of head, ♂ 0.47–0.55, ♀ 0.51–0.60; length of antennal flagellum, ♂ 0.84 (only one complete specimen); length of ultimate rostral segment, ♂ and ♀ 0.08–0.10; length of forewing, ♂ 3.21–3.83, ♀ 4.17–4.53; length of hind tibia, ♂ 0.54–0.65, ♀ 0.66–0.67.

Larva and host plant unknown. (The Uganda type-material of this species was found in the BMNH bearing similar data relating to larvae as the previous species.)

Holotype ♂, **Uganda**: F. Kawanda, 24.x.1939, nymphs in pits in leaf of forest climber (*H. Hargreaves*) (BMNH; slide mounted).

Paratypes. **Uganda**: 16 ♂, 25 ♀, same data as holotype. **Cameroun**: 1 ♀, Bamenda, 6.ii.1957, yellow tray (*V. F. Eastop*). (BMNH; slide mounted and stored in 80% ethanol.)

### The *obsoleta*-group

A poorly defined group in which the species usually have greatly reduced hindwings, well-developed anterior lobes on the hind coxae and two inner apical spurs on the hind tibia. Five Afrotropical species are included: *afrobsoleta*, *gonjae*, *boxi*, *afrosersalisia* and *mimusops*, the latter two only tentatively. All five species have host plants in the Sapotinae (Ebenaceae and Sapotaceae). Another Afrotropical member of this group is represented in BMNH by five specimens, which are too badly damaged for description, standing under a Heslop-Harrison manuscript name.

A North American species, *T. diospyri* (Ashmead, 1881), is also known to develop on *Diospyros*. Although this species shows a general resemblance to those of the *obsoleta*-group and in particular to *gonjae* and *boxi*, its hindwings are more normally developed. It may represent the sister-species of the Old World group.

*Trioza obsoleta* (Buckton, 1900), described from India, and *Megatrioza swezeyi* Crawford, 1927, described from Samoa, clearly belong to this group; the South East Asian species *Trioza asiatica* Crawford, 1915 and *Megatrioza magnicauda* Crawford, 1919 probably belong here, but I have no material for examination. *Trioza diptera* Crawford, 1919, from Singapore, also has completely reduced hindwings but, from its description, this species appears to be more closely related to *Leptynoptera sulfurea* Crawford and both develop on *Calophyllum inophyllum* (Guttiferae).

Earlier authors almost certainly would have placed all these species in *Megatrioza* but as I have not examined the type-species, *M. armata* Crawford, I am not sure of the status of the genus.

*Triozia afroboleta* sp. n.

(Figs 13, 178–182)

'Psyllidengalle'; *Diospyros mespiliformis*; Rübssaamen, 1899: 271 (Eritrea [series not traced].)

**DESCRIPTION.** Adult. Integument shiny, sparsely covered with short setae. Head, in profile, strongly depressed from longitudinal axis of body, in dorsal view as wide as mesoscutum; occipital margin sharp; vertex pentagonal, rounded downwards, lateral concavities displaced posteriorly to occipital margin and greatly reduced, median suture weak; median ocellus hardly visible in dorsal view, frons small but visible between bases of genal cones in anterior view; genal cones in parallel plane to vertex, short, broadly rounded apically; antennal flagellum 1.66–1.94 times longer than head width in ♂ and 1.44–1.77 times longer in ♀, a single rhinarium present subapically on flagellomeres 2, 4, 6 and 7, apical flagellomere with two long setae apically; clypeus with a pair of setae, ultimate rostral segment with a pair of setae. Thorax, in profile, moderately arched; pronotum hardly visible from above, strongly downcurved behind occiput; mesopraescutum, in profile, strongly rounded down to pronotum, in dorsal view with arcuate anterior margin; forewing elongate oval, narrowing to a rounded obtusangular apex, 2.46–2.87 times longer than wide, radular areas very narrow and attenuate, remainder of membrane devoid of spinules, veins bearing short setae, *R* branch obtusangular, *M* branching at or slightly distal to *Rs*–*Cu*<sub>1a</sub> line, *Cu* stem 2.0–2.7 times longer than *Cu*<sub>1b</sub>, *m*<sub>1</sub> cell value 1.97–2.41, *cu*<sub>1</sub> cell value 1.42–2.05, claval suture reaching hind margin of wing very close to wing base; hindwing (Fig. 179) greatly reduced, scale-like, costal margin bearing one seta proximal to costal break, setae distal to costal break clearly divided into two groups; hind coxa with a well-developed meracanthus and a moderately long anterior lobe; hind tibia with a group of 3–4 small pointed tubercles basally, with one outer and two inner apical spurs. Abdomen with setae on tergites 3–7 in ♂ and 4–8 in ♀; ♂ proctiger, paramere and aedeagus as in Figs 180–182; ♀ genital segment short, conical, ovipositor valves smooth.

Measurements (16 ♂, 10 ♀). Maximum width of head, ♂ 0.42–0.56, ♀ 0.48–0.54; length of antennal flagellum, ♂ 0.74–0.93, ♀ 0.75–0.88; length of ultimate rostral segment, ♂ and ♀ 0.09–0.15; length of forewing, ♂ 2.75–3.79, ♀ 3.01–3.93; length of hind tibia, ♂ 0.59–0.78, ♀ 0.65–0.79.

Fifth instar larva. Dorsal surface outline almost circular, about 1.1 times longer than wide. Antenna with six flagellomeres. Cephaloprothorax incompletely separated from rest of thorax which is entire. Forewing pad about 0.9 mm long, humeral lobe extending well forward of anterior margin of eye, hindwing pad greatly reduced and without sectasetae on lateral margin. Caudal plate about twice as wide as long, anus ventral and distant from posterior margin of abdomen. Truncate tubular sectasetae forming an even, dense marginal fringe, marginal sectasetae on cephaloprothorax longer than those on forewing pad and abdomen, postocular seta absent, sectasetae absent from dorsum.

**HOST PLANT.** Larvae, which form pit galls on the lower leaf surface, and adults collected from *Diospyros mespiliformis* (Ebenaceae).

**Holotype** ♂, **Angola:** Roçadas, R. Cunene, 19–22.ii.1972, *Diospyros mespiliformis* (*D. Hollis*) (BMNH; dry mounted).

**Paratypes.** **Angola:** 11 ♂, 18 ♀, same data as holotype; 17 ♂, 12 ♀, 3 mls N. Santa Clara, 30.iii.–1.iv.1972; 1 ♀, Bruco, 26–29.ii.1972, swept in riverine forest area (*D. Hollis*). **Tanzania:** 9 ♂, 5 ♀, Nachingwea, x.1953–iii.1954, trapped (*V. F. Eastop*). **Sudan:** larvae, SW. side Jebel Marra, Wadi Golol, 1.v.1981, *Diospyros mespiliformis*; 1 ♂, swept, 28.iv.1981 (*J. H. Martin*). **Nigeria:** 1 ♂, Bunga, 20.x.1956, *Salix ledermanni* (*V. F. Eastop*); 2 ♂, Ibadan, 4.vi.1961, yellow tray; 1 ♂, 2 ♀, 5–19.iv.1963; 1 ♂, 2.v.1963; 5 ♂, 8 ♀, 3–9.iv.1964 (*F. A. Squire*); 1 ♀, B.P. State, Gindiri, 28.x.1968 (*J. T. Medler*); 1 ♂, Zaria, Samaru, 24.xi.1970 (*J. C. Deeming*); 1 ♀, Lagos, Ikoyi, 7.iii.1975, at light (*M. A. Cornes*). **Ghana:** 1 ♀, Tafo, 29.v.1957 (*V. F. Eastop*). **Ivory Coast:** 2 ♂, 1 ♀, 10.iv.1969 (*A. Pollet*). (BMNH; MNHN; slide and dry mounted and stored in 80% ethanol.)

**COMMENTS.** This species is very closely related to *T. obsoleta* (Buckton, 1900) which is known from India and Ceylon on *Diospyros melanoxylon* and *D. tomentosa*. The Indian species differs in having a longer and slightly sinuous *Rs*, and the paramere has two sclerotised teeth apically instead of the transverse ridge as found in the Africa species. This latter point of difference, although slight, appears very consistent in all specimens examined. *T. afroboleta* shows considerable variation in the length of the ultimate rostral segment through its geographical range, that of specimens from Angola and Tanzania being relatively longer than in specimens from Sudan and West Africa.

*Trioza gonjae* sp. n.

(Figs 38, 47, 183–187, 309, 310)

**DESCRIPTION.** Adult. Integument sparsely covered with long setae (Fig. 38). Longitudinal axis of head and body in one plane; head, from above, almost as wide as mesoscutum; occipital margin sharp; vertex pentagonal, with an irregular concavity on either side of a well-defined median suture; median ocellus visible from above, frons not visible between genae; genal cones well developed, elongate conical with rounded apices, densely setose, in profile their longitudinal axis is slightly inclined upwards from that of vertex, in dorsal view cones slightly convergent apically; antennal flagellum 1.87–2.00 times longer than head width in ♂ and 1.68–1.78 times longer in ♀, a single rhinarium present subapically on flagellomeres 2, 4, 6, and 7, apical flagellomere with a long pointed seta and a short truncate seta apically; clypeus prominent, with a pair of setae, ultimate rostral segment with two pairs of setae. Thorax, in profile, weakly arched; pronotum narrow and inclined vertically down behind occiput, just visible in dorsal view; mesopraescutum, from above, longer than wide and with a subangular anterior margin, in profile anterior margin angularly bent down to pronotum; forewing elongate oval, strongly narrowing to acutangular apex, 2.98–3.29 times longer than wide, radular areas narrow, remainder of membrane devoid of spinules; veins bearing a few long setae in proximal third of wing, *R* branch a right-angle, *M* branching proximal to *Rs*–*Cu*<sub>1a</sub> line, *Cu* stem 2.36–3.21 times longer than *Cu*<sub>1b</sub>, *m*<sub>1</sub> cell value 1.91–2.08, *cu*<sub>1</sub> cell value 1.96–2.63; hindwing greatly reduced and scale-like (Fig. 184); hind coxa (Fig. 47) with a well-developed meracanthus and a well-developed anterior lobe; hind tibia with a group of small pointed tubercles basally and one outer and two or three inner spurs apically. Abdomen with setae on tergites 3–7 in ♂ and 4 and 6–8 in ♀; ♂ proctiger, paramere and aedeagus as in Figs 185–187; ♀ genital segment conical, dorsal surface of dorsal valve of ovipositor finely serrate apically.

Measurements (5 ♂, 4 ♀). Maximum width of head, ♂ 0.46–0.48, ♀ 0.47–0.51; length of antennal flagellum, ♂ 0.88–0.94, ♀ 0.81–0.91; length of ultimate rostral segment, ♂ 0.12–0.13, ♀ 0.12–0.15; length of forewing, ♂ 3.73–3.89, ♀ 4.01–4.37; length of hind tibia, ♂ 0.70–0.77, ♀ 0.71–0.78.

Fifth instar larva (Figs 309, 310). Dorsal surface outline elongate oval with clear indentations at anterior margin of eye and at base of abdomen, about 1.7 times longer than wide. Antenna 3-segmented (flagellum not divided). Cephaloprothorax separate from rest of thorax which is entire but does show partial separation of prothoracic sclerite (Fig. 309). Forewing pad about 0.9 mm long, humeral lobe extending almost to anterior margin of eye. Caudal plate about 0.75 times as long as wide, anus ventral and close to posterior margin of abdomen, anal pore area as in Fig. 310. Truncate tubular sectasetae of varying lengths forming a dense marginal fringe, a pointed postocular sectaseta or lanceolate seta present, dorsum bearing a sparse covering of tubular sectasetae.

**HOST PLANT.** Larvae and adults swept from *Diospyros squarrosus* (Ebenaceae); no galling of the host plant was observed and the larvae are apparently free-living.

Holotype ♂, **Tanzania:** S. Pare Mtns, hillside above Gonja, c. 3,000', 12–16.vi.1974, *Diospyros squarrosus* (*D. Hollis*) (BMNH; dry mounted).

Paratypes. **Tanzania:** 11 ♂, 10 ♀, larvae, same data as holotype; 1 ♀, Arusha NP, Ngurdoto Crater rim, c. 5,000', 8.vi.1974 (*D. Hollis*). (BMNH; slide and dry mounted.)

*Trioza boxi* sp. n.

(Figs 188, 189, 311, 312)

**DESCRIPTION.** Adult. Similar to *gonjae*. Differs in that vertex has a longitudinal concavity on either side of median suture; genal cones subconical with broadly rounded apices which are not convergent; ultimate rostral segment shorter and with only one pair of setae. Forewing 2.95–2.99 times longer than wide; proximal part of *c*+*sc* and *cu*<sub>2</sub> cells with brown pigmentation and membrane with a few scattered spinules in this area; *Cu* stem 2.45–2.52 times longer than *Cu*<sub>1b</sub>, *m*<sub>1</sub> cell value 1.72–1.74, *cu*<sub>1</sub> cell value 2.9–3.0; hindwing (Fig. 189) greatly reduced and scale-like. ♂ proctiger less extended laterally; dorsal surface of dorsal valve of ovipositor smooth.

Measurements (1 ♂, 1 ♀). Maximum width of head, ♂ and ♀ 0.58; length of antennal flagellum, ♀ 1.03; length of ultimate rostral segment, ♂ and ♀ 0.1; length of forewing, ♂ 5.29, ♀ 5.35; length of hind tibia, ♂ 0.88, ♀ 0.85.

Fifth instar larva (Figs 311, 312). Very similar to *gonjae*. Dorsal surface outline less elongate, about 1.5 times longer than wide. Forewing pad about 1.5 mm long, humeral lobe extending forward just in front of anterior margin of eye. Caudal plate about 0.7 times as long as wide, anal pore area as in Fig. 312. Truncate

tubular sectasetae forming an even, dense marginal fringe, lanceolate postocular seta present, dorsal surface devoid of sectasetae.

**HOST PLANT.** Adults and larvae, collected on separate occasions, from *Diospyros canaliculata* [= *xanthochlamys*] (Ebenaceae).

**Holotype** ♂, **Ghana:** 'Gold Coast, Bunsu, 7.vii.1943, *Diospyros xanthochlamys*' (H. E. Box) (BMNH; slide mounted).

**Paratypes.** **Ghana:** 2 ♀, same data as holotype; larvae, 15.i.1943. (BMNH; slide and dry mounted.)

### *Trioza afrosersalisia* sp. n.

(Figs 190–193, 313, 314)

**DESCRIPTION.** Adult. Integument sparsely covered with long setae. Head, in profile, slightly depressed from longitudinal axis of body, from above slightly narrower than mesoscutum; occipital margin sharp; vertex oval, evenly and smoothly concave and surrounded by a sharp, finely serrate ridge, integument within this depression shiny and devoid of setae, median suture just indicated; median ocellus just visible from above, frons completely covered by genae; genal cones moderately developed, conical, extending forward in parallel plane to vertex; antennal flagellum 1.75–2.00 times longer than head width, a single rhinarium present subapically on flagellomeres 2, 4, 6, and 7, apical flagellomere with one short truncate seta and one very short truncate seta apically; clypeus with a pair of setae, ultimate rostral segment with two pairs of setae. Thorax, in profile, weakly arched; pronotum hardly visible from above, in profile strongly rounded down behind occiput; mesopraescutum, in dorsal view, as long as wide and with a narrowly arcuate anterior margin, in profile strongly angled down to pronotum; forewing elongate oval, strongly narrowing to angular apex, 2.72–2.93 times longer than wide, radular areas very narrow, remainder of membrane devoid of spinules; veins bearing long setae in proximal half of wing, *R* branch acutangular, *M* branching at *Rs*–*Cu*<sub>1a</sub> line, *Cu* stem 3.29–4.38 times longer than *Cu*<sub>1b</sub>, *m*<sub>1</sub> cell value 1.77–2.07, *cu*<sub>1</sub> cell value 2.47–3.38; forewing 2.14–2.32 times longer than hindwing, costal margin of hindwing with 4–5 setae proximal to costal break, setae distal to costal break clearly divided into two groups; hind coxa with a well-developed meracanthus and an incipient anterior lobe; hind tibia without or with a very small basal spine, with one outer and two inner apical spurs. Abdominal tergites without setae; ♂ proctiger, paramere and aedeagus as in Figs 191–193; ♀ genital segment short, conical, ovipositor valves smooth.

Measurements (7 ♂, 4 ♀). Maximum width of head, ♂ 0.48–0.52, ♀ 0.49–0.54; length of antennal flagellum, ♂ 0.93–1.04, ♀ 0.86–1.01; length of ultimate rostral segment, ♂ 0.08–0.10, ♀ 0.10; length of forewing, ♂ 3.40–3.71, ♀ 3.61–4.13; length of hind tibia, ♂ 0.70–0.73, ♀ 0.66–0.73.

Fifth instar larvae (Figs 313, 314). Dorsal surface outline oval, about 1.4 times longer than wide. Antenna with five flagellomeres. Cephaloprothorax separate from rest of thorax which is entire. Forewing pad about 1.0 mm long, humeral lobe extending well forward of anterior margin of eye. Caudal plate about 0.6 times as long as wide, anus ventral and distant from posterior margin of abdomen, anal pore area as in Fig. 314. Truncate tubular sectasetae forming an even, dense marginal fringe, postocular seta absent, sectasetae absent from dorsum.

**HOST PLANT.** Larvae and adults collected from *Afrosersalisia* sp. (Sapotaceae); galling of the host plant was not noticed at the time the series, including the holotype, was collected.

**Holotype** ♂, **Tanzania:** E. Usambara Mtns, Amani Res. sta., c. 3,000', 19–27.vi.1974, *Afrosersalisia* sp. (*D. Hollis*) (BMNH; dry mounted).

**Paratypes.** **Tanzania:** 20 ♂, 11 ♀, larvae, same data as holotype. **South Africa:** 1 ♀, C.P., Mossel Bay, ix.1921; 1 ♂, 3 ♀, vi.–vii.1930 (*R. E. Turner*). (BMNH; slide and dry mounted.)

**COMMENTS.** *T. afrosersalisia* may be readily distinguished from other Afrotropical *Trioza* species by the peculiar form of the vertex. The species is tentatively placed in the *obsoleta*-group because of its reduced hindwings and the presence of an incipient anterior lobe on the hind coxa. Furthermore the host plant is related to *Diospyros*.

### *Trioza mimusops* sp. n.

(Figs 194–197, 315, 316)

**DESCRIPTION.** Adult. Integument sparsely covered with long setae. Head, in profile, moderately depressed



from longitudinal axis of body, from above narrower than mesoscutum; occipital margin sharp; vertex rounded rectangular, with a concavity on either side of median suture which is clearly defined, frontal lobes not developed but a low transverse ridge is present; median ocellus clearly visible from above, frons completely covered by genae in anterior view; genal cones well developed, rounded conical, in profile in parallel plane to vertex; antennal flagellum 1.54–1.83 times longer than head width, a single rhinarium present subapically on flagellomeres 2, 4, 6 and 7, apical flagellomere with one short and one very short seta apically, both of which are truncate; clypeus with a pair of setae, ultimate rostral segment with two pairs of setae. Thorax, in profile, moderately arched; pronotum clearly visible from above, only its anterior margin downcurved behind occiput; mesopraescutum, from above, wider than long, its anterior margin arcuate, in profile gently rounded down to pronotum; forewing elongate oval, narrowing to an acutangular apex, 2.52–2.92 times longer than wide, radular areas narrow, remainder of membrane devoid of spinules, course of *R* and *R*<sub>1</sub> marked with brown pigment; veins bearing long setae in proximal third of wing, *R* branch acutangular, *M* branching distal to or, at most, at *Rs*–*Cu*<sub>1a</sub> line, *Cu* stem 2.60–4.57 times longer than *Cu*<sub>1b</sub>, *m*<sub>1</sub> cell value 1.82–2.20, *cu*<sub>1</sub> cell value 2.00–2.93; forewing 1.99–2.17 times longer than hindwing, costal margin of hindwing with 2–6 setae proximal to costal break, no setae immediately distal to costal break and two curved setae adjacent to retinaculum; hind coxa with a well-developed meracanthus and an incipient anterior lobe; base of hind tibia swollen dorsally and bearing several small, blunt tubercles, with one outer and two inner spurs apically. Abdomen with setae on tergites 6 and 7 in ♂ and 6–8 in ♀; ♂ proctiger, paramere and aedeagus as in Figs 195–197; ♀ genital segment short, conical, dorsal surface of dorsal valve of ovipositor weakly serrate apically, ventral surface of ventral valve smooth.

Measurements (6 ♂, 6 ♀). Maximum width of head, ♂ 0.54–0.59, ♀ 0.57–0.61; length of antennal flagellum, ♂ 0.90–1.06, ♀ 0.88–1.00; length of ultimate rostral segment, ♂ and ♀ 0.09–0.10; length of forewing, ♂ 3.59–4.08, ♀ 3.93–4.53; length of hind tibia, ♂ 0.61–0.79, ♀ 0.65–0.75.

Fifth instar larva (Figs 315, 316). Dorsal surface outline very broadly oval, about 1.3 times longer than wide. Antenna with five flagellomeres. Cephaloprothorax separate from rest of thorax which is entire. Forewing pad about 0.62 mm long, humeral lobe strongly extended forward to anterior margin of cephaloprothorax. Caudal plate about 0.65 times as long as wide, anus ventral and distant from posterior margin of abdomen, anal pore area as in Fig. 316. Narrow, tubular, truncate sectasetae forming a moderately dense fringe on anterior margin of cephaloprothorax and caudal plate and a sparse fringe on the wing pads, postocular seta absent, sectasetae absent from dorsum.

**HOST PLANTS.** Adults and larvae collected from *Mimusops obovata* and *M. zeyheri*, adults only collected from *M. caffra* (Sapotaceae).

**Holotype** ♂, **South Africa:** Transvaal, Hartebeestpoort Dam, Bet El Park, 17.viii.1974, *Mimusops zeyheri* (*B. R. Pitkin*) (BMNH; dry mounted).

**Paratypes.** **South Africa:** 14 ♂, 12 ♀, same data as holotype; 7 ♂, 6 ♀, larvae, Natal, Durban Botanical Gardens, 23.viii.1974, *Mimusops obovata* (*B. R. Pitkin*); 1 ♀, Port St John, Pondoland, 1–11.vi.1923 (*R. E. Turner*); 5 ♂, 9 ♀, Transvaal, Rustenburg, 20.ii.1965, *Mimusops zeyheri*; 5 ♂, 8 ♀, larvae, 27–30.x.1966; 5 ♂, 5 ♀, larvae, 11–15.ix.1971; 1 ♀, 11–15.ix.1971, *Fagara capensis*; 15 ♂, 11 ♀, Pretoria, Hartebeestpoort, 20.v.1965, *Mimusops zeyheri*; 3 ♂, 3 ♀, 6.viii.1965; 2 ♂, 2 ♀, Natal, Umtentweni, 29.ix.1965, *Mimusops caffra*; 1 ♀, Umkomaas, 29.ix.–3.x.1965, *Bersama lucens* (*A. L. Capener*). (BMNH; NCI; slide and dry mounted and stored in 80% ethanol.)

**COMMENT.** This distinctive species is easily recognised by the shape, venation and pigmentation of the forewing (Fig. 194), and the unusual chaetotaxy of the abdominal tergites. It is tentatively placed in the *obsoleta*-group because the hindwing is only half the length of the forewing, the hind coxa has an incipient anterior lobe and the hind tibia has two inner apical spurs, and because of its host plant association.

### The cockerelli-group

For a discussion of this group see p. 56.

### *Trioza capensis* sp. n.

(Figs 27, 53, 225–228)

**DESCRIPTION.** Adult. Integument sparsely covered with short setae. Head, in profile, strongly depressed from longitudinal axis of body, from above narrower than mesoscutum; occipital margin sharp; vertex

trapezoidal, gently rounded down anteriorly, without frontal lobes or ridge, with a crescent-shaped depression on either side of the shallow median suture; median ocellus visible from above, frons visible in anterior view; genae slightly swollen ventrally; antennal flagellum 1.36–1.49 times longer than head width, a single rhinarium present subapically on flagellomeres 2, 4, 6 and 7, that of 2 with a large curved sense cone (Fig. 27), apical flagellomere with a moderately long and a short truncate seta apically; clypeus with a pair of setae, ultimate rostral segment with two pairs of setae. Thorax moderately arched; pronotum clearly visible from above; mesopraescutum, from above, much wider than long, anterior margin broadly arcuate, in profile shallowly rounded down to pronotum; forewing elongate oval, strongly narrowing to rounded rectangular apex, 2.44–2.57 times longer than wide, radular areas narrow elongate, remainder of membrane devoid of spinules; veins bearing very short setae, *R* branch acutangular, *M* branching distal to *Rs*-*Cu*<sub>1a</sub> line, *Cu* stem 3.54–4.71 times longer than *Cu*<sub>1b</sub>, *m*<sub>1</sub> cell value 1.20–1.33, *cu*<sub>1</sub> cell value 1.71–2.22; forewing 1.44–1.51 times longer than hindwing, costal margin of hindwing with 3–4 setae proximal to costal break, setae distal to costal break clearly divided into two groups; hind coxa with a well-developed meracanthus and a very small anterior lobe; hind tibia with a well-developed basal spine, a very well-developed preapical outer spur and two inner apical spurs (Fig. 53). Abdomen with setae on tergite 3 in ♂ and 3 and 4 in ♀; ♂ proctiger, paramere and aedeagus as in Figs 226–228; ♀ genital segment very short, rounded conical, ovipositor valves smooth.

Measurements (2 ♂, 3 ♀). Maximum width of head, ♂ 0.53–0.54, ♀ 0.50–0.52; length of antennal flagellum, ♂ 0.79, ♀ 0.68–0.77; length of ultimate rostral segment, ♂ and ♀ 0.09–0.10; length of forewing, ♂ 2.31–2.38, ♀ 2.54–2.72; length of hind tibia, ♂ 0.38, ♀ 0.38–0.40.

Larva unknown.

HOST PLANTS. Adults collected from *Lycium salinicola* and *Lycium ? tetrandrum* (Solanaceae).

Holotype ♂, **South Africa**: Cape Province, Aliwal North, xii.1922 (*R. E. Turner*) (BMNH; slide mounted).

Paratypes. **South Africa**: 1 ♀, same data as holotype; 1 ♀, 25 mls SSE. Merweville, 2.v.1972, *Lycium ? tetrandrum* (*D. Hollis*); 1 ♀, Nuwerus, 10.xi.1971 (*J. G. Theron*); 1 ♂, 1 ♀, OFS, Philippolis, Vaalbank, 19–30.xi.1969, *Lycium salinicolum* (*A. L. Capener*). (BMNH; NCI; slide and dry mounted.)

COMMENTS. *T. capensis* apparently belongs to the same species-group as the New World *Paratrioza cockerelli* (Sulc, 1909) and the Palearctic species of *Paratrioza*, which all develop on solanaceous hosts. The paramere is very similar to *lycii* Loginova, 1970, described from Georgia and Tadzhikistan, but *capensis* may be distinguished by the structure of the rhinarium on the 2nd flagellomere, the development and displacement of the outer apical spur on the hind tibia and the form of the apical segment of the aedeagus. Furthermore *capensis* completely lacks genal cones and has a more primitive form of thorax, the *Paratrioza* species having the mesopraescutum more produced anteriorly.

Previous authors would have placed this species in *Paratrioza* but I am not sure of the validity of the genus and prefer to place *capensis* under *Trioza*.

### The *etiennei*-group

A distinctive group of small species defined by the absence of genal cones, bifid sensilla associated with the antennal rhinaria, forewing with a broadly rounded apex, reduced meracanthi and a 3-segmented (at least partially) aedeagus. Six species are included: *etiennei*, *messarati-na*, *seranistama*, *nestasimara*, *camerounensis* and *pitkini*. Host plants, both members of the Sapotaceae, are known for two of the species, and the only known larva, that of *etiennei*, is very distinctive (Fig. 317).

### *Trioza etiennei* sp. n.

(Figs 46, 50, 198–201, 317, 318)

DESCRIPTION. Adult. Integument sparsely covered with very short setae. Head, in profile, at 90° to longitudinal axis of body, from above as wide as mesoscutum; occipital margin sharp; vertex pentagonal, rounded down to genae, with a median longitudinal ridge on either side of which is a parallel furrow, lateral margins raised and with anterolateral tubercles, median suture evanescent just above median ocellus;

latter not visible from above, frons visible in anterior view; genae smooth, rounded, without trace of cones; antennal flagellum short, 1.06–1.23 times longer than head width, a single subapical rhinarium present on flagellomeres 2, 4, 6 and 7, the proximal three each with a bifid sensillum, the distal one with a short conical sensillum, apical flagellomere with two long setae apically; clypeus with a pair of setae, ultimate rostral segment with two pairs of setae. Thorax, in profile, with mesopraescutum almost flat; pronotum strongly rounded down behind occiput, with a sharp median tubercle, and a blunt tubercle at each dorsolateral margin (cf. Fig. 203); mesopraescutum much wider than long, its anterior margin broadly arcuate; forewing elipsoid with broadly rounded apex, leading edge almost straight, 2.32–2.65 times longer than wide, radular areas broad, claval suture bordered with spinules but remainder of membrane devoid of spinules; veins bearing short setae, *R* branch acutangular, *M* branching proximal to *Rs*–*Cu*<sub>1a</sub> line, *Cu* stem 1.60–2.33 times longer than *Cu*<sub>1b</sub>, *m*<sub>1</sub> cell value 1.25–1.46, *cu*<sub>1</sub> cell value 1.07–1.38; forewing 1.14–1.22 times longer than hindwing, costal margin of hindwing with up to two setae proximal to costal break, setae distal to costal break clearly divided into two groups; hind coxa (Fig. 46) with a reduced meracanthus and without anterior lobe; hind tibia without basal tubercles, with one outer and two inner apical spurs and with a double vertical row of up to five thickened setae (Fig. 50); hind basitarsus elongate. Abdomen with setae on tergites 2–7 in ♂ and 3–8 in ♀; ♂ proctiger, paramere and aedeagus as in Figs 199–201; ♀ genital segment elongate conical, with apical half strongly elongate, ovipositor valves smooth.

Measurements (10 ♂, 5 ♀). Maximum width of head, ♂ 0.28–0.30, ♀ 0.31–0.33; length of antennal flagellum, ♂ 0.32–0.37, ♀ 0.33–0.38; length of ultimate rostral segment, ♂ 0.07–0.08, ♀ 0.08–0.09; length of forewing, ♂ 0.99–1.14, ♀ 1.14–1.32; length of hind tibia, ♂ 0.29–0.36, ♀ 0.32–0.37.

Fifth instar larva (Figs 317, 318). Dorsal surface outline elongate oval, about 2.1 times longer than wide, head and thorax clearly differentiated from abdomen, latter with a median posterior prolongation. Antenna with three flagellomeres. Cephaloprothorax separate from rest of thorax which is entire. Forewing pad about 0.42 mm long, humeral lobe weakly extended forward but not reaching hind margin of eye. Caudal plate about 1.35 times longer than wide, including posterior prolongation; anus ventral and distant from posterior margin of abdomen, anal pore area as in Fig. 318. Truncate tubular sectasetae inserted on elongate basal tubercles, and very small lanceolate setae forming a sparse marginal fringe, a single truncate tubular postocular sectaseta mounted on a basal tubercle present, arrangement of sectasetae on dorsum as in Fig. 317.

**HOST PLANT.** Larvae and adults collected from *Malacantha alnifolia* (Sapotaceae).

**Holotype** ♂, **Senegal**: Djebelor, 26.xii.1979, *Malacantha alnifolia* (*J. Etienne*) (BMNH; slide mounted).

**Paratypes.** **Senegal**: 50 ♂, 50 ♀, larvae, same data as holotype; 10 ♂, 10 ♀, larvae, Ziguinchor, 20.vii.1981. **Ghana**: 2 ♂, 1 ♀, Tafo, v.1957, yellow tray. **Nigeria**: 1 ♂, 1 ♀, Ibadan, Moor Plntn, 11.vii.1956, yellow tray (*V. F. Eastop*); 1 ♂, vi.1957; 11 ♂, 6 ♀, iv.1960; 4 ♂, 3 ♀, 19–27.iv.1961 (*F. A. Squire*); 1 ♀, Ikom, 11–12.ii.1957 (*V. F. Eastop*). (BMNH; MNHN; slide mounted and stored in 80% ethanol.)

**COMMENT.** *T. etiennei* and *messaratina* seem to be a sister pair, distinguished from the rest of the group by the presence of tubercles or projections on the pronotum. The two species may be separated from one another by the characters given in key couplet 23.

### *Trioza messaratina* sp. n.

(Figs 202–206)

**DESCRIPTION.** Adult. Very similar to *etiennei*. Median longitudinal ridge and parallel furrows of vertex less well developed and median suture weakly indicated just above median ocellus; ultimate rostral segment without setae; antennal flagellum very short, 0.69 times as long as head width, all rhinaria with bifid sensilla although that of flagellomere 7 much shorter than the others. Pronotum as in Fig. 203; forewing (Fig. 202) 2.95 times longer than wide; spinules present in posterior part of *c*+*sc*, completely covering *cu*<sub>2</sub> and anal cell, along hind margin from *cu*<sub>1</sub> to point at which *Rs* reaches wing margin; *Cu* stem 4.55 times longer than *Cu*<sub>1b</sub>, *m*<sub>1</sub> cell value 1.62, *cu*<sub>1</sub> cell value 2.89; hind tibia without vertical row of thickened setae, hind basitarsus not elongate. ♂ proctiger, paramere and aedeagus as in Figs 204–206; ♀ unknown.

Measurements (1 ♂). Maximum width of head, 0.29; length of antennal flagellum, 0.20; length of ultimate rostral segment, 0.06; length of forewing, 0.96; length of hind tibia, 0.23.

Larva and host plant unknown.

**Holotype** ♂, **Tanzania**: E. Usambara Mtns, Amani Res. sta., c. 3,000', 19–27.vi.1974, yellow tray (*D. Hollis*) (BMNH; slide mounted).

*Trioza seranistama* sp. n.

(Figs 207–211)

DESCRIPTION. Adult. Similar to *etiennaei*. Head more rounded; vertex without longitudinal ridge and associated furrows, median suture present and complete to occiput; antennal flagellum short, 0.86–0.91 times as long as head width, with a single subapical rhinarium present on flagellomeres 2, 4, 6, and 7, each with a short bifid sensillum; ultimate rostral segment with one pair of setae. Pronotum without median and lateral tubercles; forewing (Fig. 207) 2.37–2.49 times longer than wide, radular areas weak and broad, spinules present in apical areas of cells  $r_2$ ,  $m_1$ ,  $m_2$ ,  $cu_1$  and occupying most of  $cu_2$ ; veins bearing long setae,  $Cu$  stem 1.92–2.72 times longer than  $Cu_{1b}$ ,  $m_1$  cell value 1.23–1.39,  $cu_1$  cell value 1.00–1.24; forewing 1.19–1.21 times longer than hindwing, costal margin of hindwing without setae proximal to costal break, setae distal to costal break clearly divided into two groups; hind tibia without vertical rows of thickened setae; hind basitarsus short. Abdomen with setae on tergites 2 and 3 in ♂ and 3 and 4 in ♀; ♂ proctiger, paramere and aedeagus as in Figs 208–210; apical half of ♀ genital segment (Fig. 211) elongate.

Measurements (3 ♂, 1 ♀). Maximum width of head, ♂ 0.32–0.34, ♀ 0.36; length of antennal flagellum, ♂ 0.28–0.31, ♀ 0.31; length of ultimate rostral segment, ♂ 0.09, ♀ 0.10; length of forewing, ♂ 1.29–1.38, ♀ 1.51; length of hind tibia, ♂ 0.31–0.33, ♀ 0.34.

Larva and host plant unknown.

Holotype ♂, **Tanzania**: E. Usambara Mtns, Amani Res. sta., c. 3,000', 19–27.vi.1974, yellow tray (*D. Hollis*) (BMNH; slide mounted).

Paratypes. 2 ♂, 1 ♀, same data as holotype (BMNH; slide mounted).

*Trioza nestasimara* sp. n.

(Figs 212, 213)

DESCRIPTION. Adult. Very similar to *seranistama*. Differs in that rhinarium on flagellomere 4 bears a long bifid sensillum. Forewing 2.58 times longer than wide;  $Cu$  stem 1.76 times longer than  $Cu_{1b}$ ,  $m_1$  cell value 1.43,  $cu_1$  cell value 0.92; forewing 1.15 times longer than hindwing. Paramere and aedeagus as in Figs 212, 213, apical segment of aedeagus more clearly divided.

Measurements (1 ♂). Maximum width of head, 0.35; length of antennal flagellum, 0.31; length of ultimate rostral segment, 0.08; length of forewing 1.38; length of hind tibia, 0.31.

Larva and host plant unknown.

Holotype ♂, **Tanzania**: E. Usambara Mtns, Amani Res. sta., c. 3,000', 19–27.vi.1974, yellow tray (*D. Hollis*) (BMNH; slide mounted).

COMMENT. The specimen upon which this species is based was collected in the same yellow tray, during the same period as the type-series of *seranistama* and, possibly, it is an aberrant specimen of the latter. However, it would be most unusual for a psyllid species to have such variable antennal and ♂ genitalia structure, and for this reason two species are recognised here.

*Trioza camerounensis* sp. n.

(Figs 214, 215)

DESCRIPTION. Adult. Very similar to *seranistama*. Antennal flagellum 1.11–1.23 times longer than head width, each rhinarium with a long bifid sensillum; ultimate rostral segment with two pairs of setae. Forewing 2.66–2.75 times longer than wide, spinules present in cells  $m_1$ ,  $m_2$ ,  $cu_1$  and  $cu_2$ ; veins bearing short setae,  $Cu$  stem 1.67–1.78 times longer than  $Cu_{1b}$ ,  $m_1$  cell value 1.28–1.35,  $cu_1$  cell value 1.04–1.29; forewing 1.34–1.37 times longer than hindwing, costal margin of hindwing with one seta proximal to costal break. ♂ paramere and aedeagus as in Figs 214, 215, apical segment of aedeagus subdivided.

Measurements (1 ♂, 2 ♀). Maximum width of head, ♂ 0.31, ♀ 0.35; length of antennal flagellum, ♂ 0.38, ♀ 0.39–0.42; length of ultimate rostral segment, ♂ and ♀ 0.09; length of forewing, ♂ 1.63, ♀ 1.86–1.89; length of hind tibia, ♂ 0.29, ♀ 0.31–0.34.

Larva and host plant unknown.

Holotype ♂, **Cameroun**: Bamenda, 25–31.i.1957, yellow tray (*V. F. Eastop*) (BMNH; slide mounted).

Paratypes. **Cameroun**: 2 ♀, Bamenda, 21–24.i.1957, yellow tray (*V. F. Eastop*) (BMNH; slide mounted).

*Trioza pitkini* sp. n.

(Figs 26, 216–218)

**DESCRIPTION.** Adult. Integument sparsely covered with very short setae. Head, in profile, slightly depressed from longitudinal axis of body; occipital margin sharp; vertex pentagonal with a weak concavity on either side of median suture, frontal lobes moderately developed; median ocellus not visible from above, frons hidden by genae which are slightly swollen but without cones; antennal flagellum short, 1.03–1.24 times longer than head width, a single rhinarium present subapically on flagellomeres 2, 4, 6, and 7, that on 2 with a bifid sensillum (Fig. 26), apical flagellomere with two long setae apically; clypeus with a pair of setae, ultimate rostral segment with two pairs of setae. Thorax weakly arched; anterior margin of pronotum weakly downcurved behind occiput; mesopraescutum, from above, about as long as wide and with a broadly arcuate anterior margin; forewing (Fig. 216) elongate oval with rounded apex, 2.97–3.10 times longer than wide, radular areas broad, spinules present below  $R+M+Cu$  stem and  $M$  stem, this area also brown pigmented apart from hyaline areas on either sides of apices of  $M_{3+4}$ ,  $Cu_{1a}$  and  $Cu_{1b}$ ; veins with short setae,  $R$  branch acutangular,  $M$  branching distal to  $Rs-Cu_{1a}$  line,  $Cu$  stem 3.09–3.63 times longer than  $Cu_{1b}$ ,  $m_1$  cell value 1.11–1.22,  $cu_1$  cell value 2.22–2.74; forewing 1.26–1.31 times longer than hindwing, costal margin of hindwing with one seta proximal to costal break, setae distal to costal break clearly divided into two groups; hind coxa with a moderately developed meracanthus and without anterior lobe; hind tibia without basal spine, with one outer and two inner apical spurs; hind basitarsus short. Abdomen with setae on tergites 2–7 in ♂ and 3–8 in ♀; ♂ paramere and aedeagus as in Figs 217, 218; ♀ genital segment narrowed strongly in apical half and elongate, ovipositor valves smooth.

Measurements (4 ♂, 3 ♀). Maximum width of head, ♂ 0.28–0.29, ♀ 0.31; length of antennal flagellum, ♂ 0.33–0.36, ♀ 0.32–0.33; length of ultimate rostral segment, ♂ 0.07–0.09, ♀ 0.08–0.09; length of forewing, ♂ 1.43–1.53, ♀ 1.65–1.71; length of hind tibia. ♂ 0.23–0.26, ♀ 0.25–0.26.

Larva unknown.

**HOST PLANT.** Adults collected from *Chrysophyllum viridifolium* (?*pruiniforme*) (Sapotaceae).

Holotype ♂, **Kenya**: Nairobi Arboretum, c. 5,400', 25–26.vii.1974, *Chrysophyllum viridifolium* (?*pruiniforme*) (*D. Hollis* (BMNH; dry mounted).

Paratypes. 32 ♂, 15 ♀, same data as holotype (BMNH; NMK; slide and dry mounted and stored in 80% ethanol).

**COMMENT.** *T. pitkini* may be readily distinguished from other members of the *etiennei*-group by the shape, pattern and venation of the forewing (Fig. 216).

**The glabea-group**

Differs from the *etiennei*-group in that the aedeagus is 2-segmented with the apical segment thickened basally, and the forewing has a rounded acutangular apex. Two species, *glabea* and *usambarica*, are included but larvae and host plants are unknown.

*Trioza glabea* sp. n.

(Figs 219–222)

**DESCRIPTION.** Adult. Integument sparsely covered with very short setae. Median suture of vertex present and complete; genae rounded, without cones; antennal flagellum 1.61–1.70 times longer than head width, a single rhinarium present subapically on flagellomeres 2, 4, 6 and 7, those on 2 and 7 with a short conical sensillum, those on 4 and 6 with a long bifid sensillum, apical flagellomere with two long subequal setae apically; clypeus with a pair of setae, ultimate rostral segment with two pairs of setae. Forewing (Fig. 219) elongate ellipsoid with a rounded acutangular apex, 2.88–2.92 times longer than wide, radular areas narrow triangular, membrane with spinules at distal ends of cells  $r_2$  and  $m_2$ , almost completely filling  $m_1$  and  $cu_1$  and following the course of claval suture; veins bearing moderately dense rows of short setae,  $R$  branch acutangular,  $M$  branching proximal to  $Rs-Cu_{1a}$  line,  $Cu$  stem 0.60–0.64 times as long as  $Cu_{1b}$ ,  $m_1$  cell value 1.59–1.62,  $cu_1$  cell value 0.80–0.85; forewing 1.44–1.48 times longer than hindwing, costal margin of hindwing without setae proximal to costal break, setae distal to costal break clearly divided into two groups; hind coxa with a well-developed meracanthus and an incipient anterior lobe; hind tibia with a small basal spine and one outer and two inner apical spurs. Abdomen with setae on tergites 2 and 3 in ♂ and 3 and 4 in ♀; ♂ proctiger, paramere and aedeagus as in Figs 220–222, apical segment of aedeagus with a

heavily sclerotised and bilobed base; ♀ genital segment short, conical, dorsal surface of dorsal valve of ovipositor weakly serrate apically.

Measurements (1 ♂, 1 ♀). Maximum width of head, ♂ 0.40, ♀ 0.44; length of antennal flagellum, ♂ 0.68, ♀ 0.71; length of ultimate rostral segment, ♂ 0.10, ♀ 0.11; length of forewing, ♂ 2.48, ♀ 2.82; length of hind tibia, ♂ and ♀ 0.39.

Larva and host plant unknown.

Holotype ♂, **Angola**: 7 mls W Gabela, 16–18.iii.1972, at light (*D. Hollis*) (BMNH; slide mounted).

Paratypes. **Angola**: 1 ♀, same data as holotype. **Zaire** ('Congo Belge'): 1 ♀, P.N.G., Miss. H. de Saeger, Pidigala, 23.iv.1952 (*H. de Saeger*). (BMNH; MRAC; slide mounted.)

COMMENTS. *T. glabea* and *usambarica* are obviously closely related and I regard them as a sister pair. Both lack genal cones, have bifid sensilla on the antennal rhinaria, and the apical segment of the aedeagus has a thickened base. The presence of bifid sensilla suggests a possible sister-group relationship with the *etiennaei*-group.

A third species belonging to this group is represented by four specimens, from Zaire, deposited in MRAC, but this material is too badly damaged for description.

### *Trioza usambarica* sp. n.

(Figs 223, 224)

DESCRIPTION. Adult. Very similar to *glabea*. Integument more densely covered with slightly longer setae. Antennal flagellum 1.54 times longer than head width. Forewing with  $r_2$  devoid of spinules; veins bearing slightly longer setae, *Cu* stem 0.66–0.73 times as long as  $Cu_{1b}$ ,  $m_1$  cell value 1.57–1.58,  $cu_1$  cell value 0.74–0.86. ♂ paramere and aedeagus as in Figs 223, 224, apical segment of aedeagus with a less expanded base; dorsal surface of dorsal valve of ovipositor smooth.

Measurements (1 ♂, 1 ♀). Maximum width of head, ♂ 0.46, ♀ 0.51; length of antennal flagellum, ♂ 0.71 (♀ damaged); length of ultimate rostral segment, ♂ 0.13, ♀ 0.14; length of forewing, ♂ 2.64, ♀ 2.95; length of hind tibia, ♂ 0.41, ♀ 0.44.

Larva and host plant unknown.

Holotype ♂, **Tanzania**: E. Usambara Mtns, Amani Res. sta., c. 3,000', 19–27.vi.1974, yellow tray (*D. Hollis*) (BMNH; slide mounted).

Paratype. **Tanzania**: 1 ♂, similar data as holotype but swept (BMNH; slide mounted).

### Ungrouped species

Twelve species are described in this section. Some may be grouped together in pairs on the basis of overall similarity due to common possession of characters in the primitive state. The species are ordered alphabetically and each may represent a distinct species-group.

### *Trioza ficiola* sp. n.

(Figs 229–232, 319, 320)

DESCRIPTION (only slide-mounted material available for study). Adult. Integument sparsely covered with moderately long setae. Head with broadly conoid, well-developed genal cones; antennal flagellum 1.27–1.35 times longer than head width, a single rhinarium present subapically on flagellomeres 2, 4, 6 and 7, apical flagellomere with one long and one short and truncate seta apically; clypeus with a pair of setae, ultimate rostral segment with several pairs of setae. Forewing elongate ellipsoid, strongly narrowing distally to a rounded obtusangular apex, 2.52–2.92 times longer than wide, radular areas narrow triangular, remainder of membrane devoid of spinules; veins bearing short setae, *R* branch acutangular, *M* branch distal to *Rs*– $Cu_{1a}$  line, *Cu* stem 1.21–1.53 times longer than  $Cu_{1b}$ ,  $m_1$  cell value 1.53–1.64,  $cu_1$  cell value 1.67–2.20; forewing 1.73–1.78 times longer than hindwing, costal margin of hindwing with 0–2 setae proximal to costal break, setae distal to costal break weakly divided into two groups; hind coxa with a well-developed meracanthus and without anterior lobe; hind tibia with a weak basal tubercle bearing several small conical spines, with one outer and three inner apical spurs. Abdomen with setae on tergites 2 and 3 in ♂, and 3 and 4 in ♀; ♂ proctiger, paramere and aedeagus as in Figs 230–232; ♀ genital segment very short, conoid, subgenital plate truncate apically, ventral surface of ventral valve of ovipositor saw-like and dorsal surface serrate apically.

Measurements (3 ♂, 1 ♀). Maximum width of head, ♂ 0.62–0.66, ♀ 0.66; length of antennal flagellum, ♂ 0.86–0.89, ♀ 0.84; length of ultimate rostral segment, ♂ and ♀ 0.11; length of forewing, ♂ 4.01–4.11, ♀ 4.40; length of hind tibia, ♂ 0.64–0.65, ♀ 0.64.

Fifth instar larva (Figs 319, 320). Dorsal surface outline almost circular, about 1.1 times longer than wide. Antenna about 0.3 mm long (segmentation not clear in specimens available). Cephaloprothorax separated from rest of thorax which is entire. Forewing pad 0.92 mm long, humeral lobe extended forward beyond anterior margin of eye. Caudal plate about 0.5 times as long as wide, anus ventral and distant from posterior margin of abdomen, anal pore area as in Fig. 320. Elongate truncate tubular sectasetae forming a dense, entire marginal fringe, post-ocular seta absent, sectasetae absent from dorsum.

**HOST PLANT.** Adults and larvae collected from *Ficus* sp. (Moraceae). There is no information as to whether or not the larvae form pit galls on the host plant but this is highly likely judging from their shape and the arrangement of sectasetae.

**Holotype** ♂, **Mozambique:** Musape River Valley, 7.vii.1968, *Ficus* sp. (*C. J. Hodgeson*) (NCI; slide mounted).

**Paratypes.** 2 ♂, 1 ♀, larvae, same data as holotype (NCI; BMNH; slide mounted).

**COMMENTS.** Apart from the male paramere and aedeagus this species has few diagnostic features. It resembles species of the *erytreae*-group but the venation of the forewing has a higher  $m_1$  cell value and a lower  $cu_1$  cell value, and the structure of the female ovipositor is more derived than that of other members of the group.

### *Trioza fuscivena* sp. n.

(Figs 233–236)

**DESCRIPTION.** Adult. Integument sparsely covered with moderately long hairs. Head, in profile, slightly depressed from longitudinal axis of body, from above at least as wide as mesoscutum; occipital margin obtuse; vertex flattened but deeply divided anteriorly by median suture, frontal lobes weakly developed; median ocellus not visible from above, frons just visible in anterior view; genal cones narrow, conical, well developed, in profile depressed strongly from plane of vertex; antennal flagellum 1.59–1.98 times longer than head width, a single rhinarium present subapically on flagellomeres 2, 4, 6 and 7, apical flagellomere with two subequal terminal setae, the shorter with a truncate apex; clypeus with a pair of setae, ultimate rostral segment with two pairs of setae. Thorax weakly arched; pronotum, from above, with a rhomboid dorsal disc and narrowing strongly on each side; mesopraescutum, from above, longer than wide, anterior margin strongly arcuate, in profile strongly rounded down to pronotum; forewing elongate ellipsoid, narrowing to rounded acutangular apex, 2.65–2.92 times longer than wide, membrane devoid of spinules apart from narrow triangular radular areas, course of *R* stem and  $R_1$  and bases of *M* stem and *Cu* stem brown pigmented; veins sparsely clothed with moderately long hairs in basal half of wing, *R* branch acutangular, *M* branch distal to  $Rs-Cu_{1a}$  line, *Cu* stem 1.51–1.77 times longer than  $Cu_{1b}$ ,  $m_1$  cell value 1.07–1.26,  $cu_1$  cell value 1.86–2.08; forewing 1.66–1.78 times longer than hindwing, costal margin of hindwing with 4–7 setae proximal to costal break, setae distal to costal break sparse but clearly divided into two groups; hind coxa with a well-developed meracanthus and without anterior lobe; hind tibia with 3–4 small but clearly developed spines, with one outer and two inner apical spurs. Abdomen with setae on tergite 3 in ♂, and tergite 4 in ♀; ♂ proctiger very weakly expanded laterally, paramere and aedeagus as in Figs 234, 235; ♀ genital segment (Fig. 236) short, conoid, proctiger strongly downcurved apically, subgenital plate with truncate posterior margin, lower valve of ovipositor with three dorsolateral transverse ridges apically.

Measurements (4 ♂, 2 ♀). Maximum width of head, ♂ 0.50–0.54, ♀ 0.54–0.56; length of antennal flagellum, ♂ 0.94–1.05, ♀ 0.86–0.93; length of ultimate rostral segment, ♂ 0.07, ♀ 0.08; length of forewing, ♂ 3.25–3.46, ♀ 3.76–3.89; length of hind tibia, ♂ 0.66–0.70, ♀ 0.68–0.70.

Larva and host plant unknown.

**Holotype** ♂, **Cameroun:** Bamenda, i-ii.1957, yellow trays (*V. F. Eastop*) (BMNH; slide mounted).

**Paratypes.** 4 ♂, 2 ♀, same data as holotype (BMNH; slide and dry mounted).

**COMMENT.** This species is superficially similar to *nachingweae* (p. 49), principally because of the forewing pigmentation. However, the third flagellomere is not greatly reduced and *fuscivena* is not considered a member of the *neoboutonia*-group. Other differences from *nachingweae* may

be found in the short ultimate rostral segment, the longer setae on the forewing veins and the form of the male and female genitalia (Figs 234–236). No close association with any other species can be found.

***Trioza ghanaensis* sp. n.**

(Figs 28, 237–240)

DESCRIPTION. Adult. Integument sparsely covered with very short setae. Head, from above, almost as wide as mesoscutum, in profile depressed at 90° from longitudinal axis of body; vertex pentagonal, flattened dorsally, rounded down to frons, with sharp occipital margins and clearly defined median suture, lateral concavities weak, frontal lobes absent; median ocellus not visible from above, frons just visible in anterior view; genae rounded, without cones; antennal flagellum 1.44–1.47 times longer than head width, a single rhinarium present subapically on flagellomeres 2, 4, 6 and 7, those on 2 and 7 with an oval sense cone, those on 4 and 6 each with a long bifid sense cone, apical flagellomere with two long subequal terminal setae; clypeus with a pair of setae, ultimate rostral segment with two pairs of setae. Thorax strongly arched; pronotum strongly curved down behind occiput; mesopraescutum, from above, almost as long as wide, anterior margin broadly arcuate and strongly rounded down to pronotum; forewing elongate ellipsoid, strongly narrowing to obtusangular apex, 2.54–2.55 times longer than wide, radular areas elongate and narrow, rest of membrane devoid of spinules apart from small area at base of claval suture; veins bearing short setae, *R* branch acutangular, *M* branch proximal to *Rs*–*Cu*<sub>1a</sub> line, *Cu* stem 0.36–0.42 times as long as *Cu*<sub>1b</sub>, *m*<sub>1</sub> cell value 2.09–2.34, *cu*<sub>1</sub> cell value 0.75–0.82; forewing 1.74–1.80 times longer than hindwing, costal margin of hindwing with 3–6 setae proximal to costal break, 10–12 setae immediately distal to costal break and 4–6 setae adjacent to retinaculum; hind coxa with a well-developed meracanthus and without anterior lobe; hind tibia with a pair of unequally developed basal tubercles and one outer and two inner apical spurs. Abdomen with setae on tergites 2 and 3 in ♂ and 3 and 4 in ♀; ♂ proctiger, paramere and aedeagus as in Figs 238–240; ♀ genital segment conical, dorsal valves of ovipositor serrate apically.

Measurements (2 ♂, 2 ♀). Maximum width of head, ♂ 0.73–0.75, ♀ 0.75–0.78; length of antennal flagellum, ♂ damaged, ♀ 1.08–1.15; length of ultimate rostral segment, ♂ 0.22, ♀ 0.23; length of forewing, ♂ 5.27–5.35; ♀ 5.64–5.81; length of hind tibia, ♂ 0.90, ♀ 0.91–0.92.

Larva unknown.

HOST PLANT. Adults collected 'in severely galled young terminal leaves of *Malacantha* sp.' (Sapotaceae).

Holotype ♂, Ghana: Tafo, xii.1942, on *Malacantha* sp. (*H. E. Box*) (BMNH; slide mounted).

Paratypes. Ghana: 1 ♂, 3 ♀, same data as holotype. Zaire ('Congo Belge'): 4 ♀, P.N.A., Nyasheke (vol. Nyamuragira), 1820 m, 14–26, vi.1935 (*G. F. de Witte*). (BMNH; MRAC; slide and dry mounted.)

COMMENT. See under *tenuis* (p. 67).

***Trioza guiera* sp. n.**

(Figs 241–244, 321, 322)

DESCRIPTION. Adult. Integument covered with moderately long setae. Head, in profile, slightly depressed from longitudinal axis of body, from above slightly narrower than mesoscutum; occipital margin sharp; vertex with anterior margin incised by median suture, latter with an irregular concavity on either side dorsofrontally; median ocellus visible from above, frons visible in anterior view; genal cones very short, rounded; antennal flagellum short, 0.9–1.21 times as long as head width, a single rhinarium present subapically on flagellomeres 2, 4, 6 and 7, apical flagellomere with a long pointed seta and a short truncate seta terminally; clypeus with a pair of weak setae, ultimate rostral segment long, devoid of setae. Thorax weakly arched; pronotum visible from above, its anterior margin rounded down behind occiput; mesopraescutum, from above, wider than long, with broadly arcuate anterior margin, in profile strongly downcurved to pronotum; forewing ellipsoid, with rounded apex, 2.25–2.57 times longer than wide, membrane densely covered with spinules, radular areas broadly triangular; veins bearing long setae at least in proximal half of wing, *C*+*Sc* thickened at base, *R* branching from *R*+*M*+*Cu* slightly proximal to *Cu*, *R* branch acutangular, *M* branch distal to *Rs*–*Cu*<sub>1a</sub> line, *Cu* stem 0.93–1.79 times as long as *Cu*<sub>1b</sub>, *m*<sub>1</sub> cell value 1.06–1.32, *cu*<sub>1</sub> cell value 1.26–1.7; forewing 1.41–1.56 times longer than hindwing, costal margin of hindwing with 3–4 setae proximal to costal break, no setae immediately distal to costal break and 2–3 setae adjacent to retinaculum; hind coxa with a well-developed meracanthus and without anterior lobe; hind



tibia with a group of 2–3 very small spines basally and without strongly developed apical spurs. Abdomen with setae on tergites 2–7 in ♂ and 3–8 in ♀; ♂ proctiger, paramere and aedeagus as in Figs 242–244; ♀ genital segment short, conical, apex of proctiger upcurved and hook-like, valves of ovipositor smooth.

Measurements (10 ♂, 10 ♀). Maximum width of head, ♂ 0.40–0.45, ♀ 0.43–0.47; length of antennal flagellum, ♂ 0.37–0.51, ♀ 0.41–0.50; length of ultimate rostral segment, ♂ 0.10–0.13, ♀ 0.11–0.13; length of forewing, ♂ 1.62–1.84, ♀ 1.86–2.14; length of hind tibia, ♂ 0.27–0.31, ♀ 0.30–0.34.

Fifth instar larva (Figs 321, 322). Dorsal surface outline oval, about 1.4 times longer than wide, with indentations on either side at posterior margin of eye and at base of abdomen, posterior margin of abdomen with a deep indentation medially. Antenna with 4–5 flagellomeres. Cephaloprothorax separate from rest of thorax which is entire. Forewing pad about 0.37 mm long, humeral lobe weakly extending forward to posterior margin of eye. Caudal plate about 0.65 times as long as wide, anus apico-dorsal, anal pore area as in Fig. 322. Pointed conical sectasetae of unequal length forming an uneven dense marginal fringe interrupted posteromedially; blunt conical sectasetae present on either side of dorsal mid line from cephaloprothoracic suture to posterior margin of abdomen; a single conical sectaseta present on each lateral margin of the abdominal tergite immediately anterior to caudal plate.

**HOST PLANT.** Adults and larvae collected from *Guiera senegalensis* (Combretaceae). The larvae are apparently free-living and one sample collected was associated with a species of the ant genus *Crematogaster*.

**Holotype ♂, Senegal:** Manpalago, 12.55N/16.00W, 13.i.1981, *Guiera senegalensis* (*J. Etienne*) (BMNH; dry mounted).

**Paratypes. Senegal:** 43 ♂, 31 ♀, larvae, same data as holotype; 7 ♂, 7 ♀, numerous larvae, Goudemp, 23.vi.1981, *Guiera senegalensis* (*J. Etienne*). **Gambia:** 2 ♂, 2 ♀, larvae (*V. F. Eastop*). **Chad:** 5 ♀, larvae, Bebedjia 8.40N/16.33E, 10.xi.1974 (*R. M. Bink-Moenen*). **Sudan:** 15 ♂, 14 ♀, larvae, 50 km W. El Obeid, 19.iv.1981, *Guiera senegalensis*, tended by *Crematogaster* sp.; 6 ♂, 13 ♀, larvae, 140 km W. El Obeid, 21.iv.1981; 9 ♂, 8 ♀, larvae S. Darfur, Ed Da'ein, 3.v.1981; 1 ♂, 1 ♀, larvae, Ed Da'ein to Babanusa Road, 4.v.1981; larvae, 40 km SW. El Muglad, 6.v.1981 (*J. H. Martin*). (BMNH; MNHN; slide and dry mounted and stored in 80% ethanol.)

**COMMENTS.** The shape and venation of the forewing (Fig. 241) and the dense complete covering of spinules on the membrane serve to distinguish this species from other Afrotropical trioizids. Furthermore the anus of the 5th instar larva is in a dorsal position, possibly to facilitate ant-tending.

### *Trioza karroo* sp. n.

(Figs 51, 245–248)

**DESCRIPTION.** Adult. Integument sparsely covered with short setae. Head, in profile, moderately depressed from longitudinal axis of body, from above narrower than mesoscutum; occipital margin obtuse but well defined; vertex with a well-defined concavity on either side of median suture, frontal lobes weakly developed; median ocellus visible from above, frons completely covered by genal cones, latter well developed and with rounded apices, their longitudinal axis parallel with but not in same plane as vertex; antennal flagellum 1.89–2.16 times longer than head width, a single rhinarium present subapically on flagellomeres 2, 4, 6 and 7, apical flagellomere with one long and one short and truncate seta terminally; clypeus prominent and bearing a pair of setae, ultimate rostral segment without setae. Thorax weakly arched; pronotum clearly visible from above, its anterior margin rounded down behind occiput; mesopraescutum, from above, slightly wider than long, anterior margin broadly arcuate, in profile angled down to pronotum; forewing (Fig. 245) elongate, narrow, rounded apically, 3.09–3.23 times longer than wide, membrane with a broad band of brown pigmentation extending across the longitudinal axis of the wing, following the course of *R+M+Cu*, *M* stem and *M*<sub>1+2</sub> and extending across posterior half of wing, evenly spinuled and with diffuse radular areas; veins bearing short setae, *R* branch acutangular, *M* branch at *Rs-Cu*<sub>1a</sub> line, *Cu* stem 1.10–2.26 times longer than *Cu*<sub>1b</sub>, *m*<sub>1</sub> cell value 1.58–1.87, *cu*<sub>1</sub> cell value 1.47–1.79; forewing 1.23–1.32 times longer than hindwing, costal margin of hindwing bearing two setae proximal to costal break, setae distal to costal break not clearly divided into two groups; hind coxa with a well-defined meracanthus and without anterior lobe; hind tibia with a group of small tubercles on a raised bulge basally, without well-defined apical spurs but with an incomplete ring of thickened setae (Fig. 51). Abdomen with setae on tergites 2 and 3 in ♂ and 3 and 4 in ♀; ♂ proctiger and aedeagus as in Figs 246, 247 (parameres

damaged in holotype); ♀ genital segment (Fig. 248) short, conical, proctiger, in profile, with a prominent bulge posterior to anus and narrowing strongly to apex, ovipositor valves smooth.

Measurements (1 ♂, 6 ♀). Maximum width of head, ♂ 0.43, ♀ 0.41–0.46; length of antennal flagellum, ♂ 0.92, ♀ 0.85–0.98; length of ultimate rostral segment, ♂ 0.07, ♀ 0.08–0.09; length of forewing, ♂ 2.18, ♀ 2.45–2.63; length of hind tibia, ♂ 0.36, ♀ 0.36–0.40.

Larva and host plant unknown.

Holotype ♂, **South Africa**: C.P., Grabouw, 6.i.1971, swept (*J. G. Theron*) (NCI; slide mounted).

Paratypes. **South Africa**: 4 ♀, same data as holotype; 4 ♀, Ceres, iv.1925 (*R. E. Turner*). (BMNH; NCI; slide and dry mounted.)

COMMENTS (see also p. 64). *T. karroo* is easily recognised by the pigmentation of the forewing (Fig. 245) and the absence of hind tibial spurs. The male genitalia are not particularly distinctive but the form of the female proctiger (Fig. 248) is very unusual.

### *Trioza laingi* sp. n.

(Figs 249–253)

DESCRIPTION. Adult. Body sparsely covered with short setae, genal cones and legs bearing longer setae. Head, in profile, depressed almost at 90° to longitudinal axis of body, from above narrower than mesoscutum; occipital margin obtuse but defined; vertex with a well-developed concavity on either side of median suture which is deeper towards median ocellus, frontal lobes not developed; median ocellus not visible from above, frons completely covered by genae; genal cones well developed, in profile depressed from axis of vertex; antennal flagellum 1.74 times longer than head width, a single rhinarium present subapically on flagellomeres 2, 4, 6 and 7, apical flagellomere with one long and one short and truncate seta apically; clypeus with a pair of setae, ultimate rostral segment with two pairs of setae. Thorax weakly arched; pronotum clearly visible from above and rounded down behind occiput; mesopraescutum, from above slightly wider than long, anterior margin broadly arcuate, in profile gently rounded down to pronotum; forewing (Fig. 249) elongate oval with rounded apex, 2.83–3.16 times longer than wide, membrane with an even brown pigmentation extending over posterior half of wing from the line of  $R+M+Cu$ ,  $M$  stem and  $M_{1+2}$ , evenly covered with spinules and with diffuse radular areas; veins bearing short setae,  $R$  branch acutangular,  $M$  branching at or proximal to  $Rs-Cu_{1a}$  line,  $Cu$  stem 1.45–1.86 times longer than  $Cu_{1b}$ ,  $m_1$  cell value 1.19–1.22,  $cu_1$  cell value 1.07–1.40; forewing 1.23–1.25 times longer than hindwing, costal margin of hindwing with 0–1 seta proximal to costal break, setae distal to costal break clearly divided into two groups; hind coxa with a well-developed meracanthus and without anterior lobe; hind tibia with a weakly developed basal spine, with one strong outer and three inner apical spurs; basal segment of hind tarsus elongate. Abdomen with setae on tergites 2 and 3 in ♂ and 3 and 4 in ♀; ♂ proctiger, paramere and aedeagus as in Figs 250–252; ♀ genital segment (Fig. 253) very short, proctiger with rounded apex, apicodorsal surface of ventral valves of ovipositor weakly serrate.

Measurements (2 ♂, 2 ♀). Maximum width of head, ♂ 0.55–0.57, ♀ 0.59–0.61; length of antennal flagellum, ♂ 0.96, ♀ 1.06; length of ultimate rostral segment, ♂ 0.10–0.11, ♀ 0.11–0.12; length of forewing, ♂ 2.91–3.14, ♀ 3.36–3.47; length of hind tibia, ♂ 0.45–0.48, ♀ 0.47–0.49.

Larva unknown.

HOST PLANT. Possibly *Bartsia longiflora* (Scrophulariaceae).

Holotype ♂, **Kenya**: Mt Elgon, 10,300', i.1974, on yellow flowers (*S. Collins*) (BMNH; slide mounted).

Paratypes. **Kenya**: 1 ♀, same data as holotype. **Ethiopia**: 1 ♀ (without head), Simien, Lori, 11,500', beaten from low yellow-flowered bushes, *Bartsia longiflora*; 1 ♂, 3 ♀, 'Abyssinia', Mt Zuquala, c. 9,000', 22.x.1926, beaten from trees near lake shore (*H. Scott*). **Zaire** ('Congo Belge'): 1 ♀ Ruanda, Lac N'Gando ('pied volc. Karisimbi'), 2,400 m, 8.iii.1935 (*G. F. de Witte* 1216); 1 ♂ Terr. Rutshuru, 7.iv.1937 (*Miss. Prophyllactique*). (BMNH; MRAC; slide and dry mounted.)

COMMENTS. This species most closely resembles *T. obscura* Tuthill, 1952, and some undescribed species which develop on *Hebe* spp. (Scrophulariaceae) in New Zealand, but this resemblance may be due to characters of the head, thorax and forewing being in the primitive state. Within the African fauna *laingi* is similar to *karroo* (p. 64) but the two species may be separated by the characters given in key couplet 4.

The material from Mt Zuquala, Ethiopia, was deposited in the BMNH under the Laing manuscript name '*Trioza semibrunneipennis*'.

*Trioza medleri* sp. n.

(Figs 10, 39, 254, ?255)

**DESCRIPTION.** Adult. Integument densely covered with long setae (Fig. 39). Head, in profile, depressed at 90° to longitudinal axis of body, from above narrower than mesoscutum; occipital margin rounded; vertex deeply divided into two bulbous halves by median suture, eyes very prominent and rounded; median ocellus not visible from above, frons completely covered by genae; genal cones long, conical, with subacute apices; antennal flagellum (Fig. 10) 1.66 times longer than head width, a single rhinarium present subapically on flagellomeres 2, 4, 6 and 7, 1–6 with very long setae, apical flagellomere with one long and one extremely short and truncate seta apically; clypeus with a pair of setae, ultimate rostral segment with several pairs of setae. Thorax, in profile, strongly arched; pronotum, from above, with a rhomboid dorsal disc and strongly narrowing laterally, in profile strongly rounded down behind occiput; mesopraescutum, from above, slightly wider than long, anterior margin broadly arcuate, in profile rounded down to pronotum; forewing (Fig. 254) obovoid, broadly rounded distally, 2.29 times longer than wide, radular areas elongate, cell *c+sc* with a narrow diagonal band of spinules, remainder of membrane devoid of spinules; veins densely clothed with long setae, *R* branch acutangular, *M* branching proximal to *Rs*–*Cu*<sub>1a</sub> line, *Cu* stem 0.39 times as long as *Cu*<sub>1b</sub>, *m*<sub>1</sub> cell value 2.61, *cu*<sub>1</sub> cell value 0.76; forewing 1.38 times longer than hindwing, costal margin of hindwing with 0–1 seta proximal to costal break, setae distal to costal break clearly divided into two groups; hind coxa with a well-developed meracanthus and without anterior lobe; hind tibia without basal spines and with one outer and two inner apical spurs. ♂ unknown; ♀ abdomen with setae on tergite 3, genital segment short, conoid, proctiger strongly sclerotised apically, ovipositor valves smooth.

Measurements (1 ♀). Maximum width of head, 0.7; length of antennal flagellum, 1.16; length of ultimate rostral segment, 0.14; length of forewing, 3.85; length of hind tibia, 0.67.

Larva and host plant unknown.

Holotype ♀, **Nigeria**: NE. State, Ngel Nyaki, 31.iii.1970 (*J. T. Medler*) (BMNH; dry mounted).

Paratypes. 2 ♀, same data as holotype (BMNH; slide and dry mounted).

Non-paratypic material. **Zaire** ('Congo Belge'): 1 ♂, PNG, Miss. H. de Seager, II/fe/7, 4.vii.1952, 3729; 1 ♂, PFNK 7/9, 28.vii.1952, 3842 (*H. de Saeger*) (MRAC).

**COMMENTS.** This is a very distinctive species which may be easily recognised by the structure of the head, pronotum and forewing, the latter resembling those of the Hawaiian genera *Hevaheva* and *Hemischizocranium*. In overall appearance *medleri* is similar to the Indian species *Petaloly-ma basalis* (Walker, 1858) but the latter has a less cleft head which is more adpressed to the thorax, the pronotum is completely hidden dorsally, the mesonotum is less arched or produced forward, and the tibial spurs are much more strongly developed.

Apart from the type-series I have examined 2 ♂ from Zaire, deposited in MRAC, which may be conspecific but have a much shorter *m*<sub>1</sub> cell (value 1.85). The genitalia are shown in Fig. 255.

*Trioza schroederi* sp. n.

(Figs 256–260)

**DESCRIPTION.** Adult. Integument sparsely clothed with short setae. Head, in profile, depressed almost to 90° from longitudinal axis of body, from above almost as wide as mesoscutum; occipital margin broadly obtusangular; vertex rounded pentagonal, anteriorly incised by median suture and strongly rounded to genae, secondary diagonal grooves present from median ocellus backwards to lateral concavities, latter weak; median ocellus just visible from above, frons just visible in anterior view; genal cones elongate conoid, with rounded apices, in parallel plane to vertex; antennal flagellum 2.33–2.64 times longer than head width, a single rhinarium present subapically on flagellomeres 2, 4, 6 and 7, apical flagellomere with two long subequal setae apically; clypeus with a pair (rarely with a second very short pair) of setae, ultimate rostral segment with a pair of setae. Thorax weakly arched; pronotum strongly rounded down behind occiput; mesopraescutum, from above, about as long as wide, with arcuate anterior margin, in profile strongly rounded down to pronotum; forewing (Fig. 256) elongate oval with rounded obtusangular apex, 2.76–2.87 times longer than wide, membrane devoid of spinules apart from a small cloud around base of claval suture and triangular radular areas; veins bearing short setae, *R* branch acutangular, *Rs* long and sinuous, *M* branching proximal to *Rs*–*Cu*<sub>1a</sub> line, *Cu* stem 1.32–1.71 times longer than *Cu*<sub>1b</sub>, *m*<sub>1</sub> cell value 1.47–1.65, *cu*<sub>1</sub> cell value 1.29–1.68; forewing 1.5 times longer than hindwing, costal margin of hindwing

with up to eight setae proximal to costal break, setae distal to costal break clearly divided into two groups; hind coxa with a well-developed meracanthus and without anterior lobe; hind tibia with 1–2 small tubercles basally and one outer and two inner apical spurs. Abdomen with setae on tergites 2 and 3 in ♂ and 3 and 4 in ♀; ♂ proctiger, paramere and aedeagus as in Figs 257–259; ♀ genital segment (Fig. 260) short, conoid, proctiger with a weak transverse groove immediately posterior to anus, apex of ventral valve of ovipositor with two ventrolateral serrations.

Measurements (4 ♂, 2 ♀). Maximum width of head, ♂ 0.49–0.56, ♀ 0.56–0.57; length of antennal flagellum, ♂ 1.19–1.48, ♀ 1.39; length of ultimate rostral segment, ♂ 0.13–0.16, ♀ 0.14–0.15; length of forewing, ♂ 2.85–3.68, ♀ 3.49; length of hind tibia, ♂ 0.47–0.62, ♀ 0.54–0.56.

Larva and host plant unknown. One adult ♂ paratype was collected on *Myrica conifera* (Myricaceae).

Holotype ♂, **Tanzania**: Kilimanjaro, Bismark Hut, 2,500–3,000 m, S. Mawenzi, at foot of high pasture, ii.1912 (*Chr. Schröder*) (MNHU; slide mounted).

Paratypes. **Tanzania**: 6 ♂, 3 ♀, same data as holotype. **Zaire** ('Congo Belge: Ruanda'): Lac N'Gando, pied Volc. Karisimbi, 2,400 m, 6.iii.1935 (*G. F. de Witte*). **Zimbabwe** ('S. Rhodesia'): 1 ♂, Harare ('Salisbury'), iii.1957, *Myrica conifera* (*N. L. H. Krauss*). (BMNH; MNHU; MRAC; slide mounted and stored in 80% ethanol.)

Non-paratypic material (damaged specimens). **Tanzania**: 1 ♀, 1 ?, 'D. O. Afrika, Kilimandscharo', 3000–4000 m, i.1906; 2 ♀, Amani, xii.1905 (*Chr. Schröder*) (MNHU). **Zaire** ('Congo Belge'): P.N.A., Secteur Tshiaberimu, riv. Kalivina affl., Talia Nord, 2,350 m, 29.iii.1954 (*P. Vanschuytbroek & H. Synave*) (MRAC).

COMMENTS. This species shows no clear relationships to other Afrotropical species, having several features of the wing in the primitive state. It is superficially similar to *theroni* (p. 67), from which it differs in having long, well-developed genal cones and lacking supplementary rhinaria on the first flagellomere.

### *Trioza tangae* sp. n.

(Figs 18, 261–264)

DESCRIPTION. Adult. Integument covered with long setae. Head, in profile, depressed almost at 90° to longitudinal axis of body; occipital margin obtusangular; vertex pentagonal, rounded down to genae, median suture weak but complete, lateral concavities well developed; median ocellus just visible from above, frons completely covered by genal cones; latter well developed, conoid, with rounded apices; antennal flagellum 1.76–1.83 times longer than head width, a single rhinarium present subapically on flagellomeres 2, 4, 6 and 7, apical flagellomere twice as long as 7th (Fig. 18) and bearing one long and one short and truncate seta apically; clypeus with a pair of setae, ultimate rostral segment with three pairs of setae. Thorax weakly arched; pronotum strongly rounded down behind occiput; mesopraescutum, from above, about as long as wide, with a moderately arcuate anterior margin, in profile gently rounded down to pronotum; forewing (Fig. 261) elongate ellipsoid, narrowing distally to rounded obtusangular apex, 2.62–2.79 times longer than wide, membrane devoid of spinules apart from narrow radular areas and a small patch at base of claval suture; veins bearing moderately long setae at least in proximal half of wing, *R* branch acutangular, *M* branching distal to *Rs*–*Cu*<sub>1a</sub>, *Cu* stem 2.26–2.81 times longer than *Cu*<sub>1b</sub>, *m*<sub>1</sub> cell value 1.08–1.38, *cu*<sub>1</sub> cell value 1.83–2.32; forewing 1.47–1.51 times longer than hindwing, costal margin of hindwing with 0–1 seta proximal to costal break, setae distal to costal break clearly divided into two groups; hind coxa with a well-developed meracanthus and without anterior lobe; hind tibia with 3–4 small tubercles basally, with one outer and two inner apical spurs. Abdomen with setae on tergites 2 and 3 in ♂ and 3 and 4 in ♀; ♂ proctiger, paramere and aedeagus as in Figs 262–264; ♀ genital segment short, conoid, ventral valves of ovipositor arrowhead-like apically and finely serrate.

Measurements (2 ♂, 2 ♀). Maximum width of head, ♂ 0.41–0.47, ♀ 0.41–0.43; length of antennal flagellum, ♂ 0.75, ♀ 0.72–0.76; length of ultimate rostral segment, ♂ 0.08–0.10, ♀ 0.07–0.08; length of forewing, ♂ 2.30–2.61, ♀ 2.20–2.49; length of hind tibia, ♂ 0.48–0.52, ♀ 0.45–0.50.

Larva and host plant unknown.

Holotype ♂, **Tanzania**: E. Usambara Mtns, Amani Res. sta., c. 3,000', 19–27.vi.1974, yellow tray (*D. Hollis*) (BMNH; slide mounted).

Paratypes. **Tanzania**: 2 ♀, same data as holotype; 1 ♂, light-trap (*D. Hollis*); 1 ♂, Kilimanjaro, Bismark Hut, 2,500–3,000 m, S. Mawenzi, at foot of high pasture, ii.1912 (*Chr. Schröder*). (BMNH; MNHU; slide and dry mounted.)

COMMENT. This species is distinguished by its relatively long apical flagellomere and male genitalia, the latter resembling those of the *nigricornis*-group (sensu Hodkinson, 1981) in the Palaearctic Region.

*Trioza tenuis* sp. n.

(Figs 36, 37, 43, 265–267)

DESCRIPTION. Adult. Integument very sparsely covered with very short setae. Head, in profile (Fig. 37), at 90° to longitudinal axis of body, from above (Fig. 36) almost as wide as mesoscutum; occipital margin sharp dorsomedially and strongly indented by median suture of vertex; vertex also deeply cleft by median suture, lateral concavities weak; median ocellus just visible in dorsal view, frons visible between genae in anterior view; genal cones very poorly developed, rounded; antennal flagellum 1.51–1.63 times longer than head width, a single rhinarium present subapically on flagellomeres 2, 4, 6 and 7, apical flagellomere with a long pointed seta and a short truncate seta apically; clypeus with a pair of setae, ultimate rostral segment long and densely setose. Thorax (Figs 36, 37) moderately arched; from above the pronotum is more clearly visible at its lateral margins, the mesopraescutum being strongly produced forward medially, in profile pronotum strongly rounded down behind occiput and mesopraescutum angled down to pronotum; forewing (Fig. 265) elongate oval, strongly narrowing to acutangular apex, 3.08–3.19 times longer than wide, radular areas elongate triangular, remainder of membrane devoid of spinules; veins bearing short setae, *R* branch acutangular, *M* branching proximal to *Rs*–*Cu*<sub>1a</sub> line, *Cu* stem 0.28–0.35 times as long as *Cu*<sub>1b</sub>, *m*<sub>1</sub> cell value 2.33–2.55, *cu*<sub>1</sub> cell value 1.01–1.08; forewing 1.71–1.75 times longer than hindwing, costal margin of hindwing with up to four setae proximal to costal break, setae distal to costal break clearly divided into two groups; hind coxa with a well-developed meracanthus and an extremely well-developed anterior lobe; hind tibia with a well-developed basal spine and one outer and three (rarely two on one tibia only) inner spurs apically. Abdomen with setae on tergites 2 and 3 in ♂ and 3 and 4 in ♀; ♂ proctiger weakly expanded laterally, paramere and aedeagus as in Figs 266, 267; ♀ genital segment short, conical, subgenital plate with truncate apex, ovipositor valves smooth.

Measurements (2 ♂, 2 ♀). Maximum width of head, ♂ and ♀ 0.67–0.70; length of antennal flagellum, ♂ 1.09, ♀ 1.04–1.06; length of ultimate rostral segment, ♂ 0.19–0.20, ♀ 0.20; length of forewing, ♂ 4.4, ♀ 4.66–4.74; length of hind tibia, ♂ 0.64–0.66, ♀ 0.65–0.66.

Larva unknown.

HOST PLANT. Few adults collected from *Haplocoelum foliolosum* (Sapindaceae).

Holotype ♂, **Angola**: Bruco, 28.ii.–2.iii.1972, *Haplocoelum foliolosum* (*D. Hollis*) (BMNH; dry mounted).

Paratypes. **Angola**: 5 ♂, 2 ♀, same data as holotype; 1 ♀, swept in riverine forest area, 26–29.ii.1972; 1 ♂, Roçadas, 30.iii.1972 (*D. Hollis*). (BMNH; slide and dry mounted and stored in 80% ethanol.)

COMMENTS. This species shares many primitive character states with *ghanaensis* (p. 62) but has a more slender build, the forewing is narrower and the hind tibia has three inner apical spurs.

*Trioza theroni* sp. n.

(Figs 24, 268–271)

DESCRIPTION. Adult. Integument sparsely covered with short setae. Head, in profile, at almost 90° to longitudinal axis of body, from above as wide as mesoscutum; occipital margin rounded; vertex pentagonal, with a well-developed irregular concavity on either side of a shallow median suture, frontal lobes weakly developed; median ocellus just visible from above, frons just visible between genae in anterior view; genae slightly swollen and genal cones poorly developed; antennal flagellum 2.60–3.23 times longer than head width, 1st flagellomere (Fig. 24) with an apical group of 1–3 rhinaria and often with an extra rhinarium two-thirds along its length, a single rhinarium present subapically on flagellomeres 2, 4, 6 and 7, apical flagellomere with one long and one short and truncate seta apically; clypeus with several short setae, ultimate rostral segment with two pairs of setae. Thorax weakly arched; pronotum clearly visible from above but its anterior margin strongly rounded down behind occiput; mesopraescutum, from above, almost as long as wide, its anterior margin strongly arcuate and angled down to pronotum; forewing (Fig. 268) elongate oval with narrowly rounded apex, 2.61–3.06 times longer than wide, radular areas narrow triangular, remainder of membrane devoid of spinules except for cell *cu*<sub>2</sub>; veins bearing short setae, *R* branch acutangular, *M* branching proximal to *Rs*–*Cu*<sub>1a</sub> line, *Cu* stem 0.80–1.12 times as long as *Cu*<sub>1b</sub>, *m*<sub>1</sub>

cell value 1.79–2.30,  $cu_1$  cell value 0.78–0.97; forewing 1.45–1.54 times longer than hindwing, costal margin of hindwing with 1–2 setae proximal to costal break, setae distal to costal break clearly divided into two groups; hind coxa with a well-developed meracanthus and without anterior lobe; hind tibia with 1–3 basal spines and one outer and two inner apical spurs. Abdomen with setae on tergite 3 in ♂ and 4 in ♀; ♂ proctiger, paramere and aedeagus as in Figs 269–271; ♀ genital segment short, conical, proctiger with a shallow transverse groove distal to anus, ventral valve of ovipositor with two small teeth on apicoventral surface.

Measurements (7 ♂, 7 ♀). Maximum width of head, ♂ 0.42–0.59; ♀ 0.51–0.60; length of antennal flagellum, ♂ 1.20–1.85, ♀ 1.41–1.71; length of ultimate rostral segment, ♂ 0.12–0.16, ♀ 0.14–0.17; length of forewing, ♂ 2.38–3.64, ♀ 3.00–3.96; length of hind tibia, ♂ 0.39–0.53, ♀ 0.45–0.55.

Larva and host plant unknown.

Holotype ♂, **South Africa**: Cape Town, Milnerton, ii.1926 (*R. E. Turner*) (BMNH; dry mounted).

Paratypes. **South Africa**: 1 ♂, 1 ♀, same data as holotype; 6 ♀, 14–28.xii.1925 (*R. E. Turner*); 1 ♀, Cape Province, Ceres, 13.xii.1969, swept; 2 ♂, 3 ♀, 24.x.1970; 3 ♂, 3 ♀, Rawsonville, 7.xi.1970; 2 ♂, 2 ♀, 1.i.1971; 1 ♂, 2 ♀, Stellenbosch, 3.xii.1970; 1 ♀, 4.i.1971; 1 ♂, Knysna, 15.i.1972 (*J. G. Theron*); 2 ♂, Natal, Kloof, viii.1926 (*R. E. Turner*). (BMNH; NCI; slide and dry mounted and stored in 80% ethanol.)

COMMENTS. The arrangement of supplementary rhinaria on the first flagellomere in *theroni* is distinctive, but the species shows no apparent relationships to other trioziids which have developed supplementary rhinaria. *T. schroederi* (p. 65) is superficially similar to *theroni* but has well-developed genal cones and a primitive arrangement of rhinaria.

### *Trioza tundavala* sp. n.

(Figs 272–274, 323, 324)

DESCRIPTION. Adult. Integument densely covered with long setae. Head, in profile, slightly depressed from longitudinal axis of body, from above narrower than mesoscutum; occipital margin obtusangular; vertex quadrate, its anterior margin rounded downwards and deeply incised by median suture, lateral concavities shallow but clearly defined; median ocellus visible from above, frons visible in anterior view; genal cones short, broadly rounded, in profile depressed from plane of vertex; antennal flagellum 2.2 times longer than head width, a single rhinarium present subapically on flagellomeres 2, 4, 6 and 7, apical flagellomere with a long pointed seta and a short truncate seta apically; clypeus with a pair of setae, ultimate rostral segment with four pairs of setae. Thorax strongly arched; pronotum clearly visible from above, in profile rounded down to occiput; mesopraescutum, from above, slightly wider than long, anterior margin broadly arcuate; forewing (Fig. 272) ovoid with rounded apex, 2.33 times longer than wide, radular areas triangular, remainder of membrane devoid of spinules, course of *R* and  $R_1$  brown pigmented; veins bearing long setae in proximal third of wing, *R* branch acutangular,  $R_1$  about 1.5 times longer than *R* stem, *M* branching proximal to *R*<sub>3</sub>–*Cu*<sub>1a</sub> line, *Cu* stem 0.88–1.11 times as long as *Cu*<sub>1b</sub>,  $m_1$  cell value 1.44–1.48,  $cu_1$  cell value 1.29–1.34; forewing 1.72–1.76 times longer than hindwing, costal margin of hindwing with up to 11 setae proximal to costal break, setae distal to costal break clearly divided into two groups; hind coxa with a well-developed meracanthus and without anterior lobe; hind tibia without basal spine and with one outer and 2–3 inner apical spurs. ♂ unknown; ♀ abdomen with setae on tergites 3 and 4; ♀ genital segment (Fig. 273) short; proctiger (Fig. 274) short, rounded, emarginate posteriorly, anal pore ring of wax-producing cells incomplete anteriorly and forming multiple rows posteriorly; subgenital plate very short, with truncate posterior margin; ventral valve of ovipositor triangularly expanded apically and this expansion with 15–16 saw-like teeth on ventrolateral surface, dorsal surface with serrations.

Measurements (2 ♀). Maximum width of head, 0.83; length of antennal flagellum, 1.84; length of ultimate rostral segment, 0.17; length of forewing, 6.13–6.25; length of hind tibia, 0.95–0.99.

Fifth instar larva (Figs 323, 324). Dorsal surface outline very broadly oval with indentations on either side at base of abdomen and a weak indentation medially on the posterior margin, about 1.2 times longer than wide. Antenna with six flagellomeres. Cephaloprothorax separate from rest of thorax which has mesothorax and metathorax almost completely divided. Forewing pad about 2.1 mm long, humeral lobe extending forward to anterior margin of eye which is close to anterior margin of cephaloprothorax. Caudal plate 0.6 times as long as wide, anus ventral and close to posterior margin of abdomen, anal pore area as in Fig. 324. Narrow, elongate, truncate, tubular sectasetae, with roundly swollen bases, forming an even dense marginal fringe; lanceolate postocular sectasetae present, sectasetae absent from dorsum.

HOST PLANT. Larvae collected in midrib galls on upper surfaces of leaves of *Syzygium benguellense* (Myrtaceae); adults emerged from these galls.

Holotype ♀, **Angola**: Tundavala, 8–10 mls NW. Sa da Bandeira, 27–29.iii.1972, emerged from leaf gall of *Syzygium benguellense* (*D. Hollis*) (BMNH; dry mounted).

Paratypes. 3 ♀, larvae, same data as holotype (BMNH; slide and dry mounted).

COMMENT. This large, robust, pilose species has the distinctive feature that  $R_1$  is considerably longer than  $R$  stem, giving  $r_1$  a very broad proximal area. It has a similar general appearance to *Trioza palaquii* (Laing, 1930), described from specimens reared from galls of *Palaquium gutta* (Sapotaceae) from Malaya, but this may be convergence as both species live in enclosed galls.

### Doubtful species

#### *Trioza bussei* Zacher, 1915

*Trioza bussei* Zacher, 1915: 526; 1916: 419. Syntypes, larvae and adults, CAMEROUN: Soppo, on *Kickxia* (not traced).

The first published indication of this species was a brief description of the larva and a figure of the adult wing. Zacher (1916) gives a further description of the egg, all larval stages and the adult female. No diagnostic features are mentioned. The type-series was not traced and no reply was received to enquiries at the Institut für Pflanzenschutzforschung, Eberswalde.

#### *Trioza similis* Heslop-Harrison, 1961

*Trioza similis* Heslop-Harrison, 1961: 530. Holotype ♀, SOUTH AFRICA: 'Cape Prov., Tzitzikama Forest, Stormsrivierpiek, 13.i.1951, Loc. no. 137. In indigenous forest' (lost).

The original description and fig. 12 (I) mentions an anteriorly projecting epiphysis on the ventral surface of the subgenital plate, but this is not shown in fig. 12 (H). No other diagnostic features are mentioned.

## References

- Akanbi, M. O.** 1981. Preliminary notes on *Trio zamia lamborni* (Newstead) (Hem. Psyllidae), a potentially dangerous pest of *Antiaris africana*. *Entomologist's Monthly Magazine* **116**: 113–115, 1 fig.
- Ashmead, W. H.** 1881. On the Aphididae of Florida with descriptions of new species. (Paper No. 2). *Canadian Entomologist* **13**: 220–225.
- Awadallah, K. T. & Swailem, S. M.** 1971. On the bionomics of the Sycamore Fig psyllid *Pauropsylla trichaeta* Pettey. *Bulletin de la Société Entomologique d'Egypte* **55**: 193–199, 1 fig.
- Bekker-Migdisova, E. E.** 1973. On the systematics of the Psyllomorpha and the position of the group within the Order Homoptera. *Chteniya Pamyati Nakolaya Aleksandruriya Kholodovskogo 1971* (Leningrad): 90–177, 2 figs. [In Russian. English translation available from British Library Lending Division, no. RTS 8526.]
- Berg, C. C.** 1977. Revisions of African Moraceae (excluding *Dorstenia*, *Ficus*, *Musanga* and *Myrianthus*). *Bulletin du Jardin botanique national de Belgique* **47**: 267–407, 35 figs.
- Blanchard, E.** 1852. V. Afidideos. In Gay, C. (Ed.), *Historia Fisica y Política de Chile*, Zoologia 7: 306–320, pl. 3.
- Bordage, E.** 1898. Notes d'entomologie agricole tropicale. II. Un ennemi du Vanillier. *Revue Agricole de la Réunion* **2**: 524–525.
- 1914. Notes biologiques recueillies à l'Ile de la Réunion. *Bulletin Scientifique de la France et de la Belgique* (7) **47**: 407–410.
- Boselli, F. B.** 1930a. Studii sugli Psyllidi (Homoptera: Psyllidae o Chermidae), VI. Psyllidi di Formosa raccolti dal Dr. R. Takahashi. *Bollettino del Laboratorio di Zoologia Generale et Agraria del R. Istituto Superiore Agrario di Portici* **24**: 175–210, 17 figs.
- 1930b. Studii sugli Psyllidi. IX. Descrizione di una Triozina galligena su agrumi in Eritrea. *Bollettino del Laboratorio di Zoologia Generale et Agraria del R. Istituto Superiore Agrario di Portici* **24**: 228–232, 2 figs.
- 1931. Studii sugli Psyllidi (Homoptera: Psyllidae o Chermidae). X. Istituzione di un nuovo genere e

- descrizione di *Egeirotrioza ceardi* (De Bergevin) *euphratica* n. var., Triozina galligena su *Populus euphratica* in Mesopotamia. *Bollettino del Laboratorio di Zoologia Generale e Agraria del R. Istituto Superiore Agrario di Portici* **24**: 267–278, 6 figs.
- Buckton, G. B.** 1900. Description of a new species of *Psylla* destructive to forest trees. *Indian Museum Notes* **5**: 35–36.
- Caldwell, J. S.** 1940. New genera and species of jumping plant-lice from the Hawaiian Islands with descriptions of several immature stages (Homoptera: Psyllidae). *Proceedings of the Hawaiian Entomological Society* **10**: 389–397, 1 fig., pls 22, 23.
- 1944. Psyllidae from tropical and semitropical America (Homoptera). *Journal of the New York Entomological Society* **52**: 335–340, 1 pl.
- Capener, A. L.** 1970. Southern African Psyllidae (Homoptera) – 1: A check list of species recorded from South Africa, with notes on the Pettey collection. *Journal of the Entomological Society of Southern Africa* **33**: 195–200.
- 1973. Southern African Psyllidae (Homoptera) – 3: A new genus and new species of South African Psyllidae. *Journal of the Entomological Society of Southern Africa* **36**: 37–61, 123 figs.
- Carmin, J.** 1951. Two new species of *Pauropsylla* (Psyllidae, Rhynchotha). *Bulletin of the Independent Biological Laboratories Kefar-Malal* **9** (2): 1–3, 10 figs.
- Catling, H. D.** 1969a. The bionomics of the South African citrus psylla, *Trioza erytrae* (Del Guercio) (Homoptera: Psyllidae) 1. The influence of the flushing rhythm of citrus and factors which regulate flushing. *Journal of the Entomological Society of Southern Africa* **32**: 191–208, 9 figs.
- 1969b. The bionomics of the South African citrus psylla, *Trioza erytrae* (Del Guercio) (Homoptera: Psyllidae) 2. The influence of parasites and notes on the species involved. *Journal of the Entomological Society of Southern Africa* **32**: 209–223, 4 figs.
- 1969c. The bionomics of the South African citrus psylla, *Trioza erytrae* (Del Guercio) (Homoptera: Psyllidae) 3. The influence of extremes of weather on survival. *Journal of the Entomological Society of Southern Africa* **32**: 273–290, 8 figs.
- 1970. The bionomics of the South African citrus psylla, *Trioza erytrae* (Del Guercio) (Homoptera: Psyllidae) 4. The influence of predators. *Journal of the Entomological Society of Southern Africa* **33**: 341–348, 9 figs.
- 1971. The bionomics of the South African citrus psylla, *Trioza erytrae* (Del Guercio) (Homoptera: Psyllidae) 5. The influence of host plant quality. *Journal of the Entomological Society of Southern Africa* **34**: 381–391, 2 figs.
- 1972. The bionomics of the South African citrus psylla, *Trioza erytrae* (Del Guercio) (Homoptera: Psyllidae) 6. Final population studies and a discussion of population dynamics. *Journal of the Entomological Society of Southern Africa* **35**: 235–251, 4 figs.
- 1973. Notes on the biology of the South African citrus psylla, *Trioza erytrae* (Del Guercio) (Homoptera: Psyllidae). *Journal of the Entomological Society of Southern Africa* **36**: 299–306, 4 figs.
- Crawford, D. L.** 1910. American Psyllidae I (Trioziinae). *Pomona College Journal of Entomology* **2**: 228–237, figs 98–99.
- 1911. American Psyllidae IV (A partial revision of subfamilies). *Pomona College Journal of Entomology* **3**: 480–503, figs 157–160.
- 1914. A monograph of the jumping plant-lice or Psyllidae of the New World. *Bulletin of the United States National Museum* **85**: ix+186pp., 30 pls.
- 1915. Ceylonese and Philippine Psyllidae (Homoptera). *Philippine Journal of Science* (D) **10** (4): 257–267, 1 pl.
- 1918. The jumping plant-lice (Family Psyllidae) of the Hawaiian Islands. A study in insect evolution. *Proceedings of the Hawaiian Entomological Society* **3**: 430–456, pl. 8.
- 1919. The jumping plant-lice of the palaeotropics and the south Pacific islands. Family Psyllidae, or Chermidae, Homoptera. *Philippine Journal of Science* **15**: 139–207, 3 pls.
- 1927. Hemiptera. Psyllidae (Chermidae). *Insects of Samoa* **2** (1): 29–33, 4 figs.
- Dahlgren, R.** 1977. A commentary on a diagrammatic presentation of the angiosperms in relation to the distribution of character states. *Plant Systematics and Evolution*, Supplement 1: 253–283, 12 figs.
- Dębski, B.** 1918 [?]. Liste des cérides signalées en Égypte jusqu'à ce jour. *Mémoires de la Société Entomologique d'Égypte* **1** (4): 3–38.
- Del Guercio, G.** 1918. Note ed osservazioni di entomologia agraria. Il cecidio delle foglie del limone ed il suo cecidoozo in Eritrea. *Agricoltura Coloniale* **1918**: 167–169, 2 figs, 1 pl.
- Dobreaanu, E. & Manolache, C.** 1962. Homoptera Psylloidea. *Fauna Republicii Populare Romine Insecta* **8** (3): 1–376, 270 figs.



- Eastop, V. F.** 1961. Some aspects of psyllid taxonomy. *Annals and Magazine of Natural History* (13) **4**: 169.
- Edwards, J.** 1896. *The Hemiptera-Homoptera of the British Islands*, Psyllina: 224–261, pls 26–30. London.
- Emden, H. F. van** (Ed.) 1972. *Aphid technology with special reference to the study of aphids in the field*, xiv + 344 pp. London.
- Enderlein, G.** 1918. Psyllidologica V. *Zoologische Jahrbücher* (Systematik) **41**: 479–486, 7 figs, pl. 7.
- 1921. Psyllidologica VI. *Zoologischer Anzeiger* **52**: 115–122, 2 figs.
- 1926. Psyllidologica VIII. *Entomologische Mitteilungen* **15**: 397–401.
- Foerster, A.** 1848. Uebersicht der Gattungen und Arten in der Familie der Psylloden. *Verhandlungen des naturhistorischen Vereins der preussischen Rheinlande und Westfalens* **5**: 65–94.
- Ferris, G. F.** 1926. Observations on the Chermidae (Hemiptera; Homoptera). Part III. *Canadian Entomologist* **58**: 13–20, 5 figs.
- Froggatt, W. W.** 1901. Australian Psyllidae. Part II. *Proceedings of the Linnean Society of New South Wales* **1901**: 242–298, pls 14–16.
- Harris, W. V.** 1936. Notes on two injurious psyllids and their control. *East African Agricultural Journal* **1**: 498–500, 4 figs.
- Heslop-Harrison, G.** 1958. Subfamily separation in the homopterous Psyllidae – III (a–c). *Annals and Magazine of Natural History* (13) **1**: 561–579.
- 1961. Hemiptera (Homoptera) Psyllidae. *South African Animal Life* **8**: 487–532, 12 figs.
- Hodkinson, I. D.** 1981. Status and taxonomy of the *Trioza* (*Bactericera*) *nigricornis* Förster complex (Hemiptera: Triozidae). *Bulletin of Entomological Research* **71**: 671–679, 27 figs.
- Hollis, D.** 1976. Jumping plant lice of the tribe Ciriacremini (Homoptera: Psylloidea) in the Ethiopian Region. *Bulletin of the British Museum (Natural History)* (Entomology) **34**: 1–83, 191 figs.
- Kieffer, J. J.** 1905. Étude sur de nouveaux insectes et phytoptides gallicoles du Bengale. II. Psyllides. *Annales de la Société Scientifique de Bruxelles* **29**: 159–182, figs. 5–14.
- 1908. Description de galles et d'insectes gallicoles d'Asie. *Marcellia* **7**: 149–167, 4 figs, pls 3, 4.
- Kirkaldy, G. W.** 1904. Bibliographical and nomenclatorial notes on the Hemiptera – No. 3. *Entomologist* **37**: 279–283.
- Klimaszewski, S. M.** 1962. Bemerkungen über einige neotropische Blattfloh-Arten (Homoptera, Psyllidae). *Bulletin de l'Académie Polonaise des Sciences. Série de Sciences Biologiques* **10**: 251–255, 9 figs.
- 1964. Studien über die Systematik der Unterordnung Psylloidea. *Annales Zoologici, Warszawa* **22**: 81–138.
- 1968. Stosunki pokrewieństwa środkowoeuropejskich gatunków z rodzaju *Trioza* Först. (Homoptera, Psylloidea) w świetle badań metodami taksonomii numerycznej. *Annales Universitatis Mariae Curie – Skłodowska Lublin (C)* **22**: 1–20.
- 1973. The jumping plant lice or psyllids (Homoptera, Psylloidea) of the Palearctic. An annotated check-list. *Annales Zoologici, Warszawa* **30**: 155–286.
- 1975. Psylloidea koliszki (Insecta: Homoptera). *Fauna Polski* **3**: 1–294, 512 figs.
- Kuwayama, S.** 1910. Die psylliden Japans. II. *Transactions of the Sapporo Natural History Society* **3**: 53–66 + [1], pl. 2.
- Kwon, Y. J.** 1983. Psylloidea of Korea (Homoptera: Sternorrhyncha). *Insecta Koreana*, Series 2: [i] + 1–181, 32 pls.
- Laing, F.** 1923. On some Psyllidae (Hem.-Hom.) from the New World. *Annals and Magazine of Natural History* (9) **11**: 696–705, 7 figs.
- 1930. Some records of Indo-Malayan Psyllidae. *Indian Forest Records* (Entomological Series) **14** (8): 35–44, 5 figs.
- Loginova, M. M.** 1964. Psyllinea. In Bei-Bienko, G. Ya. (Ed.), Keys to the insects of the European USSR.1. *Opređelitel' po Faune SSR* **84**: 437–482, 220 figs. [In Russian, English translation, Israel program for scientific translations, Jerusalem 1967: 551–608.]
- 1970. New species of psyllids (Homoptera, Psylloidea) from Middle Asia. *Entomologisches Obozrenie* **49**: 601–623, 19 figs. [In Russian, English translation, *Entomological Review, Washington* **49**: 370–385 (1971)].
- 1972a. Revision of jumping plant lice of the tribe Pauropsyllini Crawf. (Homoptera, Psylloidea, Carsidaridae). *Entomologisches Obozrenie* **51**: 837–853, 49 figs. [In Russian, English translation, *Entomological Review, Washington* **51**: 497–505 (1973)].
- 1972b. On the fauna of Psylloidea (Homoptera) from Morocco. *Commentationes Biologicae* **47**: 1–37, 121 figs.
- Lounsbury, C. P.** 1897. Psyllidae or jumping plant lice. Citrus Psylla. *Report of the Government Entomologist, Cape of Good Hope* **1896**: 115–118, 2 figs.

- Löw, F. 1879. Zur Systematik der Psylloden. *Verhandlungen der kaiserlich-königlichen zoologisch-botanischen Gesellschaft in Wien* 28: 585–610, pl. 9.
- 1886. Neue Beiträge zur Kenntniss der Psylliden. *Verhandlungen der kaiserlich-königlichen zoologisch-botanischen Gesellschaft in Wien* 36: 149–170, pl. 6.
- Maskell, W. M. 1879. On some Coccidae in New Zealand. *Transactions and Proceedings of the New Zealand Institute (Zoology)* 11: 187–228, pls 5–8.
- 1890. On some species of Psyllidae in New Zealand. *Transactions and Proceedings of the New Zealand Institute* 21: 157–170, pls 10–12.
- Mathur, R. N. 1975. *Psyllidae of the Indian subcontinent*, xii + 429 pp., 6 pls, 136 figs. New Delhi.
- McDaniel, J. R. & Moran, V. C. 1972. The parasitoid complex of the Citrus Psylla *Trioza erytreae* (Del Guercio) [Homoptera: Psyllidae]. *Entomophaga* 17: 297–317, 3 figs.
- Miyatake, Y. 1972. Studies on the Philippine Psyllidae (Hemiptera: Homoptera) II. *Bulletin of the Osaka Museum of Natural History* 26: 11–34, 6 figs, 2 pls.
- 1981. Studies on Psyllidae of Nepal I. Results of the survey in the Kathmandu Valley, 1979. Part 1 (Hemiptera: Homoptera). *Bulletin of the Osaka Museum of Natural History* 34: 47–60, pl. 5, 7 figs.
- Moran, V. C. 1968a. The development of the citrus psylla, *Trioza erytreae* (Del Guercio) (Homoptera: Psyllidae), on *Citrus limon* and four indigenous host plants. *Journal of the Entomological Society of Southern Africa* 31: 391–402.
- 1968b. Preliminary observations on the choice of host plants by adults of the citrus psylla, *Trioza erytreae* (Del Guercio) (Homoptera: Psyllidae). *Journal of the Entomological Society of Southern Africa* 31: 403–410, 1 fig.
- Moran, V. C. & Blowers, J. R. 1967. On the biology of the South African citrus psylla, *Trioza erytreae* (Del Guercio) (Homoptera: Psyllidae). *Journal of the Entomological Society of Southern Africa* 30: 96–106, 8 figs.
- Moran, V. C. & Brown, R. P. 1973. The antennae, host plant chemoreception and probing activity of the citrus psylla *Trioza erytreae* (Del Guercio) (Homoptera: Psyllidae). *Journal of the Entomological Society of Southern Africa* 36: 191–202, 7 figs.
- Moran, V. C. & Buchan, R. P. 1975. Oviposition by the citrus psylla, *Trioza erytreae* (Homoptera: Psyllidae), in relation to leaf hardness. *Entomologia Experimentalis et Applicata* 18: 96–104, 3 figs.
- Mound, L. A. & Halsey, S. H. 1978. *Whitefly of the world. A systematic catalogue of the Aleyrodidae (Homoptera) with host plant and natural enemy data*, [vi] + 340 pp. Chichester.
- Newstead, R. 1914. VI. Homoptera (Psyllidae and Coccidae) collected in the Lagos District by W. A. Lamborn. *Transactions of the Entomological Society of London* 1913: 520–524, pl. 29.
- Orian, A. 1972. The Psylloidea of Mauritius, with a description of *Trioza eastopi* sp. nov. *Fauna of Mauritius* 1 (1): [i] + 1–6 + [iii], 10 pls.
- Oshanin, B. 1912. *Katalog der paläarktischen Hemipteren (Heteroptera, Homoptera-Auchenorrhyncha und Psylloidea)*, xvi + 187 pp. Berlin.
- Petty, F. W. 1923. A new species of psyllid. *South African Journal of Natural History* 4: 30–33, 6 figs.
- 1924. South African psyllids. *Entomology Memoirs. Department of Agriculture, Union of South Africa* 2: 21–30, pls 1–3.
- 1925. New South African psyllids. *South African Journal of Natural History* 5: 125–142, pls 12, 13.
- 1933. New species of South African psyllids, III. *Entomology Memoirs. Department of Agriculture, Union of South Africa* 8: 1–23, 2 pls.
- Pflugfelder, O. 1941. Psyllina. In Bronns, H. G., *Klassen und Ordnungen des Tierreichs*. Funfter Band: Arthropoda. 3. Abteilung: Insecta. VIII. 1–95, 75 figs. Leipzig.
- Puton, A. 1876. Notes pour servir à l'étude des Hémiptères. 3<sup>e</sup> Partie. *Annales de la Société Entomologique de France* (5) 6: 275–290.
- 1886. Catalogue des Hémiptères (Hétéroptères, Cicadines et Psyllides) de la faune paléarctiques. *Revue d'Entomologie, Caen* 5 (4–7): 1–100 [special pagination].
- Ramirez-Gomez, C. 1960. Los Psilidos de España (Conclusión). *Boletín de la Real Sociedad Española de Historia Natural (Biologica)* 57: 1–87, 4 pls.
- Riley, C. V. 1884. The Psyllidae of the United States. *Proceedings of the American Association for the Advancement of Science* 32: 319.
- 1885. Notes on North American Psyllidae. *Proceedings of the Biological Society of Washington* 2: 67–79.
- Roberts, H. 1969. Forest insects of Nigeria with notes on their biology and distribution. *Institute Paper, Commonwealth Forestry Institute, Oxford* 44: 1–206.

- Rübsaamen, Ew. H.** 1899. Mitteilungen über neue und bekannte Gallen aus Europa, Asien, Afrika und Amerika. *Entomologische Nachrichten, Berlin* **25**: 225–282, 2 pls, 18 figs.
- Samy, O.** 1972. Psyllids of Egypt [Homoptera: Psyllidae]. *Bulletin de la Société Entomologique d'Egypte* **56**: 437–480, 88 figs.
- Scott, J.** 1882a. XVII. Description of a new genus and two new species of Psyllidae from South America. *Transactions of the Entomological Society of London* **1882**: 443–448, pl. 18.
- 1882b. On certain genera and species of the group Psyllidae in the collection of the British Museum. *Transactions of the Entomological Society of London* **1882**: 449–473, pls 18, 19.
- Šulc, K.** 1909. *Trioza cockerelli* n. sp., a novelty from North America, being also of economic importance. *Casopis České Společnosti Entomologické* **6**: 102–108, 14 figs.
- 1910. Monographia generis *Trioza* Foerster. Species Regionis Palaearcticae. Pars. I., No. 1–10. *Sitzungsberichte der Königlichen Böhmisches Gesellschaft der Wissenschaften* **1910** (17): 1–34, pls 1–10.
- 1911. Monographia generis *Trioza* Foerster. Species Regionis Palaearcticae. Pars II., No. 11–20. *Sitzungsberichte der Königlichen Böhmisches Gesellschaft der Wissenschaften* **1911** (5): 1–34, pls 11–20.
- 1912. Monographia generis *Trioza* Foerster. Species Regionis Palaearcticae. Pars III., No. 21–35. *Sitzungsberichte der Königlichen Böhmisches Gesellschaft der Wissenschaften* **1912** (16): 1–63, pls 21–35.
- 1913. Monographia generis *Trioza* Foerster. Species Regionis Palaearcticae. Pars IV., No. 36–49. *Sitzungsberichte der Königlichen Böhmisches Gesellschaft der Wissenschaften* **1913** (1): 1–48, pls 36–68.
- Takahashi, R.** 1932. Aleyrodidae of Formosa. Part 1. *Report of the Department of Agriculture, Government Research Institute, Formosa, Japan* **59**: 1–52, 33 figs.
- Thomson, C. G.** 1877. XXIX. Öfversigt af Skandinaviens Chermes-arter. *Opuscula Entomologica* (Editio C. G. Thomson), Trelleborg **8**: 820–841.
- Thorne, R. F.** 1976. A phylogenetic classification of the Angiospermae. *Evolutionary Biology* **9**: 35–106, 4 figs.
- Tuthill, L. D.** 1938. Some new North American Psyllidae (Homoptera). *Entomological News* **49**: 241–246, pl. 5.
- 1939. *Neotriozella* and a new related genus (Homoptera: Psyllidae). *Bulletin of the Brooklyn Entomological Society* **34**: 51–54.
- 1943. The psyllids of America north of Mexico (Psyllidae: Homoptera) (Subfamilies Psyllinae and Triozinae). *Iowa State College Journal of Science* **17**: 443–660, 313 figs.
- 1944. Contributions to the knowledge of the Psyllidae of Mexico. *Journal of the Kansas Entomological Society* **17**: 143–159, figs 1–35.
- 1945. Contributions to the knowledge of the Psyllidae of Mexico. *Journal of the Kansas Entomological Society* **18**: 1–29, figs 36–93.
- 1952. On the Psyllidae of New Zealand (Homoptera). *Pacific Science* **6**: 83–125, 32 figs.
- 1956. A new genus of Psyllidae from Hawaii (Homoptera). *Proceedings of the Hawaiian Entomological Society* **16**: 158–161, 2 figs.
- 1959. Los Psyllidae del Perú Central (Insecta: Homoptera). *Revista Peruana de Entomologica Agricola* **2** (2): 1–27, 28 figs.
- 1964. Conocimientos Adicionales sobre los Psyllidae (Homoptera) del Perú. *Revista Peruana de Entomologia* **7** (1): 25–32, 11 figs.
- Tuthill, L. D. & Taylor, K. L.** 1955. Australian genera of the family Psyllidae (Hemiptera: Homoptera). *Australian Journal of Zoology* **3**: 227–257, 22 figs.
- Uichanco, L. B.** 1921. New records and species of Psyllidae from the Philippine Islands, with descriptions of some preadult stages and habits. *Philippine Journal of Science* **18**: 259–288, 5 pls.
- Van Der Merwe, C. P.** 1941. The Citrus Psylla (*Spanioza erytrae*, del G.). *Science Bulletin, Union of South Africa, Department of Agriculture and Forestry* **233** (Entomology Series No. 8): 1–12, 1 pl.
- Vondráček, K.** 1957. Mery-Psilloidea. *Fauna ČSR* **9**: 1–431, 265 figs.
- 1963. Jumping plant-lice (Psilloidea – Homoptera) of Central Africa. Part 1 (Congo). *Acta Entomologica Musei Nationalis Pragae* **35**: 263–290, 84 figs.
- Walker, F.** 1858. *List of specimens of homopterous insects in the collection of the British Museum*. Supplement. [4] + 369 pp. London.
- Waterston, J.** 1922. On the chalcid parasites of psyllids (Hemiptera, Homoptera). *Bulletin of Entomological Research* **13**: 41–58, 7 figs.
- White, I. M.** 1980. *Nymphal taxonomy and systematics of the Psilloidea (Insecta: Homoptera)*. [xv], 340, 12, 8, 4, 20, 8, 1pp. Unpublished Ph.D. thesis, CNA A, Liverpool Polytechnic.
- Willcocks, F. C.** 1922 [?]. *A survey of the more important economic insects and mites of Egypt*. viii + 482 + [i] pp. Cairo.

- Zacher, F. 1915. Beitrag zur Kenntnis der westafrikanischen Pflanzenschädlinge. *Tropenpflanzer, Berlin* 18: 504–534, 35 figs.  
 — 1916. Neue und wenig bekannte Pflanzenschädlinge aus unseren Kolonien. *Zeitschrift für angewandte Entomologie* 3: 418–425, 15 figs.  
 Zimmermann, E. C. 1948. Homoptera: Sternorrhyncha. Superfamily Psylloidea. *Insects of Hawaii* 5: 12–38, 15 figs.

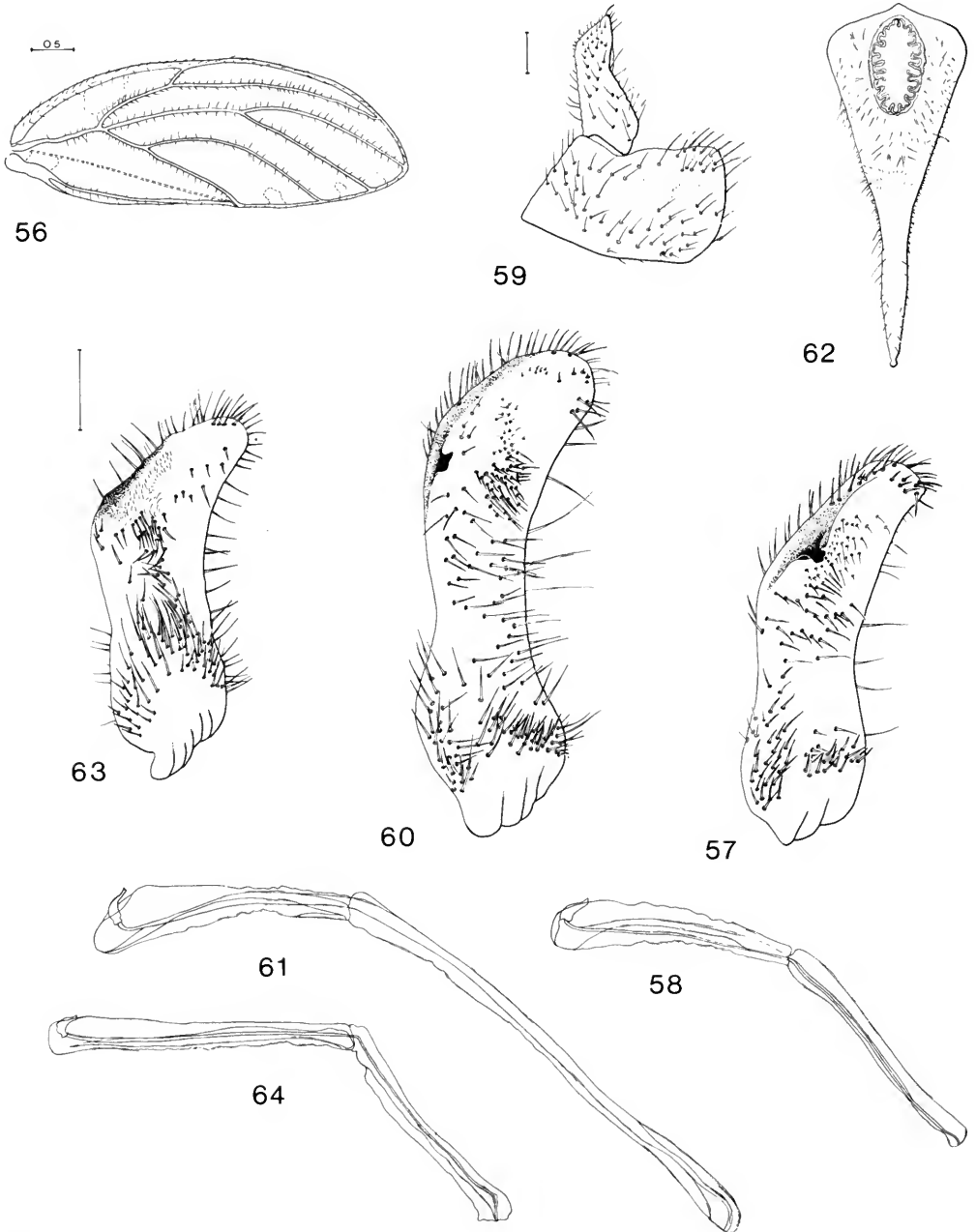

**Figs 56–64** *Triozamia* species. 56–58, *T. usambarensis*; 56, forewing; 57, paramere; 58, apical segments of aedeagus. 59–62, *T. vondraceki*; 59, ♂ proctiger, lateral view; 60, paramere; 61, apical segments of aedeagus; 62, ♀ proctiger, dorsal view. 63, 64, *T. lamborni*, 63, paramere; 64, apical segments of aedeagus.

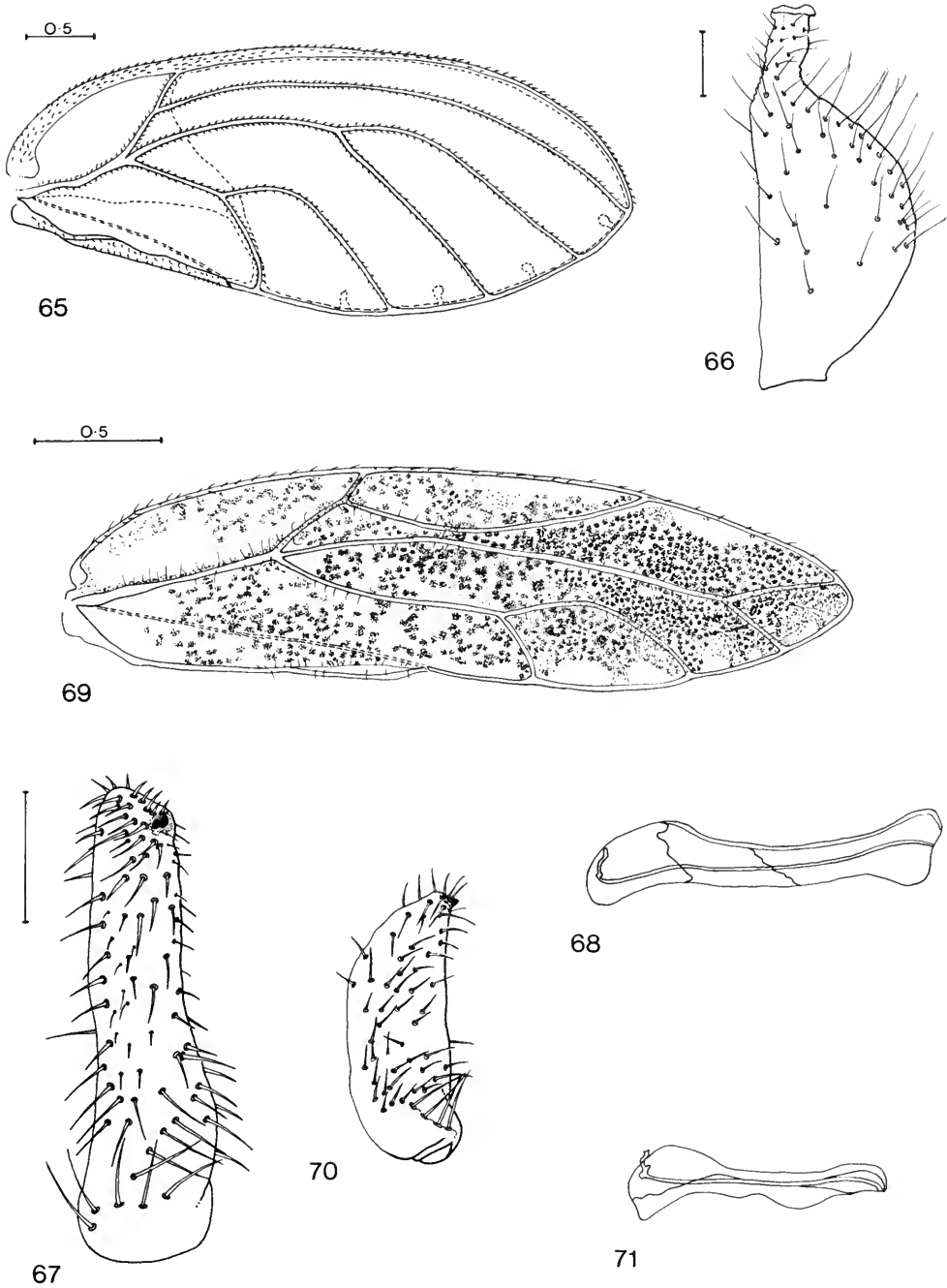

**Figs 65–71** Afrotropical Triozidae. 65–68, *Afrotrioza bersama*; 65, forewing; 66, ♂ proctiger, lateral view; 67, paramere; 68, apical segment of aedeagus. 69–71, *Trichohermes insleyi*; 69, forewing; 70, paramere; 71, apical segment of aedeagus.

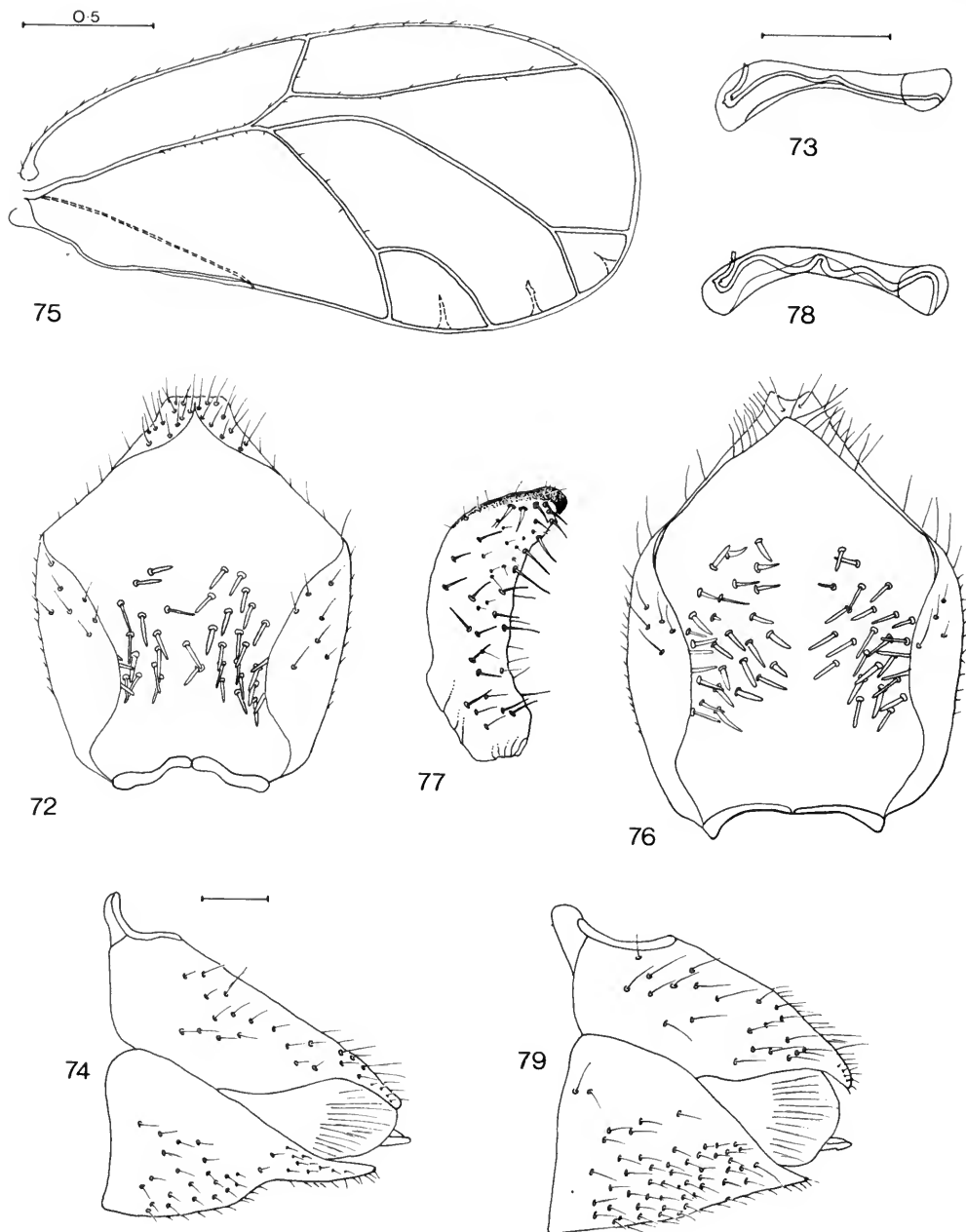

Figs 72–79 *Pauropsylla willcocksii*-group. 72–74, *P. willcocksii*; 72, ♂ proctiger, posterior view; 73, apical segment of aedeagus; 74, ♀ genital segment, lateral view. 75–78, *P. trichaeta*; 75, forewing; 76, ♂ proctiger, posterior view; 77, paramere; 78, apical segment of aedeagus. 79, *P. tatricea*, ♀ genital segment, lateral view.

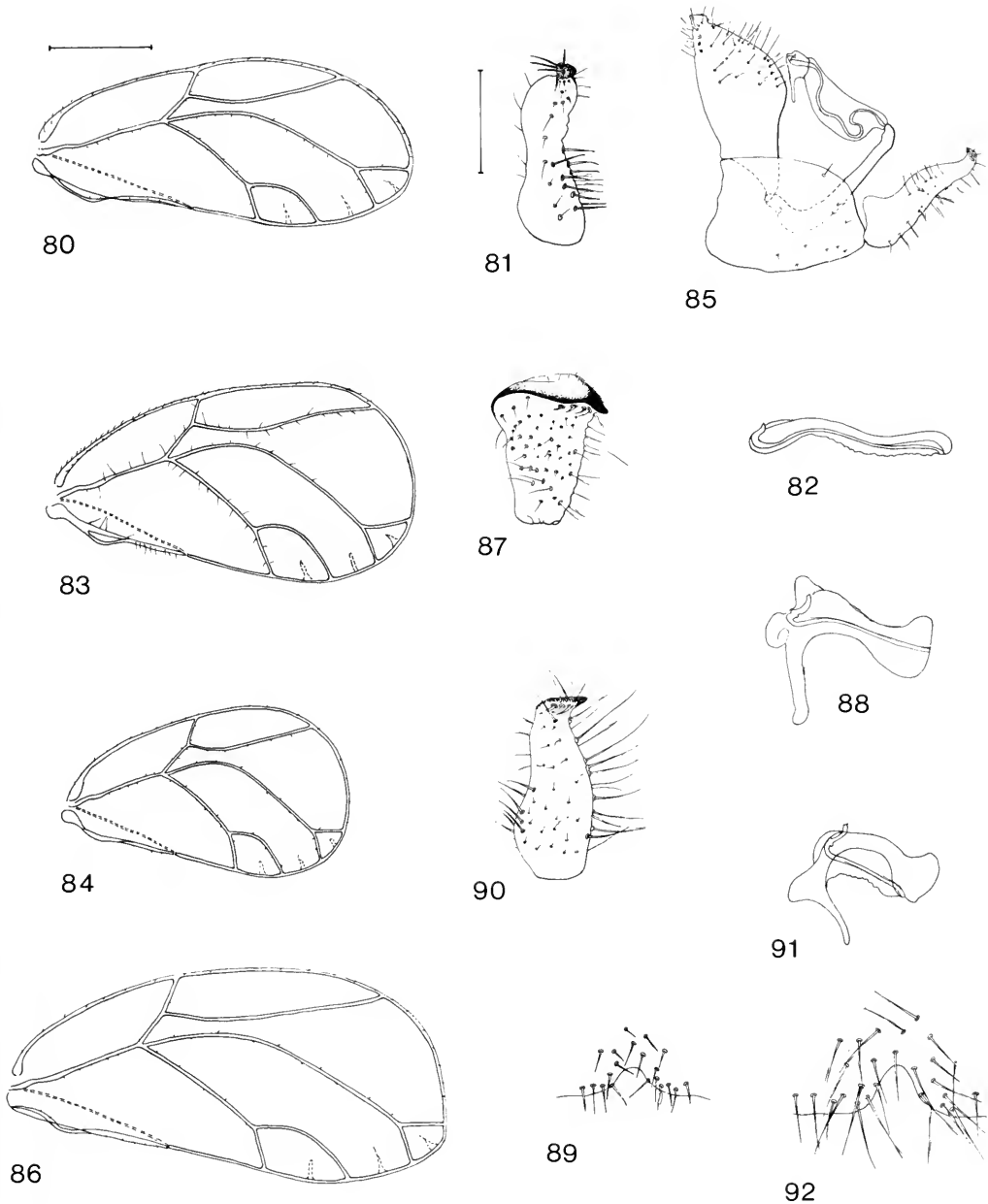

**Figs 80–92** *Pauropsylla* species. 80–82, *P. trigemma*; 80, forewing; 81, paramere; 82, apical segment of aedeagus. 83, *P. ngongae*, forewing. 84, 85, *P. brevi antennata*, 84, forewing; 85, ♂ genitalia, lateral view. 86–89, *P. septima*; 86, forewing; 87, paramere; 88, apical segment of aedeagus; 89, median posterior margin of ♀ subgenital plate, ventral view. 90–92, *P. proxima*; 90, paramere; 91, apical segment of aedeagus; 92, median posterior margin of ♀ subgenital plate, ventral view.

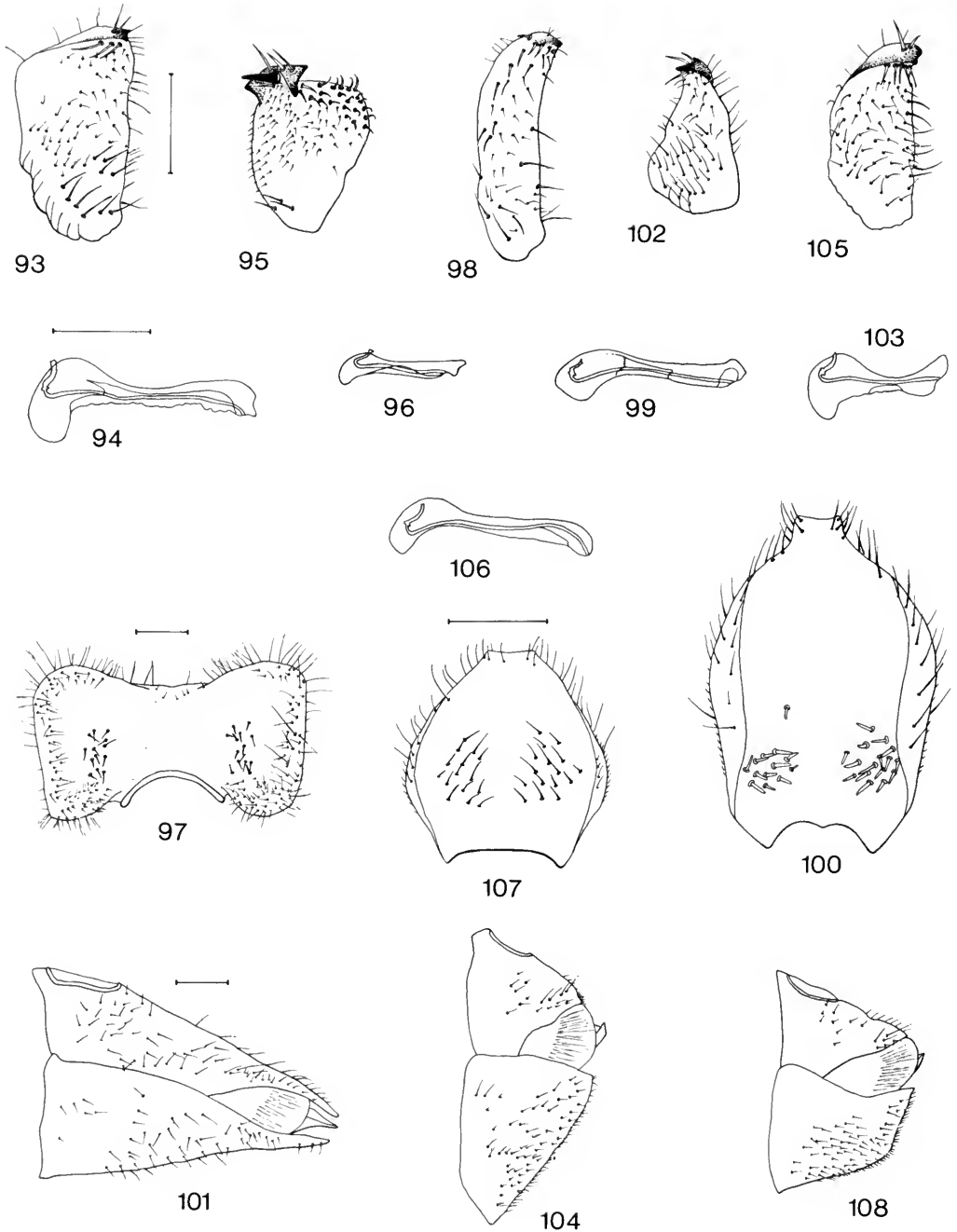

**Figs 93–108** *Pauropsylla* species. 93, 94, *P. angolensis*; 93, paramere; 94, apical segment of aedeagus. 95–97, *P. eastopi*; 95, paramere; 96, apical segment of aedeagus; 97, ♂ proctiger, posterior view. 98–101, *P. longipes*; 98, paramere; 99, apical segment of aedeagus; 100, ♂ proctiger, posterior view; 101, ♀ genital segment, lateral view. 102–104, *P. mistura*; 102, paramere; 103, apical segment of aedeagus; 104, ♀ genital segment, lateral view. 105–108, *P. senegalensis*, 105, paramere; 106, apical segment of aedeagus; 107, ♂ proctiger, posterior view; 108, ♀ genital segment, lateral view.



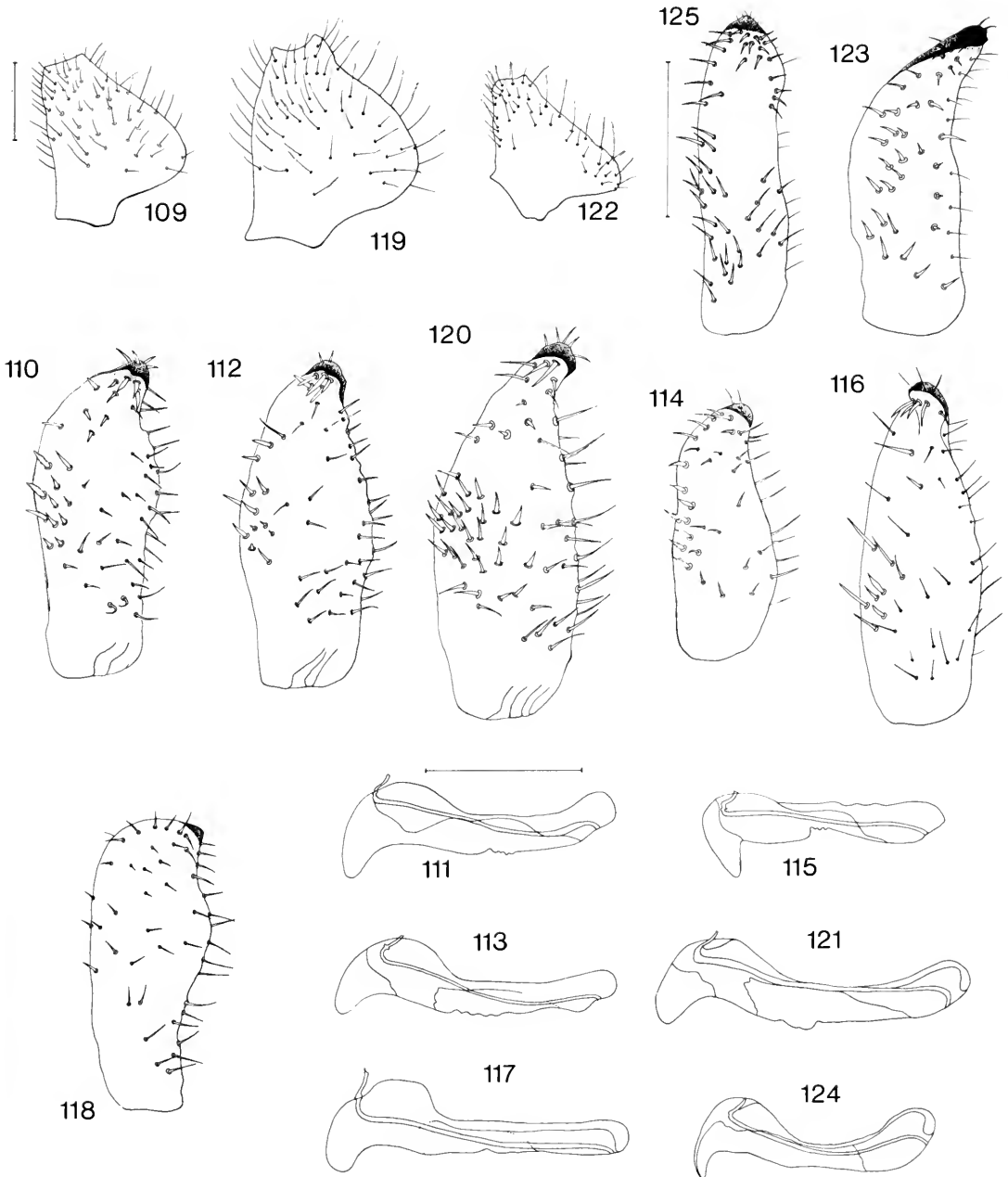

**Figs 109–125** *Trioza erythrae*-group, ♂ genitalia. 109–111, *T. erythrae*; 109, proctiger, lateral view; 110, paramere; 111, apical segment of aedeagus. 112, 113, *T. catlingi*; 112, paramere; 113, apical segment of aedeagus. 114, 115, *T. gregoryi*; 114, paramere; 115, apical segment of aedeagus. 116, 117, *T. ata*; 116, paramere; 117, apical segment of aedeagus. 118, *T. kilimanjarica*, paramere. 119–121, *T. tiliacora*; 119, proctiger, lateral view; 120, paramere; 121, apical segment of aedeagus. 122–124, *T. carvalhoi*; 122, proctiger, lateral view; 123, paramere; 124, apical segment of aedeagus. 125, *T. eafra*, paramere.

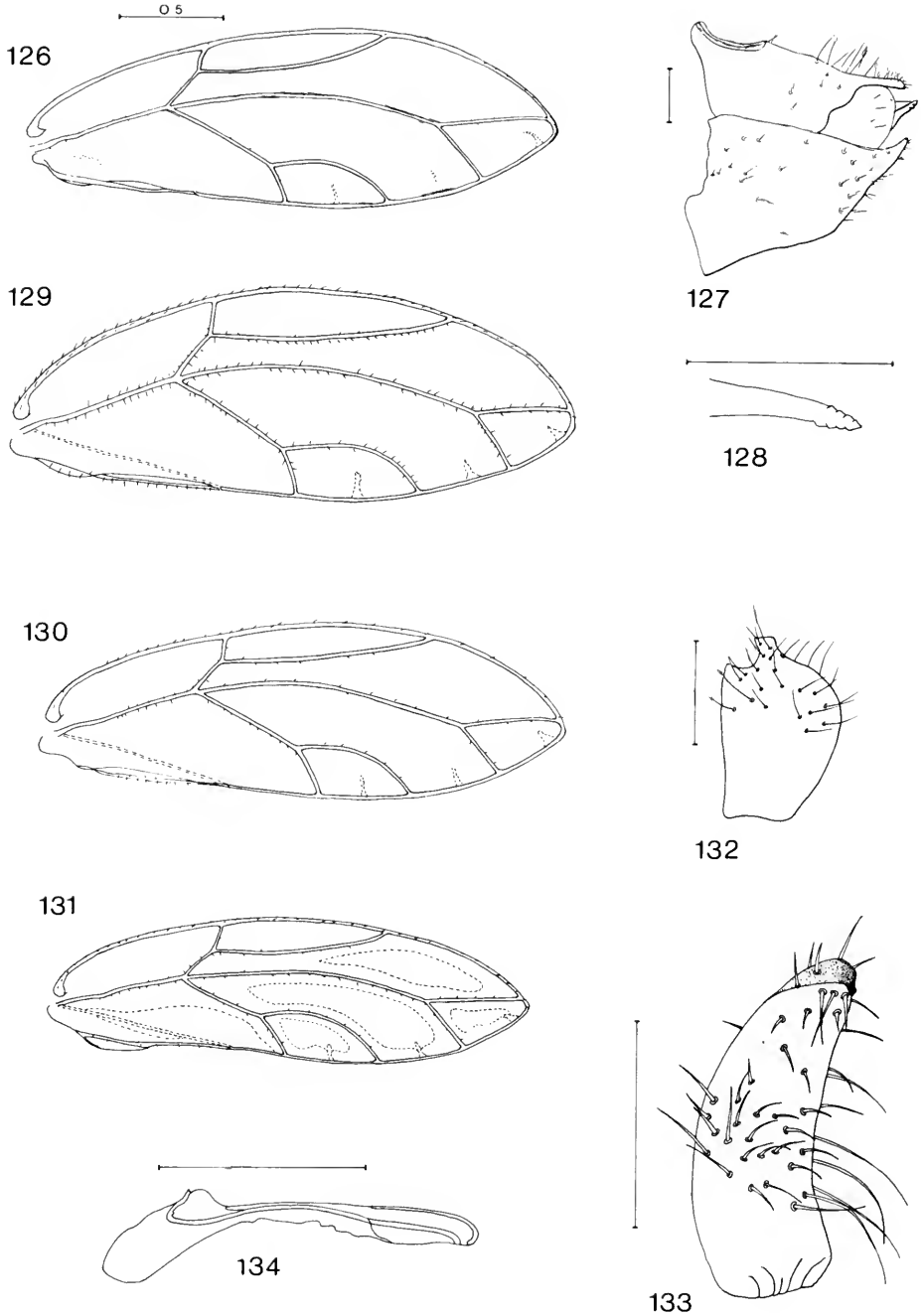

**Figs 126–134** *Trioza erythrae* and *litseae*-groups. 126, 127, *T. erythrae*; 126, forewing; 127, ♀ genital segment, lateral view. 128, *T. ata*, apex of lower valve of ovipositor. 129, *T. tiliacora*, forewing. 130, *T. carvalhoi*, forewing. 131–134, *T. xylopi*a; 131, forewing; 132, ♂ proctiger, lateral view; 133, paramere; 134, apical segment of aedeagus.

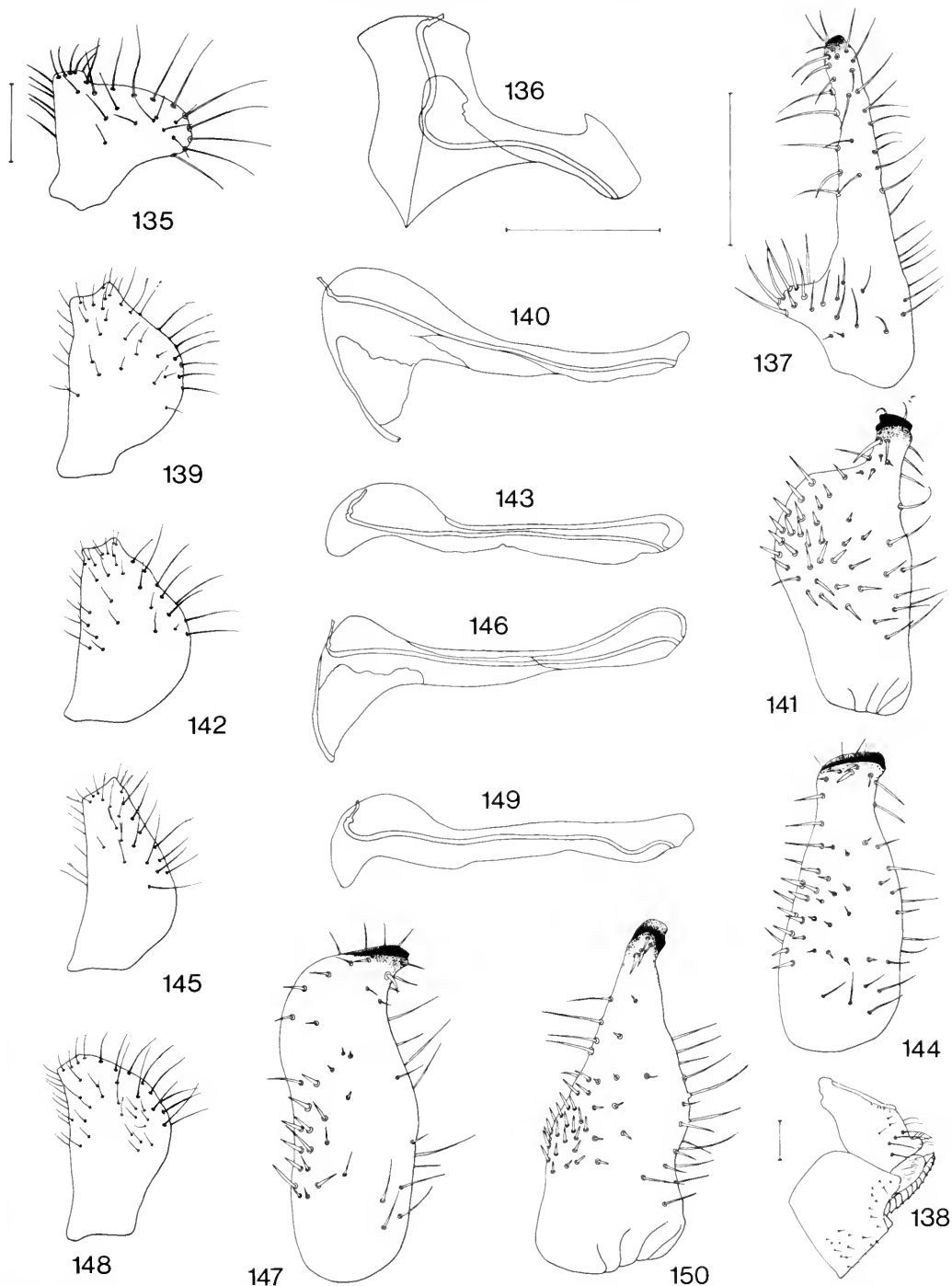

**Figs 135–150** *Trioza anomalicornis*-group. 135–138, *T. anomalicornis*; 135, ♂ proctiger, lateral view; 136, apical segment of aedeagus; 137, paramere; 138, ♀ genital segment, lateral view. 139–141, *T. kakamegae*; 139, ♂ proctiger, lateral view; 140, apical segment of aedeagus; 141, paramere. 142–144, *T. thibae*; 142, ♂ proctiger, lateral view; 143, apical segment of aedeagus; 144, paramere. 145–147, *T. tavandula*; 145, ♂ proctiger, lateral view; 146, apical segment of aedeagus; 147, paramere. 148–150, *T. luvandata*; 148, ♂ proctiger, lateral view; 149, apical segment of aedeagus; 150, paramere.

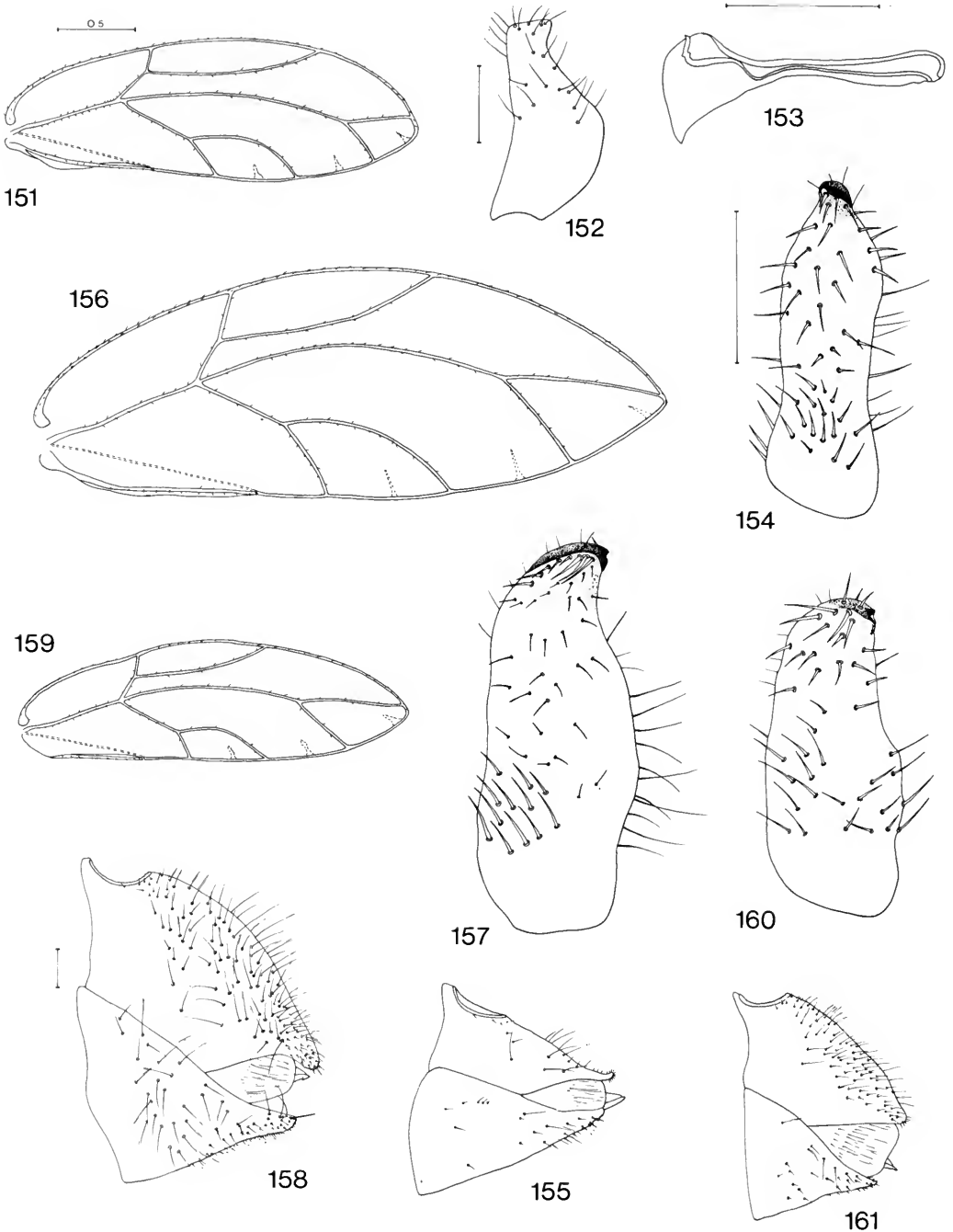

**Figs 151–161** *Trioza neoboutonia*-group. 151–155, *T. neoboutonia*; 151, forewing; 152, ♂ proctiger, lateral view; 153, apical segment of aedeagus; 154, paramere; 155, ♀ genital segment, lateral view. 156–158, *T. harteni*; 156, forewing; 157, paramere; 158, ♀ genital segment, lateral view. 159–161, *T. chiangae*; 159, forewing; 160, paramere; 161, ♀ genital segment, lateral view.

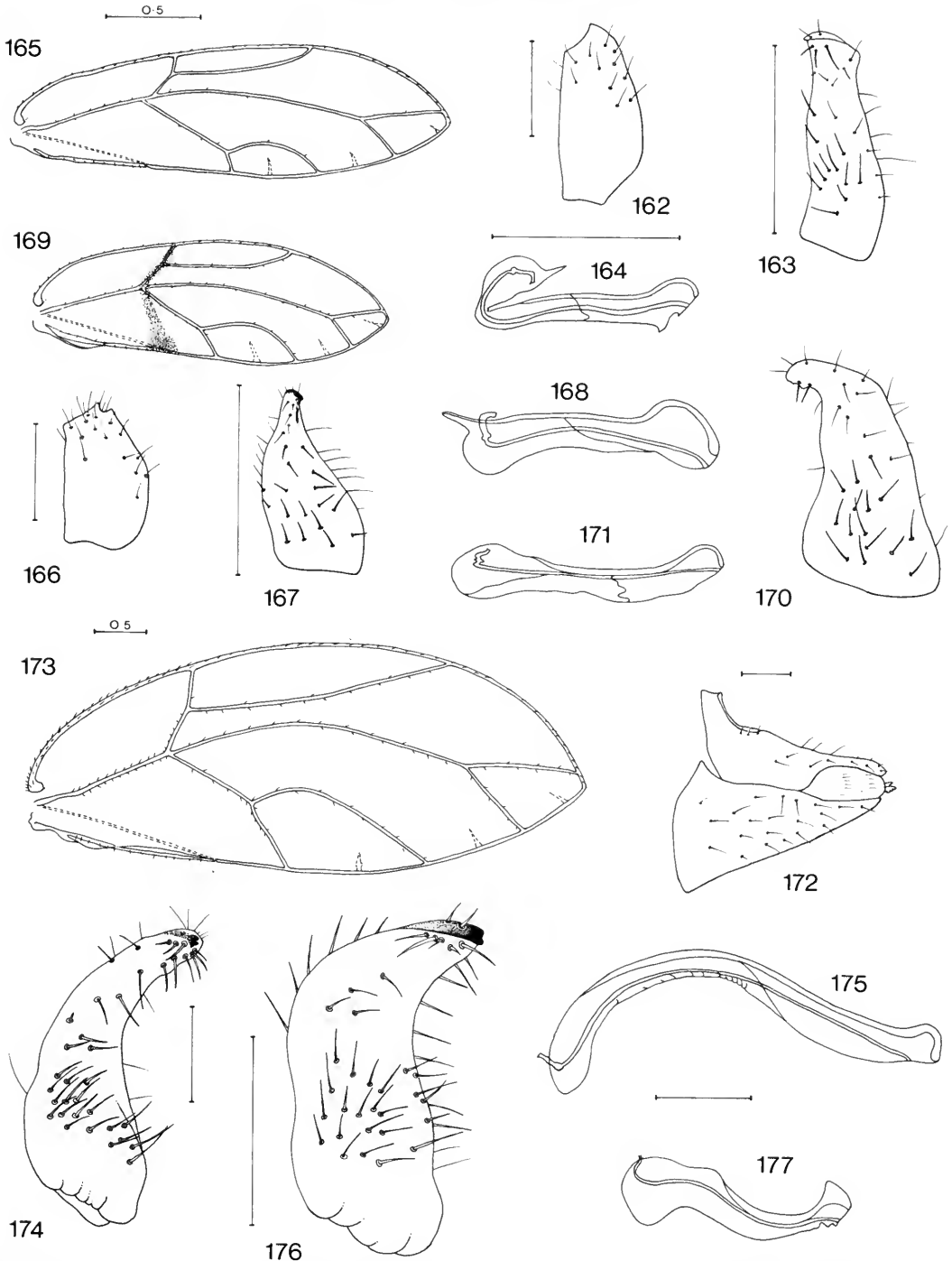

**Figs 162–177** *Trioza neoboutonia* and *hargreavesi*-groups. 162–164, *T. bamendae*; 162, ♂ proctiger, lateral view; 163, paramere; 164, apical segment of aedeagus. 165–168, *T. dinaba*; 165, forewing; 166, ♂ proctiger, lateral view; 167, paramere; 168, apical segment of aedeagus. 169–172, *T. nachingweae*; 169, forewing; 170, paramere; 171, apical segment of aedeagus; 172, ♀ genital segment, lateral view. 173–175, *T. hargreavesi*; 173, forewing; 174, paramere; 175, apical segment of aedeagus. 176, 177, *T. mirificornis*; 176, paramere; 177, apical segment of aedeagus.

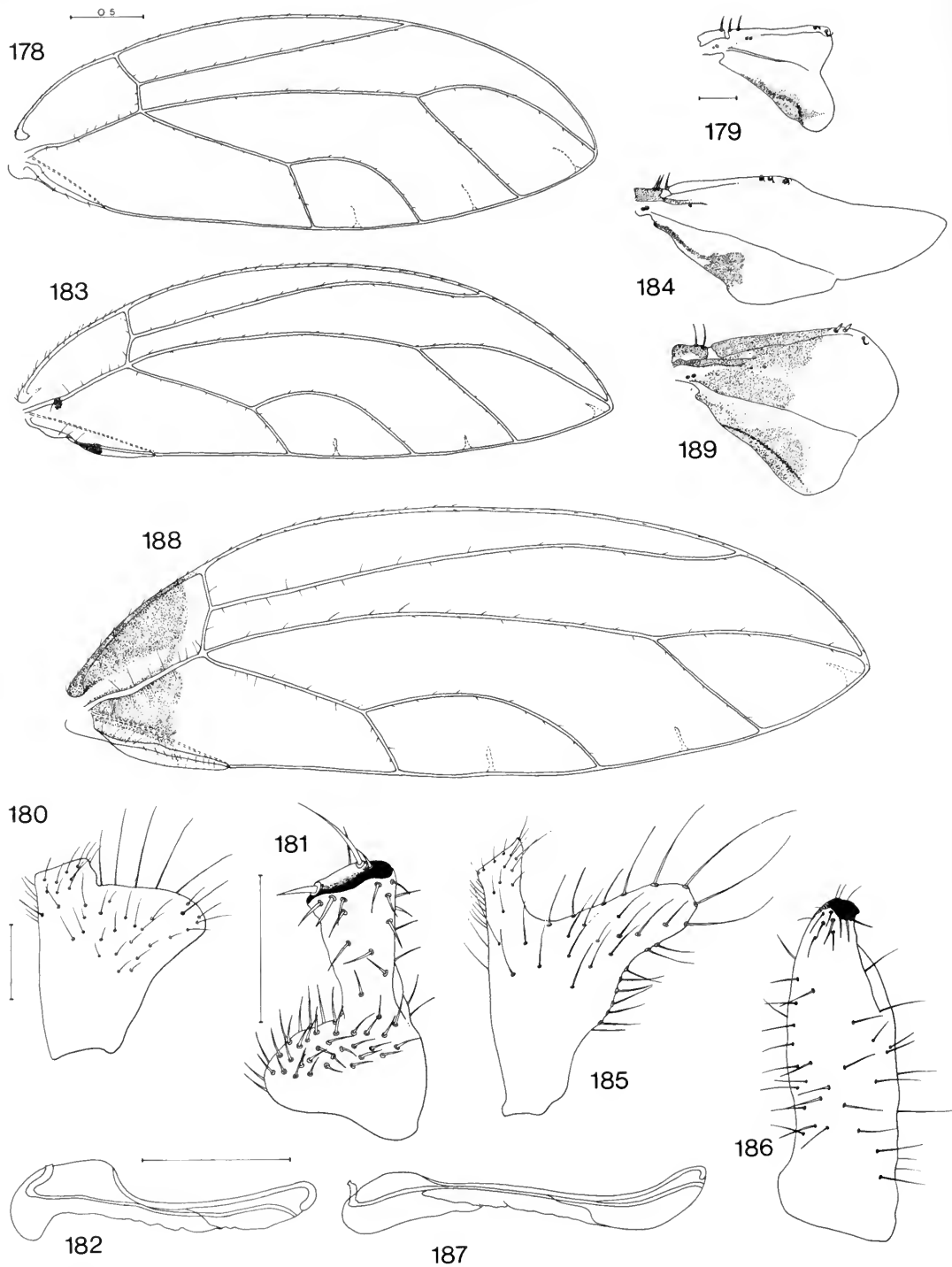

Figs 178–189 *Trioza obsolete*-group. 178–182, *T. afroboleta*; 178, forewing; 179, hindwing; 180, ♂ proctiger, lateral view; 181, paramere; 182, apical segment of aedeagus. 183–187, *T. gonjae*; 183, forewing; 184, hindwing; 185, ♂ proctiger, lateral view; 186, paramere; 187, apical segment of aedeagus. 188, 189, *T. boxi*; 188, forewing; 189, hindwing.

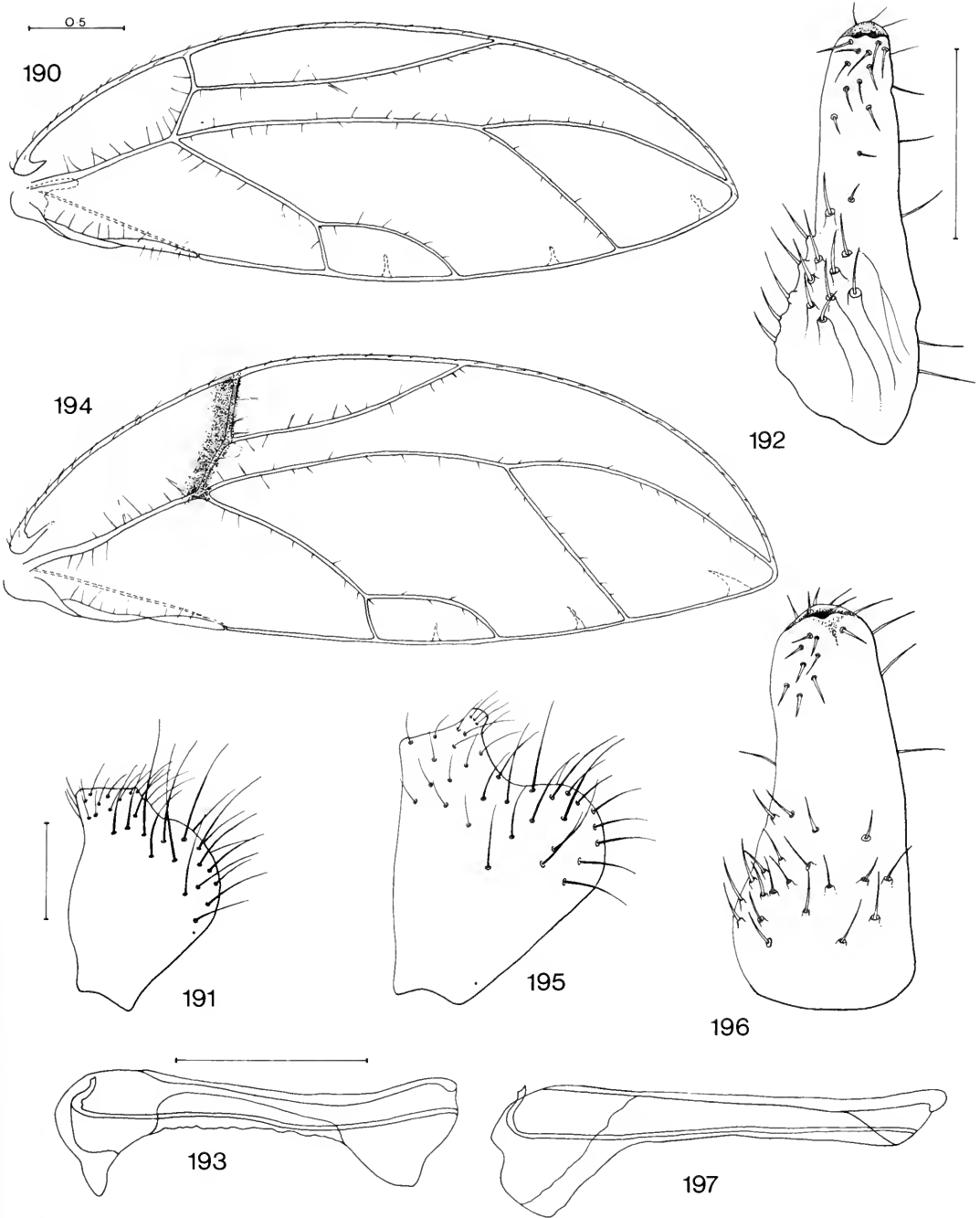

**Figs 190–197** *Trioza obsolete*-group. 190–193, *T. afrosersalisia*; 190, forewing; 191, ♂ proctiger, lateral view; 192, paramere; 193, apical segment of aedeagus. 194–197, *T. mimusops*; 194, forewing; 195, ♂ proctiger, lateral view; 196, paramere; 197, apical segment of aedeagus.

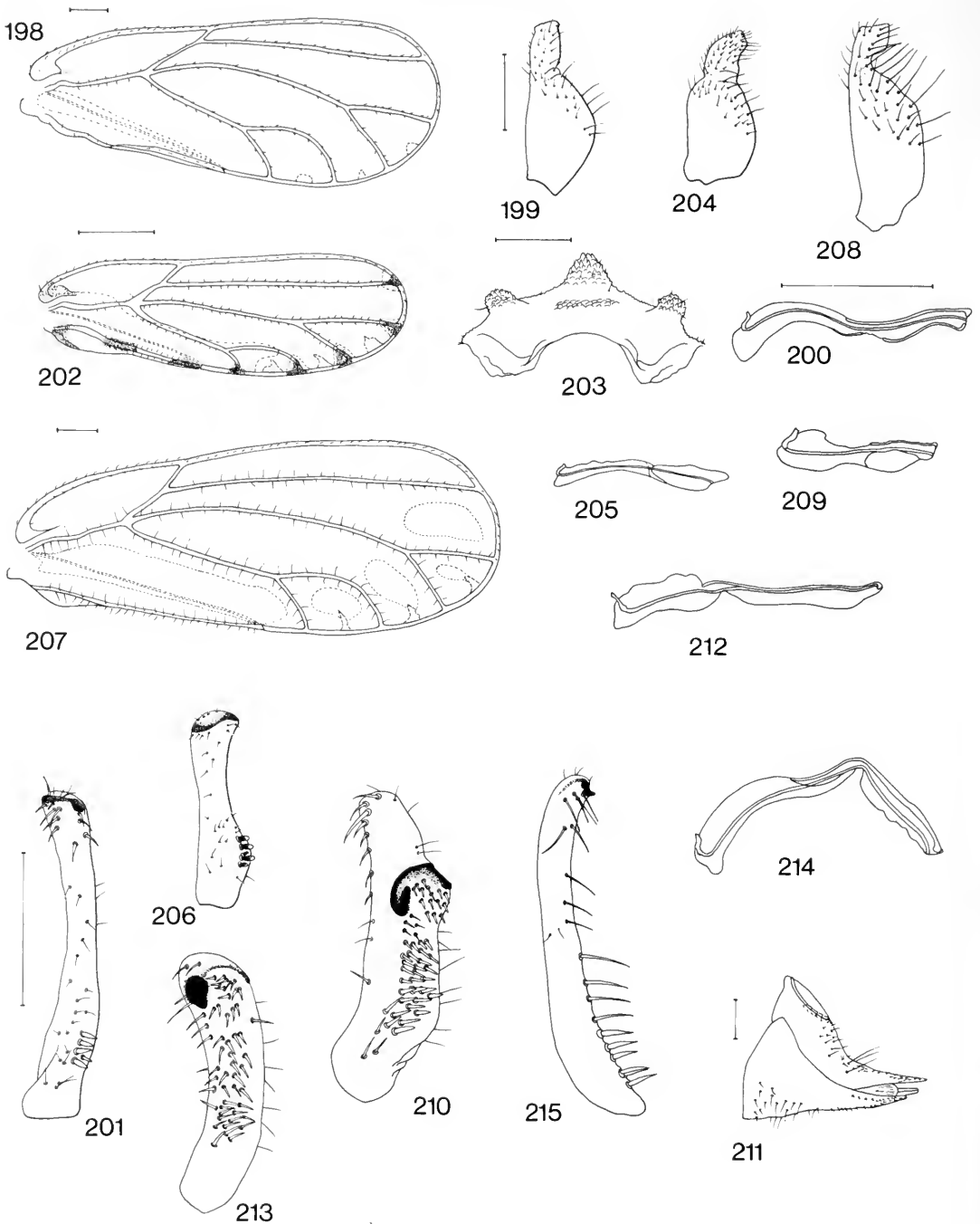

**Figs 198–215** *Trioza etiennei*-group. 198–201, *T. etiennei*; 198, forewing; 199, ♂ proctiger, lateral view; 200, apical segment of aedeagus; 201, paramere. 202–206, *T. messaratina*; 202, forewing; 203, pronotum, anterodorsal view; 204, ♂ proctiger, lateral view; 205, apical segment of aedeagus; 206, paramere. 207–211, *T. seranistama*; 207, forewing; 208, ♂ proctiger, lateral view; 209, apical segment of aedeagus; 210, paramere; 211, ♀ genital segment, lateral view. 212, 213, *T. nestasimara*; 212, apical segment of aedeagus; 213, paramere. 214, 215, *T. camerounensis*; 214, apical segment of aedeagus; 215, paramere (slightly anterior view).



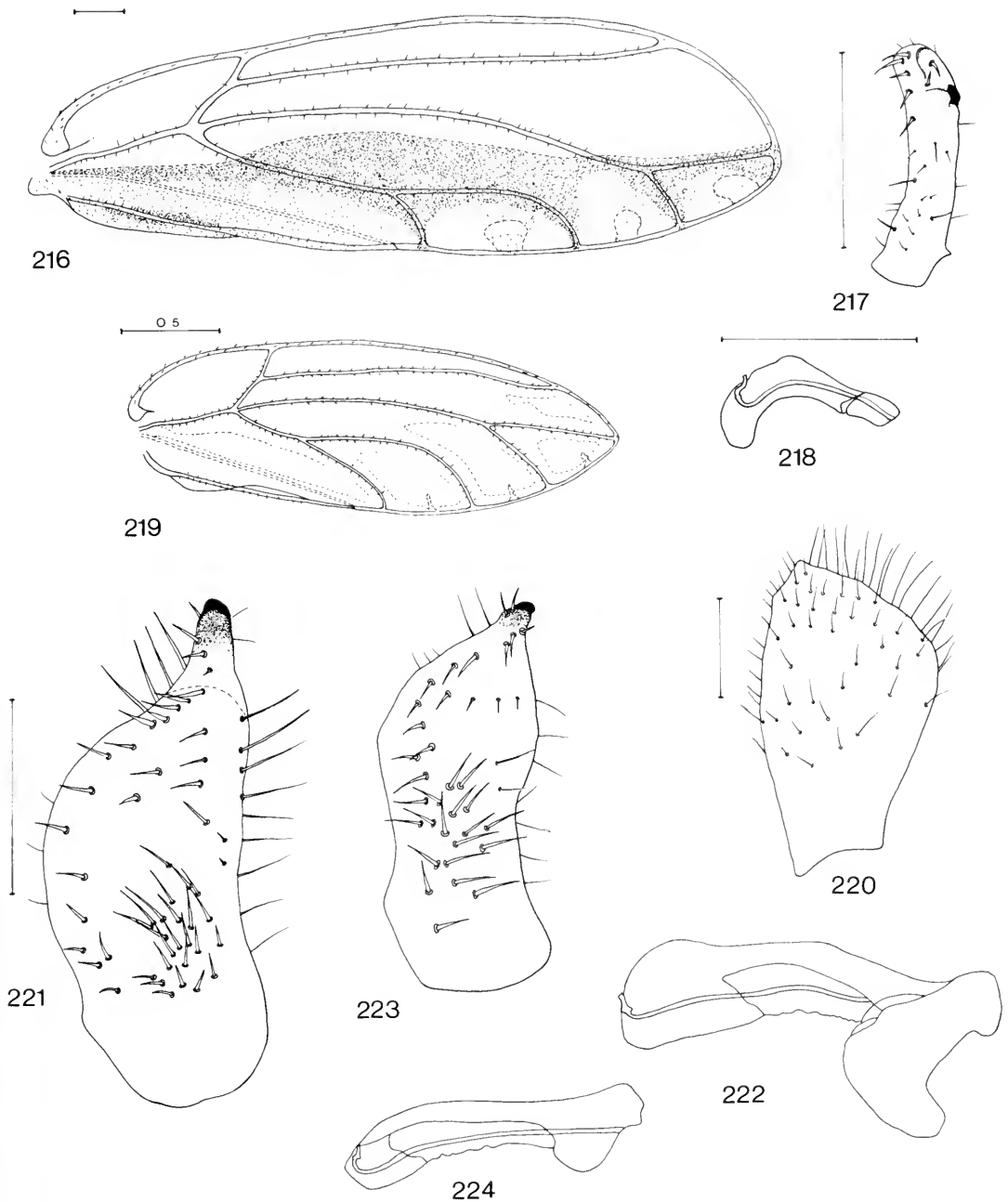

**Figs 216–224** *Trioza etiennei* and *glabea*-groups. 216–218, *T. pitkini*; 216, forewing; 217, paramere; 218, apical segment of aedeagus. 219–222, *T. glabea*; 219, forewing; 220, ♂ proctiger, lateral view; 221, paramere; 222, apical segment of aedeagus. 223, 224, *T. usambarica*; 223, paramere; 224, apical segment of aedeagus.

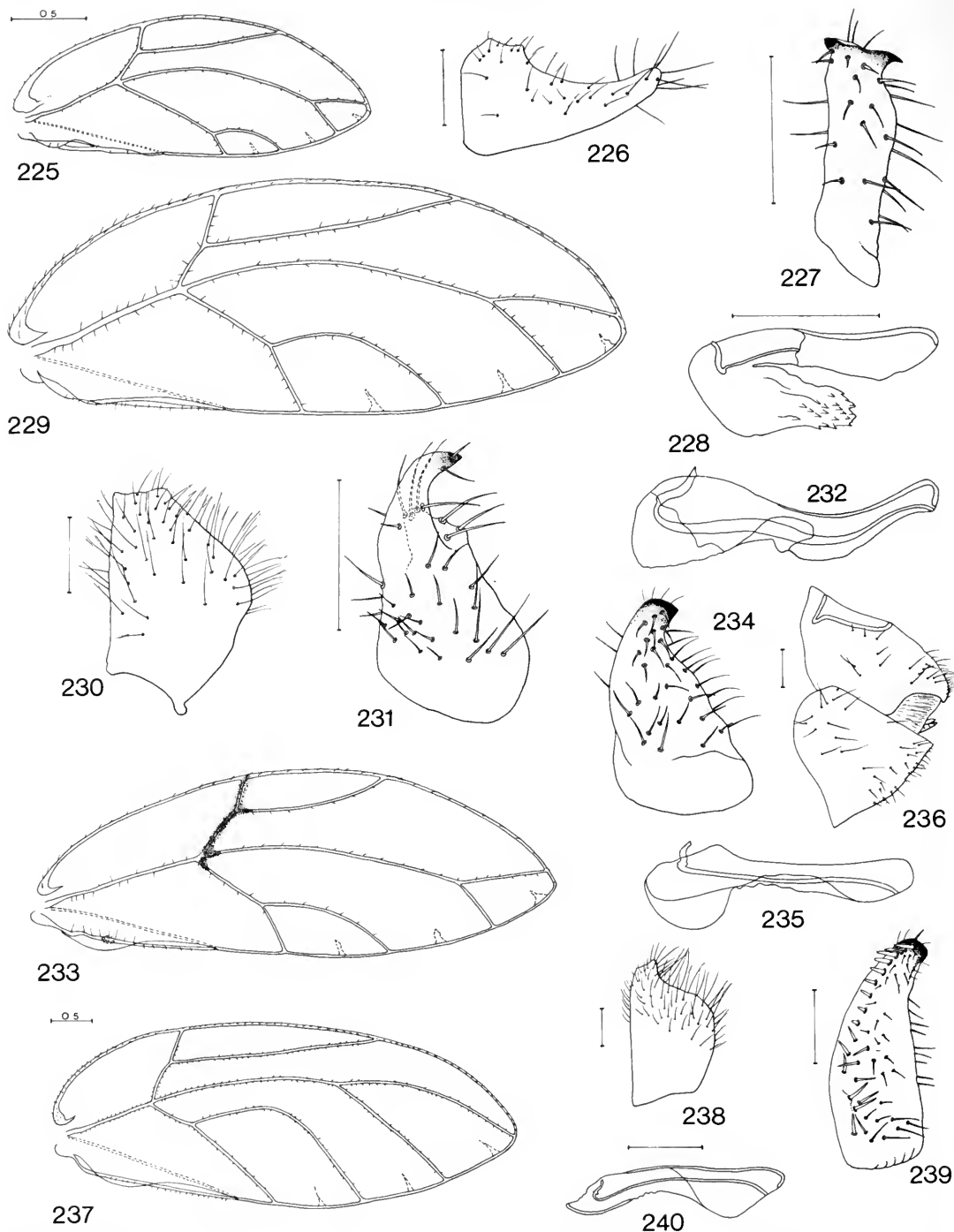

**Figs 225–240** *Trioza* species. 225–228, *T. capensis*; 225, forewing; 226, ♂ proctiger, lateral view; 227, paramere; 228, apical segment of aedeagus. 229–232, *T. ficicola*; 229, forewing; 230, ♂ proctiger, lateral view; 231, paramere; 232, apical segment of aedeagus. 233–236, *T. fuscivena*; 233, forewing; 234, paramere; 235, apical segment of aedeagus; 236, ♀ genital segment, lateral view. 237–240, *T. ghanaensis*; 237, forewing; 238, ♂ proctiger, lateral view; 239, paramere; 240, apical segment of aedeagus.

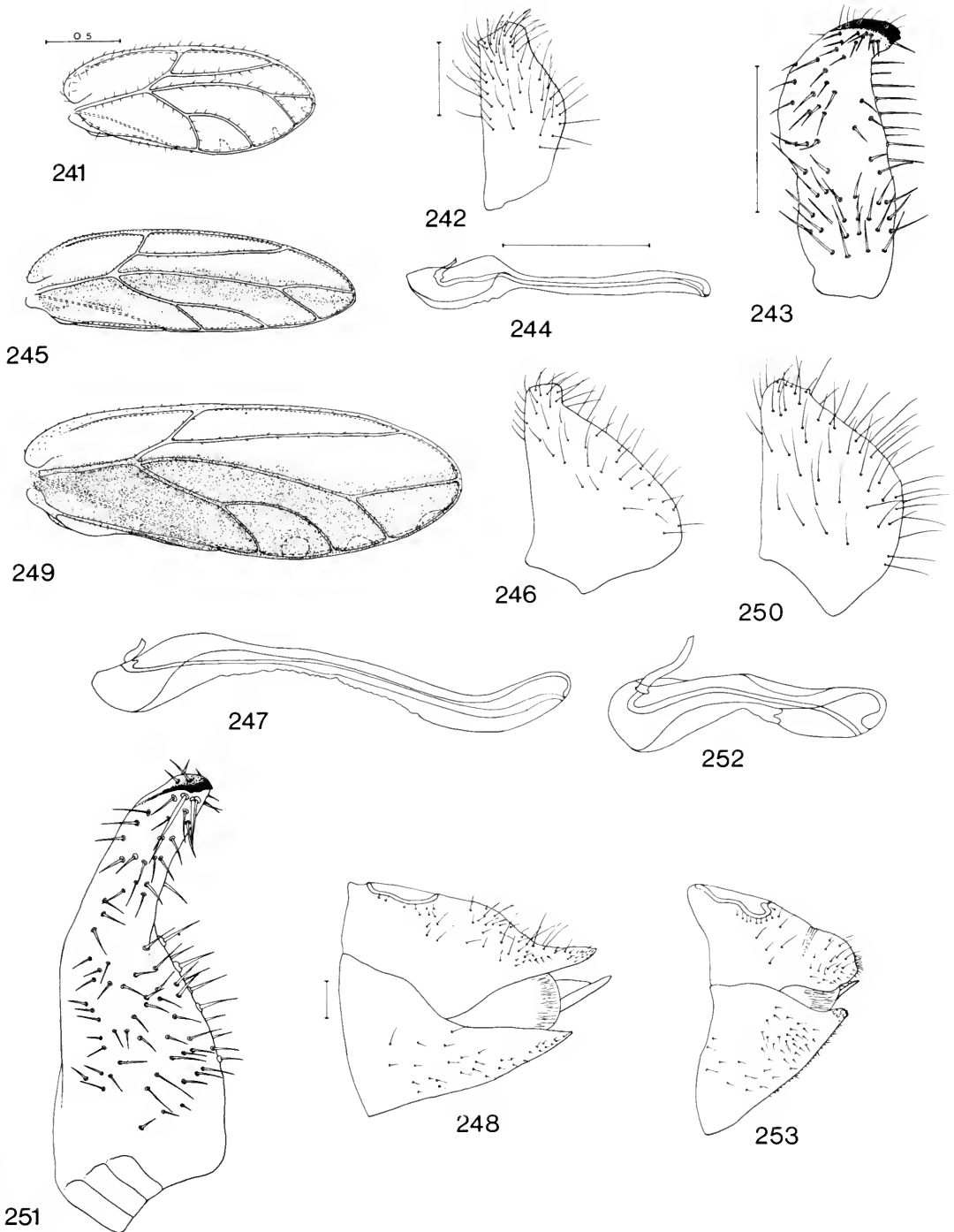

**Figs 241–253** *Trioza* species. 241–244, *T. guiera*; 241, forewing; 242, ♂ proctiger, lateral view; 243, paramere; 244, apical segment of aedeagus. 245–248, *T. karroo*; 245, forewing; 246, ♂ proctiger, lateral view; 247, apical segment of aedeagus; 248, ♀ genital segment, lateral view. 249–253, *T. laingi*; 249, forewing; 250, ♂ proctiger, lateral view; 251, paramere; 252, apical segment of aedeagus; 253, ♀ genital segment, lateral view.

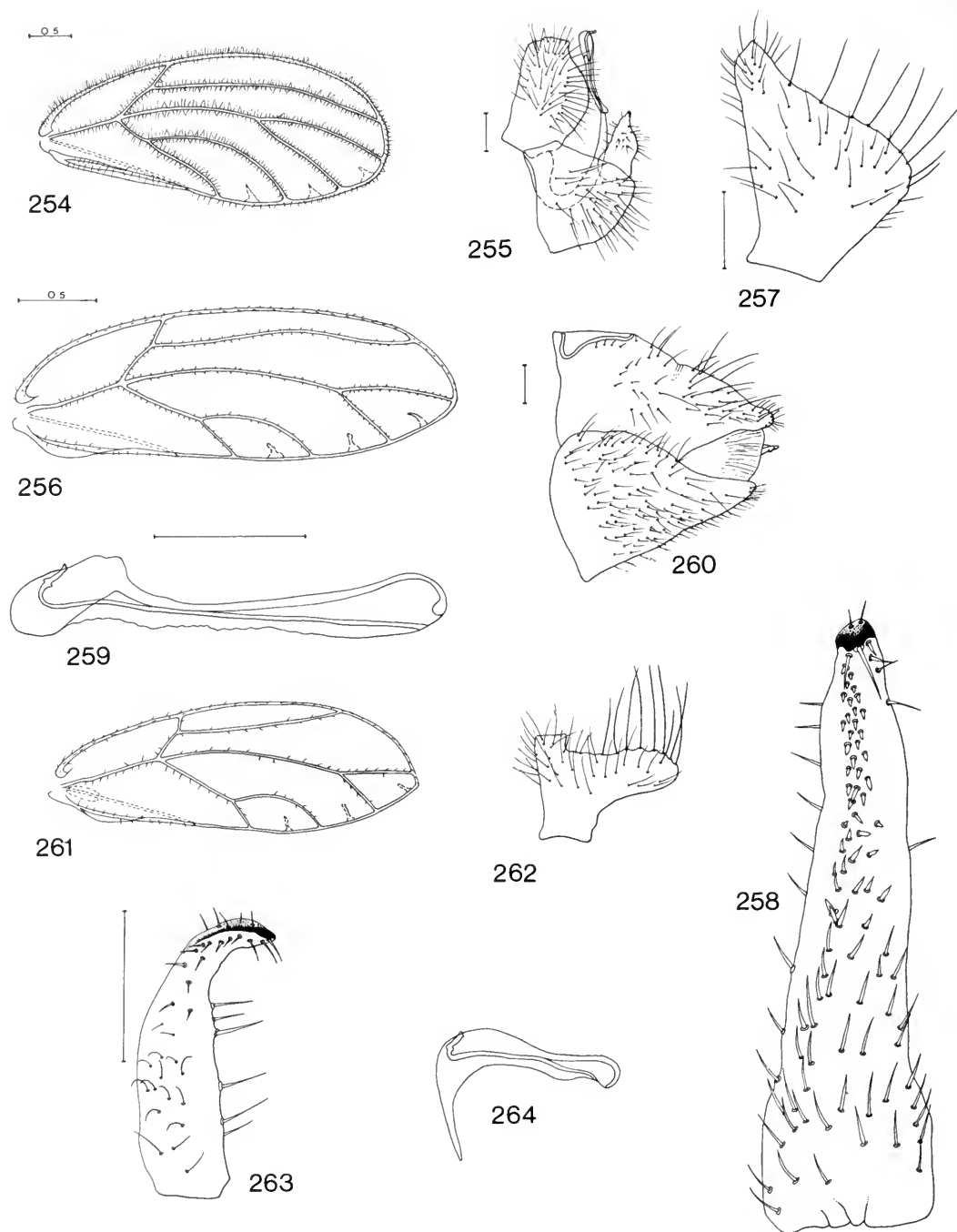

**Figs 254–264** *Trioza* species. 254, *T. medleri*, forewing. 255, *Trioza* sp. ?*medleri*, ♂ genitalia, lateral view (specimen from Zaire in MRAC). 256–260, *T. schroederi*; 256, forewing; 257, ♂ proctiger, lateral view; 258, paramere; 259, apical segment of aedeagus; 260, ♀ genital segment, lateral view. 261–264, *T. tangae*; 261, forewing; 262, ♂ proctiger, lateral view; 263, paramere; 264, apical segment of aedeagus.

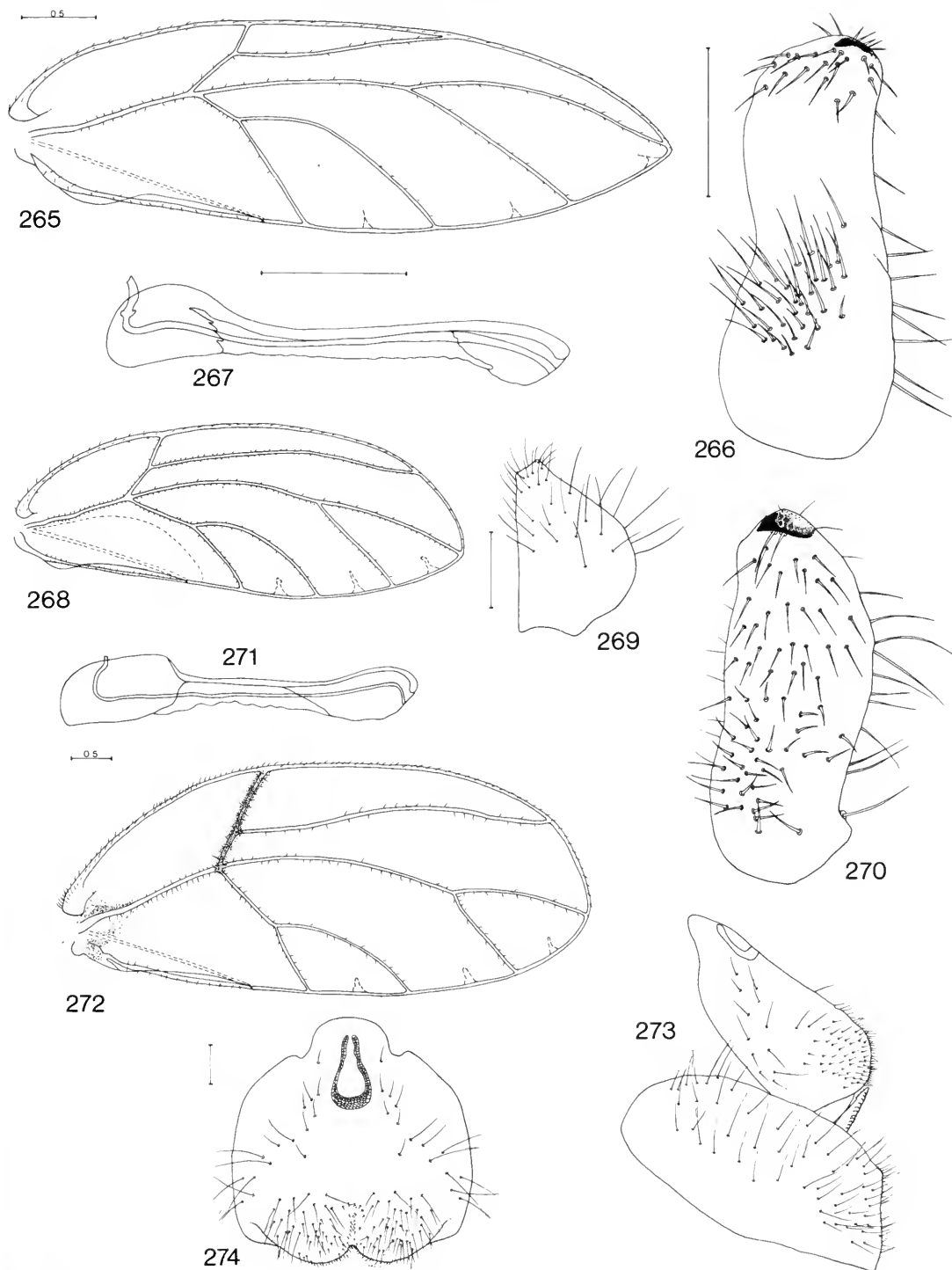

**Figs 265–274** *Trioza* species. 265–267, *T. tenuis*; 265, forewing; 266, paramere; 267, apical segment of aedeagus. 268–271, *T. theroni*; 268, forewing; 269, ♂ proctiger, lateral view; 270, paramere; 271, apical segment of aedeagus. 272–274, *T. tundavalaе*; 272, forewing; 273, ♀ genital segment, lateral view; 274, ♀ proctiger, posterodorsal view.

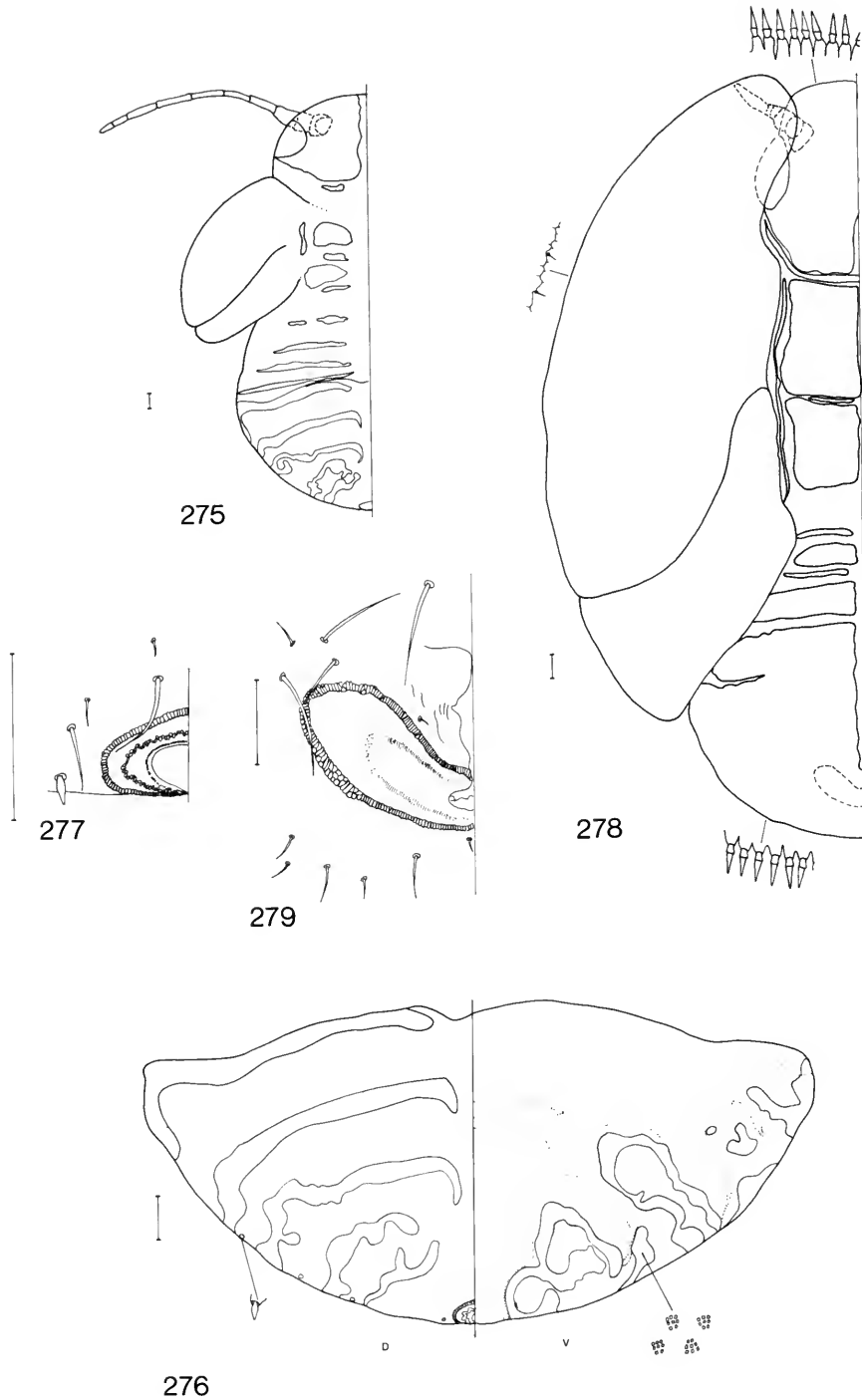

**Figs 275–279** Afrotropical Triozidae, 5th instar larvae. 275–277, *Triozamia lamborni*; 275, dorsal larva; 276, dorsal (D) and ventral (V) views of caudal plate; 277, anal pore area. 278, 279, *Afrotrioza bersama*; 278, dorsal larva; 279, anal pore area.

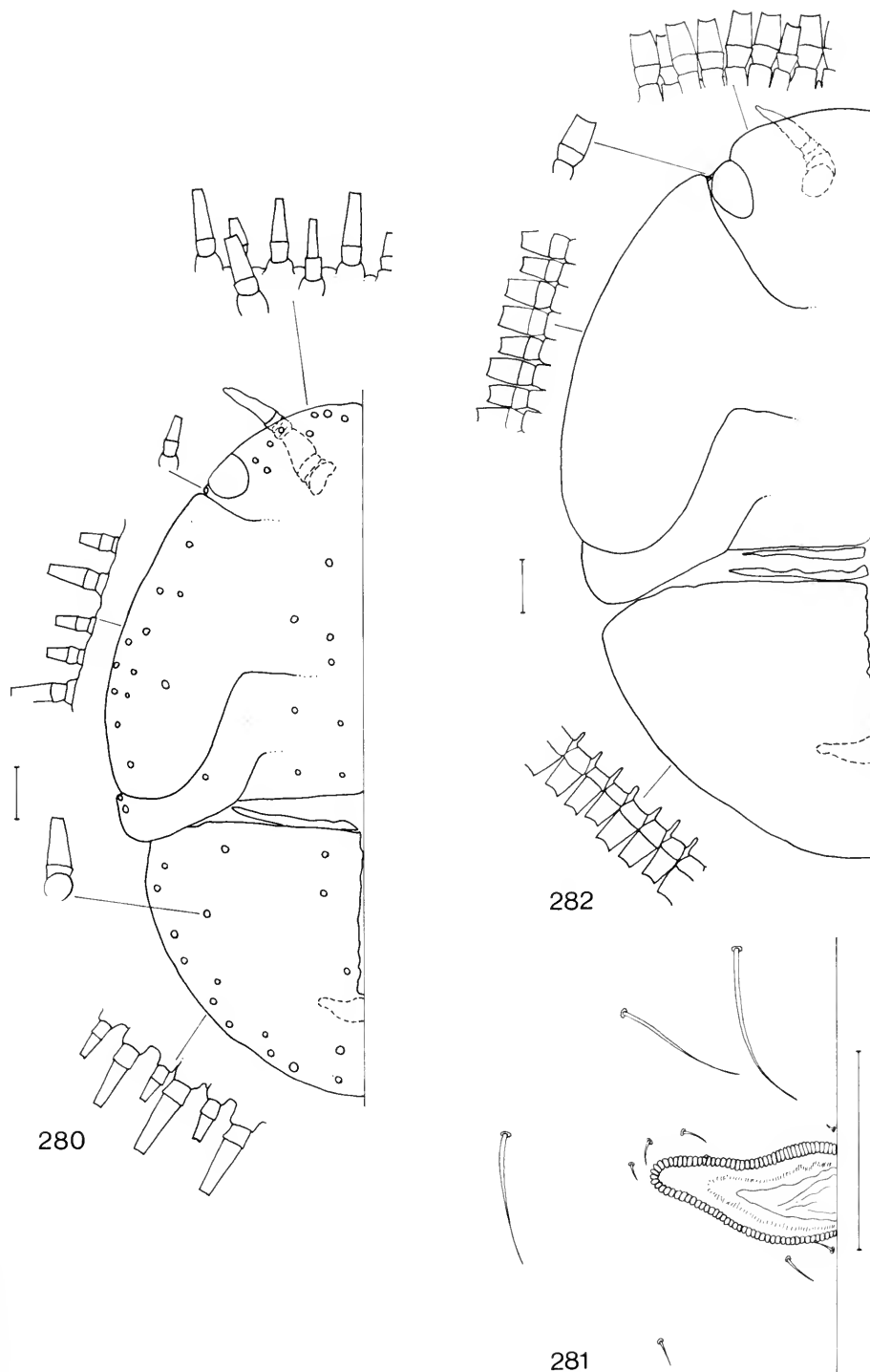

Figs 280–282 *Pauropsylla willcocksyi*-group, 5th instar larvae. 280, 281, *P. willcocksyi*; 280, dorsal view; 281, anal pore area. 282, *P. trichaeta*, dorsal view.

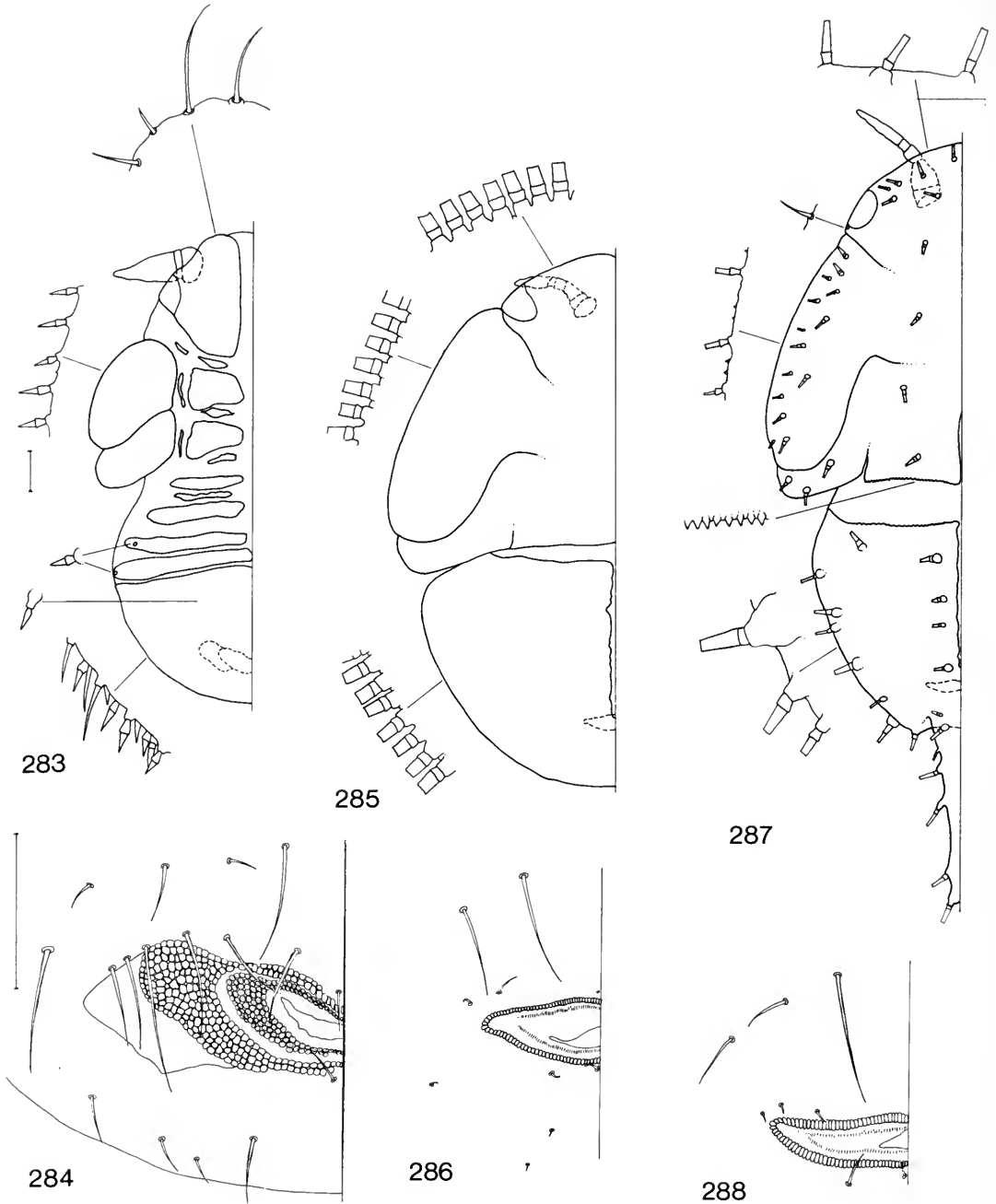

**Figs 283–288** *Pauropsylla* species, 4th and 5th instar larvae. 283, 284, *P. proxima*; 283, 4th instar larva, dorsal view; 284, anal pore area of same. 285, 286, *P. senegalensis*; 285, 5th instar larva, dorsal view; 286, anal pore area of same. 287, 288, *P. longipes*; 287, 5th instar larva, dorsal view; 288, anal pore area of same.



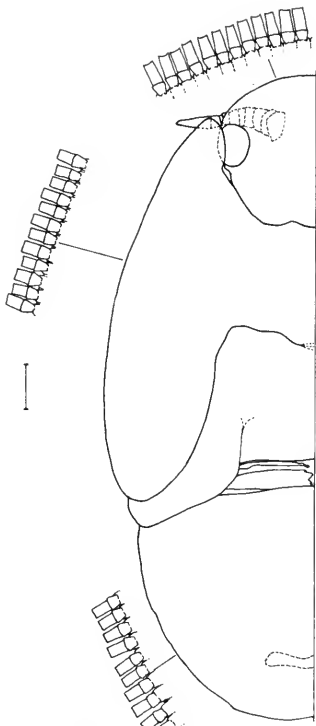

289

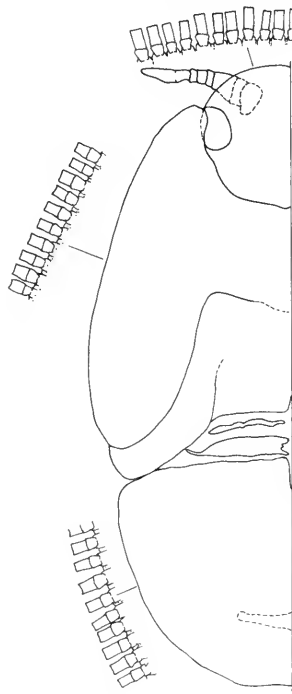

291

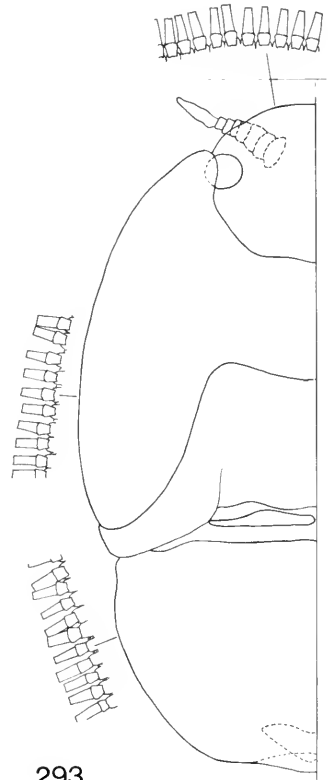

293

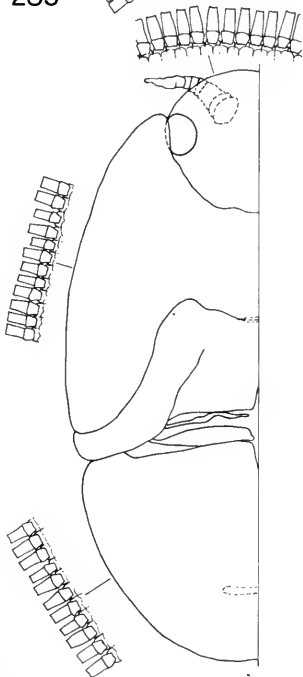

295

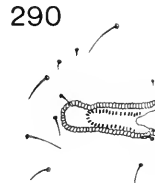

290

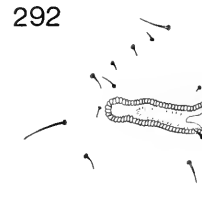

292

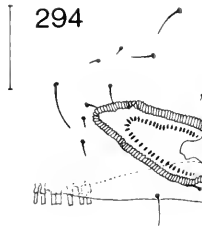

294

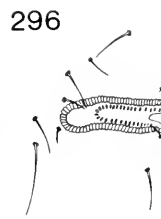

296

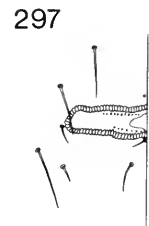

297

**Figs 289–297** *Trioza erythrae*-group, 5th instar larvae. 289, 290, *T. erythrae*; 289, dorsal view; 290, anal pore area. 291, 292, *T. catingi*; 291, dorsal view; 292, anal pore area. 293, 294, *T. tiliacora*; 293, dorsal view; 294, anal pore area. 295, 296, *T. carvalhoi*; 295, dorsal view; 296, anal pore area. 297, *T. capeneri*, anal pore area.

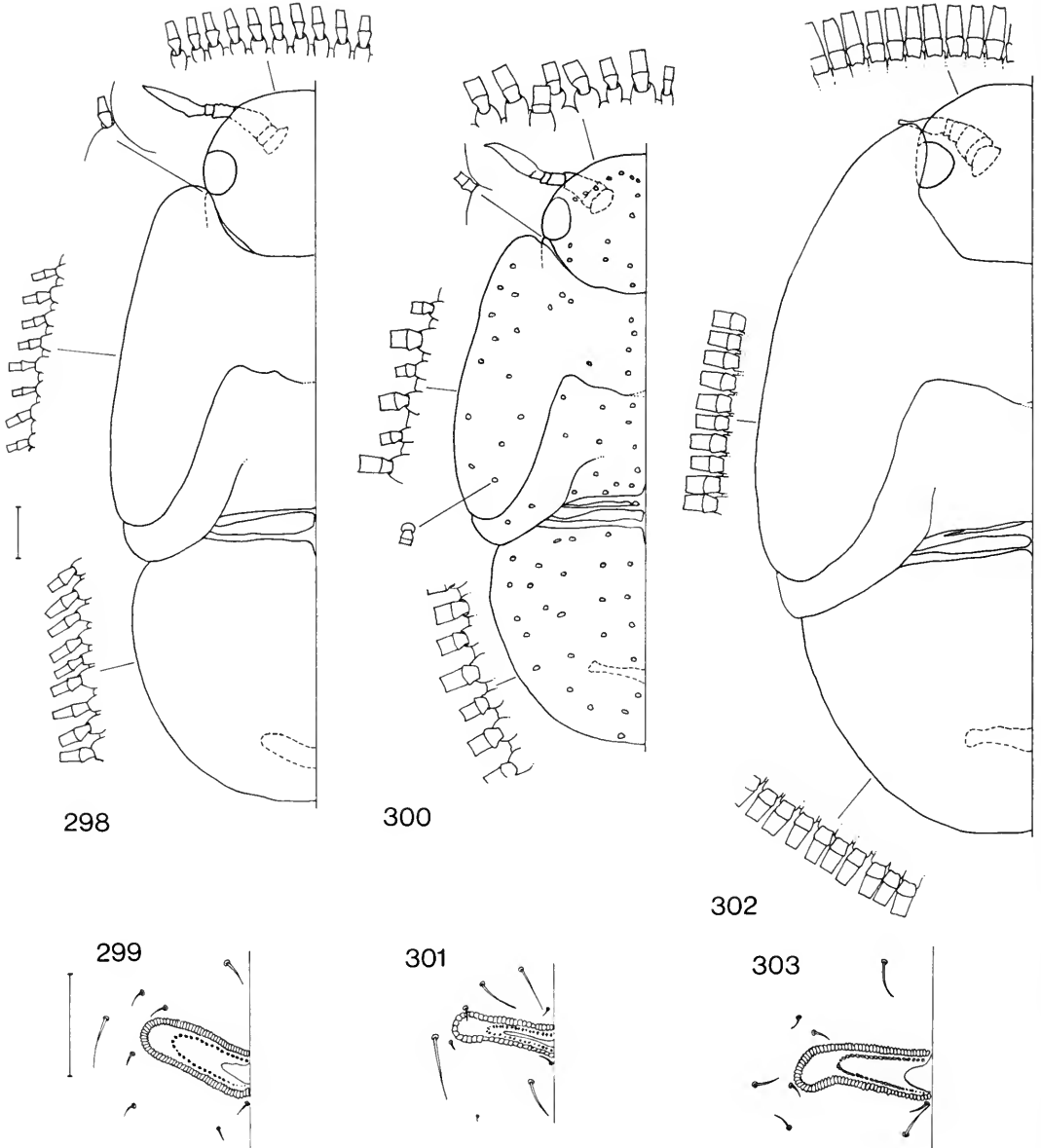

**Figs 298–303** *Trioza* species, 5th instar larvae. 298, 299, *T. xylopi*a; 298, dorsal view; 299, anal pore area. 300, 301, *T. litseae*; 300, dorsal view; 301, anal pore area. 302, 303, *T. kakamegae*; 302, dorsal view; 303, anal pore area.

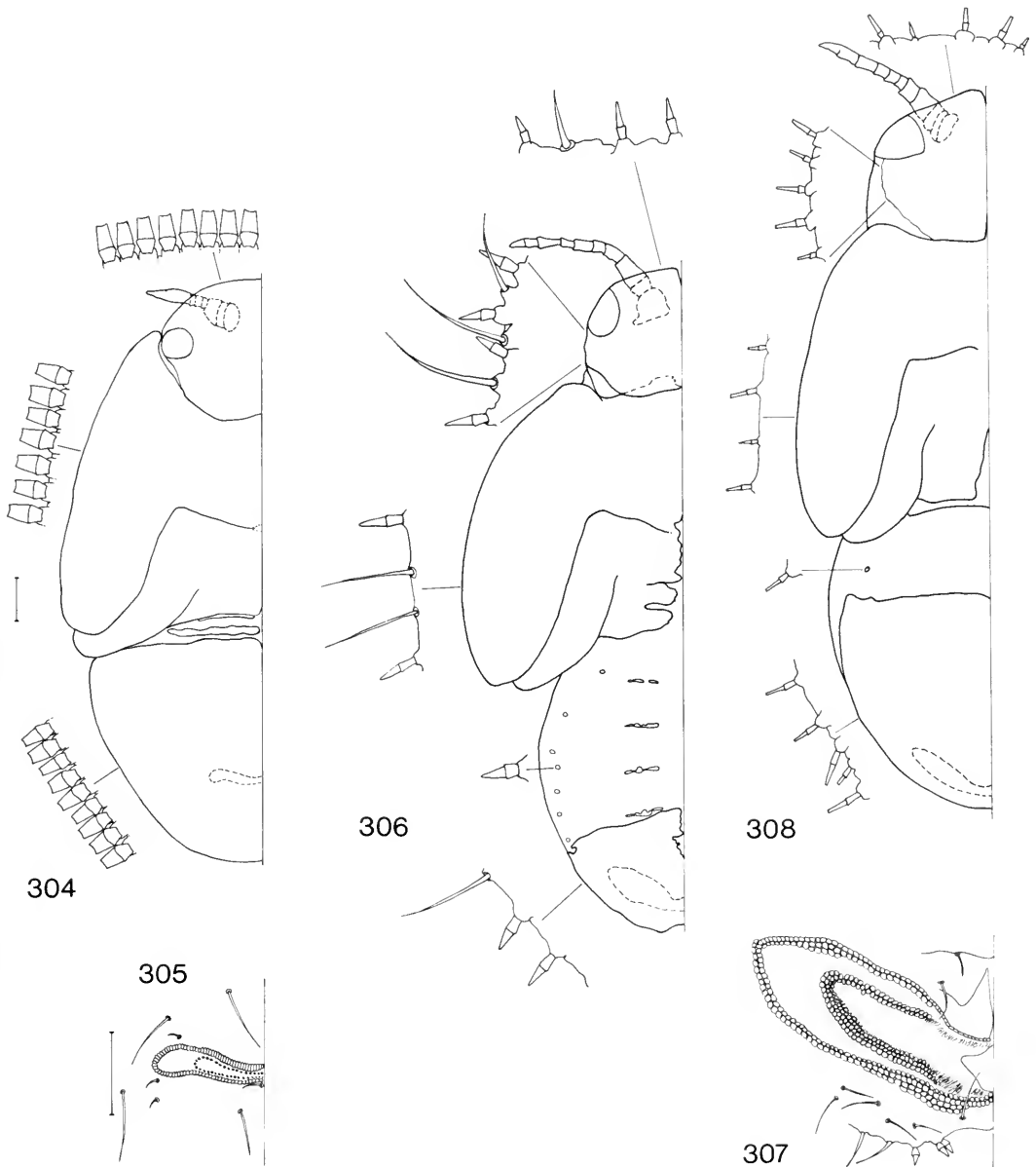

**Figs 304–308** *Trioza neoboutonia*-group, 5th instar larvae. 304, 305, *T. neoboutonia*; 304, dorsal view; 305, anal pore area. 306, 307, *T. harteni*; 306, dorsal view; 307, anal pore area. 308, *T. chiangae*, dorsal view.

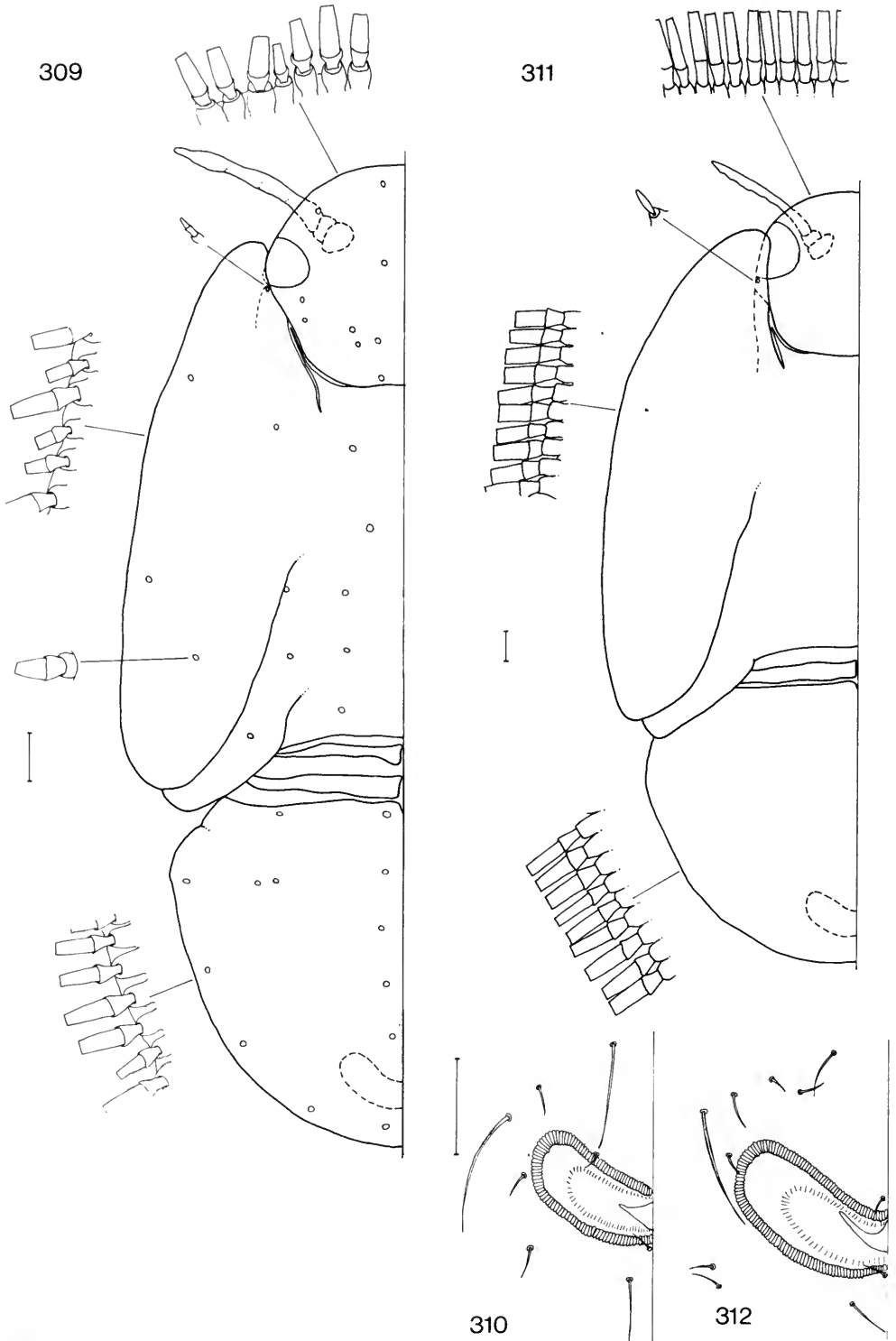

**Figs 309–312** *Trioza obsolete*-group, 5th instar larvae. 309, 310, *T. gonjae*; 309, dorsal view; 310, anal pore area. 311, 312, *T. boxi*; 311, dorsal view; 312, anal pore area.

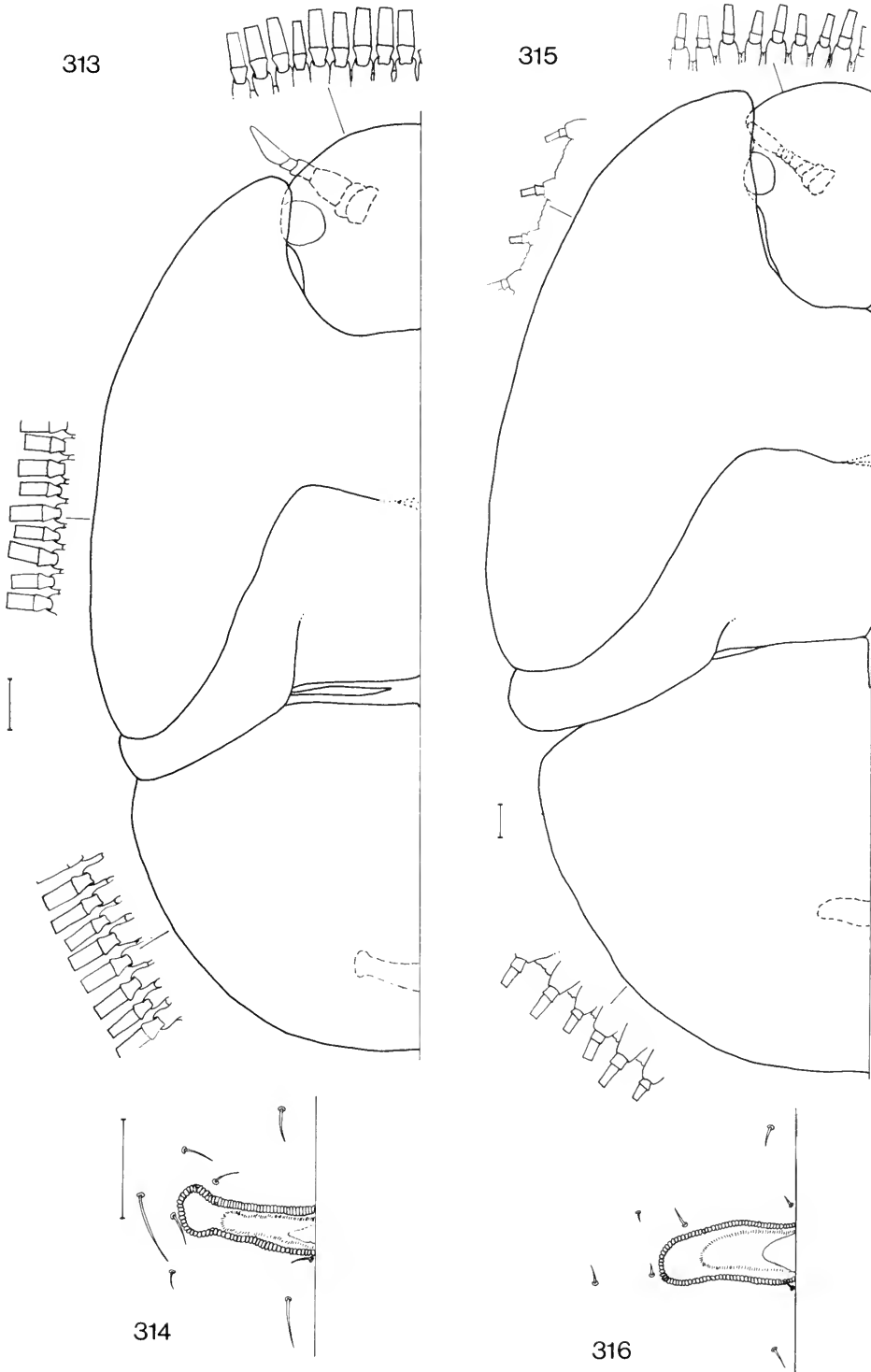

**Figs 313–316** *Trioza obsoleta*-group, 5th instar larvae. 313, 314, *T. afrosersalisia*; 313, dorsal view; 314, anal pore area. 315, 316, *T. mimusops*; 315, dorsal view; 316, anal pore area.

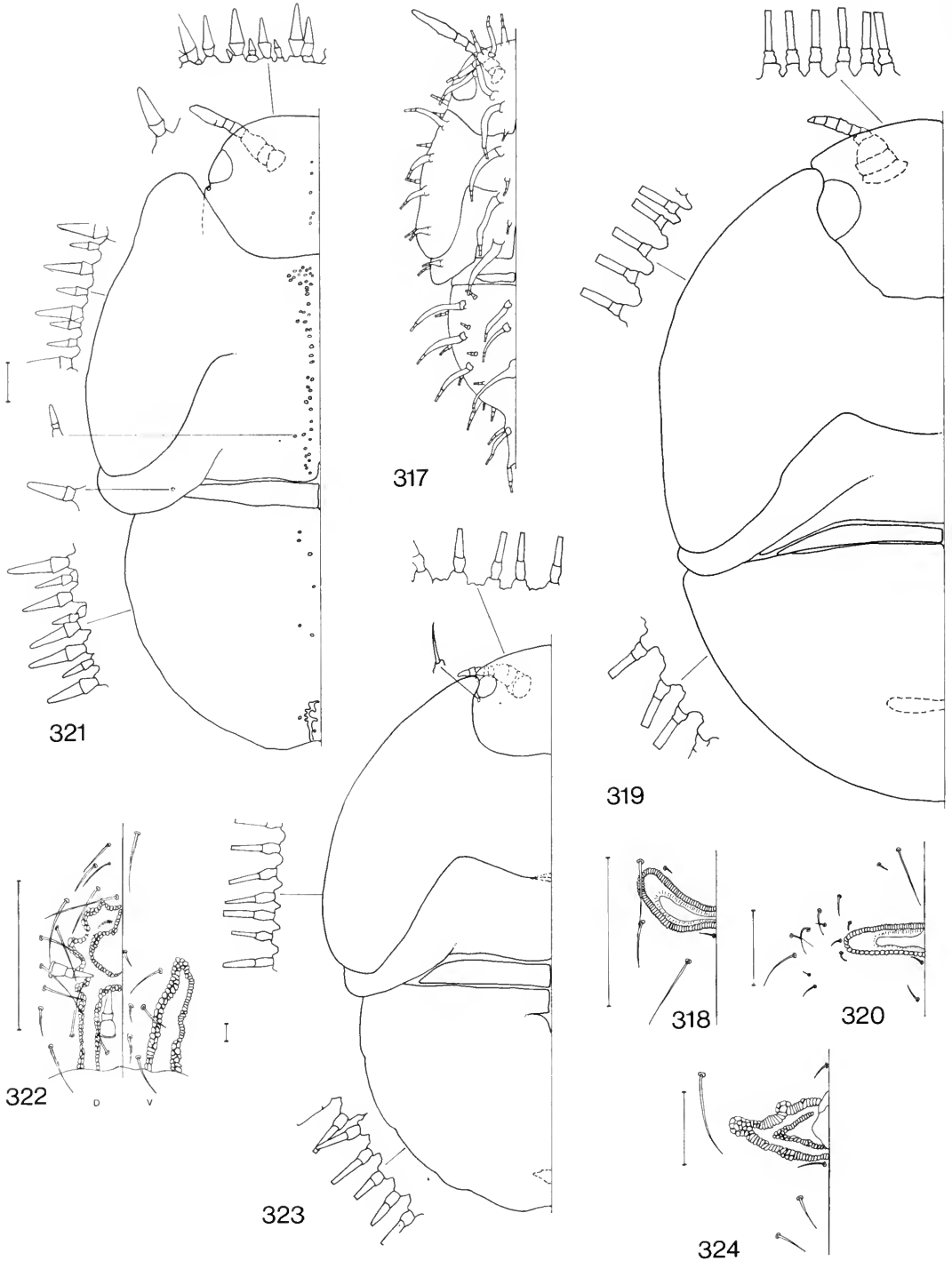

**Figs 317–324** *Troza* species, 5th instar larvae. 317, *T. etiennei*; 317, dorsal view; 318, anal pore area. 319, *T. ficicola*; 319, dorsal view; 320, anal pore area (from 4th instar larva). 321, 322, *T. guiera*; 321, dorsal view; 322, anal pore area from dorsal (D) and ventral (V) views. 323, 324, *T. tundavalaе*; 323, dorsal view; 324, anal pore area.

## Index to host plants

Invalid names are in *italics*.

Afrosersalisia sp. 5, 54  
 Anthocephalus indicus 28  
 Antiaris toxicaria africana var. ? 7, 25  
   var. africana 7, 23, 24  
   var. usambarensis 7, 24  
   var. welwitschii 24  
 Apodytes dimidiata 6, 7, 44, 45, 46  
 Bartsia longiflora 6, 64  
 Bersama sp. 4, 26  
 Beta 4  
 Brassica 4  
 Calophyllum inophyllum 51  
 Chrysophyllum pruiniforme 7, 59  
   viridifolium 7, 59  
 Cinnamomum spp. 4  
 Cissampelos owariensis 6, 40  
   sp. 5, 39  
   torulosa 5, 39  
 Citrus spp. 4, 5, 39  
 Clausena anisata 5, 39  
   inaequalis 39  
 Cussonia angolensis 5, 41  
   paniculata 5, 41  
   spicata 5, 41, 42  
 Dacrydium 4  
 Daucus 4  
 Diospyros 51, 54

canaliculata 5, 54  
 melanoxylon 52  
 mespiliformis 5, 52  
 squarrosus 6, 53  
 tomentosa 52  
 xanthochlamys 54  
 Eugenia malaccensis 4  
 Fagara capensis 5–6, 39  
 Ficus capensis 30  
   gnaphalocarpa 5, 29, 30  
   spp. 4, 5, 6, 28, 29, 30, 33, 34, 35, 61  
   sur 5, 30  
   sycomorus 4, 5, 29, 30  
   thonningii 4, 33  
 Guiera senegalensis 6, 63  
 Haplocoelum foliolosum 7, 67  
 Hebe spp. 64  
 Kickxia sp. 5, 69  
 Laurus nobilis 4  
 Litsea glutinosa 4, 6, 44  
   (*Tetrantha*) laurifolia 44  
 Lycium salinicola 5, 56  
   tetrandrum 5, 56  
 Malacantha alnifolia 6, 57  
   sp. 6, 62

Mimusops caffra 6, 55  
   obovata 6, 55  
   zeyheri 6, 55  
 Myrica conifera 66  
 Neoboutonia sp. 6, 47  
 Palaquium gutta 69  
 Persea americana 4  
 Pritchardia spp. 4  
 Rhamnus 26  
 Salix safsaf 5, 40  
 Seemannaralia gerrardii 5, 42  
 Solanum 4  
   tuberosum 4  
 Stephania abyssinica 5, 39  
 Syzygium benguelense 7, 69  
 Tiliacora sp. 7, 41  
 Toddalia lanceolata 39  
 Triclisia macrophylla 6, 40  
   patens 6, 40  
 Uapaca nitida 5, 6, 48  
 Vanilla planifolia 4, 44  
 Vepris undulata 6, 39  
 Xylopia sp. 7, 43  
 Ziziphus mucronata 5, 27

## Index

Invalid names are in *italics*; principal references are in **bold**.

Aacanthocnema 2  
 acona 2  
 adaptata 3  
 afroboleta 5, 19, 20, 51, **52**  
 afrosersalisia 5, 11, 18, 51, **54**  
 Afrotrioza 3, 4, 11, 18, **25**  
 alacris 4  
 anceps 4  
 angolensis 4, 21, **33**, 34, 35  
 anomalicornis 5, 10, 18, 21, **44–45**  
 Anomalocephala 2  
 Anomalopsyllini 28  
 Aphalaridae 9, 27, 28  
 Apsylla 28  
 armata 2, 51  
 Arytainini 8  
 asiatica 51  
 ata 5, 22, 36, **38**, 39, **40**  
 baccarum 2  
 Bactericera 2, 9  
 Bactericerinae 9, 23  
 Bactericerini 9  
 bamendae 5, 20, 46, **48–49**  
 basalis 3, 26, 65  
 beesoni 28  
 bersama 3, 4, 18, **25–26**  
 bessei 2

bicolor (Neotriozele) 2  
 bicolor (Trichohermes) 26  
 biki 29, 30  
 bivittata 2  
 boxi 5, 19, 51, **53–54**  
 breviannata 4, 21, **31–32**  
 brevicornis 28  
 bussei 5, 18, **69**  
 Calinda 2  
 Calophyidae 8  
 Calophyinae 27  
 camerounensis 5, 19, 56, **58**  
 capeneri 5, 22, 36, **38**, 39, **42**  
 capensis 5, 20, **55–56**  
 Carsidaridae 9, 27  
 Carsidarini 8  
 carvalhoi 5, 22, 36, **38**, 39, **41–42**  
 casuarina 2  
 catlingi 5, 22, 36, **37–39**  
 ceardi 2  
 Cecidotrioza 2  
 Ceropsylla 2  
 Cerotrioza 2  
 chiangae 5, 11, 22, 46, **48**  
 cinnamomi 4  
 Ciriacreminae 27  
 Ciriacreminidae 9, 23

*citri* 36  
 cockerelli 4, 55, 56  
*Colopelma* 35  
 colorata 4  
 Crawforda 2  
 dacrydii 4  
 Dasymastix 2  
 depressa 28  
 Diceraeopsylla 28  
 Dididophlebia 28  
 dinaba 5, 20, 46, **49**  
 diospyri 51  
 diptera 51  
 dunaliae 3  
 eafra 5, 20, 36, **38**, 39, **42**  
 eastopi (Pauropsylla) 4, 21, **33**  
*eastopi* (Trioza) 43  
 Egeirotrioza 2  
 elongagena 3  
 Engytatoneura 2  
 Epipsylla 8  
 Epitrioza 2, 9  
 Epitriozini 9  
 Eryngiofaga 2  
*erythrae* 36  
 erythrae (*Aleurodes*) 36  
 erythrae (*Spanioza*) 36

- erytreae (Trioza) 4, 5–6, 18, 22,  
 36–39, 44, 61  
 etiennei 6, 10, 11, 19, 56–57, 59, 60  
 eucalypti 3  
 Eutrioza 2, 9  
 Eutriziini 9  
 fasciatus 3  
 femoralis 2  
 ficicola (Pauropsylla) 28  
 ficicola (Trioza) 6, 21, 60–61  
 formiciformis 3  
 formosanus 35  
 fuscata 3  
 fuscivena 6, 20, 61–62  
 galii 35  
 ghanaensis 6, 19, 62, 67  
 gigantea 2  
 glabea 6, 19, 59–60  
 globuli 28  
 gonjae 6, 19, 51, 53  
 gregoryi 6, 22, 36, 38, 39, 40  
 guiera 6, 11, 20, 36, 62–63  
 Haplaphalara 27, 28  
 hargreavesi 6, 9, 20, 50–51  
 harteni 6, 21, 46, 47–48  
 Hemischizocraniini 9  
 Hemischizocranium 2, 9, 65  
 Hemitrioza 2  
 Heterotrioza 2  
 Hevaheva 2, 65  
 hiurai 3  
 Homotominae 8  
 immaculata 3  
 insleyi 5, 11, 18, 26–27  
 Izpania 2  
 johnsonii 3  
 kakamegae 6, 22, 44, 45  
 karroo 6, 18, 63–64  
 kilimanjarica 6, 22, 36, 38, 39,  
 40–41  
 Kuwayama 2  
 laingi 6, 18, 64  
 lamborni 3, 7, 9, 10, 11, 18, 23–24  
 lambourni 23  
 Leptotrioza 2  
 Leptynoptera 3, 9, 27, 28, 51  
 Leuronota 3, 26  
 Levidea 3, 9  
 lindbergi 2  
 lineata 3  
 litseae 4, 6, 11, 20, 43–44  
 longipes 4, 21, 33–34  
 longispiculata 28  
 luvandata 6, 22, 44, 46  
 lycii 56  
 machili 3  
 Macrohomotomini 8  
 maculata (Leuronota) 3  
 maculata (Microceropsylla) 28  
 magnicauda 51  
 magnoliae 4  
 medicaginis 2  
 medleri 6, 11, 19, 65  
 Megatrioza 2, 4, 51  
 menispermicola 6, 22, 36, 37, 38, 39,  
 40  
 menoni 28  
 merwei 36  
 mesomela 2  
 messaratina 6, 19, 56, 57  
 Metatrioza 3  
 Microceropsylla 27, 28  
 Microceropsyllini 27  
 mimosops 6, 11, 20, 51, 54–55  
 minuta 28  
 mirificornis 6, 20, 50, 51  
 mizuhonica 2  
 Moraniella 27  
 Myrmecephala 3  
 nachingweae 6, 20, 46, 49–50, 61  
 neoboutonia 6, 11, 22, 46–47, 48, 61  
 Neolithus 3  
 Neotrioza 3  
 Neotriozella 3  
 nestasimara 7, 20, 56, 58  
 ngongae 4, 21, 31, 32  
 nigra 28  
 nigricapatus 3  
 nigricapita 3  
 nigricornis (Stenopsylla) 3  
 nigricornis (Trioza) 4, 67  
 nussex 29, 30  
 obliqua 2  
 obscura 64  
 obsoleta 10, 11, 51, 52  
 ocellata 3  
 opima 2  
 Optomopsylla 3  
 Ozotrioza 3  
 palaquii 69  
 palmicola 4  
 Paracomeca 3, 9  
 Paracomecini 9  
 Paratrioza 3, 56  
 Pariaconus 3  
 Paurocephala 27, 28  
 Pauropsylla 3, 4, 5, 9, 10, 20–21,  
 27–29  
 Pauropsyllinae 9, 27, 28  
 Pauropsyllini 9, 27  
 Pautriozana 3  
 Pelmatobrachia 27, 28  
 perkinsi 2  
 perrisii 2  
 perseae 4  
 Petalolyma 3, 26, 65  
 Phacopteron 28  
 Phacopteronini 27, 28  
 phalaki 28  
 Phyllopecta 35  
 Phyllopecta 35  
 pitkini 7, 18, 56, 59  
 Powellia 35  
 prima 3  
 proxima 4, 21, 28, 32–33  
 Pseudophacopteron 28  
 Pseudotrioza 3  
 psylloptera 27, 28  
 pubescens 3  
 purpurescens 28  
 reticulata 28  
 Rhegmoza 3  
 Rhinopsylla 3, 9  
 russellae 28  
 Schedoneolithus 3  
 Schedotrioza 3  
 schroederi 7, 19, 65–66, 68  
 schwarzii 3  
 semibrunneipennis 64  
 senegalensis 5, 21, 33, 34–35  
 septima 5, 21, 32  
 seranistama 7, 20, 56, 58  
 shiwapuriensis 28  
 sideroxyli 2  
 similis 7, 18, 69  
 Siphonaleyrodes 8, 35  
 Siphonaleyrodinae 8  
 Smirnovia 2  
 sonchi 2  
 Spanioza 35  
 spondiasae 28  
 Stenopsylla 3  
 stevensi 28  
 sulfurea 3, 51  
 Swezeyana 3  
 swezeyi 51  
 Sympauropsylla 27  
 Synoza 8  
 tangae 7, 21, 66–67  
 tatricea 5, 20, 29, 30  
 tavandula 7, 22, 44, 46  
 tenuis 7, 19, 67  
 theroni 7, 9, 19, 66, 67–68  
 thibae 7, 22, 44, 45–46  
 thomasii 35  
 tiliacora 7, 22, 36, 38, 39, 41  
 tinctoria 3  
 trichaeta 5, 21, 29, 30  
 Trichohermes 3, 5, 9, 18, 25, 26  
 Trichohermini 9  
 Trichopsylla 26  
 trigemma 5, 21, 31, 32  
 trimaculata 28  
 triopsyllina 2  
 Trioza 3, 5–7, 9, 18, 28, 35–36  
 Triozamia 3, 7, 9, 11, 18, 22–23, 25  
 Triozamini 9  
 Triozaria 8  
 Triozidae 2, 8–17  
 Triozina 8  
 Triozinae 8, 9  
 Triozini 9  
 Triozoida 3  
 triozoptera 27  
 tripunctata 35  
 tuberculata 28  
 tundavalae 7, 11, 19, 68–69  
 udei 3, 27, 28  
 unica 2  
 urticae (*Chermes*) 35  
 urticae (Trioza) 3  
 usambarensis 7, 18, 24  
 usambarica 7, 19, 59, 60  
 verrucosa 28  
 vitiensis 4  
 vitreoradiata 35  
 vondraceki 7, 18, 24–25  
 walkeri 3, 26  
 willcocksii 4, 5, 10, 21, 29–30, 34  
 xylopia 7, 20, 43







## **British Museum (Natural History)**

### **Milkweed butterflies: their cladistics and biology**

**P. R. Ackery & R. I. Vane-Wright**

The Danainae, a subfamily of the Nymphalidae, contains only some 150 species, yet aspects of their biology have stimulated far more attention than can be justified by species numbers alone. In recent years, an expansive literature has grown, considering aspects of their courtship and pre-courtship behaviour, migration, larval hostplant associations, mimicry and genetics. The popularity of danaines among biologists can certainly be attributed to this combination, within one small group, of so many of the factors that make butterflies such an interesting group to study. The obvious need to place this wealth of biological data within an acceptable systematic framework provided the impetus for this volume.

Started eight years ago within the conventions of evolution by natural selection and Hennig's phylogenetic systematics, the book is now largely about natural history (what the animals have and do, where they live and how they develop) and natural groups – as revealed by a form of analysis approaching that practised by the new school of 'transformed cladistics'. The authors have prepared a handbook that will appeal to a wide range of biologists, from museum taxonomists to field ecologists.

**424 pp (approx.), 12 pp colour, 73 b/w plates, line and graphic illustrations, maps, extensive bibliography. ISBN 0 565 00893 5. Publication September 1984. Price £50, prepublication price £45.**

## **Titles to be published in Volume 49**

**Afrotropical jumping plant lice of the family Triozidae (Homoptera: Psylloidea).**

By David Hollis.

**The taxonomy of the western European grasshoppers of the genus *Euchorthippus*, with special reference to their songs (Orthoptera: Acrididae).**

By D. R. Ragge & W. J. Reynolds

**An historical review of the higher classification of the Noctuidae (*Lepidoptera*).**

By Ian J. Kitching

**The Pimplinae, Xoridinae, Acaenitinae and Lycorininae (Hymenoptera: Ichneumonidae) of Australia.**

By I. D. Gauld

**The western Palaearctic species of *Ascogaster* (Hymenoptera: Braconidae)**

By T. Huddleston

577 7075

BRITISH MUSEUM  
(NATURAL HISTORY)  
27 JUL 1984  
RECEIVED

# Bulletin of the British Museum (Natural History)

The taxonomy of the western  
European grasshoppers of the genus  
*Euchorthippus*, with special reference  
to their songs (Orthoptera: Acrididae)

D. R. Ragge & W. J. Reynolds

Entomology series

Vol 49 No 2

26 July 1984

The *Bulletin of the British Museum (Natural History)*, instituted in 1949, is issued in four scientific series, Botany, Entomology, Geology (incorporating Mineralogy) and Zoology, and an Historical series.

Papers in the *Bulletin* are primarily the results of research carried out on the unique and ever-growing collections of the Museum, both by the scientific staff of the Museum and by specialists from elsewhere who make use of the Museum's resources. Many of the papers are works of reference that will remain indispensable for years to come.

Parts are published at irregular intervals as they become ready, each is complete in itself, available separately, and individually priced. Volumes contain about 300 pages and several volumes may appear within a calendar year. Subscriptions may be placed for one or more of the series on either an Annual or Per Volume basis. Prices vary according to the contents of the individual parts. Orders and enquiries should be sent to:

Publications Sales,  
British Museum (Natural History),  
Cromwell Road,  
London SW7 5BD,  
England.

*World List* abbreviation: *Bull. Br. Mus. nat. Hist. (Ent.)*



© Trustees of the British Museum (Natural History), 1984

The Entomology series is produced under the general editorship of the  
Keeper of Entomology: Laurence A. Mound  
Assistant Editor: W. Gerald Tremewan

ISBN 0 565 06004 X  
ISSN 0524-6431

British Museum (Natural History)  
Cromwell Road  
London SW7 5BD

Entomology series  
Vol 49 No 2 pp 103-151

Issued 26 July 1984

# The taxonomy of the western European grasshoppers of the genus *Euchorthippus*, with special reference to their songs (Orthoptera: Acrididae)

D. R. Ragge & W. J. Reynolds

Department of Entomology, British Museum (Natural History), Cromwell Road, London SW7 5BD

## Contents

Synopsis.....	103
Introduction .....	103
Acknowledgements.....	104
Material.....	105
Methods .....	105
Morphology.....	105
Song.....	106
Presentation and evaluation of the data.....	110
Characters studied.....	111
Morphology.....	111
Colour pattern.....	117
Cytology .....	117
Song.....	117
<i>Euchorthippus</i> Tarbinskii.....	121
Key to the western European and North African species and subspecies of <i>Euchorthippus</i> .....	122
Descriptions of the species.....	125
General discussion .....	139
References .....	141
Index.....	151

## Synopsis

The taxonomy of the western European species and subspecies of the Gomphocerine genus *Euchorthippus* is re-examined on the basis of both morphological and song characters, making full use of such visual aids as bar-charts and scatter diagrams. It is shown that the past emphasis on the male subgenital plate as a diagnostic character has resulted in the frequent misidentification of the three main species, *declivus*, *pulvinatus* and *chopardi*. This has been particularly true in Spain, where *pulvinatus* and *chopardi* have often been misidentified as *declivus* and *pulvinatus*, respectively. It is also shown that the Jersey form *elegantulus*, previously synonymized with *declivus*, is actually a form of *pulvinatus*, and that a further population of it occurs in southern Brittany. Analyses of the songs of these species, previously thought to be of little taxonomic value, have provided strong support for these conclusions. The study embraces four further taxa known only from the western Mediterranean islands or North Africa, and the song of the Balearic species *angustulus* is fully described and analysed for the first time. Keys are given for the identification of all these species and subspecies, and their evolution and rather anomalous present distribution are briefly discussed.

## Introduction

*Euchorthippus* belongs to the Gomphocerinae, a group that includes most of the common European grasshoppers of open grassland. They are well known for their characteristic – and taxonomically useful – songs, and are frequently used in ecological and cytological studies. The subfamily includes about 150 European species, of which over 20 are pests in parts of their range, seven of them being regarded as major ones (Tsyplenkov, 1970).

*Euchorthippus* is a widespread Palaearctic genus, including 14 species living in habitats ranging from moist grassland to steppe and barren hillside. Five species occur in western Europe and one of these, *E. pulvinatus*, becomes a pest when it occurs in sufficiently dense populations, causing damage to pastureland, hayfields, cereal grasses, alfalfa and other cultivated plants in western and, especially, eastern Europe (Bei-Bienko & Mishchenko, 1951; Tsyplenkov, 1970). This species sometimes reaches densities of over 10/m<sup>2</sup> in the *Stipa*-steppe areas of the Ukraine and northern Kazakhstan, where it is by far the most numerous grasshopper (Chetyrkina, 1954; Bei-Bienko, 1961).

*Euchorthippus* is quite easy to recognize as a genus, but its species are much more difficult to identify and have frequently been confused with one another. *E. declivus*, *E. pulvinatus* and *E. chopardi* form a group of closely similar species that are very difficult to separate using the keys at present available. Among more recent studies of this group, those of Mařan (1957), Descamps (1968), Litvinova (1972) and Defaut (1982) have much improved our knowledge of their taxonomy, ecology and geographical variation. The songs of these species have been described briefly by Descamps (1968), Luquet (1978) and Schmidt & Schach (1978), but these authors attached little or no taxonomic importance to the differences between them. The main aim of our study has been to refine further the best methods for distinguishing morphologically between these species and to demonstrate the taxonomic importance of their songs.

Although we have concentrated our study on this group of three species, for each of which we have been able to study the song, we have also included morphological information on all the other species occurring in western Europe and North Africa and, in the case of *E. angustulus*, have been able to give full information on the song for the first time. The geographical area covered by our study consists of southern Europe and the Mediterranean Region from Italy westwards, including North Africa.

Morphological recognition of the species of *Euchorthippus* depends mainly on differences in size and proportion, and we have chosen to present this information in the form of visual aids such as bar-charts and scatter diagrams so that the most important differences can be seen at a glance and a specimen can be identified quickly by entering its key measurements on the appropriate diagram. Similar visual aids have been used to illustrate the significance of the differences in song.

*E. pulvinatus pulvinatus*, which does not occur in western Europe, is excluded from our study, and where the specific name 'pulvinatus' is used in our text it refers only to the western subspecies *E. p. gallicus* and *E. p. elegantulus* unless otherwise indicated.

### Acknowledgements

We are much indebted to the following, who have kindly lent us type-specimens or other material from their respective institutions:

Drs A. Čejchan, G. Demoulin, M. Donskoff, M. J. González, K. K. Günther, L. Herrera, G. Kruseman, V. Llorente and E. Tremblay.

We are also grateful to Dr A. Nadig for lending us the holotype of *E. sardous* from his private collection in Chur, Switzerland; to Dr B. Defaut, who lent us specimens of *Euchorthippus* from Brittany and Teruel province in Spain; and to Mr D. W. Baldock, who gave us, among other specimens, a female *Euchorthippus* from Guérande in southern Brittany and thus alerted us to the occurrence there of the interesting small form of *E. pulvinatus* (see p. 131). We thank Mr J. F. Burton for very kindly making available to us a tape recording of the song of a male *Euchorthippus* from Jersey.

Our thanks are due to Messrs W. G. Tremewan and B. C. Townsend, who collected live males for us from Spain and Jersey, respectively, and thus enabled us to make studio song recordings from them; to Mr E. C. M. Haes, who collected specimens for us from France; to Mr W. B. Lee, who helped us to obtain data from specimens and song oscillograms; to Dr M. Hills of the British Museum (Natural History) Biometrics and Computing Section, who advised us on statistical methods; and to Dr F. Willemse for information on the distribution of *Euchorthippus* in Greece.



Finally we should like to thank Mr P. H. Ward for his skilful preparation of the drawings shown in Figs 25–30.

## Material

Our study is based almost entirely on material in the British Museum (Natural History), amounting to about 1500 western European specimens of *Euchorthippus*. Many of these specimens were collected by us during recent visits to France and Spain.

The song analyses were based on tape recordings made by us in the field in France and Spain, and in the BMNH Acoustic Laboratory from males brought back from Jersey, France, Spain and Majorca; we were also able to make use of a tape recording kindly made available to us by Mr J. F. Burton.

We have used the following abbreviations for depositories of type-specimens.

BMNH	British Museum (Natural History), London
IEA	Istituto di Entomologia Agraria, Portici
IRSNB	Institut Royal des Sciences Naturelles de Belgique, Brussels
MNHN	Muséum National d'Histoire Naturelle, Paris
MNHU	Museum für Naturkunde der Humboldt-Universität, Berlin
NM	Národní Muzeum, Prague

## Methods

### Morphology

The morphological measurements were made using a Wild M5 microscope with a graduated eyepiece. The lengths of the head and pronotum were measured along the mid-line. The length of the fore wing was measured from the tip to the point where the fused subcostal, radial and medial veins of the flexed wing pass under the edge of the pronotum (Fig. 1, f). The length of the hind wing was measured (also when flexed) from the tip of the wing to the median posterior point of the pronotum rather than to the base of the hind wing, since this is hidden under the fore wing when the wings are flexed (Fig. 1, h). The distance from the stigma to the tip of the fore wing was measured from the centre of the stigma, which is more easily determined than its edge (Fig. 1, s). The distance by which the fore wing projected beyond the hind wing was determined by illuminating the flexed wings from below and measuring the distance between the tips of the fore and hind wings (Fig. 1, g). When the hind wing projected beyond the fore wing, the measurement was regarded as negative. The length of the hind femur was measured from the most proximal to the most distal points.

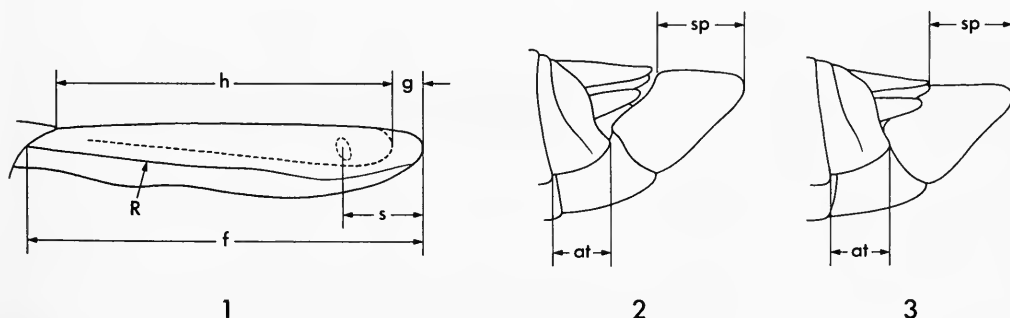

**Figs 1–3** Diagrams of (1) the flexed wings and (2, 3) male terminal abdominal segments in species of *Euchorthippus*, showing the method of measuring the length of the fore wing (f), length of the hind wing (h), distance from the stigma to the tip of the fore wing (s), projection of the fore wing beyond the hind wing (g), length of the male subgenital plate (sp) and length of male abdominal tergites 9+10 (at). R = radius. (See also the explanation in the text.)

When counting the stridulatory pegs it was sometimes necessary to relax the leg and to move it away from the body so that the stridulatory file was visible. The pegs were viewed from above, in profile, and were counted as they moved past a line on the microscope eyepiece scale. Following Perdeck (1957), bristles were included in the row and, in determining the ends of the file, a peg or bristle was excluded if its distance from the preceding peg was twice, or more than twice, the distance between the two preceding ones. The length of the stridulatory file was measured from one terminal peg or bristle (determined as above) to the other.

The lengths of the male subgenital plate and abdominal tergites 9+10 were measured following the method used by Descamps (1968) (Fig. 2) except that, when the proximal dorsal edge of the subgenital plate was hidden, the length of only the visible part of the plate was measured (Fig. 3).

As we had at our disposal well over 500 specimens of each of the two common species *declivus* and *pulvinatus*, we measured only a sample of them, following the principle that all the localities from which the specimens came should be represented by at least one measured specimen. We restricted our measurements of *albolineatus* to 10 specimens of each sex, since this North African species was outside the main scope of our study.

### Song

All the field recordings of the songs used in this study were made while the insects were in full sunshine using a Uher 4000, 4200 or 4200IC tape recorder and an AKG D202 microphone. Most of the studio recordings were made in the BMNH Acoustic Laboratory using a Kudelski Nagra IV tape recorder and Sennheiser MKH405 microphone. Recording 163 was made from a captive insect by Mr J. F. Burton using a Nagra III tape recorder. The only other recordings not made in the field (179/6, 179/9, 180/1, 180/2) were recorded at the Station Biologique d'Arcachon, Gironde, France, using a Uher 4000 tape recorder and AKG D202 microphone. For all the studio recordings a bench lamp was used to provide light and radiant heat. Further data are given in Tables 1 and 2.

The acoustic terms we have used are defined as follows.

*Calling song.* The song produced by an isolated male.

*Courtship song.* The special song produced by a male when close to a female.

*Syllable.* The sound produced by one complete up and down movement of the hind legs (Fig. 4).

*Echeme.* A first-order assemblage of syllables (Fig. 4). (Term introduced by Broughton, 1976.)

All the song measurements were taken from oscillograms made with a Mingograf 34T ink-jet recorder. Echeme duration was measured from the end of the first clearly visible syllable to the end of the last (Fig. 6). This measurement was divided by the number of syllables between these two points to give the mean syllable duration for the echeme. 'Gaps' (momentary breaks in the sound – see Fig. 4) were counted if they occurred during the louder second part of the syllable and were at least 1.25 ms in duration (Fig. 6).

Echeme repetition rate was determined only from periods of *regular* echeme repetition. To put this on an objective basis we used only sequences of four or more echemes during which no two successive intervals between echemes differed from one another by more than 10 per cent of the smaller of the two. The duration of each regular sequence of echemes was measured from the end of the first echeme to the end of the last; the number of echemes included (one fewer than the total number of echemes in the sequence) was then divided by this measurement to give the echeme repetition rate (Fig. 5).

In the field singing usually stops when the sun is hidden by a cloud, and in the studio the lack of radiant heat from a nearby bench lamp usually has a similar effect. If singing does continue in such conditions, the echeme repetition rate is normally much lower and the duration of both the echemes and syllables much greater; the number of gaps per echeme does not change noticeably. Because of this effect we have based our song data only on recordings made when the

**Table 1** Data for the field recordings of male calling songs of *Euchorthippus* used in this study. All these recordings were made from different males. Recordings 236/3, 236/4 and 236/6 were made at the type-locality of *E. chopardi*.

Species or subspecies	Locality	Date recorded and collected	Recordist	Shade air temperature	Recording No.
<i>declivus</i>	FRANCE: Lozère, near Mende, Col de Montmirat.	10.viii.1977	DRR	21°C	232/2
	FRANCE: Vaucluse, Mont Ventoux, road from Bédoin, 1100 m.	12.viii.1977	DRR	18°C	233/6
	FRANCE: Alpes-Maritimes, near Col de Vence, 930 m.	25.viii.1977	DRR	25°C	241/1
	FRANCE: Alpes-Maritimes, near Col de Vence, 940 m.	10.viii.1982	DRR	23°C	484/4
<i>pulvinatus gallicus</i>	FRANCE: Dordogne, near Le Bugue, Campagne.	24.viii.1974	DRR	30°C	134/3
	Same locality	24.viii.1974	DRR	33°C	134/5
	FRANCE: Pyrénées-Orientales, St Cyprien.	28.viii.1977	DRR	25°C	136/3
	FRANCE: Vaucluse, Mont Ventoux, near Les Bruns.	11.viii.1977	DRR	24°C	232/4
	Same locality	11.viii.1977	DRR	24°C	232/5
	FRANCE: Vaucluse, near Carpentras, Bédoin.	13.viii.1977	DRR	22°C	234/8
	Same locality	13.viii.1977	DRR	22°C	235/2
	SPAIN: Huesca, 5 km NW. of Solsona	9.ix.1978	WJR	27°C	272/3
	SPAIN: Huesca, 7 km SE. of Seo de Urgel	11.ix.1978	WJR	26°C	272/9
	Same locality	12.ix.1978	WJR	26°C	274/3
<i>chopardi</i>	FRANCE: Vaucluse, 3 km SE. of Cavaillon.	14.viii.1977	DRR	27°C	236/3
	Same locality	14.viii.1977	DRR	27°C	236/4
	Same locality	14.viii.1977	DRR	28°C	236/6
	FRANCE: Vaucluse, near Carpentras, 3 km S. of Malaucène	15.viii.1977	DRR	23°C	236/8
	Same locality	15.viii.1977	DRR	23°C	236/10
	SPAIN: Huesca, 8 km. E. of Ainsa	3.ix.1978	WJR	33°C	270/6

insect was in full sunshine or receiving radiant heat from a bench lamp, and we suggest that any recordings compared with our data should be made under similar conditions. Ambient air temperatures are also important, but less so than radiant heat as the insects can regulate their body temperature to some extent by adjusting their orientation to the incident radiation.

When combining the data from the various recordings of each species in order to find the range, overall mean and standard deviation, we treated the mean obtained from each male as an individual observation, thus minimizing the effect of variation in the songs. When comparing a song with our data, it is thus desirable to use mean values taken from as much of the song as possible.

We excluded from our analysis any echemes that were obviously atypical, such as those produced when the insect was just beginning to sing. We based our figures for echeme repetition rate on all the regular sequences in each recording, but the number of echemes used for

**Table 2** Data for the studio recordings of male calling songs of *Euchorthippus* used in this study. All these recordings were made from different males except for the following four pairs: (313/4, 316/2), (314/2, 316/1), (179/6, 180/2), (179/9, 180/1).

Species or subspecies	Locality	Date collected	Date recorded	Recordist	Air temperature	Recording No.
<i>declivus</i>	FRANCE: Landes, near Biscarrosse, Millas.	11.ix.1976	12.ix.1976	WJR	20°C	180/3
<i>pulvinatus gallicus</i>	FRANCE: Landes, Arcachon. Same locality	13.ix.1976 14.ix.1976	13.ix.1976 15.ix.1976	WJR WJR	20°C 18°C	180/4 180/8
	SPAIN: Valencia, near Requena, 700 m.	27.vii.1979	30.vii.1979	WJR	25°C	309
	Same locality	27.vii.1979	31.vii.1979	WJR	29°C	313/1
	Same locality	27.vii.1979	31.vii.1979	WJR	27°C	313/2
	Same locality	27.vii.1979	31.vii.1979	WJR	27°C	313/3
	Same locality	27.vii.1979	31.vii.1979	WJR	27°C	314/1
	Same locality	27.vii.1979	31.vii.1979	WJR	27°C	313/4
	Same locality	27.vii.1979	2.viii.1979	WJR	24°C	316/2
	Same locality	27.vii.1979	1.viii.1979	WJR	26°C	314/2
	Same locality	27.vii.1979	2.viii.1979	WJR	27°C	316/1
<i>pulvinatus elegantulus</i>	JERSEY JERSEY: Quennevais.	12.ix.1964 16.vii.1977	15.ix.1964 8.viii.1977	J.F.Burton WJR	— 27°C	163 212
	FRANCE: Loire- Atlantique, 3 km SW. of Guérande.	9.ix.1976	10.ix.1976	WJR	20°C	179/6
	Same locality	9.ix.1976	12.ix.1976	WJR	20°C	180/2
	FRANCE: Loire- Atlantique, near Guérande, Le Croisic.	9.ix.1976	12.ix.1976	WJR	20°C	179/9
	Same locality	9.ix.1976	12.ix.1976	WJR	20°C	180/1
<i>chopardi</i>	SPAIN: Valencia, near Requena, 700 m.	27.vii.1979	30.vii.1979	WJR	27°C	311/1
<i>angustulus</i>	MAJORCA: 1 km W. of Palma Nova. Same locality	16–18.ix.1981 16–18.ix.1981	21.ix.1981 22.ix.1981	WJR WJR	29°C 29°C	417 420

measuring the number of gaps per echeme, echeme duration and syllable duration was generally limited to 50 per recording. When we had two recordings taken from the same male, the mean of each character was calculated separately for each recording and these means were then combined to give a single grand mean for that male.

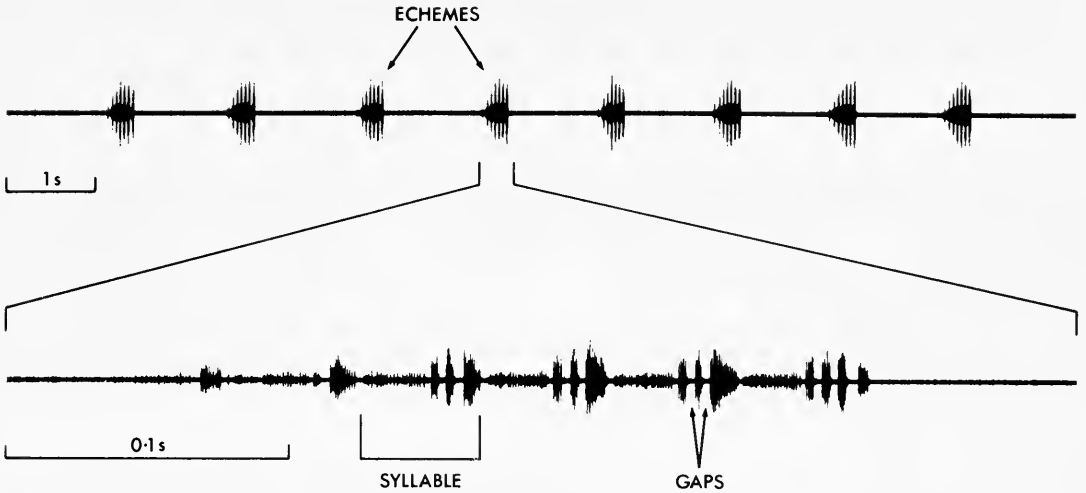
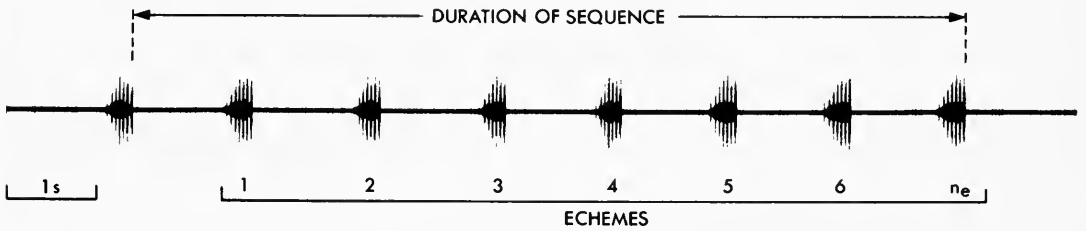
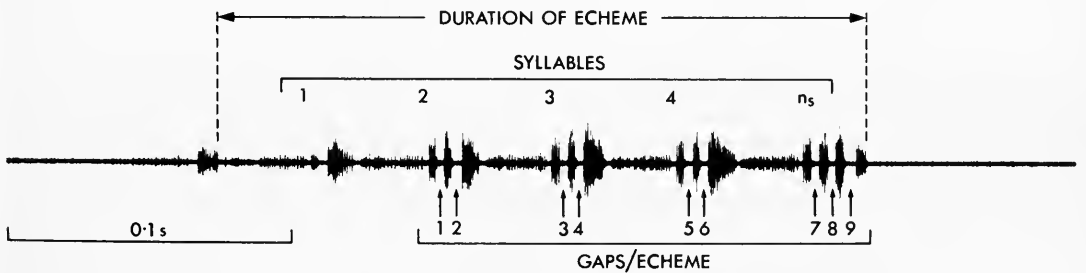

Fig. 4 Oscillograms of the male calling song of *Euchorthippus declivus*, showing the terminology used in this paper.



$$\text{ECHEME REPETITION RATE} = \frac{\text{NUMBER OF ECHEMES } (n_e)}{\text{DURATION OF SEQUENCE}}$$

Fig. 5 Oscillogram of a sequence of echemes from the male calling song of *Euchorthippus declivus*, showing the method of determining the duration of the sequence and the echeme repetition rate.



$$\text{MEAN DURATION OF SYLLABLE} = \frac{\text{DURATION OF ECHEME}}{\text{NUMBER OF SYLLABLES } (n_s)}$$

Fig. 6 Oscillogram of a typical echeme from the male calling song of *Euchorthippus declivus*, showing the method of determining the duration of the echeme, the number and duration of the syllables and the number of gaps per echeme.

### Presentation and evaluation of the data

We have chosen to present the morphological and acoustic data in the form of bar-charts (Figs 20, 82–88) because they make it possible to compare at a glance our samples of the taxa and their constituent regional populations. The components of each bar are explained in Fig. 7 (but note that in some bars the range does not extend beyond the standard deviation on one side of the

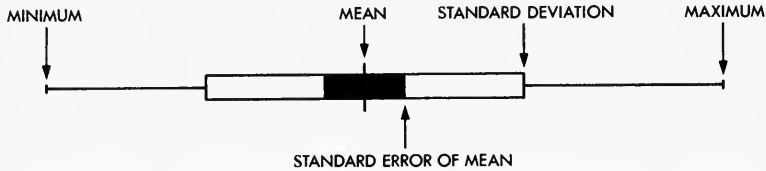

Fig. 7 Diagram explaining the components of the bars used in the bar-charts (Figs 20, 82–88). Note that in some of these bars the range does not extend beyond the standard deviation on one side of the mean and that, when the number of observations is fewer than five, the bar is given as a simple line with no statistical information beyond the range and mean.

mean). The scale used for each bar-chart was chosen to make the fullest use of the space available, and the resulting differences in scale should be taken into account when comparing the variability of different characters. All morphological measurements are given in millimetres and all temporal ones in milliseconds. For each sample,  $n$  represents the number of specimens measured or whose songs have been analysed, and on the bar-charts of acoustic data (Fig. 20)  $n_e$  represents the total number of echemes analysed. Where  $n < 5$  the bar is given as a simple line with no statistical information beyond the range and mean.

We found the bar-charts to demonstrate so clearly and quickly the differences between the taxa, and which characters are most useful in separating them, that we decided it would be pointless to subject the same data to multivariate analysis. We have occasionally applied 't' tests to determine more objectively which of two characters (or combinations of characters) gave the best separation between two taxa, but in every case these did no more than confirm what was obvious from the bar-charts.

The bar-charts also suggested combinations of characters that would give improved separations and we have plotted a selection of these in the form of scatter diagrams (Figs 8–13, 21–24). Fig. 8 shows particularly clearly the contrast in the males between *declivus* and the remaining species in the projection of the fore wing beyond the hind wing. Fig. 9 gives a complete separation of the males of *declivus*, *pulvinatus* and *chopardi*, especially if the French samples are considered alone. Figs 10 and 11 achieve a similar result for both sexes, but the French and Spanish samples have to be considered separately in order to obtain a complete separation in the males. Figs 21–24 show rather more clearly than the acoustic bar-charts (Fig. 20) the difference between the songs of *declivus*, *pulvinatus* and *chopardi*.

The best morphological separation between males of *declivus*, *pulvinatus* and *chopardi* was achieved by plotting three characters as percentages on a triangular graph (Fig. 12). The procedure for this is described by Mayr (1969) and is best explained by an example. For one specimen the following figures were obtained: number of stridulatory pegs 148, length of pronotum/length of head 1.09 and distance of stigma from tip of fore wing 2.68 mm. Since the figures for the last two characters are small compared with the first, they were multiplied by 100 and 25, respectively. The three figures used were thus 148, 109 and 67, giving the sum 324. The three characters represent 45.7 per cent, 33.6 per cent and 20.7 per cent of their sum and these percentages were used to enter a single point on the graph, the axes being arranged so that the sum of the three coordinates of each point was always 100. The graph thus shows proportions rather than absolute sizes.

Figure 12 gives perhaps the most convincing demonstration that *declivus*, *pulvinatus* and *chopardi* do not constitute a single, continuously variable species, though it does not of course

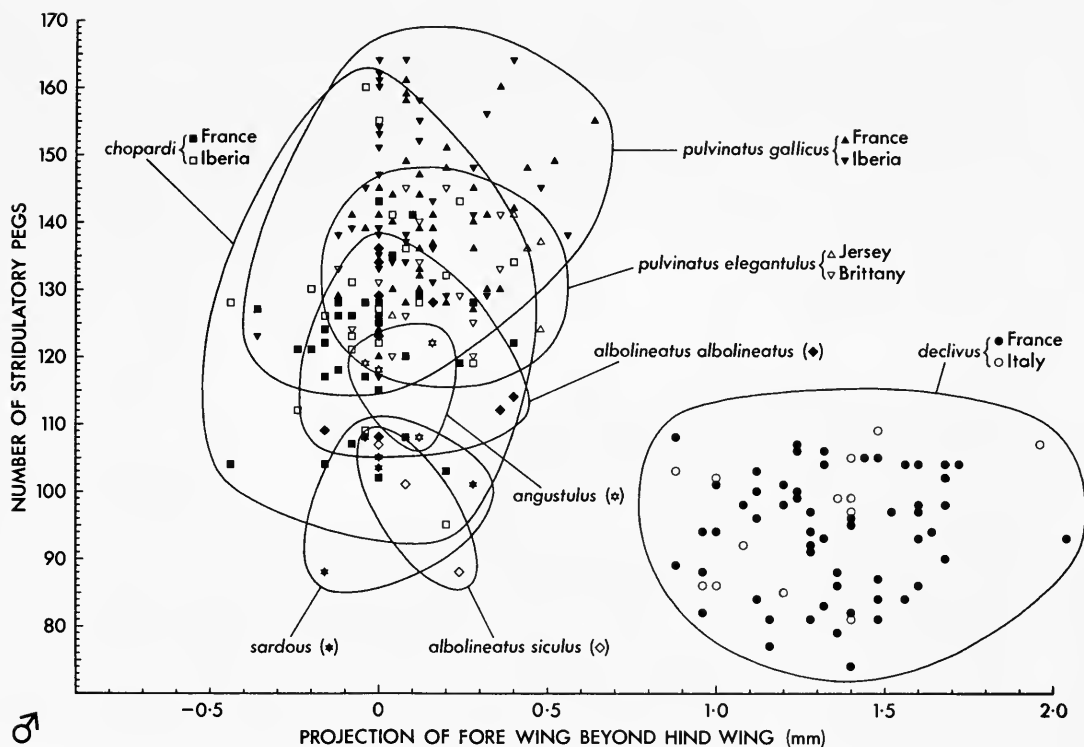

Fig. 8 Scatter diagram showing a plot of the number of stridulatory pegs against the projection of the fore wing beyond the hind wing in males of *Euchorthippus*. The negative values on the horizontal axis are for specimens in which the hind wing projects beyond the fore wing.

rule out polymorphism. Figure 13 shows that, using the same combination of characters, *albolineatus* and *angustus* resemble *chopardi*, while *sardous* is nearer to *pulvinatus*.

It should be noted that in some scatter diagrams the number of points entered is smaller than the number of specimens measured (as shown in the bar-charts), because in a few specimens *both* (or, in the case of the triangular graphs, *all four*) of the characters were not available. Where two different population symbols would have coincided exactly, only one symbol is shown in the morphological scatter diagrams; the symbol chosen is the one considered to be more useful or informative (e.g. near the edge of the cluster concerned). In the song scatter diagrams (Figs 21–24), for which fewer points were available, coincident symbols have been moved apart slightly so that both can be seen.

## Characters studied

### Morphology

We have concentrated on morphological characters that are easy to use with pinned specimens and have therefore excluded those characters of the fore wing that are often hidden behind the hind legs (e.g. the width of the medial and cubital areas) or are difficult to measure without opening and flattening the wings (e.g. the width of the fore wing). We have also tried to avoid characters that tend to change as the body shrinks after death, and have therefore used the length of the hind femur as a measure of size in preference to body length, which is often greatly altered by post mortem shrinkage (and in the females is also much influenced by gravity). We have, however, included the lengths of the male subgenital plate and abdominal tergites 9+10 because of the emphasis placed on these measurements by Descamps (1968), although we have

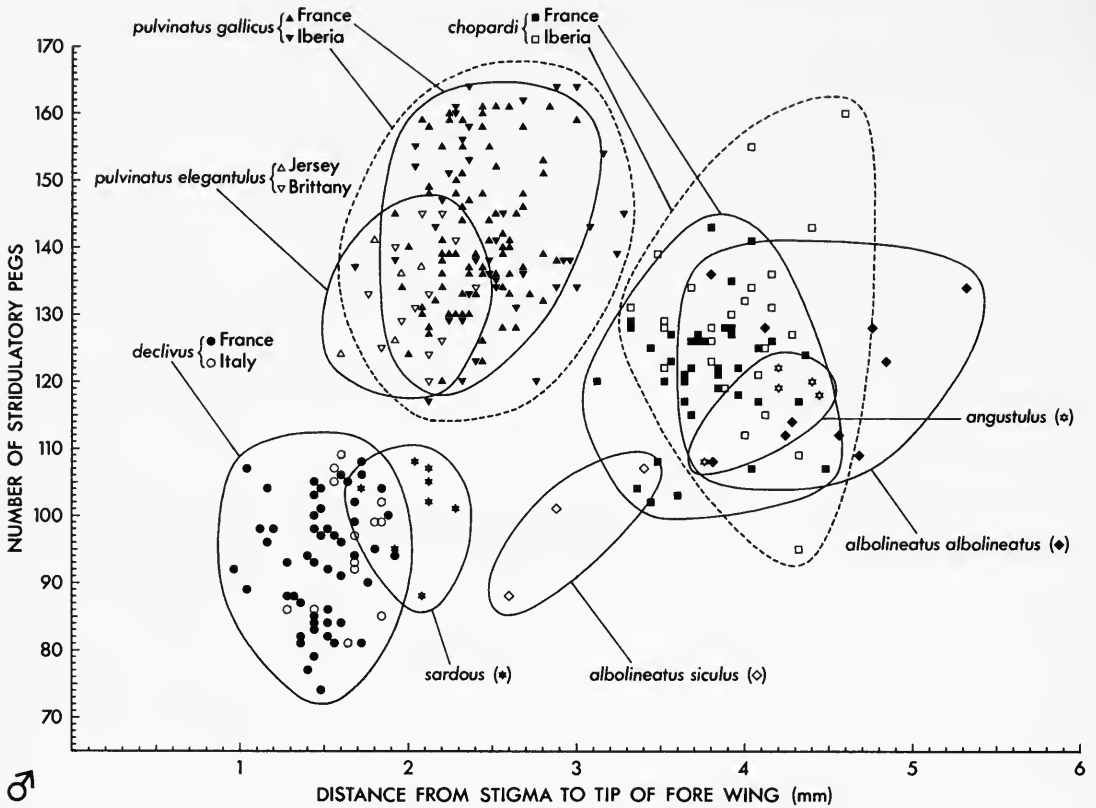

Fig. 9 Scatter diagram showing a plot of the number of stridulatory pegs against the distance from the stigma to the tip of the fore wing in males of *Euchorthippus*. To facilitate comparison broken lines are used for the two Iberian samples.

found that their usefulness is much reduced by shrinkage during drying. We suspect that the distance by which the fore wing projects beyond the hind wing is also affected by post mortem shrinkage, but this does not prevent it from being a useful character.

#### Head and pronotum

The lengths of the head and pronotum are not very useful taxonomic characters other than as measures of size or when taken as a ratio of one to the other. This ratio is frequently useful for separating *chopardi* from the other mainland species and was used by Descamps (1968) to distinguish *chopardi* from *angustulus*, *albolineatus albolineatus* and *a. siculus*. However, the pronotum/head ratios of Iberian *chopardi* show a large overlap with those of the other taxa (Figs 82, 86).

The prominence of the median and, especially, lateral carinae of the pronotum is often useful in distinguishing between species, but this character is rather difficult to use until one is familiar with the differences shown. We have attempted to show in diagrammatic cross-section (Figs 31–34) the degree of prominence of these carinae in *declivus*, *pulvinatus gallicus*, *chopardi* and *albolineatus albolineatus*. Figures 31–39 also show dorsal views of the pronotum of males of all the taxa dealt with in this paper. In most species the lateral carinae are almost straight but in *sardous* they are distinctly incurved in the prozona (Fig. 38). They are also somewhat incurved in *angustulus*, but less so in specimens from Majorca than in those from Formentera.



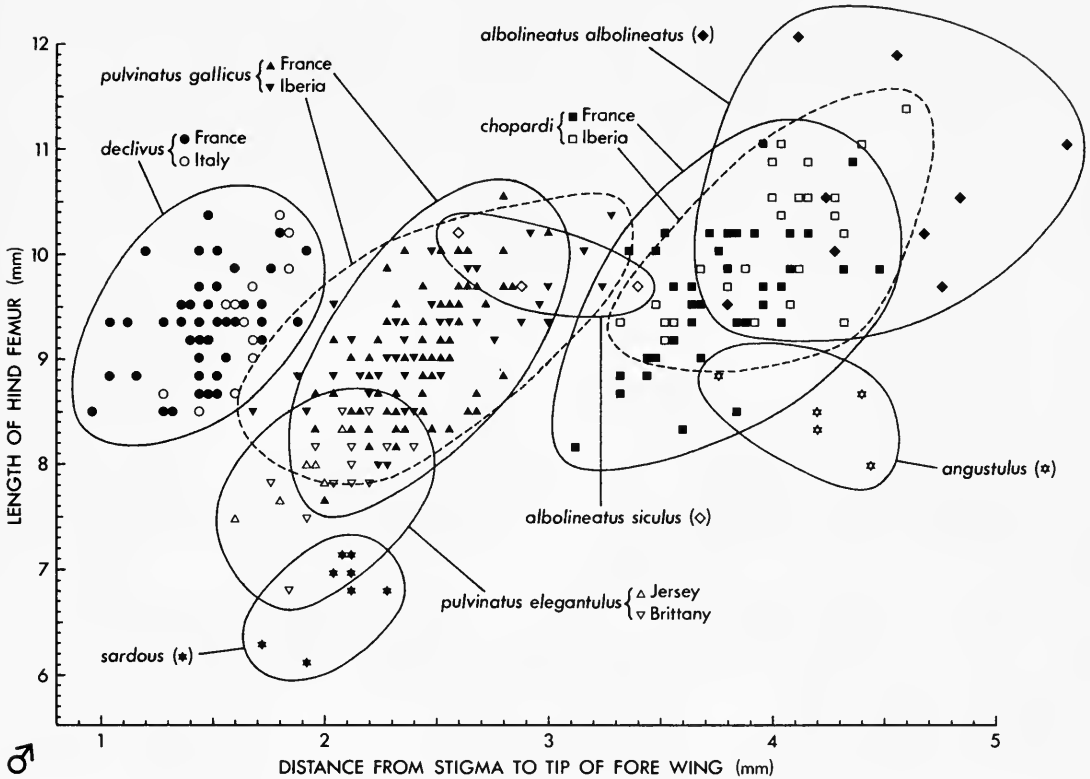

**Fig. 10** Scatter diagram showing a plot of the length of the hind femur against the distance from the stigma to the tip of the fore wing in males of *Euchorthippus*. To facilitate comparison broken lines are used for the two Iberian samples.

### Fore wing

The absolute and relative lengths of the fore wing are useful characters and have been much used by previous authors (e.g. Defaut, 1982). The position of the tip of the fore wing in relation to the hind knee or, less reliably, the apex of the abdomen provides one of the easiest methods of distinguishing between typical *declivus*, *pulvinatus gallicus* and *chopardi* in the field (Figs 25–30). The length of the fore wing is more useful when taken as a ratio with the length of the hind femur; this is particularly true in the female, in which the range of our sample of *p. gallicus* does not overlap with those of *chopardi* or *a. albolineatus* (Fig. 87).

The fore wings are short in *declivus* and become progressively longer in both sexes in the sequence *declivus*, *p. gallicus*, *chopardi* and *a. albolineatus* (Figs 83, 87).

The distance from the stigma to the tip of the fore wing is, to some extent, proportional to the length of the fore wing but provides an even better character, especially when used as a ratio with the length of the hind femur (Figs 84, 85, 88). When these two characters are plotted against each other in a scatter diagram, there is no overlap in our male samples of the populations of the three species occurring in France (*declivus*, *pulvinatus* and *chopardi*) or between the two occurring commonly in Spain (*pulvinatus* and *chopardi*) (Fig. 10). In females there is no overlap at all between our samples of *declivus*, *pulvinatus* and *chopardi* (Fig. 11), though *a. albolineatus* is very closely associated with *chopardi* in both sexes. *E. p. elegantulus* agrees with *p. gallicus* rather than with *declivus* when the measurements are plotted against the length of the hind femur (Figs 10, 11) or, in males, against the number of stridulatory pegs (Fig. 9).

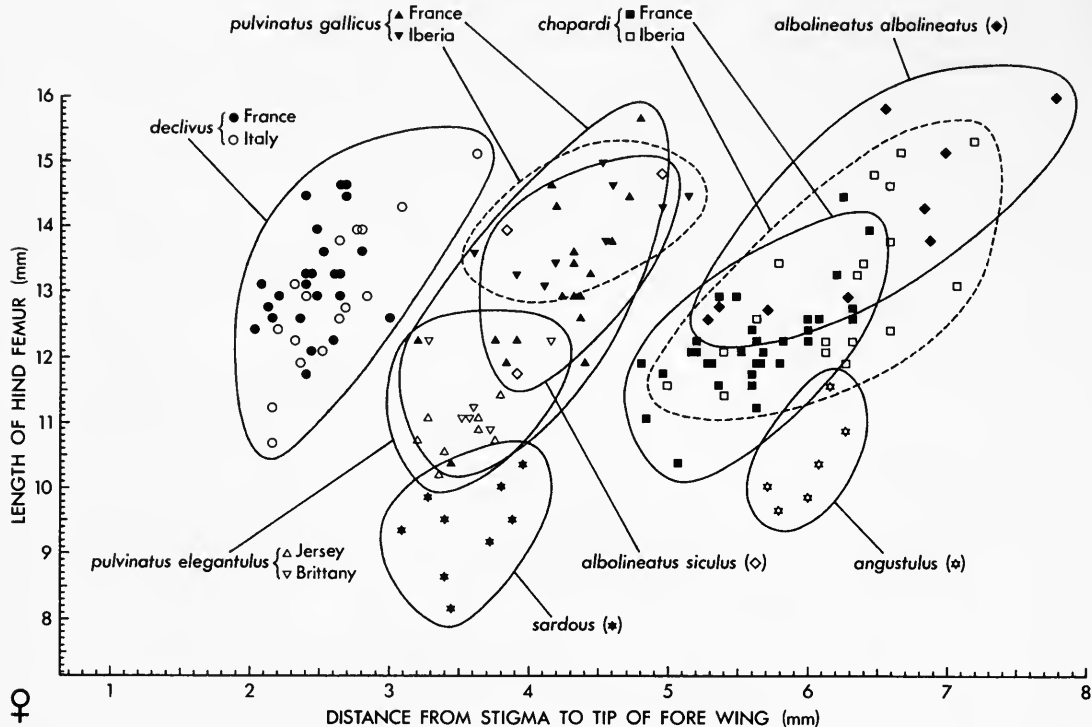

**Fig. 11** Scatter diagram showing a plot of the length of the hind femur against the distance from the stigma to the tip of the fore wing in females of *Eurchorthippus*. To facilitate comparison broken lines are used for the two Iberian samples.

### Hind wing

The length of the hind wing is often a useful character (Figs 83, 87), especially when taken as a ratio with the length of the hind femur (Figs 84, 87). In this ratio, for both sexes, *p. elegantulus* is again closer to *p. gallicus* than to *declivus*, which is distinct from all the other taxa. In the female this character separates *chopardi* from *p. gallicus*.

### Projection of the fore wing beyond the hind wing

The distinct gap between the tips of the flexed fore and hind wings provides the best character for distinguishing *declivus* from the remaining taxa (Figs 8, 84, 88). This character has been mentioned by several authors (Chopard, 1952; Descamps, 1968; Harz, 1975; Luquet, 1978; Defaut, 1982) but its significance in showing that *elegantulus* is distinct from *declivus* has not been previously realized (see p. 132).

### Hind femur

The length of the hind femur (Figs 82, 86) is useful only as a measure of size, for which purpose we have used it in ratios with the length of the fore wing, the length of the hind wing and the distance from the stigma to the tip of the fore wing (Figs 10, 11, 84, 85, 87, 88).

### Stridulatory file

Counting the stridulatory pegs takes at least a minute per specimen and ideally requires a microscope with a movable stage. We have found the effort worthwhile, however, as this character, in combination with stigma distance and pronotum/head ratio on a triangular graph,

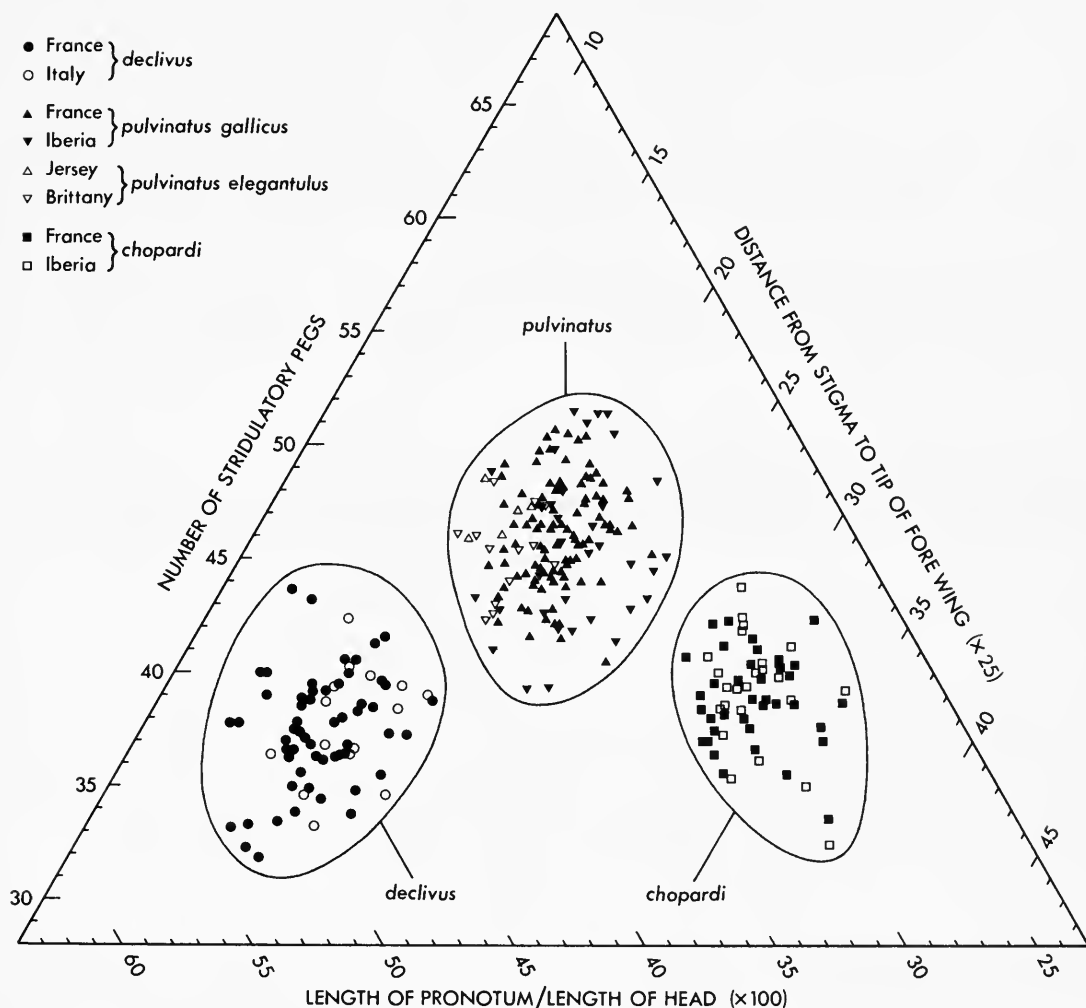

Fig. 12 Triangular graph showing the relationship between males of *Euchorthippus declivus*, *E. pulvinatus* and *E. chopardi* as determined by three diagnostic characters. (See the text for full explanation.)

has provided one of the best means of separating males of *declivus*, *pulvinatus* and *chopardi* (Fig. 12). The first two of these characters give almost as good a separation in a two-axis scatter diagram (Fig. 9). The stridulatory pegs provide another character showing the close relationship between *p. elegantulus* and *p. gallicus* (Fig. 83). *E. p. elegantulus* has, on average, slightly fewer pegs than *p. gallicus*, as would be expected from the difference in size, but in both of the two-axis scatter diagrams and in the triangular graph *p. elegantulus* is clearly more closely associated with *p. gallicus* than with *declivus*.

We have found it necessary to examine the female stridulatory pegs only in order to find the best means of separating *a. siculus* and *pulvinatus*. The pegs are smaller in females and are more likely to be replaced by hairs, but it is still usually possible to count them by viewing the file in profile. In cases where this is difficult a replica of the file can be made (see Pitkin, 1976).

We did not find the length of the stridulatory file to be a useful character, the very short file of *sardous* simply reflecting the generally small size of this species and in particular its short hind femora (cf. Figs 82 and 83).

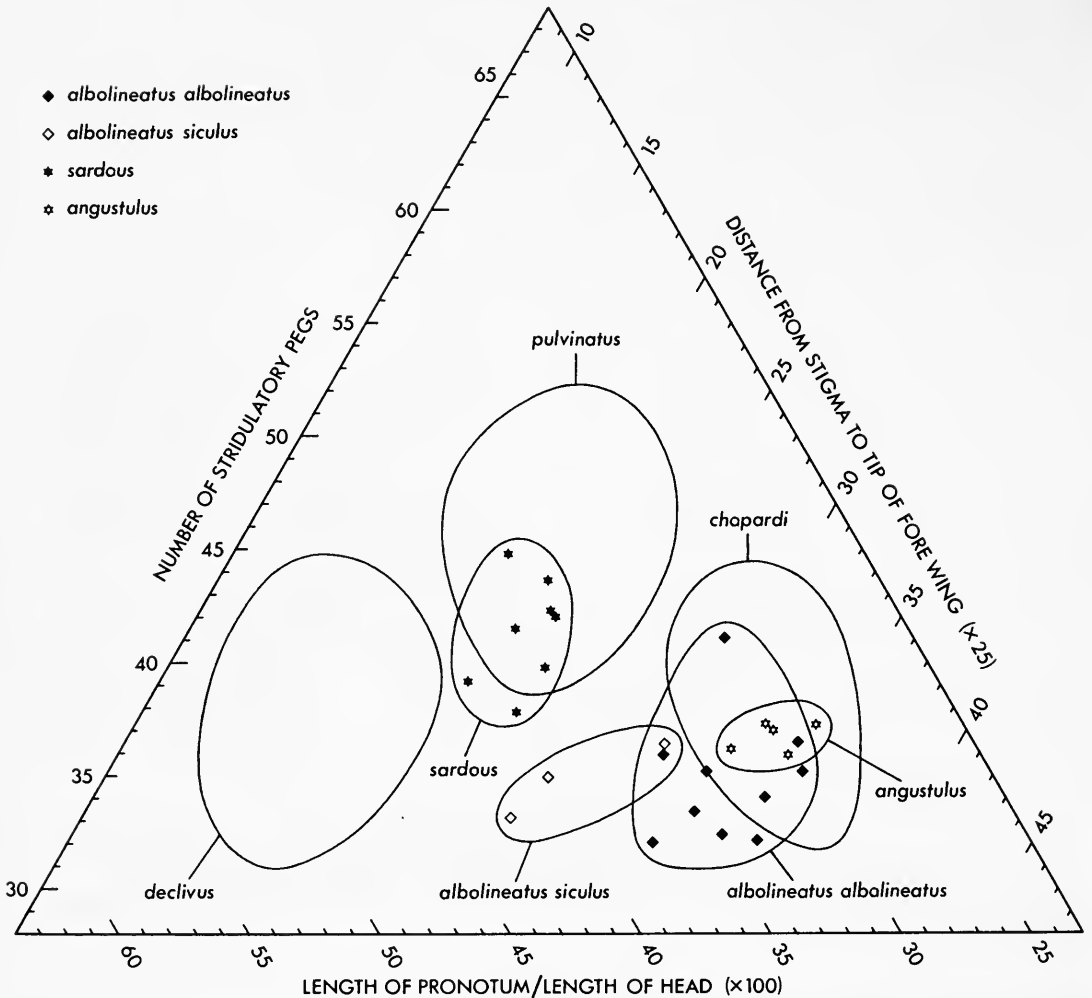

Fig. 13 Triangular graph showing the relationship between males of *Euchorthippus* as determined by three diagnostic characters. The detailed plots for *E. declivus*, *E. pulvinatus* and *E. chopardi* are shown in Fig. 12. (See the text for full explanation.)

#### Male subgenital plate and abdominal tergites 9+10

The shape of the male subgenital plate has been used as a key character by all previous authors. Descamps (1968) tried to make this character more objective by comparing the length of the subgenital plate with that of abdominal tergites 9+10, and concluded that in *declivus* and *pulvinatus* the dorsal part of the subgenital plate was longer than abdominal tergites 9+10 in profile, while in *chopardi*, *a. albolineatus*, *a. siculus*, *angustulus* and *sardous* these tergites were longer than, or subequal to, the subgenital plate.

We have found that measuring the subgenital plate accurately in dried specimens is difficult, since post mortem shrinkage may cause the proximal end of the subgenital plate to be covered by the supra-anal plate. Another problem is caused by the way in which variation in the degree of curvature of the abdomen affects the measurement of the length of tergites 9+10. Perhaps partly because of these difficulties, we have not found the ratio of the length of the subgenital plate to that of abdominal tergites 9+10 to be particularly useful; for *declivus* and *p. gallicus* the ratio is in fact less useful than the length of the subgenital plate alone (Fig. 85).

We have found the shape of the male subgenital plate to be more useful than its dimensions. It is always distinctly pointed in *declivus*, bluntly rounded in *chopardi* and intermediate in *pulvinatus* (Figs 25, 27, 29), but without some experience of the group it is easy to be misled by this character. The frequent misidentification of Spanish *p. gallicus* as *declivus* has doubtless been the result of using the male subgenital plate as the principal distinguishing character.

#### *Internal male genitalia*

We have examined the internal male genitalia of all the species included in this study and have found no taxonomically useful character.

#### **Colour pattern**

Most specimens show some degree of dark longitudinal striping, especially on the head, and in *chopardi* these stripes are particularly conspicuous (Fig. 40). We have seen a few conspicuously striped specimens that seem to be *pulvinatus* on other characters, but well-developed stripes of the kind shown in Fig. 40 are characteristic of *chopardi*.

#### **Cytology**

In common with other Gomphocerinae of the *Chorthippus*-group, the species of *Euchorthippus* in which the chromosomes have been studied have complements of 17 in the male (XO) and 18 in the female (XX) (Hewitt, 1979, Santos *et al.*, 1983). The chromosomes of *pulvinatus* have been examined by McClung (1932), Arana *et al.* (1980), Ferrer *et al.* (1981), Santos & Giráldez (1982) and Santos *et al.* (1983), while those of *albolineatus* have been described by Carlson (1936) (Carlson's specimens were identified by Hebard as *pulvinatus*, but as they came from Algeria they were almost certainly *albolineatus*, the only species of *Euchorthippus* known to occur in North Africa). Santos *et al.* (1983) have also examined the chromosomes of Spanish *chopardi* and have shown that the C-banding patterns differ quite markedly from those of Spanish *pulvinatus* (these authors refer to *chopardi* as '*albolineatus*', but Dr Santos has kindly shown us the specimens and we consider them to be *chopardi*). Although the number and gross morphology of the chromosomes are likely to be uniform throughout the genus, it would clearly be interesting to study the C-banding patterns in other species; careful comparison may also reveal differences in chiasma frequency, relative lengths of chromosomes or DNA content of equivalent nuclei (John & Hewitt, 1966; White, 1972).

Santos *et al.* (1983: 73) have succeeded in rearing artificial hybrids between *pulvinatus* and *chopardi*. This raises the possibility of natural hybrids occurring between these species, which quite often occur together. We have seen a few specimens that are intermediate between the two in some morphological characters, but in order to recognize natural hybrids with any confidence it would be necessary to investigate them genetically and, in the case of males, to analyse the calling song.

#### **Song**

There has been no comprehensive study of the acoustic behaviour of *Euchorthippus*, but several authors have published comments on the songs of one or more species. Chopard (1952) briefly outlined the calling song of *pulvinatus* and Faber (1953) described its complete acoustic repertoire, including calling, courtship and rivalry songs. Descamps (1968) published oscillograms of one echeme each of *declivus*, *pulvinatus* and *chopardi*, but found no noticeable difference between them and gave a single description of the calling and courtship songs for all three species. Luquet (1978) gave a diagram of one echeme for each of these species and suggested that the echeme was longest in *declivus*, almost as long in *chopardi* and shortest in *pulvinatus* (our own analyses, however, show the echemes to be longer in *chopardi* than in *declivus* – see Fig. 20). Luquet also found that *pulvinatus* had a more rapid 'cadence' (? echeme repetition rate) than the other two species, but he considered these differences to be

insufficient to permit identification in the field. Schmidt & Schach (1978) gave oscillograms of the courtship song of *pulvinatus* and *declivus*, and described differences in the duration of the syllables and echemes, but neither these authors nor any others have seriously suggested using the song as a taxonomic character.

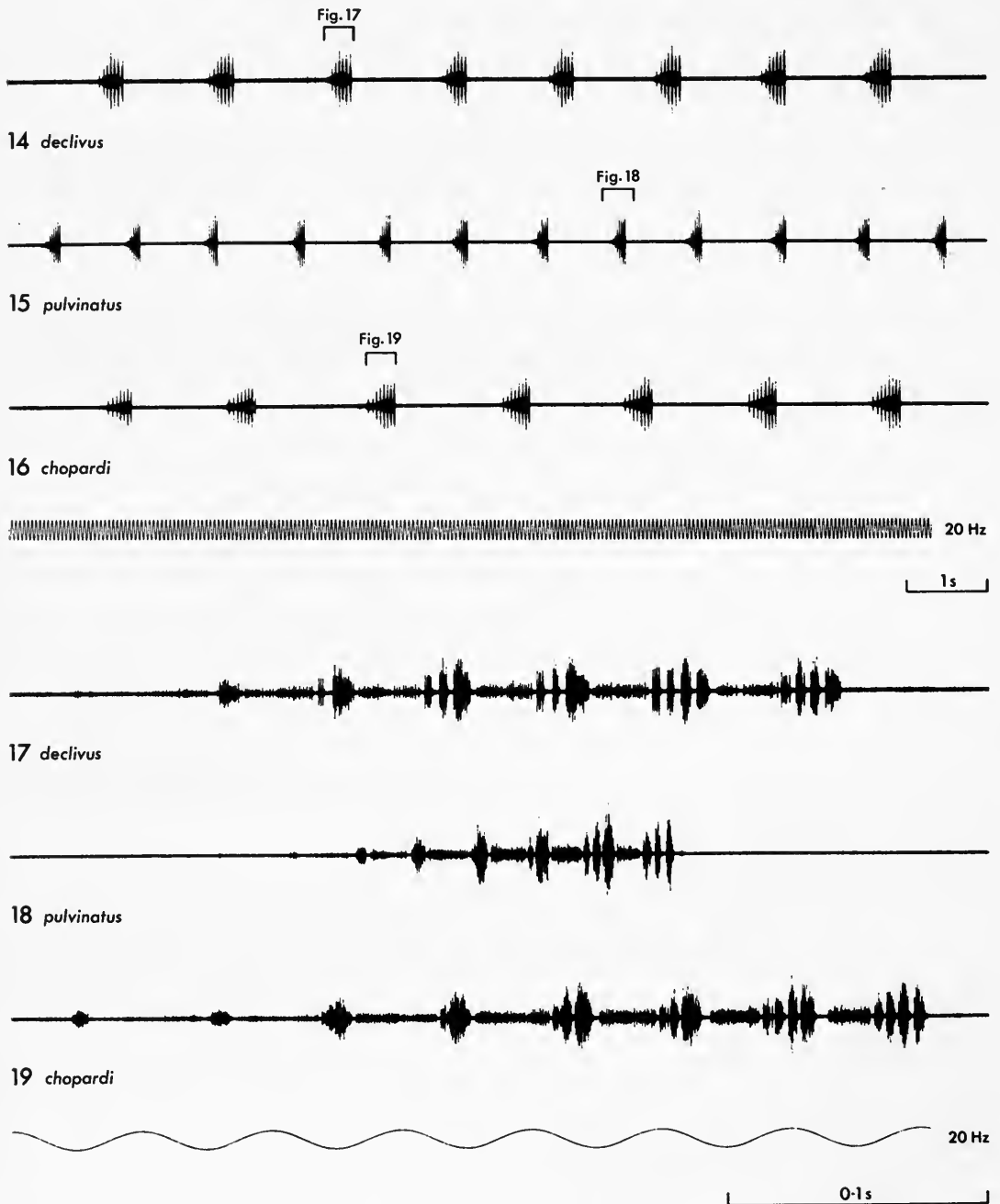

Figs 14–19 Oscillograms of typical male calling songs of (14, 17) *Euchorthippus declivus*, (15, 18) *E. pulvinatus* and (16, 19) *E. chopardi*. Figs 17–19 are faster oscillograms of the single echemes indicated in Figs 14–16. The oscillograms were taken from recordings 233/6, 232/4 and 236/8, for which full information is given in Table 1 (p. 107).

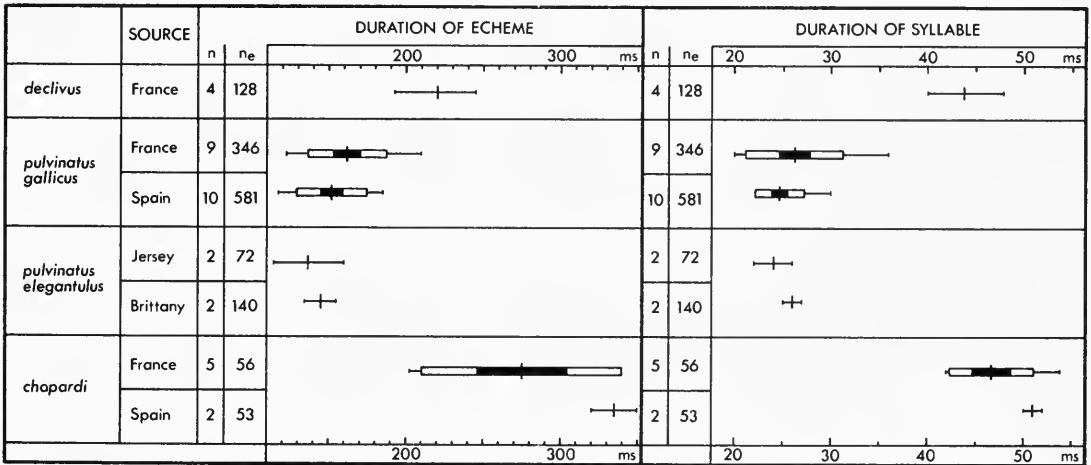
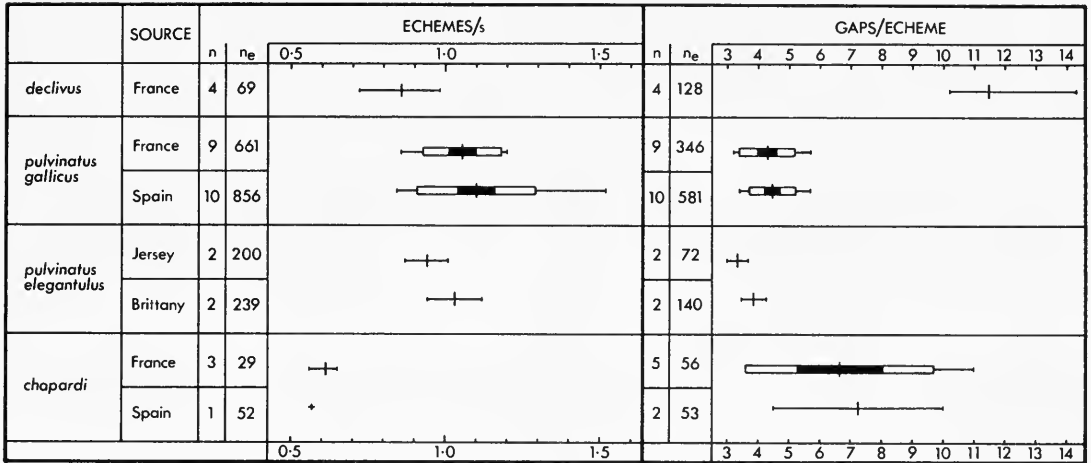

**Fig. 20** Data for four characters of the male calling songs of *Euchorthippus declivus*, *E. pulvinatus* and *E. chopardi*. For explanation of the bars see Fig. 7; n = number of males, n<sub>e</sub> = number of echemes from which data were taken. Note that in compiling these charts the mean values obtained from each male were treated as individual observations. (For further explanation see p. 110.)

While our own observations are broadly in agreement with those of these authors, our more detailed analyses have revealed good, taxonomically useful differences between the songs of *declivus*, *pulvinatus* and *chopardi*. Figures 14–19 show oscillograms of typical sequences of echemes from the male calling songs of these three species, followed by much faster oscillograms of single echemes selected from these sequences. The full data from all our recordings are given in Fig. 20 and scatter diagrams from four selected pairs of song characters are shown in Figs 21–24. The most striking difference is between the large number of gaps per echeme in *declivus* and the much smaller number in *pulvinatus*. This difference has not previously been observed although it is clearly visible in the oscillograms given by Descamps (1968: Fig. 23 – but note that the oscillogram for *declivus* is shown backwards). The number of gaps per echeme in *chopardi* is also lower than in *declivus*, but the difference is less striking and our recordings of *chopardi* show a high degree of variability in this character. Both the syllables and echemes are of shorter duration in *pulvinatus* than in *declivus*, the syllables showing the clearer contrast (Fig. 20). In all these characters the bar-charts and scatter diagrams show a close association between *p. gallicus* and *p. elegantulus* (Figs 20–24).

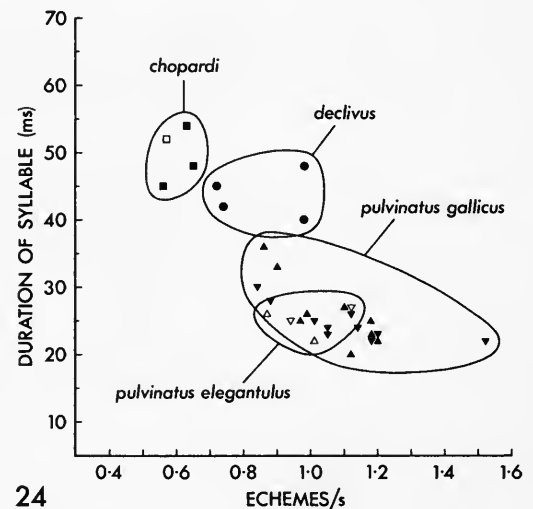
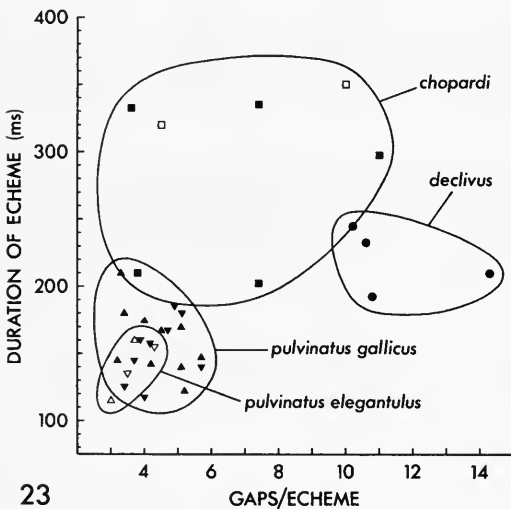
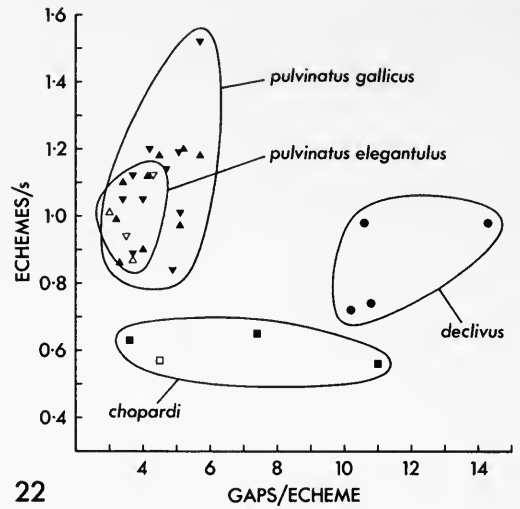
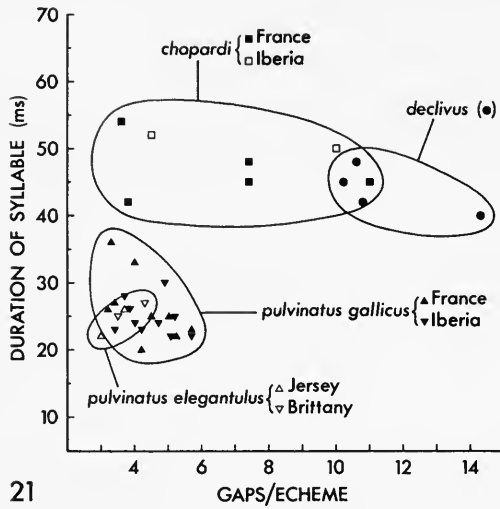

Figs 21–24 Scatter diagrams showing plots of four pairs of characters of the male calling songs of *Euchorthippus declivus*, *E. pulvinatus* and *E. chopardi*. Note that each point represents the *mean* values of the two characters obtained from one male. The symbols are explained in Fig. 21.

None of these differences in song can be measured without the help of recording and analysing equipment – indeed the gaps, which last for little more than a millisecond, are quite undetectable by the unaided human ear (though being easily resolved by the insects themselves – see, for example, the review of Autrum, 1963). The only song character that can be used as an aid to field identification is the echeme repetition rate, which can be quite easily measured using the second hand (or digital count) of a wrist-watch. As shown in Fig. 20 this character does not show striking contrasts between the species but, when they are singing in similar warm, sunny conditions, *chopardi* has a slower rate than the other two, and *pulvinatus* usually has a faster rate than *declivus*.

It should be emphasized that, for taxonomic use, measurements of all these characters should be based on as many echemes as possible and should always be taken from songs produced by *isolated* males singing in warm sunshine (or in a warm laboratory with a source of radiant heat).



The echeme repetition rate should be based only on *regular* sequences of echemes (see p. 106) and, for each male, it is the *mean* values of all these song characters that should be compared with the bar-charts and scatter diagrams (Figs 20–24).

The number of syllables in each echeme (usually 6–7, occasionally 5 or 8) appears to have little or no taxonomic value. We counted the syllables in the course of calculating the syllable duration, and it soon became clear that intraspecific variation would obscure any trend towards an interspecific difference.

### *EUCHORTHIPPUS* Tarbinskii

*Euchorthippus* Tarbinskii, 1925: 192; Uvarov, 1926: 341 [redescription]. Type-species: *Oedipoda pulvinata* Fischer de Waldheim, by original designation.

*Sinhippus* Ramme, 1939: 132. Type-species: *Sinhippus alini* Ramme [= *Euchorthippus unicolor* (Ikonnikov)], by original designation. [Synonymized by Bei-Bienko & Mishchenko, 1951: 543.]

DIAGNOSIS. ♂♀. Fastigium of vertex rather rounded and relatively blunt; foveolae rather short and shallow, each with weak carinula leading inwards and backwards from its posterior end. Antennae not clubbed. Lateral carinae of pronotum straight or slightly incurved. Pleura coarsely rugose and punctate. Inner and outer tarsal claws of different lengths. Brachypterous to macropterous. Precostal area of fore wings with small bulge on anterior margin; medial area not conspicuously widened, without intercalary vein and with irregular cross-veins. Hind wings transparent and colourless. Subgenital plate bluntly to acutely conical. Ovipositor short, without lateral teeth. General coloration brown, straw-coloured or grey (sometimes with greenish tinge but never clearly green or reddish in western European species), with longitudinal dark and light stripes on head and sometimes pronotum. Female usually with white linea scapularis.

Male calling song. In the four species whose stridulation we have studied (*declivus*, *pulvinatus*, *chopardi* and *angustulus*) the calling songs have the same basic structure though differing in detail (Fig. 4). They consist of a sequence of echemes repeated at a rate of 0.5–1.5 per second for an indefinite period, sometimes a minute or more. Oscillographic analysis shows that each echeme begins quietly, lasts about 150–350 ms and is composed of 5–8 syllables, each of which has a quiet first part and a louder second part; in at least the later part of each echeme, the louder second part of each syllable contains momentary breaks in the sound, referred to in this paper as ‘gaps’ (Fig. 4).

DISCUSSION. *Euchorthippus* is an easily recognized genus to the experienced acridologist, but its morphological diagnostic characters are rather subtle and difficult to describe. In comparison with *Chorthippus*, with which it is most easily confused, *Euchorthippus* has a more elongate head when viewed from the side, with the eyes produced anterodorsally into a more pronounced and acute angle. The foveolae are rather weakly (sometimes very weakly) developed, and from the posterior end of each one arises a feeble carinula, usually extending inwards and backwards towards the mid-line of the head, where there is often another feeble median carinula, especially on the fastigium; these carinulae are quite absent in *Chorthippus*. The difference in size between the inner and outer tarsal claws has been used by some authors as a key character, but there is sometimes a tendency towards this size difference in *Chorthippus*. The western European species of *Euchorthippus* are always brown, straw-coloured or grey and, although sometimes showing a greenish tinge, never have the clear green or reddish colours common in *Chorthippus* and other Gomphocerinae.

The calling song of the male provides a particularly good character for recognizing *Euchorthippus* in the field. The long sequences of rapidly repeated echemes are highly characteristic and quite unlike the songs of any other European Gomphocerinae we have heard. Some other Gomphocerinae (e.g. *Chorthippus parallelus* (Zetterstedt), *C. montanus* (Charpentier), *C. dorsatus* (Zetterstedt), *C. dichrous* (Eversmann), *Chrysochraon dispar* (Germar)) have calling songs composed of long sequences of echemes, but in all these cases the repetition rate is much lower, never higher than one every two seconds. The echeme-sequences of *Euchorthippus* are in fact more strongly reminiscent of those produced by some Tettigoniidae, especially such Decticinae as *Metrioptera brachyptera* (L.), *Platycleis sabulosa* Azam and *P. albopunctata* (Goeze), all of which are at least partially diurnal singers; *P. sabulosa* even has a similar number of syllables per echeme (usually 6–7), but all these species have a higher echeme repetition rate

when singing during the day, usually more than 2 echemes/s in warm sunshine. Although isolated males of *Euchorthippus* can maintain a fairly regular echeme repetition rate for quite long periods, they never quite achieve the almost mechanical regularity and very long duration (often many minutes) of the echeme-sequences of these Decticine bush-crickets.

There is no elaborate courtship song but in the presence of a female the male produces a somewhat modified song in which the echemes are quieter and the sequences longer than usual. Faber (1953) described a second stage in the courtship song of *pulvinatus* in which there is a gradual increase in the intensity, repetition rate and duration of the echemes, and in the number of syllables per echeme. Just before jumping on to the female, the male produces two or three quiet sounds, each consisting of one or two syllables, and then one loud and more extended sound of uniform intensity.

**DISTRIBUTION.** Southern Europe, most of the larger Mediterranean islands, Madeira, North Africa and temperate Asia as far as China.

**INCLUDED SPECIES.** *E. albolineatus* (Lucas), *E. angustulus* Ramme, *E. arabicus* Uvarov, *E. chenbaensis* Tu & Cheng, *E. cheui* Hsia, *E. chopardi* Descamps, *E. declivus* (Brisout), *E. madeirae* Uvarov, *E. pulvinatus* (Fischer de Waldheim), *E. sardous* Nadig, *E. transcaucasicus* Tarbinskii, *E. unicolor* (Ikonnikov), *E. weichowensis* Chang, *E. yungningensis* Cheng.

### Key to the western European and North African species and subspecies of *Euchorthippus*

The two mainland taxa *pulvinatus gallicus* and *chopardi*, both common in southern France and the Iberian Peninsula, are particularly difficult to distinguish from each other, and for reliable identification of specimens from these regions (even including females thought to be *declivus*) we recommend taking the relevant measurements and plotting them on the scatter diagrams shown in Figs 10 and 11. For males the use of the triangular graph shown in Fig. 12, although requiring more effort, will produce an even more reliable result.

- 1 Fore wings projecting beyond hind wings (when flexed) by at least 0.8 mm in ♂, usually at least 0.5 mm in ♀. Male subgenital plate long and pointed, as in Fig. 25. Distance from stigma to tip of fore wing usually less than 0.21 times length of hind femur in ♂, less than 0.25 in ♀ ..... *E. declivus* (Brisout) (p. 125)
- Fore wings not projecting beyond hind wings (when flexed) or projecting by less than 0.7 mm in ♂, usually less than 0.5 mm in ♀. Male subgenital plate shorter or less pointed, as in Figs 27 or 29. Distance from stigma to tip of fore wing usually more than 0.21 times length of hind femur in ♂, more than 0.25 in ♀ ..... 2
- 2 Pronotal lateral carinae distinctly incurved in prozona (Fig. 38); length of pronotum less than 2.1 mm in ♂, less than 3.0 mm in ♀. (Sardinia only) ..... *E. sardous* Nadig (p. 136)
- Pronotal lateral carinae straight or almost so in prozona; length of pronotum more than 2.1 mm in ♂, more than 3.0 mm in ♀. (Not known from Sardinia) ..... 3
- 3 Male subgenital plate relatively short and blunt, as in Fig. 29. Fore wings long, reaching at least base of genicular lobes of hind femora in both sexes. Distance from stigma to tip of fore wing usually more than 0.34 times length of hind femur in ♂, more than 0.38 in ♀ ..... 4
- Male subgenital plate longer and slightly pointed, as in Fig. 27. Fore wings shorter, in female not reaching base of genicular lobes of hind femora. Distance from stigma to tip of fore wing usually less than 0.34 times length of hind femur in ♂, less than 0.38 in ♀ ..... 6
- 4 Known only from southern France and the Iberian Peninsula. Pronotal lateral carinae relatively low and broad, as in Fig. 33. Head and pronotum usually with conspicuous dark and light longitudinal stripes (Fig. 40) ..... *E. chopardi* Descamps (p. 133)
- Known only from North Africa and the Balearic Islands. Pronotal lateral carinae relatively high and narrow, as in Fig. 34. Coloration more uniform ..... 5
- 5 Known only from North Africa. Larger: length of hind femur usually more than 9.4 mm in ♂, more than 12.6 mm in ♀; length of pronotum usually more than 2.7 mm in ♂; length of fore wing usually less than 1.22 times length of hind femur in ♀ ..... *E. albolineatus albolineatus* (Lucas) (p. 135)
- Known only from the Balearic Islands. Smaller: length of hind femur usually less than 9.4 mm in

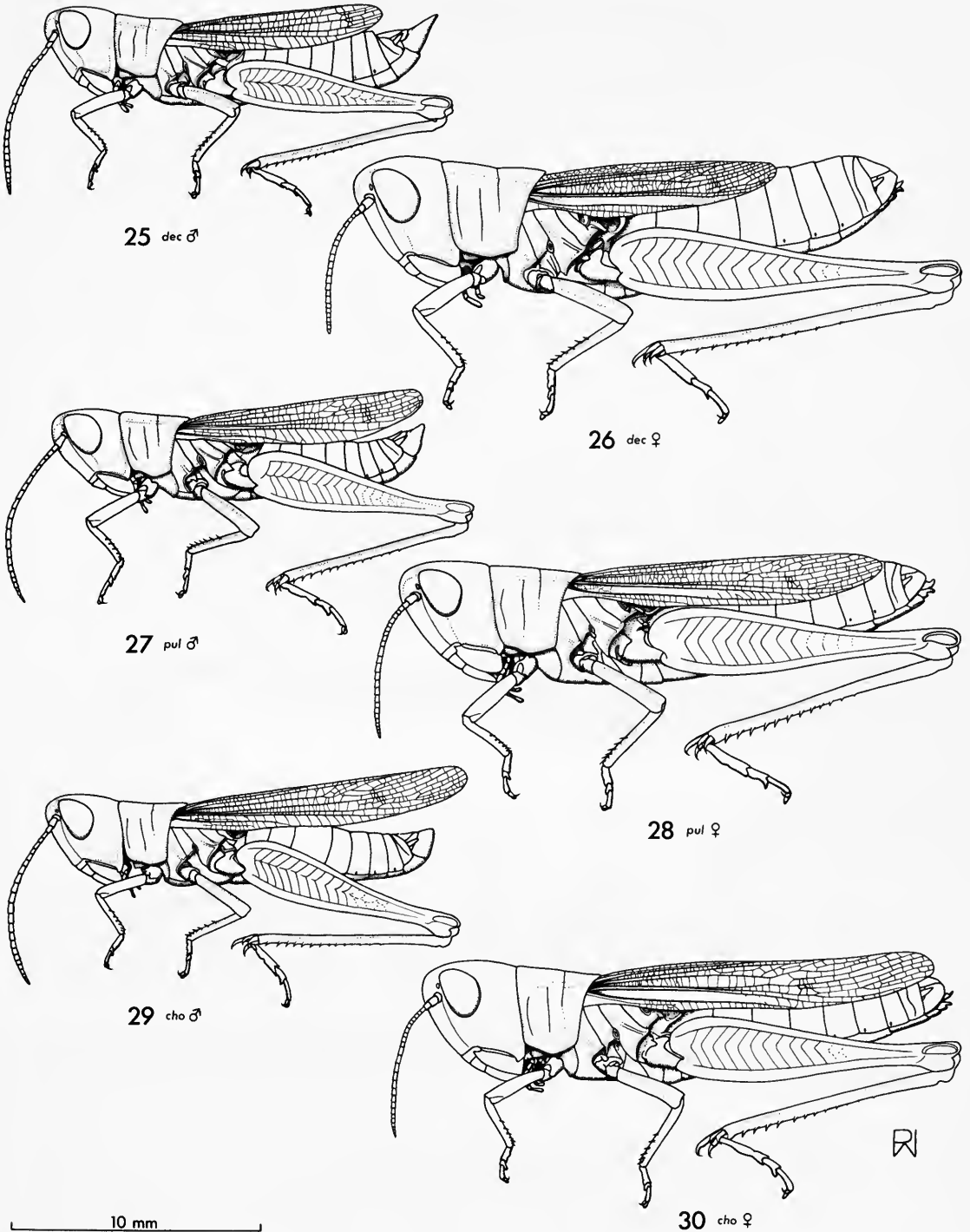

**Figs 25–30** Side view of typical specimens of each sex of (25, 26) *Euchorthippus declivus*, (27, 28) *E. pulvinatus gallicus* and (29, 30) *E. chopardi*.

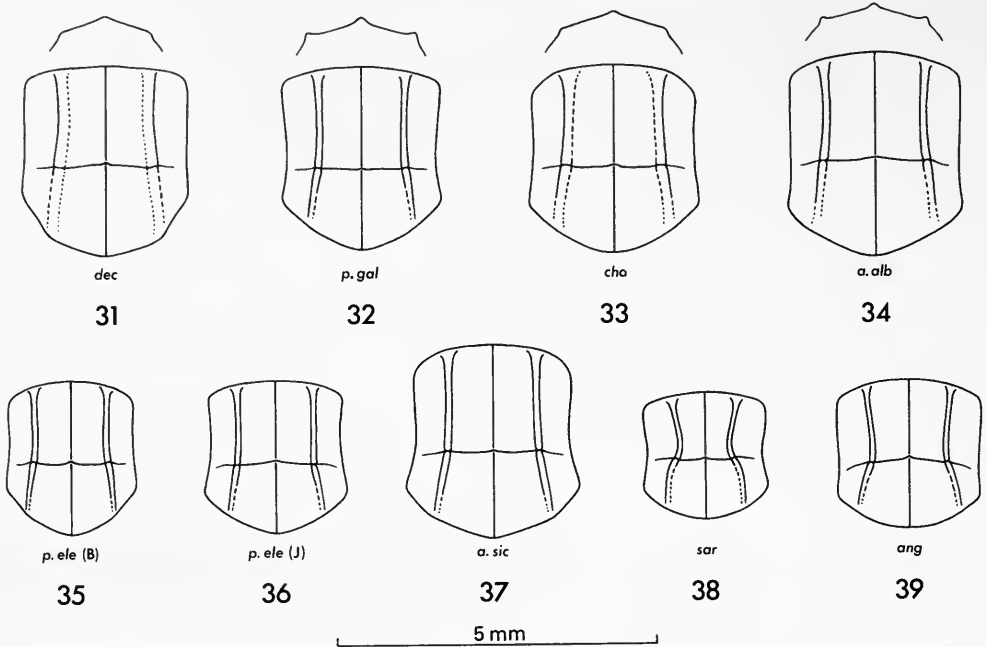

**Figs 31–39** Dorsal view of the pronotum of (31) *Euchorthippus declivus*, (32) *E. pulvinatus gallicus*, (33) *E. chopardi*, (34) *E. albolineatus albolineatus*, (35) *E. pulvinatus elegantulus* from Brittany, (36) *E. p. elegantulus* from Jersey, (37) *E. albolineatus siculus*, (38) *E. sardous*, (39) *E. angustulus*. Diagrammatic profiles of cross-sections of the pronotal disc are also shown in Figs 31–34.

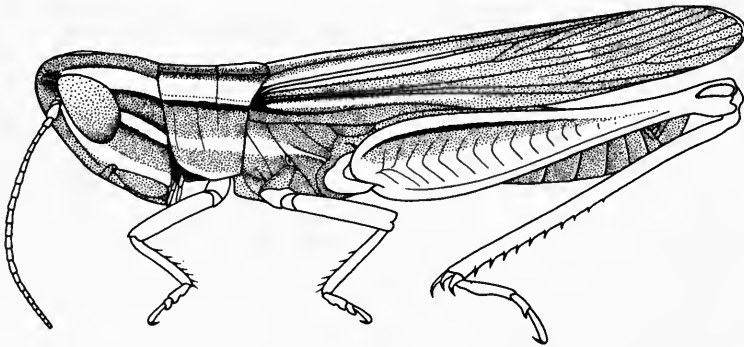

**Fig. 40** Dorsolateral view of a typical male of *Euchorthippus chopardi*, showing the characteristic colour pattern.

- ♂, less than 12.6 in ♀; length of pronotum usually less than 2.7 mm in ♂; length of fore wing usually more than 1.22 times length of hind femur in ♀ ..... *E. angustulus* Ramme (p. 137)
- 6 Known only from Sicily. Stridulatory file with fewer than 110 pegs in ♂, fewer than 105 pegs or hairs in ♀ ..... *E. albolineatus siculus* Ramme (p. 136)
- Not known from Sicily. Stridulatory file with more than 115 pegs in ♂, more than 110 pegs or hairs in ♀ ..... 7
- 7 Larger: length of head usually more than 2.4 mm in ♂, more than 3.2 mm in ♀; length of fore wing usually more than 9.2 mm in ♂, more than 11.3 mm in ♀. (Southern half of France, Iberian Peninsula) ..... *E. pulvinatus gallicus* Mařan (p. 131)
- Smaller: length of head usually less than 2.4 mm in ♂, less than 3.2 mm in ♀; length of fore wing usually less than 9.2 mm in ♂, less than 11.3 mm in ♀. (Jersey and southern Brittany) ..... *E. pulvinatus elegantulus* Zeuner (p. 131)

## Descriptions of the species

*Euchorthippus declivus* (Brisout)

(Figs 25, 26, 31)

*Acridium declivum* Brisout, [1849]: 420. LECTOTYPE ♀, FRANCE: near Paris, St-Germain (MNHN, Paris), here designated [examined].

*Stenobothrus pulvinatus* var. *gracilis* Azam, 1901: 46. LECTOTYPE ♂, FRANCE: near Clermont-Ferrand, Puy de Crouelle, viii.1896 (*M. H. du Buysson*) (MNHN, Paris), here designated [examined]. [Synonymized by Chopard, 1952: 303.]

*Euchorthippus declivus* (Brisout) Uvarov, 1926: 341.

*Euchorthippus declivus meridionalis* Jannone, 1937: 57. LECTOTYPE ♂, ITALY: Puglia, Monte Angeli, 2.ix.1935 (IEA, Portici), here designated [examined]. [Synonymized by La Greca, 1959: 138.]

*Euchorthippus declivus štichai* Mařan, 1954: 137. Holotype ♂, CZECHOSLOVAKIA: Kamemín, viii.1952 (*J. Mařan*) (NM, Prague) [examined]. [Synonymized by Harz, 1975: 924.]

DIAGNOSIS. ♂♀. Pronotal lateral carinae relatively low and broad; length of pronotum usually 0.98–1.41 times length of head. Fore wings relatively short, not or hardly reaching apical quarter of hind femora in ♂, middle of hind femora in ♀, but usually projecting beyond hind wings by at least 0.8 mm in ♂, at least 0.5 mm in ♀; distance from stigma to tip of fore wing usually less than 0.21 times length of hind femur in ♂, less than 0.25 in ♀. Length of hind wing usually less than 0.87 times length of hind femur in ♂, less than 0.78 in ♀. Male stridulatory file usually with 75–120 pegs. Male subgenital plate relatively long and pointed, as in Fig. 25. (Full data for measurements, ratios and number of stridulatory pegs are given in the bar-charts on pp. 144–150.)

Male calling song (see Figs 14, 17, 41–45). Each echeme usually with 10–15 gaps. Other song characters as shown in bar-charts (p. 119).

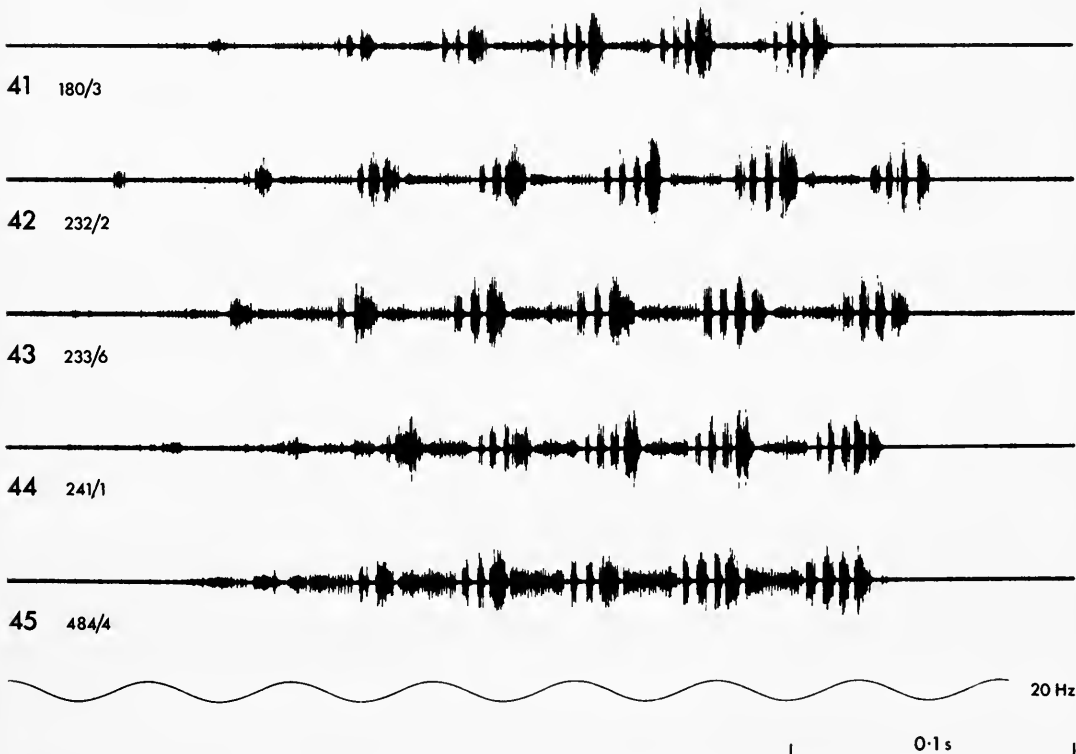

Figs 41–45 Oscillograms of single echemes from the calling songs of five French males of *Euchorthippus declivus*. The small numbers refer to the recordings from which the oscillograms were made and can be used to obtain the full data from Tables 1 and 2 (pp. 107, 108).

DISCUSSION. This is the most easily recognizable of the mainland species of *Euchorthippus* in western Europe. As can be seen in Figs 8, 84 and 88, the projection of the fore wings beyond the hind wings (when both pairs of wings are flexed) enables the males, and usually the females, to be identified at once. In all the other western Palaearctic species (except *madeirae* – see below) the tips of the two pairs of flexed wings are coincident or almost so in live or freshly killed specimens, though a very small gap often develops in dried specimens. The length of the hind wing and the distance from the stigma to the tip of the fore wing, both taken as a ratio with the length of the hind femur, also provide good characters in both sexes (see Figs 10, 11, 84, 85, 87, 88). The male is further characterized by the relatively long and pointed subgenital plate (Fig. 25).

The endemic Madeiran species *E. madeirae* Uvarov resembles *declivus* in having rather low, broad pronotal lateral carinae and short wings, with the fore wings extending well beyond the hind wings. However, the males have a much shorter and blunter subgenital plate than *declivus*, and the pronotal lateral carinae are more clearly incurved in both sexes.

There is a rare macropterous form of *declivus* in which the fore wings reach a length of 11–13 mm in the male and 13–15 mm in the female. This form has been recorded from the south-western Slovakian steppe in Czechoslovakia by Mařan (1957: 189) and from Gran Sasso, Abruzzi, Italy by Baccetti (1958: 426–428); we have seen further specimens from Rome and from near Banja Luka in Yugoslavia. In the specimens we have examined the fore wings project beyond the hind wings by much less than is typical of *declivus* and the distance from the stigma to the tip of the fore wing is usually larger, but they can be distinguished from *pulvinatus* by the relatively low pronotal lateral carinae and, in the male, the shape of the subgenital plate. Dr J. J. Presa has kindly informed us that he now believes that his records of this form from the Sierra de Guadarrama, Spain (Presa, 1978: 125) were based on misidentified *pulvinatus*.

The calling song of the male (see Figs 14, 41–45) cannot be recognized as *declivus* with the unaided ear, but oscillographic analysis shows that it has a larger number of gaps per echeme than both *pulvinatus* and *chopardi* (see p. 119 for further discussion).

In France *declivus* occurs further north than *pulvinatus* and *chopardi* and seems, as one would expect, to be more hygrophilous. It probably shows a similar ecological preference in northern Spain, but in Italy, where it is apparently the only species of *Euchorthippus* to occur on the mainland, it seems to be able to tolerate drier conditions, tending to occupy the habitats associated with all three species in France and Spain.

For discussion of the transfer of the subspecies *elegantulus* from *declivus* to *pulvinatus* see p. 131.

We have examined seven female specimens, three from the MNHN, Paris and four from the IRSNB, Brussels, that have been regarded in these institutions as syntypes of *Acridium declivum* Brisout. We have also examined a number of further specimens of both sexes from the IRSNB that had previously been in the collection of de Selys Longchamps (who had earlier acquired Brisout's collection) and that could therefore also be regarded as possible syntypes of this species. Of all these specimens only one is labelled as being from one of the four type-localities named by Brisout (1849: 420); this is one of the three female specimens from the MNHN and is labelled 'St Germain'. We feel that this is the only specimen we have examined that can be regarded with confidence as a syntype and we have accordingly selected and labelled it as lectotype.

We have examined the male and female syntypes of *Stenobothrus pulvinatus* var. *gracilis* Azam, and have selected and labelled the male as lectotype.

We have also selected and labelled a male lectotype from the type-series of *Euchorthippus declivus meridionalis* Jannone. This specimen, from Monte Angeli, is in much better condition than the male specimen labelled 'Tipo' by Jannone, which was from Altamura.

#### MATERIAL EXAMINED

Primary types (see synonymy) and 558 other specimens from the following localities.

**France.** Marne (no further data). Paris. Yvelines: St-Germain. Essonne: Lardy. Seine-et-Marne: Fontainebleau; Fontainebleau Forest; Episy. Haute-Marne: Colombey-les-Deux-Eglises. Loire-

Atlantique: Varades. Yonne: 33 km E. of Sens, near Villeneuve-l'Archevêque. Cher: 23 km S. of Briare. Nièvre: La Charité. Puy-de-Dôme: 12 km N. of Thiers; near Besse-en-Chandesse, Saurier; near Clermont-Ferrand, Puy de Crouelle; near Issoire, Clémensat. Dordogne: Bergerac; near Le Bugue, Campagne. Savoie: Flumet. Haute-Loire: St-Paulien; 5 km N. of Le Puy; 16 km S. of Cascades de la Baume. Lot: near Souillac. Ardèche: near Privas. Lozère: 34 km N. of Mende; near Mende, Col de Montmirat. Drôme: near Valdrôme. Landes: near Arcachon, Biscarrosse; near Morcenx. Vaucluse: Mont Ventoux; near Carpentras, Bédoin. Alpes-de-Haute-Provence: N. of Digne, La Rouine, 760–1070 m. Hérault: 5 km E. of Montpellier. Haute-Garonne: 15 km N. of Toulouse. Alpes-Maritimes: near St-Dalmas-de-Tende; Col de Vence, 930 m; near Grasse, Gréolières; Mt Courmette; Thorenc; St-Martin-Vésubie; Auron, 1580 m. Var: c. 4 km W. of Cannes, Esveral; near Comps-sur-Artuby, Bargème. Pyrénées-Orientales: Vernet-les-Bains, near Le Perthus.

**Spain.** Santander: Playa de Cóbrecas. León: Riaño. Huesca: Ordesa. Teruel: Montoro de Mezquita, Masada del Cerro, 1300 m; Villarluego, 1270 m.

**Italy.** Piemonte: Voltaggio. Liguria: Chiavari; Portofino, Vetta; near Sestri, Bracco Pass, 600 m. Emilia Romagna: Vetto. Toscana: near M. Amiata, 4 km SW. of Bagni San Filippo; 17 km E. of Siena; Siena, near Colleverde camp site; near Firenze, Futa Pass. Abruzzi: Gran Sasso d'Italia, Fonte Cerreto, near Staz Funivia, 340 m; G.S.I., 2 km SW. of Valle Fredda; Civitella del Tronto. Lazio: Roma; near Casa del Corta; between Acquapendente and Lake Bolzena. Puglia: Monte Angeli; Altamura. Basilicata: Venosa, 420 m; Varco di Pietrastretta, near Potenza, 850 m.

**DISTRIBUTION** (see Fig. 81). All France except for the north-western peninsulas and the extreme north and north-east; northern and north-eastern Spain; southern Switzerland; most of Italy; Sicily and Sardinia. Central and eastern Europe (as far north as southern and eastern Austria, southern Czechoslovakia and south-western Ukraine); most of the Balkan Peninsula; Asia Minor. *E. declivus* seems to be the only species of *Euchorthippus* occurring in mainland Italy, where it is widespread.

There have been a number of published records of *declivus* from various parts of Spain; the more recent ones include those of Gangwere & Morales (1970: 58), Presa (1978: 125), Herrera (1979: 59), González (1981: 61), Presa & García (1982: 130) and Defaut (1982: 82, 85). In his recent catalogue Herrera (1982: 105) lists for *declivus* eight widely scattered Spanish provinces. Following an examination of specimens kindly lent to us by Drs L. Herrera and M. J. González, we consider their records for the provinces of Navarra and Salamanca, respectively, to be based in misidentified *pulvinatus*, and Dr J. J. Presa has informed us that he now believes the same to apply to his records from the Sierra de Guadarrama and the record from Murcia province cited in his joint paper with Dr M. D. García. Dr B. Defaut has kindly lent us the specimens on which his record from Teruel province was based and we agree with his identification. We have not been able to check the basis for the remaining records but, in view of the frequent confusion between these two species in Spain, are inclined to regard all Spanish records of *declivus* as needing confirmation. Apart from those mentioned above from Teruel province, the only Spanish specimens of *declivus* we have seen were from Santander, León and Huesca provinces and were kindly lent to us by Dr G. Kruseman of the Instituut voor Taxonomische Zoölogie, Amsterdam, Dr V. Llorente of the Instituto Español de Entomología, Madrid, and Dr J. L. Santos of the Universidad Complutense, Madrid. The 97 specimens of *Euchorthippus* from the Iberian Peninsula in the BMNH are all either *pulvinatus* or *chopardi*, and we have not seen *declivus* during our own visits to Spain.

### *Euchorthippus pulvinatus* (Fischer de Waldheim)

(Figs 27, 28, 32, 35, 36)

*Oedipoda pulvinata* Fischer de Waldheim, 1846: 305. Type-material lost. Type-localities, U.S.S.R.: near Moscow; Kazan? ('Casan'); Karabag? ('Karabagh'); Caucasus.

*Euchorthippus pulvinatus* (Fischer de Waldheim) Tarbinskii, 1926: 192.

The nominate subspecies of *pulvinatus* does not occur in western Europe and has thus been excluded from this study. We have considered it best not to take it into account in the diagnosis given below, which is therefore based only on the two western subspecies *gallicus* and

*elegantulus*. Most of the characters given in the diagnosis are probably equally true of *p. pulvinatus*, but this subspecies has longer wings, the fore wings usually reaching the tips of the hind femora in both sexes. The brief diagnoses given for *gallicus* and *elegantulus* include only the characters by which these two subspecies differ from each other.

DIAGNOSIS. ♂♀. Pronotal lateral carinae relatively high and narrow; length of pronotum usually 0.88–1.20 times length of head in ♂, 0.97–1.32 in ♀. Fore wings not usually reaching tips of hind femora in ♂, not reaching bases of genicular lobes in ♀; distance from stigma to tip of fore wing usually 0.20–0.33 times length of hind femur in ♂, 0.26–0.37 in ♀. Length of hind wing usually 0.91–1.16 times length of hind femur in ♂, 0.79–1.00 in ♀. Stridulatory file usually with 115–165 pegs in ♂, 115–145 pegs or hairs in ♀. Male subgenital plate of moderate length and tending to be slightly pointed, as in Fig. 27. (Full data for measurements, ratios and number of stridulatory pegs are given in the bar-charts on pp. 144–150.)

Male calling song (see Figs 15, 18, 46–64, 66–70). Echeme repetition rate usually 0.8–1.6/s. Syllables usually lasting 20–35 ms. Other song characters as shown in bar-charts (p. 119).

DISCUSSION. This species can be easily distinguished from *declivus* by the characters listed and discussed under that species. Distinguishing *pulvinatus* from *chopardi* where their ranges overlap in southern France and the Iberian Peninsula is much more difficult, especially if a reliable reference collection is not available. *E. pulvinatus* almost always lacks the strong longitudinally striped colour pattern typical of *chopardi* (Fig. 40). The shorter fore wings (Figs 27, 28, 83, 87) and prominent, narrow pronotal lateral carinae (Fig. 32) provide good morphological characters, and the distance from the stigma to the tip of the fore wing, taken as a ratio with the length of the hind femur, is usually much smaller than in *chopardi* (Figs 85, 88).

The best numerical method we have found for separating males of these two species is by combining the number of stridulatory pegs, the distance from the stigma to the tip of the fore wing and the ratio of the length of the pronotum to the length of the head, and plotting the result on a triangular graph (Fig. 12; see p. 110 for a full explanation). A simpler but rather less effective separation can be obtained by plotting two of these characters, stridulatory pegs and stigma distance, on a two-axis graph (Fig. 9); this gives a particularly good separation for French specimens. Both sexes can be separated quite well by plotting stigma distance against length of hind femur, as shown in Figs 10, 11; there is no overlap within our French and Iberian samples, but in the male there is a slight overlap between our samples of Iberian *pulvinatus* and French *chopardi*.

Because of the variable effect of shrinkage during drying, we have not found either the shape or the dimensions of the male subgenital plate to be particularly useful in distinguishing between dried specimens of *pulvinatus* and *chopardi* (see Fig. 85 for a comparison of the dimensions).

The male calling song of *pulvinatus* can usually be distinguished from that of *chopardi* by the faster echeme repetition rate, as shown in Figs 15, 16. Oscillographic analysis shows that the duration of the echemes, and especially of the syllables, is shorter than that of *declivus* and *chopardi* (Figs 18–20).

In France the range of *pulvinatus* extends much further north than that of *chopardi* and Descamps (1968) has suggested that the former is less xerophilous than the latter (while being more so than *declivus*). There is, however, some indication from the material we have examined that this may not be so in Spain. Nearly all the specimens we have seen from the extreme south of Spain have been *pulvinatus* and, although Pascual (1978) has shown that *chopardi* occurs in the Sierra Nevada, he found it only at altitudes of 1800–2000 m, whereas *pulvinatus* occurred at the lower altitudes of 1250–1450 m.

DISTRIBUTION (see Fig. 81). In western Europe this species occurs in Jersey, France and the Iberian Peninsula. The eastern subspecies, *p. pulvinatus*, occurs as far west as Czechoslovakia (Čejchan, 1981; 1982), eastern Austria and the Balkan Peninsula, and extends eastwards through the Ukraine, southern Russia, Asia Minor, Kazakhstan and Central Asia to China. The range of this species thus appears to be divided into two by quite a large gap, approximately between longitudes 7°E and 13°E and including Switzerland, western Austria and the whole of Italy; there have been some references in the literature to the occurrence of *pulvinatus* in Italy



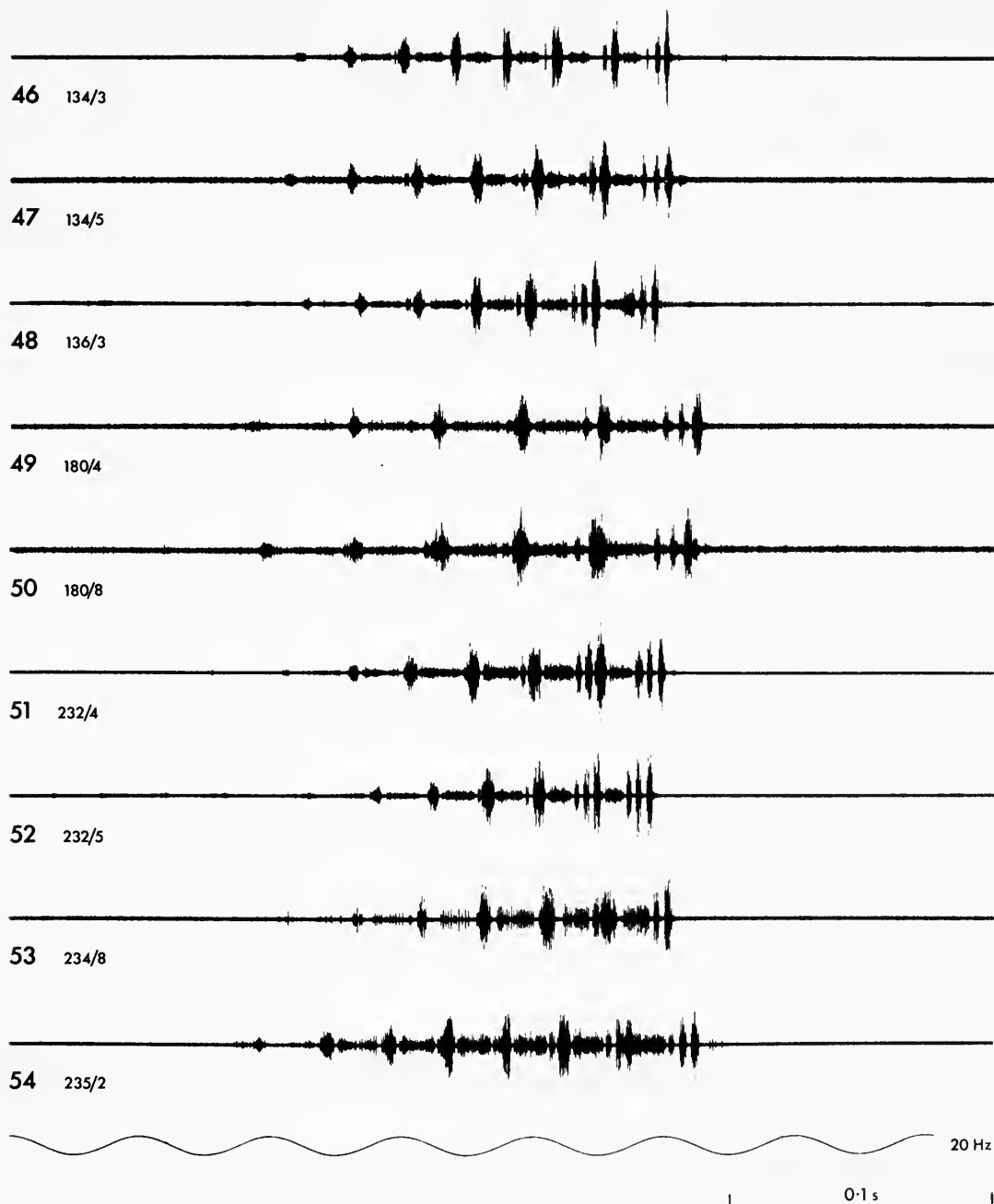

Figs 46–54 Oscillograms of single echemes from the calling songs of nine French males of *Euchorthippus pulvinatus gallicus*. The small numbers refer to the recordings from which the oscillograms were made and can be used to obtain the full data from Tables 1 and 2 (pp. 107, 108).

(e.g. La Greca, 1959: 139), but we have seen no Italian specimens of *pulvinatus* ourselves and are at present unconvinced by such references. If this gap is indeed a real one, it would clearly account for the morphological divergence between *p. gallicus* and the nominate subspecies (see also p. 140).

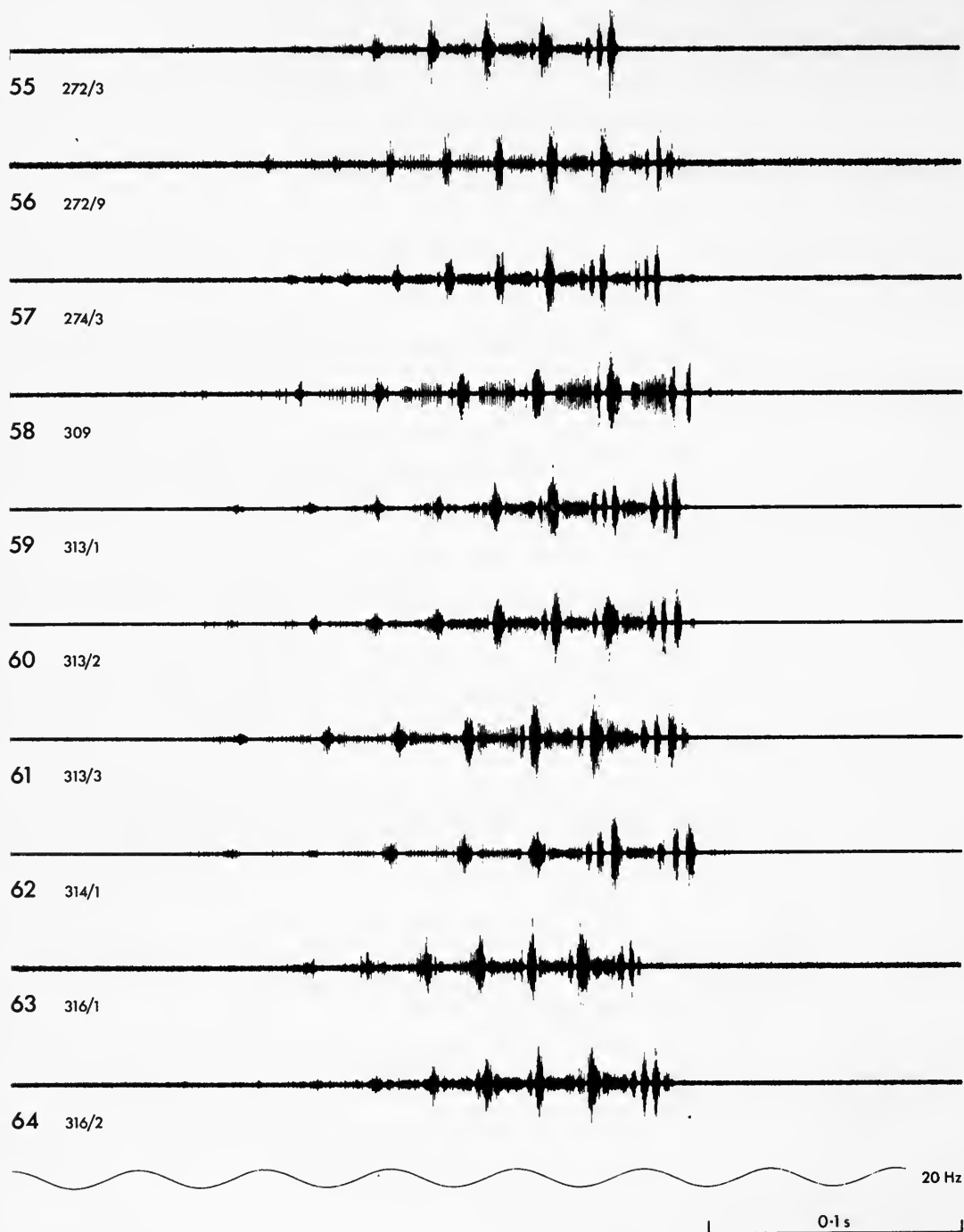

Figs 55–64 Oscillograms of single echemes from the calling songs of ten Spanish males of *Euchorthippus pulvinatus gallicus*. The small numbers refer to the recordings from which the oscillograms were made and can be used to obtain the full data from Tables 1 and 2 (pp. 107, 108).

*Euchorthippus pulvinatus gallicus* Mařan

(Figs 27, 28, 32)

*Euchorthippus pulvinatus gallicus* Mařan, 1957: 187. Holotype ♂, FRANCE: Draguignan, 1898 (*N. Kheil*) (NM, Prague) [examined].

DIAGNOSIS. ♂♀. Length of head usually more than 2.4 mm in ♂, more than 3.2 mm in ♀. Length of fore wing usually more than 9.2 mm in ♂, more than 11.3 mm in ♀. Length of hind femur usually more than 8.4 mm in ♂, more than 11.8 mm in ♀. (See also bar-charts on pp. 144–150.)

DISCUSSION. For the best methods of distinguishing *p. gallicus* from the closely similar species *chopardi*, see the species 'Discussion' for *pulvinatus* (p. 128). The relationship between this subspecies and *p. elegantulus* is discussed under that subspecies.

## MATERIAL EXAMINED

Holotype (see above) and 573 other specimens from the following localities.

**France.** Charente-Maritime: Saintes. Haute-Vienne: Limoges. Puy-de-Dôme: near Clermont-Ferrand. Dordogne: near Le Bugue, Campagne; Bergerac. Lot: near Souillac. Lot-et-Garonne: near Agen. Ardèche: near Privas. Drôme: near Nyons, 600 m; near Valdrôme. Hautes-Alpes: near Laragne-Montéglin, Saléon. Aveyron: near Millau. Landes: Arcachon; near Morcenx. Gard: between Arles and Nîmes. Vaucluse: near Carpentras, Bédoin; Mont Ventoux, near Les Bruns; 3 km SE. of Cavaillon. Hérault: several localities near Montpellier. Haute-Garonne: 15 km N. of Toulouse. Alpes-Maritimes: near Villefranche-sur-Mer; Cap d'Ail; Biot; Le Rouret; Sarrée Valley, 600 m; near Nice, Cagnes. Bouches-du-Rhône: near Cassis; Petit Camargue, 22 km SE. of Arles, near Mas Thiberte; P.C., Stes-Maries-de-la-Mer; 14 km E. of Salon. Var: Draguignan; Bagnoles; Montouroux; near Toulon, La Seyne-sur-Mer; Hyères; La St-Baume. Pyrénées-Orientales: near Banyuls-sur-Mer; near St-Cyprien Plage; St-Cyprien; Vernet-les-Bains; near Le Perthus.

**Spain.** Vizcaya: Sopelana. Burgos: 2 km S. of Lerma. Huesca: 1 km SE. of Seo de Urgel; near Ortedo, 7 km SE. of Seo de Urgel; 2 km SE. of Ainsa; 5 km NW. of Solsona. Gerona: Port Bou; near Vilajuiga. Zaragoza: 12 km E. of Caspe. Salamanca: 5 km N. of Castraz, Rio Yaltes; Cervera; Cristo de La Laguna; Rodillo. Madrid: Sierra de Guadarrama; Madrid. Guadalajara: near Pastrana. Teruel: Albarracin. Cuenca: Belmonte; near Uña. Valencia: Requena, 700 m. Jaén: Sierra de Cazorla, W. of Nava del Espino, 1600–1700 m; S.C., Nava de S. Pedro, 1400 m; S.C., Puente de Las Herrerías. Murcia: Moratalla. Huelva: near Ayamonte. Málaga: near Torremolinos, Roya Miel.

**Portugal.** Guarda: Guarda. Leiria: Serra do Condieiros, near Alcanena, Ribatejo; Caldas da Rainha. Lisboa: Mafra; Ericeira; Lisboa, Parque Florestal de Monsanto. Evora: Evora. Setúbal: R. Sado, near Marateca.

DISTRIBUTION (see Fig. 81). Central and southern France; Iberian Peninsula. The specimens on which Ebner (1931: 501) based his record of *pulvinatus* from Majorca have been lost and we consider the occurrence of this species in the Balearic Islands to be doubtful.

*Euchorthippus pulvinatus elegantulus* Zeuner

(Figs 35, 36)

*Euchorthippus elegantulus* Zeuner, 1940: 107. Holotype ♂, JERSEY: Ouainé Bay, 4.ix.1938 (*F. E. Zeuner*) (BMNH, London) [examined].

*Euchorthippus declivus elegantulus* Zeuner; Mařan, 1957: 189; Descamps, 1968: 5. [*Euchorthippus declivus* (Brisout); Harz, 1975: 924. Erroneous synonymy.]

DIAGNOSIS. ♂♀. Length of head usually less than 2.4 mm in ♂, less than 3.2 mm in ♀. Length of fore wing usually less than 9.2 mm in ♂, less than 11.3 mm in ♀. Length of hind femur usually less than 8.4 mm in ♂, less than 11.8 mm in ♀. (See also bar-charts on pp. 144–150.)

DISCUSSION. This subspecies is essentially a small form of *pulvinatus*, the head showing the size difference most clearly (see Figs 82, 86).

One of the more interesting conclusions to emerge from this study has been the fact that *elegantulus*, which has hitherto always been associated with *declivus*, is much closer to *pulvinatus* in both morphological characters and song. When Zeuner (1940) originally described *elegantulus* (as a full species) he stated that it was related to *declivus* and compared the two in several

characters while making no mention of *pulvinatus*. Chopard (1952) suggested that it 'n'est sans doute qu'une sous-espèce de *declivus*' and, probably following this lead, Mañan (1957) and Descamps (1968) treated it formally as a subspecies of *declivus*. Harz (1975) went even further, regarding it as no more than a synonym of *declivus*.

This association of *elegantulus* with *declivus* probably stemmed from the fact that the subgenital plate of the Jersey males is usually more pointed than is typical of *pulvinatus* and is sometimes nearer in shape to *declivus*. However, in all other morphological characters *elegantulus* is closer to *pulvinatus* than to *declivus*, and in some characters resembles *pulvinatus* very closely; this is well shown by the bar-charts of the projection of fore wing beyond hind wing (Figs 84, 88), by those of ratios (Figs 81, 83–87), in which the effect of size is largely eliminated, and by all the scatter diagrams, including the triangular graph (Figs 8–13). Zeuner (1940) even included in his description of *elegantulus* the fact that the median and lateral carinae of the pronotum are 'very pronounced for the genus', another character shared with *pulvinatus* but not with *declivus*. The close relationship with *pulvinatus* is confirmed by the song of *elegantulus*, which agrees closely with that of *pulvinatus gallicus* in all respects, while showing a marked contrast with *declivus* in the number of gaps per echeme and the duration of both the echemes and the syllables (Figs 20–24, 65–70).

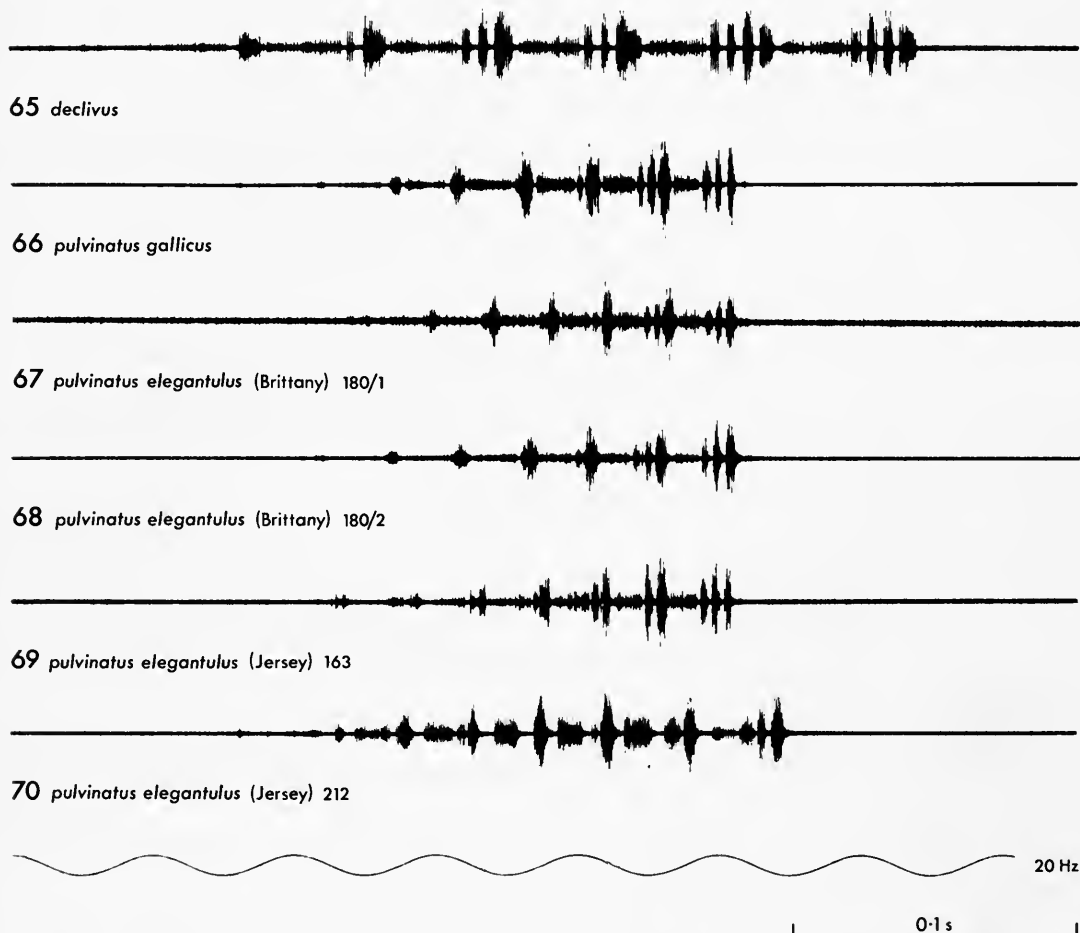

Figs 65–70 Oscillograms of single echemes from the calling songs of four males of *Euchorthippus pulvinatus elegantulus*, with typical echemes from the male calling songs of *E. declivus* and *E. pulvinatus gallicus* added for comparison. The small numbers refer to the recordings from which the oscillograms were made and can be used to obtain the full data from Table 2 (p. 108).

A further point of interest resulting from this study is that a form closely resembling the Jersey population of *elegantulus* occurs in the southern part of Brittany, in the region extending from Quiberon to Le Croisic. The Breton specimens are, on average, not quite as small as specimens from Jersey, and the male subgenital plate is usually blunter, more like typical *pulvinatus*. However, the bar-charts of absolute measurements (Figs 82–88) show that the Breton population is generally much closer to Jersey *elegantulus* than to French *gallicus*, and we think it reasonable, at least for the time being, to recognize these two populations as together constituting the subspecies *elegantulus*. When the distribution and ecology of these forms have been more thoroughly studied, it may prove to be more sensible to regard the Jersey and Brittany populations as representing no more than island and coastal forms of *gallicus*, living under rather unfavourable conditions at the northern limit of the climatic tolerance of this subspecies. A statistical comparison between our samples of *gallicus* and *elegantulus* gives *t* values of 9.5 for head length, 8.8 for fore wing length and 9.0 for hind femur length in the male, and corresponding values of 7.7, 7.3 and 6.7 in the female. The table given by Géry (1962) shows that all these values indicate a non-overlap between these samples of between 75 per cent and 90 per cent, which does not lend very strong support to their recognition as separate subspecies.

#### MATERIAL EXAMINED

Holotype (see p. 131) and 39 other specimens from the following localities.

**Jersey.** Quennevais; Blanches Banques; St Ouen's Pond; Ouainé Bay; St Helier.

**France.** Morbihan: Quiberon; Malanzac. Loire-Atlantique: 3 km SW. of Guérande; near Guérande, Le Croisic.

**DISTRIBUTION** (see Fig. 81). Known only from Jersey and the extreme south of Brittany. In addition to the four Breton localities listed above, the record of *pulvinatus* from 'landes de Plescop, environs de Vannes' given by Sellier (1947) almost certainly refers to this subspecies.

### *Euchorthippus chopardi* Descamps

(Figs 29, 30, 33, 40)

*Euchorthippus chopardi* Descamps, 1968: 8. Holotype ♂, FRANCE: Vaucluse, Cavaillon, route forestière du Luberon, 150 m (*M. Descamps*) (MNHN, Paris) [examined].

**DIAGNOSIS.** ♂♀. Head and pronotum usually with conspicuous dark and light longitudinal stripes (Fig. 40). Pronotal lateral carinae relatively low and broad, almost straight and parallel in metazona; length of pronotum usually 0.85–1.25 times length of head. Fore wings relatively long, usually reaching at least tips of hind femora in ♂, bases of genicular lobes in ♀; distance from stigma to tip of fore wing usually 0.33–0.46 times length of hind femur in ♂, 0.40–0.54 in ♀. Length of hind wing usually 0.98–1.32 times length of hind femur in ♂, 1.01–1.29 in ♀. Male stridulatory file usually with 95–160 pegs. Male subgenital plate relatively short and blunt, as in Fig. 29. (Full data for measurements, ratios and number of stridulatory pegs are given in the bar-charts on pp. 144–150.)

Male calling song (see Figs 16, 19, 71–77). Echeme repetition rate usually 0.5–0.7/s. Other song characters as shown in bar-charts (p. 119).

**DISCUSSION.** For the easy separation of this species from *declivus* see the 'Discussion' under that species. The much more difficult separation of *chopardi* from *pulvinatus* is discussed fully under the latter species. The usual longitudinally striped colour pattern of *chopardi* (Fig. 40) provides a strong indication of its identity, and this can be confirmed for males by plotting their relevant measurements and peg-counts on the triangular graph shown in Fig. 12, and for either of the sexes by plotting their measurements on the scatter diagrams shown in Figs 9–11. For the best means of distinguishing *chopardi* from *albolineatus* see the 'Discussion' under that species.

#### MATERIAL EXAMINED

Holotype (see above) and 122 other specimens from the following localities.

**France.** Vaucluse: 3 km SE. of Cavaillon (type-locality); Mont Ventoux, 600–1200 m; near Carpentras, 3 km S. of Malaucène. Hérault: 5 km E. of Montpellier. Pyrénées-Orientales: Banyuls-sur-Mer; Vernet-les-Bains; near Vernet-les-Bains, Corneilla-de-Conflent.

**Spain.** Orense: Leiro. Huesca: 8 km E. of Ainsa. Gerona: Port Bou. Zaragoza: 3 and 4.5 km E. of

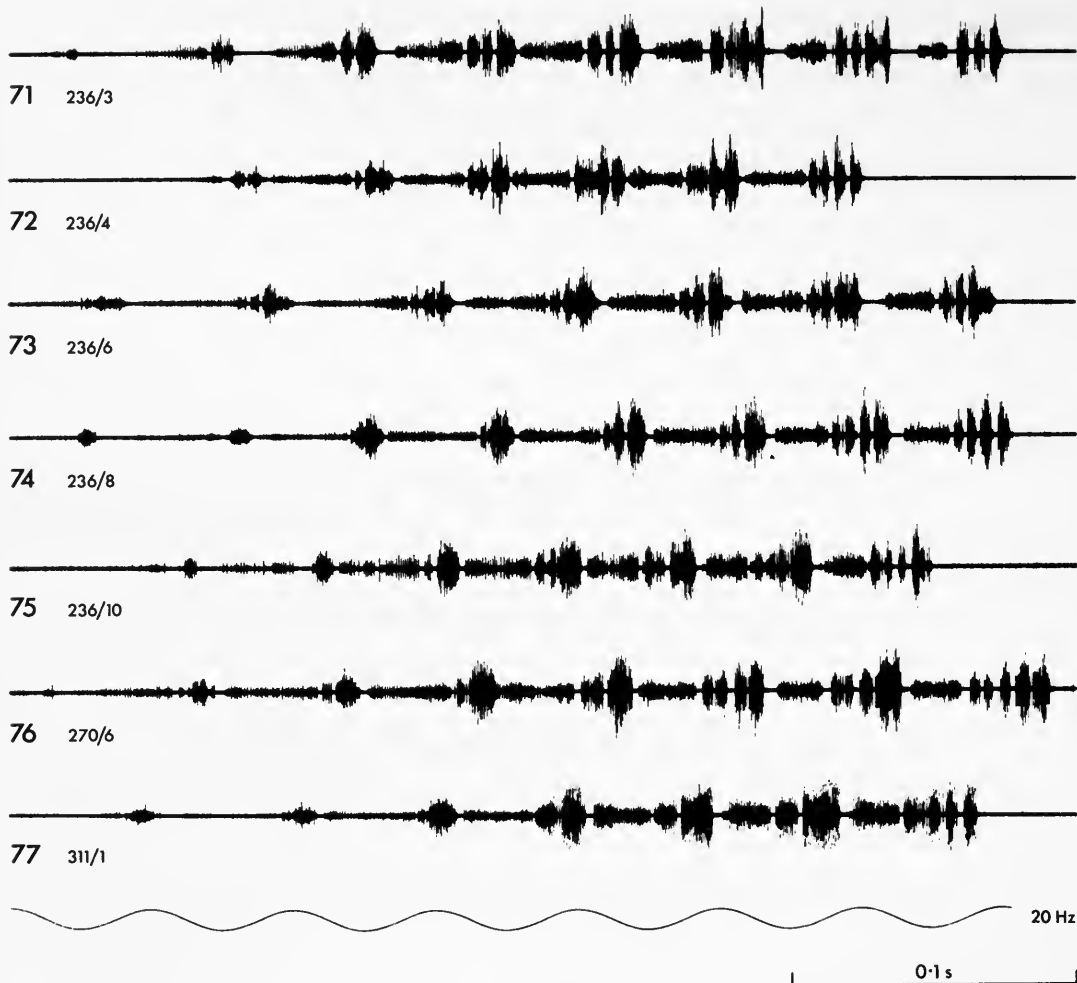

Figs 71–77 Oscillograms of single echemes from the calling songs of five French (71–75) and two Spanish (76, 77) males of *Euchorthippus chopardi*. The small numbers refer to the recordings from which the oscillograms were made and can be used to obtain the full data from Tables 1 and 2 (pp. 107, 108). Note that recordings 236/3, 236/4 and 236/6 were made at the type-locality.

Caspe. Avila: Sierra de Gredos. Madrid: Sierra de Guadarrama. Cuenca: between Cuenca and Olivares; Belmonte. Valencia: near Gandia; Requena, 700 m. Alicante: near Alicante.

Portugal. Leiria: Serra do Candieiros.

DISTRIBUTION (see Fig. 81). A species occurring widely in the Iberian Peninsula and extending its range north-eastwards into the French departments bordering the Mediterranean Sea, and Vaucluse. The only published record from the extreme south of Spain is from the Sierra Nevada at altitudes of 1800–2000 m (Pascual, 1978).

*Euchorthippus albolineatus* (Lucas)

(Figs 34, 37)

*Oedipoda albo lineata* Lucas, 1849: 38.

In view of the major differences between the Sicilian taxon *siculus* and the North African populations of *albolineatus* (see especially Figs 8–11), we have strong doubts about the current

treatment of *siculus* as a subspecies of *albolineatus* (Descamps, 1968; Harz, 1975). We have therefore not attempted to give a diagnosis that includes both these taxa, but have given each of them diagnoses as if they were distinct species. However, as this study is not primarily concerned with either of these taxa, and we have no information on their songs, we prefer to retain the currently used nomenclature for them until their relationships can be more firmly established.

***Euchorthippus albolineatus albolineatus* (Lucas)**

(Fig. 34)

*Oedipoda albo lineata* Lucas, 1849: 38. LECTOTYPE ♂, ALGERIA: Cercle de Lacalle, Boghar (*H. Lucas*) (MNHN, Paris), here designated [examined].

*Euchorthippus albolineatus* (Lucas) Uvarov, 1926: 341.

*Euchorthippus albolineatus albolineatus* (Lucas); Descamps, 1968: 5.

DIAGNOSIS. ♂♀. Pronotal lateral carinae relatively high and narrow; length of pronotum usually 1.00–1.32 times length of head. Fore wings relatively long, usually extending beyond tips of hind femora; distance from stigma to tip of fore wing usually 0.34–0.49 times length of hind femur in ♂, 0.41–0.50 in ♀. Length of hind wing usually 1.10–1.32 times length of hind femur in ♂, 1.04–1.13 in ♀. Male stridulatory file usually 3.28–4.70 mm long, with 100–140 pegs. Male subgenital plate relatively short and blunt (similar to Fig. 29). (Full data for measurements, ratios and number of stridulatory pegs are given in the bar-charts on pp. 144–150.)

DISCUSSION. *E. albolineatus* is at present the only species of the genus known from North Africa and so in practice identification presents no problems. We consider it doubtful that this species occurs in the Iberian Peninsula (see 'Distribution' below), but if it did it could be quite easily confused with *pulvinatus* and *chopardi*. As shown by the triangular graph (Fig. 13) and two-axis scatter diagrams (Figs 9–11), *a. albolineatus* and *chopardi* can be distinguished from *pulvinatus* by the same combination of characters, but in all these diagrams *a. albolineatus* and *chopardi* overlap broadly. The best numerical characters for separating the males are the length of the stridulatory file and the ratio of pronotum to head (see Figs 82, 81), but this ratio is less effective in separating the females. In qualitative characters both sexes of *a. albolineatus* usually lack the strongly striped colour pattern typical of *chopardi* and have more prominent and sharply defined lateral carinae on the pronotum (cf. Figs 33, 34).

*E. a. albolineatus* is clearly a close relative of both *chopardi* and *pulvinatus*, and is particularly close to *chopardi* in almost all its characters. If it does not occur in the Iberian Peninsula the question arises as to whether it might be better regarded as only subspecifically distinct from *chopardi*. In the absence of any information on the song we can do no more than suggest this as a possibility to be borne in mind in future studies on the group.

We have selected and labelled a male lectotype from the type-series of 10 males and 9 females of *albolineatus*.

**MATERIAL EXAMINED**

Lectotype (see synonymy) and 124 other specimens from the following localities.

**Morocco.** Great Atlas Mts, Mouldirt, 1630 m; Oued Kroumane; Meknes district, Ifrane; 10 and 30 km S. of Fez; 12 km SE. of Azrou.

**Algeria.** Near Algiers, Kouba; near Blida, Chrea, 1300 m; S. of Constantine, El Gehra; Djurdjura Mts, Bouira; Boghar; Boghari; Hauts Plateaux, Trolarel-Taza, 1100 m; Djelfa; Mascara.

**Libya.** 30 km SW. of Tripoli, near Bianchi.

DISTRIBUTION (see Fig. 81). North Africa, from western Morocco to Tripolitania. In view of the ease with which this species can be confused with *pulvinatus* and *chopardi*, we consider that the records of *albolineatus* from Portugal (Descamps, 1968: 6), Spain (Presa, 1978: 121; González, 1981: 61; Presa *et al.*, 1983) and Majorca (Kruseman, in Harz, 1975: 929) need confirmation.

***Euchorthippus albolineatus siculus* Ramme**

(Fig. 37)

*Euchorthippus pulvinatus siculus* Ramme, 1927: 161. LECTOTYPE ♂, SICILY: Fontanamurata, 17.vii.1924 (W. Ramme & W. Richter) (MNHU, Berlin), here designated [examined].

*Euchorthippus albolineatus siculus* Ramme; Descamps, 1968: 5.

DIAGNOSIS. ♂♀. Pronotal lateral carinae relatively high and narrow; length of pronotum usually 1.03–1.16 times length of head in ♂, 1.16–1.24 in ♀. Fore wings usually reaching bases of genicular lobes of hind femora in ♂, but usually failing to do so in ♀; distance from stigma to tip of fore wing usually 0.25–0.35 times length of hind femur in ♂, 0.28–0.34 in ♀. Length of hind wing usually 0.97–1.09 times length of hind femur in ♂, 0.90–0.94 in ♀. Stridulatory file usually with 85–110 pegs in ♂, 60–90 pegs or hairs in ♀. Male subgenital plate of moderate length, sometimes tending to be slightly pointed (usually intermediate between the shapes shown in Figs 27 and 29). (Full data for measurements, ratios and number of stridulatory pegs are given in the bar-charts on pp. 144–150.)

DISCUSSION. The status of *siculus* is discussed above under *albolineatus*.

The only other species of *Euchorthippus* known to occur in Sicily (according to Galvagni, 1956: 352 and other authors) is *declivus*, which can be easily distinguished from *siculus* by the characters discussed on p. 126. To judge from the three male specimens we have examined, this sex of *siculus* can be distinguished from most other species of the genus by plotting the number of stridulatory pegs against the stigma distance, as shown in Fig. 9.

The three female specimens we have examined can be separated from *chopardi* and *a. albolineatus* by the distance from the stigma to the tip of the fore wing, especially when taken as a ratio to the length of the hind femur (Figs 11, 88). The only reliable character we have found for separating females of *siculus* from this sex of *pulvinatus* is the number of vestigial pegs or hairs in the stridulatory file, as indicated in couplet 6 of the key (p. 124).

We have selected and labelled a male lectotype from the type-series of *siculus*.

## MATERIAL EXAMINED

Lectotype (see synonymy), 2 ♂, 3 ♀ paralectotypes from Fontanamurata and S. Maria de Gesù in Sicily.

DISTRIBUTION. Known only from Sicily.

***Euchorthippus sardous* Nadig**

(Fig. 38)

*Euchorthippus* [sic] *sardous* Nadig, in Nadig & Nadig, 1934: 18; La Greca, 1955: 4 [description of ♀ and discussion of relationships]. Holotype ♂, SARDINIA: Gennargentu, 1900 m, 17.vii.1930 (A. Nadig) (Coll. Nadig, Chur, Switzerland) [examined].

DIAGNOSIS. ♂♀. Pronotal lateral carinae relatively high and narrow, distinctly incurved in prozona (Fig. 38); length of pronotum less than 2.1 mm in ♂, less than 3.0 mm in ♀, usually 0.85–1.05 times length of head. Length of hind femur usually 6.1–7.1 mm in ♂, 8.2–10.4 mm in ♀. Fore wings usually reaching bases of genicular lobes of hind femora in ♂, but just failing to do so in ♀; distance from stigma to tip of fore wing usually 0.27–0.33 times length of hind femur in ♂, 0.33–0.42 in ♀. Length of hind wing usually 0.90–1.15 times length of hind femur. Male stridulatory file usually with 85–110 pegs. Male subgenital plate relatively short and blunt (similar to Fig. 29). (Full data for measurements, ratios and number of stridulatory pegs are given in the bar-charts on pp. 144–150.)

DISCUSSION. The small size of this endemic Sardinian species, and especially the short pronotum and hind femur (Figs 82, 86), enable both sexes to be easily distinguished from all other species of *Euchorthippus*. The only other species of the genus recorded from Sardinia is *declivus*, which is equally easy to recognize (see p. 126).

## MATERIAL EXAMINED

Holotype (see above) and 30 other specimens from the type-locality.

DISTRIBUTION. Known only from the type-locality.



*Euchorthippus angustulus* Ramme

(Fig. 39)

*Euchorthippus angustulus* Ramme, 1931: 191. Holotype ♂, BALEARIC ISLANDS: Formentera, Can Marti, 24-27.vii.1928 (*M. Eisentraut*) (MNHU, Berlin) [examined].

DIAGNOSIS. ♂♀. Pronotal lateral carinae relatively high and narrow. Fore wings usually extending beyond tips of hind femora (usually 1.25-1.40 times length of hind femora); distance from stigma to tip of fore wing usually 0.43-0.56 times length of hind femur in ♂, 0.50-0.61 in ♀. Length of hind wing usually 1.22-1.37 times length of hind femur in ♂, 1.19-1.32 in ♀. Male stridulatory file usually with 103-133 pegs (mean of 25 examined:  $119.0 \pm 7.70$ ). Male subgenital plate relatively short and blunt (similar to Fig. 29).

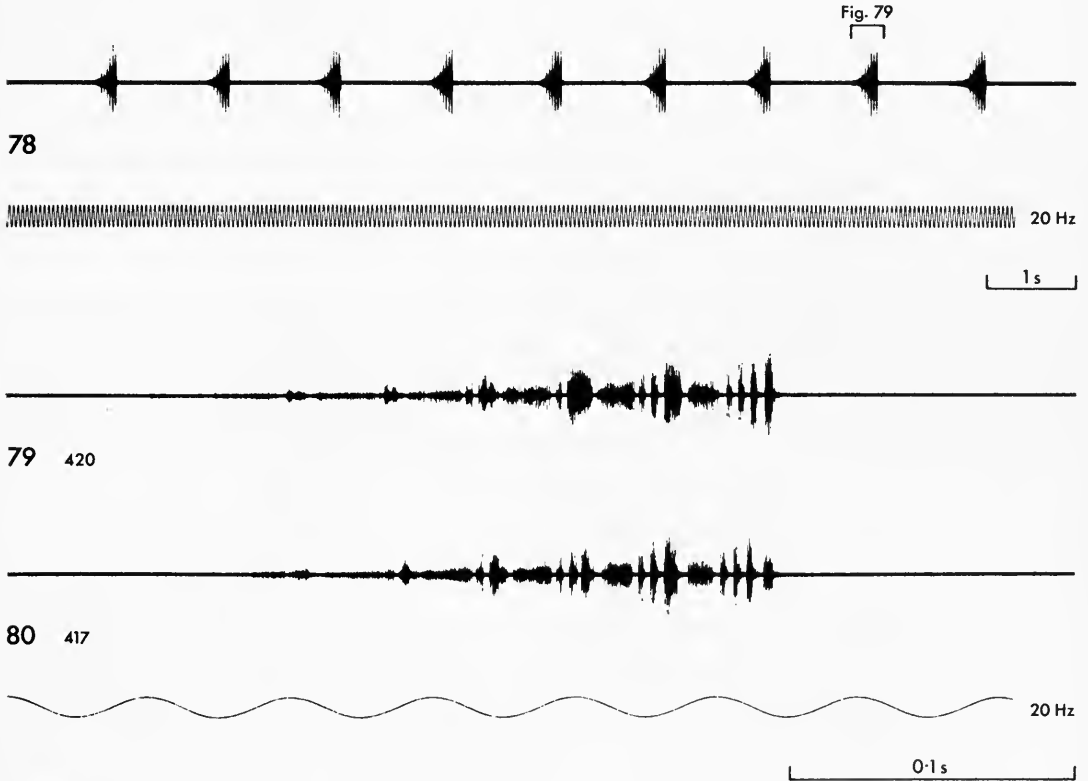

Figs 78-80 Oscillograms of the calling songs of two males of *Euchorthippus angustulus*. Fig. 79 is a faster oscillogram of the echeme indicated in Fig. 78. Fig. 80 is taken from the song of another male. The small numbers refer to the recordings from which the oscillograms were made and can be used to obtain the full data from Table 2 (p. 108).

Male calling song (Figs 78-80). An analysis of songs recorded from two males from Palma Nova, Majorca (not available at the time the bar-charts and scatter diagrams were prepared) gave the following mean values for each male. Echeme repetition rate: 0.84 and 0.85/s. Number of gaps per echeme: 5.6 and 7.4. Duration of echeme: 161 and 164 ms. Duration of syllable: 31 and 32 ms. These figures are based on a total of 179 echemes for the repetition rate and 125 echemes for the other song characters. Comparison with the bar-charts (Fig. 20) shows that the number of gaps per echeme agrees well with *chopardi*, the duration of both the echemes and the syllables is closer to *pulvinatus*, and the echeme repetition rate is intermediate between the two. This confirms Eisentraut's observations, quoted by Ramme (1931: 192), that the song of *angustulus* showed a slower echeme repetition rate than that of *pulvinatus*.

MEASUREMENTS. The specimens of *angustulus* we have examined were not available at the time the bar-charts were prepared and so their measurements are given separately below (number

measured in parentheses; mean followed by standard deviation; all measurements in millimetres). Of the 43 specimens measured, only 5 males and 7 females were available at the time the morphological scatter diagrams were prepared. The measurements of four large females of doubtful identity from northern Majorca are excluded from this list; these specimens are discussed on p. 139.

	Males	Females
Length of head	(26) 2.4-3.0, mean 2.77±0.20	(16) 2.8-3.6, mean 3.21±0.24
Length of pronotum	(25) 2.2-2.8, mean 2.50±0.12	(16) 2.8-3.4, mean 3.16±0.17
Pronotum/head	(25) 0.81-1.06, mean 0.91±0.07	(16) 0.89-1.12, mean 0.99±0.07
Length of hind femur	(25) 7.6-9.2, mean 8.42±0.42	(16) 9.7-11.6, mean 10.51±0.65
Length of stridulatory file	(25) 2.4-3.3, mean 2.88±0.22	
Length of fore wing	(25) 9.7-12.6, mean 11.31±0.61	(16) 12.6-15.6, mean 13.87±0.76
Length of hind wing	(25) 9.4-11.9, mean 10.84±0.55	(16) 12.4-14.3, mean 13.28±0.61
Fore wing/hind femur	(25) 1.27-1.40, mean 1.34±0.04	(16) 1.25-1.40, mean 1.32±0.05
Hind wing/hind femur	(25) 1.22-1.37, mean 1.29±0.04	(16) 1.21-1.32, mean 1.27±0.03
Projection of fore wing beyond hind wing	(25) -0.32-0.24, mean 0.01±0.12	(14) -0.36-0.52, mean 0.10±0.22
Distance from stigma to tip of fore wing	(26) 3.7-4.6, mean 4.16±0.25	(15) 5.6-6.3, mean 6.01±0.20
Stigma distance/hind femur	(25) 0.43-0.56, mean 0.50±0.02	(15) 0.50-0.61, mean 0.56±0.03
Length of subgenital plate	(23) 0.44-0.76, mean 0.60±0.09	
Length of abdominal tergites 9+10	(26) 0.44-0.68, mean 0.53±0.06	
Subgenital plate/abdominal tergites 9+10	(23) 0.73-1.50, mean 1.14±0.20	

**DISCUSSION.** This species, originally described from Formentera and since found in Majorca and Ibiza, is endemic to the Balearic Islands. With the possible exception of four large females from northern Majorca (discussed below), all the specimens we have seen from these islands seem to belong to *angustulus*, although *pulvinatus* and even *albolineatus* have been recorded from Majorca (Ebner, 1931; Kruseman, *in Harz*, 1975: 929). Both sexes of *angustulus* can be distinguished from *pulvinatus* by the relatively long fore and hind wings, and by the large distance from the stigma to the tip of the fore wing, all these being taken as ratios to the length of the hind femur (Figs 10, 11); the small pronotum and hind femur enable both sexes to be distinguished from *albolineatus*. From *chopardi*, which could also conceivably occur in the Balearic Islands, it can be distinguished by the prominent and narrow pronotal lateral carinae. The fact that *angustulus* males are closely associated with *chopardi* and well-separated from *pulvinatus* on the triangular graph shown in Fig. 13 suggests the possibility that *angustulus* is an island derivative from Iberian stock of *chopardi*.

Not surprisingly, the Formenteran and Ibizan specimens we have examined differ slightly from the Majorcan ones. The Formenteran holotype and allotype show a tendency for the pronotal lateral carinae to be more incurved than is typical of Majorcan specimens, in which these carinae are usually straight in the prozona. The single Ibizan male we have examined (from Talamanca) is unusually small, giving smaller values than any other male for most of the

measurements taken; the two Ibizan females examined (from Santa Eulalia del Río) were of more typical size for *angustulus*.

We have examined four female specimens from northern Majorca (one from Puerto de Pollensa, on loan from the Instituut voor Taxonomische Zoölogie, Amsterdam, and three from Alcudia, on loan from the MNHU, Berlin) that are considerably larger than any other Balearic specimens we have seen. The larger size is shown particularly by the following measurements taken from these specimens: length of pronotum 3·6–3·9 mm, length of hind femur 12·1–12·6 mm, length of fore wing 15·5–16·8 mm, length of hind wing 14·3–16·2 mm, distance from stigma to tip of fore wing 0·60–0·71 mm. The hind femora of the largest of these females are as long as those of the smallest female we have examined of *albolineatus*, and there is a small overlap in the length of the pronotum; however, the ratios of both the fore and hind wings to the hind femur in all four specimens give values that are well outside the range of these ratios in our sample of *albolineatus*. It is impossible to form definite conclusions about these four specimens without further material, and in particular associated males, but they could be no more than a large local variant of *angustulus*. It may be significant that the Albufera marsh lies just south of Alcudia; this area of marshland, which is quite unique in the Balearic Islands, could conceivably have been the source of these specimens.

#### MATERIAL EXAMINED

Holotype (see p. 137) and 42 other specimens from the following localities.

**Balearic Islands.** Formentera: Can Martí. Ibiza: Talamanca; Santa Eulalia del Río. Majorca: Palma; Palma Nova; Sóller; Puerto de Sóller; Puerto de Pollensa; Capdella.

**DISTRIBUTION.** Known only from the Balearic Islands.

### General discussion

Groups of morphologically very similar species are quite common in the Gomphocerinae. When the members of such a group intermingle in the same habitat, there are usually obvious differences between the calling songs of the males. This is not surprising since it is now generally believed – and has been proved experimentally in some cases – that such song differences provide the main reproductive isolating mechanism. The three main western European species of *Euchorthippus* – *declivus*, *pulvinatus* and *chopardi* – are sufficiently similar morphologically for misidentification to be frequent. In attempting to assign the 244 males we had at our disposal to one or other of these species on the basis of the shape and length of the subgenital plate (the character on which most emphasis has been placed in the past), we soon found that they showed a continuous gradation from the longest and most pointed *declivus* to the shortest and bluntest *chopardi*, and a large number of males defied identification on this character alone. (In terms of length, the overlap in this character can be seen clearly in Fig. 85.) Since we knew it was not unusual for two of the species to be found together, and there was no *obvious* difference in the male calling songs, we began to wonder whether they were no more than forms of a single species.

The clear morphological separation achieved by the combination of characters used in Fig. 12 made us more confident that three species were involved, and we then turned to the song in the hope of finding some evidence of an ethological barrier. Careful analysis gradually revealed differences that, although subtle and mostly undetectable by the unaided human ear, seemed sufficiently clear to provide a basis for mate recognition. It is perhaps significant that the difference in the male calling song is smallest between *declivus* and *chopardi*, which as far as we know have never been found together; *pulvinatus*, which quite often occurs with either *declivus* or *chopardi*, has a noticeably higher echeme repetition rate than either of them in addition to the further differences revealed by oscillographic analysis.

The close resemblance in both morphology and song shown by these three species suggests that they evolved from a common ancestor quite recently, probably during the Pleistocene Period. The Pleistocene glaciations, during which such an ancestor would no doubt have been pushed southwards into the Iberian, Italian and Balkan Peninsulas, seem likely to have

provided the geographical separations that would have tended to lead to morphological and ethological divergence. As can be seen from Fig. 81, there are some anomalies in the distribution of these species that we think can also be explained by the Pleistocene fluctuations in climate. These are the apparent absence of *declivus* from most of the Iberian Peninsula, in spite of its being widespread in Italy and the Balkan Peninsula; the opposite situation in *pulvinatus*, which is common in the Iberian Peninsula but apparently absent from Italy and rare in the Balkans; and the large apparent gap between the western and eastern populations of *pulvinatus*, i.e. between *p. gallicus* and *p. pulvinatus*.

One possibility is that *declivus* evolved from a population of ancestral stock isolated in the Italian Peninsula during a prolonged glacial period. In the course of subsequent warmer climatic phases such a population would have been able to spread northwards, eventually extending its range into much of western and eastern Europe, while leaving in the peninsula the existing Italian populations of *declivus* (which would have had to become adapted to the ameliorating climate). The poor penetration of *declivus* into the Iberian Peninsula could well be explained by the major barrier of the Pyrenees together with competition by other species of *Euchorthippus* already well adapted to the very hot, dry summers of the Spanish Meseta.

A population of *Euchorthippus* isolated in the Iberian Peninsula, perhaps during the same glacial period, could have given rise to *pulvinatus gallicus* as a result of a rather smaller divergence from the main body of the ancestral stock (now *pulvinatus pulvinatus*) occurring in the Balkan Peninsula and further east. Competition with *declivus*, perhaps by then well

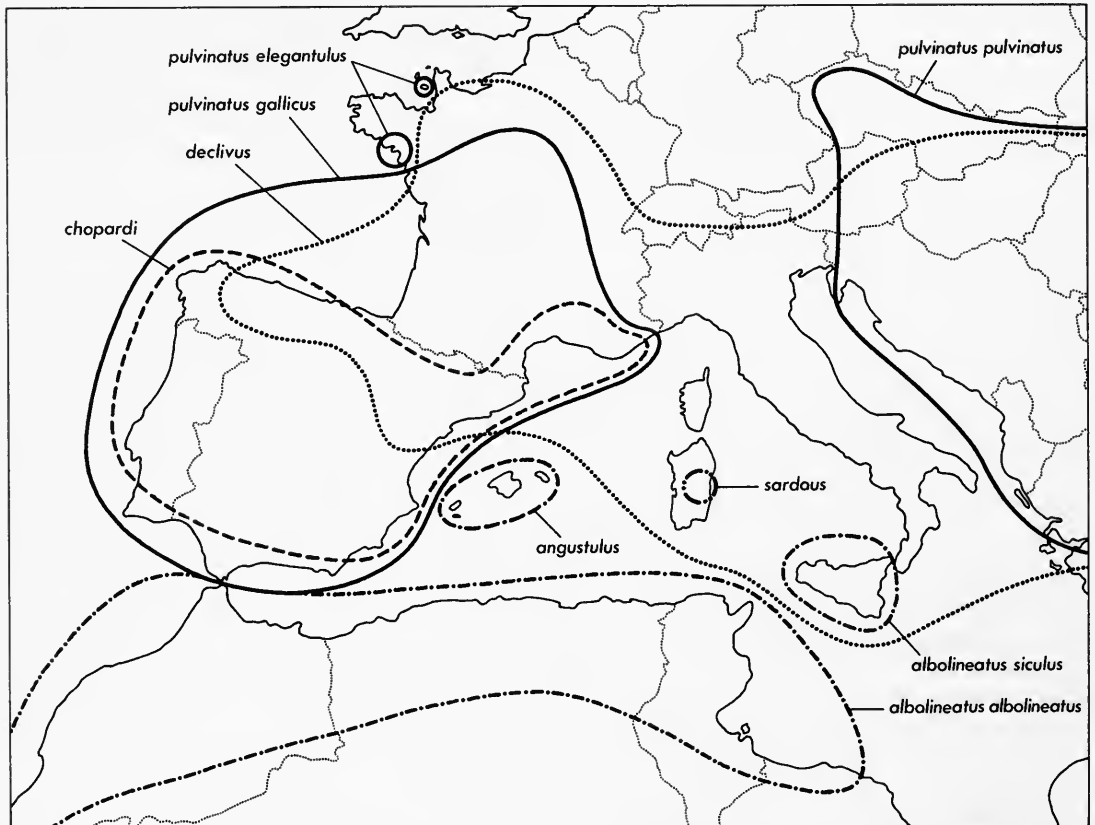

Fig. 81 Map showing the distribution of the western European and North African species of *Euchorthippus*. We regard as doubtful the past records of *E. declivus* from central and southern Spain (see p. 127), *E. pulvinatus* from Italy and Majorca (see pp. 128, 131) and *E. albolineatus* from Portugal, Spain and Majorca (see p. 135), and have therefore not taken them into account in preparing this map.

established in northern Italy and Yugoslavia, could have prevented the western and eastern populations of *pulvinatus* from coming together again.

The evolution of *albolineatus* has no doubt been the result of isolation in North Africa, and we suspect that *chopardi* is a comparatively recent northern derivative from *albolineatus* that has managed to cross the Strait of Gibraltar (perhaps at a time when it was narrower than at present) and thence spread through Spain and past the eastern end of the Pyrenees into southern France, at the same time diverging somewhat from the parental North African stock. Isolation in the Balearic Islands, Sardinia and Sicily, respectively, is sufficient to account for the evolution of *angustulus*, *sardous* and *albolineatus siculus*. Insular isolation would also account for the morphological divergence of the Jersey population of *p. elegantulus*, though the occurrence of a similar population in southern Brittany suggests that *elegantulus* may be no more than a small northern form of *p. gallicus* occurring in rather unfavourable conditions at the limit of its climatic tolerance.

Although we feel we have been able to throw some further useful light on the taxonomic problems presented by *Euchorthippus*, many questions still remain to be answered. We should welcome the opportunity to record and analyse the song of *albolineatus*, so that its relationship with the European species, particularly *chopardi*, could be better understood. An analysis of the song of the eastern subspecies *p. pulvinatus* would help to establish whether this form is truly conspecific with the western subspecies of *pulvinatus* whose songs are described and analysed in this paper. Information on the songs of *sardous* and *siculus* would also be useful in elucidating their affinities. An experimental test of the effectiveness as an isolating mechanism of the song differences we have detected would be most valuable, as would a further investigation into the related question of hybridization; such studies should take account of the possibility of pheromonal reinforcement of mate recognition, which could conceivably account for the unusually small interspecific song differences in this group. A comparative study of the chromosomes, and particularly the C-banding patterns, of all the western European species might well throw some further light on their inter-relationships. Finally, a comprehensive study of the eastern Palaearctic and Madeiran species of *Euchorthippus*, based on morphology, cytology and song, would lead nearer to a complete understanding of the taxonomy and evolution of this interesting genus.

## References

- Arana, P., Santos, J. L. & Giraldez, R. 1980. Chiasma interference and centromere co-orientation in a spontaneous translocation heterozygote of *Euchorthippus pulvinatus gallicus* (Acrididae; Orthoptera). *Chromosoma* **78**: 327–340.
- Autrum, H. 1963. Anatomy and physiology of sound receptors in invertebrates [pp. 412–433]. In Busnel, R.-G. [Ed.], *Acoustic behaviour of animals*. xx+933 pp. Amsterdam.
- Azam, J. 1901. Catalogue synonymique et systématique des Orthoptères de France (suite). *Miscellanea Entomologica* **9**: 33–48.
- Baccetti, B. 1958. Notulae orthopterologicae. X. Indagini sugli Ortotteri del Gran Sasso d'Italia per il Centro di Entomologia Alpina. *Redia* **43**: 351–450.
- Bei-Bienko, G. Ya. 1961. Some features of changes in invertebrate fauna when virgin steppe is cultivated. *Entomologicheskoe Obozrenie* **40**: 763–775. [In Russian. English translation: 1962, *Entomological Review*, Washington **40** (1961): 427–434.]
- Bei-Bienko, G. Ya & Mishchenko, L. L. 1951. Locusts and grasshoppers of the U.S.S.R. and adjacent countries. Part II. *Opredeliteli po Faune SSR, Izdavaemye Zoologicheskim Muzeem Akademii Nauk, Leningrad* **40**: 381–667. [In Russian. English translation published by Israel Program for Scientific Translations, Jerusalem, 1964, iv+291+xxi pp.]
- Brisout de Barneville, L. 1849. Catalogue des Acrididés qui se trouvent aux environs de Paris. *Annales de la Société Entomologique de France* (2) **6** (1848): 411–425.
- Broughton, W. B. 1976. Proposal for a new term 'echeme' to replace 'chirp' in animal acoustics. *Physiological Entomology* **1**: 103–106.
- Carlson, J. G. 1936. The intergeneric homology of an atypical euchromosome in several closely related Acridinae (order Orthoptera). *Journal of Morphology* **59**: 123–161.

- Čejchan, A. 1981. On the orthopteroid insects (s.l.) of Czechoslovakia. I. *Časopis Národního Muzea v Praze* **149** (1980): 125–139. [In Czech with English summary.]
- 1982. On the orthopteroid insects (s.l.) of Czechoslovakia III. *Časopis Národního Muzea v Praze* **151**: 1–13. [In Czech with English summary.]
- Chetyrkina, I. A. 1954. Acridoidea of steppes and deserts of the region of the river Ural. *Trudy Zoologicheskogo Instituta, Akademiya Nauk SSSR, Leningrad* **16**: 229–284. [In Russian.]
- Chopard, L. 1952. Orthoptéroïdes. *Faune de France* **56** (1951), 359 pp.
- Defaut, B. 1982. Quelques précisions sur la détermination, la répartition géographique et l'écologie des espèces françaises du genre *Euchorthippus* [Orth. Acrididae]. *L'Entomologiste* **38**: 82–87.
- Descamps, M. 1968. Notes sur le genre *Euchorthippus* [Orth. Acrididae]. Sa répartition dans le Vaucluse et les départements adjacents. *Annales de la Société Entomologique de France (N.S.)* **4**: 5–25.
- Ebner, R. 1931. Einige Orthopteren von Mallorca. *Boletín de la Sociedad Española de Historia Natural* **31**: 497–503.
- Faber, A. 1953. *Laut- und Gebärdensprache bei Insekten. Orthoptera (Geradflügler)*. Teil I. 198 pp. Stuttgart.
- Ferrer, E., Lacadena, J. R. & Jódar, B. 1981. Análisis de la asociación somática de cromosomas homólogos en *Euchorthippus pulvinatus gallicus* Maran (Acrididae, Orthoptera [sic]). *Revista de la Real Academia de Ciencias Exactas, Físicas y Naturales de Madrid* **74**: 639–651.
- Fischer de Waldheim, G. 1846. Orthoptères de la Russie. *Nouveaux Mémoires de la Société Impériale des Naturalistes de Moscou* **8**, iv+413 pp.
- Galvagni, A. 1956. Primo contributo alla conoscenza degli Ortoteroidi dei Colli Euganei (Veneto). *Memorie del Museo Civico di Storia Naturale di Verona* **5**: 337–359.
- Gangwere, S. K. & Morales Agacino, E. 1970. The biogeography of Iberian Orthopteroids. *Miscelánea Zoologica* **2** (5): 1–67.
- Géry, J. 1962. Le problème de la sous-espèce et de sa définition statistique (à propos du coefficient de Mayr-Linsley-Usinger). *Vie et Milieu* **13**: 521–541.
- González García, M. J. 1981. Contribución al conocimiento de los Acridoidea (Orth.) de la Dehesa Salmantina. *Boletín de la Asociación Española de Entomología* **4** (1980): 55–64.
- Harz, K. 1975. Die Orthopteren Europas II. *Series Entomologica* **11**, [viii+] 939 pp.
- Herrera Mesa, L. 1979. Contribución al conocimiento de los Acridoideos (Orth. Acridoidea) de la provincia de Navarra. *Boletín de la Asociación Española de Entomología* **3**: 45–64.
- 1982. Catalogue of the Orthoptera of Spain. *Series Entomologica* **22**, viii+162 pp.
- Hewitt, G. M. 1979. Orthoptera. Grasshoppers & crickets. *Animal Cytogenetics* **3** (Insecta 1), v+170 pp.
- Jacobs, W. 1953. Verhaltensbiologische Studien an Feldheuschrecken. *Zeitschrift für Tierpsychologie, Beiheft* **1**, vii+228 pp.
- Jannone, G. 1937. Contributi alla conoscenza dell'Ortoterofauna italiana. 1. Nota preventiva su alcune specie e subspecie nuove opoco note della Puglia e di altre regione dell'Italia meridionale e insulare. *Bollettino di Zoologia, Pubblicato dall'Unione Zoologica Italiana* **8**: 51–76.
- John, B. & Hewitt, G. M. 1966. Karyotype stability and DNA variability in the Acrididae. *Chromosoma* **20**: 155–172.
- La Greca, M. 1955. Su alcuni Mantodei e Ortoteri italiani poco noti. *Annuario dell'Istituto e Museo di Zoologia dell'Università di Napoli* **6** (1954) (12): 1–11.
- 1959. L'Ortoterofauna Pugliese ed il suo significato biogeografico. *Memorie di Biogeografia Adriatica, Istituto di Studi Adriatici* **4**: 33–170. [This paper appears to have been issued in separate form well in advance of the relevant part of the journal; we have given the year cited on the separate (1959) in preference to that cited on the journal part (1962).]
- Litvinova, N. F. 1972. Patterns of geographic variability of morphological characters in the genus *Euchorthippus* (Orthoptera, Acrididae). *Zoologicheskii Zhurnal* **51**: 821–827. [In Russian with English summary.]
- Lucas, H. 1849. Histoire naturelle des animaux articulés. Cinquième classe. Insectes. (Suite.) Deuxième ordre. Les Orthoptères. *Exploration Scientifique de l'Algérie pendant les années 1840, 1841, 1842* (Sciences physiques, Zoologie) **3**: 1–39.
- Luquet, G. C. 1978. La systématique des Acridiens Gomphocerinae du Mont Ventoux (Vaucluse) abordée par le biais du comportement acoustique [Orthoptera, Acrididae]. *Annales de la Société Entomologique de France (N.S.)* **14**: 415–450.
- Mařan, J. 1954. Die Orthopterenfauna der staatlichen Naturschutzgebiete bei Štúrovo in der Südslowakei (ČSR). *Ochrana Přírody* **9**: 132–139. [In Czech with Russian and German summaries.]

- 1957. Beitrag zur Kenntnis der europäischen Arten der Gattung *Euchorthippus* Tarb. (Orthoptera, Acrididae). *Acta Entomologica Musei Nationalis Pragae* **31**: 183–190.
- Mayr, E. 1969. *Principles of systematic zoology*. xi+428 pp. New York.
- McClung, C. E. 1932. Multiple chromosomes in the Orthoptera. *Archivos de la Sociedad de Biología de Montevideo* **7**: 1831–1848.
- Nadig, A. & Nadig, A. 1934. Beitrag zur Kenntnis der Orthopteren- und Hymenopterenfauna von Sardinien und Korsika. *Jahresbericht der Naturforschenden Gesellschaft Graubündens* **72**: 3–39.
- Pascual, F. 1978. Estudio preliminar de los Ortópteros de Sierra Nevada, I: Introducción general e inventario des especies. *Boletín de la Asociación Española de Entomología* **1** (1977): 163–175.
- Perdeck, A. C. 1957. *The isolating value of specific song patterns in two sibling species of grasshoppers (Chorthippus brunneus Thunb. and C. biguttulus L.)*. [viii+] 75 pp. Leiden.
- Pitkin, L. M. 1976. A comparative study of the stridulatory files of the British Gomphocerinae (Orthoptera: Acrididae). *Journal of Natural History* **10**: 17–28.
- Presa, J. J. 1978. *Los Acridoidea (Orthoptera) de la Sierra del Guadarrama*. 277 pp. Madrid.
- Presa, J. J. & García, M. D. 1982. Contribución al conocimiento de los Acridoidea (Orth.) de la región murciana (II): Sierra seca de revolcadores. *Boletín de la Asociación Española de Entomología* **6**: 127–132.
- Presa, J. J., Montes, C. & Ramírez-Díaz, L. 1983. Tipificación de poblaciones de saltamontes (Orth. Acrididae) en relación con la altitud, pisos y tipos de vegetación en la Sierra de Guadarrama (Sistema Central, España). *Boletín de la Asociación Española de Entomología* **6**: 249–265.
- Ramme, W. 1927. Die Dermapteren und Orthopteren Siziliens und Kretas. *Eos* **3**: 111–200.
- 1931. Beiträge zur Kenntnis der palaearktischen Orthopterenfauna (Tettig. et Acrid.). [I.] *Mitteilungen aus dem Zoologischen Museum in Berlin* **17**: 165–200.
- 1939. Beiträge zur Kenntnis der palaearktischen Orthopterenfauna (Tettig. u. Acrid.). III. *Mitteilungen aus dem Zoologischen Museum in Berlin* **24**: 41–150.
- Santos, J. L. & Giráldez, R. 1982. C-Heterochromatin polymorphism and variation in chiasma localization in *Euchorthippus pulvinatus gallicus* (Acrididae, Orthoptera). *Chromosoma* **85**: 507–518.
- Santos, J. L., Arana, P. & Giráldez, R. 1983. Chromosome C-banding patterns in Spanish Acridoidea. *Genetica* **61**: 65–74.
- Schmidt, G. H. & Schach, G. 1978. Biotopmässige Verteilung, Vergesellschaftung und Stridulation der Saltatorien in der Umgebung des Neusiedlersees. *Zoologische Beiträge (N.F.)* **24**: 201–308.
- Sellier, R. 1947. Matériaux pour un catalogue des Orthoptères et Dermaptères de Bretagne. Première liste. *Bulletin de la Société Scientifique de Bretagne* **21** (1946): 113–122.
- Tarbinskii, S. P. 1925. Materials concerning the Orthopterous fauna of the province of Altai. *Russkoe Entomologicheskoe Obozrenie* **19**: 175–195. [In Russian with English summary.]
- Tsyplenkov, E. P. 1970. *Harmful Acridoidea of the U.S.S.R.* 272 pp. Leningrad. [In Russian. English translation published by Amerind Publishing Co., New Delhi, 1978, viii+208 pp.]
- Uvarov, B. P. 1926. New or less known Acrididae from Central Asia. *Eos* **2**: 321–359.
- White, M. J. D. 1972. The value of cytology in taxonomic research on Orthoptera [pp. 27–33]. In Hemming, C. F. & Taylor, T. C. H. [Eds], *Proceedings of the International Study Conference on Current and Future Problems of Acridology, London, United Kingdom, 6–16 July 1970*. xv+533 pp. London.
- Zeuner, F. E. 1940. The Orthoptera Saltatoria of Jersey, Channel Islands. *Proceedings of the Royal Entomological Society of London (B)* **9**: 105–110.

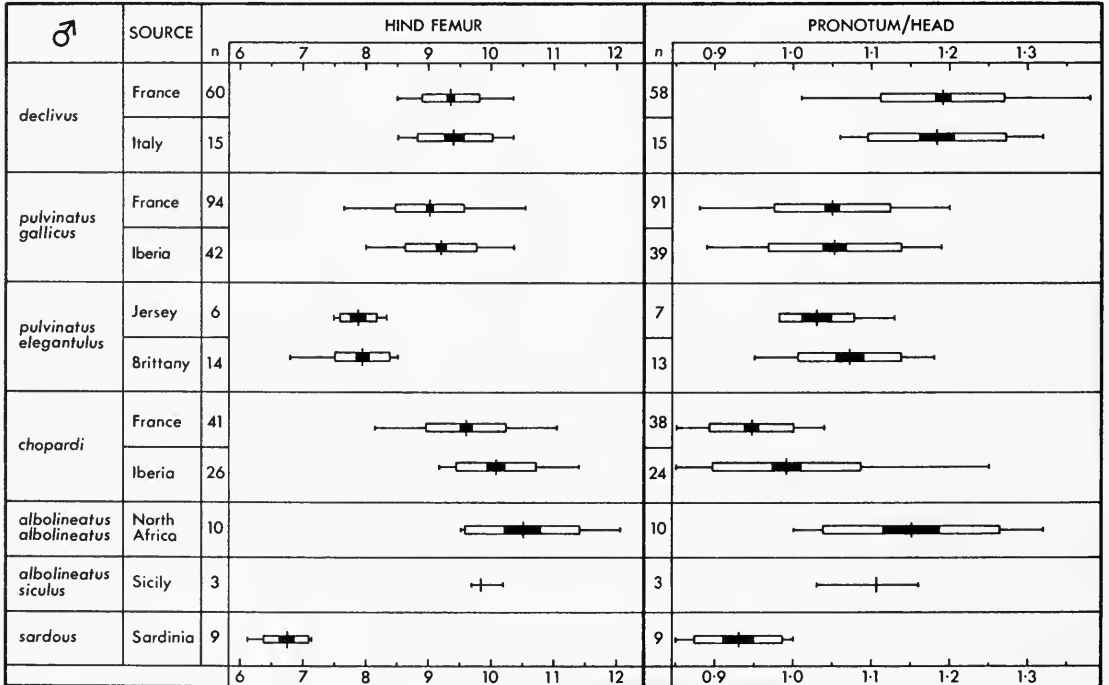
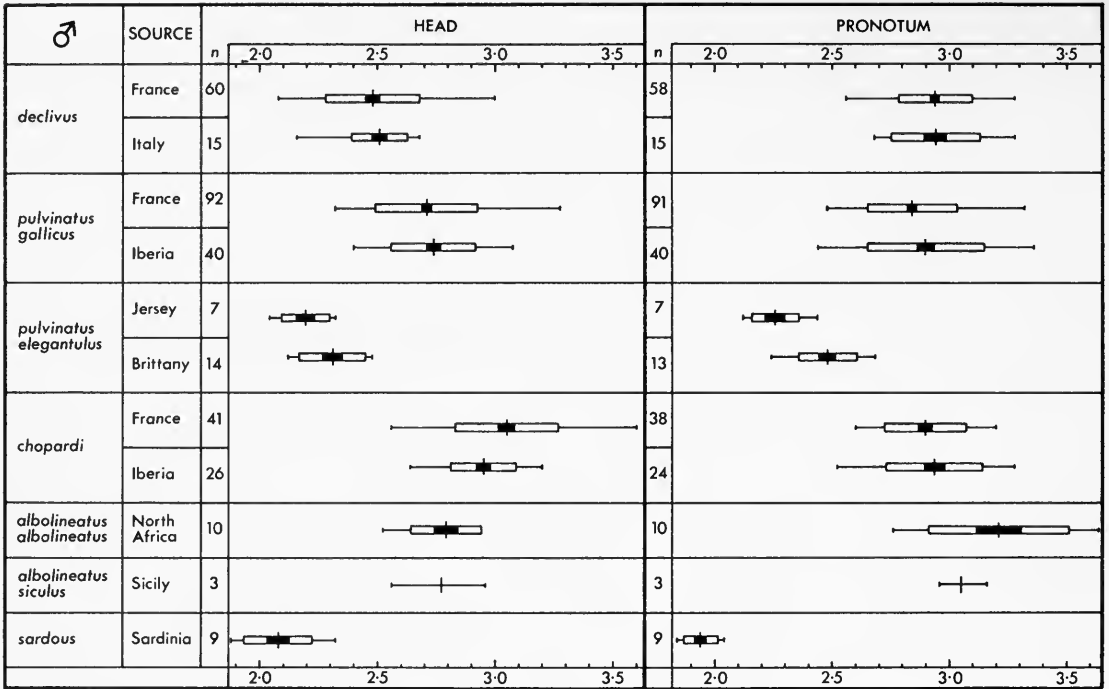

Fig. 82 Data for length of head, length of pronotum, length of hind femur, and length of pronotum divided by length of head, in males of *Euchorthippus*. Measurements are given in millimetres. For explanation of the bars see Fig. 7 (p. 110).



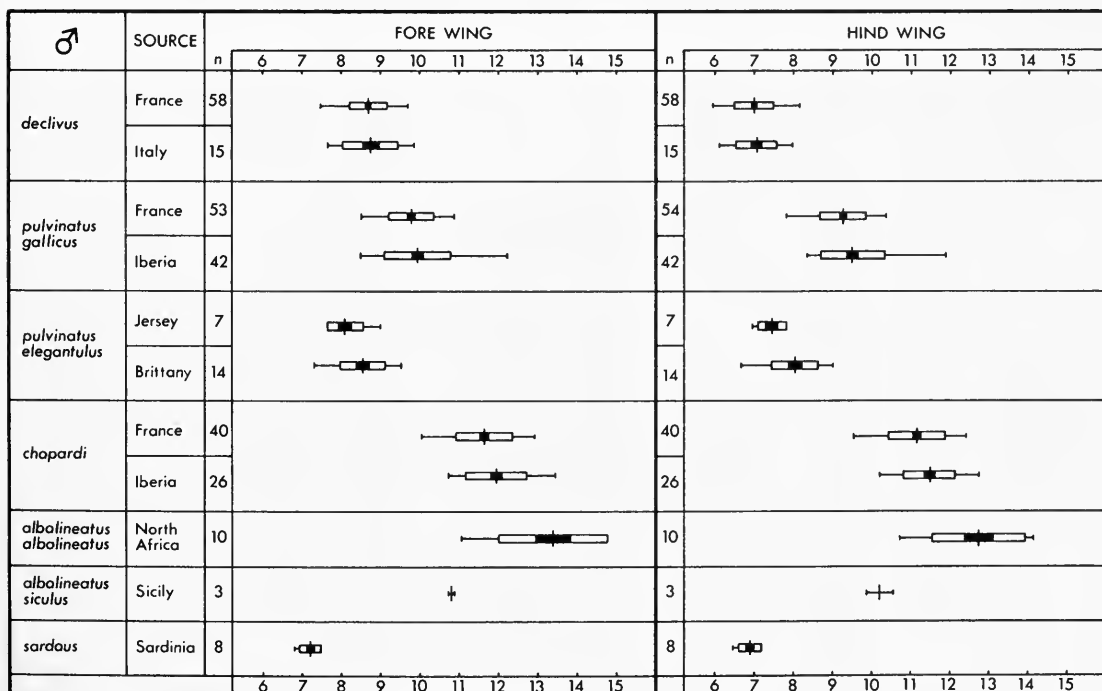
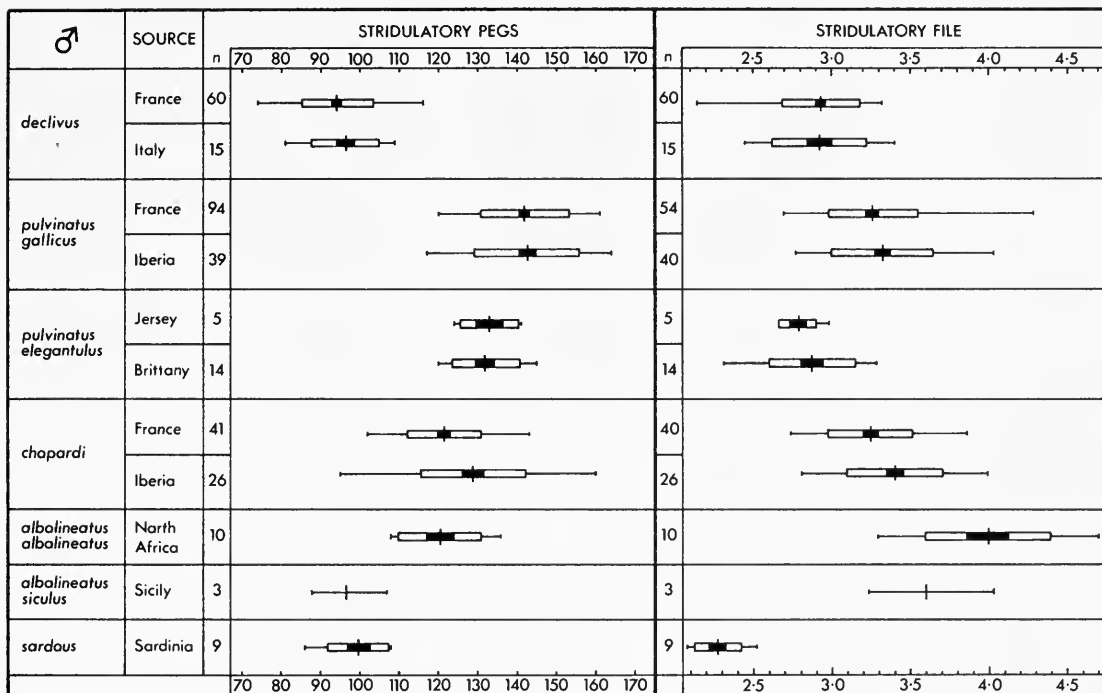

Fig. 83 Data for number of stridulatory pegs, length of stridulatory file, length of fore wing and length of hind wing in males of *Euchorthippus*. Measurements are given in millimetres. For explanation of the bars see Fig. 7 (p. 110).

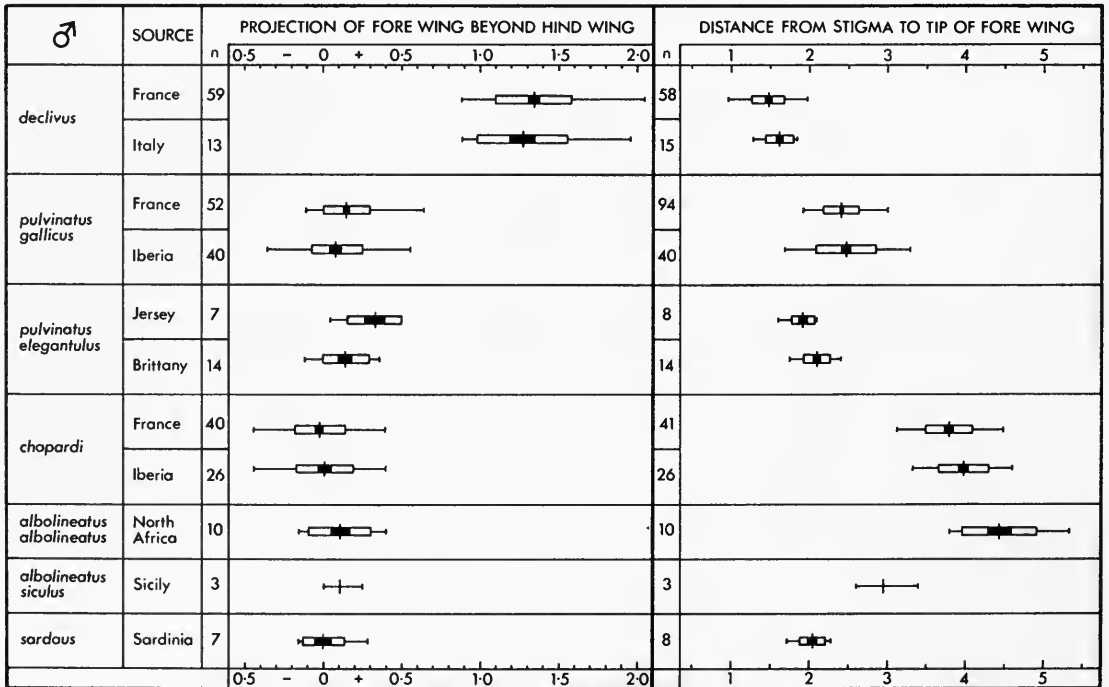
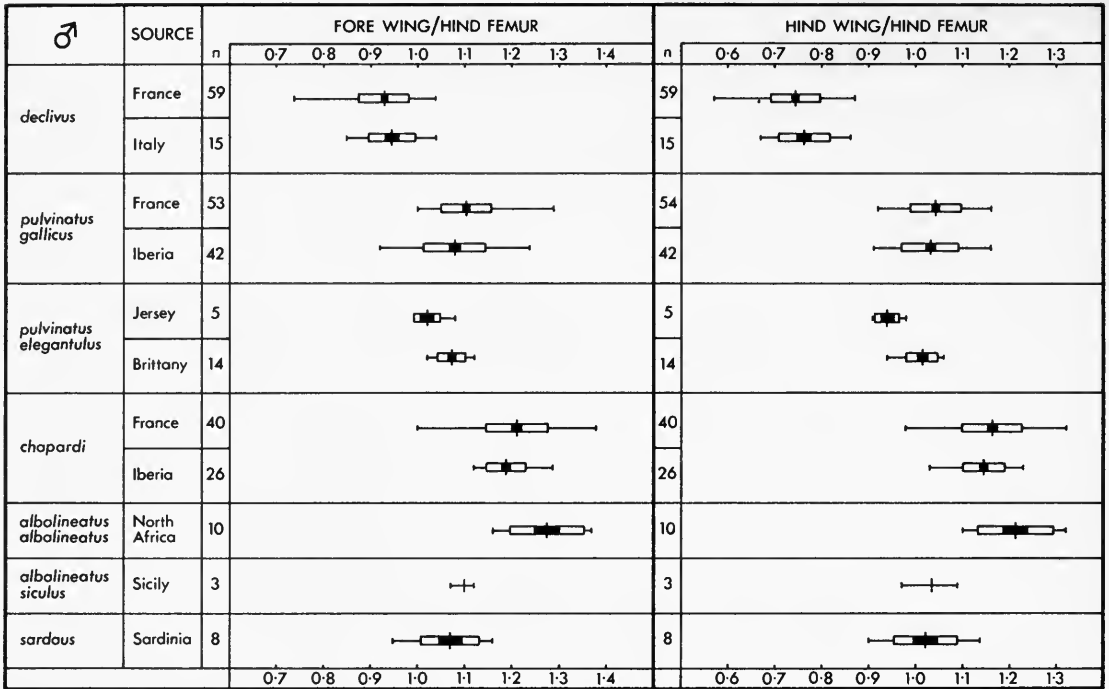

Fig. 84 Data for length of fore wing divided by length of hind femur, length of hind wing divided by length of hind femur, projection of fore wing beyond hind wing, and distance from stigma to tip of fore wing, in males of *Euchorthippus*. Measurements are given in millimetres. For explanation of the bars see Fig. 7 (p. 110).

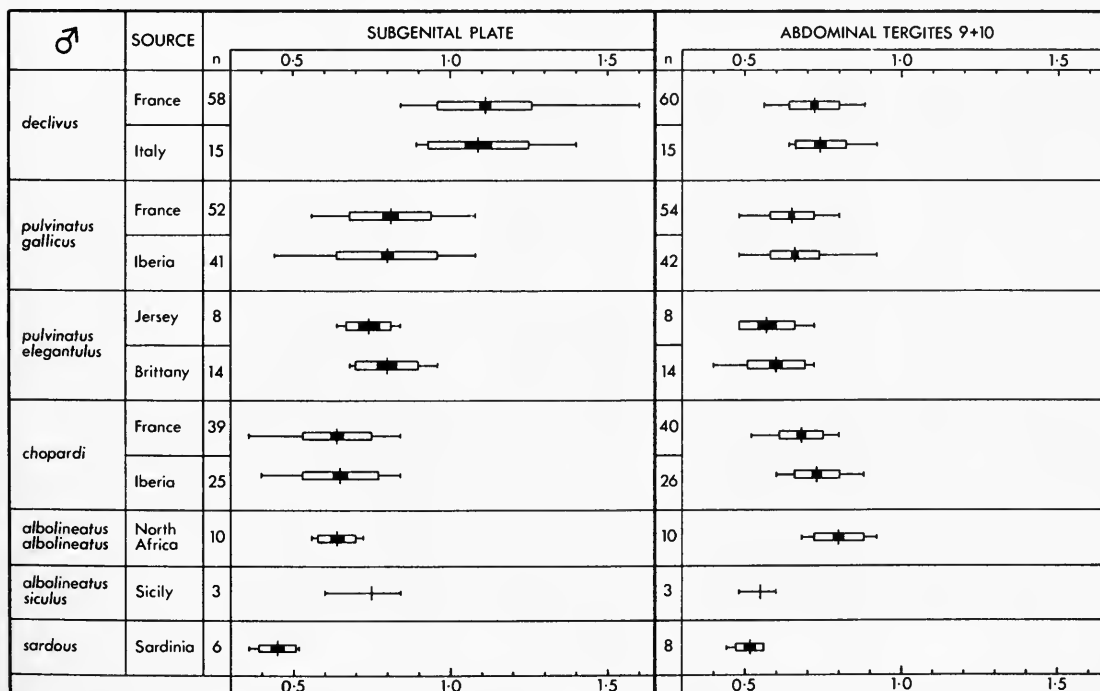
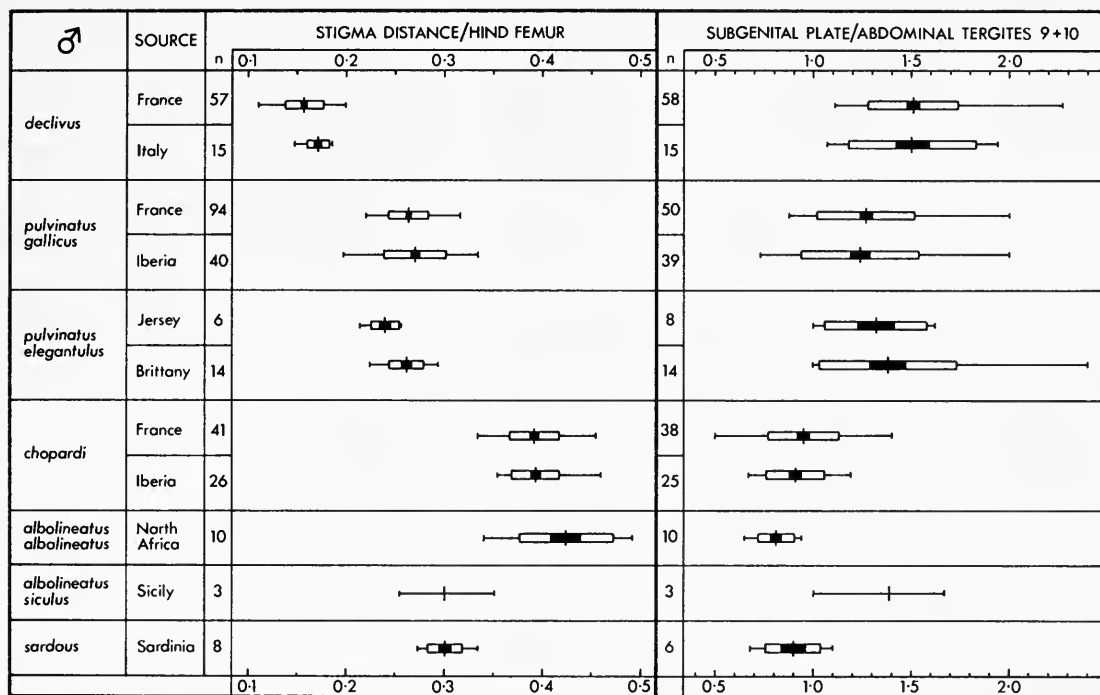

Fig. 85 Data for distance from stigma to tip of fore wing divided by length of hind femur, length of subgenital plate divided by length of abdominal tergites 9+10, length of subgenital plate, and length of abdominal tergites 9+10, in males of *Euchorthippus*. Measurements are given in millimetres. For explanation of the bars see Fig. 7 (p. 110).

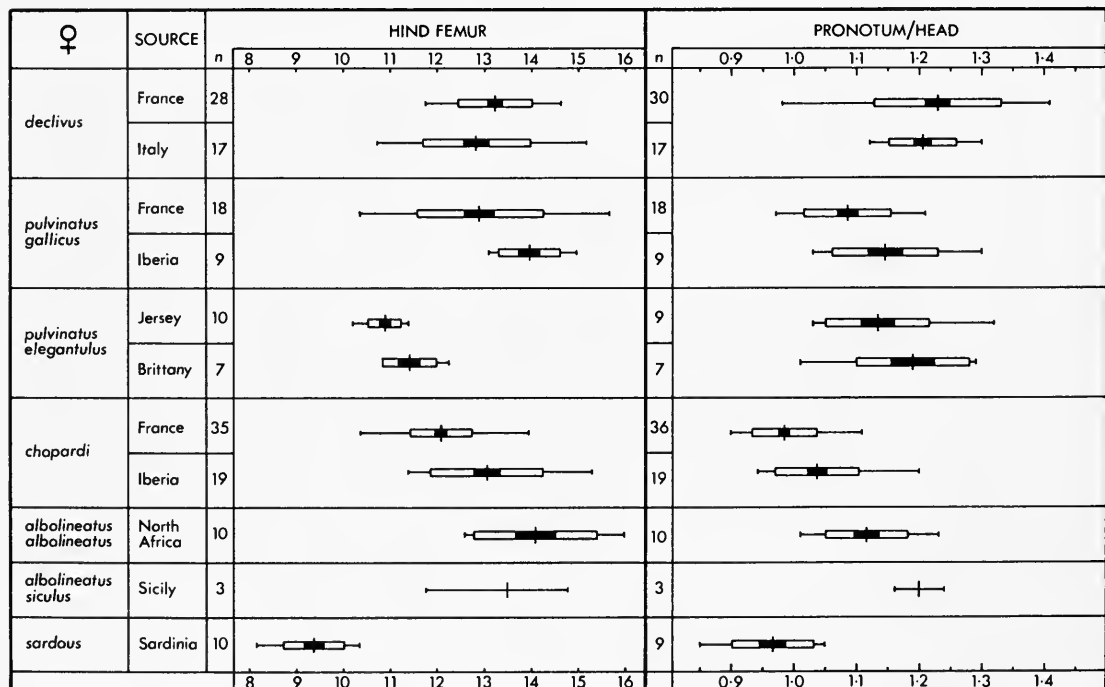
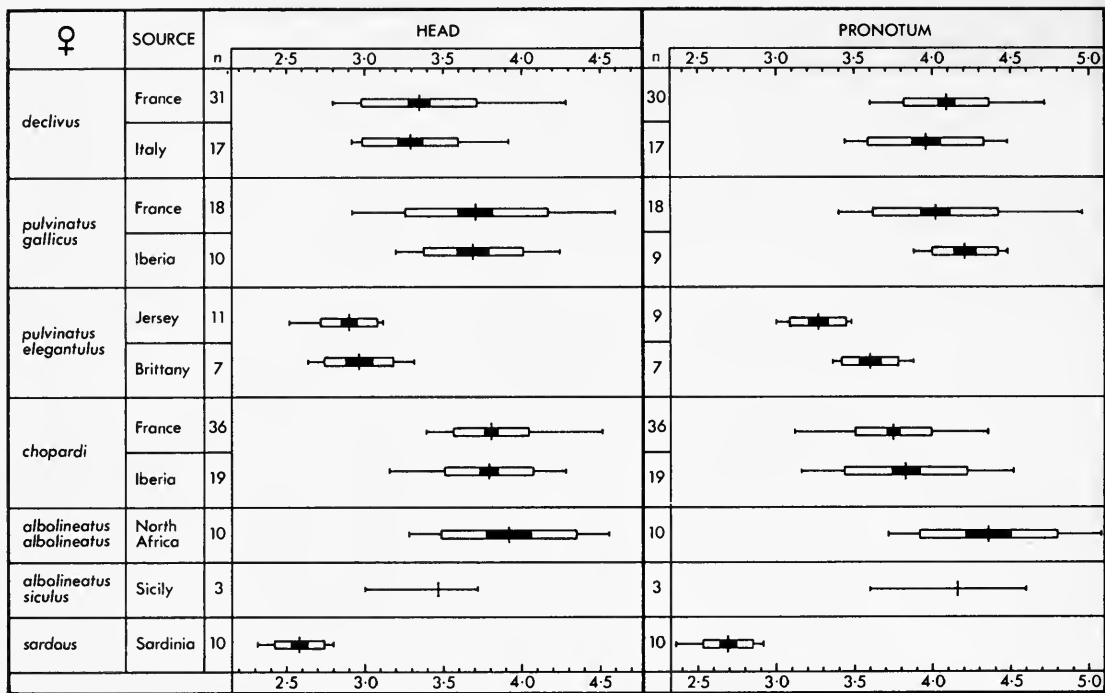
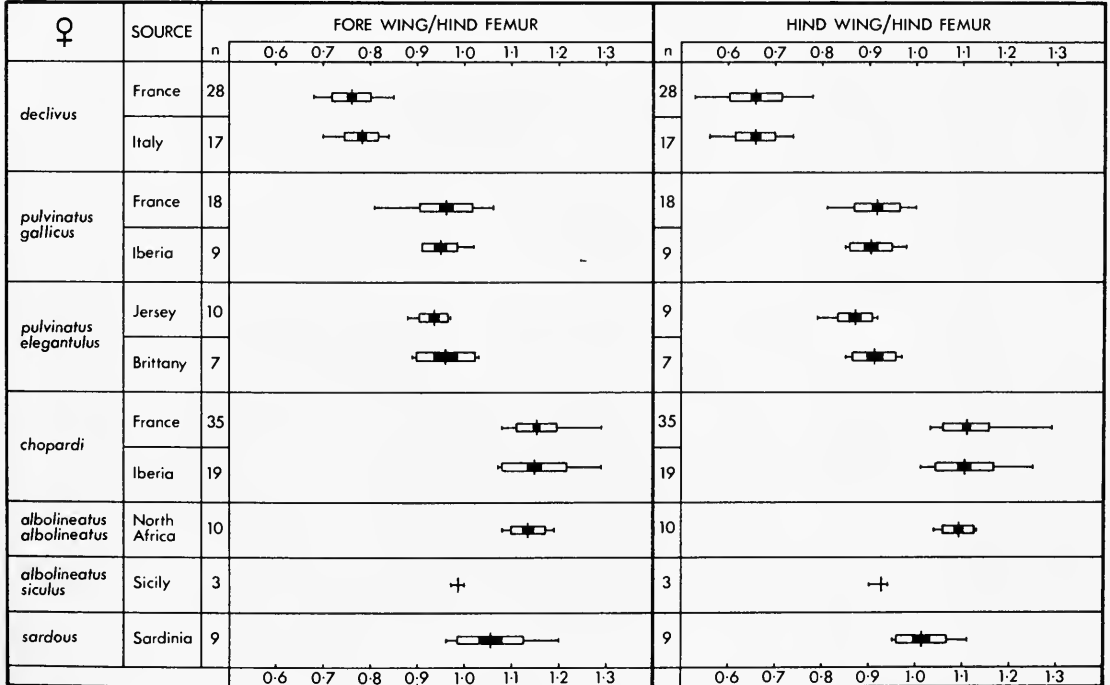
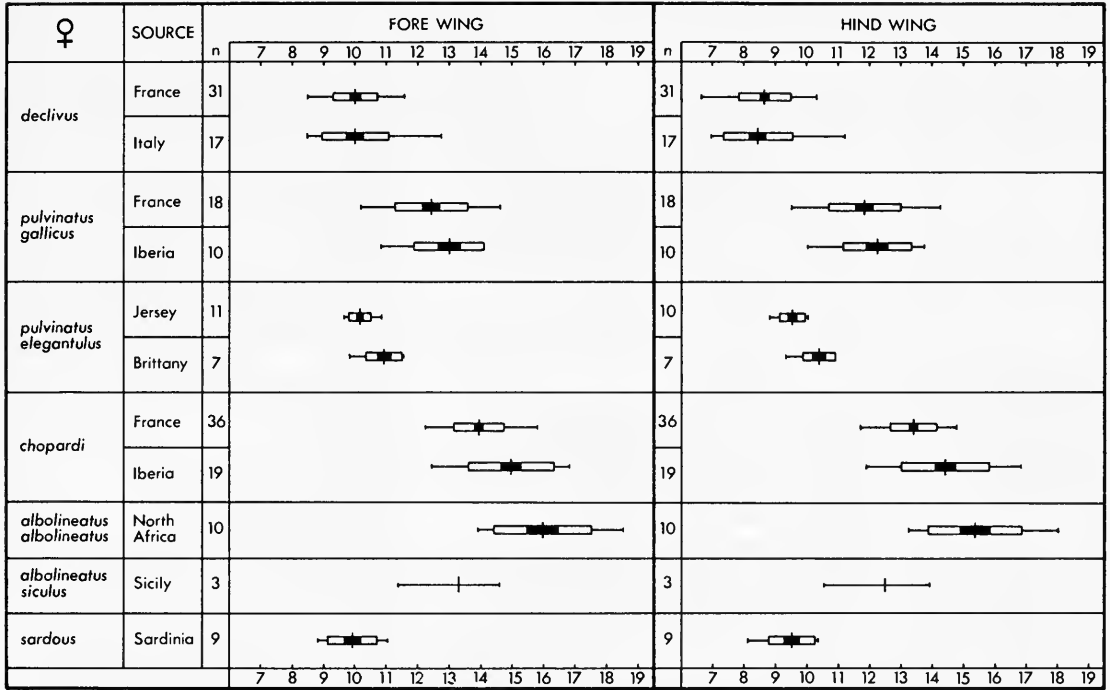

Fig. 86 Data for length of head, length of pronotum, length of hind femur, and length of pronotum divided by length of head, in females of *Euchorthippus*. Measurements are given in millimetres. For explanation of the bars see Fig. 7 (p. 110).



**Fig. 87** Data for length of fore wing, length of hind wing, length of fore wing divided by length of hind femur, and length of hind wing divided by length of hind femur, in females of *Euchorthippus*. Measurements are given in millimeters. For explanation of the bars see Fig. 7 (p. 110).

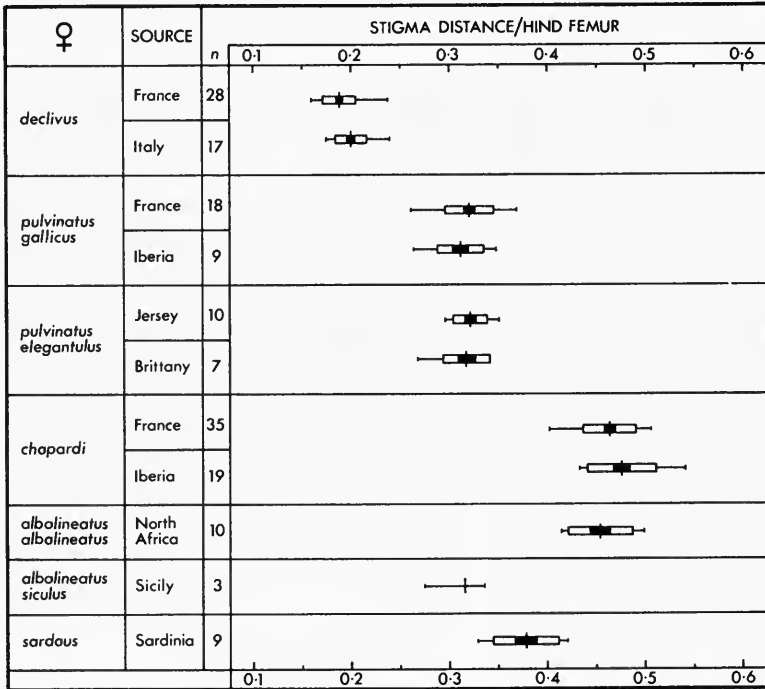
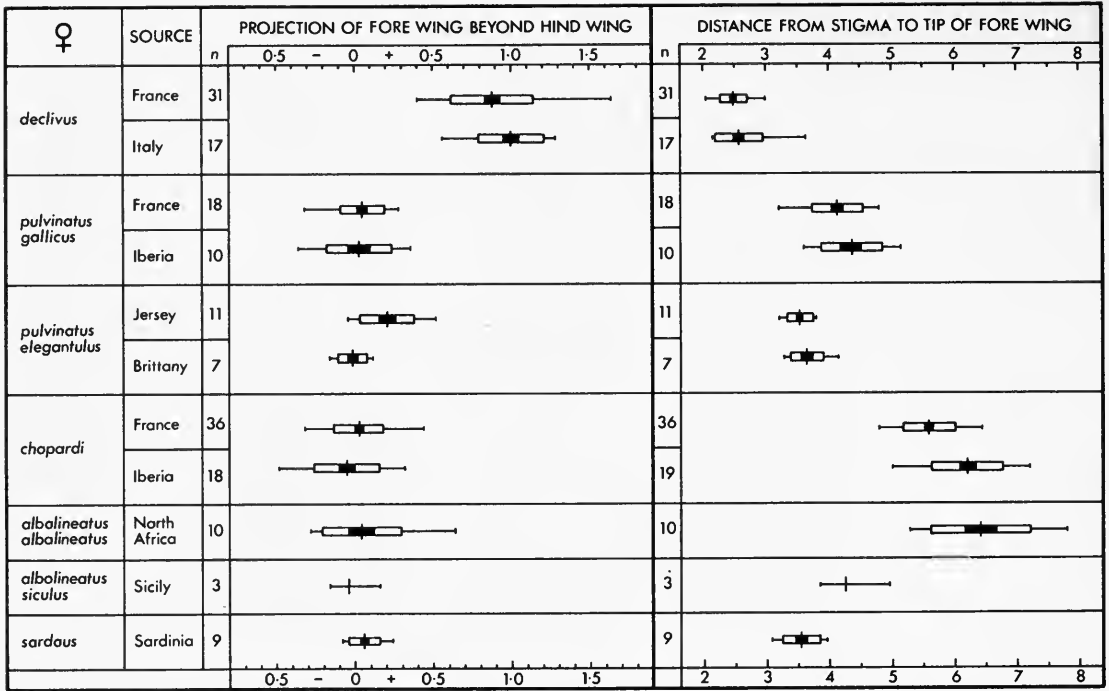

Fig. 88 Data for projection of fore wing beyond hind wing, distance from stigma to tip of fore wing, and distance from stigma to tip of fore wing divided by length of hind femur, in females of *Euchorthippus*. Measurements are given in millimetres. For explanation of bars see Fig. 7 (p. 110).

## Index

Invalid names are in *italics*; principal page references in **bold**.

- |   |  |   |
|---|--|---|
| <p>albolineatus 111, 112, 113, 116, 117,<br/>122, 124, 133, <b>134</b>, 138, 139, 141</p> <p>albopunctata 121</p> <p><i>alini</i> 121</p> <p>angustulus 111, 112, 116, 121, 122,<br/>124, <b>137</b>, 141</p> <p>arabicus 122</p> <p>brachyptera 121</p> <p>chenbaensis 122</p> <p>cheui 122</p> <p>chopardi 110, 111, 112, 113, 114,<br/>115, 116, 117, 119, 120, 121, 122,<br/>126, 127, 128, <b>133</b>, 135, 136, 137,<br/>138, 139, 141</p> <p>Chorthippus 121</p> <p>Chrysochraon 121</p> <p>declivus 110, 112, 113, 114, 115,<br/>116, 117, 118, 119, 120, 121, 122,</p> | <p><b>125</b>, 128, 131, 132, 133, 136, 139,<br/>140</p> <p>dichrous 121</p> <p>dispar 121</p> <p>dorsatus 121</p> <p>elegantulus 113, 114, 115, 119, 124,<br/>126, 128, <b>131</b>, 141</p> <p>gallicus 112, 113, 114, 115, 116, 117,<br/>119, 124, 127, 128, 129, <b>131</b>, 132,<br/>133, 140, 141</p> <p><i>gracilis</i> 125, 126</p> <p>madeirae 122, 126</p> <p><i>meridionalis</i> 125, 126</p> <p>Metrioptera 121</p> <p>montanus 121</p> <p>parallelus 121</p> | <p>Platycleis 121</p> <p>pulvinatus 104, 110, 111, 113, 115,<br/>116, 117, 118, 119, 120, 121, 122,<br/>124, 126, <b>127</b>, 135, 136, 137, 138,<br/>139, 140, 141</p> <p>sabulosa 121</p> <p>sardous 112, 115, 116, 122, <b>136</b>, 141</p> <p>siculus 112, 115, 116, 134, 135, <b>136</b>,<br/>141</p> <p><i>Sinhippus</i> 121</p> <p><i>stichai</i> 125</p> <p>transcaucasicus 122</p> <p>unicolor 121, 122</p> <p>weichowensis 122</p> <p>yungningensis 122</p> |
|---|--|---|









## **British Museum (Natural History)**

### **Milkweed butterflies: their cladistics and biology**

**P. R. Ackery & R. I. Vane-Wright**

The Danainae, a subfamily of the Nymphalidae, contains only some 150 species, yet aspects of their biology have stimulated far more attention than can be justified by species numbers alone. In recent years, an expansive literature has grown, considering aspects of their courtship and pre-courtship behaviour, migration, larval hostplant associations, mimicry and genetics. The popularity of danaines among biologists can certainly be attributed to this combination, within one small group, of so many of the factors that make butterflies such an interesting group to study. The obvious need to place this wealth of biological data within an acceptable systematic framework provided the impetus for this volume.

Started eight years ago within the conventions of evolution by natural selection and Hennig's phylogenetic systematics, the book is now largely about natural history (what the animals have and do, where they live and how they develop) and natural groups – as revealed by a form of analysis approaching that practised by the new school of 'transformed cladistics'. The authors have prepared a handbook that will appeal to a wide range of biologists, from museum taxonomists to field ecologists.

**424 pp (approx.), 12 pp colour, 73 b/w plates, line and graphic illustrations, maps, extensive bibliography. ISBN 0 565 00893 5. Publication September 1984. Price £50, prepublication price £45.**

## **Titles to be published in Volume 49**

**Afrotropical jumping plant lice of the family Triozidae (Homoptera: Psylloidea).**

By David Hollis.

**The taxonomy of the western European grasshoppers of the genus *Euchorthippus*, with special reference to their songs (Orthoptera: Acrididae).**

By D. R. Rågge & W. J. Reynolds

**An historical review of the higher classification of the Noctuidae (*Lepidoptera*).**

By Ian J. Kitching

**The Pimplinae, Xoridinae, Acaenitinae and Lycorininae (Hymenoptera: Ichneumonidae) of Australia.**

By I. D. Gauld

**The western Palaearctic species of *Ascogaster* (Hymenoptera: Braconidae)**

By T. Huddleston

17873

BRITISH MUSEUM  
(NATURAL HISTORY)  
31 AUG 1984  
PRESENTED  
GENERAL LIBRARY

# Bulletin of the British Museum (Natural History)

An historical review of the higher  
classification of the Noctuidae  
(Lepidoptera)

Ian J. Kitching

Entomology series  
Vol 49 No 3

30 August 1984

The *Bulletin of the British Museum (Natural History)*, instituted in 1949, is issued in four scientific series, Botany, Entomology, Geology (incorporating Mineralogy) and Zoology, and an Historical series.

Papers in the *Bulletin* are primarily the results of research carried out on the unique and ever-growing collections of the Museum, both by the scientific staff of the Museum and by specialists from elsewhere who make use of the Museum's resources. Many of the papers are works of reference that will remain indispensable for years to come.

Parts are published at irregular intervals as they become ready, each is complete in itself, available separately, and individually priced. Volumes contain about 300 pages and several volumes may appear within a calendar year. Subscriptions may be placed for one or more of the series on either an Annual or Per Volume basis. Prices vary according to the contents of the individual parts. Orders and enquiries should be sent to:

Publications Sales,  
British Museum (Natural History),  
Cromwell Road,  
London SW7 5BD,  
England.



World List abbreviation: *Bull. Br. Mus. nat. Hist.* (Ent.)

© Trustees of the British Museum (Natural History), 1984

The Entomology series is produced under the general editorship of the  
Keeper of Entomology: Laurence A. Mound  
Assistant Editor: W. Gerald Tremewan

ISBN 0 565 06005 8  
ISSN 0524-6431

British Museum (Natural History)  
Cromwell Road  
London SW7 5BD

Entomology series  
Vol 49 No 3 pp 153-234

Issued 30 August 1984

# An historical review of the higher classification of the Noctuidae (Lepidoptera)

Ian J. Kitching

Department of Entomology, British Museum (Natural History), Cromwell Road, London SW7 5BD

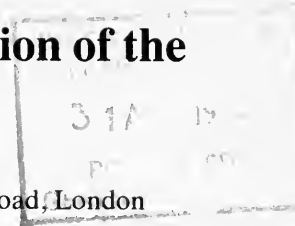

## Contents

Synopsis.....	153
Acknowledgements .....	153
Introduction .....	153
In the beginning .....	154
The American alternative.....	165
Classifications in conflict .....	168
Development of the Hampsonian monolith .....	180
The influence of immatures.....	190
The main assault .....	195
The neglected arrangement .....	210
Quo vadis, <i>Noctua</i> ? .....	214
References .....	227
Index.....	233

## Synopsis

An historical review of the development of the higher classification of the Noctuidae is presented, emphasising the interrelationships between the various systems that have been put forward and the taxonomic impact of the character complexes that have been employed. A provisional cladistic analysis of the higher noctuid taxa is performed and a tentative cladogram proposed. Many of the currently accepted subfamilies are rejected as potentially paraphyletic or polyphyletic assemblages. New, cladistic, definitions of the families Arctiidae and Noctuidae are suggested, which would necessitate the establishment of the Aganaiidae and Herminiidae as separate families.

## Acknowledgements

This study was carried out during the tenure of a Junior Research Fellowship awarded by the Trustees of the British Museum (Natural History), which is gratefully acknowledged. I thank my colleagues at the British Museum (Natural History) for their support and comments.

## Introduction

It is exceptional to find any two authors who use the same combination of subfamily names within the Noctuidae (Nye, 1975: 10).

The classification of this family [Noctuidae] rests in a state of great confusion, and few authors appear to hold similar views regarding the suprageneric taxonomy. I have concluded after spending much time (perhaps I should say wasting time) on the problem, that it is impossible to present . . . a correct suprageneric classification (Zimmerman, 1958: 197–198).

The subfamily divisions . . . are on the whole natural, but their defining characters have far too many exceptions, and some genera may perhaps be completely misplaced (Forbes, 1954: 5).

Much of the present grouping of species and genera is still debatable, and reasons for groupings are often obscure (Birch, 1972a: 189).

The moths of the family Noctuidae, sometimes known as 'owlets', constitute one of the three largest families of Lepidoptera. Estimates of the number of known species vary considerably but the most frequently quoted figure of 25,000 is still far in excess of such other groups as the butterflies (15,000–20,000) and the land-living vertebrates (about 18,000).

Not only are the noctuids a large family numerically, but they are also extremely important economically. The larvae of many genera (e.g. *Spodoptera*, *Heliothis*, *Euxoa*, *Earias* and *Trichoplusia*) are well known as army-worms, cutworms, bollworms and stem-borers and cause many millions of pounds' worth of crop loss each year. Their control, being at present primarily chemical, is also expensive. A predictive classification can thus be seen to be an essential prerequisite to the efficient use of the resources available to combat the pest species.

However, constructing such a classification is no easy task. The sheer size of the group has proved an effective deterrent (one in five lepidopteran genus-group names is noctuid; Nye, 1975), and its worldwide although primarily tropical distribution has resulted in there being few institutions where the work can be pursued on the required scale. Nevertheless, over the years, the genera of noctuids have been classified into tribes and subfamilies. Many of these taxonomic groupings, particularly the earlier ones, were inadequately characterised and this, together with differences of opinion, extensive synonymies at all levels and a dependence upon superficial characters, has led to a far from satisfactory situation.

This review is primarily historical and aims to trace and describe the development of the higher (i.e. suprageneric) classification of the noctuids from its earliest beginnings to the present day. The impact and use of the various authors' systems will be discussed, as will the characters upon which they were based (where these were reported). Finally, a provisional cladistic analysis is performed, using characters drawn from the literature. Each of the noctuid subfamilies is considered in turn, and its relationships assessed and conclusions reached as to where future research might be best directed.

Several conventions will be used subsequently and these are listed below.

1. No authors' names are used (if required, these can be found in Nye, 1975, and Watson *et al.*, 1980).
2. The generic, tribal and subfamilial names used will be those employed in the works discussed at that point in the review. If subsequent changes have been made, the most recently accepted name will be given in square brackets, immediately following the original, e.g. *Gonoptera* [*Scoliopteryx*]. Objective synonymies follow Nye (1975). Subjective synonymies generally follow Franclemont & Todd (1983) for North American taxa, Kloet & Hincks (1972) for British taxa and the BMNH card index for all other groups. Some subjective synonymies (e.g. *Heliothis*/*Helicoverpa*) may therefore not agree with the reader's opinions.
3. Where transfer of genera between subfamilies by other authors has been carried out, the name given in square brackets is the subfamily to which the genus was assigned by Nye (1975). Exceptions to this are: (a) the Agaristinae and Nolinae are treated here as subfamilies of the Noctuidae; and (b) the Acronictinae (s.str.) is separated from the Amphipyrrinae.

In addition, the names Herminiinae, Hypenodinae and Rivulinae are not employed and it must therefore be realised that many genera that correctly belong in such subfamilies are treated as belonging to others (e.g. the Hypeninae s.l.).

## In the beginning

### Early days

Linnaeus (1758) divided the moths into two large genera, *Sphinx* and *Phalaena*. The latter was further divided into seven 'subgenera': *Bombyx*, *Noctua*, *Geometra*, *Tortrix*, *Pyralis*, *Tinea* and *Alucita*. Forty species of true noctuids were contained in the section of *Noctua* described as 'spirilingues, dorso cristato', together with the thyatirid, *Phalaena Noctua* [*Achylia*] *flavicornis*. However, due to Linnaeus' reliance upon superficial characters (e.g. degree of development of



the proboscis and the body vestiture), several noctuid species were placed in *Bombyx* (e.g. *B. [Scoliopteryx] libatrix*, *B. [Colocasia] coryli* and *B. [Dicycla] oo*).

The family Noctuidae was probably first recognised as a distinct unit by Denis & Schiffermüller (1775). Their division 'Noctuae' was divided into 21 groups, based on characters drawn from all developmental stages, including larval foodplants and habits. Each group was assigned a letter of the alphabet and accompanied by short diagnoses of the larvae and adults.

Many of the groups were very heterogeneous and some contained species no longer considered to be Noctuidae. Most of the remainder combined representatives from several current subfamilies. The hypenines were included in the Pyralides as group A, 'Phalaenae Pyralides Longipalpes'.

Up to the nineteenth century, classifications were still largely based upon local faunas. However, Borkhausen (1792) considered all the European noctuid species and divided them into two large groups, the *Noctuae fasciatae* and the *Noctuae non fasciatae*. These contained six and 20 families respectively. Although characters were drawn from the morphology and habits of several life-history stages, Borkhausen utilised only the wing patterns and resting positions of the adults and ignored all other structures. As a result, the classification was not particularly natural. For example, one group consisted of those species with yellow hindwings, from such genera as *Noctua*, *Anarta*, *Polyphaenis*, *Panemeria*, *Thalpophila* and various quadrifines. Nevertheless, this arrangement, albeit imperfect, was an improvement.

Hübner (1805) divided the noctuids into three sections (the Bombycoides, Genuinae and Semigeometrae), while Haworth (1803–28) regarded the family as consisting of only three genera: *Noctua*, *Phytometra* and *Hemigeometra*, subdivided into 22, three and two sections respectively.

This brief survey of the very early history of noctuid classification is by no means comprehensive. A more detailed review of this period (1720–1835) can be found in Guenée (1852–4: xlix–xc).

### Guenée's first classification

In a paper of six parts, published between 1837 and 1841, Guenée presented the first detailed classification of the noctuids, which were variously referred to as the family Nocturni, the division Noctuae, or, most frequently, the Noctuélides. As such, this arrangement will be considered in more detail than its predecessors. Unfortunately, the system 'evolved' during the publication period, for reasons that were never stated, and this makes its description more difficult. Initially, Guenée listed 18 tribes. In addition, he also recognised the Noctuo-Bombycidae (Table 1). This last tribe mainly contained species of the family Thyatiridae, but also included three species of *Cosmia* [Amphipyridae]. A fourth *Cosmia* species, *C. trapezina*, was excluded.

Of the remaining 18 tribes, only the first six were dealt with in the first part of the paper (Guenée, 1837) and so these are the only tribes for which his original concepts are known.

Although included in the 1837 list, Guenée discussed neither the Bombycoidi nor the Pseudo-Bombycidi, but began with the third tribe, the monobasic Bryophyagidi. This contained only *Bryophila* [*Cryphia*], a genus that Guenée found difficult to place within the Noctuélides.

The Nonagridi consisted of two genera, *Nonagría* and *Gortyna*, the larvae of which are root- and stem-borers and, as such, show similar adaptations (smooth, supple integument; well-developed prothoracic and anal shields) which Guenée accepted as evidence of close relationship.

The Leucanidi comprised six genera, representing a mixture of noctuines, hadenines, acronictines and amphipyridines. They differed from the Nonagridi chiefly in that the larvae are leaf-feeders.

The last tribe dealt with by Guenée in 1837 was the Noctuelidi, consisting of seven genera, which are mostly Noctuinae but also including a few hadenines.

Guenée (1838a) continued his classification with the tribes Amphipyridi (four genera) and the Miselidi (three genera). The next tribe to be considered (Guenée, 1838b) was the Hadenidi. Ten

**Table 1** A comparison of the tribes employed by Guenée in his 'Essai'. The Roman numerals given in the second column refer to the order in which the tribes were presented at the beginning of the work (Guenée, 1837), while the Arabic numbers given in the third column are those assigned to the tribes at the conclusion of the work (Guenée, 1841*b*).

TRIBE	1837 number	1841 <i>b</i> number
Noctuo-Bombycidae	—	2 (as Noctuo-Bombycidi)
Bombycoidi	I	1
Pseudo-Bombycidi	II	—
Bryophagidi	III	3 (as Bryophagidae)
Nonagridi	IV	—
Leucanidi	V	4
Apamidi	—	5
Noctuelidi	VI	6
Amphipyridi	VII	13
Miselidi	VIII	—
Hadenidi	IX	8
Orthosidi	X	7
Xylinidi	XI	9
Heliothidi	XII	10
Ctenoceridi	XIII	—
Plusidi	XIV	11
Calpidi	—	12
Catocalidi	XV	15
Ophiusidi	XVI	14
Noctuoidi	XVII	16 (as Phalaenoidi)
Acontidi	—	17
Noctuo-Phalaenidi	XVIII	18

very diverse genera were included, from the Hadeninae, Cuculliinae, Amphipyrinae, Eute-liinae, Ophiderinae and Thyatiridae. Guenée recognised the heterogeneous nature of both this and the next tribe (Orthosidi), accepting that they were almost completely artificial. Indeed, he found difficulty in devising good characters to separate them and even went so far as to label them both 'Tribu IX'. The Orthosidi itself was described in 1839 and contained elements of all four major triffine subfamilies.

The second tribe to be considered in 1839, the Xylinidi, was composed primarily of cuculliines but also included several hadenines and a single heliothine (*Chariclea* [*Periphanes*] *delphinii*). This last species was regarded as a link between the Xylinidi and Orthosidi, and the Heliothidi, the tribe that contained the remaining heliothines, together with the hadenine genus, *Anarta*.

The next tribe in Guenée's 1837 list was the Ctenoceridi. However, he must have reconsidered its validity, for it fails to appear in sequence (Guenée, 1841*a*). Instead, the Heliothidi were followed by the Plusidi, a tribe corresponding to the current Plusiinae. In contrast, the Calpidi, absent from the 1837 list, was included and contained only a single species, *Calpe* [*Calyptra*] *thalictri*. This tribe was followed by the Ophiusidi, a mixture of catocalines and ophiderines (e.g. *Lygephila* and *Minucia*), and the Catocalidi, which consisted only of *Catocala* and the ophiderine *Catephia*.

The final part of the *Essai* (Guenée, 1841*b*) considered three tribes. For the first, Guenée used the name 'Phalaenoidi' rather than Noctuoidi (as used in Guenée, 1837). This was because he thought the sole included genus, *Brephos* [*Archiearis*] had much in common with the Phalaenides [Geometridae] and formed a link between the two families. Guenée placed the genus within the Noctuélides because it was more similar to this family in all its life-history stages than to either the Geometridae or the Pyralidae.

The Acontidi and the Noctuo-Phalaenidi were similar in such characters as the form of the larvae, antennae and the relative width of the wings. The latter tribe was seen as the natural link between the Noctuélides and the Pyrales.

The final classification of the noctuids proposed by Guenée (1841*b*) (Table 1) contained a number of changes in both the names and contents of the tribes compared to those employed in previous parts of the paper. This was true even for that part with which the list appeared. The composition of the Bombycoidi was now stated as *Colocasia* [Pantheinae], *Acronicta* and *Moma* [Acronictinae], while the Pseudo-Bombycidi had either been omitted or merged with another tribe.

The next few tribes had undergone extensive modification and rearrangement. The two genera that formed the Nonagridi were separated, with *Nonagría* placed in the Leucanidi and *Gortyna* included in a new tribe, the Apamidi. Other apamid genera included *Glottula* [Brithys], *Xylophasia*, *Apamea* (removed from the Leucanidi) and *Mithymna* [sic] [now containing only *Eriopygodes imbecilla*, not originally included in the genus].

The Noctuelidi remained more or less intact, although it had gained *Rusina* from the Leucanidi. The Orthosidi gained *Scoliopteryx* from the Hadenidi, and *Tethea* [Zenobia] and *Cosmia* from the Noctuo-Bombycidi, together with several other changes, while the Miselidi were included within the Hadenidi. Otherwise this last tribe remained virtually unaltered, like most of the others. The only significant alteration to the Ophiusidi and the Catocalidi was the transfer of *Catephia* to the former tribe.

### Alternatives to Guenée

Shortly afterwards, Duponchel (1844–6) constructed a classification of the Lepidoptera of Europe. He recognised only three families: the Diurnes (butterflies), Crepusculares (mainly sphingids) and Nocturnes. The noctuids comprised 24 tribes within the last of these (Table 2), corresponding largely to those of Guenée (1841*b*). There were, however, some notable differences.

Firstly, *Bryophila* [*Cryphia*] was included within the Bombycoides. With regard to the Nonagridi, Duponchel placed the genera *Gortyna* and *Hydroecia* [*Hydraecia*] in a separate

**Table 2** The tribes employed by Duponchel (1844–6) for the noctuid moths, within his lepidopteran division, Nocturnes.

Number	Tribe
XVI	Bombycoides
XVII	Noctuo-Bombycides
XVIII	Orthosides
XIX	Gortynides
XX	Nonagrises
XXI	Leucanides
XXII	Caradrinides
XXIII	Apamides
XXIV	Hadenides
XXV	Noctuelides
XXVI	Amphipyrides
XXVII	Xylinides
XXVIII	Heliothides
XXIX	Calpides
XXX	Plusides
XXXI	Catocalides
XXXII	Ophiusides
XXXIII	Anthophilides
XXXIV	Agrophilides
XXXV	Anomalides
XXXVI	Phalenoïdes
XXXVII	Goniatides
XXXVIII	Acontides
XXXIX	Noctuo-Phalenides

tribe, the Gortynides, and *Nonagria* as the sole genus of the Nonagridi. The Apamides were thus equivalent to Guenée's 1841 Apamidi less *Gortyna* and *Hydraecia*, while the remaining genera of his 1841 Leucanidi were distributed between two tribes, the Leucanides and the Caradrinides.

Duponchel's second innovation was the division of the Noctuo-Phalaenidi into five tribes. The first, the Anthophilides, contained four acontiine genera while the Agrophilides included two. The latter tribe also included the amphipyridine *Metaponia*. A second amphipyridine genus (*Metoptria* [*Synthymia*]) was placed in the Goniates, together with *Euclidia*, while two more amphipyridines (*Haemerosia* and *Erastria* [*Hapalotis*]), along with the acontiine *Oratoscelis* [*Calymma*] and the ophiderine *Phytometra*, constituted the Noctuo-Phalenides proper. The final tribe, the Anomalides, included a single species, *Timia* [*Axia*] *margarita*, which is currently placed in the Axiidae (Geometroidea). Thus, some of the heterogeneity of Guenée's Noctuo-Phalaenidi was removed by Duponchel, but not all.

In the following year, Herrich-Schäffer (1845) proposed a series of groupings of the moths he called the Noctuidae. He excluded the species hitherto placed in the Noctuo-Bombycidi, including them in a separate family, the Cymatophoridae [Thyatiridae]. Nevertheless, their position at the head of the Noctuidae suggests that Herrich-Schäffer still considered them to be intermediate between this family and the preceding Bombyces.

Two other families were associated with the Noctuidae. The first, the Nycteolidae, included genera presently placed in the Chloephorinae (*Chloephora*, *Earias*), Sarrothripinae (*Nycteola*), Ophiderinae (*Rivula*) and Hypeninae (*Schrankia* [*Hypenodes*]). The second family, the Brephidae, was equivalent to the Phalaenoidi.

The Noctuidae were divided into 24 subfamilies (Table 3). Herrich-Schäffer followed Duponchel in placing *Bryophila* [*Cryphia*] in the Bombycoidea [mainly Acronictinae]. He also included *Demas* [*Colocasia*] *coryli*, which Duponchel put in the Liparides [Lymantriidae] (although Guenée (1841*b*) placed it in the Bombycoidi), and *Diloba caeruleocephala*, previously

**Table 3** Herrich-Schäffer's (1845) classification of the noctuid moths.

---

Tribe 1:	Cymatophoridae
Tribe 2:	Noctuidae
Subtribe	1: Bombycoidea
	2: Orthosidae
	3: Hadenidae
	4: Xylinidae
	5: Cucullidae
	6: Gonopteridae
	7: Cerastides
	8: Amphipyridae
	9: Noctuidae
	10: Heliiothidae
	11: Maniidae
	12: Eriopidae
	13: Eurhipidae
	14: Calpidae
	15: Herminidae
	16: Metoponidae
	17: Plusidae
	18: Erastridae
	19: Ophiidae
	20: Acontidae
	21: Goniatidae
	22: Hypenidae
	23: Leptosidae
	24: Aglenidae
Tribe 3:	Nycteolidae
Tribe 4:	Brephidae

---

included in the Notodontides since Linnaeus (1758). Finally, *Symira* [*Simyra*] was removed from its long-held relationship with the wainscots (*Leucania*) (some of which *Simyra* superficially resembles) and placed near *Acronicta*, its present position.

The next two subfamilies of Herrich-Schäffer, the Orthosidi and the Hadenidi, contained most of the remaining trifine noctuids less those placed in the Noctuidae, Xylinidae and Cuculliidae. *Mania* [*Mormo*] *maura* was removed from the Amphipyridi and included with *Placodes* [*Eucarta*] *amethystina* (from the Hadenidi) in the Maniidae. *Mania* [*Naenia*] *typica* was placed in the genus *Neuria* in the Hadenidae.

The Noctuidae, Heliiothidae, Acontidae, Amphipyridae (less *Mania*), Plusidae and Calpidae were largely unchanged. Very small subfamilies were erected to accommodate *Hoporina* [*Jodia*] and *Cerastis* (Cerastides), *Eriopus* (Eriopides), *Eurhipia* [*Eutelia*] (Eurhipidae) and *Gonoptera* [*Scoliopteryx*] (Gonopteridae). New subfamilies of somewhat larger size were the Metoponidae, the Leptosidae and the Aglenidae. *Erastria* [*Hapalotis*] was removed from the Noctuo-Phalaenides of Duponchel and placed in a separate subfamily, the Erastridae.

The Ophiuinae comprised *Catephia* and *Ophiusa*, but because this last genus also included species currently assigned to such genera as *Lygephila*, the Ophiuinae was roughly equivalent to Guenée's (1841b) Catocalidi and Ophiusidi combined.

The most revolutionary aspect of Herrich-Schäffer's classification was his treatment of the deltoids. These were split into two subfamilies, the Herminidae and the Hypenidae (this also including several acontiines). The decision to include the deltoid genera *within* the Noctuidae was well ahead of its time and was only slowly to gain acceptance.

### Guenée's second classification

The next major classification of the noctuids was that of Guenée (1852–4). The influence of Duponchel and Herrich-Schäffer was evident, for the arrangement proposed (Table 4) incorporated many of their groupings. This classification was to exert a significant influence on the ideas of future workers and thus is discussed in detail.

Two major divisions of noctuids were recognised, the Noctuélites and the Deltoides. Guenée removed this latter group from the Pyrales because he considered them to have more in common with the Noctuélites. However, despite the recognition that the two groups graded almost

**Table 4** Guenée's second classification (1852–4) of the Noctuidae. Two 'divisions' were recognised, of which the former was split into two 'phalanges'. Each phalange was further divided into sections termed 'tribus', which are not equivalent concepts to the present category of tribe.

---

DIVISION: NOCTUÉLITES
PHALANGE: TRIFIDAE
TRIBU: 1 Bombycifomes
Family: 1 Noctuo-Bombycidae
2 Bryophilidae
3 Bombycoïdae
TRIBU: 2 Genuinae
Family: 1 Leucanidae
2 Glottulidae
3 Apamidae
Subfamily: 1 Gortynides
2 Xylophasides
3 Episémides
4 Apamides propres
4 Caradrinidae
5 Noctuidae
6 Orthosidae
7 Cosmidae
8 Hadenidae
9 Xylinidae
10 Heliiothidae

Table 4 – *cont.*

---

TRIBU: 3 Minores
Family: 1 Haemosoridae
2 Acontidae
3 Erastridae
4 Anthophilidae
5 Phalaenoidae
PHALANGE: QUADRIFIDAE
TRIBU: 1 Sericiae
Family: 1 Palindidae
2 Dyopsidae
TRIBU: 2 Variegatae
Family: 1 Eriopidae
2 Eurhipidae
3 Placodidae
4 Plusidae
5 Calpidae
6 Hemiceridae
7 Hyblaeidae
8 Gonopteridae
TRIBU: 3 Intrusae
Family: 1 Amphipyridae
2 Toxocampidae
3 Stilbidae
TRIBU: 4 Extensae
Family: 1 Polydesmidae
2 Homopteridae
3 Hypogrammidae
Subfamily: 1 Yridae
2 Hypogrammidae propre
TRIBU: 5 Limbatae
Family: 1 Catephidae
2 Bolinidae
3 Hypocalidae
4 Catocalidae
5 Ophideridae
Subfamily: 1 Ophideridae propre
2 Phyllodidae
TRIBU: 6 Patulae
Family: 1 Erebidae
2 Ommatophoridae
3 Hypopyridae
4 Bendidae
Subfamily: 1 Hulodides
2 Bendides propres
TRIBU: 7 Serpentinae
Family: 1 Ophiidae
2 Euclididae
3 Poaphilidae
4 Remigidae
TRIBU: 8 Pseudo-Deltoideae
Family: 1 Focillidae
2 Amphigonidae
3 Thermesidae
DIVISION: DELTOÏDES
Family: 1 Platydidae
2 Hypenidae
3 Herminidae

---

imperceptibly into one another, Guenée did not regard this to be sufficient grounds for uniting them into a single division. Thus a graded sequence was identified, passing from the Bombyciformes (through which the Noctuélites were connected to the Bombyces) through to the Pseudo-Deltoïdæ (by which the Noctuélites passed into the Deltoïdes and thence into the pyralids and geometrids).

**Noctuélites.** Within this division, Guenée recognised two large groups, which he termed 'phalanges', the Trifidæ and the Quadrifidæ. These were primarily separated on the now-infamous character of the degree of development and position of vein  $M_2$  of the hindwing. In the Trifidæ, this vein is generally much weaker than those following it, and originates at such a position that crossveins  $m_1-m_2$  and  $m_2-m_3$  are approximately equal in length. This gives the veins forming the posterior part of the discal cell a trifid appearance. In the Quadrifidæ,  $M_2$  is a strong vein originating near the posterior angle of the cell, resulting in the quadrifid configuration.

**Trifidæ.** The Trifidæ were divided into three tribes: the Bombyciformes, the Genuinæ and the Minores. Distinctions were based largely upon the superficial appearance of the adults and the number of prolegs and hairiness of the larvae. It should be noted that Guenée's concept of a 'tribe' (or tribu), to which the family was subordinate, is not equivalent to current usage, in which the tribe is subordinate to the family.

**Bombyciformes.** The first tribe was split into three families. The Noctuo-Bombycidae [Thyatiridæ] were envisaged as being intermediate between the Noctuélites and the bombycid family, Notodontides, while the Bombycoïdæ [Acronictinæ, part] formed a link with the Liparidæ [Lymantriidæ]. Guenée considered substituting the name Acronyctidæ for Bombycoïdæ but felt that to do so would obscure their relationship with the Bombyces, even though the term Acronyctidæ would result in a more uniform nomenclature. The third family, the Bryophilidæ (the Bryophagidæ of Guenée, 1837), *did*, however, have its name changed for exactly this reason.

An advance upon the 1841 list, with regard to the Bombyciformes, was the unification of the previously widely scattered elements of the Thyatiridæ (= Noctuo-Bombycidae): *Thyatira*, *Leptina* and *Cymatophora* [*Achlya*]. Guenée also followed Herrich-Schäffer (1845) by including *Simyra* in the Bombycoïdæ.

**Genuinæ.** The Leucanidæ, the first 'genuine' family, comprised those species collectively known as 'wainscots'. The adults are pale-coloured, with a simple striate pattern, and the larvae are either endophagous, boring in the stems and roots of grasses, sedges and other monocotyledonous plants, or living concealed by day and feeding by night on Poaceae. The larval habits formed the basis of two subdivisions. At present, the borers (Nonagrides) are placed in the Amphipyriinæ, while the rest (Leucanides) are put in the Hadeninæ.

The larvae of the Glottulidæ also feed internally, but in bulbous plants. The family contained only four genera (e.g. *Glottula* [*Brithys*]) representing a heterogeneous assemblage of hadenines, amphipyriines and ophiderines.

The larvae of the next three families generally conceal themselves by day, emerging only after dark to feed, although a few (*Gortyna* spp.) are root-borers. The first, the Apamidæ, shared characters of both the Noctuidæ and the Hadenidæ. Guenée recognised that the Apamidæ were heterogeneous and possibly subject to future modification and division. In order to indicate this, he separated the species into four subfamilies: the Gortynides, the Xylinides, the Episémides and the 'Apamides propres'.

In his 1841 classification, Guenée united the next family, the Caradrinidæ, with the Leucanidæ because the latter included the genus *Simyra*, which he considered to be intermediate. However, in the present work, Guenée (1852-4) had removed *Simyra* to the Bombycoïdæ and this allowed him to reinstate the Caradrinidæ as a separate family.

The fifth family, the Noctuidæ, generally conformed to the current concept of the Noctuinæ.

It consisted chiefly of three large genera: *Agrotis* (in the broadest sense), *Triphaena* [*Noctua*] and *Noctua* [*Amathes*, *Graphiphora*, *Diarsia*]. Members of the Noctuidae were characterised by holding their wings flat over the back at rest, one wing slightly overlapping the other, which distinguished them from the Leucanidae and Caradrinidae, in which the wings are held roof-wise.

Guenée found the Orthosidae very difficult to differentiate from both the Noctuidae and the Hadenidae. Biologically, many of the Orthosidae share the feature of autumn or early spring appearance as adults. The family consisted of a mixture of hadenines and cuculliines.

The Cosmidae was erected to accommodate a group of genera (e.g. *Dicycla*, *Cosmia*) that, in his *Essai*, Guenée had included in the Orthosidi and the Noctuo-Bombycidi, but that were now considered to be distantly related.

Like the Orthosidae, the Hadenidae proved very difficult to characterise. In larval features, the family approached the Apamidae and Xylinidae, whereas the adults resembled the Orthosidae. All the included genera are currently placed in either the Hadeninae or Cuculliinae, except for *Phlogophora*, which is an amphipyrene.

In contrast to the preceding families of the Genuinae, the larvae of the remaining two feed exposed on plants (with rare exceptions). The Xylinidae contained *Cucullia*, *Calocampa* [*Xylena*], *Xylina* [*Lithophane*] and their relatives, with several smaller amphipyrene genera and one, *Nystalea*, now placed in the Notodontidae. The Heliiothidae was characterised additionally by diurnally-active adults. The only alteration from the Heliiothidi of the *Essai* (Guenée, 1839) was the inclusion of *Chariclea* [*Periphanes*], a genus previously placed in the Xylinidi.

**Minores.** The last of the trifold tribes, the Minores, was divided into five families. All were characterised by the small size of the adult insects, which often resembled geometrids, pyralids or tortricids, similarities that were not contradicted, in Guenée's opinion, by the early stages. The Minores comprised a very mixed group of families, subdivided primarily on the basis of whether the adult abdomen was slender or stout.

Of the latter type, the Haemerosidae consisted of only two genera, *Haemerosia* (now placed in the Amphipyrinae) and *Lepidomys* (currently in the pyralid subfamily, Chrysauginae). The other family with stout bodies, the Acontidae, was relatively larger and contained seven genera.

The first of the slender-bodied families, the Erastridae, contained only four genera, mostly acontines but with at least one amphipyrene (*Erastria* [*Elaphria*] *venustula*). Most species of the Anthophilidae could be distinguished from the Erastridae by the lack of a forewing areole. Those possessing this structure could only be separated with difficulty. Eleven genera were included within the Anthophilidae.

The final family of the Minores was the Phalaenoïdae [Archiearinae], which Guenée continued to retain in the Trifidae.

**Quadrifidae.** The second 'phalange' of noctuids recognised by Guenée was the Quadrifidae. Although this group of tribes was 'notablement différente' from the Trifidae, the separation was not absolute. Guenée found that placing the quadrifid families into a linear sequence was much more difficult than for the Trifidae. Although he attempted to delimit the families as naturally as possible, problems still arose, particularly in those groups that seemed to have closer affinities with certain trifold genera, for example, the Bolinidae and the Acontidae, and the Eurhipidae [Euteliinae] and certain hadenids. In contrast, several families were particularly well defined, notably the Catocalidae and the Plusidae.

The Quadrifidae was divided into eight tribes on the basis of the wing venation and pattern, general facies and the labial palps.

**Sericiae.** This tribe consisted of two small, tropical families, the Palindidae (*Palindia* [*Eulepidotis*] and *Homodes*) and the Dyopsidae (*Dyops* and *Dyomyx*). Both are currently placed in the Ophiderinae.

**Variiegatae.** The second tribe was the largest in the Quadrifidae, comprising eight families.



The first of these, the Eriopidae, was small, containing only five genera. On the basis of larval characters, Guenée allied it closely with the next family, the Eurhipidae. However, he found it impossible to synonymise the two on the grounds of differences between the adults. The Eurhipidae itself formed a well-defined family, corresponding to the present Euteliinae.

Another family in which the constituent genera had, like those of the Eurhipidae, been placed in the Hadenidi was the Placodidae. Only two genera were included: *Placodes* [*Eucarta*; Amphipyridae] and *Diastema* [Acontiinae].

The largest family of the Variegatae was the Plusidae. In addition to the two genera currently assigned to the subfamily Plusiinae (*Abrostola* and *Plusia* s.l.), three other genera were also included, *Basilodes*, *Thyria* and *Plusiodonta*. Through this last genus, Guenée noted that the Plusidae graded into the Calpidae. This family had been extended to include not only *Calpe* [*Calyptra*] but also *Oraesia*, *Gonodonta* and *Hapigia*. The last of these was considered to have a hepialid or notodontid aspect, but Guenée placed it in the Calpidae because of the development of the proboscis and the palps. However, present classifications place *Hapigia* in the Notodontidae and so it is not surprising that Guenée found that this genus formed a convenient link between the Calpidae and the Hemiceridae, another family containing current notodontids (*Hemiceras* and *Canodia*). Guenée commented on the resemblance between the larvae of *Hemiceras* and *Cerura* (Notodontidae) and concluded that despite the superficial similarity of the adult insects to noctuids, the genera of the Hemiceridae, and *Hemiceras* in particular, could belong elsewhere. The transfer of *Hemiceras* and *Hapigia* to the Notodontidae was effected by Druce (1887), while *Canodia* was moved by Schaus (1901). Of the three remaining hemicerid genera, two (*Arcyophora* and *Plusiodes* [*Westermannia*]) are presently assigned to the Chloephorinae while the third, *Achantodes*, (a genus Guenée described as having the overall appearance of a large species of *Chilo*) presently resides in the Pylalidae: Glaphyriinae.

The seventh family of the Variegatae was a group of moths whose relationships are still uncertain today. Until Guenée, the Hyblaeidae had been classified in such families as the Calpidae, Ophideridae or Gonopteridae. However, Guenée's general conclusion was that the group was of uncertain position within the Noctuérites. In present-day classifications, the two constituent genera are widely separated with *Phycodes* placed in the Glyphipterigidae. The development of the current location of *Hyblaea* will be discussed in greater detail below.

The last family in the Variegatae contained seven genera (e.g. *Gonoptera* [*Scoliopteryx*], characterised by angled wings).

**Intrusae.** The third quadrifid tribe Guenée termed the Intrusae. It was divided into three families on the basis of the general facies of the larvae and adults. The first of these, the Amphipyridae, contained four genera, the majority now being placed in the Trifinae (mainly Amphipyridae), although *Barydia* has been transferred to the Notodontidae (Nye, 1975).

The Toxocampidae showed great similarity to the last family (in Guenée's opinion) and like it, was divided into two groups based upon the larvae. Five genera were included, all of which are currently assigned to the Ophiderinae. The final family, the Stilbidae, was composed of a single species, *Stilbia hybridata* [*anomala*]. Consideration of all characters led Guenée to conclude that, like *Brephos* [*Archiearis*], *Stilbia* was totally isolated within the Noctuérites. At present, *Stilbia* is an amphipyridine.

**Extensae.** Three families were recognised within this tribe on the basis of wing shape and size of the legs.

The first family, the Polydesmidae, comprised three genera (*Pantydia*, *Polydesma* and *Diatenes*) which had marked affinities with certain genera of the Intrusae, from which they could be distinguished by the wing venation. The Polydesmidae were seen as a link between the Amphipyridae and the Homopteridae. This latter family was established by Boisduval (1840) for several genera, the larvae of which resemble those of the Catocalidae.

The Hypogrammidae was considered to be somewhat heterogeneous and Guenée thought that it might eventually have to be split. In order to draw attention to this, he established two subfamilies, the Yridae and the 'Hypogrammidae propre'.

**Limbatae.** This tribe was another group Guenée considered might have to be split. It consisted of five families, of which the Catocalidae and the Ophiuridae were thought to perhaps warrant a separate tribe. They were believed to be related, through several genera, to the Patulae, and through the Catephidae to the Extensae.

The Catephidae and the Bolinidae were considered to have much in common. Seven genera comprised the former. Three (*Stictoptera*, *Odontodes* and *Lophoptera*) are currently assigned to the Stictopterinae, while of the other four, three are ophiderines, and one (*Cocytodes*) is a catocaline. There were only four genera in the Bolinidae: *Leucanitis*, *Panula*, *Bolina* [*Aleucanitis*] and *Syneda* [*Drasteria*], of which the first is presently a catocaline, the other three ophiderines.

The genus *Hypocala* was the sole component of the Hypocalidae and superficially resembled the hyblaeids. Guenée was uncertain as to its relationships, but on the basis of the form of the palps suggested a link with the Bolinidae.

Two genera, *Parthenos* [*Euparthenos*] and *Catocala*, were placed in the Catocalidae. Similarities in wing pattern suggested a relationship with the Hypocalidae and the Ophideridae. The latter family contained some species that showed similarities to the Calpidae and others that tended towards the Erebidae (Patulae) and the Ophiuridae (Serpentiae). Two subfamilies were recognised, the 'Ophideridae propre' and the Phyllodidae.

**Patulae.** All quadrifids that, despite their large size, presented an essentially phalaeniform (= geometriform) aspect, were placed in this tribe. Four families were recognised. The Erebidae was a large family of many genera that was difficult to define using absolute structural characters, although Guenée felt that the overall facies was unmistakable. The Ommatophoridae was similarly well defined in general appearance due to the large eyespot on the forewings of most species. Guenée considered this family to be very natural, despite the aberrant wing venation of genera such as *Cyligramma* (the only quadrifid genus to lack an areole) and *Argiva* [*Erebus*, part] (in which the hindwing venation is much reduced in the males).

Like the last family, the Hypopyridae was considered to form a link between the Erebidae and the Ophiuridae (Serpentiae).

Within the Bendidae, Guenée recognised two distinct subfamilies. The Hulodides comprised species of the genera *Homaea* and *Hulodes*, which are South East Asian and resemble certain species of *Hypopyra*, while the 'Bendides propres', inhabiting the Americas, included *Itonia* and *Bendis* [*Lesmone*].

**Serpentiae.** The seventh tribe of the Quadrifidae principally contained species previously recognised under the name *Ophiusa*, a genus that until then had been rather vaguely defined. The tribe was divided into four families, an arrangement Guenée considered provisional at best, because he knew so few of the larvae.

By far the largest family in the tribe (and also in the Quadrifidae) was the Ophiuridae, comprising those species with elongate larval prolegs and large, impressive adults, with velvet-like, apically-pointed forewings. It included a mixture of catocalines and ophiderines.

The sole European representative of the Euclididae (*Euclidia* [*Euclidia* + *Callisteges*]) was once placed in the Noctuo-Phalaenidi. Duponchel (1844–6) had separated it into the Goniatides but Guenée rejected that name on the grounds that it was not based upon an included genus (but see his own Bombycoidea). The six included genera were distinguished from other groups primarily by a reduced number of larval prolegs (three pairs).

The larvae of the Poaphilidae, in contrast, were characterised by four pairs of prolegs, although the adults were similar to those of the Euclididae. Seven genera were included, of which four are currently catocalines and three ophiderines.

Distinguished primarily by the form of the hindleg in the males, which is clothed with dense hair arranged in a single compressed line on each surface, the Remigidae included genera that are presently placed in both the Catocalinae and Ophiderinae.

**Pseudo-Deltoïdæ.** The last tribe in the Noctuélites graded almost imperceptibly into the division Deltoïdes, although the two groups could apparently be distinguished using certain characters of the head. Three families were recognised.

The Thermesidæ were the largest and that which approached most closely in general facies the Deltoïdes. Certain genera also showed some resemblance to genera of the Remigidæ, Ophiuidæ and Bolinidæ.

The other two families were characterised by features of the palps and body vestiture. The Focillidæ was recognisable by the form of the last palpal segment and by the somewhat angled wings. It contained four genera of ophiderines. The three genera of the second family, the Amphigonidæ, bore a superficial resemblance to *Gonoptera* [*Scoliopteryx*] *libatrix* and are now placed in the Ophiderinæ.

**Deltoïdes.** The second great division of noctuid moths was termed the Deltoïdes. Guenée considered the distinction between the last listed Noctuélites (e.g. *Palyna*, now a hypenine) and the first deltoïdes to be very fine but the two groups could be distinguished. As was discussed above, such was not the opinion of Herrich-Schäffer (1845) but Guenée could not countenance such a decision.

The Deltoïdes were divided into three families that were not assigned to tribes. The Platydidæ comprised only three genera: *Trigonia* [*Claterna*], *Macrodes* and *Platydia* [*Yidalpta*]. As if to confirm Guenée's opinion regarding the fine distinction between the Noctuélites and the Deltoïdes, these genera are currently classified in the Ophiderinæ. He believed that the Platydidæ were the most noctuid-like of the deltoïdes, although on the basis of palp, antenna, body, leg and wing characters they were unequivocally deltoïdes.

The Hypenidæ were considered by Guenée to be intermediate between the other two families and to epitomise the concept of the Deltoïdes. Most of the Hypenidæ are currently in the Hypeninæ but *Rhodina*, *Madopa* [*Colobochyla*] and *Pterhemia* are ophiderines.

The Herminidæ was the largest and most varied family of deltoïdes, and that which Guenée thought most closely approached the Pyrales. He also considered it to be the most interesting family because of the great diversity of structure found within it. Many genera have specialised structures on the antennae or eversible hair-pencils on the legs of the males, which have led one group to be termed the 'fan-foots'. Most of the herminid genera are presently classed as hypenines but two (*Cyclopteryx*, *Rivula*) are placed in the Ophiderinæ.

This then was the second arrangement of the noctuids proposed by Guenée. It was followed by Stainton (1857), as well as by Walker (1856-8) in his influential, if controversial, list of specimens in the British Museum. Not all workers, however, accepted Guenée's classification so readily, and criticism was not long in coming.

## The American alternative

### The opening move

Packard (1869) described many morphological characters of the family Noctuidæ that he considered to be of use in classification, drawn mostly from the head, thorax and wings. It was by far the most detailed comparative study conducted up to that time. Packard divided the Noctuidæ into two subgroups, approximating Guenée's Trifidæ and Quadrifidæ. However, he criticised Guenée's use of venational characters and condemned the divisions of the Trifidæ in particular, calling them 'trivial groups of genera'. Packard preferred characters such as the length and narrowness of the clypeus and the form of the antennae to those from the venation or palps. At least he felt this was true for the temperate noctuid fauna, but expressed no opinion regarding those from other areas.

Consequently, Packard removed both the Sericiæ and Variegatæ (less than Gonopteridæ) to the Trifidæ. This combined group he termed the Noctuinae, while the remainder of Guenée's quadrifids became the Catocalinæ.

### Development of Grote's classifications (1874–1890)

**1874.** In his list of North American noctuids, Grote (1874) employed Packard's two subfamilies. However, Grote also included the deltoids within the Noctuae and also associated two other groups with the family: the Noctuo-Phalaenidae [Archiearinae] and the Bombyciae [Thyatiridae]. He also agreed with Packard's opinions concerning Guenée's tribal and family groups and employed no subdivisions in the Noctuae.

These criticisms had little or no effect on English authors (e.g. Butler, 1881; Meldola, 1881; Moore, 1881; Pryer, 1883–5), who continued to follow Walker (1856–8) and hence remained faithful to Guenée.

**1882.** A brief resumé of the classification of the noctuids was provided by Grote (1882*a*). He disagreed with Lederer (1857), who had removed the Cymatophoriden [Thyatiridae] and Brepshiden [Archiearinae] from the Noctuidae and established them as separate families, and chose to include the Cymatophorina [Thyatiridae] and Brepshina [Archiearinae] within the Noctuae. This was followed by the *New check list* (Grote, 1882*b*), in which the noctuids were subdivided although no reasoning was given.

Two major groups were recognised in the Noctuae: the Bombyciae [Thyatiridae] and the Noctuelitae (Table 5).

Within the latter, two subgroups were recognised, the Nonfasciatae and the Fasciatae

**Table 5** The classification of the Noctuidae employed by Grote (1882*b*).

---

NOCTUAE
Bombyciae
Noctuelitae
(Non-Fasciatae)
Dicopinae
Bombycoidea
Noctuinae
Hadeninae
Nonagriinae
Pyrophilinae
Taeniocampinae
Orthosiinae
Cuculliinae
Nolaphaninae
Anomiinae
Litoprosopinae
Euteliinae
Ingurinae
Calpinae
Plusiinae
Stiriinae
Heliiothinae
Eustrotiinae
Hyblaeinae
Noctuo-Phalaenidi
(Fasciatae)
Catocalinae
Ophiderinae
Toxocampinae
Erebiinae
Brotiinae
Pangraptinae
Deltoides
Hypeninae

---

(Packard's Noctuinae and Catocalinae), which were further divided into 21 and eight subfamilies respectively. Many of the groups employed by Grote corresponded to Guenée's families but, because the *New check list* was the first to subdivide the American noctuid fauna, Grote found it necessary to erect a number of new subfamilies, which can be summarised as follows:

- Dicopinae: *Eutolype*, *Dicopsis* [*Psaphida*, part], *Copipanolis* [Cucullinae];  
 Pyrophilinae: *Pyrophila* [*Amphipyra*], *Caradrina* [e.g. *Athetis*] [Amphipyrinae];  
 Nolaphaninae: *Adipsophanes* [*Catabena*], *Crambodes*, *Nolaphana* [*Balsa*]  
 [Amphipyrinae];  
 Anomiinae: *Anomis*, *Aletia* [*Anomis*], *Pteraetholix* [*Amyna*], *Chytoryza* [*Illatia*]  
 [the first two are ophiderines; the third an acontiine; and the last an  
 amphipyrine];  
 Litoprosopinae: *Litoprosopus* [Ophiderinae];  
 Ingurinae: *Ingura* [*Paectes*] [Euteliinae];  
 Stiriinae: *Stilbadium*, *Stiria*, *Acopa*, *Fala*, *Plagiomimicus* [Amphipyrinae];  
 Brotiinae: *Brotis* [*Sphacelodes*] *vulneraria* [Geometridae: Ennomiinae];  
 Pangraptinae: *Syllectra*, *Pangrapta*, *Phalaenostola* [the first two are now  
 ophiderines, the last a hypenine].

In addition, several genera were moved between subfamilies. For example, the Plusiinae now included *Anarta* [*Anarta*, *Sympistis*, *Hada*], *Telesilla* [*Eucarta*] and *Lepipolys*. The deltoid genera were divided into two groups. The first, the Deltoides, contained many hypenine genera and some ophiderines (e.g. *Rivula*) while the second, the Hypeninae, consisted of *Hypena* and its relatives. The deltoids were classified within the Noctuelitae but, unlike Herrich-Schäffer (1845), Grote kept the two subgroups together at the end of the list.

In the same year, Smith (1882–3) published a synopsis in which he explicitly stated the characters used at each level of subdivision of the Noctuidae. He recognised three primary divisions characterised by the eyes being naked, hairy or lashed. Finer divisions were based upon tibial armature, clypeal modifications and the palps. However, Smith did not attach any formal names to his groups. Indeed, he considered *these divisions [to be] entirely artificial and the sequence of genera in the synopsis is not that to be followed in the systematic arrangement of the group, the object being only to enable the collector to place any unknown Noctuid into its proper genus with but little trouble.*

**1883.** The next year, Grote (1883) considered in more detail the structural characters he had used in his previous works. He reverted to Lederer's (1857) three families, in that the Noctuo-Phalaenidae were elevated to family status (as Brepidae). Also, the Bombyciae of Grote (1882b) was renamed the Thyatiridae (Cymatophoridae being inapplicable for reasons given in Harvey, 1874).

The Noctuidae themselves were divided as before but only the nonfasciate subfamilies were discussed in detail. Most were unaltered from the *New check list* but several changes had been made. For consistency, the Bombycoidea were renamed the Apatelinae, while the Euteliinae and Pyrophilinae became the Eurhipinae and Caradrinae respectively. The Bryophilinae (*Bryophila* [*Cryphia*] and its relatives) were split from the Apatelinae, while four genera (*Trichotarache* [*Acontia*, part], *Tarache* [*Acontia*, part], *Chamyris* [*Cerma*] and *Xanthodes* [*Bagisara*]) were removed from the Eustrotiinae as the Acontiinae.

Two new subfamilies were erected. The Arzaminae, comprising *Sphida* and *Arzama* [both *Bellura*] (previously placed in the Nonagriinae), and the Scolecocampinae, containing *Scolecocampa*, *Eucalyptera* [*Gabara*, part], *Cilla* [*Gabara*, part], *Amolita*, *Doryodes* and *Phiprosopus* [*Phyprosopus*].

**1886.** Meyrick (1886) was the first English author to adopt the characters advocated by Grote. However, Meyrick also employed Guenée's major divisions (based upon the development of hindwing vein  $M_2$ ), calling them the Noctuidae and Plusiadae. No further subordinate groups were used.

1890. A revised checklist of North American noctuids was published by Grote in 1890. Two subfamilies were considered, the Thyatirinae and the Noctuidae (relegated from the rank of family). The latter was divided into 25 tribes. Most of these corresponded to those of Grote's previous works but there were discrepancies.

*Arsilonche* [*Simyra*] and *Raphia* were separated from the Apatelinae and, together with *Demas* [*Colocasia*], comprised the Bombycoidi. Not only was this name potentially confusing (cf the Bombycoidae of Guenée, 1852–4) but it was not based upon the name of an included genus and therefore ran counter to Grote's (1883) previous assertions regarding the correct formation of suprageneric names.

In addition, the Noctuidae were renamed the Agrotini, and the Eurhipidae reverted to the Euteliini, with the Incurinae being included within it. New tribes were formed for *Lithophane*, *Calocampa* [*Xylena*], *Lithomia* [*Lithomoia*] and *Xylomiges* [*Egira*] (Calocampini); and *Cleophana* [*Copicucullia*] (Cleophanini). The Tarachinae lost *Trichotarache* [*Acontia*, part] to the Heliothini, while interposed between the former tribe and the Eustrotiinae was the new monobasic Cerathosiini (*Cerathosia tricolor*). This species had been described as an arctiid by Smith, near *Utetheisa*, but on the basis of wing venation and clypeal ornamentation, Grote felt certain that it was actually a noctuid. *Cerathosia* currently resides in the Acontiinae.

Grote (1890) gave only an outline of his classification of the rest of the family. More details were given in another paper (Grote, 1889–90). The Catocalinae were divided into two tribes. The Catocalini were characterised by their often brightly-coloured hind-wings and included the *New check list* subfamilies Catocalinae, Ophiderinae and Toxocampinae. The second tribe, the Pheocymini, comprised the Erebininae of the *New check list*. The wings of the included genera were generally concolorous and crossed by sinuous lines. Grote was unwilling to assign the remaining catocaline subfamilies of the *New check list*, the Brotiinae and the Pangraptinae, preferring to await a more thorough study of the Neotropical fauna.

Two tribes were recognised in the Deltoidinae. The herminiines could be distinguished by their concolorous wings, marked with continuous lines. The Hyphenini, in contrast, had unicolorous hindwings while the forewings displayed the usual noctuid markings, albeit subdued.

The fourth subfamily of the Noctuidae, the Brepinae, now contained two genera, *Brepheos* [*Archiearis*] and *Leucobrepheos*. Grote recognised certain resemblances to some Geometridae (hairy abdomen, predominantly diurnal flight period, larvae with five pairs of prolegs [!]) and similar habits) but still retained them in the Noctuidae.

Thus, by 1890, there were two competing, if somewhat internally unstable and inconsistent, systems for the classification of the Noctuidae. The first, based upon the work of Guenée, was widely accepted in Europe; the second, arising from the studies of Grote, was the primary system in use in North America. The stage was set for a comparative assessment.

## Classifications in conflict

### Tutt's comparison

After consideration of the available options, Tutt (1891–2) decided to adopt the system of Guenée, not because he thought it was more correct but because it was based upon characters of the early stages as well as the adult insect. Grote's system relied entirely on adult features. Only the points of contention as seen by Tutt will be discussed further.

**Trifidae: Bombyciformes.** Tutt considered as irrelevant the debate as to whether the Cymatophoridae [Thyatiridae] were to be placed as the last tribe in the Bombyces (Staudinger & Wocke, 1871) or as the first in the Noctuae (Guenée, Grote). He did explicitly note, however, that the eggs were of the geometrid type, and that the removal of the Cymatophoridae from the Noctuae would render the latter group more homogeneous.

Tutt concluded most authors to be in agreement over retaining the Bombycoidae (= Apatelini) and Bryophilidae in the Noctuae although Butler (1879) had dispersed the British

species of *Acronycta* [*Acronicta*] amongst the Arctiidae, Liparidae [Lymantriidae], Notodontidae and Noctuae (a position he later rescinded; Butler, 1893). Tutt also agreed with Staudinger & Wocke's (1871) inclusion of *Moma orion* [*alpinum*] in the Bombycoidae but expressed doubts regarding *Demas* [*Colocasia*] *coryli* and *Diloba caeruleocephala*, which he thought might belong elsewhere. He also rejected Grote's Bombycoidi on the grounds that Chapman (1893a) had demonstrated *Arsilonche* [*Simyra*] *albovenosa* [*venosa*] to be congeneric with *Acronycta* [*Acronicta*] *rumicis* and so *Arsilonche henrici* (the American species) could not therefore be placed in a separate tribe to the genus *Acronycta* [*Acronicta*].

**Trifidae: Genuinae.** Tutt considered this group to be far more natural, although he had reservations concerning the arrangements and contents of some of the families. He felt that, on the basis of larval habits and mode of pupation, Staudinger & Wocke's (1871) placing of the Gonopteridae in the Trifidae was correct. Tutt also believed that *Mania* [*Mormo* + *Naenia*] and *Amphipyra* might be better placed in the Trifidae, but that the Plusidae should remain in the Quadrifidae. This last point was the major difference between Guenée's Genuinae and Grote's Noctuinae.

**Trifidae: Minores.** Tutt acknowledged the anomalous nature of the Phalaenoidae (Brepidae) but retained it in the Trifidae. He considered Meyrick's (1892) transfer of this group to the Geometrina (as Monocteniadae) erroneous because the larvae have five pairs of prolegs (even though those on abdominal segments 3, 4 and 5 are reduced).

**Quadrifidae: Limbatae.** Tutt disagreed with Grote's suggestion that the Ophiderinae belonged in the Catocalini, considering that association to be based upon superficial characters. He also believed that the Toxocampinae, allied with the Catocalinae by Grote (1890), were nearer the Deltoides, a position about which 'there can be no doubt' when the larvae are examined.

**Quadrifidae: Intrusae.** This was the subclass about which Tutt had most doubts, especially when just the British representatives of the three families (Amphipyridae, Stilbidae and Toxocampidae) were examined. He did not believe that *Mania* [*Mormo*] and *Naenia* belonged in the Hadenidae (where they had been placed by Staudinger & Wocke, 1871) although he was reasonably satisfied with the position of *Amphipyra* in the Caradrinidae. Tutt also refused to accept *Aventia* [*Laspeyria*] *flexuosa* and *Boletobia* [*Parascotia*] *fuliginaria* ('an admitted geometer' – now an ophiderine) in the Noctuae, and thought the Stilbidae were sufficiently isolated to require special treatment, similar to the Brepidae.

**Deltoides.** Tutt agreed with those who placed this group as an integral part of the Noctuae, and concurred with Grote's division of the subclass into the Herminiidae and Hypenidae, groups that Tutt considered to be very natural.

Overall, Tutt's general conclusions supported Guenée's classification, but with the following suggestions.

1. *Demas* [*Colocasia*] and *Diloba* were not Noctuae.
2. The Bryophilidae had no close relationship with the Bombycoidae.
3. The Leucanidae was unnatural, *Leucania* belonged in the Noctuidae and the Nonagriidae in the Apamidae.
4. The Hadenidae and Apamidae were essentially identical.
5. The Xylinidae should be divided, because *Xylena* [*Lithophane*] and *Calocampa* [*Xylena*] were not closely related.
6. The Amphipyridae should be divided, with *Mania* [*Mormo*] and *Naenia* being placed in the Noctuidae and *Amphipyra* near the Caradrinidae.
7. The Plusidae were less closely related to the Xylinidae than were the Heliothidae.
8. The Toxocampidae were closer to the Deltoides than to the Catocalidae.
9. The Deltoides were unequivocally noctuids.

### Smith's comparison

Smith (1891) held altogether different views. The Noctuidae included three families: the Thyatiridae, the Noctuidae and the Brepidae. No subdivision was used because Smith considered Grote's subfamilies to be of no use because of their 'unequal value and impossibility of accurate definition'. Guenée's classification was not even considered. Smith's position had not altered two years later (Smith, 1893).

### Hampson's Fauna of British India

The next major work on the higher classification of the Noctuidae introduced a new name but one which was to have a considerable impact in future years. The first arrangement of noctuid genera proposed by Hampson (1893–5) pioneered an entirely novel approach to family level interrelationships. Hampson believed that the three families Agaristidae, Arctiidae and Noctuidae were very closely related and difficult to separate clearly in some instances. In particular, he thought that the 'primitive' forms of the last two families (the Nolinae and Sarrothripinae respectively) graded into each other somewhat. The Nolinae were later considered to be worthy of a separate family, based upon larval characters (Packard, 1895).

Also included within the Arctiidae, as the subfamily Nycteolinae, were nine genera currently referable to the noctuid subfamily Chloephorinae. This group of genera had always been enigmatic and had generally been placed in the Bombyces as a separate family (e.g. Smith, 1891). Hampson (1893–5) noted that they approached the Acontiinae in the structure of the hindwing vein  $Sc + R_1$  but on the basis of their 'tree-frequenting habits', retained them in the Arctiidae.

**Table 6** The first classification of the Noctuidae proposed by Hampson (1893–5).

---

NOCTUIDAE
Trifinae
Acontiinae
Palindidae
Sarrothripinae
Euteliinae
Stictopterinae
Gonopterinae
Quadrifinae
Focillinae
Deltoidinae

---

The Noctuidae were divided into 10 subfamilies (Table 6). Two (the Acontiinae and the Trifinae) were characterised by an obsolete hindwing vein  $M_2$ , while in the other eight this vein was well developed. Hampson thus used Guenée's major subdivisions rather than Packard's.

The Agaristidae [Noctuidae: Agaristinae] were considered to be a development from the Noctuidae, the first occasion on which such a relationship had been postulated. Previously, they had been considered to be near the Arctiidae and in the Bombyces (e.g. Smith, 1891).

**Trifinae.** This subfamily approximated Guenée's Genuinae and was defined primarily on the basis of wing venation (as were many of Hampson's categories). It contained those genera presently referable to the Noctuinae, Heliiothinae, Hadeninae, Cuculliinae and Amphipyriinae. The Trifinae also included *Acronycta* [*Acronicta*], but not the bryophilines (see below), and also *Toxocampa* [*Lygephila*], a view almost diametrically opposed to that held by Tutt (1891–2; 1902).

**Acontiinae.** This subfamily was distinguished from the last by the presence of a slender vein  $M_2$  in the hindwing. The larvae generally have four pairs of prolegs but reduction of those on



abdominal segments 3 and 4 occurs in some species. Most of the 29 genera are still acontiines, but the subfamily also included two acronictines (*Diphthera* [*Moma*] and *Bryophila* [*Cryphia*]); three amphipyridines (*Megalodes*, *Cosmia* and *Pachylepis*); two ophiderines (*Rivula* and *Tathodelta*) and a hypenine (*Perciana*).

**Palindiinae.** Ten genera were included in this, the first of the quadrifine groups, representing a mixture of ophiderines and chloephorines, with one sarrothripine (*Bryophilopsis*) and one amphipyridine (*Callyna*).

**Sarrothripinae.** Seventeen genera constituted this subfamily. The majority are still sarrothripines, although *Ariola* is a chloephorine, *Nolasena* an ophiderine and *Chlumetia* a euteliine. Also included was the genus *Hyblaea*. None of the defining characters of this subfamily was constant but most had raised scales on the wings and a bar-shaped retinaculum in the male.

**Euteliinae.** Only three genera were included in this subfamily (*Ingura* [*Paectes*], *Anuga* and *Eutelia*) and all three presently reside here.

**Stictopterinae.** This was another very small subfamily, of seven genera. Apart from venational characters, the constituent genera also had fairly well-developed scale tufts on the forewing and frequently a hyaline area at the base of the hindwing. Only four of the genera are still stictopterines (*Stictoptera*, *Odontodes*, *Sadarsa* and *Gyrtona*). The others comprised a chloephorine (*Maceda*), an ophiderine (*Cymatophoropsis*) and a sarrothripine (*Risoba*).

**Gonopterinae.** Eighteen genera comprised this subfamily. Again, characterisation was vague, with most of the characters also occurring in some genera of other subfamilies. Seven of the 18 genera listed are now ophiderines, the remainder being chloephorines.

**Quadrifinae.** This subfamily was by far the largest in the Noctuidae, comprising 81 genera in all. Most are now placed in the Catocalinae or Ophiderinae but the subfamily also included genera assigned to the Plusiinae (*Plusia*, *Abrostola*), Amphipyridinae (*Cetola*), Pantheinae (*Moma* [*Trichosea*], *Trisuloides*) and Chloephorinae (*Pseudocalpe* [*Arcyphora*]).

**Focillinae.** In common with many genera of the previous subfamily, the larvae of the Focillinae are semi-loopers. The legs of the adults are also modified, possessing short, stout tibiae and tarsi. Thirteen genera were included, all ophiderines.

**Deltoidinae.** This group was relatively variable regarding wing venation and showed considerable complexity in male secondary sexual characters. Hampson considered groups such as the Trifinae, Acontiinae, Focillinae and Quadrifinae to have arisen from this subfamily.

The Deltoidinae contained 40 mainly ophiderine and hypenine genera but also two acontiines, *Araeopteron* [*Araeopteron*] and *Niaccaba*.

The Archiearinae are absent from India and were therefore not considered by Hampson. The Cymatophoridae [*Thyatiridae*] comprised a separate family, placed near the Notodontidae and the Sesiidae [*Aegeriidae*]. Although not placed near the Noctuidae, Hampson stated that were he to arrange the moth families in a linear sequence, then the Cymatophoridae would follow the Noctuidae, rather than precede them as had been more or less standard practice in the past. This was because he considered them to be a side-branch from the main stem leading from the tortricids, through the noctuids and notodontids, and thence to the Bombycoidea and Geometroidea (Fig. 1). As can also be seen from Fig. 1, Hampson dismissed a direct link between the noctuids and either the pyralids or the geometrids.

#### Further development of Grote's classification

In the meantime, Grote had been reappraising his noctuid classification. On the basis of

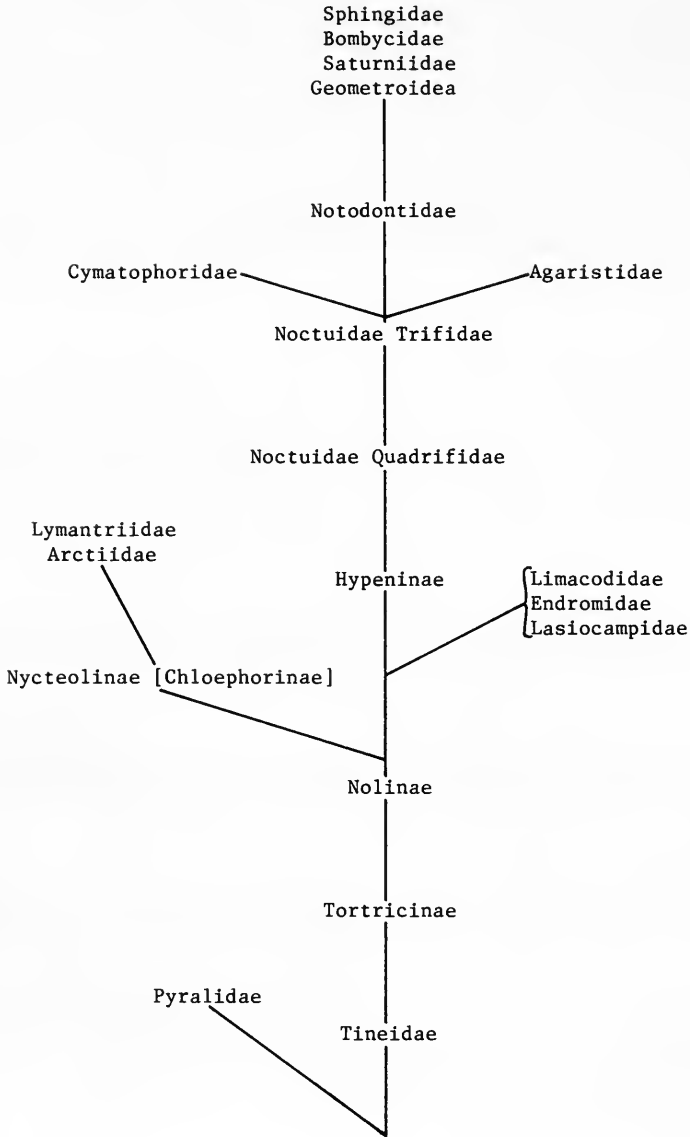

Fig. 1 Phylogeny of the higher Lepidoptera, with particular reference to the Noctuidae, proposed by Hampson (1893–5). Note that the Noctuidae are placed internally on the main stem leading from the tortricines to the geometroids and sphingids, while the arctiids form the terminus of a side-branch that splits off from the main stem below the noctuids.

[unstated] larval characters, he elevated part of the Apatelini to family status (Grote, 1895a) but continued to place them at the head of the Noctuidae. The Apatelidae, in addition to *Acronicta* and its relatives, also included *Leptina* [Baileya] (a sarrothripine), *Raphia* (an ophiderine), three pantheines (*Demas* [Colocasia], *Panthea* and *Charadra*) and three cuculliines (*Feralia*, *Arthrochlora* [Feralia] and *Momaphana* [Momophana]).

The Noctuidae became the Agrotidae on the grounds that the name *Noctua* was preoccupied in the birds. This began a long argument as to the correct family-group name for the noctuids. The subfamilies Catocalinae and Deltoidinae were not discussed in this paper (Grote, 1895a) but the remaining group (= Noctuinae) was divided into 24 tribes (Table 7), as follows.

**Table 7** The classification of the Agrotidae [Noctuidae] followed by Grote (1895*a, b*). The first publication dealt with the tribes up to and including the Hyblaeini, the second considered the subfamily Catocalinae.

---

THYATIRIDAE
APATELIDAE
AGROTIDAE
Agrotinae
Jaspidiini
Agrotini
Psaphidini
Hadenini
Bellurini
Nonagriini
Heliophilini
Scolecocampini
Balsini
Caradrinini
Orthosiini
Cleophanini
Cuculliini
Euteliini
Anomiini
Litoprosopini
Plusiini
Calpini
Stiriini
Heliiothini
Acontiini
Cerathosiini
Eustrotiini
Hyblaeini
Catocalinae
Euclidiini
Melipotini
Eulepidotini
Stictopterini
Ascalaphini
Catocalini
Ophiderini
Toxocampini
Thysaniini
Pheocymini
Pangraptini
Hexerini
Boletobiini

---

Jaspidiini. This tribe of seven genera (the Bryophilinae of Grote, 1883) had been excluded from the Apatelidae when this was raised to family rank. The name was based upon *Jaspidia* Hübner [1806], which Grote (1895*a*) had substituted for *Bryophila* Treitschke 1825.

Agrotini. The large genus *Agrotis* and four smaller genera (*Anytus* [*Sutyna*], *Richia*, *Eucoptocnemis*, *Agrotiphila*) constituted this tribe, which thus approximated the Agrotini of Grote (1890). The following were transferred out: *Adita* (Hadenini), *Copablepharon* (Heliiothini), *Ufeus* and *Pteroscia* [*Anomogyna*] (both Heliophilini).

Psaphidini. This was the Dicopini of Grote (1890).

Hadenini. Equivalent to the Hadenini of Grote (1890), the genera of this tribe had undergone considerable rearrangement and renaming.

Bellurini. This was the Arzamini of Grote (1890).

Nonagriini. This tribe now contained only the first five genera (*Nonagria* – *Tapinostola*) of the tribe of the same name in Grote (1890).

Heliophilini. The remaining three nonagriines (*Ommatostola*, *Heliophila* [*Mythimna*] and *Zosteropoda*), together with *Ufeus* and *Pteroscia* [*Anomogyna*], constituted this new tribe.

Scolecocampini. There had been no change from the Scolecocampini of Grote (1890).

Balsini. This was the Nolaphanini of Grote (1890).

Caradrinini. This tribe was essentially unchanged from the Caradrini of Grote (1890). However, *Monodes* [*Elaphria*] had been transferred to the Nonagriini (and sunk to *Platysenta*).

Orthosiini. This tribe was equivalent to the combination of the Orthosiini and Calocampini of Grote (1890).

The remaining 13 tribes were unchanged from Grote (1890) although the Tarachini had been renamed the Acontiini and lost *Trileuca* [*Schinia*, part] to the Orthosiini.

### Smith on the deltoids

Smith (1895), in his revision of the deltoids, recognised this group of moths to be devoid of exclusive defining characters, although the general facies was relatively distinctive. As restricted by him, Smith considered that the group might merit subfamily rank within the noctuids. However, he refrained from formally proposing such a grouping. Three (to Smith) very distinct tribes were included: the Heliini (*Epizeuxis* only), the Herminiini and the Hypenini. Two genera were excluded, *Pseudorgyia* and *Rivula*, both of which are now considered as ophiderines. Smith also felt that the assignment of the latter to the Nycteolidae [*Sarrothripinae*] might not have been the error most previous workers had considered it to be.

### Grote on the deltoids (and other noctuid groups)

Grote (1895*b*) considered that no stable classification could ever be achieved for the Noctuidae until the North American and European faunas were studied together. In a paper written as a conclusion to that of 1883, many of his ideas concerning noctuid classification were expanded and reinterpreted.

The Thyatiridae were omitted, support being drawn from Dyar's work on larvae, which showed the group to be structurally related to the Geometridae and Platypterigidae [*Drepanidae*]. The noctuid moths, therefore, consisted of three families, the Apatelidae, Agrotidae and Brepidae.

**Agrotidae: Agrotinae.** *Harrisimemna* was removed from the Jaspidiini and placed in the Apatelidae, while *Raphia* was moved from the latter group to the Hadenini. Grote postulated a relationship between *Raphia* and *Episema* [*Diloba*] although he had not examined the European species of those genera.

The Calocampini was resurrected but only contained *Lithomia* [*Lithomoia*] and *Calocampa* [*Xylena*]. *Lithophane* remained in the Orthosiini.

*Pyrophila* [*Amphipyra*] was removed to a monobasic tribe, the Pyrophilini. Grote agreed with Smith's placement of *Pseudorgyia* in the Scolecocampini, but having failed to find a satisfactory position for *Rivula* (he could not place it in either the Nycteolidae [*Sarrothripinae*] or the Pseudoipsidae [*Chloephorinae*]), Grote was forced to erect a new tribe to receive it, the Rivulini.

**Agrotidae: Catocalinae.** Thirteen tribes were recognised in this subfamily (Table 7).

Euclidiini: a mixture of eleven genera of catocalines and ophiderines (e.g. *Parallelia*, *Drasteria*, *Phurys* [*Ptichodis*], *Poaphila* [*Argyrostromis*]).

Melipotini: Grote included six genera in this tribe (e.g. *Hypocala*, *Melipotēs* [*Bolina*]), all of which are now ophiderines. He considered the distinction between this tribe and the last to be difficult.

Eulepidotini: *Eulepidotis* and *Palindia* [*Eulepidotis*] [Ophiderinae].

Stictopterini: *Stictoptera* and *Magusa* (the latter now an amphipyrene).

Ascalaphini: ten genera constituted this tribe, of which most are now ophiderines but *Remigia* is a catocaline, *Argillophora* an acontiine and *Fagitana* an amphipyrene.

Catocalini: *Allotria*, *Andrewsia* [*Catocala*, part] and *Catocala* [Catocalinae].

Ophiderini: *Ophideres* [Ophiderinae] and *Euparthenos* [Catocalinae].

Toxocampini: *Toxocampa* [*Lygephila*] and *Eutoreuma* [*Isogona*] [Ophiderinae].

Thysaniini: *Erebus* [*Ascalapha*] [Catocalinae], *Thysania* and *Letis* [Ophiderinae].

Pheocymini: this tribe was relatively large, containing 12 genera (e.g. *Zale*, *Yrias* [*Metria*]), of which four are now placed in the Ophiderinae and the remainder in the Catocalinae.

Pangraptini: *Phalaenostola* [Hypeninae], *Zethes*, *Syllectra* and *Pangrapta* [Ophiderinae].

Hexerini: this tribe contained only *Hexeris* [*Triprora*], now classified in the family Thyrididae.

Boletobiini: of the four included genera, two (*Boletobia* [*Parascotia*] and *Aventia* [*Laspeyria*]) are ophiderines, *Acherdoa* is an amphipyrene and *Dyaria* [*Coenodomus*] is placed in the pyralid subfamily Epipaschiinae.

**Agrotidae: Hypeninae.** Grote considered the subfamily name, Deltoidinae, which he had proposed himself in 1890, to be objectionable because it was not based upon any included genus. He thus substituted Hypeninae. Two of Smith's three tribes were retained, the Heliini being considered insufficiently distinct from the Herminiini to warrant separate status.

### The position of *Nycteola*

The nycteolines had originally been placed among the tortricids but by the late nineteenth century were generally included in the Bombyces as a separate family, most commonly known as the Nycteolidae (e.g. Smith, 1891). Frequently, a group of genera including *Earias* and *Pseudoips* was also included, but more often these genera were placed in a distinct though related family, the Pseudoipsidae.

*Nycteola* had also been referred to the Noctuidae but as a deltoid. Grote (1895*b*) disagreed with this. Examination of the immature stages revealed similarities to *Pseudoips* [*Bena*] *bicolorana* [*prasinana*] but peculiarities in the wing shape and venation led Grote to believe that *Nycteola* did not belong in either the Pseudoipsidae [Noctuidae: Chloephorinae] (which Grote recognised as distinct) or the Noctuidae.

A study of the larval chaetotaxy of *Nycteola* by Dyar, which was communicated by Grote, bore out the latter's opinions regarding the close relationship between this genus and the Pseudoipsidae, and even suggested that the two groups might not be distinct. However, Grote retained the family rank of the Nycteolidae.

Hampson (1893–5) considered the nycteolines to be a subfamily of the arctiids, closely related to the Nolinae and this postulated relationship was to recur later.

### The three classifications

By 1900, there were three main arrangements of the noctuid genera in use, those of Grote, Hampson and Tutt.

Grote's classification was the only one not based upon the families of Guenée, groups that Grote still maintained had no value. The use of his classification was largely confined to North America.

Hampson's classification was a less well-resolved version of Guenée's. It was followed without alteration by Leech (1900) while Staudinger & Rebel (1901) modified it slightly. They reintroduced the Acronyctinae, with the usual constituent genera – *Panthea*, *Trichosea*, *Moma*, *Demas* [*Colocasia*], *Acronycta* [*Acronicta*], *Simyra*, etc. – but retained *Bryophila* [*Cryphia*] in the Trifinae. The latter subfamily was expanded to include the Acontiinae and Euteliinae of Hampson. With no European representative, the Palindiinae and Stictopterinae were not considered. The Sarrothripinae were united with the chloephorines (e.g. *Earias*) and placed in a separate family, the Cymbidae, between the Nolidae and the Syntomidae [Arctiidae: Ctenuchinae]. Thus, where the sarrothripines were concerned, Staudinger & Rebel chose to accept Dyar's conclusions. The Gonopteridae and Deltoidinae were retained while the Focillinae were included in the Quadrifinae.

Whereas the other two systems had undergone only minor alterations, Tutt (1902) introduced considerable changes into his classification of the Noctuidae (Table 8).

**The Noctuides.** Despite the opinions of Grote and Hampson, Tutt still clung to the earlier ideas regarding the evolution of the noctuids. The Deltoides were considered to be the most primitive group from which at least two independent lines had evolved. One of these lines proceeded through the Minores, Genuinae and Bombycoidea to the Arctiidae and Lyman-

**Table 8** The classification of the Noctuidae followed by Tutt (1902). It represents a modified version of Guenée's second classification.

---

Family: 1 Bombycoidea
Family: 2 Noctuidae
Subfamily: 1 Noctuinae
Tribe: 1 Leucaniidi
2 Agrotidi
Subfamily: 2 Caradrinae
Tribe: 1 Stilbidi
2 Caradrinidi
Subfamily: 3 Amphipyriinae
Subfamily: 4 Apameinae
Tribe: 1 Nonagriidi
2 Apameidi
3 Carpocapsidi
4 Bryophilidi
5 Hadenidi
Subfamily: 5 Orthosiinae
Tribe: 1 Orthosiidi
2 Cosmiidi
Subfamily: 6 Calocampinae
Tribe: 1 Xylocampidi
2 Calocampidi
3 Cuculliidi
Subfamily: 7 Heliotionae
Subfamily: 8 Plusiinae
Family: 3 Acontiidae
Subfamily: 1 Acontiinae
Subfamily: 2 Erastrinae
Subfamily: 3 Anthophilinae
Family: 4 Catocalinae
Subfamily: 1 Catocalinae
Family: 5 Aveniidae
Family: 6 Phalenidae
Family: 7 Euclididae
Family: 8 Poaphilidae

---

triidae, while the other passed through the Catocalinae to the geometrids. The Geometridae were therefore highly evolved noctuids.

**Bombycoidea.** Tutt considered that the larvae of this group resembled the Arctiidae and Liparidae [Lymantriidae] and that these families may therefore have evolved from bombycoid stock. Following Grote, rather than Hampson, Tutt accorded this group family status.

**Noctuidae.** This family was essentially the equivalent of Guenée's Genuinae but with the addition of the Bryophilini, Stilbidi, Amphipyridae and Plusiinae. Eight subfamilies were recognised.

**Noctuinae.** Although Tutt divided the subfamily into three tribes (Leucaniidi, Agrotidi and Noctuidi), he treated the genera of the last two together as the Agrotidi. The Leucaniidi contained the hadenine wainscots and the Agrotidi coincided for the most part with the present Noctuinae.

**Caradrininae.** Two tribes of small inconspicuous moths formed this subfamily. The Stilbidi included *Stilbia*, *Hydrilla* [*Hydrillula*] and their relatives, while the Caradrinini included such genera as *Laphygma* [*Spodoptera*, part].

**Amphipyridae.** This tribe contained only two species, *Amphipyra pyramidea* and *A. tragopogonis*, characterised by their ability to secrete themselves into narrow crevices.

**Apaminae.** Tutt considered this family to have been 'wonderfully muddled by British authors'. He recognised the superficial similarities between the Nonagriidi and the Leucaniidi (Noctuinae) as convergent. Five tribes were included.

The Nonagriidi consisted of those wainscots with stem-boring larvae.

The Apameidi were dull-coloured and had larvae that were either root-borers or fed on low plants, often on their roots (e.g. *Gortyna*, *Xylophasia* [*Apamea*] and *Miana* [*Oligia*]). Most are now amphipyridae but there are some hadenines and noctuines.).

The Carpocapsidi (*Dianthoecia* [*Hadena*]) were distinguished by the larvae feeding exclusively on the seed-capsules of the Caryophyllaceae.

Tutt removed *Bryophila* [*Cryphia*] from its usual place near *Acronicta* and placed it in a separate tribe in the Apameinae, the Bryophilidi. He considered *Bryophila* to be a hadenoid genus, related to *Hecatera* [*Hadena*].

The last tribe of this group, the Hadenidi, was one that had been merged with the Apameidi by other authors but which many British lepidopterists thought deserved family rank. Tutt concurred with the former, being unable to find any significant distinction between the two groups, but he nevertheless retained the Hadenidi as a separate entity. Included were amphipyridae, cuculliines, and hadenines.

**Orthosiinae.** The moths that comprised this subfamily were characterised by being on the wing either very late or very early in the year. Two tribes were recognised.

The Orthosidi was a mixed bag of genera, with representatives from the present Hadeninae (e.g. *Taeniocampa* [*Orthosia*]), Cuculliinae (e.g. *Xylina* [*Lithophane*]) and Ophiderinae (*Gonoptera* [*Scoliopteryx*]).

The second tribe, the Cosmidi, was distinguished from the last by the larval habit of spinning leaves together. All are now placed in the Amphipyridae and include such genera as *Dicycla* and *Calymnia* [*Cosmia*].

**Calocampinae.** Tutt followed Grote (1895*b*) by separating *Xylina* [*Lithophane*] from the other genera previously placed in the 'Xylininae'. The remaining group was termed the Calocampinae and consisted of three tribes: the Xylocampidi (*Xylocampa*), the Calocampidi (*Calocampa* [*Xylena*] and *Lithomia* [*Lithomia*]) and the Cuculliidi (*Cucullia*).

**Heliiothinae.** The moths of this subfamily were characterised by the generally diurnally-active, colourful adults and flower-feeding larvae. All the British species currently assigned to the Heliiothinae were included, together with the hadenine *Anarta* and the amphipyryne *Heliaca* [*Panemeria*].

**Plusiinae.** Tutt now considered this subfamily to be a highly-developed group of heliothines. The reduction in the number of larval prolegs (which also occurs in other groups of noctuids) was explained as the result of convergent evolution. Only the species currently placed in this subfamily were included. Its position in the Trifidae agreed with Grote's system rather than with Guenée's.

**Acontiidae.** This family was believed by Tutt to be closely related to the Deltoides, from which they might have arisen. Three subfamilies were recognised.

The Acontiinae contained *Agrophila* [*Emmelia*] and *Acontia* [*Tyta*]. *Erastria* [*Lithacodia*, *Elaphria*] and *Banksia* [*Eustrotia*] comprised the Erastrinae while the Anthophilinae contained *Hydrelia* [*Eustrotia*] and *Thalpochares* [*Eublemma*]. All except *Tyta* (Ophiderinae) and *Elaphria* (Amphipyrynae) are currently acontiines.

**Geometriform noctuids.** At this point in the family, Tutt's nomenclature and ranking broke down, mainly because the groups concerned were poorly represented in the British fauna. Nevertheless, he considered the British species could still give some indications as to the evolutionary history and development of the Geometridae. The families discussed below, together with the Trifidae, were considered to have all arisen independently from the deltoids.

**Catocalidae.** Only one subfamily, the Catocalinae, was represented in Britain. This was the group Tutt considered to be closest to the geometrids, a relationship he thought was more obvious in certain exotic groups than in the single British genus, *Catocala*.

**Aventiidae.** This family contained only *Aventia* [*Laspeyria*] *flexula* and was erected because Tutt was unable to determine the nearest relatives of the species. The larvae have only three pairs of prolegs ('like some geometers') and a lateral row of fleshy filaments above the prolegs as in *Catocala*. The adult is deltoid in its general facies.

**Phalenidae.** Tutt retained this name for the family in preference to Brepidae. He interpreted the group as either being at a point early in the geometrid line of evolution or an isolated lineage, having undergone considerable parallel evolution with the Geometridae.

**Serpentides.** This group consisted of two families. The Euclididae contained the single genus *Euclidia* [*Euclidia*, *Callistege*], with larvae that Tutt considered to be 'remarkably geometri-form'. He did not comment on the second family, the Poaphilidae, with its single species, *Prothymia* [*Phytometra*] *viridaria*. The former family is now part of the Catocalinae, the latter part of the Ophiderinae.

**Deltoides.** Tutt interposed the Geometridae between this group and the Noctuidae. He considered the Deltoides as a group, but not the individual species, to be ancestral to the other noctuid families. Three deltoid families were recognised.

**Toxocampidae.** This was a group of moths (*Toxocampa* [*Lygephila*] and *Ophiodes* [*Minucia*]) which Tutt considered to be essentially deltoid, but that also had certain affinities with the noctuids. Tutt was probably the only lepidopterist to associate these genera with the deltoids. At present, the former genus is ophiderine, the latter catocaline.

**Hypenidae.** Five genera (*Madopa* [*Cclobochyla*], *Hypena*, *Bomolocha*, *Hypenodes* and



*Thylomiges* [*Tholomiges*]) comprised this family. Of these, the last four are still hypenines, while the first is placed in the Ophiderinae.

**Herminiidae.** This family was divided into two subfamilies: the monobasic Rivulinae (*Rivula*, now an ophiderine) and the Herminiinae, a group of three genera (*Hermina* [*Zanclognatha*, *Paracolax*], *Zanclognatha* and *Pechipogon* [*Herminia*]), commonly referred to as the 'fan-foots'.

**Miscellanea.** The Nolidae were considered to be related to the lithosiine arctiids, whilst the Nycteolidae [?Chloephorinae, ?Sarrothripinae] were a 'very highly developed group which has evidently been evolved from the Plutellidae or the Tortrices'.

*Demas* [*Colocasia*] *coryli* was placed in the Lymantriidae, while *Diloba caeruleocephala* was classified in the notodontid subfamily, Dilobinae. Also placed in a subfamily of the Notodontidae (as the Asterocopinae) were the two species of *Asterocopus* [*Brachionycha*]. Although noctuids according to virtually all previous authors, Tutt found it difficult to consider them as true noctuids despite their being 'undoubtedly closely allied'.

The Cymatophoridae [Thyatiridae] were considered to be equally closely allied to the Notodontidae and the Noctuidae (cf. Fig. 1).

These then were the three main systems for classifying the noctuids in use at the beginning of the twentieth century. However, in the period since the publication of *The Fauna of British India*, Hampson had also reassessed the interrelationships of the noctuid genera. This culminated in the publication of a system that was to become almost universally accepted and, in the long term, put the higher systematics of the Noctuidae into virtual stasis.

#### *Demas* [*Colocasia*] *coryli* – noctuid or lymantriid?

Before proceeding with Hampson's second classification, I shall return to the early 1890s to consider, in more detail, the controversy that surrounded the position of *Demas* [*Colocasia*] *coryli*.

Chapman (1893a) suggested that *Demas* should be returned to the family Liparidae [Lymantriidae], basing his conclusions upon the eggs, larvae and pupae. He also associated *Panthea coenobita* and *Diphthera* [*Trichosea*] *ludifica* with *Demas*, a group that was eventually to form part of the subfamily Pantheinae (see below).

Tutt (1895) criticised Smith (1893) for retaining *Demas* in its 'obsolete position . . . among the Noctuae', preferring to place the genus in the Lymantriidae.

Dyar (1895b) disagreed, drawing support from the studies of Poulton (1887). An investigation of the larvae of several Liparidae [Lymantriidae] had demonstrated the presence of dorsal eversible glands on abdominal segments 7 and 8 (more rarely on 8 only) in all species examined except *Demas*. If these structures proved characteristic of the family, then *Demas* had to be excluded. Dyar (1895a) had also found chaetotactic differences between the Noctuidae and the Lymantriidae, and showed that *Demas* conformed to the noctuid type. In addition, he (1895b) considered the adult to be more similar to the Noctuidae than to any other family.

Tutt (1896) replied to this, basing his conclusions upon the work of Chapman (1893a, b), then shortly afterwards, retired from the debate, having felt he had made his point. It thus befell Dyar (1896) to continue to press for the inclusion of *Demas* in the Noctuidae, by a reanalysis of Chapman's findings.

The eggs of *Demas* are vertically ribbed as in other noctuids, rather than obscurely ribbed or smooth as in the Lymantriidae. Chapman used characters such as the length and density of the setae, the form of the tubercles, especially the anterior trapezoidal (D1 sensu Hinton, 1946), and the colour. Dyar dismissed the first and last of these as being too likely to be subject to convergence while he suggested Chapman had been mistaken regarding the tubercle. In fact, *Demas* shows the strong tubercle of the noctuids rather than the condition found in the lymantriids, in which it is reduced or lost.

Dyar disputed Chapman's interpretation of homology between the dorsal glands of lymantriid

larvae and the mid-dorsal depressions found in *Demas*. To Dyar, the general facies of the larva of *Demas* was, if anything, arctiid rather than lymantriid. Overall, he concluded that Chapman's study supported the inclusion of *Demas* in the Noctuidae and not the Lymantriidae.

Grote (1896) followed Dyar, retaining *Demas* (as well as several other genera now considered to be pantheines) within the group he called the Apatelidae. However, no good adult character was given to differentiate the group from the Noctuidae and the larval characters upon which the Apatelidae was based were insubstantial.

Smith & Dyar (1898), using the conclusions reached previously by the latter author, restricted the family to include only *Demas*, *Panthea*, *Charadra*, *Harrisimemna*, *Merolonche*, *Arsilonche* [*Simyra*], and *Acronycta* [*Acronicta*]. *Raphia* and *Feralia* were rejected on larval characters, *Momophana* and *Moma* on adult characters. Of these four, the first is now an ophiderine, the next two cuculliines and *Moma* an acronictine.

Two series were recognised by Smith & Dyar. The first, the Pantheini, contained only *Demas*, *Panthea* and *Charadra* and was distinguished primarily by a quadrifine hindwing venation. Other characteristic features included hairy eyes, pectinate male antennae and a similar facies and pattern. *Raphia* also possessed these features although the hairs on the eyes are microscopic and the male genitalia are distinct. *Raphia* could not be placed satisfactorily and was therefore omitted from the Apatelidae.

The second series, the Acronyctini, consisted of the residual apatelid genera. It was characterised by a trifine hindwing venation. As this is also found in several other subfamilies, only the distinct larvae allowed Smith & Dyar to maintain the Acronyctini as a separate entity. In contrast, the Pantheini was a very distinct group of moths as adults, resembling the Acronyctini only in the larval stage. Smith & Dyar concluded that there was no real basis for a continued association between the two groups, as far as the adults were concerned. The two tribes were nevertheless collected into the noctuid subfamily Pantheinae.

The position of *Demas* in the Noctuidae was consolidated by the works of Staudinger & Rebel (1901) and Hampson (1898–1913). Only Tutt (1902) continued to regard the genus as a lymantriid.

## Development of the Hampsonian monolith

### The precursor

During the latter part of the 1890s, Hampson had been reappraising the classification of the Noctuidae. The new system, which appeared in part in Hampson (1900), was given in full in Hampson (1902).

A close relationship was still postulated between the Arctiidae [Arctiidae], Agaristidae [Noctuidae: Agaristinae] and the Noctuidae, and additionally, the Syntomiidae [Arctiidae: Ctenuchinae]. All these families agreed in having forewing vein  $M_2$  approximating the lower angle of the discal cell. This character was also found in the Pterothysanidae, Lymantriidae [Lymantriidae] and Hyspidae [Arctiidae: Aganainae] and defined what Hampson termed the 'Noctuid group of families'. This grouping largely agrees with the present superfamily Noctuoidea (if one accepts the Notodontoidea as separate). The only exception to this is the Pterothysanidae, which is now placed in the Geometroidea, although the sole species considered by Hampson, *Pterocerota virginea*, may possibly be a eupterotid (R. Carcasson, manuscript note).

Hampson (1902) did not detail the reasoning behind his new system. The characters used to separate the subfamilies were given in a key (Table 9) and were based upon those of Lederer and Grote, although employed in a novel fashion.

The Agrotinae [Noctuinae] also included some of the species currently referable to the Heliothinae (e.g. *Melicleptria* [*Heliothis*]). The other trifine subfamilies were the Mamestrinae [Hadeninae], Poliana [Cuculliinae] and Caradrinae [Acronictinae + Amphipyrrinae].

The quadrifine subfamilies comprised the Eutelinae [Euteliinae], Stictopterinae, Sarrothripinae, Acontianae [Chloephorinae], Homopterinae [Catocalinae], Mominae [Pantheinae], Plusinae [Plusiinae], Noctuinae [Ophiderinae] (and the chloephorine, *Earias*), Erastianae

**Table 9** Key to the subfamilies of the Noctuidae recognised by Hampson in his second classification of the family (modified from Hampson, 1902).

1	Maxillary palps absent .....	2
–	Maxillary palps present .....	<b>Hyblaeinae</b>
2	M <sub>2</sub> hindwing obsolescent, crossveins m <sub>1</sub> –m <sub>2</sub> and m <sub>2</sub> –m <sub>3</sub> subequal .....	3
–	M <sub>2</sub> hindwing well-developed .....	6
3	Mid- and hind-tibiae spined .....	<b>Agrotinae</b>
–	Mid- and hind-tibiae not spined .....	4
4	Eyes hairy .....	<b>Mamestrinae</b>
–	Eyes not hairy .....	5
5	Eyes with long, overhanging cilia .....	<b>Polianae</b>
–	Eyes not ciliated .....	<b>Caradrininae</b>
6	Hindwing M <sub>2</sub> approximated to M <sub>3</sub> at base .....	7
–	Hindwing M <sub>2</sub> parallel to M <sub>3</sub> .....	<b>Hypeninae</b>
7	Female frenulum simple .....	8
–	Female frenulum multiple .....	9
8	Lateral abdominal hair pencils present near anus .....	<b>Eutelinae</b>
–	Hair pencils absent, forewing with tufts of raised scales in cell .....	<b>Stictopterinae</b>
9	Male retinaculum bar-shaped .....	10
–	Male retinaculum not bar-shaped .....	11
10	Forewing with tufts of raised scales in cell .....	<b>Sarrothripinae</b>
–	Forewing without tufts of raised scales in cell .....	<b>Acontianae</b>
11	Midtibiae spined .....	<b>Homopterinae</b>
–	Midtibiae not spined .....	12
12	Eyes hairy .....	<b>Mominae</b>
–	Eyes not hairy .....	13
13	Eyes with long, overhanging cilia .....	<b>Plusianae</b>
–	Eyes not ciliated .....	14
14	Hindwing M <sub>2</sub> strong, from close to lower angle of cell .....	<b>Noctuidae</b>
–	Hindwing M <sub>2</sub> rather weak, from well above lower angle of cell .....	<b>Erastrinae</b>

[Acontinae] (and several amphipyrids, e.g. *Cnodifrontia* and *Callopietria*) and Hypeninae.

Hampson retained the name *Noctua* but applied it to the ophiderine *Noctua strix* [*Thysania agrippina*]. This was the first species listed by Linnaeus (1758) in the 'genus' *Noctua* and so was designated the type-species, following Hampson's personal rule (that is, the first listed species when the genus was described; McDunnough, 1916). Thus, the group then currently known as the Noctuidae was termed the Agrotinae.

### Hampson's Catalogue

The basic system of subfamilies was unchanged in Hampson's major work, the monumental *Catalogue of the Lepidoptera Phalaenae in the British Museum* (1898–1913). (Subsequent references to the Hampsonian system, unless qualified, refer to that proposed in this work.) The scheme of the phylogeny of the Lepidoptera as a whole had undergone some rearrangement from that published in *Fauna of British India*. The relevant parts of this new phylogenetic tree are shown in Fig. 2.

The major difference between Figs 1 and 2 is that, in the latter, the Noctuidae and related families were considered as terminal on the main stem, rather than being intermediate stages of development culminating in the Geometroidea. The relationship between the Noctuidae and Geometridae, as espoused by Tutt (1902), was thus rejected. The subgroups of the noctuids are discussed in detail below.

**Volume 2 – Arctiadae: Nolinae [Noctuidae: Nolinae].** The nolines were retained by Hampson as a subfamily of the Arctiadae [Arctiidae]. They were considered to have arisen from very early arctiid stock, close to the noctuids *Hypena* and *Sarrothripus* [*Nycteola*] (with which they share the character of tufts of scales in the forewing cell). The similarity between the cocoons of the

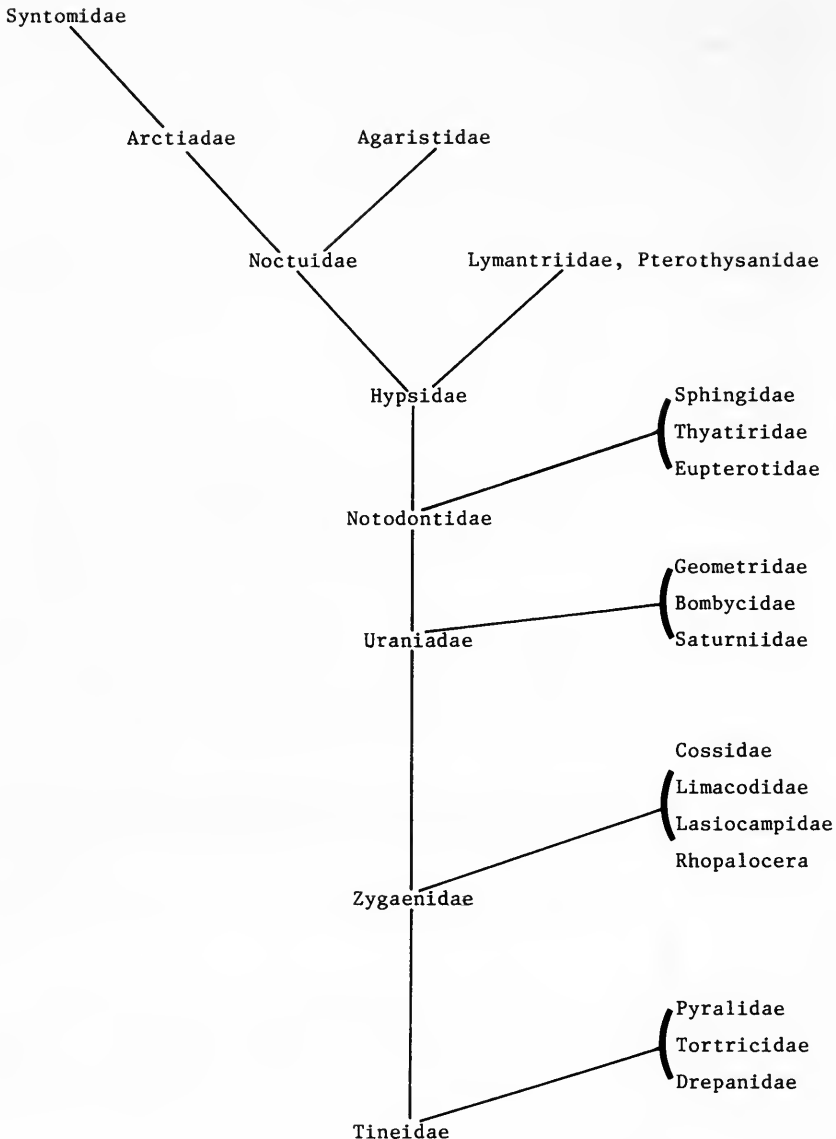

Fig. 2 Phylogeny of the higher Lepidoptera, with particular reference to the Noctuoidea, proposed by Hampson (1898–1913). There are several important differences from the previous phylogeny (Fig. 1). The noctuoid families are now considered to be terminal on the main stem and the arctiids are derived from the noctuids. In addition, the notodontids are now ancestral to the noctuids (the reverse relationship was postulated in Fig. 1). (Redrawn from Hampson, 1898–1913, 1: 16.)

nolines and certain sarrothripines and chloephorines was also noted. Hampson excluded the latter two groups from the Arctiidae, considering them better placed in the Noctuidae because of the presence of ocelli and the free origin of hindwing vein  $Sc + R_1$ .

**Volume 4 – Noctuidae: Agrotinae [Noctuinae].** This subfamily was characterised by a trifine hindwing venation and spined hind (and occasionally mid-) tibiae. Some species also had hairy or lashed (ciliated) eyes, characters of the Hadeninae and Cuculliinae respectively. This highlights a peculiar feature of the classificatory process as employed by Hampson. The major

(key) characters were treated as hierarchical. Thus, any trifine species with spined tibiae was placed in the Agrotinae irrespective of whether it also had the defining characteristics of the other subfamilies. Of the remaining species, any with hairy eyes were hadenines, though some also had lashed eyes. The cuculliines were those of the remainder with lashed eyes, while the residue, with none of these characters were, by default, acronyctines [Acronictinae + Amphipyridinae]. A similar but less hierarchical principle applied within the quadrifines.

This method of allocating genera to subfamilies can thus be seen to be arbitrary in those instances in which two or more characters conflict, due to the arbitrary order in which the key characters were ranked. Many of the species were misplaced (as considered by recent works) and it was from this realisation that the dissatisfaction with the system largely grew.

The Agrotinae contained two groups of genera corresponding to the present Noctuinae and Heliolithinae (less the pyrhrine amphipyridines).

**Volume 5 – Hadeninae.** This group corresponded to the Mamestrinae of Hampson (1902). The included genera were hairy-eyed trifines with unspined tibiae, and a few (e.g. *Trichopolia* and *Stretchia*) also had lashed eyes.

**Volume 6 – Cucullianae [Cuculliinae].** This trifine subfamily, previously referred to by Hampson (1902) as the Polianae, was characterised by bare, lashed eyes and unspined tibiae. In addition, many of the species appear as adults in the autumn or early spring, sometimes hibernating.

**Volumes 7–9 – Acronyctinae [Acronictinae + Amphipyridinae].** This immense subfamily contained almost half of the then described genera of trifine noctuids. It was characterised by absences; no tibial spining and eyes devoid of hair and lashes. Hampson placed no special emphasis on the diverse hairy larvae of the acronictas, which were incorporated within the amorphous mass.

The Acronictinae were interpreted as the most primitive trifine subfamily from which the other three, together with the Agaristidae, had evolved as separate lineages.

**Volume 10 – Erastrinae [Acontiinae].** This subfamily was the first of the Hampson quadrifine groups. Most genera had a strongly developed hindwing vein  $M_2$ , approximated at the base to  $M_3$ , but some had an almost typical trifine venation (e.g. *Eupseudomorpha*, *Cydosia*, *Graeperia* [*Heliadora*], *Tarachidia*). The last three of these remain acontiines but the first is now considered to be an agaristine. Overall, the subfamily was homogeneous in general facies but not well defined structurally. In many ways, it was intermediate between the trifine and the remaining quadrifine subfamilies. The larvae of most of the genera had the first one or two pairs of prolegs reduced or missing.

**Volume 11 – Euteliana [Euteliinae].** Characterised by a quadrifine wing venation, simple female frenulum and the presence of anal hair tufts in the males, this subfamily was essentially similar to that in Hampson (1893–5). He now considered this subfamily to be a parallel development, with the Stictopterinae, from the Noctuinae [Ophiderinae].

**Volume 11 – Stictopterinae.** This subfamily had also undergone little change. Its constituent genera also possessed the reduced female frenulum but had tufts of raised scales in the forewing cell and lacked the euteliine anal hair pencils.

**Volume 11 – Sarrothripinae.** This group was characterised by a bar-shaped retinaculum in the male and by tufts of raised scales in the forewing cell. An exception was *Eligma*, a genus now placed in the Chloephorinae (see below and also Mell, 1943). The larvae of the Sarrothripinae are sparsely covered in long hair and pupate in a boat-shaped cocoon.

**Volume 11 – Acontiana [Chloephorinae].** Many genera of this subfamily also have a

bar-shaped retinaculum in the male. However, in *Earias*, *Tyana* and several other genera, this has been replaced by a tuft of hair. All are smooth-scaled except for *Cerala* [Kerala], which has slight scale tufts in the forewing cell. (Despite this, it was not placed in the Sarrothripinae, and still is not.)

The larvae of the Acontiinae, like those of the previous subfamily, have five pairs of prolegs and spin a boat-shaped cocoon on a twig, except for *Acontia* [*Xanthodes*], *Leocyma* and possibly *Armatica*, in which the larvae are semi-loopers and pupation takes place under-Hampson considered these genera might be better placed in the Erastrianae, which would then take the name Acontianae, whence the original Acontianae would become the Eariasinae.

**Volumes 12–13 – Catocalinae.** The Catocalinae was the first of two large sections into which Hampson divided the Quadrifinae of 1893–5. They were characterised by bare, unlashd eyes, normal frenulum and retinaculum, and spines on the mid-tibiae. Those Plusianae [Plusiinae] with spined tibiae could be distinguished by the presence of lashd eyes. However, Hampson did observe that many catocaline genera were closely allied to genera in the Noctuidae [Ophiderinae] and he considered it probable that either the Catocalinae were polyphyletic, with mid-tibial spines being multiply convergent, or that the Noctuidae were polyphyletic, characterised by multiple independent loss of spines. Either way, Hampson felt the two large subfamilies might have to be united as one large subfamily. Subdivision would then have to be on other grounds. Many of the larvae of the Catocalinae are semi-loopers, a feature Hampson considered to be convergent in this group and others such as the Plusianae [Plusiinae], Noctuidae [Ophiderinae] and Hypeninae.

**Volume 13 – Mominae [Pantheinae].** This subfamily was equivalent to the tribe Pantheini of Smith & Dyar (1898). Hampson considered hindwing venation to be a more important character than larval facies and so removed the group from its association with *Acronicta* and its allies to a place among the quadrifine subfamilies.

Hampson considered the Mominae to be very natural and well characterised with two exceptions. Of these, *Elydnodes* is still a pantheine. However, *Epicausis* was transferred to the Cuculliinae by Viette (1962). On the basis of male and female genitalia, he placed it between *Daphoenura* and *Eudaphaenura*, genera that *Epicausis* also resembles in colour pattern. Viette also found that Hampson's interpretation of the hindwing venation was incorrect, for although  $M_2$  is present, it is weaker than either  $M_1$  or  $M_3$ . However, Viette neglected the fact that *Epicausis* has distinctly hairy eyes (which the other two do not; Kitching, pers. obs.) and thus resembles a third genus, the hadenine *Adaphaenura*, which also has a colour-pattern similar to that of *Epicausis*. Viette characterised the Hadeninae and Cuculliinae as having hairy and lashd eyes respectively, yet still placed *Epicausis* in the latter. With the involvement of mimicry a distinct possibility, the position of *Epicausis* and its putative allies must still be considered unsettled. Viette (1973) retained the genus in the Cuculliinae, as did Nye (1975).

**Volume 13 – Phytometrinae [Plusiinae].** Using his personal rules for type-species designation mentioned earlier, Hampson considered it necessary to rename the group of moths that had been previously known generally as the Plusiinae. The subfamily consisted of those quadrifines with lashd eyes and included the monobasic genus *Diloba*, in addition to *Abrostola*, *Phytometra* [*Plusia* s.l., part] and their relatives. Apart from *Diloba*, which Hampson considered to be aberrant (for example, the larvae possessed five pairs of fully developed prolegs), the Phytometrinae were well circumscribed.

*Diloba* itself had been considered to be notodontid, acronictine or even thyatirid. Chapman (1893a) found the genus very difficult to place. The egg is macroscopically similar to *Acronicta*, but the sculpturing is different. The larvae of the two groups have little in common, while the pupal cremaster has a slight resemblance to *Bisulcia* [*Craniophora*] (Acronictinae). Overall, Chapman considered *Diloba* to be more bombycid than noctuid and suggested that it might require a family of its own.

Hampson, however, considered *Diloba* to be noctuid. Thus, because of a quadrifine hindwing venation and lashed eyes, it *had* to be placed in the Phytometrinae.

**Volumes [14–16] (unpublished) – Noctuidae [Ophiderinae].** The publication of the *Catalogue* was suspended during the First World War for financial reasons. When Hampson retired in 1920, he left the manuscript covering the subfamily Noctuidae [Ophiderinae] (Gahan, Preface to Hampson, 1926). It is from that manuscript that the following is taken.

The Noctuidae were quadrifine noctuids with bare, unlashd eyes, which were distinguished from the Catocalinae by the unspined tibiae, and from the Polypogoninae [Hypeninae] by the third segment of the labial palp not being acuminate (most genera) and by hindwing vein  $M_2$  being approximated to the lower angle of the cell. The labial palp segment three was always acuminate in the Polypogoninae while  $M_2$  arises well above the lower angle of the cell and runs parallel to  $M_3$  (except in the *Mastigophorus*-group).

The larvae all move in semi-looper fashion, even if all the prolegs are present (except for *Raphia*, whose affinities are open to question).

**Hypeninae and Hyblaeinae.** Hampson never dealt with these groups, the last two subfamilies of the Noctuidae as he conceived it (see Table 9).

The system proposed in Hampson's *Catalogue*, albeit unfinished, was to exert a profound influence on the higher classification of the Noctuidae and is still generally accepted today. But it is possible that it too might have gone down in history as just another arrangement, were it not for its acceptance and usage by the authors of Seitz' *Die Gross-Schmetterlinge der Erde*. This, more than anything else, was responsible for confirming the primacy of Hampson's classification in noctuid systematics.

### Seitz' *Die Gross-Schmetterlinge der Erde*

The publication of the parts of this huge work that dealt with the Noctuidae spanned the years 1906 to 1944 and they were written by five authors – Jordan, Warren, Gaede, Draudt and Seitz himself.

**Volume 3 – Fauna Palaearctica: Agaristidae (Jordan).** Jordan (1906–14) followed Hampson in allying the Agaristidae [Noctuidae: Agaristinae] with the Noctuidae, considering them as merely 'day-flying Noctuidae which have preserved some generalised characters, being in other respects more spezialized [sic] than the Noctuids'. This interpretation was also espoused by Draudt (1919–44, Fauna Americana) and by Jordan & Gaede (1919–39, Fauna Africana). Originally the agaristines were placed at the head of the Bombyces, as a result of Linnaeus' (1758) opinion that antennal shape (i.e. clubbed) was of primary importance in the classification of the Noctuidae (Seitz, 1909).

**Noctuidae (Warren).** For convenience, Warren (1906–14) initially adhered to the five subfamilies used by Staudinger & Rebel (1901). The only change Warren introduced was to use the terms 'Trifidinae' and 'Quadrifidinae' for 'Trifinae' and 'Quadrifinae' respectively, because he considered the syllable 'fid' to be an integral part of the word upon which the name was based and not part of the family ending 'idae'.

With the publication of the first noctuid volume of Hampson's *Catalogue*, Warren chose to follow the new system as closely as possible but employing as few changes as possible also. As a result, complete correspondence with Hampson's subfamilies was not achieved (Table 10).

The Acronictinae, which also included the Pantheinae, was recognised as heterogeneous in wing venation but was accepted on the grounds that the included species had hairy larvae, which feed exposed, and that pupation takes place in a cocoon above ground.

The Metachrostinae, equivalent to the Bryophilidi of Tutt (1902), included only *Metachrostis* [*Cryphia*]. For the remaining noctuids, Warren thought it generally advisable to follow Hampson's arrangement.

**Table 10** Sequence of noctuid subfamilies adopted by Warren (1906–14) in Seitz' *The Macrolepidoptera of the World*.

## NOCTUIDAE

Acronictinae  
 Metachrostinae  
 Euxoinae  
 Hadeninae  
 Cucullianae  
 Amphipyridae  
 Melicleptinae  
 Heliiothidinae  
 Erastrinae  
 Eutelinae  
 Stictopterinae  
 Sarrothripinae  
 Acontinae  
 Catocalinae  
 Phytometrinae  
 Noctuinae

The Agrotinae was renamed the Euxoinae, for unstated reasons. The Hadeninae and Cucullianae [Cuculliinae] were unaltered, while the Amphipyridae represented the residue of Hampson's 'Acronyctinae' after removal of the Acronictinae (s.str.) and the Metachrostinae.

The Melicleptinae, roughly equivalent to the present Heliiothinae, was composed primarily of those triline genera with curved fore-tibial claws.

The next subfamily, the Heliiothidinae, has no modern equivalent. The genera that comprised it were characterised by small, reniform eyes (although Meyrick, 1912, regarded them as being more correctly termed ovate), a distinctly hairy vestiture and a primarily arctic-alpine distribution. Six unnamed divisions were recognised.

- I. *Anartomorpha*. This genus combined the noctuid spined tibiae with the hadenine hairy eyes. Following Hampson's character hierarchy, it is currently placed in the Noctuinae (although it is treated as a hadenine, near *Anarta*, in the BMNH collection).
- II. *Schoyenia*, *Orosagrotis* [*Euxoa* subgenus], *Grumia*, *Oxytypia*. Characterised by noctuid features, all these genera are currently placed in the Noctuinae (although *Grumia* is in the Heliiothinae in the BMNH collection).
- III. *Anarta*, *Panolis*. This division was characterised by hairy eyes and unspined, unclawed tibiae. Both genera are presently placed in the Hadeninae.
- IV. *Omia*, *Sympistis*, *Hypsophila*, *Cteipolia*. These four lashed-eyed genera are currently placed in the Cuculliinae.
- V. *Heliiothis* [*Schinia*, part], *Pyrocleptria* [*Schinia*, part]. These two genera bear the spined tibiae of the Noctuinae and the clawed fore-tibiae of the Melicleptinae [Heliiothinae]. They are currently placed in the latter subfamily.
- VI. *Xanthothrix*, *Apaustis*, *Panemeria*, *Janthinea*, *Stenoecia*, *Micriantha*, *Stemmaphora*, *Omorphina*, *Mesotrosta*. These genera comprised those with unadorned eyes and tibiae, and thus qualified as amphipyridae. All are currently accepted as such except *Omorphina*, which was classified by Hampson in the Plusiinae (Kostrowicki, 1961, considered it better placed in the Acontinae).

Warren recognised the heterogeneous nature of this new subfamily, in that its members displayed all the features used to define the previous five groups. However, he considered the shared characters to be more important. The group was conceived to be the 'scattered remnants of archaic types, the conditions of whose existence synchronised with the more rigorous climate and scantier light of an earlier cosmic period'.



The Palaearctic genera of the Erastrinae [Acontiinae] were recognised to straddle the trifine-quadrifine border, in that they possess a strongly-developed hindwing vein  $M_2$  (in contradiction to Hampson's key, Table 9) but the larvae, as far as were known, had a reduced number of prolegs. Warren treated them as intermediate between the other two large noctuid groups.

The remaining quadrifine subfamilies recognised by Warren coincided generally with those of Hampson. However, no distinction was made between the Noctuinae [Ophiderinae] and the Hypeninae, the combined group being referred to under the former name. *Diloba* was included with reservations within the Cymatophoridae [Thyatiridae] (Warren & Seitz, 1906–12).

**Volume 7 – Fauna Americana: Noctuidae (Draudt).** Draudt also largely adhered to Hampson's arrangement. However, the 'Acronyctinae' group [Acronictinae] was published before the volume in which Hampson merged it with the Amphipyriinae and so the division was maintained by Draudt. The Acronictinae was divided into two 'subordinate groups', the Mominae [Pantheinae] and the Acronictinae, which Draudt recognised as probably not being closely related but which were kept together in order to maintain the coherency of the entire work.

Warren's heliothidine genera were distributed among the other subfamilies (e.g. *Orosagrotis* [*Euxoa* subgenus] to the Agrotinae [Noctuinae] and *Anarta* to the Hadeninae). As a result, the group Warren termed the Melicleptinae, which now contained *Heliothis* [*Schinia*, part], was renamed the Heliothinae and must have added greatly to the confusion of those using the work.

Unlike Warren, Draudt did separate the Noctuinae [Ophiderinae] and Hypeninae as distinct subfamilies (1919–44: 17) although only the ophiderine part was ever published.

**Volume 11 – Fauna Indo-Australia: Agaristidae (Jordan).** In this volume, Jordan (1912–14), in addition to his previous comments regarding this family, also added that it possibly ought to be merged with Hampson's Acronyctinae. Indeed, the latter author (Volume 9) included several agaristine genera in the Acronyctinae (e.g. *Xerocerus* to *Zalissa* inclusive). Jordan also thought it feasible that the Agaristidae were polyphyletic, with Old and New World forms representing distinct lineages.

**Noctuidae (Warren, Gaede & Draudt).** The trifine subfamilies were dealt with by Warren (1912–38), who retained the system he had used in the Palaearctic volume. The only alteration was the renaming of the Metachrostinae as the Bryophilinae. The majority of the quadrifine subfamilies, up to the Catocalinae, were described by Gaede (1937–38) and the remainder left to Draudt (1938). However, of the latter, only four lines of the introduction to the Phytometrinae [Plusiinae] were produced, the rest never being published. Both authors followed Hampson's arrangement of subfamilies.

**Volume 15 – Fauna Africana: Noctuidae (Gaede).** Several modifications were made to the arrangement employed in the previous volumes. Gaede (1913–39) followed Hampson in separating the acronictines and the momines [pantheines] into distinct subfamilies, although the two were still placed contiguously at the head of the family. In addition, the Sarrothripinae were divided into four informal groups:

- (1) *Sarrothripus*-group: mostly very small with broad wings;
- (2) *Eligma*-group: large and brightly coloured;
- (3) *Gadirtha*-group: allied to the last in having long, subuliform palps and a dorso-ventrally flattened body, but being only half the size and cryptically coloured;
- (4) *Blenina*-group: with cylindrical bodies and very broad, cryptically coloured wings.

Gaede also recognised the arbitrary nature of the division between the Catocalinae and Noctuinae [Ophiderinae] but considered that combining them, and perhaps also incorporating the Erastrinae [Acontiinae] and Hypeninae, would result in a very unwieldy group. Otherwise, Gaede saw no reason for separating such generic pairs as *Hypocala-Catocala*, *Fodina-Grammodes* and *Arcte-Cocytodes*.

This work, like many other volumes of Seitz, remained unfinished due to the destruction of the press and manuscript in the Second World War.

### Satisfaction and apparent stability

The authors of 'Seitz' were not the only enthusiastic proponents of Hampson's subdivisions of the Noctuidae. Dyar (1904), in his review of the agrotine [noctuid] volume, considered Hampson's arrangement and use of characters 'highly commendable'. However, he was far from content with the nomenclatural changes imposed upon his native American fauna. In particular, Dyar objected to Hampson's refusal to adopt the names used by Hübner in the *Tentamen*.

Meyrick (1912), however, concurred with Hampson, reasoning that Hübner's names were invalid because they were published without accompanying descriptions. Meyrick did disagree with Hampson regarding the potential use of sexual characters to define genera, characters that were totally eschewed by the latter author. As a result, Meyrick found it difficult to accept many of Hampson's generic groupings. He did find some points of agreement with regard to the higher classification of the Noctuidae, which he was able to incorporate into his own arrangement of the New Zealand Caradrinina.

Meyrick employed the term 'Caradrinina' to cover the group today known as the Noctuoidea (s.str.), maintaining his view that the generic name *Noctua* and its associated group-names were inapplicable to this group of moths. In addition to the Arctiidae [Arctiidae] and the Hypsiidae [Arctiidae: Aganainae], two other families were recognised. These were the Caradrinidae and the Plusiidae, direct equivalents of the Noctuidae and Plusiidae of his earlier (1887) work. In the present study, Meyrick chose to divide the families into subfamilies, largely following Hampson's usage. He did employ different names, however (Table 11). Of these, the Plusiades also included the ophiderines. Meyrick (1928) later employed the same scheme in his *British Lepidoptera*.

**Table 11** The classification of the superfamily Caradrinina proposed by Meyrick (1912), the contents of which correspond to the current superfamily Noctuoidea, less the Lymantriidae and several small groups.

---

CARADRININA	
	Arctiidae
	Hypsiidae
	Caradrinidae
	Agrotides
	Poliades
	Melanchrides
	Caradrinides
	Plusiidae
	Hypenides
	Catocalides
	Plusiades

---

Forbes (1914) implicitly adopted the Hampsonian subfamilies although he did not employ the names as such. He was also not impressed by the vagueness of the triline-quadriline border and referred to those in which the condition was doubtful as 'intermediid'.

Barnes & McDunnough (1917) were more faithful to Hampson's system. The only alteration was the substitution of Erebinæ for Noctuinae [Ophiderinae].

Turner (1920: 120) went much further in his praise of Hampson: 'It would be difficult to over-estimate the debt which we owe to Sir George Hampson's great work. By it the study of the Noctuidae as a whole has been for the first time placed on a scientific basis'. Despite these words, Turner found it difficult, as did many other authors, to define the noctuid subfamilies precisely without recourse to 'distinctions of relatively trivial importance' (e.g. hairy eyes, spined tibiae, etc.). Overall, however, Turner considered it advisable to adopt Hampson's arrangement, primarily because no better system was available. This attitude was to become entrenched.

Turner formally relegated the agaristines to the rank of subfamily within the Noctuidae, and thus agreed with Mosher's (1916) findings on pupae (see below). He dismissed one of the usual defining characters (clubbed antennae) and could thus include several genera placed by Hampson in the Acronyctinae (as did Jordan, 1912–14). However, having done so, Turner was then quite unable to define the group.

The remaining subfamilies dealt with (up to the Acontianae [Chloephorinae]) remained unaltered, apart from the substitution of Hadeninae by Melanchrinae.

Hampson's arrangement was also accepted by Lhomme (1923–35) although again, the names of certain subfamilies had been changed (the Acronyctinae, Stictopterinae, Acontianae and Mominae became the Zenobiinae, Odontodinae, Westermanniinae and Diphtherinae respectively). This was in line with Hampson's supplement to the *Catalogue* (Hampson, 1918).

Similarly, minor nomenclatural changes apart, Hampson's subfamilies were adopted by Blackmore (1927). He agreed with Barnes & Benjamin (1923), in accepting that the Linnaean generic name *Phalaena* applied to the noctuids (rather than the geometrids, where it had more frequently been used). Hence, the family became the Phalaenidae and the subfamilies Agrotinae and Noctuinae [Ophiderinae] became the Phalaeninae and Erebininae respectively. (The family name Noctuidae was not finally stabilised until the suppression of *Phalaena* Linnaeus, 1758, by the International Commission for Zoological Nomenclature in 1957, Opinion 450.) Also, the Acronyctinae were referred to as the Apatelinae, presumably because Blackmore accepted Hübner's *Tentamen* and thus considered *Apatela* [*Apatele*] to have priority over *Acronycta* [*Acronicta*].

Finally, as an example of a study following Hampson almost to the letter, that of Prout (1929) might be mentioned. The only alteration employed was that she followed Comstock (1925) and regarded the hyblaeines as a family distinct from the noctuids (see also below).

### Noctuoidea or Noctuidae?

A rather interesting variant of the Hampsonian system of families and subfamilies of the noctuoid group of moths was supported by some South African lepidopterists, notably Janse (1937–9). He considered the differences between the noctuoid families to be far too small compared to those found in other orders, and thus, following Handlirsch's (1929) suggestions regarding ranking, reduced them all to subfamilial level in a more inclusive Noctuidae (Table 12).

Inevitably, there were conflicts with Hampson's arrangement. The sarrothripines (as Nyc-teolini) were removed from the Noctuidae on the basis of a venational character (despite the 'shape of the forewings somewhat resembling those of the Acontinae' [Chloephorinae]) and placed as a tribe in the Arctiinae [Arctiidae]. Also the hypenines were recognised as a tribe of the Noctuinae, equivalent in rank to the trifines (Trifini) and the quadrifines (Quadrifini). Consequently, most of Hampson's subfamilies were relegated to the status of subtribes.

As to Hampson's subfamilial characters, Janse considered hairy eyes and tibial spines to be fairly reliable, at least with regard to excluding genera from his Acronyctae, while lashed eyes and the condition of hindwing vein  $M_2$  were much less dependable. He also disapproved of the use Hampson made of thoracic and abdominal tufts and crests, preferring to delimit genera on the basis of structural characters, particularly those drawn from the male genitalia.

Only the Agaristinae and Noctuinae: Trifini: Acronyctae were covered by Janse (1937–9). The study was discontinued due to lack of material of non-South African type-species (Janse, 1942).

This arrangement of genera was also used by Van Son (1933), Janse (1939), and, in a modified form, by Kiriakoff (1963). The last of these works will be discussed in greater detail in a later chapter.

### Hampson to the present day

Despite considerable reservations regarding the naturalness or, in practical terms, even the usefulness, of Hampson's subfamilial classification, most workers have continued to use it, for

**Table 12** The concept of the Noctuidae employed by Janse (1937–9), which is almost identical to the current superfamily Noctuoidea. However, Janse did not consider the differences between the constituent groups (his subfamilies) to be great enough to warrant family rank.

---

NOCTUIDAE	
Syntominae	
Callimorphinae	
Liparidinae	
Arctiinae	
	Lithosiini
	Nolini
	Arctiini
	Nycteolini
Agaristinae	
Noctuinae	
	Trifini
	Hadenae
	Agrotides
	Cuculliae
	Acronyctae
	Quadrifini
	Momae
	Euteliae
	Stictopterae
	Acontiae
	Catocalae
	Plusiae
	Noctuae
	Erastriae
	Hypenini

---

example, Zimmerman (1958), Common (1968), Pinhey (1975) and Leraut (1980). Several others have made only small modifications: Viette (1962–7) separated the Melicleptrinae [Heliothinae] from the Noctuinae; Boursin (1964) additionally accepted the Apatelinae [Acronictinae] (moves that were subsequently followed by Kloet & Hincks, 1972 and Bretherton *et al.*, 1979); while Forster & Wohlfart (1971) recognised the Apatelinae and the Bryophilinae but not the Heliothinae.

Thus it seems that, minor differences in opinion regarding the precise names of the subfamilies apart, Hampson's subdivision of the family could be regarded as definitive and dominant. However, although apparently stable and imperturbable, the system was challenged, even during its publication. Hampson's classification was based largely upon superficial characters of the adults and larvae. Detailed morphological and anatomical studies of all life-history stages were to cast serious doubt on the edifice. This doubt was eventually to lead to the proposal of a new system which, although still very much dependent upon that of Hampson, was to be more securely based in structural morphology.

## The influence of immatures

### Emergence

Most classifications of Lepidoptera have been derived using primarily adult characters. However, in several groups, of which the Noctuidae are one, the economic importance of the larvae resulted in studies from which grew the realisation that not only could larval characters be useful in identification but also in classification.

Forbes (1910) was one of the first to investigate thoroughly larval morphology. Several noctuid subfamilies were considered in detail and within the Noctuinae (*sensu* the Trifinae) in particular, Forbes discovered a highly uniform structure, despite much individual variation.

Only the tribes Acronyctini [Acronictinae] and Cuculliini [Cuculliinae] could be delimited using larval characters.

Fracker (1915) also investigated larval morphology but with special emphasis upon the chaetotaxy. He agreed with Hampson that the Nycteolidae ought to be reduced to a subfamily of the Noctuidae (Sarrothripinae), having found no significant chaetotactic differences between members of the two families. The larvae of the Agaristidae [Noctuidae: Agaristinae], apart from their bright transverse striping (also found in some other noctuids, e.g. *Acronicta alni*), were also indistinguishable from those of the Noctuidae and Fracker considered the family 'should meet the same fate as the Nycteolidae'.

Within the Noctuidae itself, Fracker found the same discouraging degree of uniformity. This prompted him to write: 'with the exception of half a dozen genera, noctuid larvae are so uniform that one can often compare, part for part, every segment and appendage of larvae of two species without finding a difference either of kind or of degree'. Fracker could only divide the family into four groups, three of which contained only members of the Acronictinae and Pantheinae, while the fourth comprised all the remaining subfamilies.

Mosher (1916) found a greater range of variation in pupae and was able to characterise tentatively 10 subfamilies (largely Hampsonian). One, the Agaristinae, was included perhaps for the first time as an explicit subfamily of the Noctuidae. As had been found for the larvae, no structural differences of the pupae could reliably distinguish the agaristines from the noctuids at the family level. The Acronyctinae were heterogeneous for, in addition to the acronictines *Eulonche* and *Acronycta* [both *Acronicta*] and the amphipyrene *Achatodes*, the division also included three ophiderines (*Homopyralis* [*Metalectra*], *Plusiodonta* and *Anomis*). However, Mosher did not consider that these genera formed a natural group.

Of the remaining subfamilies, members of the Catocalinae were distinguished by the presence of an alcohol-insoluble surface bloom, while the Sarrothripinae completely lacked a cremaster and spines (although Mosher did not consider this sufficient to warrant separation from the Noctuidae).

Ripley (1923) performed an extensive study of the morphology of larval noctuids but did not interpret the results taxonomically.

The larvae of the Hypeninae were examined by Crumb (1934), who discovered two distinct types. The first corresponded to Forbes' (1918) Herminiinae while the other was found not only in the remaining hypenines but also generally in the catocaline-erebine [ophiderine] complex. In this regard, the hypenoid type (as Crumb termed the latter form) was not particularly distinct from the majority of the Noctuidae. The herminioid type of larva was divided into two subgroups and the hypenoid type into five. On the basis of the larva, it was suggested that *Rivula* might merit a separate subfamily; it certainly was not hypenine.

Dethier (1941), in his detailed study of lepidopteran larval antennae, described those of the members of 10 noctuid subfamilies (including the Rivulinae). Apart from noting the great similarity between the Agaristidae and the Noctuidae, no further remarks were made regarding the higher classification.

### The challenge from India

A major contribution to the understanding of the structure of larvae from outside the Holarctic was provided in a series of papers by Gardner on Indian Noctuidae. He subdivided the family, on the basis of previously defined larval characters (Gardner, 1941), into four groups, A–D, of which the first three were split further (Gardner, 1946a). The groups were not allocated formal names because of conflict with Hampson.

Division A (considered mostly in Gardner, 1946b) consisted of various trifine genera, the Agaristinae and some acontiines [chloephorines]. It comprised six sections.

A I: (described in Gardner, 1946a): Acronictinae, Pantheinae and *Cetola* (Amphipyrinae). The larva of the last genus was not distinctly hairy but was included because it had six setae on the external surface of the prolegs rather than three.

- A II: Amphipyridae, Hadeninae; also *Agrotis* [*Xestia*] *c-nigrum* (Noctuidae) and *Lyncestia amphix* (Ophiderinae).
- A III: Noctuidae (*Agrotis* and *Euxoa*).
- A IV: (described in Gardner, 1946a): Heliothinae (*Heliothis*, *Pyrrhia* and *Adisura*).
- A V: Acontiinae [Chloephorinae] (*Aiteta*, *Carea*, *Maurilia*, *Pseudelydna*).
- A VI: Amphipyridae (*Callyna*), Hadeninae (*Tiracola*), Chloephorinae (*Churia*), Agaristinae (*Aegocera*, *Eusemia*).

Division B (mostly dealt with in Gardner, 1947) comprised those larvae in which the prolegs of abdominal segment 3 are abruptly reduced or absent. The distinction from the genera of division C, in which the prolegs are all equal or are only gradually reduced from segment 6 to 3, was considered to be somewhat arbitrary.

- B I: (described in Gardner, 1946a): Acontiinae [Chloephorinae] (*Acontia* [*Xanthodes*]), Amphipyridae (*Elydna*, *Chasmina*, *Androlymnia*), Erastrinae [Acontiinae] (*Amyna*) and Noctuidae [Ophiderinae] (*Bocula*).
- B II: (described in Gardner, 1946a): Hypeninae (*Hypena*, *Dichromia*, *Rhynchina*, *Bomolocha*).
- B III: Plusiinae.
- B IV: Erastrinae [Acontiinae], Catocalinae (e.g. *Parallelia*, *Achaea*), Noctuidae [Ophiderinae] (e.g. *Othreis*, *Anomis*) and *Hypena* [*Sarobela*] *auroincta* [*litterata*]. Group B IV was divided into three subgroups:
- B IVa: lacking prolegs on abdominal segments 3 and 4;
- B IVb: lacking prolegs on 3 only;
- B IVc: prolegs present on 3 and 4, those of 3 distinctly reduced.

Division C (Gardner, 1948a), unlike A and B, was not subdivided. Instead, the genera were treated according to their Hampsonian subfamily. Included were the subfamilies Euteliinae, Sarrothripinae, Stictopterinae, Herminiinae, some Catocalinae and Ophiderinae, together with *Westermannia* (Chloephorinae) and the amphipyridines *Sesamia* and *Iambia*.

The final division, D (Gardner, 1947), differed from the others in setal group VI (part of the subventral group of Hinton, 1946) being bisetose on the meso- and metathorax rather than unisetose. Gardner considered that division D was artificial (he was eventually to conclude that the entire system was artificial; Gardner, 1948a), comprising as it did, *Brithys* (Hadeninae), *Selepa* (Sarrothripinae), and *Earias* and *Eligma* (Chloephorinae). These genera shared characters with the Lithosiidae [Arctiidae: Lithosiinae], Hyspidae (*Digama* [now an arctiine]) and the genera *Argina* and *Utetheisa* (Arctiidae: Arctiinae).

Gardner (1948a) considered that a natural classification of the noctuids should be based upon the number of setae in group VII (part of the subventral group of Hinton, 1946) on the first abdominal segment. This would divide the Noctuidae into two groups, representing roughly divisions A plus B, and C plus D, but with many exceptions.

The larval study was followed by a consideration of the pupae (Gardner, 1948b). The pupae of the Hadeninae, Amphipyridae, Agrotinae [Noctuidae] and Heliothinae were all found to be very similar. Several genera (e.g. *Brithys*) that were distinct as larvae, proved equally distinct as pupae. The relationship between *Cetola* and the Acronictinae suggested by the larvae was not supported by the pupae. The Euteliinae proved to be very well defined by pupal characters. The genera of Acontiinae [Chloephorinae], which had been widely dispersed on the basis of larval characters, were all very close as pupae, except *Acontia* [*Xanthodes*]. They also shared features with the Sarrothripinae. No great distinction was found between the pupae of the Catocalinae and the Noctuidae [Ophiderinae], thus giving Mosher's surface bloom character wider significance.

**Table 13** The division of the British Noctuidae proposed by Timlin (1955), based on larvae. NC = no comparison; <sup>1</sup> 1 = uniordinal, 2 = biordinal; <sup>2</sup> prolegs on abdominal segments 3 and 4 only partly developed; <sup>3</sup> except for certain *Cucullia* species.

Group	Proleg number	Secondary setae	Crotchets <sup>1</sup>	SV group of setae abdominal segment 1	Contents
1	5	+	1	NC	Most Acronyctinae [Acronyctinae], <i>Dasycompa rubiginea</i> (Cuculliinae)
2	3	-	2	2	Plusiinae ( <i>Plusia</i> [Autographa] <i>gamma</i> , <i>P.</i> [Diachrysia] <i>chrysitis</i> )
3	3	-	2	3	Plusiinae ( <i>Polychrysia moneta</i> )
4	3	-	1	3	Ophiderinae ( <i>Parascotia fuliginaria</i> )
5	4	-	1	3	Eustrotiinae [Acontiinae]
6	5 <sup>2</sup>	-	1	3	Hypeninae
7	5	-	1	3	Plusiinae ( <i>Episema</i> [Diloba] <i>caeruleocephala</i> ), Ophiderinae (part), Acronyctinae [Acronyctinae] ( <i>Apatele</i> [Acronicta] <i>alni</i> )
8	5	-	1 <sup>3</sup>	2	Agrotinae [Noctuinae], Hadeninae, Cuculliinae (except <i>D. rubiginea</i> ) Amphipyrynae, Acronyctinae [Acronyctinae] ( <i>Cryphia perla</i> [domestica]), Sarrothripinae, Westermanniinae [Chloephorinae]

### Further conflict

Timlin (1955) examined the larvae of 142 species of British noctuids, dividing the family into eight equivalent groups (Table 13). This arrangement was then contrasted with those of Hampson, Meyrick (1928) and Tams (unpublished). Tams' classification differed from Hampson's only in separating the Acronyctinae from the Amphipyrynae.

Timlin found conflicts in the following areas:

- the heterogeneity of the Plusiinae, especially regarding *Episema* [Diloba];
- the similarity between the Hylophilidae [Chloephorinae + Sarrothripinae] and the Noctuidae;
- the reduction of the prolegs in the Eustrotiinae [Acontiinae];
- the lack of a distinction between the Catocalinae and the Ophiderinae;
- the high degree of similarity between the trifine subfamilies (less the Acronyctinae).

In addition, Timlin considered the following genera might have been misplaced in classification based upon adult structures:

- Dasycompa* (Cuculliinae), which has secondary setae;
- Parascotia* (Ophiderinae), considered closer to the Hypeninae because of the reduced number of prolegs;
- Cucullia* (Cuculliinae), which is heterogeneous with respect to crotchet ordination;
- Scoliopteryx* (Ophiderinae), in which seta XD1 is nearer the midline than D1 on the prothorax, contrary to Fracker's (1915) diagnostic character for the Noctuidae;
- Episema* [Diloba], which, unlike the other plusiines, has five well-developed pairs of prolegs and uniordinal crotchets;

6, *Apatele* [*Acronicta*] *alni* and *Cryphia perla* [*domestica*] (Acronictinae), the only acronictines examined lacking secondary setae.

The next major work on noctuid larvae was that of Crumb (1956). He attempted to classify the larvae of as many North American genera and species as possible, in order to facilitate the identification of crop pests. The arrangement of subfamilies adopted is given in Table 14.

Crumb accepted the Agaristinae as a noctuid subfamily but did not discuss it further. He could not distinguish the Pantheinae and the Acronyctinae [Acronictinae] on structural grounds and so combined them under the latter name. The Heliiothinae were found to be separable into two fairly good groups but Crumb did not apply the distinction.

**Table 14** Arrangement of the noctuid subfamilies followed by Crumb (1956).

---

PHALAEINIDAE

Agaristinae  
 Acronyctinae  
 Acontiinae  
 Cuculliinae  
 Euteliinae  
 Bagisarinae  
 Hypeninae  
 Phalaeninae  
 Hadeninae  
 Ufeiinae  
 Amphipyriinae  
 Plusiinae  
 Lithacodiinae  
 Sarrothripinae  
 Catocalinae  
 Herminiinae

---

Within the remaining subfamilies, apart from the unorthodox order of listing, several other innovations were proposed. New subfamilies were erected for *Bagisara* (Bagisarinae) and *Ufeus* (Ufeiinae). They are currently considered to be tribes of the Acontiinae and Noctuinae respectively (Franclemont & Todd, 1983). The Cuculliinae was restricted to the genera related closely to *Cucullia*, the others being placed in the Amphipyriinae. The Acontiinae was restricted to *Acontia*, *Tarachidia*, *Heliocontia* [*Spragueia*] and *Pseudalypia* (the Acontiini of Franclemont & Todd, 1983) while the remainder constituted the Lithacodiinae. The Amphipyriinae were divided into eight informal groups (three of cuculliines, three of amphipyriines and two mixtures). One of the mixed groups (number 6, *Pseudanarta*, *Proxenus*, *Anorthodes*, *Platyperigea*, *Xanthia*, *Sunira* and *Anathix*) was considered to be possibly natural.

The Catocalinae (including the Ophiderinae) was divided into six informal groups, which partially correlated with the groupings of Forbes (1954) (see also below) as follows:

- 1, Erebininae: Synedini;
- 2, Catocalinae: group 3; Erebininae: second miscellaneous series (part) (*Tathorhynchus*);
- 3, Catocalinae: groups 1 and 2 (parts); Erebininae: Erebinini and Panopodini (part);
- 4, Catocalinae: groups 1, 2 and 4 (parts); Erebininae: Panopodini (part);
- 5, Erebininae: first miscellaneous series;
- 6, Erebininae: Anomiini and Scoliopterygini.

Beck (1960), in his study of the larvae of European noctuids, used a classification based upon Hampson but with several differences. The Noctuinae, Hadeninae and Zenobiinae [Amphipyriinae] were treated as tribes of the Noctuinae (following Börner's (1953) classification of the adults). The Cuculliinae and Heliiothidinae [Heliiothinae] were recognised as distinct trifine subfamilies. The Rivulinae and Herminiinae were recognised as separate while the remaining ophiderines were classified in the Catocalinae. Two tribes were recognised in the last subfamily,



the Catocalini (with two informal groups: *Laspeyria/Catocala/Mormonia/Minucia*; and *Euclidimera [Callistege]/Ectypa [Euclidia]/Lygephila*) and the monobasic Scoliopteryginae (*S. libatrix*). The ophiderine *Aedia funesta* was established in a separate subfamily, the Aediinae.

Merzheevskaya (1967) generally accepted an arrangement that was very similar to that of Beck (1960). However, the Agrotinae [Noctuidae] were divided into two tribes, the Triphaenini [Noctuidae] and the Agrotini. One unusual move transferred *Amphipyra* to the Cuculliinae, resulting in the renaming of the Amphipyrinae as the Zenobiinae.

Godfrey (1972), following Hampson's definition of the subfamily, examined the larvae of many of the North American Hadeninae and divided the subfamily into 21 informal groups.

The most recent study of noctuid larvae (Arnold, 1982) was novel in that it looked not at the morphology of the larvae but at their haematocytes. Four basic types of cells were identified: plasmotocytes (of five varieties: standard, nematoform, lamellar, podoform and vesicular), granulocytes, spherulocytes and oenocytoids.

The species of Agaristinae, Pantheinae and Acronictinae examined all had only the basic cell types, in common with five arctiids, and this complement was interpreted as primitive. The Noctuidae fell into three natural groups, which showed little agreement with Forbes' (1954) divisions. The hadenines could also be divided into three groups on the basis of plasmotocyte type. The few cuculliines examined agreed with Forbes' subdivision; the three Cuculliini had only the basic complement while *Lithophane hemina* (Xylenini, Franclemont & Todd, 1983) differed in having lamellar plasmotocytes. The Amphipyrinae proved to be heterogeneous while the two heliothidines [heliolithines] shared the unusual feature of the absence of spherulocyte staining.

Generally, classifications based upon noctuid larvae have proved to be at least partially incongruent with the Hampsonian system, while the degree of conformity with the newer arrangement exemplified by Franclemont & Todd (1983) remains to be seen. Larvae have proved to be potentially very useful in elucidating the higher classification of nymphalid butterflies (DeVries, Kitching & Vane-Wright, in prep.; Kitching, 1983, in press) where previous systems based upon adult characters have been shown to be incorrect by varying amounts. It seems likely, therefore, that no satisfactory arrangement of the noctuid genera into tribes and subfamilies can be achieved without reference to the immature stages and much work still remains to be carried out in this field.

## The main assault

### The gauntlet is thrown down

#### *Tympanal organs: the development*

Workers in noctuid systematics, from Guenée to Hampson, relied largely upon gross morphological structures to divide the group—wing venation, tibial spining, etc. The prime reason for the lack of study of other features, such as the arrangement of sutures and sclerites, was the presence of the characteristic scales of the Lepidoptera. Examination of surface structures would necessitate the removal of this vestiture, which was an anathema because of its effect on the appearance of cabinet specimens.

However, around 1910, attitudes began to change. The use of genitalia revolutionised lepidopteran systematics at the generic and specific levels, but the system that was to have the greatest impact on the higher levels was based on the tympanum.

It had been known for some time that such an organ existed (it was first referred to by Swinton, 1877) but it was Forbes (1916) who initially drew attention to the possibility of using it to help determine taxonomic relationships. Forbes (1918) employed the form of the tympanic hood to argue for the resurrection of the Herminiinae as a subfamily separate from the Hypeninae. Tympanal structures were also employed to argue that the anomalous arctiid, *Graphylesia*, was in fact a noctuid, related distantly to certain acontiine [chloephorine] genera (Forbes, 1924). The physiology and anatomy of the noctuid tympanum was further investigated by Eggers (1919; 1925).

### Application

The wider systematic implications of the tympanum in the Noctuidae were left to Richards (1932). Drawing upon the studies of Shepard (1930), Richards made a highly detailed comparison of the morphology and evolution of the structure and divided the family as follows.

**Herminiinae.** Richards agreed with Forbes (1918) that this group was distinct from the remainder of the noctuids. The included genera all possessed a prespiracular tympanal hood (i.e. the first abdominal spiracle is posterior to and therefore outside the hood), as in the other noctuid families (except the Nolidae and Agaristidae, see below), rather than a postspiracular hood (in which the spiracle is concealed beneath the hood). The former condition was considered to be primitive and led Richards to conclude that the Herminiinae were among the earliest offshoots from the noctuid lineage.

**Rivulinae.** Although the members of this rather ill-defined subfamily possessed the derived post-spiracular hood, Richards considered them to represent the most primitive noctuid subfamily. The remaining noctuid groups and the Herminiinae were interpreted as having been derived from the Rivulinae.

*Rivula* itself appeared to be the least specialised of all the Noctuidae examined by Richards, differing only slightly from the Hypsidae [Arctiidae: Aganainae] (although the latter has a *prespiracular* hood).

**Hypeninae.** Richards found it immensely difficult to subdivide the large group of genera comprising the Hypeninae, Catocalinae and Erebiniae [Ophiderinae]. He was able to distinguish the genera near *Hypena* from the remainder of the Erebiniae (except *Plusiodonta* and *Scoliopteryx*), considering them as a separate subfamily, the Hypeninae. (By way of an aside, Richards, in a footnote (10), stated that 'the immediate *Hypena* group and *Scoliopteryx* are the only quadrifids with lashed eyes outside the Plusiinae'. If this is true, then one can only conjecture as to why Hampson did not place at least the latter in the Plusiinae.) The Hypeninae were connected to the Rivulinae via *Pleonectyptera* [*Hemeroplanis*] and to more typical Erebiniae via *Pangrapta-Herminodes*.

Three informal groups were recognised within the Hypeninae:

- 1, *Pleonectyptera* [*Hemeroplanis*], with an unspecialised tympanum;
- 2, the lashed-eyed hypenines, with a double pocket IV;
- 3, *Hormoschista* and its allies, with pocket IV yet further modified.

**The erebine-catocaline complex.** This group comprised Hampson's Catocalinae and Noc-tuinae. Richards, like Gaede (1913–39), considered the distinction based upon tibial spining to be completely artificial. However, unlike the latter author, Richards found he was able to divide the combined group, albeit based upon a limited sample of genera. Richards was very aware of the limitation this placed upon his conclusions.

The genera of the erebine-catocaline complex proved very diverse, falling into a number of relatively distinct groups which were connected by intermediate forms. Six such groups were recognised.

- I. *Pangrapta/Gabara/Herminodes* group. This was the most primitive, from which the next group arose.
- II. *Anomis/Calpe/Plusiodonta* group. This was considered to be rather artificial, connecting the previous series to the 'higher' erebines. *Alabama* and *Anomis* were considered to be extreme developments, while *Plusiodonta* was tentatively placed here, although it had more in common with the Hypeninae.
- III. *Melipotis/Syneda* [*Drasteria*] group. Derived from the last mentioned, this was the most well-defined group of erebines, with a characteristic tympanal membrane and nodular sclerite. It includes *Leucanitis* and *Syneda* [*Drasteria*], genera currently assigned to the

Catocalinae and Ophiderinae respectively. These genera had tympana that Richards considered to afford 'good evidence of the artificiality of any division on spines'.

- IV. *Euparthenos/Yrias* [*Metria*]/*Zale* group. Characterised by an overhung or pouched pocket I, this group was considered to have given rise to the Stictopterinae and Plusiinae (see below).
- V. *Catocala/Erebus* [*Ascalapha*]/*Thysania* group. Richards considered this group to be rather artificially separated from the last.
- VI. *Doryodes/Euclidia* group. This group, comprised of mainstream Catocalinae, was considered to be an independent derivative of group II.

Four genera were found to be very difficult to place: *Scoliopteryx*, *Gonodonta*, *Noropsis* [*Diphthera*] and *Litoprosopus*. The last of these was described as looking like 'a combination of a Notodontid and a Plusiid' and was highly anomalous.

**Stictopterinae.** Richards considered this subfamily to be derived from the Erebinae of group IV, and possibly to have given rise to the Plusiinae, 'for which they would serve as prototype'.

**Plusiinae.** This subfamily proved to be the most homogenous and distinct of the quadrifines. It was characterised by a double hood and a swollen area of the epimeron ventral to the tympanal membrane, which was the external manifestation of an enlarged pocket IV. (A similar bulge in other genera, notably the Herminiinae, is *ventral* to pocket IV.)

**Euteliinae.** This subfamily proved enigmatic. Generally, it was considered to be a development from the Erebinae, and would thus be placed near the Stictopterinae. However, the tympana of the euteliines have much in common with those of the Erastrini. Richards was undecided as to the position and affinities of the Euteliinae.

**Erastrinae** [**Acontiinae**]. Richards derived this subfamily from the lineage linking the Rivulinae and Hypeninae, and the Erebinae, via *Eublemma* [*Eumicremma* + *Eublemma*]. From this group could be derived the acontiine [chloephorine]-sarothripine series and the trifine subfamilies. As mentioned above, the Euteliinae could be placed here also.

Two tribes were recognised by Richards. The Erastrini, in which the alula is unmodified, and the Tarachini, a very homogeneous group in which the alula is enlarged and strongly sclerotised. The tympanal membrane is concealed by the alula and the hood is correspondingly reduced or absent.

**Acontiinae** [**Chloephorinae**]. This subfamily combined the characters of both erastrine tribes and was considered to be derived from the last subfamily.

**Sarothripinae.** Richards agreed with Hampson by placing this group as a derivative of the last, with which it shares many characters, especially internally.

**Pantheinae.** The relationships of this tympanally homogeneous subfamily were obscure to Richards. The form of the tympanum could be derived from that of the trifines, erastrines or even the erebines, and he was unable even tentatively to assign it a place on his phylogenetic tree.

**The trifine subfamilies.** These groups (Agrotinae [Noctuinae], Poliinae [Hadeninae], Cuculiinae and Acronyctinae [Acronictinae + Amphipyriinae]) were not examined in detail but appeared to be highly similar. Richards considered them to be developments from the higher erastrines with which they share many internal features.

**Agaristidae.** This family was considered to be derived from the Acronyctinae.

**Nolidae.** Richards concluded that this group did not belong in the Arctiidae, but was in fact very close to the Erastrinae, from which it could possibly be derived.

Richards synthesised his findings into a phylogenetic tree (Fig. 3). The arrangement, he concluded, was not substantially different from that of Hampson apart from the position of the Plusiinae, the unknown position of the Pantheinae and Euteliinae, and the division of the Catocalinae + Ophiderinae. However, it should be noted that there are several other major conflicts.

1. Hampson placed the Acontiinae [Chloephorinae] and Sarrothripinae between the Strictopterinae and the Catocalinae whereas Richards considered them to be derivatives of the Erastrinae [Acontiinae] near the trifines.
2. The Rivulinae, noctuines [ophiderines] according to Hampson, were given subfamilial status and considered to be the most primitive noctuids by Richards.
3. The Herminiinae were separated from the Hypeninae.
4. The nolids were associated with the 'higher' noctuids rather than with the arctiids.

Thus Richards' work provided evidence that cast serious doubt upon many of the Hampsonian subfamilial relationships. Nevertheless, it was based, for the most part, on a single organ system, the components of which are not readily observable. It was also based upon observations on only a very small percentage of the species of Noctuidae, whereas Hampson's arrangement was constructed after study of most of the then-known species. The influence that Richards' work was to have, and its potential was great, remained to be seen.

### The cause is taken up

#### *Initial acceptance in the U.S.A.*

The main proponent of the taxonomic use of tympanal organs in noctuid classification continued to be W. T. M. Forbes. However, even he was disinclined to change the accepted classification (i.e. Hampson's) to conform with the more recent evidence (cf. Forbes' work on the phylogeny of the butterfly subfamily Danainae, reviewed by Ackery & Vane-Wright, 1984). Thus, in his study of the Lepidoptera of Barro Colorado Island (Forbes, 1939), he retained the nolids as a separate family (placed between the Euchromiidae: Ctenuchinae [Arctiidae: Ctenuchinae: Euchromiini] and the Arctiidae: Lithosiinae), despite noting that they possessed a tympanum similar to that of the Erastrinae [Acontiinae]. Similarly, the structure of the agaristid tympanum was mentioned as being 'of the Noctuid type' but the family status was retained and the group was left near the arctiids, between the Pericopidae [Arctiidae: Pericopinae] and the Lymantriidae.

McDunnough (1938) employed subfamily concepts (Table 15) based largely upon the work of Richards (1932) and the results of comparative studies of male genitalia, which were then being widely used following the pioneering work of Pierce (1909). The Pantheinae were associated with the Acronictinae at the head of the noctuids, a return to the older concepts of relationships rather than anything novel (but see below). The heliothines were separated from the agrotines (or phalaenines as McDunnough preferred to call them) and placed relatively distantly. The Catocalinae and Ophiderinae were considered to be one subfamily and the rivulines and herminiines were treated as distinct. The subfamily Hyblaeinae continued to be included in the noctuids, as the last listed. These three changes were revolutionary insofar as they were included in a major checklist for the first time and McDunnough's list was thus a step in the right direction.

#### *The Lepidoptera of New York and neighboring states*

The next stage in development was published by Forbes (1954). By including the results of the most recent studies on the Noctuidae, he was able to produce a classification that was the most detailed in its hierarchical structure since that of Tutt (1902) (Table 16). Based loosely upon Hampson, the noctuids were split into 14 subfamilies, many of which were further divided into tribes. In addition, and contrary to normal taxonomic practice, Forbes established 'miscel-

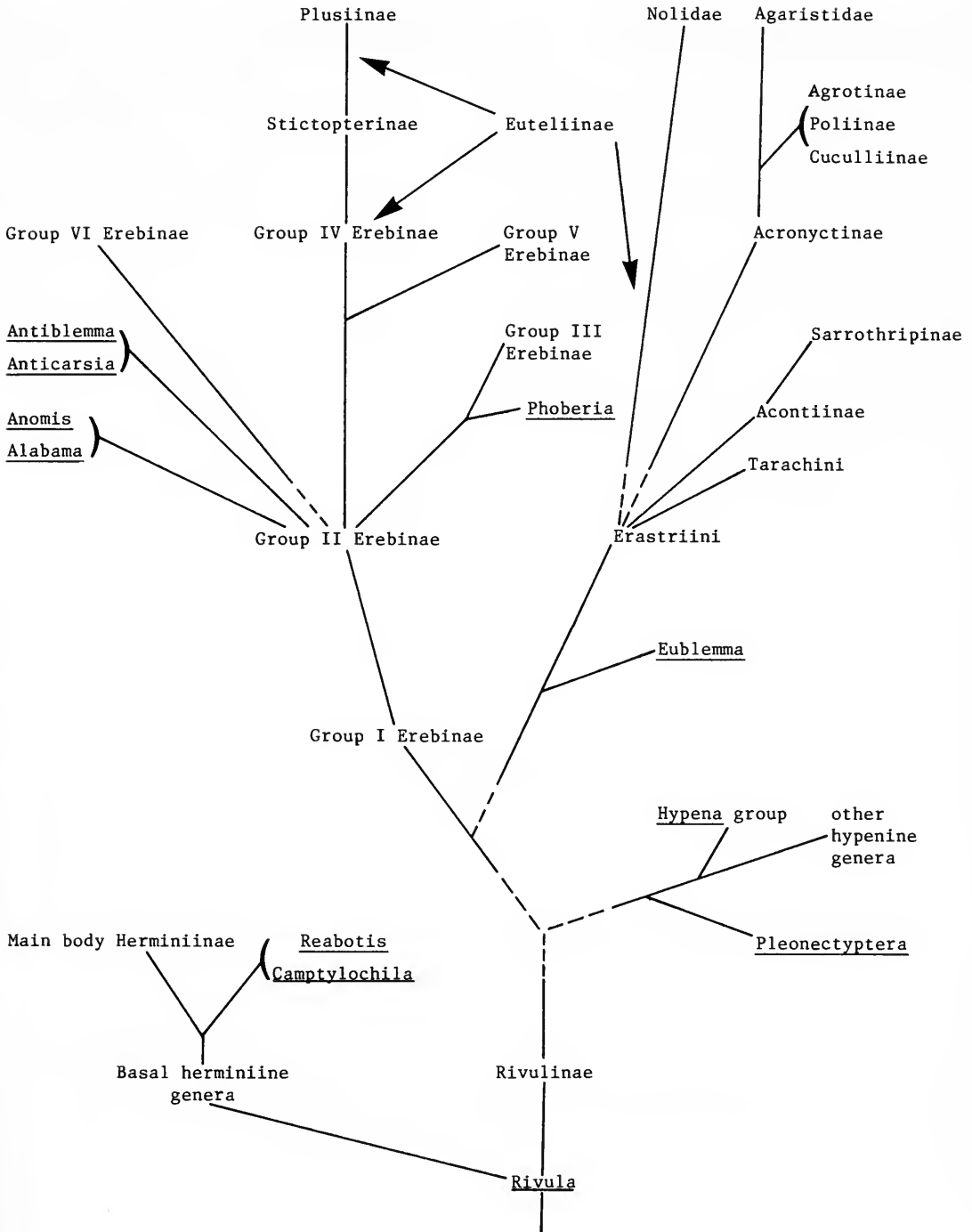

Fig. 3 Phylogenetic tree of the Noctuidae based upon characters of the tympanal organ (redrawn from Richards, 1932). Dashed lines indicate uncertain derivations, while the three arrows suggest three equally plausible positions for the subfamily Euteliinae: from the stictopterine-plusiine branch; from the group IV Erebiniae; or from the Erastrini.

**Table 15** Classification of the Phalaenidae [Noctuidae] employed by McDunnough (1938).

---

AGARISTIDAE
PHALAENIDAE
Pantheinae
Acronictinae
Phalaeninae
Hadeninae
Cucullinae
Amphipyrynae
Heliothinae
Acontiinae
Euteliinae
Sarothripinae
Plusiinae
Catocalinae
Hypeninae
Rivulinae
Herminiinae
Hyblaeinae

---

laneous series' and 'isolated genera', which were not assigned to formally named groups within subfamilies.

**Agrotinae.** Forbes used the family-group name 'Noctuidae' on the basis of '150 years of almost unchallenged use here and nowhere else'. However, he felt that to employ 'Noctuinae' for a subfamily would only invite confusion because of the previously diverse applications and so the term 'Agrotinae' was retained for the subfamily containing *Agrotis*, *Euxoa* and their allies. The Noctuinae of Hampson was termed the Erebiniae.

Forbes divided the Agrotinae into two tribes. The first, the Heliothidini, was considered to be closely allied to *Agrotis*, although some authors (e.g. McDunnough, 1938) preferred to separate the two groups widely and derive the heliothines from the acronyctine tribe, the Pyrrhiini. The Agrotini was divided into three sections based largely upon genitalic characters. The main included genera in each were as follows:

- group 1: *Agrotis*, *Eucrotopcnemis*, *Copablepheron*;
- group 2: *Peridroma*, *Pseudorthosia*, *Richia*;
- group 3: *Noctua* [*Xestia*], *Eurois*, *Actebia*, *Cerastis*.

The first and last were considered to be fairly homogeneous, despite previous minute subdivision.

**Hadeninae.** Defined primarily on the presence of hairy eyes, Forbes considered this group to be fairly homogeneous although he had reservations regarding the amaryllidaceous-feeding genus *Xanthopastis*. Three subgroups were recognised on the basis of superficial characters:

1. a *Mamestra*-type, with rough, mixed vestiture and heavy tufting;
2. a '*Taeniocampa*'-type, with very smooth mixed vestiture, dull colouring and complete pattern; and
3. a *Leucania*-type, with fine, smooth vestiture, striate pattern and a grass-feeding larva.

However, the male genitalia did not agree with this division but instead suggested a large central homogeneous mass, from which individual genera and even species diverged. Also, many genera did not fit any of the above groups.

**Cucullinae.** Forbes considered this subfamily to be possibly polyphyletic, with two series of tribes being independently derived from the Acronyctinae [Amphipyrynae + Acronictinae]. The first series (Cuculliini, Oncocnemidini and possibly the Psaphidini) were thought to be related to *Catabena*, *Oxycnemis* and some Stiriini, while the second series (Lithophanini,

**Table 16** The classification of the Noctuidae proposed by Forbes (1954).

## NOCTUIDAE

---

Agrotinae	
	Heliothidini
	Agrotini (divided into three informal groups)
Hadeninae (divided into three informal groups)	
Cuculliinae	
	Cuculliini
	Oncocnemidini
	Psaphidini
	Cleocerini
	Lithophanini
	Antitypini
Acronyctinae	
	'First series'
	Septidini
	Apameini (divided into two unnamed, intergrading subgroups)
	Arzamini
	Phlogophorini
	Dipterygiini
	Prodeniini
	'Second series'
	Apatelini
	Stiriini
	Eudryini
	Pyrrhiini
	(the Acronyctinae also included many isolated and unplaced genera)
Acontiinae	
	Eublemmini
	Erastrini
	Acontiini
	(plus several other unplaced genera)
Euteliinae	
Sarothripinae	
Pantheinae	
Plusiinae	
Catocalinae (divided into four unnamed groups)	
Erebinae	
	Erebini
	Panopodini
	Synedini
	Anomiini
	'First miscellaneous series'
	Scoliopterygini
	'Second miscellaneous series'
	'Third miscellaneous series'
Hyphenodinae	
Hypheninae	
Herminiinae	

---

Cleocerini and Antitypini) were conceivably related to such genera as *Andropolia*, *Rhizagrotis* and some of the Septidini/Apameini complex.

The Cuculliini comprised *Cucullia* only, and appeared to be closely related to the next, the Oncocnemidini, into which it intergraded in Europe. Containing six genera, the Psaphidini showed similarities to the last two tribes, as well as to the Lithophanini and the Antitypini. The Cleocerini contained only *Cleoceris* [*Brachylomia*] and *Litholomia*, while the Lithophanini, characterised by the presence of a well-developed digitus, was considered to be the dominant

group of cucullines, with 17 included genera. Although the Antitypini formed a well-defined tribe in North America, Forbes was of the opinion that such was not the case in Europe.

**Acronyctinae [Acronictinae + Amphipyrinae].** Despite its considerable size and degree of homogeneity, Forbes was able to subdivide this subfamily into two series of six and four tribes each. In addition, there were many unplaced, isolated genera.

**First series.** This group of tribes was polythetically defined by male genitalia with a normal corona, free pleurite with muscle-plate, lobed penicillus and a well-developed digitus. Six tribes were included: Septidini, Apameini (divided into two intergrading and unnamed groups), Arzamini, Phlogophorini, Dipterygiini and Prodeniini. In addition, eight isolated genera, which had some of the features of the Septidini, remained unplaced.

**Second series.** This group of tribes was characterised by the more or less general reduction or absence of a corona and digitus, an unlobed penicillus, no free ninth pleurite, a vinculum sometimes produced as a narrow strip, and larvae that are never borers or subterranean cutworms. Four tribes were recognised: Apatelini (equivalent to the most restrictive Acronictinae of previous authors), Stiriini (e.g. *Stiria*, *Plagiomimicus*), Eudryini (*Eudryas* and *Psychomorpha*) and Pyrrhiini (*Pyrrhia* and its allies). Three groups of isolated genera were also recognised:

- (A) e.g. *Cosmia*, *Amphipyra*, with high-feeding, usually green, larvae;
- (B) *Proxenus* and *Anorthodes*, with cryptically-coloured, brown larvae, feeding close to the ground or as a cutworm; and
- (C) *Galgula*, with an unknown larva, about which Forbes would not conjecture.

**Acontiinae.** With regard to this subfamily, Forbes followed Richards (1932), but recognised three tribes, not two. The extra tribe, the Eublemini, was erected to include *Eublemma* [*Eumicremma*] only which Richards considered to be a link with the deltoids. In addition, the Tarachini were renamed the Acontiini.

**Euteliinae.** Containing three genera (*Eutelia*, *Marathyssa* and *Paectes*), this subfamily was considered to be homogeneous and was unchanged from previous works.

**Sarothripinae.** Considered to intergrade with the Nolidae in the Old World, the Sarothripinae were believed to be 'an offshoot of the ancestral Noctuid type' (cf. Richards, 1932).

**Pantheinae.** This subfamily was considered to be generally well defined, although *Raphia* differed in its naked larva and in the hair on its eyes being microscopic.

**Plusiinae.** Despite being a distinctive subfamily, Forbes considered the Plusiinae might well be combined with the primarily Old World group, the Stictopterinae. In addition to the usual genera (*Abrostola* and *Plusia* s.l.), Forbes included *Phyprosopus*, because this aberrant genus would key out to this subfamily and a better position could not be suggested.

**Catocalinae.** Forbes recognised that the distinction between this subfamily and the Erebiniae [Ophiderinae] broke down outside the Holarctic region but found it a useful concept within the North American fauna. On the basis of genitalic characters, the Catocalinae were divided into four relatively distinct groups, which were not formally named.

**Erebiniae.** Forbes used Richards' analysis as a basis for his classification of this group. He agreed with Richards that all the other quadrigene subfamilies, bar possibly the Herminiinae, could be derived from it. Because the North American genera represented diverse elements and



any classification based upon these alone would be meaningless, Forbes chose to remove only five distinct groups as tribes and left the remainder in three 'miscellaneous series' corresponding to those groups to which they had been assigned by Richards.

**Erebini.** This tribe was characterised by such features as very short discal cells and distinctive tarsal spining and included *Erebus* [*Ascalapha*], *Thysania* and *Bendis* [*Lesmone*].

**Panopodini.** From the North American fauna, only *Panopoda* was included in this tribe. However, the group was much larger in the tropics, where Forbes suggested it might need subdivision. He also considered that the catocaline group 4 (*Zale* and *Euparthenos*) could be derived from a subgroup of the Panopodini.

**Synedini.** This tribe coincided with Richards' erebine-catocaline group III and, in Forbes opinion, was very homogeneous, with the exception of *Phoberia* and *Hypocala*.

**Anomiini.** This was another tribe Forbes considered to be well founded but for which he failed to elucidate the interrelationships within the subfamily. Consisting of *Anomis* and *Alabama*, the tribe corresponded to Richards' 'extreme development of group II'. Forbes also noted a possible affinity with the *Bagisara/Elydnodes* group of the Acronyctinae, and felt also that the genera *Amyna* and *Xanthodes* might belong in the Anomiini.

'First miscellaneous series'. This group represented those genera of Richards' group II that lacked the enlarged alula of the Anomiini.

**Scoliopterygini.** This erebine tribe (containing only *Scoliopteryx libatrix*) was characterised by strongly lashed eyes and a mixture of erebine and hypenine features.

'Second miscellaneous series'. The genera comprising this series were interpreted as the most primitive erebines by Richards but Forbes considered them to grade into the first miscellaneous series, via *Hypsoropha*.

'Third miscellaneous series'. Approximately equivalent to Richards' Rivulinae, this group was a mixture of primitive erebines.

**Hypenodinae.** This group was composed of the smallest of the noctuids and was characterised by the absence of ocelli (also missing in the sarrothripine *Comachara*). Forbes was uncertain whether the group deserved subfamilial or tribal rank.

**Hypeninae.** After removal of the Hypenodinae and the Herminiinae from the deltoids, the residue was placed in the Hypeninae, distinguished by long labial palps and lashed eyes.

**Herminiinae.** Forbes included 13 genera in this subfamily, which was characterised by a prespiracular tympanal hood.

The following were considered by Forbes (1960).

**Agaristidae.** The great similarity between this family and the Noctuidae (they were 'hardly distinct from the *Eudryas*-group of the Noctuidae'; but see below) did not influence Forbes and he maintained the two as separate entities.

**Nolidae.** This family was dealt with by Franclemont, who considered it to be derived from the sarrothripine noctuids and linked to them in the Old World by such genera as *Barasa*. Thus, any resemblance to the Lithosiinae (Arctiidae) was convergent. Nevertheless, the Nolidae were allocated their time-honoured position between the lithosiine arctiids and the Euchromiidae [Arctiidae: Ctenuchiinae: Euchromiini].

The system of Forbes was generally adopted by Inoue & Sugi (1958-61), although it differed in detail in several respects:

- 1, the Heliiothidinae [Heliiothinae], Apatelinae and Cryphiinae [both Acronictinae] were elevated to subfamily status;
- 2, Forbes' informal groupings of hadenines were recognised as distinct tribes: the Poliini, Orthosiini and Leucaniini;
- 3, no subdivisions were used in the Amphipyriinae, Acontiinae or Catocalini (which also included Forbes' Erebininae);
- 4, the Hyphenodinae were not recognised.

In addition, the Sarrothripinae and Chloephorinae were merged as a single subfamily, the Nycteolinae.

This usage was important insofar as it represented the first occasion on which the new American classification had been applied to an Old World fauna.

### Tympanal organs in Europe

While tympanal organs were having far-reaching consequences in noctuid taxonomy in North America, they were being virtually ignored on the other side of the Atlantic. Only Kiriakoff paid them any attention. In a series of 15 papers between 1948 and 1960, he studied many groups of the Noctuoidea, of which four are of direct relevance to the higher systematics of the Noctuidae.

The first (Kiriakoff, 1953) concerned the Hyblaeidae and will be considered further later.

The second (Kiriakoff, 1955) concluded that the Agaristidae were very close to the Noctuidae but separable on the basis of several structures, such as the pleural bulla (a large swelling at the base of the abdomen, visible externally).

Richards (1932) was uncertain whether the tympanal hood of the nolids was pre- or postspiracular, but Kiriakoff (1958) demonstrated the latter to be the case. He concurred with Richards and placed the nolids as part of the noctuid evolutionary line.

The final groups to be studied (Kiriakoff, 1960) were the herminiines, hypenines and rivulines. He agreed with Richards' distinction of the Herminiinae on the basis of the position of the tympanal hood but could not find any specific characters to allow either the separation of the Hypeninae from the Rivulinae or the differentiation of these two subfamilies from the erebine-catocaline complex. Characters such as the double pocket IV were considered to be unreliable because they 'occur in all the groups indiscriminantly'. As a result, and contrary to Richards, the Herminiinae rather than the Rivulinae were interpreted as the most primitive noctuids.

Kiriakoff (1963) eventually went even further. He proposed a classification of the Noctuoidea based upon the 'reduced rank' system of Janse (1937-9). *Endrosa* [*Setina*], a lithosiine with an unusual tympanum, was given family status in the Noctuoidea, equivalent in rank to a more inclusive Noctuidae. This family was divided into two subfamilies, the Arctiinae and the Noctuinae. The former, characterised by a prespiracular hood and a noctuid-type tympanum, also contained, in addition to the infra-families Arctiidi and Lymantriidi, the Herminiini. Within the Noctuinae, three infra-families were recognised: the Nolidi, the Noctuidi and the Agaristidi.

Kiriakoff considered his classification superior to older schemes 'because the tympanic structures undoubtedly are the most significant single set of characters that can be found in the Lepidoptera'. However, this confidence was not shared by other lepidopterists, who treated the single character complex-based classification with scepticism. It was never adopted as a serious alternative.

### Recent developments in the U.S.A.

The latest higher classification of North American Noctuidae was presented by Franclemont & Todd (1983) (Table 17). Contrary to both Richards and Forbes, they consider the Herminiinae to be an advanced group of quadrifine noctuids, while the subfamilies closest to the ancestral stock of the Noctuidae are the Sarrothripinae and Acontiinae: Eustrotiini. Franclemont also recognises the very close similarity between the trifine subfamilies and would possibly advocate their amalgamation into a single subfamily, the Noctuinae. At most, perhaps two subfamilies

**Table 17** The most recent classification of the Noctuidae, employed by Franclemont & Todd (1983). The 'Unassociated genera' of Amphipyridae are those the authors did not assign to a particular tribe.

---

NOCTUIDAE	
	Herminiinae
	Rivulinae
	Hypenodinae
	Hypeninae
	Catocalinae
	Plusiinae
	Abrostolini
	Plusiini
	Euteliinae
	Sarrothripinae
	Risobini
	Sarrothripini
	Collomenini
	Nolinae
	Acontiinae
	Cydosiini
	Eustrotiini
	Eublemmini
	Acontiini
	Bagisarini
	Pantheinae
	Acronictinae
	Acronictini
	Bryophilini
	Agaristinae
	Amphipyridae
	Apameini
	Amphipyridini
	Stiriini
	Nocloini
	'Unassociated genera'
	Cuculliinae
	Xylenini
	Feraliini
	Psaphidini
	Oncocnemidini
	Cuculliini
	Hadeninae
	Hadenini
	Eriopygini
	Glottulini
	Noctuinae
	Agrotini
	Aniclini
	Noctuini
	Ufeini
	Heliiothinae
	[Heliiothini]
	Grotellini

---

could be recognised, the Noctuinae and the Acronictinae, the latter also including the pantheines.

**Deltoids and Catocalinae.** The deltoid subfamilies (Herminiinae, Hypeninae and Hypenodi-

nae) are largely unaltered, but there are many discrepancies with Forbes' classification regarding the remainder of the family. The Rivulinae represent the third miscellaneous series of Forbes' Erebiniae, together with one genus from the second and three others. The remaining catocalines and ophiderines are combined into one large subfamily, the Catocalinae, which is not subdivided.

**Plusiinae.** The division of this subfamily follows Eichlin & Cunningham's (1978) revision although their Argyrogrammini and Autographini are merged to form one tribe, the Plusiini. *Phyprosopus* is transferred to the Catocalinae.

**Euteliinae.** This small subfamily is unaltered.

**Sarrothripinae.** Three tribes are recognised in this group. The Risobini comprises only *Baileya*; the Sarrothripini contains *Characoma*, *Nycteola* and *Iscladia*; while the Collomenini includes *Motya* and *Collomena* (two genera not considered by Forbes).

**Nolinae.** Franclemont & Todd include this erstwhile arctiid group in the Noctuidae and thus finally make one of the moves, which although mooted for decades, no-one had previously dared to perform.

**Acontiinae.** In addition to the three tribes (Eublemini, Eustrotiini (Erastrini in Forbes, 1954) and Acontiini) previously employed, two more are also considered. The Cydosiini included only *Cydosia*, briefly discussed by Forbes under *Xanthoptera* [*Thioptera*], a genus of the Erastrini, while the Bagisarini included only *Bagisara*. This genus had been variously treated as an amphipyrene and an acontiine (the suggestion that it may belong in the latter subfamily was first made by Heinrich, 1926). Whereas Forbes treated *Bagisara* as an amphipyrene (although as an 'isolated genus'), Franclemont & Todd consider it to be an acontiine.

**Pantheinae.** This is the last quadrifine subfamily listed. The Pantheinae are removed from their Hampsonian position (before the Plusiinae, a placing followed by Forbes) and put next to the trifine subfamily Acronictinae. It would thus seem that the classification concerning the relative positions of these two groups has come full-circle.

**Acronictinae.** This subfamily is interpreted in the strict sense and is divided into two tribes, the Acronictini (*Acronicta*, *Simyra* and their allies, Forbes' Apatelini) and the Bryophilini, containing only *Cryphia*, a genus unconsidered by Forbes.

**Agaristinae.** Despite Mosher (1916) and Turner (1920), only lip-service had been paid to the high degree of similarity between this group and the Amphipyrinae. The inclusion of the agaristines as a subfamily of the Noctuidae was, like the Nolinae, the first occasion on which this had occurred in a major checklist. It is hoped that the false link with the Arctiidae and the unnecessary family rank have finally been laid to rest.

**Amphipyrinae.** The largest trifine subfamily is divided into four tribes followed by a large group of 'unassociated genera'. The Apameini is approximately equivalent to the tribes comprising Forbes' 'first series' combined, but also includes some of the 'isolated genera'. The classification of the Stiriini follows Hogue (1963) and corresponds to Forbes' Stiriini except for the removal of *Stiriodes* to the Amphipyriini. Seven genera constitute the Noctloini, none of which were treated by Forbes. The Eudryini are transferred to the Agaristinae (which Forbes considered they resembled) while the Pyrrhiini are incorporated into the Heliothinae. Of the remaining 55 genera, 30 form the Amphipyriini and 25 are 'unassociated'.

**Cuculliinae.** This subfamily is divided into five tribes. The Xylenini represents the combination of Forbes' Cleocerini, Lithophanini and Antitypini. *Feralia* is removed from the Psaphidini

to a tribe of its own (the Feraliini). This former tribe, and the Oncocnemidini and the Cuculliini, are largely unchanged.

**Hadeninae.** Unlike Forbes, Franclemont & Todd divide this group into three tribes: the Hadenini, the Eriopygini and the Glottulini. However, these groups do not correspond to Forbes' informal sections. The Eriopygini consists of a series of genera related to *Orthodes*, *Tricholita* and *Ulolonche*, while the Glottulini contains only *Xanthopastis*, a genus about which Forbes was unsure.

**Noctuinae.** The heliothines are excluded from this subfamily and the remaining genera are split among four tribes. The first three, the Agrotini, the Aniclini and the Noctuini, correspond to the first, second and third sections respectively into which Forbes divided the subfamily. The fourth tribe, the Ufeini, contains only the aberrant genus *Ufeus*.

**Heliothinae.** This subfamily comprises two tribes, most genera being included in the presumed Heliothini (the name is omitted). Following Hardwick (1970), Forbes' acronyctine tribe, the Pyrrhiini are also assigned here.

The second heliothine tribe, the Grotellini, contains only *Grotella*, *Hemigrotella* and *Neogrotella*, none of which was considered by Forbes. These genera were omitted from the Heliothidinae [Heliothinae] by Hardwick (1970), who suggested that they belonged in the Stiriinae [Stiriini] near *Stiriodes* (a genus Franclemont & Todd place in the Amphipyriini).

This then is the latest classification of the Noctuidae. It was produced from the results of many studies and is highly commendable. However, it must only be considered a starting point and it remains to be seen how well it will stand up in the face of future studies of noctuids from other parts of the world. What noctuid systematists outside North America cannot afford to do is to bury their heads in the Hampsonian sand and ignore this higher classification.

### Novel character complexes

#### *Scent brushes and hair pencils*

The presence of various brushes, hair pencils and coremata, presumed to be associated with disseminating pheromones, have long been known in the Noctuidae (e.g. Pierce, 1909). Varley (1962) reviewed the structure and function of the brush organs of a number of noctuids and, unlike Pierce (1909), considered these organs to be potentially of great taxonomic value and urged further investigation.

Such a study was eventually carried out by Birch (1972a), who described the scent-brushes of a number of trifine groups. In a second paper, Birch (1972b) dealt with the relationship between chemistry and taxonomy.

The brush-organs were found to be composed of five separate structures. Birch considered there to be a particular order in which these components were lost and from this evidence concluded that the brush-organs of the trifine noctuids had arisen only once and that if a species lacked them, then it must be because of subsequent loss. The Acronyctinae [Acronictinae] were also found to lack these organs but in their case, Birch believed that this was due to their having split from the trifine lineage before the brush-organs first arose. On the basis of the most varied structure, the Cuculliinae were considered to have diverged next, followed closely by the Noctuinae. Most genera of the latter subfamily then lost their brushes. The apex of the phylogenetic tree was composed of the hadenines and the amphipyriines, which were impossible to subdivide. Hence, despite being extremely critical of the Hampsonian subfamilies, Birch, too, eventually had to use them in his final analysis. He therefore avoided the most controversial aspect of his work, that is, that the brush-organs could have suggested groupings of genera that were considerably at variance with those currently accepted.

### Compound eyes

In an impressive study of the lepidopteran compound eye, Yagi & Koyama (1963) examined several noctuid species. Three groups of genera were recognised. Group 1 comprised catocalines and ophiderines only, while group 2 included five trifines, a plusiine and a hyphenine. The species in these two groups are all nocturnal. The third group comprised the diurnally-active genus *Hyblaea*. On the basis of eye structure, Yagi & Koyama considered the hyblaeines (and also the agaristines) ought to be separated as distinct families (see also below).

This study, although superficial from the point of view of the Noctuidae, provided yet another means by which the higher classification of the Noctuidae might in future be tested.

### A variation on the Sarrothripinae

Most workers in noctuid systematics recognise the great similarity between the Sarrothripinae and the Chloephorinae, in such features as the bar-shaped retinaculum (Hampson, volume 11), pupae (Gardner, 1948*b*) and tympanal organs (Richards, 1932). On several occasions, they had even been placed together in a separate family, the Hylophilidae (e.g. Staudinger & Rebel, 1901). Within the Hampsonian framework, the two groups were regarded as subfamilies of the Noctuidae, distinguished from each other on the basis of the presence or absence of tufts of raised scales in the forewing cell.

However, Mell (1943) considered the genera comprising the Sarrothripinae and the Westermanniinae [Chloephorinae] not to be sufficiently distinct to be worth regarding as separate subfamilies. Nor did he consider that they warranted even tribal status. Instead, Mell divided the more-inclusive Sarrothripinae into eight tribes and one species group, thus:

- 1, Eligmini – *Eligma*, *Selepa*, *Triorbis*, *Gadirtha*, *Lamprothripa*;
- 2, Sarrothripini – *Sarrothripus* [*Nycteola*], *Bryophilopsis*;
- 3, Risobini – *Risoba*;
- 4, Blenini – *Blenina*;
- 5, Hylophilini – *Earias*, *Hylophilodes*, *Clethrophora*, *Hylophora* [*Pseudoips*], *Chloephora*;
- 6, Cymatophoropsiini – *Cymatophoropsis*;
- 7, Ariolicini – *Sinna*, *Gabala*, *Siglophora*, *Ariolica*;
- 8, Species-group *Tatothripa-Tympanistes*;
- 9, Careini – *Carea*, *Nertobriga*.

Of these, 2–4 contain only sarrothripines; 5, 7 and 9 only chloephorines; 1 is mainly sarrothripine with one chloephorine (*Eligma*); 8 also contains representatives of both (*Tympanistes* is the chloephorine); while 6 contains a genus currently assigned to the Ophierrinae. Unfortunately, no comparison is possible between the tribes of Mell and those of Franclemont & Todd (1983) because there are no genera held in common except *Sarrothripus* [*Nycteola*].

This expanded concept of the Sarrothripinae was employed by Aubert & Boursin (1953), although the impoverished European fauna resulted in only two tribes being required, which, perhaps conveniently, corresponded to the previously accepted groups of the Sarrothripinae (as Sarrothripini) and the Chloephorinae (as Benini, = Hylophilini sensu Mell). Probably because the genera are mostly tropical, Mell's divisions have been largely ignored, and their usefulness, if any, must await a world-wide reappraisal of the group.

Mell (1943) also erected a new noctuid subfamily, the Camptolominae. This contained only *Camptoloma*, a genus that had until then been considered to be arctiid. Mell included it in the Noctuidae on the basis of forewing venation, and considered it close to the hylophiline sarrothripines because of similarities in the genitalia and immature stages. Inoue & Sugi (1958–61) considered the genus to be worthy of a separate family, while Nye (1975) and Inoue *et al.* (1982) place it in the Arctiinae. The systematic position of this genus remains in doubt but Inoue (pers. comm. to A. Watson) believes it to be more closely related to the Arctiidae than to the Noctuidae.

### The removal of *Hyblaea*

The hyblaeines are small moths that superficially resemble stocky tortricids or miniature hypocalas (Noctuidae: Ophiderinae). On the basis of the latter resemblance, the group had long been considered to belong to the Noctuidae. Its position, as a subfamily of the Noctuidae, was virtually stabilised when it was accepted by Hampson. This was in spite of the well-developed maxillary palps, a feature unique in the Noctuidae.

The edict was first challenged by Comstock (1925) who considered the hyblaeines to be more closely related to the Thyrididae and placed the group accordingly after the pyraloids. The pupa was examined by Forbes (1933) and the supposed pyraloid affinities strengthened.

A thorough morphological study of the adult teak moth, *Hyblaea puera*, was performed by De Koning & Roepke (1949). They rejected the noctuid status of the species on the basis of:

- 1, absence of tympanum;
- 2, presence of three-segmented maxillary palps;
- 3, presence of an unusual secondary sexual organ on the male hind-tibia;
- 4, a tridentate uncus.

This last character agreed with the Thyatiridae (Pierce, 1909) but De Koning & Roepke could not include *Hyblaea* in this family because of venational differences. They also disagreed with Forbes (1933) contention that *Hyblaea* was pyraloid, although they were unable to suggest an alternative position.

Kiriakoff (1953) also noted a tympanum to be lacking in *Hyblaea* and therefore could not include the genus in either the Noctuoidea or in the Pyraloidea. Kiriakoff also reappraised the other structural characters of the Hyblaeidae. Although the family had much in common with the Tortricoidea, he eventually decided it represented a new superfamily, the Hyblaeoidea, related to the Notodontoidea and the Noctuoidea ('dans la sous-cohorte des Noctuiformes') but which had diverged from the main stem before the development of the thoracic tympanal organ in the latter groups. Later (Kiriakoff, 1963), he changed his mind, placing the Hyblaeidae in the Tortricoidea, and concluding that the family had nothing to do with the Noctuiformes after all. Despite this, most authors continued to regard the hyblaeids as either a family near the Noctuidae (e.g. Inoue & Sugi, 1958–61; Yagi & Koyama, 1963) or as a subfamily thereof (e.g. Viette, 1961).

Brock (1971) also excluded the hyblaeids from the Pyraloidea, including them in a new superfamily, the Aegerioidea, together with the Aegeriidae and the Dudgeoneidae. Pinhey (1975) noted the transfer but retained the hyblaeids at the head of the Pyraloidea.

Although Common (1975) criticised some of Brock's conclusions, the Hyblaeidae were not mentioned. However, Nye (1975) considered the Dudgeoneidae and the Hyblaeidae as pyraloid. Until the early stages are better known, the exact position of the Hyblaeidae remains doubtful.

### *Diloba*: full circle – and back again?

The early history of the aberrant species *Diloba caeruleocephala* was briefly discussed above. Several shifts in its systematic position had left it in the Plusiinae (Hampson, volume 13).

Richards (1932) examined the tympanum and found it to be typical of the Acronyctinae [Acronictinae + Amphipyrrinae] and particularly similar to that of *Trachea*. Beck (1960) also included *Diloba* in the Apatelinae [Acronictinae] although the larva was aberrant in no less than six characters. However, most authors continued to consider it as either a pantheine (e.g. Aubert & Boursin, 1953; Heslop, 1960) or as a plusiine (South, 1961). Pierce & Beirne (1941) alone placed the species in the Lymantriidae, on the basis of the male and female genitalia.

Kiriakoff (1970) disagreed with Richards' (1932) conclusions, considering the tympanal organ of *Diloba* to be distinctly notodontid. However, *Diloba* differed from the Notodontidae in possessing 'a paired abdominal bulla operculated by the counter-tympanum, not unlike the structure found in the family Agaristidae' [Agaristinae]. Thus Kiriakoff found it necessary to place *Diloba* in the monobasic family, Dilobidae.

Tams (quoted in Varley, 1962, and pers. comm. to I. W. B. Nye, 1970) believed *Diloba* to be related to the cuculliine *Psaphida*. Minet (1982) reappraised the previous work on the tympanum and concluded that Richards (1932) had been correct in his interpretation and that Kiriakoff (1970) had been wrong. In addition, Minet (1982) suggested that *Diloba* fitted perfectly into the Cuculliinae (lashed eyes, obsolescent  $M_2$  on the hindwing, cf. Hampson) and thus supported Tams' contention. Additional characters from the immature stages were used to support the inclusion of *Diloba* in the Noctuidae: eggs with radial ribs from the micropyle; larva with a prothoracic gland produced 'vertically' (as opposed to 'transversely' as in the Notodontidae) and having only a single pair of MD setae in the last larval instar (although this last character is plesiomorphic and therefore 'n'est pas significatif'). Minet did not apparently compare the genitalia of *Diloba* with those of cuculliines such as *Psaphida*.

Overall, however, the current consensus places *Diloba* either in the Notodontidae (a position followed by Kloet & Hincks, 1972; Bretherton *et al.*, 1979; Nye, 1975) or as a separate family (followed by Watson *et al.*, 1980; Leraut, 1980).

It would thus seem that, like the Hyblaeidae, the systematic position of *Diloba* is open to question yet. However, unlike the former, the problem of the affinities of *Diloba* is still firmly within the field of noctuid systematics.

## The neglected arrangement

### Preamble

By the 1920s, Hampson's system seemed to be the final word in noctuid higher classification. However, even before the dissatisfaction of workers such as Forbes set in, not all taxonomists were happy to accept the Hampsonian subfamilies. In particular, the amateur English lepidopterists rejected them, preferring to follow Meyrick, or even Guenée. After all, a new arrangement would have meant them re-ordering their collections. Eventually a classification arose that evolved into an arrangement of subfamilies which, although currently almost forgotten, bears much in common with the divisions of the Noctuidae employed recently by Franclemont & Todd (1983).

### The demise of the systems of Guenée, Staudinger & Rebel and Tutt

The early part of the twentieth century saw the virtual disappearance of the noctuid classification of Guenée (1852–4) and those derived directly from it.

In his *Moths of the British Isles*, South (1908–9) followed the division of the Noctuidae employed by Staudinger & Rebel (1901). This survived until the revision by Edelsten & Fletcher (South, 1961), when the classification of Hampson was substituted.

Following the death of Tutt in 1911, a supplement to his *British Noctuae* was produced by Turner (1926–48). Although he discussed the classifications of the noctuids used by Hampson and in 'Seitz', in order to be consistent with Tutt's earlier work, Turner employed the arrangement used therein, namely that of Guenée. Thus Tutt's classification of 1902 fell into disuse. It was eventually followed by that of Guenée; Turner's usage was its last.

### The English 'amateur' system

#### Origins

In 1907, Kirby published his *Butterflies and Moths of Europe*. In this, he acknowledged the classification of Staudinger & Rebel (1901) but preferred to use one of his own. This divided the Lepidoptera into 'macros' and 'micros'. The former was then further split into five 'superfamilies': Rhopalocera, Sphingae, Bombyces, Noctuae and Geometrae. Although Kirby removed the Cymatophoridae [Thyatiridae] from the Noctuae to the Bombyces (this heterogeneous group also contained the Nycteolidae [Sarrothripinae] and Chloephoridae [Chloephorinae]), the Noctuae still included the Brepidae [Geometridae: Archiarinae]. The remaining noctuids



were distributed among 18 subfamilies (Table 18), which appeared to have something in common with those of Herrich-Schäffer (1845) and part with those proposed by Grote in the 1880s and 1890s (see Tables 5 and 7), but also included some apparent influence from Hampson.

The Bombycoidae, a name which in various forms had previously been used to refer to several groups, here contained *Diloba* and the pantheines. These were followed by the Acronyctidae [Acronictinae] which, although it included *Bryophila* [*Cryphia*], omitted *Arsilonche* [*Simyra*] and *Simyra*. These last two genera were placed at the head of the subsequent group, the Orthosidae. This subfamily, which had previously been regarded as five (Leucaniidae, Caradriidae, Orthosiidae, Cerastidae, Amphipyridae; Herrich-Schäffer, 1845), consisted mainly of hadenines, cuculliines (e.g. *Agrochola*) and amphipyridines, with minor representation from the Acronictinae (e.g. *Simyra*) and Ophiderinae (*Scoliopteryx*).

The Agrotidae, comprising mainly *Agrotis* (s.l.) and *Triphaena* [*Noctua*], was broadly equivalent to the Noctuinae, although it did include *Brithys*, a hadenine. The Hadeninae contained the balance of the hadenines and amphipyridines.

There followed several small subfamilies. The Xylinidae (e.g. *Xylyna* [*Lithophane*], *Calocampa* [*Xylena*]), Cleophanidae (e.g. *Calophasia*, *Cleophana* [*Calophasia*, part]) and Cuculliidae (*Cucullia* only) contained most of the present Cuculliinae, although the first also included *Xylomiges* [*Egira*] (Hadeninae).

The Euteliidae (cf. Eurhipiidae in the introduction to Kirby, 1907, and Table 18) and the Heliothidae corresponded to the present subfamilies of the same names (the latter included *Pyrrhia* and its relatives). The next subfamily, the Anartidae, conformed to the residue of Warren's (1906-14) Heliothidinae after the removal of the true heliothines and it may be that Warren took over the concept from Kirby and expanded it. The Anartidae included representatives of the Amphipyridinae (*Euterpia* [*Enterpia*], *Heliaca* [*Panemeria*]), Noctuinae (*Cyrebia*), Hadeninae (*Anarta*) and Cuculliinae (*Omia*).

The Plusiidae included *Telesilla* [*Eucarta*], as well as the usual genera, *Abrostola* and *Plusia* (s.l.), while the Calpidae contained only *Calpe* [*Calyptra*]. The Acontiidae, including *Acontia* [*Tyta*], *Armada* [*Tarachepia*] and *Acontiola* [*Eustrotia* and *Ozarba*], was a mixture of ophiderines and acontiines. Most of the remaining catocalines and ophiderines were divided between the Catocalidae (e.g. *Catocala*, *Zethes*, *Aedia*) and the Ophiuinae (e.g. *Apopetes*, *Ophiusa* [*Lygephila*]). These two groups also contradicted those that Kirby, in his introduction (Table 18), said he was going to use (Ophiuinae and Toxocampidae).

**Table 18** The subdivisions of the Noctuae [Noctuidae] employed by Kirby (1907).

---

NOCTUAE

Bombycoidae  
 Acronyctidae  
 Orthosidae  
 Agrotidae  
 Hadenidae  
 Xylinidae  
 Cleophanidae  
 Cuculliidae  
 Eurhipiidae  
 Heliothidae  
 Anartidae  
 Plusiidae  
 Calpidae  
 Acontiidae  
 Ophiuinae  
 Taxocampidae  
 Noctuophalaenidae  
 Deltoidae  
 Brephidae

---

The Noctuo-phalaenidae included the rest of the acontiines and the ophiderine, *Rivula*. The Noctuae finished with the Deltoidae (including the ophiderines *Laspeyria* and *Parascotia*) and the Brepidae.

### Development

The arrangement of Kirby (1907) formed the basis of the system adopted by Heslop (1945) in his checklist of British Lepidoptera. It should be noted that Heslop, like many other earlier authors of checklists and catalogues, employed no new research, relying entirely upon the studies of others. His arrangement of the various groups was probably governed as much by personal taste as it was by explicit characters. Whatever his reasons, Heslop, again like many of his predecessors and several workers subsequently, never published his argumentation, thus rendering it virtually immune from objective criticism.

The noctuids were classed in the superfamily Agrotides and, following Meyrick (1928), divided into two families, the Caradrinidae and the Plusiidae.

Ten subfamilies were recognised in the Caradrinidae. Eight corresponded to those of Kirby: Mominae (Kirby's Bombycoidae), Acronictinae (Acronyctidae), Hadeninae, Caradrininae (Orthosiidae), Xyleninae (Xylinidae and also including the Cleophaenidae), Cuculliinae, Anartiinae and Heliolithinae. The Agrotidae was split into two groups, the Agrotinae and the Triphaeninae. The Euteliinae have no British representatives.

The Plusiidae contained five subfamilies. The Catocalidae and Ophiuridae were combined under the Catocalinae, while the Acontiidae and Noctuo-phalaenidae merged to become the Eustrotiinae [Acontiinae]. The Deltoidae became the Hypeninae while the Plusiinae remained unaltered. *Scoliopteryx* was removed from the Orthosiidae and placed in a separate quadrifine subfamily, the Gonopterinae. The Brepidae, although listed after the Hypeninae, had been moved across to head the Geometridae as a subfamily of the Monoctenidae. In common with Kirby, Heslop placed the Westermanniinae [Chloephorinae] and Sarrothripinae, as subfamilies of the Hylophilidae, in the Bombyces.

Several changes were evident in the classification employed by Heslop (1960) in his revised checklist. Some subfamilies had been renamed as a result of considerable reassessment of the application of generic names that had been performed in the interim.

The superfamily was now known as the Noctuoidea, and the Caradrinidae as the Noctuidae. Similarly, the Triphaeninae had become the Noctuinae. The Hadeninae and Caradrininae had undergone extensive reassortment and had been divided into no less than seven subfamilies:

- 1, Hadeninae – those currently recognised hadenines, less the next two groups;
- 2, Orthosiinae – *Orthosia* and *Panolis*;
- 3, Leucaniinae – the hadenine wainscots;
- 4, Nonagriinae – the amphipyrene wainscots and *Stilbia*;
- 5, Caradrininae – *Caradrina* and its close relatives, *Meristis* and *Laphygma* [*Spodoptera*, part];
- 6, Apameinae – *Apamea*, *Luperina* and their allies, including also *Prodenia* [*Spodoptera*, part];
- 7, Amphipyrinae – the remaining amphipyrenes, e.g. *Hydraecia*, *Cosmia*, *Mormo*.

Two series, 1–3 and 4–7, can be recognised as equivalent to the present Hadeninae and Amphipyrinae respectively.

The Acronictinae became the Apatelinae and finally, the cuculliine section of Kirby's Caradrinidae (e.g. *Antitype*, *Agrochola*, *Cirrhia*) was removed and established as the Dasy-poliinae.

The second family of noctuoids was the Hylophilidae, finally recognised by Heslop as correctly belonging with the noctuids, and the third was the Plusiidae. The subfamilies of the latter group now largely agreed with those of Hampson, except that the Gonopterinae was retained. Consequently, the Pantheinae was moved into the Plusiidae from the Caradrinidae, and *Parascotia* and *Laspeyria* were transferred from the Hypeninae to the Ophiderinae.

Apart from combining the Xyleninae and the Dasy-poliinae under the former name, the arrangement of Heslop (1960) was faithfully followed by Chalmers-Hunt (1962–8).

**Was Heslop on the right track?**

The most fascinating aspect to Heslop's (1960) classification of the Noctuidae is the degree to which it parallels that recently employed by Franclemont & Todd (1983). The two are compared in Table 19, demonstrating the considerable concordance, especially in the trifine subfamilies. There are, however, several discrepancies, which ought to be discussed further.

The British deltoïd fauna is impoverished relative to that in North America (13 species, excluding *Laspeyria*, as opposed to 82) and so it is not perhaps surprising that Heslop did not consider it necessary to divide the Hypeninae, particularly as the study of the tympanal organ had not been influential in British noctuid systematics.

**Table 19** A comparison of the higher classifications of the Noctuidae proposed by Heslop (1960) and Franclemont & Todd (1983).

<i>Heslop</i>	<i>Franclemont &amp; Todd</i>
PLUSIIDAE	NOCTUIDAE
Hypeninae	{ Hermiiniinae
	{ Hypenodinae
	{ Hypeninae
Ophiderinae	{ Rivulinae
Catocalinae	{ Catocalinae (part)
Plusiinae	Catocalinae (part)
Eustrotiinae	Plusiinae
Pantheinae	Acontiinae
—	Pantheinae
[Nolidae (Bombycoidea)]	Euteliinae
	Nolinae
HYLOPHILIDAE	
Sarrothripinae	Sarrothripinae
Westermanniinae	—
NOCTUIDAE	
Apatelinae	Acronictinae
—	Agaristinae
Cuculliinae	Cuculliinae: Cuculliini
Xylenini	Cuculliinae: Xylenini
Dasypliinae	
Amphipyriinae	Amphipyriinae: Amphipyriini
Caradrininae	
Apameinae	Amphipyriinae: Apameini
Nonagriinae	
Leucaniinae	
Orthosiinae	Hadeninae: Hadenini
Hadeninae	
Anartinae	
Heliiothinae	Heliiothinae: Heliiothini
Noctuinae	—
Agrotinae	Noctuinae

Heslop also retained Hampson's division into Catocalinae and Ophiderinae, including in the latter, the Rivulinae, another subfamily recognised mainly on the basis of tympanal characters. Heslop's reasoning probably coincided with that of Forbes (1954) on the same subject. However, Heslop did separate *Scoliopteryx* into the Gonopterinae. Franclemont & Todd included this genus in the Catocalinae. The Plusiinae, Acontiinae, Sarrothripinae and Acronictinae were recognised by both systems in equivalent terms (allowing for Heslop's inclusion of *Telesilla* [*Eucarta*] in the Plusiinae and his separation of the sarrothripines, together with the Westermanniinae [*Chloephorinae*], into the family Hylophilidae).

Within the trifines, the amphipyriine genera were divided into four subfamilies by Heslop. Of

these, the Apameinae and the Nonagriinae, are approximately equal to Franclemont & Todd's Apameini, although this tribe also includes *Hydraecia*, a genus Heslop placed in the Amphipyriinae. The second two of Heslop's subfamilies, the Amphipyriinae and the Caradrininae, roughly equate to Franclemont & Todd's Amphipyriini, with a few exceptions (e.g. *Prodenia* [*Spodoptera*] *litura*, which is in Heslop's Apameinae).

The cuculliine genera were placed by Heslop into three subfamilies. The Cuculliinae is equivalent to Franclemont & Todd's Cuculliini, while the Dasypliinae and Xyleninae combined approximate their Xylenini. Interestingly, if *Jodia* and *Eupsilia* are incorporated from the Xyleninae, the Dasypliinae equates to Forbes' (1954) Antitypini. The residual xylenines are then equivalent to Forbes' Lithophanini.

Heslop divided the hadenines into four subfamilies, all of which are included in Franclemont & Todd's Hadeninae: Hadenini. The two concepts of the subfamily Heliiothinae agree although a more accurate equivalence would be between Heslop's Heliiothinae and Franclemont & Todd's Heliiothinae: Heliiothini.

There are no North American representatives of those genera (*Mesogona*, *Euschesis* [*Noctua*, part], *Noctua* and *Lampra* [*Noctua*, part]) that Heslop placed in the Noctuidae, and thus his Agrotinae equates with the Noctuidae of Franclemont & Todd. However, on nomenclatural grounds, the Noctuidae (or at least *Noctua*) would belong in the Noctuidae of Franclemont & Todd, which also includes several agrotines *sensu* Heslop. The two systems are therefore in disagreement. Forbes (1954) had already noticed this discrepancy between the European and American systems and considered the reason to be that 'European tradition has treated the whole group [Noctuidae] as a single genus, except a few species (not in fact closely related to each other) with yellow hindwings. There is no agreement [with his classification] as to this subdivision'.

However, overall and considering that the two systems are based upon more or less exclusive faunas, the classifications of Heslop (1960) and Franclemont & Todd (1983) are remarkably similar. It seems likely that a reassessment of the European fauna along the lines of that of North America would result in relatively few changes in subfamily/tribal placings with respect to Heslop's groupings. The inescapable conclusion is that the English amateur lepidopterists, in refusing to accept Hampson's system, and choosing to follow Kirby and Heslop instead, were more correct than perhaps they imagined.

## Quo vadis, *Noctua*?

### Introduction

That the higher classification of the Noctuidae is in disarray and in need of extensive re-evaluation is probably the only point on which all workers in the field agree. The Hampsonian system still maintains a considerable influence, despite many efforts to loosen its stranglehold, and in this respect very little advance has been made since 1920. However, current changes in attitudes probably mean that the days of the Hampsonian system *per se* are numbered, although there remains a vast amount of work to be done before an adequate replacement can be proposed.

To this end, I will first consider the individual subfamilies, illuminating those areas where I consider future research could be most usefully directed. Secondly, I present an outline cladistic analysis of the higher classification of the Noctuidae. This should not be considered as a 'new system', but merely as the first step towards the production of one. I do not expect everyone (or even anyone) to agree with all of my interpretations and conclusions, but I hope the result will be to generate renewed interest in noctuid higher systematics.

### The individual subfamilies

**Arctiidae: Aganainae.** This group of moths has been consistently placed in the Arctiidae or else treated as a separate family closely related to the arctiids. Its importance regarding the higher systematics of the Noctuidae lies in its possible future transfer to that family.

A relationship between the Noctuidae and the Aganainae was first tacitly suggested by Gardner (1941) on the basis of larval characters. The two current aganaine species that he examined, *Hypsa* [*Asota*] *alciphron* and *H.* [*Psephea*] *ficus*, agree with the Noctuidae in having a single subventral seta on the meso- and metathorax (but see below). This contrasts with the bisetose condition found in the Arctiidae (the third 'aganaine' examined by Gardner, *Digama hearseyana*, which has a bisetose SV group, is currently placed in the Arctiinae). However, Gardner refrained from uniting the Noctuidae and Hypsidae [Aganainae], mainly because the latter lacked the ventral prothoracic gland found in the larvae of the former.

The discovery of the tymbal organ in the Arctiidae (Forbes & Franclemont, 1957; Blest *et al.*, 1963) provided a potential apomorphy by which the family could be characterised. However, its occurrence is not universal. The structure is conspicuously absent in the aganaines and a few wasp-mimicking ctenuchines (A. Watson, pers. comm.). It can be argued that the loss of the tymbal organ (and also the tympanal organ in a few species) in the latter group is concurrent with the general reduction and high degree of modification of the thoracic sclerites that has occurred in order to produce the hymenopteran facies. Tymbal loss cannot be so convincingly argued for in the aganaines, especially as it is lacking in all genera and not just a few as in the Ctenuchinae. Thus, if the Arctiidae were to be redefined, employing the presence of the tymbal organ as a synapomorphy, then the Aganainae would have to be excluded. Franclemont & Todd (1983) considered the aganaines to be 'probably an aberrant group of Noctuidae'. However, the aganaines have a pre-spiracular tympanal hood (Richards, 1932), and for this reason, I would choose to exclude them also from the Noctuidae (see Herminiinae below). The net result of these character interpretations would be the reinstatement of the Aganidae as a separate family.

**Herminiinae.** Recognised as a distinct subfamily of noctuids by several pre-Hampsonian authors (e.g. Herrich-Schäffer, 1845; Grote, 1890; Smith, 1895), the Herminiinae were considered by Hampson as part of the Hypeninae. Forbes (1918) resurrected the subfamily on the grounds of the possession of a pre-spiracular tympanal hood but the exact position of the Herminiinae within the Noctuidae remained unsettled.

The primitive position of the hood was used by Kiriakoff (1963) to argue for the exclusion of the Herminiinae from the Noctuidae and their placement within a more-inclusive 'Arctiinae'. This conclusion, however, is disputed. Richards (1932) did not consider that the Herminiinae were the most primitive noctuids, on the grounds that the 'basal group' of genera (*Paraherminia* [*Paracolax*] and *Dercetis* [*Redectis*]), which were determined as the most primitive herminiines on other characters, had the spiracle 'slightly under (ventro-anterior to) the greatly reduced hood'. Thus, Richards implicitly treated the pre-spiracular hood in the herminiines as a character reversal, a position supported recently, without further elaboration, by Franclemont & Todd (1983). I remain unconvinced and maintain that the herminiine pre-spiracular hood does represent the plesiomorphic state. If this is accepted, then, in the absence of other evidence to the contrary, the subfamily must be considered to form the sister-group of the remaining noctuids, and represents an analogous situation to that between the Arctiidae and Aganainae. If the Noctuidae were to be defined by the possession of a post-spiracular hood, the herminiines would have to be excluded. Characterisation of the resultant 'Herminiidae' would be possible on the basis of the swollen metepimeron ventral to pocket IV and perhaps the modifications of the forelegs and antennae in the males.

The results of a cladistic analysis under the alternative interpretation of polarity are less satisfactory. Following the strict cladistic approach to loss characters (Patterson, 1982), reversion of the tympanal hood to a pre-spiracular position could not be used to justify the monophyly of the Herminiinae and would also cast doubt on the use of the post-spiracular hood to characterise the family Noctuidae. If this latter character state was then rejected, we should be left in the extremely unsatisfactory position of having a family of 25,000 species *completely uncharacterised*.

Cladistics aside, however, there is little doubt that a pre-spiracular hood is a good diagnostic character for recognising the herminiines (assuming that they can be differentiated from the

aganaines). Their separation from the other 'deltoid' groups has so far only been performed for the North American fauna.

**Rivulinae.** First proposed by Richards (1932), and then also including the genera currently assigned to the Hypenodinae (q.v.), the Rivulinae was interpreted as being the most primitive noctuid subfamily. However, it was also the most difficult for Richards to characterise and thus its status is highly questionable. Forbes (1954) rejected the Rivulinae, referring most of its genera to the Erebiniae, as his third miscellaneous series. Likewise, Kiriakoff (1960) considered the Rivulinae to be insufficiently differentiated and placed both it and the Hypeninae in the Catocalinae-Erebiniae complex. Recently, only Franclemont & Todd (1983) have employed the group.

At present, there appear to be no good characters on which to base the Rivulinae. Within the subfamily, Richards included those 'primitive' noctuids that could not be placed in either the Herminiinae or Hypeninae. The rivuline genera were thus characterised by a post-spiracular hood, unlashd eyes and short labial palps, characters that can all be interpreted as inapplicable at the level of universality relevant to the Rivulinae. Thus, the monophyly of the subfamily is unsubstantiated and it remains to be seen whether future studies will reveal any additional characters to suggest the Rivulinae is not a non-group.

**Hypenodinae.** Like the preceding two subfamilies, the Hypenodinae had been recognised only in the North American fauna. Characterisation of the group is weak. Richards (1932) included the hypenodine genera in the Rivulinae, which, given the vague nature of that group, is unsatisfactory. Forbes (1954) defined the hypenodines primarily on the lack of ocelli but, as mentioned above, such a feature is inadmissible in a strict cladistic framework. Other unifying characters may exist and were hinted at by Forbes (the subfamily is 'rather homogeneous in other structures'; 1954: 381) but their exact nature is unknown. Overall, while it remains possible that the Hypenodinae is a real entity, at present it cannot be stated with certainty. Further work on other faunas is necessary before a definitive conclusion can be reached.

**Hypeninae.** The Hypeninae was characterised by Hampson primarily by the hindwing vein  $M_2$  arising from well above the lower angle of the cell and running parallel to  $M_3$ . Under such a definition, the subfamily also included the hypenodines and the herminiines.

Richards (1932) found the Hypeninae (s.str.) to be reasonably well characterised tympanally, and that, in addition, they possessed lashed eyes. The latter state is also found in the Plusiinae, Cuculliinae and the ophiderine *Scoliopteryx*. The tympanum and larvae of the last genus also resembled those of the Hypeninae (Richards, 1932: 14). Forbes (1954) added the character state of 'long and obliquely porrect [palps], normally twice as long as [the] head, with a rather long, porrect third segment'. Although it is probable that the Hypeninae, as restricted by Richards and Forbes, and employed recently by Franclemont & Todd (1983), does represent a monophyletic unit (sensu Farris, 1974), more work remains to be done. Further studies of the other deltoid subfamilies are also required in order to clarify the interrelationships of these much underworked and neglected yet phylogenetically important noctuids.

**Catocalinae.** The general consensus of opinion, faunal advantages notwithstanding, is that the division of this very large group of moths into the Catocalinae and the Ophiderinae, on the basis of mid-tibial spining, is entirely artificial and should be abandoned. However, the result of such action is a subfamily containing in excess of 10,000 named species, and probably many more awaiting discovery and description. Subdivision of this large group is therefore necessary. There are homogeneous groups of genera contained within the Catocalinae (s.l.); based around, for example, the genera *Catocala*, *Erebus*, *Parallelia*, *Anomis* and *Drasteria*, which can be defined by various structural features. However, the genera concerned represent only a very small proportion of the subfamily and the work required to completely order the Catocalinae (s.l.) is immense. Doubtless, further knowledge of the immature stages will prove invaluable – for

example, the Anomiini have malvaceous-feeding larvae; Forbes (1954: 367) – but so few are currently known that even their potential is largely unknown.

What is required is a piecemeal dissection of the group; the removal of the homogeneous generic groupings, perhaps as provisional tribes; followed by studies of the numerous isolated genera; leading finally to a coherent system. The task is so vast as to almost deny the possibility of success, especially when it is remembered that the Catocalinae may be polyphyletic with respect to the Hypeninae, Rivulinae, Hypenodinae and Acontiinae. Nevertheless, the attempt must be made, for the current state of knowledge, Richards' and Forbes' work on the North American fauna aside, is negligible.

**Plusiinae.** Of this subfamily, Richards (1932) stated that 'this is the most homogeneous and distinct of all the quadrifid groups'. Certainly, the plusiines have been recognised from the very earliest days of noctuid systematics as a natural group, but even so, their separation from the other subfamilies has been difficult. To Hampson, the plusiines were the lashed-eyed, non-deltoid, quadrifine noctuids. However, as previously noted, exceptions to this rule exist. Both *Scoliopteryx libatrix* and *Phyprosopus callitrichoides* have lashed eyes, while the eyes of the plusiine genus *Pseudeva* 'do not appear to be lashed' (McDunnough, 1944: 213).

Mosher (1916) found that the pupae of the Plusiinae showed a number of differences from those of other noctuids, most notably in the position of the labrum and the ventral extension of the wings and proboscis beyond the posterior margin of abdominal segment 4. The Plusiinae were further characterised by Richards (1932), who discovered that its members possessed a double tympanic hood and a swollen metepimeron formed by a greatly enlarged pocket IV.

Recently, Eichlin & Cunningham (1978) proposed three tribes within the Plusiinae. Of these, the Abrostolini is the best candidate for monophyly, based on the form of the clavus in the male genitalia. The Argyrogrammini is demonstrably paraphyletic, while there are doubts as to the monophyly of the Plusiini (Eichlin & Cunningham's 'Autographini') because it is primarily based on a character loss (absence of prolegs on abdominal segments 3 and 4). However, this is perhaps excusable given that the authors did not propose a cladistic classification. All three tribes may yet prove to be monophyletic but the study needs to be extended to the tropical faunas before this can be confirmed.

As to the position of the subfamily within the Noctuidae, the Plusiinae lack the proposed apomorphies of the Catocalinae (the fused pleural sclerite, J. D. Lafontaine, pers. comm.; and the bloom on the pupa, Mosher, 1916) and so it is likely that their affinities will prove not to be with that subfamily. It is possible that the plusiines will be demonstrated to be related to certain trifine groups, possibly parts of the Cucullinae, Amphipyrynae or Heliiothinae (see also below), but this is presently speculative.

**Stictopterinae.** Hampson characterised this subfamily primarily by the simplified female frenulum (the frequently used description 'single' is misleading, as the frenulum in female stictopterines often consists of more than one bristle, which are closely appressed and very difficult to discern; A. H. Hayes, pers. comm.) and the presence of tufts of raised scales in the forewing cell. Richards (1932) considered the stictopterines to be very close to the plusiines but he only examined two species of the genus *Stictoptera* (*S. melanistis*, from the Old World, and *S. clara*, a Neotropical species that should be referred to a separate genus; J. D. Holloway, pers. comm.). Both were found to possess a tympanal hood with a ventral second lobe. In *S. melanistis*, this lobe was large enough to give the impression of a double tympanal hood, similar to that found in the Plusiinae.

The lack of stictopterines in North America has resulted in very little structural information being collected for the group (*S. clara* probably never reaches north of Mexico and Cuba, despite a paratype of *S. phryganealis* [a synonym of *S. clara*] in the BMNH bearing the locality 'West Coast of America'. This designation of Walker's often meant the west coast of Central America, or even the Galapagos Islands; Hayes, 1975: 165–7). This situation will be partially alleviated in a forthcoming revision of the Bornean stictopterines by J. D. Holloway. Nevertheless, further study is required to ascertain the interrelationships of the genera and the position of

the subfamily within the Noctuidae. It is likely that the Stictopterinae will prove to be closely related to the Plusiinae, but whether it represents the sister-group of the latter remains to be demonstrated conclusively.

**Euteliinae.** Unlike many other noctuid subfamilies, several good apomorphies are known for the Euteliinae. However, none of these occurs in the morphology of either the tympanal organs or the larvae. Richards (1932) found that the tympana of the euteliines could be derived from either the catocaline (s.l.) or the acontiine types and he was unable to place them on his phylogenetic tree (Fig. 3). Similarly, Gardner (1948*a*) discovered no unifying characters in the larvae. In contrast, he (Gardner, 1948*b*) found a combination of characters in the pupae that sharply defined the Euteliinae, of which the complete lack of a cremaster was the most characteristic (although the cremaster is also absent in the Sarrothripinae and Chloephorinae; Mosher, 1916; Gardner, 1948*b*). Forbes (1954) noted that the larvae were almost completely restricted in their foodplants to members of the Anacardiaceae (although some feed on Combretaceae and Hamamelidaceae; Mell, 1943) and that the adults typically 'rest with the fore wings crumpled and partly rolled about the hind wings, and standing out obliquely to the strongly upcurved abdomen'.

The subfamily is probably monophyletic on the basis of the above characters and other, as yet undescribed, structural features (J. D. Holloway, pers. comm.). The problem of where the Euteliinae fit within the Noctuidae remains, however. The reduced female frenulum could represent a synapomorphy linking the euteliines and stictopterines, but as a loss character, it does not form very strong evidence. Similarly, the lack of a cremaster, a feature also shared with the Sarrothripinae, Chloephorinae and possibly the Nolinae is also weak. Otherwise, the euteliines are very distinct and their interrelationships with other noctuid groups are far from clear.

**Chloephorinae.** With the transfer of *Bagisara* to the Acontiinae (Heinrich, 1926) or Amphipyriinae (Forbes, 1954), and *Ipimorpha* to the Amphipyriinae (Forbes, 1954), the Chloephorinae ceased to be represented in the North American fauna. Consequently, little is known of the morphology of the group. Richards (1932) found the chloephorines combined the characters of both the acontiine tribes (Erasiriini [Eustrotiini] and Tarachini [Acontiini] and believed the group to be derived from the higher Acontiinae. Mell (1943) considered the Chloephorinae to be indistinct from the Sarrothripinae and treated the two groups as a single subfamily. A study of the larvae led Gardner (1946*a*; 1948*a*) to disperse the genera of chloephorines widely among his noctuid groups but subsequent examination of the pupae and cocoons (Gardner, 1948*b*) caused him to revise his decision. He finally placed all the chloephorines in a single group near the sarrothripines, although he considered *Acontia* [*Xanthodes*] to perhaps belong elsewhere.

There appears to be little doubt now that the Chloephorinae is very closely related to the Sarrothripinae. They share such probable apomorphies as a bar-shaped retinaculum in the males and the characteristic boat-shaped cocoon. Whether the Chloephorinae deserves subfamilial rank (based at present on the lack of the tufts of raised scales in the fore-wing cell found in the Sarrothripinae – not only an absence but also a highly homoplasious character in that similar tufts occur in the nolines and stictopterines) or merely tribal rank within the Sarrothripinae, or whether, as Mell (1943) proposed, the two-way division itself is artificial and should be replaced, is as yet debatable.

**Sarrothripinae.** This subfamily was separated from the last by Hampson on the basis of the presence of raised scales in the forewing cell. Richards (1932) found that the Sarrothripinae and Chloephorinae were tympanally very close and, like Hampson, considered the former to be derived from the latter. Gardner (1948*b*) could find only minor differences between the two subfamilies while Forbes (1954) suggested that the Sarrothripinae intergraded in the Old World with the Nolinae.

Apart from Mell's (1943) subdivision, the Sarrothripinae had always been treated as a single homogeneous entity. However, Franclemont & Todd (1983) divided the subfamily into three



tribes: the Risobini, the Sarrothripini and the Collomenini. Forbes (1954) considered *Baileya* (the sole member of the Risobini) to be totally isolated within the North American fauna and most closely allied to the Old World *Risoba*. The larvae of both genera were said to resemble those of the Euteliinae and might prove to form some sort of link between the two groups. The justification of the Collomenini is not clear. The two constituent genera (*Collomena* and *Motyia*) were not dealt with by either Mell or Forbes, and Franclemont & Todd (1983) do not give any reasons for employing the tribe.

**Nolinae.** The Nolinae also has affinities with the Sarrothripinae. Forbes (1960) derived the former from the latter, while Richards (1932) (Fig. 3) preferred an independent development from the Acontiinae. However, the boat-shaped cocoon of the nolines, together with tufted setae (similar to those found in certain sarrothripines; Forbes, 1960: 52) point towards a relationship with the Sarrothripinae, and hence the Chloephorinae. There appears to be a potentially monophyletic group of three subfamilies, which may also possibly be related to the euteliines, through the Risobini. However, such a relationship is as yet largely unverified.

**Acontiinae.** This subfamily was Hampson's least well-defined group as adults, falling as it did across the trifine-quadrifine boundary. However, he did note that 'the larvae of such as are known [have] the anterior [pair of] prolegs aborted, which is the essential distinction between the two subfamilies' [Acontiinae and Amphipyrrinae + Acronictinae]. This character was of limited use, however, because so few acontiine larvae were known at the time, and reduction of the anterior prolegs is widespread in other noctuid subfamilies. Also, there are several acontiines (e.g. *Neoerastria* [*Homophoberia*]) in which all the prolegs are present (Forbes, 1954: 270).

Richards (1932: 23) considered the acontiines 'to have been derived from some point between the Rivulinae and Hypeninae with *Eublemma* [*Eumicremma*] as the connecting link' (but see Fig. 3), and which then gave rise to the sarrothripine-chloephorine series, the Nolinae, the trifine subfamilies and the Agaristinae. The Acontiinae itself was divided into three sections: *Eublemma* [*Eumicremma*], the Erastriini [Eustrotiini] and the Tarachini [Acontiini]. Of the two tribes, probably only the second is monophyletic on the basis of the enlarged, chitinised alula. The Eustrotiini was characterised by the lack of such an alula and is therefore undoubtedly at least paraphyletic.

Forbes (1954) characterised the Eublemini (*Eublemma* [*Eumicremma*]) using probable plesiomorphies ('pocket IV double as in the deltoids, hood and alula normal, no corona or penicillus' [on the valve of the male genitalia]) and did not improve upon the definition of the Erastriini [Eustrotiini]. Franclemont & Todd (1983) largely accepted Richards' and Forbes' classification but employed two additional monobasic tribes, the Cydosiini and the Bagisarini, erected to contain two presumably, somewhat aberrant genera.

The higher classification of the Acontiinae leaves much to be desired. Only the Acontiini and the monobasic tribes are likely to be monophyletic. The Eustrotiini appears to represent a heterogeneous assemblage of genera that do not fit any of the other tribes. However, the crucial position of the subfamily in understanding the higher systematics of the Noctuidae as a whole means that a thorough (cladistic) analysis should be accorded high priority.

**Pantheinae.** As adults, apart from dubious differences in hindwing venation, the members of the Pantheinae share the same Hampsonian defining characters as the Hadeninae: unspined tibiae and hairy eyes. The larvae, however, are quite different, being clothed, except for *Raphia*, in dense tufts of secondary setae on the body and head. In the latter respect, the Pantheinae differ from the Acronictinae. Richards (1932) found them tympanally very homogeneous but highly isolated from the rest of the noctuids; so much so that he was unable to even tentatively assign them a place on his phylogenetic tree. Forbes (1954) also noted the well-defined nature of the Pantheinae, although he had reservations regarding *Raphia*. This genus corresponded to the other pantheines in its tympanum, wing venation and general facies, but differed in the microscopic hair on the eyes and the larva lacking secondary setae. Nye (1975), following

Hampson, placed *Raphia* in the Ophiderinae. *Raphia* may belong in the Pantheinae, but it could equally belong elsewhere and only a thorough understanding of the rest of the family will finally resolve the question.

Franclemont & Todd (1983) follow Forbes (1954) but also suggest the possibility of merging the Pantheinae and Acronictinae. If Richards (1932) were correct regarding the tympanal structure of the two groups, then such a move would be premature, which is not to rule it out. The two subfamilies were long considered closely related (e.g. Smith & Dyar, 1898) and the presence of secondary setae in the larvae may be a synapomorphy. However, Mosher (1916) noted that the pupa of *Charadra deridens* (the only species examined) was more arctiid than noctuid, in the shape of the body, the presence of setae arranged around the scars of the larval verrucae, the absence of an epicranial suture and in the labial palps and prothoracic femora being visible. However, the cremaster is more noctuid than arctiid, in being long and provided with hooked setae. Additionally, the pantheines have never been recorded as possessing tymbal organs. The sum total of these characters, together with Mosher's highly restricted sample, suggest that, until further information has been gathered, the pantheines are best left in the Noctuidae. Their position with regard to the other subfamilies, however, remains unknown.

**Acronictinae.** The Acronictinae is the first of the trifine subfamilies, all of which are highly uniform structurally. This has resulted in much confusion in their classification and has led to an over-reliance upon superficial characters (hairy/lashed eyes, spined tibiae). However, some order can be discerned within the trifines and one group of genera that has long been recognised as a distinctive subgroup is the Acronictinae.

Originally, the acronictines were distinguished by the presence of secondary setae on the body of the larvae. The subsequent inclusion of the bryophilines confused matters, because the larvae of these genera possess only long, primary setae. Hampson placed no emphasis on larval vestiture and included the acronictines, together with the amphipyrrines and certain heliothines in a more inclusive 'Acronyctinae', where they have generally remained.

Gardner (1946a) distinguished the acronictines as his group AI. He also included the pantheine *Diphthera* [*Trichosea*] *champa*; the amphipyrrine *Cetola dentata* and the ophiderine *Thiacidas postica* (this genus appears superficially to resemble *Raphia* and may thus be better placed in the Pantheinae – assuming *Raphia* belongs in that subfamily). Examination of the pupae led Gardner (1948b) to exclude *Cetola* from the Acronictinae and he placed it instead in the Amphipyrrinae. Mosher (1916) found the pupae to be of little use in distinguishing the Acronictinae; so much so, that she also included an amphipyrrine (*Achatodes*) and three catocalines (s.l.) (*Homopyralis* [*Metalectra*], *Anomis* and *Plusiodonta*). However, she was well aware of the unnatural nature of this grouping.

Forbes (1954) followed Hampson and treated the acronictines as a tribe (the Apatelini) within his second series of 'Acronyctinae', but the trend was reversed by Franclemont & Todd (1983). They reinstated the Acronictinae as a separate subfamily, containing two tribes, the Acronictini and the Bryophilini. As mentioned above, Franclemont suggested that the trifine noctuids might be better treated as comprising only two subfamilies: the Acronictinae (including the Pantheinae) and the Noctuidae (comprising the remainder). Unfortunately, he did not elaborate on his reasoning.

The Acronictinae, as restricted by Franclemont & Todd, probably represents a monophyletic unit but its limits are presently poorly defined. Whether it indeed is related to the Pantheinae, or is a convergent offshoot from somewhere within the Amphipyrrinae, remains to be discovered.

**Agaristinae.** For a long time, these brightly-coloured, largely diurnal and aposematic moths were accorded family rank near the Arctiidae. However, Mosher (1916) could not discover any differences in the pupae to distinguish the agaristines from the Noctuidae and thus placed them in the latter as a subfamily. Richards (1932) found the agaristine tympanal organ to be similar to those of the Acronyctinae [Acronictinae + Amphipyrrinae], although the counter-tympanal cavities of the agaristines were much enlarged. Nevertheless, he retained the family status of the group and considered the agaristines to be derived from the Acronyctinae (Fig. 3).

Gardner (1946*b*) examined two agaristine genera (*Aegocera* and *Eusemia* [*Episteme*]) and placed them in his group AVI, together with *Callyna* (Amphipyridae), *Tiracola* (Hadeninae) and *Churia* (Chloephorinae). In his subfamily summaries, Gardner (1948*a*) listed the Agaristinae between the Noctuidae and the Cuculliinae, suggesting that he considered the group to be merely aberrant triline noctuids. Forbes (1960) retained the family status whereas Franclemont & Todd (1983) treated them as a noctuid subfamily. It is probable that the Agaristinae is monophyletic, although the involvement of mimicry might complicate superficial resemblances. The relationships of the subfamily to other triline groups is currently poorly understood.

**Amphipyridae.** To Hampson, this subfamily (including the Acronictinae and the *Pyrrhia*-group heliothines) was characterised entirely by absences: hindwing vein  $M_2$  reduced, the tibiae unspined and the eyes bare and unlashd. As such, the group can be seen to be a prime candidate within the Noctuidae for paraphyly or polyphyly. Unfortunately, like the Catocalinae (s.l.), the large size of the group (it contained nearly 2,400 species in Hampson's *Catalogue*, a number that has considerably increased since; Forbes, 1954) has resulted in a long period of classificatory stasis. Richards (1932) found a high degree of uniformity in the tympanum and could not suggest any interrelationships beyond that they appeared to be derived from the higher Acontiinae, a group that itself is probably not monophyletic.

Gardner (1946*a, b*; 1947; 1948*a*) found a great deal of diversity within the larvae and allocated amphipyrids to his groups AI, AII, AVI, BI and C. In contrast, the pupae of this subfamily were, for the most part, indistinguishable from those of the Hadeninae, Noctuidae and Heliothinae that he examined.

The first attempt to subdivide the Amphipyridae, in which the characters used were stated, was provided by Forbes (1954). On the basis of the genitalia and larvae, he erected two series, each divided into several tribes. Franclemont & Todd (1983) reduced the number of tribes to four. The Apameini corresponded to Forbes' first series less the Prodeniini. This latter tribe, together with many of Forbes' isolated genera, formed the Amphipyridi, while the Stiriini was largely unchanged. Franclemont & Todd's fourth tribe, the Nocloini, the basis for which is unclear, contained seven genera not dealt with by Forbes.

Of these four tribes, the Stiriini is almost certainly monophyletic (Hogue, 1963) and the Apameini (and Nocloini?) may also prove to be. The Amphipyridi appears to be a somewhat more restricted 'dustbin' than was the Amphipyridae and is therefore likely to be at least paraphyletic. It may even be polyphyletic given that the other triline subfamilies are thought to have arisen from within its limits, as presently defined.

**Cuculliinae.** The Cuculliinae is also a prime candidate for having a polyphyletic origin (Forbes, 1954). It was circumscribed by Hampson on the basis of bare, lashed eyes and unspined tibiae, not the most convincing of characters, especially as, venation apart, it applies equally well to the majority of the Plusiinae. Lack of material prevented both Mosher (1916) and Gardner (1948*a*) from reaching more than highly tentative conclusions regarding both the internal and external relationships of the Cuculliinae based on larvae.

Forbes (1954) divided the subfamily into two series, each comprising three tribes, which he thought to have been independently derived from the 'Acronyctinae'. The Cuculliini, Oncocnemidini and Psaphidini were considered to be related to certain Stiriini (q.v.) and the genera *Oxycnemis* and *Catabena* (the latter an 'isolated genus' of acronyctines, the former not mentioned elsewhere). This latter relationship was recently strengthened by the inclusion of *Catabena* and *Oxycnemis* in the Oncocnemidini (Franclemont & Todd, 1983). The remaining three tribes, the Lithophanini, Cleocerini and Antitypini, apparently showed affinities with such genera as *Andropolia*, *Rhizagrotis* and some elements of the *Apamea-Septis* complex (all of which are currently placed in the Apameini; Franclemont & Todd, 1983). The latter authors retained the Cuculliini, Oncocnemidini and Psaphidini but considered the other three as constituting a single tribe, the Xylenini. In addition, *Feralia* was placed in the monobasic Feraliini.

Given the highly uncertain nature of the triline subfamilies in general, to find the Cuculliinae

polyphyletic would be no great surprise. Of the constituent tribes, the Psaphidini (fore-tibial modification) and the Feraliini (by virtue of it containing a single, assumed monophyletic genus) are probably monophyletic taxa. The Cuculliini and Oncocnemidini taken together may also prove monophyletic but the latter may be paraphyletic with respect to the former ('they tend to intergrade in Europe'; Forbes, 1954: 122). The Xylenini, as currently conceived, is probably paraphyletic, although the Lithophanini (*sensu* Forbes, 1954) may prove a monophyletic unit, based upon the form of the digitus in the male genitalia and the biological characteristic of an autumn adult emergence followed by hibernation. These tentative conclusions are unaffected by the nature of the Cuculliinae as a whole.

**Hadeninae.** The hadenine genera were originally separated into a number of subfamilies by early authors (e.g. the Orthosiinae, Leucaniinae, Hadeninae; see also Heslop, 1960). However, they were all brought together into a single trifine subfamily by Hampson, defined by hairy eyes and unspined tibiae. As with the other trifine groups, tympanal organs and immature stages provided little information. Mosher (1916) characterised the Hadeninae by pupae possessing 'stout straight setae or spines at the caudal end of the body'. However, she also included the heliothines *Chloridea* [*Heliothis*], *Pyrrhia* and *Rhodophora* [*Schinia*], the noctuine *Lycophotia* and the amphipyridines *Eriopus* [*Callopietria*] and *Laphygma* and *Prodenia* [both *Spodoptera*].

Forbes (1954) recognised three general facies within what he considered 'a homogeneous group', but also noted that a large proportion of the genera did not fit into any of them. Consequently, he did not formally subdivide the hadenines, unlike Franclemont & Todd (1983), who recognised three tribes. The Glottulini comprised only *Xanthopastis*, an aberrant genus Forbes considered might not be closely related to the other hadenines. The Eriopygini contained *Orthodes*, *Tricholita* and their relatives, while the Hadenini consisted of the residue. The Glottulini are probably monophyletic given, for example, their amaryllidaceous-feeding larvae (this tribe undoubtedly also includes the Old World genus *Brithys*). From the available information, the basis of the Eriopygini is unknown and consequently its status cannot be commented upon. Such is therefore also the case for the Hadenini but it is almost certainly at least paraphyletic, even assuming the Eriopygini to be adequately characterised. Within the Hadeninae, there are 'centres of monophyly', around such genera as *Xanthopastis*, *Mythimna*, *Hadena* and *Orthosia*, but their limits and interrelationships have yet to be established.

**Noctuinae.** This was the fourth and last trifine subfamily recognised by Hampson, on the basis of spined tibiae. Both Mosher (1916) and Gardner (1946*b*; 1948*a*) found no characters by which they could distinguish the larvae and pupae of the noctuines from those of most other trifine genera. The heliothine section of the Agrotinae (*sensu* Hampson) had long been recognised by early authors as a discrete group but only slowly re-emerged as a distinct entity, which varied from being classed as a tribe of the Noctuinae (Forbes, 1954) to a separate subfamily that was isolated from the Noctuinae (e.g. McDunnough, 1938). Discussion of the 'heliothine Noctuinae' is deferred to the next section.

The remaining genera of Noctuinae were split by Heslop (1960) into two groups, following European tradition, one (Noctuini) characterised by yellow hindwings, the other (Agrotini) by hindwings of a different colour (usually brown). Forbes (1954) disagreed with this system, preferring instead to recognise three informal groups based around *Agrotis*, *Peridroma* and *Noctua*, which were formalised by Franclemont & Todd (1983) as the Agrotini, Aniclini and Noctuini respectively. In addition, they recognised a fourth tribe, the Ufeini, to accommodate the aberrant genus *Ufeus* ('The genus is not really an Agrotid, but fits no better elsewhere'; Forbes, 1954: 74).

The three large tribes are relatively well defined by larval and genitalic characters but it is not clear how well these would stand up to a critical cladistic analysis. Indeed, the monophyly of the Noctuinae itself has yet to be adequately demonstrated.

**Heliothinae.** The Heliothinae was formed largely from the union of two subgroups of trifine noctuids, classified widely apart by Hampson, based around the genera *Heliothis* and *Pyrrhia*.

The former, because of their spined tibiae, were placed in the Noctuidae, while the latter, which lacked all Hampson's 'definitive characters', were relegated to 'acronyctine' obscurity.

However, the larvae of the Heliiothinae are relatively distinctive. Their habit of feeding more or less exclusively on the flowers and fruits of low-growing plants had long been recognised, but this information was subsequently supplemented by structural features (Crumb, 1926; 1956; Gardner, 1946*a,b*). Of prime importance among these were the biordinal crotchets, a feature that the group shares with most Plusiinae and some Cuculliinae.

The North American Heliiothinae were revised by Hardwick (1970). He excluded *Grotella*, *Neogrotella* and *Hemigrotella* from the subfamily, because of their slender build, distinctly quadrifine hindwing venation and the presence of multiple cornuti on the vesica, features that Hardwick considered linked the three genera with the Stiriini. However, Franclemont & Todd (1983) retained them in the Heliiothinae as the Grotellini, possibly as an interim measure.

The relationship between the Stiriini, the Heliiothinae and, possibly, the Plusiinae warrants further consideration, due to its potential profound effects upon the higher classification of the Noctuidae generally. Hogue (1963) considered the Stiriini were derived from generalised noctuid stock via forms similar to either certain Heliiothinae or Oncocnemidini, with the latter more likely (both groups possess an angled vesica bearing numerous cornuti). Furthermore, Hogue treated any resemblance to the Plusiinae to be entirely convergent.

Hardwick (1970) discussed the relationship between the Stiriini and the Heliiothinae in considerable detail and concluded that there were 'a sufficient number of features in common to suggest some immediate common ancestry'. No mention was made of the Plusiinae with reference to a relationship with the stiriines and heliiothines. That such a possibility can be entertained rests on somewhat equivocal evidence. Both the Heliiothinae and the Plusiinae have larvae with biordinal crotchets, which could be interpreted as synapomorphic. However, the larvae of the tentative sister-group of the plusiines, the Stictopterinae, have uniordinal crotchets (Gardner, 1948*a*), while the larvae of most stiriines are unknown and the crotchets of such that are have never been examined. Biordinal crotchets may, therefore, be homoplasious in the two groups. Perhaps the only overall conclusion that can be reached, like so many concerning the higher classification of the Noctuidae, is that it all depends on the results of investigations yet to be done.

### The higher classification of the Noctuidae – fact or fiction?

No adequate higher classification of the Noctuidae can yet be proposed that will serve as a replacement for the Hampsonian system. However, it is possible to construct a tentative cladogram (Fig. 4) to serve as a suitable starting-point. Only those apomorphies that can be reasonably positively identified are included, although those on several branches are highly suspect. The relative paucity of synapomorphies results in a number of extensive polychotomies and several of the groups being uncharacterised (see below). The individual branches, 1–34, will be discussed and justified seriatim, and their relative merits assessed.

1. The Arctiidae generally can be characterised by three apomorphies, none of which are present in all genera. Two are perhaps quite reliable: the presence of the tymbal organ (although this is absent/lost in some of the ctenuchines and a few other groups) and the presence of two subventral (SV) setae in the larvae on the meso- and metathorax. Only one SV seta is present in this position in the aganuids, herminiids and noctuids (Gardner, 1941), and examination of five notodontids (*Stauropus fagi*, *Notodonta dromedarius*, *Eligmodonta ziczac*, *Peridea anceps* and *Pheosia tremula*; Kitching, unpublished) showed these also possess only a single seta. The latter evidence was used in an outgroup comparison to establish the bisetose condition as apomorphic. The third arctiid apomorphy, a swollen hindwing vein  $Sc + R_1$ , is more uncertain, especially as 'swollen' has never been precisely defined.
2. No apomorphies have been discovered in the literature for the aganuid genera. As such, they are of uncertain position and it is possible for some to be more closely related to the

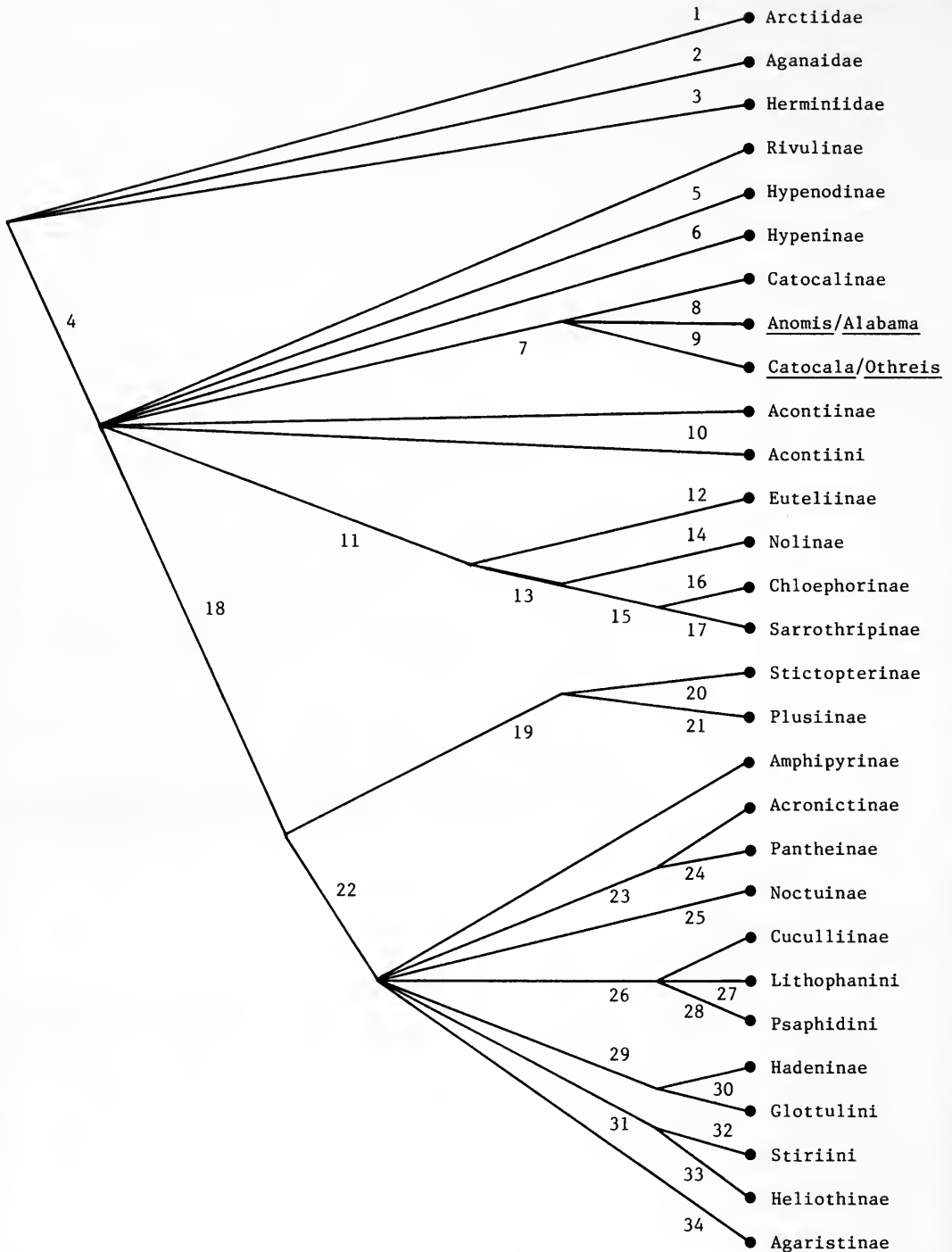

**Fig. 4** Cladogram illustrating the relationships between the various noctuid subgroups. For details regarding the characters defining each of the numbered branches, 1–34, see pp. 223–226. Seven branches are undefined by apomorphies; those subtending the Rivulinae, Catocalinae, Acontiinae, Amphipyrinae, Acronictinae, Cuculliinae and Hadeninae. For discussion of the undefined branch 2, see pp. 214–215, 223–225.

- arctiids and some to the noctuids. It may even be that some represent the sister-group of the herminiids.
3. The exclusion of the 'fan-foots' and their relatives from the Noctuidae (branch 4) is primarily on the basis of the plesiomorphic pre-spiracular hood. In addition, they may be characterised by two apomorphies: modified fore-tibiae in the males of most genera (although the exact nature of the modification is deliberately left unspecified) and a swollen metepimeron ventral to pocket IV.
  4. The Noctuidae is restricted to those groups possessing a post-spiracular hood, although this is absent in the Pantheinae (q.v.) and is greatly reduced in many other genera scattered among the other subfamilies. These can be interpreted as secondary losses but require further analysis. Two uncharacterised paraphyletic/polyphyletic assemblages are recognised within the heptachotomy that terminates branch 4, the Rivulinae and the Acontiinae.
  5. The Hypenodinae are characterised by the lack of ocelli, an unsatisfactory situation but the best that can be done at present.
  6. A similar situation pertains to the Hypeninae. Its putative apomorphies of long, 'deltoid' palps and lashed eyes are not particularly convincing.
  7. The Catocalinae (s.l.) are better characterised (fused pleural sclerite in the male genitalia and pupa with a whitish bloom) but the majority of genera and species of this vast subfamily have yet to be examined, especially with regard to the pupal character.
  - 8 & 9. These branches represent two of the many genus-groups that can be recognised in the Catocalinae (s.l.). *Anomis* and *Alabama* (the Anomiini of Forbes, 1954) are defined by an enlarged but unsclerotised alula and malvaceous-feeding larvae. *Catocala* and *Othreis* both possess a chitinous projection from the inner margin of the tympanal frame (the 'Bügel'; Eggers, 1919).
  10. Of the acontiine groups, only the Acontiini is well-characterised: tympanal hood reduced/lost, alula enlarged and sclerotised, male with paired anal hair-masses; cf. Euteliinae (Forbes, 1954: 271).
  11. This branch includes four subfamilies, tentatively grouped on the absence of a cremaster. However, this has not been confirmed for the Nolinae. The Euteliinae also bear a general resemblance in venation and the larvae of certain sarrothripine genera (Forbes, 1954: 288).
  12. The Euteliinae are perhaps the most well-defined subfamily of noctuids: frenulum reduced in the female; larvae feeding mainly on Anacardiaceae; pair of anal hair pencils present in the male; and the attitude of the adults at rest. There can be little doubt they represent a monophyletic taxon.
  13. The Nolinae, Sarrothripinae and Chloephorinae are united by the common possession of a boat-shaped cocoon with a vertical exit slit.
  - 14–17. Unfortunately, the relationships within the above group of subfamilies are unclear. The Chloephorinae and Sarrothripinae agree in the possession of a bar-shaped retinaculum in the male but the latter also agrees with the Nolinae in the presence of tufts of raised scales in the forewing cell. As the second character also occurs elsewhere in the Noctuidae (e.g. the Stictopterinae and the Plusiinae: Abrostolini), the first character is preferentially taken to represent a synapomorphy. However, it is probable that the group needs to be split up in a different manner, possibly along the lines suggested by Mell (1943). In addition, the nolines lack ocelli in the adult and have larvae with tufted setae.
  18. The 'higher noctuids' can generally be characterised by the presence of a clavus in the male genitalia. However, this structure is absent in many genera and uncertainties regarding genitalic homologies decrease confidence in this character. Secondly, the larval silk-pore of

the included subfamilies is not concealed (Crumb, 1956) and may represent a good apomorphy, although the condition in the Stictopterinae is unknown.

- 19–21. The Stictopterinae and Plusiinae share a double tympanal hood and tufts of raised scales in the forewing cell (present in the Plusiinae only in the Abrostolini). The stictopterines can be distinguished by the reduced female frenulum and possibly by the caudal extremity of the pupa being produced as 'two divergent attenuated spines borne together on a thicker median stem' (Gardner, 1948*b*: 88). The plusiines are relatively well defined, with four apomorphies: lashed eyes, a metepimeral bulge formed by an enlarged pocket IV, biordinal crotchets in the larvae and pupae in which the wings and proboscis project beyond the posterior margin of abdominal segment 4 ventrally.
22. The subfamilies subtended by this branch, the 'Trifinae', are held together on rather dubious grounds. Of the obsolescent hindwing vein  $M_2$ , nothing more needs to be said. The tympanal organs of all forms (except the Pantheinae, see branch 24) are extremely uniform and similar to those of the 'higher Erastrinae' [Acontiinae] (Richards, 1932: 29). The exact nature of this homogeneity and whether it includes any structures that can be regarded as synapomorphies was not elucidated by Richards.
- 22–24. The Acronictinae and Pantheinae are grouped on the basis of the presence of secondary setae on the larval trunk. However, the absence of such setae in the Acronictinae: Bryophilini weakens this argument, and the two subfamilies may not be closely related at all. The pantheines are further distinguished by their hairy eyes, the presence of secondary setae on the larval head, the reduction/absence of the tympanal hood and the highly modified tympanal morphology (Richards, 1932: 28).
- 25–30. Three branches (25, 26 and 29) subtend three of the currently recognised trifine subfamilies, the Noctuinae, Cuculliinae and Hadeninae respectively. This was done, not because there are good synapomorphies for the included genera (the characters employed are the classic ones of spined tibiae, lashed eyes and hairy eyes), but because to omit them would create a vast, *uncharacterised* group of genera (cf. the Catocalinae). In addition, it is probable that some of the groups will eventually be able to be defined by good apomorphies. Two tribes are split out of the Cuculliinae: the Lithophanini (well-developed digitus in the male genitalia, adult emergence generally autumnal, followed by hibernation) and the Psaphidini (fore-tibia with a terminal claw on the inner side, usually with an oblique, flat plate continuous with it; Forbes, 1954: 127); and one tribe from the Hadeninae: the Glottulini (larvae brightly-coloured, black, transversely spotted with yellow/white; feeding on the bulbs of the Amaryllidaceae).
- 31–33. The amphipyrene tribe, the Stiriini, and the Heliiothinae are associated by the clawed fore-tibiae (single in the former, multiple in the latter) and the larval preference for feeding on flowers and young fruits. The Stiriini are characterised by an angled vesica with multiple cornuti and a heavily chitinised frons in the adult, with a raised ring and various projections. The larvae of the Heliiothinae have biordinal crotchets.
34. The final noctuid subfamily to be considered is the Agaristinae. This is a highly apomorphic group: counter-tympanum several times the size of the tympanal membrane; hood very reduced/absent; adults active by day, generally brightly coloured, usually with clubbed antennae; larvae also brightly coloured, feeding largely on Vitaceae and Onagraceae.

I do not claim that the apomorphies employed in Fig. 4 are all that could be used to reconstruct the higher classification of the Noctuidae. However, they do represent all those extracted from the literature in which I have more than minimal confidence regarding the polarity, although it must be remembered that few are known to be present in all members of the group that they are being used to characterise. Many more characters are known at the subfamily level (see, for example, those cited by Forbes, 1954) but their usefulness has yet to be assessed. In addition,



there are certainly a considerable number of features known that are as yet undocumented, which must therefore necessarily fall outside the scope of this analysis.

To return to the title of this section, it would perhaps be more appropriate to refer to the Hampsonian classification as 'classification'. The system proposed by Franclemont & Todd (1983), which ranks as the main contender as an alternative, has much to commend it. However, it is of limited application until extended to encompass the world fauna and, unfortunately, until such time as the defining characters/apomorphies of the included groups are reported, such development is impossible. That there is a higher classification for this group of moths is not in question, but until careful character analyses, performed within a cladistic methodological framework, are published, the present state of confusion will reign. I hope that noctuid systematists will rise to meet the challenge.

## References

- Ackery, P. R. & Vane-Wright, R. I. 1984. *Milkweed butterflies: their cladistics and biology*. London.
- Arnold, J. W. 1982. Larval hemocytes in Noctuidae (Insecta: Lepidoptera). *International Journal of Insect Morphology & Embryology* **11**: 173–188.
- Aubert, J.-F. & Boursin, C. 1953. Les phalénides du Jura (Révision de la nomenclature et introduction à la faune des macrolépidoptères du Jura). *Bulletin Mensuel de la Société Linnéenne de Lyon* **22**: 115–126.
- Barnes, W. & Benjamin, F. H. 1923. Nomenclature notes and new species. *Contributions to the Natural History of the Lepidoptera of North America* **5**: 53–61.
- Barnes, W. & McDunnough, J. H. 1917. *Checklist of the Lepidoptera of Boreal America*. viii + 392 pp. Decatur, Illinois.
- Beck, H. 1960. *Die Larvalsystematik der Eulen (Noctuidae)*. 406 pp. Berlin.
- Birch, M. C. 1972a. Male abdominal brush organs in British noctuid moths and their value as a taxonomic character. Part I. *Entomologist* **105**: 185–205.
- 1972b. Male abdominal brush organs in British noctuid moths and their value as a taxonomic character. Part II. *Entomologist* **105**: 233–244.
- Blackmore, E. H. 1927. *Check-list of the Macrolepidoptera of British Columbia (Butterflies and moths)*. 47 pp. Victoria, British Columbia.
- Blest, A. D., Collett, T. S. & Pye, J. D. 1963. The generation of ultrasonic signals by a New World arctiid moth. *Proceedings of the Royal Society of London (B)* **158**: 196–207.
- Boisduval, J. A. 1840. *Genera et index methodicus europaeorum Lepidopterum*. vii + 238 pp. Paris.
- Borkhausen, M. B. 1792. *Naturgeschichte der europäischen Schmetterlinge* **4**, xvi + 809 pp. Frankfurt.
- Börner, C. 1953. Lepidoptera, pp. 382–421. In Brohmer, P., *Fauna von Deutschland*. Edn 7, ix + 591 pp. Heidelberg.
- Boursin, C. 1964. Les Noctuidae Trifinae de France et de Belgique. *Bulletin Mensuel de la Société Linnéenne de Lyon* **33**: 204–240.
- Bretherton, R. F., Goater, B. & Lorimer, R. I. 1979. Noctuidae, pp. 120–278. In Heath, J. & Emmet, A. M., *The moths and butterflies of Great Britain and Ireland*. **9**, Sphingidae-Noctuidae (Part I). 288 pp. London.
- Brock, J. P. 1971. A contribution towards an understanding of the morphology and phylogeny of the ditrysian Lepidoptera. *Journal of Natural History* **5**: 29–102.
- Butler, A. G. 1879. On the natural affinities of the Lepidoptera hitherto referred to the genus *Acronycta* of authors. *Transactions of the Entomological Society of London* **12**: 313–317.
- 1881. Descriptions of new genera and species of heterocerous Lepidoptera from Japan. *Transactions of the Entomological Society of London* **14**: 1–23, 171–200, 401–426, 579–600.
- 1893. Notes on the genus *Acronycta* of authors and its position in the classification of heterocerous Lepidoptera. *Annals and Magazine of Natural History* (6) **11**: 396–402.
- Chalmers-Hunt, J. M. 1962–1968. *The butterflies and moths of Kent*. **2**, Heterocera (Sphingidae – Plusiidae). 380 pp. Arbroath. [Published in parts in the *Entomologist's Record and Journal of Variation* **74–80**.]
- Chapman, T. A. 1893a. *The genus Acronycta and its allies*. iv + 116 pp. London.
- 1893b. The genus *Acronycta* and its allies. *Entomologist's Record and Journal of Variation* **4**: 97.
- Common, I. F. B. 1968. Lepidoptera (Moths and butterflies), pp. 765–866. In Mackerras, I. M., *Insects of Australia*. xiii + 1029 pp. Canberra.
- 1975. Evolution and classification of the Lepidoptera. *Annual Review of Entomology* **20**: 183–203.
- Comstock, J. H. 1925. *An introduction to entomology*. Second edition. xix + 1044 pp. Ithaca, New York.

- Crumb, S. E.** 1926. The Nearctic budworms of the lepidopterous genus *Heliiothis*. *Proceedings of the United States National Museum* **68**: 1–8.
- 1934. A classification of some noctuid larvae of the subfamily Hypeninae. *Entomologica Americana* **14**: 133–196.
- 1956. The larvae of the Phalaenidae. *Technical Bulletin. United States Department of Agriculture* no. 1135: 1–365.
- De Koning, H. S. & Roepke, W.** 1949. Remarks on the morphology of the teak moth, *Hyblaea puera* Cr. (Lep. Hyblaeidae). *Treubia* **20**: 25–30.
- Denis, J. N. C. M. & Schiffermüller, I.** 1775. *Ankündigung eines systematischen Werkes von den Schmetterlingen der Wienergegend*. 323 pp. Wien.
- Dethier, V. G.** 1941. The antennae of lepidopterous larvae. *Bulletin of the Museum of Comparative Zoology* **87**: 455–507.
- DeVries, P. J., Kitching, I. J. & Vane-Wright, R. I.** In prep. The systematic position of *Antirrhea* and *Caerois* with comments on the classification of the Nymphalidae.
- Draudt, M.** 1919–1936. Agaristidae and Noctuidae. In Seitz, A., *The Macrolepidoptera of the World*. **7**: 3–411. (Pages 412–508 consulted in the German edition, published 1919–1944.) Stuttgart.
- 1938. Phytometrines [part]. In Seitz, A., *The Macrolepidoptera of the World* **11**: 496. Stuttgart.
- Druce, H.** 1887. Lepidoptera-Heterocera. In *Biologia Centrali-Americana*. **1**: 249. London.
- Duponchel, P. A. J.** 1844–1846. *Catalogue méthodique des Lépidoptères d'Europe*. xxx + 523 pp. Paris.
- Dyar, H. G.** 1895a. Additional notes on the classification of lepidopterous larvae. *Transactions of the New York Academy of Sciences* **14**: 49–63.
- 1895b. Larva of *Demas propinquinella*; its systematic position. *Journal of the New York Entomological Society* **3**: 130–131.
- 1896. On the position of genus *Demas*. *Canadian Entomologist* **28**: 103–104.
- 1904. Review of 'Catalogue of the Lepidoptera Phalaenae in the British Museum. Vol. IV.' G. F. Hampson. *Canadian Entomologist* **36**: 27–28.
- Eggers, F.** 1919. Das thoracale bitympanale Organ einer Gruppe der Lepidoptera Heterocera. *Zoologische Jahrbücher* **41**: 273–376.
- 1925. Versuche über das Gehör der Noctuiden. *Zeitschrift für vergleichende Physiologie* **2**: 297–314.
- Eichlin, T. D. & Cunningham, H. B.** 1978. The Plusiinae (Lepidoptera: Noctuidae) of America north of Mexico, emphasizing genitalic and larval morphology. *Technical Bulletin. United States Department of Agriculture Agricultural Research Service* no. 1567: 1–222.
- Farris, J. S.** 1974. Formal definitions of paraphyly and polyphyly. *Systematic Zoology* **23**: 548–554.
- Forbes, W. T. M.** 1910. A structural study of some caterpillars. *Annals of the Entomological Society of America* **3**: 94–143.
- 1914. A table of the genera of Noctuidae of northeastern North America. *Journal of the New York Entomological Society* **22**: 1–33.
- 1916. On the tympanum of certain Lepidoptera. *Psyche* **23**: 183–192.
- 1918. Guenée's Herminidae revived. *Journal of the New York Entomological Society* **26**: 224–225.
- 1924. The family position of *Graphelysia*. *Psyche* **31**: 146–147.
- 1933. The pupa of *Hyblaea* (Lepidoptera, Hyblaeidae). *Annals of the Entomological Society of America* **26**: 490.
- 1939. The Lepidoptera of Barro Colorado Island, Panama. *Bulletin of the Museum of Comparative Zoology* **85**: 95–322.
- 1954. Lepidoptera of New York and neighboring states. Part 3. Noctuidae. *Memoirs. Cornell University Agricultural Experiment Station* no. 329: 1–433.
- 1960. Lepidoptera of New York and neighboring states. Part 4. Agaristidae through Nymphalidae including butterflies. *Memoirs. Cornell University Agricultural Experiment Station* no. 371: 1–188.
- Forbes, W. T. M. & Franclemont, J. G.** 1957. The striated band (Lepidoptera, chiefly Arctiidae). *Lepidopterists' News* **11**: 147–150.
- Forster, W. & Wohlfahrt, T. A.** 1971. *Die Schmetterlinge Mitteleuropas*. **4**, Eulen (Noctuidae). vii + 329 pp. Stuttgart.
- Fracker, S. B.** 1915. The classification of lepidopterous larvae. *Illinois Biological Monographs* **2**: 1–170.
- Franclemont, J. G. & Todd, E. L.** 1983. Noctuidae, pp. 120–159. In Hodges, R. W., et al. *Check list of the Lepidoptera of America north of Mexico*. London.
- Gaede, M.** 1913–1939. Noctuidae. In Seitz, A., *The Macrolepidoptera of the World*. **15**: 30–286. Stuttgart.

- 1937–1938. Eutelinae [Noctuidae] – Catocalinae. In Seitz, A., *The Macrolepidoptera of the World* **11**: 352–496. Stuttgart.
- Gardner, J. C. M.** 1941. Immature stages of Indian Lepidoptera (2) [Noctuidae, Hypsidae]. *Indian Forest Records* (N.S.) **6**: 253–296.
- 1946a. On the larvae of the Noctuidae (Lepidoptera) – I. *Transactions of the Royal Entomological Society of London* **96**: 61–72.
- 1946b. On the larvae of the Noctuidae (Lepidoptera) – II. *Transactions of the Royal Entomological Society of London* **97**: 237–252.
- 1947. On the larvae of the Noctuidae (Lepidoptera) – III. *Transactions of the Royal Entomological Society of London* **98**: 59–90.
- 1948a. On larvae of the Noctuidae (Lepidoptera) – IV. *Transactions of the Royal Entomological Society of London* **99**: 291–318.
- 1948b. Notes on the pupae of the Noctuidae. *Proceedings of the Royal Entomological Society of London* (B) **17**: 84–92.
- Godfrey, G. L.** 1972. A review and reclassification of larvae of the subfamily Hadeninae (Lepidoptera, Noctuidae) of America north of Mexico. *Technical Bulletin United States Department of Agriculture Agricultural Research Service* no. 1450: 1–265.
- Grote, A. R.** 1874. List of the Noctuidae of North America. *Bulletin of the Buffalo Society of Natural Science* **2**: 1–77.
- 1882a. *An illustrated essay on the Noctuidae of North America*. With ‘A colony of butterflies’. 85 pp. London.
- 1882b. *New check list of North American moths*. 73 pp. New York.
- 1883. Introduction to a study of the North American Noctuidae. *Proceedings of the American Philosophical Society* **21**: 134–176.
- 1889–1890. The Noctuidae of Europe and North America compared. *Canadian Entomologist* **21**: 121–126, 154–157, 188–193, 226–230; **22**: 26–30, 69–72, 105–109, 145–149.
- 1890. *North American Lepidoptera, revised check list of the North American Noctuidae, part I, Thyatirinae, Noctuinae*. 52 pp. Bremen.
- 1895a. List of North American Eupterotidae, Ptilodontae, Thyatiridae, Apatelidae and Agrotidae. *Abhandlungen des naturwissenschaftlichen Vereins zu Bremen* **14**: 44–128.
- 1895b. The hypenoid moths and allied groups. *Proceedings of the American Philosophical Society* **34**: 416–436.
- 1896. Die Apateliden. *Mitteilungen aus dem Roemer-Museum, Hildesheim* **3**: 1–18.
- Guenée, A.** 1837. Essai pour servir à la classification des Noctuélides (suite). *Annales de la Société Entomologique de France* **6**: 311–367.
- 1838a. Matériaux pour servir à la classification des Noctuélides (suite) (1). *Annales de la Société Entomologique de France* **7**: 107–125.
- 1838b. Matériaux pour servir à la classification des Noctuélides. *Annales de la Société Entomologique de France* **7**: 201–230.
- 1839. Essai sur la classification des Noctuélides (suite). *Annales de la Société Entomologique de France* **8**: 473–522.
- 1841a. Essai sur la classification des Noctuélides (suite) (1). *Annales de la Société Entomologique de France* **10**: 53–83.
- 1841b. Essai sur la classification des Noctuélides (suite et fin). *Annales de la Société Entomologique de France* **10**: 217–250.
- 1852–1854. In Boisduval, J. A. & Guenée, A., *Histoire naturelle des Insectes – Species général des Lépidoptères*. 5 Noctuélites. I. xcvi + 407 pp. 6 Noctuélites. II. 444 pp. 7 Noctuélites. III. 442 pp. 8 Deltoides et Pylalites. 448 pp. Paris.
- Hampson, G. F.** 1893–1895. *The fauna of British India, including Ceylon and Burma*. **1**, viii + 527 pp. **2**, xxii + 609 pp. **3**, xxviii + 546 pp. London
- 1898–1913. *Catalogue of the Lepidoptera Phalaenae in the collection of the British Museum*. 1 Syntomidae. xii + 599 pp. 2 Arctiidae (Nolinae, Lithosianae). xx + 589 pp. 3 Arctiidae (Arctianae) and Agaristidae. xix + 690 pp. 4 Agrotinae. xx + 689 pp. 5 Hadeninae. xvi + 634 pp. 6 Cucullianae. xiv + 532 pp. 7 Acronyctinae. xv + 709 pp. 8 Acronyctinae continued. xiv + 583 pp. 9 Acronyctinae continued. xv + 552 pp. 10 Erastrianae. xix + 829 pp. 11 Eutelinae, Stictopterinae, Sarrothripinae, Acontianae. xvii + 689 pp. 12 Catocalinae. xiii + 626 pp. 13 Catocalinae continued, Mominae, Phytometrinae. xvi + 609 pp. London.
- 1900. Lepidoptera Phalaenae, pp. 63–74. In Andrews, C. W., *A monograph of Christmas Island (Indian Ocean)*. xiii + 337 pp. London.

- 1902. The moths of South Africa (Part II). *Annals of the South African Museum* 2: 255–446.
- 1918. Descriptions of new genera and species of Amatidae, Lithosidae and Noctuidae. *Novitates Zoologicae* 25: 93–217.
- 1926. *Descriptions of new genera and species of Lepidoptera Phalaenae of the subfamily Noctuinae (Noctuidae) in the British Museum (Natural History)*. 641 pp. London.
- Handlirsch, A.** 1929. Gegen die übermassige Zerplitterung der systematischen Gruppen. *Zoologischer Anzeiger* 84: 85–90.
- Hardwick, D. F.** 1970. A revision of the North American Heliothidinae (Lepidoptera: Noctuidae). *Memoirs of the Entomological Society of Canada* 73: 1–59.
- Harvey, L. F.** 1874. Rectification of Treitschke's use of Hübner's generic term 'Cymatophora'. *Bulletin of the Buffalo Society of Natural Science* 1: 276–278.
- Haworth, A. H.** 1803–1829. *Lepidoptera Britannica*. Part I: xxxvi + 136 pp. Part II: pp. 137–376. Part III: pp. 377–511. Part IV: pp. 512–609. London.
- Hayes, A. H.** 1975. The larger moths of the Galápagos Islands (Geometroidea: Sphingoidea & Noctuoidea). *Proceedings of the California Academy of (Natural) Science* 15: 145–208.
- Heinrich, C.** 1926. In Bottimer, L. J., Notes on some Lepidoptera from eastern Texas. *Journal of Agricultural Research* 33: 797–819 [799].
- Herrich-Schäffer, G. A. W.** 1845. *Systematische Bearbeitung der Schmetterlinge von Europa, zugleich als Text, Revision und Supplement zu Jakob Hübner's Sammlung europäischer Schmetterlinge*. 2. Die Schwärmer, Spinner und Eulen (Hepialides-Cossides-Zygaenides-Sesiides-Sphingides-Bombycides-Noctuides-Nycteolides). 450 pp. Regensburg.
- Heslop, I. R. P.** 1945. *Checklist of the British Lepidoptera with the English names of each of the 2299 species*. 35 pp. London.
- 1960. Revised indexed check-list of the British Lepidoptera. Part I. *Entomologist's Gazette* 11: 55–66.
- Hinton, H. E.** 1946. On the homology and nomenclature of the setae of lepidopterous larvae, with some notes on the phylogeny of the Lepidoptera. *Transactions of the Royal Entomological Society of London* 97: 1–37.
- Hogue, C. L.** 1963. A definition and classification of the tribe Stiriini (Lepidoptera: Noctuidae). *Contributions in Science. Los Angeles County Museum* 64: 1–129.
- Hübner, J.** 1805. *Sammlung europäischer Schmetterlinge*. pp. 155–194. Angsburg.
- Inoue, H. & Sugi, S.** 1958–1961. *Checklist of the Lepidoptera of Japan*. 5 Noctuidae and 6 Hyblaeidae. pp. 431–683. Tokyo.
- Inoue, H., Sugi, S., Kuroko, H., Moriuti, S., & Kawabe, A.** 1982. *Moths of Japan*. 2. Plates and synonymic catalogue. 532 pp. Tokyo.
- Janse, A. J. T.** 1937–1939. *The moths of South Africa*. 3. Cymatophoridae, Callidulidae and Noctuidae (partim). xv + 435 pp. Durban.
- 1939. On the South African Cuculliae (Noctuidae). *Journal of the Entomological Society of South Africa* 1: 78–130.
- 1942. *The moths of South Africa*. 4, Part 1. Jugatae. xxv + 78 pp. Durban.
- Jordan, K.** 1906–1914. Agaristidae. In Seitz, A., *The Macrolepidoptera of the World* 3: 5–8. Stuttgart.
- 1912–1914. Agaristidae. In Seitz, A., *The Macrolepidoptera of the World* 11: 1–30. Stuttgart.
- Jordan, K. & Gaede, M.** 1913–1939. Agaristidae. In Seitz, A., *The Macrolepidoptera of the World* 15: 1–29. Stuttgart.
- Kirby, W. F.** 1907. *The butterflies and moths of Europe*. lxxii + 432 pp. London.
- Kiriakoff, S. G.** 1953. Recherches sur les organes tympaniques des lépidoptères en rapport avec la classification. X. Hyblaeidae. *Bulletin et Annales de la Société Royale Entomologique de Belgique* 89: 258–263.
- 1955. Onderzoekingen over de Gehoororganen bij Vlinders met Betrekking tot de Classificatie. XI. Agaristidae. *Verhandelingen Koninklijke vlaamse academie voor wetenschappen, letteren en schone kunsten van België* 47: 1–70.
- 1958. Recherches sur les organes tympaniques des lépidoptères en rapport avec la classification. XIV. Nolidae. *Biologisch Jaarboek* 26: 69–75.
- 1960. Recherches sur les organes tympaniques des lépidoptères en rapport avec la classification. XV. Hypeninae et Herminiinae. *Biologische Jaarboek* 28: 140–153.
- 1963. The tympanic structures of the Lepidoptera and the taxonomy of the order. *Journal of the Lepidopterists' Society* 17: 1–6.
- 1970. Die Stellung von *Diloba caeruleocephala* (L.) im Lepidopteren-System. *Nachrichtenblatt der Bayerischen Entomologen* 19: 101–104.

- Kitching, I. J.** 1983. *An analysis of danaid classifications based on differing character sets and methods*. Unpublished Ph.D. thesis, University of London. 602 pp.
- In press. Early stages and the classification of the milkweed butterflies (Lepidoptera: Danainae). *Zoological Journal of the Linnean Society*.
- Kloet, G. S. & Hincks, W. D.** 1972. *A checklist of British Insects*. Second edition (revised). Part 2. Lepidoptera. viii + 153 pp. London.
- Kostrowicki, A. S.** 1961. Studies of the Palaearctic species of the subfamily Plusiinae (Lepidoptera, Phalaenidae). *Acta Zoologica Cracoviensia* 6: 367–472.
- Lederer, J.** 1857. *Die Noctuiden Europas*. xv + 251 pp. Wien.
- Leech, J. H.** 1900. Lepidoptera Heterocera from northern China, Japan and Corea. Parts III & IV. *Transactions of the Entomological Society of London* 33: 9–161, 511–663.
- Leraut, P.** 1980. *Liste systématique et synonymique des Lépidoptères de France, Belgique et Corse*. 334 pp. Paris.
- Lhomme, L.** 1923–1935. *Catalogue des Lépidoptères de France et de Belgique*. 1. 800 pp. Douelle, Lot.
- Linnaeus, C.** 1758. *Systema Naturae* Edn 10 Regnum Animale. 1: 824 pp. Holmiae.
- McDunnough, J. H.** 1916. On the types of certain noctuid genera occurring in North America (Lepidoptera). *Entomological News* 27: 393–400.
- 1938. Checklist of the Lepidoptera of Canada and the United States of America. Part 1. Macrolepidoptera. *Memoirs. Southern California Academy of Sciences* 1: 1–272.
- 1944. Revision of the North American genera and species of the phalaenid subfamily Plusiinae (Lepidoptera). *Memoirs. Southern California Academy of Sciences* 2: 175–232.
- Meldola, R.** 1881. The developmental characters of the larvae of the Noctuae as determining the position of that group. *Transactions of the Epping Forest and County of Essex Naturalists' Field Club*. 1881: 1–10.
- Mell, R.** 1943. Beiträge zur Fauna sinica. xxiv. Ueber Phlogophorinae, Odontodinae, Sarrothripinae, 'Westermannianae' und Camptolominae (Noctuidae, Lepid.) von Kuangtung. *Zoologische Jahrbücher* 76: 171–226.
- Merzheevskaya, O. I.** 1967. *The larvae of Noctuidae, their biology and morphology (with keys)*. [In Russian.] 452 pp. Minsk.
- Meyrick, E.** 1886. Monograph of New Zealand Noctuidae. *Transactions of the New Zealand Institute* 19: 3–40.
- 1892. On the classification of the Geometrina of the European fauna. *Transactions of the Entomological Society of London* 1892: 53–140.
- 1912. A revision of the classification of the New Zealand Caradrinina. *Transactions of the New Zealand Institute* 44: 88–107.
- 1928. *A revised handbook of British Lepidoptera*. vi + 914 pp. London.
- Minet, J.** 1982. Eléments sur la systématique des Notodontidae et nouvelles données concernant leur étude faunistique à Madagascar. *Bulletin de la Société Entomologique de France* 87: 354–370.
- Moore, F.** 1881. On the genera and species of the lepidopterous subfamily Ophiderinae inhabiting the Indian region. *Transactions of the Zoological Society of London* 11: 63–76.
- Mosher, E.** A classification of the Lepidoptera based on characters of the pupa. *Bulletin of the Illinois State Laboratory of Natural History* 12: 17–159.
- Nye, I. W. B.** 1975. *The generic names of moths of the World*. 1, Noctuoidea (part): Noctuidae, Agaristidae, and Nolidae. 568 pp. London.
- Opinion 450.** 1957. Suppression under the plenary powers of the generic name 'Phalaena' Linnaeus, 1758, and validation as of subgeneric status (a) as from 1758, of the terms 'Bombyx', 'Noctua', 'Geometra', 'Tortrix', 'Pyralis', 'Tinea' and 'Alucita', as used by Linnaeus for groups of species of the genus 'Phalaena' and (b) as of 1767 of the term 'Attacus' similarly published by Linnaeus and matters incidental thereto (Class Insecta, Order Lepidoptera). *Opinions and Declarations rendered by the International Commission on Zoological Nomenclature* 15: 253–328.
- Packard, A. S.** 1869. The characters of the lepidopterous family Noctuidae. *Proceedings of the Portland Society of Natural History* 1: 153–156.
- 1895. On a new classification of the Lepidoptera. *American Naturalist* 29: 636–647, 788–803.
- Patterson, C.** 1982. Morphological characters and homology. In Joysey, K. A. & Friday, A. E. *Problems in phylogenetic reconstruction*. Systematics Association special volume 21: 21–74. London.
- Pierce, F. N.** 1909. *The genitalia of the group Noctuidae of the Lepidoptera of the British Islands*. xii + 88 pp. Liverpool.
- Pierce, F. N. & Beirne, B. P.** 1941. *The genitalia of the British Rhopalocera and the larger moths*. xiv + pp. 15–66. Oundle.
- Pinhey, E. C. G.** 1975. *Moths of Southern Africa*. 273 pp. Cape Town.

- Poulton, E. B.** 1887. Notes in 1886 upon lepidopterous larvae, etc. *Transactions of the Entomological Society of London* **20**: 281–321.
- Prout, A. E.** 1929. A catalogue of the Lepidoptera of Hainan. – Noctuidae. *Bulletin of the Hill Museum* **3**: 1–12.
- Pryer, H.** 1883–1885. A catalogue of the Lepidoptera of Japan. *Transactions of the Asiatic Society of Japan* **11**: 216–242; **12**: 35–103; **13**: 22–67, 228–235.
- Richards, A. G. Jr** 1932. Comparative skeletal morphology of the noctuid tympanum. *Entomologica Americana* **13**: 1–43.
- Ripley, L. B.** 1923. The external morphology and postembryology of noctuid larvae. *Illinois Biological Monographs* **8**: 1–102.
- Schaus, W.** 1901. A revision of the American Notodontidae. *Transactions of the Entomological Society of London* **34**: 257–344.
- Seitz, A.** 1909. III. Section: Noctuiiformes, noctuiiform moths. In Seitz, A., *The Macrolepidoptera of the World* **3**: 3–4. Stuttgart.
- Shepard, H. H.** 1930. The pleural and sternal sclerites of the lepidopterous thorax. *Annals of the Entomological Society of America* **23**: 237–254.
- Smith, J. B.** 1882–1883. A synopsis of the North American genera of the Noctuidae. *Bulletin of the Brooklyn Entomological Society* **4**: 47–52; **5**: 3–6, 11–14, 19–22, 27–30, 33–36, 43–46, 53–56.  
— 1891. *List of the Lepidoptera of boreal America*. v + pp. 6–124. Philadelphia.  
— 1893. Catalogue of the lepidopterous superfamily Noctuidae found in boreal America. *Bulletin of the United States National Museum* **44**: 1–424.  
— 1895. Contribution toward a monograph of the insects of the lepidopterous family Noctuidae of boreal North America. – A revision of the deltoïd moths. *Bulletin of the United States National Museum* **48**: 1–129.
- Smith, J. B. & Dyar, H. G.** 1898. Contributions toward a monograph of the lepidopterous family Noctuidae of boreal North America; a revision of *Acronycta* (Ochsenheimer) and of certain allied genera. *Proceedings of the United States National Museum* **21**: 1–194.
- South, R.** 1908–1909. *The moths of the British Isles*. **1**, vi + 355 pp. **2**, vi + 376 pp. London.  
— 1961. *The moths of the British Isles*. **1**. Edited and revised by H. M. Edelsten & D. S. Fletcher. 427 pp. London.
- Stainton, H. T.** 1857. *A manual of British butterflies and moths*. **1**, xii + 338 pp. London.
- Staudinger, O. & Rebel, H.** 1901. *Catalog der Lepidopteren des palaearktischen Faunengebietes*. Theil I: Famil. Papilionidae – Hepialidae. xxx + 411 pp. Berlin.
- Staudinger, O. & Wocke, M. F.** 1871. *Catalog der Lepidopteren des europaischen Faunengebietes*. xxxviii + 426 pp. Dresden.
- Swinton, A. H.** 1877. On an organ of hearing in insects with special reference to Lepidoptera. *Entomologist's Monthly Magazine* **14**: 121–126.
- Timlin, J. S.** 1955. *The classification of the larval stages of some British Agrotidae*. Unpublished Ph.D. thesis, University of London. 298 pp.
- Turner, A. J.** 1920. A revision of the Australian Noctuidae. *Transactions of the Royal Society of South Australia* **44**: 120–189.
- Turner, H. J.** 1926–1948. *Supplement to Tutt's British Noctuae and their varieties*. **1**, 364 pp. **2**, 284 pp. **3**, 295 pp. **4**, 94 pp. London.
- Tutt, J. W.** 1891–1892. *The British Noctuae and their varieties*. **1**, xvi + 164 pp. **2**, xviii + 180 pp. **3**, xxiv + 140 pp. **4**, xxviii + 144 pp. London.  
— 1895. Review: Smith, J. B., Catalogue of the lepidopterous superfamily Noctuidae found in boreal America. *Entomologist's Record and Journal of Variation* **6**: 69–72.  
— 1896. On the structural affinities of the genus *Demas*. *Canadian Entomologist* **28**: 81–82.  
— 1902. *British Moths*. xii + 368 pp. London.
- Van Son, G.** 1933. A revision of South African moths of the tribe Nolini. *Annals of the Transvaal Museum* **15**: 181–232.
- Varley, G. C.** 1962. A plea for a new look at Lepidoptera with special reference to the scent distributing organs of male moths. *Transactions of the Society for British Entomology* **15**: 29–40.
- Viette, P.** 1962. Les Noctuidae Hyblaeinae de Madagascar (Lep.). *Bulletin Mensuel de la Société Linnéenne de Lyon* **30**: 191–194.  
— 1962–1967. Noctuelles trifides de Madagascar, écologie, biogéographie, morphologie et taxonomie (Lep.). *Annales de la Société Entomologique de France* **131**: 1–825.  
— 1973. Nouvelles noctuelles de Madagascar (Lepidoptera). *Nouvelle Revue d'Entomologie* **3**: 185–191.

- Walker, F.** 1856–1858. *List of specimens of lepidopterous insects in the collection of the British Museum*. **9**: 1–252; **10**: 253–491; **11**: 493–764. London.
- Warren, W.** 1906–1914. Noctuidae. In Seitz, A., *The Macrolepidoptera of the World* **3**: 9–508. Stuttgart.
- 1912–1938. Noctuidae: Acronictinae – Amphipyriinae. In Seitz, A., *The Macrolepidoptera of the World* **11**: 31–352. Stuttgart.
- Warren, W. & Seitz, A.** 1906–1912. Cymatophoridae. In Seitz, A., *The Macrolepidoptera of the World* **2**: 321–332. Stuttgart.
- Watson, A., Fletcher, D. S. & Nye, I. W. B.** 1980. In Nye, I. W. B., *The generic names of moths of the World*. **2**, xiv + 228 pp. London.
- Yagi, N. & Koyama, N.** 1963. *The compound eye of Lepidoptera: approach from organic evolution*. 319 pp. Tokyo.
- Zimmerman, E. C.** 1958. *Insects of Hawaii*. **7**, Macrolepidoptera. ix + 542 pp. Honolulu.

## Index

Only the more important references to higher taxon names are included and those taxa mentioned in passing are omitted. The indexed authors are those whose works are discussed at length.

- Abrostolini 217  
 Acontianae 183  
 Acontiiidae 178  
 Acontinae 170, 197, 202, 206, 219, 225  
 Acontiini 219, 225  
 Acronictinae 206, 220, 226  
 Acronictini 220  
 Acronyctinae 183, 197, 202  
 Acronyctinae: first series 202  
 Acronyctinae: second series 202  
 Aganainae 214, 223  
 Agaristidae 170, 185, 187, 197, 203  
 Agaristinae 206, 220, 226  
 Agrotidae 172, 174  
 Agrotinae 174, 182, 197, 200  
 Agrotini 222  
 Amphipyriinae (sensu Franclemont & Todd) 206, 221  
 Amphipyriinae (sensu Tutt) 177  
 Amphipyriini 221  
 Aniclini 222  
 Anomiini 217, 225  
 Antitypini 221  
 Apameini 221  
 Apaminae 177  
 Apatelidae 172, 174  
 Arctiidae 181  
 Arctiidae 170, 214, 223  
 Argyrogrammini 217  
 Autographini 217  
 Aveniidae 178
- Bagisarini 219  
 Bombyciae 166  
 Bombyciformes 161, 168  
 Bombycoidea 177  
 Brepidae 158, 167, 170, 174  
 Bryophilini 220, 226
- Calocampinae 177  
 Caradrinina 188  
 Caradrininae 177
- Catocalidae 178  
 Catocalinae (sensu Franclemont & Todd) 206, 216, 225  
 Catocalinae (sensu Hampson) 184, 202  
 Catocalinae (sensu Packard) 165, 174  
 Chloephorinae 197, 218, 225  
 Cleocerini 221  
 Collomenini 219  
 Colocasia 158, 168, 169, 172, 179  
 Cucullianae 183  
 Cucullinae 197, 200, 206, 221, 226  
 Cuculliini 221, 222  
 Cydosiini 219  
 Cymatophoridae 158, 167, 171, 179
- Deltoides/Deltoides 165, 169, 178  
 Deltoidinae 171  
 Diloba 169, 179, 184, 187, 193, 209
- Epicausis* 184  
 Erastrinae 183  
 Erastriinae 197  
 Erebiniae 202  
 Erebine-catocaline complex 196  
 Eriopygini 222  
 Eublemmini 219  
 Eustrotiini 219  
 Eutelianae 183  
 Euteliinae 171, 197, 202, 206, 218, 225  
 Extensae 163
- Fasciatae 166  
 Feraliini 221, 222  
 Focillinae 171  
 FORBES, 1954 198  
 FRANCLEMONT & TODD, 1983 204, 213
- GARDNER, 1946–1948 191  
 Genuinae 161, 169  
 Geometriforum noctuides 178
- Glottulini 222, 226  
 Gonopterinae 171  
 Grotellini 223  
 GUENÉE, 1852–1854 159
- Hadeninae 183, 200, 207, 222, 226  
 Hadenini 222  
 HAMPSON, 1898–1913 181  
 Heliiothidinae (sensu Warren) 186  
 Heliiothinae 178, 207, 222, 226  
 Herminiidae 179  
 Herminiinae 196, 203, 205, 215  
*Hyblaea* 208, 209  
 Hyblacidae 209  
 Hyblacinae 185, 189  
 Hypenidae 178  
 Hypeninae 175, 185, 196, 203, 205, 216, 225  
 Hypenodinae 203, 205, 216, 225
- Immature stages 190  
 Intrusae 163, 169
- Limbatae 164, 169  
 Lithophanini 221, 226
- Minores 162, 169  
 Mominae 184
- Nocloini 221  
*Noctua* 154, 172, 188  
 Noctuae 155, 166  
 Noctuae fasciatae 155  
 Noctuae nonfasciatae 155  
 Noctuélides 155  
 Noctuelitae 166  
 Noctuélites 161  
 Noctuidae (sensu Hampson) 170, 182, 185, 187, 225  
 Noctuidae (sensu Herrich-Schäffer) 158, 170  
 Noctuidae (sensu Janse) 189, 204  
 Noctuidae (sensu Meyrick) 167

- Noctuidae (sensu Tutt) 177  
 Noctuides 176  
 Noctuina 170  
 Noctuinae (sensu Franclemont & Todd) 207, 222, 226  
 Noctuinae (sensu Hampson) 185  
 Noctuinae (sensu Packard) 165  
 Noctuinae (sensu Tutt) 177  
 Noctuini 222  
 Noctuoidea 189, 204  
 Nocturnes 157  
 Nolidae 179, 198, 203  
 Nolinae 181, 206, 219, 225  
 Nonfasciatae 166  
*Nycteola* 175  
 Nycteolidae 158, 179  
 Nycteolinae 170  
  
 Oncocnemidini 221, 222, 223  
 Orthosiinae 177  
  
 Palindiinae 171  
  
 Pantheinae 180, 197, 202, 206, 219, 225, 226  
 Patulae 164  
*Phalaena* 154, 189  
 Phalaenidae 189  
 Phalenidae 178  
 Phytometrinae 184  
 Plusiadae 167  
 Plusiinae 178, 197, 202, 206, 217, 223, 226  
 Plusiini 217  
 Poliinae 197  
 Polyogoninae 185  
 Psaphidini 221, 222, 226  
 Pseudo-Deltoideae 165  
  
 Quadrifidae 161, 162, 169  
 Quadrifinae 171  
  
 RICHARDS, 1932 196  
 Risobini 219  
 Rivulinae 196, 206, 216, 225  
  
 Sarrothripinae 171, 183, 197, 202, 206, 208, 218, 225  
 Sarrothripini 219  
 SEITZ, *Die Gross-Schmetterlinge der Erde* 185  
 Sericiae 162  
 Serpentinae 164  
 Serpentes 178  
 Stictopterinae 171, 183, 197, 217, 226  
 Stiriini 221, 223, 226  
  
 Thyatiridae 167, 170  
 Toxocampidae 178  
 Trifidae 161, 168, 169  
 Trifinae 170  
 Tympanal organs 195  
  
 Ufeini 222  
  
 Variegatae 162  
  
 Xylenini 221, 222







# **British Museum (Natural History)**

## **Milkweed butterflies: their cladistics and biology**

**P. R. Ackery & R. I. Vane-Wright**

The Danainae, a subfamily of the Nymphalidae, contains only some 150 species, yet aspects of their biology have stimulated far more attention than can be justified by species numbers alone. In recent years, an expansive literature has grown, considering aspects of their courtship and pre-courtship behaviour, migration, larval hostplant associations, mimicry and genetics. The popularity of danaines among biologists can certainly be attributed to this combination, within one small group, of so many of the factors that make butterflies such an interesting group to study. The obvious need to place this wealth of biological data within an acceptable systematic framework provided the impetus for this volume.

Started eight years ago within the conventions of evolution by natural selection and Hennig's phylogenetic systematics, the book is now largely about natural history (what the animals have and do, where they live and how they develop) and natural groups – as revealed by a form of analysis approaching that practised by the new school of 'transformed cladistics'. The authors have prepared a handbook that will appeal to a wide range of biologists, from museum taxonomists to field ecologists.

**424 pp (approx.), 12 pp colour, 73 b/w plates, line and graphic illustrations, maps, extensive bibliography. ISBN 0 565 00893 5. Publication September 1984. Price £50, prepublication price £45.**

## **Titles to be published in Volume 49**

**Afrotropical jumping plant lice of the family Triozidae (Homoptera: Psylloidea).**

By David Hollis

**The taxonomy of the western European grasshoppers of the genus *Euchorthippus*, with special reference to their songs (Orthoptera: Acrididae).**

By D. R. Ragge & W. J. Reynolds

**An historical review of the higher classification of the Noctuidae (Lepidoptera).**

By Ian Kitching

**The Pimplinae, Xoridinae, Acaenitinae and Lycorininae (Hymenoptera: Ichneumonidae) of Australia.**

By I. D. Gauld

**The Palaearctic species of *Ascogaster* (Hymenoptera: Braconidae)**

By T. Huddleston

# Bulletin of the British Museum (Natural History)

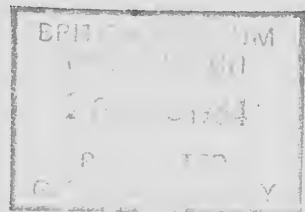

## The Pimplinae, Xoridinae, Acaenitinae and Lycorininae (Hymenoptera: Ichneumonidae) of Australia

I. D. Gauld

Entomology series

Vol 49 No 4

20 December 1984

The *Bulletin of the British Museum (Natural History)*, instituted in 1949, is issued in four scientific series, Botany, Entomology, Geology (incorporating Mineralogy) and Zoology, and an Historical series.

Papers in the *Bulletin* are primarily the results of research carried out on the unique and ever-growing collections of the Museum, both by the scientific staff of the Museum and by specialists from elsewhere who make use of the Museum's resources. Many of the papers are works of reference that will remain indispensable for years to come.

Parts are published at irregular intervals as they become ready, each is complete in itself, available separately, and individually priced. Volumes contain about 300 pages and several volumes may appear within a calendar year. Subscriptions may be placed for one or more of the series on either an Annual or Per Volume basis. Prices vary according to the contents of the individual parts. Orders and enquiries should be sent to:

Publications Sales,  
British Museum (Natural History),  
Cromwell Road,  
London SW7 5BD,  
England.



*World List* abbreviation: *Bull. Br. Mus. nat. Hist. (Ent.)*

© Trustees of the British Museum (Natural History), 1984

The Entomology series is produced under the general editorship of the  
Keeper of Entomology: Laurence A. Mound  
Assistant Editor: W. Gerald Tremewan

ISBN 0 565 06006 6  
ISSN 0524-6431

British Museum (Natural History)  
Cromwell Road  
London SW7 5BD

Entomology series  
Vol 49 No 4 pp 235-339

Issued 20 December 1984

# The Pimplinae, Xoridinae, Acaenitinae and Lycorininae (Hymenoptera: Ichneumonidae) of Australia

I. D. Gauld

Department of Entomology, British Museum (Natural History), Cromwell Road, London SW7 5BD

## Contents

Synopsis.....	235
Introduction .....	235
Material examined .....	236
Checklist of Australian Pimplinae, Xoridinae, Acaenitinae and Lycorininae .....	237
Subfamily Pimplinae .....	238
Zoogeography.....	239
Biology.....	240
Key to genera of Pimplinae occurring in Australia .....	242
Tribe Ephialtini .....	244
Tribe Polysphinctini.....	254
Tribe Pimplini .....	268
Tribe Delomeristini .....	310
Tribe Rhyssini .....	316
Subfamily Xoridinae .....	319
Zoogeography.....	320
Biology.....	320
Subfamily Acaenitinae .....	322
Zoogeography.....	322
Biology.....	322
Subfamily Lycorininae .....	327
Acknowledgements .....	331
References .....	331
Index to hosts .....	338
Index to Ichneumonidae .....	338

## Synopsis

The Australian species of the ichneumonid subfamilies Pimplinae, Xoridinae, Acaenitinae and Lycorininae are revised and keys provided to the 20 genera and 76 species occurring on the continent. A total of 35 species are newly described but four are not formally named as their status needs further investigation. The remaining 41 species are redescribed and their diagnostic features emphasized. Five new specific synonyms are proposed. For each species notes are given about geographical distribution, habitat preference and host range. Introductory sections for each subfamily include notes on zoogeography and a brief discussion of group biology. A checklist of Australian species, and indexes to hosts and parasitoids, complete the work.

## Introduction

Amongst the most important of the natural enemies of insect pests are the parasitic Hymenoptera, a very large group of animals whose larvae develop at the expense of other insects (Askew, 1971). Under normal circumstances the populations of many injurious insects are severely limited by the attacks of Parasitica and in several countries, including Australia, the ravages of accidentally imported pests have been curtailed by the introduction of one or more hymenopterans (Muldrew, 1967; Taylor, 1978). Other introduced pests have been severely attacked by

native Australian parasitoids (Tryon, 1900). During the past 20 years there has been an upsurge in interest in using Hymenoptera and other organisms for purposes of pest control (Wilson, 1960; Huffaker & Messenger, 1976) as an alternative to costly, ineffective and environmentally destructive chemical methods (Bosch, 1978). However, for biological control programmes to be successful an intimate knowledge is necessary of the life history and interactions of the pest and its parasites. A sound taxonomic basis is vital for the development of such knowledge (Hardy, 1982), for such work permits the accurate identification of an organism and hence provides constancy and universality in the usage of names, a prerequisite for the national and international communication of information.

The present work is a taxonomic study of four rather distantly related subfamilies of Australian Ichneumonidae, one of the largest groups of Parasitica. The primary aim of the paper is to provide practical keys for the identification of these insects and to collate information concerning their distribution, habitat preference and host range.

These subfamilies, the Pimplinae, Acaenitinae, Lycorininae and Xoridinae, contain a number of species common in agricultural, horticultural and forest ecosystems, including several that parasitize notorious lepidopterous and symphytan pests. No comprehensive account of the Australian species of these subfamilies has ever been published, although one or two of the pimpline genera have been revised recently for the whole of the Indo-Australian region (Gupta, 1962; Townes & Chiu, 1970; Gupta & Tikar, 1978). Several new Australian species of these genera are described herein, and simpler local keys provided for identification.

The inclusion of the four taxa Pimplinae, Acaenitinae, Lycorininae and Xoridinae together in a single work is largely a matter of convenience. The first subfamily is by far the largest and constitutes the major part of the study; the remaining three taxa are very small and share certain superficial similarities, making it sensible to deal with them at the same time. Although not closely related, these four subfamilies, together with the Banchinae and part of the Labeninae, were included by older authors (e.g. Morley, 1913a; Szépligeti, 1914) in one of the five classical ichneumonid subfamilies, the Pimplinae s.l. This heterogeneous taxon was characterized by possession of a fairly broad first tergite with subcentral or antecentral spiracles (sessile gaster) and, in females, by possession of a long ovipositor (though in fact the ovipositor is very short in some species of *Xanthopimpla*). All Australian species will run to 'Pimplinae' in Riek's (1970) key. The subfamilies may easily be separated by reference to Gauld's (1984) recent monograph on Australian ichneumonids. The Lycorininae, Xoridinae and Acaenitinae are extremely distinctive taxa and easily recognized by the possession of unique features (the co-adapted 'catch' between the metathorax and propodeum of lycorinines; the transcarinate scuto-scutellar groove and geniculate female flagellum of xoridines; the elongate female subgenital plate and accessory tooth on the tarsal claw of acaenitines). Care is required to separate some Pimplinae from Labeninae but species of the latter group have a larger clypeus and higher position of insertion of the gaster than pimplines (Townes, 1969; Gauld, 1984). None of these subfamilies should be confused with the other 'pimpline' taxon, the Banchinae, as all banchines have a dorsal subapical notch in the ovipositor; such a notch is not present in any Pimplinae, Acaenitinae, Lycorininae, Xoridinae or Labeninae.

The terminology in this work follows that of Gauld (1984).

### Material examined

The study is based on examination of almost all specimens available in collections of Australian ichneumonids. Special attention was paid to collections in agricultural institutions that contain large numbers of reared specimens. Examination of these collections has been supplemented by extensive collecting, particularly in Tasmania and the south-east. Although the resulting sample is thought to be fairly representative of the fauna of the more humid eastern part of the continent, relatively little material has been seen from the north and west. Smaller, cryptic species, such as many polyphinctines, are probably very unrepresented.

The following abbreviations have been used for museums containing Australian material.

AM Australian Museum, Sydney, New South Wales, Australia



ANIC	Australian National Insect Collection, Canberra, Australian Capital Territory, Australia
BMNH	British Museum (Natural History), London, U.K.
BPBM	Bernice P. Bishop Museum, Honolulu, Hawaii, U.S.A.
DAR	Department of Agriculture, Rydalmere, New South Wales, Australia
DAT	Department of Agriculture, Hobart, Tasmania, Australia
DFT	Department of Forestry, Hobart, Tasmania, Australia
DPIQ	Department of Primary Industries, Indooroopilly, Queensland, Australia
LSL	Linnean Society, London, U.K.
MNHN	Muséum National d'Histoire Naturelle, Paris, France
MNHU	Museum für Naturkunde der Humboldt-Universität, Berlin, D.D.R.
NM	Naturhistorisches Museum, Vienna, Austria
NMV	National Museum of Victoria, Melbourne, Victoria, Australia
PANS	Philadelphia Academy of Natural Sciences, Philadelphia, Pennsylvania, U.S.A.
QM	Queensland Museum, Fortitude Valley, Queensland, Australia
QUM	Queensland University Museum, Brisbane, Queensland, Australia
TC	Townes Collection, Ann Arbor, Michigan, U.S.A.
TM	Természettudományi Museum, Budapest, Hungary
UL	Université Laval, Quebec, Canada
UM	University Museum, Oxford, U.K.
USNM	United States National Museum, Washington D.C., U.S.A.
UZM	Zoologisk Museum, Copenhagen, Denmark
WAM	Western Australian Museum, Perth, Western Australia, Australia
ZMA	Zoologisch Museum, Amsterdam, The Netherlands

## Checklist of Australian Pimplinae, Xoridinae, Acaenitinae and Lycorininae

### PIMPLINAE

#### EPHIALTINI

Genus *ACROPIMPLA* Townes

*xantha* sp. n.

Genus *CAMPTOTYPUS* Kriechbaumer

*bicolor* Kriechbaumer

*atropos* (Morley) syn. n.

*lachesis* (Morley)

*sellatus* Kriechbaumer

*flaviceps* (Cameron) syn. n.

*clotho* (Morley) syn. n.

Genus *PARVIPIMPLA* Gauld

*petita* Gauld

Genus *SERICOPIMPLA* Kriechbaumer

*australis* Townes, Townes & Gupta

*annulipes* (Cameron)

*crenator* (F.)

*pilosella* (Cameron)

*consimilis* (Morley)

*lutea* sp. n.

Genus *ZAGLYPTUS* Foerster

*glabrinotum* (Girault)

*hollowayi* sp. n.

#### POLYSPHINCTINI

Genus *ACRODACTYLA* Haliday

*cursor* sp. n.

*micans* sp. n.

*quadrisculpta* (Gravenhorst)

*zekhem* sp. n.

Genus *DREISBACHIA* Townes

*lutea* sp. n.

Genus *ERIOSTETHUS* Morley

*carinatus* Baltazar

*maximus* sp. n.

*minimus* sp. n.

*perkinsi* (Baltazar)

*pulcherrimus* Morley

Genus *ZATYPOTA* Foerster

*bingili* sp. n.

*celer* sp. n.

*dandiensis* sp. n.

*kauros* sp. n.

*phraxos* sp. n.

*rennefer* sp. n.

*stellata* sp. n.

*velata* sp. n.

#### PIMPLINI

Genus *ALOPHOPIMPLA* Momoi

*kluia* sp. n.

Genus *ECHTHROMORPHA* Holmgren

*agrestoria* (Swederus)

*melioratorius* (F.)

*interrupta* (Brullé)

*insidiator* (Smith)

*platymischa* (Vachal)

*striata* Krieger

*conopleura* Krieger

*immaculata* Krieger

*notulatoria* var. *immaculata* Morley

*diversor* Morley

*intricatoria* (F.)

*excavata* (Guillou)

*12-guttata* (Ashmead)

*nigricornis* (Smith)

*maxima* Krieger

*fastigata* Krieger

Genus **LISSOPIMPLA** Kriechbaumer

*atra* Girault

*excelsa* (Costa)

*semipunctata* (Kirby)

*10-notata* Kriechbaumer

*8-guttata* Kriechbaumer

*rufipes* (Tryon)

*priocnemidea* Vachal

*obesa* sp. n.

*scutata* Krieger

species 1

Genus **XANTHOPIMPLA** Saussure

*amon* sp. n.

*ankhu* sp. n.

*arealis* Krieger

*gracilis* Krieger

*beauforti* Cameron

*papuana* Cameron

*australis* Krieger

*similis* Krieger

*barak* sp. n.

*binodus* Townes & Chiu

*ecaudata* Krieger

*hispida* Krieger

*minor* Krieger

*flavolineata* Cameron

*emaculata* Szépligeti

*immaculata* Morley

*hyaloptila* Krieger

*xanthostigma* Girault

*xara* Cheesman

*sesamiae* (Rao)

*fraterculus* Townes & Chiu

*hiatus* Townes & Chiu

*hirsuta* (Girault)

*ochracea* (Smith)

*caudata* (Smith)

*crassa* Krieger

*ochracea peterseni* Townes & Chiu syn. n.

*pubidorsis* Townes & Chiu

*quadridens* Townes & Chiu

*rhopaloceros* Krieger

*xanthopimploides* (Girault)

*striata* Townes & Chiu

*summervillei* (Girault)

*terminalis* (Brullé)

DELOMERISTINI

Genus **THERONIA** Holmgren

Subgenus **NOMOSPHECIA** Gupta

*melanosoma* Morley

Subgenus **PAREMA** Gupta

*penetrans* (Smith)

*cephalotes* Krieger

*fumata* Krieger

*papuana* Cameron

Subgenus **THERONIA** Holmgren

*frauca* sp. n.

*maculosa* Krieger

*viridicans* Morley

*steindachneri* Krieger

*dubia* Krieger

*teiae* (Cameron)

*antherae* (Cameron)

*fumipennis* Morley syn. n.

*claripennis* Morley

RHYSSINI

Genus **EPIRHYSSA** Cresson

*biroi* Mocsáry comb. rev.

Genus **MEGARHYSSA** Ashmead

*nortoni* (Cresson)

*quebecensis* (Provancher)

Genus **RHYSSA** Gravenhorst

*persuasoria* (L.)

XORIDINAE

Genus **XORIDES** Latreille

Subgenus **CYANOXORIDES** Cameron

*australiensis* (Szépligeti)

*crudelis* (Turner)

species 1

ACAENITINAE

Genus **YEZOCERYX** Uchida

*amaryllyx* sp. n.

*apicipennis* (Turner)

*coelyx* sp. n.

*dinyx* sp. n.

*tantalyx* sp. n.

species A

LYCORININAE

Genus **LYCORINA** Holmgren

*canberra* sp. n.

*splendidula* sp. n.

*turneri* sp. n.

species 1

### Subfamily PIMPLINAE

The Pimplinae is a moderately large subfamily, but as certain genera contain one or two large, strikingly patterned and common species, it is often the numerically best represented subfamily in general collections. Such collections will be found to be dominated by only three or four species, typically Pimplini, that are common in suburban situations, and also, less frequently, by rhyssines, conspicuous on account of their exceptional size and long ovipositors. Such a situation applies throughout most of the world. In Australia, collections are dominated by species of the genera *Lissopimpla* and *Echthromorpha*, whilst in Palaearctic collections the related and

biologically similar genera *Pimpla* and *Itopectis* predominate. The numerous other smaller or more cryptic pimelines are less often collected and, although many appear to be quite widespread, few are usually present in most museums. Malaise traps generally yield small numbers, but good series can often only be taken by more specialist collecting, such as careful examination of tree bark inhabited by spiders, or 'stalking' the brightly coloured arboreal *Xanthopimpla* species in forest understorey vegetation. Many species are only ever encountered in one particular habitat and these 'rare' taxa may prove to be very common when one knows just where to look. This ecological specialization coupled with the great range of biological diversity exhibited by the subfamily makes the Pimplinae one of the most attractive of all ichneumonid groups for biological investigation.

The Pimplinae is currently subdivided into seven tribes, Delomeristini, Ephialtini, Rhyssini, Pimplini, Neoxoridini, Polysphinctini and Diacritini, but authors have not reached agreement about their exact limits (compare Finlayson, 1967 and Townes, 1969). The Ephialtini is probably the most primitive group, and is the paraphyletic 'grade-group' from within which all the other groups have probably arisen. The Delomeristini appears to be a polyphyletic assemblage and, as it is not yet possible to unambiguously assign its members to other taxa, for the present it is left intact as a tribe. The remaining five tribes seem to be natural holophyletic (in the sense of Hennig, 1966) groups, although the definition of one, the Polysphinctini, can be altered depending upon whether a classification is formulated on larval or adult characters (Townes, 1969; Gupta & Tikar, 1978). Throughout the world approximately 76 genera are recognized, but disagreement over some generic limits means this number is liable to fluctuate for some time. Only 17 of these genera are known to occur in Australia (Gauld, 1984), and several of these (e.g. *Alophopimpla*, *Acropimpla* and *Camptotypus*) are restricted to tropical Queensland; others, such as *Xanthopimpla* and *Zatypota*, appear to be more diverse in the north.

In the following account 62 Australian named species are formally described, of which 23 are new. One morphological segregate of *Lissopimpla* is keyed separately and described but its taxonomic status remains uncertain.

### Zoogeography

For the Indo-Australian region as a whole the general picture of pimpline distribution is one of rapid decrease, both in number of species and genera, from the Asian continental shelf eastwards. This is particularly the case for the Ephialtini which is represented by 20 genera in South East Asia, six in New Guinea and five in Australia, and for the Rhyssini which has seven genera in Asia, five in New Guinea but only one present in Australia. *Acropimpla* is represented by 27 species in South East Asia, two in New Guinea and one in Australia whilst Gupta (1962) demonstrated a progressive west-east reduction in numbers of species and species-groups of *Theronia*. In some groups New Guinea has apparently acted as a centre for secondary radiation. This is particularly noticeable in the case of *Xanthopimpla* for the *splendens*-group (Townes & Chiu, 1970) and is possibly also true for *Camptotypus*. In both these cases the genera seem to have had an Asian origin.

There is a marked relationship between the pimpline fauna of Australia and New Guinea. Of a total of 42 species (excluding polysphinctines) found in Australia, 17 (i.e. 40%) also occur in New Guinea. Many of the species apparently endemic to Australia have their closest or very close relatives to the north. This is particularly obvious for many species of *Xanthopimpla*, *Zaglyptus*, *Acropimpla* and *Alophopimpla*. In none of these genera is there any indication of substantial radiation in Australia, though in a few cases (e.g. *Zaglyptus*) sister-species pairs do occur there.

The most obvious interpretation of this data is to suggest that the Australian fauna has been derived from that of the Old World tropics, presumably within the last five million or so years, as before that time the continent was remote from South East Asia (Audley-Charles *et al.*, 1981). Any hypothesis that advocates a southern origin for these pimelines needs to account for their rapid spread into South East Asia and their extreme radiation, despite possible competitive pressure from numerous Old World pimelines (as many genera are not present in Australia).

Furthermore there are no obvious affinities between the Australian pimpline fauna and that of the southern neotropics. The only endemic Australian genus, *Parvipimpla*, seems to be related to *Camptotypus* and most pimpline and ephialtine Australian genera are not present in South America. The few that are (e.g. *Xanthopimpla*, *Zaglyptus*) are tropicopolitan taxa and the Australian species belong to quite different species-groups from New World taxa. The same is true for *Theronia*; Neotropical species belong to an exclusively Neotropical subgenus (Townes & Townes, 1966) and are not at all closely related to Australian species.

The polysphinctines have been excluded from the above discussion for the reason that virtually nothing is known of them in any region other than north temperate areas. The Australian *Dreisbachia* is probably very closely related to a New Guinea species (Momoi, 1966) and *Eriostethus* has numerous northern congeners. This latter genus was thought by Gauld (1984) to have possible close phylogenetic affinity with some Neotropical species, but subsequent study suggests that the apparent similarities may be the result of evolutionary convergence (see p. 259).

### Biology

Biologically the Pimplinae is both one of the most diverse and one of the more primitive subfamilies of Ichneumonidae. Pimplines utilize a wide range of holometabolous insect larvae and pupae as hosts, though a few even attack spiders' egg sacs. One specialized group, the Polysphinctini, is unique amongst ichneumonids in parasitizing immature spiders. In general pimplines attack relatively mature hosts and usually curtail further host-development by envenomation during parasitization (Chrystal & Skinner, 1932; Morgan & Stewart, 1966; Spradbery, 1968; Price, 1973). The pimpline's venom, produced by accessory glands associated with the reproductive system (Togashi, 1963), is injected by the ovipositor prior to oviposition. It may kill the host or induce permanent paralysis (Cushman, 1926). Smithers (1956) observed that larvae of a psychid stung by *Sericopimpla* (but not parasitized) remained immotile but usually 'fresh' for over two months. The majority of pimplines are ectoparasites of concealed endopterygotes and such immobilization is presumably necessary to prevent the host damaging the pimpline egg or young larva. Smithers (1956) observed that *Sericopimpla* eggs artificially placed on unparalysed psychid larvae were destroyed prior to eclosion. Envenomation by the endoparasitic Pimplini may be necessary to reduce the host's haemocyte reaction which is usually more pronounced in more mature larvae (Puttler, 1961; Bosch, 1964). However, Carton (1973) observed that careful placement of the egg was necessary for *Pimpla* to minimize encapsulation, whilst Führer & Kilincer (1972) noted that the newly hatched larvae of some other species migrate rapidly to the host's head and destroy the cephalic ganglion by histolysis. Unlike other pimplines, polysphinctines generally do not curtail host development. Species of *Polysphincta* and *Acrodactyla* have a powerful paralyzing venom which they use to immobilize a spider. After stinging and attaching an egg the pimpline departs and the spider recovers and lives actively (Nielsen, 1923; Cushman, 1926).

Parasitoids, such as most Pimplinae, that adopt the strategy of attacking mature hosts, generally lay large, well-developed eggs (Price, 1975) and undergo quite rapid larval development. The size of pimpline eggs can readily be appreciated from the tables given by Iwata (1958). A species of *Sericopimpla* has 'sausage-shaped' eggs  $2.4 \times 0.4$  mm whilst a specialist endoparasitoid of similar body size (e.g. *Meniscus*) has eggs between  $0.33 \times 0.08$  mm and  $0.71 \times 0.16$  mm, that is around one-twentieth of the volume. Even very small pimplines, such as *Zatypota*, have eggs  $0.74 \times 0.22$  mm in size. Many very large species, such as *Megarhyssa*, have extremely elongate eggs (up to 14 mm long) which deform to facilitate passage down the long ovipositor (Spradbery, 1970). To successfully form such large eggs many female pimplines need protein-rich food. In addition to feeding at flowers, like the males, these females frequently consume haemolymph exuding from the punctures they make in pupae used as hosts (Graham, 1947; Leius, 1960). Some pimplines seek out and kill prey to obtain such fluid nourishment (Cole, 1967) and, as the prey is often the larvae or pupae of the host species, the ichneumonid is often a more important mortality factor than estimation of percentage of parasitism may suggest.

As pimpline eggs are large, adult females have relatively few mature oocytes in the oviduct at any one time. Iwata (1960) calculated the average number to be about six with a maximum of generally less than 20, except in a few species such as *Iseropus* which are gregarious parasites. Banchines, which are similar-sized ichneumonids, but specialist endoparasites, have on average 53 mature oocytes, with a maximum of 176. The eggs of many pimplines are deposited on or near the paralysed larva (Smithers, 1956; Morgan & Stewart, 1966) though those of Pimplini are placed within the host's haemocoel, often in the thorax (Carton, 1973). One striking feature of some pimplines is their apparent inefficiency in oviposition. Smithers (1956) observed that *Sericopimpla* may attempt to sting a psychid larva over 100 times, and is often engaged for an hour or more attacking a single individual. Morgan & Stewart (1966) observed that *Rhyssa* made between five and 12 insertions of the ovipositor to make a single successful attack.

Pimpline eggs hatch quite rapidly, often one or two days after oviposition, and early larval development proceeds very rapidly with generally only one or two days between ecdyses (Rosenberg, 1934; Smithers, 1956; Rojas-Rousse & Benoit, 1977). The final larval instar is of longest duration, frequently exceeding the length of the sum of all others. This contrasts markedly with some specialist endoparasitoids where the first larval instar is extremely protracted (Tothill, 1922). The exact number of instars pimpline larvae pass through is difficult to ascertain (Rojas-Rousse & Benoit, 1977) but may often be five or six; individual intraspecific variation may occur (Smithers, 1956). The cocoon of pimplines is generally only rudimentary though some polysphinctines spin thick and very characteristic ones (Figs 98, 99). Diapause, when it occurs, is usually in the prepupal stage though at least one European species aestivates as an adult (Cole, 1967).

As most pimplines incapacitate their hosts they need little physiological or cytological compatibility with the latter as do many specialist endoparasites (Salt, 1968). Consequently pimplines often utilize a very wide range of hosts. This is particularly true for some Pimplini which search disturbed habitats for pupae. For example *Echthromorpha intricatoria* has been reared from pupae of Anthelidae, Lymantriidae, Noctuidae and Nymphalidae. Many species of Ephialtini and some Theroniini are specialized, not immunologically, but in their adaptations for reaching particular hosts. In such groups the apex of the ovipositor is often characteristic of a species (Townes & Townes, 1960). Although these morphological adaptations are associated with a particular niche (e.g. decaying wood), within each niche quite different species may be used as hosts. For example, one Nearctic species of *Dolichomitus* is restricted to timber-borers in certain trees, but will parasitize larvae of Buprestidae, Cerambycidae and Sesiidae if available (Townes & Townes, 1960). Pimplinae not only often utilize a wide range of hosts, but many attack a variety of different-sized hosts. Consequently size variation in adults of some species may be very large. For example, females of *Rhyssa persuasoria* in Europe have a fore wing length range of 9 to 25 mm. Females of some species are facultatively arrhenotokous, laying fertilized (i.e. female) eggs in large hosts and unfertilized (male) eggs in smaller ones. Thus the females are, on average, larger than the males.

The evolutionary biology of the Pimplinae is a fascinating subject, and although incompletely known both from phylogenetic and biological standpoints, more information exists for the group than probably any other ichneumonid subfamily. The ancestral ichneumonoids are believed to have been parasites of wood-borers (Königsmann, 1978) such as cerambycid or siricid larvae. Such habits are retained by a number of structurally rather primitive ephialtines. The Rhyssini and Poemeniini are biologically similar though the adults are somewhat more specialized morphologically than ephialtines. They are difficult to place phylogenetically (each being characterized by several autapomorphies) but may represent early branches from the ephialtine stock. Several evolutionary lineages of ephialtines have given rise to single species that parasitize aculeates nesting in old borings in timber (e.g. Jussila & Käpylä, 1975). Such a switch from timber-boring larvae to larvae (usually aculeate) inhabiting timber borings is a common feature in ichneumonids and occurs amongst labenines (Gauld, 1983) and gabuniine mesostenines (Gupta & Gupta, 1983). A large number of species related to ephialtine parasites of timber-borers have become associated with endopterygotes that pupate on cracks in trees, under bark etc. (Rosenberg, 1934; Perkins, 1942). Further evolutionary change has followed

one of three major biological pathways – progressive association with cocoons; association with borers in non-ligneous or partially lignified tissue; or specialization on more or less exposed hosts. Whilst in evolutionary terms the latter may have been derived from either of the former these different biological adaptations represent three alternative areas of specialization for pimelines. One apparent phyletic lineage of Ephialtini (the *Tromatobia*-subgroup) has specialized in being cocoon parasites. Oviposition is apparently stimulated by the presence of silk on which the ichneumonid alights prior to probing for a host. Several species in this group are gregarious (Iwata, 1961). Amongst the hosts used are psychid larvae, various lepidopterous cocoons and also spider egg-sacs. The polysphinctines are probably derived from this lineage. Presumably the *Tromatobia*-subgroup arose from ephialtines that probed for cocoons through bark or other plant tissue.

Other ephialtines attack borers in non-lignified or partially lignified tissue such as *Pseudopimpla*, which attacks cephids (Bruzese, 1982) mining *Rubus* stems, and *Alophosternum*, which parasitizes leaf miners (Townes, 1969). Many *Scambus* species attack hosts of this type. One European species attacks immature larvae of a bud-mining tortricid (Winter, 1979) whilst another species probably attacks gall-forming Diptera in reed beds. Some species are gregarious (Iwata, 1961).

The species that attack fairly exposed hosts include the majority of Pimplini. They are endoparasitic (a common feature of parasitoids of exposed hosts) but exhibit few of the specialized immunological mechanisms of more advanced endoparasitic ichneumonids. The host is little more than 'a piece of meat' and is either virtually killed by envenomation prior to oviposition or has its cephalic region destroyed at the earliest opportunity by the newly hatched parasitoid larva (Führer & Kilincer, 1972). One genus of Pimplini, *Itopectis*, includes a number of species that are facultative hyperparasites. A similar adaptation occurs in Australia in some species of *Theronia*, a genus whose species exhibit a considerable range of biological adaptations. It is possible that all *Theronia* species are parasites of hymenopterous larvae, either of Parasitica as hyperparasites through Lepidoptera, or in aculeate nests (Guṛta, 1962; Short, 1978). A rather similar host range is found in the family Trigonalidae (Clausen, 1940). It is quite possible that all of the Delomeristini are parasitic only on Hymenoptera and the initially apparently heterogeneous facies presented by the genera of this group is an indirect result of specialization on different hymenopterous hosts, such as sawflies in the case of *Delomerista* (Furniss & Dowden, 1941), rhyssines in the case of *Pseudorhyssa* (Spradbery, 1969), and stem-nesting aculeates in the case of *Perithous* (Danks, 1971).

A great deal of additional work needs to be undertaken to develop this subject. Particularly valuable would be studies of the comparative anatomy of the reproductive systems, analyses of venoms and studies of larval morphology. Biological observations on the poorly known Australian fauna would also be invaluable, especially if they involved such virtually unstudied genera as *Alophopimpla*, *Acropimpla*, *Camptotypus*, *Parvipimpla* and *Epirhyssa*. One of the principal aims of this work is to stimulate such investigations.

### Key to genera of Pimplinae occurring in Australia

The tribal groupings in the Pimplinae are based to a large extent on structures of the final instar larvae (Finlayson, 1967; Short, 1978). The characters used to place adults in tribes are subtle, subject to variation and difficult for an inexperienced person to appreciate. For ease of identification the key given below is direct to genus.

- |   |   |                             |
|---|---|-----------------------------|
| 1 | Mesoscutum without sharp, transverse wrinkles or rugae; last visible tergite of ♀ gaster not cornute.....   | 2                           |
| – | Mesoscutum with sharp transverse wrinkles or rugae; last visible tergite of ♀ gaster ending in a short horn.....  | 15                          |
| 2 | Epicnemial carina entirely absent; posterior margins of tergites 3–5 incised.<br>3 <i>r–m</i> lacking in fore wing and hind wing with first abscissa of <i>Cu</i> <sub>1</sub> shorter than <i>cu–a</i> |                             |
|   |   | <b>PARVIPIMPLA</b> (p. 249) |
| – | Epicnemial carina present, at least ventrally; posterior margins of tergites 3–5 not conspicuously incised.....   | 3                           |

- 3 Hind wing with *cu-a* more than 1.8 times as long as first abscissa of *Cu*<sub>1</sub> (Fig. 7) (or sometimes with distal abscissa of *Cu*<sub>1</sub> and *M* basally united (Fig. 6)); distal abscissa of *Cu*<sub>1</sub> present; fore tarsal claws of ♀ simple ..... 4
- Hind wing with *cu-a* about equal to or shorter than first abscissa of *Cu*<sub>1</sub> (Fig. 8), or with distal abscissa of *Cu*<sub>1</sub> absent; fore tarsal claws of ♀ with a basal lobe..... 8
- 4 Hind femur with a ventral tooth; face with vertical impression either side of raised mid-line  
*LISSOPIMPLA* (p. 273)
- Hind femur without a ventral tooth; face without vertical impressions ..... 5
- 5 Mandibles not twisted; labrum concealed when mandibles closed; clypeus transverse and entire ..... 6
- Mandibles strongly twisted; labrum exposed when mandibles closed; clypeus elongate, or if transverse then divided by a transverse ridge ..... 7
- 6 Propodeal spiracle almost circular; propodeum dorsally without carinae; occipital carina dorsally absent ..... *ALOPHOPIMPLA* (p. 269)
- Propodeal spiracle elliptical; propodeum dorsally with lateral and lateromedian longitudinal carinae discernible; occipital carina complete ..... *THERONIA* (p. 310)
- 7 Malar space equal to or longer than basal mandibular width; marginal cell or fore wing with distal infumate spot; fore wing with *cu-a* distal to *Rs&M* ..... *ECHTHROMORPHA* (p. 269)
- Malar space shorter than basal mandibular width; marginal cell of fore wing with *cu-a* more or less opposite base of *Rs&M*..... *XANTHOPIMPLA* (p. 276)
- 8 Fore wing with *3r-m* present, enclosing a subtriangular or rhombic areolet ..... 9
- Fore wing with *3r-m* absent ..... 11
- 9 Pterostigma bright yellow, contrasting with infumate wings and dark veins; pleural carina absent (Fig. 9); occipital carina obsolescent or absent mediodorsally.... *CAMPTOTYPUS* (p. 245)
- Pterostigma blackish, concolorous with other veins; pleural carina present (Fig. 10); occipital carina present mediodorsally ..... 10
- 10 Eye with a strong indentation opposite base of antenna (Fig. 4); hind ocellus separated from eye by about its own diameter; head behind eyes very strongly narrowed  
*SERICOPIMPLA* (p. 249)
- Eye with weak indentation opposite base of antenna (Fig. 5); hind ocellus separated from eye by more than its own diameter; head behind eyes evenly rounded..... *ACROPIMPLA* (p. 244)
- 11 Propodeum with lateral subapical tubercles (Fig. 11); ovipositor shaft in profile parallel-sided, the apex abruptly tapered with proximal tooth bearing an elongate, free tip; segment 5 of hind tarsus quite slender, about 2.5 times as long as broad ..... *ZAGLYPTUS* (p. 252)
- Propodeum without lateral subapical tubercles; ovipositor shaft in profile evenly tapered from centre to apex, apical teeth indistinct, the most proximal never with an elongate free tip; segment 5 of hind tarsus stout, 2.0 times or less as long as broad ..... 12
- 12 Mesoscutum with a small crest near anterior end of notaulus; propodeum in profile rather long, often coarsely sculptured (Fig. 85)..... *ACRODACTYLA* (p. 254)
- Mesoscutum without an anterior crest; propodeum in profile rather evenly rounded, generally smooth and polished (Figs 88–91) ..... 13
- 13 Mesoscutum with central lobe evenly and closely pubescent; surface of eye bearing scattered long conspicuous hairs; ovipositor slightly up-curved ..... *DREISBACHIA* (p. 258)
- Mesoscutum without hair centrally; surface of eye with, at most, inconspicuous short hair; ovipositor straight or up-curved near apex ..... 14
- 14 Hind tibia with a longitudinal hairless furrow on inner surface; ovipositor projecting beyond apex of gaster by more than 0.9 times length of hind tibia ..... *ERIOSTETHUS* (p. 258)
- Hind tibia without a hairless furrow internally; ovipositor projecting beyond apex of gaster by less than 0.5 times length of hind tibia ..... *ZATYPOTA* (p. 263)
- 15 Pronotum mediodorsally with a depression centrally, but without a deep transverse furrow separating an anterior lip-like portion; first sternite not fused to tergite; ♀ with sternites 2–4 with a median pair of tubercles..... *RHYSSA* (p. 318)
- Pronotum mediodorsally with deep transverse groove separating off a recurved anterior lip; first sternite fused to tergite; ♀ with sternites 2–4 bearing tubercles near anterior edge ..... 16
- 16 Fore wing without *3r-m*; tergite 1 without dorsolateral carinae anteriorly; tergite 2 with thyridia contiguous with anterior margin ..... *EPIRHYSSA* (p. 316)
- Fore wing with *3r-m* present, enclosing rhombic areolet; tergite 1 with dorsolateral carinae on anterior 0.1; tergite 2 with thyridia separated from anterior margin..... *MEGARHYSSA* (p. 317)

## Tribe EPHIALTINI

(= Pimplini sensu Townes)

The Ephialtini is undoubtedly a paraphyletic assemblage as it is the group from within which the Polysphinctini has arisen. It also is possibly paraphyletic with respect to the Pimplini. As a paraphyletic 'group' the Ephialtini can only be characterized by its lack of the apomorphic features of other tribes, but like that notorious paraphyletic taxon, the Reptilia, the Ephialtini is both practically recognizable and a functionally useful category (vide Charig, 1981).

Ephialtines are mostly moderately large to large insects and usually possess an ovipositor that is as long as or longer than the gaster; this organ is slender, parallel-sided and tapered only apically, unlike that of the Polysphinctini which is elongately tapered. The fore wing may or may not lack  $3r-m$  (this vein is usually present in the Pimplini) and the first abscissa of  $Cu_1$  in the hind wing is more than 0.6 times the length of  $cu-a$  (it is less than 0.5 in Pimplini). Ephialtines do not have specialized pulvilli as do polysphinctines, nor the reduced larval hypostoma characteristic of pimplines.

Currently 32 genera are recognized; these are divisible into four generic groups, the *Ephialtes*-group, the *Alophosternum*-group, the *Pseudopimpla*-group and the *Camptotypus*-group. The *Ephialtes*-group, characterized by a more or less complete occipital carina and basal lobes present on all female claws, comprises two ill-defined subgroups, the *Ephialtes*-subgroup with a medianly dipped occipital carina, flat clypeus, centrally membranous female subgenital plate and less oblique ovipositor teeth, and the *Tromatobia*-subgroup with a less obviously dipped occipital carina, more convex clypeus, fairly evenly sclerotized female subgenital plate and a very oblique proximal tooth on the ovipositor. The former subgroup is primarily Holarctic and Neotropical and contains 15 genera, including *Scambus*, *Ephialtes* and *Dolichomitus*. It is not represented in Australia. The *Tromatobia*-subgroup is cosmopolitan and contains seven genera, three of which, *Acropimpla*, *Sericopimpla* and *Zaglyptus*, occur in Australia. Two other genera, *Tromatobia* and *Clistopyga*, occur in New Guinea. The other three generic groups differ from the *Ephialtes*-group in having a broadly incomplete occipital carina. The monobasic *Pseudopimpla*-group is Palaearctic whilst the *Alophosternum*-group, which contains two genera, is primarily eastern Palaearctic and Nearctic. Only the *Camptotypus*-group, characterized by the incomplete occipital carina, glabrous mesosternum and long straight ovipositor, is represented in Australia. This group is tropicopolitan. It comprises seven genera, three of which are Old World/Australian and the remaining four are Neotropical. Of the Palaeotropical genera, *Hemipimpla* is restricted to Africa, *Parvipimpla* to Australia, whilst *Camptotypus* is Indo-Australian.

Biologically there is some difference between the five groupings listed above, though little is known of the *Camptotypus*-group. The *Alophosternum*-group is associated with leaf-mining larvae (Cushman, 1933), whilst *Pseudopimpla* is a parasite of cephid stem-miners (Bruzese, 1982). The *Ephialtes*-subgroup is parasitic on a variety of holometabolous insect larvae and pupae concealed in plant tissue (e.g. stem-borers, fruit-miners); oviposition is thus through the plant tissue. The *Tromatobia*-subgroup is parasitic in 'cocoon' of various kinds, including psychid larval cases, lepidopterous cocoons and spider egg-sacs. Not only is oviposition through silk but, unlike the previous subgroup, the adult ichneumonid is usually in contact with the silk. Many members of this group are gregarious.

Gauld (1984) recognized five ephialtine genera as occurring in Australia; a species of *Liotryphon*, purported to have been introduced from Europe was in fact not liberated in Australia (Froggatt, 1909). The majority of Australian ephialtines occur in tropical Queensland where they are encountered fairly frequently. Some species of *Sericopimpla* and *Zaglyptus* are more widely distributed, particularly in the wet sclerophyll forests of the eastern part of the continent.

**ACROPIMPLA** Townes

*Selenaspis* Roman, 1910: 191. Type-species: *Hemipimpla alboscuteellaris* Szépliget, by original designation. [Homonym of *Selenaspis* Bleeker, 1858.]



*Acropimpla* Townes, 1960b: 159. Type-species: *Charitopimpla leucostoma* Cameron, by original designation.

Medium-sized species, fore wing length 7–8 mm; clypeus with a median apical notch; eye weakly indented opposite antennal socket (Fig. 5); malar space 0.3 times as long as basal mandibular width; occipital carina complete. Epomia short; epicnemial carina strong; propodeum without carinae, spiracle circular. Female with claws basally lobate; fore wing with  $3r-m$  present, enclosing a broad rhombic areolet; hind wing with first abscissa of  $Cu_1$  longer than  $cu-a$ . Lateromedian carina of tergite 1 not reaching to end of segment; tergites 2–4 with lateromedian swellings; ovipositor straight, projecting beyond apex of gaster by 1.5 times length of hind tibia. Wings infumate with pterostigma black.

REMARKS. A moderately large genus most species of which occur in the Oriental region. A few are Holarctic and some Ethiopian. Gupta & Tikar (1978) recognized 26 Oriental species but none from south-east of Mindanao.

I have seen two apparent species from east of Weber's line, one from New Guinea and a second, closely related one from Australia.

*Acropimpla* species are known to parasitize a variety of Microlepidoptera, especially Pyralidae (Gupta & Tikar, 1978). Oviposition may be through silk (Townes, 1969).

### *Acropimpla xantha* sp. n.

(Fig. 5)

Face very weakly convex, sparsely punctate; malar space 0.3 times basal mandibular width; occipital carina very weakly dipped mediodorsally. Mesoscutum with notauli fairly strong, reaching posteriorly to near level of centre of tegulae; scutellum smooth, convex; mesopleuron highly polished, virtually impunctate with subtegular ridge normally convex; metapleuron smooth and polished, submetapleural carina present but only slightly raised. Propodeum abruptly declivous, smooth and polished; lateromedian longitudinal carinae absent, pleural carina present. Fore wing with  $cu-a$  opposite base of  $Rs&M$ ; hind wing with first abscissa of  $Cu_1$  longer than  $cu-a$ , distal abscissa of  $Cu_1$  present but weak. Gaster with tergite 1 with lateromedian carinae extending about 0.8 times length; lateral carina present, virtually complete except for petiolar spiracle; tergites 2+ with weak tubercles, with coarse shallow punctures on tergite 2, the punctures on succeeding tergites progressively more obscure; subgenital plate centrally membranous; ovipositor projecting beyond apex of gaster by 1.5 times length of hind tibia, its most proximal tooth oblique, subtending an angle of  $30^\circ$  to shaft.

Female yellow, scape dorsally, pedicel and flagellum entirely, frons above antennal insertion, vertex and most of genae above lower margin of eye, shining black; ovipositor sheath black. Wings strongly infumate, pterostigma dark brown. Male unknown.

REMARKS. A distinctive species easily recognized from all other Indo–Australian species by its colour. It belongs to group A of Gupta & Tikar (1978), a group of species characterized by the smooth convex propodeum.

*A. xantha* is only known from a single specimen collected in tropical Queensland.

HOST RECORDS. None.

#### MATERIAL EXAMINED

Holotype ♀, Australia: Queensland, Atherton, ii.1975 (Howden) (TC).

### CAMPTOTYPUS Kriechbaumer

*Camptotypus* Kriechbaumer, 1889: 311. Type-species: *Camptotypus sellatus* Kriechbaumer, by subsequent designation, Viereck, 1914: 27.

*Erythropimpla* Ashmead, 1900a: 57. Type-species: *Erythropimpla abbottii* Ashmead (= *Pimpla olynthia* Cameron), by original designation.

*Trichiothecus* Cameron, 1903: 136. Type-species: *Trichiothecus ruficeps* Cameron (= *Ichneumon rugosus* DeGeer), by monotypy.

Medium-sized to moderately large species, fore wing length 9–14 mm; clypeus with a median apical notch; eye weakly indented opposite antennal socket; malar space 0.5–1.0 times as long as basal mandibular width; occipital carina obsolescent or absent dorsally, present laterally and ventrally. Epomia weak; epicnemial carina present, not strong; propodeum virtually without carinae, spiracle subcircular (Fig. 9).

Female with claws basally lobate; fore wing with  $3r-m$  present, enclosing a broad, rhombic areolet; hind wing with first abscissa of  $Cu_1$  longer than  $cu-a$ . Lateromedian carinae of tergite 1 reaching end of segment; tergites 2, 3 and to a lesser extent 4 with diagonal furrows delimiting raised central areas; tergites 3–5 sometimes with a small incision laterally so posterolateral corner is produced as a blunt tooth; ovipositor straight, projecting beyond apex of gaster by 2·2–3·2 times length of hind tibia. Wings strongly infumate with pterostigma yellow.

**REMARKS.** *Camptotypus* is a moderately large genus containing 24 recognized species restricted to the Indo–Australian region. It is very closely related to the Afrotropical genus *Hemipimpla* Saussure. Although now treated as separate genera (Gupta & Tikar, 1978; Gauld, 1984), some authors (e.g. Townes, 1969) consider *Hemipimpla* a subgenus of *Camptotypus*.

Gauld (1984) listed five nominate species as occurring in Australia but remarked that two names, *sellatus* Kriechbaumer and *bicolor* Kriechbaumer, had remained unassociated as the whereabouts of the type-material was not known (Gupta & Tikar, 1978). Study of the species now known to occur in Australia, and examination of Kriechbaumer's original descriptions, has enabled these two species to be identified with reasonable certainty and this has necessitated synonymizing two of the other names.

*Camptotypus* species are conspicuous ichneumonids that can be observed flying in clearings in rain forest. Their colour pattern and mottled wings are reminiscent of some braconines and I have collected both flying in the same clearing. Few host records exist for the genus. One Asian species have been reared from *Hyblaea* sp. (Lepidoptera: Hyblaeidae) (Sonan, 1930), whilst one African species of *Hemipimpla* parasitizes an *Epicampoptera* (Lepidoptera: Drepanidae) (LePelley, 1954); a second species has been reared from *Belonogaster* nests (Hymenoptera: Vespidae) (Keeping & Crewe, 1983).

### Key to Australian species of *Camptotypus*

- 1 Hind tibia strongly flattened and broadened so it is less than 6·0 times as long as apically broad (Fig. 55); tergite 4 of gaster closely punctate, the punctures virtually contiguous (Fig. 63); ♀ with ovipositor 2·2–2·6 times as long as hind tibia ..... *bicolor* Kriechbaumer (p. 246)
- Hind tibia subcylindrical, not obviously flattened, at least 7·0 times as long as apically broad (Fig. 54); tergite 4 of gaster more sparsely punctate, the punctures separated by at least 0·5 times their own diameters (Fig. 64); ♀ with ovipositor 2·8–3·2 times as long as hind tibia ..... 2
- 2 Gaster more or less entirely black, or with tergite 1 brownish; head dorsally whitish yellow; hind legs black ..... *sellatus* Kriechbaumer (p. 248)
- Gaster with anterior and posterior tergites brownish, the ♀ with tergites 3 and 4, the ♂ with tergites 4–6 blackish or infuscate; head dorsally black; hind legs brown, only tarsus blackish ..... *lachesis* (Morley) (p. 247)

### *Camptotypus bicolor* Kriechbaumer

(Figs 55, 63)

*Camptotypus bicolor* Kriechbaumer, 1889: 311. Holotype ♀, AUSTRALIA (depository unknown).

*Hemipimpla atropos* Morley, 1914: 94. Lectotype ♀, AUSTRALIA (BMNH), designated by Townes *et al.*, 1961: 21 [examined]. **Syn. n.**

*Camptotypus (Camptotypus) atropos* (Morley) Townes *et al.*, 1961: 21.

*Camptotypus atropos atropos* (Morley) Gupta & Tikar, 1978: 213.

Fore wing length 12–14 mm; upper tooth of mandible slightly broader than the lower but approximately the same length. Mesoscutum with notauli strongly impressed anteriorly, reaching to level of centre of tegulae; submetapleural carina fairly strongly broadened and thickened anteriorly; propodeum abruptly declivous, posteriorly slightly convex. Hind tibia less than 6·0 times as long as maximally broad, flattened, with spurs slightly shorter than apical breadth (Fig. 55). Tergite 1 of gaster in profile dorsally centrally angulate, the surface of the petiole and postpetiole meeting at about 130°, in dorsal aspect with carinae extending to posterior margin, the area between them smooth, with scattered punctures posteriorly; tergites 3 and 4 centrally coarsely and very closely punctate (Fig. 63); posterolateral corners of tergites 3–5 slightly truncated, not developed into teeth; ovipositor projecting beyond apex of gaster by 2·2–2·6 times length of hind tibia.

Female and male head, alitrunk, tergites 1, 2 and often 3 of gaster yellowish brown; flagellum brown,

centrally infusate, distally pale; legs orange, hind tarsus sometimes infusate; remainder of gaster blackish. Wings strongly infumate, clear at extreme proximal end and below pterostigma; pterostigma yellow.

**REMARKS.** *C. bicolor* has previously remained as an unrecognized species as the location of the type is unknown (Gupta & Tikar, 1978). However, Kriechbaumer's original description leaves little doubt as to its identity. The phrase 'Fulvis . . . abdomine basi excepta . . . nigris' clearly identifies it as this species and although not all specimens have the hind tarsus black some do. *C. lachesis*, which to some extent resembles this species, is unlikely to be conspecific with *C. bicolor* as in *lachesis* the head is black dorsally. Kriechbaumer does not state head colour except by the general statement 'fulvis'. Furthermore, the gaster of *lachesis* is fulvous anteriorly and posteriorly.

Gupta & Tikar (1978) recognized three subspecies on minor colour differences, but for the present these are ignored as one may expect colour variation in any sexually reproducing species that has a fairly wide and discontinuous geographical distribution.

The rather shortened, flattened hind tibia and tarsus make *C. bicolor* one of the most distinctive species of *Camptotypus*.

This species is uncommon in Australia; it also occurs in the Moluccas, New Guinea and New Britain (Gupta & Tikar, 1978).

**HOST RECORDS.** None.

#### MATERIAL EXAMINED

**Australia:** 1 ♀ (lectotype of *atropos*), Queensland, Mackay (Turner) (BMNH).

**Australia:** 1 ♀, Northern Territory, Daly River Mission, x.1974 (Hutchinson) (ANIC); 2 ♀, Queensland, Redlynch, xi.1938 (Sternitzky) (BMNH); 3 ♀ (paralectotypes), same data as lectotype (BMNH).

### *Camptotypus lachesis* (Morley)

(Fig. 54)

*Hemipimpla lachesis* Morley, 1914: 94. Lectotype ♀, AUSTRALIA (BMNH), designated by Townes *et al.*, 1961: 23 [examined].

*Camptotypus (Camptotypus) lachesis* (Morley) Townes *et al.*, 1961: 23.

*Camptotypus lachesis* (Morley); Gupta & Tikar, 1978: 209.

Fore wing length 9–13 mm; upper tooth of mandible slightly broader than the lower, of more or less the same length. Mesoscutum with notauli strongly impressed anteriorly, reaching to level of centre of tegulae; submetapleural carina anteriorly parallel-sided, posteriorly evenly tapered; propodeum abruptly declivous, posteriorly biconcave. Hind tibia cylindrical, about 7.0 times as long as apically broad, with spurs slightly longer than apical breadth (Fig. 54). Tergite 1 of gaster in profile dorsally from fairly abruptly rounded to angulate, in dorsal aspect with carinae complete to posterior margin of segment, the area between them smooth, with scattered punctures posteriorly; tergites 3 and 4 centrally coarsely punctate, the punctures separated by about 0.5 or more times their own diameter; posterolateral corners of tergites 3–5 slightly truncated, not developed into teeth; ovipositor projecting beyond apex of gaster by 3.0–3.2 times length of hind tibia.

Female head dorsally black, ventrally yellow; antenna black, distal apices yellowish brown; alitrunk, tergites 1–3 and 6+ of gaster and legs brownish orange; hind tarsi and tergites 3 and 4 of gaster black. Wings infumate distal to about *cu-a* except for an area below pterostigma; pterostigma yellow. Male similar to female but with tergites 4–6 infusate, remainder of gaster fulvous.

**REMARKS.** This species is quite easily recognized on account of its colour pattern, especially the dorsally black head and centrally black gaster. The holotype is labelled 'Victoria' but I doubt that this is correct as all other specimens of *Camptotypus* are tropical. However, I have previously had no reason to doubt the veracity of French's locality data.

*C. lachesis* is otherwise known only from Northern Territory and north Queensland.

#### MATERIAL EXAMINED

**Australia:** 1 ♀ (lectotype), 'Victoria' (French) (BMNH); 1 ♂ (paralectotype), Queensland, Mackay (Turner) (BMNH).

**Australia:** 14 ♀, 5 ♂, Northern Territory, Queensland (AM; ANIC; BMNH; TC) (Map 4).

*Camptotypus sellatus* Kriechbaumer

(Figs 9, 64)

*Camptotypus sellatus* Kriechbaumer, 1889: 311. Holotype ♀, AUSTRALIA (depository unknown).*Erythropimpla flaviceps* Cameron, 1911a: 206. Lectotype ♀, AUSTRALIA (ZMA), designated by Townes *et al.*, 1961: 22. [Junior secondary homonym of *Camptotypus flaviceps* (Smith).] **Syn. n.***Hemipimpla clotho* Morley, 1914: 93. Lectotype ♀, AUSTRALIA (BMNH), designated by Townes *et al.*, 1961: 22 [examined]. **Syn. n.***Camptotypus* (*Camptotypus*) *clotho* (Morley) Townes *et al.*, 1961: 22.*Camptotypus* (*Camptotypus*) *flaviceps* (Cameron) Townes *et al.*, 1961: 22.*Camptotypus* (*Camptotypus*) *sellatus* Kriechbaumer; Townes *et al.*, 1961: 24.*Camptotypus flaviceps* (Cameron); Gupta & Tikar, 1978: 204.

Fore wing length 13–14 mm; upper tooth of mandible slightly broader and longer than the lower. Mesoscutum with notauli weakly impressed anteriorly; submetapleural carina quite narrow, slightly broadened anteriorly; propodeum abruptly declivous, posteriorly rather flat. Hind tibia subcylindrical, about 7.0 times as long as maximally broad, with spurs longer than apical breadth. Tergite 1 of gaster in profile dorsally convex, without a central angulation, in dorsal aspect with carinae extending more or less to hind margin, the area between them smooth, at most with superficial punctures posteriorly; tergites 3 and 4 centrally with large punctures separated by 0.5–1.0 times their own diameters (Fig. 64); posterolateral corners of tergites 3–5 slightly incised, produced into blunt teeth; ovipositor projecting beyond apex of gaster by 2.8–3.2 times length of hind tibia.

Female and male head whitish yellow; flagellum blackish, often with scape reddish brown; alitrunk and anterior two pairs of legs orange brown; gaster and hind legs black. Wings strongly and relatively uniformly infumate; pterostigma yellow.

**VARIATION.** In some specimens tergite 1 of the gaster is reddish brown; the mid tarsus may be infusate. A small hyaline area may be present below the pterostigma. One New Guinea specimen has the propodeum strongly infusate.

**REMARKS.** *C. sellatus* has previously remained as an unrecognized species because the location of the type is unknown (Gupta & Tikar, 1978; Gauld, 1984). Only three species of *Camptotypus* seem to occur in Australia, and as the type-locality of *sellatus* is given as Australia (Kriechbaumer, 1889) presumably the name must refer to one of them. Kriechbaumer's original description states 'pedibus posticis et abdomine nigris' and this is the only Australian species that has the hind legs and gaster black. This species has previously been known under the name *C. flaviceps* (Cameron) (Gupta & Tikar, 1978), despite the fact that *flaviceps* (Cameron) is a junior secondary homonym of *flaviceps* (Smith). The fact that *flaviceps* (Smith) is a rejected name as it is a junior primary homonym of *Pimpla flaviceps* Brullé does not affect its availability for purposes of secondary homonymy so therefore Gupta & Tikar (1978) should have used *clotho* (Morley) as the name for this species.

Structurally *C. sellatus* is very similar to *C. basalis* Cameron, a New Guinea species. Probably *basalis* is only a colour variation of *sellatus*.

In Australia *C. sellatus* is easily recognized on account of its colour pattern. In profile tergite 1 of the gaster is dorsally more evenly rounded than either other Australian species.

*C. sellatus* occurs in New Guinea and tropical Queensland.

**HOST RECORDS.** In New Guinea this species was found 'attacking larva on leaf of *Cassia grandis*' (BMNH).

**MATERIAL EXAMINED**

**Australia:** 1 ♀ (lectotype of *clotho*), Queensland, Cairns, iii.1902 (BMNH); 2 ♀, same data (BMNH); 6 ♀, 6 ♂, Mackay (Turner) (BMNH) (all paralectotypes).

**Australia:** 13 ♀, 3 ♂, Northern Territory, Queensland (AM; ANIC; BMNH; TC) (Map 3). **Papua New Guinea:** 3 ♀ (BMNH).

**PARVIPIMPLA** Gauld

*Parvipimpla* Gauld, 1984: 67. Type-species: *Parvipimpla minuta* Gauld, by original designation.

Lower face subquadrate; clypeus flat, apically bilobed with a median apical notch; apical margin of clypeus thin; malar space shorter than basal mandibular width; mandibles of moderate length, weakly tapered with upper tooth slightly the longer. Occipital carina absent. Antennae rather short, those of male without tyloids.

Alitrunk highly polished, very sparsely punctate and with only scattered hairs; epomia present but short; mesoscutum in profile abruptly rounded, notauli strongly impressed, reaching back to level of centre of tegulae; epicnemial carina absent; propodeum without carinae; submetapleural carina absent.

All tarsal claws of female with conspicuous basal lobe, those of male simple; distal tarsal segments slightly broadened.

Fore wing with *3r-m* absent; *cu-a* more or less opposite base of *Rs&M*. Hind wing with distal abscissa of *Cu<sub>1</sub>* present; first abscissa of *Cu<sub>1</sub>* about 0.6 times length of *cu-a*.

Gaster smooth and highly polished; tergite 1 relatively long, without obvious lateromedian longitudinal carinae; tergite 2 with oblique grooves cutting off anterior corners and a pair of weaker diagonal impressions posteriorly cutting off hind corners so that the centre of the tergite is a convex rhombus; tergites 3 and 4 with grooves on posterior 0.6; hind margin of tergites 3–5 incised, the membranous incision narrow medially, broadest close to lateral margin but not extending laterally right to corner. Male subgenital plate transverse, simple; female with ovipositor about as long as gaster, cylindrical, with a nodus and with about seven strong oblique teeth on lower valve.

REMARKS. *Parvipimpla* belongs to the *Camptotypus* genus-group (Townes, 1969), a group represented in the Indo–Australian region by only this genus and *Camptotypus*. The absence of *3r-m*, lack of epicnemial carina and long *cu-a* in the hind wing serve to distinguish *Parvipimpla* from *Camptotypus*.

A single endemic Australian species is known. Nothing is known of the biology of this insect.

***Parvipimpla petita*** Gauld

*Parvipimpla petita* Gauld, 1984: 68. Holotype ♀, AUSTRALIA (DPIQ) [examined].

Fore wing length 6–7 mm. Head highly polished with few scattered punctures; ocelli forming a nearly equilateral triangle; flagellum of female with 20 segments, male with 19. Alitrunk highly polished, almost without punctures and with long pale sparse hairs. Legs with conspicuous long hairs. Gaster smooth and polished with a few minute hair-bearing punctures posteriorly and laterally on the tergites.

Female head, alitrunk and anterior two pairs of legs reddish brown; pedicel, flagellum, tergites of gaster, hind tibia and tarsus and ovipositor sheath black; remainder of hind leg blackish red; membranous incision of tergites 3+ white. Wings infumate, pterostigma blackish. Male similar except face white, all coxae yellowish brown, hind femur and tibia yellowish with indistinct infumation.

REMARKS. The striking colour pattern is like that of many other similar-sized Australian Parasitica (e.g. *Eriostethus*, one species of *Philogalleria*, some Braconinae etc.). It is characteristic of Australia.

HOST RECORDS. None.

## MATERIAL EXAMINED

Australia: 1 ♀ (holotype), New South Wales, Urbenville, Tooloom scrub, 22–23.iii.1975 (Cantrell) (DPIQ); 1 ♂ (paratype), Queensland, Mt Nebo, ii. (TC).

**SERICOPIMPLA** Kriechbaumer

*Sericopimpla* Kriechbaumer, 1895: 135. Type-species: *Pimpla sericata* Kriechbaumer, by monotypy.

*Charitopimpla* Cameron, 1902: 48. Type-species: *Charitopimpla flavobalteata* Cameron, by monotypy.

*Philopsyche* Cameron, 1905: 137. Type-species: *Philopsyche albobalteata* Cameron (= *Pimpla sagrae* Snellen van Vollenhoven), by monotypy.

Moderately large species, fore wing length 11–15 mm; clypeus with median apical notch; eye large, strongly indented opposite antennal socket (Fig. 4); malar space very short; occipital carina complete. Epomia strong; epicnemial carina complete; propodeum without distinct carinae except laterally (Fig. 10); propodeal spiracle circular. Female with claws basally lobate; fore wing with *3r-m* present, enclosing

triangular areolet; first abscissa of  $Cu_1$  in hind wing, longer than  $cu-a$  (Fig. 8). Lateromedian carinae of tergite 1 not reaching to posterior margin; tergites 2–4 of gaster with lateromedian swellings; ovipositor slightly decurved, projecting beyond apex of gaster by 1.8–2.2 times length of hind tibia.

**REMARKS.** *Sericopimpla* is a moderately large Palaetropical genus containing 13 Indo–Australian species and one widespread Afrotropical species. One of the Oriental species extends as far north as Korea and Japan and in Australia species occur in the temperate south. The species are very similar to each other, differing primarily in colour and superficial sculpture, and a number may prove to be extreme variants of other, more widespread species.

*Sericopimpla* belongs to the *Acropimpla*-group of genera (Townes, 1969), species of which usually oviposit through silk. As far as is known the hosts of *Sericopimpla* are psychids. Only the biology of one species, the Afrotropical *S. sericata* Kriechbaumer (= *abdominalis* Morley), has been studied in detail (Skaife, 1921; Smithers, 1956). This species was observed to repeatedly insert its ovipositor into the psychid ‘bag’ in an attempt to sting the larva. If stung, the larva became paralysed and remained alive but immotile. An egg would then be laid either on the host larva or else enmeshed in the innermost strands of the ‘bag’. After eclosion the parasitoid larva commenced feeding, usually on the abdomen of the host. It underwent four or five rapid larval instars and then a more protracted final instar. The mature larva is furnished with clusters of hooks on the dorsum of the abdominal segments which enable it to move around within the bag. Although the Afrotropical species is apparently solitary (and Smithers (1956) observed destruction of supernumerary *Sericopimpla* larvae by the most developed parasitoid larva), at least one Oriental species, *S. albicincta* (Morley), is gregarious as there is a psychid case (?*Eumeta*) in the BMNH from which 10 male and five female specimens emerged.

Three species occur in Australia. One, *S. lutea*, is particularly distinctive, both in colour and morphology, whilst the other two are structurally similar and seem to be very closely related to several Oriental species. These two species are widely distributed in Australia and also occur in New Guinea; the third, *S. lutea*, is only known from tropical Queensland.

### Key to Australian species of *Sericopimpla*

- 1 Alitrunk and gaster predominantly yellow; mesopleuron swollen below subalar prominence; scutellum strongly convex in profile (Fig. 61). ..... *lutea* sp. n. (p. 252)
- Alitrunk and gaster black with tegulae and posterior margins of gastral tergites yellow-marked; mesopleuron not swollen below subalar prominences; scutellum almost flat (Fig. 62) ..... 2
- 2 Hind tibia with black band near proximal 0.2; mesoscutum with sparse punctation, the punctures widely interspaced (Fig. 57) ..... *australis* Townes, Townes & Gupta (p. 250)
- Hind tibia with proximal 0.6 white, without a proximal black band; mesoscutum densely punctate, the punctures interspaced by only about their own diameters (Fig. 56) ..... *crenator* (F.) (p. 251)

### *Sericopimpla australis* Townes, Townes & Gupta

(Fig. 57)

*Philopsyche annulipes* Cameron, 1912: 186. Holotype ♀, AUSTRALIA (BMNH) [examined]. [Secondary homonym of *Charitopimpla annulipes* Cameron, 1905.]

*Sericopimpla australis* Townes *et al.*, 1961: 17. [Replacement name for *annulipes* Cameron, 1912.]

*Sericopimpla annulipes* (Cameron) Gupta & Tikar, 1978: 176.

Fore wing length 11–14 mm. Mandible evenly tapered with lower tooth very slightly shorter than the upper; lower face elongate; about 0.8 times as broad as long; face sparsely punctate; genae moderately strongly narrowed behind eyes. Mesoscutum centrally sparsely and shallowly punctate, the punctures separated by more than their own diameters (Fig. 57); scutellum coarsely punctate posteriorly. Mesopleuron quite finely punctate, not swollen below subalar prominences. Propodeum centrally smooth, laterally and posteriorly closely punctate, with lateromedian carinae vestigial. Tergite 1 of gaster with scattered punctures, tergites 2–4 fairly closely punctate. Ovipositor projecting beyond apex of gaster by 2.0–2.2 times length of hind tibia.

Black; scape ventrally in part, palpus, hind corner of pronotum, tegula, anterior two pairs of legs, hind trochanter, trochantellus, much of tarsus and hind margin of gastral tergites, yellow; hind tibia whitish

yellow, distal 0.3 and band near proximal 0.2 black; distal hind tarsal segments blackish. Wings hyaline, pterostigma black.

**REMARKS.** This species is structurally very similar to *S. crenator* and, although the differences given in the key work well for material to hand, I have some doubt as to whether they are really distinct. They appear to be synchronous and sympatric and attack, at least some of the time, the same host species.

*S. australis* is somewhat less common than *S. crenator* but it is similarly widely distributed, though I have seen no material from Northern Territory, South Australia or Tasmania. Although Gupta & Tikar (1978) mentioned that this species occurs in New Guinea they did not validate their record by reference to any material or collection. There is in the BMNH a recently collected female of this species from Popondetta, Papua New Guinea, confirming that *S. australis* occurs on that island.

**HOST RECORDS.** *Clania ignobilis* (Walker) (Chadwick & Nikitin, 1976); *Hyalarcta huebneri* (Westwood) (Chadwick & Nikitin, 1976), both Lepidoptera: Psychidae. In both cases the material on which these records were based has been examined in DAR and the identity of the ichneumonids confirmed.

#### MATERIAL EXAMINED

**Australia:** 1 ♀ (holotype of *annulipes*), New South Wales, Mittagong (*Froggatt*) (BMNH).

**Australia:** 19 ♀, 14 ♂, Australian Capital Territory, New South Wales, Queensland, Victoria, Western Australia (AM; ANIC; BMNH; DAR) (Map 1). **Papua New Guinea:** 1 ♀ (BMNH).

### *Sericopimpla crenator* (F.)

(Figs 1, 56, 62)

*Pimpla crenator* F., 1804: 114. Holotype ♀, AUSTRALIA (Kiel).

*Ichneumon crenator* (F.) Thunberg, 1822: 277.

*Philopsyche pilosella* Cameron, 1911b: 337. Holotype ♂, AUSTRALIA (BMNH) [examined]. [Synonymized by Townes *et al.*, 1961: 18.]

*Exeristes consimilis* Morley, 1914: 27. Holotype ♂, AUSTRALIA (BMNH) [examined]. [Synonymized by Betrem, 1932: 23.]

*Charitopimpla pilosella* (Cameron) Betrem, 1932: 23.

*Sericopimpla crenator* (F.) Townes *et al.*, 1961: 17.

Fore wing length 12–15 mm. Mandible evenly tapered, with lower tooth shorter than the upper; lower face elongate, about 0.8 times as broad as long; face sparsely but distinctly punctate; genae strongly narrowed behind eyes. Mesoscutum centrally closely punctate, the punctures separated by only about their own diameters or less, laterally more sparsely punctate, but still distinctly so (Fig. 56); scutellum coarsely punctate. Mesopleuron anteroventrally finely, evenly punctate, not swollen below subalar prominence. Propodeum centrally smooth, laterally and posteriorly closely punctate, with lateromedian carinae vestigial. Tergite 1 of gaster with quite coarse punctures, tergites 2–4 quite coarsely and closely punctate. Ovipositor projecting beyond apex of gaster by 2.0–2.2 times length of hind tibia.

Black; scape ventrally, palpus, hind corner of pronotum, tegula, anterior two pairs of legs, hind trochanter, trochantellus and tarsus and posterior parts of gastral tergites, whitish yellow; hind tibia whitish with distal 0.25 black; distal hind tarsal segments often infusate. Wings hyaline, pterostigma black.

**REMARKS.** This species is very similar in general appearance to *S. australis* but is distinguishable by the colour of the hind tibia and coarse sculpture of the mesoscutum. *S. crenator* is probably the commonest Australian *Sericopimpla*. I have seen material from all states except South Australia. It is also widely distributed throughout New Guinea and the New Hebrides (Gupta & Tikar, 1978).

**HOST RECORDS.** *Clania ignobilis* (Walker) (ANIC); *C. tenuis* Rosenstock (ANIC); *Hyalarcta huebneri* (Westwood) (Heather, 1976); *H. nigrescens* (Doubleday) (Chadwick & Nikitin, 1976); *Oiketiscus elongatus* Saunders (Chadwick & Nikitin, 1976) (all Lepidoptera: Psychidae).

## MATERIAL EXAMINED

**Australia:** 1 ♀ (holotype of *pilosella*), New South Wales, Mittagong (BMNH); 1 ♂ (holotype of *consimilis*), Queensland, Mackay (BMNH).

**Australia:** 85 ♀, 49 ♂, from all states except South Australia (AM; ANIC; BMNH; NMV; QM; TC) (Map 2).

*Sericopimpla lutea* sp. n.

(Figs 4, 10, 58, 61)

Fore wing length 11–13 mm. Mandible strongly narrowed with lower tooth shorter than the upper; malar space virtually obliterated; lower face subquadrate, about 0.9 times as broad as long, 1.2 times median height from clypeal suture to level of antennal bases; face virtually impunctate. Mesoscutum centrally sparsely punctate, lateral lobes with few isolated punctures, highly polished (Fig. 58); scutellum impunctate, polished, in profile very convex (Fig. 61). Mesopleuron with coarse punctures, pyramidally swollen below subalar prominences. Propodeum smooth, polished, with well-developed lateromedian longitudinal carinae. Tergite 1 of gaster with few punctures, tergites 2+ coarsely and quite closely punctate. Ovipositor projecting beyond apex of gaster by 1.8 times length of hind tibia.

Bright yellow; flagellum, scape internally, vertex of head, mesoscutal marks and ovipositor sheath black; hind tarsi infusate. Wings weakly infumate with apices of fore wings strongly infumate; pterostigma black.

**REMARKS.** A distinctive species on account of its colour pattern. The swollen mesopleuron, convex scutellum, broad face and weakly punctate mesoscutum are other characteristic features of this species. It is only known to occur in northern Queensland.

**HOST RECORDS.** None.

## MATERIAL EXAMINED

Holotype ♀, **Australia:** Queensland, 31 km NW. by N. of Cooktown (15°18'S; 145°01'E), 250 m, 20.v.1977 (*Common & Edwards*) (ANIC).

Paratypes. 1 ♀, **Australia:** Queensland, Mackay, 1909 (BMNH); 1 ♀, Cape York, iv.1973 (*Monteith*) (ANIC); 1 ♀, Mackay, 8.vi.1931 (*Burns*) (NMV); 1 ♀, Mackay (BMNH).

*ZAGLYPTUS* Foerster

*Zaglyptus* Foerster, 1869: 166. Type-species: *Polysphincta varipes* Gravenhorst, by subsequent designation, Woldestedt, 1877: 17.

Medium-sized species, fore wing length 4–8 mm; clypeal margin concave; occipital carina complete. Epomia weak; epicnemial carina complete; propodeum without carinae but with lateral subapical tubercles (Fig. 11); propodeal spiracle subcircular. Female with claws basally lobate, male with fore femur ventrally with a small tubercle near distal end, the area distal to this concave; fore wing with *3r-m* absent; hind wing with distal abscissa of *Cu*<sub>1</sub> present or absent, if present then with first abscissa of *Cu*<sub>1</sub> about equal in length to *cu-a* or very slightly shorter, or if absent with *Cu*<sub>1</sub> and *cu-a* confluent, smoothly arcuate. Lateromedian carinae of tergite 1 not reaching to posterior margin; tergite 2 of gaster with oblique grooves delineating a central, raised, rhombic area; tergites 3–4 with transverse tubercles; ovipositor straight, projecting beyond apex of gaster by about 1.2 times length of hind tibia, with most proximal tooth of lower valve with an elongate free tip.

**REMARKS.** *Zaglyptus* is a moderately small cosmopolitan genus with nine described species in the Indo–Australian region. Two species occur in Australia, *Z. glabrinotum* and *Z. hollowayi*. They are closely related and belong to the *nigrolineatus*-group as defined by Gupta (1961). The two Australian species seem to be very closely related to the New Guinea species *Z. grandis* Gupta.

*Zaglyptus* species are believed to attack spiders in retreats; the spider is stung to death and the ichneumonid larvae are believed to consume both the spider's eggs and body (Nielsen, 1935; Townes, 1969). European species have been reared from Clubionidae and Araneidae (Aubert, 1969).

**Key to Australian species of *Zaglyptus***

- 1 Hind wing with distal abscissa of *Cu*<sub>1</sub> present; *Cu*<sub>1</sub> and *cu-a* angled at junction (Fig. 59); punctures on tergites 3–4 of gaster coarse, close and deep ..... *glabrinotum* (Girault) (p. 253)



Hind wing with distal abscissa of  $Cu_1$  absent;  $Cu_1$  and  $cu-a$  together forming a slightly arcuate reclivous vein (Fig. 60); punctures of tergites 3–4 moderately coarse, scattered and shallow..... *hollowayi* sp. n. (p. 253)

***Zaglyptus glabrinotum* (Girault)**

(Figs 11, 59)

*Polysphincta glabrinotum* Girault, 1925: 541. Holotype ♀, AUSTRALIA (QM) [examined].

*Zaglyptus? glabrinotum* (Girault) Townes *et al.*, 1961: 20.

*Zaglyptus glabrinotum* (Girault) Townes, 1971a: 470.

Fore wing length 5–8 mm. Mandible with upper tooth stout, tapered to a sharp point, about 2.0 times length of the lower; clypeus convex in profile; ocelli moderately small, the posterior ones separated from eye by about their own diameter. Alitrunk highly polished, virtually impunctate; notauli strongly impressed, submetapleural carina reduced to an anterior tooth. Fore wing with  $cu-a$  opposite base of  $Rs&M$ ; hind wing with distal abscissa of  $Cu_1$  present (Fig. 59). Gaster with tergites 3–4 with coarse, close deep punctures centrally and on lateral tubercles; ovipositor projecting beyond apex of gaster by 1.2 times length of hind tibia.

Yellow; dorsal surface slightly brownish yellow; flagellum dorsally infusate, distal apex pale; extreme posterior end of propodeum with a pair of black areas near insertion of gaster; distal apex of hind tibia and hind tarsi 1–3 infusate; ovipositor sheath black. Wings hyaline; pterostigma black, proximal and distal corner pale.

**REMARKS.** A distinctive species easily recognized by the hind wing venation. It appears to be the more common of the two Australian species. It is known from Queensland, Northern Territory and northern New South Wales.

**HOST RECORDS.** None.

**MATERIAL EXAMINED**

**Australia:** 1 ♀ (holotype of *glabrinotum*), Queensland, Yeronga, vi.1924 (QM).

**Australia:** 1 ♀, New South Wales, Blue Mt, 150 m, i. (TC); 1 ♂, Grosevale nr Richmond, iii.1972 (*McAlpine & Holloway*) (AM); 1 ♀, Northern Territory, 14 km NW. Cape Crawford (16°34'S; 135°41'E), xi.1975 (*Cardale*) (ANIC); 1 ♀, 1 ♂, Queensland, Biggenden, Bluff Rg., viii.1971 (*Frauca*) (ANIC); 1 ♀, Brisbane, i–vi. (TC); 3 ♀, Bundaberg, 1., vi., viii.1971–1973 (*Frauca*) (ANIC); 1 ♀, Fernvale, xi–xii. (TC); 1 ♀, 1 ♂, Mt Glorious, v. (TC); 1 ♀, Mt Nebo, iii. (TC); 3 ♀, 1 ♂, Mt Tambourine, ix–x.1976–78 (*Galloway*) (BMNH); 1 ♀, Stanthorpe ii–iii. (TC).

***Zaglyptus hollowayi* sp. n.**

(Fig. 60)

Fore wing 4–6 mm; mandible with upper tooth stout, tapered to a sharp point, about 1.8 times as long as the lower; clypeus moderately strongly convex in profile; ocelli small, the posterior ones separated from eye by more than their own diameter. Alitrunk very highly polished, impunctate; notauli strongly impressed; submetapleural carina reduced to an anterior tooth. Fore wing with  $cu-a$  more or less opposite  $Rs&M$ ; hind wing with distal abscissa of  $Cu_1$  absent,  $Cu_1$  &  $cu-a$  forming a smooth, very slightly arcuate line (Fig. 60). Gaster with tergites 3–4 with moderately coarse, scattered, shallow punctures; ovipositor projecting beyond apex of gaster by 1.1–1.2 times length of hind tibia.

Similar in colour to *Z. glabrinotum* but with interocellar area of holotype yellowish and hind tarsi only slightly infusate at distal apices of segments 1–3. The female paratype has the interocellar area black.

**REMARKS.** This species is named in honour of Mr Geoff Holloway as a gesture of thanks for organizing the trip on which the holotype was collected.

*Z. hollowayi* is very similar to *Z. glabrinotum* except for the characters mentioned in the key and in having less extensively infusate hind legs. It is known from forests in Queensland and New South Wales.

**HOST RECORDS.** None.

**MATERIAL EXAMINED**

Holotype ♀, **Australia:** New South Wales, Mt Royal Nat. Pk., ii.1983 (*Gauld*) (AM).

Paratypes. **Australia:** 1 ♀, Queensland, Mt Tambourine, xi.1977 (*Galloway*) (BMNH); 1 ♂, Shipton's Flat, x.1980 (*Cardale*) (ANIC).

### Tribe POLYSPHINCTINI

The Polysphinctini is a holophyletic group of genera characterized by the possession of enlarged pulvilli, inflated tarsal segments and an evenly tapered, very sharply pointed ovipositor. Most species lack vein *3r-m* in the fore wing. Larval polysphinctines are external parasites of spiders and they are furnished with 'holdfast organs' used to maintain the larva on the host (Nielsen, 1923; Short, 1978). These holdfast organs are single or paired dorsal tubercles covered in curved spines. The cocoon of many polysphinctines is unusual in having a small hole in the ventral end via which the meconium is voided. The supposedly primitive polysphinctines (e.g. *Schizopyga*) attack spiders in retreats whilst many genera attack free-living araneids. A prospective host is stung and immobilized before an egg is attached to the body. Subsequently, the spider recovers from envenomation and continues its normal life but with a polysphinctine egg and eventually larva developing externally. As the larva grows it is visible as a whitish 'muffler' usually near the anterior end of the opisthosoma. The spider host is not killed until the parasite reaches its final larval instar (Townes, 1969).

The Polysphinctini is a specialized offshoot of the Ephialtini and many steps in the biological and morphological evolution of the group are extant (Townes, 1969). This means that it is difficult to decide where to delineate the tribe. Larval holdfasts are found in several genera of Ephialtini such as *Sericopimpla*, though this is traditionally regarded as an ephialtine genus (Baltazar, 1961; Townes, 1969; Gupta & Tikar, 1978). More controversial is the placement of the genera *Tromatobia*, *Zaglyptus* and *Clistopyga*. Some authors (Finlayson, 1967; Gupta & Tikar, 1978) place these genera in the Polysphinctini; others (Townes, 1969; Aubert, 1969) treat them as ephialtines. Like the Polysphinctini these genera often lack an areolet and are associated with spiders, though apparently as carnivores devouring eggs in egg sacs. Unlike the polysphinctines none has a specialized tarsus and pulvilli. *Tromatobia* and *Zaglyptus* have typical ephialtine ovipositors with a parallel-sided shaft abruptly tapering to a point distally. The ovipositor of *Clistopyga* is more like that of a polysphinctine but is finely sculptured, not smooth. Although the delineation of the Polysphinctini is somewhat arbitrary it is suggested that the term be used for only the genera known (or believed) to attack spiders (rather than their eggs), that have modified pulvilli and distal tarsal segments and that possess tapered, polished ovipositors. This definition excludes *Tromatobia*, *Zaglyptus* and *Clistopyga*.

World-wide the Polysphinctini contains 13 genera, four of which, *Acrodactyla*, *Dreisbachia*, *Eriostethus* and *Zatypota*, occur in Australia. *Eriostethus* is a moderately large genus confined to the Indo-Australian region. The other taxa are probably cosmopolitan but they are rather infrequently collected and consequently little is known about their distribution other than isolated records from widely separated areas.

In Australia polysphinctines are predominantly tropical and moist forest insects. Except for some species of *Eriostethus*, which can be very common in Queensland, most are rather uncommon and seldom collected though Malaise traps at suitable sites generally take several species in a year. Nielsen (1923) remarks on a high incidence of parasitism being observed amongst spiders but I believe this was an exceptional observation. Collecting evidence, based mostly on Palaearctic experience, suggests some species may be locally common for a short period, then not be seen in numbers for several years. The large number of *Dreisbachia* taken on Black Mountain, Canberra in November-December, 1978 and the subsequent virtual disappearance of the species (two specimens collected since then despite considerable collecting activity) suggests such population fluctuations may occur in Australia.

### *ACRODACTYLA* Haliday

*Acrodactyla* Haliday, 1839: 117 [as a subgenus of *Pimpla* F.]. Type-species: *Pimpla (Acrodactyla) degener* Haliday, by subsequent designation, Westwood, 1840: 57.  
*Acrodactyla* Haliday; Westwood, 1840: 57 [raised to genus].

*Colpomeria* Homgren, 1859: 126. Type-species: *Colpomeria laevigata* Holmgren (= *Ichneumon quadrisculptus* Gravenhorst), by monotypy.

*Symphylus* Foerster, 1871: 105. Type-species: *Symphylus hadrodactylus* Foerster (= *Pimpla (Acrodactyla) degener* Haliday), by original designation. [Homonym of *Symphylus* Dallas, 1851.]

*Polemophthorus* Schulz, 1911: 22. [Replacement name for *Symphylus* Foerster.]

Small to medium-sized insects, fore wing length 3–6 mm; palp formula 5, 4 or 5, 3; clypeus convex, apically slightly flattened; eye surface bare; occipital carina complete. Epomia strong; mesoscutum polished, glabrous to sparsely pubescent, with a crest near anterior end of notaulus; epicnemial carina present; propodeum in profile long, dorsally with some traces of carinae, often coarsely sculptured. Tarsal claws of female basally lobate; hind tibia of female internally uniformly hirsute; fore wing with 3*r-m* absent; hind wing with distal abscissa of *Cu*<sub>1</sub> present or absent, first abscissa of *Cu*<sub>1</sub> longer than *cu-a*. Tergites 2–4 polished, sparsely punctate with weakly defined central rhombic areas; ovipositor straight or slightly up-curved, projecting beyond apex of gaster by 0.3–0.6 times length of hind tibia.

REMARKS. A moderate-sized genus with most species in the Holarctic and Oriental regions. Townes (1969) recognized three species-groups – the *madida*-group, the *degener*-group and the *quadrisculpta*-group. Several authors (e.g. Aubert, 1969; Carlson, 1979) treat the latter group as a separate genus, *Colpomeria*, but intermediates do occur (Townes, 1969). Furthermore, the *quadrisculpta*-group seems to grade into *Pterinopus* Townes, a Madagascan genus and the status of this as a distinct group needs critical re-evaluation in the light of recent collecting in India and South East Asia.

Four species of *Acrodactyla* occur in Australia. Two, *A. quadrisculpta* and *A. micans*, belong to the *quadrisculpta*-group; *A. cursor* apparently belongs to the *degener*-group whilst *A. zekhem* appears to be intermediate.

No hosts are recognized for Australian *Acrodactyla* species but in Europe species have been reared from Araneidae, Linyphiidae and Tetragnathidae (Aubert, 1969). The latter family also serves as host for a Nearctic species (Howell & Pienkowski, 1972).

**Key to Australian species of *Acrodactyla***

- 1 Ocelli large, the posterior one separated from the eye by about 0.3 times its minimum diameter (Fig. 81); face narrow, its minimum width 0.5–0.6 times distance from apex of clypeus to insertion of antenna..... **zekhem** sp. n. (p. 257)
- Ocelli not exceptionally large, the posterior one separated from the eye by at least its minimum diameter (Fig. 82); face moderately wide, its minimum width 0.7–0.8 times distance from apex of clypeus to insertion of antenna..... 2
- 2 Metapleuron fairly smooth, at most with traces of wrinkling; fore and mid femora slender, not inflated and specialized ventrally; hind wing with distal abscissa of *Cu*<sub>1</sub> absent, not even represented by an angulation at junction of *Cu*<sub>1</sub> and *cu-a* (Fig. 79) ..... **cursor** sp. n. (p. 255)
- Metapleuron coarsely reticulo-rugose (Fig. 85); fore and mid femora inflated, distally constricted ventrally and with a blunt median ventral tooth (Fig. 80); hind wing with distal abscissa of *Cu*<sub>1</sub> present, at least discernible as a short stub at junction of *Cu*<sub>1</sub> and *cu-a* (Fig. 78) 3
- 3 Alitrunk entirely black; tergite 1 of gaster rather stout, 1.4–1.5 times as long as posteriorly broad; hind leg with third tarsal segment 1.7–1.8 times as long as broad  
**quadrisculpta** (Gravenhorst) (p. 256)
- Alitrunk predominantly orange, only propodeum, metapleuron and mesosternum black; tergite 1 of gaster slender, 1.7–1.8 times as long as posteriorly broad; hind leg with third tarsal segment about 2.0 times as long as broad ..... **micans** sp. n. (p. 256)

***Acrodactyla cursor* sp. n.**

(Fig. 79)

Fore wing length 3 mm; face moderately wide, about 0.8 times as broad as long; clypeus apically truncate; malar space about 0.8 times basal mandibular width; ocelli small, the lateral one separated from eye by about 2.0 times its minimum diameter. Mesopleuron smooth and shining; metapleuron more or less smooth, with isolated punctures and traces of wrinkling posteriorly; propodeum fairly smooth with lateromedian longitudinal carinae obsolescent. Fore and mid legs with femora cylindrical, slender, unspecialized; hind leg with trochantellus bearing a small ridged protuberance ventrally; third hind tarsal

segment 2.0–2.3 times as long as broad. Hind wing with distal abscissa of  $Cu_1$  absent, not even discernible as an angulation at junction of  $Cu_1$  and  $cu-a$  (Fig. 79). Gaster with sternite 1 smooth; tergite 1 about 1.8 times as long as posteriorly broad, with weak longitudinal carina reaching to near centre, tergites 2–4 with weak convex areas; ovipositor straight, projecting beyond the apex of the gaster by 0.4–0.5 times length of hind tibia.

Female head, alitrunk and tergite 1 of gaster black, tergites 2+ blackish brown; fore and mid legs brownish orange, coxae, distal ends of trochanters and mouthparts whitish; hind legs brownish, trochanter and trochantellus slightly paler. Male unknown.

REMARKS. This small species is easily recognized on account of its dark colour and slender femora. It belongs to the *degener*-group of Townes (1969) though it differs from any described species in having only sparse hair on tergite 4. It is only known to occur in Tasmania.

HOST RECORDS. None.

#### MATERIAL EXAMINED

Holotype ♀, **Australia**: Tasmania, Roseberry, iv. (TC).

Paratypes. **Australia**: 1 ♀, Tasmania, Hellyer Gorge, i–ii. (TC); 1 ♀, Waldheim, 800m, i–ii. (BMNH).

### *Acrodactyla micans* sp. n.

(Figs 80, 82, 85)

Fore wing length 3–6 mm; face moderately wide, 0.7–0.8 times as broad as long; clypeus apically truncate; malar space about 1.0 times basal mandibular width; ocelli moderately small, the lateral one separated from eye by about 1.0 times its minimum diameter (Fig. 82). Mesopleuron smooth and polished, metapleuron coarsely reticulo-rugose (Fig. 85); propodeum rugulose, with lateromedian carinae long and strong, usually with a small area superomedia separated from an elongate area petiolaris. Fore and mid legs with femora inflated, abruptly tapered distally and ventrally, bearing a median tooth-like process (Fig. 80); hind leg with trochantellus ventrally unspecialized; third hind tarsal segment about 2.0 times as long as broad. Hind wing with distal abscissa of  $Cu_1$  present, rather faintly pigmented but reaching almost to margin of wing. Gaster with sternite 1 rugose; tergite 1 1.7–1.8 times as long as posteriorly broad, with quite well-defined lateromedian longitudinal carinae extending for 0.8 of its length; tergites 2–4 with obvious convex areas and conspicuous shallow transverse furrows; ovipositor very slightly up-curved, extending beyond apex of gaster by 0.5–0.6 times length of hind tibia.

Female and male head, mesosternum, propodeum, metapleuron and first segment of gaster black, remainder of alitrunk orange, tergites 2+ of gaster brownish; mouthparts, coxae and trochanters white, remainder of fore and most of mid legs orange or brownish, mid tarsus infuscate; hind femur, tibia and tarsus dark brown or blackish.

VARIATION. Some females have an indication of a median pale band on the hind tibia.

REMARKS. *A. micans* is very similar to *A. quadrisculpta* except that it is more slender, the propodeal sculpture is slightly coarser, the terminal four segments of the gaster are more evenly hirsute and the tarsi are more elongate. The most striking difference is in colour pattern.

This species seems to be restricted to the south-east of Australia.

HOST RECORDS. None.

#### MATERIAL EXAMINED

Holotype ♀, **Australia**: New South Wales, Kiandra, Alpine Creek, iii.1962 (*Riek*) (ANIC).

Paratypes. **Australia**: 1 ♀, Australian Capital Territory, Blundell's, iv.1930 (*Graham*) (ANIC); 1 ♀, Blundell's, iv.1930 (*Tonnoir*) (ANIC); 2 ♀, Blundell's, xi.1930 (*Graham*) (ANIC); 1 ♀, New South Wales, Kiandra, Alpine Creek, iii.1962 (*Riek*) (BMNH); 1 ♀, Kiandra, ii.1963 (*Riek*) (ANIC); 1 ♂, Tasmania, Mole Ck., ii.1923 (*Edwards*) (BMNH).

### *Acrodactyla quadrisculpta* (Gravenhorst)

(Fig. 78)

*Ichneumon quadrisculptus* Gravenhorst, 1820: 378. Holotype ♂, ITALY (lost).

*Colpomeria quadrisculpta* (Gravenhorst) Schmiedeknecht, 1907: 1178.

*Polysphincta quadrisculpta* (Gravenhorst) Meyer, 1934: 96.

*Acrodactyla quadrisculpta* (Gravenhorst) Townes *et al.*, 1965: 35.

Fore wing length 3–4 mm; face moderately wide, 0.80–0.85 times as broad as long; clypeus apically truncate; malar space about 1.0 times basal mandibular width; ocelli small, the lateral one separated from eye by 1.2–1.4 times its own minimum diameter. Mesopleuron finely punctate, polished, metapleuron coarsely reticulo-rugose; propodeum rugulose, with lateromedian longitudinal carinae strong, usually with a small rectangular area superomedia separated from an elongate area petiolaris. Fore and mid legs with femora inflated, abruptly tapered distally and ventrally, bearing a median tooth-like process; hind leg with trochantellus ventrally unspecialized, third hind tarsal segment 1.7–1.8 times as long as broad. Hind wing with distal abscissa of  $Cu_1$  present but faint (Fig. 78). Gaster with sternite 1 rugulose; tergite 1 1.4–1.5 times as long as posteriorly broad, with strong lateromedian carina extending about 0.8 of its length; tergites 2–4 with moderately weak convexities; ovipositor very slightly up-curved, extending beyond apex of gaster by 0.3–0.5 times length of hind tibia.

Female and male black; legs pale yellowish, hind tibia centrally white, proximally and distally infuscate; mouthparts yellowish.

**REMARKS.** This species was described from Europe and is known to occur quite widely throughout the western Palaearctic region (Aubert, 1969). Presumably it was inadvertently introduced into Australia. The Australian specimens differ from 'typical' European specimens in having the scape dark, not ventrally pale marked.

**HOST RECORDS.** In Europe this species attacks tetragnathid spiders (Nielsen, 1937; Capener, 1938).

**MATERIAL EXAMINED**

**Australia:** 1 ♀, 4 ♂, Queensland, Kuranda, vi–vii.1913 (Turner) (BMNH). **Europe:** 5 ♀, 5 ♂, various localities (BMNH).

***Acrodactyla zekhem* sp. n.**

(Fig. 81)

Fore wing length 3 mm; face narrow, 0.5–0.6 times as broad as long; clypeus narrowly truncate, almost evenly convex; malar space short, less than 0.4 times basal mandibular width; ocelli large, the lateral one separated from eye by about 0.3 times its own minimum diameter (Fig. 81). Mesopleuron smooth and polished; metapleuron coriaceous, with few rugae posteriorly; propodeum almost smooth with lateral longitudinal carinae strong, defining an elongate area, the area superomedia not clearly delineated. Fore and mid legs with femur very slightly inflated, otherwise unspecialized; hind leg with tibia slightly flattened ventrally; third hind tarsal segment about 3.0 times as long as broad. Hind wing with distal abscissa of  $Cu_1$  exceptionally weak, discernible as a slight angling and stub at junction of  $Cu_1$  and  $cu-a$ . Gaster with sternite 1 rugose; tergite 1 1.8–1.9 times as long as broad, with strong lateromedia longitudinal carinae reaching 0.8 of its length; tergites 2–4 with weak convexities; ovipositor straight, its apex up-curved, ovipositor projecting beyond apex of gaster by 0.4–0.5 times length of hind tibia.

Female yellowish brown, head black, gaster infuscate; flagellum brown, scape yellowish, mouthparts whitish; legs concolorous with alitrunk and coxae slightly paler. Male similar to female but with base of antenna and coxae white.

**REMARKS.** This small species from tropical Queensland is immediately recognizable by its enlarged ocelli and short malar space. The enlarged ocelli and eyes suggest a nocturnal habit. The holotype was collected at light.

**HOST RECORDS.** None.

**MATERIAL EXAMINED**

Holotype ♀, **Australia:** Queensland, Moses Ck, 45 km N. by E. Mt Finnigan (15°47'S; 145°17'E), x.1980 (Cardale) (ANIC).

Paratypes. **Australia:** 1 ♀, Queensland, same data as holotype (ANIC); 3 ♂, Gap Ck, 5 km ESE. Mt Finnigan v.1981 (Naumann) (ANIC); 1 ♂, Mt Webb N.P., 50 km N. Cooktown, vii.1976 (Monteith & Monteith) (ANIC); 1 ♂, 4 km SSE. Cape Tribulation, nr Daintree, xi.1981 (Colless) (ANIC).

**DREISBACHIA** Townes

*Laufeia* Tosquinet, 1903: 381. Type-species: *Laufeia mira* Tosquinet, by monotypy. [Homonym of *Laufeia* Simon, 1889.]

*Dreisbachia* Townes, 1962: 38. [Replacement name for *Laufeia* Tosquinet.]

Small insects, fore wing length 4–5 mm; palp formula 5, 3; clypeus of female flat, in same plane as face, its apical margin truncate, that of male more clearly separated from face; surface of eye bearing long hairs; occipital carina complete. Epomia present; epicnemial carina present but with upper end rather far from anterior margin of pleuron; mesoscutum subpolished, with close pubescence; propodeum in profile evenly rounded, dorsally without distinct carinae, polished. Tarsal claws of female with basal lobes; hind tibia of female internally uniformly hirsute; fore wing with *3r-m* absent; hind wing with distal abscissa of *Cu*<sub>1</sub> absent; tergites 2–4 polished, with weak central rhombic areas; ovipositor weakly but evenly up-curved, projecting beyond apex of gaster by 0.6 times length of hind tibia.

REMARKS. A small genus with few species scattered widely throughout the world. The majority have *3r-m* present in the fore wing though Momoi (1966) described a New Guinea species lacking this vein, and the Australian species is similar.

The possession of hair on the eyes and uniformly on the mesoscutum, the rather flattened mesoscutum, the inflated fore femora and the broad, evenly narrowed genae, together with the flat face and clypeus of the female suggest that *Dreisbachia* may be related to *Afrosphincta* and the more specialized *Schizopyga*. *Afrosphincta* is only known from a single male and if a female were available it may prove to be congeneric with *Dreisbachia* – thus necessitating the placement of the name *Dreisbachia* as a junior synonym.

A single species occurs in eastern Australia. Its hosts are not known, but the ichneumonid's external morphology suggests that it attacks spiders in retreats. European species are known to attack spiders of the families Drassodidae (Aubert, 1969) and Clubionidae (BMNH collections).

***Dreisbachia lutea* sp. n.**

Fore wing length 4–5 mm; ocelli small, the lateral one separated from eye by 1.6 times its own maximum diameter; malar space about 0.3 times basal mandibular width; head in dorsal view with genae moderately broad, evenly narrowed behind eyes; occipital carina complete. Mesoscutum with notauli moderately strongly impressed; mesopleuron smooth, with few fine scattered punctures; metapleuron highly polished, almost entirely smooth; propodeum with transverse carinae absent, metapleural carina complete, spiracle adjacent to this carina. Mid legs with tarsal segments 2–4 very short, together not as long as basitarsus; tergite 1 of gaster centrally somewhat striate, tergites 2+ quite coarsely punctate centrally; gaster quite slender; ovipositor weakly up-curved, projecting beyond apex of gaster by 0.6 times length of hind tibia.

Female and male head black, face, clypeus, mouthparts and ventral surface of antenna proximally yellow; remainder of antenna brownish; alitrunk and gaster yellowish brown, laterally brighter yellow; tergites 7+ black; legs yellowish, hind femur distally black, hind tarsi infuscate. Wings hyaline.

VARIATION. In a few individuals a trace of *3r-m* is discernible in the fore wing. It is usually not complete and even if it is, it is only present in one wing.

REMARKS. A distinctive little species on account of its colour pattern. It is only known from Malaise trap catches on Black Mt in Canberra.

HOST RECORDS. None.

## MATERIAL EXAMINED

Holotype ♀, **Australia**: Australian Capital Territory, Canberra, xi.1978 (*Tidemann*) (ANIC).

Paratypes. **Australia**: 12 ♀, 2 ♂, Australian Capital Territory, Canberra, xi–xii.1978 (*Tidemann*) (ANIC; BMNH); 1 ♀, Canberra, i.1979 (*Short*) (ANIC); 1 ♂, Canberra, ix.1981 (*Gauld*) (BMNH).

**ERIOSTETHUS** Morley

*Eriostethus* Morley, 1914: 34. Type-species: *Eriostethus pulcherrimus* Morley, by monotypy.

*Millironia* Baltazar, 1964: 394. Type-species: *Millironia trifasciata* Baltazar, by original designation.

Medium-sized insects, fore wing length 4–13 mm; palp formula 4, 3; clypeus in profile convex, its margin

slightly rounded; eye surface bare, occipital carina present and strong, or weak or absent. Epomia absent; epicnemial carina present; mesoscutum polished, glabrous; propodeum in profile evenly rounded, dorsally smooth, without carinae except rarely in some males. Tarsal claws of female basally lobate; hind tibia of female with an internal longitudinal glabrous groove; hind wing with distal abscissa of  $Cu_1$  absent. Tergites 2-4 smooth to with rounded lateromedian prominences; ovipositor straight or slightly up-curved near apex, projecting beyond apex of gaster by 0.9-1.2 times length of hind tibia.

REMARKS. A moderate-sized genus centred in New Guinea, with a number of species in Australia, South East Asia and Samoa.

The systematic position of this genus is somewhat perplexing. Gauld (1984) suggested it might be related to some Neotropical genera, including *Hymenoepimecis* and *Acrotaphus* which it resembles in general appearance. All are elongate insects and have small rather globose heads on long prothoraxes which lack epomia; the ovipositors are very long (for polysphinctines) in both cases. However, close examination suggests these similarities may be the result of evolutionary convergence; both genera have specializations not found in the other. The most significant is the possession of the tibial groove in *Eriostethus*; this structure is presumably used to manipulate the ovipositor. Such a feature is not present in the Neotropical genera. *Eriostethus* lacks the distal abscissa of  $Cu_1$  in the hind wing. This feature is particularly significant as some *Eriostethus* are quite large insects and the loss of this vein is, in polysphinctines, closely correlated with small size. This loss of a wing vein coupled with the reduction in palp number (another feature associated with small size) suggest that *Eriostethus* may have been derived from a group of small polysphinctines such as *Zatypota*. The males of species of these two genera are very similar and differ from other polysphinctines in having a 4, 3 palp formula. *Hymenoepimecis* and *Acrotaphus* on the other hand show no reduction in palp formula and have vein  $Cu_1$  present in the hind wing. Apart from obvious specializations these two genera have a number of features in common with *Polysphincta*. Thus both *Eriostethus* and *Hymenoepimecis*/*Acrotaphus* are undoubtedly highly specialized tropical forest polysphinctines but it is suggested they are derived from different ancestors spreading south.

Five species of *Eriostethus* occur in Australia, though one, *E. maximus*, exhibits a considerable range of variation and may eventually be found to comprise more than one species.

There are no host records from Australia but recently I have seen a specimen from New Guinea reared from *Acanthosoma* or a similar genus of jewel spiders (Araneidae) (Fig. 97).

**Key to Australian species of *Eriostethus***

- 1 Gaster with lateral part of sternites 2-3 weakly sclerotized, not pigmented; fore wing with *Rs* & *M* conspicuously bowed or angled so that the concave side is internal; *cu-a* usually proximal to base of *Rs* & *M*, oblique; basal cell glabrous except for a band of hair along anterior margin (Fig. 83) ..... *maximus* sp. n. (p. 260)
- Gaster with lateral part of sternites 2-3 with black-pigmented sclerotized patches; fore wing with *Rs* & *M* more or less straight; *cu-a* about opposite base of *Rs* & *M*, subvertical; basal cell hirsute or with a glabrous central area, always with hairs in posterodistal corner (Fig. 84) ..... 2
- 2 Occipital carina present as a distinct though often narrow flange ..... 3
- Occipital carina absent or sometimes vestigial but not raised ..... 4
- 3 Ocelli very large, the lateral one separated from eye by less than 0.2 of its minimum diameter; interocellar area yellowish orange; propodeum uniformly orange ..... *perkinsi* (Baltazar) (p. 262)
- Ocelli of moderate size, the lateral one separated from eye by 0.4-0.5 of its minimum diameter; interocellar area blackish; propodeum blue-black ..... *carinatus* Baltazar (p. 260)
- 4 Ocelli small, the ♀ with lateral one separated from eye by at least its own minimum diameter, that of ♂ by 0.8-0.9 times its own diameter; propodeum and mid coxa orange ..... *minimus* sp. n. (p. 261)
- Ocelli of moderate size, the lateral one separated from eye by 0.4-0.8 times its own minimum diameter; propodeum and mid coxa bluish black ..... *pulcherrimus* Morley (p. 262)

*Eriostethus carinatus* Baltazar

(Fig. 90)

*Eriostethus carinatus* Baltazar, 1964: 392. Holotype ♀, AUSTRALIA (BMNH) [examined].

Fore wing length 6–9 mm; ocelli of moderate size, the lateral one separated from eye by 0.4–0.5 times its minimum diameter; malar space 0.9–1.0 times basal mandibular width; genae evenly narrowed behind eyes; occipital carina complete but not strongly raised. Pronotum mediodorsally rather short. Fore wing with *cu-a* very slightly oblique, opposite base of *Rs&M*; *Rs&M* virtually straight, almost vertical; basal cell with a glabrous central area, peripherally hirsute; hind wing with *Cu<sub>1</sub>+cu-a* almost vertical so anterodistal corner of subbasal cell is 80–85°. Gaster quite stout, tergite 2 of female about 0.7 times as long as posteriorly broad; lateral part of sternites 2–3 sclerotized, with conspicuous pigmented spots; ovipositor projecting beyond apex of gaster by 1.0 times length of hind tibia.

Female head, prothorax, mesoscutum and anterior part of mesopleuron reddish brown; antenna, interocellar area and remainder of alitrunk black; gaster black; tergite 1 margined laterally and posteriorly and tergites 2+ posteriorly margined with white; fore leg reddish brown, hind two pairs black; face, fore coxa and tarsus infusate; wings strongly infumate, especially near base. Male similar to female but with tergite 2 very extensively white.

Cocoon: silvery grey, fibrous, 16 mm long, 2 mm maximum diameter, tapering evenly from centre; posterior end terminating in small hole, 1 mm diameter and anterior to this are seven small fin-like ribs; anterior end elongately tapered to a fibrous 'tufted' top, which is almost completely cut off during emergence (Fig. 98).

REMARKS. This species resembles *E. pulcherrimus* in colour and has often been mistaken for it in collections. *E. carinatus* is recognizable on account of the presence of a sharp occipital carina and by possession by a black interocellar area. The stub of a vein on *2m-cu* which Baltazar (1964) mentions as a distinguishing feature of this species is a teratological deformity of the holotype.

HOST RECORDS. None.

## MATERIAL EXAMINED

Australia: 1 ♀ (holotype), Victoria (*French*) (BMNH).

Australia: 1 ♀, New South Wales, Mt Kosciusko, xii.1924 'on snow on summit' (*Dunstan*) (BMNH); 3 ♀, 2 ♂, Tasmania, Hobart (*Cole*) (ANIC); 1 ♂, Western Australia, Yallingup, ix-x.1913 (*Turner*) (BMNH).

*Eriostethus maximus* sp. n.

(Figs 2, 83)

Fore wing length 4–13 mm; ocelli very large, the lateral ones contiguous or almost contiguous with eye; malar space 0.6–0.7 times basal mandibular width; genae very strongly narrowed behind eyes; occipital carina complete, very strongly raised laterally and dorsally. Pronotum mediodorsally very long. Fore wing with *cu-a* oblique, proximal to base of *Rs&M*; *Rs&M* conspicuously bowed or angled centrally so concave side is proximal; basal cell glabrous except for a band of hair anteriorly (fig. 83); hind wing with *Cu<sub>1</sub>+cu-a* slightly oblique so anterodistal corner of subbasal cell is 75–80°. Gaster relatively slender, tergite 2 of female 1.0–1.3 times as long as posteriorly broad; lateral part of sternites 2–3 weakly sclerotized, not pigmented; ovipositor projecting beyond apex of gaster by 1.0–1.2 times length of hind tibia.

Female orange-brown with antenna, except at extreme base, blackish, tergites 3+ blackish, all tergites margined posteriorly with white; hind legs brownish, tibia and tarsus infusate. Wings slightly infumate. Male similar to female though often slightly paler.

VARIATION. Although the majority of specimens closely conform in colour to the description, occasional small specimens (particularly females) have been found with tergite 2 and even tergite 1 blackish and the hind trochanter and femur also nigrescent. In some extreme cases even the hind coxa is infusate. These specimens have tergite 2 quadrate and have the ovipositor projecting beyond the apex of the gaster by about the length of the hind tibia, putting them on the extremities of the ranges of both these characters. However, they do not differ in these features from small-sized but 'normally coloured' individuals, suggesting that they are merely



extreme variants. I have chosen to exclude these somewhat atypical specimens from the paratype material.

**REMARKS.** *E. maximus* is easily distinguished from other Australian *Eriostethus* on account of the unusual bend in *Rs&M* and the posteriorly glabrous basal cell. It is apparently closely related to two tropical species, *E. nodata* (Baltazar) and *E. krombeini* (Baltazar), which occur in the Philippines and New Guinea respectively. *E. maximus* is larger and differs in colour from these species. This species seems to be restricted in Australia to tropical Queensland.

**HOST RECORDS.** None.

**MATERIAL EXAMINED**

Holotype ♀, **Australia:** Queensland, 1 km N. of Rounded Hill (15°17'S; 145°13'E), v.1981 (*Naumann*) (ANIC).

Paratypes. **Australia:** 1 ♂, Queensland, Annan R., 3 km W. by S. Black Mt (15°41'S; 145°12'E), ix.1980 (*Cardale*) (ANIC); 2 ♀, 1 ♂, Annan R., 3 km W. by S. Black Mt (15°41'S; 145°12'E), iv.1981 (*Naumann*) (ANIC); 1 ♀, Capt. Billy Ck (11°40'S; 142°50'E), vii.1975 (*Monteith*) (ANIC); 1 ♀, 1 ♂, Dividing Rg., 15 km W. Capt. Billy Ck, vii.1975 (*Monteith*) (ANIC); 2 ♀, 1 ♂, 14 km W. by N. Hope Vale Mission (15°16'S; 144°59'E), x.1980 (*Cardale*) (ANIC); 1 ♂, 7 km N. Hope Vale Mission (15°14'S; 145°07'E), x.1980 (*Cardale*) (ANIC); 4 ♀, 14 km W. by N. Hope Vale Mission (15°16'S; 144°59'E), v.1981 (*Naumann*) (ANIC); 1 ♂, 1.5 km SE. Kuranda, v.1980 (*Naumann & Cardale*) (ANIC); 4 ♀, Leo Creek, McIlwraith Rg, 30 km NE. Coen, vi-vii.1976 (*Monteith*) (ANIC); 1 ♀, Lockerbie Area, iv.1973 (*Monteith*) (ANIC); 2 ♂, 3.5 km SW. by S. Mt Baird (15°10'S; 145°07'E), v.1981 (*Naumann*) (ANIC); 1 ♀, 4 ♂, 1 km SE. Mt Cook (15°30'S; 145°16'E), x.1980 (*Cardale*) (ANIC); 2 ♀, 1 ♂, Mt Cook Nat. Pk (15°29'S, 145°16'E), v.1981 (*Naumann*) (ANIC); 1 ♀, 3 km NE. Mt Webb (15°03'S; 145°09'E), v.1981 (*Naumann*) (ANIC); 1 ♀, 1 ♂, Peach Ck. Xing, 25 km NNE. Coen, vii.1976 (*Monteith*) (ANIC); 2 ♀, 2 ♂, 1 km N. Rounded Hill, nr Hope Mission (15°17'S; 145°13'E), x.1980 (*Cardale*) (BMNH); 5 ♀, 4 ♂, 5 km W. by N. Rounded Hill (15°17'S; 145°10'E), x.1980 (*Cardale*) (ANIC); 1 ♀, 1 km N. Rounded Hill, nr Hope Mission (15°17'S; 145°13'E), v.1981 (*Naumann*) (ANIC); 1 ♂, Sarina, xii. (TC); 1 ♀, 1 ♂, Shipton's Flat (15°47'S; 145°59'E), v.1981 (*Naumann*) (ANIC); 1 ♀, Split Rock, 14 km S. Laura, vi.1975 (*Monteith*) (ANIC); 1 ♀, Upper Lankelly, Ck, vi.1971 (*Monteith*) (ANIC); 1 ♂, Wenlock R. at Moreton, vi.1975 (*Monteith*) (ANIC); 1 ♂, Northern Territory, Casuarina Beach, Darwin, x.1972 (*Colless*) (ANIC).

Non-paratype material. **Australia:** 7 ♀, 4 ♂, Queensland (ANIC).

***Eriostethus minimus* sp. n.**

Fore wing length 4–6 mm; ocelli small, the lateral one separated from eye by 1.0–1.3 times its minimum diameter; malar space 1.2–1.3 times basal mandibular width; genae long, quite evenly narrowed behind eye; occipital carina absent dorsally and laterally except at ventro-lateral extremity. Pronotum mediodorsally moderately long. Fore wing with *cu-a* almost vertical, subopposite base of *Rs&M*; *Rs&M* slightly curved, somewhat oblique; basal cell uniformly hirsute; hind wing with *Cu*<sub>1</sub>+*cu-a* moderately oblique so anterodistal corner of subbasal cell is 75–80°. Gaster moderately stout with tergite 2 of female 0.8–0.9 times as long as posteriorly broad; lateral part of sternites 2–3 sclerotized, with pigmented spots; ovipositor projecting beyond apex of gaster by 1.0 times length of hind tibia.

Female head, alitrunk and anterior two pairs of legs orange; antenna and hind leg black; gaster black, tergites margined laterally and posteriorly with white; wings weakly infumate. Male similar to female but with ocelli slightly larger, fore and mid coxa whitish and tergite 1 and 2 extensively pale.

**REMARKS.** This species is close to *E. pulcherrimus*. The males of both species are very similar, the most obvious difference being in colour, but the females are readily distinguishable on account of their small ocelli. *E. minimus* is only known from Queensland and New South Wales.

**MATERIAL EXAMINED**

Holotype ♀, **Australia:** Queensland, Bundaberg, vii.1971 (*Frauca*) (ANIC).

Paratypes. **Australia:** 1 ♂, New South Wales, 1920 (*Froggatt*) (ANIC); 1 ♀, Springwood, i. (TC); 1 ♂, Taralga, i. (TC). Queensland. 1 ♀, Brisbane, ix.1962 (*Lisle*) (UQM); 1 ♀, Bundaberg, vii.1971 (*Frauca*) (BMNH); 4 ♂, Mackay, on citrus, v.1959 (*Campbell*) (ANIC); 1 ♀, Maryborough, on guava, iv.1959 (*Campbell*) (ANIC); 1 ♂, Mt Glorious, xii.1976 (*Bouček*) (BMNH); 2 ♀, Mt Tambourine, xii-i. (TC); 1 ♀, Stanthorpe, i. (TC).

*Eriostethus perkinsi* (Baltazar)

*Millironia perkinsi* Baltazar, 1964: 400. Holotype ♀, AUSTRALIA (BMNH) [examined].

*Eriostethus perkinsi* (Baltazar) Gauld, 1984: 71.

Fore wing length 6–10 mm; ocelli very large, the lateral one virtually contiguous with the eye; malar space 0.7–0.8 times basal mandibular width; gena strongly narrowed behind eye; occipital carina complete, quite strongly raised dorsally. Pronotum mediodorsally of moderate length. Fore wing with  $cu-a$  almost vertical, virtually opposite base of  $Rs&M$ ;  $Rs&M$  slightly oblique, straight; basal cell fairly uniformly hirsute; hind wing with  $Cu_1+cu-a$  moderately oblique so anterodistal corner of subbasal cell is 60–65°. Gaster moderately slender with tergite 2 of female 0.9–1.1 times as long as posteriorly broad; lateral part of sternites 2–3 sclerotized, with pigmented spots; ovipositor projecting beyond apex of gaster by about 1.0 times length of hind tibia.

Female head and alitrunk orange, gaster black, tergites margined posteriorly with white, anterior two also margined laterally with white; antenna black; anterior two pairs of legs orange, hind legs black. Wings hyaline. Male similar to female but usually with face and fore and mid coxae pale yellowish.

REMARKS. The very large ocelli distinguish *E. perkinsi* from all other species of *Eriostethus* with a straight  $Rs&M$ . This species is quite clearly intermediate between the 'genera' *Eriostethus* and *Millironia* as defined by Baltazar (1964). *E. perkinsi* is quite widely distributed in Australia but is rather uncommon in collections. It is known from Australian Capital Territory, Queensland and Western Australia.

HOST RECORDS. None.

## MATERIAL EXAMINED

Australia: 1 ♀ (holotype), Queensland, Kuranda, vi–vii.1913 (*Turner*) (BMNH).

Australia: 5 ♀, Australian Capital Territory, Canberra, i–ii.1959–60 (*Riek*) (ANIC). Queensland: 1 ♀, Bluff Rg, nr Biggenden, viii.1971 (*Frauca*) (ANIC); 2 ♀, Brisbane, xii.1972 (*Sedlacek*) (TC); 1 ♀, Einasleigh R, 22 km S. by W. Lyndhurst, xi.1981 (*Colless*) (ANIC); 2 ♂, Mackay, v.1959 (*Campbell*) (ANIC); 1 ♀, Mt Cook Nat. Pk, v.1981 (*Naumann*) (ANIC); 1 ♀, Shipton's Flat, x.1980 (*Cardale*) (ANIC); 1 ♀, Yeppoon, i.1975 (*Howden*) (TC); 1 ♀, Western Australia, Drysdale R., viii.1975 (*Cardale*) (ANIC).

*Eriostethus pulcherrimus* Morley

(Fig. 84)

*Eriostethus pulcherrimus* Morley, 1914: 35. Holotype ♀, 'AUSTRALASIA' (BMNH) [examined].

Fore wing length 6–12 mm; ocelli of moderate size, the lateral one separated from the eye by 0.4–0.8 times its own minimum diameter; malar space 0.9–1.1 times as long as basal mandibular width; genae long, fairly evenly narrowed behind eye; occipital carina absent dorsally and laterally though junction of gena and occiput is usually discernible as a low ridge. Pronotum mediodorsally moderately long. Fore wing with  $cu-a$  almost vertical, subopposite to base of  $Rs&M$ ;  $Rs&M$  slightly curved, somewhat oblique; basal cell with a median glabrous patch (Fig. 84); hind wing with  $Cu_1+cu-a$  quite strongly oblique so anterodistal corner of sub-basal cell is 60–65°. Gaster moderately stout with tergite 2 of female 0.8–1.0 times as long as posteriorly broad; lateral part of sternites 2–3 sclerotized, with pigmented spots; ovipositor projecting beyond apex of gaster by 0.9–1.1 times length of hind tibia.

Female head, alitrunk except propodeum and fore leg orange; antenna, propodeum and hind leg black; mid leg infusate, coxa blackish; gaster black, tergites 1 and 2 extensively and 3+ marginally white. Male similar to female.

VARIATION. In specimens from Queensland and New South Wales tergites 1 and 2 are almost entirely white and the latter is clearly transverse; in specimens from Tasmania and southern Victoria tergite 2 is quadrate and both tergites 1 and 2 are black with a pale hind margin.

REMARKS. *E. pulcherrimus* is very similar to *E. minimus*, but may be distinguished not only by the characters given in the key but also by having  $Cu_1+cu-a$  more oblique in the hind wing and by having a glabrous centre to the basal cell of the fore wing.

Morley (1914) expressed doubts that the holotype came from Australia. I see no reason to doubt an Australian origin as the holotype agrees almost exactly in structure and colour pattern

with recent material collected in southern Queensland. This species is widely distributed throughout eastern Australia, from tropical Queensland south to Tasmania.

HOST RECORDS. None.

MATERIAL EXAMINED

'Australasia': 1 ♀ (holotype) (*Damel*) (BMNH).

Australia: 63 ♀, 19 ♂, Australian Capital Territory, New South Wales, Queensland, Tasmania, Victoria (ANIC; BMNH; QUM; TC).

**ZATYPOTA** Foerster

*Zatypota* Foerster, 1869: 166. Type-species: *Ichneumon percontatorius* Müller, by subsequent designation, Viereck, 1914: 156.

*Polysphinctopsis* Habermehl, 1917: 167. Type-species: *Polysphincta examina* Schmiedeknecht (= *Glypta albicoxa* Walker), by monotypy.

*Lycorinopsis* Haupt, 1954: 110. Type-species: *Lycorinopsis rhombifer* Haupt (= *Ichneumon percontatorius* Müller), by original designation.

Small insects, fore wing length 4–5 mm; palp formula 4, 3; clypeus moderately convex in profile, its apical margin slightly rounded; ocelli normal; eye surface almost bare; occipital carina usually present, very rarely incomplete or even absent. Epomia present; epicnemial carina strong; mesopleuron subpolished, virtually glabrous; propodeum in profile evenly rounded, smooth, with lateromedian longitudinal carinae. Tarsal claws of female basally lobate; hind tibia of female without a glabrous groove internally; fore wing with 3*r-m* absent; hind wing with distal abscissa of *Cu*<sub>1</sub> absent or faint, if present then first abscissa of *Cu*<sub>1</sub> is much longer than *cu-a*. Tergites 2–4 with oblique grooves delimiting an almost rhombic central area; ovipositor straight, projecting beyond apex of gaster by less than 0.5 times length of hind tibia.

REMARKS. *Zatypota* is a moderately large genus widely distributed throughout the world. It may well be the largest polysphinctine taxon as most species are small, inconspicuous insects which favour damp habitats. They are seldom collected in any number, but Malaise traps in virtually any locality will yield a few specimens.

I have seen eight undescribed species from Australia but I have to hand three males that cannot be placed. It is likely that they represent additional species.

The hosts of Australian species are not known but in western Europe specimens are not uncommonly reared as ectoparasites of immature Theridiidae.

**Key to Australian Species of *Zatypota***

- 1 Propodeum with posterior transverse carina entirely absent, lateromedian carina absent (Fig. 95); occipital carina absent or incomplete mediodorsally ..... 2
- Propodeum with posterior transverse carina present, usually complete, and with, at the very least, traces of lateromedian carinae extending forward from it, often with lateromedian carinae reaching anterior end of propodeum (Figs 94, 96); occipital carina complete, mediodorsally strongly raised ..... 3
- 2 Hind wing with distal abscissa of *Cu*<sub>1</sub> absent (Fig. 86); head in dorsal aspect with genae long, evenly narrowed; hind tibia black ..... *rennefer* sp. n. (p. 267)
- Hind wing with distal abscissa of *Cu*<sub>1</sub> present (Fig. 87); head in dorsal aspect with genae evenly rounded; hind tibia white, proximally and distally black ..... *velata* sp. n. (p. 267)
- 3 Juxtacoxal carina present on metapleuron, usually complete (Fig. 89) ..... 4
- Juxtacoxal carina absent (Figs 90, 91) ..... 5
- 4 Vertex of head extensively black, frontal orbits bright yellow; ovipositor sheath projecting beyond apex of gaster by 0.45 times length of hind tibia; female with mid leg with third tarsal segment about 1.5 times length of fourth tarsal segment ..... *stellata* sp. n. (p. 268)
- Vertex of head and upper orbits entirely orange; ovipositor sheath projecting beyond apex of gaster by 0.35 times length of hind tibia; female with mid leg with third tarsal segment 1.8–2.2 times length of fourth tarsal segment ..... *bingili* sp. n. (p. 264)
- 5 Metapleuron virtually smooth and highly polished (Figs 88, 91); head in dorsal view predominantly or at least partly orange, sometimes with interocellar area black ..... 6
- Metapleuron rugose or rugulose, weakly polished (Fig. 90); head in dorsal view entirely black or black with pale orbital stripes ..... 7

- 6 Propodeal spiracle adjacent to metapleural carina (Fig. 88); latero-median longitudinal carinae complete from posterior transverse carina forward to propodeal margin (Fig. 94); tergites 2–4 of gaster black with large white triangular or rhombic central area..... *dandiensis* sp. n. (p. 265)
- Propodeal spiracle separated from metapleural carina by more than its own diameter (Fig. 91); lateromedian longitudinal carinae present on posterior transverse carina, anteriorly absent (Fig. 96); tergite 2 of gaster black, 3–4 black with hind margin white ..... 2 *phraxos* sp. n. (p. 266)
- 7 Malar space very long, 1.5–1.8 times basal mandibular width (Fig. 92); gaster with tergites 2–4 unicolourous or with posterior margin narrowly pale-marked; head dorsally entirely black ..... *kauros* sp. n. (p. 266)
- Malar space moderately long, 1.1 times basal mandibular width (Fig. 93); gaster with tergites 2–4 dark brown with conspicuous cream-coloured central areas; head dorsally with frontal orbits yellow, the yellow mark curving backwards behind the ocelli ..... *celer* sp. n. (p. 264)

*Zatypota bingili* sp. n.

(Fig. 89)

Fore wing length 3–4 mm; ocelli small, the lateral one separated from the eye by 1.6–2.0 times its own minimum diameter; malar space 0.6–0.8 times basal mandibular width; head in dorsal aspect with genae moderately broad, fairly evenly rounded behind the eye; occipital carina complete, sharply raised; flagellum with 26–27 segments. Mesoscutum smooth, with notauli very strongly impressed to anterior margin; mesopleuron smooth with few fine punctures ventrally; metapleuron smooth; juxtacoxal carina more or less complete. Propodeum with posterior transverse carina complete, lateromedian carinae extending from posterior transverse carina to anterior margin, anteriorly slightly convergent, enclosing a somewhat wedge-shaped area; propodeal spiracle separated from metapleural carina by almost its own diameter, but connected to it by a small carina-like ridge (Fig. 89). Mid leg of female with third tarsal segment 1.8–2.2 times as long as the fourth segment. Fore wing with  $2r-m$  about 0.2 times as long as abscissa of  $M$  between  $2r-m$  and  $2m-cu$ ; hind wing with distal abscissa of  $Cu_1$  absent entirely. Gaster with lateral part of sternites 3–6 very weakly sclerotized, unpigmented; tergite 2 with strongly impressed, almost smooth grooves defining rhombic central area. Ovipositor projecting beyond apex of gaster by 0.35 times length of hind tibia.

Female head and alitrunk orange, antenna blackish, clypeus pale yellowish near margin; gaster with tergite 1 brownish orange, tergites 2+ black, 6 and 7 with narrow white margins; fore and mid legs orange, hind leg orange with tibia and tarsus black, femur slightly infusate; wing hyaline, pterostigma blackish brown. Male unknown.

REMARKS. *Z. bingili* resembles *Z. rennefer* and *Z. phraxos* in general colour pattern but differs from both in possessing a well-developed juxtacoxal carina and lacking strongly sclerotized sternal plates. The only other Australian *Zatypota* with a juxtacoxal carina is *Z. stellata* which differs from *bingili* in many features, including colour pattern, relative lengths of tarsal segments and length of ovipositor.

*Z. bingili* is only known from tropical Queensland.

HOST RECORDS. None.

MATERIAL EXAMINED

Holotype ♀, Australia: Queensland, Cedar Ck, via Bingil Bay, v.1980 (Naumann & Cardale) (ANIC).

Paratype. Australia: 1 ♀, Queensland, Moses Ck, 4 km N. by E. Mt Finnigan, x.1980 (Cardale) (ANIC).

*Zatypota celer* sp. n.

(Fig. 93)

Fore wing length 4 mm; ocelli moderately small, the lateral one separated from the eye by 1.2 times its own minimum diameter; malar space 1.1 times basal mandibular width (Fig. 93); head in dorsal aspect with genae rather short, evenly narrowed behind eyes; occipital carina complete, distinctly raised; flagellum with 21 segments. Mesoscutum smooth with notauli very strongly impressed to anterior margin; mesopleuron highly polished; metapleuron weakly polished, rugose; juxtacoxal carina absent. Propodeum with posterior transverse carina complete, lateromedian longitudinal carinae present, delimiting an elongate rectilinear area; propodeal spiracle contiguous with metapleural carina. Mid leg with third tarsal segment 1.8 times as long as the fourth segment. Fore wing with  $2r-m$  obliterated by fusion of  $R_s$  and  $M$  in left wing,

in right wing with  $2r-m$  very short, about 0.1 times as long as abscissa of  $M$  between  $2r-m$  and  $2m-cu$ ; hind wing with distal abscissa of  $Cu_1$  absent entirely. Gaster with lateral part of sternites 3–6 weakly sclerotized, pigmented; tergite 2 with deep trans-striate grooves delimiting a rhombic central area. Ovipositor projecting beyond apex of gaster by about 0.5 times length of hind tibia.

Female head black, mouthparts, clypeus, facial and frontal orbits and lower part of gena yellow; antenna brownish, proximally yellow; alitrunk and gaster blackish, mesoscutal margin, pronotal margin, scutellum, mesepimeron, central areas of tergites 2–5 and most of legs whitish yellow; hind tibia proximally and distally infusate. Male similar to female but with central area of tergite 2 blackish.

**REMARKS.** *Z. celer* is immediately recognizable on account of its colour pattern. Only it and *Z. dandiensis* have whitish central marks on the gastral tergites. *Z. celer* differs from *dandiensis* in the sculpture of the metapleuron and in having striate grooves on the gastral tergites.

*Z. celer* is only known from Queensland.

**HOST RECORDS.** None.

**MATERIAL EXAMINED**

Holotype ♀, **Australia:** Queensland, Brisbane, ix-x.1972 (*Sedlacek*) (TC).

Paratype. **Australia:** 1 ♂, Queensland, Shipton's Flat (15°47'S; 145°14'E), x.1980 (*Cardale*) (ANIC).

***Zatypota dandiensis* sp. n.**

(Figs 88, 94)

Fore wing length 3–5 mm; ocelli small, the lateral one separated from eye by 1.6–1.8 times its own minimum diameter; malar space 1.0–1.3 times basal mandibular width; head in dorsal aspect with genae quite broad and evenly tapered behind the eye; occipital carina complete, sharply raised; flagellum with 20–23 segments. Mesoscutum smooth with notauli rather shallow; mesopleuron smooth and highly polished, with sparse fine pubescence ventrally; metapleuron similar but with very fine punctures at bases of hairs; juxtacoxal carina absent (Fig. 88). Propodeum with posterior transverse carina complete; lateromedian carinae complete from posterior transverse carina to anterior margin, enclosing an elongate rectangular area (Fig. 94); propodeal spiracle contiguous with metapleural carina. Mid leg of female with third tarsal segment 1.8–2.3 times length of fourth segment. Fore wing with  $2r-m$  0.1–0.3 times as long as abscissa of  $M$  between  $2r-m$  and  $2m-cu$ ; hind wing with distal abscissa of  $Cu_1$  entirely absent. Gaster with lateral part of sternites 3–6 sclerotized and pigmented; tergite 2 with strongly impressed, smooth grooves delineating rhombic central area. Ovipositor projecting beyond apex of gaster by 0.4–0.5 times length of hind tibia.

Female head orange, interocellar area, marks on genal orbits and antenna blackish; clypeus at least marginally yellow; alitrunk anteriorly orange, posteriorly with much of mesopleuron and entire metapleuron and propodeum black; gaster black, tergites 2–4 centrally white, tergite 5 usually white marked; fore leg orange, mid and hind legs black, with coxae and trochanters white and usually with small, indistinct whitish marks on outer side of tibiae; wings infumate; pterostigma black. Male similar to female but alitrunk orange except for propodeum and metathorax which are black; mid femur orange-brown, hind femur black with distal apex white, hind tibia black, centrally white.

**VARIATION.** Two small females in the Townes collection and the female from Canberra have a colour pattern like that of the males. The wings of these specimens are less densely infumate than other females.

**Cocoon:** found under bark; 10 mm long, 2.5 mm in maximum diameter, cylindrical, tapered to both ends, one of which is open as a small hole 1 mm diameter; outer surface irregularly fluted, whitish with loops of thick golden silk protruding randomly (Fig. 99).

**REMARKS.** *Z. dandiensis* is immediately recognizable on account of its striking and handsome colour pattern. The only other Australian species with a similarly coloured gaster is *Z. celer*, but this species has a different coloured head and alitrunk and a rugose metapleuron.

*Z. dandiensis* is widely distributed throughout the southern half of Australia.

**HOST RECORDS.** None.

**MATERIAL EXAMINED**

Holotype ♀, **Australia:** Australian Capital Territory; Canberra, iv.1962 (*Riek*) (ANIC) (with cocoon).

Paratypes. **Australia:** 1 ♂, Australian Capital Territory. Canberra, xii.1958 (*Riek*) (ANIC); 1 ♀,

Canberra, ii.1978 (*Tidemann*) (ANIC); 1 ♂, New South Wales, Wambool Common, 18 km ESE. Bathurst, iv.1980 (*Cardale*) (ANIC); 1 ♀, Queensland, Stanthorpe, xii. (TC); 1 ♀ Tasmania, Mt Field NP, 250 m, i-ii.1983 (*Gauld*) (BMNH); 1 ♀, Port Arthur, i-ii. (TC); 1 ♀, Western Australia, Yallingup, xii.1913 (*Turner*) (BMNH).

***Zatypota kauros* sp. n.**

(Figs 90, 92)

Fore wing length 2.5–3.0 mm; ocelli small, the lateral one separated from eye by 1.2–1.3 times its own minimum diameter; malar space 1.5–1.8 times as long as basal mandibular width (Fig. 92); head in dorsal view with genae moderately long, strongly narrowed behind eye; occipital carina complete, present as a strong raised flange; flagellum with 14–16 segments. Mesoscutum smooth with notauli strongly impressed to anterior margin; mesopleuron smooth and polished; metapleuron finely rugose; juxtacoxal carina absent. Propodeum with posterior transverse carina present; lateral longitudinal carinae present from transverse carina forward to anterior margin of propodeum, enclosing an elongate rectilinear area; propodeal spiracle contiguous with metapleural carina (Fig. 90). Mid leg with third tarsal segment 1.6–1.8 times as long as fourth segment. Fore wing with *2r-m* obliterated by the fusion of *Rs* and *M*, or if present then thicker than long; hind wing with distal abscissa of *Cu<sub>1</sub>* entirely absent. Gaster with lateral part of sternites 3–6 sclerotized and pigmented; tergite 2 with quite strongly impressed, smooth grooves defining a rhombic central area. Ovipositor projecting beyond apex of gaster by about 0.4 times length of hind tibia.

Female head, black; antenna infusate, base of antenna, clypeal margin and mouthparts yellow; alitrunk, gaster and legs brownish, mesoscutal margin, subalar prominence and coxae yellowish. Wings hyaline; pterostigma dark brown. Male similar to female but with propleuron, mesopleuron, metathorax, propodeum and gaster blackish, tergites 2+ paler margined; coxae whitish, the hind one infusate proximally; hind tarsus infusate.

VARIATION. A single female collected with the holotype differs in having much of the mesopleuron, metathorax and propodeum blackish; the anterior end of tergite 1 is infusate as are the last two tergites. It is on the basis of this variation I have associated the male. I doubt that the extreme difference in colour pattern is normal sexual dichromatism but probably variation, as the male was collected further south.

REMARKS. A distinctive species on account of its more or less totally black head, long malar space and short antennae. It is known from southern Queensland and Australian Capital Territory.

HOST RECORDS. None.

MATERIAL EXAMINED

Holotype ♀, Australia: Queensland, Stanthorpe, 1000 m, i. (TC).

Paratypes. Australia: 3 ♀, Queensland, Stanthorpe, 1000 m, xii., iii. (TC); 1 ♂, Australian Capital Territory, Canberra, Black Mt, x.1981 (*Gauld*) (BMNH).

***Zatypota phraxos* sp. n.**

(Figs 91, 96)

Fore wing length, 4.5–5.5 mm; ocelli small, the lateral one separated from eye by 1.3–1.4 times its own minimum diameter; malar space 0.6–0.7 times basal mandibular width; head in dorsal aspect with genae broad, evenly tapered behind eye; occipital carina complete, sharply raised; flagellum with 25–26 segments. Mesoscutum polished, notauli quite strongly impressed, reaching anterior margin; mesopleuron highly polished, smooth; metapleuron similar; juxtacoxal carina absent. Propodeum with posterior transverse carina complete, lateromedian longitudinal carinae vestigial, present only at junction with posterior transverse carina (Fig. 96); propodeal spiracle separated from metapleural carina by more than its own diameter, the two joined by a raised carina-like ridge (Fig. 91). Mid leg with third tarsal segment 1.6–1.9 times as long as fourth segment. Fore wing with *2r-m* 0.1–0.2 times as long as abscissa of *M* between *2r-m* and *2m-cu*; hind wing with distal abscissa of *Cu<sub>1</sub>* entirely absent. Gaster with lateral part of sternites 3–6 sclerotized and pigmented; tergite 2 with quite strongly impressed, smooth grooves defining a rhombic central area. Ovipositor projecting beyond apex of gaster by 0.4 times length of hind tibia.

Female head, alitrunk and anterior part of tergite 1 orange; antenna blackish; posterior part of tergite 1 and tergites 2+ black, tergite 2 with posterolateral corner white, tergites 3+ with posterior margin

narrowly white; anterior two pairs of legs orange; hind leg with coxa orange; distally infusate, remainder of leg blackish. Wings weakly infumate; pterostigma pale translucent brown. Male unknown.

REMARKS. *Z. phraxos* is distinctive in having the posterior transverse carina of the propodeum complete but the lateromedian longitudinal carinae vestigial. In colour it resembles *Z. rennefer* and to some extent *Z. bingili*.

It is only known from tropical Queensland.

HOST RECORDS. None.

#### MATERIAL EXAMINED

Holotype ♀, **Australia**: Queensland, 1.5 km SE. Kuranda, v.1980 (*Naumann & Cardale*) (ANIC).

Paratypes. **Australia**: 1 ♀, Queensland, Kuranda, vi-vii.1913 (*Turner*) (BMNH); 1 ♀, Mt Cotton, iv.1966 (*Chong*) (QUM).

### *Zatypota rennefer* sp. n.

(Figs 86, 95)

Fore wing length 6 mm; ocelli small, the lateral one separated from eye by 1.5 times its own minimum diameter; malar space 0.8 times basal mandibular width; head in dorsal aspect with genae moderately broad, evenly tapered behind eye to margin of occiput where there is an abrupt corner, but the occipital carina is not present; flagellum with 30 segments. Mesoscutum smooth, with notauli quite strongly impressed to anterior margin; mesopleuron smooth and polished; metapleuron smooth; juxtacoxal carina absent. Propodeum with posterior transverse and lateromedian carinae entirely absent (Fig. 95); propodeal spiracle separated from metapleural carina by its own diameter, the two joined by a raised carina-like ridge. Mid leg with third tarsal segment 1.4 times as long as the fourth segment. Fore wing with  $2r-m$  0.2 times as long as abscissa of  $M$  between  $2r-m$  and  $2m-cu$ ; hind wing with distal abscissa of  $Cu_1$  entirely absent (Fig. 86). Gaster with lateral part of sternites 3-6 sclerotized and pigmented; tergite 2 with moderately impressed smooth grooves defining a rhombic central area. Ovipositor projecting beyond apex of gaster by 0.3 times length of hind tibia.

Female head, alitrunk and anterior two pairs of legs orange; antenna except scape ventrally, gaster and hind legs except coxa, mainly black; tergites 3+ posteriorly white margined, tergite 2 with white spots in posterolateral corners; tergite 1 laterally pallid; hind coxa orange; distally infusate. Wings weakly infumate; pterostigma blackish. Male unknown.

REMARKS. *Z. rennefer* resembles *Z. phraxos* in shape and colour pattern, but differs in lacking an occipital carina and having reduced propodeal carination. The only other Australian species with these carinae incomplete is *Z. velata* which is immediately recognizable by the presence of a distal abscissa for  $Cu_1$  in the hind wing.

*Z. rennefer* is only known from southern Queensland.

HOST RECORDS. None.

#### MATERIAL EXAMINED

Holotype ♀, **Australia**: Queensland, Stanthorpe, 1000 m, iii. (TC).

### *Zatypota stellata* sp. n.

Fore wing length 3.5 mm; ocelli small, the lateral one separated from eye by 1.6 times its own minimum diameter; malar space 0.9 times basal mandibular width; head in dorsal aspect with genae moderately wide, quite strongly narrowed behind eyes; occipital carina complete, sharply raised; flagellum with 26 segments. Mesoscutum smooth with notauli strongly impressed, not quite reaching anterior margin; mesopleuron smooth and polished; metapleuron with upper part smooth, lower part with slight rugosity; juxtacoxal carina complete. Propodeum with posterior transverse carina complete, lateromedian longitudinal carinae present, extending from posterior transverse carina forward to anterior margin of propodeum, anteriorly convergent and defining an elongate wedge-shaped area, unusual in having lateral carina almost complete; propodeal spiracle separated from metapleural carina by 0.5 times its own diameter. Mid leg with third tarsal segment about 1.5 times as long as fourth segment. Fore wing with  $2r-m$  about 0.1 times as long as abscissa of  $M$  between  $2r-m$  and  $2m-cu$ ; hind wing with distal abscissa of  $Cu_1$  absent entirely. Gaster with lateral part of sternites 3-6 sclerotized, weakly pigmented; tergite 2 with moderately strongly impressed grooves defining a rhombic central area, the grooves tending to be weakly

trans-striate. Ovipositor projecting beyond the apex of gaster by 0.35 times length of hind tibia.

Female head black, facial and frontal orbits, clypeal margin, area below antennal insertion and lower 0.2 of gena, yellow; antenna brownish; scape ventrally paler. Alitrunk and gaster reddish brown; anterior margin of mesoscutum, scutellum, margin of pronotum, subalar prominence, mesepimeron and tegula bright yellow; ovipositor sheath darker brownish. Legs reddish brown with coxae and trochanteral segments yellow; hind tibia centrally pale, proximally and distally infusate. Wings almost hyaline; pterostigma dark brown. Male unknown.

REMARKS. *Z. stellata* is the only Australian species of *Zatypota*, apart from *Z. bingili*, which has a juxtacoxal carina. It is most easily separated from the latter on account of its colour pattern.

*Z. stellata* is only known from north Queensland.

HOST RECORDS. None.

#### MATERIAL EXAMINED

Holotype ♀, Australia: Queensland, 5 km W. by N. Rounded Hill, nr Hope Vale Mission (15°17'S; 145°10'E), x.1980 (*Cardale*) (ANIC).

### *Zatypota velata* sp. n.

(Fig. 87)

Fore wing length 3–6 mm; ocelli moderately large, the lateral one separated from the eye by about 1.0 times its own minimum diameter; malar space 0.5–0.7 times basal mandibular width; head in dorsal aspect with genae moderately short, abruptly narrowed behind eyes; occipital carina interrupted mediodorsally; flagellum with 20–22 segments. Mesoscutum smooth with notauli weakly impressed; mesopleuron smooth and polished; metapleuron smooth; juxtacoxal carina absent. Propodeum with posterior transverse and lateromedian longitudinal carinae absent; propodeal spiracle close to but not quite contiguous with metapleuron carina. Mid leg with third tarsal segment 1.8–1.9 times as long as fourth segment. Fore wing with  $2r-m$  0.2–0.3 times as long as abscissa of *M* between  $2r-m$  and  $2m-cu$ ; hind wing with distal abscissa of  $Cu_1$  present, reaching almost to margin of wing (Fig. 87). Gaster with lateral part of sternites 3–6 sclerotized and pigmented; tergite 2 with deep, smooth grooves defining a central rhombic area. Ovipositor projecting beyond apex of gaster by 0.5 times length of hind tibia.

Female and male head, antenna, propleuron, propodeum and most of gaster black, remainder of alitrunk orange-brown; tergites 3+ of gaster with hind margin white marked, tergite 2 with white spots laterally; fore leg brownish to blackish with indistinct pale patches on femur; tibia and often with tarsi pallid; mid and hind legs black; tibia broadly white centrally. Wings infumate; pterostigma blackish.

REMARKS. A very distinctive species on account of the complete distal abscissa of  $Cu_1$  in the hind wing. This vein is completely absent in other Australian species.

*Z. velata* is only known from Canberra.

HOST RECORDS. None.

#### MATERIAL EXAMINED

Holotype ♀, Australia: Australian Capital Territory, Canberra, x–xi.1946, ex bark-living spider (*Riek*) (ANIC).

Paratypes. Australia: 2 ♀, 16 ♂, Australian Capital Territory, Canberra, x–xi.1946, ex bark-living spider (*Riek*) (ANIC; BMNH); 1 ♀, Canberra, iii.1960 (*Riek*) (ANIC); 1 ♀, Canberra, iv.1961 (*Riek*) (ANIC).

### Tribe PIMPLINI

(= Ephialtini sensu Townes)

The Pimplini constitutes a holophyletic group of genera, whose component taxa are most easily recognized by their final instar larvae; these have a strongly developed epistomal arch and a totally reduced hypostoma. The adults are small to large insects with the ovipositor never conspicuously longer than the gaster, an almost straight mesopleural suture and the first abscissa of  $Cu_1$  in the hind wing very short.

World-wide the Pimplini contains nine genera, four of which, *Alophopimpla*, *Echthromorpha*, *Lissopimpla* and *Xanthopimpla*, occur in Australia. With the exception of *Alophopimpla*



these are large tropicopolitan taxa. The other pimpline genera are mainly sub-boreal and north temperate insects though a few species occur on higher ground in the tropics.

In Australia, the Pimplini includes some of the commonest and most conspicuous of all ichneumonids. Several are quite large, brightly patterned insects, frequently observed in suburban habitats. The majority of the rare species are apparently restricted to humid forests and consequently are most commonly encountered along the eastern coastal ranges of the continent.

### ***ALOPHOPIMPLA* Momoi**

*Alophopimpla* Momoi, 1966: 160. Type-species: *Alophopimpla polia* Momoi, by original designation.

Medium-sized species, fore wing length 6 mm; clypeus with margin slightly concave; mandible not twisted, moderately narrowed; occipital carina dorsally absent. Epicnemial carina present; mesopleuron without trans-striate grooves; mesopleural suture not centrally angled; propodeum without carinae dorsally, spiracle subcircular. Tarsal claws of female without basal lobes, with spatulate bristles; hind femur simple. Fore wing with  $3r-m$  present enclosing a rhombic areolet; hind wing with first abscissa of  $Cu_1$  about 0.3 times length of  $cu-a$ . Tergites of gaster smooth and polished; ovipositor projecting beyond apex of gaster by 1.0–1.4 times length of hind tibia.

REMARKS. A small genus with two species, one in Australia and the other, the type-species, in New Guinea (Momoi, 1966). Nothing is known of the biology or habits of these insects.

### ***Alophopimpla kluia* sp. n.**

Mandible with upper tooth slightly the longer; posterior ocellus separated from eye by about 0.5 times its maximum diameter, interocellar distance 0.6 times maximum ocellar distance. Antenna slightly clavate; scape apically obliquely truncate 60°; flagellum with 23 segments, the penultimate distal ones slightly longer than broad. Epomia virtually absent; epicnemial carina present. Scutellum carinate laterally only at extreme anterior end. Submetapleural carina weak, not raised anteriorly; propodeum with concavity present above and before spiracles. Fore tibia distally inflated; fore tarsal segments 3 and 4 bearing long stout bristles. Fore wing with  $cu-a$  opposite base of  $Rs&M$ ; areolet moderately small. Gaster with tergite 1 of female barely longer than posteriorly broad, the sternite extending 0.2 of its length. Ovipositor slightly decurved, projecting beyond apex of gaster by 1.4 times length of hind tibia; lower valvulae simple, not enclosing the upper.

Head and antenna black; alitrunk reddish brown, posteriorly infusate; gaster black, profusely white-marked on most of tergites 1 and 2, 3 posteriorly and laterally, 4+ posteriorly, and on all sternites. Anterior two pairs of legs white, femora and tibiae black-striped, tarsi reddish; hind leg black with large irregular white marks on coxa, trochanter and femur. Wings strongly and uniformly infumate.

REMARKS. A distinctive pimpline in Australia on account of its colour pattern. It resembles the New Guinea species *A. polia* except that the epomia is much shorter and weaker, the epicnemial carina is present, the areolet is smaller and the ovipositor longer.

HOST RECORDS. None.

#### MATERIAL EXAMINED

Holotype ♀, **Australia**: Queensland, Mt Tambourine, xi.1977 (*Galloway*) (ANIC).

### ***ECHTHROMORPHA* Holmgren**

*Echthromorpha* Holmgren, 1868: 406. Type-species: *Echthromorpha maculipennis* Holmgren (= *Ichneumon agrestorius* Swederus), by subsequent designation, Ashmead, 1900a: 57.

*Syene* Snellen van Vollenhoven, 1878: lxxvi. Type-species: *Cryptus notulatorius* F. (= *Ichneumon agrestorius* Swederus), by subsequent designation, Townes, 1960a: 43.

*Stagmopimpla* Saussure, 1892: 16. Type-species: *Stagmopimpla hyalina* Saussure (= *Ichneumon agrestorius* Swederus), by subsequent designation, Viereck, 1914: 136.

*Rhynchopimpla* Kriechbaumer, 1894a: 51. Type-species: *Pimpla interrupta* Brullé (= *Ichneumon agrestorius* Swederus), by monotypy.

*Polyamma* Kriechbaumer, 1894b: 304. Type-species: *Pimpla continua* Brullé sensu Kriechbaumer (= *Ichneumon agrestorius* Swederus), by monotypy.

*Chrysopimpla* Cameron, 1899: 185. Type-species: *Chrysopimpla ornatipes* Cameron (= *Ichneumon agrestorius* Swederus), by subsequent designation, Viereck, 1914: 32.

*Allotheronia* Ashmead, 1900a: 55. Type-species: *Allotheronia 12-guttata* Ashmead (= *Cryptus intricatorius* F.), by original designation.

*Glyptogastra* Ashmead, 1900a: 57. Type-species: *Glyptogastra hawaiiensis* Ashmead, by original designation.

*Polyhamma* Dalla Torre, 1901: 455. [Unjustified emendation.]

Medium to large-sized species, fore wing length 8–22 mm; clypeal margin slightly concave; mandibles strongly narrowed, twisted; occipital carina complete. Epicnemial carina complete; mesopleuron without trans-striate grooves; mesopleural suture very slightly angled centrally; propodeum without distinct carinae dorsally, sometimes with hypophyses, spiracle elliptical. Tarsal claws of female large, without a strong basal lobe, but with a spatulate bristle; hind femur simple. Fore wing with *3r-m* present, enclosing a subpetiolate, rhombic areolet; marginal cell with infumate spot distally; hind wing with first abscissa of *Cu*<sub>1</sub> very short or obsolete (Fig. 6). Tergites of gaster somewhat polished, with or without punctures; ovipositor projecting beyond apex of gaster by 0.9–1.4 times length of hind tibia, usually slightly decurved.

REMARKS. *Echthromorpha* is a moderately large genus centred in the Papuan subregion but with a few species in Africa. One species, *E. agrestoria* is extremely widespread. It appears to migrate (Common, 1954) and has spread across the south Pacific, colonizing many remote islands (Perkins, 1952; Mason, 1974).

Three species occur in Australia. One, *E. intricatoria*, is particularly common in the cooler parts of the south-east and may be observed in large numbers searching low vegetation and tree roots in wooded areas. The related but largely allopatric species *E. agrestoria* is more common in the north. The third species, *E. nigricornis*, is predominantly a tropical insect. None of the Australian species is endemic.

*Echthromorpha* species are known to parasitize a variety of lepidopterous pupae and prepupae including those of Noctuidae, Hesperiiidae, Agaristidae, Anthelidae, Bombycidae, Lycaenidae, Lymantriidae, Nymphalidae, Psychidae, Xyloryctidae, Papilionidae, Tortricidae and Saturniidae (Gauld, 1984).

### Key to Australian species of *Echthromorpha*

- 1 Malar space 0.8–1.0 times as long as basal mandibular width (Fig. 14); infumate spot at distal apex of fore wing very weak; alitrunk and gaster uniformly orange ..... ***nigricornis*** (Smith) (p. 272)
- Malar space 1.3–1.5 times as long as basal mandibular width (Fig. 15); infumate spot at distal apex of fore wing distinct; alitrunk and usually gaster, at least, marked with black ..... 2
- 2 Propodeal apophyses distinct; metapleuron uniformly punctate (Fig. 12); alitrunk and gaster black, with ivory markings ..... ***intricatoria*** (F.) (p. 271)
- Propodeal apophyses absent; metapleuron with a large, smooth area anteriorly (Fig. 13); alitrunk and gaster yellowish with black markings ..... ***agrestoria*** (Swederus) (p. 270)

### *Echthromorpha agrestoria* (Swederus)

(Fig. 13)

*Ichneumon agrestorius* Swederus, 1787: 279. Holotype ♀, TAHITI (BMNH) [examined].

*Ichneumon melioratorius* Fabricius, 1793: 147. Holotype ♀, TAHITI (BMNH) [isotypic with *I. agrestorius*] [examined].

*Pimpla interrupta* Brullé, 1846: 91. Holotype ♀, NEW CALEDONIA (MNHN) [examined]. [Synonymized by Townes *et al.*, 1961: 38].

*Pimpla insidiator* Smith, 1863: 9. Lectotype ♀, MISOOL (UM), designated by Townes *et al.*, 1961: 37 [examined]. [Synonymized by Townes, 1958: 42.]

*Noiopimpla platymyscha* Vachal, 1907: 120. Lectotype ♀, NEW CALEDONIA (MNHN), designated by Townes *et al.*, 1961: 38 [examined]. [Synonymized by Townes, 1958: 43.]

*Echthromorpha striata* Krieger, 1909: 306. Lectotype ♀, TAHITI (NM), designated by Townes *et al.*, 1961: 34. [Synonymized by Morley, 1913a: 44.]

*Echthromorpha conopleura* Krieger, 1909: 321. Lectotype ♀, MARIANA IS. (not Brazil as stated) (MNHU), designated by Townes *et al.*, 1961: 35. [Synonymized by Townes, 1958: 42.]

- Echthromorpha immaculata* Krieger, 1909: 331. Lectotype ♂, FIJI (NM), designated by Townes *et al.*, 1961: 37. [Synonymized by Townes, 1958: 42.]
- Echthromorpha agrestorius* (Swederus) Morley, 1909: 135.
- Echthromorpha agrestoria* (Swederus); Morley, 1913a: 44.
- Echthromorpha notulatoria* var. *immaculata* Morley, 1913a: 46. Lectotype ♂, 'INDIA' (probably Mariana Is.) (BMNH), designated by Townes *et al.*, 1961: 46. [Synonymized by Townes, 1958: 42.] [Junior primary homonym of *Echthromorpha immaculata* Krieger.]
- Echthromorpha diversor* Morley, 1913a: 47. Holotype ♂, 'SOLOMON IS.' or 'NEW HEBRIDES' (BMNH) [examined]. [Synonymized by Perkins, 1952: 536.]

Medium to large-sized species, fore wing length 8–18 mm. Malar space 1.3–1.5 times as long as basal mandibular width; face centrally very sparsely punctate. Mesoscutum moderately closely punctate, scutellum strongly convex; post-scutellum 1.5–2.0 times as long as broad. Mesopleuron ventrally closely punctate, dorsally almost impunctate; epicnemial carina reaching almost to subalar prominence; meta-pleuron anteriorly smooth, posteriorly punctate (Fig. 13). Propodeum dorsally punctate anteriorly, posteriorly smooth, without apophyses. Tergites 2–4 of female gaster very closely and coarsely punctate centrally, those of male more sparsely punctate. Ovipositor projecting beyond apex of gaster by 0.9–1.0 times length of hind tibia, its apex depressed with weak dorsal ridges.

Yellowish orange, black-marked on frons, interocellar area, occiput, mesoscutum in three stripes, pronotum, epicnemium and tergites 2–6 except posteriorly. Flagellum infuscate, legs, propodeum and posterior apex of gaster orange. Wings hyaline with distinct infumate spots present on distal apices of fore wings.

**VARIATION.** Considerable variation in the extent of the black colour exists; many smaller specimens and some large ones have only the frons, interocellar area and mesoscutal vittae black.

**REMARKS.** Townes *et al.* (1961) recognized a number of subspecies largely on colour pattern. The ones included above in synonymy fall within the range of variation I have observed in Australian species. Almost certainly many of the other 'subspecies' are also mere colour varieties and probably the best course of action is to treat the whole *agrestoria* complex as a single species without recognizing subspecies.

As recognized above, *E. agrestoria* is widespread throughout the south Pacific and Melanesia, extending west to about the Moluccas. In Australia it is primarily restricted to Queensland with isolated records from northern New South Wales. It is apparently common on Lord Howe Island (Map 5).

**HOST RECORDS.** HesperIIDae: *Parnara amalia* (Semper) (DPIQ). Noctuidae: *Anomis flava* (F.) (DPIQ); *A. lyona* (Swinhoe) (DPIQ). Tortricidae: *Cryptophlebia ombrodelta* (Lower) (Ironside, 1974).

#### MATERIAL EXAMINED

**Tahiti:** 1 ♀ (holotype of *agrestorius* and *melioratorius*) (BMNH). **New Caledonia:** 1 ♀ (holotype of *interrupta*) (MNHN). **Indonesia:** 1 ♀ (lectotype of *insidiator*), Misool (UM). **'India'** (probably Mariana Is.): 2 ♂ (lectotype of *notularia* var. *immaculata*) (BMNH). **'Solomon Is.'** or **'New Hebrides':** 1 ♂ (paralectotype of *notularia* var. *immaculata*) (Liddell) (BMNH).

**Australia:** 34 ♀, 27 ♂, New South Wales, Queensland (ANIC, BMNH, QM, QUM).

### *Echthromorpha intricatoria* (F.)

(Figs 6, 12, 15)

*Cryptus intricatorius* Fabricius, 1804: 77. Holotype ♀, 'NOVA CAMBRIA' (UZM).

*Ichneumon intricatorius* (Fabricius) Thunberg, 1822: 278.

*Pimpla excavata* Guillou, 1841: 322. Holotype ♀, AUSTRALIA (lost).

*Pimpla intricatoria* (Fabricius) Erichson, 1842: 254.

*Echthromorpha intricatoria* (Fabricius) Krieger, 1899: 59.

*Allotheronia 12-guttata* Ashmead, 1900a: 55. Holotype ♀, NEW ZEALAND (USNM) [examined]. [Synonymized by Parrott, 1952: 163.]

Medium to large-sized species, fore wing length 9–18 mm. Malar space 1.3–1.5 times as long as basal mandibular width (Fig. 15); face centrally coarsely punctate. Mesoscutum coarsely punctate, scutellum

abruptly declivous posteriorly; postscutellum 1.2–1.3 times as broad as long. Mesopleuron fairly evenly closely and coarsely punctate; epicnemial carina reaching about 0.7–0.8 of way up mesopleuron; metapleuron uniformly closely punctate (Fig. 12). Propodeum dorsally closely reticulopunctate, grading posteriorly to trans-striate, apophyses distinct. Tergites 2–4 of gaster virtually impunctate centrally, smooth and polished. Ovipositor projecting beyond apex of gaster by 1.0–1.2 times length of hind tibia, its apex depressed and with upper valve bearing strong ridges.

Black; face, genae, antenna, fore leg, mid leg excluding coxa and hind leg except for coxa and trochanteral segments, orange; subalar prominences, axillae, upper and lower posterior corners of mesopleuron, postscutellum, a spot on metapleuron, propodeal apophyses and paired spots on tergites 1–6 ivory or pale yellow. Wings almost hyaline, with a strongly infumate spot at apex of fore wing.

**REMARKS.** This is one of the commonest southern insects in Australia. It can often be observed in large numbers in damp, shaded habitats such as woodland understorey. It is found in drier localities also, though less frequently. *E. intricatoria* is also quite common in New Zealand (Parrott, 1952). It has been recorded from New Guinea (Morley, 1915) and India (Morley, 1913*b*) though almost certainly these records are based on misidentifications.

In Australia this species is one of the more commonly reared ichneumonids and is known from a considerable range of lepidopterous hosts, suggesting it has little host specificity. It is of possible economic importance as frequently it can be found parasitizing pests such as cutworms (Froggatt, 1910).

**HOST RECORDS.** Agaristidae: *Phalaenoides glycinae* Lewis (ANIC). Anthelidae: *Anthela denticulata* (Newman) (Cameron, 1912); *A. xantharcha* (Meyrick) (QM). Bombycidae: *Bombyx mori* (L.) (Chadwick & Nikitin, 1976). Hesperidae: *Hesperilla chrysotricha* (Meyrick & Lower) (Parrott, 1957); *H. donnysa* Hewitson (Parrott, 1957). Lycaenidae: *Ogyris olane* Hewitson (Parrott, 1957). Lymantriidae: *Euproctis edwardsi* (Newman); *Olene mendosa* Hübner (Chadwick & Nikitin, 1976); *Teia anartoides* Walker (ANIC; DAT). Noctuidae: *Persectania ewingii* (Westwood) (Martyn *et al.*, 1977); *Spodoptera exempta* (Walker) (Chadwick & Nikitin, 1976). Nymphalidae: *Vanessa itea* (F.) (ANIC). Psychidae: *Hylarcta huebneri* (Westwood) (Chadwick & Nikitin, 1976); *Lomera caespitosa* (Oke) (Chadwick & Nikitin, 1976). Xyloryctidae: *Neodrepta luteotactella* (Walker) (DPIQ).

In New Zealand it has been recorded from a variety of other hosts including *Epiphyas postvittana* (Gourlay, 1926; Dumbleton, 1932).

#### MATERIAL EXAMINED

**New Zealand:** 1 ♀ (holotype of *I2-guttata*) (USNM).

**Australia:** 156 ♀, 112 ♂, Australian Capital Territory, New South Wales, Queensland (SE.), South Australia, Tasmania (including Bass Strait Islands), Victoria, Western Australia (Map 6).

### *Echthromorpha nigricornis* (Smith)

(Fig. 14)

*Pimpla nigricornis* Smith, 1865: 64. Holotype ♂, PAPUA NEW GUINEA (UM) [examined].

*Echthromorpha maxima* Krieger, 1909: 334. Holotype ♀, MOLUCCAS (NM). [Synonymized by Perkins, 1952: 536.]

*Echthromorpha fastigata* Krieger, 1909: 336. Holotype ♀, MOLUCCAS (NM). [Synonymized by Townes *et al.*, 1961: 45.]

*Echthromorpha nigricornis* (Smith) Perkins, 1952: 536.

Very large species, fore wing length 20–22 mm. Malar space 0.8–1.0 times as long as basal mandibular width (Fig. 14); face centrally coarsely punctate. Mesoscutum coarsely and closely punctate, scutellum in profile almost pyramidal; postscutellum transverse, about 2.5 times as broad as long. Mesopleuron polished, with large close punctures posteroventrally, the punctures sparser dorsally; epicnemial carina reaching about 0.6 of way up mesopleuron; metapleuron anteriorly entirely smooth, posteroventrally coarsely and closely punctate. Propodeum dorsally coarsely punctate in anterior 0.4, posteriorly smooth, apophyses absent. Tergite 2 of gaster with few punctures centrally, tergites 3 and 4 more closely punctate but still with punctures separated by usually more than their own diameter. Ovipositor projecting beyond apex of gaster by 1.4 times length of hind tibia, its apex depressed and with upper valve bearing fine ridges.

Orange; flagellum and interocellar area infuscate, legs golden yellow. Wings very weakly infumate, with weak trace of darker infumate spot in distal end of marginal cell.

**REMARKS.** This large species is easily distinguished by the shorter malar space and weak spot on the fore wing. It is widely distributed from the Moluccas to the Solomon Is. but in Australia it is restricted to Queensland and northern New South Wales.

**HOST RECORDS.** Papilionidae: *Ornithoptera priamus euphorion* (Gray) (Morley, 1913a). Saturniidae: *Antheraea saccopoea* Turner (AM).

**MATERIAL EXAMINED**

**Papua New Guinea:** 1 ♂ (holotype of *nigricornis*) (UM).

**Australia:** 1 ♀, New South Wales, Eltham, ii.1929 (*Chadwick*) (DAR); 2 ♀, 2 ♂, Queensland, Middle Claudie River, ix-x.1974 (*Daniels*) (AM); 1 ♀, Townsville, xii.1901 (*Dodd*) (ANIC); 2 ♂, same data (BMNH); 1 ♀, Mt Webb Nat. Pk, 15°04'S, 145°07'E, iv.1981 (*Naumann*) (ANIC).

**LISSOPIMPLA** Kriechbaumer

*Lissopimpla* Kriechbaumer, 1889: 309. Type-species: *Lissopimpla 8-guttata* Kriechbaumer (= *Pimpla excelsa* Costa), by subsequent designation, Ashmead, 1900a: 55.

*Xenopimpla* Cameron, 1898: 28. Type-species: *Rhyssa semipunctata* Kirby (= *Pimpla excelsa* Costa), by monotypy.

*Trichrus* Tosquinet, 1903: 373. Type-species: *Trichrus stupenda* Tosquinet (= *Pimpla basalis* Snellen van Vollenhoven), by monotypy.

*Notiopimpla* Vachal, 1907: 118. Type-species: *Notiopimpla priocnemidea* Vachal (= *Pimpla excelsa* Costa), by subsequent designation, Viereck, 1914: 101.

Medium to large-sized species, fore wing length 7–18 mm; clypeus divided into basal and apical parts by a transverse suture, its margin convex; mandibles strongly narrowed, twisted; occipital carina complete. Epicnemial carina present; mesopleuron with impressed trans-striate grooves; mesopleural suture angled slightly centrally; propodeum with traces of carinae, usually with apophyses and a central low crest, spiracle elliptical. Tarsal claws of female large, without basal lobes, with spatulate bristle; hind femur with a ventral tooth. Fore wing with *3r-m* present, enclosing a large rhombic areolet; hind wing with first abscissa of *Cu*<sub>1</sub> very short or obliterated. Tergites of gaster polished, almost smooth; ovipositor projecting beyond apex of gaster by 0.75–1.70 times length of hind tibia, slightly decurved.

**REMARKS.** A small genus occurring in the Indo–Australian region with most species in Australia and nearby south Pacific Islands. They are morphologically very alike and differ most conspicuously in colour pattern.

The genus is widely distributed throughout Australia, and one species, *L. excelsa*, is very common. It can frequently be observed in gardens probing with its ovipositor in grass tussocks. The hosts of *Lissopimpla* species are the pupae and prepupae of various Lepidoptera, especially Noctuidae.

**Key to Australian species of *Lissopimpla***

- 1 Median transverse groove of mesopleuron impressed to mesopleural furrow, trans-striate for its entire length (Fig. 17); gaster tricoloured, tergites 1–4 black with lateral yellow spots, tergites 5 reddish; ♀ with ovipositor projecting beyond apex of gaster by 1.4–1.7 times length of hind tibia; ♂ with median yellow triangle on frons below ocellus..... ***excelsa*** (Costa) (p. 274)
- Median transverse groove of mesopleuron not extending to mesopleural furrow (Fig. 16), or if reaching the furrow then posteriorly weak, not trans-striate; gaster bicoloured or rarely unicolorous; ♀ with ovipositor projecting beyond apex of gaster by 1.0 or less times length of hind tibia; ♂ with frons centrally black..... 2
- 2 All coxae black; face of ♀ entirely black, that of ♂ pale yellow with a central black mark; fore wing with *cu-a* proximal to base of *Rs&M* by about 0.5 times its length..... ***atra*** Girault (p. 274)
- All coxae reddish brown, rarely the hind ones infuscate basally; face of ♀ marked with red or pale yellow, that of ♂ entirely pale yellow; fore wing with *cu-a* proximal to base of *Rs&M* by 0.1–0.2 times its own length..... 3

- 3 Subalar prominence concolorous with mesopleuron; gaster unicolorous brownish red, without white marks; ovipositor projecting beyond apex of gaster by 1.0 times length of hind tibia..... species 1 (p. 276)
- Subalar prominence conspicuously white-marked; gaster with more or less distinct pale marks laterally on tergites 1–4 at least; ovipositor less than 1.0 times length of hind tibia..... 4
- 4 Gaster of ♀ rather stout, tergite 3 about 2.1 times as broad as long; ovipositor projecting beyond apex of gaster by less than 0.8 times length of hind tibia; posterior transverse carina of propodeum indistinct..... *obesa* sp. n. (p. 275)
- Gaster of ♀ slender, tergite 3 1.7–1.8 times as broad as long; ovipositor projecting beyond apex of gaster by 0.85–0.95 times length of hind tibia; posterior transverse carina of propodeum sharp, usually complete between apophyses..... *scutata* Krieger (p. 276)

### *Lissopimpla atra* Girault

*Lissopimpla atra* Girault, 1924a: 1; Townes, 1971a: 464. Holotype ♀, AUSTRALIA (QM) [examined].

*Lissopimpla atra* Girault, 1924b: 1. [Reprint of original description.]

Medium-sized species, fore wing length 8–10 mm. Flagellum with a distinct white mark centrally. Mesopleuron with transverse median groove strongly impressed to near centre; metapleuron posterodorsally evenly convex. Propodeum dorsally coarsely transversely wrinkled, laterally coriaceous anterior to spiracle; lateral longitudinal and posterior transverse carinae virtually complete, central area raised, elongately rectangular. Forewing with *cu-a* proximal to base of *Rs&M* by 0.4–0.5 times its own length. Gaster of female with tergite 3 1.6 times as broad posteriorly as long. Ovipositor projecting beyond apex of gaster by 1.0 times length of hind tibia.

Female black, only femora reddish. Wings quite strongly infumate. Male similar to female but with lower face except centrally, orbits, prominences on alitrunk and sometimes by corner of tergites 1–3 of gaster, white-marked.

REMARKS. A rather uncommon species most easily recognized by the entirely black coxae.

HOST RECORDS. None.

#### MATERIAL EXAMINED

Australia: 1 ♀ (holotype), Queensland, Brisbane, iv. 1914 (*Hacker*) (QM).

Australia: 1 ♀, 7 ♂, Queensland, Bundaberg, various dates (*Frauca*) (ANIC).

### *Lissopimpla excelsa* (Costa)

(Figs 3, 17)

*Pimpla excelsa* Costa, 1864: 69. Holotype ♀, AUSTRALIA (depository unknown).

*Rhyssa semipunctata* Kirby, 1883: 202. Holotype ♀, NEW ZEALAND (BMNH) [examined]. [Synonymized by Schulz, 1912: 353.]

*Lissopimpla 10-notata* Kriechbaumer, 1889: 310. Syntypes ♀, ♂ AUSTRALIA (Radoszkowsky Coll., ? in Jagielloński University, Cracow, Poland). [Synonymized by Schulz, 1912: 353.]

*Lissopimpla 8-guttata* Kriechbaumer, 1889: 310. Holotype ♀, AUSTRALIA (Radoszkowsky Coll., ? in Jagielloński University, Cracow, Poland). [Synonymized by Schulz, 1912: 353.]

*Xenopimpla semipunctata* (Kirby) Cameron, 1898: 26.

*Theronia rufipes* Tryon, 1900: 140. Syntypes ♀, ♂, AUSTRALIA (depository unknown). [Synonymized by Morley, 1914: 46.]

*Lissopimpla semipunctata* (Kirby) Dalla Torre, 1901: 406.

*Notiopimpla priocnemidea* Vachal, 1907: 119. Lectotype ♀, AUSTRALIA (MNHN), designated by Townes *et al.*, 1961: 48 [examined]. [Synonymized by Townes *et al.*, 1961: 48.]

*Lissopimpla excelsa* (Costa) Schulz, 1912: 353.

Medium-sized to very large species, fore wing length of female 9–18 mm, of male 7–12 mm. Flagellum without a distinct white band. Mesopleuron with transverse median groove strongly impressed, reaching to mesopleural furrow; metapleuron with convexity at posterodorsal end (Fig. 17). Propodeum dorsally finely trans-striate, laterally finely striate anterior to spiracle, lateral longitudinal and posterior transverse carinae obsolescent, central raised area cornute, somewhat flattened anteriorly to form a narrow inverted isosceles triangle. Fore wing with *cu-a* proximal to *Rs&M* by 0.2–0.3 times its own length. Gaster of female with tergite 3 1.6–1.7 times as broad posteriorly as long. Ovipositor long, projecting beyond apex of gaster by 1.4–1.7 times length of hind tibia.

Female brownish orange, yellow-marked on orbits, notaular crests, laterally before scutellum and often on margin of postscutellum and metapleuron. Gaster black, tergites 1–4 with paired pale yellow spots posteriorly, tergites 5+ orange. Ovipositor sheath black. Flagellum and hind tibia and tarsus infuscate. Wings proximally very strongly infumate, bluish black, distally less strongly coloured. Male similar to female but more extensively yellow-marked on subalar prominence, mesepimeron, scutellum and on anterior lateral margin of tergite 1. Frons black with triangular yellow mark below ocellus. Wings less strongly infumate.

**VARIATION.** The most obvious variation is in size though morphologically this is a rather uniform species. The smaller males generally have tergites 1–4 paler than large specimens. Some aspects of variation are discussed by Parrott (1952).

**REMARKS.** This is one of the commonest and most conspicuous of Australian ichneumonids. It is often found in gardens and females can sometimes be observed probing with their ovipositors in grass tussocks. *L. excelsa* is commonly reared as a parasite of a variety of Lepidoptera, particularly noctuids, and accounts of its biology are given by Tryon (1900) and Smith & Caldwell (1947). Males of *L. excelsa* are known to pollinate the orchid *Cryptostylis leptochila* by attempting to mate with the flowers (Coleman, 1928) and occasional specimens may be taken with the orchid pollinia attached to the tip of the gaster.

*L. excelsa* is, on account of its colour pattern, the most distinctive species in the genus. It is widely distributed throughout Australia though it seems to be relatively uncommon in the western part of Tasmania. The species also occurs in New Zealand, Fiji and the Kermadec Is. (Morley, 1913a; Parrott, 1952).

**HOST RECORDS.** Anthelidae: *Anthela denticulata* (Newman) (Cameron, 1912). Noctuidae: *Achaea janata* (L.) (Morley, 1913a); *Mythimna convecta* (Walker) (Chadwick & Nikitin, 1976); *M. separata* (Walker) (Tryon, 1900); *Spodoptera exempta* (Walker) (ANIC); *S. mauritia* (Boisduval) (Tryon, 1900); *Tiracola plagiata* Walker (Temperley, 1930). Pyralidae: *Cactoblastis* sp. (Chadwick & Nikitin, 1976).

A number of other host records from New Zealand are given by Parrott (1952).

**MATERIAL EXAMINED**

**New Zealand:** 1 ♀ (holotype of *semipunctata* (BMNH)). **Australia:** 1 ♀ (lectotype of *prionemidea*) Melbourne (MNH).

**Australia:** 197 ♀, 164 ♂, from all states (Map 7) (AM, ANIC, BMNH, DAH, DAR, NMV, QM).

***Lissopimpla obesa* sp. n.**

Medium-sized species, fore wing length 9 mm. Flagellum with white ring from segments 7–14. Mandibles very strongly tapered, lower tooth minute; malar space 1.5 times length of basal mandibular width. Mesopleuron with transverse median groove rather broad and shallow, reaching only to centre; metapleuron postero-dorsally entirely convex. Propodeum dorsally coarsely trans-striate, laterally with area anterior to spiracle coriaceous, lateral longitudinal carinae complete, posterior transverse carina weak; central area slightly raised, rectangular. Fore wing with *cu-a* proximal to *Rs* & *M* by about 0.1 times its own length. Gaster rather stout, tergite 3 about 2.1 times as broad posteriorly as long. Ovipositor projecting beyond apex of gaster by 0.75 times length of hind tibia.

Orange, marked with yellowish white on orbits, margin of pronotum, subalar prominence, mesoscutum anteriorly, centrally and before scutellum, spots on mesopleuron, postscutellum, propodeal apophyses and laterally on tergites 1–5. Flagellum infuscate except for band. Wings hyaline.

**REMARKS.** This species is distinctive on account of its relatively stout gaster, short ovipositor and indistinct propodeal transverse carina. It appears to be closely related to *L. scutata*.

**HOST RECORDS.** None.

**MATERIAL EXAMINED**

Holotype ♀, **Australia:** Queensland, Murchie's Scrub, Watalgan Forest, 9 km off Rosedale Rd, xii.1973 (*Frauca*) (ANIC).

*Lissopimpla scutata* Krieger

(Fig. 16)

*Lissopimpla scutata* Krieger, 1899: 50. Lectotype ♀, AUSTRALIA (MNHU), designated by Townes *et al.*, 1961: 49 [examined].

Medium-sized to moderately large species, fore wing length of female 7–11 mm, of male 7–9 mm. Flagellum with a distinct white mark centrally. Mesopleuron with transverse median groove impressed to centre; metapleuron posterodorsally evenly convex (Fig. 16). Propodeum dorsally transversely coarsely striate, laterally coriaceous or somewhat striate anterior to spiracle, lateral longitudinal and posterior transverse carina sharp and virtually complete, central part raised into a tubercle, not obviously extended anteriorly. Fore wing with *cu-a* proximal to base of *Rs&M* by 0.2 times its own length. Gaster of female with tergite 3 1.7–1.8 times as broad posteriorly as long. Ovipositor projecting beyond apex of gaster by 0.85–0.95 times length of hind tibia.

Female black with profuse pale marks on orbits, notaular crests, mesoscutum centrally and laterally before scutellum, subalar prominences and mesopleuron between grooves, scutellum, postscutellum, propodeal apophyses and hind corners of tergites 1–5; legs reddish, hind tibia and tarsus infusate. Wing weakly infumate. Male similar to female but with lower face entirely pale.

VARIATION. There are a number of small specimens, in ANIC and BMNH, which have the fore wing length 7–8 mm, and the gaster and the lower part of the alitrunk predominantly reddish-coloured. These individuals may represent a distinct species but no characters other than colour could be found to separate them from smaller specimens of typical *scutata*.

REMARKS. *L. scutata* is another relatively common species though its range is mostly more northern than that of *L. excelsa*. It is easily recognized by its characteristic colour pattern which resembles that of *Echthromorpha intricatoria*, although the two species are allopatric.

HOST RECORDS. None.

Material examined

Australia: 1 ♀ (lectotype), Queensland, Cooktown (MNHU).

Australia: 27 ♀, 19 ♂, New South Wales, Queensland (Map 8) (AM, ANIC, BMNH, QM, QUM).

*Lissopimpla* species 1

Medium-sized species, fore wing length 9 mm. Flagellum with white central band. Mesopleuron with median transverse furrow, shallow, reaching only to centre; metapleuron posterodorsally evenly convex. Propodeum very like that of *L. scutata*. Fore wing with *cu-a* proximal to base of *Rs&M* by 0.2 times its own length. Gaster with tergite 3 1.9 times as broad posteriorly as long. Ovipositor projecting beyond apex of gaster by 1.0 times length of hind tibia.

Reddish brown, only pale-marked on notaular crest and mesepimeron. Ovipositor sheath black. Wings infumate.

REMARKS. This species is very similar to *L. scutata* except that it is strikingly different in colour. It is also similar to the New Caledonian species, *L. pacifica*, from which it principally differs in size.

HOST RECORDS. None.

MATERIAL EXAMINED

Australia: 1 ♀, Queensland, Mt Tambourine, x.1978 (*Galloway*) (BMNH).

*XANTHOPIMPLA* Saussure

*Xanthopimpla* Saussure, 1892: 13. Type-species: *Xanthopimpla hova* Saussure, by subsequent designation, Ashmead, 1900a: 56.

*Chloropimpla* Saussure, 1892: 13. Type-species: *Chloropimpla dorsigera* Saussure, by monotypy.

*Notopimpla* Krieger, 1899: 106. Type-species: *Pimpla terminalis* Brullé, by monotypy.

*Neopimploides* Viereck, 1912: 151. Type-species: *Neopimploides syleptae* Viereck (= *Ichneumon punctatus* F.), by original designation.

*Austrapophua* Girault, 1926: 135. Type-species: *Austrapophua xanthopimploides* Girault (= *Xanthopimpla rhopaloceros* Krieger), by subsequent designation, Walkley, 1963: 116.



Small to moderately large-sized species, fore wing length 4–13 mm; clypeus transversely divided, margin straight; mandibles strongly narrowed and twisted about 90°; occipital carina complete. Epicnemial carina present; mesopleural suture generally not angled centrally; propodeum usually with strong carinae, spiracles oval to elliptical. Tarsal claws of female without basal lobes, usually large with spatulate bristles. Fore wing with *3r-m* present or absent; hind wing with first abscissa of *Cu*<sub>1</sub> about 0.3 or less times as long as *cu-a* (Fig. 7). Tergite 1 moderately slender; tergites 2–5 polished, usually rather sparsely punctate; ovipositor from barely projecting beyond apex of gaster to projecting by 1.5 times length of hind tibia.

**REMARKS.** *Xanthopimpla* is a very large tropicopolitan genus, most species of which occur in the Indo–Papuan area. Townes & Chiu (1970) revised the genus and erected 19 species-groups. These groups are difficult to recognize unless one has access to an extensive collection, but they have held up well for the considerable additional material collected recently. Most Australian species belong to the *rhopaloceros*-group or the *splendens*-group, two species complexes which have undergone considerable radiation in New Guinea.

*Xanthopimpla* species are conspicuous bright yellow ichneumonids. Most are profusely black-speckled and early authors (e.g., Krieger, 1899) placed considerable emphasis on the patterns of black spots on the gastral tergites. However, not only are these patterns generally sexually dimorphic, but there is individual variation within a sex. Frequently spots may be missing in smaller individuals, though some species can be characterized by apparently never having spots on certain tergites. The majority of species of *Xanthopimpla* are restricted to forests at various altitudes, from coastal mangrove swamp to montane moss-forest. A few species, such as *X. flavolineata*, are associated with disturbed areas and are not uncommon in agricultural ecosystems where they parasitize a variety of lepidopterous pests.

Gauld (1984) recorded 15 named and two undescribed species from Australia. A further undescribed species has been seen and these three taxa are described below. The majority of species are found in the tropical parts of Australia.

**Key to Australian species of *Xanthopimpla***

- 1 Fore wing with *3r-m* absent (Fig. 42) ..... 2
- Fore wing with *3r-m* present, enclosing a rhombic areolet (Figs 39–41) ..... 6
- 2 Area superomedia complete laterally and posteriorly (Fig. 33); pleural carina of propodeum extending only as far forward as level of spiracle (Fig. 21); scutellum in profile pyramidal ..... *hirsuta* (Girault) (p. 304)
- Area superomedia not delineated (Figs 28, 30, 35); pleural carina of propodeum complete, extending to front edge of propodeum (Fig. 22); scutellum in profile weakly to strongly convexly rounded ..... 3
- 3 Anterior transverse carina of propodeum present laterally (Fig. 28); mid coxa with a blunt prominence on anterolateral side ..... *rhopaloceros* Krieger (p. 307)
- Anterior transverse carina of propodeum entirely absent (Figs 30, 35); mid coxa without a blunt prominence ..... 4
- 4 Propodeum without a tubercle above and just behind spiracle (Fig. 30); posterior transverse carina of mesosternum centrally broadened and with a deep median V-shaped notch; punctures of tergite 3 centrally very fine ..... *summervillei* (Girault) (p. 309)
- Propodeum with a tubercle above and just behind spiracle (Fig. 35); posterior transverse carina of mesosternum broadened lateral to centre, medially with wide U-shaped notch; punctures of tergite 3 centrally coarse ..... 5
- 5 Submetapleural carina distinct; propodeal tubercle very strong (Fig. 22); ovipositor long ..... *quadridens* Townes & Chiu (p. 306)
- Submetapleural carina absent (Fig. 23); propodeal tubercle weak; ovipositor very short ..... *binodus* Townes & Chiu (p. 301)
- 6 Lateral longitudinal carinae of scutellum present only at extreme anterior end, the scutellum flat; propodeum with lateromedian longitudinal and anterior transverse carinae virtually absent (Fig. 36); distal flagellar segment truncate with a distinct elliptical flat area on apex (Fig. 47) ..... *terminalis* (Brullé) (p. 309)
- Lateral longitudinal carinae of scutellum distinct for more than 0.5 times scutellar length, the scutellum convex to pyramidal; propodeum with part of lateromedian or anterior transverse

- carinae or both discernible (Figs 37, 38); distal flagellar segment rounded or somewhat truncate, but if truncate sharply ended with a flat area ..... 7
- 7 Fore wing with  $2m-cu$  joining  $M$  very close to outer corner of areolet (Fig. 40); lower anterior corner of pronotum sharply angled about  $95^\circ$  and ♀ with ovipositor projecting 0.9 times length of hind tibia ..... *hiatus* Townes & Chiu (p. 304)
- Fore wing with  $2m-cu$  joining  $M$  almost equidistant between  $2r-m$  and  $3r-m$  (Fig. 39) or closer to  $2r-m$ ; lower anterior margin of pronotum rounded off, or if rarely rather sharply angled then with ovipositor less than 0.6 times as long as hind tibia, ovipositor otherwise various ..... 8
- 8 Notauli very strongly impressed, reaching to or behind the level of the hind edge of tegulae; mesopleuron with a strongly impressed sternaulus (Fig. 18) ..... 9
- Notauli weak to strongly impressed but short, at most reaching to level of centre of tegulae; mesopleuron with sternaulus weak or indistinct (Figs 19, 20) ..... 13
- 9 Lower anterior part of metapleuron diagonally striate (Fig. 18); scutellum with lateral carinae reaching about 0.8 times scutellar length ..... 10
- Lower anterior part of metapleuron without diagonal striae; scutellum with lateral carinae reaching to apex ..... 11
- 10 Clypeus with a median swelling near upper margin which is most obvious in the ♀; propodeum with anterior transverse carina present laterally (Fig. 26); tergite 1 of gaster usually with a pair of black marks; hind tibia with 5–9 preapical bristles ..... *striata* Townes & Chiu (p. 308)
- Clypeus medially almost flat; propodeum with anterior transverse carina vestigial or absent laterally (Fig. 31); tergite 1 of gaster entirely yellow; hind tibia with 3–4 preapical bristles ..... *amon* sp. n. (p. 279)
- 11 Hind tibia with 5–7 preapical bristles (Fig. 44); area superomedia not defined laterally, confluent with areae lateralis (Fig. 34) ..... *barak* sp. n. (p. 300)
- Hind tibia with 0–3 preapical bristles (Fig. 43); area superomedia laterally defined by lateromedian longitudinal carina, separated from areae lateralis (Figs 25, 38) ..... 12
- 12 Wings strongly and uniformly infumate; ovipositor sheath barely protruding beyond apex of gaster; mesopleuron ventrally closely and coarsely punctate ..... *ecaadata* Krieger (p. 302)
- Wings hyaline with apices slightly infumate; ovipositor sheath protruding beyond apex of gaster by 0.5 times length of hind tibia; mesopleuron ventrally very finely and sparsely punctate ..... *pubidorsis* Townes & Chiu (p. 306)
- 13 Propodeum with area superomedia large, elongate (though sometimes absent laterally), more than 1.1 times as long as wide and with section of lateromedian longitudinal carina between anterior and posterior transcarinae (or if absent the distance) more than 0.6 times as long as part of lateromedian longitudinal carina anterior to anterior transcarina (Fig. 29); tergite 1 of gaster slender, at least 1.3 times as long as posteriorly broad;  $Rs$  in fore wing strongly sinuate (Fig. 39) ..... 14
- Propodeum with area superomedia various, either small and subquadrate or larger and transverse, usually with section of lateromedian longitudinal carina between anterior and posterior transcarinae very short (Figs 24, 32, 37); tergite 1 of gaster subquadrate, less than 1.2 times as long as posteriorly broad;  $Rs$  in fore wing weakly sinuate (Fig. 41) ..... 15
- 14 Gaster more or less entirely yellow; tergite 1 with carina from spiracle to anterior margin of segment (Fig. 49); notaulus weak, not reaching to centre of tegulae ... *flavolineata* Cameron (p. 302)
- Gaster with black spots at least on tergites 3, 4 and 5, sometimes on all tergites (Fig. 50); tergite 1 without carina to spiracle (Fig. 48); notauli strongly impressed, reaching to level of centre of tegulae ..... *arealis* Krieger (p. 299)
- 15 Scutellum in profile pyramidal (Fig. 19); propodeum with a swelling anterior to spiracle; mesopleuron strongly swollen centrally; area superomedia very transverse, about 2.7 times as broad as long, with carinae very strong (Fig. 24) ..... *fraterculus* Townes & Chiu (p. 303)
- Scutellum in profile convex (Fig. 20); propodeum without a conspicuous swelling anterior to spiracle; mesopleuron weakly swollen centrally; area superomedia various, if transverse then usually less than 2.5 times as broad as long and often with some carinae weak ..... 16
- 16 Posterior transverse carina of mesosternum broadened into rounded lobes, with a wide central notch (Fig. 45); ovipositor very long, projecting beyond apex of gaster by more than 1.0 times length of hind tibia (Fig. 51); proximal 0.1 of hind tibia black ..... *australis* Krieger (p. 300)
- Posterior transverse carina of mesosternum centrally produced into a pair of high posteriorly directed keels with a deep V-shaped central notch (Fig. 46); ovipositor shorter, projecting beyond apex of gaster by no more than 0.8 times length of hind tibia; hind tibia entirely yellow ..... 17

- 17 Area superomedia small, slightly longer than broad (Fig. 32); tergite 3 of gaster highly polished, with sparse punctures ..... *ankhu* sp. n. (p. 279)  
 - Area superomedia moderately large, transverse (Fig. 37); tergite 3 of gaster with moderately dense punctures ..... *ochracea* (Smith) (p. 305)

*Xanthopimpla amon* sp. n.

(Figs 18, 31)

Clypeus very weakly convex, medially flat; face shallowly and rather sparsely punctate. Flagellum with 36 segments, the distal one slightly flattened, apically rounded. Lower anterior corner of pronotum rather abruptly rounded. Mesoscutum with notauli very strongly impressed, reaching far behind level of hind margin of tegulae; central lobe of mesoscutum with fine hairs laterally, in the middle glabrous. Scutellum very convex, carinate laterally to 0.7-0.8 of its length. Mesopleuron quite strongly swollen centrally with a pronounced constriction just below the swelling, anteroventrally sparsely punctate; sternaulus deep, extending almost entire length of mesopleuron (Fig. 18); metapleuron with diagonal striae present in lower anterior corner, otherwise smooth; submetapleural carina strong. Posterior transverse carina of mesosternum centrally broadened into two rounded lobes, with a median V-shaped cleft. Propodeum moderately long, posterior transverse carina complete, strong; lateromedian carinae present anteriorly; anterior transverse carina either present but very weak, or absent; tubercle vestigial (Fig. 31). Mid coxa unspecialized; hind tibia with 3-4 preapical bristles, largest bristle on hind tarsal claws spatulate. Fore wing length 5-6 mm; 3*r-m* present enclosing a rather broad petiolate rhombic areolet; 2*m-cu* joining areolet slightly proximal to centre; *Rs* arcuate; *cu-a* opposite base of *Rs* & *M*. Gaster with tergite 1 about 1.2 times as long as posteriorly broad, without a carina extending from near spiracle to anterior end of segment. Tergite 3 centrally almost impunctate. Ovipositor projecting beyond apex of gaster by 0.2-0.3 times length of hind tibia, its apex almost cylindrical.

Female yellow, black-marked on interocellar area, mesoscutum in three stripes, propodeum in an anterior transverse band, tergites 3-5 in paired spots, tergites 7 and 8 with transverse band. Anterior end of hind tibia infusate; tergite 2 with weak lateral spots. Apex of wing infumate. Male similar to female.

**VARIATION.** The paratype female has the mesoscutal stripes confluent to form a large black area, tergite 6 has paired black spots in the holotype but only weak marks in the paratypes.

**REMARKS.** This small species belongs to the *splendens*-group of Townes & Chiu (1970). It is quite similar to *X. striata* in having a striate metapleuron, incompletely carinate scutellum, strong notauli and a deep sternaulus. It differs from *X. striata* in being smaller and more delicate, in not having a centrally swollen clypeus, having a vestigial anterior propodeal transverse carina, having fewer tibial bristles, being more sparsely punctate, generally, having a more convex mesopleuron and in the position of black gastral marks.

**HOST RECORDS.** None.

**MATERIAL EXAMINED**

Holotype ♀, **Australia:** Queensland, Mt Tambourine, x. (TC).

Paratypes. **Australia:** 1 ♂, Queensland, Brisbane, i-vi.1971 (*Sedlacek*) (TC); 1 ♀, 'North Queensland' (BMNH).

*Xanthopimpla ankhu* sp. n.

(Figs 20, 32, 46)

Clypeus very weakly convex; face strongly and coarsely punctate. Flagellum with 35 segments, the distal one slightly flattened, apically rounded. Lower anterior corner of pronotum fairly abruptly rounded. Mesoscutum with notauli moderately shallow, reaching about the level of fore edge of tegulae; central part of mesoscutum sparsely hirsute. Scutellum moderately convex, carinate laterally to apex. Mesopleuron weakly swollen centrally, anteroventrally quite coarsely punctate, sternaulus vestigial (Fig. 20); metapleuron smooth, submetapleural carinae present. Posterior transverse carina of mesosternum very abruptly raised near centre, produced into two acute lobes separated by a narrow V-shaped cleft (Fig. 46). Propodeum moderately long, carinae strong with a small elongate area superomedia discernible that is about 0.9 times as broad as long; tubercle weak (Fig. 32). Mid coxa unspecialized; hind tibia with 6-8 preapical bristles, largest bristle on hind tarsal claw spatulate. Fore wing length 6-7 mm; 3*r-m* present,

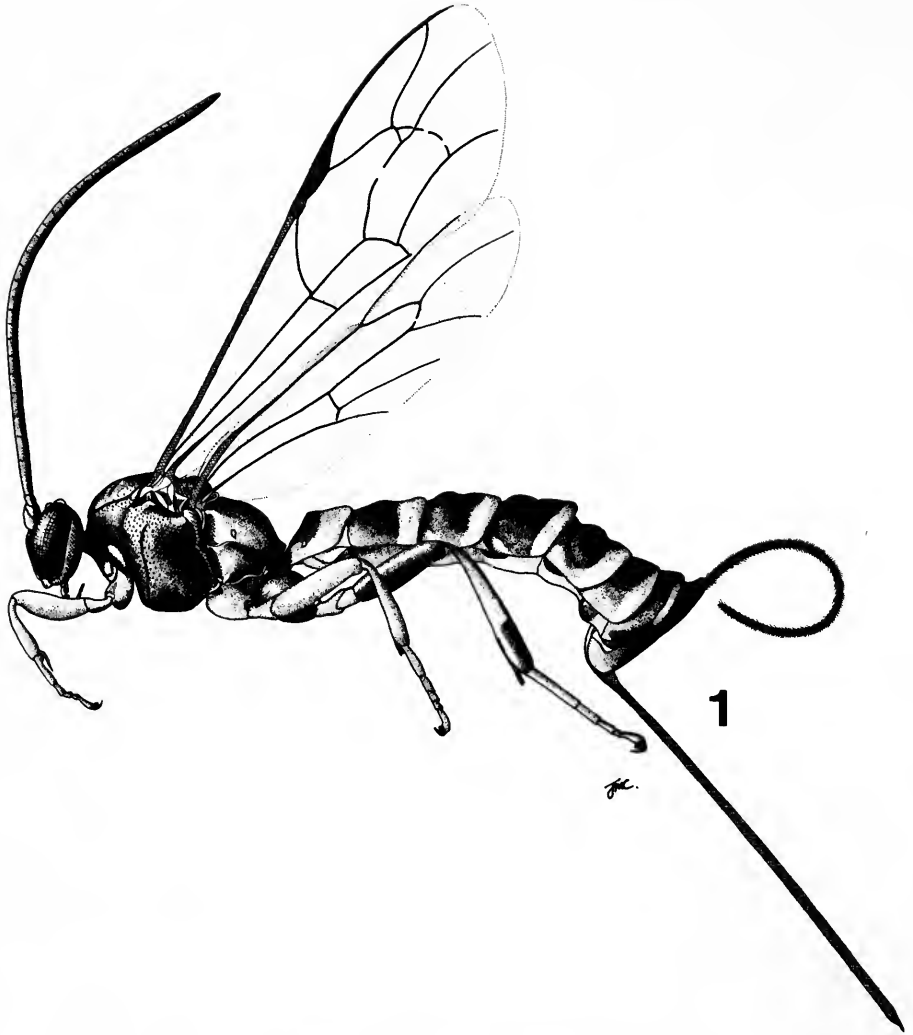
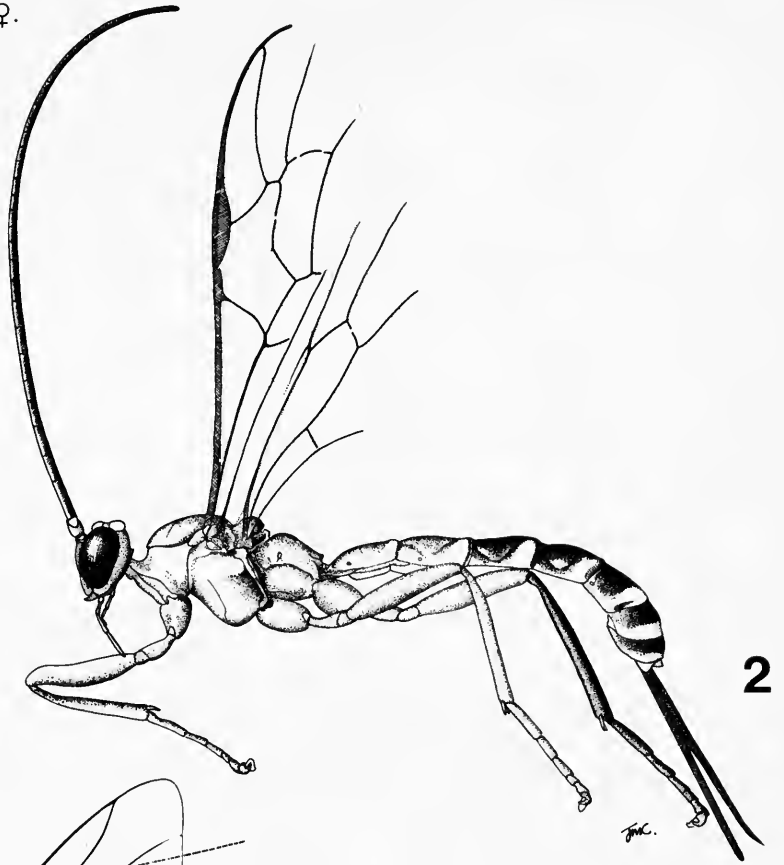
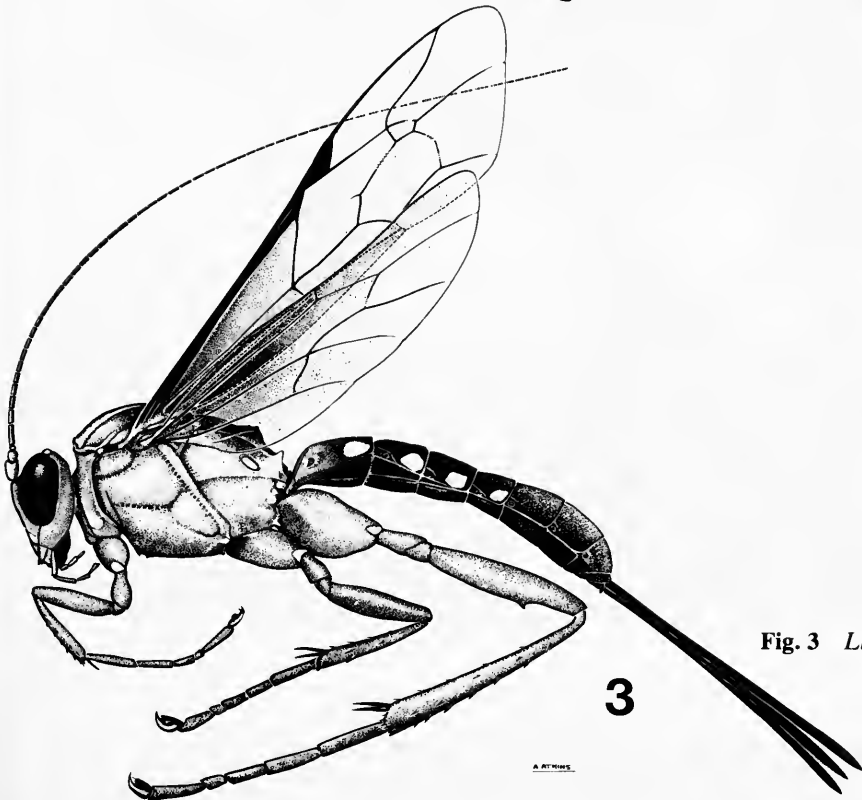

Fig. 1 *Sericopimpla crenator*, ♀.

Fig. 2 *Eriostethus maximus*, ♀.



2



3

Fig. 3 *Lissopimpla excelsa*, ♀.

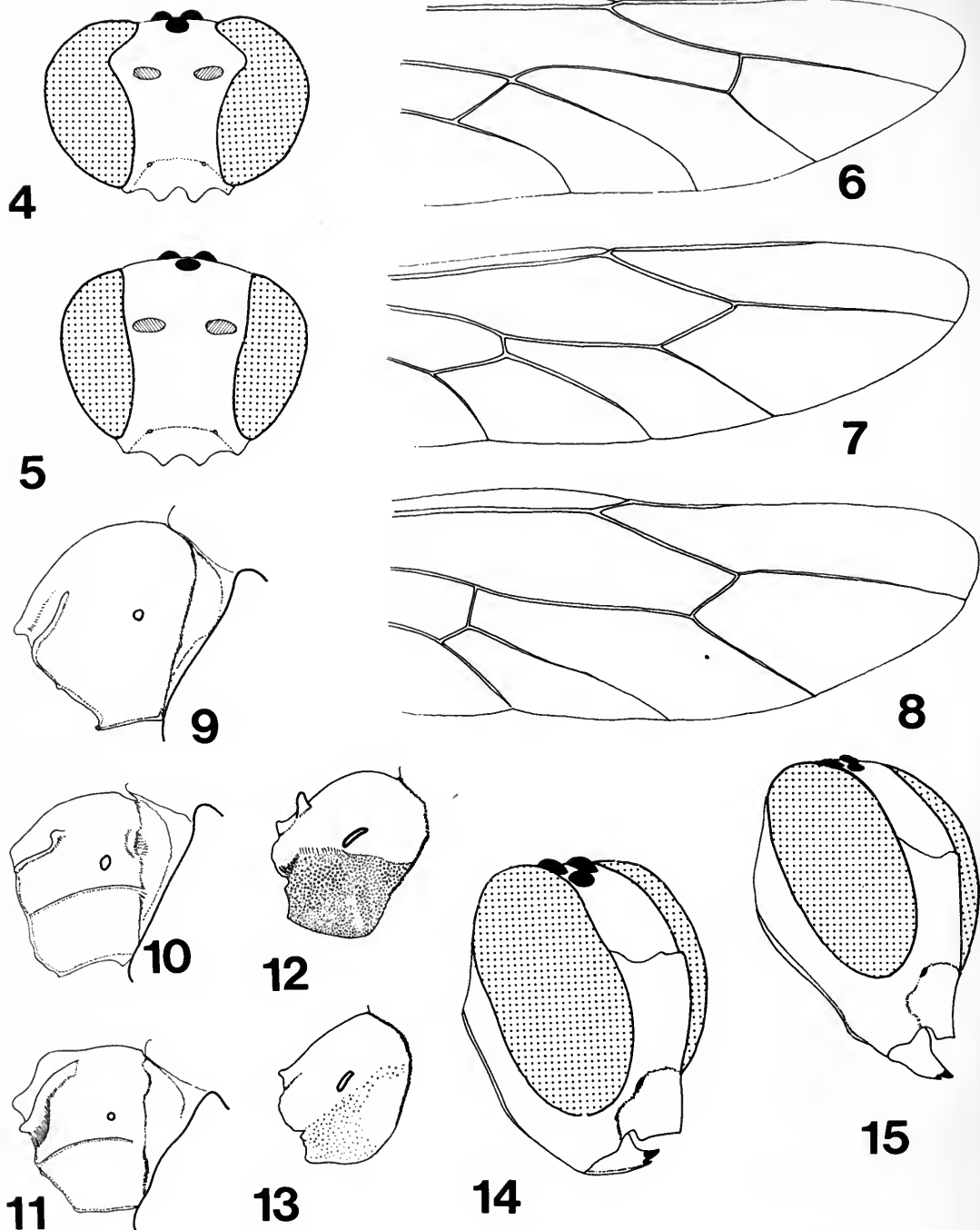

**Figs 4–15** 4, 5, head, anterior view, of (4) *Sericopimpla lutea*; (5) *Acropimpla xantha*. 6–8, hind wing of (6) *Echthromorpha intricatoria*; (7) *Xanthopimpla hiatus*; (8) *Sericopimpla lutea*. 9–13, propodeum, lateral view, of (9) *Camptotypeus sellatus*; (10) *Sericopimpla lutea*; (11) *Zaglyptus glabrinotum*; (12) *Echthromorpha intricatoria*; (13) *E. agrestoria*. 14, 15, head, lateral view, of (14) *E. nigricornis*; (15) *E. intricatoria*.

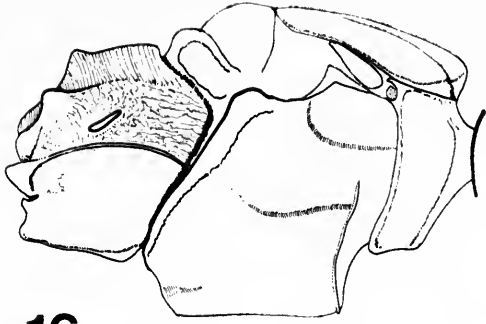

16

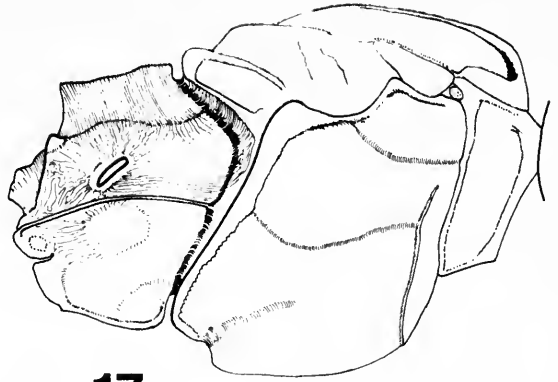

17

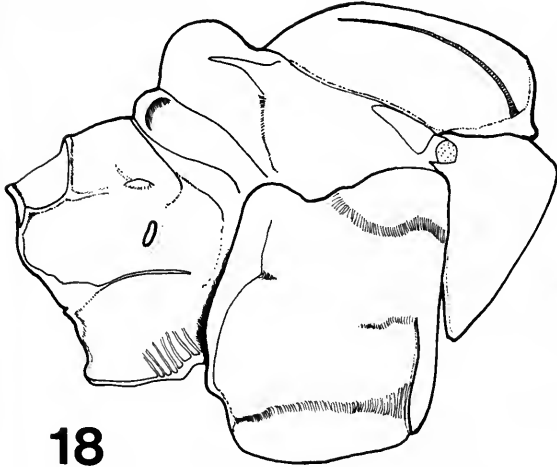

18

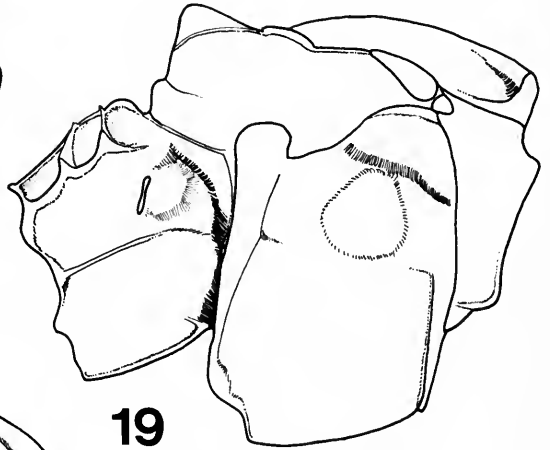

19

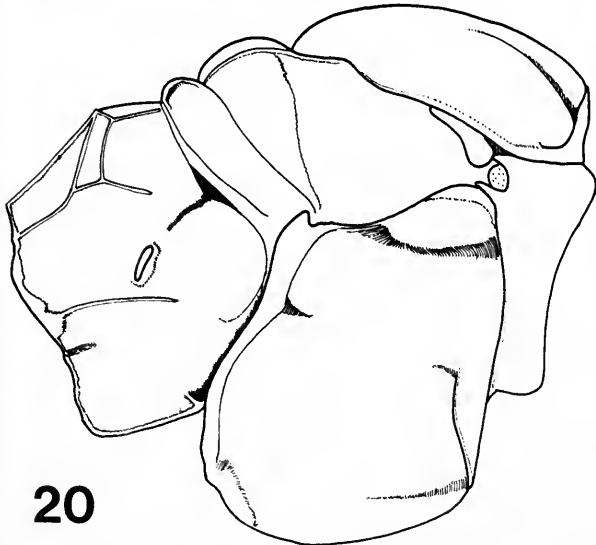

20



21

Figs 16–21 16–20, alitrunk, lateral view, of (16) *Lissopimpla scutata*; (17) *L. excelsa*; (18) *Xanthopimpla amon*; (19) *X. fraterculus*; (20) *X. ankhu*. 21, propodeum, lateral view, *X. hirsuta*.

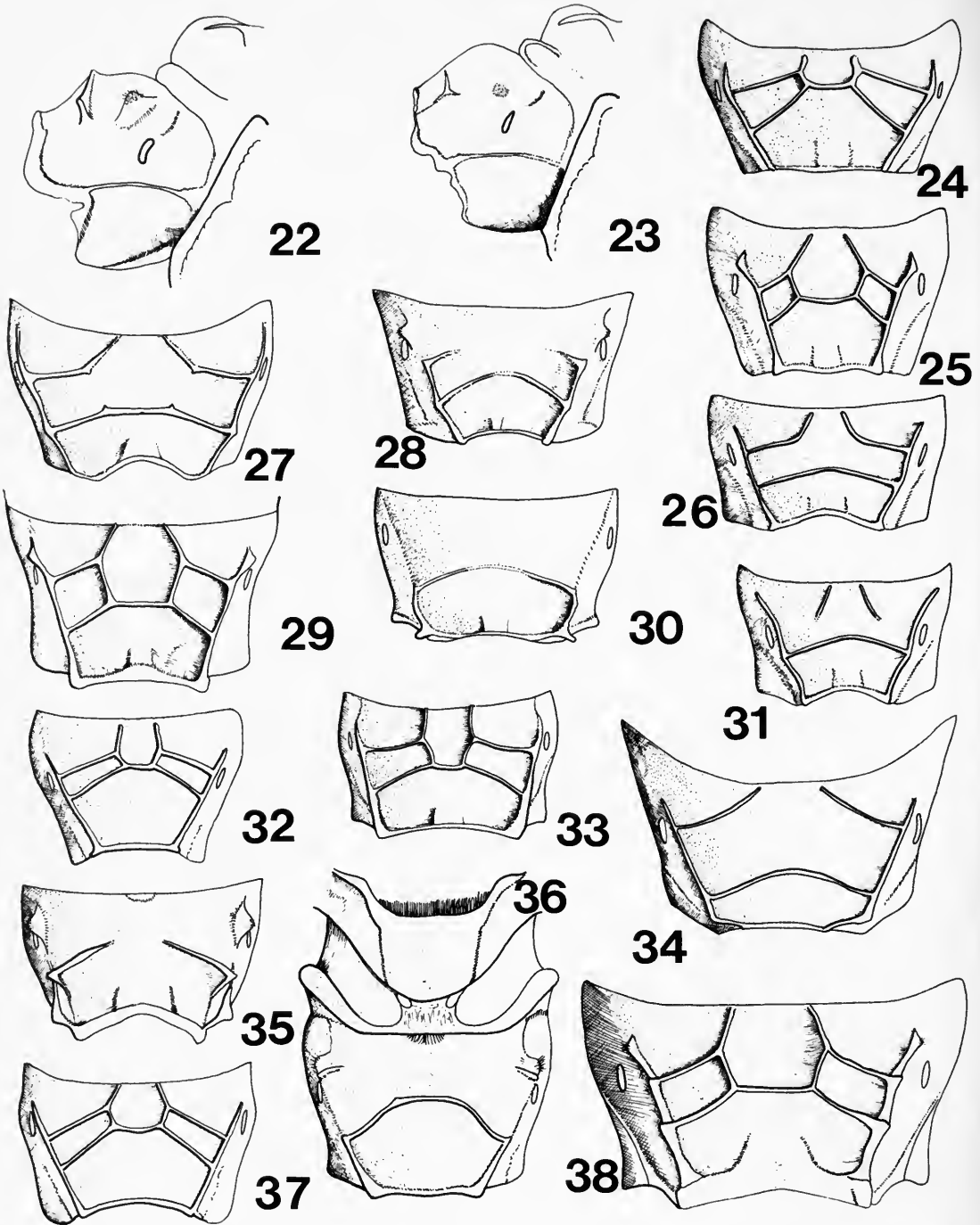

**Figs 22–38** 22, 23, propodeum, lateral view, of (22) *Xanthopimpla quadridens*; (23) *X. binodus*. 24–38, propodeum, dorsal view, of (24) *X. fraterculus*; (25) *X. pubidorsis*; (26) *X. striata*; (27) *X. hiatus*; (28) *X. rhopaloceros*; (29) *X. arealis*; (30) *X. summervillei*; (31) *X. amon*; (32) *X. ankh*; (33) *X. hirsuta*; (34) *X. barak*; (35) *X. quadridens*; (36) *X. terminalis*; (37) *X. ochracea*; (38) *X. caudata*.



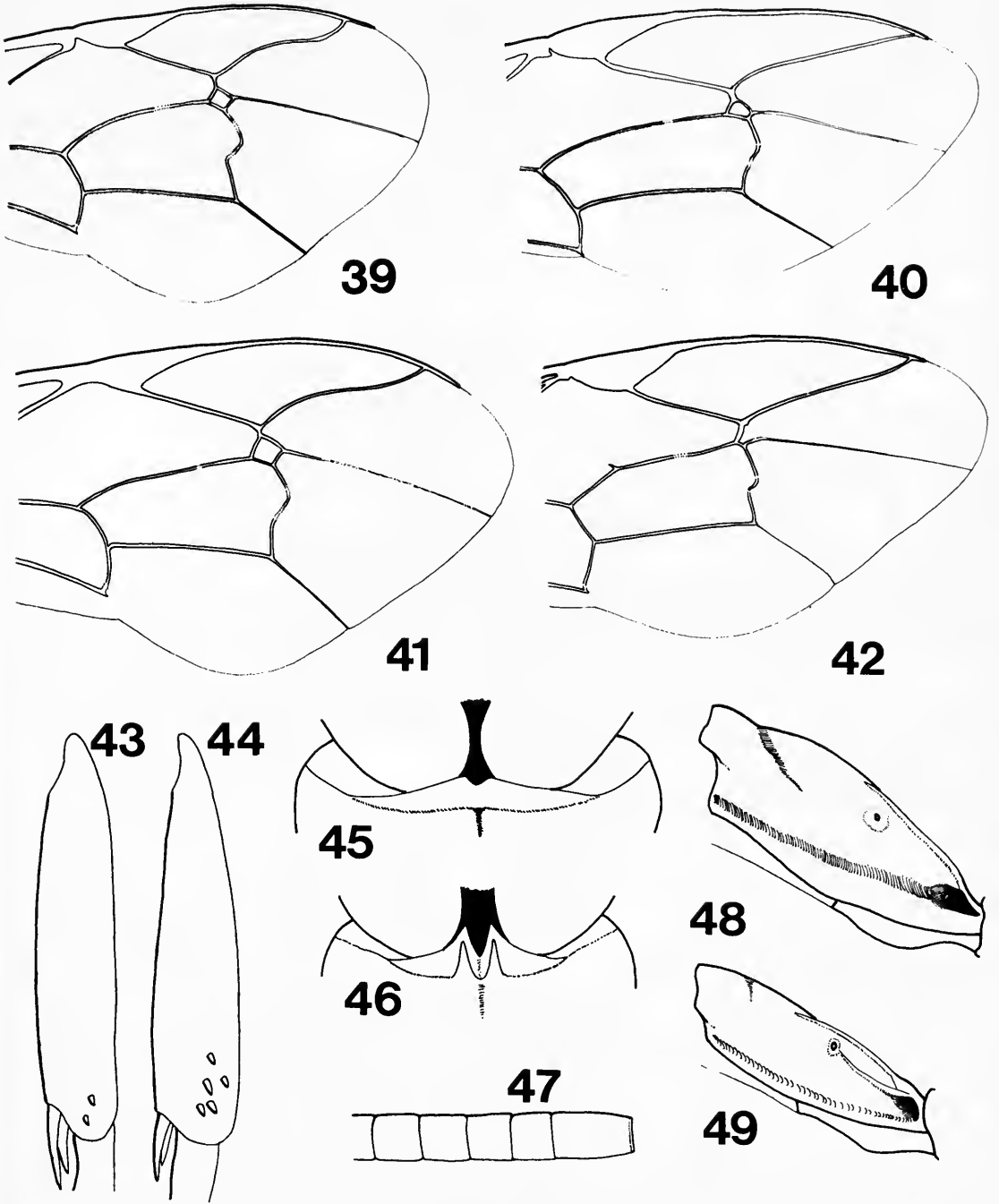

**Figs 39–49** 39–42, fore wing of (39) *Xanthopimpla flavolineata*; (40) *X. hiatus*; (41) *X. australis*; (42) *X. quadridens*. 43, 44, hind tibia of (43) *X. ecaudata*; (44) *X. barak*. 45, 46, posterior transverse carina of mesosternum of (45) *X. australis*; (46) *X. ankhu*. 47, tip of antenna, *X. terminalis*. 48, 49, segment 1 of gaster, lateral view, of (48) *X. arealis*; (49) *X. flavolineata*.

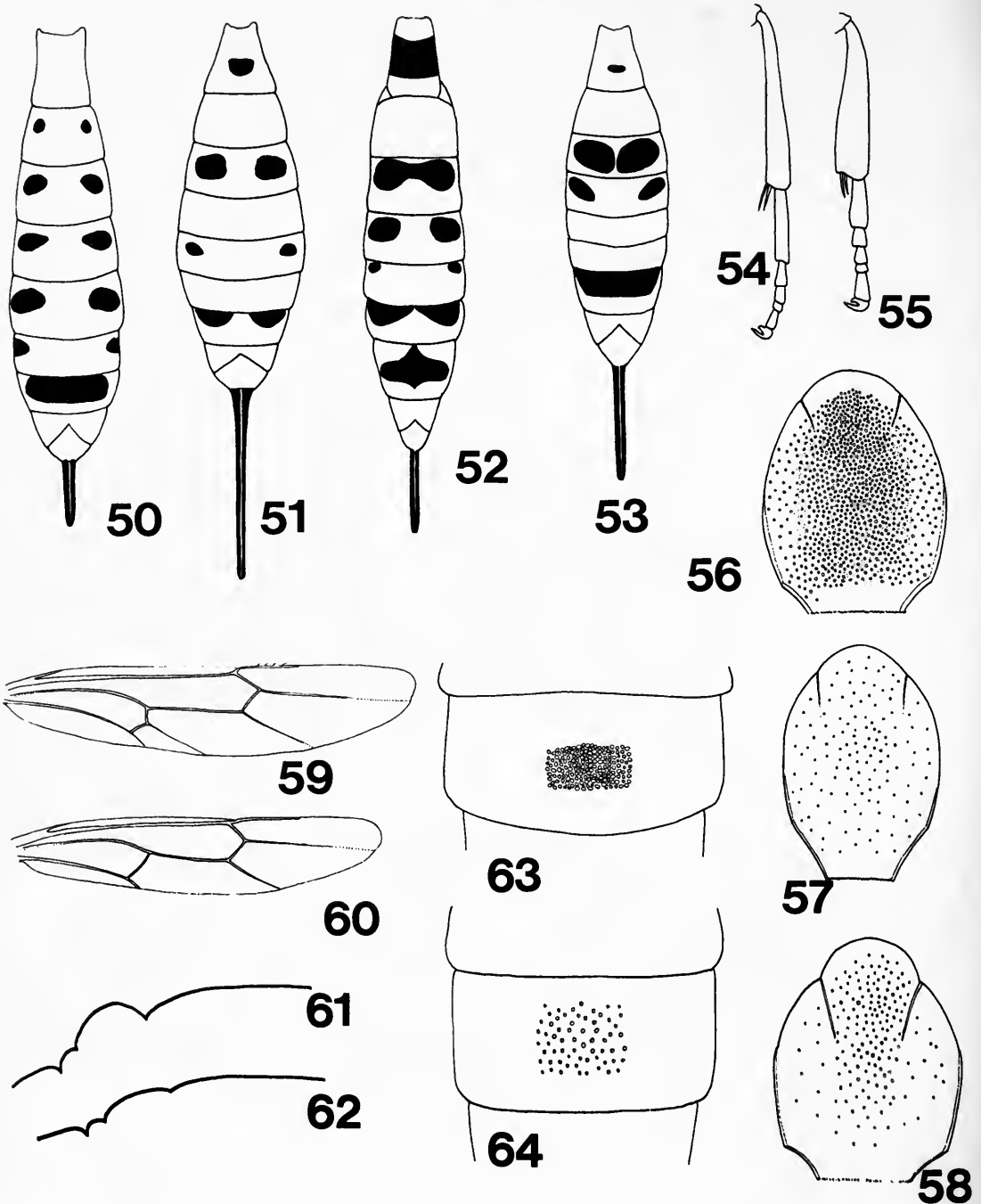

**Figs 50-64** 50-53, gaster, dorsal view, of (50) *Xanthopimpla arealis*, ♀; (51) *X. australis*, ♀; (52) *X. rhopaloceros*, ♀; (53) *X. summervillei*, ♀. 54, 55, hind leg (54) *Camptotypus lachesis*; (55) *C. bicolor*. 56-58, mesoscutum, dorsal view, of (56) *Sericopimpla crenator*; (57) *S. australis*; (58) *S. lutea*. 59, 60, hind wing of (59) *Zaglyptus glabrinotum*; (60) *Z. hollowayi*. 61, 62, scutellar profile of (61) *Sericopimpla lutea*; (62) *S. crenator*. 63, 64, tergite of gaster of (63) *Camptotypus bicolor*; (64) *C. sellatus*.

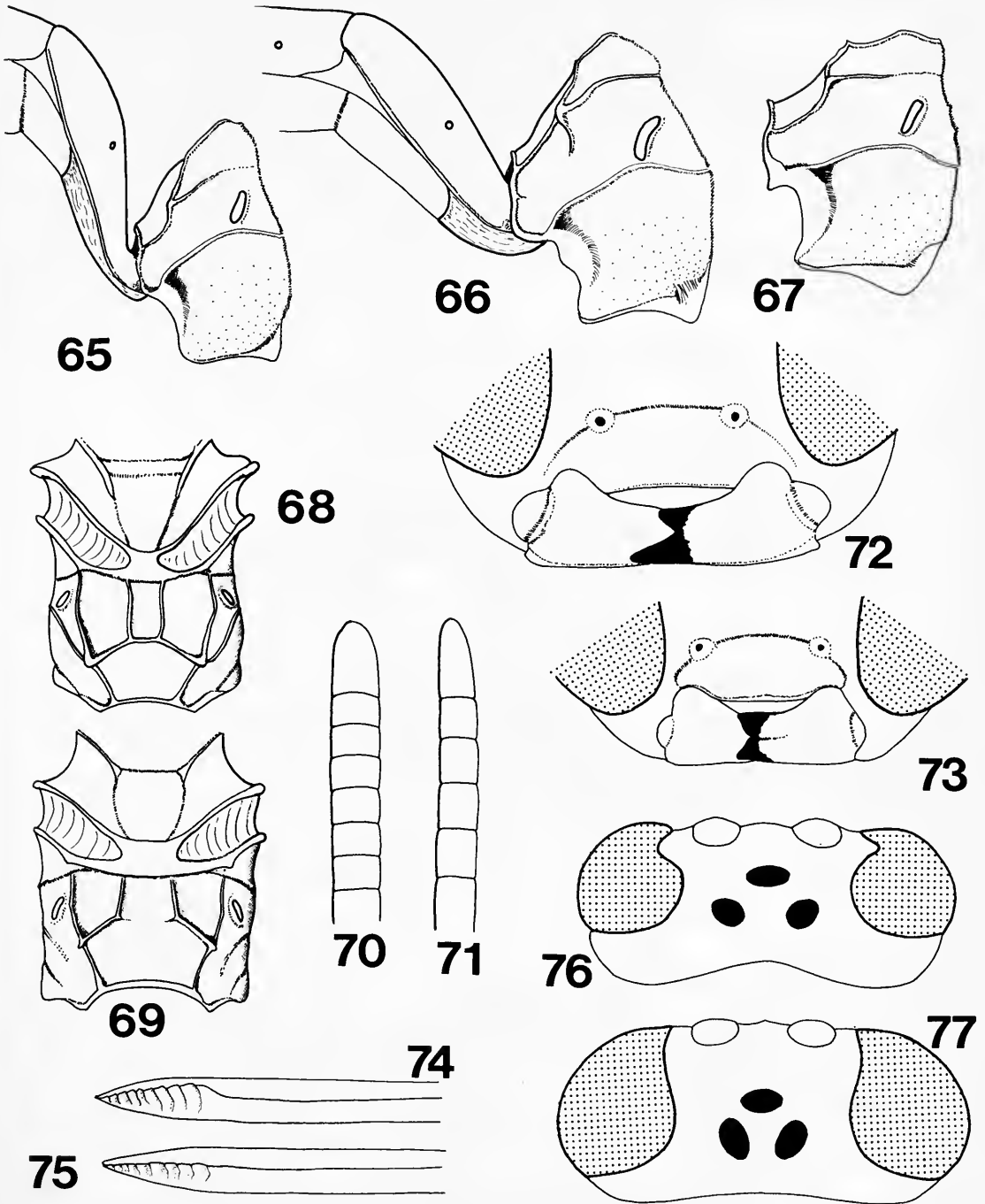

**Figs 65–77** 65, 66, propodeum and tergite 1, lateral view, of (65) *Theronia fraucai*; (66) *T. steindachneri*. 67, propodeum, lateral view, *T. maculosa*. 68, 69, scutellum and propodeum, dorsal view, of (68) *T. maculosa*; (69) *T. steindachneri*. 70, 71, tip of flagellum, ♀ of (70) *T. steindachneri*; (71) *T. fraucai*. 72, 73, clypeus and mandibles of (72) *T. melanosoma*; (73) *T. maculosa*. 74, 75, tip of ovipositor of (74) *T. penetrans*; (75) *T. maculosa*. 76, 77, head, dorsal view, of (76) *T. fraucai*; (77) *T. penetrans*.

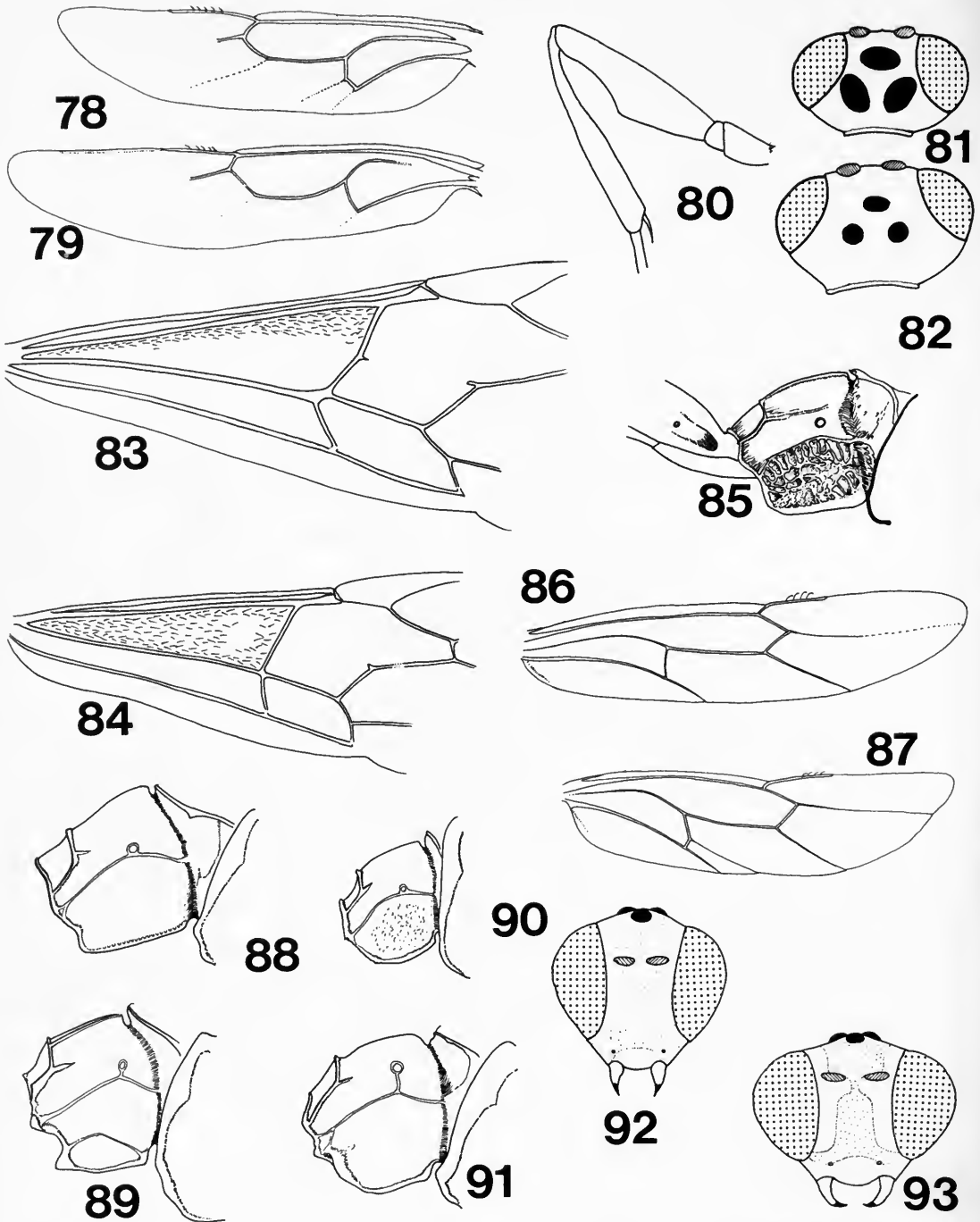

**Figs 78–93** 78, 79, hind wing of (78) *Acrodactyla quadrisculpta*; (79) *A. cursor*. 80, fore leg, *A. micans*. 81, 82, head, dorsal view, of (81) *A. zekhem*; (82) *A. micans*. 83, 84, fore wing of (83) *Eriostethus maximus*; (84) *E. pulcherrimus*. 85, propodeum, lateral view, *Acrodactyla micans*. 86, 87, hind wing of (86) *Zatypota rennefer*; (87) *Z. velata*. 88–91, propodeum, lateral view, of (88) *Z. dandiensis*; (89) *Z. bingili*; (90) *Z. kauros*; (91) *Z. phraxos*. 92, 93, head, anterior view, of (92) *Z. kauros*; (93) *Z. celer*.

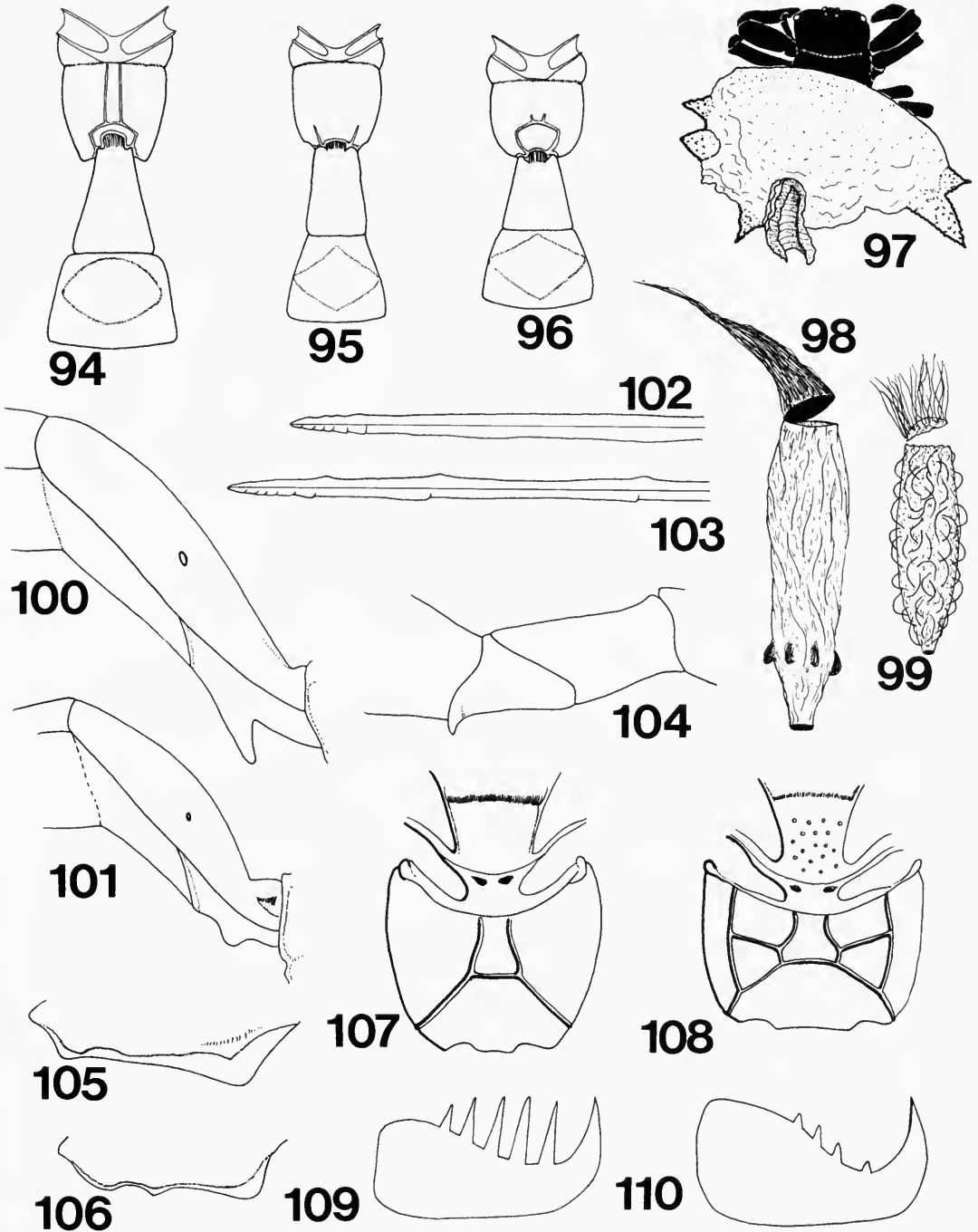

**Figs 94-110** 94-96, propodeum and anterior gastral tergites, dorsal view, of (94) *Zatypota dandiensis*; (95) *Z. rennefer*; (96) *Z. phraxos*. 97, larval remains of *Eriostethus* on spider. 98, 99, cocoons of (98) *Eriostethus carinatus*; (99) *Zatypota dandiensis*. 100, 101, segment 1 of gaster, lateral view, of (100) *Yezoceryx coelyx*; (101) *Y. apicipennis*. 102, 103, ovipositor tip of (102) *Y. apicipennis*; (103) *Y. tantalyx*. 104, hind trochantellus, *Y. tantalyx*. 105, 106, submetapleural carina of (105) *Y. amaryllyx*; (106) *Y. coelyx*. 107, 108, scutellum and propodeum, dorsal view, of (107) *Lycorina turneri*; (108) *L. splendidula*. 109, 110, ♀ claws of (109) *L. turneri*; (110) *L. canberrae*.



Map 1 Distribution of *Sericopimpla australis*.

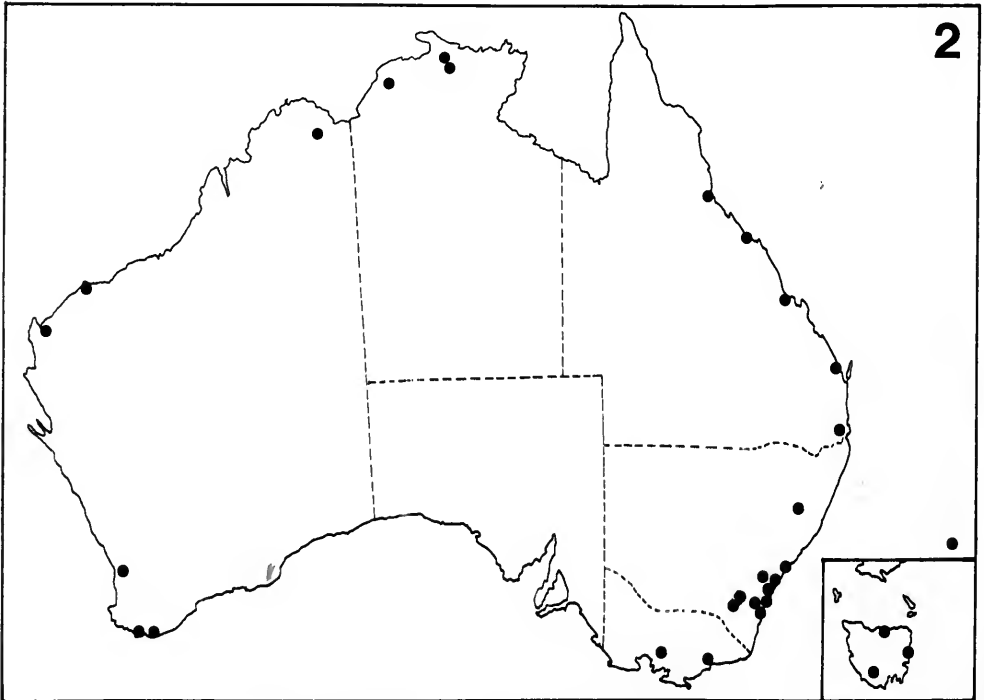

Map 2 Distribution of *Sericopimpla crenator*.

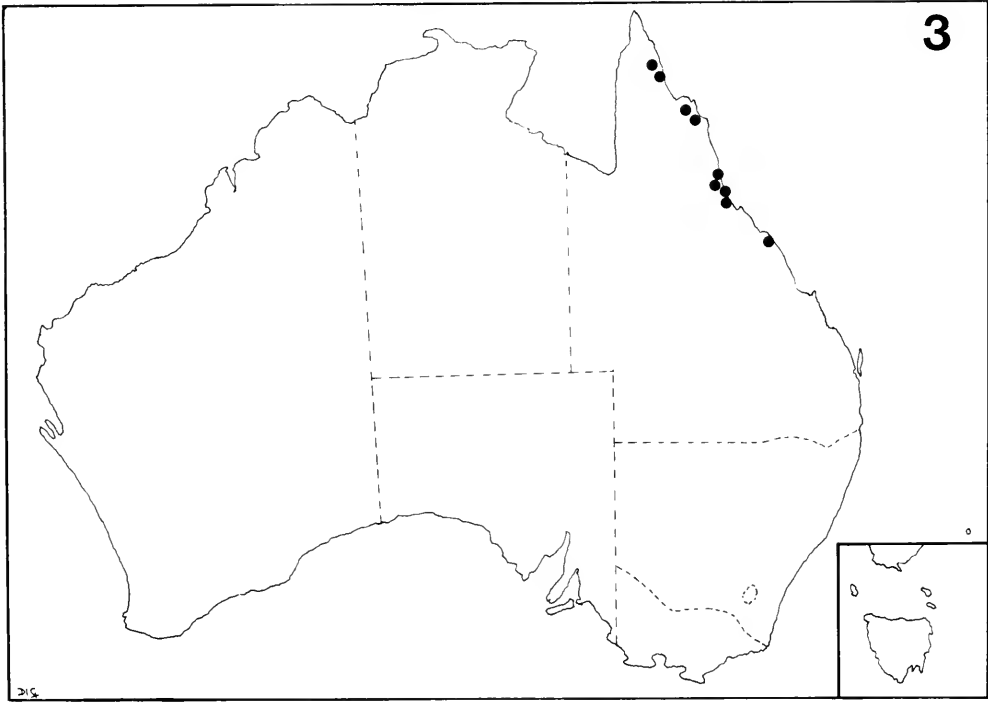

Map 3 Distribution of *Camptotypus sellatus*.

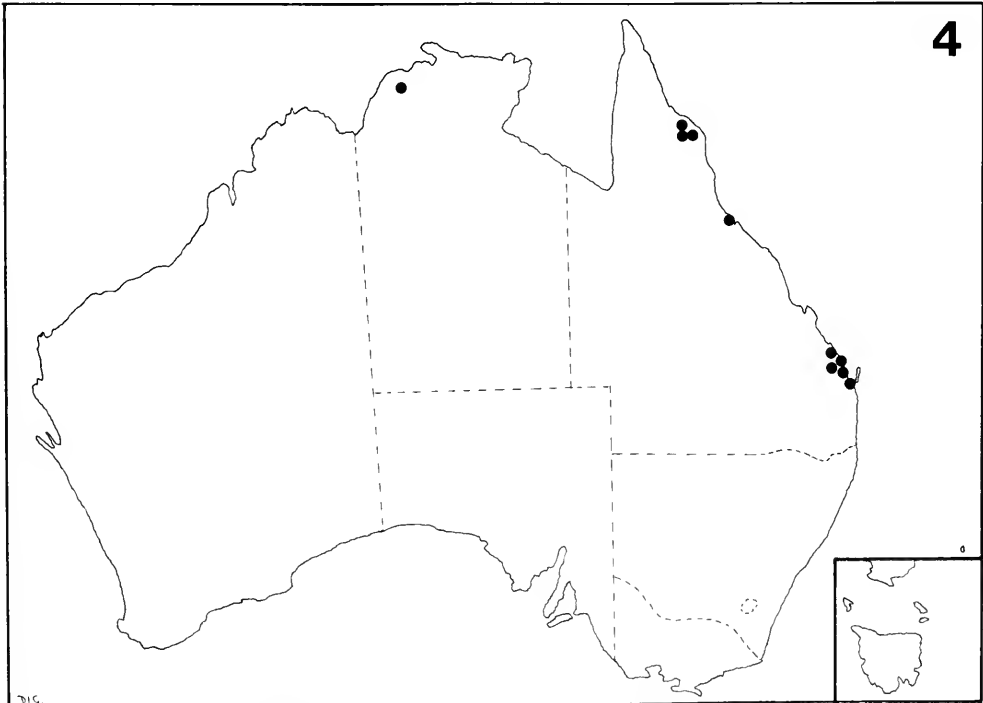

Map 4 Distribution of *Camptotypus lachesis*.

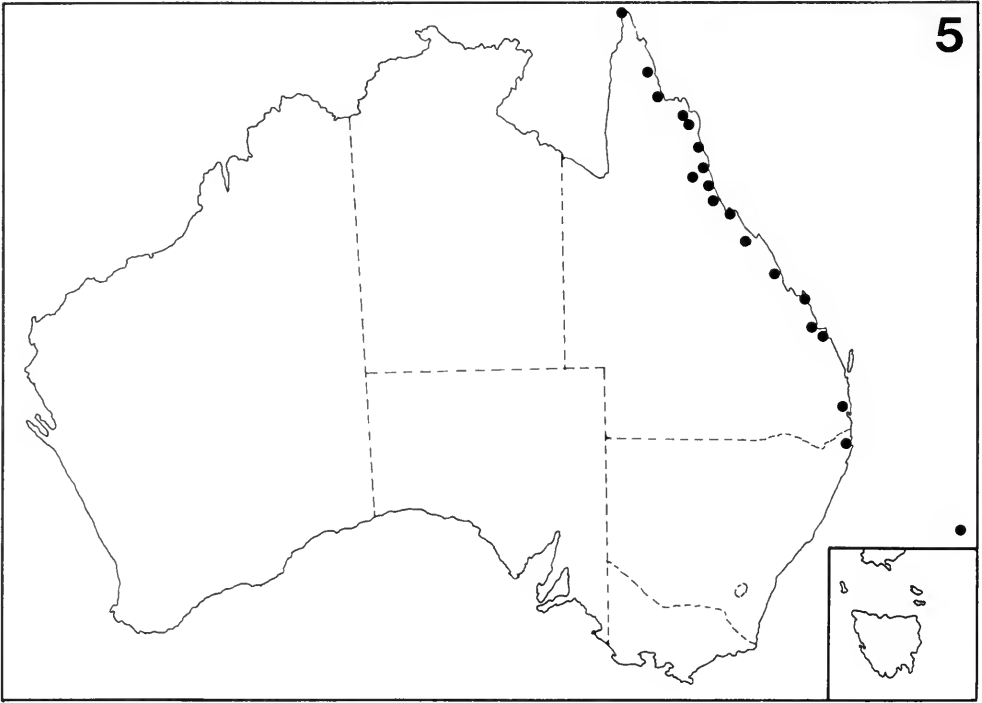

Map 5 Distribution of *Echthromorpha agrestoria*.

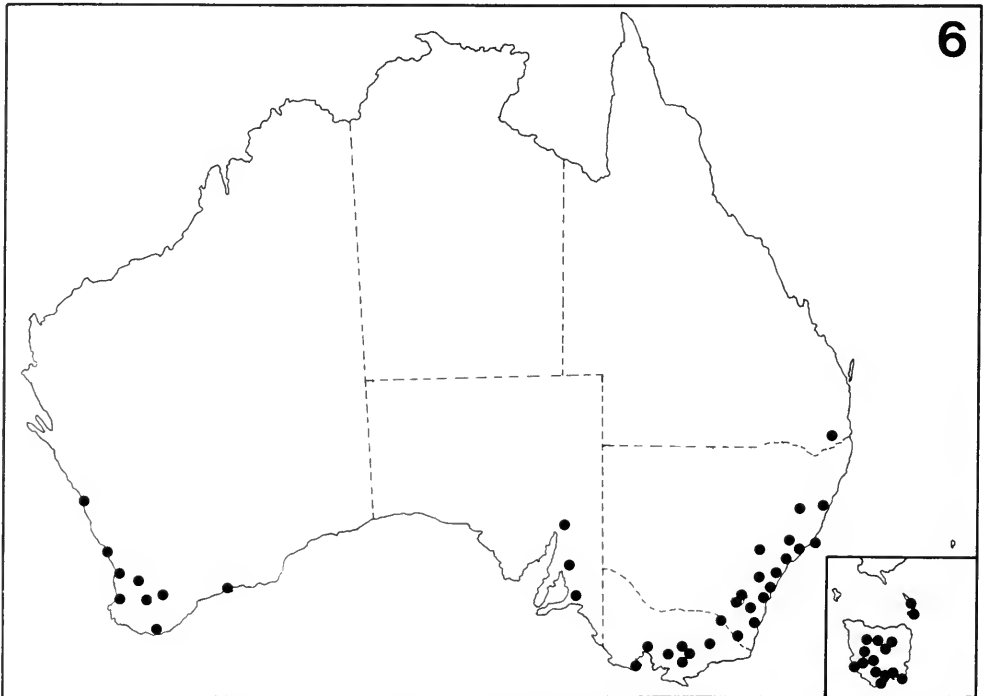

Map 6 Distribution of *Echthromorpha intricatoria*.



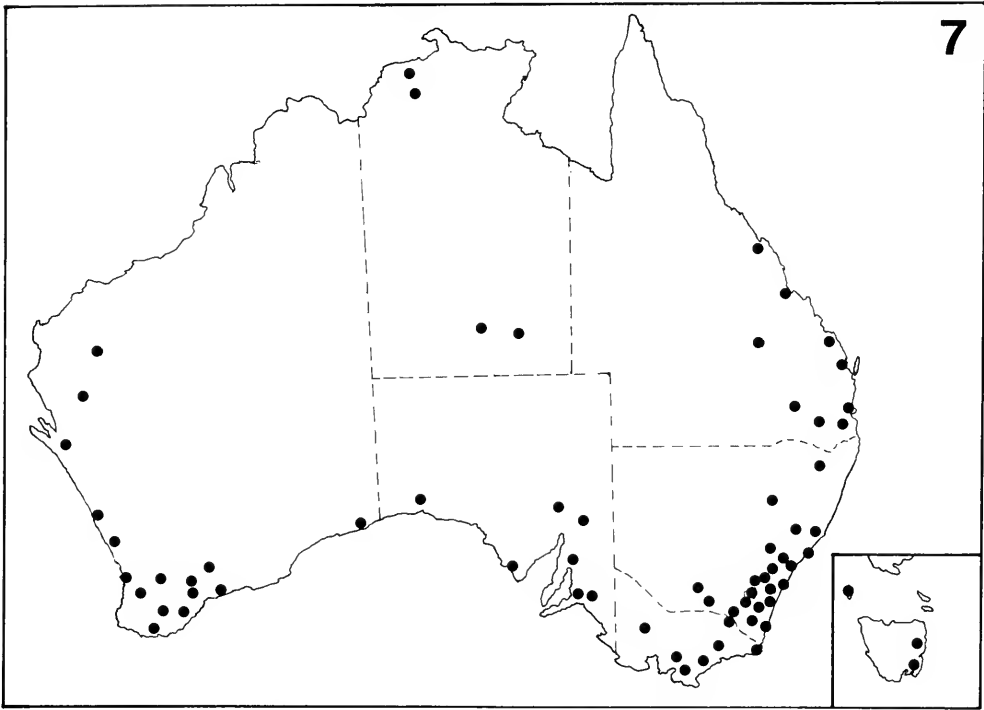

Map 7 Distribution of *Lissopimpla excelsa*.

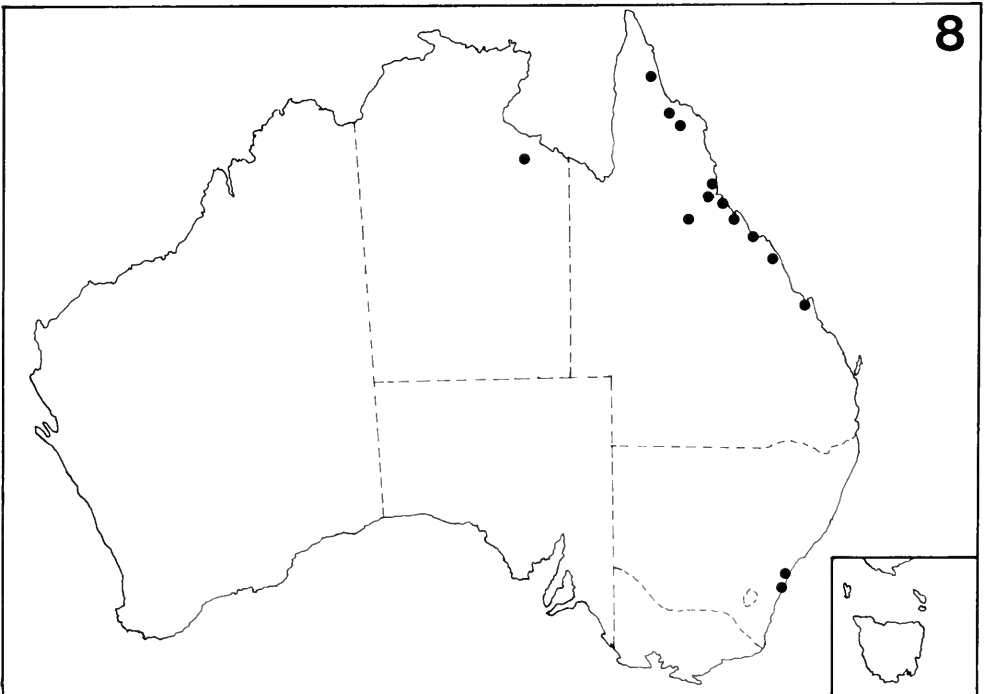

Map 8 Distribution of *Lissopimpla scutata*.

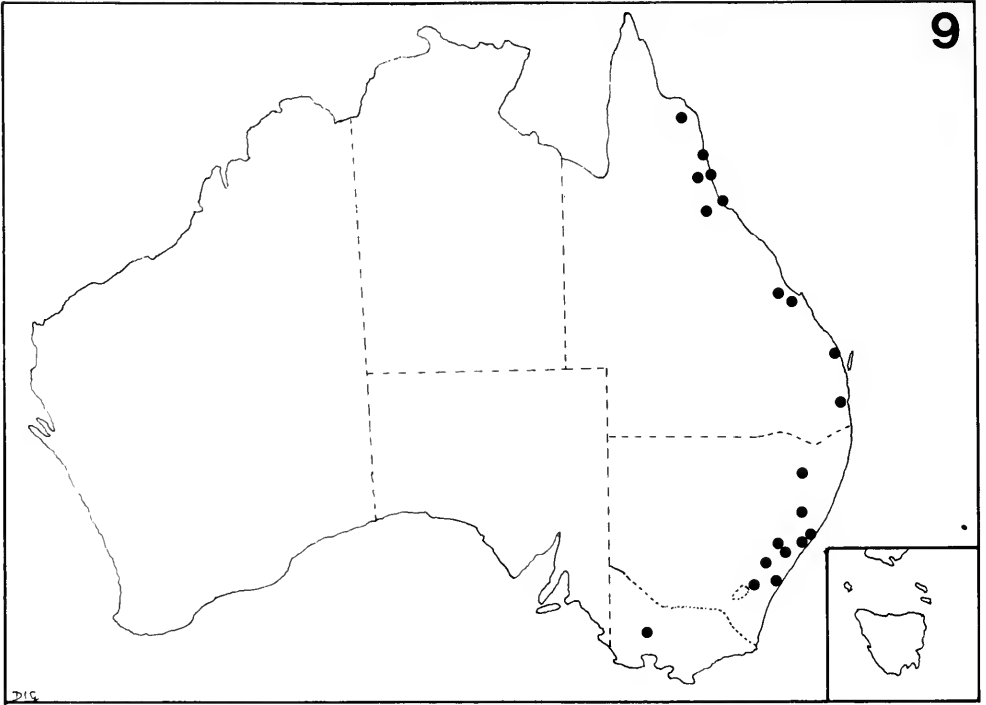

Map 9 Distribution of *Xanthopimpla arealis*.

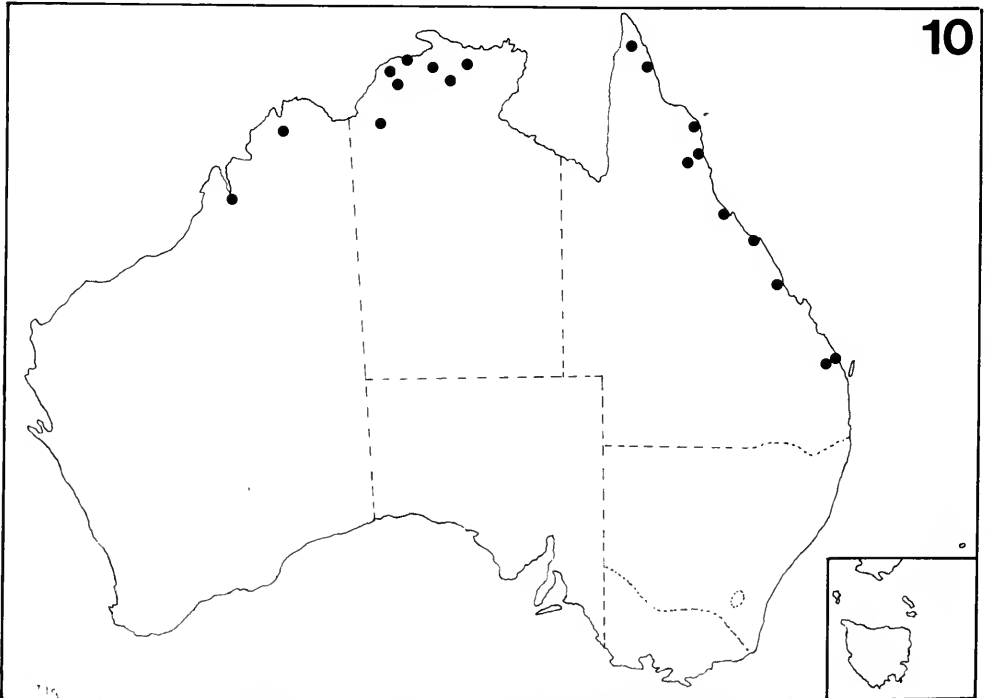

Map 10 Distribution of *Xanthopimpla australis*.

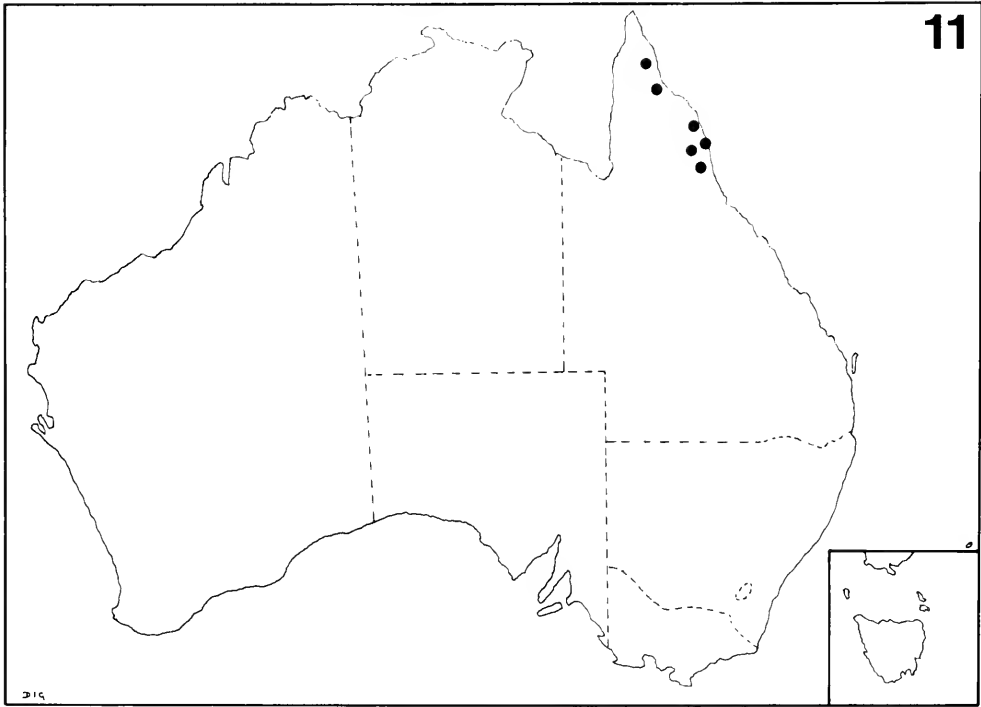

Map 11 Distribution of *Xanthopimpla ecaudata*.

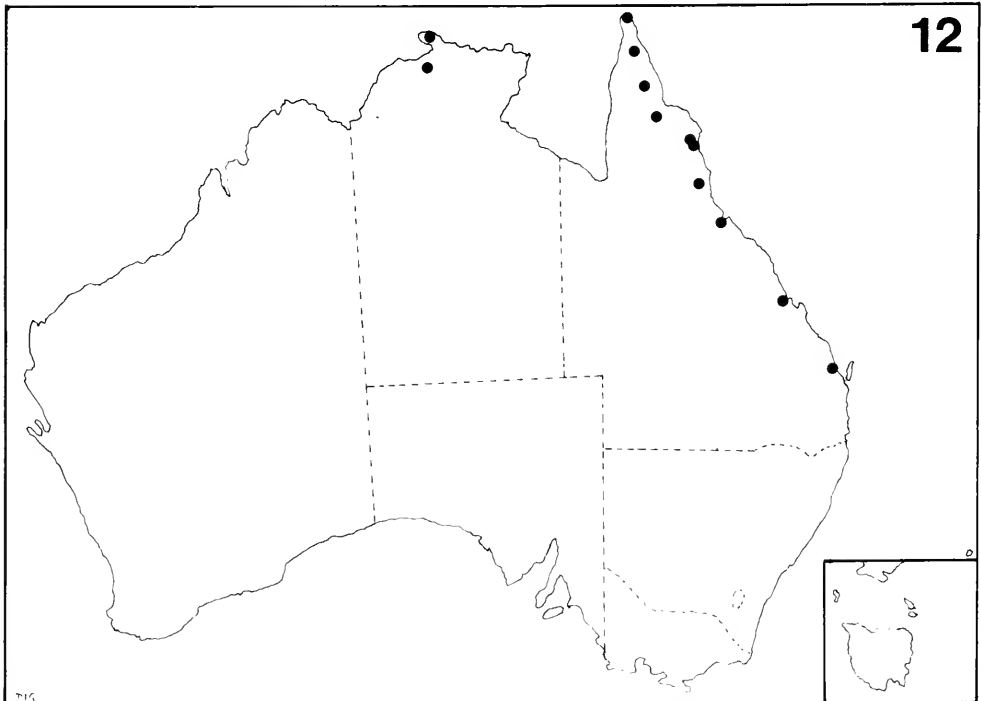

Map 12 Distribution of *Xanthopimpla ochracea*.

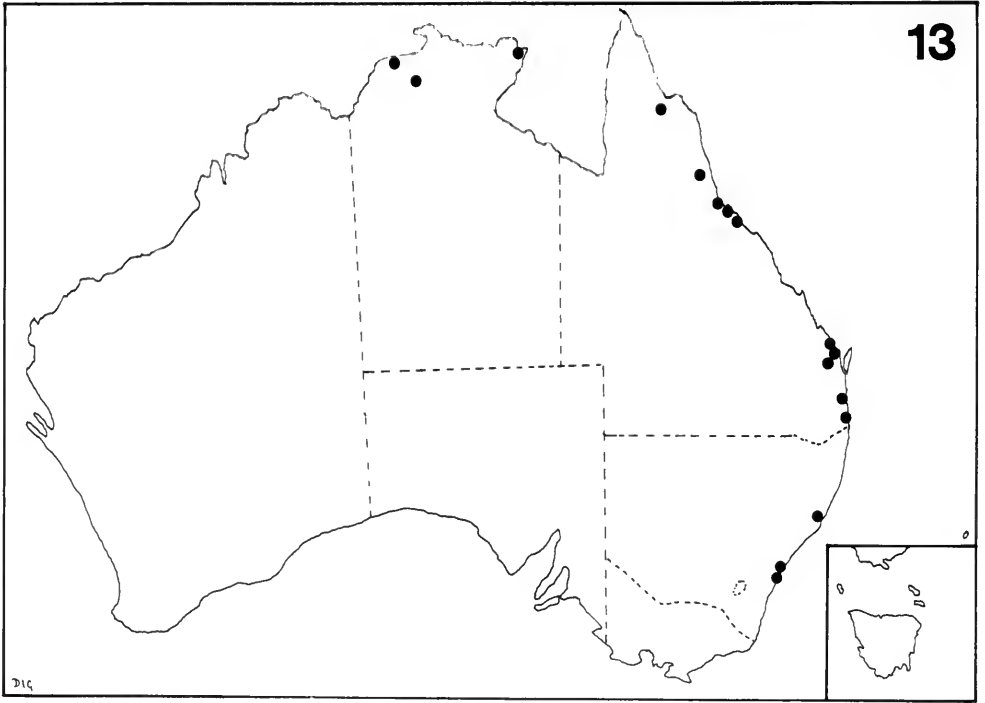

Map 13 Distribution of *Xanthopimpla flavolineata*.

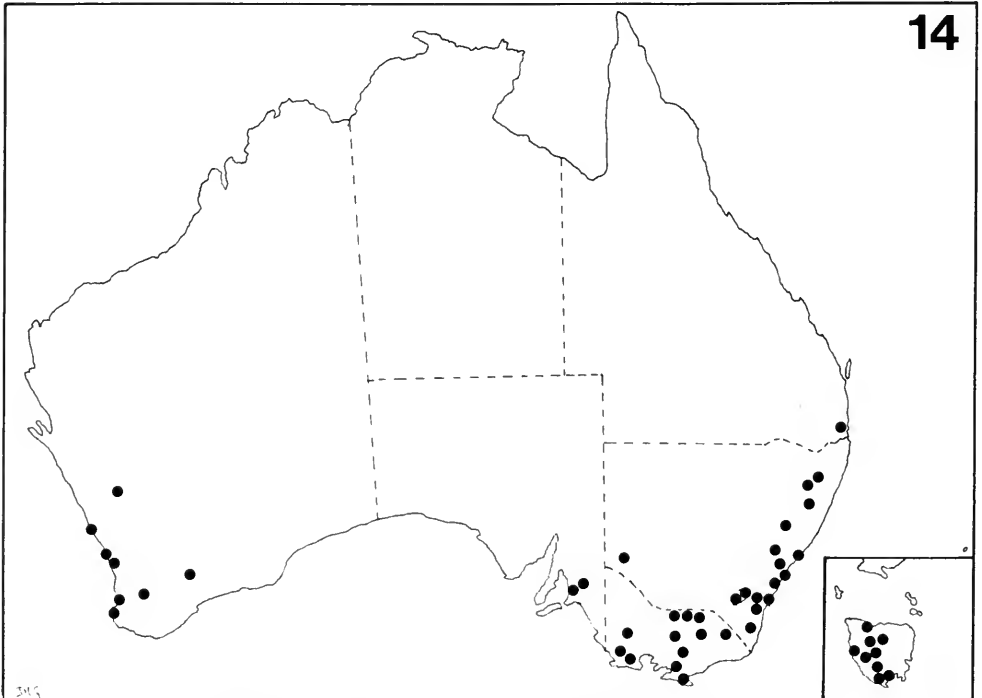

Map 14 Distribution of *Xanthopimpla rhopaloceros*.

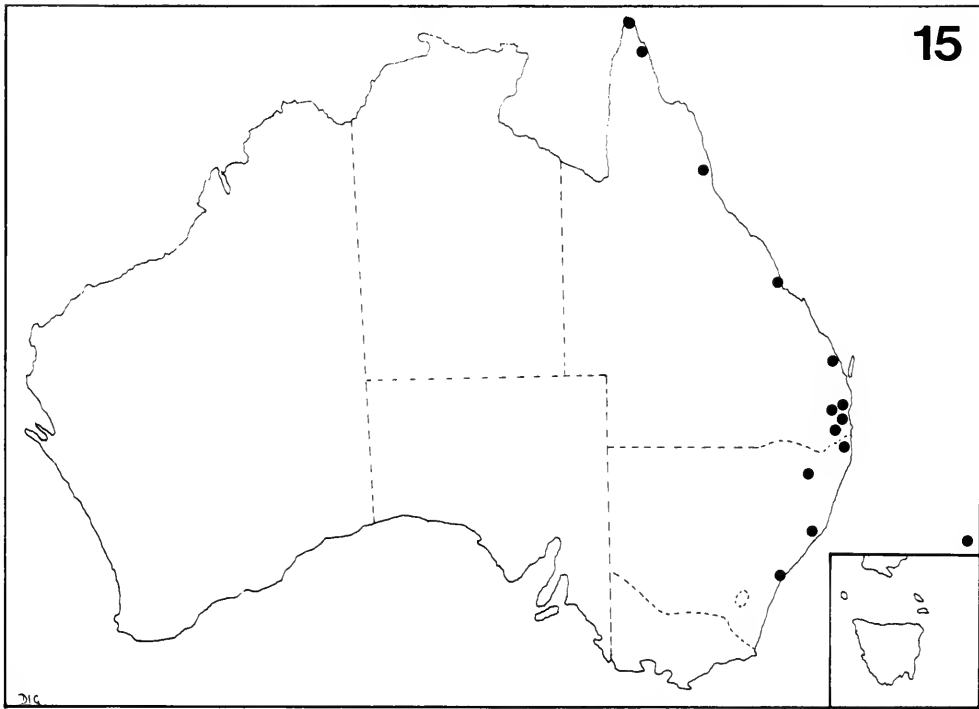

Map 15 Distribution of *Xanthopimpla summervillei*.

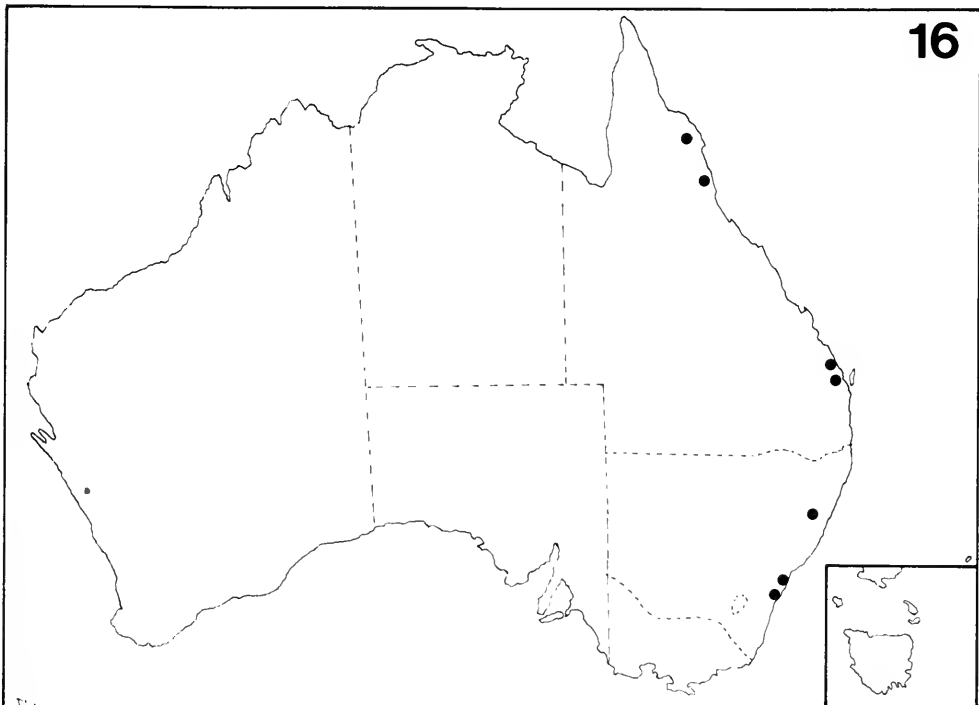

Map 16 Distribution of *Xanthopimpla terminalis*.

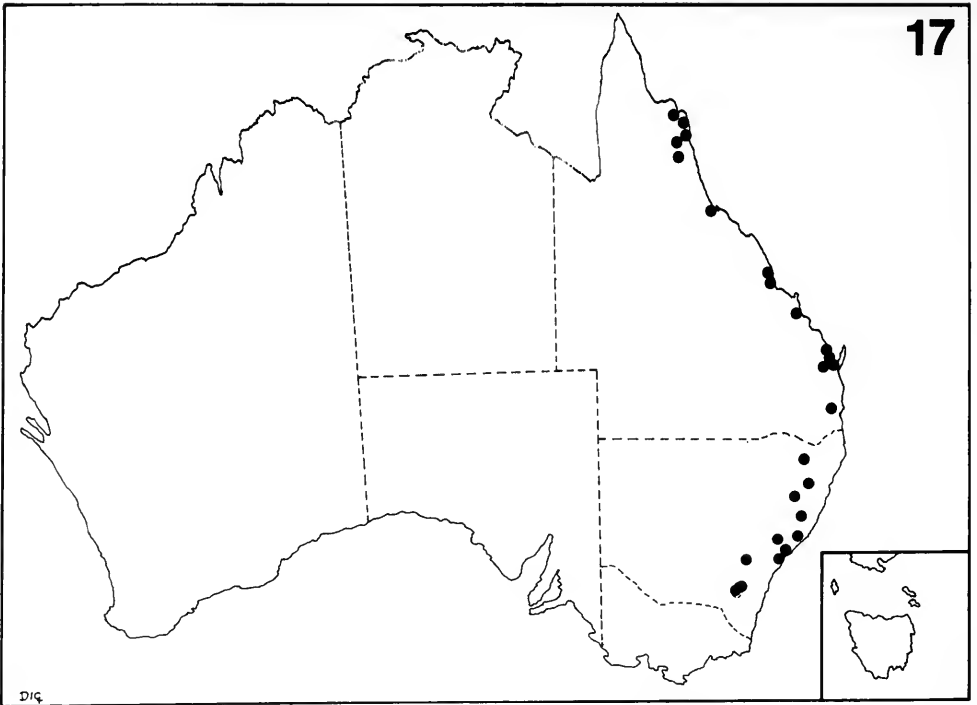

**Map 17** Distribution of *Theronia steindachneri*.

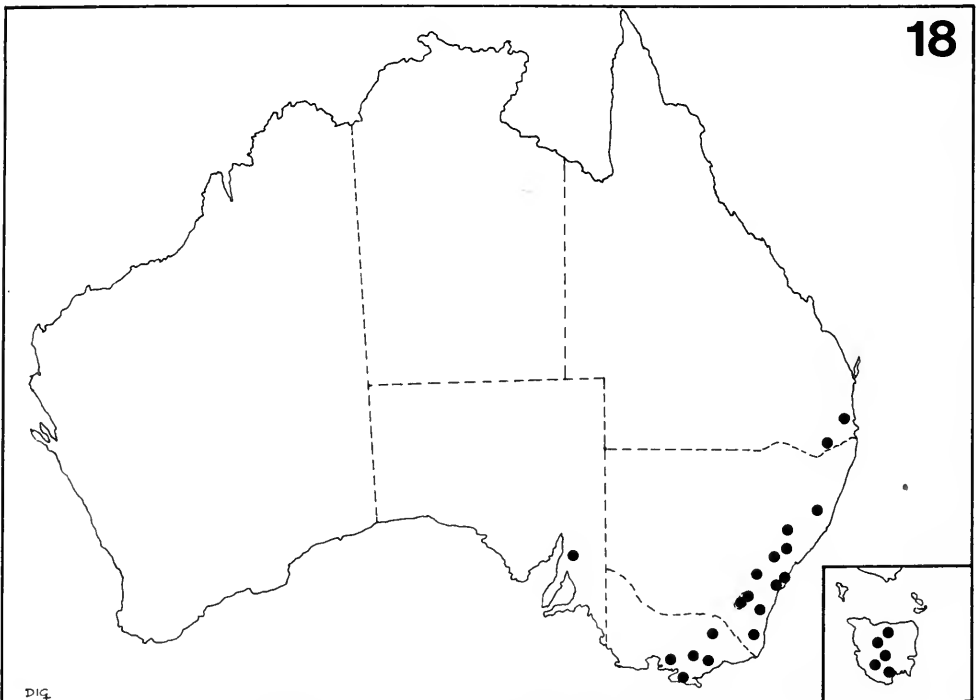

**Map 18** Distribution of *Theronia maculosa*.

enclosing a moderately small areolet; *2m-cu* joining areolet near centre; *Rs* slightly sinuate; *cu-a* opposite base of *Rs* & *M*. Gaster with tergite 1 about as long as posteriorly wide, without a carina joining spiracle to anterior margin of tergite. Tergite 3 with large shallow, rather sparse punctures. Ovipositor projecting beyond apex of gaster by 0.6–0.7 times length of hind tibia, slightly decurved.

Female yellow. Scape, most of flagellum, interocellar area and ovipositor sheath, black; mesoscutum, propodeum and tergites 3–5, 7 and 8 with brownish spots. Wings hyaline. Male like female except that tergites 7 and 8 are black-marked.

REMARKS. *X. ankh* belongs to the *ochracea*-group. It can be distinguished from *ochracea* (the only other Australian species in this group) by the shape of the area superomedia. The gaster is also far less strongly sculptured.

HOST RECORDS. None.

#### MATERIAL EXAMINED

Holotype ♀, **Australia**: Queensland, Bundaberg Ck, in mangroves, x.1977 (*Frauca*) (ANIC).

Paratypes. **Australia**: 1 ♀, 2 ♂, same data as holotype; 1 ♀, same locality, iii.1976 (*Frauca*) (ANIC).

### *Xanthopimpla arealis* Krieger

(Figs 29, 48, 50)

*Xanthopimpla gracilis* Krieger, 1899: 74. Holotype ♂, PAPUA NEW GUINEA (MNHU). [Synonymized by Townes & Chiu, 1970: 70.]

*Xanthopimpla arealis* Krieger, 1899: 93; Townes & Chiu, 1970: 70. Holotype ♀, AUSTRALIA (MNHU) [examined].

*Xanthopimpla beauforti* Cameron, 1907: 45. Lectotype ♂, IRIAN JAYA (BMNH), designated by Townes *et al.*, 1961: 51 [examined]. [Synonymized by Townes & Chiu, 1970: 70.]

*Xanthopimpla papuana* Cameron, 1907: 46. Holotype ♀, IRIAN JAYA (ZMA). [Synonymized by Townes *et al.*, 1961: 51.]

Clypeus flat; face finely punctate. Flagellum with 37–39 segments, the distal one slightly flattened, truncate. Lower anterior corner of pronotum obtusely rounded. Mesoscutum with notauli very strongly impressed but reaching only to about level of centre of tegulae; central part of mesoscutum sparsely hirsute. Scutellum moderately convex, carinate to posterior margin. Mesopleuron weakly swollen centrally, anteroventrally quite finely punctate, sternaulus impressed; metapleuron smooth, submetapleural carina complete. Posterior transverse carina of mesosternum strongly raised, with a deep V-shaped notch centrally. Propodeum long with posterior transverse carina complete, anterior one absent centrally, laterally strong and angled at junction with anterior part of lateromedian carinae; lateromedian longitudinal carinae vestigial between transverse carinae but area superomedia discernible, 1.1–1.2 times as long as broad; tubercle weak (Fig. 29). Mid coxa unspecialized; hind tibia with 4–7 preapical bristles, largest bristle on hind tarsal claw spatulate. Fore wing length 8–10 mm; *3r-m* present, enclosing a broad rhombic areolet; *2m-cu* joining areolet in centre; *Rs* strongly sinuous; *cu-a* opposite base of *Rs* & *M*. Gaster with tergite 1 1.3–1.5 times as long as posteriorly broad, without a carina extending from near spiracle to anterior end (Fig. 48). Tergite 3 closely and coarsely punctate. Ovipositor projecting beyond apex of gaster by 0.4–0.5 times length of hind tibia.

Female yellow with black marks on interocellar area, spots on lobes of mesoscutum and anterolateral areas of propodeum and tergites 3–5 of gaster (Fig. 50). Wings hyaline. Male similar but generally with black marks on all tergites of gaster except rarely the first.

VARIATION. There is a considerable range of variation in the spots on the gaster of the female. A pair of spots are present on at least tergites 3–5, sometimes 2–6. Tergite 7 generally has a black bar whilst tergite 1 may occasionally have one so that at its most extreme all but the last two tergites will be black-marked too.

REMARKS. This Australo-Papuan species was placed by Townes & Chiu (1970) in the *splendens*-group. Unlike other Australian representatives of this complex it has rather short notauli that reach only to about the level of the centre of the tegulae and has less pronounced scutellar carinae and a weaker sternaulus. *X. arealis* resembles *X. flavolineata* in being slender, having a large elongate area superomedia and a sinuous vein *Rs*. Whether or not *X. arealis* should be placed in the *citrina*-group in preference to the *splendens*-group is likely to be debated for some time.

HOST RECORDS. None.

MATERIAL EXAMINED

**Australia:** 1 ♀ (holotype of *arealis*), New South Wales (MNHU). **Irian Jaya:** 1 ♂ (lectotype of *beaufortii*), Etna Bay (BMNH).

**Australia:** 34 ♀, 17 ♂, Queensland, New South Wales (Map 9). **Papua New Guinea:** 2 ♀, 1 ♂. (ANIC; BMNH.) The single record for this species from Victoria (Townes & Chiu, 1970) is based on a correctly identified specimen but possibly it is erroneously labelled as recent collecting has not yielded specimens from south of about 35°.

*Xanthopimpla australis* Krieger

(Figs 41, 45)

*Xanthopimpla australis* Krieger, 1899: 102; Townes & Chiu, 1970: 215. Lectotype ♀, AUSTRALIA (MNHU), designated by Townes *et al.*, 1961: 51 [examined].

*Xanthopimpla similis* Krieger, 1899: 103. Holotype ♀, AUSTRALIA (MNHU). [Synonymized by Krieger, 1914: 133.]

Clypeus flat; face weakly but closely punctate. Flagellum with 37–39 segments, the apical one rounded distally. Lower anterior corner of pronotum rounded. Mesoscutum with notauli quite strongly impressed but short, not reaching to level of anterior edge of tegulae; central part of mesoscutum with fine sparse hairs. Scutellum moderately convex, carinate laterally to hind margin. Mesopleuron barely swollen centrally, antero-ventrally finely and sparsely punctate; metapleuron smooth, submetapleural carina strong. Posterior transverse carina of mesosternum broadened centrally into rounded lobes with a wide median notch (Fig. 45). Propodeum rather short, with posterior transverse carina entire and anterior transverse carina complete laterally; area superomedia laterally defined, short and strongly transverse, about 0.4 times as long as broad; tubercle vestigial. Mid coxa unspecialized; hind tibia with 6–8 subapical bristles, largest bristle on hind tarsal claw not explanate. Fore wing length 5–12 mm; *3r-m* present, enclosing a shortly petiolate, broadly rhombic areolet; *2m-cu* joining slightly distal to centre; *Rs* sinuous (Fig. 41); *cu-a* opposite base of *Rs&M*. Gaster with tergite 1 1.1 times as long as posteriorly broad, without a carina extending from spiracle to anterior margin; tergite 3 with strong, moderately dense punctation. Ovipositor projecting beyond apex of gaster by 1.2–1.3 times length of hind tibia, its apex slightly decurved, slightly flattened.

Female yellow, interocellar area, transverse band on mesoscutum, proximal 0.1 of hind tibia, central spot on tergite 1 and lateral spots on tergites 3 and 7, black. Wings hyaline. Male similar to female but with tergites 1 and 3–7 black-marked.

VARIATION. Some larger females have tergite 5 black-marked and rarely, very small specimens lack the black mark on tergite 1.

REMARKS. This species belongs to the *punctata*-group. In Australia *X. australis* is easily recognized by the long ovipositor and rather characteristic colour pattern (Fig. 51). Townes & Chiu (1970) recognize three subspecies of which only the nominate one occurs in Australia. The other two are Melanesian and though I do not consider these warrant distinction, I have avoided listing them as synonyms pending further study.

HOST RECORDS. Gelechiidae: *Pectinophora scutigera* (Holdaway) (DPIQ).

MATERIAL EXAMINED

**Australia:** 1 ♀ (lectotype of *australis*), Queensland, Cooktown (MNHU).

**Australia:** 44 ♀, 28 ♂, Northern Territory, Queensland, Western Australia (Map 10) (AM; ANIC; BMNH; TC).

*Xanthopimpla barak* sp. n.

(Figs 34, 44)

Clypeus flat; face finely, sparsely punctate. Flagellum with 35–36 segments, the apical one rounded terminally but flattened laterally. Lower anterior corner of pronotum rounded. Mesoscutum with notauli very strongly and deeply impressed, reaching behind level of hind margin of tegulae; mesoscutum centrally punctate, with dark sparse pubescence. Scutellum strongly convex, with lateral carinae reaching to hind margin. Mesopleuron moderately swollen centrally, anteroventrally finely but quite closely punctate;



sternaulus distinct; metapleuron smooth, submetapleural carina distinct. Posterior transverse carina of mesosternum centrally broadened into rounded lobes, with an indistinct median notch. Propodeum rather short, with anterior and posterior transverse carinae present, the lateromedian ones absent so area superomedia is confluent with areae lateralis; tubercle weak (Fig. 34). Mid coxa unspecialized; hind tibia with 5–7 preapical bristles (Fig. 44), largest bristle on hind tarsal claw spatulate. Fore wing length 6–7 mm; *3r-m* present, enclosing a shortly petiolate transverse areolet; *2m-cu* joining areolet distal to centre; *Rs* sinuous; *cu-a* opposite base of *Rs&M*. Gaster with tergite 1 about 1.1 times as long as broad posteriorly; spiracle not joined to anterior margin by carina; tergite 3 with close coarse punctures. Ovipositor projecting beyond apex of gaster by 6.0 times length of hind tibia, its apex slightly depressed and truncated so in dorsal view it is blunt.

Female yellow, only interocellar area and ovipositor sheath black; antenna infusate. Wings hyaline, distally infumate. Male similar to female.

REMARKS. *X. barak* belongs to the *splendens*-group. It can easily be separated from the other Australian species of this group by the characters given in the key but especially by the more spinose hind tibia.

HOST RECORDS. None.

#### MATERIAL EXAMINED

Holotype ♀, Australia: Queensland, 14 km W. by N. of Hope Vale Mission (15° 16'S, 144° 59'E), v.1981 (Naumann) (ANIC).

Paratype. 1 ♂, same data as holotype.

### *Xanthopimpla binodus* Townes & Chiu

(Fig. 23)

*Xanthopimpla binodus binodus* Townes & Chiu, 1970: 290. Holotype ♂, NEW CALEDONIA (BPBM).

Clypeus with a faint median dorsal swelling, otherwise flat; face strongly and closely punctate. Flagellum with about 35 segments, with distal one rounded apically. Lower anterior margin of pronotum fairly evenly rounded. Mesoscutum with notauli deep, reaching to about level of centres of tegulae, mesosternum centrally glabrous. Scutellum strongly convex, carinate laterally about 0.6 of its length. Mesopleuron centrally weakly swollen, anteroventrally finely punctate; sternaulus vestigial; metapleuron smooth; submetapleural carina absent (Fig. 23). Posterior transverse carina of mesosternum weakly raised with a broad median U-shaped notch. Propodeum moderately long, only posterior transverse carina distinguishable dorsally and this is obsolescent centrally; tubercle weak but clearly raised, punctate. Mid coxa unspecialized; hind tibia with 6–8 preapical bristles, largest bristle on hind tarsal claw not spatulate. Fore wing length 5–8 mm; *3r-m* absent; *Rs* fairly evenly arcuate; *cu-a* opposite base of *Rs&M*. Gaster with tergite 1 1.1–1.2 times as long as posteriorly broad, without a carina joining spiracle to anterior margin of tergite. Tergite 3 with close coarse punctures. Ovipositor projecting beyond apex of gaster by about 0.3 times length of hind tibia, its apex subcylindrical.

Female yellow, only interocellar area, mesoscutum centrally, scutoscuteellar groove, paired spots on tergite 1 and proximal end of hind tibia, blackish; tergite 4 with pale brownish spots. Wings slightly infumate distally. Male similar to female but with black marks on at least tergites 3–6, often all tergites of gaster.

REMARKS. This species belongs to the *rhopaloceros*-group. It is the only Australian species with *3r-m* absent that has a coarsely punctate third tergite and lacks the submetapleural carina. In Australia this species exhibits striking sexual dichromatism, the gaster of the female having black or brownish markings only on tergites 1 and 4 (or also on tergites 3 and 7 in New Caledonian specimens), and on at least tergite 3–6 in the male. Townes & Chiu's (1970) recognition of two subspecies based on colour differences of the gaster is thus highly questionable as they overlooked sexual colour difference and have seen only one sex of the 'subspecies' from the Loyalty Is.

HOST RECORDS. None.

#### MATERIAL EXAMINED

New Caledonia: 1 ♀, 1 ♂ (paratypes), Pueblo Coast, ix–x.1949 (Cheesman) (BMNH).

Australia: 1 ♀, Queensland, Biggenden, Bluff Range, vii.1971 (Frauca) (ANIC); 1 ♂, Cunningham Pass, iii (TC); 1 ♂, Toowoomba, iii (TC).

*Xanthopimpla ecaudata* Krieger

(Figs 38, 43)

*Xanthopimpla hispida* Krieger, 1899: 70. Holotype ♀, 'W. MALAYSIA' (MNHU). [Synonymized by Townes & Chiu, 1970: 93.]

*Xanthopimpla ecaudata* Krieger, 1899: 71; Townes & Chiu, 1970: 93. Lectotype ♀, MOLUCCAS (MNHU), designated by Townes *et al.*, 1961: 54 [examined].

*Xanthopimpla minor* Krieger, 1899: 73. Holotype ♂, PAPUA NEW GUINEA (MNHU). [Synonymized by Townes & Chiu, 1970: 93.]

Clypeus rather flat; face quite coarsely punctate. Flagellum with 44–45 segments, the distal one flattened, terminally rounded. Lower anterior corner of pronotum obtusely rounded. Mesoscutum with notauli very strongly impressed, reaching almost to hind margin, central part of mesoscutum with sparse dark pubescence. Scutellum very strongly convex, almost pyramidal, laterally carinate to hind margin. Mesopleuron weakly swollen centrally, anteroventrally coarsely and closely punctate, sternaulus moderately impressed; metapleuron smooth, punctate posteriorly, submetapleural carina complete. Posterior transverse carina of mesosternum strongly raised, with a very narrow, V-shaped median notch. Propodeum moderately long, with posterior transverse carina complete, anterior one strong, absent centrally; lateromedian longitudinal carinae usually not present or weak between transverse carinae, rarely distinct in larger females; area superomedia elongate; tubercle weak (Fig. 38). Mid coxa unspecialized; hind tibia with 0–3 preapical bristles (Fig. 43), largest bristle on hind tarsal claw spatulate. Fore wing length 6–7 mm; *3r-m* present, enclosing a rhombic areolet; *2m-cu* joining areolet slightly distal to centre; *Rs* sinuate; *cu-a* opposite base of *Rs* & *M*. Gaster with tergite 1 1.1 times as long as broad posteriorly, with a strong carina extending from near spiracle to anterior end of segment. Tergite 3 closely punctate. Ovipositor barely projecting beyond apex of gaster.

Female yellow, only interocellar area and antenna black in Australian specimens. Wings strongly infumate.

**VARIATION.** The few Australian specimens examined are quite alike in having dark wings, but elsewhere this species does not have such strong alar infumation.

**REMARKS.** A widespread Melanesian-tropical Australian species occurring as far west as the Moluccas and east to the Solomons. *X. ecaudata* belongs to the *splendens*-group of Townes & Chiu (1970). It is a group easily recognized by the very long, deep notauli. In Australia *X. ecaudata* is easily recognized by its very short ovipositor.

**HOST RECORDS.** None.

**MATERIAL EXAMINED**

**Indonesia:** 1 ♀ (lectotype of *ecaudata*), Moluccas, Kai (MNHU).

**Australia:** 12 ♀, 4 ♂, Queensland. **Indonesia:** 9 ♀, 7 ♂, Moluccas; Irian Jaya. **Papua New Guinea:** 2 ♀, 4 ♂. **Solomon Is:** 4 ♀ (Map 11).

*Xanthopimpla flavolineata* Cameron

(Figs 39, 49)

*Xanthopimpla flavolineata* Cameron, 1907: 48; Townes & Chiu, 1970: 114. Holotype ♀, IRIAN JAYA (ZMA) [examined.]

*Xanthopimpla emaculata* Szépligeti, 1908: 256. Holotype ♀, JAVA (TM). [Synonymized by Townes & Chiu, 1970: 115.]

*Xanthopimpla immaculata* Morley, 1913b: 115. Holotype ♀, INDIA (depository unknown, ?New Delhi) [paratype ♀ examined.] [Synonymized by Cushman, 1925: 46.]

*Xanthopimpla hyaloptila* Krieger, 1914: 35. Holotype ♂, AUSTRALIA (MNHU). [Synonymized by Townes & Chiu, 1970: 115.]

*Xanthopimpla xanthostigma* Girault, 1925: 38. Holotype ♀, AUSTRALIA (QM) [examined]. [Synonymized by Townes & Chiu, 1970: 115.]

*Xanthopimpla xara* Cheesman, 1936: 179. Holotype ♀, NEW HEBRIDES (BMNH) [examined]. [Synonymized by Townes & Chiu, 1970: 115.]

*Metopius sesamiae* Rao, 1953: 184. Holotype ♂, INDIA (Dehra Dun). [Synonymized by Townes & Chiu, 1970: 115.]

Clypeus slightly convex near upper margin; face fairly evenly punctate. Flagellum with 36–40 segments, the distal one flattened and terminally rounded. Lower anterior corner of pronotum rounded off about 90°. Mesoscutum with notauli weak, barely reaching to level of anterior margin of tegulae; central part of mesoscutum virtually glabrous. Scutellum moderately convex; carinate to posterior margin. Mesopleuron weakly convex centrally, anteroventrally finely and closely punctate, sternaulus indistinct; metapleuron smooth, submetapleural carina complete. Posterior transverse carinae of mesosternum moderately strongly raised, with a median notch. Propodeum long, posterior transverse carina complete, anterior one present laterally, lateromedian carinae complete, defining a large elongate area superomedia that is 1.1–1.2 times as long as broad; tubercle vestigial. Mid coxa unspecialized; hind tibia with 5–6 preapical bristles, largest bristle on hind tarsal claw spatulate. Fore wing length 4–8 mm; *3r-m* present, enclosing a rhombic petiolate areolet; *2m-cu* joining areolet near centre; *Rs* strongly sinuous (Fig. 39); *cu-a* opposite base of *Rs* & *M*. Gaster with tergite 1 1.3–1.5 times as long as broad posteriorly, with a carina extending from near spiracle to anterior end (Fig. 49). Tergite 3 moderately sparsely punctate. Ovipositor projecting beyond apex of gaster by about 0.5 times length of hind tibia.

Female yellow, interocellar area and ovipositor sheath black. Wings hyaline. Male similar to female.

**REMARKS.** *X. flavolineata* is a widespread Indo–Australian species that frequents open areas of coarse grassland and cereal crops. It is placed by Townes & Chiu in the *citrina*-group, a mainly Afrotropical complex. In Australia *X. flavolineata* may be recognized by its slender appearance, large elongate area superomedia and sinuous *Rs*. It is rather similar to *X. arealis* from which it may be distinguished by characters given in the key.

**HOST RECORDS.** In Asia this species is a common parasite of pyralids and noctuids that bore in rice, maize and sugar-cane (Townes & Chiu, 1970), though it has not been reared in Australia.

#### MATERIAL EXAMINED

**Indonesia:** 1 ♀ (holotype of *flavolineata*), Irian Jaya, Merauke (ZMA). **India:** 1 ♀ (paratype of *immaculata*), Bengal, Chapra (*Mackenzie*) (BMNH). **Australia:** 1 ♀ (holotype of *xanthostigma*), Queensland, Amamoor Forest (QM). **New Hebrides:** 1 ♀ (holotype of *xara*), Malekula (*Cheesman*) (BMNH).

**Australia:** 33 ♀, 14 ♂, New South Wales; Northern Territory; Queensland (Map 13) (AM; ANIC; BMNH; TC).

### *Xanthopimpla fraterculus* Townes & Chiu

(Figs 19, 24)

*Xanthopimpla fraterculus* Townes & Chiu, 1970: 33. Holotype ♂, AUSTRALIA (TC) [examined].

Clypeus slightly convex near upper end; face strongly punctate. Flagellum with 37–41 segments, the distal one slightly flattened, apically rounded. Lower anterior corner of pronotum evenly rounded. Mesoscutum with notauli deep but short, barely reaching to level of anterior margin of tegulae; central part of mesoscutum sparsely hirsute. Scutellum pyramidal, carinate laterally to hind margin. Mesopleuron strongly swollen just above centre, anteroventrally coarsely punctate; sternaulus vestigial (Fig. 19); metapleuron smooth, submetapleural carina strong. Posterior transverse carina of mesosternum strongly raised, centrally with a broad V-shaped notch. Propodeum rather short with carinae strong, defining a short transverse area superomedia that is about 2.7 times as broad as long; propodeum unusual in having a strong swelling in front of spiracle; tubercle vestigial (Fig. 24). Mid coxa unspecialized; hind tibia without preapical bristles; largest bristle on hind tarsal claws spatulate. Fore wing length 9–11 mm; *3r-m* enclosing a fairly large rhombic areolet, *2m-cu* joining it about in centre; *Rs* sinuate; *cu-a* opposite *Rs* & *M*. Gaster with tergite 1 1.1–1.2 times as long as broad posteriorly, usually with a carina extending forwards from near anterior margin of spiracle. Tergite 3 sparsely but coarsely punctate. Ovipositor projecting beyond apex of gaster by about 0.7–0.9 times length of hind tibia, noticeably decurved.

Female yellow, upper part of scape, interocellar area, vertex, mesoscutum in 3 stripes and a transverse posterior bar and ovipositor sheath, black. Wings slightly infumate, apices more darkly so. Male similar to female though with at least tergite 3 bearing indistinct blackish spots.

**VARIATION.** This is one of the most variable species in the extent of black marking. Some females have paired black spots on tergites 2–4 and spots on the hind femora whilst a few have spots on tergites 2–6 and black bars on tergites 7 & 8 and paired spots on the hind femora. One specimen even has indistinct spots on tergite 1.

**REMARKS.** *X. fraterculus* belongs to the *regina*-group (Townes & Chiu, 1970) and is one of the

easiest Australian species to recognize on account of its pyramidal scutellum and the swelling on the propodeum in front of the spiracle. The only other species with a relatively long ovipositor and strongly transverse area superomedia with which it could be confused is *X. australis*, which has a quite different colour pattern with a single transverse black stripe in the centre of the mesoscutum rather than the four marks characteristic of *X. fraterculus*.

HOST RECORDS. None.

MATERIAL EXAMINED

**Australia:** 1 ♂ (holotype), Western Australia, Fitzroy R. crossing, v.1969 (*Alexander & Otte*) (TC); 1 ♀ (paratype), Northern Territory, Brock's Creek, iv.1931 (*Campbell*) (ANIC); 1 ♂ (paratype), Queensland, Brisbane, xi.1918 (*Hacker*) (QM).

**Australia:** 13 ♀, 3 ♂, Northern Territory, Queensland, Western Australia.

*Xanthopimpla hiatus* Townes & Chiu

(Figs 27, 40)

*Xanthopimpla hiatus* Townes & Chiu, 1970: 256. Holotype ♀, AUSTRALIA (QM) [examined].

Clypeus fairly flat; face strongly punctate. Flagellum with 38–39 flagellar segments, the distal one slightly flattened and slightly truncated. Lower anterior corner of pronotum sharply angled about 90°. Mesoscutum with notauli deeply impressed, reaching to level of hind margins of tegulae; central part of mesoscutum fairly evenly hirsute. Scutellum quite strongly convex, carinate laterally for its entire length. Mesopleuron weakly swollen centrally, anteroventrally finely and closely punctate, sternaulus vestigial; metapleuron smooth, submetapleural carina complete. Posterior transverse carina of mesosternum strongly raised, centrally with a deep V-shaped notch. Propodeum of moderate length, anterior transverse carinae present laterally, curved forward lateromedially to join anterior part of lateromedian longitudinal carinae, centrally absent; posterior transverse carina complete, median portion of lateromedian longitudinal carina vestigial, indicating a transverse area superomedia that is about 1.6 times as broad as long; tubercle present at lateral end of anterior transverse carina above and slightly behind propodeal spiracle (Fig. 27). Mid coxa unspecialized; hind tibia with 2–4 preapical bristles; largest bristle of hind tarsal claws spatulate. Fore wing length 10–12 mm; *3r-m* present, enclosing a small obliquely trapezoidal petiolate areolet; *2m-cu* joining areolet near outer corner (Fig. 40); *Rs* moderately arcuate; *cu-a* virtually opposite *Rs&M*. Gaster with tergite 1 1.1–1.2 times as long as posteriorly broad, without a distinct carina joining spiracle to anterior margin of segment. Tergite 3 with close coarse punctures centrally. Ovipositor projecting beyond apex of gaster by 0.9–1.0 times length of hind tibia, slightly decurved with its dorsal apex flattened weakly.

Female yellow, black-marked on interocellar area, mesoscutum in 3 almost contiguous spots, posterior part of tegula and ovipositor sheath. Wings hyaline with infumate distal apex. Male unknown.

REMARKS. *X. hiatus* belongs to the *elegans*-group as defined by Townes & Chiu (1970). It is the only Australian representative of this group which is easily recognizable by the sharply angled pronotal corner. *X. hiatus* is also distinctive in having *2m-cu* joining the areolet very close to the outer corner.

HOST RECORDS. None.

MATERIAL EXAMINED

**Australia:** 1 ♀ (holotype), New South Wales, Tootoom, i.1926 (*Hacker*) (QM); 1 ♀ (paratype), Queensland, Cairns (BMNH); 1 ♀ (paratype), Mackay, v.1909 (*Turner*) (BMNH); 1 ♀ (paratype), Mt Glorious, ii.1961 (*Gressitt & Gressitt*) (TC).

**Australia:** 6 ♀, New South Wales, Queensland.

*Xanthopimpla hirsuta* (Girault)

(Figs 21, 33)

*Austrapophua hirsuta* Girault, 1930: 2. Holotype ♀, AUSTRALIA (QM) [examined].

*Xanthopimpla hirsuta* (Girault) Townes *et al.*, 1961: 56; Townes & Chiu, 1970: 272.

Clypeus flat, more strongly transverse than is usual for the genus; face closely punctate. Flagellum incomplete. Lower anterior corner of pronotum about 95°, slightly rounded. Mesoscutum with notauli strongly impressed, reaching about to level of centre of tegulae; central part of mesoscutum sparsely

hirsute. Scutellum pyramidal with carina extending almost to posterior margin. Mesopleuron moderately weakly swollen centrally, anteroventrally closely and quite coarsely punctate, sternaulus absent; metapleuron smooth, unusual in not being defined anterodorsally as pleural carina extends only to level of spiracle; submetapleural carina strong (Fig. 21). Posterior transverse carina of mesosternum weak, only slightly broadened centrally. Propodeum moderately long, anterior transverse carina complete laterally, posterior transverse carina complete, strong, lateromedian carinae defining an area superomedia which is much narrower posteriorly than centrally, the entire area being as long as centrally broad; tubercle weak (Fig. 33). Mid coxa unspecialized; hind tibia with about 4 preapical bristles; largest bristle on hind tarsal claw slender, not spatulate. Fore wing length 11 mm; *3r-m* absent; *Rs* simply arcuate; *cu-a* slightly proximal to base of *Rs&M*. Gaster with tergite 1 1.2 times as long as posteriorly broad, with carina extending from near spiracle to anterior end. Tergite 3 with coarse contiguous punctures centrally. Ovipositor projecting beyond apex of gaster by 0.1 times length of hind tibia, the ovipositor apex slightly decurved, the lower valve with a distinct median ventral keel, not enclosed by upper valve.

Female yellow, black-marked on interocellar area, back of head, mesoscutum in three stripes and on scuto-scutellar groove, paired spots on tergites 1, 3-5 and transverse black band on tergite 7. Wings hyaline, distally infumate. Male unknown.

**REMARKS.** A very distinctive species on account of the complete area superomedia and incomplete areolet. Townes & Chiu (1970) placed *X. hirsuta* in the *incompleta*-group, but the ovipositor is not very like that of the other species as the lower valve is not enclosed by the upper valve. I believe it should be placed in the *rhopaloceros*-group.

**HOST RECORDS.** None.

**MATERIAL EXAMINED**

**Australia:** 1 ♀ (holotype), Queensland, Herbert River, Macknade? v.1912 (QM).

***Xanthopimpla ochracea* (Smith)**

(Fig. 37)

*Pimpla ochracea* Smith, 1859: 172. Holotype ♀, MOLUCCAS (UM) [examined].

*Pimpla caudata* Smith, 1863: 10. Holotype ♀, MISOOL (UM) [examined]. [Synonymized by Townes & Chiu, 1970: 126.]

*Xanthopimpla* (?) *caudata* (Smith) Krieger, 1899: 65.

*Xanthopimpla* (?) *ochracea* (Smith) Krieger, 1899: 65.

*Xanthopimpla crassa* Krieger, 1899: 97. Lectotype ♀, PAPUA NEW GUINEA (MNHU), designated by Townes *et al.*, 1961: 53. [Synonymized by Townes & Chiu, 1970: 126.]

*Xanthopimpla ochracea ochracea* (Smith); Townes & Chiu, 1970: 126.

*Xanthopimpla ochracea petersenii* Townes & Chiu, 1970: 125. Holotype ♀, NEW IRELAND (UZM). **Syn. n.**

Clypeus weakly convex; face quite coarsely punctate. Flagellum with 35-38 segments, the distal one flattened, rounded off. Lower anterior corner of pronotum fairly abruptly rounded. Mesoscutum with notauli short, deep, reaching nearly to level of centre of tegulae; central part of mesoscutum sparsely hirsute. Scutellum moderately strongly convex, carinate laterally to apex. Mesopleuron weakly swollen centrally, anteroventrally quite coarsely punctate, sternaulus weak, discernible; metapleuron smooth or with some striation, submetapleural carina distinct. Posterior transverse carina of mesosternum very abruptly raised near centre, produced into two acute lobes separated by a narrow V-shaped cleft, these lobes usually strengthened by a thicker outgrowth from the sternum. Propodeum short, anterior and posterior transverse carinae strong; lateromedian carinae present between transverse carinae, enclosing a transverse area superomedia that is 1.8-1.9 times as broad as long; tubercle vestigial (Fig. 37). Mid coxa unspecialized; hind tibia with 6-8 preapical bristles; largest bristle on hind tarsal claw spatulate. Fore wing length 6-9 mm; *3r-m* present, enclosing a moderately small, slightly oblique areolet; *2m-cu* joining areolet near centre; *Rs* very slightly sinuate; *cu-a* opposite base of *Rs&M*. Gaster with tergite 1 about as long as posteriorly broad, slightly more slender in males; petiolar spiracle without a carina extending from near it to anterior margin of segment. Tergite 3 moderately densely punctate. Ovipositor projecting beyond apex of gaster by 0.8 times length of hind tibia.

Female yellow, black-marked at least on interocellar area and ovipositor sheath. Wings weakly infumate. Male similar to female but with a pair of lateral spots on propodeum and spots on tergites 3-7 black.

**VARIATION.** Many females are as extensively black marked as the males. Some individuals of

both sexes have black marks on the mesoscutum and on tergite 1 a pair of faint brownish spots. Occasionally males have only the interocellar area black.

REMARKS. This species belongs to the *ochracea*-group of Townes & Chiu (1970) and is distinguished by the strongly raised posterior transverse carina of the mesosternum. Townes & Chiu (1970) recognized seven subspecies. Several of these would seem to warrant specific status and in the present work I have restricted *ochracea* to the *ochracea ochracea* and *ochracea peterseni* of Townes & Chiu.

HOST RECORDS. None.

MATERIAL EXAMINED

**Indonesia:** 1 ♀ (holotype of *ochracea*), Moluccas, Aru (UM); 1 ♀ (holotype of *caudata*), Misool (UM). **Australia:** 2 ♀ (paratypes of *ochracea peterseni*), Queensland, N. Stradbroke Is. (QM).

**Australia:** 15 ♀, 10 ♂, Northern Territory, Queensland (Map 12). **Indonesia:** 3 ♀, 2 ♂, Irian Jaya, Misool. **Papua New Guinea:** 2 ♀, 3 ♂. (BMNH; TC)

*Xanthopimpla pubidorsis* Townes & Chiu

(Fig. 25)

*Xanthopimpla pubidorsis* Townes & Chiu, 1970: 86. Holotype ♀, IRIAN JAYA (RHN) [examined].

Clypeus flat; face finely punctate. Flagellum with 36–37 segments, the distal segment only slightly flattened, terminally rounded abruptly. Lower anterior margin of pronotum obtusely rounded. Mesoscutum with notauli deeply impressed, reaching to level of hind margin of tegulae; median lobe of mesoscutum with fine pale pubescence. Scutellum convex, carinate laterally to entire length. Mesopleuron weakly swollen centrally, anteroventrally finely and very sparsely punctate; sternaulus distinct, posteriorly fairly shallow; metapleuron smooth, submetapleural carina distinct. Posterior transverse carina of mesosternum very broad, with a small median notch. Propodeum moderately long, anterior and posterior transverse carinae complete, lateromedian carinae delimiting a large area superomedia that is slightly longer than broad; tubercle moderately weak (Fig. 25). Mid coxa unspecialized; hind tibia with 0–1 preapical bristles; largest bristle on hind tarsal claw spatulate. Fore wing length 7–8 mm; *3r-m* present enclosing a rather broad rhombic areolet; *2m-cu* joining very slightly distal to centre; *Rs* slightly arcuate; *cu-a* opposite base of *Rs&M*. Gaster with tergite 1 elongate, 1.2 times as long as broad posteriorly, without carina extending from near spiracle to anterior end. Tergite 3 with very superficial punctures. Ovipositor projecting beyond apex of gaster by about 0.5 times length of hind tibia.

Female yellow, only scape partially, interocellar area and ovipositor sheath blackish. Wings hyaline, apices slightly infumate. Male similar to female.

REMARKS. *X. pubidorsis* belongs to the *splendens*-group and may be recognized by the combination of strong notauli, deep sternaulus, complete scutellar carinae, smooth metapleuron and finely punctate mesopleuron. Unlike *X. barak* this species always has the area superomedia delineated laterally.

HOST RECORDS. None.

MATERIAL EXAMINED

**Irian Jaya:** 1 ♀ (holotype), Sigi Camp, 1350 m, ii.1939 (*Toxopeus*) (RNH).

**Australia:** Queensland, 1 ♂, Capsize Ck, 64 km N. of Archer Xing, Cape York, vi.1975 (*Monteith*) (ANIC); 1 ♀, 1 ♂, Claudie R., v.1966 (*McAlpine*) (AM); 1 ♀, Claudie R., 2 km W. of Mt Lomond, xii.1971 (*McAlpine & Holloway*) (AM); 1 ♂, Gap Ck, 15°50'S, 145°20'E, v.1981 (*Naumann*) (ANIC); 1 ♀, Peach Ck. Xing, 25 km NNE. Coen, vii.1976 (*Monteith & Monteith*) (ANIC).

*Xanthopimpla quadridens* Townes & Chiu

(Figs 22, 35, 42)

*Xanthopimpla quadridens* Townes & Chiu, 1970: 278. Holotype ♂, AUSTRALIA (NMV) [examined].

Clypeus flat; face strongly punctate. Flagellum with 36–38 segments, the distal segment evenly rounded apically. Lower anterior corner of pronotum very obtusely angled. Mesoscutum with notauli deeply impressed, reaching almost to level of hind edges of tegulae; central part of mesoscutum with few sparse

hairs. Scutellum weakly convex, carinate laterally for its entire length. Mesopleuron weakly swollen centrally, anteroventrally quite closely and coarsely punctate; sternaulus vestigial; metapleuron obsoletely punctate, submetapleural carina distinct, discernible as a wide flat ridge (Fig. 22). Posterior transverse carina of mesosternum weakly raised, centrally with a broad U-shaped notch. Propodeum short; anterior transverse and lateromedian longitudinal carinae absent, posterior transverse carina distinct, centrally interrupted, laterally raised into flanges; lateral tubercle present above and slightly behind propodeal spiracle, the tubercle with conspicuous fine setiferous punctures (Fig. 35). Mid coxa unspecialized; hind tibia with 5–8 preapical bristles; largest bristle of hind tarsal claws slender. Fore wing length 11–12 mm; *3r-m* absent (Fig. 42); *Rs* almost straight; *cu-a* opposite base of *Rs* & *M*. Gaster with tergite 1 1.4–1.5 times as long as broad posteriorly, without distinct carina joining spiracle to anterior margin of segment. Tergite 3 with coarse close punctures centrally. Ovipositor projecting beyond apex of gaster by 1.0–1.1 times length of hind tibia, slightly decurved, its tip cylindrical.

Female yellow, black-marked on interocellar area, frons and occiput continuously, posterior part of tegula, mesopleuron in a stripe below subalar prominence, three adjacent spots on mesoscutum, scutellar groove, anterior of propodeum except centrally, hind coxa with a spot, distal apices of femur and tibia, proximal apex of tibia, hind tarsal segment 5, gaster with central transverse bar on tergite 1, bars on tergite 1, bars on tergites 3, 4, 6–8; tergites 5 and 9 with lateral black spots. Wings hyaline. Male similar to female.

**VARIATION.** Some specimens may have minute black spots laterally on tergite 2 and the spots of tergite 5 centrally confluent to form a dumb-bell-like mark. A few males are less extensively black and only have lateral black spots on tergites 3–6.

**REMARKS.** This species is the largest one without an areolet. It is easily recognized by the conspicuous propodeal tubercles, long ovipositor and complete submetapleural carina. *X. quadridens* belongs to the *rhopaloceros*-group as defined by Townes & Chiu (1970).

**HOST RECORDS.** None.

#### MATERIAL EXAMINED

**Australia:** 1 ♂ (holotype), Victoria, Warburton, i.1955 (*Neboiss*) (NMV).

**Australia:** 1 ♀, New South Wales, Mt Keira, xii.1981 (*Holloway*) (AM); 5 ♀, 1 ♂, Queensland, Mt Glorious, x–xi. (TC); 1 ♂, Mt Tambourine, x. (TC); 1 ♀, Victoria, Burnley (*Prescott*) (NMV); 1 ♀, Kallista, iii. 1952 (*Burns*) (NMV).

### *Xanthopimpla rhopaloceros* Krieger

(Figs 28, 52)

*Xanthopimpla rhopaloceros* Krieger, 1914: 23; Townes & Chiu, 1970: 285. Lectotype ♂, AUSTRALIA (MNHU), designated by Townes *et al.*, 1961: 66 [examined].

*Austrapophua xanthopimploides* Girault, 1926: 135. Holotype ♀, AUSTRALIA (QM) [examined]. [Synonymized by Townes & Chiu, 1970: 285.]

*Xanthopimpla xanthopimploides* (Girault) Townes *et al.*, 1961: 72.

Clypeus flat; face strongly closely punctate. Flagellum with 33–34 segments, the terminal segment evenly rounded apically. Lower anterior corner of pronotum evenly rounded. Mesoscutum with notauli deep, extending only to level of centre of tegulae; central lobe of mesoscutum sparsely hirsute. Scutellum weakly convex, carinate almost to hind margin. Mesopleuron centrally very weakly swollen, anteroventrally sparsely punctate; sternaulus vestigial; metapleuron smooth, submetapleural carina absent. Posterior transverse carina of mesosternum moderately broadened, with a wide V-shaped central notch. Propodeum moderately long; anterior and lateromedian carinae absent; posterior transverse carina complete; tubercle quite strong (Fig. 28). Mid coxa with a blunt prominence on anterolateral side; hind tibia with 9–15 preapical bristles; largest bristle on hind tarsal claw not spatulate. Fore wing length 4–11 mm; *3r-m* absent; *Rs* almost straight; *cu-a* opposite base of *Rs* & *M*. Gaster with tergite 1 1.2 times as long as posteriorly broad, without a carina joining spiracle to anterior margin of tergite. Tergite 3 with coarse close punctures. Ovipositor projecting beyond apex of gaster by about 0.4 times length of hind tibia, its apex subcylindrical.

Female yellow, black marks on interocellar area, occiput, mesoscutum in three stripes, scutoscutellar groove, on anterior transverse band on propodeum, a central band on tergites 1, 3 and 7, paired spots on tergites 2, 4 and 6, hind tibia proximally and distally and hind basitarsus proximally. Wings hyaline. Male similar to female but with mesoscutal stripes usually fused to form a single black area.

VARIATION. Some specimens have faint black dots on tergite 5 whilst others have no black mark on tergite 2. Not infrequently tergites 6 and 7 are almost entirely black.

REMARKS. This species belongs to the *rhopaloceros*-group of Townes & Chiu (1970). *X. rhopaloceros* is easily recognized by the characteristic shape of the mid coxa, the lack of an areolet, and the colour pattern. It differs from the related *X. summervillei* most obviously in having a strong black band on tergite 1 (Fig. 52) and in having the occiput black. *X. summervillei* never has a black occiput and at the most only a vague brownish central mark on tergite 1.

HOST RECORDS. Nolidae: *Uraba lugens* Walker (DPIQ). Tortricidae: *Epiphyas postvittana* (Walker) (Dumbleton, 1940); *Merophyas divulsana* (Walker) (DPIQ).

#### MATERIAL EXAMINED

**Australia:** 1 ♂ (lectotype of *rhopaloceros*), South Australia, Adelaide (MNHU); 1 ♀ (holotype of *xanthopimploides*), Queensland, Riverview (QM).

**Australia:** 74 ♀, 31 ♂, Australian Capital Territory, New South Wales, Queensland, South Australia, Tasmania, Victoria, Western Australia (Map 14) (AM; ANIC; BMNH; DAH; QM; TC).

### *Xanthopimpla striata* Townes & Chiu

(Fig. 26)

*Xanthopimpla striata* Townes & Chiu, 1970: 91. Holotype ♀, AUSTRALIA (BPBM) [examined].

Clypeus swollen centrally near upper margin; face coarsely but sparsely punctate. Flagellum with 41 segments. Lower anterior corner of pronotum fairly evenly rounded but with lower corner of epomia right-angled and projecting, appearing superficially like the corner of pronotum. Mesoscutum with notauli very strongly impressed almost to hind margin; central part of mesoscutum with sparse dark pubescence. Scutellum very strongly convex, carinate laterally about 0.8 of its length. Mesopleuron weakly swollen centrally, anteroventrally coarsely and closely punctate; sternaulus deeply impressed; metapleuron anteroventrally striate, posteriorly punctate, submetapleural carina complete. Posterior transverse carina of mesosternum moderately broad, with a deep median V-shaped notch. Propodeum of moderate length, with posterior and anterior transverse carinae strong, the latter absent centrally; lateromedian longitudinal carinae indistinct but area superomedia discernible transverse; lateral tubercle indistinct (Fig. 26). Mid coxa unspecialized; hind tibia with 6–9 preapical bristles, fewer in male; largest bristle on hind tarsal claw spatulate. Fore wing length 7–8 mm; *3r-m* present, enclosing a moderately large rhombic areolet; *2m-cu* joining areolet at centre; *Rs* arcuate; *cu-a* virtually opposite base of *Rs* & *M*. Gaster with tergite 1 1.3 times as long as broad posteriorly, with a strong carina extending from near spiracle to anterior end of segment. Tergite 3 with fine, close, rather elongate punctures. Ovipositor projecting beyond apex of gaster by 0.3–0.4 times length of hind tibia, its apex subcylindrical.

Female yellow, black-marked on interocellar area, vertex, mesoscutum centrally and indistinctly laterally, and gaster with spots laterally on tergites 1–3 and 7 centrally. Apex of wings infumate. Male similar to female but with only interocellar area, mesoscutum centrally, propodeum centrally, paired spots of tergites 2–6 and remaining tergites transversely banded black.

VARIATION. Some females have paired black spots present on tergites 4 and 5 and have some black on the propodeum anteromedially, like the male.

REMARKS. *X. striata* belongs to the *splendens*-group as defined by Townes & Chiu (1970). Superficially this species may be mistaken for members of the *elegans*-group on account of the apparently sharply angulate anterior corner of the pronotum. However, this angulation is the lower corner of the epomia and not the pronotal margin which underlies this projection and is evenly rounded. In species of the *elegans*-group it is the actual pronotal margin that is sharply angled. Unlike *X. hiatus*, the only Australian member of the *elegans*-group, *X. striata* has a striate metapleuron, regularly rhombic areolet with *2m-cu* joining in centre, a rather short ovipositor and strongly impressed sternaulus.

HOST RECORDS. None.

#### MATERIAL EXAMINED

**Australia:** 1 ♀ (holotype), Queensland, Cairns (*Kusche*) (BPBM).



**Australia:** 1 ♂, Queensland, Ellis Beach, N. of Cairns, iv.1967 (*Colless*) (ANIC). **Papua New Guinea:** 2 ♀, Dumpu, 250 m, i–ii.1979 (*Sedlacek*) (TC).

*Xanthopimpla summervillei* (Girault)

(Figs 30, 53)

*Austrapophua summervillei* Girault, 1926: 136. Holotype ♀, AUSTRALIA (QM) [examined].

*Xanthopimpla summervillei* (Girault) Townes *et al.*, 1961: 70.

*Xanthopimpla summervillei summervillei* (Girault) Townes & Chiu, 1970: 295.

Clypeus flat; face quite strongly, closely punctate. Flagellum with 32–34 segments, the terminal segment evenly rounded apically. Lower anterior corner of pronotum evenly rounded. Mesoscutum with notauli deep, extending beyond level of centre of tegulae; central lobe of mesoscutum very sparsely hirsute. Scutellum moderately strongly convex, carinate for 0.8 of its length. Mesopleuron centrally very weakly swollen, anteroventrally smooth; sternaulus vestigial; metapleuron smooth, submetapleural carina absent. Posterior transverse carina of mesosternum quite strongly broadened, with a deep median V-shaped notch. Propodeum moderately long, anterior transverse carina present laterally, often reaching lateromedian carinae which are only present anteriorly; posterior transverse carina complete; tubercle entirely absent, its possible former position indicated only by long hairs (Fig. 30). Mid coxa unspecialized; hind tibia with 6–10 preapical bristles; largest bristle on hind tarsal claw not spatulate. Fore wing length 4–8 mm; *3r–m* absent; *Rs* slightly sinuous; *cu–a* opposite base of *Rs* & *M*. Gaster with tergite 1 1.1–1.3 times as long as posteriorly broad, without a carina joining spiracle to anterior margin of tergite. Tergite 3 with very fine sparse setiferous punctures. Ovipositor projecting beyond apex of gaster by 0.7–0.8 times length of hind tibia, its apex subcylindrical.

Female yellow, black-marked on interocellar area, mesoscutum in a broad transverse band, anterior part of propodeum, bands on tergites 3, 4 and 7 and hind tibia proximally. Male similar to female but with black spots on tergites 4–6 and proximal black mark on hind tibia less distinct. Apex of fore wing infumate.

**VARIATION.** In some females the black band on tergite 3 is present as two barely confluent spots. A few have a faint brownish mark on tergite 1 centrally.

**REMARKS.** *X. summervillei* belongs to the *X. rhopaloceros*-group of Townes & Chiu (1970). Like two of the other Australian species of this group (*X. binodus* and *X. rhopaloceros*) it lacks the submetapleural carina. It can be distinguished from these other species most easily by its characteristic colour pattern (Fig. 53).

Townes & Chiu (1970) recognize four subspecies. The nominate one is restricted to Australia.

**HOST RECORDS.** None.

**MATERIAL EXAMINED**

**Australia:** 1 ♀ (holotype), New South Wales, Tweed Heads (QM).

**Australia:** 17 ♀, 11 ♂, New South Wales, Queensland (Map 15) (ANIC; BMNH: TC).

*Xanthopimpla terminalis* (Brullé)

(Figs 36, 47)

*Pimpla terminalis* Brullé, 1846: 96. Holotype ♀, AUSTRALIA (MNHN) [examined].

*Notopimpla terminalis* (Brullé) Krieger, 1899: 107.

*Xanthopimpla terminalis* (Brullé) Townes *et al.*, 1961: 70; Townes & Chiu, 1970: 300.

Clypeus flat; face rather finely punctate. Flagellum with 37–39 segments, the most distal segment somewhat flattened, distally truncate so antenna has a small elliptical flat area at the end (Fig. 47). Lower anterior corner of pronotum produced into a sharp tooth. Mesoscutum with notauli deep but short, barely reaching to level of anterior margin of tegulae; central part of mesoscutum virtually glabrous. Scutellum rather flat, carinate laterally only at extreme base. Mesopleuron very weakly swollen centrally, anteroventrally very finely and sparsely punctate, sternaulus absent; metapleuron smooth, submetapleural carina present. Posterior transverse carina of mesosternum slightly raised, with a minute central notch. Propodeum moderately long, posterior transverse carina complete, anterior and lateromedian carinae absent; tubercle strong (Fig. 36). Mid coxa unspecialized; hind tibia with three preapical bristles arranged in a straight line; largest bristle on hind tarsal claws spatulate. Fore wing length 12–13 mm; *3r–m* present, enclosing a small areolet, *2m–cu* joining areolet close to proximal side, *Rs* sinuate; *cu–a* opposite base of

*Rs&M.* Gaster with tergite 1 longer than posteriorly broad, without a carina joining spiracle to anterior margin of tergite. Tergite 3 with large, shallow, close punctures. Ovipositor projecting beyond apex of gaster by 1.0–1.1 times length of hind tibia, exceptional in having a small swelling on upper valve near apex.

Female yellow, scape, interocellar area, head behind vertex, three mesoscutal marks and ovipositor sheath only, black. Wings slightly infumate, apices more distinctly so. Male similar to female, but mesoscutal marks more extensive and tergite 1 with a pair of black spots, tergite 3 with traces of spots.

REMARKS. *X. terminalis* belongs to the *terminalis*-group as defined by Townes & Chiu (1970). In Australia it is one of the most distinctive species, easily recognized by the flat acarinate scutellum, apically specialized antennae (in both sexes) and nodulate ovipositor. It is quite closely related to the Papuan species *X. interceptor* (Smith). *X. terminalis* has recently been collected flying amongst the understorey vegetation in wet forest. It seems to prefer very shaded habitats and often flies quite high, 2–3 m from the ground.

HOST RECORDS. None.

#### MATERIAL EXAMINED

Australia: 1 ♀ (holotype), no further data (MNHN).

Australia: 9 ♀, 2 ♂, New South Wales, Queensland (Map 16) (AM; ANIC; BMNH; TC).

### Tribe DELOMERISTINI

(= Theroniini sensu Townes)

This tribe, a rather heterogeneous assemblage of taxa, includes six genera, *Atractogaster*, *Delomerista*, *Hybomischos*, *Pseudorhyssa*, *Perithous* and *Theronia*, placed together on account of the absence of a basal tooth on the fore tarsal claw of the female, the unusually elongate male subgenital plate and the often delineated, rather long, area superomedia. The final instar larvae all possess a large internal tooth on the mandible and have a well developed hypostoma (Short, 1978).

*Pseudorhyssa*, *Delomerista* and *Atractogaster* are north temperate genera whilst *Perithous* and *Hybomischos* also occur on some higher mountains in the Oriental region (Gupta, 1982a, b). *Theronia*, a predominantly tropicopolitan genus, is the only delomeristine genus represented in Australia.

### Theronia Holmgren

Medium to moderately large-sized species, fore wing length 7–14 mm; clypeus with margin slightly concave; mandible not twisted, weakly to moderately narrowed; occipital carina complete. Epicnemial carina present; mesopleural suture centrally angled; propodeum with strong carinae, spiracles elongately oval. Tarsal claws of female without basal lobes, usually large with spatulate bristle. Fore wing with *3r-m* present, enclosing a rhombic areolet; hind wing with first abscissa of *Cu*<sub>1</sub> about 0.3 times length of *cu-a*. Tergite 1 rather slender; tergites 2–5 smooth and highly polished; ovipositor projecting beyond apex of gaster by 1.2–1.9 times length of hind tibia.

REMARKS. *Theronia* is a large, mainly tropicopolitan genus with a few species occurring in temperate areas. Traditionally it has been divided into a number of subgenera (Gupta, 1962; Townes, 1969) although these are more reasonably comparable with the species-groups used in related genera (e.g. *Xanthopimpla*). Gauld (1984) recognized three subgenera as occurring in Australia, *T. (Theronia)*, *T. (Parema)* and *T. (Nomosphacia)*.

*Theronia* species are mostly yellowish or green insects which seem to be restricted to forest habitats. In flight they are conspicuous amongst the vegetation but some species spend protracted periods host-searching on foot, particularly amongst the leaf litter and along earthen banks. When caught, *Theronia* species sink their large claws into their captor (or his net). These claws are difficult to disengage and usually break near their bases at the level of an apparently fluid filled cavity. Townes (1940) postulated these may function as poison fangs to deter predators but as yet this has not been proven.

Species of the subgenus *Nomosphacia* are known to be parasites of vespids (Gupta, 1962) but the majority of *Theronia* species are associated with Lepidoptera. Although recorded as primary

parasites (Gupta, 1962) there is increasing evidence to suggest many are hyperparasitic, particularly on other pimelines (Townes, 1940; Short, 1978). Whether hyperparasitism is obligatory or facultative is not known but in the field *T. (T.) maculosa* is found in the same microhabitat as *Echthromorpha intricatoria*, at the same time, but in lesser numbers.

Five species of *Theronia* occur in Australia. One, *T. (P.) penetrans* is also widespread in Sulawesi, the Moluccas and New Guinea whilst the other four are endemic. The tropical species *T. (N.) melanosoma* is very closely related to two Melanesian species, *T. (N.) elegans* Gupta and *T. (N.) diligens* (Smith).

As the subgenera occurring in Australia have recently been redefined (Gauld, 1984) the key given below is direct to species though the subgenera are shown in brackets.

**Key to Australian species of *Theronia***

- 1 Lower tooth of mandible about twice as long as the upper (Fig. 72); ovipositor projecting beyond apex of gaster by 1.8–1.9 times length of hind tibia; hind tibia blackish (*Nomosphacia*) ..... ***melanosoma*** Morley (p. 311)
- Lower tooth of mandible almost equal in length to upper (Fig. 73); ovipositor projecting beyond apex of gaster by 1.2–1.5 times length of hind tibia; hind tibia yellowish or brownish ..... 2
- 2 Lateral longitudinal carina of ♀ extending more than 0.6 of length of scutellum; ovipositor with lower valve partially enclosing the upper (Fig. 74); posterior ocelli separated by about minimum ocellar diameter, so ocellar triangle is a narrow-based isosceles triangle (Fig. 77) (*Parema*) ..... ***penetrans*** (Smith) (p. 312)
- Lateral longitudinal carina of ♀ extending at most 0.5 of length of scutellum; ovipositor with lower valve simple, not enclosing the upper (Fig. 75); posterior ocelli separated by at least maximum ocellar diameter, the ocellar triangle thus being almost equilateral (Fig. 76) (*Theronia*) ..... 3
- 3 Propodeum with anterior parts of lateromedian longitudinal carinae subparallel, the area superomedia more or less closed posteriorly (Fig. 68); submetapleural carina fairly evenly broadened anteriorly (Fig. 67); tergites of gaster with greenish tinge (most pronounced in fresh material) and with pairs of black spots on at least tergites 2–4 ..... ***maculosa*** Krieger (p. 314)
- Propodeum with anterior parts of lateromedian longitudinal carinae posteriorly divergent, the area superomedia not closed posteriorly (Fig. 69); submetapleural carina abruptly broadened anteriorly into an acute flange (Figs 65, 66); tergites of gaster yellow to orange-brown, without paired spots ..... 4
- 4 Sternite 1 of ♀ reaching to or slightly beyond centre or tergite 1 (Fig. 65); hind femur with close, short pubescence ventrally; distal flagellar segments slightly longer than broad, the flagellum slightly tapered towards end (Fig. 71); mesoscutum with three black longitudinal stripes ..... ***frauca*** sp. n. (p. 313)
- Sternite 1 of ♀ reaching 0.2–0.3 of length of tergite 1 (Fig. 66); hind femur with long sparse pubescence ventrally; distal flagellar segments slightly broader than long, the flagellum parallel-sided towards end (Fig. 70); mesoscutum without black marks ..... ***steindachneri*** Krieger (p. 315)

***THERONIA* subgenus *NOMOSPHECIA* Gupta**

*Theronia (Nomosphacia)* Gupta, 1962: 68. Type-species: *Theronia zebroides* Krieger, by original designation.

Mandible moderately tapered, with lower tooth almost twice the length of the upper (Fig. 72). Scutellum with lateral longitudinal carinae present only at extreme anterior end. Lower valve of ovipositor partially enclosing the upper.

***Theronia (Nomosphacia) melanosoma* Morley**

(Fig. 72)

*Theronia melanosoma* Morley, 1914: 47. Lectotype ♀, AUSTRALIA (BMNH), designated by Townes *et al.*, 1961: 74 [examined].

*Theronia (Nomosphacia) melanosoma* Morley; Gupta, 1962: 76.

Fore wing length 9–14 mm. Genae strongly constricted behind the eyes; posterior ocellus separated from eye by 1.1 times maximum ocellar diameter, interocellar distances 0.7 times maximum ocellar diameter, the ocellar triangle higher than broad. Occipital carina complete. Antenna setaceous; scape apically truncate 45°; flagellum with 37–39 segments, the penultimate distal segments transverse. Scutellum carinate laterally only at extreme anterior end. Propodeum with lateral longitudinal carinae complete, lateromedian carinae divergent posteriorly and confluent with posterior transverse carina which is absent centrally; propodeal spiracle elliptical; submetapleural carina strongly broadened anteriorly. Fore tibia simple; fore tarsal segments 3 and 4 without stout bristles; hind femur with short close hairs ventrally. Fore wing with *cu-a* slightly distal to base of *Rs&M*; areolet large and slightly transverse. Gaster of female with tergite 1 1.4–1.5 times as long as posteriorly broad, its sternite reaching 0.4 of its length. Ovipositor projecting beyond apex of gaster by 1.8–1.9 times length of hind tibia. Head, alitrunk and most of fore leg reddish brown; tarsi, antenna, most of hind leg and gaster black; tergites 2–7 margined posteriorly with yellow. Wings strongly infumate.

**VARIATION.** Some specimens have less extensive black areas of coloration and have the hind femora, trochanters, coxae and the scapes reddish brown.

**REMARKS.** A very distinctive species on account of its mandible. *T. (N.) melanosoma* appears to be restricted to the tropical north-east of Australia.

**HOST RECORDS.** None.

**MATERIAL EXAMINED**

**Australia:** 1 ♀ (holotype), 2 ♀, 3 ♂ (paratypes), Queensland, Kuranda near Cairns, ii.1902 (*Turner*) (BMNH).

**Australia:** 1 ♀, Queensland, Cape York Pen., Iron Rg., v.1974 (*Walford-Huggins*) (AM); 1 ♂, Cape York Pen., Lockerbie Area, iv.1973 (*Monteith*) (ANIC); 3 ♀, 1 ♂, Claudie, 8 km W. Mt Lamond, i.1972 (*McAlpine & Holloway*) (AM); 1 ♂, Dividing Rg., 11°40'S, 142°45'E, vii.1972 (*Monteith*) (ANIC); 1 ♀, Gordonvale, x.1924 (BMNH); 1 ♂, 7 km N. of Hope Vale Mission, 15°14'S, 145°07'E, x.1980 (*Cardale*) (ANIC); 5 ♀, 2 ♂ Middle Claudie R., ix.1974 (*Daniels & Moulds*) (AM).

***THERONIA* subgenus *PAREMA* Gupta**

*Theronia (Parema)* Gupta, 1962: 54. Type-species: *Theronia nigrobalteata* Cameron, by original designation.

Mandibles weakly tapered with teeth about equal. Scutellum with lateral longitudinal carina extending 0.6–0.8 of its length. Lower valve of ovipositor partially enclosing the upper (Fig. 74).

***Theronia (Parema) penetrans* (Smith)**

(Fig. 74)

*Pimpla penetrans* Smith, 1859: 173. Lectotype ♀, MOLUCCAS (UM), designated by Townes *et al.*, 1961: 75 [examined].

*Xanthopimpla(?) penetrans* (Smith) Krieger, 1899: 65.

*Theronia cephalotes* Krieger, 1899: 116. Lectotype ♀, SULAWESI (MNHU), designated by Townes *et al.*, 1961: 75. [Synonymized by Townes *et al.*, 1961: 75.]

*Theronia fumata* Krieger, 1899: 118. Lectotype ♀, PAPUA NEW GUINEA (MNHU), designated by Townes *et al.*, 1961: 75. [Synonymized by Townes *et al.*, 1961: 75.]

*Theronia papuana* Cameron, 1911a: 209. LECTOTYPE ♀, IRIAN JAYA (BMNH), here designated [examined]. [Synonymized by Townes *et al.*, 1961: 75.]

*Theronia penetrans* (Smith) Morley, 1914: 45.

*Theronia penetrans cephalotes* Krieger; Townes *et al.*, 1961: 75.

*Theronia penetrans penetrans* (Smith); Townes *et al.*, 1961: 75.

Fore wing length 6–11 mm. Genae strongly constricted behind eyes; posterior ocellus separated from eye by 1.2–1.3 times maximum ocellar diameter, interocellar distance 0.8 times maximum ocellar diameter, the ocellar triangle higher than broad (Fig. 77). Occipital carina complete. Antenna slightly setaceous; scape apically truncate 50°; flagellum with 38–40 segments, the penultimate distal segments slightly broader than long. Scutellum carinate laterally 0.6–0.7 of its length. Propodeum with lateromedian carinae present anteriorly, parallel, lateral longitudinal carinae complete and posterior transverse carina weak, centrally absent; propodeal spiracle elliptical; submetapleural carina strongly and abruptly widened anteriorly into

an acute lobe. Fore tibia unspecialized; fore tarsal segments 3 and 4 without stout bristles; hind femur with short close hair ventrally. Fore wing with *cu-a* distal to base of *Rs&M*; areolet of moderate size, oblique. Gaster of female with tergite 1 1.5–1.7 times as long as broad, its sternite reaching almost to centre. Ovipositor projecting beyond apex of gaster by 1.3 times length of hind tibia.

Orange-brown, the flagellum and hind tarsus blackish. Wings strongly infumate.

**VARIATION.** The Australian examples are slightly smaller than the Papuan specimens but morphologically otherwise virtually identical, although there is a little variation in the shape of the area superomedia. Over its range from Sulawesi to Australia there is considerable variation in propodeal sculpture, depth of facial punctures, infumation of wings and extent of darker markings on the body. Gupta (1962) recognized two subspecies though remarking that intergradation occurred at least on many characters.

**REMARKS.** This species can be recognized easily by the form of the ovipositor and closeness of the posterior ocelli. It is only known to occur in northern Queensland though it is widespread from Sulawesi to New Guinea.

**HOST RECORDS.** None.

**MATERIAL EXAMINED**

**Indonesia:** 1 ♀ (lectotype of *penetrans*), Moluccas, Aru (UM); 1 ♀, (lectotype of *papua*), Irian Jaya, Alkmaar (BMNH).

**Australia:** 1 ♀, 1 ♂, Queensland, Moses Ck, 4 km N. by E. Mt Finnigan (15°47'S, 145°17'E), x.1980 (*Cardale*) (ANIC); 1 ♂, Shipton's Flat (15°47'S, 145°14'E), x.1980 (*Cardale*) (ANIC); 1 ♂, same locality, v.1981 (*Naumann*) (ANIC).

***THERONIA* subgenus *THERONIA* Holmgren**

*Theronia* Holmgren, 1859: 123. Type-species: *Pimpla flavicans* F. (= *Ichneumon atalante* Poda), by monotypy.

*Pseudacoenites* Kriechbaumer, 1892: 219. Type-species: *Pseudacoenites moravicus* Kriechbaumer (= *Pimpla laevigata* Tachek), by monotypy.

*Poecilopimpla* Cameron, 1903: 141. Type-species: *Poecilopimpla lucida* Cameron, by monotypy.

*Orientotheronia* Morley, 1913b: 146. Type-species: *Orientotheronia rufescens* Morley (= *Pimpla zebra* Snellen van Vollenhoven), by original designation.

*Theronia* (*Theronia*) Holmgren; Gupta, 1962: 9.

Mandible weakly to moderately narrowed, subequally bidentate (Fig. 73). Scutellum with lateral carinae extending 0.2–0.5 of its length. Lower valve of ovipositor not enclosing the upper (Fig. 75).

***Theronia* (*Theronia*) *frauca* sp. n.**

(Figs 71, 76)

Fore wing length 6–7 mm. Mandible moderately narrowed, the teeth almost equal. Genae evenly rounded behind eyes; posterior ocellus separated from eye by 1.2–1.3 times its maximum diameter, interocellar distance 1.0 times maximum ocellar diameter, the ocellar triangle equilateral (Fig. 76). Occipital carina complete. Antenna setaceous; scape truncate apically 50°; flagellum with 33–34 segments, the penultimate distal segments slightly longer than broad (Fig. 71). Scutellum with lateral carinae extending 0.3–0.5 of its length. Propodeum with lateral longitudinal carinae complete, lateromedian carinae present anteriorly, divergent posteriorly and contiguous with ends of posterior transverse carina which is absent centrally; propodeal spiracle elliptical; submetapleural carina strongly broadened anteriorly. Fore tibia unspecialized; fore tarsal segments 3 and 4 without bristles; hind femur with short hairs ventrally. Fore wing with *cu-a* distal to base of *Rs&M*; areolet large, almost rhombic. Gaster of female with tergite 1 1.6–1.7 times as long as posteriorly broad, dorsally flattened and with its sternite reaching to or slightly beyond centre (Fig. 65). Ovipositor projecting beyond apex of gaster by 1.3–1.4 times length of hind tibia, the lower valve simple.

Yellowish, with three black stripes on mesoscutum; yellow colour slightly infusate close to ocelli and on scape. Flagellum dark brown; femora dorsally and tergites extensively reddish yellow. Ovipositor sheath black. Wings almost completely hyaline.

**REMARKS.** A small insect not obviously closely related to other Australian species. The rather

slender tergite 1 with the elongate sternite immediately distinguishes *fraucal* from *steindachneri* and although it resembles *maculosa* more in this feature the propodeal carination is quite different.

*T. (T.) fraucal* is known only from Queensland.

HOST RECORDS. None.

MATERIAL EXAMINED

Holotype ♀, **Australia**: Queensland, coast range near Biggenden, viii.1974 (*Frauca*) (ANIC).

Paratypes. **Australia**: 1 ♂, same locality as holotype, x.1976 (*Frauca*) (ANIC); 1 ♀, same locality, viii.1977 (*Frauca*) (ANIC); 1 ♂, Brisbane-Indooroopilly Road, xi.1976 (*Bouček*) (BMNH); 1 ♀, Pine Ck, S. of Bundaberg, ix.1976 (*Frauca*) (BMNH).

*Theronia (Theronia) maculosa* Krieger

(Figs 67, 68, 73)

*Theronia maculosa* Krieger, 1906: 239. Lectotype ♀, AUSTRALIA (MNHU), designated by Townes *et al.*, 1961: 74.

*Theronia viridicans* Morley, 1914: 46. Holotype ♀, AUSTRALIA (BMNH) [examined]. [Synonymized by Townes *et al.*, 1961: 74.]

*Theronia (Theronia) maculosa* Krieger; Gupta, 1962: 46.

Fore wing length 8–12 mm. Mandible weakly narrowed, the teeth almost equal. Genae evenly constricted behind the eyes; posterior ocellus separated from eye by 1.0 times its maximum diameter, interocellar distance 0.8 times maximum ocellar diameter, the ocellar triangle almost equilateral. Occipital carina complete. Antenna setaceous; scape apically truncate 55°; flagellum with 40–42 segments, the penultimate distal segments subquadrate. Scutellum carinate 0.2–0.4 of its length. Propodeum with lateral longitudinal carinae complete, lateromedian carinae anteriorly strong, almost parallel and with rectilinear area supermedia almost closed posteriorly (Fig. 68); propodeal spiracle elliptical; submetapleural carina evenly broadened anteriorly (Fig. 67). Fore tibia unspecialized; fore tarsal segments 3 and 4 without strong bristles; hind femur with rather short hairs ventrally. Fore wing with *cu-a* opposite or slightly distal to base of *Rs&M*; areolet rather narrow, oblique. Gaster of female with tergite 1 1.6–1.8 times as long as broad, its sternite reaching almost to centre. Ovipositor projecting beyond apex of gaster by 1.4–1.5 times length of hind tibia.

Yellowish brown, with flagellum, marks on base and apex of hind femur and hind tarsus blackish; gaster frequently with black spots on tergites 1–5. Wings moderately infumate.

VARIATION. Whilst alive most specimens have a greenish gaster and frequently also green hind legs but this colour fades rapidly after death. Some variation in the distribution of black spots occurs but all specimens seem to have them on tergites 2–4.

REMARKS. A common and rather widespread endemic Australian species (Map 18) found mostly in cooler damp woodlands. It is readily distinguished from other *Theronia* species by the black spots on some gastral tergites. It is the only Australian species with a pronounced greenish tinge, and freshly emerged females are often brilliant emerald-green.

HOST RECORDS. Anthelidae: *Anthela acuta* (Walker). Saturniidae: *Antheraea astrophela* Walker (Chadwick & Nikitin, 1976). Short (1978), on the basis of dissection of a cocoon of *Antheraea* sp. from which *Theronia* had emerged, suggested *Theronia* is hyperparasitic, using Pimplini as hosts.

MATERIAL EXAMINED

**Australia**: 1 ♀ (holotype of *viridicans*), Tasmania, 1877 (*Atkinson*) (BMNH).

**Australia**: 97 ♀, 34 ♂, Australian Capital Territory, New South Wales, south-eastern Queensland, South Australia, Tasmania, Victoria (Map 18) (AM; ANIC; BMNH; DAT; NMV; TC).

*Theronia (Theronia) steindachneri* Krieger

(Figs 69, 70)

- Theronia steindachneri* Krieger, 1906: 320. Lectotype ♀, AUSTRALIA (NM), designated by Townes *et al.*, 1961: 76.
- Theronia dubia* Krieger, 1906: 320. Lectotype ♀, AUSTRALIA (MNHU), designated by Townes *et al.*, 1961: 76. [Synonymized by Townes *et al.*, 1961: 76.]
- Neotheronia teiae* Cameron, 1912: 183. Holotype ♂, AUSTRALIA (BMNH) [examined]. [Synonymized by Townes *et al.*, 1961: 76.]
- Neotheronia antherae* Cameron, 1912: 184. Holotype ♀, AUSTRALIA (BMNH) [examined]. [Synonymized by Townes *et al.*, 1961: 76.]
- Theronia steinbachneri* Krieger; Morley, 1914: 39. [Misspelling.]
- [*Theronia viridicans* Morley; Morley, 1914: 47. Misidentification, in part.]
- Theronia fumipennis* Morley, 1914: 47. Holotype ♀, AUSTRALIA (BMNH) [examined]. **Syn. n.**
- Theronia claripennis* Morley, 1914: 48. Holotype ♂, AUSTRALIA (BMNH) [examined]. [Junior secondary homonym of *Theronia claripennis* Cameron, 1911a.] [Synonymized by Townes *et al.*, 1961: 76.]
- Habropimpla antherae* (Cameron) Girault, 1925: 39. [Unjustified emendation.]
- Theronia (Theronia) steindachneri* Krieger; Gupta, 1962: 34.
- Theronia (Theronia) fumipennis* Morley; Gupta, 1962: 35.

Fore wing length 7–12 mm. Mandible weakly narrowed, the teeth almost equal. Genae rounded behind eyes, in larger specimens somewhat inflated; posterior ocellus separated from eye by 1.1–1.2 times its maximum diameter, interocellar distance 0.7–0.8 times maximum ocellar diameter, the ocellar triangle slightly higher than broad. Occipital carina complete. Antenna stout, not distally tapered; scape apically truncate 45–50°; flagellum with 37–39 segments, the penultimate distal segments slightly broader than long (Fig. 70). Scutellum carinate 0.2–0.5 of its length, generally most extensively carinate in the male. Propodeum with lateral longitudinal carinae complete; lateromedian carinae present anteriorly, rather far apart and divergent posteriorly, confluent with lateral remnants of posterior transverse carina (Fig. 69); propodeal spiracle elliptical; submetapleural carina very strongly broadened anteriorly, often bearing coarse striae. Fore tibia unspecialized; fore tarsal segments 3 and 4 without stout bristles; hind femur with long rather sparse hairs ventrally. Fore wing with *cu-a* slightly distal to base of *Rs&M*; areolet quite large, oblique. Gaster of female with tergite 1 1.4–1.5 times as long as broad, its sternite extending 0.2–0.3 of its length (Fig. 66). Ovipositor projecting beyond apex of gaster by 1.2–1.3 times length of hind tibia, the lower valve simple.

Orange, with antenna and hind tarsus mainly blackish. Wings weakly to moderately infumate.

**VARIATION.** Specimens from northern Queensland have more strongly infumate wings and often slightly narrower genae.

**REMARKS.** Gupta (1962) treated *fumipennis* as a separate species on account of the slightly narrower genae, paler wings and less strongly ridged submetapleural carina. The latter character is so variable as to be useless, whilst many specimens of a variety of species have slightly more infumate wings in the more equatorial region of their ranges. This leaves only the head shape and here intermediates exist so I have chosen to regard *fumipennis* as a synonym.

*T. steindachneri* appears to be a more northerly species than *T. maculosa* and is most frequently collected in Queensland and northern New South Wales. The more southern records (e.g. Australian Capital Territory) all refer to specimens collected in late summer.

**HOST RECORDS.** Lymantriidae: *Teia anartoides* Walker (BMNH). Noctuidae: *Pericyma cruegeri* (Butler) (DPIO). Psychidae: *Hyalarcta huebneri* (Westwood) (QM). Saturniidae: *Antheraea astrophela* Walker (Cameron, 1912).

**MATERIAL EXAMINED**

**Australia:** 1 ♂ (holotype of *teiae*). New South Wales, Tenterfield, reared ex *Teia anartoides* (Froggatt) (BMNH); 1 ♀ (holotype of *antherae*). New South Wales, Richmond, reared ex *Antheraea astrophela* (Froggatt) (BMNH); 1 ♀ (holotype of *fumipennis*), Queensland, Townsville (Dodd) (BMNH); 2 ♀ (paratypes), Mackay (Turner) (BMNH); 1 ♂ (holotype of *claripennis*), New South Wales, Sydney, 1856 (Cumming) (BMNH); 1 ♂ (paratype), Queensland, Mackay (Turner) (BMNH); 1 ♀ (paratype), Victoria (French) (BMNH).

**Australia:** 53 ♀, 17 ♂, Australian Capital Territory, New South Wales, Queensland (Map 17) (AM; ANIC; BMNH; DAR; DPIQ; QM; QUM).

### Tribe RHYSSINI

The Rhyssini is an apparent holophyletic group of pimelines characterized by the possession of a cornute process on the last gastral tergite of the female and by the presence of transverse rugae on the mesoscutum. The group includes some of the largest of ichneumonids and females are particularly distinctive on account of their very long ovipositor. Rhyssines are all believed to be parasites of wood-boring holometabolous insect larvae, and recorded hosts include Siricidae, Xiphydriidae, Syntexidae and Cerambycidae. The hosts of the numerous tropical species are virtually unknown.

The tribe includes eight genera which are clearly divisible into two groups. These are the monobasic *Rhyssa*-group, characterized by possession of numerous primitive features such as having sternite 1 free, possessing a relatively unspecialized pronotum and not having a ridge on the median trochantellus, and the *Epirhyssa*-group containing the genera *Lytarmes*, *Epirhyssa*, *Cyrtorhyssa*, *Rhyssella*, *Megarhyssa*, *Myllenyxis* and *Triancyra*. This latter group is characterized by several apomorphic features including having sternite 1 fused to the tergite, having a flange along the fore margin of the pronotum and possessing a ridge on the median trochantellus. The least specialized genus, *Rhyssa*, is Holarctic whilst many of the most highly specialized genera of the *Epirhyssa*-group are tropical. Three genera are known to occur in Australia. *Rhyssa* and *Megarhyssa* were introduced to Victoria and Tasmania in an attempt to control *Sirex* infestations in *Pinus* plantations; *Epirhyssa* is apparently a recently colonist of the north of Queensland.

### *EPIRHYSSEA* Cresson

*Epirhyssa* Cresson, 1865: 39. Type-species: *Epirhyssa speciosa* Cresson, by subsequent designation, Viereck, 1914: 52.

*Rhyssonota* Kriechbaumer, 1890: 489. Type-species: *Rhyssonota tristis* Kriechbaumer, by monotypy.

*Hierax* Tosquinet, 1903: 255. Type-species: *Hierax raptor* Tosquinet, by monotypy. [Homonym of *Hierax* Vigers, 1826.]

*Sychnostigma* Baltazar, 1961: 75. [Replacement name for *Hierax* Tosquinet.]

Large species, fore wing length (9)15–17 mm; clypeus with a trace of a median apical tooth, laterally tuberculate; occipital carina complete, mediodorsally dipped. Pronotum mediodorsally with a deep transverse groove separating off recurved anterior lip; epicnemial carina present; propodeum without distinct carinae, spiracle elliptical. Female with claws simple; fore wing with *3r-m* absent; hind wing with first abscissa of *Cu*<sub>1</sub> short, less than 0.2 times length of *cu-a*. Sternites 2–4 of female bearing tubercles near anterior edge; tergite 2 with thyridia contiguous with anterior margin; tergites 2–4 smooth; ovipositor straight, projecting beyond apex of gaster by about 4.0 times the length of hind tibia.

**REMARKS.** *Epirhyssa* is a large tropicopolitan genus, the majority of species of which seem to inhabit lowland tropical rain forest. Kamath & Gupta (1972) recognized 39 Indo–Australian species but a number of unplaced specimens are to hand. These may represent additional species or the described species may encompass a greater range of morphological variation than Kamath & Gupta discerned. Recently collected material favours the latter suggestion.

Two species occur in New Guinea and it is with slight hesitation that I consider the sole Australian specimen conspecific with one of these.

### *Epirhyssa biroi* Mocsáry comb. rev.

*Epirhyssa biroi* Mocsáry, 1905: 17. Holotype ♀, PAPUA NEW GUINEA (TM) [examined].

*Ahyborhyssa biroi* (Mocsáry) Enderlein, 1919: 152.

*Sychnostigma biroi* (Mocsáry) Townes *et al.*, 1961: 87; Kamath & Gupta, 1972: 169.

Face transversely striate, tending to vertically striate centrally adjacent to clypeus; fron transversely semicircularly wrinkled, vertex sparsely punctate. Flagellum with 37 segments. Mesopleuron with subtegular ridge convex, without a pronounced posterior concavity; epicnemial carina present, weak, its upper end



about on level of mesopleural pit, remote from anterior margin of pleuron; mesopleuron sparsely punctate on upper part, ventrally becoming more coarsely and closely obliquely punctate; epicnemium closely punctate, the area behind fore coxae striate; metapleuron sparsely punctate. Propodeum dorsally smooth, evenly convex, at most with minute punctures. Tergites of gaster smooth and polished, the posterior tergites with fine punctures.

Yellow with mandibles and antenna black; vertex black, the area of this colour extending to base of antenna, to orbits and down onto the occiput above the foramen. Alitrunk black-marked on hind margin of pronotum, fore margin of mesopleuron, mesoscutum anteriorly and centrally and metanotum narrowly; fore femur black-striped; hind tarsus brown, the distal segment black; gaster yellowish with anterior and often posterior margins of tergites infuscate; ovipositor sheath blackish brown, distally yellowish brown. Wings infumate, apices very strongly so; pterostigma black.

**REMARKS.** Only a single Australian specimen is at hand. It appears to be conspecific with the New Guinea material studied but the combination of all specimens encompasses a greater range of variation than previously recognized in the genus. However, a considerable range of variation is known to occur in one of the few well-studied rhyssines, *Rhyssa persuasoria* (Spradbery & Ratkovsky, 1974), so similar extensive variation may be expected in related taxa. The Australian specimen differs from the Papuan examples in having more finely punctate meso- and metapleurae and a weaker epicnemial carina. Amongst the Papuan specimens there is considerable variation in the degree of infuscation of the wings. Some exceptionally small specimens from Wau have the wings hyaline except distally. Some specimens have well-developed black marks at the anterior and posterior margins of the gastral tergites whilst in one specimen the gaster is more or less entirely yellow. The hind tarsi are usually infuscate though almost imperceptibly so in some individuals.

*E. biroi* is known in Australia only from tropical Queensland. It is widely distributed throughout New Guinea and is not uncommon in lowland rain forest. It is here recorded for the first time from New Britain.

**HOST RECORDS.** None.

**MATERIAL EXAMINED**

**Papua New Guinea:** 1 ♀ (holotype), Simbang on Huon Gulf (*Biro*) (TM).

**Australia:** 1 ♀, Queensland, Shipton's Flat (15°47'S; 145°14'E), x.1980 (*Cardale*) (ANIC). **New Britain:** 1 ♀, Cape Hoskins, vi.1970 (*Stibick*) (TC). **Papua New Guinea:** 1 ♀, Popondetta, x.1968 (*Hassan*) (BMNH); 1 ♀, Wau, 1200 m, vii-viii.1970 (*Robinson*) (TC); 1 ♀, 1 ♂, Wau, 1000 m, x.1979 (*Gauld*) (BMNH).

**MEGARHYSSA** Ashmead

*Thalessa* Holmgren, 1859: 122. Type-species: *Ichneumon clavatus* F. (= *Ichneumon gigas* Laxmann), by subsequent designation, Ashmead, 1900a: 53. [Homonym of *Thalessa* Adams, 1843.]

*Megarhyssa* Ashmead, 1900b: 368. [Replacement name for *Thalessa* Holmgren.]

*Megalorhyssa* Schulz, 1906: 115. [Unjustified emendation.]

Very large species, fore wing length 20–30 mm (Australian specimens); clypeus with a weak median apical tooth, laterally tuberculate; occipital carina usually obsolescent centrally. Pronotum mediodorsally with a deep transverse groove cutting off anterior recurved lip; epicnemial carina present; propodeum without distinct carinae, spiracle oval. Female with claws simple; fore wing with  $3r-m$  present, enclosing large, triangular areolet; hind wing with first abscissa of  $Cu_1$  very short, less than 0.2 times length of  $cu-a$ . Sternites 2–4 of female bearing tubercles near anterior edge; tergite 2 with thyridia separated from anterior margin; tergites 2–4 smooth; ovipositor straight, projecting beyond apex of gaster by about 6.0 times length of hind tibia.

**REMARKS.** A moderate-sized Holarctic and Oriental genus with a single North American species, *M. nortoni*, introduced into Tasmania and Victoria to control *Sirex* infestations in *Pinus radiata* plantations (Taylor, 1976; Neumann & Minko, 1981). A second species, *M. emarginatoria* (Thunberg), was also introduced into Tasmania in 1964, but the females displayed little interest in the *Sirex* infested timber (Taylor, 1967) and the species has not become established. *M. nortoni* has become an important factor in controlling the population of *Sirex* in the south-east of Australia (Taylor, 1978).

***Megarhyssa nortoni* (Cresson)**

*Rhyssa nortoni* Cresson, 1864: 317. Holotype ♀, U.S.A. (PANS).

*Thalessa nortoni* (Cresson) Cresson, 1870: 169.

*Thalessa Quebecensis* Provancher, 1873: 447. Lectotype ♀, CANADA (UL), designated by Barron, 1975: 543. [Synonymized by Morley, 1913a: 16.]

*Megarhyssa nortonii* (Cresson) Dalla Torre, 1901: 481. [Unjustified emendation.]

*Megarhyssa quebecensis* (Provancher) Dalla Torre, 1901: 481.

*Megarhyssa nortoni* (Cresson); Townes & Townes, 1960: 417.

Face slightly coriaceous; frons transversely wrinkled; vertex punctate finely, centrally tending to striate behind ocellar triangle. Mesopleuron ventrally coarsely punctate; metapleuron smooth, almost impunctate. Scutellum transversely striate; propodeum dorsally smooth.

Head black, facial and frontal orbits and gena yellow; alitrunk brown, notauli, margins of most sclerites, most of mesopleuron and axilla black; pronotum centrally, metapleuron in part, scutellum, postscutellum and hind corners of propodeum yellow; coxae black, remainder of legs yellowish or brownish; gaster brown, tergites black-margined and with tergites 3–7 with a pair of yellow spots. Wings weakly, uniformly infuscate; pterostigma brown.

REMARKS. Carlson (1979) suggests this North American native may be conspecific with the Palearctic species *M. gigas* (Laxmann) but confirmation of this requires more detailed study. *M. nortoni* is believed to be the only established species of *Megarhyssa* in Australia. It differs from the European species, *M. emarginatoria* Thunberg, in having a slightly shorter ovipositor (that of *emarginatoria* is about 8 times the length of the hind tibia) and in colour. The genal orbits of *emarginatoria* are black and the coxae orange.

A considerable number of observations have been made on the biology of this species in North America (e.g., Essig, 1926; Madden, 1968) whilst its mating behaviour in New Zealand is documented by Nuttall (1973).

HOST RECORDS. *Sirex* species. In North America it is also known to parasitize other Siricinae such as species of *Xeris* and *Urocerus* (Carlson, 1979).

## MATERIAL EXAMINED

**Australia:** 5 ♀, 2 ♂, Tasmania, Hobart, ii.1967 (Taylor) (BMNH). **U.S.A., Canada:** 10 ♀, 10 ♂, various localities including material compared with the holotype by H. K. Townes (BMNH; TC).

**RHYSSA** Gravenhorst

*Rhyssa* Gravenhorst, 1829: 260. Type-species: *Ichneumon persuasorius* L., by subsequent designation, Westwood, 1840: 59.

*Cryptocentrum* Kirby, 1837: 260. Type-species: *Cryptocentrum lineolatum* Kirby, by monotypy.

*Pararhyssa* Walsh, 1873: 109. Type-species: *Ichneumon persuasorius* L., by subsequent designation, Viereck, 1914: 111.

Medium-sized to very large species, fore wing length 7–25 mm; clypeus with a median apical tooth, without lateral tubercles; occipital carina mediodorsally incomplete. Pronotum with a mediodorsal depression, without a deep transverse furrow separating anterior lip-like portion; epicnemial carina present; propodeum without distinct carinae, often transversely striate, spiracle oval. Female with claws simple; fore wing with 3r-m present enclosing a triangular areolet; hind wing with first abscissa of  $Cu_1$  short, less than 0.3 times length of  $cu-a$ . First sternite not fused with tergite; sternites 2–4 of female bearing tubercles near centre; tergite 2 with thyridia near to anterior margin; tergites 2–4 smooth; ovipositor straight, projecting beyond apex of gaster by more than 4.0 times length of hind tibia.

REMARKS. *Rhyssa* is a relatively small genus, species of which are common parasites of siricids in the north temperate region. A species, *R. persuasoria*, was first introduced into the southern hemisphere in 1928–31 in an attempt to control *Sirex noctilio* in New Zealand (Miller & Clark, 1935). The discovery of *S. noctilio* in a *Pinus radiata* plantation near Hobart, Tasmania in March 1952 (Gilbert & Miller, 1952) prompted the Tasmanian Department of Agriculture to approach the New Zealand authorities (DSIR and the Forest Research Institute) for shipments of *R. persuasoria*. In 1957 this rhyssine was liberated in Tasmania and by 1959 it seemed to have become established (Taylor, 1967). In 1961 *Sirex* was discovered in Victoria (Irvine, 1962) and

the following year the National Sirex Fund was established to promote an extensive programme of research on *Sirex* and its parasites. In subsequent years many parasites were introduced into Australia, including eight species of *Rhyssa*. These were – *R. alaskensis* Ashmead (49 ♀ from south western U.S.A.); *R. amoena* Gravenhorst (12 ♀ from Europe); *R. crevieri* (Provancher) (31 ♀ from eastern Canada); *R. hoferi* Rohwer (34 ♀ from Arizona and New Mexico); *R. howdenorum* Townes (95 ♀ from the south-eastern U.S.A.); *R. jozana* Matsumura (26 ♀ from Japan); *R. lineolata* (Kirby) (30 ♀ from New Zealand and 30 ♀ from Canada and the U.S.A.); *R. persuasoria* (L.) (1622 ♀ from Europe, Turkey, Morocco, North America, Japan and India) (Taylor, 1976). Of these, only *R. persuasoria* seems to have become firmly established (Neumann & Minko, 1981).

### *Rhyssa persuasoria* (L.)

*Ichneumon persuasorius* L., 1758: 562. Lectotype ♂, 'EUROPE' (LSL), designated by Fitton, 1978: 371 [examined].

*Pimpla persuasoria* (L.) F., 1804: 112.

*Rhyssa persuasoria* (L.) Gravenhorst, 1829: 267; Townes & Townes, 1960: 406.

Face somewhat coriaceous; frons smooth; vertex punctate, more closely and finely so laterally. Meso- and metapleuræ quite closely punctate; scutellum transversely striate; propodeum transversely weakly striate, with a median longitudinal depression. Male with sternites 2–4 undivided.

Female blackish; orbits, marks on pronotum, subalar prominence, tegula, hind corner of mesopleuron, scutellum, postscutellum, hind part of metapleuron, propodeum posteriorly, hind margin of tergite 1 and two pairs of spots on hind margins of tergites 2+, whitish; legs orange, hind leg distal to femur progressively infuscate. Wings more or less hyaline; pterostigma blackish. Male much less extensively pale-marked than female, black; face except clypeus, frontal and genal orbits partially, pronotum dorsally and double paired spots on tergites 2+, white. Legs and wings similar in colour to those of female.

**REMARKS.** This introduced species is established in *Pinus* plantations in Tasmania and Victoria, but there is some danger that others of the various *Rhyssa* species introduced and presumed not to have become established may be overlooked or misidentified as *R. persuasoria*. This has happened in New Zealand where *R. lineolata* (Kirby), an introduced Nearctic species, has recently been rediscovered and appears to have become established (Zondag & Nuttall, 1961). It is therefore worth emphasizing the following features.

*R. persuasoria* is mainly black and has paired spots or sometimes bars on the hind margins of tergites 2–4, the temple is at least partly pale-marked, the antennae are unicolorous blackish and the male has sternites 2–4 of the gaster entire. All other species introduced at various times to Australia differ in one or more features. *R. hoferi* is basically brownish and, like *R. howdenorum*, has continuous pale bands on the hind margins of tergites 2–4 of the gaster. *R. alaskensis*, *R. crevieri*, *R. lineolata*, *R. amoena* and *R. jozana* have sternites 2–4 of the male gaster longitudinally divided into three and often have pale-banded antennae; *R. alaskensis* has the temple entirely black.

A detailed account of the biology of *R. persuasoria* is given by Morgan & Stewart (1966) whilst Spradbery (1970) details the host-finding behaviour.

**HOST RECORDS.** In Australia, *Sirex noctilio* F. (Siricidae). In the north temperate region *R. persuasoria* is recorded as a parasite of a variety of other Siricinae. In the U.S.A. it is also recorded from Syntexidae (Carlson, 1979) whilst there are a number of early European records of this species attacking cerambycid larvae (Aubert, 1969).

#### MATERIAL EXAMINED

**Australia:** 10 ♀, 8 ♂, Tasmania, (ANIC; BMNH). **Europe:** 187 ♀, 174 ♂, various localities.

**'Europe':** 1 ♀ (lectotype) (LSL).

### Subfamily XORIDINAE

The Xoridinae is one of the smaller subfamilies containing, world-wide, four genera. Three of these are North Temperate, the fourth, *Xorides*, is quite large and cosmopolitan. It is represented in Australia by three species.

### Zoogeography

Of the four genera in the Xoridinae only *Xorides* occurs outside the North Temperate region. Species of this genus are not uncommon in temperate and tropical forests. *Xorides* is currently divided into 10 subgenera (Townes, 1969), four of which occur in the Oriental region. Only one subgenus, *X. (Cyanoxorides)*, extends to Australia and I have only seen species of this group from Queensland and northern New South Wales.

### Biology

Xoridines are parasites of wood-boring Coleoptera and Symphyta. Most usually larvae serve as hosts but pupae and even adults within their cocoon may be parasitized. The families Cerambycidae and Siricidae are the commonest hosts though a number of other coleopterous families are also attacked. There are a number of studies on the biology of xoridines in Europe and North America and that of Chrystal & Skinner (1931) serves as a typical example. These authors observed that the female xoridine oviposited through the bark into the host gallery. A single egg was deposited on or near the cerambycid larva. Although it was never observed they consider it highly likely that the host larva was stung and paralysed prior to oviposition. Larvae that had been oviposited on were virtually immotile but alive, and even if the xoridine egg failed to hatch the cerambycid larva remained unmoving for weeks before eventually dying. The elongate, fusiform egg hatched about eight days after oviposition and the first instar larva immediately began attacking the host. It fed by burying its mandibles in the host's integument and sucking the body fluids. Growth was rapid and after six or seven days the larva moulted. The second instar larva resembled the first and lasted a further four or five days. At about this time the host larva was found to be dead. The third larval instar was stouter with a less well-developed head. This continued to feed on the host for six to seven days before moulting. The fourth and final instar larva consumed the entire host except for the head capsule and chitinous exoskeleton in five or six days. It then remained motionless for several days before spinning a capacious cocoon. The larva was observed to overwinter in this cocoon and pupated in the spring of the following year. The duration of the pupal stage was short, with the adult emerging after nine or ten days.

The head of the final instar xoridine larva is quite strongly sclerotized and the antennae are papilliform, which is probably the plesiomorphic condition for ichneumonids. The epistomal arch is incomplete but the other sclerites are well formed. The mandibles are large with numerous small accessory teeth. Short (1978) considered xoridine larvae to be structurally primitive.

### *XORIDES* subgenus *CYANOXORIDES* Cameron

*Cyanoxorides* Cameron, 1903: 141. Type-species: *Cyanoxorides brookei* Cameron, by monotypy.

*Spiloxorides* Cameron, 1903: 143. Type-species: *Spiloxorides ruficeps* Cameron, by monotypy.

*Xorides (Cyanoxorides)* Cameron; Townes & Townes, 1960: 491.

Flagellum of female with subapical angulation, the segment proximal to this angulation bearing peg-like seta; flagellum of male filiform with conspicuous long fine pubescence; pronotum specialized with dorsal carinae and strong epomia; epicnemial carina present; scuto-scutellar groove with a median carina; posterior transverse carina of mesosternum interrupted before mid coxae. Fore wing with *cu-a* proximal to base of *Rs* & *M*. Gaster with tergite 2 with anterior corners impressed, with traces of diagonal furrows and a central depression which may be raised to form a median longitudinal ridge posteriorly.

REMARKS. The flagellum, pronotum, scuto-scutellar groove and gastral sculpture are distinctive features enabling these insects to be easily recognized.

### Key to Australian species of *Xorides (Cyanoxorides)*

- 1 Alitrunk and gaster entirely orange-brown, only distal margin of tergite 7 pale-banded; flagellum unicolorous black; propodeum with carinae sharply raised and straight, clearly delineating regular areas ..... species 1 (p. 322)

- Alitrunk and gaster partly to almost completely black; flagellum with a conspicuous white band in distal part; propodeum with irregular and often indistinctly delineated carinae ..... 2
- 2 Alitrunk black; gaster predominantly black, tergite 1 anteriorly reddish, tergites 7+ posteriorly white-banded; propodeum with lateral areae reticulo-rugose ..... *australiensis* (Szépligeti) (p. 321)
- Alitrunk black with large pale marks laterally; gaster black with tergite 1 anteriorly and tergites 1+ posteriorly pale-banded; propodeum with lateral areae punctate with scattered rugae ..... *crudelis* (Turner) (p. 321)

***Xorides (Cyanoxorides) australiensis* (Szépligeti)**

*Cyanoxorides australiensis* Szépligeti, 1914: 420. Holotype ♀, AUSTRALIA (TM) [examined].

*Xorides (Cyanoxorides) australiensis* (Szépligeti) Townes *et al.*, 1961: 107.

Fore wing length 11–13 mm. A shining species with head and much of alitrunk very finely punctate. Propodeum with carinae rather weak and irregular with numerous subsidiary carinulae radiating from them; lateral areae reticulo-rugose. Gaster almost matt, tergite 1 centrally puncto-coriaceous, posteriorly becoming striato-coriaceous.

Female black, face except centrally, upper orbits, genae in part and flagellar bands, white; tergite 1 anteriorly reddish, tergites 7+ posteriorly white-banded. Legs golden yellow, distal 0.5 of hind femur, distal 0.4 of hind femur and hind tarsal segment 5 black, remaining hind tarsal segments white. Male similar to female except with smaller pale markings on head.

REMARKS. *X. australiensis* is easily recognized by its colour pattern, but it is chromatically very similar to a mesostenine, *Gotra gilberti* (Turner). Both species can be found resting on tree trunks in rain forest and they are not easily distinguished in the field. However, *X. australiensis* and *G. gilberti* are quite unlike in detailed morphology (Gauld, 1984). The *Gotra* species can be distinguished by its wedge-shaped areolet and simple female flagellum. *Xorides* lacks an areolet and the female has a subapical angulation in the flagellum. *X. australiensis* is apparently the most common Australian xoridine and is widely distributed in Queensland and south into northern New South Wales.

HOST RECORDS. None.

MATERIAL EXAMINED

**Australia:** 1 ♀ (holotype of *australiensis*), 'New South Wales' (TM).

**Australia:** 1 ♀, Queensland, Brisbane, xi.1976 (*Bouček*) (BMNH); 1 ♀, Brisbane, Long Pocket, 1977 (*Galloway*) (BMNH); 1 ♂, Bundaberg, Baldwin Swamp, ii.1973 (*Frauca*) (ANIC); 2 ♀, Mt Glorious, xii.1976 (*Bouček*) (BMNH); 1 ♀, Mt Tambourine, i.1936 (*Hacker*) (BMNH); 1 ♀, Mt Tambourine, x-xi.1978 (*Galloway*) (BMNH); 3 ♀, Watalgan Rg., ix-xii.1972, v.1974 (*Frauca*) (ANIC).

***Xorides (Cyanoxorides) crudelis* (Turner)**

*Xylonomus crudelis* Turner, 1919: 553. Holotype ♀, AUSTRALIA (BMNH) [examined].

*Xorides (Cyanoxorides) crudelis* (Turner) Townes & Townes, 1960: 494.

Fore wing length 12–14 mm. A weakly polished species with fine punctures laterally on gaster, dorsally almost impunctate. Propodeum with carinae rather weak and irregular with numerous subsidiary radiating carinulae; lateral areae punctate with scattered rugae. Gaster almost matt, tergite 1 centrally punctate, posteriorly becoming puncto-reticulate.

Female black with flagellar band, face, upper orbits, genae in part, marks on vertex, much of pronotum, mesopleuron and propodeum laterally, tergite 1 anteriorly and posteriorly and tergites 2+ posteriorly, white-marked. Legs orange, all coxae white-marked; hind trochanteral segments, distal 0.2 of hind femur, distal 0.4 of hind tibia and hind tarsal segment 5 blackish, remainder of hind tarsus white. Male unknown.

REMARKS. *X. crudelis* can be easily separated from *australiensis* by the striped black and white gaster. It is a rather uncommon insect and possibly restricted to northern Queensland.

HOST RECORDS. None.

MATERIAL EXAMINED

**Australia:** 1 ♀ (holotype), Queensland, Kuranda (*Turner*) (BMNH).

**Australia:** 1 ♀, Queensland, 6 km S. Daintree, in rain forest, x.1966 (*Taylor*) (ANIC); 1 ♀, Gordonvale, 1919 (BMNH).

*Xorides (Cyanoxorides)* species 1

Fore wing length 4 mm. A shining species with alitrunk dorsally rather coarsely punctate, laterally finely but strongly punctate. Propodeum with carinae very strong, sharply raised, without carinulae, and delineating regular areas; lateral areas smooth with few scattered rugae. Gaster weakly polished, tergite 1 centrally puncto-reticulate, posteriorly tending to obsolescent striations.

Male with head black, face, upper orbits and genae white-marked; flagellum unicolorous blackish; alitrunk and gaster orange-brown, only distal margin of tergite 7 whitish. Legs brownish orange, all tibiae distally infuscate; hind femur with distal 0.1 blackish, hind basitarsus proximally and tarsal segment 5 black, remainder of tarsus white.

**REMARKS.** The single specimen known is a male. Considering the chromatic differences it is unlikely to be the unknown male of *crudelis* although structurally the species are fairly similar. I have avoided formally naming the species until a female is collected when proper comparison may be made with other Australian species.

**HOST RECORDS.** None.

**MATERIAL EXAMINED**

**Australia:** 1 ♂, Queensland, Shipton's Flat (15°47'S; 145°14'E), x.1980 (*Cardale*) (ANIC).

## Subfamily ACAENITINAE

The Acaenitinae is a moderately large subfamily, but often one of the most poorly represented in general collections. The majority of species are moderately large insects and the females have a conspicuous long ovipositor. They are usually brightly coloured and are amongst the most striking of all ichneumonids. Acaenitines are parasites of wood-boring insect larvae, particularly those of Coleoptera (Townes & Townes, 1962), and most species appear to be restricted to forest habitats.

The subfamily is divided into two tribes, the Coleocentrini and the Acaenitini. The latter is represented in Australia by a single genus, *Yezoceryx*.

**Zoogeography**

The Coleocentrini comprises seven small genera most of which are restricted to the Palaearctic region. Two, *Coleocentrus* and *Mesoclistus*, are represented in North America. The former also occurs in the mountains on the Palaearctic/Oriental interface (Townes, 1971b). The Acaenitini comprises 18 genera and includes most species of the subfamily. All genera occur in the Old World although three, *Arotus*, *Spilopteron* and *Yezoceryx*, are also represented in North America. The former extends as far south as about 15°N but otherwise acaenitines are absent from the Neotropical region. The greatest diversity of species appears to be in everwet South East Asia and one genus in particular, *Yezoceryx*, is very large. A recent series of short collecting trips to Brunei yielded over 20 species of *Yezoceryx*, most of which were represented by single specimens. *Yezoceryx* seems to be very closely related to the Afrotropical genus *Phorotrophus*; the former is probably paraphyletic with respect to the latter. Several species of *Yezoceryx* occur in New Guinea and in the present work six are believed to occur in Australia. Almost certainly the group has spread rather recently to Australia from Asia.

**Biology**

Virtually nothing is known about the biology of acaenitines except that they are parasites of wood-boring holometabolous insect larvae. The most usual hosts appear to be Coleoptera, but there are records from Sesiidae and Siricidae (Aubert, 1969). It is not known for certain whether acaenitines are endo- or ecto-parasites. Townes (1969: 34) includes them in his 'section II' (internal parasites) together with such known endoparasitoids as Diplazontinae, Anomaloniinae, Metopiinae, Collyriinae and Ichneumoninae. However, Aubert (1969) states that several European species are 'sans doute ectoparasite larvaire'. Neither author actually says on what evidence his statement is based and both Townes, in later works (e.g. 1971b), and other authors who have examined larval remains (e.g. Short, 1978) have conspicuously avoided stating

whether they are ecto- or endoparasites. Observations appear to have been made only on final instar larvae found with host remains (Baumann, 1927, 1933; Finlayson, 1970).

Several features suggest acaenitines may be endoparasitic.

1. The ovipositor tip is rather unspecialized and shows little difference between closely related species. Those of many ectoparasites differ strikingly.
2. The ovaries usually contain relatively large numbers of rather small mature oocytes. Iwata (1960) gave an average value of 46 for Japanese Acaenitini and stated 'in comparison with its body size the mature egg of this group is generally small in size . . .'. Endoparasites generally have larger numbers of smaller eggs than similar-sized ectoparasites.
3. The mandibles of the final instar larvae are rather small and simple. Those of many ectoparasites are large and often denticulate. The general form of the cephalic capsule of the final instar larva is quite different from that of most ectoparasites (Short, 1978). This evidence is of course circumstantial and the controversy will not be settled until firm biological observations are made.

**YEZOCERYX** Uchida

*Yezoceryx* Uchida, 1928: 25. Type-species: *Yezoceryx scutellaris* Uchida, by original designation.

Small to moderately large insects, fore wing length 6–15 mm; occipital carina complete across midline. Propodeum with some carinae but generally with area superomedia and area petiolaris confluent. Tarsal claws with a small to large accessory tooth near apical tooth. Fore wing lacking 3*r*–*m*. First sternite with a weak to strong ventral swelling, the swelling without conspicuous hairs. Female subgenital plate large, in profile triangular and extended posteriorly; ovipositor apex without a notch.

REMARKS. *Yezoceryx* is a large genus with numerous species in the Indo–Australian region, several in the eastern Palaearctic and one in North America. Gauld (1984) suggested seven species occur in Australia but re-examination of initial sorting and some progress in associating sexes has reduced the number to five or possibly six, the putative sixth being only known from males.

Three of the species, *Y. amaryllyx*, *Y. coelyx* and species A, are closely related and form an endemic Australian species-complex. *Y. apicipennis* belongs to a monobasic species-group whilst the remaining two species, *Y. tantalyx* and *Y. dinyx*, appear to be closely related to some undescribed Indo–Papuan species.

**Key to Australian species of *Yezoceryx***

- |   |   |                                      |
|---|---|--------------------------------------|
| 1 | Females; ovipositor projecting far beyond apex of gaster .....  | 2                                    |
| – | Males .....   | 6                                    |
| 2 | Posteroventral margin of hind trochantellus raised into a slightly protruding crest (Fig. 104); lower valve of ovipositor with two weak teeth, widely separated from each other and distant from the distal teeth (Fig. 103); clypeus with a strong transverse ridge above median tooth; tergites 1–7 yellow and blackish-banded .....  | <i>tantalyx</i> sp. n. (p. 326)      |
| – | Posteroventral margin of hind trochantellus simple; lower valve of ovipositor with teeth only at distal apex, or teeth not discernible; clypeus without a transverse ridge, or if ridge present it is absent above median tooth or the median tooth projects from a ridge; tergites 1–7 usually unicolorous, if yellow and black banding is present then it is not on tergite 1 ..... | 3                                    |
| 3 | Ovipositor very long, projecting beyond apex of gaster by 2.6 times length of hind tibia; ovipositor sheath dark-coloured with a white subapical band; distal 0.3 of flagellum pale yellow, remainder brown; metapleuron closely and coarsely punctate .....  | <i>dinyx</i> sp. n. (p. 326)         |
| – | Ovipositor projecting beyond apex of gaster by 2.2 or less times length of hind tibia; ovipositor sheath blackish with extreme distal apex pale; flagellum blackish, brown-marked on proximal 2 or 3 and the extreme distal segments only; metapleuron sparsely punctate or closely and finely punctate .....   | 4                                    |
| 4 | Ovipositor projecting beyond apex of gaster by approximately 1.0 times length of hind tibia, the apex of the upper valve bearing weak teeth (Fig. 102); gaster black with white spots on hind margins of tergites; mesopleuron with sparse scattered punctures; sternite 1 with a weak blunt protuberance (Fig. 101).....   | <i>apicipennis</i> (Turner) (p. 324) |

- Ovipositor projecting beyond apex of gaster by approximately 2.0 times length of hind tibia, the apex simple; gaster almost entirely ochre-yellow; mesopleuron moderately closely punctate; sternite 1 with a strong pointed protuberance (Fig. 100)..... 5
- 5 Metapleuron finely and closely punctate, the punctures tending to be oval and form lines, thus creating impression of striations; mesoscutum yellow with a small black mark in middle of central lobe; submetapleural carina strongly expanded anteriorly, but centrally without a small tooth (Fig. 105)..... *amaryllyx* sp. n. (p. 324)
- Metapleuron with scattered fine punctures; mesoscutum yellow with a large black mark on both lateral and central lobes; submetapleural carina expanded anteriorly but with a small tooth centrally (Fig. 106)..... *coelyx* sp. n. (p. 325)
- 6 Tergite 1 of gaster black; flagellum orange; metapleuron with irregular wrinkles posteriorly ..... *apicipennis* (Turner) (p. 324)
- Tergite 1 of gaster yellow or predominantly yellow; flagellum blackish; metapleuron posteriorly punctate ..... 7
- 7 Gaster yellow with tergites 2-7 black-marked near anterior end ..... species A (p. 327)
- Gaster entirely yellow ..... 8
- 8 Face laterally with punctures close, tending to form striae radiating to centre; mesoscutum with three black marks ..... *coelyx* sp. n. (p. 325)
- Face laterally with punctures discrete, without any trace of striae; mesoscutum with a small central black spot..... *amaryllyx* sp. n. (p. 324)

### *Yezoceryx amaryllyx* sp. n.

(Fig. 105)

Fore wing length 11-15 mm. Orbits moderately strongly, divergent ventrally; face with coarse close punctures, without striae ventrolaterally; clypeus quite blunt, without a transverse ridge above the median apical tooth; labrum slightly bilobate; mandibles quite stout, striate, the lower tooth about 1.3 times as long as the upper; malar space 0.70-0.85 times as long as basal mandibular width, genal sulcus moderately strongly impressed. Distal end of flagellum almost parallel-sided, apically rounded. Epicnemium and lower part of mesopleuron with close fine punctures that tend to be arranged in rows suggesting striae; metapleuron similar but with striae pronounced; submetapleural carina narrow, strongly expanded anteriorly (Fig. 105). Propodeum with anterior and posterior transverse carinae developed as lateral crests, the area between them concentrically striate. Hind trochantellus unspecialized. Fore wing with  $2r-m$  generally more than 2.0 times length of  $M$  between  $2r-m$  and  $2m-cu$ , often with a slight angulation near top; hind wing with distal abscissa of  $Cu_1$  slightly curved. Sternite 1 in midline reaching about 0.6 of way to spiracles, with a strong, flattened very acutely pointed protuberance. Ovipositor projecting beyond apex of gaster by 2.0-2.1 times length of hind tibia, its apex with fine inconspicuous teeth.

Female and male yellow-ochre, flagellum black with first two segments orange-marked, mesoscutum with a small black mark centrally; proximal end of hind femur, distal apex of hind tibia and hind tarsus blackish; ovipositor sheath blackish, proximally and distally paler. Wings slightly infumate, fore wing with distal apex strongly infumate.

REMARKS. This species is very similar to *Y. coelyx* both in colour and structure. They are the only two Australian acaenitines that are predominantly yellow. *Y. amaryllyx* can be separated from *coelyx* not only by the differences given in the key but also in being slightly larger and 'more robust'.

*Y. amaryllyx* is only known from Queensland.

#### MATERIAL EXAMINED

Holotype ♂, Australia: Queensland, Coolangatta, xii.1912 (QM).

Paratypes. Australia: 1 ♀, Queensland, Brisbane, xi.1972 (*Sedlacek*) (TC); 1 ♀, 2 ♂, Moggil, xi-xii. (TC); 1 ♀, Mt Cootha, xi-xii. (TC); 1 ♂, Mt Glorious, i. (TC); 1 ♂, Mt Nebo, ii. (TC).

### *Yezoceryx apicipennis* (Turner)

(Figs 101, 102)

*Chorischizus apicipennis* Turner, 1919: 36. Holotype ♀, AUSTRALIA (BMNH) [examined].  
*Yezoceryx apicipennis* (Turner) Townes *et al.*, 1961: 325.



Fore wing length 6.5–9.5 mm. Orbits barely divergent ventrally; face with coarse sparse punctures, with a slight trace of striation centrally; clypeus with traces of ridge only at lateral extremities, the area above the tooth flat; labrum slightly bilobed apically; mandibles stout, striate, with lower tooth about 1.5 times length of the upper; malar space 0.75 times as long as basal mandibular width; genal sulcus strongly impressed. Distal apex of flagellum slightly clavate. Epicnemium and lower half of mesopleuron with fine very sparse punctures separated by more than twice their own diameters; metapleuron smooth, with very sparse scattered punctures, posteriorly somewhat wrinkled; submetapleural carina narrow, quite strongly broadened anteriorly. Propodeum with anterior transverse carina complete, the posterior transverse carina centrally incomplete, the area between these carinae with a few transverse striae. Hind trochantellus unspecialized. Fore wing with  $2r-m$  1.2 times length of  $M$  between  $2r-m$  and  $2m-cu$ ; hind wing with distal abscissa of  $Cu_1$  curved down near distal end. Sternite 1 very short, in the mid-line reaching only 0.4 of way to level of spiracle, with a rather weak, fairly blunt protuberance (Fig. 101). Ovipositor projecting beyond apex of gaster by 0.9–1.0 times length of hind tibia, its apex bearing about 7 weak teeth on lower valve and about 5 on the upper (Fig. 102).

Female head and alitrunk orange-brown, interocellar area partially, mesoscutum centrally, scutoscute-lar groove, hind end of scutellum, anterior part of propodeum and posterior part of metapleuron blackish; gaster black, tergites 1 and 2 with white spots near hind margin, tergites 3+ with a pair of such spots, tergites 5 and 6 additionally with whitish membranous area present; sternites black, margined with white, the anterior ones almost entirely pale; ovipositor sheath black, extreme distal end slightly paler. Legs orange, hind tarsus infusate. Wings hyaline, the fore wing with an infumate patch only at distal apex. Male similar to female but with protuberance on sternite 1 more pronounced. Dorsal surface of head and alitrunk more extensively dark-marked, propodeum black; pronotum and mesopleuron brownish-marked.

**REMARKS.** This distinctive species is easily recognizable by its short ovipositor and characteristic colour pattern. The wings differ from those of other Australian acaenitines in having shorter, stouter and more sparsely distributed microtrichia, and the ovipositor is unusual in having teeth on the upper valve.

The male herein associated with the female differs strikingly in the colour pattern of the head and alitrunk though that of the gaster is similar. The association of sexes is based on locality, colour pattern of gaster, similarity in punctation of meso- and metapleurae and resemblance in venation.

*Y. apicipennis* is only known from the south-west of Australia; it is the only acaenitine known to occur outside Queensland.

#### MATERIAL EXAMINED

**Australia:** 1 ♀ (holotype), Western Australia, Yallingup, ix.1913 (*Turner*) (BMNH).

**Australia:** 1 ♂, Western Australia, Yallingup, xii.1913–i.1914 (*Turner*) (BMNH); 1 ♀, 70–75 km ENE. Norseman, xi.1978 (*Houston*) (WAM).

#### *Yezoceryx coelyx* sp. n.

(Fig. 106)

Fore wing length 7–10 mm. Orbits moderately strongly divergent ventrally; face with coarse close punctures, these punctures forming rows on lower part of face, giving appearance of radiating striae ventrolaterally; clypeus quite blunt, without a transverse ridge above the median apical tooth; labrum very slightly bilobed or truncate; mandibles moderately slender with lower tooth barely longer than the upper; malar space 0.8–0.9 times as long as basal mandibular width, genal sulcus weakly impressed. Distal end of flagellum not clavate. Epicnemium and lower part of mesopleuron closely punctate, metapleuron with rather superficial moderately sparse fine punctures; submetapleural carina narrow, broadened anteriorly and with a small tubercle just behind centre (Fig. 106). Propodeum with both anterior and posterior transverse carinae present, incomplete, and not strongly rounded into crests, the area between them transversely striate. Hind trochantellus unspecialized. Fore wing with  $2r-m$  1.2–1.5 times as long as abscissa of  $M$  between  $2r-m$  and  $2m-cu$ ; hind wing with distal abscissa of  $Cu_1$  curved. Sternite 1 in midline reaching about 0.7 of way to spiracle of tergite 1, with a strong, flattened, acutely pointed protuberance (Fig. 100). Ovipositor projecting beyond apex of gaster by 2.0–2.1 times length of hind tibia, its apex with fine inconspicuous teeth.

Female and male yellow, antenna black, scape and first flagellar segments yellowish-marked laterally, interocellar area, mesoscutum in three stripes, hind end of scutellum, proximal end of hind femur, distal

end of hind tibia and all hind tarsus, black. Wings almost hyaline, the apex of the fore wing infumate.

REMARKS. This species is similar to *Y. amaryllyx* from which it can be separated by the characters given in the key. It is only known from Queensland.

MATERIAL EXAMINED

Holotype ♀, **Australia**: Queensland, O'Reilly's Guest House, on edge of rain forest, via Canungra, ii-iii.1980 (DPIQ).

Paratypes. **Australia**: 5 ♀, Queensland, Mt Glorious, xii.1976 (*Bouček*) (BMNH); 1 ♀, Mt Glorious, vi.1977 (*Hiller*) (BMNH); 1 ♀, 1 ♂, Mt Glorious, x-xi. (TC); 3 ♂, Mt Tambourine, xi. (TC); 1 ♀, Mt Tambourine, xi.1977 (*Galloway*) (BMNH); 1 ♀, Mt Tambourine, x-ix.1978 (*Galloway*) (BMNH).

*Yezoceryx dinyx* sp. n.

Fore wing length 6 mm. Orbits strongly divergent ventrally; face with coarse shallow punctures, without striae; clypeus with transverse ridge present laterally, centrally absent so part above median tooth is flat; labrum concealed; mandibles weakly tapered, slightly striate, with lower tooth about 1.5 times as long as the upper; malar space 1.0 times as long as basal mandibular width, genal sulcus quite strong. Distal apex of flagellum slightly clavate. Epicnemium and lower part of mesopleuron with very coarse punctures separated by about their own diameter; metapleuron with very coarse scattered punctures; submetapleural carina moderately strong. Propodeum with both anterior and posterior transverse carinae present, widely separated, the area between them rugose. Hind trochantellus unspecialized. Fore wing with  $2r-m$  equal to length of  $M$  between  $2r-m$  and  $2m-cu$ ; hind wing with distal abscissa of  $Cu_1$  curved down near distal end. Sternite 1 reaching virtually to level of spiracle of tergite 1, swollen centrally, the swelling with a sharp edge anteriorly. Ovipositor projecting beyond apex of gaster by 2.6 times length of hind tibia, its apex smooth, without apparent teeth on either upper or lower valves.

Female head blackish, face and postorbital marks yellowish; malar space brownish; antenna blackish brown, scape ventrally yellowish, distal 9 or so flagellar segments bright yellow; alitrunk and gaster blackish brown, hind corners of meso- and metapleurae brownish, scutellum and posterior end of propodeum orange-brown; posterior margins of gastral segments narrowly yellow. Legs orange, hind trochanter, trochantellus, tibia and tarsus infusate. Ovipositor sheath blackish with a white subapical band. Wings hyaline, the fore wing with distal apex and region adjacent to stigma infumate. Male unknown.

REMARKS. *Y. dinyx* is a very distinctive little species on account of the long ovipositor, the white-banded ovipositor sheath and the rather extensive area of coarse punctures, especially on the lateral parts of the alitrunk. The first segment of the gaster is more slender than that of other Australian acenitines and the sternite correspondingly more elongate; the subgenital plate is somewhat shorter than that of other *Yezoceryx* species.

MATERIAL EXAMINED

Holotype ♀, **Australia**: Queensland; Mt Spec, 800 m, iii.1964 (*Common & Upton*) (ANIC).

*Yezoceryx tantalyx* sp. n.

(Figs 103, 104)

Fore wing length 7-12 mm. Orbits strongly divergent ventrally; face coarsely punctate, ventrolaterally arranged in rows giving the effect of striae; clypeus with a strong transverse ridge above the median tooth; labrum almost evenly rounded apically; mandibles moderately strongly tapered, striate, with lower tooth about 1.3 times length of the upper; malar space 0.9-1.0 times as long as basal mandibular width, with a strong genal sulcus. Distal apex of flagellum slightly clavate. Epicnemium and mesopleuron with very close fine punctures separated by about their own diameter; metapleuron fairly uniformly sparsely punctate; submetapleural carina narrow. Propodeum with anterior transverse carina more or less complete, the posterior transverse carina discontinuous but discernible. Hind trochantellus with posteroventral margin raised into a slightly protruding crest (Fig. 104). Fore wing with  $2r-m$  about equal to or shorter than abscissa of  $M$  between  $2r-m$  and  $2m-cu$ ; hind wing with distal abscissa of  $Cu_1$  exceptionally sinuous. Sternite 1 short, reaching about 0.5 of way to spiracle, somewhat swollen, the swelling convexly not angularly rounded. Ovipositor projecting beyond apex of gaster by 2.7-3.1 times length of hind tibia, the ovipositor apex with lower valve bearing two weak teeth, widely separated from each other and distant from the distal teeth, upper valve simple (Fig. 103).

Female head yellow, dorsally black; antenna black, scape ventrally yellow, distal apex of flagellum pallid. Mesoscutum, much of mesopleuron, anterior part of propodeum and metapleuron near insertion of hind coxa brownish, black; pronotum, scutellum, subalar prominence, mesopleuron centrally and ventrally, remainder of propodeum and metapleuron, yellow. Gaster blackish brown with posterior 0.3 of tergite 1, posterior 0.4 of tergites 2-4 and lateral extremities of other tergites yellow; sternites and subgenital plate predominantly yellowish. Legs yellow-brown, anterior two pairs of coxae yellow, hind coxa, tibia and tarsus infuscate; ovipositor sheath blackish. Wings hyaline, fore wing with apex and area adjacent to pterostigma infumate. Male unknown.

**VARIATION.** Two specimens are large (fore wing length *ca* 12 mm) whilst three from the Townes collection are notably smaller (fore wing length *ca* 7 mm). The smaller specimens are slightly more extensively yellow-marked, especially on the mesoscutum and mesopleuron. However, in structure they closely resemble the larger specimens.

**REMARKS.** *Y. tantalyx* is probably the most distinctive Australian *Yezoceryx* on account of the modified hind trochantellus, but it also has a number of other unusual features including the positioning of the ovipositor teeth, the sinuous 1A in the hind wing and the clypeal ridge.

This species is only known from Mt Tambourine, Queensland.

#### MATERIAL EXAMINED

Holotype ♀, **Australia:** Queensland, Mt Tambourine (*Davidson*) (QM).

Paratypes. **Australia:** Queensland, 1 ♀, Mt Tambourine, i.1936 (*Hacker*) (BMNH); 3 ♀, Mt Tambourine, xii. (TC).

### *Yezoceryx* species A

Fore wing length 10-13 mm. Orbits rather weakly divergent ventrally; face coarsely punctate, tending towards being striate lateroventrally; clypeus with margin blunt, without a ridge above median apical tooth; labrum weakly bilobed; mandibles moderately stout, with lower tooth about 1.3 times length of the upper; malar space 0.7 times as long as basal mandibular width, the genal sulcus weak. Distal end of flagellum not clavate. Epicnemium and lower part of mesopleuron closely punctate, metapleuron more sparsely so; submetapleural carina moderately wide, broadened anteriorly and with a small thickening centrally. Propodeum with anterior and posterior transverse carinae represented as crests, not continuous, the area between them transversely striate. Hind trochantellus unspecialized. Fore wing with  $2r-m$  more than 2.0 times length of abscissa of  $M$  between  $2r-m$  and  $2m-cu$ ; hind wing with distal abscissa of  $Cu_1$  curved. Sternite 1 in midline reaching 0.7 of way to spiracle, with a strong flattened, acutely pointed protuberance.

Female yellow, with most of flagellum, scape dorsally, vertex of head, three mesoscutal stripes, scuto-scutellar groove, anterior edges of tergites 2-7 (either as spots or bars) black. Legs yellow, hind femur proximally black, hind tarsus black, hind tibia infuscate. Male unknown.

**REMARKS.** This group of specimens is structurally rather similar to *Y. coelyx*, although it is both larger and has a slightly different colour pattern. It may be merely an extreme 'form' of *coelyx* but for the present it was thought better to treat it as being tentatively distinct until females can be collected. Males of most species of *Yezoceryx* are structurally very similar and difficult to separate.

#### MATERIAL EXAMINED

**Australia:** 3 ♂, Queensland, Stanthorpe, 700 m, i. (TC).

### Subfamily LYCORININAE

This small subfamily is taxonomically rather isolated. Townes (1970) placed it close to the Banchinae, but the characters supporting this association are plesiomorphic features such as the possession of an unspecialized petiole with spiracles placed antecentrally. The egg is most curious, being leech-like and sinuous (Iwata, 1958), quite unlike that of any other ichneumonid. The structure of the cephalic capsule of the final instar larva (Finlayson, 1976; Short, 1978) is unlike that of the Banchinae as the mandibular teeth are denticulate, like those of many species of Tryphoninae and Phygadeuontinae. Unlike these ectoparasitoids the Lycorininae lack a distinct labral sclerite.

Some species have been reared from various Microlepidoptera, most usually pyralids in leaf-rolls (Finlayson, 1976), but no details of the biology of the group are known, not even whether the larva is endo- or ectoparasitic. Were such observations to be made they would be invaluable in helping to place this enigmatic subfamily.

Townes (1970) recognized three closely related genera, but Gauld (1984) treated all species as belonging to a single genus, *Lycorina*.

### *LYCORINA* Holmgren

*Lycorina* Holmgren, 1859: 126. Type-species: *Lycorina triangulifera* Holmgren, by monotypy.

*Toxophoroides* Cresson, 1873: 406. Type-species: *Lycorina? apicalis* Cresson, by original designation.

*Chlorolycorina* Cushman, 1920: 9. Type-species: *Glypta scitula* Cresson, by original designation.

*Gonioglyphus* Seyrig, 1932: 22. Type-species: *Lycorina (Gonioglyphus) fici* Seyrig, by monotypy.

Small to medium-sized insects, fore wing length 3–7 mm; clypeus separated from face by groove, with margin slightly concave medially; mandible bidentate; malar space with an impressed groove running from eye to mandible; frons simple. Occipital carina complete or narrowly interrupted mediodorsally; genal carina joining hypostomal carina above base of mandible. Flagellum cylindrical, unspecialized. Notauli vestigial; sternaulus absent; posterior transverse carina of mesosternum absent. Propodeum with dorso-lateral corner projecting anteriorly and engaging a small hook on the metanotum; propodeum with or without carinae. Fore tibia without a tooth on apical margin; tarsal claws strongly pectinate. Fore wing with  $3r-m$  absent;  $2r-m$  longer than abscissa of  $M$  between  $2r-m$  and  $2m-cu$ ;  $2m-cu$  with one bulla; pterostigma broadly triangular; marginal cell moderately long. Hind wing with first abscissa of  $R_s$  longer than  $r-m$ ; distal abscissa of  $Cu_1$  present or absent. Gaster with tergite 1 broad, dorsally convex with spiracles before the centre, sternite not reaching to spiracles; tergites 2–4 with strongly impressed, striate grooves defining triangular central areas. Female with subgenital plate large, triangular, centrally membranous; ovipositor projecting beyond apex of gaster by 1.15–1.70 times length of hind tibia, its apex with a strong nodus.

*Lycorina* is one of the more distinctive ichneumonid taxa on account of the grooves on tergites 2–4 and their unique propodeal/metathoracic 'catch'. It is a moderate-sized genus with species occurring in almost all zoogeographical regions. Three or perhaps four species occur in Australia. These represent two species-groups, the *turneri*-group with a carinate propodeum and long tarsal pectinae, and the *canberrae*-group with a smooth propodeum and short tarsal pectinae. The latter group resemble the Neotropical species (formerly considered a separate genus, *Toxophoroides*) in the lack of propodeal carinae, but it is not possible to decide whether this results from evolutionary convergence or is indicative of phylogenetic affinity. The *turneri*-group is tropical, and resembles some Indo-Papuan species.

#### Key to species of *Lycorina* occurring in Australia

- 1 Propodeum with distinct carinae, at least with posterior transverse one more or less complete (Figs 107, 108); hind tarsal claw with long pectinae (Fig. 109); ♀ with anterior coxae pale ..... 2
- Propodeum without discernible carinae, rarely with a trace of lateromedian ones anteriorly; hind tarsal claw with short sparse pectinae (Fig. 110); ♀ with all coxae black ..... 3
- 2 Scutellum slightly longer than broad anteriorly, centrally sparsely punctate (Fig. 108); mesoscutum black with two yellow longitudinal stripes; upper end of epomia raised into strong crest; wings hyaline ..... *splendidula* sp. n. (p. 329)
- Scutellum transverse, slightly broader anteriorly than long, centrally smooth, impunctate (Fig. 107); mesoscutum unicolorous orange-brown; upper end of epomia not raised into a strong crest; wings infumate ..... *turneri* sp. n. (p. 330)
- 3 Alitrunk entirely blue-black; head orange, interocellar area black ..... species 1 (p. 330)
- Alitrunk predominantly reddish brown; head dorsally extensively blackish ..... *canberrae* sp. n. (p. 328)

#### *Lycorina canberrae* sp. n.

(Fig. 110)

Fore wing length 5–7 mm. Face moderately strongly convex with a weak median tubercle just below antennal insertion, genal carina joining hypostomal carina well away from base of mandible; occipital carina mediodorsally obsolescent. Pronotum with upper end of epomia raised into a small crest; mesoscutum moderately long, in dorsal view 1.2–1.3 times as long as broad, without discernible notauli,

smooth and shining, virtually impunctate except for minute setiferous punctures anteriorly and anterolaterally; scutellum distinctly broader anteriorly than long, with isolated minute punctures, lateral carinae well developed, reaching about 0.7 of length of scutellum; mesopleuron smooth and polished with isolated fine punctures, posteromedially moderately impressed below speculum; metapleuron polished, with fine sparse punctures, juxtacoxal carina usually complete. Propodeum convex, without carinae, or at very most with only vestiges of lateromedian longitudinal carinae present anteriorly. Hind tarsal claws with short, sparse pectinae (Fig. 110). Gaster with triangular areas defined on tergites 2–4, those on 1 and 5 not complete, the grooves defining these areas all strongly trans-striate; laterotergites 2 and 3 broad, folded under, with strongly pigmented sclerotized central areas; ovipositor projecting beyond apex of gaster by 1.60–1.65 times length of hind tibia; posterior margin of tergite 8 mediodorsally produced to form a blunt process that projects almost as far as cercus.

Female with head blackish, face, mouthparts and marks above eyes yellow, flagellum distally brown; alitrunk orange-brown, margin of pronotum, propleuron and ventral part of metapleuron blackish; gaster black with posterior and often lateral margins of tergites whitish, tergite 1 usually extensively white with central black spot. Legs black, fore and mid femora and tibiae striped longitudinally with pale yellow, tarsi more brownish; ovipositor sheath black, distally pale. Wings infumate, pterostigma brown. Male similar to female but with propodeum extensively black, genae ventrally and fore and mid coxae and trochanters white-marked.

**REMARKS.** This species is easily distinguished from *L. turneri* and *L. splendidula* by the lack of propodeal carinae and indistinct pectinae on the tarsal claws. It is morphologically more or less identical to 'species 1'.

This is the most widely distributed Australian species, occurring in Australian Capital Territory, New South Wales, Queensland, Victoria and Western Australia.

**HOST RECORDS.** None.

**MATERIAL EXAMINED**

Holotype ♀, **Australia:** Australian Capital Territory, Canberra, Black Mt, ix.1981 (*Gauld*) (ANIC).

Paratypes. **Australia:** 1 ♀, New South Wales, Mt Keira, on edge of rain forest, ii.1983 (*Gauld*) (BMNH); 1 ♀, Queensland, Mapleton, x.1967 (BMNH); 1 ♀, Victoria, no further locality data, 1912 (*French*) (BMNH); 1 ♂, Western Australia, 50 km S. Coolgardie, x.1958 (*Riek*) (ANIC).

***Lycorina splendidula* sp. n.**

(Fig. 108)

Fore wing length 3–5 mm. Face moderately convex, without a distinct median tubercle; genal carina meeting hypostomal carina just before base of mandible; occipital carina complete. Pronotum with upper end of epomia raised into a strong tooth; mesoscutum rather long, in dorsal view 1.3–1.4 times as long as broad, with weak notaular indentations and some punctures, in larger specimens the punctures running together to form transverse striae; scutellum slightly longer than broad anteriorly, punctate, with strong lateral carinae; mesopleuron with isolated punctures, posteromedially strongly impressed below speculum; metapleuron almost impunctate with juxtacoxal carina almost complete. Propodeum with small but distinctly defined area superomedia; posterior transverse carina complete (Fig. 108). Hind tarsal claws with long, strong pectinae. Gaster with triangular area defined on tergites 1–5, the grooves transversely striate; laterotergites 2 and 3 narrow, folded under, weakly sclerotized and inconspicuous; ovipositor projecting beyond apex of gaster by 1.15–1.25 times length of hind tibia; posterior margin of tergite 8 dorsally truncate forming a more or less straight line between cerci.

Female yellow; dorsal surface of antenna, frons centrally, vertex, occiput, mesoscutum in three longitudinal vittae, ventral part of mesopleuron and extreme anterior corner of propodeum, black; pronotum centrally, tergites 6+ of gaster, subgenital plate, ovipositor sheath except distal apex, brownish. Wings hyaline; pterostigma brown. Male unknown.

**REMARKS.** This distinctive species is easily recognized by its extensively yellow colour pattern. It is more slender than other Australian lycorinines and has a more strongly sculptured alitrunk and a more rigid gaster with slightly coarse sculpture. It appears to be closely related to *L. turneri* which it resembles in the structure of the claws and carination of the propodeum. *L. splendidula* has a smaller, more completely defined area superomedia than *L. turneri* and differs also in having the genal carina joining the hypostomal carina slightly away from the base of the mandible.

This species occurs in tropical Queensland.

**MATERIAL EXAMINED**

Holotype ♀, **Australia:** Queensland, Cooktown, Mt Cook N.P. (15°29'S; 145°16'E), x.1980 (*Cardale*) (ANIC).

Paratype. **Australia:** 1 ♀, Queensland, Mackay, 1909 (*Turner*) (BMNH).

***Lycorina turneri* sp. n.**

(Figs 107, 109)

Fore wing length 4–6 mm. Face moderately convex, without a distinct median tubercle; genal carina meeting hypostomal carina at base of mandible; occipital carina complete. Pronotum with upper end of epomia slightly raised to form a weak flange; mesoscutum moderately long, in dorsal view 1.1–1.2 times as long as broad, without discernible notauli, smooth and shining, impunctate; scutellum distinctly broader anteriorly than long, with isolated minute punctures, lateral carinae moderately well developed, reaching to near centre; mesopleuron smooth and polished with isolated fine inconspicuous punctures, posteromedially only slightly impressed below speculum; metapleuron smooth with isolated fine punctures, with juxtacoxal carina almost complete. Propodeum with a weakly indicated transverse area superomedial; posterior transverse carina usually complete but other carina may be absent, weakly indicated or in larger specimens distinct (Fig. 107). Hind tarsal claws with long strong pectinae (Fig. 109). Gaster with triangular area defined on tergites 2–4, that of tergites 1 and 5 indistinct, the grooves defining these areas not clearly trans-striate; laterotergites 2 and 3 moderately wide, folded under, weakly sclerotized, inconspicuous; ovipositor projecting beyond apex of gaster by 1.55–1.70 times length of hind tibia; posterior margin of tergite 8 dorsally truncate, forming a more or less straight line between cerci.

Female orange-brown; head black with mouthparts, face except orbits and marks on vertex pale yellow. Gaster with tergites 1 and 2 laterally yellow, 1–5 centrally black, 3+ black also laterally and often also posteriorly except for extreme posterolateral margin which is yellow-marked; ovipositor sheath dark brown, its distal apex paler. Hind leg blackish, coxa dorsally brownish orange. Wings strongly infumate, pterostigma dark brown. Male similar to female but with fore and mid coxae pallid, almost white.

**REMARKS.** The propodeal carination of this species is rather variable but at least the posterior transverse one is distinct, enabling it to be separated from *L. canberrae*. It differs from *L. splendidula* most obviously in colour pattern but the two species also differ in many subtle morphological details as can be seen by contrasting the descriptions.

This species is named in honour of the late R. E. Turner who collected a short series in Kuranda in 1913.

It occurs in tropical Queensland.

**MATERIAL EXAMINED**

Holotype ♀, **Australia:** Queensland, Gap Ck., 5 km ESE. Mt Finnigan (15°50'S; 145°20'E), v.1981 (*Naumann*) (ANIC).

Paratypes. **Australia:** 1 ♂, Queensland, same data as holotype (ANIC); 1 ♀, Mossman, i. (TC); 2 ♀, 1 ♂, Kuranda, 350 m, v–vi.1913 (*Turner*) (BMNH).

***Lycorina* species 1**

Morphologically this is virtually identical to *L. canberrae* though the pleural punctures in the Tasmanian specimens are sparser. It differs strikingly in colour pattern.

Female head orange, interocellar area and proximal part of antenna black, flagellum distally brownish; alitrunk, legs and gaster black, fore and mid femora and tibiae white-striped, segments of gaster broadly infumate, pterostigma dark brown. Male similar to female but with fore and mid coxae and hind tibia white-marked.

**REMARKS.** The characteristic colour pattern occurs in a variety of small temperate Australian Hymenoptera. However, as this group of specimens are so similar to *L. canberrae* I am sceptical that they warrant specific recognition. They do not have a clearly separate range and I have not formally described them pending further study.

**MATERIAL EXAMINED**

**Australia:** 1 ♀, New South Wales, Araluen Hill, 100 m, x.1981 (*Gauld*) (BMNH); 1 ♀, 1 ♂, Tasmania, Coles Bay, ii–iii.1981 (TC).

## Acknowledgements

I thank the Australian Government who, through the agency of ABRS, provided me with a grant to study in Australia. I am particularly grateful to the following Australian entomologists for their help and encouragement in a variety of ways: Dr Ian Naumann and Miss Jo Cardale in Canberra; Dr Ian Galloway, Dr Ted Dahms, Dr Geoff Monteith and Ms Margaret Schneider in Brisbane; Mr Geoff Holloway in Sydney; Mr Dennis Farrugia, Dr Artur Neboiss and Dr Ken Walker in Melbourne; Ms Margaret Williams in Hobart and Dr Terry Houston in Perth. The whole insect figures were drawn by Jonathan Carter and Andrew Atkins. Dr Ian Common and Mr Ted Edwards gave invaluable help concerning Australian Lepidoptera. I am especially grateful to Dr Henry Townes for his comments at various stages in the work and to my colleagues at the BMNH, particularly Dr Mike Fitton, Mr Mick Day, Dr Andy Austin and Dr Gaden Robinson for their helpful discussion of numerous points. Finally I would like to thank Darren Gauld for drawing the maps and Ms Pam Mitchell for collating data, typing the manuscript and checking references.

## References

- Ashmead, W. H. 1900a. Classification of the ichneumon-flies, or the superfamily Ichneumonoidea. *Proceedings of the United States National Museum* **23**: 1–220.
- 1900b. Some changes in generic names in Hymenoptera. *Canadian Entomologist* **32**: 368.
- Askew, R. R. 1971. *Parasitic Insects*. xvii+316 pp. London.
- Aubert, J. F. 1969. *Les ichneumonides ouest paléarctiques et leurs hôtes 1*. 299 pp. Paris.
- Audley-Charles, M. G., Hurley, A. M. & Smith, A. G. 1981. Continental movements in the Mesozoic and Cenozoic. In Whitmore, T. C. (ed.), *Wallace's line and plate tectonics*. 91 pp. Oxford.
- Baltazar, C. R. 1961. The Philippine Pimplini, Poemeniini, Rhyssini and Xoridini (Hymenoptera, Ichneumonidae, Pimplinae). *Monographs of the National Institute of Science and Technology, Manila* **7**: 1–130.
- 1964. *Eriostethus* Morley, and a new polysphinctine genus. *Pacific Insects* **6**: 388–401.
- Barron, J. R. 1975. Provancher's collection of insects, particularly those of Hymenoptera, and a study of the types of his species of Ichneumonidae. *Naturaliste canadien* **102**: 387–591.
- Baumann, C. 1927. Beobachtungen über die Metamorphose der Schlupfwespen *Coleocentrus excitator* Podá und *Ephialtes manifestator* L. *Zeitschrift für Morphologie und Ökologie der Tiere* **9**: 313–332.
- 1933. Zur Kenntnis der Metamorphose von *Ephialtes manifestator*, *Coleocentrus excitator* und *Echthrus reluctator*. *Zoologischer Anzeiger* **102**: 143–155.
- Betrem, J. G. 1932. Eine neue aus Manga-früchten gezüchtete Pimpline (Fam. Ichneumonidae). *Treubia* **14**: 21–28.
- Bosch, R. van den 1964. Encapsulation of the eggs of *Bathyplectes curculionis* (Thomson) (Hymenoptera; Ichneumonidae) in larvae of *Hypera brunneipennis* (Boheman) and *Hypera postica* (Gyllenhal) (Coleoptera; Curculionidae). *Journal of Insect Pathology* **6**: 343–367.
- 1978. *The pesticide conspiracy*. 226 pp. New York.
- Brullé, M. A. 1846. In Lepeletier de Saint-Fargeau, A. L. M., *Histoire naturelle des insectes* 4. Hyménoptères. viii+680 pp. Paris.
- Bruzzese, E. 1982. Observations on the biology of *Pseudopimpla pygidiator* Seyrig (Hym., Ichneumonidae), a parasite of the blackberry stem boring sawfly *Hartigia albomaculatus* (Stein) (Hym., Cephidae). *Entomologist's Monthly Magazine* **118**: 249–252.
- Cameron, P. 1898. Notes on a collection of Hymenoptera from Greymouth, New Zealand, with descriptions of new species. *Memoirs and Proceedings of the Manchester Literary and Philosophical Society* **42**(1): 1–53.
- 1899. Hymenoptera Orientalia: or contributions to a knowledge of the Hymenoptera of the Oriental zoological region, part 8. The Hymenoptera of the Khasia Hills, first paper. *Memoirs and Proceedings of the Manchester Literary and Philosophical Society* **43**(1): 1–220.
- 1902. On the Hymenoptera collected by Mr Robert Shelford at Sarawak, and on the Hymenoptera of the Sarawak Museum. *Journal of the Straits Branch of the Royal Asiatic Society* **37**: 29–140.
- 1903. Description of new genera and species of Hymenoptera taken by Mr Robert Shelford at Sarawak, Borneo. *Journal of the Straits Branch of the Royal Asiatic Society* **39**: 89–181.

- 1905. On some new genera and species of Hymenoptera collected by the Revd. J. A. O'Neill, S.J. chiefly at Dunbrody, Cape Colony. *Records of the Albany Museum* 1: 245–265.
- 1907. Hymenoptera of the Dutch expedition to New Guinea in 1904 and 1905. Part 3. Parasitic Hymenoptera. *Tijdschrift voor Entomologie* 50: 27–57.
- 1911a. Hymenoptera (except Anthophila and Formicidae). *Nova Guinea* 9: 185–248.
- 1911b. On a collection of parasitic Hymenoptera (chiefly bred) made by W. W. Froggatt, in New South Wales, with descriptions of new genera and species. Part 1. *Proceedings of the Linnean Society of New South Wales* 36: 333–346.
- 1912. On a collection of parasitic Hymenoptera (chiefly bred) made by W. W. Froggatt, in New South Wales, with descriptions of new genera and species. Part 3. *Proceedings of the Linnean Society of New South Wales* 37: 172–216.
- Capener, A. L.** 1938. Notes on a spider parasite, believed to be *Colpomeria quadrisculpta* Gr. *Journal of the Society for British Entomology* 1: 209–210.
- Carlson, R. W.** 1979. Family Ichneumonidae. In Krombein, K. V., Hurd, P. D., Smith, D. R. & Burks, B. D., *Catalog of the Hymenoptera in America north of Mexico* 1: 1–1198. Washington.
- Carton, Y.** 1973. Biologie de *Pimpla instigator* F. 1793 [Ichneumonidae, Pimplinae]. *Entomophaga* 18: 25–39.
- Chadwick, C. E. & Nikitin, M. I.** 1976. Records of parasitism in the families Ichneumonidae, Braconidae and Aulacidae. *Journal of the Entomological Society of Australia (N.S.W.)* 9: 28–38.
- Charig, A.** 1981. Cladistics: a different point of view. *Biologist* 28: 19–20.
- Cheesman, L. E.** 1936. Hymenoptera of the New Hebrides and Banks Islands. *Transactions of the Royal Entomological Society of London* 85: 169–195.
- Chrystal, R. N. & Skinner, E. R.** 1931. Studies in the biology of *Xylonomus brachylabris* Kr. and *X. irrigator* F., parasites of the larch longhorn beetle, *Tetropium gabrieli* Weise. *Forestry* 5: 21–33.
- 1932. Studies on the biology of the woodwasp *Xiphydria prolongata* Geoffr. and its parasite *Thalessa curvipes* Grav. *Scottish Forestry Journal* 46: 36–51.
- Clausen, C. P.** 1940. *Entomophagous Insects*. 688 pp. New York.
- Cole, L. R.** 1967. A study of the life-cycles and hosts of some Ichneumonidae attacking pupae of the green oak leaf roller moth, *Tortrix viridana* (L.) (Lepidoptera: Tortricidae). *Transactions of the Royal Entomological Society of London* 119: 267–281.
- Coleman, E.** 1928. Pollination of an Australian orchid by the male ichneumonid *Lissopimpla semipunctata* Kirby. *Transactions of the Entomological Society of London* 76: 533–539.
- Common, I. F. B.** 1954. A study of the ecology of the adult Bogong moth *Agrotis infusa* (Boisd.) (Lep., Noctuidae), with special reference to its behaviour during migration and aestivation. *Australian Journal of Zoology* 2: 223–263.
- Costa, A.** 1864. Descrizione di taluni insetti stranieri all'Europa. *Annali Museo Zoologica della Universite Napoli* 2 (1862): 66–155.
- Cresson, E. T.** 1864. Descriptions of North American Hymenoptera in the collection of the Entomological Society of Philadelphia. *Proceedings of the Entomological Society of Philadelphia* 3: 257–321.
- 1865. On the Hymenoptera of Cuba. *Proceedings of the Entomological Society of Philadelphia* 4: 1–200.
- 1870. Descriptions of new species belonging to the subfamily Pimplariae found in America north of Mexico. *Transactions of the American Entomological Society* 3: 143–172.
- 1873. Descriptions of Mexican Ichneumonidae. *Proceedings of the Academy of Natural Sciences of Philadelphia* 25: 374–413.
- Cushman, R. A.** 1920. The North American ichneumon-flies of the tribes Lycorini, Polysphinctini and Theroniini. *Proceedings of the United States National Museum* 58: 7–48.
- 1926. Some types of parasitism among the Ichneumonidae. *Proceedings of the Entomological Society of Washington* 28: 25–51.
- 1933. Descriptions of new ichneumon-flies with taxonomic notes. *Proceedings of the United States National Museum* 82: 1–16.
- Dalla Torre, C. G.** 1901. *Catalogus Hymenopterorum* 3. vii+1141 pp. Leipzig.
- Danks, H. V.** 1971. Biology of some stem-nesting aculeate Hymenoptera. *Transactions of the Royal Entomological Society of London* 122: 323–399.
- Dumbleton, L. J.** 1932. The apple leaf-roller (*Tortrix postvittana* Walk.). *New Zealand Journal of Science and Technology* 14: 83–92.
- 1940. *Tortrix postvittana* Walk. and its parasites in Australia. *New Zealand Journal of Science and Technology (A)* 21: 322a–336a.
- Enderlein, G.** 1919. Beiträge zur Kenntnis aussereuropäischer Ichneumoniden 4. Einige neue Pimpliden.



- Sitzungsberichte der Gesellschaft Naturforschender Freunde zu Berlin* 1919: 146–153.
- Erichson, W. F.** 1842. Beiträge zur Insekten-fauna von Vandiemensland. *Archiv für Naturgeschichte* 8: 83–287.
- Essig, E. O.** 1926. *Insects of western North America*. ix+1035 pp. New York.
- Fabricius, J. C.** 1793. *Entomologica Systematica*. viii+519 pp. Hafniae.
- 1804. *Systema Piezatorum . . . adjectis synonymis, locis, observationibus*. 439 pp. Brunsvigae.
- Finlayson, T.** 1967. A classification of the subfamily Pimplinae (Hymenoptera: Ichneumonidae) based on final-instar larval characteristics. *Canadian Entomologist* 99: 1–8.
- 1970. The final-instar larval characteristics of *Coleocentrus rufus* (Hymenoptera: Ichneumonidae). *Canadian Entomologist* 102: 905–907.
- 1976. Cephalic structures and spiracles of final-instar larvae of the genus *Toxophoroides* (Hymenoptera: Ichneumonidae: Lycorinae). *Canadian Entomologist* 108: 981–984.
- Fitton, M. G.** 1978. The species of “*Ichneumon*” (Hymenoptera) described by Linnaeus. *Biological Journal of the Linnean Society* 10: 361–383.
- Foerster, A.** 1869. Synopsis der Familien und Gattungen der Ichneumonen. *Verhandlungen des Naturhistorischen Vereins der Preussischen Rheinlande und Westfalens* 25: 135–221.
- 1871. Übersicht der Gattungen und Arten der Plectiscoiden. *Verhandlungen des Naturhistorischen Vereins der Preussischen Rheinlande und Westfalens* 28: 71–123.
- Froggatt, W. W.** 1909. Report on parasitic and injurious insects. *Report of the Department of Agriculture of New South Wales 1907–1908*: 64–65.
- 1910. Friendly insects. *Agricultural Gazette of New South Wales* 21: 334–350.
- Führer, E. & Kilincer, N.** 1972. Die motorische Aktivität der endoparasitischen Larven von *Pimpla turionellae* L. und *Pimpla flavicoxis* Ths. [Hym., Ichneum.] in der Wirtspuppe. *Entomophaga* 17: 149–163.
- Furniss, R. L. & Dowden, P. B.** 1941. Western hemlock sawfly, *Neodiprion tsugae* Middleton, and its parasites in Oregon. *Journal of Economic Entomology* 34: 46–52.
- Gauld, I. D.** 1983. The classification, evolution and distribution of the Labeninae, an ancient southern group of Ichneumonidae (Hymenoptera). *Systematic Entomology* 8: 167–178.
- 1984. *An introduction to the Ichneumonidae of Australia*. 413 pp. London.
- Gilbert, J. M. & Miller, L. W.** 1952. An outbreak of *Sirex Noctilio* in Tasmania. *Australian Forestry* 16: 63–69.
- Girault, A. A.** 1924a. *Lèse majesté, new insecta and robbery*. 1 p. Gympie.
- 1924b. *New insecta from Queensland*. 1 p. Gympie.
- 1925. Records of Australian ichneumon-flies (Hymenoptera). *Insecutor Inscitiae Menstruus* 13: 35–40.
- 1926. A miscellany of new species of the lower Hymenoptera from Australia, with notes. *Insecutor Inscitiae Menstruus* 14: 133–137.
- 1930. *New pests from Australia VIII*. 5 pp. Brisbane.
- Gourlay, E. S.** 1926. *Echthromorpha intricatoria* F. in New Zealand. *Entomologist's Monthly Magazine* 62: 169–171.
- Graham, A. R.** 1947. Feeding of *Pimpla examiner* Ratz. on host pupae exposed for parasitism. *Annual Report of the Entomological Society of Ontario* 1947: 44–45.
- Gravenhorst, J. L. C.** 1820. Monographia ichneumonum Pedemontanae regionis. *Mémoires des Académie Sciences Torina* 24: 275–388.
- 1829. *Ichneumonologia Europaea* 3. 1097 pp. Vratislaviae.
- Guillou, M.** 1841. [Untitled, in Sociétés Savantes.] *Revue Zoologique par la Société Cuvierienne* 1841: 321–325.
- Gupta, S. & Gupta, V.** 1983. The tribe Gabuniini (Hymenoptera: Ichneumonidae). *Oriental Insects Monographs* 10: 1–313.
- Gupta, V. K.** 1961. A revision of the oriental species of the genus *Zaglyptus* (Hymenoptera: Ichneumonidae). *Indian Journal of Entomology* 22: 244–257.
- 1962. Taxonomy, zoogeography and evolution of Indo-Australian *Theronia* (Hymenoptera: Ichneumonidae). *Pacific Insects Monographs* 1: 1–142.
- 1982a. A review of the genus *Perithous*, with descriptions of new taxa (Hymenoptera: Ichneumonidae). *Contributions of the American Entomological Institute* 19(4): 1–20.
- 1982b. A study of the genus *Hybomischos* (Hymenoptera: Ichneumonidae). *Contributions of the American Entomological Institute* 19(5): 1–5.
- Gupta, V. K. & Tikar, D. T.** 1978. *Ichneumonologia Orientalis*, part 1. The tribe Pimplini (Hymenoptera: Ichneumonidae: Pimplinae). *Oriental Insects Monographs* 1: 1–312.

- Habermehl, H.** 1917. Beiträge zur Kenntnis der paläarktischen Ichneumonidenfauna. *Zeitschrift für Wissenschaftliche Insektenbiologie* **13**: 161–168.
- Haldy, A.** 1839. Descriptions of new British insects, indicated in Mr Curtis's guide. *Annals of Natural History* **2** (1838): 112–121.
- Hardy, D. E.** 1982. The role of taxonomy and systematics in integrated pest management programmes. *New Bulletin of the Entomological Society of Queensland* **10**: 19–24.
- Haupt, H.** 1954. Fensterfänge bemerkenswerter Ichneumoniden. *Deutsche Entomologische Zeitschrift* (N.F.) **1**: 99–116.
- Heather, N. W.** 1976. An outbreak of the leaf bagworm *Hyalarcta huebneri* (Westw.) (Lepidoptera: Psychidae) in forest plantations of *Pinus radiata* in Queensland. *Queensland Journal of Agricultural and Animal Sciences* **33**: 145–154.
- Hennig, W.** 1966. *Phylogenetic Systematics*. xiii+263 pp. Urbana, Illinois.
- Holmgren, A. E.** 1859. Conspectus generum Pimpliarum Sueciae. *Öfversigt af Kongliga Vetenskaps-Akademiens Förhandlingar* **16**: 121–132.
- 1868. Hymenoptera. *Kongliga Svenska Fregatten Eugenie's Res omkring jorden Zoologie* **6**: 391–442.
- Howell, J. O. & Pienkowski, R. L.** 1972. Notes on the biology of a spider parasite *Colpomeria kincaidii* Ashmead [Hymenoptera, Ichneumonidae]. *Entomophaga* **17**: 5–7.
- Huffaker, C. B. & Messenger, P. S.** (eds) 1976. *Theory and practice of biological control*. 788 pp. New York.
- Ironside, D. A.** 1974. Biology of *Macadamia* nut-borer (*Cryptophlebia ombrodelta* (Lower)). *Queensland Journal of Agricultural and Animal Sciences* **31**: 201–212.
- Irvine, C. J.** 1962. Forest and timber insects in Victoria, 1962. *Victoria's Resources* **4**: 40–43.
- Iwata, K.** 1958. Ovarian eggs of 233 species of the Japanese Ichneumonidae. *Acta Hymenopterologica Fukuoka* **1**: 63–74.
- 1960. The comparative anatomy of the ovary in Hymenoptera. Part V. Ichneumonidae. *Acta Hymenopterologica Fukuoka* **1**: 115–169.
- 1961. Biological observations on Ichneumonidae. *Acta Hymenopterologica Fukuoka* **1**: 315–325.
- Jussila, R. & Käpylä, M.** 1975. Observations on *Townesia tenuiventris* (Hlmg.) (Hym., Ichneumonidae) and its hosts *Chelostoma maxillosum* (L.) (Hym., Megachilidae) and *Trypoxylon figulus* (L.) (Hym., Sphecidae). *Annales Entomologici Fennici* **41**: 81–86.
- Kamath, M. K. & Gupta, V. K.** 1972. Ichneumonologia Orientalis, Part 2. The tribe Rhyssini (Hymenoptera: Ichneumonidae: Pimplinae). *Oriental Insects Monographs* **2**: 1–300.
- Keeping, M. G. & Crewe, R. M.** 1983. Parasitoids, commensals and colony size in nests of *Belongaster* (Hymenoptera: Vespidae). *Journal of the Entomological Society of Southern Africa* **46**: 309–323.
- Kirby, W. F.** 1837. In Richardson, J., Swainson, W. & Kirby, W. F., *Fauna Boreali-Americana* **4**. xxxiv+325 pp. Norwich.
- 1883. Notes on new or little-known species of Hymenoptera chiefly from New Zealand. *Transactions of the Entomological Society of London* **1883**: 199–203.
- Königsmann, E.** 1978. Das phylogenetische System der Hymenoptera 3. Terebrantes (Unterordnung Apocrita). *Deutsche Entomologische Zeitschrift* (N.F.) **25**: 1–55.
- Kriechbaumer, J.** 1889. Nova genera et species Pimplidarum. *Entomologische Nachrichten* **15**: 307–312.
- 1890. Ichneumoniden-Studien. Neue Ichneumoniden des Wiener Museums. *Annalen des Naturhistorischen Hofmuseums Wien* **5**: 479–491.
- 1892. Xylonomiden und Pimpliden-Studien. Die Xylonomiden-Gattung *Perosis* Frst. und deren mir bekannte Arten. *Pseudacoenites* n.g., Pimplidarum. *Entomologische Nachrichten* **18**: 211–220.
- 1894a. Hymenoptera ichneumonidea a medico nautico Dr Joh. Brauns in itinere ad oras Africae occidentalis lecta. *Berliner Entomologische Zeitschrift* **39**: 43–55.
- 1894b. Hymenoptera Ichneumonidae. *Berliner Entomologische Zeitschrift* **39**: 297–318.
- 1895. Hymenoptera nova exotica Ichneumonidea. *Sitzungsberichte der Naturforschenden Gesellschaft zu Leipzig* **1893/4**: 124–136.
- Krieger, R.** 1899. Über einige mit *Pimpla* verwandte Ichneumonidengattungen. *Sitzungsberichte der Naturforschenden Gesellschaft zu Leipzig* **1897/8**: 47–124.
- 1906. Ueber die Ichneumonidengattung *Theronia* Holmgren. *Zeitschrift für Systematische Hymenopterologie und Dipterologie* **6**: 231–240.
- 1909. Ueber die Ichneumonidengattung *Echthromorpha* Holmgren. *Mitteilungen aus dem Zoologischen Museum in Berlin* **4**: 295–344.
- 1914. Ueber die Ichneumonidengattung *Xanthopimpla* Saussure. *Archiv für Naturgeschichte* **80**(6): 1–148.

- Leius, K.** 1960. The attractiveness of different foods and flowers to the adults of some hymenopterous parasites. *Canadian Entomologist* **92**: 369–376.
- LePelley, R. H.** 1954. *Agricultural Insects of East Africa*. x+307 pp. Nairobi.
- Linnaeus, C.** 1758. *Systema Naturae*. . . Edition 10. ii+1384 pp. Holmiae.
- Madden, J. L.** 1968. Behavioural responses of parasites to the symbiotic fungus associated with *Sirex noctilio* F. *Nature (London)* **218**: 189–190.
- Martyn, E. J., Hudson, N. M., Hardy, R. J., Terauds, A., Rapley, P. E. L., Williams, M. A., Ireson, J. E. & Miller, L. A.** 1977. Insect pest occurrences in Tasmania 1975–76. *Insect Pest Survey* **9**: 1–27.
- Mason, W. R. M.** 1974. An endemic subspecies of *Echthromorpha agrestoria* on Easter Island (Hymenoptera: Ichneumonidae). *Canadian Entomologist* **106**: 935–936.
- Meyer, N. F.** 1934. Schulpfwespen die in Russland in den letzten Jahren aus Schädlingen gezogen sind. *Zeitschrift für angewandte Entomologie* **20**: 611–618.
- Miller, D. & Clark, A. F.** 1935. *Sirex noctilio* (Hym.) and its parasites in New Zealand. *Bulletin of Entomological Research* **26**: 149–155.
- Mocsáry, A.** 1905. Rhyssae sociarumque species in collectione Musei Nationalis Hungarici. *Annales Musei Nationalis Hungarici* **3**: 1–20.
- Momoi, S.** 1966. Some new Ichneumonidae (Hymenoptera) from New Guinea and adjacent areas. *Pacific Insects* **8**: 152–164.
- Morgan, D. & Stewart, N. C.** 1966. The effect of *Rhyssa persuasoria* (L.) (Ichneumonidae) on a population of *Sirex noctilio* F. (Siricidae). *Transactions of the Royal Society of New Zealand* **8**: 31–38.
- Morley, C.** 1909. On the Ichneumonidae of the Banksian collection in the British Museum. *Entomologist* **42**: 131–137.
- 1913a. *A revision of the Ichneumonidae*. . . 2. Tribes Rhyssides, Echthromorphides, Anomalides and Paniscides. ix+140 pp. London.
- 1913b. *The fauna of British India, including Ceylon and Burma*. Hymenoptera 3. Ichneumonidae 1; Ichneumones Deltoidei. 532 pp. London.
- 1914. *A revision of the Ichneumonidae*. . . 3. Tribes Pimplides and Bassides. ix+149 pp. London.
- 1915. In Turner, R. E., Meade-Waldo, G. & Morley, C., *Report on the Hymenoptera collected by the British Ornithologist's Union Expedition and the Wollaston Expedition in Dutch New Guinea*. 112 pp. London.
- Muldrew, J. A.** 1967. Biology and initial dispersal of *Olesicampe (Holocremnus)* sp. nr. *nematorum* (Hymenoptera: Ichneumonidae), a parasite of the larch sawfly, recently established in Manitoba. *Canadian Entomologist* **99**: 312–321.
- Neumann, F. G. & Minko, G.** 1981. The *Sirex* woodwasp in Australian radiata pine plantations. *Australian Forestry* **44**: 46–63.
- Nielsen, E.** 1923. Contributions to the life history of the pimpline spider parasites (*Polysphincta*, *Zaglyptus*, *Tromatobia*) (Hym., Ichneum.) *Entomologiske Meddelelser* **14**: 137–205.
- 1935. A third supplementary note upon the life histories of the polysphinctas (Hym., Ichneum.). *Entomologiske Meddelelser* **19**: 193–215.
- 1937. A fourth supplementary note upon the life histories of the polysphinctas (Hym., Ichneum.). *Entomologiske Meddelelser* **20**: 25–28.
- Nuttall, M. J.** 1973. Pre-emergence fertilization of *Megarhyssa nortoni* (Hymenoptera: Ichneumonidae). *New Zealand Entomologist* **5**: 112–117.
- Parrott, A. W.** 1952. New Zealand Ichneumonidae 2. The tribe Echthromorphini (Pimplinae). *Transactions of the Royal Society of New Zealand* **80**: 155–170.
- 1957. Notes on the host relation of some Australian Ichneumonidae, with a description of a new species. *Memoirs of the National Museum of Victoria* **21**: 79–82.
- Perkins, J. F.** 1942. On a new species of *Ephialtes* parasitizing the codling moth. *Bulletin of Entomological Research* **33**: 171–174.
- 1952. *Echthromorpha* from the Marquesas and Society Islands (Hymenoptera: Ichneumonidae). *Proceedings of the Hawaiian Entomological Society* **14**: 533–536.
- Price, P. W.** 1973. Reproductive strategies in parasitoid wasps. *American Naturalist* **107**: 684–693.
- 1975. In Price, P. W. (ed.), *The evolutionary strategies of parasitic insects and mites*. 244 pp. New York.
- Provancher, L.** 1873. Les ichneumonides de Québec avec description de plusieurs espèces nouvelles. *Naturaliste canadien* **5**: 435–452.
- Puttler, B.** 1961. Biology of *Hyposoter exiguae* (Hymenoptera: Ichneumonidae), a parasite of lepidopterous larvae. *Annals of the Entomological Society of America* **54**: 25–30.
- Rao, S. N.** 1953. Notes on the Indian Ichneumonidae. *Indian Forest Records (Entomology)* **8**: 159–225.

- Riek, E. F. 1970. Hymenoptera. In: *Insects of Australia* xiii+1029 pp. Melbourne.
- Rojas-Rousse, D. & Benoît, M. 1977. Morphology and biometry of larval instars of *Pimpla instigator* (F.) (Hymenoptera: Ichneumonidae). *Bulletin of Entomological Research* **67**: 129–141.
- Roman, A. 1910. Notizen Schlupfwespensammlung des schwedischen Reichsmuseums. *Entomologisk Tidskrift* **31**: 109–196.
- Rosenberg, H. T. 1934. The biology and distribution in France of the larval parasites of *Cydia pomonella* L. *Bulletin of Entomological Research* **25**: 201–256.
- Salt, G. 1968. The resistance of insect parasitoids to the defence reactions of their hosts. *Biological Reviews of the Cambridge Philosophical Society* **43**: 200–232.
- Saussure, H. de 1892. Hyménoptères. In Grandidier, A., *Histoire physique naturelle et politique de Madagascar* **20**. xxi+590 pp. Paris.
- Schmiedeknecht, O. 1907. *Opuscula Ichneumonologica* **15**: 1121–1200.
- Schulz, W. A. 1906. *Spolia Hymenopterologica*. 356 pp. Paderborn.
- 1911. Zweihundert alte Hymenopteren. *Zoologischen Annalen (Würzburg)* **4**: 1–220.
- 1912. Einige Bemerkungen über Schlupfwespen. *Zeitschrift für Wissenschaftliche Insektenbiologie* **8**: 353–354.
- Seyrig, A. 1932. Les ichneumonides de Madagascar 1. Ichneumonidae pimplainae. *Mémoires de L'Académie Malgache* **11**: 1–183.
- Short, J. T. R. 1978. Larvae of Ichneumonidae. *Memoirs of the American Entomological Institute* **25**: 1–508.
- Skaife, S. H. 1921. Some factors in the natural control of the wattle bagworm. *South African Journal of Science* **17**: 291–301.
- Smith, F. 1859. Catalogue of hymenopterous insects collected by A. R. Wallace at the islands of Aru and Key. *Journal and Proceedings of the Linnean Society of London (Zoology)* **4**: 132–178.
- 1863. Catalogue of the hymenopterous insects collected by A. R. Wallace in the islands of Mysol, Ceram, Waigiu, Bouru and Timor. *Journal and Proceedings of the Linnean Society of London (Zoology)* **6**: 6–48.
- 1865. Description of new species of hymenopterous insects from the islands of Sumatra, Sula, Gilolo, Salwatty and New Guinea collected by A. R. Wallace. *Journal and Proceedings of the Linnean Society of London (Zoology)* **8**: 61–94.
- Smith, J. H. & Caldwell, N. E. H. 1947. Army worm and other noctuid outbreaks during 1946–47. *Queensland Agricultural Journal* **65**: 396–401.
- Smithers, C. N. 1956. On *Philopsyche abdominalis* Morley (Hym., Ichneumonidae), a parasite of *Acanthopsyche junodi* Heylaerts (Lep., Psychidae). *Journal of the Entomological Society of Southern Africa* **19**: 225–249.
- Snellen van Vollenhoven, S. C. 1878. Espèces nouvelles ou peu connues d'Hyménoptères térébrants. *Tijdschrift voor Entomologie* **21**: 153–177.
- Sonan, J. 1930. A few host known Ichneumonidae found in Formosa (Hym.) (2). *Transactions of the Natural History Society of Formosa* **26**: 103–107.
- Spradbery, J. P. 1968. A technique for artificially culturing ichneumonid parasites of woodwasps (Hymenoptera: Siricidae). *Entomologia Experimentalis et Applicata* **11**: 257–260.
- 1969. The biology of *Pseudorhyssa sternata* Merrill (Hymenoptera: Ichneumonidae), a cleptoparasite of siricid woodwasps. *Bulletin of Entomological Research* **59**: 291–297.
- 1970. The immature stages of European ichneumonid parasites of siricine woodwasps. *Proceedings of the Royal Entomological Society of London* **45(A)**: 14–28.
- Spradbery, J. P. & Ratkovsky, D. A. 1974. An analysis of geographic variation in the parasitoid *Rhyssa persuasoria* (L.) (Hymenoptera: Ichneumonidae). *Bulletin of Entomological Research* **64**: 653–668.
- Swederus, N. S. 1787. Fortsättning af Beskrifningen på 50 nya species af insecter. *Kungliga Svenska Vetenskapsakademiens Handlingar* **8**: 276–290.
- Széligeti, G. V. 1908. E. Jacobons'sche Hymenopteren aus Semarang. *Notes from the Leyden Museum* **29**: 209–260.
- 1914. Ichneumoniden aus der Sammlung des ungarischen National-Museums. *Annales Musei Nationalis Hungarici* **12**: 414–434.
- Taylor, K. L. 1967. The introduction, culture, liberation and recovery of parasites of *Sirex noctilio* in Tasmania, 1962–67. *CSIRO Division of Entomology Technical Paper* **8**: 1–19.
- 1976. The introduction and establishment of insect parasitoids to control *Sirex noctilio* in Australia. *Entomophaga* **21**: 429–440.
- 1978. Evaluation of the insect parasitoids of *Sirex noctilio* (Hymenoptera: Siricidae) in Tasmania. *Oecologia* **32**: 1–10.

- Temperley, M.** 1930. Life history notes on the banana fruit-eating caterpillar (*Tiracola plagiata* Walk.). *Queensland Agricultural Journal* **33**: 251–261.
- Thunberg, C. P.** 1822. Ichneumonidea, Insecta Hymenoptera illustrata. *Mémoires de l'Académie Impériale des Sciences de Saint Pétersbourg* **8**: 249–281.
- Togashi, I.** 1963. A comparative morphology of the poison glands in the adults of ichneumon-flies (Hym., Ichneumonidae). *Kontyû* **31**: 297–304.
- Tosquinet, J.** 1903. Ichneumonides nouveaux. *Mémoires de la Société Royale Entomologie de Belgique* **10**: 1–402.
- Tothill, J. D.** 1922. The natural control of the fall webworm (*Hyphantria cunea* Drury) with an account of its several parasites. *Bulletin of the Department of Agriculture of Canada, Entomology Branch* **19**: 1–107.
- Townes, H.** 1940. A revision of the Pimplini of eastern North America (Hymenoptera: Ichneumonidae). *Annals of the Entomological Society of America* **33**: 283–323.
- 1958. Hymenoptera: Ichneumonidae, Stephanidae and Evanidae. *Insects of Micronesia* **19**(2): 35–87.
- 1960a. The application of the name *Syene* (Hymenoptera: Ichneumonidae). *Proceedings of the Entomological Society of Washington* **62**: 43.
- 1960b. In Townes, H. & Townes, M., Ichneumon-flies of America north of Mexico: 2, subfamilies Ephialtinae, Xoridinae, Acaenitinae. *Bulletin of the United States National Museum* **216**(2): 1–676.
- 1962. A new generic name in the polysphinctine ichneumonids. *Proceedings of the Entomological Society of Washington*. **64**: 38.
- 1969. Genera of Ichneumonidae 1. *Memoirs of the American Entomological Institute* **11**: 1–300.
- 1970. Genera of Ichneumonidae 3. *Memoirs of the American Entomological Institute* **13**: 1–307.
- 1971a. A review of the Ichneumonidae described by Girault. *Proceedings of the Entomological Society of Washington* **72**: 458–470.
- 1971b. Genera of Ichneumonidae 4. *Memoirs of the American Entomological Institute* **17**: 1–372.
- Townes, H. & Chiu, S.-C.** 1970. The Indo-Australian species of *Xanthopimpla* (Ichneumonidae). *Memoirs of the American Entomological Institute* **14**: 1–372.
- Townes, H., Momoi, S. & Townes, M.** 1965. A catalogue and reclassification of eastern Palearctic Ichneumonidae. *Memoirs of the American Entomological Institute* **5**: 1–661.
- Townes, H. & Townes, M.** 1960. Ichneumon-flies of America north of Mexico: 2, subfamilies Ephialtinae, Xoridinae, Acaenitinae. *Bulletin of the United States National Museum* **216**(2): 1–676.
- 1966. A catalogue and reclassification of Neotropical Ichneumonidae. *Memoirs of the American Entomological Institute* **8**: 1–367.
- Townes, H., Townes, M. & Gupta, V. K.** 1961. A catalogue and reclassification of Indo-Australian Ichneumonidae. *Memoirs of the American Entomological Institute* **1**: 1–522.
- Tryon, H.** 1900. Caterpillar plague. *Queensland Agricultural Journal* **6**: 135–147.
- Turner, R. E.** 1919. Notes on the Ichneumonidae in the British Museum 1. *Annals and Magazine of Natural History* **9**(3): 550–558.
- Uchida, T.** 1928. Dritter Beiträge zur Ichneumoniden-fauna Japans. *Journal of the Faculty of Agriculture of Hokkaido Imperial University* **25**: 1–115.
- Vachal, J.** 1907. Hyménoptères de la Nouvelle-Calédonie. *Revue d'Entomologie, Caen* **26**: 113–123.
- Viereck, H. L.** 1912. Descriptions of five new genera and twenty six new species of ichneumon-flies. *Proceedings of the United States National Museum* **42**: 139–153.
- 1914. Type species of the genera of ichneumon-flies. *Bulletin of the United States National Museum* **31**: 1–186.
- Walkley, L. M.** 1963. The type-species of *Austrapophua* Girault. *Proceedings of the Entomological Society of Washington* **65**: 116.
- Walsh, B. D.** 1873. Descriptions of north American Hymenoptera. *Transactions of the Academy of Sciences of Saint Louis* **3**: 65–166.
- Westwood, J. O.** 1840. *An introduction to modern classification of insects, 2 and synopsis of the genera of British insects*. 587+158 pp. London.
- Wilson, F.** 1960. A review of the biological control of insects and weeds in Australia and Australian New Guinea. *Technical Communication of the Commonwealth Institute of Biological Control* **1**: 1–102.
- Winter, T. G.** 1979. On the biology of *Rhyacionia duplana logaea* Durrant (Lepidoptera: Tortricidae). *Entomologist's Gazette* **30**: 257–265.
- Woldestedt, F. W.** 1877. Ueber eine Sammlung schlesischer Ichneumoniden. *Bulletin de l'Académie des Sciences de Saint Pétersbourg* **22**: 1–402.
- Zondag, R. & Nuttall, M. J.** 1961. *Rhyssa lineolata* (Kirby) (Hymenoptera: Ichneumonidae: Pimplinae). A species new to New Zealand. *New Zealand Entomologist* **2**(6): 40–44.

## Index to hosts

- Achaea janata* 275  
 Agaristidae 270  
*Anomis flava* 271  
*Anomis lyona* 271  
*Anthela acuta* 314  
*Anthela denticulata* 272, 275  
*Anthela xantharcha* 272  
 Anthelidae 241, 270  
*Antheraea astrophela* 314, 315  
*Antheraea saccopoea* 273  
*Antheraea* sp. 314  
 Araneidae 252, 259
- Belonogaster* 246  
 Bombycidae 270  
*Bombyx mori* 272  
 Buprestidae 241
- Cactoblastis* sp. 275  
 Cephidae 242  
 Cerambycidae 241, 316  
*Clania ignobilis* 251  
 Clubionidae 252, 258  
*Cryptophlebia ombrodelta* 271
- Drassodidae 258
- Epicampoptera* 246  
*Epiphyas postvittana* 272, 302  
*Euproctis edwardsi* 272
- Hesperiidae 270  
*Hesperilla chrysotricha* 272  
*Hesperilla donnyssa* 272  
*Hyalarcta huebneri* 251, 272, 315  
*Hyalarcta nigrescens* 251  
*Hyblaea* sp. 246
- Lomera caespitosa* 272  
 Lycaenidae 270  
 Lymantriidae 241, 270
- Merophyas divulsana* 308  
*Mythimna convecta* 275  
*Mythimna separata* 275
- Neodrepta luteotactella* 272  
 Noctuidae 241, 270, 303  
 Nymphalidae 241, 270
- Ogyris olane* 272  
*Oiketicus elongatus* 251  
*Olene mendosa* 272  
*Ornithoptera priamus euphorion* 273
- Papilionidae 270  
*Parnara amalia* 271  
*Pectinophora scutigera* 300  
*Pericyma cruegeri* 315
- Persectania ewingii* 272  
*Phalaenoides glycinae* 272  
 Psychidae 244, 250, 270  
 Pyralidae 245, 303, 328
- Saturniidae 270  
 Sesiidae 241, 321  
*Sirex noctilio* 318, 319  
*Sirex* sp. 317, 318  
 Siricidae 316, 321  
*Spodoptera exempta* 272, 275  
*Spodoptera mauritia* 275  
 Syntexidae 316, 319
- Teia anartoides* 272, 315  
 Tetragnathidae 257  
 Theridiidae 263  
*Tiracola plagiata* 275  
 Tortricidae 242, 270
- Uraba lugens* 308  
*Uroceros* sp. 318
- Vanessa itea* 272
- Xeris* sp. 318  
 Xiphyriidae 316  
 Xyloryctidae 270

## Index to Ichneumonidae

- Invalid names are in *italics*;  
 principal references are in **bold**.
- Acaenitinae 236, 238, **322**  
 Acrodactyla 237, 240, 243, **254**  
 Acropimpla 237, 239, 242, 243,  
**244**, 250  
 agrestoria 237, **270**, 271, 282, 292  
 Alophopimpla 237, 239, 242, 243,  
 268, **269**  
 amaryllyx 238, 289, 323, **324**, 326  
 amon 238, 278, **279**, 283, 284  
 ankhu 238, 278, **279**, 283, 284, 285,  
 299  
*annulipes* 237, 250  
*antherae* 238, 315  
 apicipennis 238, 289, 323, **324**, 325  
 arealis 238, 278, 284, 285, 286, 294,  
 299, 303  
 atra 238, 273, **274**  
*atropos* 237, 246  
 australiensis 238, **321**  
 australis Krieger 238, 279, 285,  
 286, 294, **300**, 304
- australis Townes, Townes & Gupta  
 237, **250**, 290
- barak 238, 278, 284, 285, **300**, 301,  
 306  
*beauforti* 238, 299  
 bicolor 237, **246**, 247, 286  
 bingili 237, 263, **264**, 267, 268, 288  
 binodus 238, 277, 284, **301**, 309  
 biroi 238, **316**, 317
- Camptotypus 237, 239, 240, 242,  
 243, 244, **245**, 246, 247, 248,  
 249
- canberrae 238, 289, **328**, 330  
 carinatus 237, 259, **260**, 289  
*caudata* 238, 305  
 celer 237, **264**, 265, 288  
*cephalotes* 238, 312  
*claripennis* 238, 315  
*clotho* 237, 248  
 coelyx 238, 289, 323, 324, **325**  
*conopleura* 237, 270  
*consimilis* 237, 251
- crassa* 238, 305  
 crenator 237, 250, **251**, 280, 286,  
 290  
 crudelis 238, **321**  
 cursor 237, **255**, 288  
 Cyanoxorides 238, **320**
- dandiensis 237, 264, **265**, 288, 289  
*decem-notata* 238, 274  
 Delomeristini 238, 239, 242, **310**  
 dinyx 238, 323, **326**  
*diversor* 237, 270  
 Dreisbachia 237, 240, 243, 254, **258**  
*dubia* 238, 315  
*duodecem-gutata* 237, 271
- ecaudata 238, 278, 284, 285, 295,  
**302**  
 Echthromorpha 237, 238, 241, 244,  
 268, **269**, 270  
*emaculata* 238, 302  
 Ephialtini 237, 239, 241, 242, 243,  
**244**, 254  
 Epirhyssa 238, 242, 243, **316**

- Eriostethus* 237, 240, 243, 254, **258**, 259, 289  
*excavata* 237, 271  
*excelsa* 238, 273, **274**, 275, 281, 283, 293  
  
*fastigata* 237, 272  
*flaviceps* 237, 248  
*flavolineata* 238, 277, 278, 285, 296, 299, **302**, 303  
*fraterculus* 238, 278, 283, 284, **303**, 304  
*fraucal* 238, 287, 311, **313**, 314  
*fumata* 238, 312  
*fumipennis* 238, 315  
  
*glabrinotum* 237, 252, **253**, 282, 286  
*gracilis* 238, 299  
  
*hiatus* 238, 278, 282, 284, 285, **304**, 308  
*hirsuta* 238, 277, 283, 284, **304**, 305  
*hispida* 238, 302  
*hollowayi* 237, 252, **253**, 286  
*hyaloptila* 238, 302  
  
*immaculata* Krieger 237, 271  
*immaculata* Morley,  
*Echthromorpha* 237, 271  
*immaculata* Morley,  
*Xanthopimpla* 238, 302  
*insidiator* 237, 270  
*interrupta* 237, 270  
*intricatoria* 237, 270, **271**, 272, 276, 282, 292, 311  
  
*kauros* 237, 264, **266**, 288  
*kluia* 237, **269**  
  
*lachesis* 237, 246, **247**, 286, 291  
*Lissopimpla* 238, 239, 243, 268, **273**  
*Lissopimpla* species 1 238, 274, **276**  
*lutea* Dreisbachia 237, **258**  
*lutea* Sericopimpla 237, 250, **252**, 282, 286  
*Lycorina* 238, **328**  
*Lycorina* species 1 238, 328, **330**  
*Lycorininae* 236, 238, **327**  
  
*maculosa* 238, 287, 298, 311, **314**, 315  
  
*maxima* 237, 272  
*maximus* 237, 259, **260**, 261, 281, 288  
*Megarhyssa* 238, 240, 243, 316, **317**, 318  
*melanosoma* 238, 287, **311**, 312  
*melioratorius* 237, 270  
*micans* 237, 255, **256**, 288  
*minimus* 237, 259, **261**, 262  
*minor* 238, 302  
  
*nigricornis* 237, 270, **272**, 282  
*Nomospechia* 238, 310, **311**  
*nortoni* 238, 317, **318**  
  
*obesa* 238, 274, **275**  
*ochracea* 238, 279, 284, 295, 299, **305**  
*ochracea peterseni* 238, 305, 306  
*octo-guttata* 238, 274  
  
*papuana* Cameron, Parema 238, 312  
*papuana* Cameron, Xanthopimpla 238, 299  
*Parema* 238, 310, **312**  
*Parvipimpla* 237, 240, 242, 244, **249**  
*penetrans* 238, 287, 311, **312**  
*perkinsi* 237, 259, **262**  
*persuasoria* 238, 317, 318, **319**  
*petita* 237, **249**  
*phraxos* 237, 264, **266**, 267, 288, 289  
*pilosella* 237, 251  
*Pimplinae* 236, 237, **238**, 240, 241  
*Pimplini* 237, 238, 239, 240, 241, 242, 244, **268**, 314  
*platymischa* 237, 270  
*Polysphinctini* 237, 239, 240, 244, **254**  
*prionemidea* 238, 274  
*pubidorsis* 238, 278, 284, **306**  
*pulcherrimus* 237, 259, 260, 261, **262**, 288  
  
*quadridens* 238, 277, 284, 285, **306**, 307  
*quadrisculpta* 237, 255, **256**, 288  
*quebecensis* 238, 318  
  
*rennefer* 237, 263, 264, **267**, 288, 289  
  
*rhopaloceros* 238, 277, 284, 286, 296, 301, 305, **307**, 308, 309  
*Rhyssa* 238, 241, 243, 316, **318**  
*Rhyssini* 238, 239, 241, **316**  
*rufipes* 238, 274  
  
*scutata* 238, 274, 275, **276**, 283, 293  
*sellatus* 237, 245, 246, **248**, 282, 286, 291  
*semipunctata* 238, 274  
*Sericopimpla* 237, 240, 241, 243, 244, **249**, 250, 254  
*sesamiae* 238, 302  
*similis* 238, 290  
*splendidula* 238, 289, 328, **329**, 330  
*steindachneri* 238, 287, 298, 311, 314, **315**  
*stellata* 237, 263, 264, **267**, 268  
*striata* 237, 270  
*striata* 238, 278, 279, 284, **308**  
*summervillei* 238, 277, 284, 286, 297, 308, **309**  
  
*tantalix* 238, 289, 323, **326**, 327  
*teiae* 238, 315  
*terminalis* 238, 277, 284, 285, 297, **309**, 310  
*Theronia* 238, 239, 240, 242, 243, **310**, 313  
*turneri* 238, 289, 328, 329, **330**  
  
*velata* 237, 263, 267, **268**, 288  
*viridicans* 238, 314  
  
*xantha* 237, **245**, 282  
*xanthostigma* 238, 302  
*Xanthopimpla* 236, 238, 239, 240, 243, 268, **276**, 277, 310  
*xanthopimploides* 238, 307  
*xara* 238, 302  
*Xorides* 238, 319, **320**  
*Xorides* species 1 238, 320, **322**  
*Xoridinae* 236, 238, **319**, 320  
  
*Yezoceryx* 238, 322, **323**  
*Yezoceryx* species A 238, 324, **327**  
  
*Zaglyptus* 237, 239, 240, 243, 244, **252**, 254  
*Zatypota* 237, 240, 243, 254, 259, **263**  
*zekhem* 237, 255, **257**, 288









## **British Museum (Natural History)**

# **Milkweed butterflies: their cladistics and biology**

**P. R. Ackery & R. I. Vane-Wright**

The Danainae, a subfamily of the Nymphalidae, contains only some 150 species, yet aspects of their biology have stimulated far more attention than can be justified by species numbers alone. In recent years, an expansive literature has grown, considering aspects of their courtship and pre-courtship behaviour, migration, larval hostplant associations, mimicry and genetics. The popularity of danaines among biologists can certainly be attributed to this combination, within one small group, of so many of the factors that make butterflies such an interesting group to study. The obvious need to place this wealth of biological data within an acceptable systematic framework provided the impetus for this volume.

Started eight years ago within the conventions of evolution by natural selection and Hennig's phylogenetic systematics, the book is now largely about natural history (what the animals have and do, where they live and how they develop) and natural groups – as revealed by a form of analysis approaching that practised by the new school of 'transformed cladistics'. The authors have prepared a handbook that will appeal to a wide range of biologists, from museum taxonomists to field ecologists.

**424 pp (approx.), 12 pp colour, 73 b/w plates, line and graphic illustrations, maps, extensive bibliography. ISBN 0 565 00893 5. Publication September 1984. Price £50, prepublication price £45.**

## **Titles to be published in Volume 49**

**Afrotropical jumping plant lice of the family Triozidae (Homoptera: Psylloidea).**

By David Hollis.

**The taxonomy of the western European grasshopper of the genus *Euchorthippus*, with special reference to their songs (Orthoptera: Acrididae).**

By D. Ragge & W. J. Reynolds

**An historical review of the higher classification of the Noctuidae.**

By Ian Kitching

**The Pimplinae, Xoridinae, Acaenitinae and Lycorininae (Hymenoptera: Ichneumonidae).**

By I. D. Gauld

**The Palaearctic species of *Ascogaster* (Hymenoptera: Braconidae)**

By T. Huddleston

BRITISH MUSEUM  
LONDON  
7 JULY 84  
PRESENTED

# Bulletin of the British Museum (Natural History)

The Palaearctic species of *Ascogaster*  
(Hymenoptera: Braconidae)

T. Huddleston

Entomology series

Vol 49 No 5

20 December 1984

The *Bulletin of the British Museum (Natural History)*, instituted in 1949, is issued in four scientific series, Botany, Entomology, Geology (incorporating Mineralogy) and Zoology, and an Historical series.

Papers in the *Bulletin* are primarily the results of research carried out on the unique and ever-growing collections of the Museum, both by the scientific staff of the Museum and by specialists from elsewhere who make use of the Museum's resources. Many of the papers are works of reference that will remain indispensable for years to come.

Parts are published at irregular intervals as they become ready, each is complete in itself, available separately, and individually priced. Volumes contain about 300 pages and several volumes may appear within a calendar year. Subscriptions may be placed for one or more of the series on either an Annual or Per Volume basis. Prices vary according to the contents of the individual parts. Orders and enquiries should be sent to:



Publications Sales,  
British Museum (Natural History),  
Cromwell Road,  
London SW7 5BD,  
England.

*World List* abbreviation: *Bull. Br. Mus. nat. Hist.* (Ent.)

© Trustees of the British Museum (Natural History), 1984

The Entomology series is produced under the general editorship of the  
Keeper of Entomology: Laurence A. Mound  
Assistant Editor: W. Gerald Tremewan

ISBN 0 565 06007 4  
ISSN 0524-6431

Entomology series  
Vol 49 No 5 pp 341-392

British Museum (Natural History)  
Cromwell Road  
London SW7 5BD

Issued 20 December 1984

# The Palaearctic species of *Ascogaster* (Hymenoptera: Braconidae)

T. Huddleston

Department of Entomology, British Museum (Natural History), Cromwell Road, London  
SW7 5BD

## Contents

Synopsis .....	341
Introduction .....	341
Biology .....	342
List of host records .....	342
Taxonomic history .....	343
Synonymic list of species .....	344
Taxonomic characters .....	345
Depositories .....	346
Characteristics of subfamily Cheloninae .....	347
<i>Ascogaster</i> Wesmael .....	348
The species-groups .....	348
Key to species .....	348
The <i>semenovi</i> -group .....	352
The <i>caucasica</i> -group .....	353
The <i>abdominator</i> -group .....	357
The <i>annularis</i> -group .....	360
The <i>bidentula</i> -group .....	364
The <i>quadridentata</i> -group .....	371
Species inquirendae .....	380
Excluded species .....	381
Acknowledgements .....	381
References .....	382
Index .....	392

## Synopsis

The cosmopolitan genus *Ascogaster*, which is parasitic on Microlepidoptera, is revised for the Palaearctic zoogeographical region. A key to species is given. Thirty species are recognized; four of them are described as new. Twenty-two synonyms are newly established; one species (*nigrator*) is transferred to *Ascogaster* from *Chelonus* and one (*maculata*) from *Ascogaster* to *Phanerotoma*.

## Introduction

It is imperative that biological studies are founded on a basis of sound taxonomy; the results of such studies are otherwise vitiated. The taxonomy of the Braconidae has been composed piecemeal over the last 200 years or so and relatively few taxa have received comprehensive up-to-date attention. Many taxa therefore need to be completely revised, at least within a single zoogeographical region. This revision is concerned with the Palaearctic species of *Ascogaster*, a chelonine braconid genus.

*Ascogaster* is a cosmopolitan genus parasitic upon Microlepidoptera, principally Tortricidae. *A. quadridentata* has frequently been recorded as a parasite of the codling moth (*Cydia pomonella*) and other pests of fruit trees (see Evenhuis & Vlug, 1983). This species and probably several others merit consideration for use in biological control programmes.

## Biology

Very little work has been done on the biology of *Ascogaster* and, as far as is known, the species are solitary endoparasites of Microlepidoptera, principally Tortricidae. They lay their eggs into the egg of the host and, as van Achterberg (1976: 47) has pointed out, this is clearly an adaptation to the use of hosts whose larvae live in concealment, thereby deriving some protection against the attacks of parasites and predators. In his studies of *Ascogaster quadridentata*, Rosenberg (1934) found that the development of the parasite is slow and its larva is in its first instar when the host larva has completed its development. If the host larva then goes into hibernation the parasite remains within as a first-stage larva, otherwise it passes rapidly through two further instars and emerges from the host to pupate. Rosenberg's work and that of Cox (1932), Boyce (1936) and Allen (1962) are fairly full accounts of the biology of *A. quadridentata* and they also give much information on the larval morphology of the parasite. The larval characteristics of chelonines are discussed in more general terms by Short (1952) and Capek (1970). Host-searching and egg-laying behaviour has recently been studied in *reticulata* parasitic on the smaller tea tortrix (*Adoxophyes* sp.), an important pest of tea in Japan (Kainoh & Tamaki, 1982; Kainoh, Hiyori & Tamaki, 1982).

There are many host records in the literature on *Ascogaster*, collated by Shenefelt (1973). Much of this information, however, is of little value because of doubt about the accuracy of identification of the parasite species involved; undoubtedly host species are also sometimes misidentified. Host data cited here are therefore only from the specimens examined for this revision except for the hosts from which the type-specimens of *reticulata* were reared (as given by Watanabe, 1967: 43). These records are listed below.

## List of host records

Hosts	SPECIES OF <i>Ascogaster</i>
<b>LEPIDOPTERA</b>	
<b>TINEIDAE</b>	
<i>Infurcitinea argentimaculella</i> (Stainton)	<i>grahami</i>
<b>YPONOMEUTIDAE</b>	
<i>Yponomeuta padella</i> (L.)	<i>rufidens, quadridentata</i>
<b>COLEOPHORIDAE</b>	
<i>Coleophora hornigi</i> Toll	<i>armata</i>
<b>OECOPHORIDAE</b>	
<i>Tubuliferola subochreella</i> (Doubleday)	<i>klugii</i>
<b>GELECHIIDAE</b>	
<i>Recurvaria leucatella</i> (Clerck)	<i>annularis</i>
<b>MOMPHIDAE</b>	
<i>Sorhagenia lophyrella</i> (Douglas)	<i>grahami</i>
<b>TORTRICIDAE</b>	
<i>Cydia pomonella</i> (L.)	<i>quadridentata</i>
<i>Cydia funebrana</i> (Treitschke)	<i>quadridentata</i>
<i>Cydia pallifrontana</i> (Lienig & Zeller)	<i>quadridentata</i>
<i>Spilota ocellana</i> (Denis & Schiffermüller)	<i>quadridentata</i>
<i>Epiblema uddmanniana</i> (L.)	<i>quadridentata</i>
<i>Epiblema roborana</i> (Denis & Schiffermüller)	<i>bidentula</i>
<i>Epinotia cruciana</i> (L.)	<i>bidentula</i>
<i>Endothenia gentianaean</i> (Hübner)	<i>dispar</i>
<i>Endothenia quadrimaculana</i> (Haworth)	<i>canifrons</i>
<i>Pandemis corylana</i> (Fabricius)	<i>rufidens</i>
<i>Pandemis cerasana</i> (Hübner)	<i>rufidens</i>
<i>Pandemis heparana</i> (Denis & Schiffermüller)	<i>rufidens, annularis</i>
<i>Pandemis</i> sp.	<i>bidentula</i>
<i>Archips oporana</i> (L.)	<i>reticulata</i>
<i>Archips issikii</i> Kodama	<i>reticulata</i>
<i>Adoxophyes orana</i> (Fischer von Röslerstamm)	<i>reticulata</i>



<i>Archips pulchra</i> (Butler)	<i>reticulata</i>
<i>Croesia bergmanniana</i> (L.)	<i>rufidens</i>
GEOMETRIDAE	
<i>Eupithecia venosata</i> (Fabricius)	<i>bidentula</i>

### Taxonomic history

*Ascogaster* was erected by Wesmael (1835: 226) for 10 species which he described as new. Wesmael also correctly recognized that several of Nees von Esenbeck's species of '*Chelonus*' came within the definition of the new genus but he also included *Chelonus dentata* [= *Phanerotoma dentata*]. This obviously anomalous placement was based upon the examination of only a single specimen and was corrected by Wesmael's (1838: 165) erection of the genus *Phanerotoma* for *dentata*. Wesmael possessed outstanding taxonomic skill and his discrimination of species was always sound even though he worked with few specimens of each species. This was the general practice in the nineteenth century and the results are generally considered to be more or less inadequate when judged by modern standards.

Latreille (1809) was the first to describe (as *Sigalphus*) a species which can be unequivocally assigned to *Ascogaster*. The description would no doubt be adequate to differentiate the species if one had only Latreille's material of the genus available for study. Unfortunately I have been unable to locate Latreille's specimen and the description alone is insufficient for the certain identification of the species. Its interpretation must therefore rest upon inference; this question is discussed in the text upon *rufipes* (Latreille).

Nees von Esenbeck (1816) described (as *Sigalphus*) four species which were subsequently transferred by him (1834) to *Chelonus* and by Wesmael to *Ascogaster*. Three of Nees von Esenbeck's species are certainly identifiable from his descriptions but the other, *similis*, is not.

Curtis (1837) described four species of *Ascogaster*. Fortunately his collection is still available for study and his inadequate descriptions can therefore be interpreted with confidence. One of his species is here considered valid.

Herrich-Schäffer (1838) described (as *Chelonus*) 10 species of *Ascogaster*; his original material appears to be lost and his descriptions are generally difficult to interpret, but Reinhard's paper (see below) is of considerable help in this matter. Two of Herrich-Schäffer's species are here considered valid.

In his revision of *Ascogaster*, Reinhard (1867) described three new species, one of which I consider to be valid. Despite Thomson's (1892: 1715) dismissal of Reinhard's revision as 'unfit for use', it includes much useful information. Reinhard's most significant contribution lies in his redescrptions and placements of species more or less inadequately described by Herrich-Schäffer and Ratzeburg. Reinhard's descriptions are much superior to those of the original authors and were often based on syntypic material which no longer exists. Without Reinhard's paper the placement of many of those species would be difficult, perhaps impossible.

Thomson (1874; 1892) revised the Swedish species of *Ascogaster*, describing nine species as new. However, Thomson appears not to have fully understood Wesmael's species and all his names are here placed in synonymy, except for *lapponicus* which could not be identified.

There have been only two previous attempts to monograph the Palaearctic species of *Ascogaster*. Marshall (*in* André, 1888) and Fahringer (1934) included the genus in their reviews of the Palaearctic braconid fauna. The admirably ambitious scope of these works severely limited their usefulness; neither author was able to give sufficiently rigorous attention to the large number of species involved. Their interpretation of the species was in general based on the descriptions rather than on a critical re-examination of original material. Marshall at least realised that some descriptions were inadequate and this left him unable, for instance, to include Thomson's species of *Ascogaster* in his key. Both Marshall and Fahringer exhibited a too facile acceptance of the significance of any character proposed as a taxonomic discriminant by original authors and made little attempt to search for worthwhile characters. Moreover, Marshall and probably Fahringer worked with small numbers of specimens and this made it impossible for them to assess intraspecific variation. Thus the contribution of these major works to the understanding of the species of *Ascogaster* has been insignificant.

Telenga (1941) revised the *Ascogaster* species of the U.S.S.R.; his taxonomy was much superior to that of Marshall and Fahringer and his work is still useful. Hellén (1953) reviewed the Finnish *Ascogaster* fauna and established two new synonymies.

Graham (1955), in an unpublished doctoral thesis on the European species of *Ascogaster* (and *Chelonus*), was the first worker to approach the subject systematically. His arrangement of the species was based on the examination of a large amount of material, including the critical reappraisal of the available type-specimens. Graham's thesis was considerably superior to previous work on the genus and only Tobias (1976) has produced anything of comparable quality on *Ascogaster* (mainly of the eastern Palaearctic region). However, because Graham's work was never published, his nomenclatorial decisions were never validated. I carried out my revision of the Palaearctic species of *Ascogaster* without first examining his manuscript so as to avoid being influenced when solving taxonomic difficulties. Many of the conclusions at which I have thus independently arrived agree with those reached by Graham. I have, however, ascribed to some species wider limits of variation than did Graham and I have therefore placed in synonymy some names which he regarded as representing valid species, albeit sometimes tentatively.

Isolated descriptions by various authors are scattered throughout the literature (Dahlbom, 1833; Lucas, 1849; Ratzeburg, 1844; 1848; 1852; Ruthe, 1855; Wollaston, 1858; Marshall, 1897; Szépligeti, 1896; 1908; Ashmead, 1906). Many of these authors appear to have had but little understanding of the species.

### Synonymic list of species

#### *semenovi*-group

- excavata* Telenga
- kasachstanicus* Tobias syn. n.
- semenovi* Telenga
- kyushuensis* Yoneda syn. n.

#### *caucasica*-group

- bicarinata* (Herrich-Schäffer)
- mlokossewitchi* Kokujev
- caucasica* Kokujev
- rostrata* Szépligeti
- excisa* (Herrich-Schäffer)
- longiventris* Tobias syn. n.
- kasparyani* Tobias

#### *abdominator*-group

- abdominator* (Dahlbom)
- instabilis* Wesmael
- fulviventris* Curtis
- femoralis* (Herrich-Schäffer)
- rufiventris* (Herrich-Schäffer)
- pallida* Ruthe
- dentifer* Tobias
- punctulator* Kirchner
- nachtshevanica* Abdinbekova

#### *annularis*-group

- annularis* (Nees von Esenbeck)
- exigua* sp. n.
- gonocephala* Wesmael
- grahami* sp. n.
- klugii* (Nees von Esenbeck)
- ruficeps* Wesmael
- neesii* Reinhard syn. n.

#### *bidentula*-group

- albitarsus* Reinhard
- leptopus* Thomson

#### *arisanica* Sonan

- bidentula* Wesmael
- multiarticulatus* Ratzeburg
- gibbiscuta* Thomson syn. n.
- fuscipennis* Thomson syn. n.
- atamiensis* Ashmead syn. n.

#### *consobrina* Curtis

- longicornis* sp. n.
- perkinsi* sp. n.
- rufidens* Wesmael
- rufipes* (Herrich-Schäffer)
- laevigator* (Ratzeburg)

#### *varipes* Wesmael

- cavifrons* Thomson syn. n.
- sternalis* Thomson
- jaroslawensis* Kokujev syn. n.

#### *quadridentata*-group

- armata* Wesmael
- pulchellus* (Curtis)
- esenbeckii* Curtis syn. n.
- luteicornis* (Herrich-Schäffer)
- brevicornis* Wesmael
- monilicornis* (Herrich-Schäffer)
- canifrons* Wesmael
- graniger* Thomson syn. n.
- dispar* Fahringer
- spinifer* Tobias syn. n.
- koslovi* Tobias syn. n.
- quadridentata* Wesmael
- impressus* (Herrich-Schäffer)
- nigricornis* Thomson syn. n.
- cynipum* Thomson syn. n.
- egregius* Kokujev syn. n.
- nigrator* (Szépligeti) syn. n.
- epinotiae* Watanabe syn. n.

*reticulata* Watanabe  
*rufipes* Latreille  
*elegans* (Nees von Esenbeck)  
*fasciatus* (Dahlbom)  
*ratzeburgii* Marshall syn. n.  
*soror* Telenga syn. n.  
*scabricula* (Dahlbom)  
*limitatus* Wesmael syn. n.  
*clypealis* Thomson syn. n.

*contracta* (Ratzeburg)  
*dentiventris* Telenga  
*erythrothorax* Marshall  
*kabystanica* Tobias  
*lapponica* Thomson  
*pallidicornis* Curtis  
*quadridens* (Herrich-Schäffer)  
*rubripes* (Lucas)  
*similis* (Nees von Esenbeck)  
*tersa* Reinhard

SPECIES INQUIRENDAE  
*atriceps* (Ratzeburg)

### Taxonomic characters

**Sexual dimorphism.** A few species of *Ascogaster* show little sexual dimorphism; most, however, exhibit some generally rather subtle differences between the sexes. Female antenna often shorter and broader than that of male, generally with areas of felt-like pubescence on underside of medial flagellar segments. Male antenna generally more copiously covered with hairs and more richly supplied with tyloids than in female. Carapace of female often shorter, broader and more rounded than that of male, with posteroventral rim often closer to apex and therefore less rounded posteroventrally. In several species in which the female has large genitalia the posteroventral rim of the carapace is modified in various ways in order, presumably, to facilitate the extrusion of the ovipositor (e.g. flanged in *excavata*, *semenovi*; emarginate in *annularis*; produced in *kaspanyani*); these characteristics are not present in the males of these species. In many species facial hair of male longer and much denser than in female.

**Ocelli.** Size of ocelli varies little and therefore of limited use in discrimination of species; however, relative positions of ocelli are characteristic at species-group level. Two character-states of the ocellar triangle are defined as follows: where a straight line drawn between the anterior borders of posterior ocelli also touches anterior ocellus, the ocelli are referred to as being 'on line'; where a line between posterior ocelli passes behind anterior ocellus without touching it, the ocelli are referred to as being 'not on line'. Variations in size and protuberance of the eyes are sometimes useful characteristics for differentiation of species; in none, however, do the eyes exhibit a significant degree of convergence.

**Clypeus.** Shape, sculpture and apical armature of clypeus generally of great significance. Apical border of clypeus often bears one or more tubercles which, in some species, are tooth-like. There is little variation within a species in the clypeal tubercles which are therefore of considerable value as a taxonomic character. The dentate clypeal armature is extremely rare in *Chelonus* although a characteristic feature of many species of *Ascogaster*. It appears to be largely confined to the Palaearctic species of the latter genus and is commoner in those of the eastern part of the region.

**Facial hair.** Hair on face generally pointing downwards except for a patch between bases of antennae; in some species, however, the hair points upwards, at least on upper part of face. This characteristic varies little within a species and is of considerable use for differentiation of species-groups. It is more easily seen in males because their facial hair is generally denser than that of females, but it always requires oblique lighting to be properly examined.

**Gaster.** Shape of carapace sometimes varies within a species but nonetheless furnishes useful characters for species differentiation if the possibility of variation is constantly borne in mind. Specimens with a deformed carapace are of not infrequent occurrence. Hypopygium generally small, not projecting beyond apex of carapace, at least in dead specimens. In some species (e.g. *excisa*, *semenovi*) hypopygium large, projecting beyond apex of carapace. Ovipositor in these species generally long and often exerted.

**Genitalia.** In chelonines, the genitalia are often retracted beneath the carapace and are thus difficult to see, particularly in dried specimens. It is difficult to determine the sex of such specimens, especially in those species which exhibit little secondary sexual dimorphism. If a view can be obtained into the carapace, however, the female can be distinguished as such because the hypopygium has a convex apical border whereas the corresponding male sternite is strongly emarginate. Also, the hypopygium often has a medial longitudinal fold revealing the course of the ovipositor beneath. When the latter projects beyond the hypopygium it is usually possible to recognise it because the ovipositor sheaths are nearly always close together and apically rounded, whereas the corresponding structures in the male genitalia are generally widely separated, strongly tapered and curved.

**Colour.** In *Ascogaster*, as in most groups of Braconidae, undue importance has been given to colour-characteristics by many authors. In my opinion differences in colour are not sufficient to differentiate species of *Ascogaster*. Shu-Sheng & Carver (1982) have provided experimental confirmation of the lability of colour in one species of Aphidiinae and have briefly reviewed previous studies of this phenomenon in Parasitica. In some species (e.g. *varipes*, *canifrons*) the carapace of some females is black, in others distinctly banded with yellow at the base. There are no intermediate stages between the two colour-patterns nor any associated morphological discriminants. In *abdominator*, on the other hand, all intermediates between extreme colour-variants occur. Presence or absence of strongly contrasted light-coloured bands on the legs appears to vary but little within a species, though the colour itself is subject to variation; this is therefore a useful characteristic for differentiation of species. Two species in the Palaearctic fauna have predominantly light-coloured heads (*klugii*, *gonocephala*); although there is considerable variation in head-colour within these species it is a useful ancillary character for their identification.

**Wing venation.** In much previous work on *Ascogaster* significance has been ascribed to relatively minor differences in venation. Wharton (1980), writing about Alysiinae, has shown the probability of error inherent in the use of small differences in venation as taxonomic discriminants, and his conclusion is probably equally valid when applied to the chelonines. Yoneda (1978) has analysed and illustrated variation in forewing venation in *semenovi* (= *kyushuensis*).

**Sculpture.** In chelonines, sculpture is more strongly developed than that of other groups of Braconidae. At first sight the taxonomic significance of the sculpture of Cheloninae is obscured by its richness. Differences in sculpture in *Ascogaster*, however, are of considerable significance, particularly at species-group level. Thus sculptural characteristics of face, vertex, mesonotum and mesopleuron are of first importance. Sculpture of the carapace is sometimes useful in the discrimination of species but the differences are generally rather too subtle to be useful taxonomic characters. Presence or absence of rugosity on the hind coxa is sometimes a useful specific character.

The morphological terms used are defined in Richards (1977).

## Depositaries

AS	Academy of Sciences, Leningrad.
BMNH	British Museum (Natural History), London.
CC	Capek collection, Prague.
EH	Haeselbarth collection, Munich.
ELKU	Entomological Laboratory, Kyushu University, Fukuoka.
HNHM	Hungarian Natural History Museum, Budapest.
IP	Institut für Pflanzenschutzforschung, Eberswalde.
IPO	Instituut voor Plantenziektenkundig Onderzoek, Wageningen.
IRSNB	Institut Royal des Sciences Naturelles de Belgique, Brussels.
LC	Lukas collection, Trencin.
MC	Maeto collection, Ibaraki.
MNHN	Museum National d'Histoire Naturelle, Paris.

NCM	Norwich Castle Museum, Norwich.
NMV	National Museum of Victoria, Melbourne.
NM	Naturhistorisches Museum, Vienna.
NR	Naturhistoriska Riksmuseet, Stockholm.
RNH	Rijksmuseum van Natuurlijke Historie, Leiden.
RSM	Royal Scottish Museum, Edinburgh.
SC	Stelfox collection in USNM, Washington.
TC	Townes collection, American Entomological Institute, Ann Arbor.
UEI	Entomological Institute, Hokkaido University, Sapporo.
USNM	[U.S. National Museum] National Museum of Natural History, Washington D.C.
ZC	Zaykov collection, Plovdiv.
ZI	Zoological Institute, The University, Lund.
ZMB	Zoologisches Museum, Humboldt Universität, Berlin.
ZMC	Zoologisk Museum, Copenhagen.

### Characteristics of subfamily Cheloninae

More than 10,000 species of Braconidae have been described and it is probable that there are at least 40,000 species in nature; it is therefore one of the largest families in the Hymenoptera. The Cheloninae, with at least 800 described species, is one of the larger subfamilies of the 22 into which the Braconidae is at present divided (*see van Achterberg, 1976*).

The Cheloninae are distinguished from all other subfamilies of Braconidae by the possession of a complete posterior mesopleural carina. This structure is generally absent in other Braconidae and, when present, is broadly interrupted in front of the mid coxae. All Cheloninae have a heavily sculptured gastral carapace formed by the fusion of tergites 1–3, the remaining parts of the gaster being normally concealed beneath the carapace. This feature occurs in a number of genera in other subfamilies, most of them not closely related to the Cheloninae; these taxa therefore bear a superficial resemblance to the Cheloninae, undoubtedly as a result of convergence. This matter has been dealt with in great detail in an excellent review by Dudarenko (1974). In the Palaearctic region the genera most likely thus to be confused with Cheloninae are *Symphya* (Alysiinae), easily distinguished by its exodont mandibles, *Triaspis* and *Schizoprymnus* (Helconinae sensu van Achterberg, 1976), which have only two submarginal cells in the forewing whereas chelonines have three. In other zoogeographical regions there are genera possessing a gastral carapace also in, for example, Braconinae (*Physaria*), Rogadinae (*Spinaria*), Hormiinae (*Cedria*), Microgasterinae (*Fornicia*, *Buluka*), Opiinae (*Coleopius*), Meteoridiinae (*Urosigalphus*). The gastral carapace is nonetheless a valuable characteristic for the differentiation of Cheloninae if the possible exceptions are borne in mind. Chelonines also always have three submarginal cells in the forewing and the ovipositor is generally not exerted or, if it is, it is most often short and always has a slender needle-like apex. In the majority of species the ovipositor is thick at the base, abruptly narrowed shortly before the apex, short and rarely exerted. In a few species the ovipositor is slender throughout its length and requires but little reduction in breadth to attain a fine point; this type of ovipositor is often exerted. In some species of *Chelonus* the ovipositor is thick at the base, evenly tapered to the apex and often strongly upcurved.

Two groups of genera of the Cheloninae are represented in the Palaearctic region; the *Phanerotoma*-group, in which the carapace is divided by crenulate sutures into three tergites and the body colour is predominantly testaceous, and the *Chelonus*-group, in which the carapace is entire with no trace of sutures (except in occasional deformed specimens) and the body colour is predominantly black. The latter group is represented in the Palaearctic region by two genera, *Ascogaster* and *Chelonus*, which can be distinguished as follows.

- 1 First submarginal cell always divided from first discal cell by vein *Rs+M* (Fig. 2); eyes never conspicuously hairy ..... **ASCOGASTER** Wesmael
- First submarginal cell and first discal cell confluent, vein *Rs+M* never present (Fig. 1); eyes always conspicuously hairy ..... **CHELONUS** Panzer

There are several ancillary characters which are useful in placing some species in the two genera. The clypeus often has apical tubercles in *Ascogaster* but rarely in *Chelonus*. The face is generally strongly rugose in *Chelonus*, sometimes punctate in *Ascogaster*. The hair on the face generally points downwards in *Ascogaster*, upwards in *Chelonus*. The males of some species of *Chelonus* have a supragenital aperture at the apex of the carapace; this characteristic is never present in *Ascogaster*.

### ASCOGASTER Wesmael

*Ascogaster* Wesmael, 1835: 226. Type-species: *Ascogaster instabilis* Wesmael (= *abdominator* (Dahlbom)), by subsequent designation (Foerster, 1862: 244).

*Cascogaster* Baker, 1926: 482. Type-species: *Cascogaster fullawayi* Baker, by original designation. [Synonymized by Watanabe, 1937: 75.]

### The species-groups

The 30 Palaearctic species of *Ascogaster* are here divided into six informal groups based on the sculpture and vestiture of the face and the armature of the clypeus. I have made use of the species-group concept because it has the advantage of being flexible – its limits can be extended or restricted without nomenclatural disturbance. It therefore seems to me to be ideally suited for use in the Braconidae in which the fragmentary knowledge of the species in most genera precludes their sensible division into formal subgeneric units.

The *semenovi*- and *caucasica*-groups have in common a rather slender habitus with long legs and long slender gasters and concomitantly elongate female genitalia. The female carapace is often modified posteroventrally either by the development of bizarre flanges or by the strong depression of this part of the carapace. Two species in the *caucasica*-group do not have such modification of the carapace, but in these species the hypopygium is grossly elongated in *caucasica* and the ovipositor is elongate in *bicarinata*, the least modified species of its group. The males in the two groups have conspicuously more elongate, slender gasters than their females and the male antennae are also considerably more elongate. These species-groups therefore exhibit much stronger sexual dimorphism than is usual. The habitus of the *abdominator*- and *annularis*-groups has certain features in common with the preceding groups. Thus species of the *abdominator*-group are rather slender with elongate legs, though the female carapace is not modified and the ovipositor and hypopygium are short. The degree of sexual dimorphism is therefore less in the *abdominator*-group. All the species of the latter group share the upwardly directed facial vestiture of the *semenovi*- and *caucasica*-groups. The *annularis*-group also consists of species which are rather elongate and slender, but the female carapace is generally but little modified and the hypopygium and ovipositor only moderately elongate. The degree of sexual dimorphism is even less marked in the *annularis*-group than in the *abdominator*-group and only three of the five species of the former group have upwardly directed facial vestiture. The species of the *semenovi*-, *caucasica*-, *abdominator*- and *annularis*-groups are evidently more closely related to each other than to the remaining species of the genus. The *bidentula*- and *quadridentata*-groups of species have in common a generally short, squat habitus with rather short, thick legs, a short, often deep carapace and a short hypopygium and ovipositor. The facial vestiture in these groups is always downwardly directed.

### Key to species

- |   |   |   |
|---|---|---|
| 1 | Ovipositor sheaths broad, flat (Figs 4, 6); ventral opening of carapace strongly narrowed posteriorly and with a strong flange posterolaterally but this not projecting beyond apex of carapace; clypeus with dentate flanges laterally (Fig. 5) or a broad, spatulate medial projection (Fig. 3).....  | 2 |
| – | Ovipositor sheaths not conspicuously broad and flat; if ventral opening of carapace strongly narrowed posteriorly and with a posteroventral flange ( <i>excisa</i> ) then ovipositor sheaths conspicuously slender and flange projecting beyond apex of carapace (Figs 23, 24); clypeus with no dentate flanges laterally or broad spatulate projection medially (except <i>longicornis</i> , cf. Figs 41, 42)..... | 3 |

- 2(1) Clypeus with conspicuous dentate flanges laterally (Fig. 5); carapace more pointed posteriorly (Fig. 6); ovipositor sheaths broader, knife-like (Fig. 6) *semenovi* Telenga (p. 352)
- Clypeus with no dentate flanges laterally but with a broad, spatulate medial projection (Fig. 3); carapace more rounded posteriorly (Fig. 4); ovipositor sheaths less broad, more evenly rounded at apex (Fig. 4)..... *excavata* Telenga (p. 352)
- 3(1) Apical border of clypeus with one or two large dentate tubercles medially (Figs 7–9, 13–15, 17), laterally often strongly reflexed inwards; face always distinctly punctate, never rugose, often reticulate-punctate, sometimes finely reticulate-rugulose; hairs on upper part of face directed upwards ..... 4
- Apical border of clypeus with very small medial tubercles (Figs 37, 51, 54) or with none, or if with a single large, dentate tubercle medially than face strongly irregularly rugose (except *perkinsi*, Fig. 43); hairs on upper part of face directed downwards (except for a small area between bases of antennae), or if occasionally directed upwards, face strongly, transversely rugose (*exigua*, *gonocephala*, *klugii*) ..... 10
- 4(3) Clypeus with a single apical tooth (Figs 7–9); hypopygium short, rarely projecting beyond apex of carapace and then by little (Figs 10–12); hind coxa generally strongly rugose, at least dorsally ..... 5
- Clypeus with two median apical teeth (Figs 13–15, 17): hypopygium generally long, projecting beyond apex of carapace (Figs 20, 22–24) (but generally not in *bicarinata*, Fig. 21); hind coxa generally conspicuously smooth with minute punctures except dorsally reticulate-punctate ..... 7
- 5(4) Apical border of clypeus produced into apical tooth (Fig. 7) strong, dentate tubercle between antennae; face shining, more sparsely punctate; carapace shorter more rounded in lateral view (Fig. 12) ..... *dentifer* Tobias (p. 359)
- Apical border of clypeus truncate (Figs 8, 9); if tubercle present between antennae then it is weak; face matt, reticulate-punctate or rugulose; carapace longer, less rounded in lateral view (Figs 10, 11) ..... 6
- 6(5) Notaulices obsolescent, generally almost indistinguishable from punctures on mesonotum; antenna longer, 33–36 segmented, dilated medially; ovipositor sheaths thicker (Fig. 10) *abdominator* (Dahlbom) (p. 357)
- Notaulices weak but distinct; antenna shorter, 27–30 segmented, not dilated medially; ovipositor sheaths slender (Fig. 11) ..... *nachitshevanica* Abdinbekova (p. 359)
- 7(4) Carapace of ♀ strongly narrowed distally (Fig. 19), strongly flattened dorsoventrally (Fig. 20); finely and regularly reticulate rugose; ♀ hind leg orange-testaceous *kasparyani* Tobias (p. 356)
- Carapace of ♀ not strongly narrowed or dorsoventrally flattened distally, normally rounded (Figs 21–24); more coarsely reticulate rugose, at least anteriorly, the longitudinal element predominant; ♀ hind leg black, only tibia lighter in colour ..... 8
- 8(7) Carapace of ♀ with a bifurcate flange posteroventrally (Figs 23, 24); propodeum broadly impressed medially; hypopygium long, narrow in lateral view (Fig. 23); ovipositor abruptly upcurved distally; labiomaxillary complex not exerted. *excisa* Herrich-Schäffer (p. 355)
- Carapace of ♀ with no bifurcate flange posteroventrally; propodeum not impressed medially; hypopygium shorter, broader (Figs 21, 22); ovipositor evenly and slightly upcurved over its whole length, not abruptly upcurved distally; labiomaxillary complex generally exerted, at least slightly (Figs 15–18) ..... 9
- 9(8) Labiomaxillary complex strongly exerted, labial palps inserted at a point distinctly beyond mandibles (Figs 15, 16); hypopygium generally extruded (Fig. 22), always at least slightly longer than hind basitarsus, often considerably so; genae in face view contracted (Fig. 15), face and clypeus not protuberant, rather straight in profile (Fig. 16) *caucasica* Kokujev (p. 354)
- Labiomaxillary complex weakly exerted, labial palps inserted at a point distinctly behind mandibles (Figs 17, 18), hypopygium generally not extruded, always distinctly shorter than hind basitarsus (Fig. 21); genae in face view more rounded (Fig. 17); face and clypeus protuberant, rounded in profile (Fig. 18) ..... *bicarinata* Herrich-Schäffer (p. 354)
- 10(3) Antenna short, generally less than 30 segments in ♀ (except sometimes in *gonocephala* and in *exigua*); apical border of clypeus rounded, neither produced nor with teeth; carapace rather flat, sometimes with a posteroventral notch (Figs 33, 34); ovipositor slender, long; sheaths slender; radius emitted from distal third of pterostigma (Fig. 25) ..... 11

- Antenna long, generally more than 30 segments in ♀ (except *brevicornis*); apical border of clypeus either produced or with one, two or three teeth (rounded in *varipes*, *reticulata*, *armata*); carapace rounded, generally deep, without posteroventral notch (Figs 60, 61, 69, 70, 74). Ovipositor short, thick, abruptly narrowed shortly before apex; sheaths short, wide; radius generally emitted from about middle of pterostigma (Fig. 2) ..... 15
- 11(10) Face completely irregularly rugose, transverse-striate element often predominating; hairs on upper part of face directed upwards; head generally pale in colour, sometimes completely so except for ocellar triangle, sometimes partly so, rarely completely black ... 12
- Face sometimes punctate, shining, sometimes finely regularly reticulate-rugose; hairs on upper part of face directed downwards (except sometimes between bases of antennae); head always completely black save only occasionally the clypeus ..... 14
- 12(11) Temple straight, strongly contracted, produced posterolaterally into strongly backwardly directed flanges (Fig. 26); vertex rather depressed; strong dentate tubercle between bases of antennae..... *gonocephala* Wesmael (p. 362)
- Temple rounded, not strongly contracted, not produced posterolaterally (Figs 27, 28); vertex convex, not depressed; no tubercle between bases of antennae ..... 13
- 13(12) Carapace in ♀ not conspicuously long and narrow, at most about twice as long as broad, reaching maximum breadth in distal half and roundly tapered to apex (Fig. 35)  
*klugii* (Nees von Esenbeck) (p. 363)
- Carapace in ♀ elongate, narrow, about 2.5 times as long as broad, broadest in proximal third and tapering to apex (Fig. 36)..... *exigua* sp. n. (p. 361)
- 14(11) Carapace of ♀ emarginate posteroventrally (Fig. 34), often tapered and slightly truncate in dorsal view; temple at least equal to eye in dorsal view (Fig. 29); carapace always with two yellow patches at base..... *annularis* (Nees von Esenbeck) (p. 360)
- Carapace of ♀ at most slightly emarginate posteroventrally, rounded in dorsal and lateral view (Figs 31, 32); temple shorter than eye in dorsal view (Fig. 30), strongly contracted; carapace sometimes without yellow patches at base ..... *grahami* sp. n. (p. 362)
- 15(10) Face generally completely smooth, punctate, sculpture of clypeus not contrasting strongly with that of face; face sometimes finely and regularly reticulate-rugose (*varipes*); mesonotum generally predominantly punctate; clypeus rounded apically or produced (Fig. 45) or emarginate (Fig. 42), sometimes with two (Figs 51, 54) or three (Fig. 37) medial teeth, occasionally with one (Fig. 43)..... 16
- Face completely, strongly irregularly rugose, never finely reticulate, sculpture of clypeus often smooth, punctate in contrast to that of face; mesonotum generally coarsely rugose so that notaulices indistinct; clypeus generally produced medially with a single medial tubercle (except in *armata*, *reticulata*), never with more (Figs 62, 72, 79)..... 23
- 16(15) Mandible at base with a deep, semicircular depression (Fig. 38); apical border of clypeus transversely impressed, without medial teeth or excision; hind coxa always strongly, transversely striate, at least in part ..... *varipes* Wesmael (p. 370)
- Mandible at base with a vertical, parallel-sided depression; if apical border of clypeus transversely impressed then medially excised or with teeth or tubercles (Figs 37, 51); hind coxa largely smooth punctate ..... 17
- 17(16) Apical border of clypeus medially with three small but distinct dentate tubercles (Fig. 37); mandible broad, not strongly twisted, ventral border reflexed forward into a distinct flange (Fig. 40); carapace broad, short (Fig. 39)..... *rufidens* Wesmael (p. 369)
- Apical border of clypeus medially with a small excision flanked by two small tubercles (Figs 51, 54), or produced into a blunt point (Fig. 45), or emarginate (Fig. 42); mandible relatively slender, twisted, without a distinct flange on ventral border but often with a carina from between the teeth to the ventral border at base; carapace generally less broad (Figs 44, 53), sometimes longer (Figs 46, 48, 52) ..... 18
- 18(17) Antenna very long, 47–50 segmented; apical border of clypeus broadly shallowly emarginate medially (Fig. 42); mesopleuron dorsally completely coarsely reticulate-rugose, precoxal suture not distinct..... *longicornis* sp. n. (p. 368)
- Antenna shorter, at most 41-segmented; apical border of clypeus medially either excised with two small tubercles or produced (Figs 45, 51, 54); mesopleuron dorsally at least in part smooth, punctate, precoxal suture distinct ..... 19
- 19(18) Carapace elongate, clavate, always broadest in posterior third (Figs 46, 48); apical border of clypeus produced medially, generally without medial excision or tubercles (Fig. 45) ... 20
- Carapace short, broadest at about mid-point (Figs 44, 53), if elongate clavate (Fig. 52) then



- clypeus not produced medially and with a distinct medial excision flanked by two tubercles (Fig. 54) ..... 21
- 20(19) Carapace finely rugose and with a downwardly directed anterior flange (Fig. 47), antenna shorter, 33–34 segmented; hind leg yellow, except coxa at base black, apex of femur and sometimes of tarsus infusate ..... *consobrina* Curtis (p. 367)
- Carapace more coarsely rugose and with anteroventral flange not directed downwards; antenna longer, 37–39 segmented; hind leg dark with base of tibia and of tarsus ivory or pale yellow ..... *albitarsus* Reinhard (p. 364)
- 21(19) Clypeus with a single medial apical tooth (Fig. 43); clypeus not distinctly divided from face; propodeum and carapace finely regularly reticulate-rugose ..... *perkinsi* sp. n. (p. 368)
- Clypeus with two medial apical teeth, generally with a small excision between them (Figs 51, 54); if excision obsolete than medial clypeal border a narrow, spatulate projection, never a medial tooth; clypeus distinctly divided from face; propodeum and carapace more coarsely reticulate-rugose ..... 22
- 22(21) Head massive, distinctly rounded behind eyes (Fig. 49), broader than mesonotum; carapace long (Fig. 52); propodeum long dorsally ..... *arisanica* Sonan (p. 365)
- Head less massive, contracted behind eyes (Fig. 50), about equal in breadth to mesonotum; carapace short (Fig. 53); propodeum short dorsally ..... *bidentula* Wesmael (p. 366)
- 23(15) Antenna very short, 21–23 segmented in female; apical segments of flagellum distinctly separated (Fig. 67) with copious long erect bristles ..... *brevicornis* Wesmael (p. 373)
- Antenna longer, generally more than 30 segmented in female; flagellar segments not distinctly separated and hairs shorter, adpressed ..... 24
- 24(23) Head behind eyes strongly contracted, temples rather straight (Fig. 59); genae in face view contracted, long (Fig. 58); ♀ antenna long, 39–40 segmented ..... *canifrons* Wesmael (p. 374)
- Head behind eyes not strongly contracted, often at least slightly expanded, always rounded (Figs 56, 63, 66, 68, 78) genae in face view rounded (Figs 62, 76, 79); ♀ antenna shorter, 30–36 segmented ..... 25
- 25(24) Interantennal carina strongly raised into an erect triangular flange between scapes (Fig. 57); apical border of clypeus rounded with at most a weak trace of a medial tubercle; propodeum with a weak medial transverse carina which is never raised into strong medial tubercles ..... *armata* Wesmael (p. 372)
- Interantennal carina present but never strongly raised into a triangular flange between scapes; apical border of clypeus produced medially, generally with a strong medial tubercle (except *reticulata*, *scabricula*); propodeum with strongly raised medial tubercles (except *rufipes*) ..... 26
- 26(25) Temple generally equal in length to eye in dorsal view (Figs 63, 66); carapace short, deep in lateral view, posteroventral rim distinctly in front of apex (Figs 60, 61) ..... 27
- Temple generally conspicuously longer than eye in dorsal view, rounded (Figs 68, 78); carapace longer, posteroventral rim less conspicuously in front of apex (Figs 69, 70, 74) .. 28
- 27(26) Apex of clypeus not impressed, produced, with a distinct medial tubercle (Fig. 62); hind tibia pale at base but never with a distinct pale band medially; hind coxa striate dorsally, generally black ..... *quadridentata* Wesmael (p. 376)
- Apex of clypeus transversely impressed, its edge more or less straight with no medial tubercle (Fig. 65); hind tibia with a medial pale-coloured band; hind coxa smooth, punctate dorsally, generally yellow, sometimes infusate at base *reticulata* Watanabe (p. 377)
- 28(26) Carapace rather narrow, almost parallel-sided in dorsal view (Fig. 77), slender in lateral view (Fig. 69); carapace of ♀ pale yellow in proximal third; legs pale, all coxae yellow, at least in part ..... *rufipes* (Latreille) (p. 378)
- Carapace more rounded or tapered in dorsal view (Figs 73, 75), stouter in lateral view (Figs 70, 74); carapace of ♀ always black; legs darker, all coxae black ..... 29
- 29(28) Clypeus not distinctly divided from face, apex with a conspicuous dentate tubercle medially (Fig. 72); mandible produced ventrally at base with no flange beneath *dispar* Fahringer (p. 375)
- Clypeus divided from face by a deep groove, apex forming a blunt point medially but with no dentate tubercle (Fig. 76); mandible not produced ventrally at base, with a flange beneath (Fig. 71) ..... *scabricula* (Dahlbom) (p. 379)

The *semenovi*-group

Face punctate, generally reticulate-punctate, hairs on upper part of face pointing upwards. Clypeus with lateral dentate flanges or a broad medial projection, never with dentate tubercles.

The two species of this group are known only from the eastern part of the Palaearctic region, and are uncommon. They both have unusually stout female genitalia and the posteroventral part of the female carapace is strongly excised and laterally flanged, presumably to facilitate the use of these enlarged organs.

*Ascogaster excavata* Telenga

(Figs 3, 4)

*Ascogaster excavatus* Telenga, 1941: 311. Lectotype ♀, U.S.S.R.: Voronezh, Shipovo, 17.vi.1898 (*Silant'ev*) (AS) [examined]. [Lectotype selected by Tobias.]

*Ascogaster kasachstanicus* Tobias, 1964: 183. Holotype ♂, U.S.S.R.: Kazakhstan, Tselinogr. oblast, 17 km from mouth of river Shapdara, 21.vi.1957 (*Tobias*) (AS) [examined]. **Syn. n.**

The data of the lectotype agree with those cited for one of Telenga's (1941: 312) syntypes of *excavata*. Tobias selected and labelled the lectotype but I have been unable to discover where or whether the designation was published.

The holotype of *kasachstanica*, a male, of course lacks the extremely modified carapace which makes *excavata* so distinctive. Tobias was evidently misled by this extreme dimorphism and so described *kasachstanica* as distinct. The latter species, however, has most of the characteristics which distinguish *excavata* and I have no doubt that they are conspecific. In the original material of *excavata*, Telenga had specimens of this species from Kazakhstan.

♀. Antennae missing. Head contracted behind eyes but not strongly so. Temple about equal in length to eye in dorsal view, not strongly rounded. Ocelli moderately large, OO = 3.0 OD; ocellar triangle acute. Frons behind antennae not strongly excavate, with a strong medial carina from face almost to anterior ocellus. Eyes not strongly protuberant. Face about twice as broad as high, not strongly protuberant, reticulate-punctate. Hair on upper part of face directed upwards and forwards, sparse. Clypeus about twice as broad as high, not strongly protuberant, reticulate-punctate; apical border produced medially into a broad, blunt projection without tubercles. Mandibles long, slender, strongly twisted. Pronotum projects in front of mesonotum; lateral surface smooth anteroventrally with minute punctures, strongly reticulate-rugose dorsally. Notaulices foveolate, rest of mesonotum reticulate-punctate. Precoxal suture distinct, foveolate; rest of mesopleuron densely punctate, dorsally reticulate-punctate except anterodorsally rugose. Propodeum reticulate-rugose. Carapace long, oval, rather pointed distally in dorsal view; posteroventrally rather truncate, the ventral rim only narrowly separated posteriorly and expanded into a strong flange which is deeply notched medially; smooth, shining punctate in distal half, dorsally and anteriorly reticulate-punctate with some weak rugosity. Hypopygium long, narrow, projecting beyond ventral rim of carapace. Ovipositor thick at base, abruptly narrowed shortly before apex; sheaths broad, flat. Hind coxa smooth, punctate.

Colour black; gaster and legs brown except tibiae yellow.

♂. Same as ♀ except carapace narrower and with posteroventral flange less strongly raised, not emarginate medially.

HOSTS. Unknown.

REMARKS. This species is closely related to *semenovi* from which it can be distinguished by the characteristics cited in the key to species. *A. excavata* is conspicuously smooth – no other Palaearctic species of *Ascogaster* has as smooth and punctate a carapace.

*Ascogaster semenovi* Telenga

(Figs 5, 6)

*Ascogaster semenovi* Telenga, 1941: 310. Holotype ♀, MONGOLIA: Alashan, Dyn-juan-in, 23.vi.1908 (*Koslov*) (AS) [examined].

*Ascogaster kyushuensis* Yoneda, 1978: 291. Holotype ♀, JAPAN: Kyushu, Fukuoka Pref., Fukuoka city, Wakozaki, 22.v.1975 (*Yoneda*) (ELKU) [not examined]. **Syn. n.**

Telenga cited data for only one specimen of *semenovi*. I have examined the specimen bearing precisely these data and, agreeing with Telenga's description of *semenovi*, no doubt this specimen is the holotype. It has lost its head but is otherwise well preserved. Yoneda's description and excellent figures of *kyushuensis* are quite sufficient for this species to be identified and the name placed as a synonym of *semenovi*.

♀. Antenna short, 22-segmented. Flagellum dilated medially, strongly tapered to apex, distally serrate beneath; medial segments at least as broad as long, some broader than long, rest of segments distinctly longer than broad but only three basal ones as much as twice as long as broad. Head broad, rounded behind eyes. Temple about equal to eye in dorsal view. Ocelli small, OO = 4OD; ocellar triangle acute. Frons behind antennae moderately depressed, strongly transversely striate-rugose. Eyes moderately protuberant. Genae contracted below. Face slightly protuberant, about twice as broad as high, reticulate-punctate; densely hairy, the hairs on the upper part of face pointing upwards. Clypeus moderately protuberant, densely punctate though slightly less densely than face; apical border rounded medially, without teeth or incision, produced laterally into broad dentate flanges which point forwards and downwards in front of rest of clypeus. Mandible long, twisted, the teeth blunt, broad, not distinctly separated. Pronotum projecting little in front of mesonotum; laterally rugose-foveolate. Notaulices deep, foveolate; rest of mesonotum punctate except where notaulices coalesce in a reticulate-rugose area. Precoxal suture deep foveolate; rest of mesopleuron punctate but with a deep foveolate groove anterodorsally, the anterior end of this groove and middle of precoxal suture joined by a further foveolate groove. Propodeum strongly reticulate-rugose, with a medial transverse carina dividing it into a short dorsal surface and a long posterior surface; the dorsal surface with a medial areola formed by two short medial longitudinal carinae. Carapace long, slender, sharply pointed in dorsal and lateral views, finely reticulate-rugose except posterolaterally polished, punctate; ventral rim strongly converging posteriorly, with a broad flange which is strongly incised medially. Hypopygium very long, projecting beyond ventral rim of carapace. Ovipositor long, broad, abruptly narrowed shortly before apex. Hind coxa smooth, punctate.

Colour black; sternites and legs brown except fore tibia yellow, ovipositor sheaths translucent, pale brown.

♂. Same as ♀ except antenna longer, 27–28 segmented; flagellum less strongly dilated, not distally serrate, all segments longer than broad with copious tyloidae and a conspicuous band of light-coloured hairs at junction of each segment; occipital carina joins genal carina a little way behind mandibles and expanded into a prominent flange beneath base of mandible; ventral rim of carapace not expanded posteriorly into a flange, generally less strongly pointed.

#### MATERIAL EXAMINED

9 ♂, 3 ♀. **Japan:** 7 ♂, Fukuoka city, Hakozaki, 22.v.1978 (*Maetô*) (BMNH; MC); 2 ♂, Fukuoka city, Ohori, 22.v.1976 (*Maetô*) (MC). **Mongolia:** holotype ♀ of *semenovi*; 2 ♀, 'de Cha Tcheou a Kan Tcheou' Nan Chan, north slope, 1000–2000 m, vi.1908 (*Vaillant*) (BMNH; MNHN).

**HOSTS.** Unknown.

**REMARKS.** This remarkable species is easily distinguished by the dentate flanges on its clypeus and by the characteristics of the ovipositor sheaths.

#### The *caucasica*-group

Face punctate, generally reticulate-punctate, hairs on upper part of face pointing upwards. Clypeus medially excised, with two prominent dentate tubercles.

The four species of this group are commoner in the eastern part of the Palearctic region though the range of *excisa* extends as far west as France and that of *bicarinata* to Spain. All species in this group have exceptionally long, slender female genitalia and a large hypopygium. The clypeal teeth are least well developed in *kaspariyani* which also has the most highly modified female carapace of any in the group.

*Ascogaster bicarinata* (Herrich-Schäffer)

(Figs 17, 18, 21)

*Chelonus bicarinatus* Herrich-Schäffer, 1838: 154. Syntypes. GERMANY (lost).*Ascogaster mlukossewitchi* Kokujev, 1895: 78. Holotype ♀, U.S.S.R.: 'Lagodechi' (*Mlukossewitch*) (AS) [examined]. [Synonymised by Szépligeti, 1908: 409.]

Reinhard (1867: 368) redescribed *bicarinata* after having examined Herrich-Schäffer's original material. This detailed redescription is precise and I have based my interpretation of the species upon it. I do not believe that Reinhard could have overlooked the conspicuously exerted labiomaxillary complex of *rostrata* (= *caucasica*) or that he would have failed to mention it had it been present in the syntype of *bicarinata*. I therefore reject Fahringer's (1934: 517) placement of *rostrata* in synonymy with *bicarinata*.

♀. Antenna long, 25–26 segmented. Flagellum generally evenly tapered from base to apex, occasionally slightly dilated medially; all segments considerably longer than broad except terminal three or four which are quadrate. Head broad, distinctly broader than mesonotum, roundly contracted behind eyes. Temple about equal to eye in dorsal view. Occiput deeply concave. Ocelli small, OO = 5.0 OD; ocellar triangle obtuse but ocelli not on line. Frons behind ocelli slightly depressed. Eyes protuberant. Malar space long; genae in face view moderately convex. Face moderately protuberant, slightly less than twice as broad as high, reticulate-punctate, often with some weak rugosity medially; hair on upper part of face points upwards. Clypeus protuberant, slightly less densely punctate than face; apical border folded inwards with two strong dentate tubercles medially. Labiomaxillary complex projecting more or less beneath the head; exerted part never as long as malar space; labial palps inserted behind mandibles. Mandibles long, slender, strongly twisted. Prothorax projecting in front of mesonotum; pronotum dorsolaterally rugose, rest punctate. Notaulices foveolate, coalescing posteriorly in a reticulate-rugose area; rest of mesonotum punctate. Precoxal suture shallow, foveolate; rest of mesopleuron densely punctate except anterodorsally rugose. Propodeum not distinctly divided into dorsal and posterior surfaces; strongly rugose, often the longitudinal rugae predominating; with two weak posterolateral tubercles. Carapace oval, rather flattened; strongly reticulate-rugose, the longitudinal element predominating except distally where the sculpture is weaker and more regular reticulate-rugose. Hypopygium short, not projecting beyond posteroventral rim of carapace; distinctly shorter than basal segment of tarsus. Ovipositor long, thin, gradually tapered, upcurved. Hind coxa smooth, punctate, sometimes with weak rugae dorsally.

Colour black. Carapace sometimes orange-testaceous at base; apex of femur, tibia and tarsus of foreleg, tibia of midleg and medial band of tibia of hindleg testaceous.

♂. Same as ♀ except antenna longer, 30–32 segmented; all flagellar segments distinctly longer than broad, terminal segments not quadrate; carapace more slender in dorsal view, flatter in lateral view; legs darker, generally completely black except for femur at apex and tibia testaceous, occasionally mid and hind tibiae somewhat lighter but never testaceous.

## MATERIAL EXAMINED

32 ♂, 35 ♀. Bulgaria, Greece, Spain, Turkey, U.S.S.R., Yugoslavia.

HOSTS. No reared material examined.

REMARKS. This species is closely similar to *caucasica* with which it has generally been confused. The labiomaxillary complex is often more or less exerted in *bicarinata* but never as strongly as in *caucasica*; the characteristics of the hypopygium, ovipositor and head that are cited in the key serve amply to differentiate the two species. Both *bicarinata* and *caucasica* are generally darker than most other species of *Ascogaster* but the ♀ carapace of *bicarinata* is sometimes tinged with orange-testaceous, that of *caucasica* never is.

*Ascogaster caucasica* Kokujev

(Figs 15, 16, 22)

*Ascogaster causicus* Kokujev, 1895: 82. Holotype ♀, U.S.S.R.: 'Lagodechi', v.1881 (AS) [examined].*Ascogaster rostratus* Szépligeti, 1896: 178. Lectotype ♂, HUNGARY: Budapest, Gellerth, 19.v.1895 (Szépligeti) (HNHM), designated by Papp in Shenefelt, 1973: 817 [examined].

Kokujev stated that he had a single female of *caucasica*; this specimen, bearing the data cited in the description, is now in AS, Leningrad. Fahringer (1934: 517) synonymised *rostrata* with

*bicarinata* Herrich-Schäffer and the two species have often been confused in collections, but the characteristics distinguishing them are given above in the key to species. Telenga (1941: 316) synonymised *caucasica* with *bicarinata*, evidently following Fahringer's misinterpretation of the latter species.

♀. Antenna moderately long, 25–26 segmented. Flagellum not conspicuously dilated medially, slightly tapered apically; basal segment distinctly more than three times as long as broad, each following segment slightly shorter until preapical segment which is about as long as broad. Head contracted behind eyes. Occiput deeply concave. Temple about equal to length of eye in dorsal view. Ocelli minute, OO = 5 OD; widely separated. Eyes small, round, protuberant. Malar space long, about 1.5 times basal breadth of mandible. Genae in face view contracted, not strongly rounded. Face almost twice as broad as high, rather flat, not strongly protuberant, densely reticulate-punctate, often with a distinct rugose element. Hair on upper part of face directed upwards. Clypeus not protuberant, weakly and evenly convex, apical border reflexed backwards at sides, medially produced into two prominent dentate tubercles; polished and densely punctate, sometimes reticulate. Mandible long, strongly twisted, ventrally expanded at base. Labiomaxillary complex elongate, projecting conspicuously beneath head; exerted part distinctly longer than malar space; labial palps inserted at least one third of distance along exerted part, distinctly beyond mandibles. Prothorax projecting in front of mesonotum with a strongly impressed foveolate groove medially. Notaulices shallow, foveolate, coalescing posteriorly in a coarsely rugose area; rest of mesonotum polished, reticulate-punctate. Precoxal suture irregularly rugose; rest of mesopleuron reticulate-punctate. Propodeum rounded, not abruptly divided or posteromedially impressed; coarsely irregularly rugose with no distinct carinae but with small lateral tubercles. Carapace long, slightly acuminate, not rounded posteroventrally, reticulate-rugose, the longitudinal element predominating anteriorly. Hypopygium exceptionally long, sometimes projecting beyond the posteroventral rim of carapace. Ovipositor very long, slender, gradually tapering to apex; generally covered by hypopygium for most of its length but occasionally protruding to a distance at least equal to the length of the hind tibia.

Colour black; wings infumate, legs yellow-marked.

♂. Same as ♀ except that antenna longer, 32–33 segmented; carapace narrower, flatter, slightly rounded posteroventrally.

#### MATERIAL EXAMINED

21 ♂, 15 ♀. **Bulgaria:** 2 ♂, 1 ♀, Rhodopi, Sh. poljana, v.1976 (*Zaykov*) (ZC); 1 ♀, Rhodopi, D. Lukovo, v.1977 (*Zaykov*) (ZC). **Cyprus:** 1 ♀, Yermosoyia, 3.iv.1978 (*Teunissen*) (RNH); 1 ♀, Episcopi Forest, 20–23.iv.1950 (BMNH); 1 ♂, Yerolakko, 25.iv.1948 (*Longfield*) (BMNH); 3 ♂, Limassol, 1–5.v.1934 (*Mavromoustakis*) (BMNH); 1 ♂, Kellaki, 2000 ft, 10.iv.1952 (BMNH); 1 ♀, Nicosia, 20–23.iv.1934 (*Mavromoustakis*) (BMNH); 2 ♂, Yerasa, 24.iii.1947 (*Mavromoustakis*) (BMNH). **Czechoslovakia:** 1 ♂, 1 ♀, Sturovo, 25.v.1959 (*Strejcek*) (CC). **Greece:** 3 ♂, 1 ♀, Prov. Attiki, Marathon, 21.iv.1978 (*Papp*) (HNHM); 3 ♂, 1 ♀, Athens, Mt Pendeli, 25.iv.1980 (*Teunissen*) (RNH); 1 ♂, Delphi, 22–23.iv.1980 (*Teunissen*) (RNH); 1 ♂, Lesbos, Milies, 21.v.1980 (*Teunissen*) (RNH); 1 ♀, Kerkyra, 16–30.v.1971 (*Aartsen & Wolschrijn*) (RNH). **Hungary:** lectotype ♂ of *rostratus*. **Iran:** 1 ♂, 3 ♀, Susa (*Escalera*) (BMNH). **Spain:** 1 ♂, Ventas, St Barbara, 29.iii.1980 (*Teunissen*) (RNH). **Turkey:** 1 ♀, Adana, 7.v. (*Vachal*) (MNHN). **U.S.S.R.:** holotype ♀ of *causicus*. **Yugoslavia:** 1 ♀, Lake Ochrid, 16.vi.1958 (*Coe*) (BMNH).

HOSTS. No reared material examined.

REMARKS. The strongly exerted labiomaxillary complex of this species immediately distinguishes it from any other Palaearctic species of *Ascogaster*. The strongly dentate clypeus, the upwardly pointing facial vestiture and the elongate, slender habitus of *caucasica* show its close relationship with *bicarinata*, *excisa* and *kasparyani*.

#### *Ascogaster excisa* (Herrich-Schäffer)

(Figs 14, 23, 24)

*Chelonus excisus* Herrich-Schäffer, 1834: 154. Syntypes, GERMANY (lost).

*Ascogaster longiventris* Tobias, 1964: 184. Holotype ♂, U.S.S.R.: Kazachstan, Kokshetay, 15.vi.1957 (*Tobias*) (AS) [examined]. **Syn. n.**

The identity of this species is clear from Herrich-Schäffer's description and from his excellent figure. The remarkable posteroventral modification of the female carapace makes *excisa* one of the least liable to misinterpretation of all species of *Ascogaster*.

♀. Antenna long, 28–31 segmented. Flagellum not dilated medially, strongly tapered apically; basal five or six segments at least twice as long as broad, rest distinctly longer than broad except apical seven or eight which are almost quadrate. Head not strongly contracted behind eyes. Temple slightly shorter than eye in dorsal view. Occiput deeply concave. Ocelli minute, OO = 4 OD; not on line. Eyes protuberant. Malar space only slightly greater than basal breadth of mandible. Face moderately protuberant, about twice as broad as high, densely and regularly reticulate-punctate; hairs on upper part of face directed upwards. Clypeus moderately protuberant, reticulate-punctate; apical margin incised medially with two blunt dentate tubercles flanking the incision, laterally weakly reflexed backwards. Mandible large, only slightly twisted, punctate. Pronotum not projecting strongly in front of mesonotum; laterally reticulate-punctate except for a medial longitudinal foveolate groove. Notaulices deep, foveolate, coalescing posteriorly in a rugose-foveolate area; rest of mesonotum reticulate-punctate. Precoxal suture broad, reticulate-foveolate; rest of mesopleuron reticulate-punctate, except dorsally rugose. Propodeum posteromedially impressed; anteriorly with two short longitudinal carinae which terminate in two blunt tubercles one on each side of medial depressed area; reticulate-rugose. Carapace about twice as long as broad, ventral rim produced posteriorly into a broad, bifurcate flange. Hypopygium long and rather narrow in side-view, generally extruded and projecting behind the carapace. Ovipositor very long, slender; abruptly upcurved shortly before apex. Hind coxa generally smooth, polished with only weak puncturation, occasionally reticulate-punctate anterodorsally, sometimes also with obsolescent transverse rugae dorsally.

Colour black; legs brownish-testaceous except all coxae and trochanters black, hind femur and all tarsi infuscate.

♂. Same as ♀ except antenna longer; flagellum not tapered apically, all segments distinctly longer than broad; carapace narrower in dorsal view, posteroventral rim distinctly in front of apex; legs darker, mid and hind femur black, fore femur dark proximally.

#### MATERIAL EXAMINED

23 ♂, 19 ♀. **Bulgaria:** 22 ♂, 2 ♀, Rhodopi, Bojno, 6.vii.1976 (*Zaykov*) (ZC); 5 ♀, same data except 24.vii.1975. **France:** 3 ♀, Drôme, Col de Macuegne, i.viii.1979 (*Graham*) (BMNH); 2 ♀, Lozère, R. Lot, Mende, 3–8.vii.1924 (*Moseley*) (BMNH); 1 ♀, Chateau Arnoux, 10.viii.1972 (*Bouček*) (BMNH); 4 ♀, Dept. Vaucluse, Castellet, 20.vii.1974 (*Gijswijt*) (RNH); 1 ♀, Var, Montauroux, 1.vii.1960 (*Van der Vecht*) (RNH); 1 ♀, Var, Ste Baume, 19.vii.1951 (*Granger*) (MNHN). U.S.S.R.: holotype ♂ of *longiventris*.

**HOSTS.** No reared material examined.

**REMARKS.** The rounded carapace with the posteroventral rim distinctly in front of the apex is a useful supplementary character for distinguishing the male of *excisa* from those of *rostrata* and *bicarinata* in which the carapace of the male is not strongly rounded posteriorly and the posteroventral rim is only slightly in front of the apex. In describing *longiventris*, Tobias evidently had not appreciated the considerable sexual dimorphism of this species; nonetheless he correctly pointed out its relationship with *bicarinata*.

#### *Ascogaster kasparyani* Tobias

(Figs 13, 19, 20)

*Ascogaster kasparyani* Tobias, 1976: 233. Holotype ♂, U.S.S.R.: Gruzia, Bogdanovka, 28.vi.1967 (*Kasparyan*) (AS) [examined].

♀. Antenna long, slender, more than 28-segmented. Flagellum slender, not dilated medially, first segment about three times as long as broad, next 10 or so segments at least twice as long as broad, rest at least slightly longer than broad. Head not strongly contracted behind eyes. Temple slightly shorter than eye in dorsal view. Occiput deeply concave. Ocelli small, OO = 3.0 OD; not on line. Eyes small, protuberant. Malar space long, about twice basal breadth of mandible. Face about twice as broad as high, moderately protuberant, coarsely reticulate-punctate; hairs on upper part of face directed upwards. Clypeus protuberant, narrower than face; apical margin incised medially, weakly reflexed laterally. Mandible moderately twisted. Pronotum projecting strongly in front of mesonotum; laterally reticulate-rugose. Notaulices shallow, indistinct reticulate-rugose, coalescing posteriorly in a strongly reticulate-rugose area; rest of mesonotum reticulate-punctate. Precoxal suture indistinct, most of mesopleuron laterally irregularly reticulate-rugose, ventrally reticulate-punctate. Propodeum rounded, completely regularly reticulate-rugose with two weak medial longitudinal carinae at base. Carapace long, slender, about 2.5 times as long as broad, gradually diminished in breadth from about proximal third; narrow and rounded distally in dorsal

view; in lateral view rather flat, the proximal tenth strongly dorsoventrally flattened; completely finely regularly reticulate-rugose. Hypopygium at least slightly exerted. Ovipositor long, slender, strongly upcurved. Hind coxa polished with minute punctures.

Colour black, antenna at base and legs orange-testaceous, carapace more or less light-marked.

♂. Same as female except carapace rounded, not dorsoventrally flattened at apex; colour darker, carapace black, legs black except fore tibia yellow, mid and hind tibiae brown.

#### MATERIAL EXAMINED

1 ♂, 2 ♀. **Greece:** 1 ♀, Rhodes, Kremasti Hills, 24–30.vi.1958 (*Mavromoustakis*) (BMNH); 1 ♀, Empona, 18–19.vi.1968 (*Mavromoustakis*) (BMNH). **U.S.S.R.:** holotype ♂.

**HOSTS.** Unknown.

**REMARKS.** The long, exerted hypopygium, the long, slender, upcurved ovipositor and the upwardly directed hair on the upper part of the face show the relationship of *kasparyani*, *caucasica*, *excisa* and *bicarinata*. The characteristics of the carapace distinguish *kasparyani* from all other Palaearctic species of the genus.

### The *abdominator*-group

Face punctate, often reticulate-punctate, hairs on upper part of face pointing upwards. Clypeus with a single prominent dentate tubercle.

Two of the three species of this group are widely distributed in the more northerly parts of the Palaearctic region, the third, *nachitshevanica*, is known only from the U.S.S.R. and Mongolia. All species in the group have a short ovipositor and a short hypopygium which are generally concealed beneath the carapace. *A. dentifer* is rather different in head and body-shape from the other two species which form a close pair differentiated on small differences in the antennae, the notaulices and the genitalia.

### *Ascogaster abdominator* (Dahlbom)

(Figs 9, 10)

*Chelonus abdominator* Dahlbom, 1833: 165. Holotype ♀, SWEDEN: 'Esperod', Fallén colln (ZI) [examined]. [Synonymised with *instabilis* by Thomson, 1874: 583.]

*Ascogaster instabilis* Wesmael, 1835: 227. Syntypes, BELGIUM: Wesmael colln (IRSNB) [examined]. **Syn.**

*Ascogaster fulviventris* Curtis, 1837: folio 672. Holotype ♂, GREAT BRITAIN: England, Curtis colln (NMV) [examined]. [Synonymised with *instabilis* by Fischer, 1965: 11.]

*Chelonus femoralis* Herrich-Schäffer, 1838: 154. Syntypes, GERMANY (lost). [Synonymised with *instabilis* by Reinhard, 1867: 364.]

*Chelonus rufiventris* Herrich-Schäffer, 1838: 154. Syntypes, GERMANY (lost). [Synonymised with *instabilis* by Reinhard, 1867: 364.]

*Ascogaster pallida* Ruthe, 1855: 293. LECTOTYPE ♀, GERMANY: 'Freienwalde', 16.vii.1854, Ruthe colln (BMNH), here designated [examined]. [Synonymised with *instabilis* by Reinhard, 1867: 364.]

There is a single ♀ in Fallén's collection, labelled 'C. abdominator' in Dahlbom's handwriting. There is no indication that Dahlbom had more than one specimen before him when describing this species and I therefore accept this specimen as holotype of *abdominator*. Dahlbom obviously mistook the sex of his specimen, citing it as male in his description – the holotype bears a label upon which this error is repeated. Thomson (1874: 583) synonymised *abdominator* with *instabilis* despite the fact that the latter species is clearly a junior synonym of *abdominator*. Thomson's placement has been followed by all subsequent workers, but there is no justification for continuing this incorrect usage. Wesmael (1835: 229) stated that he possessed six males and two females of *instabilis*. At present there are six males and five females labelled 'Ascogaster instabilis mihi' in Wesmael's collection; all of these specimens are conspecific and agree with Wesmael's description of *instabilis*. Obviously, however, there are more female specimens labelled as 'instabilis' than Wesmael claimed to possess, thus they cannot all belong to the syntype series. A lectotype has not been selected because the species is so distinctive. There is

one male in Curtis' collection named *fulviventris*. It agrees in every particular with what Curtis wrote about *fulviventris* and I regard this specimen as the holotype of that species. The specimen was labelled as 'type' by Nixon in 1948; it is well within the limits of variation of *abdominator*.

Reinhard placed *femoralis* Herrich-Schäffer and *rufiventris* Herrich-Schäffer in synonymy with *instabilis* without indicating that he had seen the original material of *femoralis*. (Herrich-Schäffer himself stated in his description of *rufiventris*, that his original specimen of this species had been destroyed.) There is nothing in Herrich-Schäffer's descriptions of *femoralis* and *rufiventris* which precludes Reinhard's placement of them.

There are two female specimens from Ruthe's collection in the BMNH which agree with his description of *pallida*. One of them bears a label in Ruthe's handwriting 'Asc. pallidus m. Freienwalde 16.7.54'; these are precisely the data cited by Ruthe in his description of *pallida* except that he gave the date of capture as '18.7.54'. This discrepancy is probably due to an error of transcription, all too easily made when copying figures from a barely legible handwritten label. These specimens are undoubtedly syntypic material and the female bearing Ruthe's handwritten label is here designated lectotype of *pallida*.

♀. Antenna long, 32–36 segmented. Flagellum dilated medially, strongly tapered to apex; all segments at least as long as broad. Head large, roundly contracted behind eyes. Temple about equal to eye in dorsal view. Occiput strongly concave. Ocelli small, OO = 3.0–3.5 OD; not on line. Eyes small, protuberant. Malar space about half height of eye. Face protuberant, about twice as broad as high, reticulate-punctate, sometimes rugose medially and occasionally completely so; pubescence short, fine and directed upwards and outwards on upper part of face. Clypeus protuberant, reticulate-punctate, ventral border reflexed beneath so that in front view clypeus appears truncate; medially with a large dentate tubercle. Mandible strongly twisted with numerous long inwardly-directed hairs at base. Pronotum projecting strongly in front of mesonotum; dorsally with a strong transverse fold which becomes laterally a foveolate groove. Notaulices largely obsolete, visible at the anterior border of the mesonotum as a small reticulate-rugose area, otherwise indistinguishable from the puncturation of the mesonotum. Mesonotum smooth reticulate-punctate. Precoxal suture broad, shallow, foveolate-rugose; mesopleuron laterally reticulate-rugose, ventrally punctate. Prepectal carina strongly raised into a flange behind each fore coxa, deeply notched medially. Propodeum rather flat, reticulate-rugose, carinae inconspicuous; generally with small medial and lateral tubercles. Carapace rounded posteriorly, only slightly rounded posteroventrally. Hypopygium short, truncate, never projecting strongly beyond end of carapace. Ovipositor short, straight, abruptly tapered shortly before apex.

Colour black; antenna at base, forelegs and proximal part of carapace yellow or sometimes the latter ivory, mid and hind legs at least partly light-marked; carapace sometimes completely yellow. Occasionally clypeus, face and pronotum orange-yellow, at least in part.

♂. Same as ♀ except antenna longer, flagellar segments longer, thinner though the number of segments is not greater; pubescence on face longer and white in colour so that it appears much denser than that of ♀; carapace longer, narrower, sometimes almost parallel-sided anteriorly; colour darker, antenna generally black, carapace often completely dark.

#### MATERIAL EXAMINED

267 ♂, 127 ♀. Belgium, Bulgaria, Czechoslovakia, France, Germany, Great Britain, Ireland, Netherlands, Sweden, U.S.S.R., Yugoslavia.

HOSTS. No reared material examined

REMARKS. This species is common and widespread in the region. The characteristics of the clypeus and the face and the virtual absence of notaulices easily differentiate *abdominator* from all other Palaearctic species. Indeed, the latter characteristic alone is almost diagnostic though in some species in the *caucasica*-group the notaulices are rather weak and in those species of the *quadridentata*-group in which the mesonotum is strongly rugose the notaulices are therefore indistinct. This species is extremely labile in colour, varying from almost completely black to almost completely yellow, though the majority of specimens are largely black-bodied except that the carapace is more or less pale-marked.



*Ascogaster dentifer* Tobias

(Figs 7, 12)

*Ascogaster dentifer* Tobias, 1976: 236. Holotype ♂, U.S.S.R.: Armenia, Kefansky region, Tsav. wood, 28.vi.1971 (*Kulitskij*) (AS) [examined].

*Chelonus punctulator* Kirchner, 1867: 119. [Nomen nudum; attributed to Foerster.]

♀. Antenna long, 36–37 segmented, pedicel often protuberant posterolaterally. Flagellum weakly dilated medially, proximal segments distinctly longer than broad, 2.0–3.0 times as long as broad at base of flagellum, rest of segments about as long as broad, those at apex about half breadth of medial ones. Head not strongly contracted behind eyes, rounded. Temple about 1.5 times length of eye in dorsal view. Occiput strongly concave. Ocelli small, OO = 3.5–4.0 OD, not on line but in an obtusely angled triangle. Frons deeply excavate behind antennae, the depressed area smooth, polished. Strong dentate lamella between bases of antennae. Face protuberant, about 1.5 times as broad as high, convex, shining, punctate; hair on upper part of face directed upwards. Clypeus about twice as broad as high, convex, shining, punctate; apical border slightly reflexed inwards laterally, medially produced into a strong dentate tubercle. Mandible strongly twisted. Pronotum projecting distinctly in front of mesonotum; rugose. Propleurae reticulate-punctate. Notaulices distinct, foveolate, coalescing posteriorly in a reticulate-rugose area; rest of mesonotum closely, even reticulately, punctate. Precoxal suture shallow, foveolate-rugose; rest of mesopleuron punctate except anterodorsally rugose. Propodeum rather depressed, finely and regularly reticulate-rugose with two medial longitudinal carinae and one medial transverse carina, the latter raised into blunt crests postero-laterally. Carapace oval, rather broadly rounded posteriorly, posteroventral rim considerably in front of apex. Ovipositor short, straight, stout, abruptly tapered shortly before apex. Sheaths clavate with brush of long hairs at apex. Hypopygium short. Hind coxa transversely rugose.

Colour black; base of antenna testaceous, carapace with two yellow patches anterolaterally; pronotum sometimes more or less yellow-marked; fore trochanter, femur at apex, tibia, mid and hind trochanters and tibiae at base yellow or testaceous; all tarsi infusate.

♂. Same as ♀ except antenna longer, all segments at least as long as broad, most distinctly longer than broad; carapace narrower in dorsal view with no yellow patches anteroventrally; legs often darker, less extensively pale-marked.

## MATERIAL EXAMINED

77 ♂, 11 ♀. Bulgaria, Czechoslovakia, France, Germany, Great Britain, Hungary, Italy, Switzerland, U.S.S.R., Yugoslavia.

HOSTS. Unknown.

REMARKS. This species is superficially similar to *perkinsi*; both have smooth, punctate faces and a well-developed medial tubercle on the clypeus and are similar in stature and colour. The facial hair of *dentifer*, however, always points upwards on the upper part of the face while that of *perkinsi* does not, but the sparseness of the facial vestiture in *dentifer* may result in this characteristic being overlooked. However, in *dentifer* there is a well-developed dentate flange between the antennae which is not present in *perkinsi*, and the latter species has a conspicuous longitudinal flange on the basal segment of the hind tarsus which is lacking in *dentifer*.

I have examined four specimens (1 BMNH; 3 MNHN) of *dentifer* which are labelled 'Chelonus punctulator Foerster' in Foerster's handwriting. No description was published by Foerster but the name *Chelonus punctulator* was listed by Kirchner (1867: 119).

*Ascogaster nachitshevanica* Abdinbekova

(Figs 8, 11)

*Ascogaster nachitshevanicus* Abdinbekova, 1969: 69. Holotype ♀, U.S.S.R.: Azerbaidzhan, Ordubad, 20.v.1967 (*Adamidzh*) (AS) [examined].

♀. Antenna short, 27–30 segmented. Flagellum not dilated medially, strongly narrowed at apex, all segments distinctly longer than broad except terminal segments which are moniliform. Head broad, transverse, roundly contracted behind eyes. Temple 1.0–1.5 times length of eye in dorsal view. Occiput strongly concave. Ocelli small, OO = 4.0 OD, almost on line. Eyes small, protuberant. Face slightly protuberant, about twice as broad as high, reticulate-punctate, sometimes weakly rugulose medially; hair on upper part of face directed upwards. Clypeus transverse, apically impressed and truncate with a strong

dentate tubercle medially; reticulate-punctate. Mandible long, slender, twisted. Pronotum projecting in front of mesonotum; rugose laterally. Notaulices shallow but distinct; rest of mesonotum reticulate-punctate. Precoxal suture broad, reticulate-foveolate; mesopleuron anterodorsally rugose, rest densely punctate. Propodeum completely coarsely reticulate-rugose with a medial transverse carina and two medial longitudinal carinae dorsally but these sometimes indistinct; no distinct propodeal tubercles. Carapace strongly narrowed posteriorly, generally also more or less dorsoventrally flattened in lateral view; posteroventral rim at apex of carapace; coarsely reticulate-rugose at base, more finely rugose towards apex. Hypopygium at most slightly exerted. Ovipositor sheaths conspicuously slender. Hind coxa smooth, punctate except dorsally weakly rugose.

Colour black; antenna at base, tegula, sometimes carapace anterolaterally and legs orange-testaceous except hind coxa dark, at least at base; sometimes mid and hind femora dark medially, hind tibia dark at apex; all tarsi infusate.

♂. Unknown.

#### MATERIAL EXAMINED

4 ♀. **Mongolia:** 3 ♀, Chövsgöl aimak, 8 km N. of Somon Burenchaan, 1450 m, 20.vi.1968 (*Kaszab*) (HNHM). **U.S.S.R.:** holotype ♀.

HOSTS. Unknown.

REMARKS. This species is closely similar to *abdominator*. The characteristics cited in the key to species, together with differences in the shape of the carapace, are sufficient to distinguish the two species, but whether these differences would hold good in a longer series of *nachtshevanica* is open to question.

### The *annularis*-group

Face punctate, hairs on upper part pointing downwards or rugose, hairs on upper part pointing upwards. Clypeus without medial excision or tubercles, apical border more or less convex.

The five species in this group are all more or less small in size, rather flat and have long, slender ovipositors; the emission of the radius from conspicuously beyond the middle of the stigma is a venational feature characteristic of the group. Four of the species of this group are widely distributed, at least in north-western Europe, although *gonocephala* is uncommon. The fifth member of the group, *exigua*, is known only from the holotype from Mongolia. The latter species is the most highly modified of the group, having an exceptionally elongate, slender carapace; it is also the only one with long antennae.

#### *Ascogaster annularis* (Nees von Esenbeck)

(Figs 25, 29, 33, 34)

*Sigalphus annularis* Nees von Esenbeck, 1816: 264. Syntypes, GERMANY (lost).

Nees von Esenbeck's description of *annularis* is clear and detailed enough for the species to be identified with confidence as the one described below.

♀. Antenna short, 21–24 segmented. Flagellum sometimes slightly dilated medially, moderately tapered to apex, all segments distinctly longer than broad except terminal three or four about as long as broad, often more or less moniliform. Head broad, slightly broader than mesonotum, roundly contracted behind eyes. Temple about as long as eye in dorsal view or slightly longer. Occiput moderately concave. Ocelli moderately large, OO = 2.5–3.0 OD; not on line. Frons behind antennae shallowly excavate, polished. A weak medial carina extends from a tubercle on upper part of the face, between antennae. Eyes large, protuberant. Malar space equal to about half height of eye. Face weakly convex, about twice as broad as high, shining, punctate, with sparse, downwardly pointing hairs. Clypeus weakly convex, shining, punctate; apical border slightly reflexed, evenly rounded or occasionally more or less straight medially, never with any trace of tooth or excision. Mandible small, strongly twisted. Pronotum projecting distinctly in front of mesonotum; rugose except ventrolaterally smooth, punctate. Notaulices shallow, foveolate, coalescing posteriorly in a finely rugose area; rest of mesonotum smooth punctate. Precoxal suture reticulate-foveolate; rest of mesopleuron smooth punctate except anterodorsally rugose. Propodeum finely irregularly rugose; divided by a transverse medial carina into dorsal and posterior surfaces, the dorsal

rather flat, with a distinct central areola. Carapace distinctly longer than thorax and propodeum; elongate oval and often truncate posteriorly in dorsal view, rather shallow in lateral view; posteroventrally emarginate. Hypopygium long, often projecting beyond carapace. Ovipositor long, sheaths slender, clavate. Hind coxa finely rugose; hind tibia somewhat swollen. Radius emitted from stigma conspicuously beyond middle.

Colour black; antenna brown, lighter at base; mandibles, foreleg testaceous, midleg testaceous except tibia and tarsus infuscate, tibia with a light medial band; hindleg dark except trochanter and femur yellow or testaceous, at least in part, and tibia with an ivory or pale yellow band medially; carapace always with two yellow patches at base.

♂. Same as ♀ except antenna longer, 22–25 segmented; flagellum not dilated medially, all segments about twice as long as broad; carapace not truncate posteriorly or emarginate posteroventrally.

#### MATERIAL EXAMINED

65 ♂, 74 ♀. **Bulgaria, Czechoslovakia, France, Germany, Great Britain, Greece, Hungary, Netherlands, Sweden.**

**HOSTS.** *Pandemis heparana* (Denis & Schiffermüller) (Lepidoptera: Tortricidae), *Recurvaria leucatella* (Clerck) (Lepidoptera: Gelechiidae).

**REMARKS.** This is one of the smallest Palaearctic species of *Ascogaster*, averaging about 2.5 mm in length. The small size of *annularis* together with its characteristic colour pattern of yellow at the base of the gaster and pale-banded hind tibia make it readily recognisable. The only species which shares these characteristics, though it often lacks the yellow on the carapace, is *grahami* which is very closely related to *annularis* and can be differentiated by the characters cited in the key.

### *Ascogaster exigua* sp. n.

(Figs 28, 36)

♀. Antenna long, 35 segmented. Flagellum weakly dilated medially, strongly tapered to apex, all segments longer than broad, apical ones only slightly longer than broad. Head broader than mesonotum, rounded behind eyes. Temple slightly shorter than length of eye in dorsal view. Ocelli large, OO = 2.5 OD; not on line. Face protuberant, about twice as broad as high, conspicuously transversely striate-rugose; hair on upper part pointing upwards. Clypeus narrow, convex, apical part weakly transversely depressed; smooth, punctate; apical border rounded, with no trace of medial tubercles. Mandibles small, strongly twisted. Pronotum projecting but little in front of mesonotum; laterally densely punctate, ventrally weakly rugose. Notaulices foveolate, coalescing posteriorly in a reticulate-foveolate area; rest of mesonotum shining, punctured, rather flat dorsally. Precoxal suture shallow, foveolate; rest of mesopleuron smooth, punctate. Propodeum flat dorsally, depressed, with medial transverse carina, two weak medial longitudinal carinae and lateral longitudinal carinae; completely finely reticulate-rugose. Carapace elongate, about three times as long as broad, broadest at about a third of its length from base; reticulate-rugose proximally, the longitudinal element predominant, distally smooth shining with minute punctures; posteroventral rim reaching apex. Hypopygium not exerted. Hind coxa largely smooth, punctate.

Colour black; antenna brown except testaceous at base; all legs testaceous except hind tibia, all coxae and all tarsi infuscate.

♂. Unknown.

#### MATERIAL EXAMINED

Holotype ♀, **Mongolia:** Zavchan aimak, Choit church, 26 km ENE. from See Tehnen nuur, 13.vii.1968 (*Kaszab*) (HNHM).

**HOSTS.** Unknown.

**REMARKS.** The shape of the head, the sculpture and vestiture of the face and the point where the radius joins the pterostigma show the relationship of this species to *klugii*. The shape of the carapace and the strongly depressed body distinguish *exigua* from all other Palaearctic species of the genus.

*Ascogaster gonocephala* Wesmael

(Fig. 26)

*Ascogaster gonocephalus* Wesmael, 1835: 240. Holotype ♂, BELGIUM: Brussels, Wesmael colln (IRSNB) [examined].

Wesmael stated that he had a single male of this species. Two males in Wesmael's collection bear labels in Wesmael's handwriting '*Ascogaster gonocephalus mihi* ♂'; both are conspecific and agree precisely with Wesmael's description except that on the specimen which has complete antennae the segments number 31, not 30 as stated as Wesmael. This latter specimen, however, bears a small label '12 Jn.' and as Wesmael's original specimen was collected in June, I accept this specimen as the holotype of *gonocephala*.

♀. Antenna long, 30 segmented. Flagellar segments at base at least twice as long as broad; apical segments very small, much shorter and narrower than preceding ones. Head broad, strongly contracted behind eyes. Temple straight, about half length of eye in dorsal view; produced backwards on each side into a strong flange; vertex behind ocelli depressed, occipital carina obsolete. Ocelli large, OO = 2.0-2.5 OD. Eyes large, protuberant. Face broad, 2.5-3.0 times as broad as high, not strongly protuberant, rugose, the transverse striae predominant; short medial vertical carina produced into a strong dentate tubercle between bases of antennae; hair on face pointing upwards. Clypeus not strongly protuberant, distinctly divided from face; narrow, about half as broad as face; rugose-punctate; apical border reflexed forwards, rounded, without tubercles. Mandibles strongly twisted. Notaulices deep, foveolate, coalescing posteriorly in a broad reticulate-rugose area. Precoxal suture broad, reticulate-foveolate. Propodeum rugose, dorsally reticulate with strong medial and lateral tubercles. Carapace rather long, slightly tapered posteriorly, not distinctly rounded posteroventrally. Ovipositor thin, slightly upcurved, evenly tapered. Ovipositor sheaths slender.

Colour black; scape ventrally, face (except sometimes medially), genae ventrally, tegula and legs reddish-yellow. Coxae, hind femur distally, hind tibia distally and tarsus black or at least infusate; hind tibia at base whitish yellow.

♂. Same as ♀ except that antenna longer, narrower, the apical segments not conspicuously shorter or narrower than preceding ones; hindleg more extensively infusate.

## MATERIAL EXAMINED

3 ♂, 3 ♀. **Belgium:** 2 ♂ (including holotype), Brussels, colln Wesmael (IRSNB). **France:** 1 ♂, Var, Montauroux, 1.viii.1970 (*Van der Vecht*) (RNH). **Great Britain:** 1 ♀, Hampshire, Totton, 14.viii.1952 (*Vardy*) (BMNH). **Yugoslavia:** 1 ♀, Srbija, Drazevac, nr Belgrade, 27-28.vi.1981 (*Day & Fitton*) (BMNH). ? **Hungary:** 1 ♀, no data (HNHM).

HOSTS. No reared material examined.

REMARKS. Morphologically *gonocephala* is closely similar to *klugii*; it differs from all other species of *Ascogaster* by the curious posterior prolongation of the genae.

*Ascogaster grahami* sp. n.

(Figs 30-32)

♀. Antenna short, 20-24 segmented. Flagellum only slightly dilated, moderately contracted to apex; all segments distinctly longer than broad, apical two or three only slightly longer than broad, almost quadrate. Head slightly broader than mesonotum, contracted behind eyes, strongly contracted ventrally in face view. Temple shorter than eye in dorsal view. Ocelli large, OO = 2.5-3.0 OD; not on line. Eyes large, protuberant. Face about twice as broad as high, moderately protuberant, shining, more or less densely punctate, sometimes with weak rugae laterally; hair pointing downwards except between bases of antennae. Clypeus not protuberant, more or less densely punctate; apical border weakly rounded without teeth or excision. Mandibles slender, strongly twisted. Pronotum projecting but little in front of mesonotum; reticulate-punctate and rugose laterally. Notaulices foveolate, indistinct anteriorly, coalescing posteriorly in a broad, finely reticulate-rugose area; rest of mesonotum densely punctate, shining. Precoxal suture foveolate-rugose; rest of mesopleuron punctate except anterodorsally rugose. Propodeum divided by a medial transverse carina with lateral longitudinal and often medial longitudinal carinae; finely, regularly reticulate-rugose. Carapace oval, rounded posteriorly, at most slightly emarginate postero-

ventrally. Hypopygium long but generally not exerted. Ovipositor long, about half as long as carapace, evenly upcurved, slender; ovipositor sheaths slender. Hind coxa rugose laterally and ventrally.

Colour black except antenna at base testaceous, palps pale yellow or ivory; tegula and legs yellow or testaceous except coxae and tarsi infusate, at least in part; femur of mid leg sometimes infusate dorsally; femur of hindleg infusate in dorsal and ventral longitudinal bands; tibia of midleg sometimes and of hindleg always infusate but with a medial pale band. Carapace generally black but occasionally suffused with yellow at base, rarely with distinct pale areas.

♂. Same as ♀ except antenna longer, 22–26 segmented; all flagellar segments conspicuously longer than broad; carapace more elongate, less rounded; legs often lighter in colour.

#### MATERIAL EXAMINED

58 ♂, 112 ♀. Holotype ♀, **Great Britain**: England, Hampshire, New Forest, Beaulieu Road, 25.vi.1959 (Clark) (BMNH).

Paratypes. **Czechoslovakia**: 1 ♀, Praha, Kosire, 27.vii.1961 (Strejček) (CC); 1 ♀, Kamenica, 11.vii.1961 (Strejček) (CC); 1 ♀, Banská Stianica, 24.vii.1958 (Čapek). **France**: 1 ♀, Brout Vernet (du Buysson) (MNHN); 3 ♀, Vien, 1877 (Giraud) (MNHN). **Germany (West)**: 1 ♀, Geierlambach, Heidebeere (Haeselbarth) (HC); 1 ♀, Ober-Bayern, Wessling, 12.viii.1975 (Haeselbarth) (HC); 2 ♀, Ruthe colln (BMNH). **Great Britain**: 4 ♀, same data as holotype (BMNH); 1 ♀, Hampshire, Awbridge, vii.1981 (Vardy) (BMNH); 1 ♂, Droxford (ex *Sorhagenia lophyrella*) 20.v.1977 (Langmaid) (RSM); 6 ♂, 4 ♀, Kent, Faversham (ex *Infurcitinea argentimaculella*) 9.vii.1977 (Bradford) (RSM); 18 ♂, 26 ♀, London, Bedford Park, vii.1929 (Waterston) (BMNH); 23 ♂, 3 ♀, same data except 'on leaves of *Tilia*' 7.vi.1925 (BMNH); 3 ♂, same data but no date (BMNH); 3 ♂, 9 ♀, London, Earls Court, 26.vi.1937 (Nixon) (BMNH); 1 ♀, Cambridgeshire, Monks Wood NNR, 17–29.vii.1978 (Fitton & Noyes) (BMNH); 2 ♀, Northamptonshire, Spratton, vii.1975 (Gauld) (BMNH). **Italy**: 4 ♂, 3 ♀, Ancona, ex *Ficus*, 1978 (Cola & Freude) (HC). **Netherlands**: 45 ♀, Wijster (Dr.), opposite Biol. Station, various dates, vii–viii (van Achterberg) (RNH). **Sweden**: 1 ♀, Skåne, Höör district, 22.vi.1938 (Perkins) (BMNH); 1 ♀, Skåne, Loderup, 22.vii.1938 (Perkins) (BMNH).

**HOSTS.** *Infurcitinea argentimaculella* (Stainton) (Lepidoptera: Tineidae) [larvae feeding in moss on wall]; *Sorhagenia lophyrella* (Douglas) (Lepidoptera: Momphidae).

**REMARKS.** This species is closely similar to *annularis* with which it has been generally confused in collections. The two species are not easy to distinguish and the only differences between them are summarised in the key. Waterston (1926: 174) misidentified this species as *annularis*.

### *Ascogaster klugii* (Nees von Esenbeck)

(Figs 27, 35)

*Sigalphus klugii* Nees von Esenbeck, 1816: 263. Syntypes, GERMANY (lost).

*Ascogaster ruficeps* Wesmael, 1835: 242. Holotype ♀, BELGIUM: Brussels, Wesmael collection (IRSNB) [examined]. [Synonymised by Hellén, 1953: 86.]

*Ascogaster neesii* Reinhard, 1867: 368. Syntype ♂, GERMANY (ZMB) [examined]. **Syn. n.**

Nees von Esenbeck's description of *klugii* applies equally well to both *ruficeps* and *gonocephala* save only that he makes no mention of the gross modifications of the head characteristic of the latter species. Nees von Esenbeck would certainly have mentioned so striking a feature had it been present in the species he was describing, and I therefore accept Hellén's synonymy of *ruficeps* with *klugii*. Wesmael stated that he had a single female of *ruficeps*. One specimen in Wesmael's collection bears his label 'Ascogaster ruficeps mihi ♀' and agrees precisely with his description of *ruficeps*. I accept it as the holotype, which, although in rather poor condition, is nonetheless clearly identifiable.

Two specimens (♂♀) in Reinhard's collection, named as *neesii*, are conspecific and agree with Reinhard's description. The locality data of the ♀ do not agree with those cited by Reinhard; the specimen is therefore not syntypic. The specimens assignable to *neesii* are all smaller than typical *klugii*, their eyes are relatively larger, temples shorter and more strongly contracted and the thorax flatter and more depressed. I consider these differences to be size-related and *neesii* therefore to be within the limits of variation of *klugii*.

♀. Antenna 27–29 segmented. Flagellum sometimes dilated, the medial segments broader than long, sometimes not dilated, the medial segments then longer than broad; strongly tapered, apical six or so segments much shorter and narrower than rest of flagellum, generally almost moniliform. Head broad, distinctly broader than mesonotum, more or less roundly contracted behind eyes. Temple slightly shorter than eye in dorsal view. Occiput strongly concave. Ocelli small, OO = 3.0–3.5 OD; not on line. Frons not strongly excavate. Face broad, at least twice as broad as high, slightly protuberant, medially distinctly rugose, the transverse element predominating; hair on face fine, inconspicuous, pointing upwards on upper half of face. Clypeus only weakly convex, narrow, about half as broad as face. densely rugose-punctate with a row of foveae just behind thickened apical border. Mandibles small, strongly twisted. Pronotum projecting in front of mesonotum, transverse striate dorsally, laterally largely reticulate-punctate with fine rugosity ventrally. Notaulices anteriorly indistinct foveolate, merging with the reticulate-punctate sculpture of mesonotum; posteriorly coalescing in a broad rugose, foveolate area; mesonotum reticulate-punctate. Precoxal suture narrow, rugose foveolate, rest of mesopleuron punctate. Propodeum rather depressed; strongly, irregularly reticulate-rugose, generally only a medial transverse carina distinct though sometimes weak medial longitudinal carinae visible, at least in part, only weak tubercles present laterally. Carapace elongate, oval, coarsely reticulate-rugose anteriorly, more finely reticulate-rugose posteriorly; rather flat in lateral view; posteroventral rim slightly in front of apex. Ovipositor slender; ovipositor sheaths long, slender. Hypopygium not long, produced medially to an apical point. Hind coxa smooth, punctate.

Colour black; antenna pale at base, generally yellow or testaceous, occasionally basal flagellar segments ivory; head varies from completely pale testaceous or yellow (except stemmaticum black) to completely black, except inner orbits pale-marked; pronotum in part and carapace anterolaterally yellow or testaceous. Legs completely pale yellow or testaceous except sometimes (in darker specimens) apex of hind tibia infusate and occasionally, hind leg completely brown.

♂. Same as ♀ except flagellum not dilated medially, not strongly tapered apically, the six apical segments not conspicuously shorter and narrower than preceding ones; carapace narrower.

#### MATERIAL EXAMINED

93 ♂, 124 ♀. Austria, Belgium, Bulgaria, Czechoslovakia, Finland, France, Germany, Great Britain, Sweden.

HOSTS. *Tubuliferola subochreella* (Doubleday) (Lepidoptera: Oecophoridae).

REMARKS. This species and *gonocephala* are closely similar in structure; the only differences are found in the head and are cited in the key. Extensive pale coloration of the head is found only in *klugii* and *gonocephala* in Palaearctic *Ascogaster*, thus both species are fairly easy to recognise. The colour of the head is very variable, however, and it is not infrequently largely black.

### The *bidentula*-group

Face punctate, hairs on upper part pointing downwards. Clypeus with one, two or three small, dentate tubercles or medially produced or emarginate.

Four of the eight species of this group are common and widespread; *albitarsus* is uncommon, *arisanica* is known from China and Japan and *perkinsi* and *longicornis* only from Japan. This is the most disparate group of species; *varipes*, *perkinsi* and *longicornis* could each be regarded as *species sola*. Indeed, *varipes* could also be regarded as transitional with the *quadridentata*-group.

### *Ascogaster albitarsus* Reinhard

(Fig. 48)

*Ascogaster albitarsus* Reinhard, 1867: 364. LECTOTYPE ♂, POLAND: Gdansk (ZMB), here designated [examined].

*Ascogaster leptopus* Thomson, 1874: 584. LECTOTYPE ♀, SWEDEN: Thomson colln (ZI), here designated [examined]. [Synonymised by Hellén, 1953: 86.]

The single male specimen named *albitarsus* in Reinhard's collection agrees precisely with Reinhard's description and is therefore accepted as a syntype and here designated lectotype.

Four specimens (3 ♂, 1 ♀) are in Thomson's collection above the name *leptopus*; they are conspecific and agree precisely with Thomson's description of that species. I here designate as

lectotype the female which Graham restricted as type – his decision was not validated by publication. I have no doubt that Hellén was correct to synonymise *leptopus* with *albitarsus*.

♀. Antenna long, 39 segmented. Flagellum tapered, medial segments about as long as broad, segments at apex much narrower, slightly longer than broad. Head not strongly contracted behind eyes. Temple slightly longer than eye in dorsal view. Occiput concave. Ocelli almost on line,  $OO = 2.5 OD$ . Frons weakly excavate; strongly striate-rugose. Face about 1.5 times as broad as high; weakly convex; reticulate-punctate with a weak median tubercle dorsally. Clypeus weakly protuberant; apical border produced medially and slightly reflexed forwards, occasionally with a weak indication of two tubercles; smooth, shining, densely punctate but not reticulate. Mandible long, moderately twisted. Pronotum not projecting strongly in front of mesonotum; finely, densely rugose laterally. Notaulices foveolate, coalescing posteriorly in a large reticulate-rugose area; rest of mesonotum densely reticulate-punctate. Precoxal suture broad, strongly reticulate-rugose anteriorly; narrow and rather weak posteriorly. Mesopleuron anterodorsally strongly rugose; rest of mesopleuron densely punctate. Propodeum short, broad, divided by a medial transverse carina into dorsal and posterior areas, dorsal area coarsely reticulate-rugose; posterolaterally with stout, blunt teeth, medially with two rather weak teeth. Carapace long, clavate, reaching its maximum breadth in posterior third; coarsely reticulate-rugose; posteroventral rim somewhat before apex. Hypopygium and ovipositor short. Hind coxa densely punctate.

Colour black; antenna testaceous in basal half; legs dark except apex of femur, tibia and tarsus of foreleg yellow, base of tibia and of tarsus of mid-leg, base of tibia and basal segment of tarsus of hind leg pale yellow or ivory.

♂. Same as ♀ except antenna longer, all flagellar segments distinctly longer than broad; fore and midlegs more or less light in colour, sometimes completely pale yellow.

#### MATERIAL EXAMINED

13 ♂, 3 ♀. **Ireland:** 1 ♂, S. Tipperary, Burnt Woods, 1.x.1947 (*Daltry*) (SC). **Poland:** lectotype ♂ of *albitarsus*. **Sweden:** 3 ♂, 1 ♀ (lectotype of *leptopus*), Thomson colln (ZI); 5 ♂, 1 ♀, Narke, Barsta, 11.ix.1931 (*Roman*) (NR); 1 ♂, Uppland, 23.viii. (*Roman*) (NR); 1 ♀, Varmso (NR); 2 ♂, data indcipherable (NR).

**HOSTS.** Unknown.

**REMARKS.** I have examined 3 ♂, 1 ♀ from Japan which differ from *albitarsus* in that the head is more rounded behind the eyes, the mesopleuron is less strongly and less extensively rugose, the carapace is smooth, punctate posteriorly and the light-coloured basal bands on hind tibia and tarsus are less distinct. These differences, too slight to warrant the description of a new species, are nevertheless enough to exclude these specimens from *albitarsus*, at least at present. The limits of variation given for *albitarsus* have, however, been based on the examination of so little material that they will probably require revision when more specimens are available for study.

### *Ascogaster arisanica* Sonan

(Figs 49, 52, 54)

*Ascogaster arisanicus* Sonan, 1932: 79. Holotype ♂, TAIWAN: Arisan, 2.v.1917 (*Shiraki & Sonan*) [not examined].

Reinhard synonymised *bidentula* with *rufipes* but I have retained them as separate species. Watanabe (1937: 77) synonymised *arisanica* with *rufipes*, following Reinhard's interpretation of the latter species. I have based my interpretation of *arisanica* on specimens named as *rufipes* by Watanabe; they are not, however, conspecific with *bidentula* (= *rufipes* sensu Reinhard) or with *rufipes* as I have interpreted it.

♀. Antenna long, 36–39 segmented. Flagellum dilated medially, moderately contracted at apex; all segments longer than broad but medial ones only slightly so. Head distinctly broader than mesonotum; often slightly expanded behind eyes; strongly rounded. Temple at least 1.5 times length of eye in dorsal view. Occiput strongly concave. Ocelli moderately large,  $OO = 3.0 OD$ ; almost on line. Face about 1.5 times as broad as high, evenly convex, densely punctate, sometimes reticulate-punctate, sometimes with weak rugosity medially. Clypeus evenly convex, about twice as broad as high, not distinctly divided from face; densely punctate, the punctures larger than those on face; apical border produced, with a distinct medial excision flanked by two tubercles. Mandible stout, weakly twisted, strongly striate-punctate at

base. Pronotum projecting strongly in front of mesonotum, with a strongly impressed Y-shaped groove dorsally; rugose laterally. Notaulices broad, shallow, rugose, coalescing posteriorly in a reticulate-rugose area. Mesonotum narrow; densely punctate, generally reticulate-punctate medially. Precoxal suture broad, shallow, reticulate-foveolate; rest of mesopleuron smooth, punctate except dorsally rugose. Propodeum rather long dorsally, divided medially by a weak, transverse carina which is raised into strong medial and lateral flanges; dorsally coarsely reticulate-rugose. Carapace elongate, distinctly longer than thorax and propodeum; generally broadest in distal half; posteroventral rim conspicuously in front of apex. Hypopygium and ovipositor short. Hind coxa smooth, punctate.

Colour black; antenna at base testaceous, palps pale yellow; legs testaceous except mid tibia and tarsus generally infusate apically, hind coxa infusate at base, hind femur, tibia and tarsus infusate at apex, hind tibia generally ivory in basal half, basal segment of hind tarsus ivory or pale yellow except sometimes at apex of segment. Hind coxa and femur sometimes almost completely black; in these darker specimens the legs are brown rather than testaceous and the mid coxa, femur and tibia are extensively black-marked.

♂. Same as ♀ except antenna shorter, 33–37 segmented; flagellum not dilated medially; head not expanded behind eyes; carapace narrower, less rounded, flatter.

#### MATERIAL EXAMINED

29 ♂, 40 ♀. Japan.

HOSTS. No reared material examined.

REMARKS. This species is structurally very close to *bidentula*, but it can be distinguished by the more massive head and the more elongate carapace.

### *Ascogaster bidentula* Wesmael

(Figs 50, 51, 53)

*Ascogaster bidentulus* Wesmael, 1835: 230. Holotype ♀, BELGIUM: 'Charleroy', Wesmael colln (IRSNB) [examined].

*Chelonus multiarticulatus* Ratzeburg, 1852: 25. Syntypes, GERMANY (lost). [Synonymised by Reinhard, 1867: 365.]

*Ascogaster gibbiscuta* Thomson, 1874: 586. LECTOTYPE ♀, SWEDEN: Skåne, 'F' (?) 14.viii., Thomson colln (ZI), here designated [examined]. **Syn. n.**

*Ascogaster fuscipennis* Thomson, 1892: 1718. LECTOTYPE ♀, SWEDEN: 'Hbg.' [= Helsingborg] Thomson colln (ZI), here designated [examined]. **Syn. n.**

*Ascogaster atamiensis* Ashmead, 1906: 191. Holotype ♀. JAPAN: 'Atami' (*Koebele*) (USNM) [examined]. **Syn. n.**

Wesmael (1835: 231) stated that he had only one female specimen when describing *bidentulus*. At present, two specimens in Wesmael's collection bear Wesmael's label '*Ascogaster bidentulus* mihi ♀'. One of these has obviously been misplaced, as it is a female of *rufidens*; the other agrees perfectly with Wesmael's description of *bidentulus* and is here accepted as the holotype.

Reinhard (1867: 365) regards *bidentula* and *rufipes* as conspecific, but this is rejected here (see *rufipes*). Reinhard, however, had correctly identified *bidentula* and placed *multiarticulatus* in synonymy with it after having examined Ratzeburg's original material. This synonymy is accepted here.

Thomson (1874: 586) did not state what material he possessed when describing *gibbiscuta*. In his collection there are six specimens so named (2 ♂, 4 ♀). The four females are conspecific and I designate as lectotype that which bears Thomson's labels 'gibbiscuta' and 'Skan' and a square red label 'type' added by Graham. I can find no structural difference between *gibbiscuta* and *bidentula*; although *gibbiscuta* is more extensively pale-marked than typical *bidentula* I consider this to be infraspecific.

The specimen in Thomson's collection which agrees with his description of *fuscipennis* and which was labelled as lectotype by Graham is here designated lectotype. The only significant structural difference between *fuscipennis* and *bidentula* is the form of the clypeus. In *fuscipennis* the apical border is produced medially but without the paired tubercles or the excision of *bidentula*. However, I have seen specimens in which the structure of the clypeus is intermediate – the tubercles are present but not divided by an excision. I therefore consider this characteristic to be variable in *bidentula* and so regard it and *fuscipennis* as conspecific.



♀. Antenna long, 33–36 segmented. Flagellum slightly dilated medially, contracted in apical third, medial segments about as long as broad, apical ones distinctly longer than broad. Head contracted behind eyes; more or less strongly rounded. Temple slightly longer than eye in dorsal view. Frons strongly rugose except sometimes medially smooth, punctate (particularly in small specimens). Occiput concave. Ocelli moderately large,  $OO = 3.0 OD$ , ocellar triangle obtuse, ocelli almost on line. Face about 1.5 times as broad as high, moderately convex with a small medial tubercle on upper half from which runs a weak carina which extends back to the lower part of frons; reticulate-punctate, pubescence very long, silvery. Tentorial pits minute with small but distinct tubercles dorsally. Clypeus weakly divided from face; not strongly protuberant, smooth, densely punctate; ventral border somewhat retracted but produced medially into two small but distinct dentate tubercles. Mandible moderately twisted. Pronotum projects in front of mesonotum; weakly rugose. Notaulices distinct foveolate, rest of mesonotum densely punctate except posteriorly reticulate-rugose where notaulices coalesce. Precoxal suture coarsely foveolate-rugose, most of mesopleuron dorsally strongly rugose (so that precoxal suture is often rather indistinct), ventrally smooth, punctate. Propodeum strongly rugose, divided by a strong medial transverse carina which is raised medially and laterally into strong dentate flanges. Carapace short, oval, broadest at mid point; coarsely, irregularly reticulate-rugose; posteroventral rim distinctly in front of apex. Hypopygium short. Ovipositor short, straight, thick at base, abruptly narrowed shortly before apex. Ovipositor sheaths short, strongly clavate at apex. Hind coxa smooth, punctate, sometimes reticulate-punctate dorsally but never strongly transversely rugose.

Colour black; proximal half of antenna testaceous, rest brown or brownish-testaceous; legs yellow except all coxae dark, at least in part, fore and mid femur slightly infusate, hind femur dark brown except at base, tibiae at least slightly infusate at apex, tarsi infusate except hind basitarsus pale yellow or ivory at base.

#### MATERIAL EXAMINED

162 ♂, 92 ♀. Belgium, Bulgaria, Finland, France, Germany, Great Britain, Ireland, Japan, Netherlands, Sweden.

HOSTS. *Epiblema roborana* (Denis & Schiffermüller), *Epinotia cruciana* (Linnaeus), *Pandemis* sp. (Lepidoptera: Tortricidae), *Eupithecia venosata* (Fabricius) (Lepidoptera: Geometridae).

REMARKS. I have examined 10 specimens (4 ♂, 6 ♀) in which the female antenna is longer (39–41 segmented), the facial sculpture slightly coarser and the legs more extensively yellow-marked than in typical specimens of *bidentula*. They are also slightly larger and the differences may thus be related to size.

### *Ascogaster consobrina* Curtis

(Figs 45–47)

*Ascogaster consobrina* Curtis, 1837: folio 672. Holotype ♂, GREAT BRITAIN: England (NMV) [examined].

Curtis did not state how many specimens he had before him when describing *consobrina*, but 1 ♂, 2 ♀ are in his collection above this name. The two females are not accepted as syntypes because they differ from Curtis' brief but precise description in several features. The male agrees exactly with Curtis' description and I accept this specimen as the holotype of *consobrina* as there is no indication that Curtis had more than one specimen of the species. The two females are conspecific and belong to *rufidens*; one was labelled 'type' by Nixon in 1948.

♀. Antenna long, 33–34 segmented. Flagellum slightly dilated medially, not strongly narrowed at apex, all segments longer than broad, generally distinctly so but sometimes medial segments only slightly longer than broad. Head not strongly contracted behind eyes. Temple distinctly longer than eye in dorsal view. Occiput deeply concave. Ocelli moderately large,  $OO = 3.0 OD$ ; almost on line. Eyes moderately protuberant. Malar space slightly less than twice basal breadth of mandible. Face about 1.5 times as broad as high, strongly projecting dorsally, rather straight in profile, reticulate-punctate, often with a few vertical rugae medially and with a strong medial carina running from upper part of face between antennal sockets. Clypeus raised medially; apical border not retracted, produced into a broad, blunt point with no impression or tubercle; slightly less densely punctate than face. Mandible twisted distally. Pronotum not projecting in front of mesonotum; finely, densely rugose laterally. Notaulices distinct, foveolate anteriorly, coalescing from about mid-point of mesonotum in a broad, reticulate-rugose area; rest of mesonotum punctate. Precoxal suture distinct, foveolate. Mesopleuron laterally finely rugose-punctate except general-

ly for a polished, largely impunctate area just dorsal to precoxal suture, ventrally always sparsely punctate, shining. Propodeum finely, irregularly rugose, transverse carina strongly raised into medial and lateral tubercles. Carapace rather elongate, clavate, widened in posterior third; anterolateral flange dentate, projecting distinctly beneath the rim of carapace; posteroventral rim only slightly in front of apex; finely reticulate-rugose. Hypopygium short. Ovipositor sheaths clavate. Hind coxa punctate, often weakly rugose dorsally.

Colour black; antenna at base and mandible brown; legs yellow except tarsi infusate, hind coxa black at base, generally hind femur and tibia infusate at apex.

♂. Same as ♀ except antenna 31–33 segmented, flagellum not dilated medially.

#### MATERIAL EXAMINED

63 ♂, 28 ♀. **Belgium, Czechoslovakia, France, Germany, Great Britain, Ireland, Japan, Netherlands, Sweden.**

HOSTS. No reared material examined.

### *Ascogaster longicornis* sp. n.

(Figs 41, 42)

♀. Antenna long, 47–50 segmented. Flagellum weakly dilated medially. Strongly narrowed at apex, medial segments about as long as broad, rest distinctly longer than broad. Head broad, rounded behind eyes, not strongly contracted. Temple slightly longer than eye in dorsal view. Occiput deeply concave. Ocelli in line, moderately large, OO = 3.5 OD. Eyes large, not protuberant. Malar space short, about one-third height of eye. Face about 1.3 times as broad as high, evenly convex, reticulate-punctate. A weak carina extends from a tubercle on the upper part of face to the frons; expanded into a blunt tubercle between antennae. Clypeus almost as broad as face; weakly convex, reticulate-punctate; apical border rounded except in medial quarter a weakly emarginate projection. Mandible large, slightly twisted. Pronotum projecting in front of mesonotum; dorsolaterally reticulate-foveolate. Notaulices foveolate; rest of mesonotum densely punctate except posteromedially reticulate-rugose. Precoxal suture not distinct because upper part of mesopleuron completely coarsely rugose, generally reticulate, ventral part smooth, punctate. Propodeum completely coarsely and evenly reticulate-rugose with prominent medial and lateral tubercles, the medial pair pyriform, the lateral ones blunt, dentate. Carapace oval in dorsal view, clavate in lateral view, posteroventral rim distinctly in front of apex; finely reticulate-rugose. Ovipositor short, straight, abruptly narrowed shortly before apex; ovipositor sheaths clavate. Hind coxa smooth, punctate; hind tibia incassate; hind tarsus slightly laterally compressed.

Colour black: palps ivory, mandibles and antenna brown except antenna at base testaceous; carapace at base yellow; foreleg yellow, tarsus infusate apically; midleg pale except femur sometimes, tibia and tarsus at apex infusate; hindleg dark except coxa (infusate only dorsally) and trochanter yellow. Mid and hind tibia with ivory band near base.

♂. Same as ♀ except that antenna longer but sometimes with slightly fewer segments; not dilated medially; all flagellar segments distinctly longer than broad; legs generally lighter in colour. In two of the males examined apical border of clypeus rufous.

#### MATERIAL EXAMINED

6 ♂, 7 ♀. Holotype ♀, **Japan**: Mt Tachibana, Fukuoka city, 22.ix.1979 (*Maetô*) (ELKU).

Paratypes. **Japan**: 1 ♂, same data as holotype; 1 ♀, same data except 14.vii.1979 (MC); 5 ♂, 3 ♀, Hiroshima Pref., Shobara, 23.viii.1976 (*Maetô*) (2 ♂, 2 ♀, BMNH; rest MC); 2 ♀, Fukuoka city, Minami Park, 19.v.1977 (*Maetô*) (BMNH; MC).

HOSTS. Unknown.

REMARKS. This species is perhaps most closely related to *bidentula*. *A. longicornis* is easily distinguished from all other Palaearctic species by its conspicuously long antennae and by the characteristics of its clypeus. It is a large (up to 7.0 mm) stout species though the males tend to be rather smaller on average.

### *Ascogaster perkinsi* sp. n.

(Figs 43, 44)

♀. Antenna long, 36–38 segmented. Flagellum weakly dilated medially, contracted apically, medial segments about as broad as long, rest distinctly longer than broad. Head contracted behind eyes. Temple

slightly longer than eye in dorsal view. Occiput deeply concave. Ocelli moderately large, OO = 3.0–3.5 OD, ocellar triangle obtuse but ocelli not on line. Frons with two depressed, polished impunctate areas behind antennae. Eyes moderately protuberant. Face about 1.5 times as wide as high, protuberant, evenly convex, reticulate-punctate, shining, with a medial tubercle from which a weak carina runs to anterior ocellus. Clypeus weakly divided from face, narrow, about half as broad as face; protuberant; shining, densely punctate, sometimes reticulate-punctate; apical border strongly impressed laterally, medial area raised and produced forwards into a distinct tooth. Mandible small, moderately twisted. Pronotum projecting in front of mesonotum, laterally reticulate-punctate dorsally with a deep pit medially. Notaulices weak, foveolate; rest of mesonotum reticulate-punctate. Precoxal suture foveolate; mesopleuron above precoxal suture reticulate-foveolate anteriorly, smooth, punctate posteriorly; mesopleuron ventrally densely punctate. Propodeum completely finely reticulate-rugose, divided medially by a transverse carina with medial and lateral tubercles, the medial pair of tubercles broad, stout and not strongly raised particularly in small specimens, the lateral pair more prominent, pyriform. Carapace short, oval in dorsal view, clavate in lateral view; posteroventral rim distinctly in front of apex. Hind coxa smooth, punctate. Hind tibia incrassate. Hind tarsus slightly laterally compressed, basal segment with a conspicuous flange ventrally which has a row of short bristles along its edge and a row of longer bristles at its base on each side.

Colour black; antenna at base, mandible and tegula testaceous; legs yellow except mid tibia dark at apex, hind femur and tibia dark at apex, mid and hind tarsi infusate; carapace yellow at base.

♂. Same as ♀ except antenna shorter, 32–34 segmented; flagellum not dilated medially; carapace less extensively pale-marked.

#### MATERIAL EXAMINED

27 ♂, 9 ♀. Holotype ♀, **Japan**: Mt Tachibana, Fukuoka City, 23.vi.1979 (*Maetō*) (ELKU).

Paratypes. **Japan**: 11 ♂, 2 ♀ same data as holotype (BMNH, MC); 3 ♂, same data except 18.vi.1978 (MC); 2 ♂, 4 ♀, Nagano Pref., Shimashima-dani, 1000–1300 m, 28.vii.1980 (*Takemoto*) (BMNH, MC); 5 ♂, Oiya Pref., Kuju, Bogazuru (*Maetō*) (MC); 2 ♂, 1 ♀, Kamikochi, 22–30.vii.1954 (*Townes*) (TC); 4 ♂, Mt Norikura, 2000 m, 30.vii.1954 (*Townes*) (TC).

HOSTS. Unknown.

REMARKS. This species is morphologically very similar to *dentifer* (q.v.). *A. perkinsi* is not closely related to any species in the *bidentula*-group and in the structure of its clypeus it shows affinities with the *quadridentata*-group. I dedicate this species to the memory of the late Dr J. F. Perkins, a gifted and generous former colleague.

### *Ascogaster rufidens* Wesmael

(Figs 37, 39, 40)

*Ascogaster rufidens* Wesmael, 1835: 231. Holotype ♀, BELGIUM: Charleroy, colln Wesmael (IRSNB) [examined].

*Chelonus rufipes* Herrich-Schäffer, 1838: 154. Syntypes, GERMANY (lost). [Junior secondary homonym of *rufipes* (Latreille, 1809); synonymised by Reinhard, 1867: 366.]

*Chelonus (Ascogaster) laevigator* Ratzeburg, 1852: 25. Syntypes, GERMANY (lost). [Synonymised by Reinhard, 1867: 365.]

Wesmael (1835: 233) stated that he had a single specimen of *rufidens*. One specimen in Wesmael's collection bears his label '*Ascogaster rufidens mihi* ♂' and agrees precisely with the description of that species except that the antennae are now more mutilated than originally stated. It is here accepted as holotype. Wesmael believed this specimen to be a male and so labelled it, but I consider it to be a female though the retraction of the genitalia beneath the carapace makes it difficult to discern the sex, particularly so as *rufidens* exhibits no sexual dimorphism.

Reinhard stated that he had examined Ratzeburg's original specimen of *laevigator* and he cited characters for *rufidens* which show that he had correctly identified that species. The above synonymy is therefore accepted.

Reinhard (1867: 366) placed *rufipes* Herrich-Schäffer in synonymy with *rufidens* although apparently without having seen the original material. Herrich-Schäffer's description and figure are entirely consistent with Reinhard's placement.

♀. Antenna long, 33–35 segmented. Flagellum not distinctly dilated medially, all segments at least as long as broad, generally longer than broad. Head contracted behind eyes but not strongly so. Temple about equal to eye in dorsal view. Occiput strongly concave. Ocelli small OO = 3 OD, ocellar triangle obtuse, ocelli almost on line. Eyes protuberant but not large. Malar space about half height of eye. Face not strongly protuberant, densely punctate, sometimes reticulate-punctate, densely hairy; a weak tubercle medially below antennal bases, generally with a weak carina extending back between the antennae, sometimes almost reaching anterior ocellus. Clypeus not protuberant, sculpture same as face; apical border convex, with medially three small dentate tubercles. Mandibles stout, only slightly twisted, ventral border reflexed, produced into a stout flange extending from mandibular articulation to base of ventral tooth. Pronotum transversely rugose dorsally with a distinct medial pit and a small raised triangular area of fine punctures immediately in front of mesonotum; lateral surface of pronotum punctate dorsally, rugose ventrally with a medial foveolate groove. Propleuron reticulate-punctate. Notaulices deep, foveolate. Mesoscutum broad, reticulate-punctate. Precoxal suture broad, anteriorly rugose-foveolate, posteriorly narrow foveolate; mesopleuron rugose dorsally, rest smooth punctate. Propodeum completely strongly reticulate-rugose, divided into dorsal and posterior surfaces by a medial transverse carina which is produced posterolaterally into two stout blunt crests. Carapace broad, rugose, sometimes with one or two faintly impressed lines in positions suggesting the suturiform articulation (such a condition was noted by Wesmael in his description of *rufidens* and is indeed visible in the holotype). Hypopygium short. Ovipositor sheaths short, widened apically where there is a brush of long hairs. Hind coxa smooth, punctate.

Colour black; antenna at base, mandibles, palps yellow or testaceous. Legs yellow except coxae black, at least in part, all tarsi infusate, hind femur and tibia infusate.

♂. Same as ♀.

#### MATERIAL EXAMINED

81 ♂, 41 ♀. Belgium, Czechoslovakia, France, Germany, Great Britain, Hungary, Ireland, Netherlands, Sweden.

HOSTS. *Croesia bergmanniana* (L.), *Pandemis cerasana* (Hübner), *Pandemis corylana* (Fabricius), *Pandemis heparana* (Denis & Schiffermüller) (Lepidoptera: Tortricidae). *Yponomeuta padella* (L.) (Lepidoptera: Yponomeutidae).

REMARKS. The unique clypeal armature of *rufidens* has ensured that it is one of the least misinterpreted species of *Ascogaster*. The characteristics of the mandibles, which appear to have been overlooked by previous workers, are also invaluable taxonomic discriminants. Evenhuis & Vlug (1983) have pointed out that the principal hosts of *rufidens* belong to the Tortricidae, Tortricinae which lay their eggs in batches. In contrast to this *quadridentata* attacks Tortricidae, Olethreutinae the females of which lay their eggs separately on the host plants.

### *Ascogaster varipes* Wesmael

(Fig. 38)

*Ascogaster varipes* Wesmael, 1835: 234. LECTOTYPE ♀, BELGIUM: Brussels, colln Wesmael (IRSNB), here designated [examined].

*Ascogaster cavifrons* Thomson, 1874: 585. LECTOTYPE ♀, SWEDEN: Skåne, Torekov, vii.1860 (*Thomson*) (ZI), here designated [examined]. **Syn. n.**

*Ascogaster sternalis* Thomson, 1874: 587. LECTOTYPE ♀, SWEDEN: Småland (Thomson) (ZI), here designated [examined]. [Synonymised by Telenga, 1941: 322.]

*Ascogaster jaroslawensis* Kokujev, 1895: 86. Holotype ♀, U.S.S.R.: 'Jaroslaw' (AS) [examined]. **Syn. n.**

Wesmael (1835: 235) stated that he possessed two males and six females of *varipes*. Two males and four females are present above this name in Wesmael's collection, each bearing Wesmael's label '*Ascogaster varipes mihi*'. They are conspecific and agree precisely with Wesmael's description of *varipes*. Wesmael assigned two of his series of six females to a 'var. 2'; these specimens are among the surviving syntypes and there is also a male labelled 'var. 1'. I designate as lectotype of *varipes* the better-preserved of the two females from the main syntypic series.

Thomson did not state how many specimens he had before him when describing *cavifrons*; at present six are in his collection above this name. One of these is a male of *abdominator* and cannot be a syntype of *cavifrons* because it does not agree with the original description;

Thomson's remarks upon *abdominator* show him to have been thoroughly familiar with that species. Of the five remaining specimens (2 ♂, 3 ♀) four are certainly conspecific and agree with Thomson's description of *cavifrons*, the fifth (♂) is in poor condition and is impossible to identify. I designate as lectotype the female bearing Thomson's labels 'Tkov., 7 '60' '♀' *cavifrons* m.' and a square red label 'Type' added by Graham. *A. cavifrons* comes well within the range of variation of *varipes*, agreeing closely with Wesmael's 'var. 2'.

Of the four specimens in Thomson's collection above the name *sternalis*, I designate as lectotype the best preserved specimen that was labelled as 'type' by Graham. The strongly raised acetabular carina used by Thomson to differentiate *sternalis* seems to me to be only of infraspecific value; apart from this characteristic, *sternalis* agrees with *varipes* in every particular and Telenga's synonymy is therefore accepted. The holotype ♀ of *jaroslawensis* has lost its head but I have no doubt that it is conspecific with *varipes*.

♀. Antenna long, 34–35 segmented. Flagellum dilated medially, strongly tapered to apex, most distal segments about as long as broad. Head rounded behind eyes, often expanded, particularly in larger specimens. Temple about 1.0–1.5 times length of eye in dorsal view. Occiput strongly concave. Ocelli in obtuse triangle but not on line, OO = 3.0–3.5 OD. Frons behind antennae excavate, the depressed area smooth with a weak medial carina which runs from between the antennae to just in front of the fore ocellus. Eyes not strongly protuberant. Genae generally convex in face view. Face protuberant, always distinctly and evenly convex, about twice as broad as high, generally reticulate-punctate but sometimes finely and regularly reticulate-rugose. Clypeus transversely convex dorsally, the ventral half transversely depressed, its border slightly reflexed without tooth or impression medially; reticulate-punctate. Mandible large, strongly twisted with a deep semicircular depression at base. Pronotum projecting slightly in front of mesonotum; rugose-punctate. Notaulices distinct, foveolate, rest of mesonotum punctate except posteriorly reticulate-rugose and ventrally punctate; precoxal suture not easily distinguished from rugosity on mesopleuron. Propodeum completely reticulate-rugose, divided by a medial carina which is expanded into prominent dentate flanges laterally and two broad low protuberances medially between which dorsal surface of propodeum weakly depressed, sometimes with a short, medial longitudinal carina. Carapace oval, generally rather deep distally, posteroventral rim distinctly in front of apex; reticulate-rugose at base, rugose-punctate apically. Hypopygium short. Ovipositor short, straight, abruptly narrowed shortly before apex; ovipositor sheaths short, clavate. Hind coxa strongly transversely rugose.

Colour black; carapace sometimes pale yellow at base, legs generally predominantly black, only femora at apex and tibiae yellow; hind tibia infuscate at apex, occasionally legs predominantly yellow with only apex of hind femur and apex of mid and hind tibiae and all tarsi dark.

♂. Same as ♀ except antenna not dilated medially; carapace only rarely pale-marked and then weakly and not in a distinct basal patch; legs often darker.

#### MATERIAL EXAMINED

165 ♂, 127 ♀. Austria, Belgium, Bulgaria, Czechoslovakia, France, Germany, Great Britain, Hungary, Netherlands, Sweden, U.S.S.R., Yugoslavia.

HOSTS. No reared material examined.

REMARKS. This species is readily recognisable by the semicircular depression at the base of the mandible and by the characteristics of its face and clypeus. The mandibular depression is best seen if the head is examined in anterolateral view under oblique illumination; it is often invisible in full anterior view. *A. varipes* is a conspicuously short, stout species with a short, deep, strongly rounded carapace; *reticulata* and *quadridentata* share this characteristic, however, and may thus be confused with *varipes*, particularly those specimens of the latter species which have rather rugose faces. Neither *reticulata* nor *quadridentata*, however, has a semicircular depression at the base of the mandible, *quadridentata* always has a medial tubercle on the clypeus, and *reticulata* has a smooth, punctate hind coxa.

#### The *quadridentata*-group

Face strongly, irregularly rugose, hair on upper part pointing downwards. Clypeus generally with medial dentate tubercle, occasionally with none but never with more than one.

The eight species of this group are all heavily sculptured, having the head and thorax more or less completely rugose. The dentate tubercle on the clypeus is absent in *armata* and *reticulata* and is

often weak in *scabricula*; these species are readily distinguished from all other Palaearctic species by the characteristics of the head and carapace, as cited in the key. The species of this group are generally widely distributed throughout the Palaearctic region – indeed *quadridentata* is known to be Holarctic – but *armata*, *canifrons* and *scabricula* are uncommon and *reticulata* is as yet known only from Japan and Czechoslovakia.

### *Ascogaster armata* Wesmael

(Figs 56, 57)

*Ascogaster armatus* Wesmael, 1835: 233. LECTOTYPE ♀, BELGIUM: Brussels, colln Wesmael (IRSNB), here designated [examined].

*Chelonus pulchellus* Curtis, 1829: 105 [Nomen nudum.]

*Ascogaster esenbeckii* Curtis, 1837: folio 672. LECTOTYPE ♀, GREAT BRITAIN: England, Glanvilles Wootton, vii, grass in meadows (NMV), here designated [examined]. [Replacement name for *pulchellus* Curtis, 1829.] Syn. n.

*Chelonus luteicornis* Herrich-Schäffer, 1838: 154. Syntypes, GERMANY (lost). [Synonymised by Reinhard 1867: 263.]

Wesmael (1835: 234) stated that he possessed three females and one male of *armata*. There are three females and two males in Wesmael's collection each bearing his label 'Ascogaster armatus mihi'; they are conspecific and agree precisely with the description of *armata*. I designate the best preserved female as lectotype and the other two females as paralectotypes. No doubt one of the two males is the male syntype referred to by Wesmael but it cannot be differentiated.

I have examined two specimens from Curtis's collection, one labelled 'pulchellus' and the other 'Type of *Ascogaster esenbeckii* Curtis det G. E. J. Nixon 1948'. These specimens are conspecific and agree precisely with Curtis' description; that labelled 'Type' by Nixon bears no data whereas the other specimen has a label with the data published by Curtis. I have therefore designated the latter specimen as lectotype of *esenbeckii*, and it comes well within the limits of variation of *armata*. Marshall (1885: 142) synonymised *esenbeckii* with *instabilis*, giving no reason for his action but probably basing it on Curtis' description. I have no doubt that this placement is incorrect.

It is quite clear from the descriptions of *luteicornis* and *annularis* that Herrich-Schäffer's figures of these two species were transposed. Thus figure 154.7 depicts *luteicornis* and 154.8 *annularis*. Reinhard (1867: 263) synonymised *luteicornis* and *armata* based on an examination of specimens sent to him as *luteicornis* by Herrich-Schäffer. It is clear from Reinhard's description that he had correctly identified *armata* and I therefore accept his synonymy.

♀. Antenna long, 36–39 segmented. Flagellum dilated medially, medial segments distinctly broader than long, apical five or six segments nearly moniliform; densely covered in short, thick adpressed bristles. Head subcubic, not strongly contracted behind eyes. Temple 1.5–2.0 times length of eye in dorsal view. Occiput strongly concave. Ocelli small, OO = 4 OD; ocellar triangle obtuse, ocelli almost on line. Frons behind antennae deeply excavate, generally smooth, shining and delimited laterally by a weak carina. A medial carina extends from upper part of face between antennae to anterior ocellus; grossly expanded between antennae into an erect triangular lamina. Eyes small. Malar space about half height of eye. Face protuberant, about twice as broad as high, strongly rugose, generally striate-rugose but sometimes reticulate medially with a weak tubercle medially at which point arises the interantennal carina. Clypeus protuberant though not strongly so, deeply divided from face; apical border convex, not protruding medially and without distinct tooth or tubercle; largely reticulate-punctate. Mandible stout, not twisted, densely punctate with long hairs. Pronotum projecting slightly in front of mesonotum; with a medial transverse groove dorsally, reticulate-rugose laterally; propleuron reticulate-rugose. Notaulices present but indistinct because mesonotum strongly rugose, posteriorly reticulate; medial lobe of mesoscutum often with a reticulate-punctate area anteriorly. Precoxal suture indistinct; mesopleuron completely reticulate-rugose except sometimes reticulate-punctate ventrally, but mesolcus rugose or reticulate. Propodeum strongly reticulate-rugose, divided into dorsal and posterior surfaces by a weak transverse carina which is produced posterolaterally into stout blunt teeth. Carapace long, rather narrow; finely reticulate-rugose, posteriorly rugulose-punctate. Ovipositor short, straight, abruptly tapered just before apex; ovipositor sheaths with apical brush of long hairs. Hind coxa transversely striate on dorsal and outer surface; hind tibia densely reticulate-punctate. Wings rather short, infumate.

Colour black, basal segments of antenna light in colour; fore tibia completely, mid and hind tibia at least partly and gaster proximally yellow.

♂. Same as ♀ except that flagellum not expanded medially, medial segments about as long as broad, gaster almost always completely black.

#### MATERIAL EXAMINED

13 ♂, 13 ♀. **Belgium:** 2 ♂, 3 ♀ (including lectotype), Wesmael colln (IRSNB). **France:** 2 ♂, St M. Vesubie, 27–29.vii.1950 (*Granger*) (MNHN); 1 ♀, Chavith; 30.vii.1882 (*de Gaulle*) (MNHN). **Great Britain:** 4 ♂, Stephen's colln (BMNH) 2 ♀, Curtis colln (lectotype & paralectotype of *Ascogaster esenbeckii*) (NMV); 1 ♀, Marshall colln (BMNH); 1 ♀, Hampshire, Portodown nr Portchester, 16.vii.1971 (*Else*) (BMNH); 1 ♂, Sussex, Hailsham marshes, 27.vii.1949 (*Ford*) (BMNH); 1 ♀, Surrey, Coulsdon, Happy Valley, 13.viii.1978 (*Noyes*) (BMNH); 1 ♀, Kent, Chattenden, 12.vii.1949 (*Ford*) (BMNH); 1 ♂, Buckinghamshire, Buttlers Hangings nr West Wycombe, 24.vii.1978 (*Shaw*) (RSM); 1 ♀, Leicestershire (*Matthews*) (BMNH); 1 ♂, Cardiganshire, Tresaith coll. vi.1979 [ex *Coleophora paripennella*] (*Simpson*) (RSM). **Hungary:** 1 ♀, Nagyvisnyo, 1–8.viii.1956 (*Mihalyi*) (HNHM); 1 ♂, Nemetbanyo Jager-volgy, 17.vii.1973 (*Papp*) (HNHM). **Italy:** 1 ♂, Campi, Riva s Garda, 550 m, 7.vii.1966 (*Haeselbarth*) (HC). **Netherlands:** 1 ♀, Bemelerberg Exc. St Petersburg, 20.vii.1950 (RNH).

**HOSTS.** *Coleophora hornigi* Toll [= *paripennella* auctt.] (Lepidoptera: Coleophoridae).

**REMARKS.** The massive head of this species together with its strongly excavate frons distinguish it from all other species of *Ascogaster*. The strong, dentate flange between the scapes is also a distinctive characteristic shared only by *dentifer* which is otherwise quite a different insect. *A. armata* has no medial tooth on the clypeus, a characteristic found otherwise only in *reticulata* and *scabricula* in the *quadridentata*-group.

### *Ascogaster brevicornis* Wesmael

(Fig. 67)

*Ascogaster brevicornis* Wesmael, 1835: 239. Syntypes, BELGIUM: Wesmael colln (IRSNB) [examined].

*Chelonus monilicornis* Herrich-Schäffer, 1838: 154. Syntypes, GERMANY (lost). [Synonymised by Reinhard, 1867: 367.]

Wesmael (1835: 240) stated that he had three males and one female of this species. Two males and two females in Wesmael's collection are labelled '*Ascogaster brevicornis mihi*' in Wesmael's handwriting; they are conspecific and agree with the original description. Clearly, however, there is a discrepancy between the sex of his specimens as given by Wesmael and that of the specimens which now stand above *brevicornis* in his collection. Thus there is doubt about the syntype status of the females and, as the characteristics which differentiate *brevicornis* are best exhibited by that sex, I have not designated a lectotype.

Reinhard placed *monilicornis* and *brevicornis* together in synonymy with *similis*. It is clear from Reinhard's description that he had correctly identified *brevicornis* and Herrich-Schäffer's description and figure of *monilicornis* support Reinhard's placement of these species. I do not, however, believe that *similis* and *brevicornis* are conspecific because the thorax and scutellum of *brevicornis* are always coarsely rugose whereas those of *similis* were described as finely and closely punctulate.

♀. Antenna short, 22–23 segmented. Flagellum slightly dilated medially, all segments considerably broader than long, preapical segments slightly broader than long, apical segment longer than broad, pointed, all segments in distal half of flagellum distinctly separated. Head roundly contracted behind eyes. Temple about equal in length to eye in dorsal view. Vertex strongly rugose, in part reticulate. Ocelli small, OO = 4 OD; ocellar triangle obtuse, the ocelli almost on line. Eyes fairly large but not protuberant. Face not strongly protuberant, about twice as broad as high, strongly rugose, generally reticulate-rugose medially with a small tubercle from which a weak carina extends back between antennae and ends at anterior ocellus. Clypeus not protuberant polished, punctate; apical border projecting slightly forwards, produced into a blunt tooth medially. Mandible not twisted, punctate at base. Pronotum dorsally with a deeply impressed foveolate transverse groove; laterally strongly rugose-reticulate. Propleuron reticulate-rugose. Notaulices deep, foveolate. Mesoscutum strongly rugose. Mesopleuron almost completely reticulate-rugose, precoxal suture therefore indistinct. Propodeum completely reticulate-rugose, divided by a

weak, transverse carina produced into medial and postero-lateral pairs of stout dentate crests. Carapace viewed dorsally widest at about mid-point, tapering evenly to apex; laterally angulate posteroventrally, the ventral rim reaching almost to apex; completely strongly reticulate-rugose. Ovipositor short. Ovipositor sheaths wide, polished, with a brush of long hairs apically. Hind coxa rugose on outer surface.

Colour black: antenna at base, fore tibia completely, mid and hind tibia at base yellow.

♂. Same as ♀ except that antennal segments longer, less distinctly separated; ventral rim of carapace not reaching apex.

**MATERIAL EXAMINED**

15 ♂, 29 ♀. **Belgium, Czechoslovakia, France, Germany, Great Britain, Hungary, Ireland, Netherlands, Switzerland.**

**HOSTS.** No reared material examined.

**REMARKS.** This species closely resembles *quadridentata*; the female of *brevicornis* is easily distinguished from *quadridentata* by its short, thick apically moniliform antenna. Further, the number of antennal segments (♂, ♀) is different in the two species; 21–23 segments in *brevicornis* and more than 30 in *quadridentata*. The carapace also differs; in *brevicornis* the ventral rim reaches almost to the apex, in *quadridentata* it is always distinctly before the apex. The shape of the carapace viewed dorsally is also generally rather different, that of *brevicornis* being much more distinctly tapered and less rounded than that of *quadridentata*. The shape of the carapace in the latter species, however, is rather variable.

*Ascogaster canifrons* Wesmael

(Figs 58, 59)

*Ascogaster canifrons* Wesmael, 1835: 236. LECTOTYPE ♀, BELGIUM: Liège (*Robert*) (IRSNB), here designated [examined].

*Ascogaster graniger* Thomson, 1892: 1791. LECTOTYPE ♀, SWEDEN: Skåne, Pålsjö (ZI), here designated [examined]. **Syn. n.**

Wesmael (1835: 237) stated that he possessed one female and one male of *canifrons*; two such specimens are in his collection above the name *canifrons*, both labelled 'Ascogaster canifrons mihi'. They are conspecific and agree precisely with Wesmael's description; I consider them syntypes and designate the female as lectotype.

There are five specimens (2 ♂, 3 ♀) in Thomson's collection above the name *graniger*. The three females and one of the males are conspecific and agree with the original description; the second male mounted on the same pin below the first belongs to the *bidentula*-group. The lectotype is from Pålsjö (type-locality) and was selected and labelled as 'type' by Graham. It is well within the limits of variation of *canifrons*. One of the female specimens bears the labels 'L-d' (Lapland) and 'lapponicus' in Thomson's handwriting. At first sight, therefore, this specimen appears to be the holotype of *lapponica* but it disagrees with Thomson's description of that species in several respects. It has been pointed out by Huddleston (1980: 3) and Fitton (1982: 4) that species labels in Thomson's handwriting were not placed on the specimens by him and that the presence of such a label on a pin is not reliable evidence of the identity of the specimen.

♀. Antenna long, 39–40 segmented. Flagellum not dilated medially, strongly contracted distally, proximal and distal segments distinctly longer than broad, medial segments broader than long. Head large, strongly contracted behind eyes. Temple not rounded, slightly longer than eye in dorsal view. Occiput deeply concave. Ocelli small, OO = 3.0–3.5 OD, almost on line. Frons depressed behind antennae, strongly transversely rugose. Eyes not strongly protuberant. Face about 1.5 times as broad as high, moderately protuberant, completely rugose with a strong medial tubercle from which a weak carina extends back between the antennae to the anterior ocellus. Clypeus narrow, about half breadth of face; moderately protuberant, shallowly reticulate-punctate, apical border weakly convex with a distinct sharp tubercle medially. Mandible stout, not strongly twisted. Pronotum projecting slightly in front of mesonotum; rugose. Mesonotum completely densely rugose; notaulices not distinct. Mesopleuron completely coarsely reticulate-rugose; precoxal suture not distinct. Propodeum completely coarsely reticulate-rugose, not distinctly carinate but for a medial transverse carina which is expanded medially into two small blunt teeth and laterally into two larger ones. Carapace long, oval, densely and irregularly reticulate-rugose,



posteroventral rim slightly in front of apex. Hypopygium short. Ovipositor short, straight, abruptly narrowed shortly before apex; ovipositor sheaths short, broad, clavate with a copious tuft of hairs distally. Hind coxa distinctly rugose.

Colour black; mouthparts, antenna at base, foreleg (except coxa and tarsus infusate) and sometimes anterior third of carapace yellow; midleg yellow except coxa, femur at base, tibia at apex and tarsus infusate; hind leg dark except trochanter, trochantellus, base and apex of femur, base of tibia and sometimes tarsus in part yellow.

♂. Same as ♀ except antenna longer, medial flagellar segments as long as broad; carapace completely black, its posteroventral rim distinctly in front of apex.

#### MATERIAL EXAMINED

4 ♂, 11 ♀. **Belgium**: lectotype ♂ of *canifrons*. **Czechoslovakia**: 1 ♀, Trencin, Kostolna, 11.vii.1976 (*Lukas*) (LC); 1 ♂, Bohemia, K. Studenec, 18.vii.1955 (*Sedivy*) (CC). **Great Britain**: 1 ♀, Cambridgeshire, Abbots Ripton, Monks Wood NNR, 17–28.viii.1978 (*Fitton & Noyes*) (BMNH). **Ireland**: 2 ♀, Co. KD., Royal Canal, 3.viii.1949 & 15.vii.1950 (*Stelfox*) (SC); 1 ♂, same data except 30.vi.1950; 1 ♀, Co. KD, Landenstown, 20.viii.1941 (*Stelfox*) (SC); 1 ♀, Co. KD., Landenstown, 20.viii.1941 (*Stelfox*) (SC); 1 ♀ Co. WX., Killurin, 22.vii.1937 (*Stelfox*) (SC). **Mongolia**: 1 ♀, Central aimak, 11 km ESE. from Somon, Bajanzogt 1600–1700 m, 26.viii.1968 (*Kaszab*) (HNHM). **Sweden**: lectotype ♀ of *graniger*; 1 ♂, 2 ♀ (paralectotypes of *graniger*), Thomson coll.

**HOSTS.** *Endothenia quadrimaculana* (Haworth) (Lepidoptera: Tortricidae).

**REMARKS.** Papp (1967; 1971) has previously recorded this species from Mongolia. The long antenna and contracted temples and genae distinguish *canifrons* from all other species in the *quadridentata*-group. The strong transverse rugae on the frons are a striking feature of the species.

### *Ascogaster dispar* Fahringer

(Figs 70, 71, 73)

*Ascogaster dispar* Fahringer, 1934: 524. LECTOTYPE ♀, AUSTRIA: '13.v.12' (NM), here designated [examined].

*Ascogaster spinifer* Tobias, 1964: 185. Holotype ♂, U.S.S.R.: 9.vi.1958 (*Tobias*) (AS) [examined]. **Syn. n.** *Ascogaster koslovi* Tobias, 1972: 601. Holotype ♀, MONGOLIA: 3–4.vii.1968 (*Koslov*) (AS) [examined].

#### Syn. n.

There are four specimens (1 ♂, 3 ♀) above the name *dispar* in the NM collection bearing labels with dates from 13.v.1912 to 25.vi.1912 and the number 7–144; one also has a label bearing the host data cited by Fahringer and another a label '*Ascogaster dipsaris* m.' in Fahringer's handwriting. All these specimens are conspecific and agree precisely with Fahringer's description of *dispar* and I have no doubt that they are syntypes of that species. Fahringer obviously changed the specific epithet before publication.

The holotype of *spinifer* and that of *koslovi* are rather smaller than typical specimens of *dispar* but they are within the limits of variation of that species.

♀. Antenna 33–35 segmented. Flagellum slightly dilated medially, strongly tapered to apex; medial segments about as long as broad, following segments slightly longer than broad. Head broad, often slightly broader than mesonotum; slightly expanded then strongly rounded contracted behind eyes. Temple always distinctly longer than eye in dorsal view. Occiput strongly concave. Frons moderately depressed, reticulate-rugose. Ocelli almost on line, OO = 3.5–4.0 OD. Face about twice as broad as high, weakly convex, completely finely rugose, medially slightly raised and more closely rugose. Clypeus weakly convex, smooth, punctate; apical border retracted except medially produced and with a dentate tubercle. Mandibles moderately twisted, stout, produced ventrally at base so that generally they project beneath the head capsule; strongly rugose-punctate with no flange beneath at the base. Pronotum projects distinctly in front of mesonotum; striate-rugose except laterally often a small central smooth, punctate area. Notaulices indistinct. Most of mesonotum strongly reticulate-rugose, often with small densely punctate areas laterally and anteriorly but sometimes transversely rugose anteriorly. Precoxal suture indistinct; mesopleuron laterally strongly reticulate-rugose, ventrally with smooth, punctate areas. Propodeum completely strongly reticulate-rugose; divided by a medial transverse carina which is strongly raised into a medial pair and a lateral pair of dentate flanges. Carapace elongate oval, generally strongly narrowed posteriorly in dorsal

view; slightly depressed and rounded in lateral view; posteroventral rim slightly in front of apex. Ovipositor short, straight. Ovipositor sheaths clavate. Hind coxa finely transversely striate.

Colour black; apex of femur, and tibia of foreleg, apex of femur of midleg testaceous.

♂. Same as ♀ except antenna longer, 33–36 segmented; flagellum not dilated medially, all segments distinctly longer than broad; propodeum rounded, the flanges generally much weaker; posteroventral rim of carapace distinctly more in front of apex.

#### MATERIAL EXAMINED

25 ♂, 21 ♀. Austria, Bulgaria, Czechoslovakia, France, Great Britain, Greece, Hungary, Iran, Mongolia, Switzerland, Turkey, U.S.S.R., Yugoslavia.

HOSTS. *Endothenia gentianaeanana* (Hübner) (Lepidoptera: Tortricidae).

REMARKS. The shape of the head is rather variable in this species; whereas in most specimens it is rather massive, expanded behind the eyes and strongly rounded, in smaller specimens it is not expanded behind the eyes, less strongly rounded, even weakly contracted. Thus some of the smaller specimens of *dispar* rather resemble *quadridentata*; in *dispar*, however, the mandible is always ventrally expanded at the base and never has a flange beneath, and in *quadridentata* the mandible is not expanded at the base and always has a small flange ventrally. Further, in *dispar* the clypeus is not distinctly differentiated from the face except by a change in sculpture; in *quadridentata* the clypeus is distinguishable from the face by a fold. The medial apical tooth of the clypeus is always long and pointed in *dispar*, less so in *quadridentata*.

### *Ascogaster quadridentata* Wesmael

(Figs 60, 62, 63, 64)

*Ascogaster quadridentata* Wesmael, 1835: 237. Lectotype ♀, BELGIUM: Brussels, colln Wesmael (IRSNB), designated by Shaw, (1984) [examined].

*Chelonus impressus* Herrich-Schäffer, 1838: 153. Syntypes, GERMANY (lost). [Synonymised by Reinhard, 1867: 367.]

*Ascogaster nigricornis* Thomson, 1892: 1719. LECTOTYPE ♀, SWEDEN: Thomson colln (ZI), here designated [examined]. **Syn. n.**

*Ascogaster cynipum* Thomson, 1892: 1720. Holotype ♂, SWEDEN: Thomson colln (ZI) [examined]. **Syn. n.**

*Ascogaster egregius* Kokujev, 1895: 83. Holotype ♂, U.S.S.R. (AS) [examined]. **Syn. n.**

*Chelonus nigrator* Szépligeti, 1896: 303. Holotype ♀, YUGOSLAVIA: Buccari, 16.viii.1889 (*Biró*) (HNHM) [examined]. **Syn. n.**

*Ascogaster epinotiae* Watanabe, 1937: 76. Holotype ♀, JAPAN: Hokkaido, Sapporo, 14.vii.1927 (*Uchida*) (UEI) [examined]. **Syn. n.**

Wesmael (1835: 239) described *quadridentata* from five males and two females. Seven specimens in his collection bear the label '*Ascogaster quadridentata mihi*', agree with the original description and are conspecific.

Reinhard examined Herrich-Schäffer's original material of *Chelonus impressus* and his placement of this species in synonymy with *quadridentata* is therefore accepted.

Three specimens (1 ♂, 2 ♀) are in Thomson's collection above the name *nigricornis*; they are probably conspecific but the male and one of the females are in poor condition and are not readily identifiable. I designate as lectotype the better-preserved female, labelled 'type' by Graham. It agrees precisely with Thomson's description and is within the limits of variation of *quadridentata*.

The holotype of *Chelonus nigrator* Szépligeti bears a label with the data cited in the description and is within the limits of variation of *quadridentata*. The holotype of *epinotiae* Watanabe is smaller than average for *quadridentata* but is within the limits of variation of that species.

One male in the collection of the AS, Leningrad agrees precisely with what Kokujev wrote about *egregius*, is labelled 'Asc. egregius m.' in Kokujev's handwriting and is here accepted as the holotype. It comes within the limits of variation of *quadridentata*.

♀. Antenna long, 29–33 segmented. Flagellum slightly dilated medially, weakly tapered to apex, medial flagellar segments at most slightly longer than broad, generally slightly broader than long. Head rounded

behind eyes. Temple contracted (more strongly so in smaller specimens); about equal in length to eye in dorsal view. Occiput moderately concave. Frons slightly excavate behind eyes, generally strongly rugose. Vertex rugose, sometimes reticulate-rugose. Ocelli on line,  $OO = 3.0-3.5 OD$ . Eyes fairly large, not protuberant. Malar space about half height of eye. Face protuberant, about twice as broad as high; finely irregularly rugose, occasionally almost reticulate, with a small medial tubercle on the upper part of face, a fine carina extending from this to the anterior ocellus. Clypeus about half breadth of face, not strongly protuberant; polished, punctate except sometimes rugose laterally; apical border produced medially to a point and often with a small but distinct dentate tubercle. Mandibles moderately twisted, always with a small dentate flange formed at the junction of hypostomal and genal carinae, projecting beneath the base of the mandible. Pronotum projecting slightly in front of mesonotum; strongly rugose-reticulate laterally. Notaulices rather indistinct, obscured by the strong reticulate-rugose sculpture of mesonotum though deep and easily seen under oblique illumination. Precoxal suture likewise obscured; mesopleuron completely coarsely reticulate-rugose except random small areas smooth, punctate. Propodeum coarsely regularly reticulate-rugose with a medial transverse carina raised into a medial pair and a lateral pair of prominent dentate flanges. Carapace oval, generally laterally compressed posteriorly so that it appears sharply pointed in dorsal view, sometimes the point is produced into a tubercle, particularly in specimens of smaller than average size, in larger specimens the apex is often rounded, not pointed in dorsal view; posteroventral rim distinctly in front of apex. In some specimens, particularly those of smaller than average size, the carapace narrower in dorsal view and flatter. Hind coxa always strongly transversely striate-rugose.

Colour black, antenna at base brown or testaceous, mandibles brown, base of femur and tibia of foreleg, base of tibia of midleg and base of tibia of hind leg testaceous. Sometimes legs more extensively testaceous, in the lightest specimens only hind coxa black and mid and hind legs only lightly infuscate in the areas which are normally dark. Occasional specimens have a small pale mark at base of carapace on its lateral border but it is always diffuse.

♂. Same as ♀ except antenna longer, flagellum not dilated medially, all flagellar segments longer than broad.

#### MATERIAL EXAMINED

130 ♂, 121 ♀. Belgium, Bulgaria, Czechoslovakia, France, Germany, Great Britain, Greece, Hungary, Italy, Japan, Netherlands, Sweden, Turkey, U.S.S.R., Yugoslavia.

HOSTS. *Cydia pomonella* (L.), *Cydia funebrana* (Treitschke), *Cydia pallifrontana* (Lienig & Zeller), *Epiblema uddmanniana* (L.), *Spilonota ocellana* (Denis & Schiffermüller) (Lepidoptera: Tortricidae). *Yponomeuta padella* (L.) (Lepidoptera: Yponomeutidae).

REMARKS. It has been common practice for any specimen of *Ascogaster* with prominent flanges on the propodeum to be identified as *quadridentata*; this characteristic, however, is possessed by many species in the *quadridentata*- and *bidentula*- groups so it is not a reliable means of discriminating *quadridentata*. *A. quadridentata* is a common and widespread Holarctic species, rather variable in colour, size and certain other characteristics, probably because of its many host species. The smaller specimens tend to be darker in colour, more slender-bodied, with a prominent apical tubercle on the carapace, more coarsely sculptured and with shorter temples; Watanabe (1937) described the small form of *quadridentata* as *epinotiae*. I am convinced that these differences are infraspecific, resulting from the small size. The characteristics cited above occur sporadically in otherwise typical *quadridentata* and in small specimens, one or more of the differentiating characteristics is often of the normal *quadridentata* form. There is therefore no combination of characteristics by which the small form can be maintained as a distinct species. Larger specimens are stouter in build, the carapace generally more rounded apically and the head relatively more massive; they bear a close resemblance to *scabricula*. *A. quadridentata* also has a superficial resemblance to *brevicornis* (q.v.).

#### *Ascogaster reticulata* Watanabe

(Figs 61, 65, 66)

*Ascogaster reticulatus* Watanabe, 1967: 41. Holotype ♂ [cited as ♀], JAPAN: Hokkaido, Asahigawa, 15.vi.1966 (*Kamijo*) (UEI), [examined].

Watanabe (1967: 42) confused the sexes of this species, describing the male as female and vice versa. The carapace of *reticulata* is very deep and the ventral opening short and it is therefore

difficult to examine the genitalia. Watanabe reasonably concluded that the specimens with the longer antennae were male, as is usual in Braconidae. In *reticulata*, however, as in several other species of *Ascogaster*, the converse is true.

♀. Antenna long, 35–38 segmented. Flagellum weakly dilated medially, tapered to apex, two or three of medial segments about as long as broad, rest distinctly longer than broad. Head strongly contracted behind eyes. Temple about as long as eye in dorsal view or slightly shorter. Occiput moderately concave. Ocelli large, OO = 2.5 OD; on line. Eyes moderately large. Malar space about half height of eye. Face about 1.5 times as broad as high, protuberant, coarsely irregularly rugose; a strong carina running from upper part of face between antennae to fore ocellus; ventral border of antennal scrobes produced, forming a flange which projects forwards and upwards from face. Clypeus not strongly protuberant, narrower than face; transversely depressed in apical half, strongly punctate, matt, apical border almost flat without any trace of tooth or tubercle. Mandible fairly stout, slightly twisted. Pronotum projecting slightly in front of mesonotum, coarsely irregularly rugose laterally. Notaulices indistinct, foveolate. Rest of mesonotum reticulate-rugose posteriorly and laterally; transversely rugose and foveolate anteromedially. Precoxal suture indistinct among strong reticulate-rugose sculpture of mesopleuron, ventrally mesopleuron generally punctate. Propodeum completely coarsely reticulate-rugose, divided by a medial transverse carina which is raised medially and laterally into prominent dentate flanges. Carapace short, deep; posteroventral rim conspicuously in front of apex so that ventral opening is only slightly more than two-thirds total length of carapace. Hind coxa smooth punctate; basitarsus of hindleg with a ventral longitudinal keel bearing a row of short, stout bristles on its edge and with a row of long, erect bristles on either side.

Colour black; antenna at base, mandible, palps testaceous; foreleg testaceous except tarsus infusate, midleg testaceous except tibia at apex and tarsus infusate, hindleg testaceous except base of coxa, apex of femur, tibia and tarsus more or less heavily infusate but tibia with an ivory or pale yellow medial band.

♂. Same as ♀ except antenna shorter, 32–34 segmented, flagellum barely dilated medially and weakly tapered to apex.

#### MATERIAL EXAMINED

7 ♂, 6 ♀. **Czechoslovakia**: 4 ♂, 4 ♀, Banská Štiavnica (*Čapek*) (CC; BMNH); 1 ♂, Klák, 1959 (*Čapek*) (CC); 1 ♀, Kajlovka, 1962 (*Čapek*) (CC). **Japan**: holotype ♂; 1 ♂, 1 ♀ (paratypes), same data as holotype.

**HOSTS.** *Adoxophyes orana* (Fischer von Röslerstamm), *Archips issikii* Kodama, *Archips oporana* (L.), *Archips pulchra* (Butler) (Lepidoptera: Tortricidae).

**REMARKS.** The exceptionally short, deep carapace of this species is most distinctive and is only likely to be confused with that of *varipes* from which *reticulata* is easily distinguished by its strongly, irregularly rugose face and smooth, punctate hind coxae.

I have examined one specimen from Korea (Yeson (*Paik*) (RNH)), reared from an apple leafroller (probably *Adoxophes orana*), that is probably conspecific with *reticulata* although it has a coarsely reticulate-rugose face, the carapace yellow at the base and the legs lighter in colour.

### *Ascogaster rufipes* (Latreille)

(Figs 69, 77–79)

*Sigalphus rufipes* Latreille, 1809: 14. Syntypes, FRANCE (lost).

*Sigalphus elegans* Nees von Esenbeck, 1816: 264. Type-material, GERMANY (lost). [Synonymised by Thomson, 1892: 1716.]

*Chelonus fasciatus* Dahlbom, 1833: 163. LECTOTYPE ♀, SWEDEN (ZI), here designated [examined]. [Synonymised by Thomson, 1874: 583.]

*Ascogaster ratzeburgii* Marshall, 1885: 146. Holotype ♂, GREAT BRITAIN: Norfolk, Brundall, 3.vii.1881 (*Bridgman*) (NCM) [examined]. **Syn. n.**

*Ascogaster soror* Telenga, 1941: 324. Lectotype ♂, U.S.S.R.: 'Sinelnikovo', vi.1930 (AS) [examined]. [Lectotype selected by Tobias.] **Syn. n.**

I have not been able to locate Latreille's specimens of *rufipes* and the description of the species is insufficient for it to be identified with certainty. Several interpretations of the name have been used and this has led to some confusion. Thomson's (1892: 1716) remarks upon *rufipes* cleared away some of the confusion, showing that Nees von Esenbeck's interpretation of *rufipes* was

incorrect. Thomson put forward his own interpretation of *rufipes* and so tactfully rejected that of Reinhard (1867: 365) who regarded *rufipes* and *bidentula* as conspecific. It is clear from his description that he had identified Wesmael's species correctly, but I cannot accept that *bidentula* fits Latreille's description of *rufipes* and so reject Reinhard's interpretation and follow Thomson's. Nees von Esenbeck's description of *elegans* fits perfectly well with Thomson's interpretation of *rufipes*.

Four specimens are named *fasciatus* in the Fallén collection. Two are conspecific and one bears a label 'C. fasciatus Dbm var a' in Dahlbom's handwriting; I designate this specimen as lectotype. The third specimen bearing a small label 'var b' in Dahlbom's handwriting belongs to *varipes* and the fourth bearing the label 'var c' in Dahlbom's handwriting is a male *abdominator*.

The holotype of *ratzeburgii* comes well within the limits of variation of *rufipes*. The lectotype of *soror* has three labels, one bearing the data published by Telenga, a second in Telenga's handwriting, 'Ascogaster soror sp.n. ♂' and a third bearing Tobias' lectotype designation (though I have not been able to find where, or whether this was published); *soror* comes well within the limits of variation of *rufipes*.

♀. Antenna 34–37 segmented. Flagellum generally slightly broader medially than at base, then tapering to apex, most segments longer than broad, a few medial segments about as long as broad. Head slightly expanded behind eyes, then roundly contracted. Temple about 1.5 times length of eye in dorsal view. Occiput strongly concave. Frons behind antennae excavate. Ocelli small, OO = 3.5 OD; ocellar triangle obtuse, ocelli almost on line. Weak carina extends from upper part of face to fore ocellus. Eyes not protuberant. Genae in face view rounded. Face protuberant, about twice as broad as high, reticulate-rugose. Clypeus weakly protuberant; smooth, punctate; apical border produced medially into a large dentate tubercle. Mandibles short, stout, moderately twisted. Pronotum projecting distinctly in front of mesonotum, laterally completely rugose except for a polished medial area. Mesonotum almost completely strongly reticulate-rugose except sometimes a small punctate area laterally. Notaulices indistinguishable. Precoxal suture indistinguishable, almost all mesopleuron strongly reticulate-foveolate. Propodeum completely regularly reticulate-rugose, divided by a medial transverse carina which is raised into strong flanges laterally and weak ones medially; dorsal surface rather long. Carapace rather long and narrow, coarsely reticulate-rugose, the longitudinal element predominant, especially anteriorly; posteroventral rim not reaching apex of carapace. Hypopygium short. Ovipositor short, straight, abruptly narrowed shortly before apex. Ovipositor sheaths thick. Hind coxa polished, punctate, with fine transverse rugae dorsally.

Colour black, apical border of clypeus often rufous, mandibles at base testaceous; carapace at base yellow for slightly more than a third of its length; legs yellow or testaceous except all tarsi generally infusate, at least in part, hind coxa at base and mid and hind tibiae often also infusate.

♂. Same as ♀ except antenna 32–35 segmented; carapace longer, narrower, always completely dark; legs generally darker.

#### MATERIAL EXAMINED

91 ♂, 39 ♀. Czechoslovakia, France, Great Britain, Hungary, Ireland, Netherlands, Spain, Sweden, U.S.S.R., Yugoslavia.

HOSTS. No reared material examined.

REMARKS. Smaller and more delicate than most other species in the *quadridentata*-group; only *brevicornis* and the smaller specimens of *quadridentata* are of comparable size. *A. rufipes* also exhibits more sexual dimorphism than others in the *quadridentata*-group; it was Marshall's failure to appreciate this which led him to describe the male of *rufipes* as a distinct species even though he collected it with the female (for which he used the name *elegans*).

#### *Ascogaster scabricula* (Dahlbom)

(Figs 68, 71, 74–76)

*Chelonus scabriculus* Dahlbom, 1833: 166. LECTOTYPE ♀, SWEDEN: Fallén colln (ZI), here designated [examined].

*Ascogaster limitatus* Wesmael, 1838: 163. LECTOTYPE ♀, BELGIUM: Wesmael colln (IRSNB), here designated [examined]. Syn. n.

*Ascogaster clypealis* Thomson, 1892: 1719. LECTOTYPE ♀, SWEDEN: Öland, Thomson colln (ZI), here designated [examined]. **Syn. n.**

Four specimens in Fallén's collection are named *scabriculus*; I designate as lectotype the specimen labelled 'C. scabriculus Dbm. var. a' in Dahlbom's handwriting. It agrees with Dahlbom's description of 'scabriculus var. a' and is labelled '♂' although I believe it to be ♀. The other three specimens belong each to a different species; the only one which bears a label in Dahlbom's handwriting 'var. c' belongs to *rufidens*. Fahringer (1934: 544) synonymised *scabricula* with *similis* which, from his description he obviously interpreted as being conspecific with *brevicornis*; I reject this placement of *scabricula*. Wesmael (1838: 164) stated that he had examined two specimens of *limitatus*. In Wesmael's collection there is one specimen labelled 'Ascogaster limitatus mihi'; it agrees precisely with Wesmael's description and I accept it as a syntype. Wesmael gave the number of antennal segments as 33; in the material I have examined the number ranges from 30–32.

Three females (one without a head) are above the name *clypealis* in Thomson's collection; they are conspecific and agree with the original description. I designate as lectotype the best-preserved female, which Graham labelled as type despite the presence on the pin of a label '4-dentatus' in Thomson's handwriting; the significance of such labels is discussed under *canifrons*.

♀. Antenna 30–32 segmented. Flagellum dilated medially, tapered to end, most segments in distal half quadrate, in proximal half longer than broad (only three or four at base as much as twice as long as broad). Head rounded, more or less expanded behind eyes. Temple about 1.5 times length of eye in dorsal view. Occiput strongly concave. Ocelli small, OO = 3.5 OD; almost on line. Frons behind antennae slightly excavate, strongly rugose. Eyes small, not protuberant. Face protuberant, about twice as broad as high, completely regularly reticulate-rugose, divided from clypeus by a deep furrow. Anterior tentorial pits deep. Clypeus protuberant, polished, densely punctate, but with some rugae laterally; apical border produced medially with no distinct tubercle. Mandible moderately twisted, densely punctate at base. Genal carina joining hypostomal carina at base of mandible, forming a small flange which projects beneath base of mandible. Pronotum projecting but little in front of mesonotum, completely coarsely rugose. Mesonotum broad, almost completely rugose, the notaulices more or less indistinguishable. Mesopleuron completely coarsely reticulate-rugose, precoxal suture indistinguishable. Propodeum divided into dorsal and posterior surfaces by a weak medial transverse carina which is raised into two low broad humps medially and into two strong flanges laterally; completely, regularly reticulate-rugose with no distinct carinae. Carapace rounded, about 1.5 times as long as broad, deep; posteroventral rim not significantly in front of apex. Hypopygium short. Ovipositor short, straight, thick at base, abruptly narrowed shortly before apex. Hind coxa punctate except dorsally transversely striate.

Colour black, fore tibia pale, at least in part.

♂. Same as ♀ except posteroventral rim of carapace distinctly before apex; head more strongly contracted.

#### MATERIAL EXAMINED

5 ♂, 12 ♀. **Belgium:** 1 ♀ (lectotype of *limitatus*). **France:** 3 ♂, Lent, Ain (*Audras*) (MNHN); 1 ♂, Megere, vi.1948 (*Granger*) (MNHN); 1 ♂, 'env. Paris', 20.vi.1889 (*Chrétien*) (MNHN); 1 ♀, Chartrettes, 21.vi.1942 (MNHN); 1 ♀, Drôme, Chap-en-Vercors, vii.1938 (MNHN); 1 ♀, St. M-Vésudie, 27.vii.1950 (*Granger*) (MNHN); 1 ♀, Le Vésinet, 1867 (*Sichel*) (MNHN). **Sweden:** 3 ♀, Solna, Bergshamra, viii.1976 (*Quinlan & Huddleston*) (BMNH); 1 ♀ (lectotype of *scabricula*) (ZI); 1 ♀ (lectotype of *clypealis*) (ZI); 2 ♀ (paralectotypes of *clypealis*), Thomson colln (ZI).

HOSTS. No reared material examined.

#### Species inquirendae

##### *Ascogaster atriceps* (Ratzeburg)

*Chelonus atriceps* Ratzeburg, 1844: 33. ?Syntype, GERMANY (IP) [examined].

The purported syntype of *C. atriceps* is in too poor condition to be identified.

***Ascogaster contractus*** (Ratzeburg)

*Chelonus contractus* Ratzeburg, 1848: 24. Syntypes, GERMANY (lost).

***Ascogaster dentiventris*** Telenga

*Ascogaster dentiventris* Telenga, 1941: 311. Syntypes, U.S.S.R. (lost).

***Ascogaster erythrothorax*** Marshall

*Chelonus erythrothorax* Marshall, 1898: 171. Syntypes, FRANCE (lost).

***Ascogaster kabystanicus*** Tobias

*Ascogaster kabystanicus* Tobias, 1976: 235. Holotype ♂, U.S.S.R.: Azerbaidzhan, 19.v.1972 (*Kasparyan*) (AS) [examined].

This species belongs to the *caucasica*-group in which the males are extremely difficult to differentiate.

***Ascogaster lapponicus*** Thomson

*Ascogaster lapponicus* Thomson, 1874: 588. Syntypes, SWEDEN (lost).

***Ascogaster pallidicornis*** Curtis

*Ascogaster pallidicornis* Curtis, 1837: folio 672. Syntypes, GREAT BRITAIN (lost).

One specimen named *pallidicornis* in Curtis's collection disagrees in most particulars with the original description and cannot therefore be a syntype.

***Ascogaster quadridens*** (Herrich-Schäffer)

*Chelonus quadridens* Herrich-Schäffer, 1838: 154. Syntypes, GERMANY (lost).

This species has been placed in synonymy with *quadridentata* but the latter never has pale marks at the base of the carapace as described for *quadridens*.

***Ascogaster rubripes*** (Lucas)

*Chelonus rubripes* Lucas, 1849: 339. Syntypes, ALGERIA (lost).

***Ascogaster similis*** (Nees von Esenbeck)

*Chelonus similis* Nees von Esenbeck, 1816: 262. Syntypes, GERMANY (lost).

***Ascogaster tersus*** Reinhard

*Ascogaster tersus* Reinhard, 1865: 366. Syntypes, GERMANY (lost).

One specimen named *tersus* in Reinhard's collection disagrees with the original description and cannot therefore be a syntype.

**Excluded species*****Phanerotoma maculata*** (Wollaston) **comb. n.**

*Ascogaster maculata* Wollaston, 1858: 24. Holotype ♀, MADEIRA (BMNH) [examined].

**Acknowledgements**

I thank the following for their kindness in lending me the type-specimens and much of the other material upon which this revision is based: Dr C. van Achterberg (Leiden); Dr A. A. Allen (Reigate); Mr S. Belokobylskij (Leningrad); Dr M. Capek (Prague); Mr R. Danielsson (Lund); Dr P. Dessart (Brussels); Dr M. Fischer (Vienna); Dr M. W. R. de V. Graham (Oxford); Dr E. Haeselbarth (Munich); Dr K.-J. Hedqvist (Stockholm); Dr A. Irwin (Norwich); Dr J. Lukas (Trencin); Dr K. Maeto (Kyushu); Dr P. M.

Marsh (Washington); Prof. Morge (Berlin); Dr J. Papp (Budapest); Dr B. Petersen (Copenhagen); Dr M. R. Shaw (Edinburgh); Dr S. R. Shaw (Washington); Dr B. Sigwalt (Paris); Dr S. Takaga (Sapporo); Dr V. I. Tobias (Leningrad); Dr H. K. Townes (Ann Arbor); Dr H. J. Vluc (Wageningen); Dr A. Zaykov (Plovdiv). I also thank Mr U. Gardenfors (Lund), Dr G. E. J. Nixon and Mr C. R. Vardy (BMNH) for help with translations, and my wife, Linda, for typing the manuscript.

## References

- Abdinbekova, A. A.** 1969. Braconids (Hymenoptera, Braconidae) of the lesser Caucasus in Azerbaidzan. *Isvestyia Akademii Nauk Azerbaidzenskoi SSR* 1969 (5): 69–76.
- Achterberg, C. van** 1976. A preliminary key to the subfamilies of the Braconidae (Hymenoptera). *Tijdschrift voor Entomologie* 119: 33–78.
- Allen, H. W.** 1962. Parasites of the oriental fruit moth in the eastern United States. *Technical Bulletin of the United States Department of Agriculture* no. 1265: 136 pp.
- Ashmead, W. H.** 1906. Descriptions of new Hymenoptera from Japan. *Proceedings of the United States National Museum* 30: 169–201.
- Baker, C. F.** 1926. Braconidae-Cheloninae of the Philippines, Malaya, and Australia. *The Philippine Journal of Science* 31: 451–489.
- Boyce, H. R.** 1936. Laboratory breeding of *Ascogaster carpocapsae* Viereck with notes on biology and larval morphology. *Canadian Entomologist* 68: 241–246.
- Capek, M.** 1970. A new classification of the Braconidae (Hymenoptera) based on the cephalic structures of the final instar larva and biological evidence. *Canadian Entomologist* 102: 846–875.
- Cox, J. A.** 1932 *Ascogaster carpocapsae* Viereck, an important parasite of the codling moth and the oriental fruit moth. *Technical Bulletin of the New York State Agricultural Experimental Station* no. 188: 1–26.
- Curtis, J.** 1829. *A guide to an arrangement of British insects* vi pp. + 256 columns. London.
- 1837. *British Entomology* 14: folio 672. London.
- Dahlbom, A. G.** 1833. Försök till beskrifning öfver Hymenopterslägtet Chelonus, med dertill hörande Skandinaviska arter. *Kongliga Swenska Vetenskaps-Academiens Handlingar* 53: 147–167.
- Dudarenko, G. P.** 1974. Formation of the abdominal carapace in braconids (Hymenoptera, Braconidae) and some aspects of the classification of the family. *Entomological Review*, Washington. 53: 80–90 [translated from the Russian in *Entomologicheskoye Obozneniye*].
- Evenhuis, H. H. & Vluc, H. J.** 1983. The hymenopterous parasites of leaf-feeding apple tortricids (Lepidoptera, Tortricidae) in the Netherlands. *Tijdschrift voor Entomologie* 128: 109–135.
- Fahringer, J.** 1934. *Opuscula braconologica 3 Palaearctische Region* 2 (5–8): 321–594.
- Fischer, M.** 1965. Die Braconiden des Steiermärkischen Landesmuseums Joanneum in Graz (Hymenoptera, Braconidae). *Abteilung für Zoologie und Botanik am Landesmuseum Joanneum* 21: 3–29.
- Fitton, M. G.** 1982. A catalogue and reclassification of the Ichneumonidae (Hymenoptera) described by C. G. Thomson. *Bulletin of the British Museum (Natural History)* (Entomology) 45: 1–119.
- Foerster, A.** 1862. Synopsis der Familien und Gattungen der Braconen. *Verhandlungen des naturhistorischen Vereines der preussischen Rheinlande und Westfalens* 19: 225–288.
- Graham, M. W. R. de V.** 1955. A taxonomic revision of the Chelonine Braconidae (Insecta, Hymenoptera). Unpublished thesis, Oxford.
- Hellén, W.** 1953. Die *Ascogaster*-arten Finnlands (Hym., Brac.). *Notulae Entomologicae* 33: 84–88.
- Herrich-Schäffer, G. A. W.** 1838 In Panzer, G. W. F., *Deutschlands Insecten* Heft 153–54. Regensburg.
- Huddleston, T.** 1980. A revision of the western Palaearctic species of the genus *Meteorus* (Hymenoptera: Braconidae). *Bulletin of the British Museum (Natural History)* (Entomology) 41: 1–58.
- Kainoh, Y., Hiyori, T. & Tamaki, Y.** 1982. Kairomone of the egg-larval parasitoid, *Ascogaster reticulatus* Watanabe (Hymenoptera: Braconidae). *Applied Entomology and Zoology* 17: 102–110.
- Kainoh, Y. & Tamaki, Y.** 1982. Searching behaviour and oviposition of the egg-larval parasitoid, *Ascogaster reticulatus* Watanabe (Hymenoptera: Braconidae). *Applied Entomology and Zoology* 17: 194–206.
- Kirchner, L.** 1867. *Catalogus Hymenopterorum Europae* 285 pp. Vindobonae.
- Kokujev, N.** 1895. Fragments Braconologiques. *Horae Societatis Entomologicae Rossicae* 29: 77–95.
- Latreille, P. A.** 1809. *Genera Crustaceorum et Insectorum* 4: 399 pp. Paris.
- Lucas, H.** 1849. *Exploration Scientifique de l'Algérie*, Zoologie 3: 527 pp. Paris.
- Marshall, T. A.** 1885. Monograph of British Braconidae, Part 1. *The Transactions of the Entomological Society of London* 1885: 1–280.
- 1888. In André, E., *Species des Hyménoptères d'Europe et d'Algérie* 4: 603 pp.
- 1897–1900. In André, E., *Species des Hyménoptères d'Europe et d'Algérie* 5 bis: 373 pp.



- Nees von Esenbeck, C. G.** 1816. *Ichneumonides adsciti*, in genera et familias divisi. *Magazin. Gesellschaft Naturforschender Freunde zu Berlin* 7 (1813): 243–277.
- 1834. *Hymenopterorum Ichneumonibus affinium monographiae, genera Europaea et species illustrantes* 1: 320 pp. Stuttgart & Tubingen.
- Papp, J.** 1967. Ergebnisse der zoologischen Forschungen von Dr. Z. Kaszab in der Mongolei Braconidae (Hymenoptera) 1. *Acta Zoologica Academiae Scientiarum Hungaricae* 13: 191–226.
- 1971. Results of the Zoological Explorations of Dr. Z. Kaszab in Mongolia. Hymenoptera: Braconidae II. *Acta Zoologica Academiae Scientiarum Hungaricae* 17: 51–90.
- Ratzeburg, J. T. C.** 1844. *Die Ichneumonen der Forstinsekten in forstlicher und entomologischer Beziehung* 1: 224 pp. Berlin.
- 1848. *Die Ichneumonen der Forstinsekten in forstlicher und entomologischer Beziehung* 2: 238 pp. Berlin.
- 1852. *Die Ichneumonen der Forstinsekten in forstlicher und entomologischer Beziehung* 3: 272 pp. Berlin.
- Reinhard, H.** 1867. Beiträge zur Kenntniss einiger Braconiden-Gattungen. *Berliner entomologische Zeitschrift* 11: 251–274.
- Richards, O. W.** 1977. Hymenoptera. Introduction and key to families 2nd ed. *Handbooks for the Identification of British Insects* 6 (1): 100 pp.
- Rosenberg, H. T.** 1934. The biology and distribution in France of the larval parasites of *Cydia pomonella* L. *Bulletin of Entomological Research* 25: 201–256.
- Ruthe, J. F.** 1855. Beiträge zur Kenntniss der Braconiden. *Stettiner entomologischer Zeitung* 16: 291–294.
- Shaw, S. R.** 1984. A taxonomic study of Nearctic *Ascogaster* and a description of a new genus *Leptodrepana* (Hymenoptera: Braconidae). *Entomography* 2: 1–54.
- Shenefelt, R. D.** 1973. *Catalogue Hymenopterorum (Nov. ed.)* part 10 Braconidae 6: 813–936. S'Gravenhage.
- Short, J. R. T.** 1952. The morphology of the head of larval Hymenoptera with special reference to the head of Ichneumonoidea including a classification of the final instar larvae of the Braconidae. *Transactions of the Royal Entomological Society of London* 103: 27–84.
- Shu-Sheng, L. & Carver, M.** 1982. The effect of temperature on the adult integumental coloration of *Aphidius smithi*. *Entomologia Experimentalis et Applicata* 32: 54–60.
- Sonan, J.** 1932. Notes on some Braconidae and Ichneumonidae from Formosa with descriptions of 18 new species. *Transactions of the Natural History Society of Formosa* 22: 66–86.
- Szépligeti, G.** 1896. Adatok a Magyar fauna Braconidainak ismerethéhez. *Természetrájl Füzetek* 19: 165–186.
- 1908. Braconiden aus der Sammlung des ungarischen national Museums II. *Annales Historico-Naturales Musei Nationalis Hungarici* 6: 397–427.
- Telenga, N. A.** 1941. Insects Hymenoptera, Family Braconidae, Subfamily Braconinae (continued) and Sigalphinae. *Fauna SSSR* 5 (3): 466 pp.
- Thomson, C. G.** 1874. Öfversigt af Sveriges Sigalpher. *Opuscula entomologica* 6: 553–588.
- 1892. Bidrag till Braconidernas kändedom. *Opuscula entomologica* 16: 1659–1751.
- Tobias, V. I.** 1964. New species and genus of Braconids (Hymenoptera, Braconidae) from Kazachstan. *Trudi Zoologicheskovo Institutu, Leningrad* 34: 177–234.
- 1972. New species of braconids (Hymenoptera, Braconidae) from Mongolia. *Nasekome Mongolii* 9: 585–612.
- 1976. Braconidae of the Caucasus. *Opredelitel Po Faune SSSR* 110: 1–286.
- Watanabe, C.** 1937. A contribution to the knowledge of the Braconid fauna of the Empire of Japan. *Journal of the Faculty of Agriculture Hokkaido Imperial University* 42 (1): 1–188.
- Waterston, J.** 1926. *Ascogaster annularis* Nees (Hym.) in the London district and a note on its probable host. *Entomologist* 59: 174.
- Wesmael, C.** 1835. Monographie des Braconides de Belgique. *Nouveaux Mémoires de l'Academie Royale des sciences et belles-lettres de Bruxelles* 9: 1–252.
- 1838. Monographie des Braconides de Belgique. *Nouveaux Mémoires de l'Academie Royal des sciences et belles-lettres de Bruxelles* 11: 1–166.
- Wharton, R. A.** 1980. Review of the Nearctic Alysini (Hymenoptera, Braconidae) with discussions of generic relationships within the tribe. *University of California publications in entomology* 88: 1–112.
- Wollaston, T. V.** 1858. Brief diagnostic characters of undescribed Madeiran insects. *Annals and Magazine of Natural History* (3) 1: 18–28.
- Yoneda, Y.** 1978. A new species of the genus *Ascogaster* Wesmael (Hymenoptera, Braconidae) from Japan. *Kontyû* 46: 291–296.

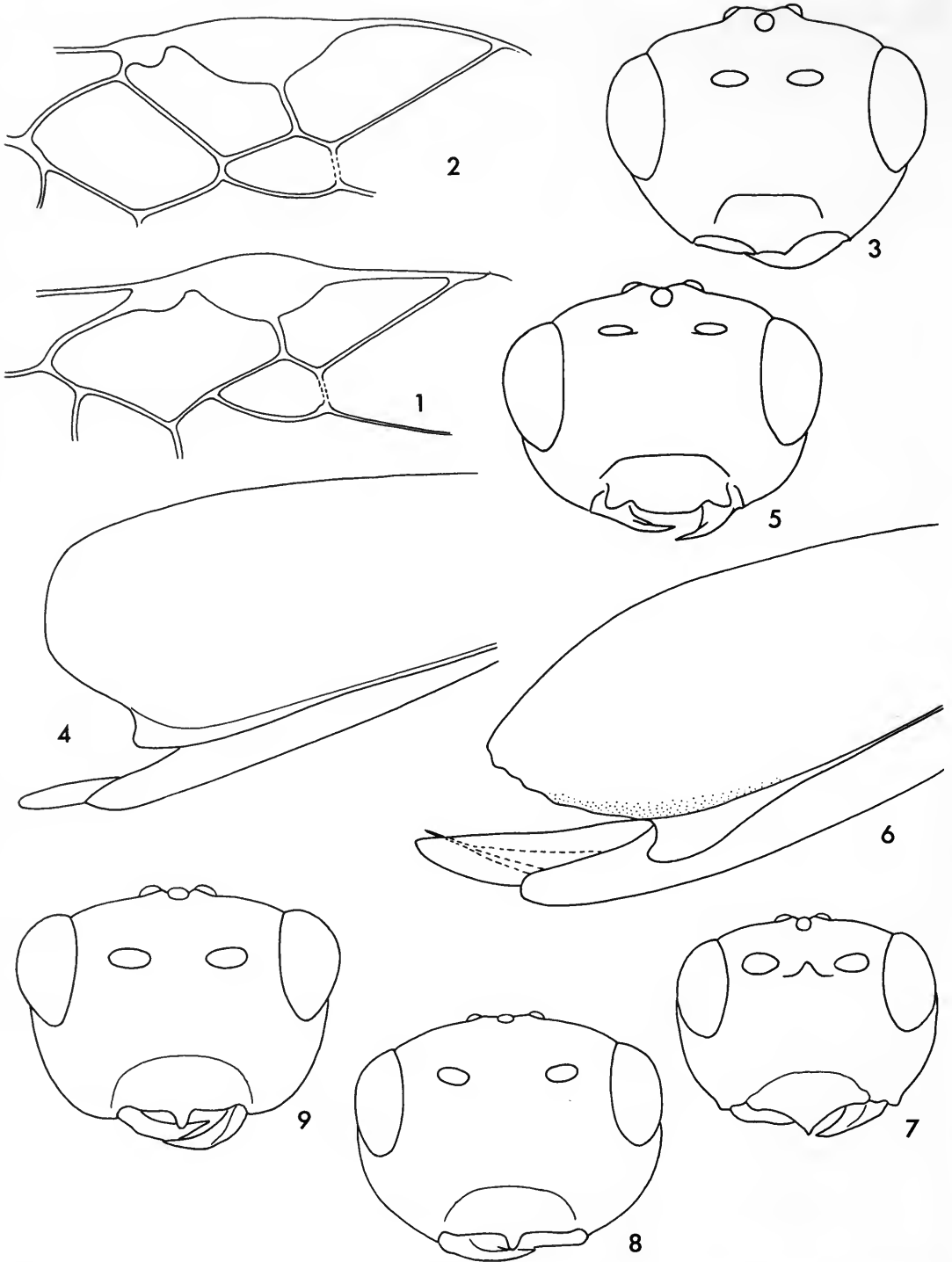

**Figs 1-9** 1, *Chelonus* sp., forewing, anterodorsal. 2, *Ascogaster rufidens* Wesmael, forewing, anterodorsal. 3, 4, *A. excavata* Telenga; (3) head, frontal; (4) carapace, distal. 5, 6, *A. semenovi* Telenga; (5) head, frontal; (6) carapace, distal. 7, *A. dentifer* Tobias, head, frontal. 8, *A. nachitshevanica* Abdinbekova, head, frontal. 9, *A. abdominalator* (Dahlbom), head, frontal.

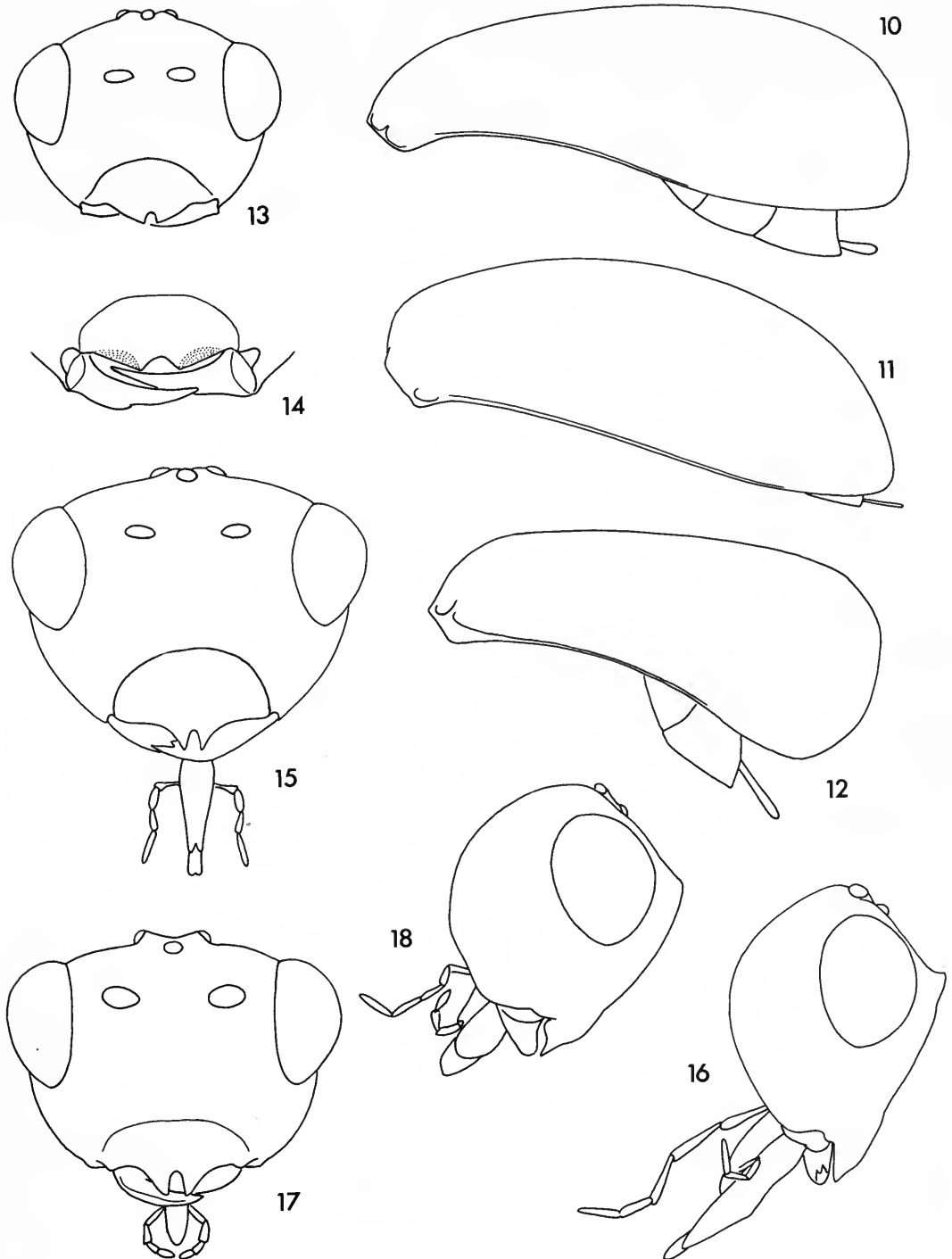

**Figs 10–18** 10, *Ascogaster abdominalator* (Dahlbom), carapace, lateral. 11, *A. nachitshevanica* Abdinbekova, carapace, lateral. 12, *A. dentifer* Tobias, carapace, lateral. 13, *A. kasparyani* Tobias, head, frontal. 14, *A. excisa* (Herrich-Schäffer), clypeus, anteroventral, 15, 16, *A. caucasica* Kokujev; (15) head, frontal; (16) head, lateral. 17, 18, *A. bicarinata* (Herrich-Schäffer); (17) head, frontal; (18) head, lateral.

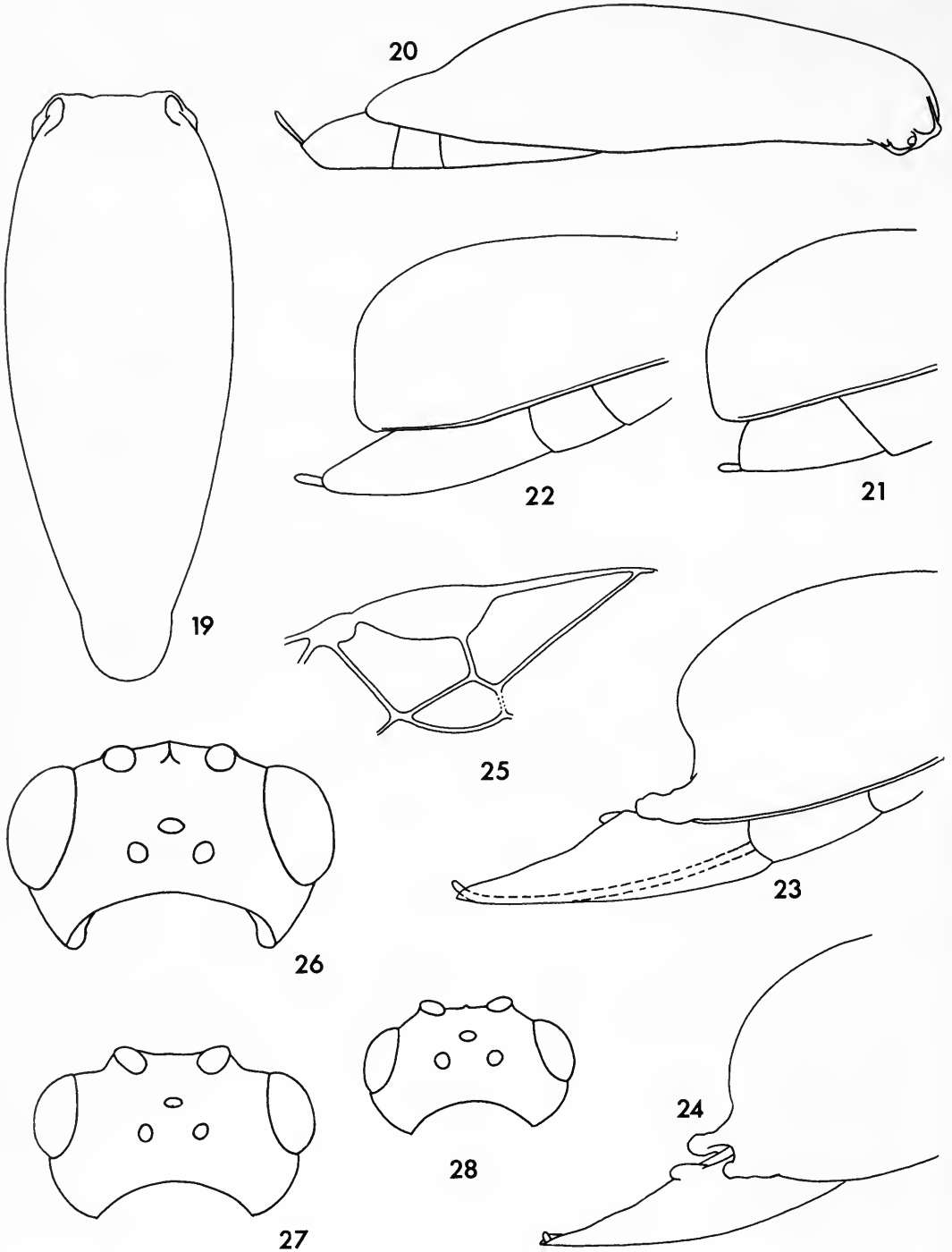

**Figs 19–28** 19, 20, *Ascogaster kasparyani* Tobias; (19) carapace, dorsal; (20) carapace, lateral. 21, *A. bicarinata* (Herrich-Schäffer), carapace, distal. 22, *A. caucasica* Kokujev, carapace, distal. 23, 24, *A. excisa* (Herrich-Schäffer); (23) carapace, lateral; (24) carapace, posterolateral. 25, *A. annularis* (Nees), forewing, anterodistal. 26, *A. gonocephala* Wesmael, head, dorsal. 27, *A. klugii*, (Nees), head, dorsal. 28, *A. exigua* sp. n., head, dorsal.

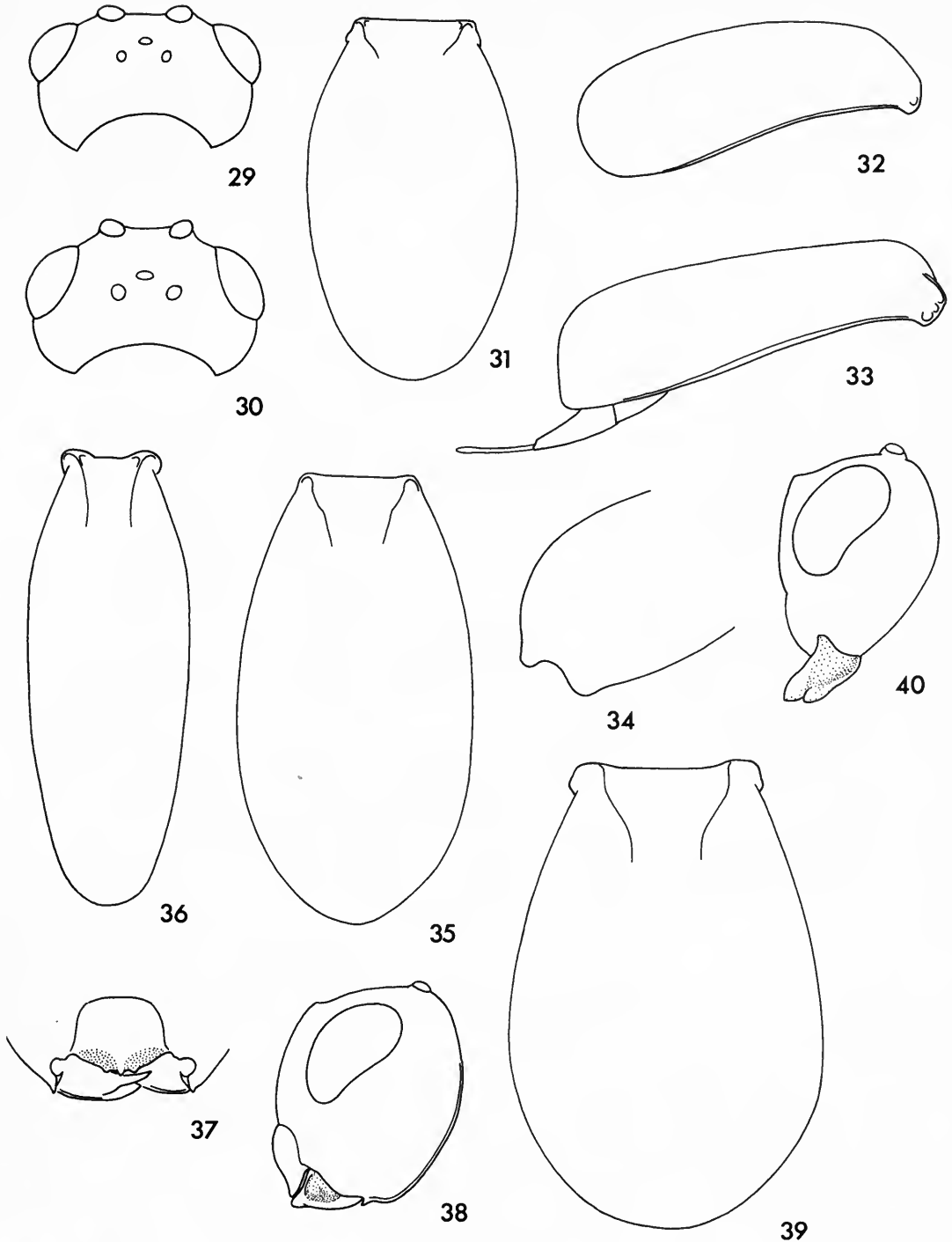

**Figs 29–40** 29, *Ascogaster annularis* (Nees), head, dorsal; 30–32, *A. grahami* sp. n.; (30) head, dorsal; (31) carapace, dorsal; (32) carapace, lateral. 33, 34. *A. annularis* (Nees); (33) carapace, lateral; (34) carapace, posterolateral. 35, *A. klugii* (Nees), carapace, dorsal. 36, *A. exigua* sp. n., carapace, dorsal. 37, *A. rufidens* Wesmael, clypeus, anteroventral. 38, *A. varipes* Wesmael, head, lateral. 39, 40, *A. rufidens* Wesmael; (39) carapace, dorsal; (40) head, lateral.

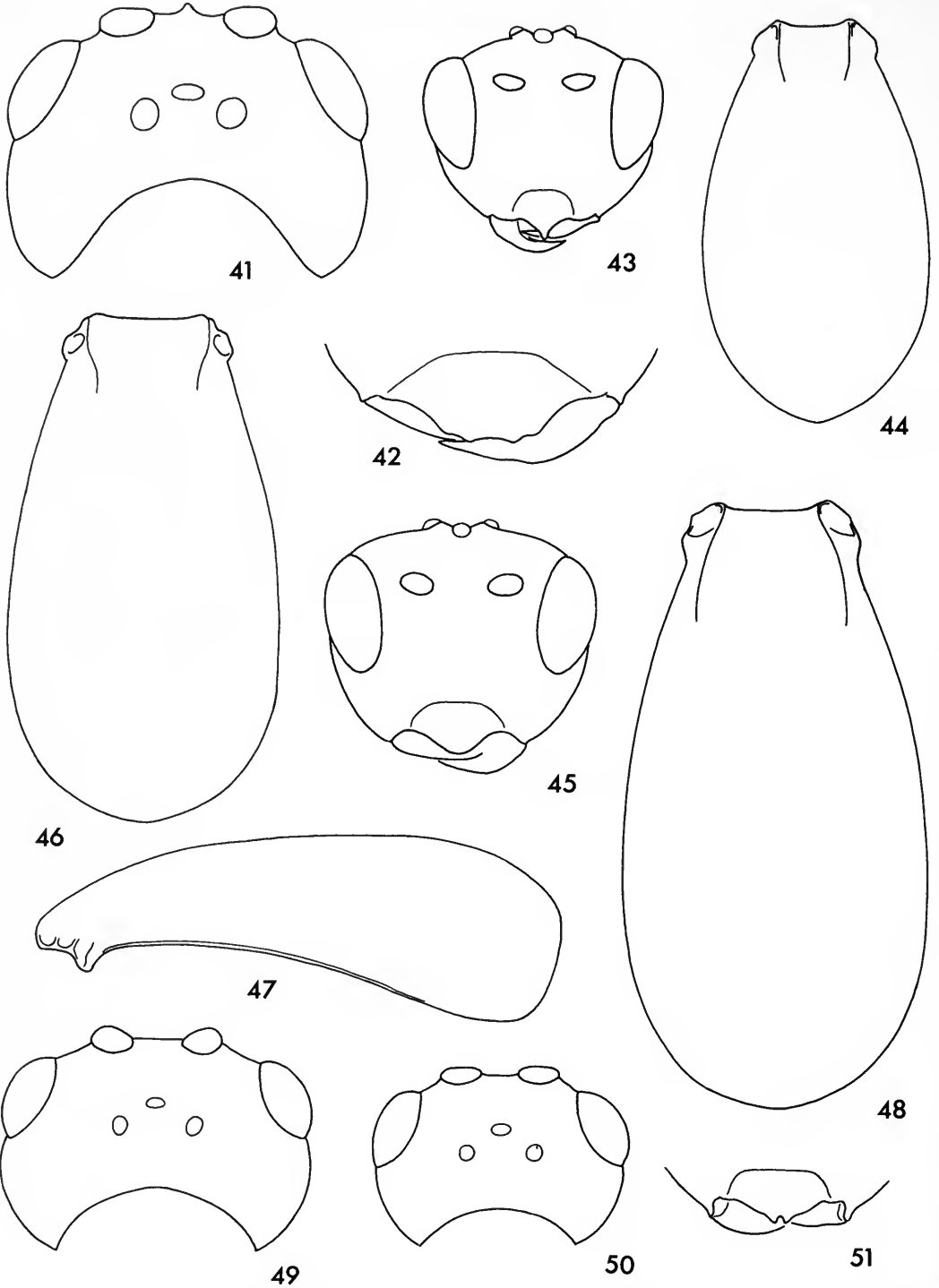

**Figs 41–51** 41, 42, *Ascogaster longicornis* sp. n.; (41) head, dorsal; (42) clypeus, anteroventral. 43, 44, *A. perkinsi* sp. n.; (43) head, frontal; (44) carapace, dorsal. 45–47, *A. consobrina* Curtis; (45) head, frontal; (46) carapace, dorsal; (47) carapace, lateral. 48, *A. albitarsus* Reinhard, carapace, dorsal. 49, *A. arisanica* Sonan, head, dorsal. 50, 51, *A. bidentula* Wesmael; (50) head, dorsal; (51) clypeus, anteroventral.

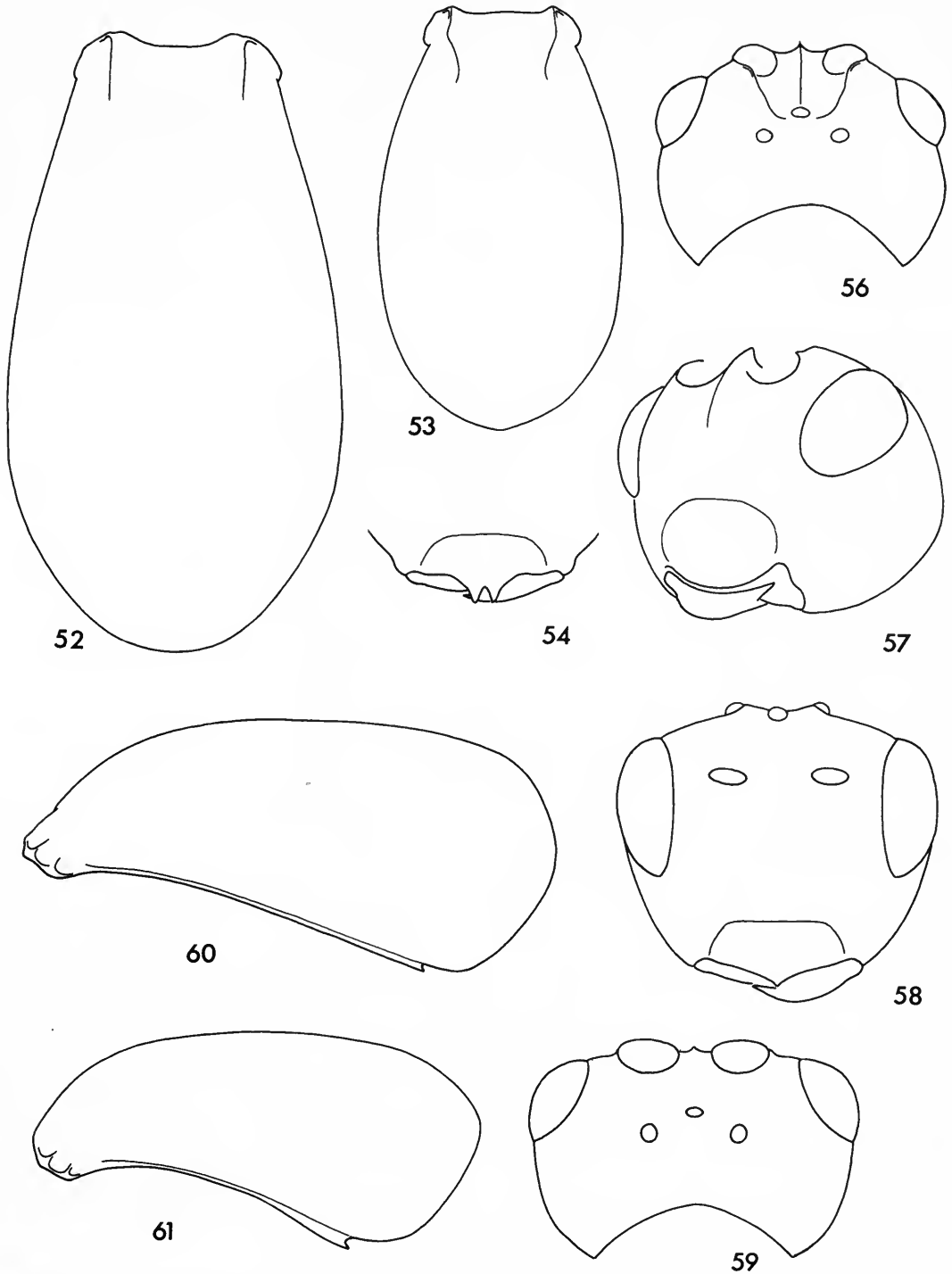

**Figs 52–61** 52, *Ascogaster arisanica* Sonan, carapace, dorsal. 53, *A. bidentula* Wesmael, carapace, dorsal, 54, *A. arisanica* Sonan, clypeus, anteroventral. 56, 57, *A. armata* Wesmael; (56) head, dorsal; (57) head, anterolateral. 58, 59, *A. canifrons* Wesmael; (58) head, frontal; (59) head, dorsal. 60, *A. quadridentata* Wesmael, carapace, lateral. 61, *A. reticulata* Watanabe, carapace, lateral.

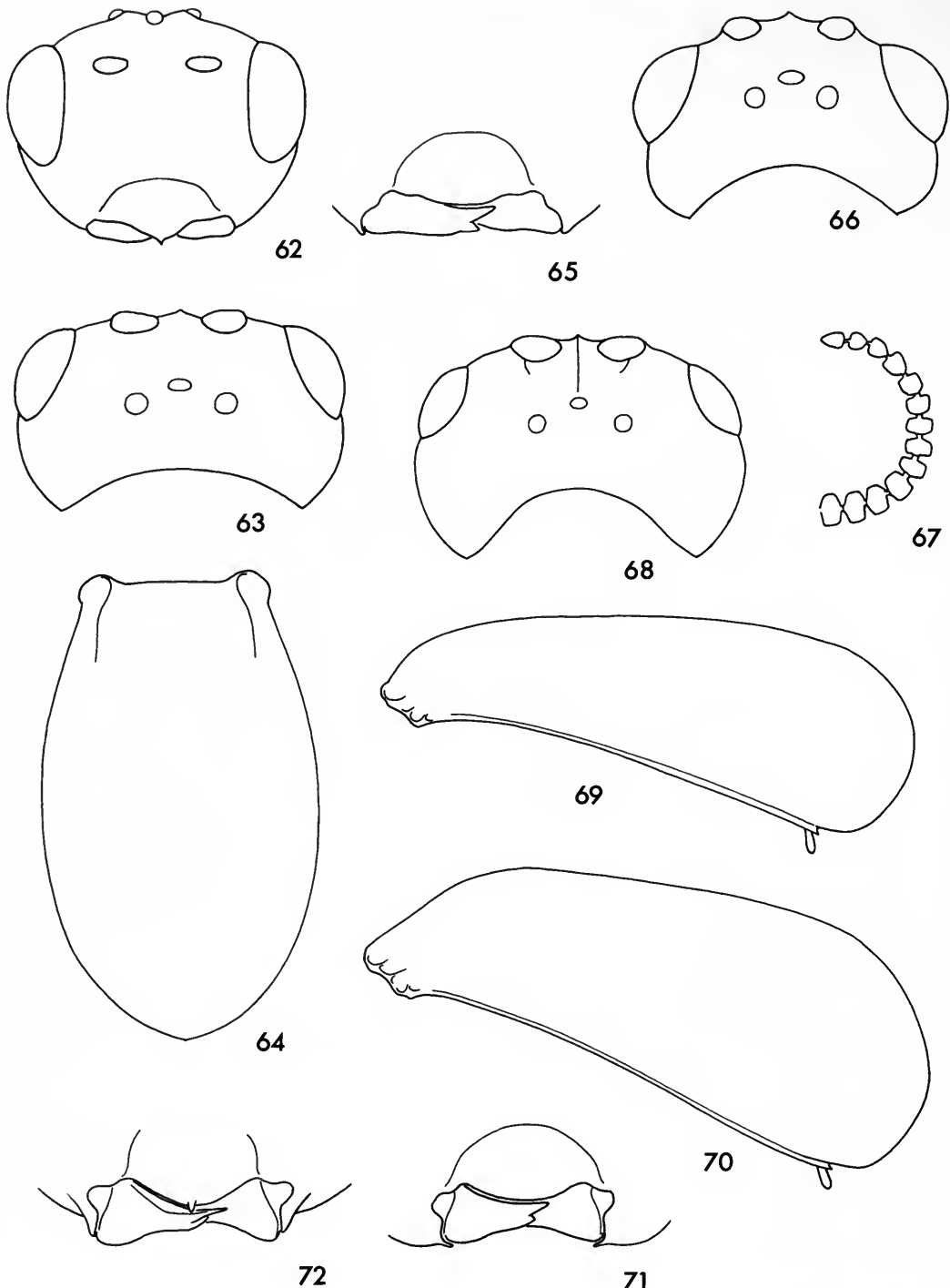

**Figs 62-72** 62-64, *Ascogaster quadridentata* Wesmael; (62) head, frontal; (63) head, dorsal; (64) carapace, dorsal. 65, 66, *A. reticulata* Watanabe; (65) clypeus, anteroventral; (66) head, dorsal. 67, *A. brevicornis* Wesmael, antenna, distal. 68, *A. scabricula* (Dahlbom), head, dorsal. 69, *A. rufipes* (Latreille), carapace, lateral. 70, *A. dispar* Fahringer, carapace, lateral. 71, *A. scabricula* (Dahlbom), mandibles, anteroventral. 72, *A. dispar* Fahringer, mandibles, anteroventral.



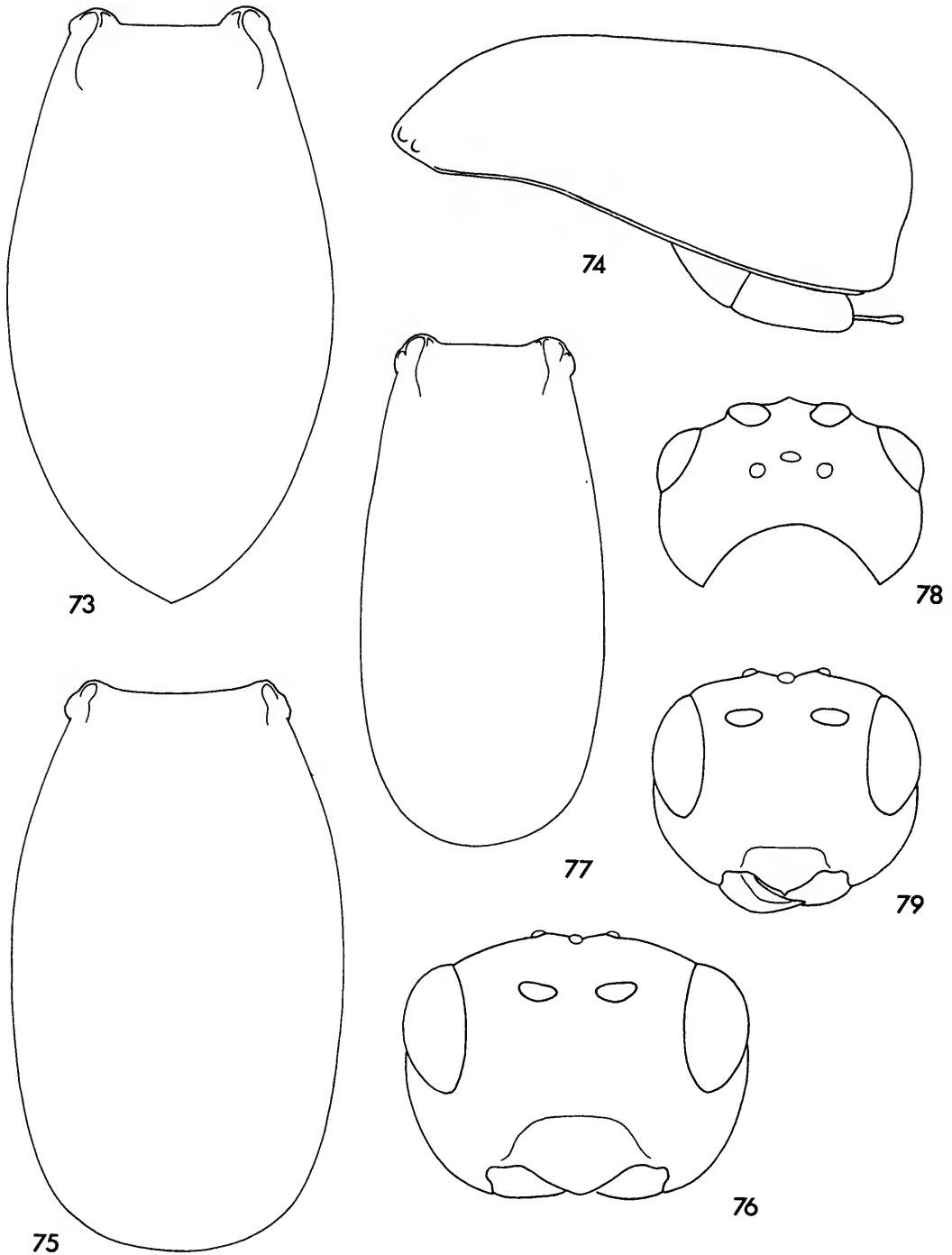

**Figs 73–79** 73, *Ascogaster dispar* Fahringer, carapace, dorsal. 74–76, *A. scabricula* (Dahlbom); (74) carapace, lateral; (75) carapace, dorsal; (76) head, frontal. 77–79, *A. rufipes* (Latreille); (77) carapace, dorsal; (78) head, dorsal; (79) head, frontal.

## Index

Synonyms are in *italics*.

abdominator 357  
 albitarsus 364  
 annularis 360  
 arisanica 365  
 armata 372  
 atamiensis 366  
 atriceps 380

bicarinata 354  
 bidentula 366  
 brevicornis 373

canifrons 374  
 caucasica 354  
 cavifrons 370  
 clypealis 380  
 consobrina 367  
 contracta 381  
 cynipum 376

dentifer 359  
 dentiventris 381  
 dispar 375

egregius 376  
 elegans 378  
 epinotiae 376  
 erythrothorax 381  
 esenbeckii 372  
 excavata 352  
 excisa 355  
 exigua 361

fasciatus 378

*femoralis* 357  
*fulviventris* 357  
*fuscipennis* 366

*gibbiscuta* 366  
 gonocephala 362  
 grahami 362  
 graniger 374

*impressus* 376  
*instabilis* 357

*jaroslawensis* 370

*kabystanica* 381  
*kasachstanicus* 352  
 kasparyani 356  
 klugii 363  
 koslovi 375  
*kyshuensis* 352

*laevigator* 369  
*lapponica* 381  
*leptopus* 364  
*limitatus* 379  
 longicornis 368  
*longiventris* 355  
*luteicornis* 372

*maculata* 381  
*mlokossewitschi* 354  
*monilicornis* 373  
*multiarticulatus* 366

*nachtshevanica* 359

*neesii* 363  
*nigrator* 376  
*nigricornis* 376

*pallida* 357  
*pallidicornis* 381  
 perkinsi 368  
*pulchellus* 372  
*punctulator* 359

*quadridens* 381  
 quadridentata 376

*ratzeburgii* 378  
 reticulata 377  
 rostrata 354  
 rubripes 381  
 ruficeps 363  
 rufidens 369  
*rufipes* (Herrich-Schäffer) 369  
*rufipes* (Latreille) 378  
*rufiventris* 357

scabricula 379  
 semenovi 352  
*similis* 381  
 soror 378  
*spinifer* 375  
*sternalis* 370

*tersa* 381

varipes 370

**British Museum (Natural History)**

## **Milkweed butterflies: their cladistics and biology**

**P. R. Ackery & R. I. Vane-Wright**

The Danainae, a subfamily of the Nymphalidae, contains only some 150 species, yet aspects of their biology have stimulated far more attention than can be justified by species numbers alone. In recent years, an expansive literature has grown, considering aspects of their courtship and pre-courtship behaviour, migration, larval hostplant associations, mimicry and genetics. The popularity of danaines among biologists can certainly be attributed to this combination, within one small group, of so many of the factors that make butterflies such an interesting group to study. The obvious need to place this wealth of biological data within an acceptable systematic framework provided the impetus for this volume.

Started eight years ago within the conventions of evolution by natural selection and Hennig's phylogenetic systematics, the book is now largely about natural history (what the animals have and do, where they live and how they develop) and natural groups – as revealed by a form of analysis approaching that practised by the new school of 'transformed cladistics'. The authors have prepared a handbook that will appeal to a wide range of biologists, from museum taxonomists to field ecologists.

**424 pp (approx.), 12 pp colour, 73 b/w plates, line and graphic illustrations, maps, extensive bibliography. ISBN 0 565 00893 5. Publication September 1984. Price £50.**

## **Titles to be published in Volume 49**

**Afrotropical jumping plant lice of the family Triozidae (Homoptera: Psylloidea).**

By David Hollis.

**The taxonomy of the western European grasshopper of the genus *Euchorthippus*, with special reference to their songs (Orthoptera: Acrididae).**

By D. Ragge & W. J. Reynolds

**An historical review of the higher classification of the Noctuidae.**

By Ian Kitching

**The Pimplinae, Xoridinae, Acaenitinae and Lycorininae (Hymenoptera: Ichneumonidae).**

By I. D. Gauld

**The Palaearctic species of *Ascogaster* (Hymenoptera: Braconidae)**

By T. Huddleston





BOIARD  
15 DEC 1987

