

HARVARD UNIVERSITY



Library of the
Museum of
Comparative Zoology

Bulletin OF THE
Museum of
Comparative
Zoology

Volume 144
1972-1973

HARVARD UNIVERSITY
CAMBRIDGE, MASSACHUSETTS 02138 U.S.A.

CONTENTS

No. 1.	Rhinoceroses from the Pliocene of Northwestern Kenya. By Dick A. Hooijer and Bryan Patterson. July 1972	1
No. 2.	Pelycosaurian Reptiles from the Middle Pennsylvanian of North America. By Robert Reisz. July 1972	27
No. 3.	Social Biology of the Neotropical Wasp <i>Mischocyttarus drewseni</i> . By Robert L. Jeanne. September 1972	63
No. 4.	Studies in the Milliped Order Chordeumida (Diplopoda): A Revision of the Family Cleidogonidae and a Reclassification of the Order Chordeumida in the New World. By William A. Shear. October 1972	151
No. 5.	Romeriid Reptiles from the Lower Permian. By John Clark and Robert L. Carroll. March 1973	353
No. 6.	Nautiloid Cephalopods from the Julfa Beds, Upper Permian, Northwest Iran. By Curt Teichert and Bernhard Kummel. March 1973	409
No. 7.	The Nearctic Species of the Genus <i>Dolomedes</i> (Araneae: Pisauridae). By James Edwin Carico. March 1973	435
No. 8.	The Glandulocaudine Characid Fishes of the Guayas Basin in Western Ecuador. By Tyson R. Roberts. March 1973	489

Bulletin OF THE
Museum of
Comparative
Zoology

Rhinoceroses from the Pliocene of
Northwestern Kenya

DICK A. HOOIJER AND BRYAN PATTERSON

PUBLICATIONS ISSUED
OR DISTRIBUTED BY THE
MUSEUM OF COMPARATIVE ZOOLOGY
HARVARD UNIVERSITY

BULLETIN 1863-
BREVIOIRA 1952-
MEMOIRS 1864-1938
JOHNSONIA, Department of Mollusks, 1941-
OCCASIONAL PAPERS ON MOLLUSKS, 1945-

Other Publications.

- Bigelow, H. B., and W. C. Schroeder, 1953. Fishes of the Gulf of Maine. Reprint, \$6.50 cloth.
- Brues, C. T., A. L. Melander, and F. M. Carpenter, 1954. Classification of Insects. \$9.00 cloth.
- Creighton, W. S., 1950. The Ants of North America. Reprint, \$10.00 cloth.
- Lyman, C. P., and A. R. Dawe (eds.), 1960. Symposium on Natural Mammalian Hibernation. \$3.00 paper. \$4.50 cloth.
- Peters' Check-list of Birds of the World, vols. 2-7, 9, 10, 12-15. (Price list on request.)
- Turner, R. D., 1966. A Survey and Illustrated Catalogue of the Teredinidae (Mollusca: Bivalvia). \$8.00 cloth.
- Whittington, H. B., and W. D. I. Rolfe (eds.), 1963. Phylogeny and Evolution of Crustacea. \$6.75 cloth.
- Proceedings of the New England Zoological Club 1899-1948. (Complete sets only.)
- Publications of the Boston Society of Natural History.

Authors preparing manuscripts for the *Bulletin of the Museum of Comparative Zoology* or *Breviiora* should send for the current Information and Instruction Sheet available from Ms Penelope Packard, Editor, Publications Office, Museum of Comparative Zoology, Harvard University, Cambridge, Massachusetts 02138, U.S.A.

RHINOCEROSES FROM THE PLIOCENE OF NORTHWESTERN KENYA

DICK A. HOOIJER¹ AND BRYAN PATTERSON

ABSTRACT. A large brachypotherine, *Brachypotherium lewisi* sp. nov., is described from Lothagam-1; it is the last recorded member of the group. The genus has been present in Africa since the early Miocene and presumably immigrated from Eurasia somewhat before that time. Whether or not the African and Eurasian forms thereafter evolved in parallel is uncertain, but *B. lewisi* could have descended from the early Miocene *B. snowi* (Fourtau) of Egypt. Fragmentary remains from Ngorora and Sahabi are identified as *B. sp. cf. B. lewisi*. An upper molar from Lothagam-1 is referable to *Ceratotherium* and is the earliest record of the genus. This tooth is indistinguishable from those of specimens found in the later Kanapoi and Ekora sediments. *C. praecox* sp. nov. is based on this material. Fragments from the Mursi and the Chemeron (locality J. M. 507), previously identified as *C. simum*, are reassigned as *C. sp. cf. C. praecox*. The new species shows decided resemblances to *Diceros*, indicating that the white rhinoceroses diverged from the black during Pliocene time. Apart from the European Pontian *D. pachygnathus* (Wagner), the scantily recorded history of the *Diceros* group is wholly African. Quaternary specimens of *D. bicornis* and *C. simum simum* are recorded in an Appendix.

INTRODUCTION

Paleontological expeditions to Kenya from this Museum discovered and worked Pliocene deposits in southeastern Turkana District during the years 1965 to 1968. These deposits, Kanapoi (Patterson, 1966), Lothagam Hill and Ekora (Patterson, Behrensmeyer and Sill, 1970), have yielded a variety of vertebrates and molluscs, in-

cluding the rhinocerotid remains here reported upon.

Two rhinoceroses are now known from Lothagam-1: a large *Brachypotherium*, represented by two incomplete skulls, two lower jaws, jaw fragments, isolated teeth, an atlas and portions of a femur, and an early form of *Ceratotherium*, known from a single incomplete upper molar. This is the only specimen in the Lothagam collection to reveal the presence of any relative of the living African forms. The Kanapoi and Ekora collections contain three incomplete skulls, three incomplete jaws, various teeth, and a humerus of a *Ceratotherium* that is inseparable on the evidence from the one occurring at Lothagam; it is less advanced than *C. simum* (Burchell) in skull structure and resembles *Diceros bicornis* (L.) in dental characters.

Specimens of *Brachypotherium* found *in situ* at Lothagam were in fine-grained sediments, those of *Ceratotherium* at Kanapoi and Ekora in coarse, including conglomeratic, ones.

The expeditions that collected these and other specimens were supported by National Science Foundation Grants GP-1188 and GA-425 to Patterson. We are also indebted to the Wenner-Gren Foundation for Anthropological Research for a grant to Hooijer. The drawings are by Miss Margaret Estey, the photographs by Drs. V. J. Maglio and R. C. Wood, and the drafting by Mr. Laszlo Meszoley. The abbreviation KNM stands for Kenya National Museum.

¹ Rijksmuseum van Natuurlijke Historie, Leiden, Netherlands.

Family RHINOCEROTIDAE Owen

Genus *Brachyotherium* Roger*Brachyotherium lewisi* sp. nov.²

Diagnosis. Size very large; condylobasal length of type skull over 70 cm, antero-transverse diameters of M_1 - 2 some 90 mm as opposed to 70 mm in *B. brachyppus* (Lartet) or *B. snowi* (Fourtau) from Miocene of Europe and Egypt, respectively. Nasals hornless, slender, not very long, deepest point of nasomaxillary notch above P_1 , anterior border of orbit above front of M^2 , frontals flat and hornless, inferior squamosal processes united below subaural channel. Upper incisors very large, upper cheek teeth brachyodont, ectoloph flattened behind paracone style, antecrochet moderate, protocone constriction slight, external cingula often present. Lower canines present, brachyodont cheek teeth with external groove between anterior and posterior lophids usually flattened out, external cingula often developed. Trochanter tertius of femur strongly developed.

Type. KNM LT 88, skull, crushed dorso-ventrally, with cheek teeth and alveoli of incisors, lacking right zygomatic arch, right condyle and much of the occiput and roof of the cranium.

Hypodigm. The type and the following specimens: KNM LT 94, skull, crushed obliquely, with much of right side missing, LM^2 in place, LI^1 , RM^2 , parts of LM^1 and 3 and an incomplete atlas; KNM LT 91, left mandible with P_2 - M_3 , lacking coronoid process; KNM LT 90, symphysis and incomplete horizontal rami with LP_{2-4} , RP_{2-3} , alveoli of C and P_1 ; KNM LT 84, incomplete R horizontal ramus of juvenile with dm_1 - M_1 ; KNM LT 95, incomplete symphysis and portion of left ramus of juvenile with unerupted P_2 , M_2 , incomplete M_1 and alveoli of dc, dm_1 ; KNM LT 85, incomplete LI_1 ; KNM LT 87, RP^1 ; KNM

LT 99, RP^2 , incomplete LP^2 ; KNM LT 100, incomplete LP^2 and LM^2 ; KNM LT 80, incomplete RP^3 ; KNM LT 96, incomplete P_4 and M_1 ; KNM LT 93, incomplete RM^3 ; KNM LT 82, RM_1 ; KNM LT 84, incomplete RM_2 ; KNM LT 83, P_{2-4} ; KNM LT 86, portions of lower cheek teeth including LM_1 or $_2$ and RM_3 ; KNM LT 97, incomplete left femur, including a portion of the shaft at and distal to the third trochanter and parts of the distal end.

Horizon and locality. Late Pliocene, Lothagam-1, Members B and C (type from top of B, see Fig. 1 for details of stratigraphic distribution); Lothagam Hill, southeastern Turkana District, Kenya.

Description and discussion. The type skull (Fig. 2) is dorsoventrally crushed; the height of the left orbit being reduced to a bare centimeter. The depressed nasofrontal area of the skull is slightly displaced toward the left and shifted backward relative to the premaxillaries and the palate. The whole of the left zygomatic arch is preserved, however, and apparently only slightly distorted. The right orbit is less compressed than the left, but its anterior and upper borders are incomplete. The anterior border of the orbit is above the anterior border of M^2 . Behind the orbital region the whole of the top of the skull and the occiput is missing. The frontoparietal crests behind the postorbital processes of the frontals cannot be traced, and the least width of the cranium behind the orbits cannot be determined with any reasonable degree of accuracy. The temporal crest on the right side is partially preserved, and is rather thin. It is not clear from this specimen whether the two inferior squamosal processes unite below the external auditory meatus, but the second skull, KNM LT 94, described below, shows that they do.

The nasal bones are rather small, not more than 12 cm long, and tapering toward the tip, which remains some 15 cm behind the anterior ends of the premaxillaries. The distance from the nasal tip to

²Named for Mr. Arnold D. Lewis, member of three of the Museum's African expeditions and finder of the type specimens of both species here described.

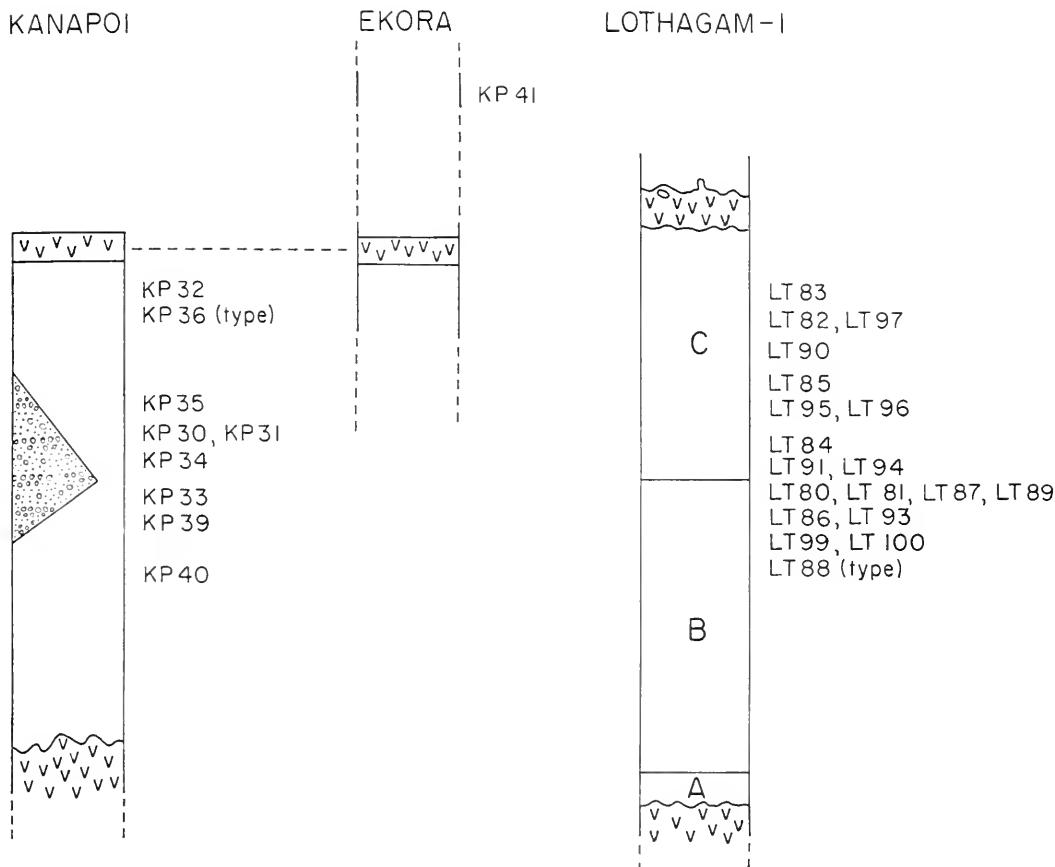

Figure 1. Stratigraphic distribution of rhinoceros specimens in the Kanapoi, Ekora, and Lothagam-1 formations. All Kanapoi and Ekora specimens are *Ceratotherium praecox* sp. nov. All Lothagam-1 specimens are *Brachypotherium lewisi* sp. nov. except for LT 89, which is *Ceratotherium praecox* sp. nov. ref. Lothagam-1 is neither in scale nor in sequence with Kanapoi and Ekora. All numbers have the prefix KNM.

the front of the premaxillaries is, however, as a result of crushing clearly greater than it originally was. There is no indication of a nasal horn boss, nor does the frontal surface bear any indication of the former presence of a horn. The shape of the nasomaxillary notch cannot be made out in the specimen. The infraorbital foramen, however, can be seen on the left side; it is placed above P⁴.

The premaxillaries are short and wide; they show two alveoli for the upper incisors, partially filled with matrix. The interval between them is 25 mm, and both are distorted, with the borders damaged.

The right alveolus measures 55 mm antero-posteriorly and 30 mm transversely, the left 35 mm anteroposteriorly and 40 mm transversely. The true shape of the upper incisor or the length of its root cannot be made out from this, but KNM LT 94 has a well-preserved upper incisor that is described below.

The cheek teeth are excellently preserved although well worn. The posterior margin of the palate is damaged in the median line; the two lateral palatine foramina, however, are clearly seen and are on a level with the protoloph of M³. The width of the palate is 120 mm between the M³,



Figure 2. *Brochypotherium lewisi* sp. nov. KNM LT 88, type. Ventral view of skull. $\times 0.25$.

TABLE I. SKULL MEASUREMENTS OF *BRACHYPTHERIUM LEWISI* (mm)

	KNM LT 88	KNM LT 94
Length from occipital crest to nasal tip	—	ca. 580
Condylobasal length	710	—
Length from anterior border of orbit to external auditory meatus	300	345
Length from tip of premaxillaries to P ²	80	—
Width across premaxillaries	125	—
Width of frontals over superior borders of orbits	250	ca. 260
Width across zygomatic arches	ca. 520	—

and 80 mm between the P³. The right cheek tooth series is well aligned, with the internal borders forming a nearly straight line, whereas of the left tooth series P¹ and M¹ are somewhat displaced inward and P² is pushed outward a little. In both the right and the left cheek tooth series there is a longitudinal crack, 3–4 mm wide, running through P³ to M² at about one-third of the crown widths from the external borders, leaving P² and M³ unaffected.

P² is the foremost tooth present, but there is a trace of the alveolus for a small tooth in front of it, either a persistent milk tooth or a P¹. P² is worn down to a height of 27 mm on the right, and of 34 mm on the left side, measured externally, at its maximum. There is neither a paracone nor a metacone style, the ectoloph being slightly convex anteroposteriorly as well as vertically. There is a faint external cingulum, most marked in the posterior part of the crown. The crown is wider behind than in front, and has a small crochet but no antecrochet or crista. The mediusinus has a narrow, V-shaped entrance, as protocone and hypocone are closely approximated basally. There is a strong and continuous internal cingulum, 14 mm high, marking off a shallow pit at the end of the mediusinus internal to the protocone-hypocone junction. The mediusinus is very deep,

nearly 15 mm, much deeper than the postsinus, which is longer than wide. It is not quite cut off from the posterior crown border as the cingulum is indented behind the postsinus, and the deepest point of the notch has not yet been reached by wear.

P³, 34 mm high as worn externally on the right, against 32 mm on the left side, has a very slight paracone style and no metacone style, the external cingulum, shown posteriorly only, a weak crochet and no antecrochet or crista, as in P². Unlike that tooth it is wider in front than behind. The internal cingulum is as well developed as that in P². The pit closed off between it and the adjoining bases of proto- and hypocone is as in P², and the postsinus is just isolated from the posterior crown margin. It is 7 mm deep, while the mediusinus is just over 15 mm in depth, from the occlusal surface.

In P¹, external height, as worn, 31 mm on both sides, the paracone style is slightly more marked than that in P³, and there is no metacone style. The external cingulum is virtually absent, while the anterior cingulum is strong, as in P³, but the internal cingulum is interrupted along the faces of protocone and hypocone, forming a strong ledge at the mediusinus entrance that is 14 mm high from the crown base. The antecrochet begins to show, and the crochet is weaker than that in P³ (an antecrochet increases, a crochet decreases toward the base of the mediusinus). The postsinus is closed off behind and only 4–5 mm deep, half the depth of the mediusinus.

M¹ is much worn down, to ca. 15 mm at the middle of the ectoloph. The antecrochet is weak but marked off by a groove (the posterior protocone fold). There are no traces of a crochet or crista in this advanced stage of wear. The internal cingulum shows as a 10 mm high ledge at the entrance to the mediusinus only, while the external cingulum is present only along the posterior half of the base of the ectoloph. The paracone style is hardly visible, and the ectoloph behind it perfectly flat.

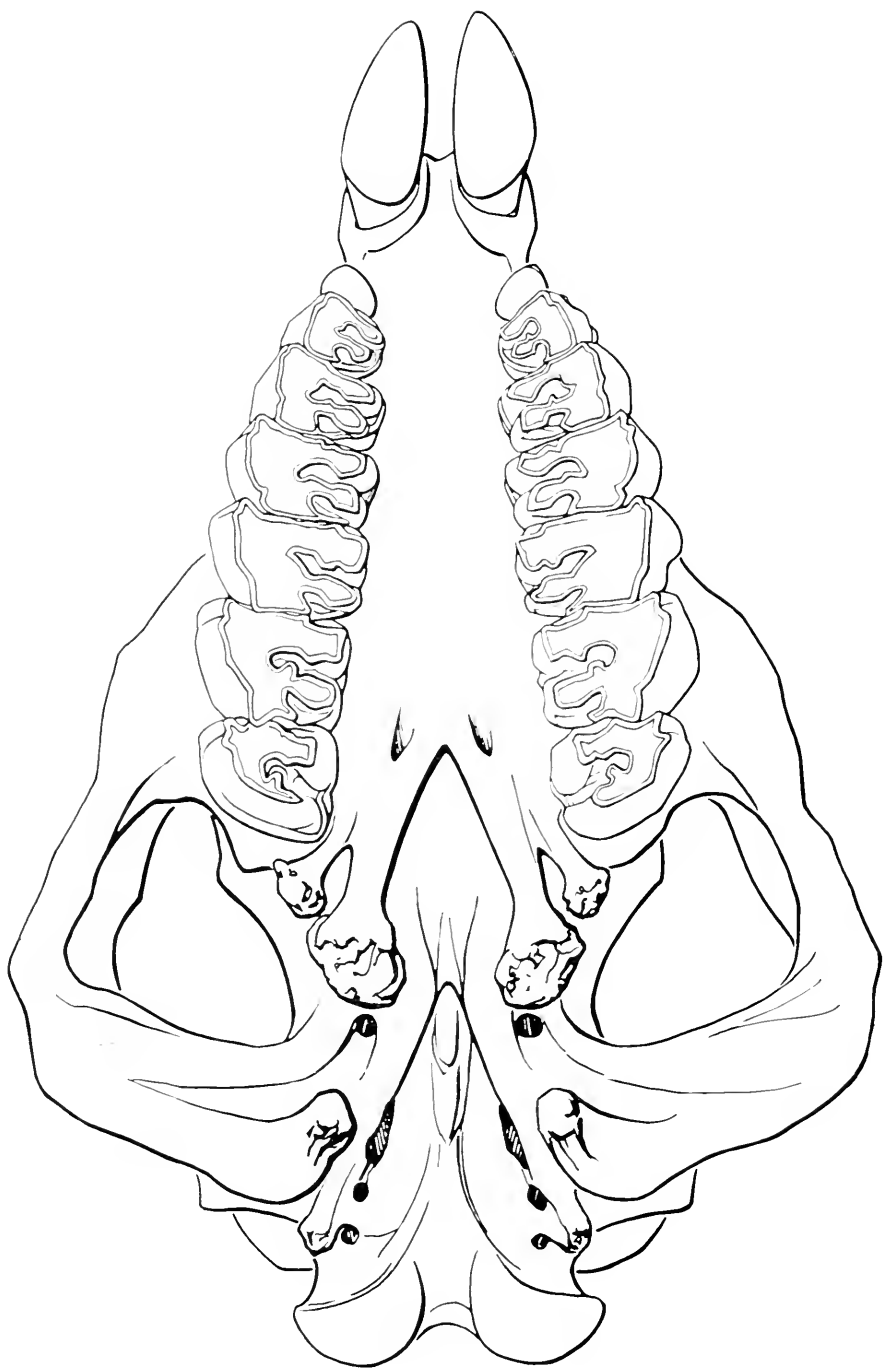

Figure 3. Restoration of ventral view of *Brachypatherium lewisi* sp. nov. based on KNM LT 88 (type) and KNM LT 94. $\times 0.25$.

TABLE 2. MEASUREMENTS OF UPPER TEETH OF *BRACHYOTHERIUM** (mm)

	<i>B. auren-</i> <i>ianense</i>	<i>B. snowi</i>	<i>B. gold-</i> <i>fussi</i>	KNM LT 88	<i>B. lewisi</i> KNM LT 99	KNM LT 100	<i>B. sp. cf.</i> <i>B. lewisi</i> Sahabi
P ² , length	25	31	—	36	36	36	—
ant. width	35	43	—	48	49	50	—
post. width	—	45	—	51	51	52	—
P ³ , length	30	36	—	49	—	—	—
ant. width	46	60	—	72	—	—	—
post. width	—	56	—	67	—	—	—
P ⁴ , length	38	42	48	—	—	—	—
ant. width	55	69	65	84	—	—	—
post. width	—	61	59	73	—	—	—
M ¹ , length	42	48	ca. 51	ca. 65	—	—	—
ant. width	58	72	70	90	—	—	—
post. width	—	62	60	76	—	—	—
p. tr.: a. tr.	—	0.86	0.86	0.84	—	—	—
						KNM LT 94	
M ² , length	50	60	65	ca. 70	—	—	—
ant. width	60	74	69	86	—	87	99
post. width	—	64	57	72	—	71	92
p. tr.: a. tr.	—	0.86	0.82	0.84	—	0.82	0.93
						KNM LT 93	
M ³ , length	52	64	—	70	—	—	—
ant. width	55	—	—	80	—	—	—
Length ext. face	—	—	64	86	81	—	—
L P ² -M ³	240	275	—	330	—	—	—
L P ² -P ⁴	90	110	—	145	—	—	—

* Those of *B. snowi* taken from a cast kindly provided by Dr. Elwyn Simons.

M², worn externally to 30 mm from the crown base in the middle, shows both the antecrochet and the crochet; neither of these are very prominent but together they give the medisinus a sinuous course. The posterior as well as the anterior protocone fold are weakly developed, marking off the protocone; the cingulum is reduced internally to a mere knob, not more than 6 mm high, at the medisinus entrance. The paracone style, somewhat damaged in the left M², is more marked than that in M¹, showing a sharp parastyle fold in front that flattens out at the crown base. The ectoloph behind the paracone style is flattened. The medisinus is about 15 mm deep, the postsinus only half as deep as the medisinus.

M³ has a distinct paracone style, marked off in front by a sharp parastyle fold at the level reached by wear, which is 45 mm from the crown base in the middle of the external surface. The style and fold flatten out near the crown base. The external surface, or ecto-metaloph, shows no bulge at the base of the metacone but is regularly convex. The posterior cingulum is a marked ridge with a series of knobs, about 25-30 mm wide transversely. The crochet is prominent and rounded, extending half-way across the medisinus, the antecrochet internal to it on the opposite wall of the medisinus is not very prominent in this not very advanced stage of wear. The entrance to the medisinus is low and wide, the bases of proto- and hypocone being some 14 mm

apart; midway between these there is a marked ridge along the medisinus base, starting from the base of the crochet, and joining the internal cingulum. This internal cingulum forms a strong ridge, nearly 20 mm long, connecting the bases of protocone and hypocone, but absent along the flattened internal base of the protocone. The protocone constriction is marked by shallow anterior and posterior grooves. Measurements of the upper teeth are given in Table 2.

Although not a single molar is unworn, it is clear from the inward inclination of the ectolophs that the molars of the Lothagam rhinoceros are brachyodont. This, coupled with the flattening of the ectolophs, the weak antecrochets, and slightly marked protocone constrictions, and the occasional presence of external cingula, stamp the molars as those of *Brachypotherium*. This is a genus of rhinocerotids known from the Burdigalian through Pontian of Europe, with two species previously known from Africa, viz., *B. snowi* (Fourtau) from the early Miocene of Moghra, Egypt (Fourtau, 1920), and *B. heinzeli* Hooijer (1963, 1966) from the Miocene of Congo, Kenya and Uganda. Measurements of the upper teeth of the Lower Burdigalian (earliest Miocene) *B. aurelianense* (Nouel) from France (Nouel, 1866) as well as *B. goldfussi* (Kaup) of the Pontian (after Kaup, 1854) are given in Table 2; the dentition of the Upper Vindobonian *B. brachypus* (Lartet) is very similar, in fact almost indistinguishable from that of *B. goldfussi*, and measurements of *B. brachypus* as well as of *B. heinzeli* upper teeth have already been given in Hooijer (1966: 144, Table 13). It is clear from Table 2 that the teeth of the Lothagam rhinoceros greatly exceed in size those of the other *Brachypotherium* species, including *B. snowi* from Egypt. As far as the structural characters go, the upper dentition of *B. brachypus* figured by Depéret (1887, pl. XXIII) shows continuous internal as well as external

cingula in P²-M² (M³ is only erupting and the base is not exposed). The antecrochets are weak and the crochets strong as may be expected in a dentition in such an early stage of wear. The ectolophs show the characteristic flattening. In *B. aurelianense*, which has the smallest tooth dimensions, the upper dentition has rather marked antecrochets in P¹-M² for the early wear stage; the internal cingular development is not shown in the illustration (Nouel, 1866, pl. 4). The upper jaw of *B. snowi* (Fourtau, 1920: 38) is that of an old individual, in which the medisinus is largely worn away. Both *B. aurelianense* and *B. snowi* possess large upper incisors by which the other brachypotherines are characterized. The skull characters of *B. aurelianense* will be dealt with after the description of the second Lothagam rhinoceros skull, KNM LT 94.

This specimen (Fig. 4, A and B) is crushed in a different way from the holotype, which helps in understanding what the original, undistorted, skull shape of *B. lewisi* may have been. The crushing has been such that the height was little affected although the dorsal surface slopes markedly down from right to left. Most of the right half of the skull is gone; the left half has the zygomatic arch, only slightly broken and distorted, and the orbito-frontal and parieto-occipital portions rather well preserved. The top of the occiput and a portion of the temporal crest are missing. The left premaxillary is broken off through the alveolus for I¹, the tip of the nasals is slightly restored. The nasal bones are, again, slender and clearly hornless, and extend forward to above the anteriormost cheek tooth, for which only a small alveolus, 25 mm long and 20 mm wide, remains. The nasomaxillary notch is 15 cm deep from the nasal tip, and extends backward to above the alveolus for the last premolar. The infraorbital foramen is on the same level. The length from the deepest point of the nasomaxillary notch to the anterior border of the orbit is 11 cm, and

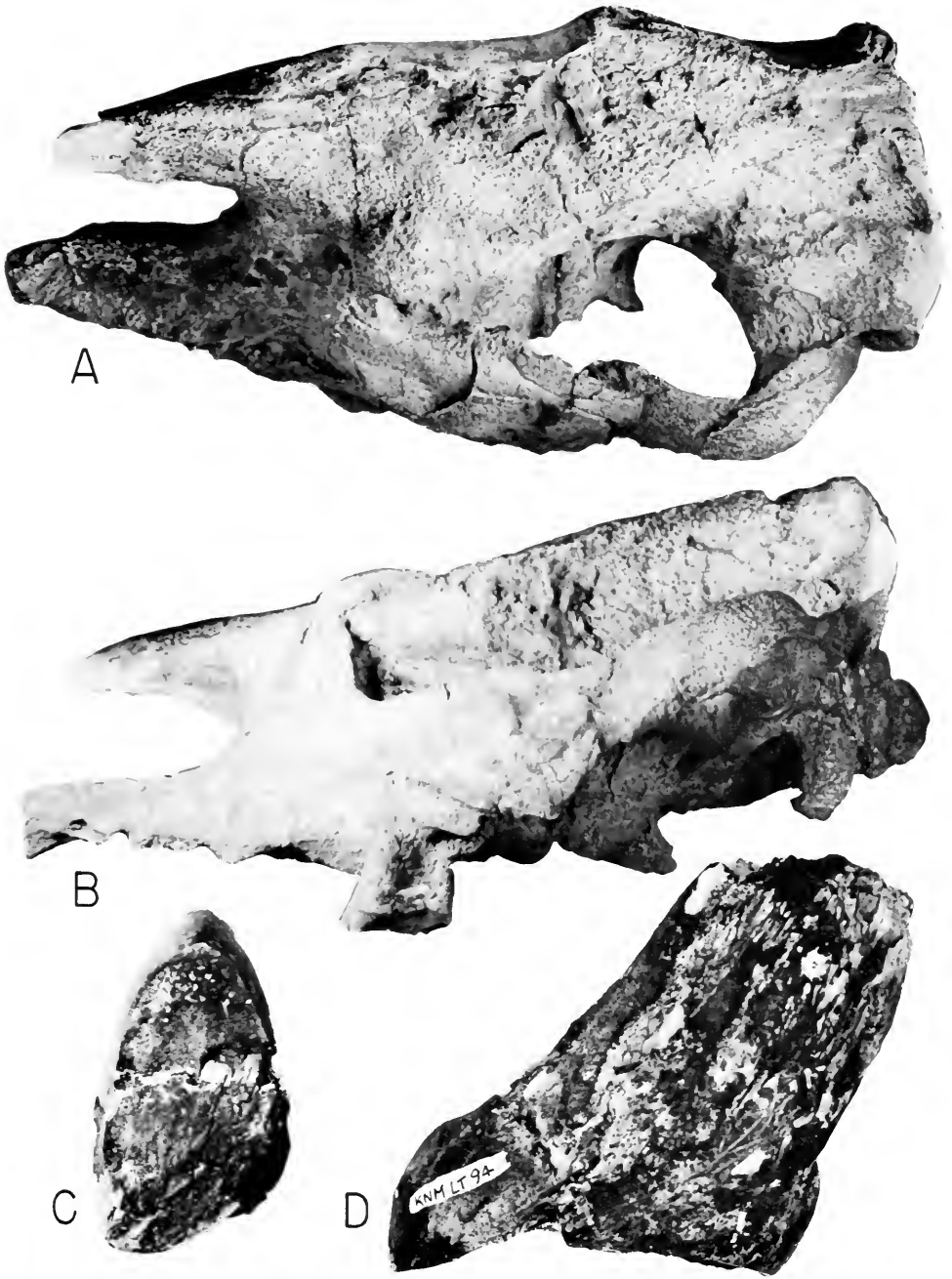

Figure 4. *Brachypatherium lewisi* sp. nov. KNM LT 94. A, dorsal, and B, left lateral views of skull. C, crown, and D, lateral views of left I^1 . A and B $\times 0.2$, C $\times 0.55$, and D $\times 0.61$.

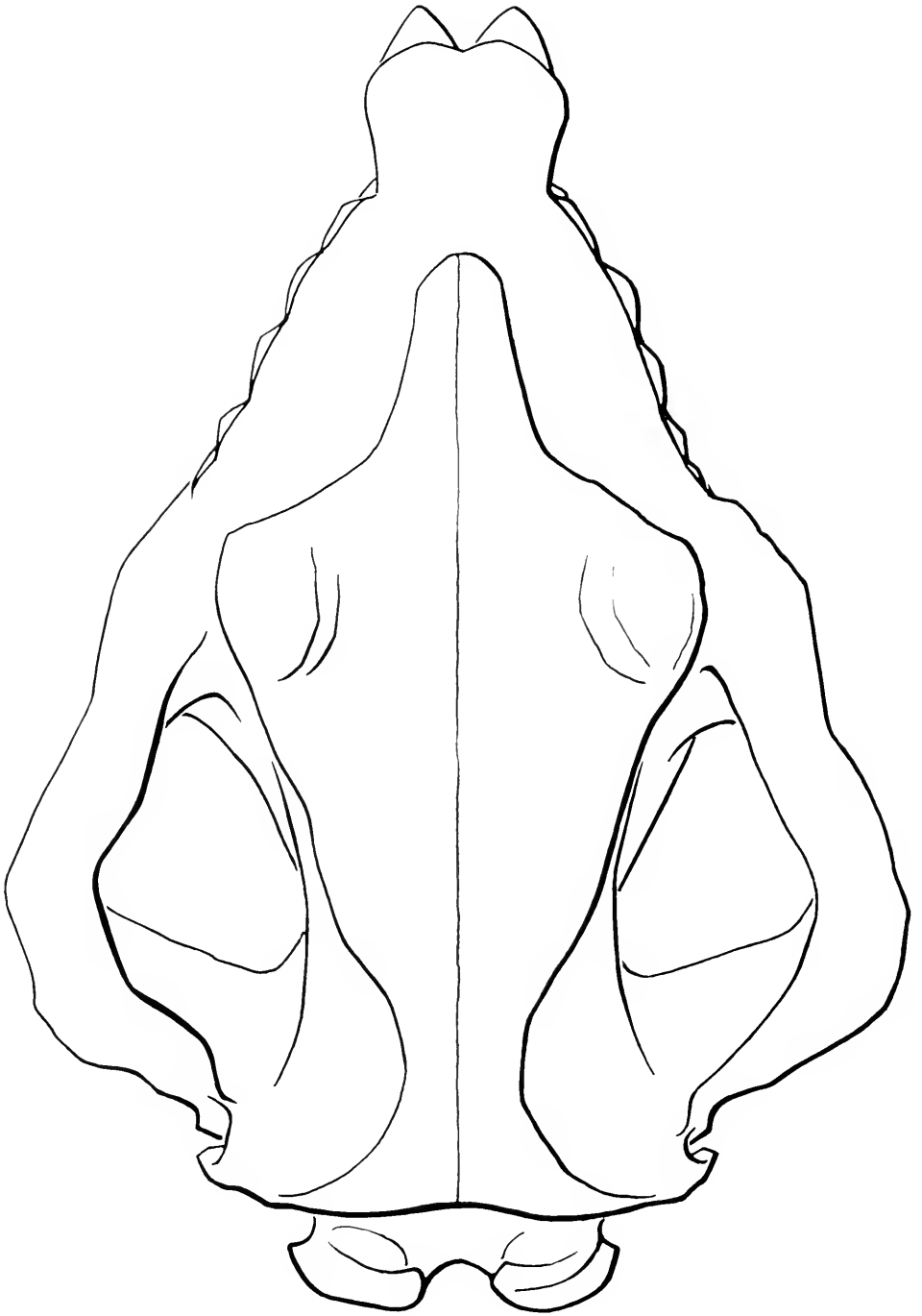

Figure 5. Restoration of dorsal view of *Brachypotherium lewisi* sp. nov. based on KNM LT 94 and KNM LT 88 (type). $\times 0.25$.

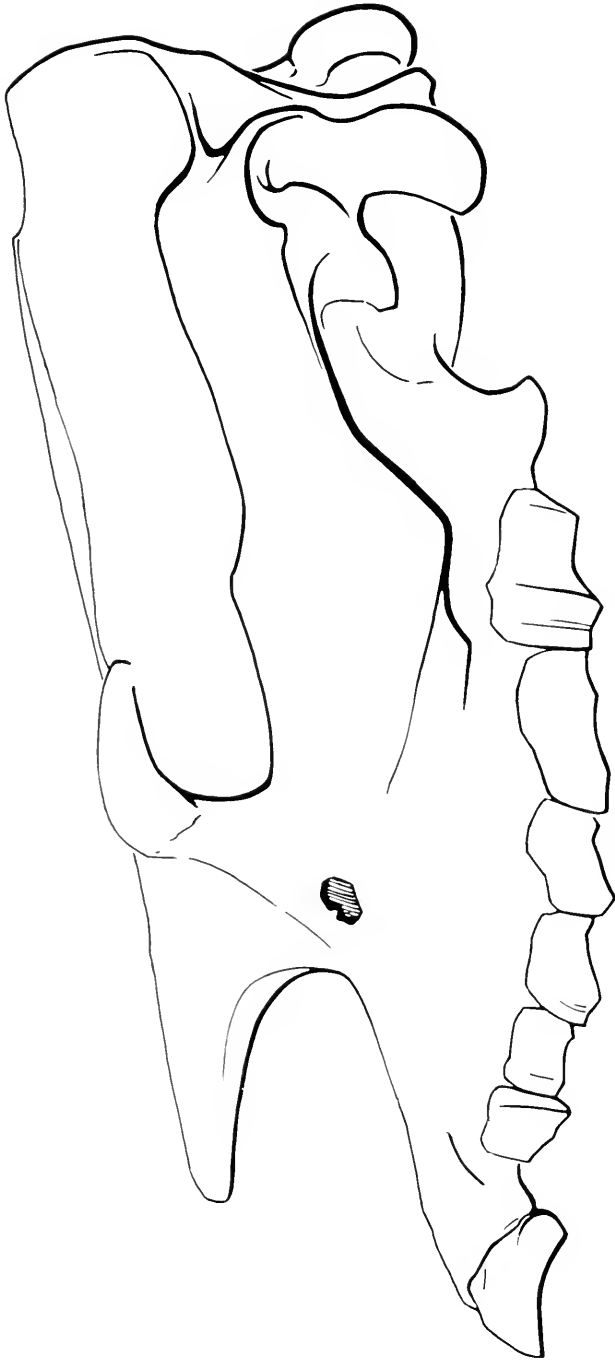

Figure 6. Restoration of left lateral view of *Brachypotherium lewisi* sp. nov. based on KNM LT 94 and KNM LT 88 (type).
× 0.25.

the anterior border of the orbit is above the front of M^2 . The superior border of the orbit is swollen, and the orbital cavity itself is 8 cm high. There is no indication of a frontal horn. The parieto-occipital crests converge behind, the least distance between them being only 45 mm. The upper portion of the occiput is missing, as it is in the type skull, and the left occipital condyle only is preserved. The distance from the posterior border of the condyle to the posterior border of M^2 on the same side of the skull is 35 cm, somewhat less than the same dimension in the type, which is otherwise smaller in the length from anterior border of orbit to external auditory meatus (see Table 1). The zygomatic widths are rather different in the two skulls, being greater in the shorter skull, but in either measurement some distortion has to be taken into account, and the actual widths most probably were not so dissimilar. The widths of the frontals over the upper borders of the orbits appear to differ hardly at all in the two specimens.

A composite reconstruction of the skull of *B. lewisi*, based on these differently crushed skulls, is given in Figures 3, 5, and 6.

The skull of *Brachypotherium aurelianense*, as described by Nouel (1866), measures only 50 cm from occipital crest to tip of nasals, and its zygomatic width is 35 cm; the skull, therefore, is relatively wider than that of the Lothagam species. The nasals, as measured from the nasofrontal suture (this suture does not show in the Lothagam skulls) are 20 cm long, and are thickened not far from the tip, which is taken by Nouel as evidence for the former presence of a narrow nasal horn. There is further a rounded elevation on the frontals indicating a second horn. The depth of the nasomaxillary notch from the tip of the nasals is 16 cm, and the distance from the deepest point of this notch to the orbit is 8 cm, shorter relative to the depth of the nasomaxillary notch than in the Lothagam species. The premaxillaries are

incomplete in the skull of *B. aurelianense*, but isolated large upper incisors have been found in the same deposits and there seems no doubt that *B. aurelianense* possessed incisors of this type, as do other species of *Brachypotherium*. The cheek teeth P^2-M^3 (P^1 is represented by an alveolus) are decidedly smaller than those of later *Brachypotherium* species (Table 2). The upper jaw of *B. snowi* has cheek teeth as large as those in *B. brachypus* or *B. goldfussi*, and shows a large alveolus for P^1 . The incisor, however, is placed more forward relative to the premolars in *B. snowi* than in *B. lewisi*: the interval between the incisor alveolus and the P^2 is nearly 90 mm, as opposed to some 40 mm in the larger Lothagam skull.

Of the dentition of KNM LT 94 only LM^2 is in place, although RM^2 , LI^1 and parts of LM^1 and P^3 were found in the adjoining matrix. M^2 is more worn than that in the type skull, down to 25 mm from the crown base externally, but is otherwise exceedingly similar to it in both structure and dimensions (Table 2). The posterior cingulum of M^3 is somewhat weaker than in the type, forming a ridge only 15 mm wide; but the ridge along the mediusinus base is the same; the inner cingulum of M^1 is slightly more developed. The left upper incisor (Fig. 4, C and D) measures 65 mm anteroposteriorly and 45 mm transversely just below the crown at the base of the root. The root, as preserved, is 7 cm long and has a blunt apex, 45 by 35 mm in diameters. The distorted alveoli in the type skull would have lodged upper incisors of the same dimensions. The crown bulges out above the root and its anteroposterior and transverse diameters are 90 mm and 44 mm, respectively. An isolated anterior portion of LI^1 (KNM LT 85) is somewhat less worn; it shows a convex external and a flat internal surface, which form an edge in front that is distinct at the occlusal surface and fades away toward the crown base. The width of the crown is over 30 mm; the anterior crown height is

TABLE 3. MEASUREMENTS OF MANDIBLE AND LOWER TEETH OF *BRACHYPOTHERIUM* (mm)

	<i>B. snowi</i>	<i>B. goldfussi</i>		<i>B. lewisi</i>	
				KNM LT 91	KNM LT 90
Length P ₂ -M ₃	—	—	—	295	290
P ₁ to back of angle	—	—	—	540	—
Height of condyle	—	—	—	250	—
Height at M ₃	95	—	—	110	—
Symphysis, length	126	—	—	ca. 140	125
Symphysis, least width	57	—	—	—	50
Symphysis, anterior width	72	—	—	—	60
Condyle, width	—	—	—	140	—
P ₁ , length	15	—	—	26	—
width	11	—	—	15	—
P ₂ , length	27	—	—	—	34
ant. width	19	—	—	20	19
post. width	22	—	—	25	25
P ₃ , length	34	41	—	42	41
ant. width	25	—	—	26	24
post. width	27	26	—	32	31
P ₄ , length	43	—	43	43	46
ant. width	—	—	—	31	31
post. width	28	—	35	40	36
					KNM LT 84
M ₁ , length	—	48	47	—	53
ant. width	—	—	—	41	—
post. width	—	39	33	45	—
					KNM LT 81
M ₂ , length	57	60+	52	62	—
ant. width	—	—	—	38	—
post. width	37	34	32	43	ca. 44
M ₃ , length	62	61	58	55	—
ant. width	—	—	—	38	—
post. width	34	30	30	40	—

55 mm as preserved; of the massive root only the basal 4 cm are preserved. Like the other teeth, the upper incisor is larger than those of other known species of *Brachypotherium*; the complete upper incisor of *B. goldfussi* (Kaup, 1854: 2, pl. 1, fig. 13) has a crown 81 mm in length, while the width in other specimens varies from 23 to 33 mm. The upper I of *B. aurelianense* (Nouel, 1866, pl. 4, fig. 2) is 66 mm long as is the alveolus for the upper incisor in *B. snowi*. Upper incisors referred to *B.*

heinzeli Hooijer (1963: 47, pl. VII, fig. 2; 1966: 142) have crown diameters 76 to 80 mm long and 24 to 30 mm wide. Certain other teeth in the Lothagam-I collection deserve mention. KNM LT 100 includes the inner and outer portions of LM² (anterior width ca. 90 mm), worn down externally to only 25 mm from the base, and LP², worn to an external height of 20 mm. KNM LT 93, RM³ lacking most of the protoloph, bears a weak posterior cingulum, and the same, wide, ridged internal

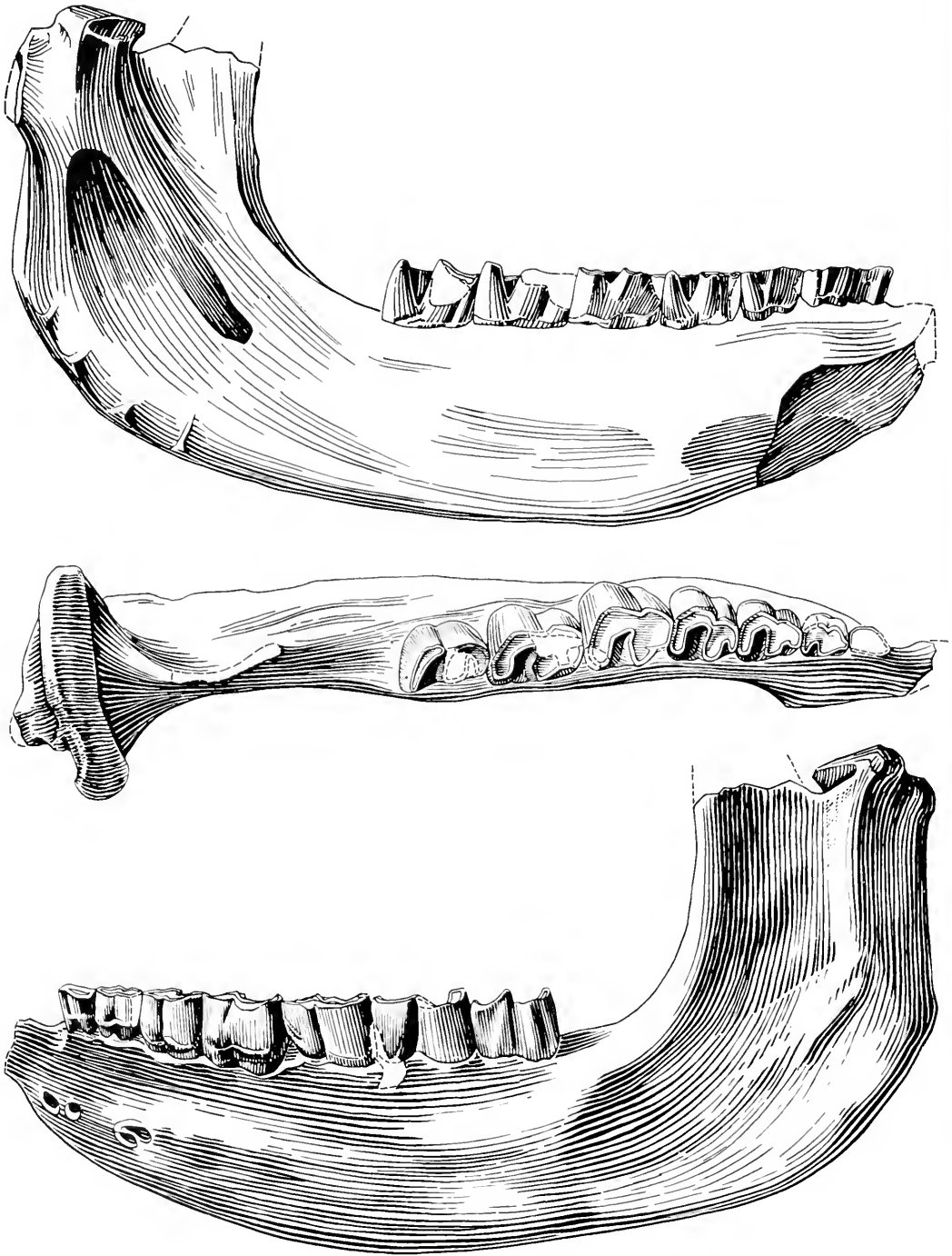

Figure 7. Left ramus of *Brachypatherium lewisi* sp. nov., KNM LT 91, in medial, dorsal and lateral views. $\times 0.25$.

entrance to the mediusinus as do the other specimens of this tooth. An entire RP^2 and an LP^2 lacking the outer surface (KNM LT 99) agree closely in dimensions with the corresponding teeth in the type skull (Table 2). RP^3 (KNM LT 80), lacking the outer surface, has a mediusinus extending outward from the internal crown border for a length of 40 mm, exactly as in P^3 of the type skull, which is worn to the same extent. We interpret as P_1 an isolated (KNM LT 87) tooth having a gently convex ectoloph 29 mm in length, a basal cingulum, a subtriangular crown, and a posterior width of 20 mm; the dimensions tally well with those of the alveolus for P^1 in skull KNM LT 94. The single root is pointed, slightly curved inward apically, and 4.5 cm long as preserved.

The left half of a mandible (KNM LT 91) includes part of an alveolus for the lower canine, the crowns of P_1 and worn P_2 to M_3 (Fig. 7; measurements in Table 3). The main feature of the cheek teeth is the flattening of the external groove between metalophid and hypolophid; external cingula occur in the premolars and also, although somewhat less distinctly developed, in the molars. These are, in the main, the characteristics of the lower cheek teeth in advanced brachypotherines (Hooijer, 1966: 145).

A second mandible, KNM LT 90 (Fig. 8A) has the symphyseal region preserved and shows the alveoli of the two lower tusks, 30 by 20 mm in diameters. There are no traces of teeth between these alveoli; in the mandible of *B. snowi* (Fourtau, 1920: 42) there are two small ones between those of the canines. The length of the symphysis of KNM LT 90 and the length of P_2 - M_3 are slightly less than those of KNM LT 91; the least and the anterior width of the symphysis are less than those in *B. snowi* (Table 3). There is no trace of an external cingulum in the teeth of this specimen, and the flattening out of the external groove is not so marked either, indicating a certain amount of individual

TABLE 4. MEASUREMENTS OF UNWORN LOWER PREMOLARS OF *BRACHYPOTHERIUM LEWISI* (mm)

	ant. post.	ant. transv.	post transv.	height, external
P_2	35	—	24	47
P_3	43	26	—	55
P_1	—	33	—	56

variation in these characters. An isolated RM_2 (KNM LT 81), incomplete antero-internally, shows the completely flattened external groove as well as the external cingulum, and there is also a fragment of a lower molar (KNM LT 100) with the same features.

Unworn, although incomplete, lower premolars are known (KNM LT 83), and these reveal the full heights of the crowns (Table 4). KNM LT 86 includes external portions of lower molars with flattened external grooves and, occasionally, external cingula. The unworn hypolophid of RM_3 is 37 mm wide at the base, 34 mm high externally, and 27 mm high postero-internally. The unworn anterior lophid of LM_1 or $_2$ is not less than 62 mm high; its width cannot be given.

The two lower molars of *Brachypotherium goldfussi* figured by Kaup (1834: 63, pl. XII, figs. 13 and 14) show the flattened external groove and the external cingulum. One of these molars, entire, is 61 mm long by 30 mm wide, and represents M_3 ; the other, incomplete behind, is at least 60 mm long, and its width is 34 mm. Other lower molars are recorded by Kaup (1854:3, pl. 2, figs. 14-16), and their measurements, and those of a mandible figured by De Blainville, are given in Table 3. An M_2 of *B. heinzellini* from Napak, Uganda (Hooijer, 1966:146, pl. 8, fig. 2), is shorter and wider, 56 by 37 mm, and an unrecorded M_3 from Napak (IIC, 1965) is 60 mm long by 33 mm wide; the Lothagam molars are wider than these.

The full lower milk dentition is preserved in an incomplete right ramus, KNM LT 84 (Fig. 10, C and D), which also contains

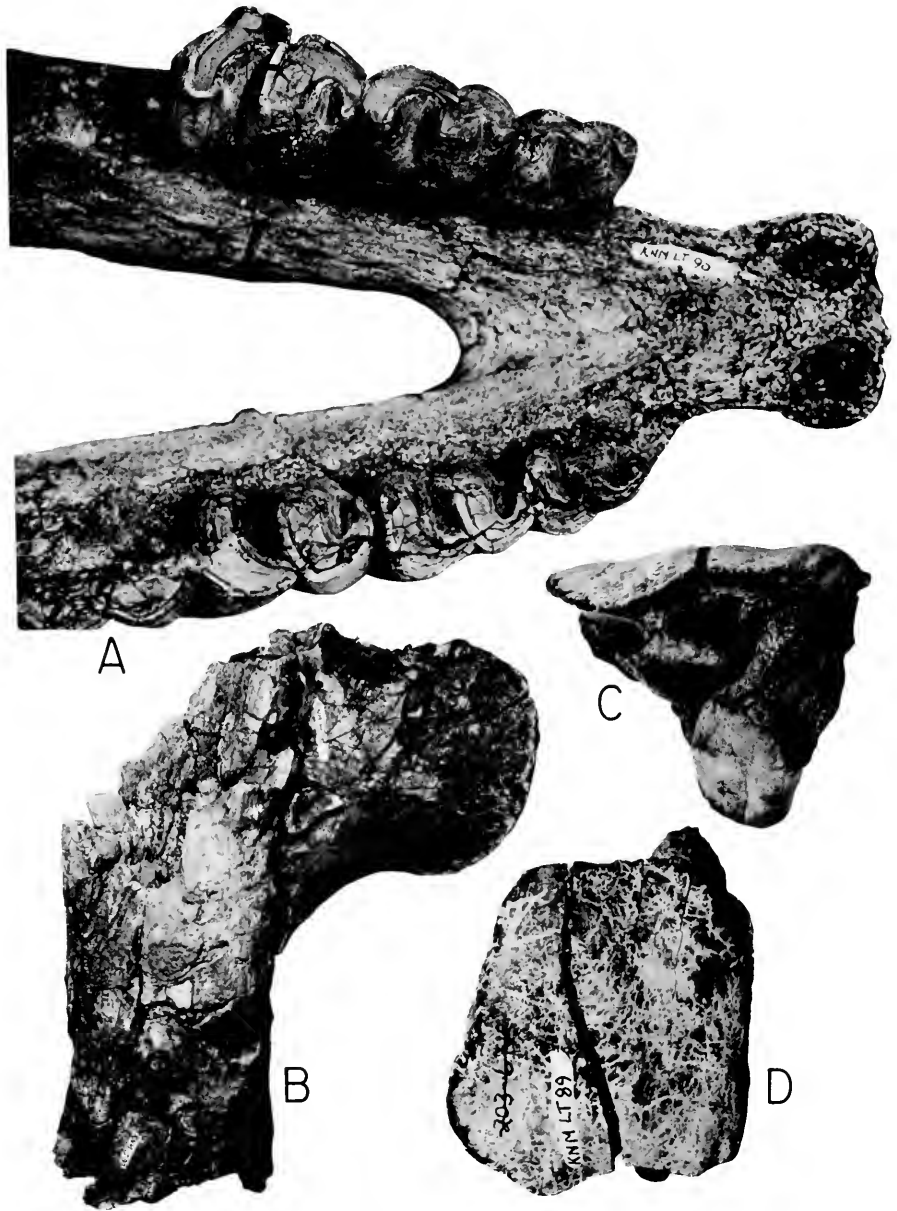

Figure 8. A and B, *Brachypotherium lewisi* sp. nov. A, KNM LT 90, dorsal view of anterior portion of mandible. $\times 0.5$. B, KNM LT 97, portion of shaft of left femur showing third tracheanter, anterior view. $\times 0.3$. C and D, *Ceratotherium praecox* sp. nov. ref. KNM LT 89, crown and lateral views of right M^2 . $\times 0.6$.

M_1 and the alveolus for M_2 . The milk molars show moderately flattened external grooves and very weak external cingula.

As Table 5 shows, the milk molars of *B.*

lewisi from Lothagam exceed those of *B. brachypus* in size. DM_{2-4} and M_1 of this species (Upper Vindobonian of La Grive-Saint-Alban) have been figured by Depéret

TABLE 5. MEASUREMENTS OF LOWER MILK MOLARS OF *BRACHYOTHERIUM LEWISI* (mm)

	<i>B. brachypus</i>	<i>B. lewisi</i>	<i>B. sp. cf. B. lewisi</i>
		KNM LT 84	Ngorora
DM ₁ , length	—	ca. 20	—
width	—	12	—
DM ₂ , length	25	32	—
ant. width	—	—	—
post. width	—	18	—
DM ₃ , length	36	43	46
ant. width	—	21	21
post. width	—	23	24
DM ₁ , length	39	46	—
ant. width	—	25	—
post. width	—	26	—

(1887, pl. XXIV), who believed them (p. 223) to be DM₁₋₄. Measurements were not given; the lengths of the crowns in Table 5 have been taken from his figures. The La Grive specimen has a strong external cingulum at the posterior lophid of DM₃. The length of DM₂-M₁ is 150 mm in *B. brachypus*, against no less than 172 mm in *B. lewisi*.

Of postcranial material from Lothagam-1 there is an incomplete atlas belonging to skull KNM LT 94. One of the wings is complete, indicating that the full width was some 36 cm. There is also a shaft of a left femur, KNM LT 97 (Fig. 8B), with a very large third trochanter, 11-12 cm high and projecting 11 cm beyond the shaft, the dimensions of which just below the process are 9 cm transversely and 7.5 cm antero-posteriorly. These bones indicate an animal nearly of the size of *Ceratotherium simum*, the full atlas width of which is 38 cm, and the corresponding shaft diameters of the femur are 9 by 6 cm. The third trochanter in *C. simum* is proportionately smaller, however, measuring only 9 cm in height and projecting but 7 cm beyond the shaft.

There is fragmentary evidence of very large brachypotherines in earlier Pliocene African deposits. D'Erasmus (1954) de-

scribed and figured a large M¹ or ², identified as *Teleoceras* sp., from the Sahabi of Libya, which is somewhat older than Lothagam-1. Impressed by its size, Hooijer (1968: 90) suggested that this tooth might represent a species of *Indricotherium*. *B. lewisi* reveals its correct position. The Sahabi molar possesses an ectoloph that is flattened posterior to the paracone style, a weak antecrochet, a crochet that extends half way across the medisinus and, to judge from d'Erasmus's figure, a trace of an external cingulum; all these are characters seen in the Lothagam material. The specimen exceeds in size all M¹ and M² in our collection. Ngorora, Kenya, a deposit approximately 10 million years old, has yielded a large lower milk molar with an external cingulum that has been identified as *Brachypotherium* sp. (Hooijer, 1971). The dimensions of this tooth, L dm₃, are very close to those of *B. lewisi* (Table 5). More material is of course needed to settle the specific status of the Sahabi and Ngorora forms; for the present we may list them as *Brachypotherium* sp. cf. *B. lewisi*.

The genus has been present in Africa since early Miocene time. Presumably the group was an immigrant one, descendant from a Eurasian species close, or possibly ancestral to, the European *B. aurelianensis*. Whether, once established, the African species evolved in that continent in parallel to the Eurasian ones is an open question; descent of *B. lewisi* from *B. snowi* of Moghra could have taken place during the time available, however.

Ceratotherium Gray

In the Lothagam-1 collection there is one specimen of a rhinoceros that is not referable to *Brachypotherium lewisi*. This is KNM LT 89, a nearly unworn right M² lacking the lingual portion of the metaloph (Fig. 8, C and D).

This tooth differs from that of *B. lewisi* in being more hypsodont, with a very flattened ectoloph that bears only a faint

trace of a paracone style, a decided anterior protocone fold, a posteriorly bulging inner portion of the protocone but no anterochet, a strong crochet, a small crista and a postsinus as deep as the medisinus. These are molar characters seen in the living African rhinoceroses, and it is clear that we have a specimen of this group in Lothagam-1.

The ectoloph is very gently undulating, being a little depressed at the base between the roots, slightly convex at the middle in the upper part of the crown and a little concave in the upper part of the posterior half. Wear on the ectoloph reaches back only to the place of origin of the crochet; the total height of the crown at the metaloph can thus be measured, as can the maximum length. The crown is higher than it is long. The anterior border of the ectoloph, the parastyle, is essentially straight; the posterior border, the metastyle, inclines posteriorly, from the root on, to form a posterior convexity in the upper third of the crown. The anterointernal corner of the crown is angular. The anterior cingulum is well developed but there is no cingulum around the flattened medial face of the protocone. What is preserved of the medisinus entrance shows no cingulum either. This entrance was clearly narrow and V-shaped. A sharp protocone fold is present in the anterior face of the protoloph above the cingulum. There is no indication of a posterior protocone fold such as would be involved in the formation of an anterochet. On the contrary, the inner portion of the protoloph is swollen basally to give the effect of a backward curvature to the lingual portion of the loph. Within the medisinus, just buccal to the posterior bulge of the protocone, is a long, robust crochet that arises from the buccal end of the metaloph and extends almost fully across the sinus; it maintains its size to the base of the crown. A small, narrow crista, 5 mm in length at the stage of wear reached, projects from the ectoloph near the antero-external corner of the medisinus.

It falls well short of reaching the crochet and is confined to the upper part of the crown; had wear gone on for 6 or 7 mm more all trace of it would have disappeared. The postsinus is fully as deep as the medisinus.

This molar shows resemblances to both *Diceros* and *Ceratotherium*. Similarity to the former is seen in the angular, not rounded, anterointernal corner and non-oblique protoloph, and in the failure of crochet and crista to meet (this last is usual in *Diceros* while the reverse is usual in *Ceratotherium*, but occasional individuals of the one show the character of the other). Resemblances to *Ceratotherium* are the weakly undulating ectoloph with barely indicated paracone style, the greatest length of the ectoloph at the apical third and not at the middle, the V-shaped, not U-shaped, entrance of the medisinus, the depth of the postsinus equalling that of the medisinus and, strikingly, the degree of hypsodonty. An unerupted M^2 of a Recent *D. bicornis* (MCZ Dept. of Mammalogy, no. 51479) has an ectoloph height at the metaloph of 56 mm and an ectoloph length of 54 mm, whereas KNM LT 89 measures 74 mm in height and 63 mm in length. (The early stage of *D. bicornis* from the Usno and Shungura formations, Omo, no doubt had an even lower M^2 ; two unworn M^2 from these deposits have heights 1 mm greater than lengths, whereas in Recent specimens height exceeds length in this tooth by 10 mm, or more—Hooijer, 1969: 87).

We believe that KNM LT 89 represents a species that had departed from a *Diceros* ancestry in the direction of *Ceratotherium* and that it should be placed in that genus as the earliest representative so far known.

All rhinoceros remains from the Kanapoi and the Ekora are attributable to an extinct species of *Ceratotherium* that is also intermediate in many respects between the two living genera. The Lothagam specimen cannot be separated from it on the evidence available.

Ceratotherium praecox sp. nov.

Diagnosis: Skull differing from *C. simum* (Burchell) in greater concavity of skull roof, cranium less extended posteriorly, occiput more vertically inclined; cheek teeth not as hypsodont, loph and lophids not markedly oblique, anterointernal corners of upper teeth not rounded, no medifossettes in P^4 - M^2 and no fossettids in lower cheek teeth, internal cingula in upper cheek teeth variable.

Type. KNM KP 36, incomplete skull with damaged LM^{2-3} and RP^4 - M^3 , lacking anterior portion, left zygomatic arch, basi-cranium and much of the skull roof.

Hypodigm. The type and the following specimens: KNM KP 30, occipital portion and nasals, numerous fragments; KNM KP 41, distorted skull with RP^2 - M^3 , $Ldm^{1(?)}$ - P^3 , lacking much of left side, palate and basicranium; KNM KP 40, incomplete Ldm^2 ; KNM KP 35, incomplete RP^2 ; KNM KP 32, incomplete rami with LP_2 - M_3 , RP_3 - M_3 ; KNM KP 33, portion of L ramus with part of unerupted P_3 , P_4 unerupted and unworn M_2 ; KNM KP 30, condylar region of L ramus; KNM KP 34, portion of L ramus with roots of molars; KNM KP 39, incomplete R humerus.

Horizons and localities. Kanapoi and Ekora formations (for details of stratigraphic distribution see Fig. 1); Kanapoi and Ekora, southeastern Turkana District, Kenya.

Referred specimen. KNM LT 89, little worn M^2 , lacking posterointernal portion. Lothagam-1, top Member B; Lothagam Hill, southeastern Turkana District, Kenya. Described above.

Previous finds of Plio-Pleistocene rhinoceroses in East Africa have been recorded by Hooijer (1969). *C. simum* is clearly present from the White Sands of the Usno formation (<3.3 m.y.) on. Two fragmentary specimens from earlier horizons that were referred to the living species in that paper demand reconsideration in the light of the evidence here presented.

These are the fragment of left maxillary with worn and damaged M^{1-3} from the Chemeron Formation (locality J. M. 507) and the fragments of left maxillary with damaged P^1 and M^{2-3} from the "lower level" (=Mursi formation) at Omo (Hooijer, 1969: 77, 86, pl. 2, fig. 1, pl. 5, figs. 4-5). The Chemeron and the Mursi correlate faunally with the Kanapoi, and we now suspect that these specimens are likely to be *C. praecox*. In support of this, M^2 lacks the medifossette and has an angulate anterointernal corner; the Mursi specimen has a medifossette in M^3 , but unfortunately our new material contains no well-preserved example of this tooth. Pending further knowledge, we list both as *C. sp.* cf. *C. praecox*.¹

Description and discussion. The type skull, KNM KP 36 (Fig. 9, A), lacks the anterior portion; the foremost tooth on the right side being P^1 and on the left M^2 . Both M^3 are badly broken and the remaining cheek teeth are either damaged or missing. The sides of the skull are very imperfect, especially the left, but on the right the anterior and lower border of the orbit is preserved, as is almost the entire zygomatic arch. The anterior border of the orbit is placed above the anterior border of M^2 , as in *D. bicornis*, rather than above that of M^3 , as in *C. simum*. The posterior elongation of the occipital portion of the cranium, so characteristic of Recent *Ceratotherium*, is likewise not in evidence. The pterygoid fossa and the median protuberance of the basisphenoid are shaped as in *Diceros*, the posterior zygomatic root is not placed so high above the palatal level as in Recent *Ceratotherium* nor so far behind the palate. The occipital surface is very

¹A clearly recognizable *C. simum germano-africanum* does occur in the Chemeron but at locality J. M. 91, which is younger (ca. 2 m.y.—V. J. Maglio, personal communication). This subspecies occurs at Laetolil, probably from the upper level which has a similar age. A right M^3 of the same form comes from Kanam West. Part, at least, of Kanam correlates with Kanapoi, but it is uncertain that all of it does.

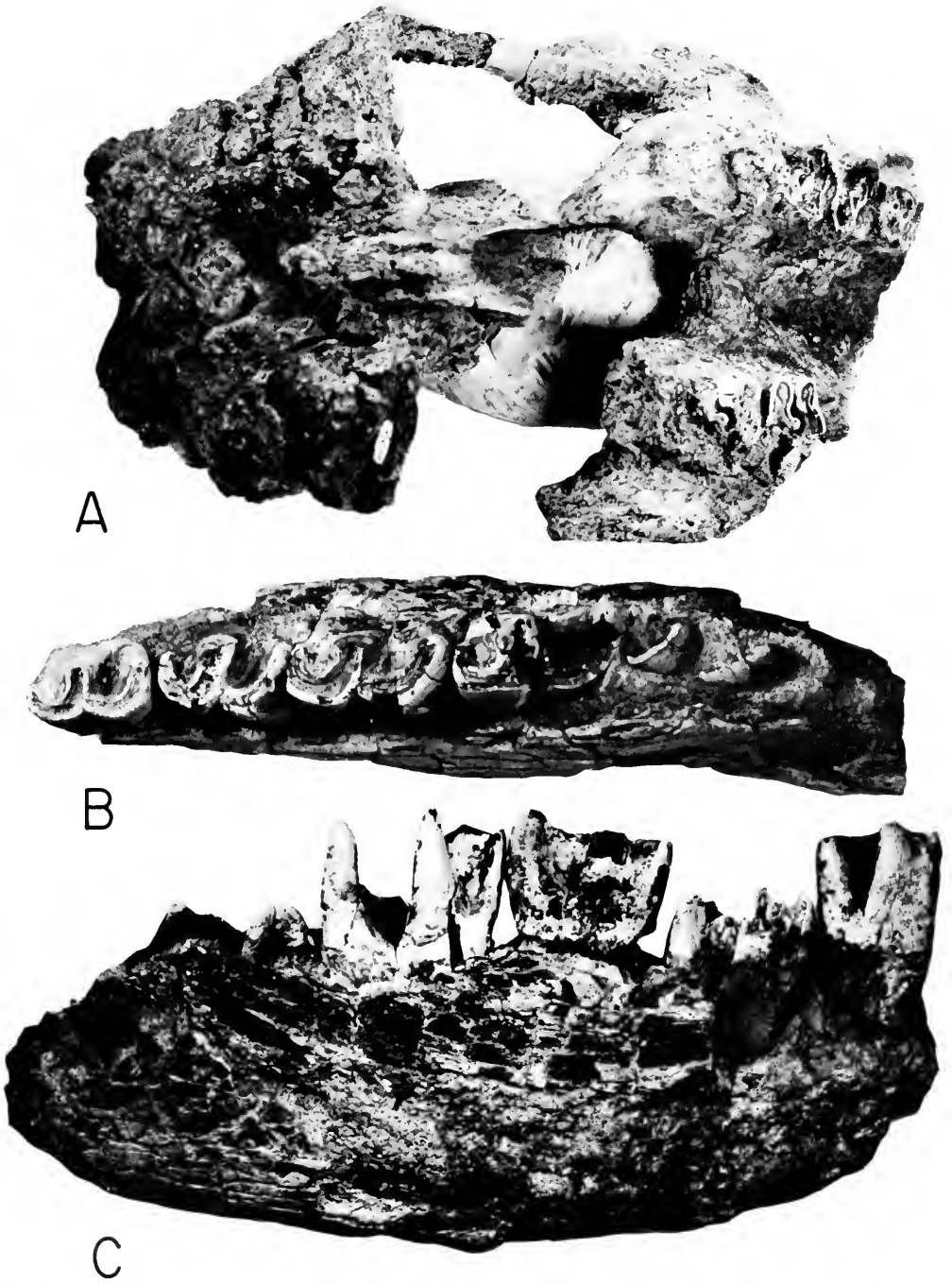

Figure 9. *Ceratotherium praecox* sp. nov. A, KNM KP 36, type, ventral view of incomplete skull. $\times 0.19$. B and C, KNM KP 32. Dorsal, B, and medial, C, views of portion of left ramus with P₃-M₃. $\times 0.4$.

TABLE 6. MEASUREMENTS OF SKULLS OF *DICEROS* AND *CERATOTHERIUM* (mm)

	<i>D. bicornis</i>			<i>C. praecox</i>	<i>C. simum</i>	
	MCZ 15693	MCZ 27135	MCZ 8397	KNM KP 36	MCZ 34850	MCZ 24917
Length of P ¹ -M ³	185	180	180	205	205	190
From M ³ to back of postglenoid process	185	160	170	sin. dext. 230 250	270	275
From ant. border of orbit to back of occip. crest	365	345	360	ca. 440	500	510
Zygomatic width	320	315	310	340	355	330
Least width of cranium	110	110	120	120	130	115
Width over both M ²	200	200	195	240	230	220

poorly preserved and the condyles are missing, but it is nevertheless clear that the inclination of the occiput is not nearly as marked as in the modern white rhino. The occipital crest is tolerably well preserved, and its posterior notch, although developed, is not as deep as in *C. simum*. In all these characters, therefore, the Kanapoi *Ceratotherium* is not far removed from *Diceros*. Most of the dorsal surface of the skull is missing, but the occipital portion, from about half-way between the anterior and the posterior zygomatic roots backward, is there and begins its rise only above the posterior zygomatic root, as in *D. bicornis*, rather than being weakly concave throughout as in *C. simum*. The cranial measurements that can be taken (Table 6) show that this skull is somewhat larger than Recent skulls of *D. bicornis* (MCZ, Dept. Mamm. nos. 15693, 27135, and 8397) and is also more elongated postdentally (cf. length P¹-M³ vs. length from M³ to back of postglenoid process), although not to the extent seen in Recent *C. simum* (MCZ, Dept. Mamm., nos. 34850 and 24917). Since the occiput is superficially damaged above, only the approximate depth of the occipital notch can be given, which is 20 mm as against 20-30 mm in *D. bicornis*, and 50 mm in *C. simum*.

The dentition is very defective, but the anterior crown portions preserved show that the metaloph is transverse in its

course, and that the protoloph bulges posteriorly in its lingual third, forming three-fifths of the internal surface, thus less obliquely placed than in *C. simum*. The postsinus is as deep as the medisinus, and there is no medifossette. The teeth thus present the same characters as does the Lothagam M² described above, typical of an emerging *Ceratotherium*. Because of advanced wear the crown heights cannot be determined. The internal cingulum is slight in P⁴, absent in the molars.

Skull KNM KP 30 from Kanapoi consists of a great many fragments, from which it has been possible to restore the occipital portion; this shows a sudden rise in profile from about 12 cm in front of the crest to the top, making the dorsal profile as a whole more deeply concave than in *C. simum*. The only dimensions that can be given are the least distance between the frontoparietal crests, 80 mm, and the least width of the cranium, ca. 140 mm; this was evidently a wider skull than the type. A very small portion of the occipital crest, on the left side, is preserved, showing that the posterior indentation of the crest was shallow, again as in the type. What little is preserved of the posterior occipital surface shows that the occiput, although more inclined posteriorly relative to the dorsal surface than in *D. bicornis*, is less posteriorly inclined relative to the dorsal surface than in *C. simum*. It is just possible to

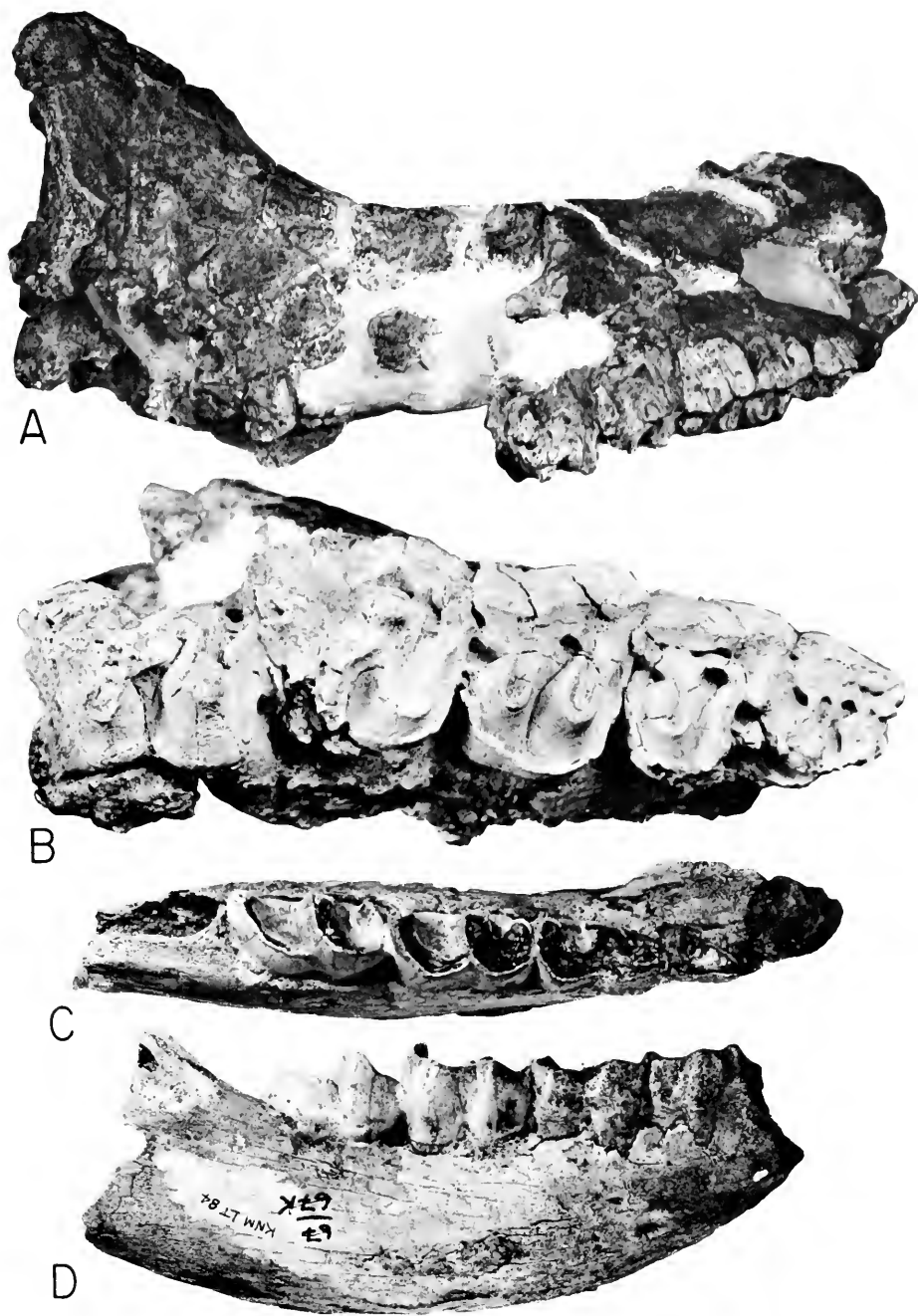

Figure 10. A and B, *Ceratotherium praecox* sp. nov. KNM KP 41. A, right lateral view of distorted skull (see p. 23). $\times 0.2$. B, crown view of right P^2 - M^3 . $\times 0.52$. C and D, *Brachypotherium lewisi* sp. nov. KNM LT 84. Dorsal, C, and right lateral, D, views of juvenile right ramus with dm_{1-4} , M_1 . $\times 0.38$.

measure the angle between the dorsal plane, along the left temporal crest, and the occipital plane, of which a portion is preserved just below the nuchal crest where the temporal crest would have intersected if had it been straight instead of curving off laterally. The portion of the occipital surface preserved is part of a crest running from the nuchal crest downward, which converges with its fellow on the other side to a point in the median line above the occipital foramen. The angle that may thus be measured is 65 degrees; it is 65, 70, and 80 degrees in the three *D. bicornis* skulls, and 45 and 50 degrees in the two *C. simum* skulls used for comparison.

The only other portion of this specimen that could be restored from the fragments is the nasal, but it too is defective and mostly from the right side. The width cannot be determined exactly as the median line is not well marked off, but it would appear to have been *ca.* 160 mm, which is about as in *C. simum* (160–190 mm) and wider than in *D. bicornis* (125–145 mm), as would be expected in such a wide skull.

A third skull of this early *Ceratotherium* (Fig. 10, A, B) comes from the slightly younger Ekora formation (KNM KP 41) and has been crushed, distorted and partially fragmented in the ground. The dorsal profile, as preserved, is certainly too flat in the nasofrontal region and too steeply rising in the parieto-occipital region. Although the specimen is somewhat twisted lengthwise and only the right maxillary is in contact (the left being detached), it nevertheless shows the elongation of the postdental portion, which in this species surpasses *Diceros*. Nasal and frontal horn bosses do not appear to have been extensive. The angle between the dorsal and occipital surfaces of the occiput cannot be calculated. The naso-maxillary notch extends to a point above the anterior border of P³ and the anterior border of the orbit is above the anterior border of M², as in the type.

The anterior premolar, possibly a per-

TABLE 7. MEASUREMENTS OF UPPER TEETH OF *C. PRAECOX* AND *D. BICORNIS* (mm)

	<i>C. praecox</i>	<i>D. bicornis</i>
	KNM KP 41	
P ² , length	30	29–32
ant. width	36	33–44
post. width	42	38–50
P ³ , length	40	36–44
ant. width	—	50–57
post. width	51	51–60
P ⁴ , length	—	43–51
ant. width	59	59–67
post. width	54	55–66
M ² , length	67	58–70

sisting DM¹, is *in situ* on the left side; it is considerably worn, with a transverse crown diameter of some 22 mm. P² is well preserved on the left side, P³ incomplete anterointernally on both sides, and P⁴ present on the right side. These premolars are in a good state of preservation, and compare very well with those of modern *D. bicornis* having heavy internal cingula and protoloph and metalophs in the transverse position, but differing in the absence of a paracone style, the ectolophs being as flattened and undulating as those in modern *Ceratotherium*. The postsinuses are as deep as, or only slightly shallower than, the medisinuses. All the premolars of KNM KP 41 have well-developed crochets, but only in LP³ is the crochet joined by a crista to isolate a medifossette, which is usually present in all cheek teeth of *C. simum*. The molars, of which only the right series is preserved and of which the external parts are gone, have weak inner cingula, which is the only detectable difference from the Lothagam M².

A left condylar portion of a mandible, KNM KP 31 is intermediate between living *Diceros* and living *Ceratotherium* in several respects: 1) the distance from dental foramen to base of posteromedial articular surface is somewhat greater than in *Diceros* but much smaller than in *Ceratotherium*,

TABLE 8. MEASUREMENTS OF LOWER TEETH OF *CERATOTHERIUM* AND *DICEROS* (mm)

	<i>C. praecox</i>	<i>D. bicornis</i>
	KNM KP 32	
P ₂ , width	20	17-19
P ₃ , length	41	35-38
ant. width	27	21-23
post. width	28	25-27
P ₄ , length	47	41-44
ant. width	29	25-27
post. width	33	29-31
M ₁ , length	52	— —
post. width	34	29-32
M ₂ , length	54	50-53
ant. width	34	28-32
post. width	34	31-34

indicating that the jaw orientation was evidently more nearly as in *Diceros*; 2) the condylar area is more massive and wider below the condyle than in our specimens of *Ceratotherium simum*; and, 3) the surface anterior to the medial portion of the condyle is flatter and more rugose than in *Diceros* and as flat but less rugose than in *Ceratotherium*. The medial surface beneath the condyle is more markedly concave than in either of the two living forms.

A right and a left (Fig. 9, B, C) ramus of the mandible (KNM KP 32) preserve LP₂, L and RP₃, erupting P₄, M₁₋₂, and erupting M₃. These teeth do not show any tendency to form the fossettids typical of *C. simum*. They are a little larger than in *D. bicornis*, and are higher-crowned. The height of the unworn posteriointernal

column of M₂ is 51 mm, as against 36 mm in a Recent specimen of that species (MCZ, Dept. Mamm., no. 41993). In striking contrast to more advanced *Ceratotherium* there is no greater obliquity in the posterior portions of meta- and hypolophid in the fossil than in Recent *D. bicornis*. An erupting M₂ in a left mandibular ramus (KNM KP 33) has a posterior height of ca. 53 mm, showing once again the greater hypsodonty in the Kanapoi teeth as compared to Recent *D. bicornis*.

A somewhat imperfect right humerus (KNM KP 39) is the only postcranial element of a rhinoceros found thus far at Kanapoi. The caput and the proximal tuberosities, as well as the distal portion of the shaft and the trochlea and condyles, are superficially damaged, but the bone does not appear to differ in any major way from the humeri of modern *Diceros* and *Ceratotherium*; in dimensions it slightly exceeds the former but is notably less robust than the latter.

The *Diceros* group of rhinoceroses may have been essentially confined to Africa throughout their history, although their origin, if it occurred there, is at present wholly obscure. Until recently the earliest known species were the early Pliocene *Diceros pachygnathus* (Wagner) and *D. douariensis* Guérin from Europe and North Africa, respectively. On this basis a Eurasian origin could plausibly have been argued, but the discovery of the rather aberrant *Paradiceros mukirii* in the late Miocene Fort Ternan deposit (Hooijer, 1968) casts a different light on the matter, intimating, as it does, an African—not a

TABLE 9. MEASUREMENTS OF HUMERUS OF *CERATOTHERIUM* AND *DICEROS* (mm)

	<i>C. praecox</i>	<i>D. bicornis</i>	<i>C. simum</i>
	KNM KP 39		
Length from caput to medial condyle	355	345-350	400-410
Width over caput and posterior part of lateral tuberosity	ca. 160	145-160	180-190
Width at deltoid tuberosity	140	130-140	170-175
Greatest distal width	ca. 160	150-155	175-180

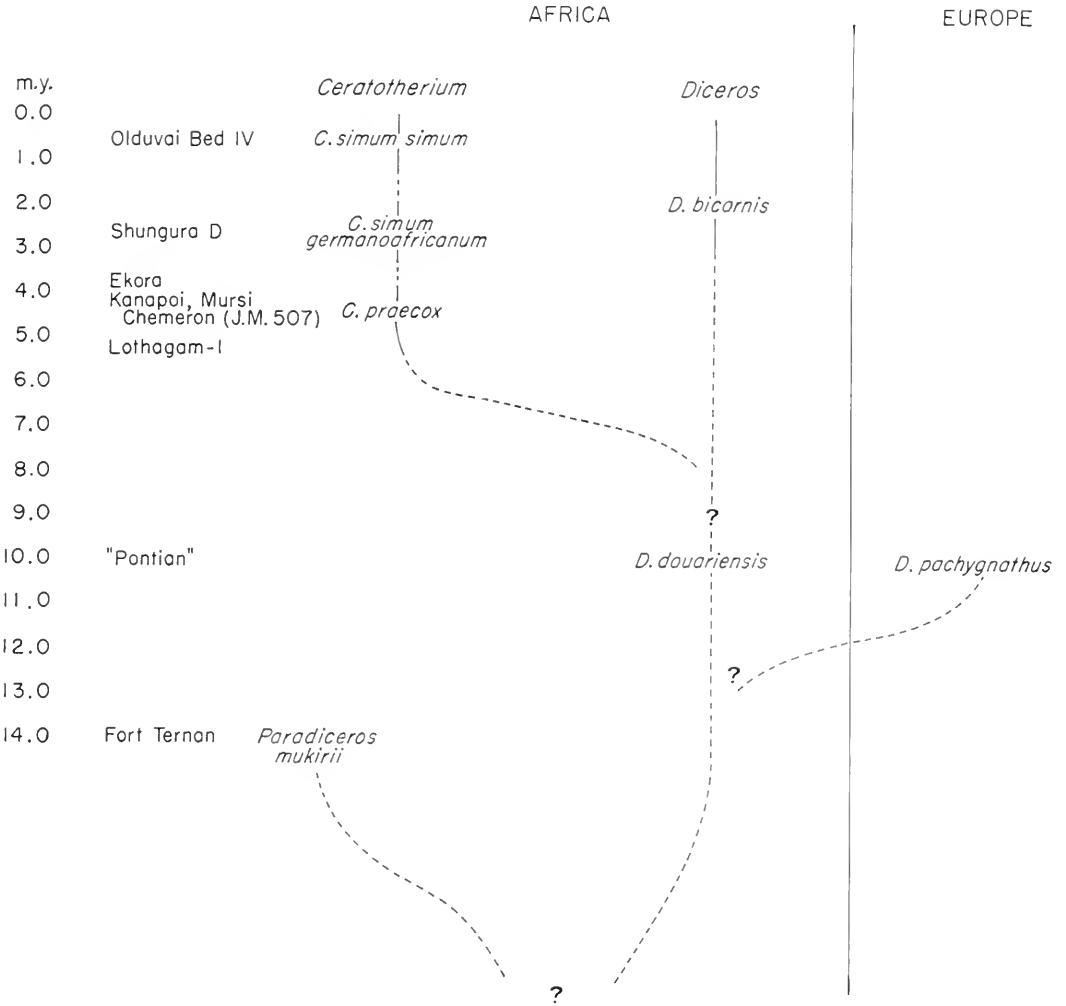

Figure 11. Chronology and geography of the *Diceros* group of the Rhinocerotidae.

Eurasian—Miocene history of which we are at present ignorant. Whatever the case, the later history, so far as known, is wholly African and *D. pachygnathus* is still the only extra-limital species (Fig. 11). Thenius (1955) has offered the suggestion that *Ceratotherium* diverged from *Diceros* in the course of the Pliocene; the discovery of *C. praecox* goes far toward confirming this.

REFERENCES CITED

DEPÉRET, C. 1887. Recherches sur la succession des faunes de vertébrés miocènes de la Vallée

du Rhône. Arch. Mus. Hist. Nat. Lyon, 4: 45-313.

ERASMO, G. D'. 1954. Sopra un molare di *Teleoceras* del giacimento fossilifero di Sahabi in Cirenaica. Rendiconti Accad. XL, (4) 4 & 5: 89-102.

FOURTAU, R. 1920. Contribution à l'étude des vertébrés miocènes de l'Égypte. Cairo (Govt. Press), xii + 122 pp.

HOOIJER, D. A. 1959. Fossil rhinoceroses from the Limeworks Cave, Makapansgat. Pal. Africana, 6: 1-13.

———. 1963. Miocene Mammalia of Congo. Ann. Mus. Roy. de l'Afrique Centrale, Tervuren, Sci. Géol., 46: ix + 1-77.

- . 1966. Miocene rhinoceroses of East Africa. *Foss. Mamm. Africa*, **21**: 117–190.
- . 1968. A rhinoceros from the Late Miocene of Fort Ternan, Kenya. *Zool. Med. Museum Leiden*, **43**: 77–92.
- . 1969. Pleistocene East African rhinoceroses. *Foss. Vert. Africa*, **1**: 71–98.
- . 1971. A new rhinoceros from the Late Miocene of Loperot, Turkana District, Kenya. *Bull. Mus. Comp. Zool.*, **142**: 339–392.
- KAUP, J. J. 1834. Description d'ossements fossiles de mammifères inconnus jusqu'à présent, qui se trouvent au Muséum grandducal de Darmstadt, **3**: 33–64, atlas pls. 10–15.
- . 1854. Beiträge zur näheren Kenntniss der urweltlichen Säugethiere, **1**: viii + 1–31.
- MAGLIO, V. J. 1970. Early Elephantidae of Africa and a tentative correlation of African Pliocene deposits. *Nature (London)*, **225**: 328–332.
- NOUËL, E. 1866. Mémoire sur un nouveau rhinocéros fossile. *Mém. Soc. d'Agric. Sci., Belles-Lettres et Arts d'Orléans*, ser. 2, **8**: 241–251.
- PATTERSON, B. 1966. A new locality for early Pleistocene fossils in northwestern Kenya. *Nature (London)*, **212**: 577–581.
- PATTERSON, B., A. K. BEHRENSMEYER, AND W. D. SILL. 1970. Geology and fauna of a new Pliocene locality in northwestern Kenya. *Nature (London)*, **226**: 918–921.
- THIENIUS, E. 1955. Zur Kenntniss der unterpliozänen Dicerós-Arten (Mammalia, Rhinocerotidae). *Ann. Naturhist. Mus. Wien*, **60**: 202–211.

APPENDIX

Late Pleistocene Rhinoceros Remains

In order to round out the accounts given here and in Hooijer (1971) of the rhinoceros collected by the Museum's African expeditions, we append this note on two

late Pleistocene or, in the case of one, possibly Holocene, specimens obtained.

On the return trip from Turkana in 1963 a brief stop was made at exposures of the Kapthurin formation west of Lake Baringo and just south of the lava cliff that parallels the road near Kampi ya Samaki. Apart from two small fragments of a cranial roof of *Homo*, the only find of note made there was a rather complete skull of *Diceros*. Metrically and morphologically the specimen is indistinguishable from Recent specimens of *D. bicornis*.

Occasionally, isolated teeth of animals such as *Equus* can be picked up on the surface of Kanapoi (and Lothagam) exposures but have not been found *in situ* in the formation. Into this category falls an isolated P⁴ of *Ceratotherium simum* lacking most of the protoloph and with superficial damage to the ectoloph (KNM KP 38). Mineralization apart, the specimen is indistinguishable from corresponding teeth of *C. s. simum*. As regards provenance of such surface finds, there are two possibilities. There recently have been, and in a few places still are, patches of sediment dating back to ca. 3,000 B. C. The artifacts found at Kanapoi are associated with these and the teeth may also be. The second possibility is that they have weathered out of coarse sediments thinly deposited in the Kanapoi area following a late Pleistocene period of erosion that preceded the present one. These sediments can be seen here and there in a few of the former gullies that have been exposed by the cutting of the current ones.

Bulletin of the
Museum of
Comparative
Zoology

Pelycosaurian Reptiles from the
Middle Pennsylvanian of North America

ROBERT REISZ

HARVARD UNIVERSITY
CAMBRIDGE, MASSACHUSETTS, U.S.A.

VOLUME 144, NUMBER 2
12 JULY 1972

PUBLICATIONS ISSUED
OR DISTRIBUTED BY THE
MUSEUM OF COMPARATIVE ZOOLOGY
HARVARD UNIVERSITY

BULLETIN 1863-
BREVIOIRA 1952-
MEMOIRS 1864-1938
JOHNSONIA, Department of Mollusks, 1941-
OCCASIONAL PAPERS ON MOLLUSKS, 1945-

Other Publications.

Bigelow, H. B., and W. C. Schroeder, 1953. Fishes of the Gulf of Maine. Reprint, \$6.50 cloth.

Brues, C. T., A. L. Melander, and F. M. Carpenter, 1954. Classification of Insects. \$9.00 cloth.

Creighton, W. S., 1950. The Ants of North America. Reprint, \$10.00 cloth.

Lyman, C. P., and A. R. Dawe (eds.), 1960. Symposium on Natural Mammalian Hibernation. \$3.00 paper, \$4.50 cloth.

Peters' Check-list of Birds of the World, vols. 2-7, 9, 10, 12-15. (Price list on request.)

Turner, R. D., 1966. A Survey and Illustrated Catalogue of the Teredinidae (Mollusca: Bivalvia). \$8.00 cloth.

Whittington, H. B., and W. D. I. Rolfe (eds.), 1963. Phylogeny and Evolution of Crustacea. \$6.75 cloth.

Proceedings of the New England Zoological Club 1899-1948. (Complete sets only.)

Publications of the Boston Society of Natural History.

Authors preparing manuscripts for the *Bulletin of the Museum of Comparative Zoology* or *Breviiora* should send for the current Information and Instruction Sheet available from Ms Penelope Packard, Editor, Publications Office, Museum of Comparative Zoology, Harvard University, Cambridge, Massachusetts 02138, U.S.A.

PELYCOSAURIAN REPTILES FROM THE MIDDLE PENNSYLVANIAN OF NORTH AMERICA

ROBERT REISZ¹

TABLE OF CONTENTS

Abstract	27
Introduction	27
Acknowledgments	30
Suborder Ophiacodontia	30
Family Ophiacodontidae	30
<i>Archacothyris florensis</i> gen. et sp. nov.	31
<i>Echinerpeton intermedium</i> gen. et sp. nov.	45
Other pelycosaurian material from Florence, Nova Scotia	50
<i>Protoclepsydrops haplous</i>	52
Interrelationships of primitive Pelycosauria	54
The origin of pelycosaurians	55
References	60

ABSTRACT. At least five species of pelycosaurians have been found in the Middle Pennsylvanian terrestrial deposit of Florence, Nova Scotia. *Archacothyris florensis* is a primitive but typical ophiacodont, while *Echinerpeton intermedium* is an ophiacodont with some sphenacodont characteristics, including elongate neural spines. Vertebral material from three other pelycosaurians is also present. The occurrence of this rich fauna in the Middle Pennsylvanian permits reconsideration of the taxonomic interrelationships of primitive pelycosaurians. Although ophiacodonts did not diverge as drastically from the ancestral romeriid pattern as sphenacodonts or edaphosaurs, none of the known early ophiacodonts could be ancestral to the other suborders. Even if pelycosaurians evolved from a single romeriid species, the separation of the major pelycosaurian lineages must have occurred early in the evolution of the order, probably at about the time of the formation of the Joggins deposits. Comparison of romeriid captorhinomorphs and the

earliest pelycosaurians indicates that the temporal opening developed in response to selection for more efficient use of the jaw musculature in forms of increasing body size.

INTRODUCTION

The Order Pelycosauria represents the earliest stage in the evolution of mammal-like reptiles. Early work on forms from the Lower Permian redbeds of Texas and New Mexico by Cope (1877, 1878), Case (1907), Williston (1911), and von Huene (1925) demonstrated the prominence of the group among primitive fossil reptiles.

Our current understanding of the order is based primarily on the work of Romer and Price (1940). This extensive study indicated that the Pelycosauria comprised a large order with at least three major lineages: 1) Suborder Ophiacodontia—primitive amphibious piscivores; 2) Suborder Sphenacodontia—advanced terrestrial carnivores; 3) Suborder Edaphosauria—specialized swamp-dwelling herbivores. Most pelycosaurians are known from the Lower Permian (Autunian) of North America and Europe (see chart of geological horizons, Fig. 1). In the Pennsylvanian, fossil remains are limited both in variety and numbers, but are sufficient to show that pelycosaurians were already highly diversified. Upper Pennsylvanian (Stephanian) localities from which pelycosaurians are known are limited to: 1) The McLeansboro Formation near Danville, Illinois: fragmentary skeletal elements

¹ Redpath Museum, McGill University, Montreal.

	EUROPEAN STAGES	AMERICAN SERIES	LOCALITIES	
PENNSYLVANIAN	Stephanian	Monongahela	Kounova Jasper County	
		Conemaugh	Pittsburgh Garnett Danville	
	Westphalian	D	Allegheny	Nyřany Linton Florence
		C		
		B	Pottsville	Joggins
		A		
	Namurian			

Figure 1. Pennsylvanian stratigraphy. The chart is based on Moore et al. (1944).

of a single ophiacodont genus, *Clepsydropus* (Cope, 1875). 2) The Matoon Formation of Jasper County, Illinois: numerous fragments of a varanopsid sphenacodont, *Milosaurus mccordi* (DeMar, 1970). 3) The Conemaugh Group near Pittsburg, Pennsylvania: *Edaphosaurus* (Romer and Price, 1940) just below the Ames Limestone, and a

large ophiacodont pelycosaur, *Clepsydrops magnus* (Romer, 1961), just above the Ames Limestone. 4) The Upper Pennsylvanian Round Knob Formation of Garnett, Kansas: a complete presacral vertebral column belonging to an edaphosaur designated as *Edaphosaurus ecordi*, an ophiacodont pelycosaur similar to *Clepsydrops* (Peabody, 1957), and an undescribed sphenacodont. 5) The late Stephanian of Kounova, Bohemia: a small *Edaphosaurus* similar to that from the Round Knob Formation, and a number of bones of a large sphenacodont, *Macromerion schwarzenbergii* (Romer, 1945).

Indications are that, by the time of deposition of the Danville bonebed (the oldest of the above localities), considerable differentiation of the pelycosaur groups had already taken place, and that the ophiacodonts had already entered upon a stage of structural stability (Romer and Price, 1940: 34). This idea is supported by other finds in the Stephanian indicating the presence of highly evolved members of all three pelycosaur suborders. From this evidence, it is inferred that the Pelycosauria must have originated well down in the Pennsylvanian, at least in the early Pottsville or Namurian.

Romer and Price (1940: 34) pointed out the need to discover and investigate "fossiliferous beds of early and middle Pennsylvanian (Westphalian) age of a more terrestrial type than the coal swamp deposits" so typical of the age, in order to establish a better understanding of the origins of the Pelycosauria.

In 1964, Carroll described a fossil from the upright lycopod tree stumps of Joggins, Nova Scotia, which he named *Protoclepsydrops* and identified as a very primitive pelycosaur. Since the age of this deposit is Westphalian B, *Protoclepsydrops* would be the oldest known pelycosaur. The affinities of this animal are open to question, however, because of the similar nature of the humerus to that of the subsequently described romeriid captorhinomorph, *Paleothyris* (Carroll, 1969). (The original identification of *Protoclepsydrops* was mainly

based on the nature of the humerus.) The affinities of *Protoclepsydrops* will be discussed later in this paper.

Between the Joggins deposit and the Danville bonebed there is a great gap in time. An extensive pelycosaurian fauna from Florence, Nova Scotia, which will be described in this paper, provides considerable information about the representatives of the order living during this time interval. The Florence locality was discovered by a field party from Harvard University under the direction of Dr. A. S. Romer in 1956. As at Joggins, the vertebrates are found within the stumps of upright lycopods of the genus *Sigillaria*. The trees, rooted above the Lloyd Cove coal seam of the Morien Group, were exposed by strip mining. The age of the locality was established by Bell (1966: 62) to be equivalent to the Westphalian D. The Florence locality is hence younger than the Joggins deposit, where the earliest reptiles were found, and about the same age as the traditional Pennsylvanian coal swamp deposits of Linton, Ohio, and Nýřany, Czechoslovakia. As at Joggins, the fauna consists almost entirely of terrestrial vertebrates, rather than swamp and pond dwellers common to Linton and Nýřany.

Five tree stumps were collected in all, but most of the vertebrates came from one tree, No. 3. In addition to the pelycosaur to be described in this paper, at least 18 specimens of a romeriid captorhinomorph (Carroll, 1969), a single specimen of a small limnoscelid (Carroll, 1967), and several skulls of the edopoid amphibian *Cochleosaurus* have been found. The tree was 12 to 15 feet in height, with three blocks at successively lower levels, indicated as A, B, and C, with intervening layers of unproductive shale. The base of a tree stump was collected in 1965 by a McGill-Princeton field party. According to Dr. Baird's field notes, this tree (designated as block D for convenience) stood between the still recognizable cavities left by trees No. 3 and 5, so it is part of the Harvard party's tree No. 4.

Several types of pelycosaur were found

in the tree, with the greatest amount of material being located in block B. These finds represent the earliest adequately known pelycosaurs whose affinities can be definitely established. They add very much to our knowledge of the anatomy of the early members of this group. Two pelycosaurs that are almost complete will be described first; some fragmentary pelycosaurian material will be discussed later.

The manner of preservation of these pelycosaurs makes systematic description difficult. Most the specimens are badly disarticulated, even to complete separation of the component skull bones. The bones in block D are particularly poorly preserved.

The following abbreviations are used in this paper:

AMNH American Museum of Natural History, New York

BM(NH) British Museum (Natural History)

ČGH National Museum, Prague

CM Carnegie Museum, Pittsburgh

DMSW private collection of D. M. S. Watson, Cambridge University

MB Humboldt Museum, Berlin

MCZ Museum of Comparative Zoology, Harvard University

RM Redpath Museum, McGill University, Montreal

SGL Sächsisches Geologisches Landesamt, Leipzig

WM Walker Museum, Chicago University

YPM Yale Peabody Museum

ACKNOWLEDGMENTS

I wish to thank Dr. A. S. Romer for the loan of this material to the Redpath Museum. His contribution goes far beyond the discovery of these particular specimens, however; his painstaking study of the Lower Permian reptiles provides an indispensable background for the study of both pelyco-

saur and captorhinomorphs, and a high standard for all students of vertebrate palaeontology. I also thank Dr. R. L. Carroll, of the Redpath Museum, McGill University, who encouraged me to study the material described here and who also gave me considerable guidance and advice. This study owes much to Professor B. Patterson of the Museum of Comparative Zoology, Dr. J. H. Ostrom of the Peabody Museum and Dr. E. S. Gaffney, of the American Museum of Natural History, who allowed me to examine the collections of pelycosaur material in Harvard, Yale, and the American museums. I also wish to thank Dr. D. Baird of Princeton University for his very helpful advice. The study was partially supported by grants from the National Research Council of Canada.

SYSTEMATIC DESCRIPTIONS

Class *REPTILIA*

Subclass *SYNAPSIDA*

Order *Pelycosauria*

Suborder *Ophiacodontia*

Family *OPHIACODONTIDAE*

Genus *Archaeothyris* n. gen.

Type species. Archaeothyris florensis new species.

Known distribution. Middle Pennsylvanian of eastern North America.

Diagnosis. Small ophiacodont pelycosaur with well-ossified skeleton. Skull resembles that of *Ophiacodon uniformis*, except for the relative shortness of the antorbital region and the horizontal ventral margin of the maxilla. The mid-dorsal centra are elongate. Neural arches are not swollen; the neural spines are 9 ± 3 mm high and 6 ± 1 mm wide at the top. The humerus has a deep groove running proximally above the entepicondylar foramen and the entepicondyle is not expanded. The ectepicondyle is at 85 degrees to the plane of the distal end. The supinator process is stout. The pubic tubercle is well developed. Metatarsals and phalanges are elongate.

Archaeothyris florensis n. sp.

Etymology. Greek *archaeo*, ancient, plus *thyris*, window, in reference to the earliest evidence of a temporal opening. *Florensis*, from the name of the locality, Florence.

Holotype. Museum of Comparative Zoology, Harvard, MCZ 4079, block B.-1, partial skull, several vertebrae, humerus, cervical ribs.

Paratypes. MCZ 4080, block A, pelvis, sacral vertebra, axis; MCZ 4081, block B, caudal vertebrae; MCZ 4082, block B, anterior dorsal vertebrae; MCZ 4083, block B, assorted postcranial elements; MCZ 4084, block B, caudal vertebrae, articulated; MCZ 4085, block B, lower jaw elements, frontal; MCZ 4086, block C, metacarpals; MCZ 4087, block C, presacral vertebrae; RM 10056, block D, maxilla, dentary, presacral and caudal vertebrae, interclavicle, calcaneum.

Horizon and locality. Morien Group, within 25 feet above the Lloyd Cove coal seam, equivalent to the Westphalian D of Europe. Dominion Coal Co., strip mine No. 7, two miles north of Florence, Cape Breton County, Nova Scotia.

Diagnosis. Same as for genus.

Description. *Skull:* On the basis of the material from block B (MCZ 4079) and D (RM 10056), a reconstruction of the skull has been attempted (Fig. 2). The skull resembles that of *Ophiacodon* except that the antorbital region is not strongly elongated. The approximate length of the skull is 92 mm; the orbit is about 21 mm in diameter. The posterior rim of the orbit is 31 mm from the posterior tip of the quadrate. The maximum height of the skull (25 mm) is reached in the region of the orbit. The skull is relatively narrow and has a well-developed temporal opening bounded by the postorbital, squamosal, and the jugal. The sculpturing resembles that seen in other pelycosaurs. It is more pronounced on the dorsal surface than on the lateral.

Of the skull roof (Fig. 3), the right frontal, postfrontal, parietal, and squamosal are found in close association—only slightly

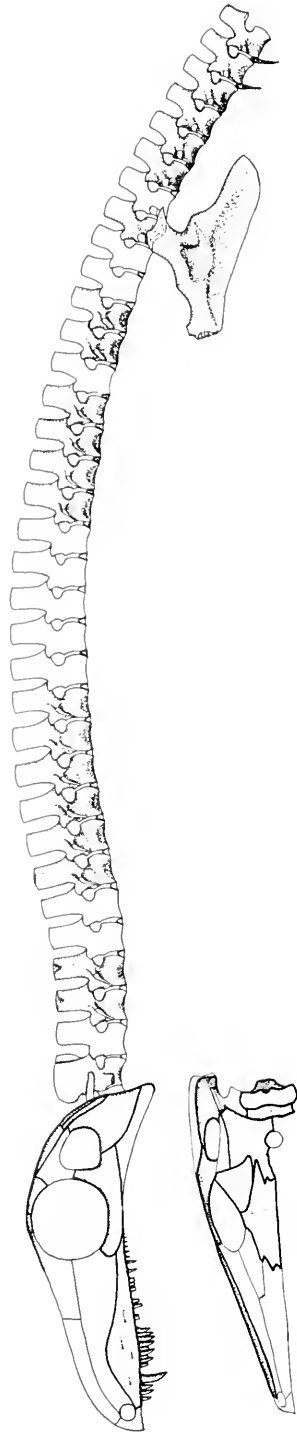

Figure 2. *Archaeothyris florensis*, partial reconstruction. The angle of the occiput to the skull table is uncertain. $\times 0.5$.

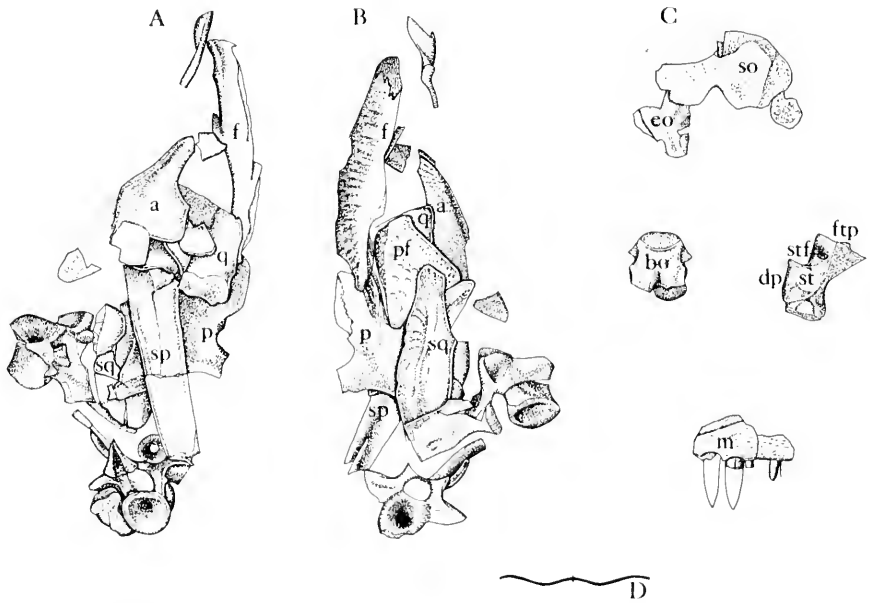

Figure 3. Type of *Archaeothyris florens*, MCZ 4079. A, skull and vertebral elements in ventral view; B, dorsal view of A; C, isolated skull elements; D, outline of dorsal surface of the frontal. Stapes $\times 1.4$. All others $\times 1$. Abbreviations used in figures: a, angular; ba, basioccipital; d, dentary; dp, dorsal process; ea, exoccipital; f, frontal; ftp, footplate; ha, haemal arch; m, maxilla; p, parietal; pf, postfrontal; q, quadrate; sa, supraoccipital; sp, splenial; sq, squamosal; st, stapes; stf, stapedial foramen.

disarticulated, but showing their surfaces of attachment and overlap. The frontal is only moderately elongated: it is 33 mm in length, with a maximum width of 11 mm. A second frontal, approximately 20 percent larger than that in block B.-1, is found in block B.-22 (MCZ 4085). In comparison with that of other ophiacodonts, the frontal in this animal is shorter and also wider in the supraorbital region. The ratio of median length of the frontal to the median length of the parietal in *Ophiacodon uniformis* is 3:1, while in this genus it is only 2:1. Anteriorly, the frontal interdigitates with the nasal, extending 1 to 3 mm underneath it. Anterolaterally, the frontal comes in contact with the prefrontal over a length of 11 mm. The prefrontal is missing in block B.-1, but the area of attachment can be readily seen. Between the prefrontal and the postfrontal, the frontal extends laterally to reach the orbital margin over

a length of 5 mm. This part of the orbital margin is relatively straight, but the posterior end of it reaches further laterally than its anterior end. In this feature *Archaeothyris* is different from *Ophiacodon*, in which the orbital margin is concave, and the anterior and posterior margins extend equally far from the midline. Dorsally the bone is marked by fine sculpturing on the orbital margin (these markings are different from the general sculpturing of the skull). The curved nature of the frontal in cross section is shown in Figure 3. This curvature is followed with great fidelity by the postfrontal, creating a swelling over the orbital region.

The postfrontal is relatively large; its anterior and inner surfaces connect to the frontal (except for the posterior portion of its inner surface where it is separated by a thin strip of the parietal). Viewed from above, the orbital margin of the postorbital curves gently, following the arch of the

frontal. In *Ophiacodon* the dorsal orbital margin is much more strongly curved.

The posterior margin of the frontal and postfrontal extends over the parietal and fits within dorsal grooves that provide an extended surface of attachment. The parpineal foramen is located towards the posterior end of the parietal. On the underside there is an invagination around the foramen that probably housed the greater part of the parpineal organ and its accessory structures. The parietals cover a large part of the table and are bounded on the sides by the postorbitals. Posterolaterally the parietal extends far backwards, a notch at the end receiving the anterior portion of the supratemporal. The dorsal surface of the skull ends with the parietals, the interparietal and the tabulars being part of the uppermost region of the occiput. The concavity at the end of the table is interrupted at the midline by a slight backward projection of the parietals, offering attachment to the nuchal ligament. There are no tabular bones preserved in the tree.

The squamosal occupies a large area in the posterior part of the cheek region. It forms almost 50 percent of the margin of the temporal fenestra. Anteroventrally, the squamosal overlaps the jugal for a considerable portion of its length. Above the temporal opening, the squamosal is in contact with the postorbital, extending slightly underneath it. The squamosal-parietal contact is not strong (the skull roof is not firmly attached to the cheek region). The posterodorsal margin of the squamosal forms the main component of the ridge sloping down from the skull table to the quadrate. The dorsal portion of the posterior margin of the squamosal is covered superficially by the supratemporal, as indicated by a groove, and the lateral portion of the tabular. The squamosal extends inwards beneath these elements so that it underlies the posterolateral corner of the parietal. The area of the squamosal that lies underneath the tabular is so extensive that it is expected to come in contact with the paroccipital process and the inner sur-

face of the lateral border of the supraoccipital (Romer and Price, 1940: 56). It is difficult to assess the area of contact of the squamosal with the quadratojugal because of the incompleteness of the lower edge of the squamosal and because there is no quadratojugal preserved in the tree.

An almost complete maxilla is found in block D (RM 10056). A small fragment of this bone is also found in block B. The maxilla in block D is 40 mm long and 10 mm high at its highest point. The lower margin is almost straight, while in the genus *Ophiacodon* and in most sphenacodonts, the convexity of the lower margin of the maxilla is conspicuous. The internal surface of the maxilla is more important from the taxonomic point of view than is the lateral one. The lower margin of the bone is thickened and turned inward to form a continuous shelf with the palate. This shelf is striated posterior to the canines for attachment to the palatine and the ectopterygoid and is considerably thickened above the canines. Immediately above this area of swelling, the maxilla is braced by a ridge extending to the top of the bone. In other ophiacodonts the maxilla is strengthened by a well-formed vertical ridge, while in sphenacodonts this area is thickened but without the development of a definite ridge. This type of buttressing in *Archacothyrus* and sphenacodonts may be more primitive than that observed in ophiacodonts. It is also observed in another pelycosaur from Florence and in some primitive romeriid captorhinomorphs. The highest point on the upper expansion of the maxilla is reached 15 mm from the anterior end of the bone, 6 mm posterior to the region of the canines.

There are 21 teeth implanted in the subthecodont manner on the maxillary shelf. There is place for at least seven more teeth. The number of teeth in this maxilla is low in comparison with that in other ophiacodonts: *Varanosaurus acutirostris* has 46 teeth, *Ophiacodon mirus* (37), *Ophiacodon uniformis* (32), and *Ophiacodon retroversus* (36). In relationship to this low

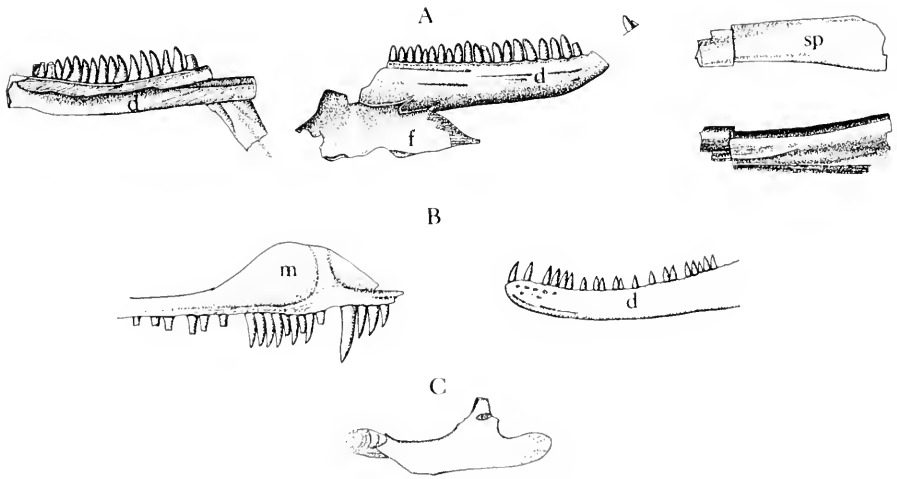

Figure 4. *Archaeothyris florensensis*. A, MCZ 4085, medial and lateral views of the dentary and of the splenial; B, RM 10056, maxilla in medial view and dentary in lateral view; C, MCZ 4089, jugal in lateral view. All $\times 1$. See Fig. 3 for key to abbreviations.

number of teeth, the maxilla is relatively shorter than in other ophiacodonts and as a consequence of this the snout region is less elongated. According to Romer and Price (1940: 89), the length of the maxilla is determined by the dentition and not vice versa. There are only three precanine teeth in RM 10056, a number indicative of strongly developed canines, while in *Ophiacodon* there are from five to seven teeth present anterior to the canines (Romer and Price, 1940: 89). The canine (only one is in place, a second is being replaced) is strongly developed (7 mm in length). The teeth are simple structures, slightly compressed, and sharply pointed. Towards the tip, the teeth bend slightly backwards and are serrated on the medial surface. This serration occurs only on the inside half of the tooth and only towards the tip. It is unlike the labyrinthine infolding seen in the Ophiacodontidae, in which there are deep grooves at the base of the teeth.

An isolated jugal is present in block A, MCZ 4089 (Fig. 4). There is no feature of this bone that would prevent it from belonging to the type of *Archaeothyris* except its small size. It is about 50 percent too small to fit the skull as it has been re-

stored. It is essentially a triradiate structure with long anterior and moderately developed dorsal and posterior rami surrounding a well-developed temporal opening. It is 22 mm long and 10 mm high at the post-orbital bar. The anterior process extends far forward under the orbit and articulates with the lacrimal over a width of 2 mm. It extends a further 5 mm beneath the posterior limit of the lacrimal. The ventral surface for articulation with the maxilla is 11 mm long. At the end of this surface, the jugal reaches the lower edge of the skull, as indicated by the ventral curvature of the bone at this point. The extent of exposure to the ventral border of the skull is less here than in any other pelycosaur with the exception of *Varanops*, in which the jugal does not reach the margin of the skull at all. More posteriorly, the jugal is bounded by the quadratojugal. Articulating marks on the lateral surface of the posterior ramus indicate that the jugal was covered by the squamosal dorsally and the quadratojugal ventrally. Dorsally the posterior and anterior processes form part of the temporal opening and the orbit respectively. The jugal extends only 4.5 mm under the orbit and 3.5 mm under the temporal opening, in-

dicating that the skull was low in outline and that the orbit occupied most of the lateral side of the skull. The dorsal process of the jugal forms roughly half of the post-orbital bar. The upper portion of this process has been lost. It can, however, be established that the type of infolding seen on the *Ophiacodon* dorsal process is not present on this jugal. A somewhat similar jugal has been found at Garnett, belonging to an undescribed sphenacodont pelycosaur (from the Redpath Museum collection). This type of jugal is generally primitive in character and is also found in *Varanosaurus*.

A fragment of one of the palatal elements is also found in block B.-1. Since it bears denticles, it is either part of the pterygoid, the palatine, or the ectopterygoid. In ophiacodonts the palatal elements are covered by single rows of teeth, while this particular fragment is completely covered by teeth. This kind of palatal dentition is found only in sphenacodonts and on the transverse flange of the pterygoid in primitive romeriid captorhinomorphs. Since this fragment is the only known element of the palate, a reconstruction of this area is not possible.

Wedge-shaped between the frontal, the post-frontal, and the angular in block B.-1, MCZ 4079, is the quadrate with a fragment of the pterygoid next to it. The dorsal portion of the quadrate is a sheet of bone about 1.5 mm thick, applied to the outer side of the pterygoid. It extends laterally as well as posteriorly to come in contact with the quadratojugal. Dorsally, the ossified portion of the quadrate is not large enough to reach the squamosal or the paroccipital process. A cartilaginous extension of the quadrate may have reached these areas to complete the posterior wall of the chamber containing the temporal muscles (Romer and Price, 1940: 61). Posteroventrally, the bone changes from a sheetlike nature into a more massive structure that bears the articular surface for the lower jaw. Just dorsal to this area, the lateral surface is indented to form the internal margin of the quadrate foramen. Ventrally, the articulating surface is broken, but it can be seen that

it originally consisted of two rounded ridges, possibly separated by a longitudinal depression as in other pelycosaur. The inner ridge is smaller than the outer one.

The following bones from the occipital region of the skull are present in the type: the supraoccipital, the exoccipital, the interparietal, and the stapes (MCZ 4079). A basioccipital was found in block B.-21, but the size and characteristics of this bone allow it to be associated with *Archaeothyris*. As in *Ophiacodon*, the bones of the braincase are only suturally articulated, whereas in all other pelycosaur they tend to fuse.

The supraoccipital is 20 mm wide and 11 mm tall. The only feature that differentiates this bone from the one in *Ophiacodon uniformis* is its more rounded lateral margins. A partial exoccipital is found suturally attached to the supraoccipital. Its articulating surface for the proatlas is placed more laterally than in *O. uniformis*. The bone extends further laterally than in *Ophiacodon*, occupying the whole of the ventral margin of the supraoccipital. A portion of the connecting surface for the basioccipital is seen on the ventral margin of the bone. Laterally, the exoccipital extends slightly under the opisthotic. The ventral surface of the basioccipital is seen in Figure 3. The occipital condyle is 5.5 mm in width. Laterally, close to the condylar area, the connecting surface of the exoccipital is seen. Between this area and the ventral ramus of the bone there is a notch not observed in *Ophiacodon uniformis*. This small fragment of the interparietal indicates that there was only one postparietal element, which is similar to the one seen in *O. uniformis*.

The stapes is typically pelycosaurian in its configuration. The shaft, however, is extremely short. It was probably continued in cartilage. The distal portion of the shaft, as preserved, is compressed to a thin sheet of bone. The dorsal process extends laterally at 90 degrees to the shaft, as in the primitive romeriids *Paleothyris* and *Hylonomus*, to form an oval articular surface that is roughly parallel to the longitudinal axis of the shaft. The relative proportions of the

footplate and the dorsal process are about intermediate between those seen in *Ophiacodon* and those of *Dimetrodon*. In *Ophiacodon* the footplate is much larger than the dorsal process, while in *Dimetrodon* the reverse is the case. In this stapes, however, the two structures are about the same size.

Three fragments of the lower jaw are present in block B, and an incomplete dentary is found next to the maxilla in block D. The description to follow is a composite of all three specimens. The dentary carries the single lateral tooth row on its upper border and forms a large part of the outer surface of the jaw. Anteriorly it forms the major part of the jaw and is bounded ventrally by the splenial. It bears the type of sculpturing seen in *Ophiacodon uniformis*. Posteriorly the dentary is bounded by the splenial and angular successively (Fig. 4). There are 16, 20, and 22 teeth respectively in the three fragmentary jaws, but a total number of at least 25 is expected in a complete dentary. The teeth are similar to those seen on the maxilla, except for the absence of canines. The dentary bends upward at its front end and the second and third teeth are slightly larger than the remainder. The splenial forms the internal surface of the jaw, connecting dorsally to the internal ridge of the dentary that bears the teeth. Ventrally it connects to the outer side of the dentary, extending down to enclose the Meckelian canal. The splenial does not extend to the outer surface of the jaw as in other ophiacodonts. The angular is a large bone forming part of both the internal and external surface of the jaw. In the area of the Meckelian fossa it forms the ventral portion of a lateral fenestra, as in some other ophiacodonts. On the posterior part of the jaw this bone becomes very thin where it was succeeded by the surangular. Neither surangular, articular, nor coronoid bones have been identified in the tree.

The axial skeleton. Although most of the known elements of the axial skeleton are disarticulated and found at four different levels in the tree, their affinity with this genus is reasonably certain. As a conse-

quence of the scattering of the bones, the exact number of presacral vertebrae cannot be determined. Romer and Price (1940: 93) give 27 as the number of presacrals for ophiacodonts and sphenacodonts. Primitive romeriid captorhinomorphs have from 26 to 32 presacral vertebrae, but *Archaeothyris* is close enough in time and osteology to the other known pelycosaurs that a presacral count of 27 or very close to it is expected. It is also expected that this animal would have had two sacral vertebrae. There is no direct evidence for this, but the shape of the iliac blade fragment in block A, MCZ 4080, suggests that there were only two sacral ribs. Presumably the tail was comparable in length to that of later pelycosaurs, which have 50–70 segments.

The description of the individual vertebrae of this animal is based on several specimens. In general, the vertebrae resemble those in the most primitive members of the Ophiacodontia. They have large pleurocentra, small crescentic intercentra, strong and well-developed transverse processes, unswollen neural arches, and high neural spines, in comparison with those of most romeriids. The arches are firmly attached to the centra, the line of suture between them indicated by a rugose ridge posterior and ventral to the transverse process. The centra and neural arches are always found attached to each other in blocks A, B, and C, but the few vertebral elements found in block D have their centra and neural arch elements separated. The vertebral elements found in block D are of the same size as in other blocks, so that the level of maturity would be expected to be similar to those found above them. The reason for finding separate centra and neural arches in block D can be found in the nature of the preservation in this block. The matrix is poorly consolidated and is full of plant material. It is probable that material in this part of the tree accumulated more slowly than in the remainder, and allowed more weathering of the bones.

Of the atlas-axis complex, only the axis is preserved, with arch and centrum firmly

fused. This element was found in block A (MCZ 4080), immediately underneath the first sacral vertebra. It is of a rather primitive nature; the general proportions are intermediate between those of some romeriids and those of the most "primitive" pelycosaurs, the ophiacodonts. The centrum is 8 mm long and 5.5 mm high at the posterior rim. In most pelycosaurs the bevelling for the intercentrum is extensive in the cervical region, but in *Archaeothyris* it is insignificant.

Pelycosaurs typically have a ridge of bone to strengthen the ventral side of the centrum. The level of development of this ridge, or keel, varies among different pelycosaurs, as well as in different regions of the vertebral column of a single animal. In the axis, this ridge extends ventrally, forming a nearly straight line between the ends of the centrum. The ventral margin is slightly rounded. The lateral surface of this ridge at the lower middle of the centrum is concave in section.

Above the anterior rim of the centrum there are paired facets that would have articulated with the uppermost part of the atlas centrum, indicating that the axis intercentrum is located immediately below the atlas centrum (Fig. 5) and possibly fused to it. Here, as in all ophiacodonts, the atlantal centrum is not expected to reach the ventral surface of the column. In sphenacodonts and edaphosaurs, on the other hand, the axial intercentrum is large and is positioned posterior to the atlas centrum. The atlantal centrum reaches the ventral surface of the column, but this ventral exposure is quite narrow. (In the Middle Pennsylvanian romeriid *Paleothyris*, the atlantal centrum is indistinguishably fused to the axis intercentrum. On the other hand, the configuration in *Hylonomus*, the most primitive romeriid, resembles that seen in sphenacodonts and edaphosaurs.) The presence of the axis intercentrum underneath the atlantal centrum necessitates the formation of paired accessory connecting surfaces above the rim of the axis centrum, because the height of the axis intercentrum is added

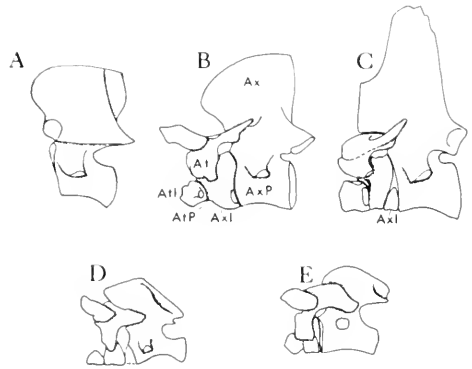

Figure 5. Comparison of the atlas-axis complex in three pelyosaurian and two romeriid genera to show the position of the axis intercentrum. A, *Archaeothyris florensis*, MCZ 4080, $\times 1$; B, *Ophiacodon retroversus*, MCZ 1121 (Romer and Price, 1940, text-fig. 44), $\times 0.25$; C, *Dimetrodon limbatus*, MCZ 1347 (Romer and Price, 1940, plate 23), $\times 0.25$; D, *Hylonomus lyelli*, BM(NH) R.4168, (Carroll, 1964, text-fig. 2), $\times 2$; E, *Paleothyris acadiona*, MCZ 3484 (Carroll, 1969, text-fig. 5), $\times 2.5$. Abbreviations used in the figure: At, atlas centrum; Atl, atlas intercentrum; Ax, axis neural arch; AtP, atlas pleurocentrum; AxI, axis intercentrum; AxP, axis pleurocentrum.

to the height of the atlas centrum. Immediately above this articulating area are the anterior zygapophyses. Between the zygapophyses and the top of the anterior central connecting surface there is a recess that is also present on the *Ophiacodon* axis. There is also a deep groove extending from the lowermost edge of the anterior zygapophyses to the ventral edge of the posterior zygapophyses.

The transverse process is very stout and has a large articulating surface. There is a little "webbing" seen anteroventrally. The transverse process extends without a break to the upper margin of the centrum. In anterior view the transverse process extends far laterally and downward at about 65 degrees to the vertical axis of the vertebra. The neural spine is moderately tall, and extends anteriorly beyond the level of the zygapophyses. A similarly shaped anterior extension is seen in the primitive romeriid captorhinomorph *Hylonomus*. In *Ophiacodon* the neural spine also extends far anteriorly, but the shape of this process is

different from that seen in *Archaeothyris*. Posteriorly, the neural spine has paired grooves for the attachment of axial ligaments. This feature is seen in several romeriids, including *Paleothyris* and *Protorthyris*, but not in any other pelycosaurs.

Twelve vertebral elements from the trunk region are seen in block B in close association with the skull (MCZ 4079). Others are present in blocks C and D. In general proportions these vertebrae resemble the presacrals of other primitive pelycosaurs. The length of the centrum is almost 40 percent greater than its height. In later and larger ophiacodonts there is a tendency for the width and the height of the centrum to increase at a greater rate than the length, so that the relative length decreases. The configuration of the ventral ridge (keel) varies throughout the column. It is most pronounced in the cervical region. The sacrals are stout and more rounded in contour and there is little keel development in the caudal region. There is a tendency for the posterior edge of the centrum, as viewed laterally, to have a slightly convex outline, and for the anterior edge to be slightly concave. In end view, the centra have the configuration of a laterally compressed oval, pierced above the midline for the passage of the notochord.

An intercentrum located in block B is crescentic in outline; its outer surface describes an arc of almost 90 degrees. Since this intercentrum is well developed, it seems probable that the intercentral space was larger than in other pelycosaurs. It is also probable that in life the intercentra had large cartilaginous extensions, reaching high up between the ends of the centra.

The nature of the transverse process is very important in associating this genus with the Ophiacodontia. The processes on the cervical and anterior dorsal vertebrae are markedly shorter than in other suborders. In the mid-dorsal region they arise from a high position on the arch, almost level to the zygapophysyal surface, and extend directly laterally. The

articulating surface of the transverse process is narrow. A thin portion of the surface extends anteroventrally toward the front of the centrum. This anteroventral extension of the transverse process is separated from the surface for the capitulum by only a slight gap for the passage of the segmental artery. This type of anteroventral extension of the articulating surface is seen only in the trunk region of other ophiacodonts. No "webbing" is present in sphenacodonts or edaphosaurs. The head of the rib is formed in such a manner that there is complementary webbing between the tubercular and capitular heads. In the mid-dorsals the capitular head articulates with the intercentrum but there is a tendency for it to move onto the anterior rim of the same centrum in the lumbar, sacral, and anterior caudal vertebrae.

As in other ophiacodonts, the anterior zygapophyses are supported by buttresses extending upward and forward beyond the pedicels of the neural arch. These buttresses are quite prominent. The posterior zygapophyses are braced by paired supports descending and expanding from the base of the neural spine. The zygapophysyal surfaces extend laterally to the limits of the centra and are moderately tilted. Romer and Price (1940: 103) emphasize the importance of the angle of the zygapophyses in separating the different suborders of pelycosaurs and in distinguishing pelycosaurs from other early reptiles. In *Archaeothyris* this angle is difficult to establish exactly because the number of presacral vertebrae is small; the actual articulating surfaces are not straight, but oval in outline, and a little crushing can change the angle considerably. An approximate angle of 25 ± 5 degrees can, however, be established for the anterior dorsal vertebrae. In most ophiacodonts the angle is around 30 degrees in the dorsals; in most sphenacodonts and edaphosaurs the figure is higher, frequently close to 45 degrees. In the anterior cervicals the angle is less; in the sacrals and caudals it tends to be greater.

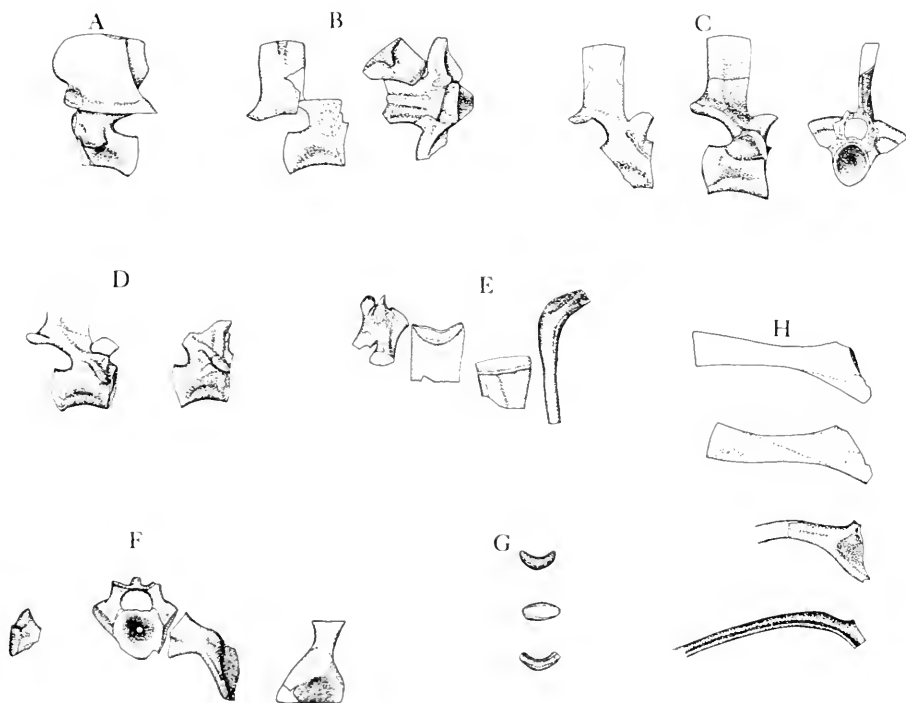

Figure 6. *Archaeothyris florensis*, postcranial skeletal elements. A, axis in lateral view, MCZ 4080; B, cervicals, in lateral and dorsal view, MCZ 4079; C, three dorsal vertebrae in lateral and anterior views, MCZ 4082; D, two posterior dorsal vertebrae in lateral view, MCZ 4083; E, two fragmentary neural spines together with a rib and a caudal vertebra, MCZ 4083; F, first sacral vertebra with its ribs in anterior view, the articular surface of the right rib, and the anterior and lateral views of the right rib, MCZ 4080; G, presacral intercentrum in anterior, ventral, and posterior views, MCZ 4083; H, cervical, MCZ 4079, anterior, MCZ 4081, and posterior dorsal ribs, MCZ 4083. All $\times 1$.

The neural spines are well developed. They are greatly expanded anteroposteriorly to more than half the length of the centrum. Towards the top the spine expands further, so that the ends are nearly in contact. The spines are typically narrow transversely. The spine is situated towards the back of the vertebra, with the posterior margin in line with the posterior end of the centrum. The proportions of the neural spines vary in different areas of the vertebral column. The spines on the anterior dorsals expand laterally towards the top as well as transversely. When viewed from above the spine looks barrel-shaped. The unfinished end of the spine invades the lateral surface, expanding the head even more at this point. More posteriorly along the column, the spines tend to become

bladlike structures. Towards the sacrum, the neural spines become shorter, yet their width remains the same.

The nature of the iliac blade indicates that only two sacral ribs come in contact with it, as in ophiacodonts in general. The first sacral vertebra with its rib is preserved in block A (MCZ 4080) (Fig. 6). The spine and the posterior zygapophyses have been lost. The sacral rib is almost complete. The centrum is stouter than that of the presacrals—a feature commonly seen in pelycosaurs. The ventral keel on the centrum is rounded in cross section. The transverse process is located on the extreme anterior portion of the vertebra and extends farther down the body of the centrum than in presacrals: it is very massive and extends little laterally. The capitular facet is located on

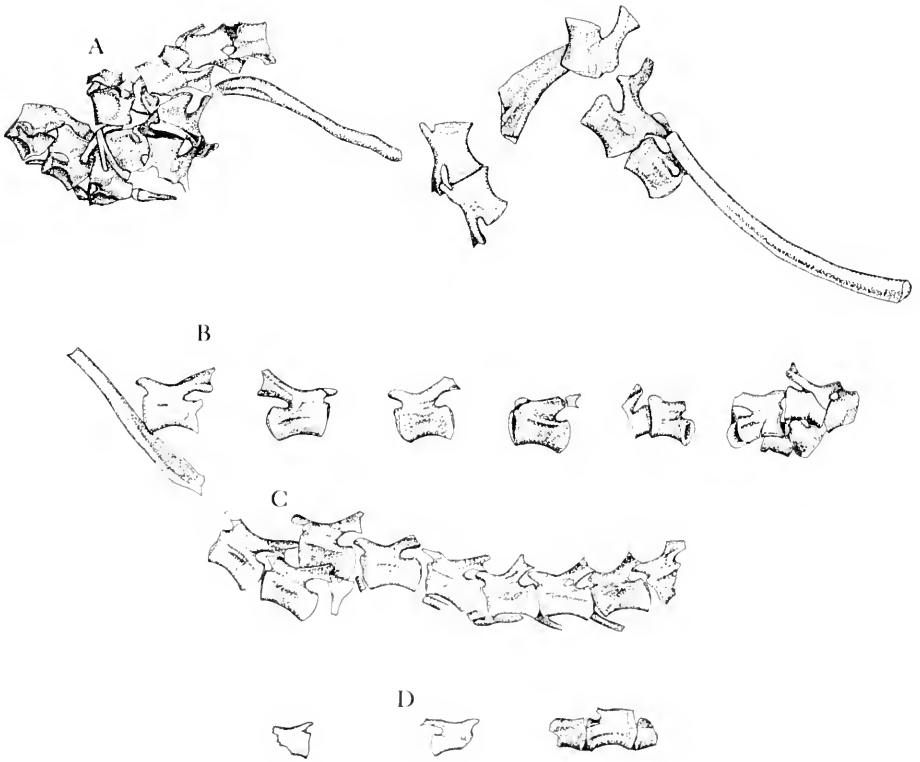

Figure 7. *Archaeothyris florensens*. A, proximal caudal vertebrae, one cervical rib, and two isolated presacral ribs, MCZ 4081; B, mid-caudal vertebrae, not in articulation, and an isolated presacral rib, MCZ 4083; C, mid-caudal vertebrae, in articulation, MCZ 4084; D, posterior caudal vertebrae, MCZ 4081. All $\times 1$.

the body of the centrum, in close proximity to the transverse process. The two articulating facets are separated only by a small groove. The capitular facet is triangular in shape, with its tip pointing ventrally, almost reaching the ventral margin of the anterior central rib. Neither the second sacral vertebra nor its rib have been found in the tree.

Over forty caudal vertebrae were observed in the four blocks, representing all the regions of the tail. The anterior vertebrae are only slightly less stout than the sacral known from block A. They possess a ventral keel that disappears by the end of the rib-bearing series, where the lower surface of the centrum becomes flattened. The tubercular and capitular facets are present on the proximal caudals but are eliminated posteriorly, indicating the loss of the ribs.

The capitular facets are not visible on the centrum beyond the sixth caudal. By the twelfth caudal, only stubby lateral projections are visible, and they may simply be transverse processes. As indicated by the nature of the tubercular and capitular articulating areas, the anterior ribs are not fused to the centra. In this feature, *Archaeothyris* is very primitive. Other pelycosaurs have their caudal ribs fused to the centra (Romer and Price, 1940: 110). The length of the zygapophyses in the caudal region exceeds their width. The neural spines decrease in size in the caudal region and are not present on the distal portion of the tail beyond about the 35th caudal. Normal intercentra continue back into the proximal caudal region. This is seen in Figure 7 where two normal intercentra are seen be-

tween three proximal caudal centra. The intercentra behind the first four caudal centra develop into typical haemal arches, as seen in the same figure. The first chevron is already completely developed.

With the exception of the first sacral rib, all the ribs belonging to this genus are found separated from the vertebrae. Ribs are typically present on every vertebra from the atlas to the proximal caudals in pelycosaurs and other primitive reptiles. There is one cervical rib preserved in block B-1 (MCZ 4079) (Fig. 6), and one in block B-20 (MCZ 4051) (Fig. 7), lying underneath some caudal vertebrae. Webbing is present between the capitulum and tuberculum, but because transverse processes in the cervical region point strongly downward, this webbing is not extensive. According to Romer and Price (1940: 110), other ophiacodonts lose the connecting web in the cervical ribs. The head of the rib is moderately expanded dorsoventrally. The shaft is straight and the distal end is flattened and expanded in the shape of a paddle as in other ophiacodonts and romeriids.

In typical dorsal ribs, the head is greatly expanded dorsoventrally with the tubercular and capitular heads connected by a thin sheet of bone. The main body of the rib is circular in section, with a ridge running along its posterodorsal margin. The curvature of the ribs indicates that the trunk was rather high and narrow, as in most primitive carnivorous reptiles. Towards the posterior dorsal region the ribs become much shorter and there is a tendency for the transverse process to move onto the centrum. The heads of the ribs become much smaller with a corresponding reduction of the webbing.

The first sacral rib, preserved in block A (MCZ 4050), is almost complete. It was in articulation with the vertebra, but not fused to it. The rib is very short and massive; the plate is not as wide as that of *Ophiacodon*. The rib expands laterally for about 5 mm, then changes direction sharply

and extends almost straight ventrally. The outer margin of the lateral expansion is angled in such a manner that it points towards the posterior sacrals. The downward projection of the rib is slightly cupped and terminates in an almost straight horizontal ventral border. Posteriorly, the rib seems to have only a limited area of contact with the second sacral rib, in contrast with the case in *Ophiacodon*, in which this area of contact is extensive (a probable accommodation to greater body size and weight). There are no ribs preserved in the tree that can be identified as the second sacral. The general similarity of *Archaeothyris* to other ophiacodonts and the extent of the iliac blade suggest that a second sacral rib had been present however. No caudal ribs have been found.

Appendicular skeleton. Of the shoulder girdle, only a fragmentary interclavicle is known, preserved in block D. The right portion of the anterior blade and part of the shaft is represented by bone. The parts in between are known only as an impression. The major part of the shaft is preserved as a separate fragment in the same block. The configuration of the anterior portion of the shaft is important diagnostically. In *Archaeothyris*, as in other ophiacodonts, the head constricts strongly, to make the shaft relatively constant in width. In sphenacodonts, however, the anterior portion of the shaft is wide so that the head and shaft are not clearly differentiated.

An almost complete pelvis is preserved in block A. The major parts of the three elements are preserved either as bone or as impression on the right side, except that the iliac blade is broken off at its base. Fragments of the left ischium and pubis are also preserved. As in most tetrapods, the ilium is fused to the pubis and ischium and forms the upper part of the acetabulum. The sutures between the bones are represented by slight rugosities in the areas outside the acetabulum. The ilium constricts strongly into the neck above the acetabulum. This constriction is closely comparable

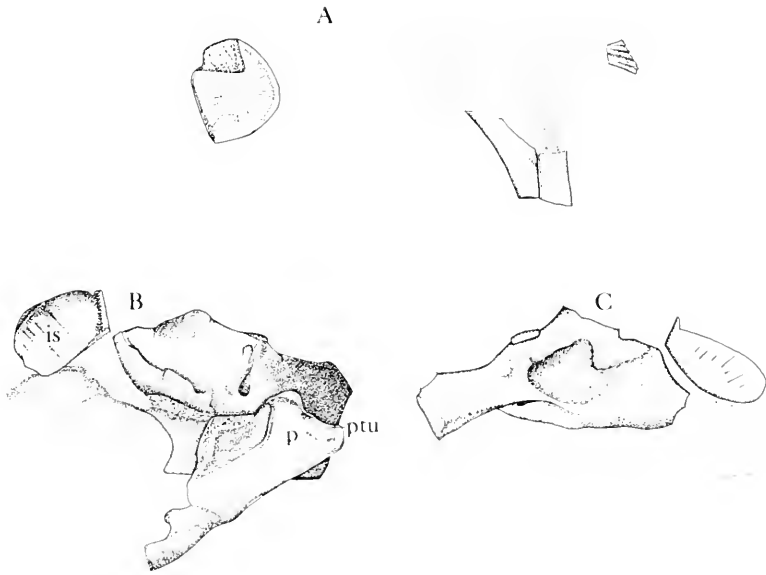

Figure 8. *Archæothyris florensis*. A, calcaneum, RM 10056, unidentified limb bone, fragmentary interclavicle; B, pelvic girdle material, MCZ 4080; C, lateral view of B. All $\times 1$. Abbreviations used in figure: is, ischium; p, pubis; ptu, pubic tubercle.

to the ones seen in the more primitive ophiacodonts. In sphenacodonts there is less constriction. Hence it is probable that only two sacral ribs were present in this animal and not three sacrals as in sphenacodonts, in which the iliac blade is greatly expanded. The articular surface of the acetabular cavity is similar in configuration to that of *Clepsydrops colletti* (Romer and Price, 1940: 127). It is only in the ventral rim of the acetabulum that the pelvis in block A differs from that of *Clepsydrops*. In *Archæothyris* the acetabular rim describes a semicircle, with the dorsal tip of the acetabulum being the center. In *Clepsydrops*, however, this lower rim is practically straight. On the whole, the acetabulum faces rather more dorsally than in the more advanced pelycosaur and in this it resembles that of *Clepsydrops*. The pubic and ischiadic parts of the acetabulum turn sharply outward close to the rim.

The dorsal margin of the pubis forms a thickened ridge that runs to the tip of this element and slants downward. This ridge

bears, close to the anterior limit, a prominent lateral pubic tubercle that provides attachment for the inguinal ligament and pubotibialis muscle. This tubercle tends to be of small size in the genus *Ophiacodon*. The tubercle in *Archæothyris* is comparable in size to those of *Clepsydrops colletti* and *Varanosaurus wichitaensis*. The anterior margin of the pubis is wider than in ophiacodonts in general and has a large area of unfinished bone at the end. The obturator foramen is situated on the blade-like ventral process of the pubis, immediately underneath the acetabulum.

The ischium is thickened immediately behind the acetabulum and forms a thinner, ridged upper margin posteriorly. This ridge overhangs the platelike region below it and, as it passes backwards, the upper margin of the ischium turns downward towards the symphysis.

The left humerus was found in the proximity of the skull. It is only 38 mm in length (approximately 40 percent of the length of the skull). The twist of the distal upon the

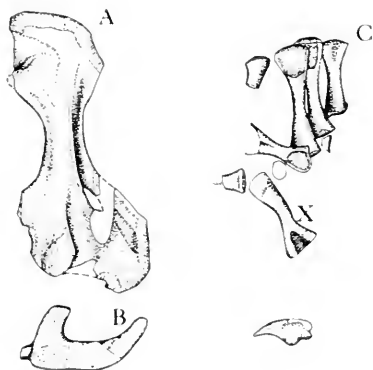

Figure 9. *Archaeothyris florens*. A, humerus in dorsal view, MCZ 4079; B, distal end of A; C, metacarpals, and claw, MCZ 4083; X, femur of a small romeriid. All $\times 1$.

proximal plane is about 65 degrees, a very primitive condition. In other pelycosaurs this angle ranges from about 35 to 60 degrees—the higher figures being found in ophiacodonts. In general proportions, this humerus resembles that of *Varanosaurus* and *Clepsydrops*, although it is smaller. Since the head is very little expanded, the articular surface occupies the entire extent of the proximal end of the humerus. There is little curvature seen on this articulating surface. The latissimus tubercle corresponds well in size to that seen in primitive ophiacodonts in general. The shaft of the humerus is short and very massive. The entepicondyle is little developed in comparison to that seen in Lower Permian ophiacodonts. The entepicondylar foramen is located within a deep groove that extends along the dorsal surface of the humerus to the proximal end. Such a groove is not seen in any other pelycosaurian humerus, with the possible exception of *Protolepsydrops*, in which there is a slight deepening close to the entepicondylar foramen. There is extensive rugosity on the entepicondyle indicating the area of attachment of the flexor musculature. The ectepicondyle slopes very sharply dorsally from the general distal surface. The angle between the ectepicondyle and the plane of the distal end is about 80 degrees. The

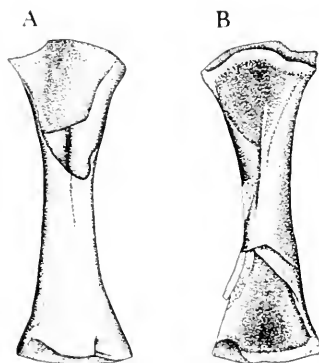

Figure 10. *Archaeothyris florens*, RM 10056. A, femur in dorsal view; B, ventral view of A. $\times 1$.

summit of this ridge is about 5 mm above the general dorsal surface. The anterior margin of the supinator process projects sharply from the general surface of the bone. The distal surface of this process is blunt and faces forward. It is at about the level of the entepicondylar foramen, as in all pelycosaurs, but well beneath the ectepicondyle and separated from it by a deep ectepicondylar groove. The ectepicondylar notch is relatively shallow. The radial articulation was broken off and only a small part of the ulnar articulating surface is seen.

In block D there is a femur that can be associated with this animal. This bone, 42 mm in length, seems to have belonged to an immature individual, since neither the proximal nor the distal head—so important in characterization—are well ossified. A rudimentary adductor crest is visible on the ventral side of the femur. Even in this immature state, this femur is longer than the humerus in block B. There are few features in this particular femur to compare with the femora in other pelycosaurs.

An almost complete calcaneum is found in the same fragment in block D as the interclavicle (RM 10056). This element is weakly ossified and the proximal end is crushed in such a manner that this region is shifted to the right. The area where the perforating foramina would be expected

is broken off. The bone is 12 mm in length and 10 mm wide. In general proportions this calcaneum resembles that found in *Varanosaurus*.

A set of metacarpals is found in block C. They probably belong to this genus. They are long slender structures, indicative of small size. The longest (probably the 4th) is 15 mm in length and the shortest one (1st) is 9.5 mm.

No other limb elements whose affinities with this genus are certain were found in the tree.

Discussion. On the basis of the material found in the four blocks of the tree, a partial reconstruction of the skeleton has been made (Fig. 2). *Archaeothyris* is a relatively small pelycosaur with a well-ossified skeleton. This degree of ossification and the nature of preservation suggests a terrestrial habitat. Members of the genus *Ophiacodon* are less well ossified and come from coal-swamp and deltaic deposits. It has been suggested by Romer and Price (1940) that *Ophiacodon* was an amphibious animal. The size of the skull and the nature of the teeth indicate that *Archaeothyris* had the capability to feed on larger invertebrates than did the romeriids, and it is also probable that it could have preyed on the smaller tetrapods.

Taxonomic position. On the basis of the known skeletal elements, *Archaeothyris* appears to be a very primitive pelycosaur, with characteristics that suggest a close relationship to the genus *Ophiacodon*. The similarities of *Archaeothyris* to the well known members of the Ophiacodontidae enable us to place this genus in the same family. It is sufficiently differentiated by certain primitive and specialized features, however, for it to be recognized as a distinct genus.

The following features in *Archaeothyris* are primitive: 1) The length of the prefrontal and maxilla indicate that the skull is less elongated than in *Ophiacodon*. The lower edge of the maxilla is straight, as in all romeriid captorhinomorphs (in the more advanced pelycosaurs there is a tendency

towards a curved maxilla). 2) The type of buttressing above the canines in *Archaeothyris* is seen in some romeriids, but is also retained among sphenacodonts. In later ophiacodonts, a more specialized type of buttressing is present. 3) The stapes is very similar to those seen in the romeriids *Paleothyris* and *Hylonomus* in the relative position of the dorsal process. In other pelycosaurs the articulating surface of the dorsal process is at 45 degrees to the articulating surface of the footplate, whereas in *Archaeothyris* and romeriids the angle between the two articulating surfaces is about 90 degrees. 4) The nature of the centra, intercentra, transverse processes (with webbing), and high neural spines confirms the association of *Archaeothyris* to the most primitive members of the family Ophiacodontidae. The width of the neural spines (in mid-dorsals) is greater than in other ophiacodonts. Wide neural spines are directly associated with long centra, a very primitive feature in pelycosaurs. As in romeriids, the proximal caudal ribs are not fused in *Archaeothyris*; they are fused in later pelycosaurs. 5) The pelvic girdle is very similar to the type of pelvis seen in such primitive ophiacodonts as *Clepsydrops* and *Varanosaurus*. It has a pubic tubercle seen only in the most primitive ophiacodonts. 6) The humerus is like those of *Clepsydrops* and *Varanosaurus*, the most primitive ophiacodonts. *Ophiacodon* humeri tend to be more advanced in the size of their entepicondyle.

The following features in *Archaeothyris* are specialized: 1) The blade of the first sacral rib is not as wide as in the genus *Ophiacodon*. It is therefore suggested that the second sacral rib also came into contact with the iliac blade, whereas in *Ophiacodon* the second sacral rib only supports the first one. 2) The humerus has a very stout supinator process and a deep groove on the dorsal surface running from the entepicondylar foramen to the proximal head. 3) The canines on the maxilla are very well developed and there are only three precanine teeth.

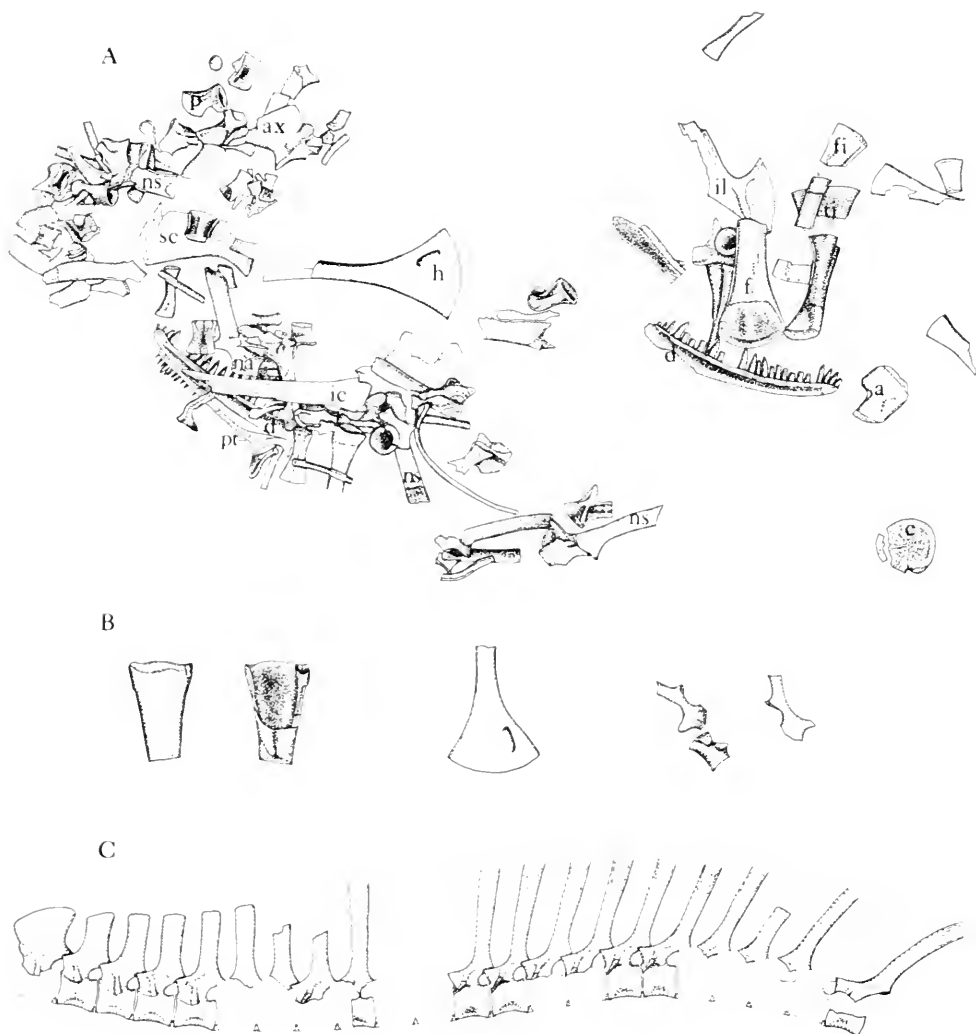

Figure 11. Type of *Echinerpeton intermedium*, MCZ 4090. A, partial skeleton; B, other skeletal elements belonging to the type specimen, dorsal and ventral view of femur, humerus, and two proximal caudal vertebrae; C, partial reconstruction. $\times 1$. Abbreviations used in the figure: o, ostagolus; ax, axis neural arch; d, dentary; f, femur; fi, fibula; h, humerus; ic, interclavicle; il, ilium; na, neural arch; ns, neural spines; p, pleurocentrum; pt, pterygoid; sc, scapula; ti, tibia.

Genus *Echinerpeton* n. gen.

Type species. Echinerpeton intermedium new species.

Known distribution. Middle Pennsylvanian of eastern North America.

Diagnosis. Very small ophiacodont pel-

ycosaur, with very high neural spines. Ratio between height and width of mid-dorsal neural spine—7:1. Primitive axis vertebra. Neural arches not swollen. Webbing present on the transverse processes of the dorsal vertebrae. Primitive iliac blade.

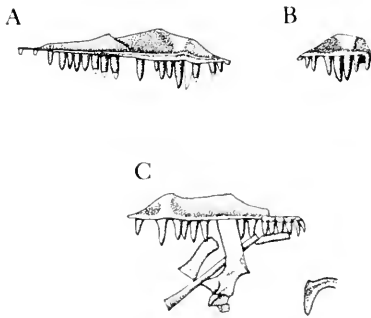

Figure 12. *Echinerpeton intermedium*. Maxillae: A, MCZ 4092; B, MCZ 4093; C, RM 10057 (also neural arch, fragmentary rib and phalanx). All $\times 1$.

Echinerpeton intermedium n. sp.

Etymology. Greek *echino*, spiny, plus *erpeton*, reptile. *Intermedium*, intermediate, in reference to the presence of numerous characteristics intermediate between those of typical ophiacodonts and sphenacodonts.

Holotype. Museum of Comparative Zoology, Harvard, MCZ 4090, block B.-1, partial skeleton, immature individual.

Paratypes. MCZ 4091, block A, almost complete interclavicle, vertebral material; MCZ 4092, block B.-22, a left maxilla, complete; MCZ 4093, block B.-22, a fragment of a right maxilla; MCZ 4094, block C.-12, fragments of three neural arches belonging to a more mature individual than MCZ 4090; RM 10057, block D, an almost complete right maxilla, a neural arch, rib, and a phalanx.

Horizon and locality. Morien Group, within 25 feet above the Lloyd Cove coal seam, equivalent to the late Westphalian D of Europe. Dominion Coal Co., strip mine No. 7, 2 miles north of Florence, Cape Breton County, Nova Scotia.

Diagnosis. Same as for genus.

Description. Much of the description is based on a single, somewhat scattered skeleton (MCZ 4090) (Fig. 11). Isolated material from five additional individuals can be questionably associated.

Skull. The only skull elements that can be associated with this genus are three

maxillae (Fig. 12) and two dentaries. A complete left maxilla (MCZ 4092), and a fragmentary right maxilla (MCZ 4093) are found in block B.-22. In block D, an almost complete right maxilla (RM 10057) was found lying close to the neural arch, a rib, and a phalanx.

The complete maxilla (block B.-22) is 28 mm long and reaches a maximum height of only 3.5 mm behind the canines. The ventral surface of the maxilla is straight, as in romeriid captorhinomorphs and primitive pelycosaur (*Archaeothyris*, *Varanops*, and *Haptodus*). In most ophiacodonts and sphenacodonts, the lower edge of the maxilla is curved. Above the "canines" the maxilla is curved. On the inside surface, has the type of buttressing seen in *Archaeothyris*, sphenacodonts, and some romeriids. The teeth are simple conical structures and are slightly serrated towards the tip. The "canines" are not strongly differentiated, being only slightly longer than the teeth next to them. There are three teeth anterior to the "canines" on the complete maxilla and on the fragmentary maxilla from the same block, but only one on the maxilla from block D. Here, the other two teeth were probably lost after death.

Both dentaries are preserved in block B.-1 (Fig. 11), the right one being partially buried under other bones, while the left one is completely exposed. It is gently curved and bears 23 teeth. The posterior-most margin is missing; it is probable that a total of 25 teeth was originally present on this element. The extent of the outside surface of the dentary indicates that the lower jaw was quite narrow. The teeth are implanted on a ridge that extends medially from the upper side of the dentary. The variation of tooth length in the dentary complements that of the maxilla. This type of variation in the tooth length is very similar to that seen in primitive romeriids. The anterior three teeth are not perpendicular to the upper edge of the dentary but point slightly forward. In some advanced pelycosaur (*Sphenacodon ferocior*, *Dimetrodon milleri*, *Dimetrodon limbatus*), a simi-

lar situation exists but the anterior teeth are larger than those behind them, while in *Echinerpeton* these teeth are not strongly differentiated. At the posterior end of the dentary, the teeth are very small.

Axial skeleton. The incomplete nature and disarticulation of the type specimen, MCZ 4090, makes determination of the exact number of presacral vertebrae impossible. Partial reconstruction of the skeleton has been attempted, however (Fig. 11). On the basis of this reconstruction there must have been at least 23 presacral vertebrae. Since the typical number of presacrals in the great majority of pelycosaurs is 27, it is probable that at least four are missing in this specimen. The vertebrae in the anterior portion of the column are found in close association with each other but are not articulated, and the centra have separated from their neural arches. The mid-dorsal and anterior dorsal vertebrae are found scattered all over the block. There is also some vertebral material of a very similar nature in blocks C and D.

The centra are not elongated. In the cervical and anterior dorsal regions they are 5 mm long and 4 mm high at the posterior rim. The centra in the mid-dorsal and posterior dorsal vertebrae are about equal in length and height. In the primitive romeriid *Hylonomus* and in *Archaeothyris*, the centra are more elongated. In later ophiacodonts, however, the centra tend to be compressed; this shortening of the centrum is most strongly marked in *Ophiacodon retroversus*. The keel development, more prominent in the anterior region of the column, never reaches the levels found in advanced sphenacodonts in which prominent ventral keels are present and the centra have strongly excavated lateral margins.

In *Echinerpeton* the ventral lip of the centra is not strongly bevelled for the reception of the intercentra, indicating that there were wide intercentral spaces. Dorsally, the wedges into which the neural arch pedicels fit are conspicuous and extend along two-thirds of the length of the centrum.

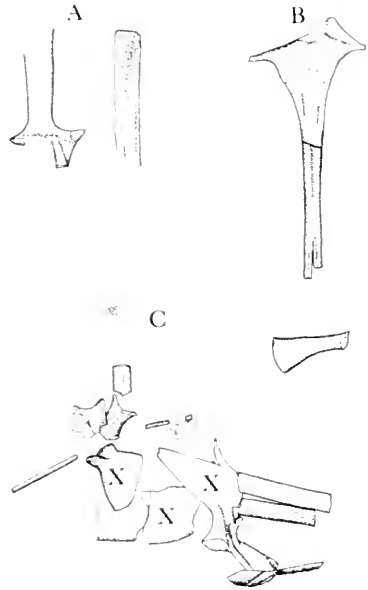

Figure 13. *Echinerpeton intermedium*. A, two fragmentary neural arches, MCZ 4094; B, interclavicle, MCZ 4091; C, three presacral vertebral elements; X, skeletal elements belonging to a small romeriid, MCZ 4091. All $\times 1$.

No intercentra were found in the deposits that could possibly be identified as belonging to this genus.

The neural arches do not show the type of excavation at the base of the spines seen in the more advanced sphenacodonts (Fig. 13). The zygapophyses do not have strongly tilted articular surfaces, nor are they as close to the midline as in typical sphenacodonts. In mid-dorsals, the angle of the zygapophyses is estimated to be about 35 degrees. In most ophiacodonts the angle is approximately 30 degrees, while in most sphenacodonts it is about 45 degrees.

The transverse processes are relatively high on the anterior portion of the neural arch. In the cervicals they tend to point strongly downward, so that they appear as lateral bulges on the neural arch. From the anterior dorsal region to the 23rd presacral, all the transverse processes extend far laterally, and tip gently downward. Their tubercular facets are shaped in a fashion similar to that seen in ophiacodonts.

showing a small amount of "webbing" that extends anteriorly and ventrally from the main head of the articular surface. In the caudal region (Fig. 11), the articular surface for the rib is on the centrum; the neural arch bears no transverse process.

There is no vertebral material from the posterior trunk or sacral regions and little from the caudal.

The axis neural spine is a strongly developed structure that extends far anteriorly and posteriorly. The spine reaches its highest point at its posterior end, as in many sphenacodonts, and it is broadest along its dorsal margin, as in ophiacodonts and some romeriid captorhinomorphs. In sphenacodonts the greatest lateral expansion is reached well before the dorsal end of the spine. The condition seen in *Echinerpeton* is probably more primitive than that seen in pelycosaurs in general.

The most striking feature in this animal is the length of the neural spines in the trunk region. Along the known parts of the column they vary considerably, and reach proportions comparable to those seen in *Sphenacodon*. The neural spines reach their greatest length around the 15th presacral vertebra, at which point they also increase in width towards the top.

The dorsal portion of the neural spine is very thin in cross section and is strongly fluted. The spines do not have a definite dorsal ending but become so thin at the top that it becomes difficult to establish whether they are broken or not. A neural spine from block C (Fig. 13) is larger than the ones in block B; here the dorsal tip of this spine ends definitely, indicating a higher level of ossification. This spine also becomes very thin towards the tip, however. On the basis of the relatively smaller size and lower degree of ossification, it is probable that the animal in block B.-1 is an immature individual. It is, therefore, expected that in mature individuals the neural spines of the dorsals would be even taller than those seen in the type specimen.

As shown by the anterior caudals found in block B.-1 (MCZ 4090), the neural spines

in the caudal region lose height quite rapidly. The spines of the two vertebrae are already short and lateral, and transverse spread has also decreased markedly.

Numerous ribs are found scattered in block B.-1 (Fig. 11), and a fragment of a rib is found in block D (Fig. 12). The tubercular and capitular heads are connected by a thin sheet of bone that corresponds to the webbing seen on the transverse processes. This type of webbing is seen only in ophiacodonts and never in Permian sphenacodonts. In typical ophiacodonts the mid-dorsal ribs have extensive webbing. In this animal the webbing is not strongly developed because the ventral edge of the rib comes close to the centrum and only then turns down towards the intercentrum. The capitulum extends far ventrally to reach the small intercentrum. A complete mid-dorsal rib, found in block B.-1, indicates that the body of the animal was high and narrow.

Appendicular skeleton. Of the shoulder girdle, only the interclavicle and the scapula are known. The head of the interclavicle from block A (Fig. 13) is 15 mm wide; the shaft is 30 mm long and its width varies greatly along its length. These general proportions fit well with those found in pelycosaurs in general. Romeriids have relatively wider heads. Anteriorly, the shaft is 9 mm in width but diminishes gradually to 2.5 mm midway in its length. It is two-pronged at the end. In ophiacodonts, the shaft does not vary so greatly in width; in sphenacodonts, the shaft is somewhat similar to that of *Echinerpeton*, but there is no definite point where the head ends and the shaft begins. A fragmentary scapula is found in block B.-1 (Fig. 11). Exposed in medial view, the width of the blade at the dorsal end is 9 mm and the dorsoventral height of the bone is 16 mm. These proportions are intermediate between those of typical ophiacodonts and sphenacodonts.

The distal part of both humeri are present in the type specimen (Fig. 11). The fragment of the right humerus is 26 mm long, while the left one is 16 mm long. The

distal ends of both humeri are 12 mm wide. The bones are weakly ossified and almost featureless, as are the humeri of the immature sphenacodont *Haptodus* (Gaudry, 1886). The distal head is essentially a triangular structure with an arc for the base. The typical pelycosaurian structures present on more mature humeri are not visible here. There is no ectepicondyle or supinator process and the entepicondyle does not have the shape comparable to that in mature pelycosaurs. Only a very simple entepicondylar foramen is present, its lower margin being only 2 mm from the end of the bone. The shaft is long, slender, and almost round in section. The part of the proximal head visible on the right humerus indicates that the bone was strongly twisted. It is estimated that the complete humerus in the type specimen was 25 mm in length.

Of the pelvic girdle only the ilium is present (Fig. 11). It is very primitive. The iliac blade is narrow and points posteriorly, as in ophiacodonts and romeriids in general. In sphenacodonts the blade is strongly expanded anteriorly to receive the three sacral ribs. The area that might have shown a trough for the dorsal musculature is not preserved.

The heads of both femora are present in the type specimen (Fig. 11). These fragments are about the same size and are immature and primitive. A simple adductor crest is present on the shaft. The tibia, lying close to the fibula and the femur, is not complete, but shows that it has a broad proximal end (9 mm wide), a narrow shaft, and a relatively small distal end (4 mm wide). The bone is 20 mm long. The fibula is also incomplete, but shows the same elongation as the tibia and has well-developed distal and proximal heads. The astragalus is an essentially L-shaped structure as in typical ophiacodonts. The surface of the astragalus that connects to the calcaneum shows the beginnings of a foramen towards its distal end. The calcaneum, also found in the type specimen, is poorly ossified. It is an almost round disc, but shows the corresponding margin of the foramen

on its connecting surface with the astragalus.

Four of the metatarsals are also found in block B.-1. They are long elements when compared to the rest of the skeleton, but this is typical of small primitive reptiles. In romeriids of similar size, the hands and feet are large and the metatarsals as well as the phalanges tend to be elongate.

Some other distal limb elements are also found in block B.-1 and in other blocks. The association of these elements with the genus *Echinerpeton* is not certain, however.

Discussion. On the basis of the immature type specimen (MCZ 4090), a partial reconstruction has been made (Fig. 11). This reconstruction shows that *Echinerpeton* is a small reptile with very high neural spines. The more mature specimens are up to 50 percent bigger than the type. From the dentition and size, it is probable that *Echinerpeton* (at least in its immature state) fed on small invertebrates, such as the millipedes found in the same tree.

The affinities of this pelycosaur are harder to establish than those of the ophiacodont pelycosaur described above. This is because the most complete specimen is very immature, many of the most diagnostic portions of the skeleton are not known, and because the animal is so primitive that it is difficult to establish which features are simply primitive and which can be used to establish its affinities.

The following features in *Echinerpeton* indicate its primitive nature: 1) The lower edge of the maxilla is straight, as in *Archaeothyris*, *Haptodus*, and *Varanops*. The butressing above the canines is similar to that seen in *Archaeothyris* and some romeriids (in sphenacodonts this primitive feature is retained). The teeth are simple conical structures, canines are not very strongly differentiated (sphenacodonts have greatly differentiated canines). 2) The centra are simple structures; the bevelling for receiving the intercentra is not strongly developed. 3) The transverse processes on the cervical vertebrae are similar to those seen in some romeriid captorhinomorphs. 4) The

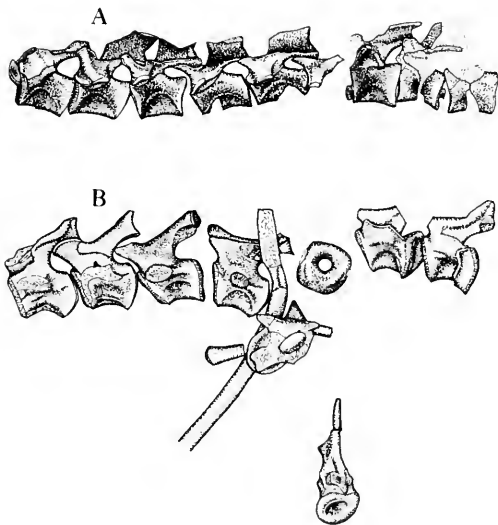

Figure 14. Unnamed pelycosaurs. A, 9 presacral vertebrae, MCZ 4088; B, 9 proximal caudal vertebrae, fragmentary rib and phalanx, MCZ 4095. All $\times 1$.

iliac blade is extremely primitive in nature, rather similar to those found in romeriids. It is probable that there were only two sacral ribs, as in some romeriids and all ophiacodonts.

The following features of *Echinerpeton* show its affinities to ophiacodonts: 1) In the trunk region the transverse processes have the type of webbing seen only in ophiacodonts. The neural spines do not have the type of excavation at the base as that seen in sphenacodonts. 2) The centra are slightly compressed anteroposteriorly, a tendency followed in ophiacodonts. 3) The zygapophyses are only moderately tilted. 4) The astragalus and calcaneum are similar to those seen in primitive ophiacodonts.

The following features in *Echinerpeton* suggest affinities with sphenacodonts: 1) The neural spines are very high, narrow, bladelike structures. Similarly high neural spines are found in some primitive sphenacodonts, e.g., *Sphenacodon*. There is, however, no reason to believe that only sphenacodonts and edaphosaurs developed high neural spines. 2) The nature of the axis neural spine is somewhat similar to that in

sphenacodonts in that its highest point is reached at its posterior end. On the other hand, the spine is similar to those in ophiacodonts in that it is broadest along its dorsal margin.

This particular pelycosaur shows the close relationship between primitive ophiacodonts and sphenacodonts. There is actually little in the features of this animal that prevents it from being close to the ancestry of sphenacodonts.

OTHER PELYCOSAURIAN MATERIAL FROM FLORENCE, NOVA SCOTIA

Other material, of a generally pelycosaurian nature, is present in tree No. 3, but cannot be associated with the previous two genera. These specimens are too incomplete to be given generic names. They are worth describing, however, because they show the extent of radiation pelycosaurs had undergone by the Middle Pennsylvanian.

I. An articulated series of nine anterior dorsal vertebrae, including three intercentra (Fig. 14), is preserved in block B (MCZ 4088). The centra are about 6 mm long on their ventral side and 5 mm high at the posterior rim. They are strongly keeled. The ventral region of the keel is very thin in cross section, although still rounded at the margin. In comparably developed sphenacodonts, the keel has a sharp ventral margin. In side view, the ventral margin of the keel shows little concavity, whereas in other pelycosaurs the concavity tends to be greater. The centrum is strongly concave in cross section, a feature seen only in strongly keeled forms. Here we have a very specialized type of ventral strengthening of the centrum. It is questionable whether the nature of the ventral ridge is diagnostic in such early forms as described in this paper. The use of this particular feature (see Romer and Price, 1940: Fig. 17) in separating the three pelycosaur suborders is justifiable only when these three major lineages have become fully differentiated in the Lower Permian.

The ends of the centra are formed in such a manner that there are large intercentral spaces ventrally. Dorsally the anterior and posterior ends of the centra touch. This type of bevelling for the intercentra is probably very primitive, and is seen in some very primitive romeriids (Carroll, 1970: fig. 8f). The intercentra are well developed, but do not show the lateral facets where the capitulum would be expected to articulate. The nature of the intercentral spaces suggests that the intercentra had cartilaginous dorsal extensions.

The transverse processes have the type of webbing seen in typical ophiacodonts; however, it does not extend as far ventrally as in other members of the family. Dorsally, the articulating surface of the transverse process is not as rounded in section as in other ophiacodonts. The zygapophyses, which extend far beyond the anterior and posterior margins of the centrum, are moderately tilted. The angle of this tilt is estimated to be more than 35 degrees, a condition seen in sphenacodonts. The zygapophyses are close to the midline. The neural spines are different from the type usually seen in pelycosaurs. They are only 5 mm high, yet are extremely wide. At the base they are 6.5 mm wide; dorsally they constrict to 5.5 mm and then expand again to become as wide at the top as they are at the base.

Although the specimen shows some primitive as well as ophiacodont and sphenacodont characters, the determination of its exact taxonomic position among pelycosaurs has to await the discovery of more complete specimens.

II. Eight caudal vertebrae (Fig. 14) are found in block B (MCZ 4095). The centra are massive structures solidly fused to the neural arches. The anterior and posterior articulating surfaces of the centra are strongly developed and on the ventral region there is marked bevelling to accommodate the intercentra.

The neural arches are not swollen, but are stoutly built. The transverse processes are broken off on the first two vertebrae, but

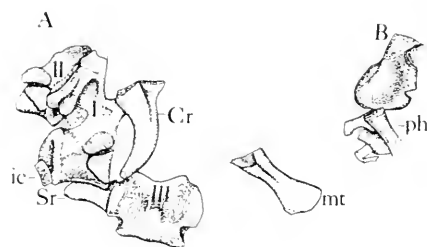

Figure 15. Unnamed sphenacodont pelycosaur. A, three sacral vertebrae and a caudal rib, MCZ 4096; B, astragalus and other distal limb elements, MCZ 4097. $\times 1$. Abbreviations used in the figure: ic, intercentrum; mt, metatarsal; ph, phalanx; Cr, caudal rib; Sr, sacral rib; I—1st sacral vertebra, II—2nd sacral vertebra, III—3rd sacral vertebra.

the broken surfaces indicate that both the capitular and tubercular heads of the ribs were attached to the centrum. The transverse process on the 3rd vertebra is intact, but has only one articulating surface—the diapophysis. This articulating surface indicates that the caudal ribs are not fused to the transverse process. The articulating surfaces are smaller on the 4th and 5th vertebrae and are completely lost by the 6th.

Here there is only a very slight swelling where the transverse process would have been.

The anterior and posterior zygapophyses extend far beyond the rims of the centra. The angle between the articulating surface of the zygapophyses is slight—about 30 degrees (in ophiacodonts the tilt in the caudal region is greater). The neural spines are very small and occupy the extreme posterior region of the neural arch. The spine in the isolated caudal is 5 mm long and only 1 mm in diameter. The affinities of this string of caudals are difficult to assess.

III. Three closely associated sacral vertebrae and a caudal rib are found in block C (MCZ 4096) (Fig. 15). Among pelycosaurs, only advanced sphenacodonts have three sacrals. They are stoutly built and have different proportions than the vertebrae in *Archaeothyris*. The centra are 8 mm long and 8 mm high at the posterior rim. There is no keel. In the ventral region of the central rims there is bevelling to accom-

modate the intercentra, but there is no "lip" formation as seen in advanced ophiacodonts. There is no bevelling of this type in the primitive ophiacodonts from this locality.

The diapophyses, which are huge in all three vertebrae, extend onto the centra. They are developed to a greater extent than in *Archaeothyris*, being 5 mm long and up to 3 mm in height. There are slight differences in the shape of these articulating surfaces from centrum to centrum. The presence of these surfaces indicates that the ribs did not fuse to the transverse process, as is the case in advanced sphenacodonts. The parapophyses are located on the centrum directly underneath the diapophyses. They are essentially triangular in shape and are separated from the diapophyses by a small groove. The parapophysis on the 3rd sacral is not as strongly developed as in the 1st and 2nd ones; it is only 2 mm long and 3 mm tall. The parapophyses on the other sacrals are 4 mm long and 5 mm tall. They are all located close to the anterior rim of the centrum.

The neural arches on the 2nd and 3rd sacral vertebrae are broken off, but there is an almost complete neural arch on the first sacral. It is typically sphenacodont in nature, being strongly excavated above the transverse process. The zygapophyses are well developed, but only the anterior ones extend well beyond the anterior margin of the centrum. The posterior ones extend only to the level of the central rim, as in *Dimetrodon* (Romer and Price, 1940, plate 25). In *Ophiacodon*, the anterior and posterior zygapophyses extend well beyond the respective central rims (Romer and Price, 1940, text-fig. 45). The articulating surfaces of the zygapophyses are strongly tilted (40 degrees) and are close to the midline. The angle of this tilt is close to that seen in the sacral region of *Dimetrodon limbatus*. Although the top of the neural spine is missing, it can be seen that the spine is not bladelike in nature as in ophiacodonts, but diminishes in width towards the top.

The 3rd sacral vertebra has preserved in position its left rib, which is only 8 mm long. The body of the rib is bladelike in nature and is slightly cupped on the dorsal surface. The distal end of the rib has an unfinished area 5 mm long and 1.5 mm wide that probably provided attachment to the 2nd sacral rib. The manner of attachment is similar to that of the two sacral ribs in *Ophiacodon retroversus* (Romer and Price, 1940, text-fig. 45). This type of attachment is more primitive than the one seen in *Dimetrodon*, where all three ribs make contact with the iliac blade. In the specimen under discussion, the third rib does not make contact with the iliac blade; it only supports the other two sacral ribs.

The caudal rib lying close to the three vertebrae is short and curves posteriorly, as in all pelycosaur. The presence of articulating surfaces on the tuberculum and capitulum indicates that this rib was not fused to the transverse process.

The structural differences between these sacrals and the vertebrae of *Echinerpeton* are too great for them to belong to a mature specimen of that genus.

There is in block C an astragalus (MCZ 4097) that also may be a sphenacodont. It is fairly well ossified, 10 mm long and 8 mm wide at the distal end. In spite of this great distal width, the astragalus is not L-shaped as in ophiacodonts and in *Varanops*. It is somewhat intermediate between the condition in the above genera and the condition in *Dimetrodon* (Romer and Price, 1940, text-fig. 41).

Protoclepsydrops haplous

A possible pelycosaur from the Westphalian B of Joggins, Nova Scotia, has been described by Carroll (1964: 79-82). *Protoclepsydrops* (Fig. 16) was assigned to the Order Pelycosauria on the basis of the configuration of the humerus. The other skeletal elements in the type, RM 3166, were not particularly indicative of pelycosaurian affinities. They are extremely small, poorly defined, and badly preserved. The humerus

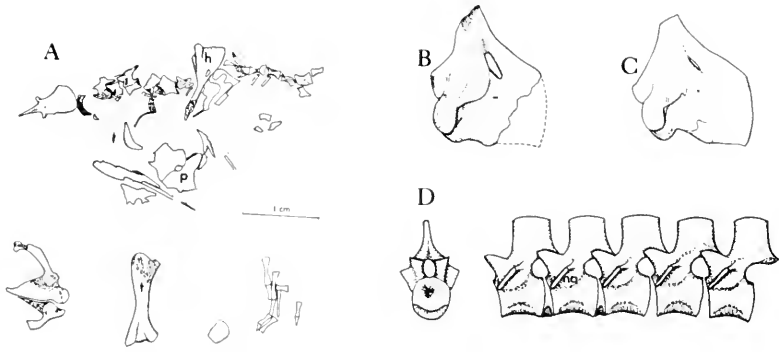

Figure 16. *Protoclepsydrops haplous*. A, type specimen, RM 3166 (Carroll, 1964; text-fig. 13). B, distal end of the humerus, DMSW B.239; C, distal end of humerus, BM(NH) R.5778 (Carroll, 1964; text-fig. 14); D, anterior and lateral view of presacral vertebrae, RM 12202. All $\times 1$. Abbreviations used in the figure: h, humerus; f, femur; na, neural arch; p, parietal.

in the type specimen has a prominent supinator process, distinguishing it from most captorhinomorph humeri. Two other humeri with supinator processes were associated with the genus, although they were of much larger size. Subsequently, a romeriid captorhinomorph, *Paleothyris*, from the Westphalian D of Florence, Nova Scotia, was described by Carroll (1969) as having a well developed supinator process, and the humerus as a whole was very similar to that in the immature type specimen of *Protoclepsydrops*. The supinator process in *Paleothyris* and in the type specimen of *Protoclepsydrops* is located very close to the distal articulating surface of the humerus, whereas in all well known pelycosaurs the supinator process is located much higher up the distal head of the humerus, close to the level of the entepicondylar foramen. Considered by itself, there is little to justify the inclusion of the type specimen of *Protoclepsydrops haplous* in the Order Pelycosauria.

The two larger humeri designated as paratypes of *Protoclepsydrops haplous* are more pelycosaurian in nature. They are very similar to the humerus in *Archaeothyris* in the nature and relationship of the entepicondyle and ectepicondyle. More significantly, the supinator process on the humerus of DMSW B.239 is stoutly built and

is in a position comparable to that in *Archaeothyris*. On the other hand, the supinator process of the humerus of BM(NH) R.5778 is in an intermediate position between that seen in the type specimen of *Protoclepsydrops* and that seen in *Archaeothyris*. This humerus is considered less mature than DMSW B.239 because the entepicondylar foramen is smaller and the supinator process is not as stout. It is highly probable that these three specimens represent growth stages in a single species.

In the Redpath Museum collection there are six anterior trunk vertebrae (RM 12202) whose size fits well with that of the large humeri of *Protoclepsydrops haplous*. They (Fig. 16) are well ossified, with the centra and neural arches fused, but with the line of attachment indicated by a rugose ridge running below the transverse process. In the more advanced pelycosaurs and in most romeriids, the anterior and posterior articulating rims of the vertebrae are part of the centrum. In these vertebrae, however, as in *Archaeothyris*, the upper region of the anterior rim is part of the neural arch. Such a condition is apparently very primitive, reflecting the condition noted in *Gephyrostegus* (Carroll, 1970).

The centra are 5 mm long in the ventral region and 4 mm high at the posterior rim. There is no keel. The only known inter-

centrum is well developed; it is 1.5 mm long. In order to accommodate the intercentrum, the centrum is about 1.5 mm shorter at the bottom than it is at the top. This type of bevelling is extremely primitive, but is also seen in some of the pelycosaurs from Florence, Nova Scotia.

The neural arches are not swollen. The transverse processes are strongly developed, extending far laterally and slightly downward as in the anterior dorsals of the most primitive ophiacodont pelycosaur *Archaeothyris*. The articulating surface of the transverse process is straight and extends anteroventrally. The width of the articulating surface remains constant, forming a long, fairly thin facet for the articulation with the tuberculum of the rib. This type of articulating surface is directly antecedent to the type seen in the primitive ophiacodonts.

The zygapophyses extend beyond the lateral limits of the centrum and the surfaces are tilted at only about 20 degrees (this angle is less than in any other primitive pelycosaur). The neural spine is well developed; it is 5.5 mm tall and 4.5 mm wide at the base. This width in relation to the length of the centrum is comparable to that seen in *Archaeothyris*; in romeriids the spines tend not to be so wide.

The extremely primitive nature of *Protoclepsydraps haplous* prevents the determination of its exact taxonomic position within the Pelycosauria. The nature of the humerus and of the transverse processes on the newly described vertebrae indicates possible association of this genus with the Suborder Ophiacodontia (see Fig. 17).

INTERRELATIONSHIPS OF PRIMITIVE PELYCOSAURIA

The discovery of this new material requires reconsideration of interrelationships of primitive pelycosaurs. The pelycosaurs found in the early to middle Pennsylvanian deposits of Joggins and Florence, Nova Scotia, confirm the idea that there was extensive radiation of this order long before the appearance of the well-known Autunian

genera. This radiation seems to have encompassed not only the swamps and lowlands, but also the upland regions.

The ophiacodonts and sphenacodonts from Florence represent the earliest pelycosaurs whose taxonomic position can be established. These genera show that the families of Ophiacodontidae and Sphenacodontidae were already distinct at this time. Although no edaphosaurs were found in the trees from Florence, it is expected that this pelycosaurian lineage had also differentiated by the middle Pennsylvanian. The genus *Archaeothyris* is a fairly typical member of the family Ophiacodontidae. There are actually no features in this genus that would prevent it from giving rise to the genus *Ophiacodon*. Although it is the most primitive member of the Ophiacodontidae, it is already too specialized to have been ancestral to any of the other pelycosaurian lineages present in the Lower Permian. Labeling of the Suborder Ophiacodontia as "primitive" is unacceptable in light of the specialized characteristics seen in all known genera. The configuration of the atlas-axis complex and the nature of the transverse processes prevent even its earliest known members from being ancestral to the sphenacodonts or the edaphosaurs. The type of diapophyses seen in ophiacodonts, sphenacodonts, and edaphosaurs can be derived from the type seen in primitive romeriids (see Fig. 17). The type of diapophyses in sphenacodonts and edaphosaurs cannot, however, be easily derived from those seen in even the earliest ophiacodont.

The specialized nature of these structures in the earliest known ophiacodonts raises the possibility of separate derivation of the major lineages of pelycosaurs from the romeriids. The question is whether only a single romeriid species that had developed a temporal opening gave rise to all pelycosaurs, or whether the different lineages of pelycosaurs developed from different romeriid species. The second alternative implies that the pelycosaurian temporal opening developed several times. Although the conservative nature of the temporal opening

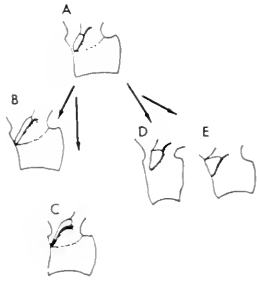

Figure 17. Evolution of the transverse processes in pelycosaurs. A, the primitive romeriid pattern, based on MB 1901.1379 (Carroll, 1970; Text-fig. 8); B, *Protoclepsydrops haplous*, RM 12202; C, pattern seen in ophiacodonts, based on *Archaeothyris florensensis*, MCZ 4079; D, the sphenacodont pattern, based on MCZ 1347 (Romer and Price, 1940, plates 24 E); E, the edaphosaur pattern, based on MCZ 1531 (Romer and Price, 1940, plate 36C).

in all pelycosaurs suggests that it was developed only once, it will require a considerable increase in the knowledge of Pennsylvanian pelycosaurs to confirm or deny the monophyly of the group. In any case, the possibility of polyphyly of the Pelycosauria within the Romeriidae does not pose any significant phylogenetic problem, because the possible ancestors were closely related and formed only a single adaptive assemblage. Comparison of early ophiacodonts and sphenacodonts shows great similarities between the two groups. *Echinerpeton* is somewhat intermediate between the two suborders.

The usually accepted taxonomic position of the genus *Varanosaurus* may be questioned on the basis of its vertebral structure. Romer and Price (1940: 216-222) suggested that *Varanosaurus* is a very primitive ophiacodont pelycosaur. The type of neural arch seen in this genus, however, is not present in any other pelycosaur or any romeriid. This suggests that *Varanosaurus* is not primitive but specialized. There is considerable increase in size from early romeriids. *Varanosaurus* solved the problems involved in strengthening the vertebral column to support more weight in a different way from other pelycosaurs, and also developed a different type of movement

within the vertebral column. In all other pelycosaurs the zygapophyses are tilted so that forces acting perpendicular to the zygopophyseal surfaces meet in the neural spine. The neural spines are strongly developed to provide support. Limited movement between the vertebrae can occur in all directions. In *Varanosaurus*, however, the zygapophyses are not tilted, and the forces acting on these surfaces are oriented vertically. Therefore, a large amount of bone is necessary directly above the zygapophyses in order to resist this force. The extra amount of bone gives the swollen appearance to the neural arches. The angle of the zygapophyseal surfaces in *Varanosaurus* greatly limits the axial rotation of the vertebral column, but enhances the amount of lateral undulatory movement.

The configuration of the vertebrae indicates that *Varanosaurus* must have separated very early from the main line of pelycosaurian evolution. The type of neural arch seen in *Varanosaurus* also developed independently in the Lower Permian captorhinids, limnoscelids, diadectids, and seymouriamorphs in response to increase in size.

THE ORIGIN OF PELYCOSAURS

On the basis of the known Lower Permian pelycosaurs and cotylosaurs, Romer and Price (1940: 178) supported Watson's suggestion that the captorhinomorphs were ancestral to the pelycosaurs. They noticed the great similarities between pelycosaurs and two small romeriid captorhinomorphs, *Romeria* and *Protorothyris* (Price, 1937). On the basis of our present knowledge of the early romeriids and of the Westphalian pelycosaurs described in this paper, a more exact relationship between these two groups can be established.

The family Romeriidae, thought to be ancestral to most, if not all, advanced reptilian groups, is represented in the Pennsylvanian by the following genera: *Hylonomus* and *Archerpeton* (Carroll, 1964), from the Westphalian B of Joggins, Nova Scotia;

Cephalerpeton (Gregory, 1950), from the Westphalian C of Mazon Creek, Illinois; *Paleothyris* (Carroll, 1969), from the Westphalian D of Florence, Nova Scotia; and three others of about the same age, from Nýřany, Czechoslovakia, and Linton, Ohio (Carroll, 1972). The morphological differences between Pennsylvanian romeriids are slight. They are all small, well-ossified reptiles with similar body proportions and dental patterns. These features suggest that they all fed on small invertebrates and were terrestrial in habit.

Although the pelycosaurs are thought to have arisen well before the formation of the Joggins deposits (probably in pre-Westphalian time), it is worth while to compare the earliest romeriid, *Hylonomus*, with the earliest known ophiacodont pelycosaur, *Archaeothyris*. The morphological similarities between these genera are so great that their common ancestry among earlier romeriids is unquestionable. The suggestion that pelycosaurs evolved from anthracosaurs, independent of captorhinomorphs (Hotton, 1970), is not supported by the evidence.

The differences between the earliest romeriids and the primitive pelycosaurs are related to the development of the temporal opening and the subsequent pelycosaurian radiation into different adaptive zones. The classical explanation for fenestration offered by Gregory and Adams (1915) and Case (1924) is based on the premise that open spaces in the skull permit bulging of the closing jaw musculature. This explanation did not, however, take into consideration the adaptive value of fenestration before it reached the size to function in this manner. In a more comprehensive study of the problems involved in fenestration, Frazzetta (1968) proposed that thickened and thinned areas of the skull were produced by the patterns of muscular stress. Selection may have achieved areas of stress sufficiently reduced at the junction of the bones of the cheek region that these elements failed to meet, thus giving rise to the initial stage of

fenestration. Moreover, he suggested that the potentially more secure areas of muscle attachment afforded by the rim of an opening may have been of direct adaptive significance (Frazzetta, 1968: 156).

The development of a temporal opening in pelycosaurs may be correlated with the increase in body size that is observed in this group. The length of the humerus in romeriids and pelycosaurs provides a good indication of the size of the respective genera (Fig. 18). Pelycosaurs between the Westphalian B and the Upper Stephanian show exponential increase in size.

Romeriids, however, retain essentially the same body size from the Lower Pennsylvanian into the Lower Permian.

The following changes are observed as pelycosaurs increase in size:

1. There is considerable change in the skull to trunk ratio. As primitive pelycosaurs increase in snout-vent length from 20 to 120 cm, the skull to trunk ratio increases from 34 to 64 percent (Fig. 19). The increase in the ratio of skull to trunk length with greater size is related to the fact that the body volume increases in proportion to the third power of linear dimensions, whereas the mouth area increases only to the square. The jaw mechanics and method of feeding are apparently very similar in primitive pelycosaurs and their direct ancestors, the romeriids. With increase in body bulk, a proportionately greater area of jaw surface is necessary in order that the larger animal may obtain an equivalent amount of food. In specialized sphenacodonts and edaphosaurs the mechanism of feeding is so different from that seen in primitive pelycosaurs and romeriids that the criteria used in comparing the earlier forms do not apply.

2. In order to have a greater area of jaw surface, the skull of pelycosaurs not only becomes larger, but the antorbital region of the skull becomes relatively longer. In romeriids, the antorbital region is about equal in length to the postorbital. In *Archaeothyris*, on the other hand, the ratio be-

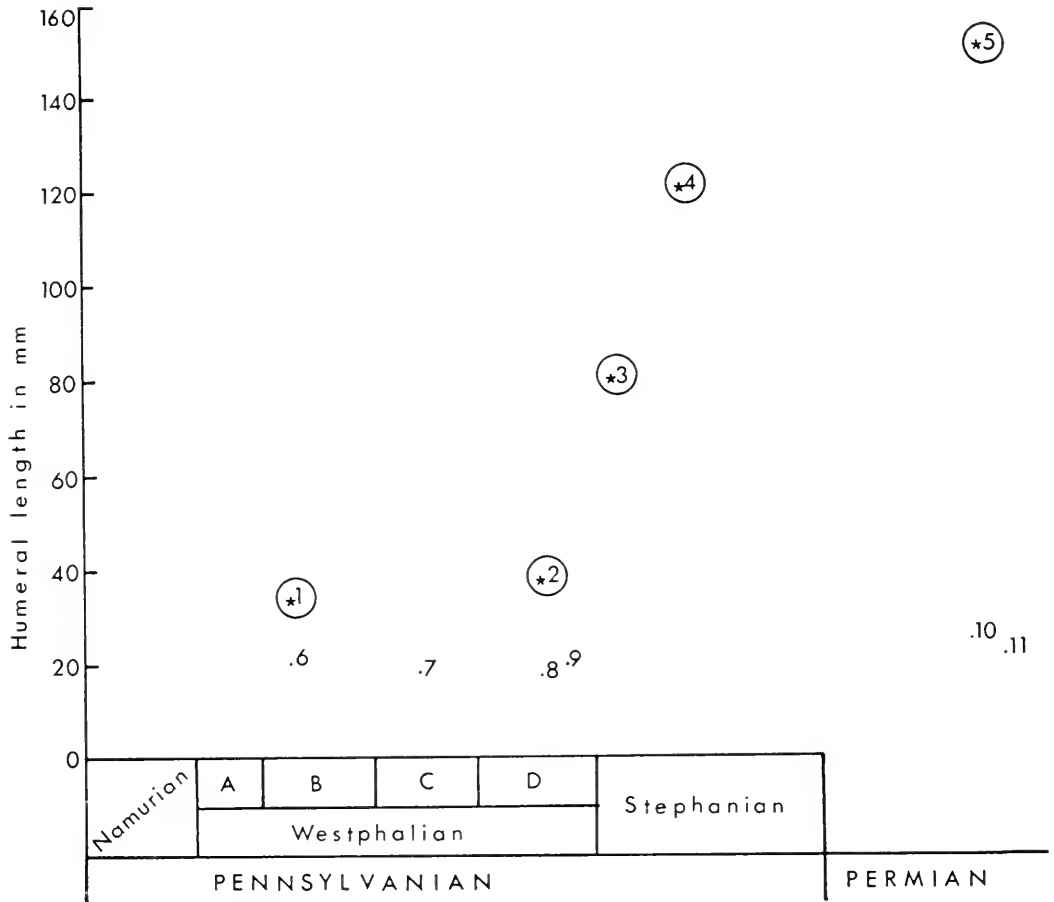

Figure 18. Relationship between humeral length and relative age of the following genera:

1. *Protaclepsydrops haplous*, DMS W.B. 239, pelycosaur; 2. *Archaeothyris florensis*, MCZ 4079, pelycosaur; 3. *Clepsydraps colletti*, WM 6542, pelycosaur (Romer & Price, 1940, Table 4); 4. *Clepsydraps magnus*, CM 13942, pelycosaur (Romer, 1961); 5. *Ophiacodon retroversus*, MCZ 1426, pelycosaur (Romer & Price, 1940, Table 4); 6. *Hylanomus lyelli*, RM 21126, romeriid (Carroll, 1964); 7. *Cephalerpeton ventriarmatum*, VPM 796, romeriid; 8. *Paleothyris acadiana*, MCZ 3482, romeriid; 9. "*Gephyrostegus bohemicus*," ČGH III B21.C.587, romeriid; 10. Undescribed, MCZ 1474, advanced romeriid; 11. Undescribed, MCZ 1478, advanced romeriid.

tween the two regions is about 2:1; in larger Permian ophiacodonts the ratio is even greater. In *Ophiacodon mirus* and *Ophiacodon uniformis* the ratio is 3.5:1.

3. The jaws in romeriids and pelycosaur function as simple levers. The fulcrum of the lever is at the point of articulation of the lower jaw with the quadrate. The force is supplied by muscles that are limited to the postorbital region in general and the subtemporal fossae in particular.

These muscles work at a mechanical disadvantage; the greatest amount of force is applied at the point of articulation between the jaws rather than at the teeth. In pelycosaur, the mechanical disadvantage of the jaw-lever system is even greater than in the romeriids because the muscles are closer to the fulcrum (Fig. 20). This means that greater power has to be applied by the jaw muscles of pelycosaur than of romeriids in order to provide the same amount of force

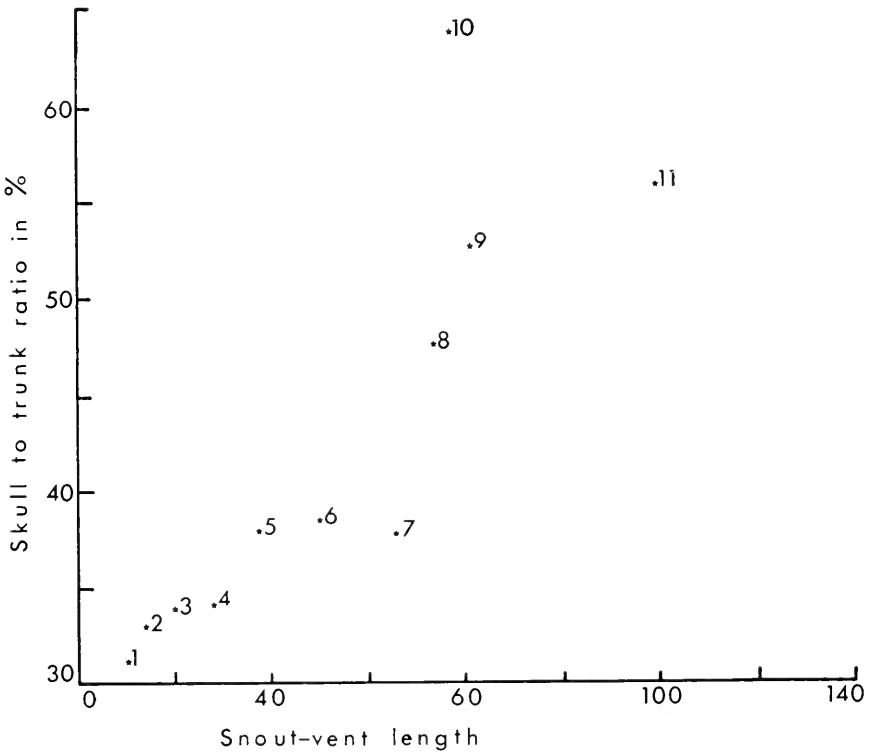

Figure 19. Relationship between the skull-trunk ratio and the snout-vent length in the following genera:

1. *Paleothyris acadiana*, MCZ 3481, romeriid coptorhinomorph; 2. *Hylonomus lyelli*, BM(NH) R.4168, romeriid coptorhinomorph; 3. *Echinerpetan intermedium*, MCZ 4090, primitive pelycosaur; 4. *Haptodus longicaudatus*, SGL, primitive pelycosaur; 5. *Archaeothyris florensis*, MCZ 4079, primitive pelycosaur; 6. *Varanops brevirostris*, WM 606, primitive pelycosaur; 7. *Haptodus saxonicus*, SGL, primitive pelycosaur; 8. *Varanosaurus acutirostris*, AM 4174, primitive pelycosaur; 9. *Ophiacodon mirus*, WM 671, pelycosaur; 10. *Ophiacodon uniformis*, MCZ 1366, pelycosaur; 11. *Ophiacodon retraversus*, WM 458, pelycosaur.

at the anterior tip of the jaws. In order to be able to exert greater force, either a greater mass of jaw muscle is necessary or more efficient use of a limited amount. This is where a temporal opening would be of direct advantage.

There are several other changes in jaw structure between romeriids and pelycosaurs that may be noted:

1. The length of the tooth-bearing portion of the jaw becomes relatively greater.
2. Because the area of insertion of the jaw musculature on the lower jaw is closer to the fulcrum in pelycosaurs than in romeriids, the animal could open its mouth wider with the same amount of muscular

distention, to accommodate larger prey (Fig. 20).

3. At the same time, more rapid motion at the tip of the jaw is possible, a definite advantage in catching prey.

These arguments suggest that the original development of the temporal opening occurred in romeriids that were initially of small size. After the temporal opening developed and became stabilized, these forms, which could now be termed pelycosaurs, could diversify and increase substantially in size. This suggests also that it is the absence of a specialized temporal region as such that limited the size of romeriids (Fig. 18).

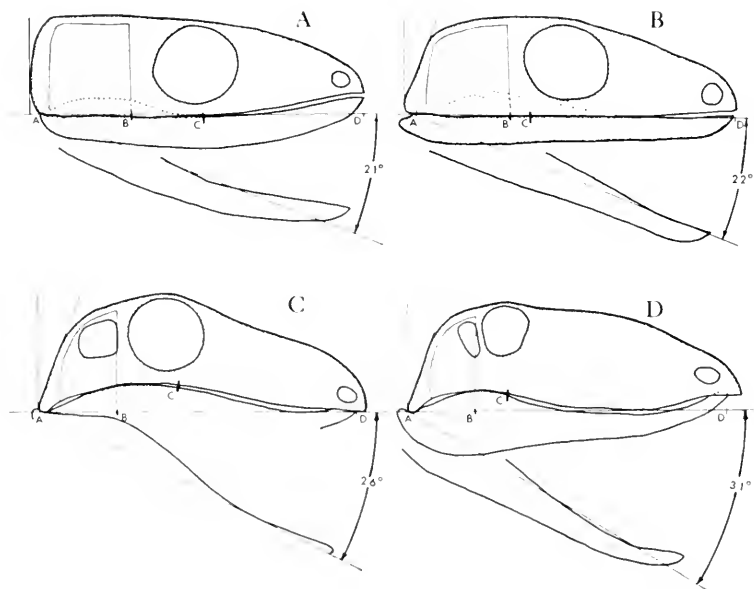

Figure 20. Comparison of the jaw mechanisms in romeriids and primitive ophiacodontids. A. *Hylanamus lyelli*, RM 12016. $\times 1.2$ [Carroll, 1964; text-fig. 1]; B. *Paleothyris acadiana*, MCZ 3483. $\times 1.6$ [Carroll, 1969; text-fig. 12]; C. *Archaeothyris florens*, MCZ 4079. $\times 0.5$; D. *Ophiacodon uniformis*, MCZ 1366. $\times 0.25$ [Romer & Price, 1940, plate 1].

A—fulcrum of lever.

B—furthest point from fulcrum on which the jaw muscle can act.

$\frac{AB}{AD}$ —mechanical advantage in jaw mechanism.

CD—length of tooth row.

Angle shown is the angle of opening of the jaw when jaw muscles extend by 50 percent of their original length.

Stippled area—location of adductor jaw musculature.

Although the Limoscelidae and the Captorhinidae do not develop temporal openings, they show an increase in size similar to that seen in pelycosaurs. Limoscelids are very primitive in nature and have little to do with the ancestry of other more advanced reptiles. They seem to have solved the problems involved with increase in size by developing great lateral expansion of the temporal region to accommodate a greater mass of jaw musculature. The captorhinids represent another sterile lineage that has solved this problem in a similar fashion. On the other hand, pelycosaurs retain the narrow configuration of the skull observed in romeriids, but develop a temporal fenestra. This temporal opening enabled the pelycosaurs to reach a position of

dominance in the Lower Permian. The same basic pattern is retained in their descendants, the primitive therapsids, which were dominant terrestrial vertebrates for much of the later Permian and the Triassic. The entire system of jaw musculature was again reorganized in the later group in relationship to the origin of mammals.

Other differences between romeriid and pelycosaurian skulls can also be associated with the changes in the temporal musculature. In romeriids the postorbital and the supratemporal bones do not come into contact. In pelycosaurs, the postorbital extends posteriorly to reach the supratemporal in order to strengthen the cheek region above the temporal opening. Primitive pelycosaurs tend to have the position of jaw

articulation well posterior to the back of the skull roof, so that the margin of the cheek slopes posteriorly. This feature may have developed primarily to increase the area available for jaw musculature. The resulting change in orientation of the muscles might also serve to modify the nature of jaw mechanics as suggested by Olson (1961) from a static pressure system toward a kinetic inertial system.

There are several features of the postcranial skeleton in which early pelycosaurs are more primitive than even the earliest known romeriids. Two equal-sized distal centralia are retained in the foot. The lateral centrale has become the dominant element in even the most primitive romeriids. The neural arch forms the dorsal part of the anterior articulating rim of the vertebra in primitive pelycosaurs, whereas in most romeriids all of the anterior articulating rim is formed by the centrum. A distinct axis intercentrum is retained in all pelycosaurs, although this element became partially fused to the atlas centrum in ophiacodonts. This element is lost or indistinguishably fused in all romeriids except *Hylonomus*. These features are of minor anatomical significance, but they indicate that pelycosaurs diverged from the primitive reptilian stock prior to the appearance of the earliest known romeriids.

The structure of the limbs and girdles in early pelycosaurs can be considered more specialized or advanced than that observed in the romeriids. These changes from the primitive reptilian pattern can be attributed to accommodation to the greater body size achieved by even the earliest known pelycosaurs.

REFERENCES

- BARGHUSEN, H. R. 1968. The lower jaw of cynodonts (Reptilia, Therapsidae) and the evolutionary origin of mammal-like adductor jaw musculature. *Postilla*, No. 116: 1-49.
- BELL, W. A. 1966. Carboniferous plants of eastern Canada. *Geol. Surv. Canada, Paper* 66-11: 1-76.
- CARROLL, R. L. 1964. The earliest reptiles. *Jour. Linn. Soc. (Zool.)*, **45**: 61-83.
- . 1967. A limnoscelid reptile from the Middle Pennsylvanian. *Jour. Paleontology*, **41**: 1256-1261.
- . 1969. A Middle Pennsylvanian captorhinomorph and the interrelationships of primitive reptiles. *Jour. Paleontology*, **43**: 151-170.
- . 1970. The ancestry of reptiles. *Phil. Trans. R. Soc. London, Ser. B*, **257**: 267-308.
- , AND BAIRD, D. 1972. Carboniferous stem-reptiles of the family Romeriidae. *Bull. Mus. Comp. Zool.*, **143**(5): 321-364.
- CASE, E. C. 1907. Revision of the Pelycosauria of North America. *Carnegie Inst. Washington*, **55**: 1-176.
- . 1924. A possible explanation of fenestration in the primitive reptilian skull, with notes on the temporal region of the genus *Dimetrodon*. *Mus. Geol. Univ. Michigan, Contrib.*, 2(1): 1-12.
- COPE, E. D. 1875. On fossil remains of reptilia and fishes from Illinois. *Proc. Philadelphia Acad. Nat. Sci.*, 1875: 404-411.
- . 1877. Descriptions of extinct Vertebrata from the Permian and Triassic formations of the United States. *Proc. Am. Philos. Soc.*, **17**: 182-193.
- . 1878. Descriptions of extinct Batrachia and Reptilia from the Permian formation of Texas. *Proc. Am. Philos. Soc.*, **17**: 505-530.
- DEMAR, R. 1970. A primitive pelycosaur from the Pennsylvanian of Illinois. *Jour. Paleontology*, **44**: 154-163.
- FRAZZETTA, T. H. 1968. Adaptive problems and possibilities in the temporal fenestration of tetrapod skulls. *Jour. Morph.*, **125**: 145-158.
- GAUDRY, A. 1886. Sur un nouveau genre de reptile trouvé dans le Permien d'Autun. *Bull. Soc. Géol. de France*, 3me ser., **14**: 430-433.
- GREGORY, J. T. 1950. Tetrapods of the Pennsylvanian nodules from Mazon Creek, Illinois. *Am. Jour. Sci.*, **248**: 833-873.
- GREGORY, W. K., AND ADAMS, L. A. 1915. The temporal fossae of vertebrates in relation to the jaw muscles. *Science, n.s.*, **41**: 763-765.
- HOTTON, N. III. 1970. *Mauchchuinkia bassa*, gen. et sp. nov. An Anthracosaur (Amphibia, Labyrinthodontia) from the Upper Mississippian. *Kirtlandia*, **12**: 1-38.
- HUENE, F. VON. 1925. Ein neuer Pelycosaurier aus der unteren Permformation Sachsens. *Geol. Pal. Abh. Jena, Bd.* **18**, (Neue Folge 14): 215-264.
- MOORE, R. C. 1944. Chairman, Pennsylvanian Subcommittee of the National Research Council Committee on Stratigraphy. Correlations of Pennsylvanian Formations of North America. *Bull. Geol. Soc. Amer.*, **55**: 657-706.

- OLSON, E. C. 1961. Jaw mechanisms: Rhipidistians, amphibians, reptiles. *Am. Zool.*, **1**: 205-215.
- . 1965. New Permian vertebrates from the Chickasha formation of Oklahoma. *Oklahoma Geol. Survey, Circ.* **70**: 1-70.
- PEABODY, F. E. 1957. Pennsylvanian reptiles of Garnett, Kansas: *Edaphosaurus*. *Jour. Paleontology*, **31**: 947-949.
- PRICE, L. I. 1937. Two new cotylosaurs from the Permian of Texas. *Proc. New England Zool. Club*, **16**: 97-102.
- ROMER, A. S. 1945. The later Carboniferous vertebrate fauna of Kounova (Bohemia) compared with that of the Texas redbeds. *Amer. Jour. Sci.*, **243**: 417-442.
- . 1961. A large ophiacodont pelycosaur from the Pennsylvanian of the Pittsburgh region. *Breviora*, No. 144: 1-7.
- , AND PRICE, L. I. 1940. Review of the Pelycosauria. *Geol. Soc. Amer. Sp. Paper* **28**: 1-538.
- WATSON, D. M. S. 1921. The basis of classification of the Theriodontia. *Proc. Zool. Soc. London*, pt. 1: 35-98.
- WILLISTON, S. W. 1911. *American Permian vertebrates*. Chicago Univ. Press. 145 pp.

Bulletin of the
Museum of
Comparative
Zoology

Social Biology of the Neotropical Wasp
Mischocyttarus drewseni

ROBERT L. JEANNE

PUBLICATIONS ISSUED
OR DISTRIBUTED BY THE
MUSEUM OF COMPARATIVE ZOOLOGY
HARVARD UNIVERSITY

BULLETIN 1863-
BREVIOIRA 1952-
MEMOIRS 1864-1938
JOHNSONIA, Department of Mollusks, 1941-
OCCASIONAL PAPERS ON MOLLUSKS, 1945-

Other Publications.

- Bigelow, H. B., and W. C. Schroeder, 1953. Fishes of the Gulf of Maine. Reprint, \$6.50 cloth.
- Brues, C. T., A. L. Melander, and F. M. Carpenter, 1954. Classification of Insects. \$9.00 cloth.
- Creighton, W. S., 1950. The Ants of North America. Reprint, \$10.00 cloth.
- Lyman, C. P., and A. R. Dawe (eds.), 1960. Symposium on Natural Mammalian Hibernation. \$3.00 paper, \$4.50 cloth.
- Peters' Check-list of Birds of the World, vols. 2-7, 9, 10, 12-15. (Price list on request.)
- Turner, R. D., 1966. A Survey and Illustrated Catalogue of the Teredinidae (Mollusca: Bivalvia). \$8.00 cloth.
- Whittington, H. B., and W. D. I. Rolfe (eds.), 1963. Phylogeny and Evolution of Crustacea. \$6.75 cloth.
- Proceedings of the New England Zoological Club 1899-1948. (Complete sets only.)
- Publications of the Boston Society of Natural History.

Authors preparing manuscripts for the *Bulletin of the Museum of Comparative Zoology* or *Breviora* should send for the current Information and Instruction Sheet available from Ms Penelope Packard, Editor, Publications Office, Museum of Comparative Zoology, Harvard University, Cambridge, Massachusetts 02138, U.S.A.

SOCIAL BIOLOGY OF THE NEOTROPICAL WASP *MISCHOCYTTARUS DREWSENI*¹

ROBERT L. JEANNE²

TABLE OF CONTENTS

Table of Contents	63		
Abstract	64		
I. Introduction	65		
II. Materials and Methods	65		
A. Taxonomy and Distribution	65		
B. Locations of the Study	66		
C. Period of the Study	66		
D. Methods of Study	67		
III. The Colony Cycle—A Brief Outline	69		
IV. Habitat and Nest Site	69		
V. Nest Construction	71		
A. Nest Architecture and Size	71		
B. Nest Material	72		
C. Foraging for Nest Material	72		
D. Nest Initiation	73		
E. Cell Initiation	74		
F. Cell Heightening	74		
G. Addition of Pulp to Caps of Pupal Cocoons	74		
H. Moulting	75		
VI. Trophic Relations	76		
A. Proteinaceous Food	76		
1. Method of Foraging	76		
2. Prey	78		
3. Distribution to Adults on the Nest	78		
4. Distribution of Solid Insect Food to the Larvae	79		
5. Distribution of Liquid to Adults and Larvae	80		
B. Carbohydrate Food	81		
1. Sources	81		
2. Distribution of Nectar to Adults on the Nest	82		
3. Distribution of Nectar to Larvae and Storage of Nectar	83		
C. Larval Trophallaxis	84		
D. Behavior Associated with Feeding and Trophallaxis	85		
1. Abdominal Vibration	85		
2. 'Pecking'	85		
3. Rubbing	86		
4. Discussion	86		
VII. Enemies and Defense	87		
A. Enemies	87		
1. Predators of Brood	87		
a. Ants	87		
b. Other Predators	87		
2. Predators of Adults	88		
3. Parasites	88		
4. Social Parasitism	89		
B. Defense of Brood	89		
1. Defense Against Ants	89		
2. Alarm Reaction to Flying Insects	90		
3. Alarm Reaction to Large Objects	90		
4. Variations in Aggressiveness	91		
VIII. Division of Labor	91		
A. Specialization According to Caste	91		
1. Activities of the Queen versus the Workers	91		
2. Activities of Nonworkers	94		
3. Activities of Males	95		
B. Temporal Separation of Tasks During the Day	95		
IX. Dominance and Caste Determination	96		
A. The Nature of Dominance-Subordination Behavior	96		
B. The Solicitation-Domination Continuum	98		
C. Patterns of Dominant and Sub- ordinate Behavior	99		
1. Rates of Dominance Interactions	99		
2. Age Distribution of Dominant and Subordinate Behavior on Established Colonies	100		

¹ This paper is based on a thesis presented to Harvard University in partial fulfillment of the requirements for the Ph. D. in Biology.

² Present address: Department of Biology, Boston University, 2 Cummington Street, Boston, Mass. 02215.

3. Linear Hierarchy on Established Colonies	102
4. Discussion	103
D. Queen Determination on Pre-emergence colonies	103
1. Dominance, Food Flow, and Work	103
2. Differential Egg-eating	104
3. Empty Cells as Stimuli to Oviposition	105
4. Age of Co-foundresses	105
5. Discussion	106
E. Queen Supersedure on Established Colonies	106
1. The Nature of Supersedure Behavior	107
2. Age of Superseded Queens	107
3. Age of Superseding Queens	109
4. Changing Rates of Oviposition	109
5. Changing Rates of Domination	111
6. Sex of the Offspring of Superseding Queens	111
7. Discussion	112
X. Life Cycle of the Colony and Its Individuals	113
A. Duration of Brood Stages	113
1. Eggs	113
2. Larvae	113
3. Pupae	115
B. Survivorship of Adults	115
C. The Colony Cycle	118
1. Colony Founding	118
a. Seasonal asynchrony of colony founding	118
b. Association of foundresses	118
2. Colony Development	119
a. The egg substage	120
b. The larval substage	120
c. The pupal substage	122
d. Emergence of workers	122
e. Emergence of males and nonworkers	123
f. Decline	124
3. The Regulation of the Colony Cycle	126
a. Pre-emergence growth	129
b. Post-emergence growth and decline	131
c. Role of the brood	133
d. Role of the nonworker-male/worker ratio (NwM/W)	134
e. The initial high value of NwM/W	136
f. Factors causing changes in NwM/W	137
Acknowledgments	141
List of References	142
Index	149

ABSTRACT

The biology of the social wasp *Mischocyttarus drewseni* (Hymenoptera, Vespidae) is described from the Lower Amazon region of Brazil. The study is based on direct observation of marked adults and on daily records of brood development of 53 colonies under natural conditions.

M. drewseni inhabits areas of low vegetation and prefers to nest under eaves of buildings, in sheds and barns, and in other protected sites. The nest is a single, uncovered, round comb of hexagonal paper cells, suspended horizontally from a long, narrow stem. Nesting material consists of woody plant fibers chewed up and mixed with small amounts of salivary secretion that hardens into a tough, chitinlike material. The nest stem is built up almost entirely of this secretion.

Adults and larvae both feed on arthropod prey and on plant nectar and honeydew. Workers find prey by sight, pouncing from flight on any irregularity in the outline of a stem or twig. Nectar is collected from floral and extra-floral sources. When nectar is abundant it is stored in the form of droplets on the walls of cells containing eggs. Larvae produce a clear salivary secretion that is eaten by adults.

M. drewseni protects its brood from certain predaceous ants by chemical means. At the base of the terminal sternite is a gland whose product is secreted onto a tuft of hair. Females apply this secretion by rubbing the tuft against the nest stem, where it is effective in keeping scout ants from gaining access to the nest and discovering the brood. Dominance encounters between females on the nest resemble those described for *Polistes* in that there exists a linear hierarchy, at the top of which is the egg-laying queen; the hierarchy results in a trophic advantage to higher-ranking females. It differs from *Polistes* in that subordinate females are involved in dominance interactions primarily during the first two weeks of adult life. Degree of participation in dominance interactions is apparently closely related to the state of ovarian development.

There is a division of labor between queens and workers. Queens are at the top of the dominance hierarchy, are the primary egg-layers, prepare cells to receive eggs, initiate construction of most cells, and forage primarily for pulp. Workers are subordinate to queens, heighten cell walls, forage for pulp and food, distribute food to nest-mates and larvae, and bring water to the nest for cooling.

New colonies are founded by offspring of declining colonies; this may occur at any time of the year. Most colonies are founded by single females, though up to eight sibling females may associate to found a colony. The first three or four offspring develop rapidly; subsequent larvae

take much longer to develop. As workers emerge and begin to help the foundress care for brood, the larval development time gradually decreases again. At the time the first pupae appear the first unfertilized eggs are laid, these giving rise to the first adult males six weeks later. At about the time males appear, nonworking females also begin to appear on the nest. For the next ten weeks or so males and nonworking females emerge at a high rate, while the number of workers emerging gradually diminishes. There are no morphological differences between workers, queens, and nonworkers, though workers tend to be somewhat smaller.

Evidence is presented to support the hypothesis that decline and termination of colony development is dependent primarily upon changes in the ratio of males and nonworkers to workers, and not upon the reproductive condition of the queen.

In the typical colony the founding female does not remain as queen for the entire life of the colony, but is superseded by an offspring who succeeds in out-dominating her and forcibly ejecting her from the nest. The new queen is in turn eventually ousted by a younger nestmate. The average life span of four colonies was 160 days, while the average egg-laying life of five queens was only 49 days.

The average life span (total time on the nest as adult) of queens was 61 days, of workers 31 days, of nonworkers 5.0 days, and of males 4.8 days. Survivorship curves are given for workers, nonworkers, and males. Though the total number of adults produced by a colony may approach 200, because of the relatively short life span of adults, there are rarely more than 30 adults in a colony at any one time.

I. INTRODUCTION

Mischocyttarus is the largest genus of social wasps, surpassing even *Polistes* in number of species described (186). Yet, unlike the cosmopolitan genus *Polistes*, *Mischocyttarus* has achieved its extraordinary diversity wholly within the New World, where it is one of 20 genera in the vespidae subfamily Polistinae. With the exception of *Polistes*, which is the only one of these whose range brings it into the backyards of naturalists the world over, all of these genera are tropical and for this reason have remained little studied. The presumed tropical origin of the social Vespidae (Richards and Richards, 1951; van der Vecht, 1966) and the rich diversity

of genera and species in the tropics are strong arguments for carrying the study of vespidae biology into these regions. This paper reports the first detailed study of the social biology of tropical *Mischocyttarus*.

Most of what is known about the biology of *Mischocyttarus* is scattered through a relatively small literature (H. von Ihering, 1896; Ducke, 1907, 1914; Williams, 1928; Bequaert, 1933; Rau, 1933; Vesey-Fitzgerald, 1938; Snelling, 1953). O. W. Richards revised the genus in 1945 and included extensive biological notes. Zikán's revision (1949) contains fragmentary biological observations. In two other papers (1935, 1951) Zikán records biological observations on *Mischocyttarus*.

Mischocyttarus invited study for several reasons. First, the morphological distinctiveness of the genus suggested that there exists specialized behavior not found in other genera. Second, the remarkable diversity of nest structure within the genus suggested an equal diversity of behavioral adaptations. Third, the large number of species hinted at a successful adaptive radiation, possibly based on specialized behavior. Finally, its small colonies and open nest structure facilitated detailed observations of all activities of adults on the nest at all times. I decided to conduct the study in the equatorial tropics for two reasons. First, it seemed appropriate to study the genus close to the center of its distribution, where it presumably evolved. Second, I was interested in choosing an area with minimal seasonal fluctuations of climate in hopes of exposing the intrinsic factors that regulate colony cycle. *M. drewseni* was selected because it was the most abundant species in the study region.

The present study has as its primary aim to provide an account of the details of the social organization and life cycle of *Mischocyttarus drewseni*, based on direct observation of the activities of marked adult wasps and on records of colony development. It is hoped that it will provide a basis for future comparative studies

within the genus, as well as for comparison with other genera. The most significant new findings presented are: 1) discovery of the means by which *M. dreuseni* protects its brood against destruction from ants; 2) the relation of age of adults to their involvement in dominance interactions; 3) survivorship statistics for workers, nonworkers, and males; 4) relationship between duration of the larval stage and stage of colony development; and 5) the details of colony development, with a tentative interpretation of the factors regulating it.

II. MATERIALS AND METHODS

A. TAXONOMY AND DISTRIBUTION

The most recent revision of the hymenopteran superfamily Vespoidea is that of Richards (1962). He divided the group into three families: Masaridae, Eumenidae, and Vespidae. Within the Vespidae, which comprise the groups that have achieved sociality, Richards has included three subfamilies: Stenogastrinae, Vespinae, and Polistinae. The Stenogastrinae comprise three genera occurring in the Oriental and Australian regions. The three vespine genera are primarily of the north temperate regions. The Polistinae contain 25 genera, most of them tropical in distribution, though *Polistes* is cosmopolitan. The subfamily Polistinae is divided into three tribes: Ropalidiini, Polybiini, and Polistini. The Polybiini comprise 22 genera, 19 of them, including *Mischocyttarus*, limited to the New World.

The genus *Mischocyttarus* is separated from other Polybiini primarily on the basis of the asymmetrical tarsal lobes of the adults. The larvae are also distinct from those of other genera in that they possess one, two, or three lobes on the ventral side of the first abdominal segment, and an enlarged first thoracic spiracle (Reid, 1942).

The genus has been revised by Richards (1945) and by Zikán (1949); Willink (1953)

revised the Argentinian species. Zikán (1949) states that the 165 species in his revision, when added to the species in Richards' list, bring the total number of species in the genus to 225, but in fact many of those in Zikán's key are also present in that of Richards. By my count, there are 183 different species in the two revisions. Add to these the three new species described by Willink, and the total number of described species reaches 186.

The genus ranges from southwestern Canada and southeastern United States to northern Argentina, with the greatest number of species occurring in the tropics. *Mischocyttarus dreuseni* has been recorded from Surinam, Guyana, Venezuela, Colombia, Peru, Brazil, Paraguay, and Argentina. Five varieties and races have been described. The species is a medium-sized wasp, 15–18 mm long, dark-brown to black in color. Its body is slender, and the first abdominal segment is elongated.

B. LOCATIONS OF THE STUDY

The data for this study were gathered in the field in the Lower Amazon region of Brazil. Field observations on *M. dreuseni* were made at two localities: Belém, Pará (1°27'S, 48°29'W), on the southern shore of the bay of Guajará and 120 km from the sea, and Fazenda Taperinha, on the Rio Ayayá (a *paraná*, or lateral channel, of the main Amazon stream), approximately 40 km east of Santarém, Pará (2°26'S, 45°41'W). Both localities are well within the limits of the Amazonian rainforest, or "Ilylaea." Altitudes at both localities are less than 30 meters.

Although Belém averages 27 percent more precipitation per year, both localities experience approximately the same monthly distribution of rainfall. January through June are the wettest months, July through December the driest. The average monthly temperature fluctuates within less than 1°C (26.3–26.8°C) at Belém and within less than 2°C (25.7–27.4°C) at Taperinha. Thus, by far the most notice-



able seasonal change at both localities is amount of rainfall. Rainfall and temperature data for both localities are summarized in Tables 1 and 2. Since both localities are near the equator, day length varies but little from 12 hours throughout the year.

C. PERIOD OF THE STUDY

The field study lasted from 20 August 1967 to 31 May 1969. Most of the period from 20 August 1967 through 15 May 1968 was spent in Belém. Continuous observations were made at Taperinha from 15 May 1968 until 8 May 1969, with the exception of the period from 1 August to 14 October 1968. Other interruptions of continual observations were necessary but were minor.

D. METHODS OF STUDY

This study is based primarily on 520 hours of direct observation of colonies of *Mischocyttarus drewseni** *in situ*. Data were taken from 53 colonies of *M. drewseni*, 19 at Belém and 34 at Taperinha.

The adults of 20 of the colonies of *M. drewseni* at Taperinha were marked for individual identification. When a colony was first discovered, the usual procedure was to anaesthetize the entire adult population with ether. Ether was preferred to CO₂ because of its availability and ease of administration. According to W. E. Kerr (personal communication), ether has less effect on subsequent behavior of stingless

* Determination confirmed by O. W. Richards, Imperial College, London.

bees than does CO₂. As each new adult emerged it was carefully removed from the nest with forceps, etherized, and marked.

Adults were marked on the thorax with Testor's "Pla" model airplane dope. This was found to be satisfactory, though it was necessary to keep the dope at the right consistency by the use of linseed oil as a thinner. The dope thickened with repeated opening of the bottles. Spots applied with dope that was too thick tended to flake off. If the dope was too thin, the spots tended to spread over the surface of the mesonotum and into the articulations of the tegulae, hindering flight. When this happened, it was necessary to remove the paint with fine forceps after it had dried and re-mark the individual. Such manipulations did not affect the wasps in any visible way.

Colonies of *M. drewseni* were numbered consecutively. Adults were identified as members of a given colony with a combination of two of five colors, one spot on either side of the midline of the scutellum. All adults within a colony were numbered consecutively in order of emergence by the use of a code of five colors in five positions on the mesonotum. (The only exceptions to consecutive numbering were numbers 20, 30, and 40 of colony 174, which were marked after number 10 and before number 11.) Marking in this way caused no apparent ill effects, nor did it hinder normal movements of the wasps.

Adult behavior was observed at all times of the day. Notes were recorded on tape in the field and transcribed at the end of each day. For some colonies adult activities were timed with a stopwatch.

At the end of each observation day each nest was checked for brood development. For ease of tabulation of these data the cells of each nest were numbered. The first cell constructed was number "1," then, as new cells were added to this, they were numbered in a spiral manner. This spiral numbering system was found to be the best way of approximating the order in which

cells were added. In nests discovered later in their development it was sometimes not possible to be sure which was the original cell. In such cases a central cell was arbitrarily denoted "1." The content of each cell was recorded as either "empty," "egg," "larva," or "pupa." Larvae were divided into "small," "medium," and "large," though the criterion was relative size and was not based on instars. For purposes of the study a "larva" became a "pupa" when it had spun its silken cocoon, closing the cell. Newly constructed cells were recorded.

Rates of egg eating and abortion were obtained from these data and supplemented by direct observation. A larva replaced by an egg or empty cell was assumed aborted. An egg replaced by an empty cell was assumed eaten. Pupae disappearing in significantly less than the average time of development were assumed aborted.

The following designation of colony stages is followed:

Pre-emergence stage: from nest initiation to emergence of the first adult offspring.

1) *Egg substage*: from nest initiation to eclosion of the first larva.

2) *Larval substage*: from eclosion of the first larva to the spinning of the first cocoon.

3) *Pupal substage*: from the spinning of the first cocoon to emergence of the first adult.

Postemergence stage: from emergence of the first adult through decline.

1) *Pre-male substage*: from emergence of first adult to emergence of first male.

2) *Postmale substage*: from emergence of the first male to beginning of decline.

3) *Decline*: from beginning of irreversible reduction of brood population through final abandoning of the nest.

This classification is preferred to Yoshikawa's (1962) division of the cycle into "solitary," "superindividual," "social," and three "hibernant" stages. The term "solitary" is both inaccurate, since several females may associate to found a colony,

and misleading, for it suggests an affinity with the life cycle of solitary species, a relation that may or may not exist. The hibernant stages are irrelevant to tropical life cycles, since daughter colonies are founded immediately upon the disintegration of parent colonies.

I have followed Eberhard's (1969) classification of females:

Queen: the primary egg-layer.

Worker: a female that foraged for insects or pulp during its recorded stay on a nest.

Nonworker: a female that did not forage. For purposes of calculating caste ratios, females that subsequently became workers were classed as nonworkers during their first three days as adults, since they did no work during this period of "maturation."

The following terminology is used in referring to females on multiple-foundress nests:

Co-foundress: any one of the females associating to form a multiple-foundress colony. Co-foundresses include the *queen* and her *subordinates*.

Photographs were made with a 35 mm camera using a 135 mm lens extended with a bellows. Electronic ring-flash provided illumination. Motion pictures were used in the analysis of certain movements.

III. THE COLONY CYCLE—A BRIEF OUTLINE

Colonies of *M. drewseni* are founded by a single female working alone, or by several females in association. As soon as the first cell is built an egg is laid in it. Cells are added at a rate of about one a day, each receiving an egg as it is built, until the first eggs hatch. Nest growth stops and does not begin again until the first larvae spin cocoons and pupate. After the first adult offspring emerge the rate of growth (in terms of cells initiated) increases slightly. The first 15 or so offspring are all females, most of which develop worker behavior and assist on the

nest. After this males and nonworking females as well as workers emerge. The nest continues to grow in size, and the proportion of males and nonworkers increases relative to the total adult population for three to four months. Around this time the rate of nest growth decreases to zero, the incidence of abortion of larvae and pupae rises, increasing numbers of cells are left empty, and the adult population diminishes until the nest is empty of brood and abandoned. The entire cycle requires approximately six months.

The colony cycle will be discussed in greater detail below (The Colony Cycle, p. 118).

IV. HABITAT AND NEST SITE

According to Ducke (1905) *Mischocyttarus drewseni* inhabits fields and open places. My own experience corroborates this finding. The colonies in Belém were in a swampy area of tall grass with isolated clumps of small trees (Plate I, fig. 1). The nests at Taperinha were in a clearing on "terra firma" along the edge of the Rio Ayayá (Plate I, fig. 2). This area was grazed by cattle, goats, and horses from approximately March through July. The vegetation consisted of low grass with scattered trees and clumps of shrubs 1–3 m tall. All foraging activities of the adult wasps were confined to these areas of low vegetation. I have never seen either nests or foragers of *M. drewseni* in forest of any kind.

Five days of searching the rather small (about ten acres) clearing in the Ducke Forest Reserve, 26 km north of Manaus in the state of Amazonas, turned up no nests of *M. drewseni*. It may be that this area was cleared so recently (about five years before) and remained so isolated (surrounded by several km of rainforest) that the habitat had not yet been colonized by the species. The same was true at Curuá, a logging camp about 60 km east of Santarém. Although the clearings and areas

TABLE 3. Nesting situations and substrates of *M. drewseni*.

	Nest	Situation	Approximate height above ground (m)	Substrate	Direction of exposure
Belém	180	window lintel	5	bare wood	south
	180a	" "	"	" "	"
	180b	" "	"	" "	"
	181	" "	"	" "	west
	182	" "	"	" "	"
	183	cave	"	" "	north
	184	window lintel	2.5	" "	south
	194	" "	"	" "	north
	195	cave	6	" "	west
	195a	window lintel	2	" "	"
	195b	" "	"	" "	"
	195c	" "	"	" "	"
	195d	" "	"	" "	"
	195e	" "	"	" "	south
	195f	" "	"	" "	north
	195g	" "	5	" "	"
	195h	" "	"	" "	"
	195i	window lintel	"	" "	south
	195j	cave	"	" "	west
	Taperinha	165	" "	"	" "
166		inter-willow-branch cavity	2.5	" "	west
166		" " " " " "	"	" "	"
167		" " " " " "	"	" "	"
168		" " " " " "	"	" "	"
169		" " " " " "	"	" "	"
172		cave	"	" "	south
174		" "	"	" "	east
175		" "	1.5	" "	"
225		" "	"	" "	north

of young second-growth vegetation were quite extensive, and although I spent nine days of intensive searching there, I turned up only one colony of *M. oecothrix*, a forest-dwelling species (Richards, 1945). Again, the habitat was less than five years old and was very isolated from similar habitats.

Table 3 gives nesting situation and substrate for each of the 53 nests of *M. drewseni* found. All but one of the nests were built on man-made structures. Of these, 46 (88 percent) were attached to unpainted wood. Painted wood was

avoided; often a spot from which paint had peeled was chosen in preference to surrounding painted surfaces. Plate II, figs. 3 and 4 show nesting sites at Taperinha.

Nest 349 was the only nest that was constructed on a natural substrate. It was attached to the midrib on the underside of a leaf in the center of a low clump of dense shrubbery (Plate I, fig. 2). Unfortunately, the nest was destroyed, probably by passing cattle, a few days after it was initiated. Had the nest grown to maturity its weight would undoubtedly

TABLE 3 (continued). Nesting situations and substrate of *M. drewseni*.

Nest	Situation	Approximate height above ground (m)	Substrate	Direction of exposure
29	inside open barn	2.5	steel roofing	west
31	" " "	"	" "	"
37	aves	1.2	bare wood	south
38	back of roofing tiles	1.2	ceramic tile	west
34	fence rail	1.2	bare wood	"
263	aves	1.2	" "	north
34	back of fence rails	1.1	" "	west
19	inside open barn	1.	steel roofing	east
42	under roof eave of gallery	2.	bare wood	west
47	aves	2.	" "	south
44	under roof eave of eave	2.	leaf litter	all sides
35	inside open barn	1.	steel roofing	west
34	under roof eave of gallery	2.1	bare wood	"
38	aves	1.	" "	east, west
38	aves	1.	" "	east
38	"	1.	" "	"
41	"	1.	" "	south
42	back of roofing tiles	1.	ceramic tile	"
42	aves	1.	bare wood	east
43	aves	1.	" "	east, west
42	aves	1.	" "	north
43	"	"	" "	east
43	"	"	" "	"
43	back of roof	1.	" "	east, west

have caused the leaf to hang vertically. I suspect, therefore, that *M. drewseni* does not normally choose leaves of this size as nest sites. *Polistes canadensis*, which builds nests of a size similar to that of *M. drewseni*, also builds on man-made structures if available, but in the wild chooses the undersides of large limbs, hollows in trees, and the undersides of palm fronds and spathes. *M. drewseni* probably also utilizes such sites in the wild.

Twenty-three of the nests had a west-facing exposure, while only eight were open to the north, twelve to the south, and ten to the east. These differences are significant at the 1 percent level (Chi Square). The apparent preference for west-facing

exposure may be real; prevailing winds are from the east, with occasional storms from both the northeast and the southeast. On the other hand, it may merely reflect an unequal distribution of suitable nest sites among the four directions. The data are too few and the requirements for nest site too poorly understood to distinguish between these alternative conclusions.

None of the nests studied was so exposed as to be rained upon in a storm. Only one nest was obviously affected by weather: nest 347 was destroyed when the roofing board from which it was suspended was torn away in a high wind.

Height above the ground varied considerably (Table 3) and seemed to be

secondary to securing suitable protection from the weather.

V. NEST CONSTRUCTION

A. NEST ARCHITECTURE AND SIZE

The nest of *Mischocyttarus drewseni* consists of a single, discoid comb suspended from its center by a narrow stem (Plate III, fig. 5). The comb consists of hexagonal cells which open on its underside, or face (Plate III, fig. 6). There is no envelope surrounding the nest. The average diameter of completed cells was 4.75 mm (range: 4.40–4.95 mm) (measured between midpoints of opposite walls). There was no difference in size of cells that produced workers, nonworkers and males; indeed, the same cell in a nest sometimes produced all three castes in three different generations of brood. The average thickness of cell walls was 0.28 mm (range: 0.23–0.31 mm). Eight mature nests averaged 14 cells in diameter (range: 11–20). The nest stems of 21 nests averaged 19 mm in length (range: 12–31 mm). The stems of mature nests were 1–2 mm in diameter.

B. NEST MATERIAL

The nest of *M. drewseni* is constructed of woody plant fibers. The origins of 37 loads of pulp were observed. Of these, 18 (49 percent) were taken from the bare wood of planks, fence rails, and posts. Fifteen loads (40 percent) were collected from the dried cortex of the living or dead stems of *Stachytarpheta cayennensis* (Verbenaceae), a low, herbaceous plant. Also utilized was the dried bark of dead trees (3 loads of 37 = 8 percent), and the dried stem of an unidentified herbaceous vine (1 load in 37 = 3 percent).

C. FORAGING FOR NEST MATERIAL

A forager going after nest material often first imbibed water (7 times in 15 trips). Foragers landed on grass and other low plants near the nest, then crawled down

along a stem until they reached a deep leaf axil which contained a drop of water from the last rain. Or they went to puddles of standing water, where they landed on low plants or grass, then crawled down a stem until the surface of the water was reached. Finally, foragers obtained water from wet mud. This water, presumably stored in the crop, was carried to the source of nest material, where it was regurgitated gradually onto the surface as the nest material was collected.

The primary function of the water is probably to cause the fibers to adhere to one another as they are collected into a ball. It may also serve as a vehicle for the small amount of nest construction secretion that is apparently mixed with the fibers to make them adhere to one another on the nest (Richards and Richards, 1951). The water may also serve to soften the fibers to facilitate their removal from the substrate. It is possible that a crop full of water suffices for two or more loads of material, and for this reason a forager need not stop for water prior to each collection. For instance, in one case a forager made two trips for nest material without stopping for water, but on the third trip she did. Regardless of whether or not water was first imbibed, the ball of pulp collected was always moist enough to stick together.

The plant fibers are removed from the substrate with the mandibles. The wasp works with the grain and works backward, collecting the loosened fibers into a wet ball of pulp held behind the mandibles. The material is collected into an amorphous mass, not in a continuous strip as in *Polistes canadensis* (Eberhard, 1969, and personal observation), even though the sources used by the two species may be identical. If suitable material is scattered over the surface, as is often the case with the cortex of living *Stachytarpheta* stems, the wasp may have to move from place to place along the stem in order to find enough. In four to seven minutes the wasp collects a ball approaching the size of her

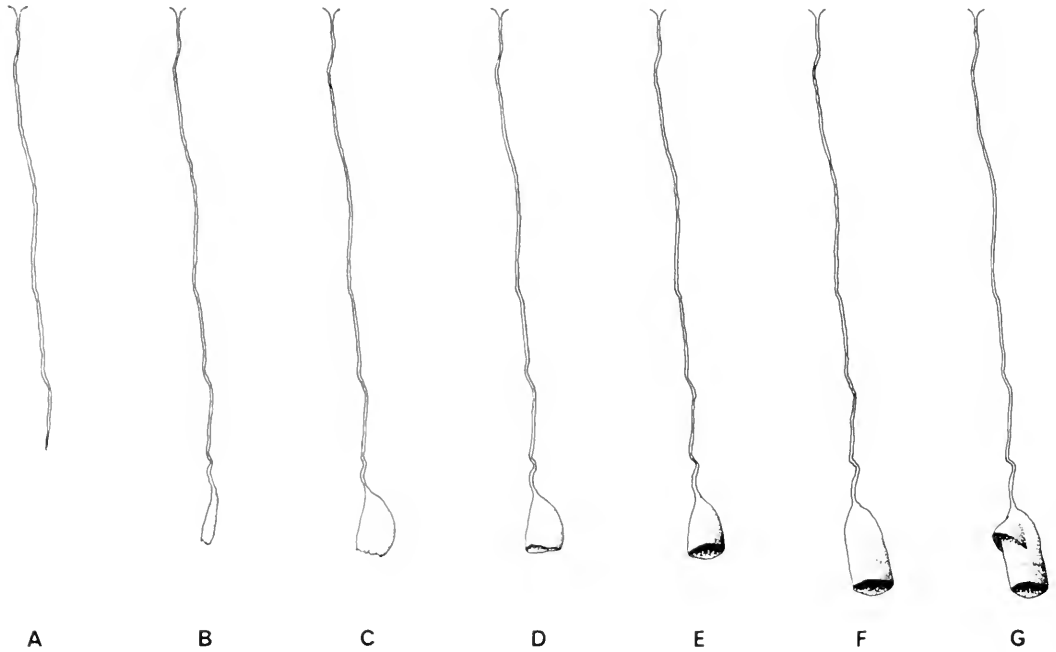

Figure 1. Stages in the initiation of a nest of *M. drewseni*. One day and seven loads of pulp were required for the single foundress to progress from stage A to G.

head (2–4 mm). She adjusts it briefly in her mandibles, using her forelegs to maneuver it, then returns to the nest. As far as it was possible to determine, the forelegs are not used to aid in holding the load during carriage.

At the nest the load of pulp may either be shared with one or more others on the nest, including the queen, or the forager may apply it to the nest herself (see Division of Labor, p. 91). In any case there is little further mastication of the pulp. The fibers are thus apparently merely removed from the substrate, moistened and mixed with a small amount of nest construction material and applied to the nest. The particles of material are coarse and chip-like.

A given forager frequently returned repeatedly over a period of hours or days to the same source for nest material. In one such case the same forager returned four times in succession over the course of

90 minutes to the same dead *Stachytarpheta* plant. Further evidence of this was frequently seen in the nest itself. One nest was constructed entirely of pulp of four discrete colors: black, gray, dark brown, and light brown. Observation revealed that each of the four workers was responsible for one of the colors, suggesting that each had its own private source of material to which it returned repeatedly.

D. NEST INITIATION

Figure 1A–G shows successive stages in early nest construction (nest 347). By the end of the first day the single foundress had succeeded in constructing the nest stem (Fig. 1A). This consisted of an extremely thin (0.2–0.3 mm) filament of pulp mixed with a large amount of a secretion produced by a gland that opens in the oral cavity. I call this material the “nest construction secretion.” The thoracic portion of the labial gland has been reported to be

the source of the building cement in *Vespa* (Janet, 1903). At 17:30 a final load of pulp was added to the lower end of the stem and was flayed out into a flat expansion (Fig. 1B). At 09:30 on the following day the wasp added the next load, using it to broaden the expansion (Fig. 1C). At 10:30 she added the next load, this time thickening the lower end of the expansion (Fig. 1D). At 11:00 the third load of the day was used to fashion a shallow cup, the base of the first cell (Fig. 1E). The next loads were used to heighten the walls of this first cell (Fig. 1F). By 14:30 this cell contained an egg and a second cell had been started (Fig. 1G). By 10:00 the following morning a third cell had been initiated, and by noon the second cell contained an egg and a fourth cell had been constructed.

E. CELL INITIATION

The second cell of a newly founded nest may be placed on any side of the cylindrical first cell. Subsequent cells, however, always straddle the groove between two adjacent cells. The first load of pulp is used to form a crescent-shaped ridge across the groove at the upper end of the cells. This is then expanded into a half of a hemisphere to form the floor of the cell. An egg is usually laid in the new cell by about this stage.

F. CELL HEIGHTENING

As the larvae grow the walls of their cells are heightened by the workers to keep pace. A worker with pulp moves over the face of the nest, rapidly inspecting the cells with her antennae, until she finds one in need of heightening. This is apparently judged by the length of the larva relative to the length of its cell, and not on the basis of the length of the cell relative to adjacent cells, since a cell containing an isolated large larva may be heightened several millimeters beyond the walls of surrounding cells.

Often when a worker moves about the

nest with a load of pulp the larvae become active, stretching their bodies so that they project beyond the rims of their cells. Some movement accompanies this stretching behavior. Larvae never respond in this way to the movements of a worker with a lump of solid food. Perhaps this response on the part of the larvae informs the worker with pulp as to which larval cells are most in need of heightening.

The load of pulp is usually applied in its entirety during the first pass or two, leaving a thick, lumpy rim to the cell. Then it is worked with the mandibles for several minutes until a uniformly thin wall is achieved. Occasionally only part of a load is used on a single cell and the rest applied elsewhere.

The walls between adjacent cells are straight, resulting in the hexagonal shape of cells surrounded on all sides. A worker heightening a cell uses one antenna inside each of the two cells sharing the wall she is heightening, in the manner Eberhard (1969) described for *Polistes*. Apparently by sensing the far walls of these cells, the antennae act as guides to keep the new work straight and centered.

Once a cell has produced an adult and received a new egg, the adults chew the walls down, reducing them somewhat in height, and apply the resulting bit of material elsewhere on the nest.

The wasps construct the entire nest using a single technique, namely the shaping of pulp into walls of a uniform thickness. Unlike certain other vespid genera, *Mischocyttarus* does not spread pulp in a thin layer over a surface.

G. ADDITION OF PULP TO CAPS OF PUPAL COCOONS

When a larva is ready to pupate it spins a silken cocoon in the upper end of its cell, closing the opening of the cell and sealing itself inside. Within a few hours after this, the workers apply pulp in a series of low ridges to the surface of this cap, effectively covering it with pulp (Plate III, fig. 6).

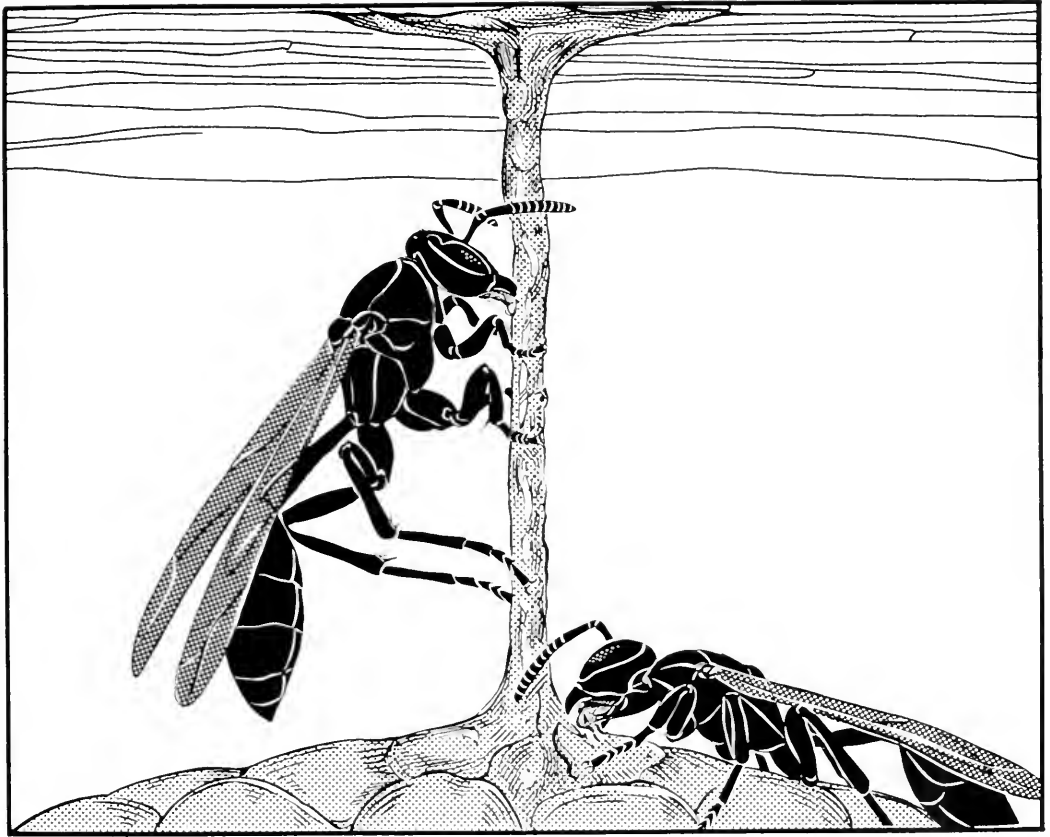

Figure 2. Mouthing: application of nest construction secretion. The wasp on the left is applying secretion to the nest stem itself, and the wasp on the right is mouthing the point of attachment of the stem to the comb. In this manner the nest support is strengthened as the nest grows and gains in weight.

This is also practiced by *M. lecointei*, *M. collarellus*, and, according to Vesey-Fitzgerald (1938), by *M. surinamensis*. This has at least two effects: 1) it serves to stiffen the delicate silk cap, making it less susceptible to damage as the adults move about over the nest face, and 2) it serves to camouflage the bright white of the silk, making the nest a more uniform color and less conspicuous from below.

Certain other species of *Mischocyttarus* (e.g., *M. injucundus* and *M. fitzgeraldi*) do not do this, but apparently apply the nest construction secretion to the caps. This has the same two effects as the application of pulp.

II. MOUTHING

As the nest increases in size the nest stem is continually thickened by repeated applications of the nest construction secretion. A wasp climbs the nest stem and "mouths" the base of attachment, using a licking movement of her mouthparts, then she slowly works her way backward down the stem until the top of the nest is reached (Fig. 2). This is repeated for up to 30 minutes at a time. The secretion hardens into a tough, plasticlike material. The stem from a large nest, when cut transversely, is seen to consist of many extremely thin concentric layers of this material surrounding the original pulp core. These layers can

be peeled off in small sheets of extremely thin pliable film.

The material is also applied in lesser amounts to the entire nest surface, gradually decreasing in thickness from the point of attachment of the stem to the periphery of the comb. One or a few layers are applied to the outer walls of all cells, right down to their rims.

The material no doubt serves primarily to lend strength and rigidity to the nest structure. The stem of a large nest is extremely strong and is only slightly flexible. If the material is carefully peeled from a portion of the nest surface, the remaining wood fibers are easily teased apart, suggesting that the material greatly aids in bonding the particles of nest material. The material also provides a waterproof coating to the nest, preventing it from being weakened should it be rained upon. Droplets of stored nectar and water for nest cooling also are prevented from soaking into the nest material.

Where the material is several layers thick, as on the stem and upper parts of the comb, it is very dark brown in color, almost perfectly matching the coloration of the adult wasps. In other species of *Mischocyttarus* the color of the nest construction secretion parallels the color of the wasps: dark-colored species (*M. injucundus*, *fitzgeraldi*, *drewseni*, *labiatus*) produce dark-colored secretion, while light-colored species (*M. lecointei*, *collarellus*, *surinamensis*) produce light-colored secretion (personal observation).

VI. TROPHIC RELATIONS

A. PROTEINACEOUS FOOD

1. Method of Foraging

M. drewseni always flew close to the ground. Even if a nest was several meters above the ground, a departing forager invariably flew directly down to within half a meter of the ground, then leveled out.

The flight of a forager was one of two types. If the forager was searching for

insects she flew slowly and erratically among tall grasses and weeds, often landing for a second or so. If the forager was after pulp or nectar she usually had a few sources to which she repeatedly returned. The flights to these sources were usually direct, though a forager sometimes started out searching for insects and then ended up going after nectar. The direct flights were low, just above the "canopy" of the low herbage, and at the speed of a very fast walk, perhaps 8–10 kph.

Most foraging was done within 40–50 m of the nest, though on several occasions I followed a forager for more than 75 m before losing it, either because it flew across some barrier impassable to me (such as out over the flooded vegetation along the edge of the river), or because I confused it with a forager of *Polybia sericea*, which *M. drewseni* apparently mimics.

The following example serves to illustrate the technique most frequently used by foragers hunting for prey.

On 19 June 1968 forager no. 13 of colony 168 left the nest and flew to a dead tree that stood about 20 m from the nest. This tree was about 6 m tall and quite shrubby; most of the twigs were still intact. The leaf nodes on the twigs were enlarged, forming conspicuous swellings 5–6 mm in diameter and spaced every 5–8 cm along the otherwise linear twigs. The forager flew slowly among these twigs, pouncing frequently on the nodular swellings from a distance of a few centimeters. In each instance she merely grasped the twig with her fore- and midlegs for an instant without landing, or she would land on it for a second or less, then fly on to the next. In this manner she rapidly inspected several dozen of these nodules until she happened upon a small, well-camouflaged silk sac attached to one of the twigs. She quickly tore this open with her mandibles and removed the organism that was inside, apparently an insect pupa. The wasp chewed it for a minute or so, reducing it to a round pulpy

mass, then she returned directly to the nest with the lump held in her mandibles.

On several occasions I observed wasps attacking small prey trapped in spiders' webs. For example, no. 4 of colony 268 pounced on a male ant about 4 mm long that was hanging from a small web in a low bush. After seizing the ant the wasp hung from the spider web by her hindlegs while she chewed the ant into a small ball. She then climbed the web to a leaf and continued chewing. After a minute she flew to a nearby bush and chewed for another 30 seconds, then returned to the nest with the lump. The pattern of capturing the prey, then hanging from the web upside down while subduing the prey, and finally moving to a better position for further chewing always occurred when prey was taken from webs.

In the morning hours foragers sometimes flew along the fence surrounding the meteorological station, searching for prey trapped in the spider webs that had been built during the night between the top two strands of barbed wire. On one occasion I watched a forager fly along the top strand of wire, pouncing on every one of the wire barbs and inspecting it to see if it was prey.

In summary *M. drewseni* hunts on the wing, evidently responding to visual cues in its search for prey. The essence of the technique seems to be to fly among twigs, stems of tall grass, or anything else that provides a linear outline on which irregularities stand out against the background. Such an irregularity releases the next step, which is for the wasp to pounce quickly upon it, usually from a distance of 4–10 cm, and rapidly inspect it. The rapid pounce from flight apparently is an adaptation to minimize the chance that an alert and agile prey will escape. If the object is an appropriate prey it is quickly chewed up for carriage to the nest. Objects hanging free, such as in spiders' webs, release the same behavior.

The size of the object no doubt plays an important role in releasing the behavior.

The smallest object *M. drewseni* foragers pounced upon was an homopteran about 3 mm long, and the largest a *Trypoxylon* wasp about 15 mm long, though this latter was rejected. A forager was never observed to capture any prey that was too large to be chewed up and carried back to the nest in one trip. On the other hand, if the first prey was very small, it was sometimes completely chewed up in the field and the tiny solid fragment remaining discarded. The forager then often searched for another prey.

The following observed exception to the usual foraging technique is of interest: A forager landed on the lower part of an orb web, then began to climb up it. The spider, from its position in the center of the web, began to vibrate the web violently up and down. The wasp paused briefly, then resumed climbing toward the center. When the wasp got to within 2 cm of the spider, the spider dropped from the web. It appeared as though this act of the spider was deliberate, as if to escape the approaching wasp. The wasp then flew off. The cross-strands of the web were sticky to the touch, yet it was evidently these that the wasp was climbing on.

One of the most distinctive morphological characteristics of the genus *Mischocyttarus* is the asymmetry of the tarsal lobes of the mid- and hindlegs. The inner lobes are elongated, especially those of the distal tarsal segments. In the group *M. labiatus*, to which *M. drewseni* belongs, this feature is quite well developed. It is conceivable that this is an adaptation for climbing on spider webs in search of prey. The elongated inner lobes may hook over the fine strands of silk, acting in the manner of telephone lineman's spikes. This hypothesis accounts for the fact that the asymmetry of the tarsal lobes is most pronounced on the hindlegs and nonexistent on the forelegs. When a wasp climbs a web, the force on the hindlegs is proximal, therefore the hooks point away from the body. On the forelegs, however, the force

is distal—the wasp is hanging from these legs—and here the tarsal claws act as hooks. The inner tarsal claws of the hind and midlegs are also elongated, possibly an adaptation to hanging upside down from the web as the prey is chewed. By this argument the claws of the foretarsi might also be expected to be asymmetrical, since they are used in climbing. Their symmetry is perhaps explained by the fact that the forelegs are used extensively in the manipulation of prey after capture and during chewing, and also in cell construction. It is possible that asymmetry of the foreclaws would render them unfit for these other tasks.

On the one occasion on which I observed prey capture in another species of *Mischocyttarus*, a forager of *M. lecoinctei* hovered in front of a small spider (body 3–4 mm long) hanging from a single thread of silk between two leaves. The wasp then darted at the spider, grabbed it and flew backward with it, tearing it from the thread. It then landed on a nearby leaf and chewed up its prey, for about 45 seconds, then flew to another leaf to chew for another minute. It is possible that this wasp normally lands on spider webs, just as does *M. drewseini*, but did not in this instance because the single thread did not provide enough support.

The only previous record of prey-capture in *Mischocyttarus* is Williams' (1928) mention of *M. labiatus* "examining the orbs of spiders and robbing them of their smaller entangled prey." Unfortunately, he did not make clear whether the foraging wasp actually landed on the web.

On the other hand, wasps of other genera, which do not possess the asymmetrical tarsal lobes, sometimes take prey from spiders' webs but without landing on them. On two occasions I observed *Polybia occidentalis* snatch male ants from orb webs without landing, and Williams (1928) says that *Stenogaster depressigaster* regularly removes tiny insects ensnared in

spiders' webs, but without landing on the web.

This method of visually finding prey from flight, as used by *Mischocyttarus* and apparently by *Stenogaster*, differs from that used by such species as *Polybia sericea* and *Polistes canadensis*, both of which search for prey by crawling about over the leaves of grass and other low vegetation.

2. Prey

Because foragers so rapidly chewed captured prey beyond recognition, it was rare that the prey could be identified. I have seen *M. drewseini* foragers taking the following as prey: eggs from the silken case of an arthropod, probably a spider; a small moth from a spider web; male ants from spider webs; a small hemipteran nymph; a small tettigoniid grasshopper. A small weevil and a large *Trypoxylon* wasp were rejected. Small spiders when crushed and offered to wasps on the nest were readily accepted. I have never known *M. drewseini* to be attracted to fresh meat or fish, though these were often accessible to them and readily attracted wasps of certain other genera.

The only published prey records for *Mischocyttarus* are those of Snelling (1953) for *M. flavitarsis* in California. He states that their prey consists mostly of flies and caterpillars, but that they are also attracted to meat, hides, and fish. Although the prey preferences of this species appear to be different from those of *M. drewseini*, the data are not extensive enough to permit the recognition of significant differences.

3. Distribution to Adults on the Nest

When a forager returned to the nest with a masticated lump of food she usually paused for a few seconds. At this time one or more adults on the nest, including the queen and males, approached the forager to solicit the lump. The forager often turned to face her nestmate and held the lump forward, as though to offer it. The

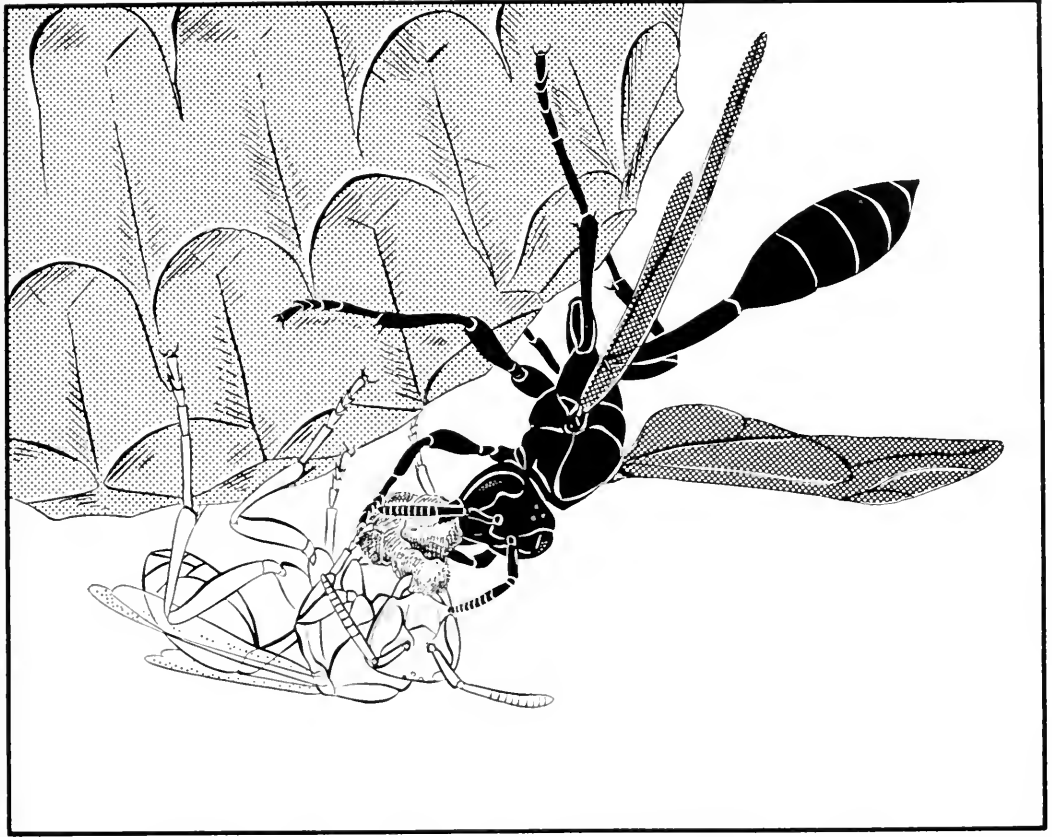

Figure 3. Sharing a lump of insect food with a nestmate. In this case the nestmate has accepted insect food brought by the forager (left), and the lump is being split. The antennae of the soliciting wasp (right) are occasionally tapped against the lump (left antenna is in motion). The antennae of the forager, on the other hand, are still. Note the submissive posture of the solicitor (head low, wings spread, abdomen raised).

solicitor antennated the food briefly, then usually took the whole lump or chewed a piece from it. Or, after tasting it, the would-be solicitor moved away without taking any. During exchange, which often lasted for half a minute, the antennae of the solicitor were used primarily to tap the lump itself and were not used against the sides of the face of the forager, as they were when liquid was being solicited (see p. 83). The forager also occasionally tapped the lump with her antennae during the exchange, though her antennae were used relatively little (Fig. 3). After the soliciting wasp had taken a part of the

lump, she in turn frequently shared it with others.

4. Distribution of Solid Insect Food to the Larvae

Lumps of food were chewed for several minutes by males and females alike. The wasp chewed forward on the lump while rotating it towards her with the forelegs; thus, when viewed from the left side, the lump rotated clockwise. During the course of chewing, the lump became somewhat smaller and considerably drier in appearance; apparently as they chewed the wasps extracted liquid from the mass and

stored it in the crop. In the case of females, the remaining solid fragment was then fed to the larger larvae. The adult adjusted her grip on the lump so that a small portion protruded in front of the mandibles, while the bulk of it was held behind. The larva removed the smaller fragment and ingested it whole, with no real chewing. The adult masticated the lump again briefly, then readjusted it prior to feeding the next larva. This was repeated until the lump was gone. Sometimes a larva did not ingest a bit of food, which then remained on its mouthparts. A worker sooner or later discovered it, removed it and chewed it briefly, then fed it to another larva.

Transfer of solid food was always directly to the mouthparts of the larva. The pair of prominent lobes on the ventral surface of the first abdominal segment of the larva was not used to support the food, as Reid (1942) suggested, and was in fact in no way involved in feeding.

Males and nonworkers who had taken lumps from foragers chewed them even longer than did workers. The remaining dry fragment was then usually fed to larvae, though it was often merely dropped.

The extraction of liquid during the chewing of solid food also occurs in *Belonogaster junceus* (Roubaud, 1916) and *Polistes fadwigae* (Yoshikawa, 1962). According to Yoshikawa (1962), workers of *P. fadwigae* tear pieces of meat from the lump with their forelegs and present them to the larvae, rather than letting the larvae remove the pieces. The passing of solid food to larvae via nestmates occurs in *Belonogaster* (Roubaud, 1916) and in *Polistes gallicus* (Heldmann, 1936). Roubaud (1916) reported that males of *Belonogaster* regularly take lumps from foragers and chew them, though he did not say whether or not they pass them on to larvae. In 75 hours of observation Heldmann (1936) saw a male of *Polistes gallicus* chew a bit of caterpillar and feed it to a larva on only one occasion. Apparently this be-

havior of males is much rarer in *P. gallicus* than in *M. drewseini*.

5. Distribution of Liquid to Adults and Larvae

After a worker had given up her lump of food, either to other adults or directly to the larvae, her nestmates often approached her to solicit for the liquid extract that she took into her crop during mastication of the prey. It was almost always the queen, males, and nonworkers who solicited this liquid; the mature workers rarely did. The mechanism of the solicitation was identical to that involved in soliciting for nectar (see p. 83).

Roubaud (1916), though observing that females of *Belonogaster junceus* extract liquid from prey by masticating it, apparently did not believe that any of this liquid is regurgitated to the larvae; he concluded that all liquid exchanges between larvae and adults are trophallactic exchanges in which the adult solicits salivary secretion from the larvae. Heldmann (1936), however, noticed that *Polistes gallicus* does feed insect juice to the larvae, and Yoshikawa (1962) reported that it is standard procedure in *Polistes fadwigae*.

In an experiment to confirm that this occurs in *M. drewseini*, I macerated small spiders with blue vegetable coloring. These "prey" were readily accepted by females on the nest and chewed in the normal manner. Initially very wet, the masses were reduced after several minutes' chewing to quite dry lumps; obviously, a good deal of the liquid had been ingested. After feeding the lumps to larvae as described above, the adults visited larvae and regurgitated the liquid, leaving a blue-colored droplet on the mouthparts of each. Of 289 foragers returning with insect food to nest 268.70.2 percent regurgitated liquid to the larvae.

Very young larvae received proteinaceous food only in the liquid form. On a nest containing only eggs and young larvae, the queen macerated a lump of food, extracting the liquid, then discarded the lump

and visited the larvae, regurgitating the liquid to them. This same relation was confirmed for *Polistes fadwigae* by Yoshikawa (1962) and for *P. antemalis* by Morimoto (1954a). Younger larvae do not have sclerotized mouthparts and are probably unable to pull bits of solid food from the main lump held by the workers.

Though they regularly took and chewed lumps of food, extracting the juice, then sometimes fed the lump to larvae, males of *M. drewseni* never regurgitated the liquid to the larvae.

There was no way to prove that adults retained some of the liquid they had extracted from prey for their own consumption. That this is probably the case is indicated by the following observations: a) single foundresses on pre-larva nests occasionally foraged for prey, returned to the nest, masticated the lump for several minutes, then dropped the dried fragment; b) males frequently chewed lumps of insect material, evidently extracting liquid for themselves; c) 22.8 percent of the foragers who returned to nest 268 with lumps of food subsequently fed liquid neither to larvae nor to other adults, presumably keeping it for themselves. Roubaud (1916) concluded on the basis of similar evidence that adults of *Belonogaster junceus* eat insect juice. Heldmann's (1936) observations of *Polistes gallicus* suggest that the same is true of that species. Rau (1928a, 1930) reported seeing queens of *Polistes pallipes* and *P. variatus* eating insect food when no larvae were present. Elsewhere (1939) he reported that males of *P. pallipes* feed on insects brought by the foragers.

B. CARBOHYDRATE FOOD

1. Sources

Nectar was the most important source of carbohydrate. This was obtained from the buds and flowers of such plants as *Alternanthera ficoidea* (Amaranthaceae), *Hyptis atrorubens* (Labiatae), *Clidemia hirta* (Melastomataceae), and *Jatropha*

gossipifolia (Euphorbiaceae) and from the surfaces of the green seed capsules of *Heliotropium indicum* (Boraginaceae).^{*} *M. drewseni* workers also visited nipple-like extrafloral nectaries that occur on the stems of an unidentified alfalfalike legume, preferring these to the flowers of the same plant. They also sometimes obtained honeydew from the coccid *Antonina graminis*.^{**} These mealy-bugs were found at the leaf axils of a creeping grass. They were 2-3 mm long and covered with a thick white powdery coating. Protruding from the posterior end of each insect was a thin white tube about 1 cm long. The tips of these tubes often contained droplets of honeydew, which was sweet to the taste. The foraging wasps crawled down into the grass where these coccids occurred and went from one to another, collecting the droplets. There was nothing to suggest that the wasps elicited secretion of the droplets.

Snelling (1953) reported that *M. flavitarsis* in California collects nectar from the flowers of *Melilotus indica*, *M. alba* (Leguminosae) and *Helianthus bolanderi* (Compositae), and Bequaert (1933) captured a male of *M. cubensis* at flowers of *Lantana camara* (Verbenaceae) in Cuba. There is no record in the literature of any *Mischocyttarus* collecting honeydew from coccids or other Hemiptera, though Williams (1928) reported seeing *Parachartergus apicalis* in Ecuador gathered at clusters of young Membracidae, apparently attracted by the honeydew these bugs secreted. I have seen *Stelopolybia testacea* and *Pseudopolybia vespiceps* behaving the same way in Belén. Whether any of these species actually "milk" the bugs to elicit the secretion is not known.

A good source of nectar was repeatedly visited by the wasp that had discovered it, but there was apparently no communica-

^{*} All plants were determined by Dr. Murça Pires, IPEAN, Belém, Pará.

^{**} Determined by D. J. Williams, Commonwealth Inst. of Ent., London.

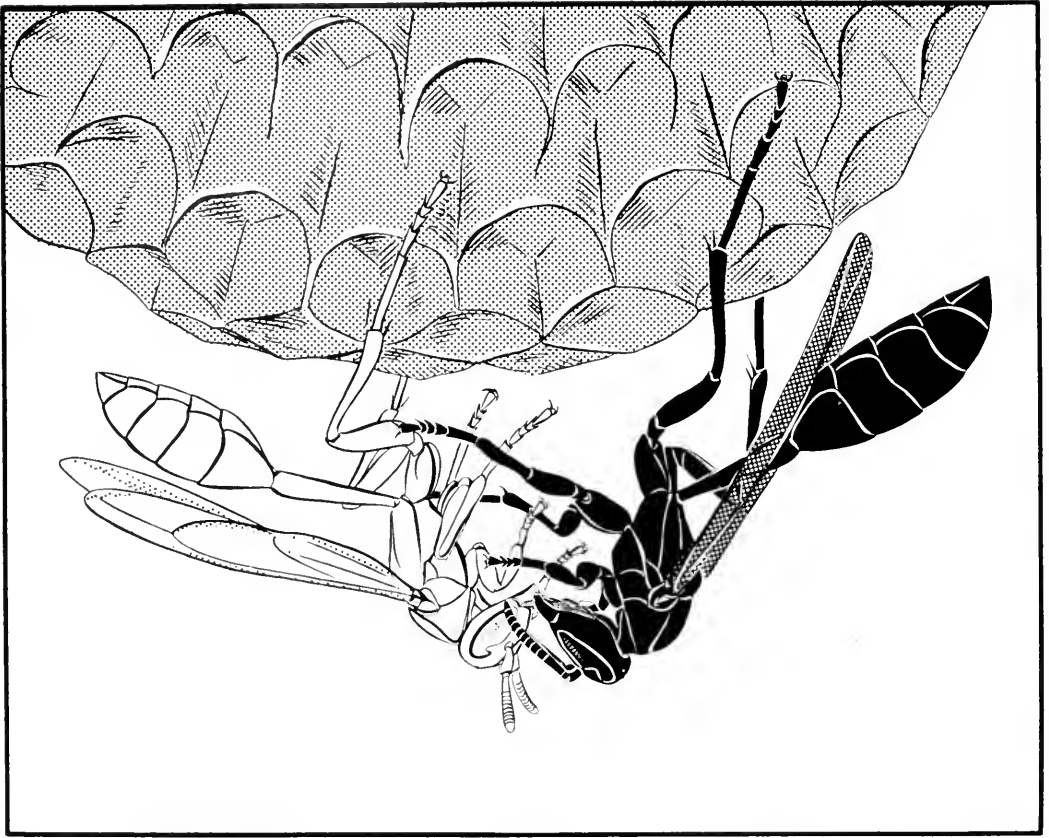

Figure 4. Exchange of nectar. The queen (right) is soliciting nectar from a forager. Note the position of the solicitor's antennae against the gence of the forager.

tion of its location to nestmates. I placed droplets of blue-colored sugar solution on the flowers of *Clidemia hirta*, which a marked forager was visiting for nectar. After discovering the solution the wasp made six consecutive trips in an hour and a half to the same site, stocking up on the sugar solution each time. During this time no other wasp visited the source. Three days later I repeated the experiment with another wasp from the same colony. In slightly over 3 hours she returned 20 times to the source. An interesting incident occurred when another wasp of the same colony landed near the forager while the latter was stocking up on sugar solution. The forager responded by chasing her nest-

mate from the plant, hardly an act of cooperation for the good of the colony.

2. Distribution of Nectar to Adults on the Nest

It was rarely possible to determine whether a forager brought nectar or was returning empty. If, upon landing on the nest a forager was either immediately solicited from by her nestmates or went to the larvae, it was assumed that she had brought nectar. This was precisely the behavior of foragers for whom colored sugar solution was provided in the field, as described above; that they were yielding it up to both adults and larvae at the nest was confirmed by residues of the colored

liquid on the mouthparts of the recipients after each exchange. In a small proportion of instances, foragers returned to the nest and groomed or rested without exchanging with either adults or larvae, then after some minutes visited larvae. Whether on these visits the foragers were feeding the larvae or soliciting secretion from them in trophallactic exchange was rarely clear. For purposes of analysis, it has been assumed that the latter was the case. Another uncertainty is due to the fact that foragers sometimes captured insects and chewed them up in the field, discarding the solid parts, then returned to the nest with insect juice in the crop. I suspect that this was somewhat rare, and that it is safe to assume that the majority of returns with liquid only were returns with nectar.

When a nectar forager returned to the nest, her nestmates, including the queen, nonworkers, and males, often solicited some of her liquid load. The solicitor approached the forager's head and rubbed its antennae vigorously against the mandibles, genae, and eyes of the forager as their mouthparts came into contact (Fig. 4). The forager usually held her antennae above the head of the solicitor and occasionally tapped them against the top of the head. Exchange of liquid lasted from less than a second to several seconds. There was wide variation in the vigor with which solicitation occurred. In the case of males the violence with which they solicited nectar probably depended upon how hungry they were. In the case of the queen and other females, however, it appeared to depend upon the relative dominance of the solicitor versus the forager.

Often when nectar was not shared with the nestmates (48.6 percent of the 356 observed returns), the forager appeared willing to offer to them but none approached, apparently because they were not hungry. In a few cases the forager turned away from those who approached her and went directly to the larvae.

I observed only one instance in which

a female solicitor of nectar was in turn immediately solicited from by a nestmate. In eight cases solicitors immediately fed larvae with nectar they had just received from foragers. Males were never observed to pass nectar on either to other adults or to larvae.

3. Distribution of Nectar to Larvae and Storage of Nectar

After sharing part of her nectar load with nestmates, a forager usually then fed nectar to the larvae (92.9 percent of 356 foragers). From one to many larvae were visited for from one to two seconds each. With each regurgitation of a droplet of the nectar onto the mouthparts of a larva, segments of the gaster visibly telescoped into one another, a phenomenon apparently associated with the pumping action of the crop. Vibrations of the abdomen occasionally accompanied nectar feeding (see Abdominal Vibration, p. 85).

Workers often spent more than a minute visiting each newly eclosed larva. Rau (1928a) described this kind of behavior in *Polistes pallipes* and concluded that the larvae were being fed liquid. If this is true, it is hard to understand why the visits should last so long. It may be possible that these larvae were being attended to in some other way; perhaps they were being cleaned.

Cells containing eggs were sometimes seen to contain clear droplets of nectar clinging to their walls. These droplets apparently were reserves, stored up when nectar was abundant. One of the experiments described above, in which a forager was provided with colored nectar, supports this conclusion. The forager shared its first load with a male and with larvae, leaving a blue droplet on the mouthparts of each larva visited. The next load was stored in egg cells. The third and fourth loads were shared with the queen and the larvae, and the remainder stored in egg cells. Out of the next 15 trips, she shared with nestmates 10 times, fed larvae 11 times, and stored

the remainder of each of 13 loads in egg cells. The stored droplets, in this artificial case as many as four to a cell, were gradually depleted over a period of from one to two days.

Nectar droplets were stored only in cells containing eggs, never in larval cells, though Rau (1928a) noted that *Polistes* in North America occasionally stores it in cells with larvae a few days old. The facts that droplets in a cell were often placed on the wall opposite the egg and near the mouth of the cell, and that they were usually used up before the egg hatched, indicates that they were not placed there for the newly eclosed larva to feed upon directly. Rau (1928a) reached the same conclusion for *Polistes pallipes*. I have seen nectar droplets on nests of *M. lecoinctei*, *M. injucundus*, and *M. collarellus*. The nectar-storing habit occurs in *M. injucundus* and *M. ater* in Trinidad (Vesey-Fitzgerald, 1938) and in unidentified Mexican species of *Mischocyttarus* (Rau, 1940), and is widespread in *Polistes* (Janet, 1903; Rau, 1928a, 1939; Heldmann, 1936). It occurs elsewhere in the tribe Polybiini, including *P. rejecta* and *P. occidentalis* (Vesey-Fitzgerald, 1938), and *Metapolybia* sp., reaching a culmination in *Brachygastra mellifica* and *B. lecheguana* (Schwarz, 1929). *Belonogaster junceus*, however, is said by Roubaud (1916) never to store nectar.

Heldmann (1936) noticed that the number of droplets stored in egg cells by *Polistes gallicus* was especially high with the approach of bad weather, implying that these wasps have the ability to sense the approach of a period of poor foraging and the "foresight" to lay in a supply of nectar in advance of it. I have no evidence for this in *M. drewseii*. The experiment cited above, in which I supplied a forager with a limitless supply of nectar, was done when the weather was fair for several days. This suggests that the amount of stored nectar depends primarily upon the law of supply and demand, just as Rau (1928a) concluded to be the case for *Polistes*.

That the larvae of *M. drewseii* are fed nectar has been demonstrated. The following two facts indicate that adults also feed on nectar: a) the foundress on a nest that has not yet produced any larvae sometimes collected nectar, stored the droplets in the egg cells, then depleted these droplets over a period of a day or two, presumably for her own use; b) males solicited nectar from returning foragers, as demonstrated by the experiment with colored honey solution, and apparently did not pass it on to larvae.

C. LARVAL TROPHALLAXIS

The larvae produce copious amounts of a clear secretion upon tactile stimulation of the head region. That this is a secretion and not a regurgitate was demonstrated by feeding a larva a large amount of colored sugar solution and then immediately stimulating it about the mouthparts. The resulting liquid was always clear. The source of this secretion (in *Vespa*) is said to be the labial gland (Janet, 1903; Maschwitz, 1966b).

In a test to determine the attractiveness of this secretion to adult wasps I offered droplets of it on the tip of a glass rod. Females eagerly lapped it up and licked the glass rod at some length. Alternate offerings of pure water were rejected. Males also accepted secretion thus proffered, though less eagerly than females. Using radioactive tracers, Morimoto (1960) has provided a rigorous demonstration that adult *Polistes chinensis* do take up the secretion.

Because of the difficulty of detecting which way liquid was passing between a larva and an adult, the data regarding how frequently trophallaxis occurred are only approximate. Often workers visited larvae after completing a task on the nest, after a long rest, or just before leaving the nest to forage. On such visits the workers spent five to ten seconds at each larva, much longer than the typical visits of a forager feeding nectar or insect juice. These longer visits probably involved trophallactic ex-

change. For example, on one occasion a worker returned to her nest (230) with a load of pulp and rested. After three minutes she began to heighten a cell, taking six minutes to complete the task. She groomed for 40 seconds, then visited larvae for one minute and 20 seconds, groomed briefly and left the nest. When she visited larvae in the shorter peripheral cells of the nest it was possible to see that she gently bit or mouthed the mouthparts of the larvae with her mandibles. Each larva responded either by producing a droplet of secretion, or, apparently if it has none to yield, by retracting into the cell and pulling its abdominal lobes over its head.

All the adults of the colony, including males, visited the larvae for the salivary secretion. When an adult emerged from its cocoon its first act was to visit one or two larvae, where it apparently obtained this secretion. These contacts were quite long, frequently lasting 30–60 seconds.

Ishay and Ikan (1968a, b) have found that adults of *Vespa orientalis* lack proteolytic enzymes but that larvae have them. On the basis of their work they have concluded that the larvae digest proteins in the insect food given to them by the adults and that the function of larval trophallaxis is to provide the adults with the protein digestion products. Whether or not this is true for *Vespa orientalis*, my observations suggest that it is probably not true for *M. drewseni*, since adults apparently do ingest protein as they malaxate prey, even when no larvae are present in the nest. The evidence for *M. drewseni* fits the simpler hypothesis of Maschwitz (1966b) that the larval secretion functions as a colony food reserve in times of poor foraging.

D. BEHAVIOR ASSOCIATED WITH FEEDING AND TROPHALLAXIS

1. Abdominal Vibration

Frequently, while a female visited larval cells, she vibrated her gaster rapidly up and down, flexing it at the joint between

the first and second abdominal segments. The vibrating occurred as the wasp left one cell and entered the next; during the actual contact with the larva, the abdomen was quiet. At the end of each vibration the gaster was usually bent down almost 90° at the end of the petiole, then was gradually straightened during contact with the larva. The intensity of vibration varied greatly, from a violent movement in which the ventral side of the gaster struck the surface of the nest, often producing an audible sound, to a mere perfunctory twitch or two in which no contact was made with the nest.

Abdominal vibration sometimes accompanied the feeding of liquids to larvae, as shown by experiments with colored sugar solution. However, feeding also occurred without vibration. During a series of visits a worker sometimes vibrated during the first few visits and not during later ones, or vice versa. Sometimes she did not vibrate at all. Abdominal vibrating accompanied 72 percent of visits in which insect juice was fed to larvae, and 61 percent of the nectar-feeding visits (nest 268). Again, because of the difficulty of determining whether a worker was giving or taking liquid during a visit to a particular larva, these figures may not be completely accurate.

There was a good correlation between vibration and visits to larval cells as opposed to egg cells. On several occasions I fed colored honey water to foragers, then observed them return to the nest and alternate between feeding larvae and placing droplets on the walls of egg cells. Such foragers vibrated prior to entering a larval cell, but usually not before entering an egg cell. The few exceptions to this latter rule occurred when a visit to an egg cell immediately followed a visit to a larva, as though the wasp had mistakenly expected another larva. I never saw a foundress vibrate on a nest that did not yet contain any larvae; as soon as the first larvae eclosed, however, vibration occurred.

Females occasionally vibrated during trophallactic visits to the larvae, though there are no reliable data regarding the frequency. It never accompanied the distribution of solid food to the larvae. Males never vibrated their abdomens.

2. "Pecking"

Another form of behavior, which I call "pecking," also accompanied the visiting of larvae, but much less frequently than abdominal vibration. In a typical sequence, a female inserted her head partway into an open cell, then rapidly vibrated her whole body forward and backward, giving the impression that she was violently pecking at something in the cell. This often continued for 10–30 seconds. In some cases the contact of the head with the cell wall produced an audible rattle. There was no apparent contact with the brood in the cell. This was observed a total of 14 times; in 12 cases it was done by the queen, twice by workers. It was more frequently done in egg cells (six out of ten) than in larval cells (four out of ten). In 13 out of 14 cases (93 percent) the sequence of behavior was as follows: visiting larvae and vibrating the abdomen, pecking, grooming, resting. In the other case a queen fed a lump of food to the larvae, pecked, then dominated a subordinate. Neither adults nor larvae responded in any visible way to this behavior.

3. Rubbing

A third type of behavior may be related to these other two. This resembled the rubbing of the gaster over the surface of the nest stem and back of the comb during application of the ant-repellent secretion (see below, p. 89), except that it was done on the face of the comb as a female moved over the open cells. The movement was a forward and backward "scrubbing" of the underside of the gaster against the edges of the open cells at a rate of about three times per second. Though contact was made with the nest surface, no sound

was ever detected. Such behavior often preceded visiting the larvae, especially if the individual had just come onto the face of the nest from a rest position on the side or back of the comb. There was no evident response, either on the part of larvae or other adults, to this behavior. Males never rubbed their gasters in this manner.

The function of these behavior patterns is not clear. The fact that adults placed droplets on the walls of egg cells without having vibrated indicates that this movement is not associated with the mechanics of regurgitation. There was no visible response on the part of the other adults during any of these movements. The most likely hypothesis is that it is some kind of signal to the larvae, transmitted as vibrations through the nest. Yet I could never detect any response in the larvae, neither movement nor production of larval secretion. If the adults are communicating something to the larvae, it is apparently not essential that it be done before every visit. If it is a signal, it is likely that it is transmitted to all the larvae in the nest, regardless of the position of the adult, and perhaps after a few visits with vibration all the larvae are alerted.

4. Discussion

Roubaud (1916), in describing *Belonogaster junceus*, reported that after a worker feeds a lump of food to the larvae, she goes from larva to larva, "quivering and vibrating her wings" before each visit. According to Roubaud, this causes the larvae to exude secretion, which the worker then sucks up. Rau (1928b, 1938) described three related types of behavior in *Polistes pallipes* queens. In one the gaster is vigorously moved from side to side over the open edges of the cells, causing an audible rattle. In the second, the gaster may be rubbed rapidly forward and backward over the cells. Third, the whole body may be moved rapidly forward and backward while the head is in a cell. Rau reported that all of these movements produce an

audible rasping sound, all cause the larvae to produce beads of salivary secretion, and the queens always poke their heads into the cells immediately afterwards. His interpretation was that the function of these movements is to induce the larvae to produce droplets of secretion for the adults. Heldmann (1936) reported that *Polistes gallicus* workers "rattle" the gaster vigorously from side to side over the surface of the comb, a behavior apparently identical to the first type described by Rau for *P. pallipes*. Heldmann, however, claimed that this occurred prior to giving up nectar and insect juice to larvae rather than prior to trophallactic exchange. He does not cite Rau's 1928 work.

It appears that what I call "abdominal vibration" in *M. drewseni* is analogous to the wing quivering in *Belonogaster junceus* and the side-to-side abdominal "rattling" in *Polistes pallipes*. What I call "rubbing" may be analogous to the forward-backward movement of the gaster in *Polistes pallipes* described by Rau, except that it is audible in *P. pallipes* and not in *M. drewseni*. The "pecking" behavior of *M. drewseni* appears to be identical to the third type of behavior Rau described for *P. pallipes* queens, except that in *P. pallipes* it was followed by trophallactic visits to the larvae, whereas in *M. drewseni* it was followed by grooming and resting.

My own observations agree with Heldmann's in that the "rattling" or "vibration" may precede feeding as well as trophallaxis. If this is so, then Rau's conclusion that these movements function to elicit salivary secretion from the larvae would seem not to apply to *M. drewseni* and *P. gallicus*.

A rigorously carried out comparative study of this behavior in several species of each of the three genera is badly needed. If the behavior does indeed have the same function in each of the three genera, then here may be an opportunity to study the evolution of a stereotyped behavior pattern.

TABLE 4. NATURAL CAUSES OF COLONY TERMINATION IN *M. DREWSENI*.

	Number of colonies	Percent
Declined normally	6	32
Foundress(es) died	3	16
Destroyed by ants	2	10
Destroyed by wind	1	5
Destroyed by unknown causes	7	37
	19	

VII. ENEMIES AND DEFENSE

A. ENEMIES

1. Predators of Brood

a. *Ants*. Of 19 colonies of *Mischocyttarus drewseni* that either declined or were destroyed by natural causes, two were destroyed by ants (colony 168 by *Monomorium pharaonis* and 264 by *Camponotus abdominalis*)* (Table 4). Once the ants gained access to the nest, destruction was complete down to the last egg and droplet of nectar. In each case several of the adult wasps remained near the nest for several days after the ants were gone, but would not land on it. Two adults of one colony (264) subsequently founded a new nest (295).

Records of ants attacking other species of *Mischocyttarus* included one case of *Crematogaster* sp. attacking a nest of *M. lecointei*, one case of *Crematogaster* sp. attacking a nest of *M. labiatus*, and one case of a ponerine ant attacking the brood of *M. lecointei*.

Though I witnessed no attack by *Eciton* on *Mischocyttarus*, there are records in the literature of these ants preying upon other Polistinae (Fiebrig, 1907; Wheeler, 1925; Myers, 1929; Schwarz, 1931; Vesey-Fitzgerald, 1935), and no doubt this genus constitutes a significant threat to social wasps in general.

* All ants determined by Dr. Edward O. Wilson, Biological Laboratories, Harvard University, Cambridge, Mass.

b. *Other predators.* No other predators were caught in the act of attacking the brood of *M. drewseni*. However, seven of 19 nests (37 percent) were destroyed at night such that the cells were badly damaged or the entire comb was missing, as if bitten off at the lower end of the nest stem. All these nests were small. Elsewhere (Jeanne, 1970b) I discuss the possibility that the predators were bats. Nests of *M. lecointei* were also occasionally destroyed in this manner.

Zikán (1951) claimed that the major enemies of *Mischocyttarus* colonies are birds, but that monkeys are also important. *Piranga rubra* attacks wasps' nests and eats brood (Rau, 1941b; Hamaker, 1936; Alvarez del Toro, 1950). Bertoni (1911) stated that a woodpecker (*Leuconerpes candidus*) is a serious enemy of *Polybia occidentalis*.

2. Predators of Adults

Predation of adults was rare. Spiders are probably among the most serious predators of the adult wasps. On one occasion a male *M. drewseni* was captured by the spider *Ariadna gracilis*;^{*} apparently the wasp had come near the entrance of the tubular silken nest in which the spider was hiding. On another occasion a large mygalomorph spider snatched a *Polistes canadensis* forager out of the air and paralyzed it. Yoshikawa (1963b) reported that a worker of *P. fadwigae* was caught in a spider web and killed. Vesey-Fitzgerald (1938) found an adult *M. surinamensis* captured by a salticid spider.

Other insects are probably also important enemies of adult wasps. On one occasion I discovered a large praying mantis stationed about 30 cm from a nest of *Polybia occidentalis*. As foraging wasps returned to the nest, the mantis captured and ate those that flew close to it. Vesey-

Fitzgerald (1938) noted that the fly *Nusa erythropygæ* (Asilidae) has been collected carrying *Polybia rejecta*. On the other hand, *M. drewseni* were not touched by any of the several species of dragonflies that commonly patrolled the open areas where the wasps foraged. More than once I watched large dragonflies hover a few centimeters in front of flying foragers, as though sizing them up, but they never attempted to capture the wasps, even though the slow-flying *M. drewseni* would have been easy prey.

The only record of a vertebrate preying upon adult wasps is Vesey-Fitzgerald's (1938) discovery of *M. surinamensis* in the gizzard of a swift.

3. Parasites

I never found a nest of *Mischocyttarus* containing parasitized brood. On several occasions I have seen ichneumonids land on nests of *M. drewseni* and *M. lecointei* and inspect them briefly before flying off. As far as I was able to determine none ever laid eggs. In most cases adults on the nest would spot them and move toward them, causing them to take off. Richards (1945) summarized the literature on parasites of *Mischocyttarus*.

When colonies of *M. drewseni* began to decline and empty cells began to appear, a tiny brown and yellow moth was often seen to visit the nest and run rapidly in and out of the cells. The adult wasps rarely paid any attention to these moths. Though many nests were collected after they had been abandoned, none of them ever produced any of these moths, as they might have been expected to had the moths been ovipositing.

Rau (1941a) reported that larvae of the moth *Chalcoela iphitalis* feeds on the larvae of *M. basimacula* in Mexico. This and several other species of Lepidoptera are parasitic on the larvae and pupae of *Polistes* (Rau, 1941a; Vesey-Fitzgerald, 1938), and others are scavengers on the exuviae (Swezey, 1910; Vesey-Fitzgerald, 1938).

^{*} Determined by Dr. Joseph A. Beatty, Dept. of Zoology, Southern Illinois University, Carbondale, Illinois.

Vesey-Fitzgerald (1938) found *M. surinamensis* pupae parasitized by an ichneumonid and by a dipteran. He also frequently found larvae of phorid flies in the cells of *M. labiatus*, apparently feeding on the exuviae and on the wasp pupae.

Of 760 adult *M. drewseni* marked for identification only two (0.26 percent) were stylopized. Both were females. *M. flavitarsis* from Arizona has been found stylopized (Salt and Bequaert, 1929). Ducke (1910) says that stylopization of the genus is common, but Richards (1945) found only two stylopized specimens in 1335 examined.

On two occasions dead *M. drewseni* females were found clinging to the nest in a lifelike manner. There was no sign of injury to these wasps. Presumably they died of an internal parasite or of a disease.

4. Social Parasitism

There was no evidence of social parasitism in *M. drewseni*. Zikán (1949) has discussed the possibility of social parasitism. He listed 23 species of *Mischocyttarus* that he assumed to be parasitic on closely related species, although his reasons for assuming so were based on minor morphological differences.

B. DEFENSE OF BROOD

1. Defense Against Ants

In view of the ubiquity of predaceous ants in the tropics, the relatively low rate of destruction by ants of colonies of *M. drewseni* cited above (p. 87) led me to suspect that these wasps do not rely solely on the chance that their nests will not be discovered by ants, and indeed they do not. At frequent intervals females rubbed the ventral side of the tip of the gaster along the stem and upper part of the comb of the nest for two to three seconds (Plate IV, fig. 7). At the base of the terminal (sixth) gastral sternite of female *M. drewseni* is a small, nonsclerotized area bearing a tuft of long hairs (van der Vecht, 1968). This tuft often appeared moist in living wasps,

suggesting that it carried a glandular secretion, which is brushed onto the nest stem. The following experiment pointed to the conclusion that this secretion is effective in keeping at least some predaceous ants from traversing the nest stem and discovering the brood.

Series of "artificial nests" were set up by fastening a row of glass capillary tubes 65 mm long in a vertical position (simulating the nest stem) and providing them with small squares of Brazil nutmeat at their upper ends (simulating brood). Half of the tubes were provided with smears of secretion 10–15 mm long by rubbing them against the tuft of hair of from one to four living wasps. Alternate tubes were left unsmearcd as controls. As ants (*Monomorium pharaonis* was used in all tests) began to explore each tube the following data were recorded: (1) the number of ants to ascend the tube partway, turn around and descend, and (2) the number of ants to reach the nut meat at the top of the tube. With few exceptions, the ants failing to reach the bait on the secretion-smearcd tubes stopped and turned around at the smear itself. When ten ants had reached the bait on a given tube the number of ants to ascend only partway was totalled. In 38 trials (19 smeared tubes vs. 19 unsmeared tubes) the number of ants turning back before reaching the bait was significantly greater for the smeared tubes than for the unsmeared tubes ($P < .001$).

A second set of trials was run in which the control tubes were smeared with one of several materials, including water, Vaseline, salivary fluid of *M. drewseni*, or rubbed against the fourth or fifth sternite of *M. drewseni*. In 30 trials (15 secretion-smearcd vs. 15 control-smearcd tubes) the number of ants stopping at the smear of secretion was significantly greater than those stopping at the smear of control substance ($P < .001$). (For data and a more detailed description of these experiments see Jeanne, 1970a.)

Tests involving actual nests of *M. drewseni* bear out the conclusion reached from

these experiments. Wasp larvae removed from their cells and affixed to the substrate around the base of attachment of an active nest attracted *Monomorium pharaonis* in large numbers in a matter of hours, yet none of these ants succeeded in getting down the nest stem; though many attempted (96 in 11 minutes in one case), none got more than a few millimeters before turning back. The results were the same if the adult wasps were removed from the nest so they could not actively defend it.

It is clear that the secretion smeared on the nest stem is an effective repellent to at least some ants. Whether the effect is due to the chemical or physical nature of the substance is not certain. However, two observations suggest that it is the chemical nature of the secretion to which the ants respond. First, very little secretion is applied to the nest stem; so little, in fact, that the stem appears completely dry and clean both to the eye and to the touch. Second, when ants contacted a smear of the secretion on the experimental glass tubes, they often retracted violently from it and groomed their antennae extensively, indicating that the smear was "distasteful" to them. The control materials never elicited such behavior.

The structure of the nest and the morphology of the adult wasp have apparently co-evolved toward the optimization of this defense behavior. The nest stem is long, providing a long barrier for ants to cross. The first abdominal segment of *M. dreuseni* is elongated, enabling the application of secretion over most of the length of the stem. The small diameter of the stem, and its smooth, nonabsorbent surface are features that minimize the amount of secretion required to keep the stem adequately covered.

It is during the pre-emergence stage of colony development that colonies of *M. dreuseni* are most vulnerable to ants, since the founding female must leave the nest unattended to forage. Defense of the type

evolved by *M. dreuseni* enables her to do so without increasing the risk that the nest will be discovered by ants during her absence. The repellent properties of the secretion are probably ineffective against army ants (*Eciton* spp.), which forage en masse. But my impression is that the chance that a nest will fall in the path of such a raid is low enough for most colonies to mature and produce sexuals before being attacked.

2. Alarm Reaction to Flying Insects

Adults on the nest respond to insects flying near the nest to a degree corresponding to how close and how persistently the intruder approaches. Probably size and proximity of the insect are directly correlated in evoking a given response; thus, a smaller insect must be closer than a larger one to evoke the same degree of response. If the insect was relatively far from the nest (about 25–50 cm for a large insect such as *Polistes*) the female *M. dreuseni* merely turned toward the movement. If the insect came closer, the wasp spread her wings and darted at it. If the intruder persisted, or came very close, the wasp flew at it and drove it away. This latter behavior occurred only in response to larger insects. There was apparently no discrimination of form or coloration by the wasps; they appeared to respond indiscriminantly to movement.

Each wasp on the nest responded to a flying insect directly and independently of the response of nestmates; that is, each wasp had to see the movement herself to respond. Wasps on the opposite side of the nest could not see the movement and did not respond (but compare the reaction to large objects, below). Adults on the nest were not particularly alert to smaller flying insects. In several instances small insects (such as mosquitos) flew close to the nest, or even landed on it, apparently without being seen by the wasps.

The "darting and wing-flipping" that *Polistes fuscatus* performs in the presence

of the ichneumonid parasite *Pachysomoides fulvus* has been interpreted as a "special parasite alarm" behavior (Eberhard, 1969). No such behavior occurred in *Mischocyttarus drewseni*, though the buzzing of the wings in the presence of large intruders (see next section) may be homologous with it.

3. Alarm Reaction to Large Objects

If a large object, such as the investigator's hand, was moved toward a nest, the first response of the wasps was to turn to face the movement. If the object continued to approach, the wasps first spread their wings, then raised the anterior ends of their bodies, lifting the forelegs from the nest (Plate IV, fig. 8). With more intense disturbance, they bent their abdomens around to one side and buzzed their wings. Finally, one or more of them sometimes flew at the object and attempted to sting it. Newly emerged females less than 24 hours old as well as mature adults exhibited this defensive behavior.

While wasps were responding to a disturbance by bending their abdomens to the side and buzzing their wings, a strong odor, resembling soap or stale saltines, was often detectable. The same odor was detected at the site of a sting, where it lasted for a minute or two. This substance may be an alarm odor. It is possible that the source of such a pheromone is a gland that opens in the sting chamber, and by bending the abdomen to the side and buzzing the wings the wasps disperse the chemical. Rau (1939) noticed that *Polistes variatus* spreads its wings and produces a "pleasantly sweetish" odor when disturbed.

If an object approached the nest such that the wasps on the opposite side could not see it, these wasps did not show the alarm behavior unless those who could see the object buzzed their wings. Then all the wasps on the nest became alert, spread their wings and raised their forelegs from the nest. If the buzzing stopped, these others began to settle down. Apparently

either the vibration of the buzzing or the dispersal of odor communicates alarm. This may be homologous to the "wing-flipping" observed in *Polistes fuscatus* (Eberhard, 1969).

During the course of the study I was stung by *M. drewseni* eight times. The pain varied considerably, probably in proportion to the amount of venom injected, but never lasted more than a few minutes. In a typical sting, received on the arm, the pain reached a maximum after several seconds, then began to subside gradually. There was a small red dot, representing the puncture of the sting. After ten minutes a swollen welt had increased to 7-8 mm in diameter. After half an hour this had changed to a slightly swollen red area 3 cm in diameter. After six hours only the small red puncture remained; there was no pain in the area, even when pressed.

4. Variations in Aggressiveness

There was often a marked increase in the aggressiveness of a colony in the late afternoon and early evening. At this time of day it was often not possible to approach a mature colony, however carefully, without alarming the adults and sometimes causing one or more to fly off at me and attempt to sting. The same colonies had a much higher threshold of aggressiveness during the day.

There was a definite positive correlation of aggressiveness with number of adults on a nest. Sometimes it was difficult to approach closely a small, single-foundress nest without causing the adult to flee. The same colony later in its development was often impossible to approach without eliciting aggressive behavior.

VIII. DIVISION OF LABOR

A. SPECIALIZATION ACCORDING TO CASTE

1. Activities of the Queen versus the Workers

Tables 5 and 6 give the rates at which various tasks were performed by co-found-

TABLE 5. Division of labor among co-foundresses of colony 258. Rates are given as the number of times the task was performed per hour of observation. Numbers in parentheses give the absolute number of times the task was performed. Adults are arranged in order of dominance rank. Number 66 is the queen.

Adult	Hrs. obs.	Foraging			Cell Construction				No. eggs laid	Rate of domin.
		Pulp	Insect	Nectar	Init.	Height.	Rubbing	Mouthing		
66	47	.04(2)	0	.02(1)	0	.08(4)	0	.02(1)	13	.44(2)
57	46	.10(5)	.04(2)	.06(3)	0	.13(6)	.09(4)	.06(3)	2	.06(3)
60	28	.16(6)	0	.31(12)	.05(2)	.10(4)	.18(7)	.05(2)	1	.08(3)
54	45	.09(4)	.02(1)	.22(10)	0	.09(4)	.04(2)	.02(1)	0	.02(1)
74	46	.04(2)	.11(5)	.13(6)	0	.04(2)	.04(2)	.02(1)	0	0
35	46	.15(7)	.04(2)	.26(12)	.02(1)	.13(6)	.11(5)	.06(3)	0	0
16	16	0	0	.32(5)	0	0	0	.06(1)	0	0
21	16	0	0	.06(1)	0	0	0	0	0	0
No. times task performed		(26)	(10)	(50)	(3)	(26)	(20)	(12)	16	(28)

resses of representative pre-emergence colonies (258 and 310). Table 7 gives the same data for a representative postemergence colony (268). In both pre-emergence and postemergence colonies the queen was the primary egg-layer. The task of preparing a previously used cell to receive a fresh egg involved removing the torn silken cap and was virtually always done by the egg-layer immediately before oviposition.

In any dominance-subordinance encounter the queen was always dominant. Usually the queen was involved in dominance interactions more frequently than her subordinates (exception: worker no. 2 on

nest 268 dominated her subordinates more frequently than did the queen; Table 7).

The queen on 310 foraged for insects as well as for pulp, though pulp predominated in her loads (Table 6). Neither the queen on 258 nor any of the three queens on 268 ever foraged for insects, though of 16 loads foraged by six queens on other postemergence nests, four were insects. Thus, although pulp predominated among their loads, queens did not specialize in pulp foraging to the exclusion of insect food, as do queens of *Polistes fuscatus*, *P. canadensis* (Eberhard, 1969), and *P. gallicus* (Pardi, 1951).

TABLE 6. Division of labor among co-foundresses of colony 310. Rates are given as the number of times the task was performed per hour of observation. Number of times each task was performed is given in parentheses. Adults are arranged in order of emergence on the parent nest (23), except that the queen (no. 50) is given first. The rates of domination were too low to establish a linear hierarchy among the co-foundresses.

Adult	Hrs. obs.	Foraging			Cell Construction				No. eggs laid	Rate of domin.
		Pulp	Insect	Nectar	Init.	Height.	Rubbing	Mouthing		
50	39	.43(17)	.07(3)	0	0	.46(18)	.08(3)	0	8	.08(3)
49	39	.10(4)	.15(6)	.31(12)	.02(1)	.07(3)	.10(4)	0	0	0
57	39	.02(1)	.04(2)	.26(10)	.02(1)	0	.23(9)	0	0	0
47	25	.04(1)	0	.04(1)	0	.04(1)	.04(1)	0	0	0
54	25	.16(4)	.04(1)	.12(3)	.04(1)	.12(3)	.08(2)	0	0	0
No. times task performed		(27)	(12)	(26)	(3)	(25)	(19)	0	8	(3)

TABLE 7. Division of labor among queens and workers of colony 268. Data are from post-emergence stage only. Rates are given as the number of times the task was performed per hour of observation. Number of times each task was performed is given in parentheses. Adults are arranged in order of emergence. Numbers 1, 8, and 36 are queens.

Adult	Hrs. obs.	Foraging			Cell Construction			No. eggs laid	Rate of domin.	
		Pulp	Insect	Nectar	Init.	Height.	Rubbing			Mouthing
1	51	.02(1)	0	.02(1)	.02(1)	.12(6)	0	.02(1)	8	.45(23)
2	45	.24(11)	.11(5)	.22(10)	0	.14(4)	.18(8)	.04(2)	0	.51(23)
3	91	.05(5)	.10(9)	.18(16)		.04(4)	.05(5)	0	0	.01(1)
4	34	.00(17)	.47(16)	.14(8)	0	.50(17)	.32(11)	.06(2)	0	0
5	93	.05(5)	.40(37)	.20(18)	0	.04(4)	.06(6)	.03(3)	0	.01(1)
6	124	.04(6)	.11(14)	.17(34)	0	.02(2)	.04(5)	.01(1)	0	0
7	40	.33(14)	.24(11)	.17(8)	0	.33(14)	.02(1)	.02(1)	0	.13(6)
8	42	.16(15)	0	0	.02(1)	.40(33)	.01(1)	0	22	1.91(157)
9	117	.14(5)	.23(13)	.24(18)	0	.13(4)	.02(2)	0	0	0
10	48	.16(9)	.23(11)	.73(35)	0	.14(9)	.02(1)	.02(1)	0	.04(2)
11	114	.10(23)	.13(27)	.32(37)		.16(19)	0	0	0	.01(1)
20	94	.10(16)	.13(20)	.13(20)		.11(12)	0	.01(1)	0	.04(4)
22	88	.11(17)	.33(29)	.13(22)		.10(8)	.10(1)	.02(2)	0	.01(1)
27	7	.11(11)	.31(17)	.14(11)		.11(11)	0	0	0	.19(10)
28	50	.10(5)	.10(9)	.10(16)		.10(5)	.01(1)	0	0	.06(3)
29	50	.10(5)	0	.10(9)		.10(5)	.06(3)	0	0	.08(4)
32	50	.05(6)	.07	.14(17)		.10(6)	0	0	0	.03(2)
35	86	.03(13)	.08(7)	.10(16)		.03(5)	.10(2)	0	0	.08(7)
36	86	.01(1)	0	0	.01	.03(3)	0	0	14	1.51(130)
49	16	.10(2)	.10(7)	.10(1)		.06(1)	0	.06(1)	0	0
52	71	.10(2)	.02(1)	.10(1)		.04(2)	0	0	1	0
53	71	0	.02(1)	.10(17)		.02(1)	0	0	0	0
73	37	.10(1)	.10(18)	.10(9)		.14(1)	0	0	0	0
86	27	.10(4)	.10(7)	.10(4)		.10(4)	0	0	0	.04(1)
96	22	.09(2)	.09(5)	.04(1)		.09(2)	0	0	0	.04(1)
98	20	.05(1)	.05(1)	.05(2)		.05(1)	0	0	0	.05(1)
107	16	0	0	.06(2)		0	0	0	0	0
No. times task performed		(184)	(257)	(333)	(6)	(190)	(150)	(15)	45	(378)

None of the six cell initiations observed on pre-emergence nests were done by queens (Tables 5 and 6). On the other hand, all five of those seen on postemergence nest 268 were performed by queens (Table 7). The two cell initiations seen on all other postemergence nests were done by workers. Initiation of new cells by subordinates occurs in *Polistes fuscatus*, but not in the tropical *P. canadensis* (Eberhard, 1969).

A forager returning with pulp usually applied it to the nest herself. However, 40 loads out of 195 (20 percent) were shared. Each shared load was always shared (never given up entire) with only one nestmate and that nestmate was without exception the queen.

Most or all of the pulp used by the queens of pre-emergence colonies was foraged by them, while most of the pulp used by queens of postemergence colonies was received from foragers.

Lumps of food were more frequently shared with nestmates than were pulp loads. Of 311 loads brought to three nests, 223 (72 percent) were shared. The remaining 28 percent were fed directly to larvae by the forager. Each load was shared with an average of 1.9 nestmates (range: 1-5), and the forager often gave up the entire load, keeping none for herself. They were shared with any nestmate, including queen, nonworkers, and males. On one nest (268) 208 loads of insect food were shared with 294 nestmates, of which 84 (29 percent) were queens. In 79 percent of the cases queens masticated the lumps, then fed them to larvae; in 21 percent they passed them on to other adults.

Queens foraged for nectar at very low rates or not at all. Co-foundresses and workers, however, foraged at high rates. Of 356 loads of nectar, 183 (51 percent) were shared with an average of 1.5 nestmates each (range: 1-5). Queens solicited nectar from returning foragers at high rates. Their subordinates solicited nectar at rates decreasing roughly with their social rank. Of 289 recipients of nectar, 41 (14 percent) were queens and virtually all the rest were males and nonworkers.

Queens on all nests rubbed and mouthed the nest stem little or not at all.

Fanning the nest when the temperature reached a critical point was done by queens, workers, and occasionally by nonworkers and males. Bringing water and spreading it over the nest for cooling was done primarily by workers.

In summary, queens: 1) were dominant and usually dominated at higher rates than subordinates; 2) were the primary egg-layers; 3) prepared used cells to receive eggs; 4) foraged primarily for pulp, rarely for nectar or insects; 5) initiated cells on postemergence nests, but not on pre-emergence nests; 6) heightened cells; 7) distributed insect food to larvae and nestmates; 8) solicited pulp, insects and nectar from returning foragers; 9) rarely mouthed or rubbed the nest stem; and, 10) some-

times fanned the nest and hauled water for cooling.

Workers: 1) were subordinate; 2) foraged for pulp, insects and nectar; 3) distributed insects and nectar to nestmates and larvae; 4) initiated cells; 5) heightened cell walls; and, 6) fanned the nest and hauled water.

Thus pre-emergence colonies differed from postemergence colonies in that in pre-emergence colonies: 1) subordinates sometimes oviposited; 2) subordinates rather than the queen initiated cells; 3) queens themselves foraged for most of the pulp they applied to the nest; and, 4) subordinates as well as the queen frequently solicited nectar and solid food from returning foragers.

2. Activities of Nonworkers

Nonworkers obtained food by soliciting insect food or nectar from returning foragers and by soliciting secretion from larvae. They chewed solid food, extracting liquid, then either passed the remaining fragments on to nestmates, fed them to larvae, or dropped them (especially in the case of small fragments). Nonworkers often left the nest for varying periods, presumably either to forage for themselves or to mate with males. When they returned they did not feed larvae. They fanned the nest when it was heated above a certain critical temperature. They also showed defensive behavior in response to intruders. Finally, they took part in dominance interactions.

It is necessary here to emphasize that the distinction between "workers" and "nonworkers" is somewhat artificial. Nonworkers by definition do not forage for pulp or insects. Yet individuals that came under the nonworker definition sometimes performed other workerlike tasks. Thus, on six occasions nonworkers returned to the nest, apparently with nectar, which they gave up to nestmates or to larvae. On another occasion a nonworker chewed down the walls of a recently emptied cell

and applied the pulp elsewhere on the nest. Nonworkers were twice seen to bring water to the nest for cooling and to fan the nest on five occasions. On the other hand, some "workers" worked at extremely low rates. Such cases suggest that "worker" behavior and "nonworker" behavior may be continuous, and that the distinction between "worker-ness" and "nonworker-ness" is a matter of degree.

Despite such uncertainties, however, the two castes do seem to exist. The criterion used to define a worker, *i.e.*, returns to nest with a solid load, was chosen because it was easy to apply and was consistent with Eberhard's (1969) terminology. It has the virtue of including in the worker category approximately those who contribute to the growth and maintenance of the colony by supplying materials. Nectar foraging was not included in the definition of worker status because of the difficulty of determining with certainty when a forager was actually returning with nectar in its crop. To judge from Table 7, however, which includes nectar foraging rates based on somewhat arbitrary criteria (see *Trophic Relations*, p. 76 ff.), pulp and insect foragers were also nectar foragers. The six cases mentioned in which nonworkers definitely returned with nectar involved only four individuals out of a total of 43 nonworkers. It is quite possible that, had they been observed more extensively, these four would have been seen to forage for pulp and insects as well, and could have been called workers. Thus, if anything, the limited definition of worker leads to the inclusion of some true workers in the nonworker class.

3. Activities of Males

Males solicited insect food and nectar from returning foragers for their own consumption. When males were abundant on a nest, they often mobbed returning foragers, giving the impression that they were hungry. They did not pass nectar on to larvae, though often after they chewed a

bit of insect material for several minutes they fed it to a larva. They seemed to rely primarily on foragers for food and solicited from larvae relatively infrequently. Males fanned their wings when the sun struck them on the nest. They sometimes grasped a female with the legs or bit a member with the mandibles and held on for several minutes. The meaning of this is not clear.

B. TEMPORAL SEPARATION OF TASKS DURING THE DAY

Certain tasks were performed more frequently at some times of day than at others. Figure 5 plots rate at which four tasks were performed against hour of the day.

Pulp foraging (Fig. 5A) began early in the day and continued at a fairly steady rate until 13:00 hours, after which it declined. This may have been related to the availability of water, which was used in the removal of pulp from plant stems, planks, etc. In the early morning (06:00–08:00) such substrates were frequently quite moist from condensation of dew during the night. Later in the day, when pulp sources had dried out, foragers sought water from wet mud, droplets trapped in leaf axils, and other places where rain-water was stored. Such sources were more likely to dry up during the hottest part of the day (early afternoon) than at other times. This may help to explain low rates of pulp foraging from 14:00 on.

Insect foraging (Fig. 5B) began an hour or so later in the morning than pulp foraging and remained high until midafternoon, when it tapered off. This pattern may be related to the activity patterns of insects sought as prey, though there are no data bearing on this.

The limitation of mouthing the nest stem strictly to the early morning hours was most striking (Fig. 5C). This was the first task the workers performed at the beginning of daily activity. It was rarely performed after 08:30 and never after 11:00. Deleurance (1957) found the same daily

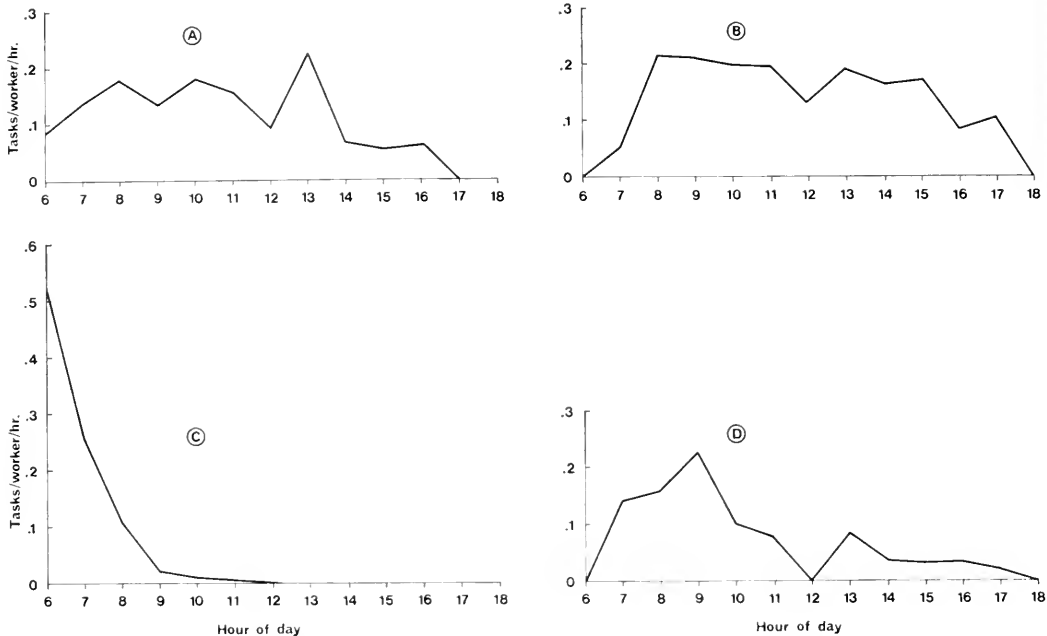

Figure 5. Temporal division of labor. A. Foraging for pulp. B. Foraging for insects. C. Mouthing the nest stem (application of nest construction secretion). D. Rubbing the nest stem (application of ant repellent secretion).

rhythm of petiole construction to exist in *Polistes gallicus* reared in the laboratory. The significance, I think, is clear. Applying a new layer of nest construction material to the nest stem effectively covers up the previous day's coat of defense secretion. In terms of the most efficient use of the defense secretion, it is obviously best to apply the entire day's supply of nest construction secretion to the stem first, then put the defensive secretion on top of that, rather than mixing the two activities throughout the day. The heaviest concentration of rubbing activity did indeed closely follow mouthing (Fig. 5D).

IX. DOMINANCE AND CASTE DETERMINATION

A. THE NATURE OF DOMINANCE-SUBORDINANCE BEHAVIOR

In encounters between two females of a colony one of the pair usually dominated over the other. The violence with which one individual dominated another varied,

as did the degree to which the subordinate individual showed submissive behavior.

In the mildest form of domination the dominant wasp merely turned and darted or rushed toward the subordinate but did not make contact with it. The subordinate either did not respond at all, merely flinched, or moved away.

In the most typical form of domination the dominant rushed at the subordinate and violently mouthed its body with the mandibles while antennating it vigorously. This was often accompanied by a rapid forward-and-backward "pecking" motion of the entire body. The face and top of the head of the subordinate were most frequently attacked in this way, but the thorax, wing bases, abdomen, and legs were also attacked. The most typical response of the subordinate was what I call the "submissive posture." This is not the same as Pardi's "position of akinesis" (Pardi, 1948b), in which the body is appressed to the nest, head bent and antennae and legs in flexion. The submissive

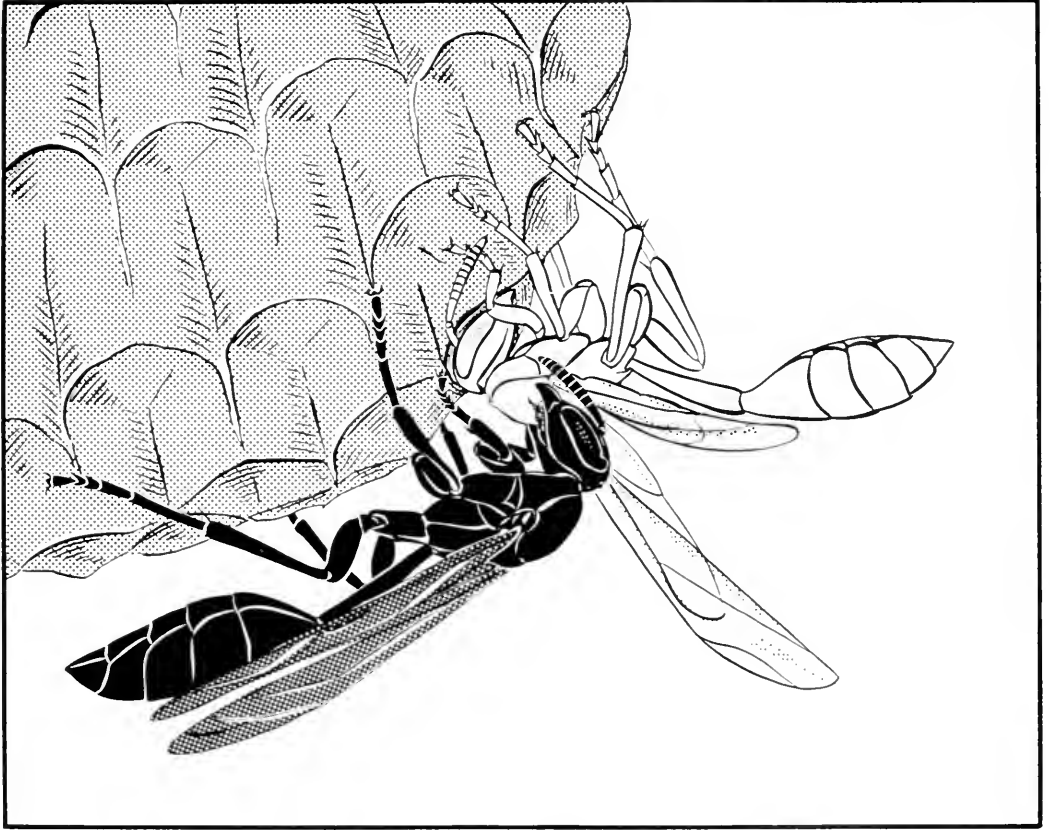

Figure 6. Domination. The dominating wasp (left) is violently mouthing the thorax of the subordinate with her mandibles. The subordinate is responding with an extremely submissive posture: head down against the nest surface, abdomen raised, and wings spread.

posture in *M. drewseni* in its least pronounced form consisted in bending the head down and raising the abdomen slightly. In the most extreme form the rear end of the body was raised so that the long axis of the body was nearly perpendicular to the nest surface, the front of the head pressed against the nest surface, and the wings spread (Fig. 6).

If the subordinate tried to escape, the dominant often chased after her. Sometimes a very dominant individual stopped dominating a subordinate and stood directly before it for several seconds as if watching it. During this time the subordinate usually remained in the submissive posture. If the subordinate moved to come

out of its submissive posture, the dominant immediately rushed forward and mouthed it violently again. This was often repeated several times before the dominant finally moved away. An extremely subordinate wasp sometimes remained in the submissive posture for a minute or more after the dominant wasp had moved away. Such an individual was sensitive to movement of any wasp near it, responding by raising its abdomen and depressing its head even more.

During the intervals in which the dominant wasp watched the subordinate, the dominant often vibrated its gaster in a rapid up-and-down motion, causing an audible rattle as it struck the nest surface.

This "vibration" was of the same sort that often accompanied the visiting of larvae (see Trophic Relations, p. 76 ff.). The vibration itself had no visible effect on the subordinate. In a few instances a subordinate responded to this form of domination by regurgitating a small droplet of liquid from its crop and offering it to the dominant. The dominant sometimes lapped it up, but usually it did not. A less submissive individual, such as an older worker, when attacked by a dominant wasp, merely stopped what it was doing and lowered its head slightly until the domination stopped.

In some cases the dominant individual, after mouthing the subordinate, grasped an antenna, a wing, or a leg in its mandibles, tugged on it with a jerking motion for several seconds, then merely held onto it for as long as a minute without moving. The subordinate at first did not move, but then usually gingerly tried to extricate itself by pulling away. Sometimes this caused the dominant to renew its vigorous tugging on the member, though often the subordinate managed to escape.

In the most severe form of domination the dominant wasp grappled with a subordinate, grasping it with the legs around the body while trying to bite or even sting it. The subordinate either remained passive or tried to escape. On rare occasions this struggle was so violent as to cause the pair to fall from the nest, and on one occasion resulted in the death of one of the pair.

Newly emerged adults (one to two days old) moved about the nest but little and rested with their bodies appressed to the nest surface. They were rarely dominated. Their response to the rare dominations they received and to males seeking to solicit food was to press the body even closer to the nest and draw the legs in close to the body. This resembled akinesis in *Polistes gallicus* (Pardi, 1948b). As they matured they began to respond to domination with the typical submissive posture.

B. THE SOLICITATION-DOMINATION CONTINUUM

Often it was not possible to determine whether an interaction was a domination or whether one wasp was soliciting liquid food from the other. The initiator of an interaction often vigorously mouthed the mouthparts of a forager, to which the forager usually responded by moderate submission. In such encounters the initiator was obviously the more dominant, yet an exchange of fluid sometimes occurred. A difficulty arises in trying to classify such encounters as either solicitations or dominations. The most natural interpretation seems to be one that places the two phenomena on the same continuum.

At one end of the scale were cases of obvious solicitation, in which a soliciting wasp approached a just-returned forager and mouthed its mouthparts, its head lower than the forager's, to which the forager responded by regurgitating a droplet. In encounters of this type the soliciting wasp was evidently less dominant than the forager. At the other end of the scale were clear-cut cases of domination, such as when the queen violently attacked a subordinate and mouthed it about the head and thorax, ignoring any attempts on the part of the subordinate to offer a droplet of food. Between these two extremes the behavior of each participant seemed to vary continuously in degree of dominance. The behavior of the initiator ranged from simple begging at the low end of the scale to out-and-out domination at the upper end. The behavior of the other ranged from extreme submission and attempts to escape at the low end to unsubmitive yielding of a droplet at the upper end.

Males commonly approached returning foragers as well as other females on the nest, and even other males, to beg for regurgitated droplets by mouthing and antennating the mandibles of the donor. Often the female responded submissively, either by assuming the submissive posture, or by escaping to another part of the nest.

Such encounters were often quite violent and were frequently indistinguishable from domination of one female by another. The females appeared to be acting submissively to the males. It is possible that by acting in a submissive way the females may indicate to the solicitor that they have no liquid to give.

The point I wish to stress is the apparent continuity between "soliciting" for food and "dominating" subordinates. This suggests that dominance behavior had its origins in trophic exchanges between nest-mates. At least trophic exchanges often seem to provide the context in which differentially aggressive individuals come into the repeated contact that, according to West (1967), is a necessary condition for the establishment of a dominance order. Though West has provided a theoretical explanation of the adaptive value of a dominance hierarchy, the phylogeny of the phenomenon remains unexplored.

C. PATTERNS OF DOMINANT AND SUBORDINATE BEHAVIOR

1. Rates of Dominance Interactions

Compared with *Polistes gallicus*, the rate at which dominance encounters occurred in *M. drewseni* was low. Most of the contacts between co-foundresses were peaceful exchanges of pulp or food. On most nests, the number of dominations among co-foundresses was less than 0.10 domination per female per hour of observations (Table 8). In contrast to this, among the seven co-foundresses of a comparable pre-emergence colony of *P. gallicus* there were 109 interactions in only eight hours (Pardi, 1946), a rate of 1.94 dominations per female per hour, or about 20 times the rate in *M. drewseni*.

In *M. drewseni* many individuals on multiple-foundress pre-emergence nests were not involved at all in dominance interactions. The interactions in colony 258, for example, involved only nine (32 percent) of the 28 possible pair combi-

TABLE 8. MEAN FREQUENCY OF DOMINANCE INTERACTIONS ON MULTIPLE-FOUNDRESS COLONIES IN THE PRE-EMERGENCE STAGE OF *M. DREWSENI*. DAYS OBSERVED GIVE THE SPAN OVER WHICH OBSERVATIONS WERE MADE. RATE OF DOMINATION IS EXPRESSED IN NUMBER OF DOMINATIONS PER WASP PER HOUR OF OBSERVATION.

Colony no.	No. co-foundresses	No. dominations	Hrs. obs.	Days obs.	Rate of domination
223	2	0	17.8	31	0
237	3	0	4.8	8	0
258	8	27	16.0	17	.07
295	2	1	11.9	27	.04
310	5	3	39.0	36	.02
421	2	1	2.2	36	.22

nations (Table 9), and in colony 310 only two (20 percent) of the ten possible pairs (Table 10). On a pre-emergence nest of *P. gallicus* with seven co-foundresses observed by Pardi (1946), 20 (95 percent) of the 21 possible pair interactions occurred.

Domination interactions among female offspring of a colony also occurred at a lower rate than in *P. gallicus*. Table 11 gives the number of interactions for each pair of females on colony 265. In 148 hours of observation over 106 days there were only 434 dominations among 70 females. (Not all of the females were present on the nest for the entire period.) This compares with 589 dominations observed in only 14 hours and 45 minutes among nine females of a colony of *P. gallicus* (Pardi, 1946).

2. Age Distribution of Dominant and Subordinate Behavior on Established Colonies

Dominance interactions appeared to involve primarily the queen and the younger offspring at any given time. Though workers may live for 11 weeks or longer, it was primarily during their first ten days that they were involved in dominance encounters, both as dominant and as subordinate. A newly emerged female required about three days to "mature." During this time she remained on the nest and was largely

Table 9. Numbers of dominance interactions among pairs of individuals in a colony of *Formica ruginodis* during 40 hours of observation from 1. July to 31 July 1968. Frequency of domination or submission, number of interactions per hour of observation.

Subordinate individual	Dominant individual					Total interactions	Total frequency submission	Total individuals submitted to
	66	67	68	71	72			
66	-	-	-	-	-	0	0	0
67	11	-	-	-	-	11	11	1
68	0	-	-	-	-	0	0	0
71	1	-	-	-	-	1	1	1
72	1	-	1	-	-	2	2	1
16	-	-	-	-	-	0	0	0
21	-	-	-	-	-	0	0	0
<hr/>								
Total dominations	12	0	0	0	0	12	12	2
<hr/>								
Mean frequency domination	0.3	0	0	0	0	0.3	0.3	0.2
<hr/>								
Total individuals dominated	1	0	0	0	0	1	1	1
<hr/>								

inactive, except to solicit food from passing foragers or secretion from larvae. She was practically ignored as an object of domination by the queen and other dominant nestmates. In the days following, however,

she was dominated more and more frequently, until her fifth day, when the average rate of domination reached a maximum of over one domination per hour. From day five the rate at which she was dominated

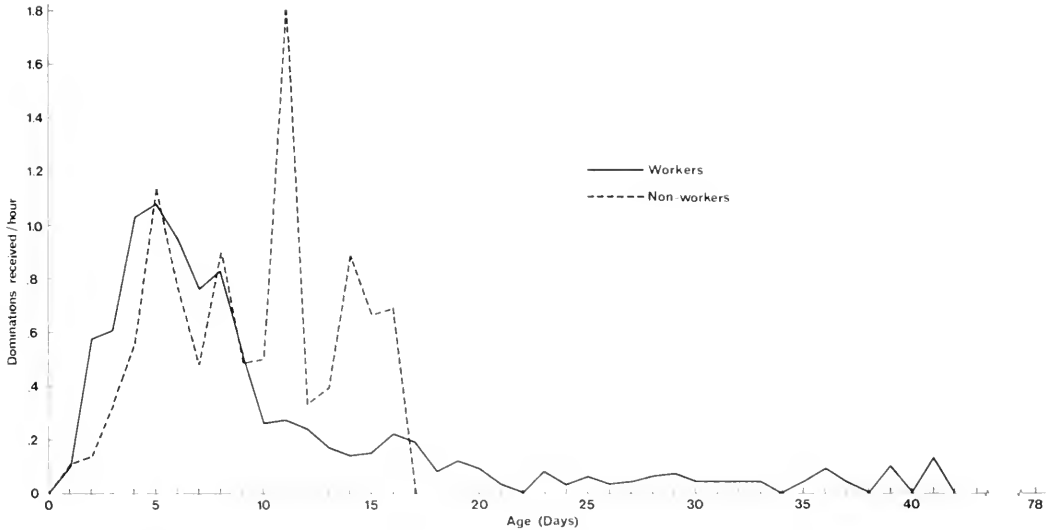

Figure 7. Rate of submission versus age. The ordinate gives the average number of times a wasp of a given age was dominated per hour of observation. Data pooled from three colonies (174, 268, 342).

declined rapidly until about the tenth day. For the next ten days it declined more. As a worker aged, she became markedly less submissive to domination; rather than going into submissive posture she usually merely lowered the head slightly until the dominant wasp stopped its attack, then she immediately resumed whatever task she was doing when the domination began. A similar pattern was followed by nonworkers, except that they underwent a high average rate of domination for as long as they remained on the nest (Fig. 7).

The concentration of the amount of domination received in one part of the life span indicates that dominance behavior is not directed indiscriminately at any nestmate, but that some condition or characteristic of the subordinate perceptible to the dominating wasp both releases the dominant behavior and causes it to be directed at the subordinate. This supports Pardi's (1947) hypothesis that a wasp recognizes certain characteristics of individuals that reflect their social rank relative to itself. Pardi suggested that odor differences (possibly based on slight differences in amount or kind of food received) may provide the

cues, or that signals may be subtle differences in demeanor, perceived visually by the dominating wasp. Pardi appeared to favor olfactory discrimination, at least in part because it complements his idea that the existence of the dominance hierarchy confers a trophic advantage on high-ranking members of the colony. There is as yet no way of distinguishing between these hypotheses; indeed, odor and behavior may both be involved.

Whatever the characteristics of a subordinate wasp that cause it to be dominated by a dominant nestmate, one thing appears clear: these characteristics undergo an ontogenetic development, reaching a maximum at an age of six days in workers and diminishing afterwards. Pardi (1948b) states that ovaries of *P. gallicus* females undergo a development, reaching a maximum at age 15 days (the ascending phase) thereafter regressing in development. Wasps whose ovaries are in the ascending phase dominate those whose ovaries are in the regressing phase. If young females are dominated sufficiently while their ovaries are in the ascending phase, their development is apparently effectively suppressed

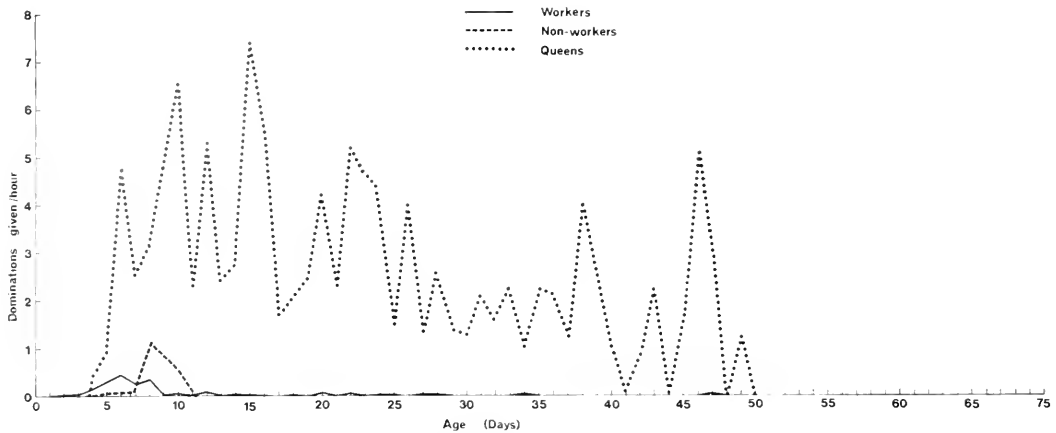

Figure 8. Rate of domination versus age. The ordinate gives the average number of times wasps of a given age dominated nestmates per hour of observation. Data pooled from three colonies (178, 268, 342).

and they become workers. Once their ovarian development is suppressed they apparently require no further domination. Eberhard reached a similar conclusion for *Polistes canadensis*. She suggested "that interactions among adults at the time of emergence or shortly thereafter affect the behavior (caste) of emerging females" (Eberhard, 1969: 71-72). She found that the four females that emerged just before or during a period of conflict following queen removal were nonworkers, but that the next 11, which emerged after the establishment of a new queen, were workers.

The tendency to dominate others also appeared to be greatest among workers around the sixth day of adulthood and to diminish essentially to zero by the tenth day (Fig. 8). The peak for nonworkers came later, on about the eighth day. Queens were most dominant during their earlier days (Fig. 8). Beyond the age of about two weeks their rate of domination gradually diminished.

3. Linear Hierarchy on Established Colonies

Pardi's work with *Polistes gallicus* has shown that a linear dominance hierarchy is established among the female inhabitants of a nest on the basis of the outcome of

dominance interactions between all possible pairs of individuals (Pardi, 1948b). Except for the period just prior to foundation and during the later stages of the colony, when "triangles" occur, the hierarchy is "typically" and "rigorously" linear.

Inasmuch as the outcomes of interactions between a given pair of females are usually the same, *i.e.*, one acts as dominant and the other as subordinate, the same sort of linear hierarchy could be said to exist among the females of a colony of *M. drewseni*. But because workers were not involved in dominance interactions for most of their lives, only a fraction of the female population of a postemergence nest was at any one time involved in dominance interactions. For this reason it is somewhat meaningless to try to determine the strict order of the linear hierarchy among all female offspring. Rather, dominance activity centered among offspring two to ten days old (plus the queen) and hence with time the roster of females involved constantly changed as older ones dropped out and younger ones entered. Thus the role of the "beta" wasp—the most dominant wasp besides the queen—constantly changed hands, passing down the line from older to younger offspring. Instead of moving to the lower end of the dominance scale as

they lost their dominant positions, older females apparently "dropped out" altogether as they assumed worker duties. This dynamic aspect of the linear hierarchy can be seen in Figures 9 and 10.

4. Discussion

The dominance-subordinance interactions described here are similar to those described for *Polistes* (Pardi, 1948b; Morimoto, 1961a, b; Yoshikawa, 1963a; Eberhard, 1969), and apparently function in the same way, namely, to maintain a single egg-laying queen on the nest. Dominance interactions have the effect of conferring upon the queen a trophic advantage while forcing the tasks requiring absence from the nest upon the subordinates; the unequal distribution of food and work, along with the possible direct effects of dominance, results in enhancing ovarian development of the queen while suppressing it in workers (Pardi, 1948b). The workers do not develop to the stage where they challenge the queen in her role of sole egg-layer.

The point brought out by the data presented here is that ovarian development of young females can apparently be suppressed only during a certain critical age, lying in the interval of two to 15 days. This is evidently during the ascending phase of ovarian development. It is during this age that females are dominated most heavily. Once a female has become "worker-ized" she no longer needs to be dominated and is for the most part left alone.

D. QUEEN DETERMINATION ON PRE-EMERGENCE COLONIES

The behavior of subordinates on multiple-foundress pre-emergence nests was more nearly like that of the queen than was the behavior of workers on postemergence nests. This suggests that among co-foundresses of a colony, several or all are fecundated and have the potential of becoming queens and that the one that eventually becomes queen is determined during the

pre-emergence stages of the colony. Pardi (1940) found that all associate foundresses of *P. gallicus* may be fecundated and have developed ovaries, i.e., are "true queens." Rodrigues (1968) found that all the co-foundresses of colonies of *P. versicolor* may be fecundated and have the same degree of ovarian development. Several factors seem to be involved in the establishment of one of them as queen.

1. Dominance, Food Flow, and Work

Pardi (1946, 1948b) and Pardi and Cavalcanti (1951) have shown that enhancement of ovary development is associated with a dominant position, and that regression of ovaries follows a period of subordinance to a dominant female. They suggested that the effect is due (in part) to the higher rate of energy consumption in the subordinates on the one hand, and the trophic advantage of high-ranking females on the other. Roubaud (1916) stated that in *Belonogaster* the females that do not forage receive more food and undergo rapid ovarian development, producing ripe eggs by the age of 10–15 days. Females that forage, however, are less well nourished; their ovaries contain eggs, but the ripening of these eggs is delayed as long as they are working as foragers and are poorly fed, even though such females may be fecundated.

The same processes seem to be operating in *M. drowseni*. As was seen (Tables 9 and 10), the queens on pre-emergence multiple-foundress colonies dominated at much higher rates than subordinates. The queen of colony 258 foraged and performed other tasks at low rates compared to her subordinates (Table 5) (though the queen of colony 310 worked harder than her subordinates). The number of times an individual solicited food (nectar and insect) from returning foragers increased with social rank; thus with few exceptions, food passed upward through the social order, from subordinate to dominant (Tables 12 and 13).

TABLE 17. Exchange of foraged food (insects and nectar) between pairs of co-foundresses on colony 258.

Recipient	Donor								Total Received
	66	57	60	54	74	35	16	21	
66		2	4	7	4		2		19
57			7	7	2	2	1		19
60				2	2		2		10
54						6			6
74							1		1
35									1
16									6
21									0
Total Given	2	2	11	10	7	18	3	0	64

TABLE 18. Exchange of foraged food (insects and nectar) between pairs of co-foundresses on colony 310.

Recipient	Donor				Total Received
	30	40	35	54	
30		1	1		2
40				1	1
35					0
54				1	1
Total Given	0	1	1	1	4

2. Differential Egg-eating

Heldmann (1936), Pardi (1942), Deleurance (1963), Gervet (1964a), and Eberhard (1969) have observed differential egg-eating in *Polistes* and attributed to it an important role in queen determination.

Subordinates on multiple-foundress colonies oviposited very infrequently. In 28 hours of observation of colonies 258 and 310 while they were still in the egg substage, on only two occasions were subordinates seen to oviposit (both on 258). Whether these eggs were eaten by the queen was not observed. Observations on 258 were begun four days before the first eclosion; it is possible that in the first few days after founding, oviposition by subordinates was more frequent. In the case of colony 310, though observations were

begun nine days before eclosion of larvae, no subordinate was seen to oviposit. This exclusiveness of the queen in the role of egg-layer was associated with the low level of dominance interactions for that colony.

Egg-eating was observed more frequently on 258 after the first larvae eclosed. In five instances eggs of known origin were observed being eaten. In four of these the eggs were eaten by the females that had laid them (the queen on three occasions and no. 57 on one occasion). On the fifth occasion an egg laid by no. 57 was eaten by the queen. Usually when a female ate her own egg she would do so immediately after laying it, suggesting that she was not mistaking her own egg for that of a nestmate. It was not only fresh eggs that were

eaten. In many instances eggs that had gone untouched through several hours of continuous observation were found to have been eaten by the end of the day. Daily records of the contents of brood cells indicate that eggs in all stages of development were eaten. Only ovipositing females ate eggs (queens of 258 and 310, and no. 57 of 258). Oviposition often followed egg-eating, but not necessarily in the same cell.

The egg-eating that occurred after larvae eclosed was probably what is called "nutritional egg-eating" ("oophagie nutritiale") by Cervet (1964a). It will be discussed below (Colony Development, p. 119 ff.). If true differential egg-eating is limited by definition to the egg substage of colony development, the data are insufficient to conclude whether or not it occurs in *M. drewseni*.

3. Empty Cells as Stimuli to Oviposition

According to Deleurance (1950) empty cells stimulate oviposition in *Polistes*. By keeping all cells filled with her own eggs, the queen prevents subordinates from ovipositing (Brian, 1958).

On nests 258 and 310 there were usually one or two empty cells throughout the egg substage of colony development (Figs. 17 and 20). The low rate of oviposition by subordinates on these nests in spite of the presence of empty cells suggests that the queen need not keep all cells filled to prevent subordinates from ovipositing.

4. Age of Co-foundresses

Hamilton (1964a, b) has proposed a genetical theory to account for the sterility of daughter workers on the parental nest. West (1967) has extended this theory to account for the acceptance of nonreproductive roles by the auxiliaries on a pre-emergence nest. According to West, the establishment of a dominance hierarchy among associates serves to maximize k , the fraction by which the addition of each associate enhances the reproductive success of the egg-laying queen. She suggested that

TABLE 14. AGES OF CO-FOUNDRESSES OF COLONY 258 AT TIME OF FOUNDING.

No.	Dominance rank	Age (days)
66	1	10
57	2	14
60	3	14
54	4	21
74	5	1
35	6	36
16	7	46
21	8	52

dominance may act as a "measuring stick" of relative reproductive capacity," by which "siblings sort themselves into groups according to relative reproductive capacity" (West, 1967: 1584).

Evidence from colony 258 suggests that relative age is largely responsible for the initial differences in reproductive capacity among co-foundresses. As was seen in Figure 8, females reached a peak of dominance toward the end of their first week. If their ovaries developed completely they began oviposition by their tenth day (Table 15). After that, their dominance gradually diminished over a period of weeks. Thus, other factors being equal, and ignoring the individual variation that no doubt exists, it could be expected that, of a collection of females of various ages, the one nearest in age to seven to ten days will be most likely to dominate others and become queen. This is apparently what happened among the foundresses of colony 258. The queen was ten days old at the time of founding and the ages of the subordinates increased with their rank in the dominance order (with the exception of no. 74) (Table 14). Numbers 21, 16, and 35, the oldest of the co-foundresses, had actually already been workers on the parent colony and were being dominated very little at the time that colony declined (Fig. 10). Likewise, they hardly participated in dominance interactions on colony 258 (Fig. 10 and Table 9). Numbers 54, 57, and 60,

the next oldest, were nonworkers on nest 174. The oldest of these (no. 54) had been dominated on the parent nest (primarily by the queen, no. 26) and by the time colony 258 was founded her activity in dominance interactions had decreased markedly (Fig. 10 and Table 9). She laid no eggs on 258. Numbers 57 and 60, however, both 14 days old at the time of 258's founding, were apparently young enough still to require dominance. Both these individuals laid eggs on 258 (Table 5) and both were dominated at high rates by no. 66 (Fig. 10 and Table 9). Number 74 was only 1 day old on the date of 258's founding, and no doubt did not join until several days later. Since her ovaries were presumably beginning to develop, she was dominated while on 258 (Table 9).

On colony 310, founded by five females from colony 230, the situation was somewhat different in that the rate of dominance was almost zero and there was no oviposition by subordinates. The queen dominated two of her associates on only three occasions (Table 11). Unfortunately, precise age data are not available, but all co-foundresses had been on the parent nest at least 18 days before 310 was founded, except for no. 57, who had emerged 14 days before 310's founding. Number 50 was the dominant wasp on 230 prior to its decline and was probably the queen. Evidently the dominance hierarchy had been established among the co-foundresses of 310 even before they left the parent nest.

5. Discussion

Flanders (1945, 1946) has proposed that the rate of oviposition may contribute to the determination of caste characteristics as well as sex in the social Hymenoptera, and, more recently (1970), he has argued that adult caste ratios are regulated through the selective cannibalization of caste-biased eggs. According to Flanders, eggs laid at a slow rate lose more of their yolk to ovisorption and do not contain enough nutritive material to produce

queenlike individuals. Wilson (1953) has argued that this hypothesis does not stand up when applied to ants, although Eberhard (1969) admits the possibility that in *Polistes* behavioral differences between worker and nonworker castes may be affected during the egg stage. She points to the concurrent emergence of males and nonworkers in *Polistes fuscatus* colonies and the relationship between oviposition rate and sex ratio as support for this hypothesis.

In *M. dreuseni* the appearance of nonworkers coincided approximately with that of males (Figs. 43, 45, and 46), but there were important exceptions. In particular, the fact that no. 2, the very first offspring to emerge on nest 342, superseded no. 1 as queen argues strongly against any determination of caste characteristics, behavioral or physiological, in the egg or larval stage in this species. In view of this evidence, I think it is quite probable that most, if not all, caste differences between workers and nonworkers in *M. dreuseni* are determined behaviorally in the adult stage. Of course size differences, which may influence behavior in the adult, are determined in the larval stage.

The initial differences in age, hence ovarian development, lead to the establishment of the dominance hierarchy among co-foundresses. This in turn leads to a division of labor, such that those high in the dominance order remain on the nest and perform more of the queen duties, while the lower subordinates forage for food and nest material. The more strenuous work required of foragers and their trophic disadvantage probably are the major factors responsible for the lack of development of their ovaries.

E. QUEEN SUPERSEDURE ON ESTABLISHED COLONIES

The forcible ejection from the nest of the queen by an offspring or younger sibling, who then becomes the new queen, was a fairly regular and apparently normal occurrence. In the course of its entire

development (approximately 160 days) colony 26S had three successive queens. Number 8 superseded her mother, no. 1, and was in turn superseded by no. 36, her sibling. Colony 342 had four queens in its first 155 days. Number 2 took over from no. 1, her mother; no. 10 took over from no. 2, her sibling; and no. 103 took over from no. 10, her mother. On colony 174 no. 1 and no. 26 co-existed on the nest, both laying eggs, for 24 days before no. 26 finally dominated no. 1 and chased her from the nest when the colony was in decline. The succession of queens that took place on colonies 26S and 174 is markedly apparent in Figures 9 and 10, respectively.

Butler (1957) has described queen supersedure in colonies of honeybees. He defined it as "the process by which a colony of honeybees replaces its queen without swarming." Since the same definition can be applied to the process in *M. drewseni*, as described below, use of the same term seems appropriate. The term "usurpation" has been used (for *Polistes*) to denote the process whereby a *foreign* female drives out the queen of a colony of the same species and becomes the new queen (Yoshikawa, 1955). Since the two processes are apparently different, it is probably best to retain the two separate terms.

1. The Nature of Supersedure Behavior

Colony 26S was founded by no. 1 alone. Figure 9 shows dominance interactions beginning on 3 November 1968, the day on which the first two offspring (no. 2 and no. 3) emerged. Thus, the entire period for which dominance activity was possible for no. 1 as a queen is shown in Figure 9. Her rate of domination was quite low; in fact, much of the domination of the first few offspring was done by no. 2 during her first week. After that period no. 1 dominated no. 2 almost exclusively, while no. 2's rare dominations were directed against her younger sisters.

On 30 November no. 8 emerged. She was dominated on her third and fourth

days by no. 1 and by no. 7. By the end of her first week, however, no. 8 had become extremely dominant, directing her attention to her contemporaries, nos. 7, 9, 10, and 11. By 7 December she had begun ovipositing. She did not have any dominance interactions with no. 1 prior to this time; in fact, the two seemed to avoid each other, though when they did come into proximity no. 1 would dart tentatively in no. 8's direction as though torn between a tendency to dominate and a fear of no. 8. Number 8 did not show submissiveness on these occasions. They co-existed in this way until 12 December, when no. 8 began to dominate no. 1 violently. At 4 p.m. no. 8 grappled so violently with no. 1 that the pair fell from the nest. Number 8 returned to the nest immediately, but no. 1 flew to a weed, where she remained for several minutes. By 5 p.m. no. 1 had returned to the nest and was resting in extreme submissive posture while no. 8 rested on the nest face. This was the last time no. 1 was seen on the nest. After this date, no. 8 took over as full-fledged queen, and continued to dominate the younger offspring.

Number 36 emerged on 28 December 1968, and by 3 January 1969, she was beginning to dominate her contemporaries. She in turn was dominated only once by no. 8 and once by no. 33. By 11 January no. 36 was ovipositing, and no. 8 and no. 36 were avoiding each other. After 12 January no. 8 disappeared. I saw no encounter between no. 8 and no. 36, though there may have been one.

By the time observations on the colony ended (18 February) it had begun to appear as if no. 126 may have been about to supersede no. 36 (see Fig. 9). If so, her reign was short-lived, for the colony declined within a week.

2. Age of Superseded Queens

Table 15 gives the histories of founding and superseding queens. Six cases of supersedure were observed. Two additional changes of queens were recorded on colo-

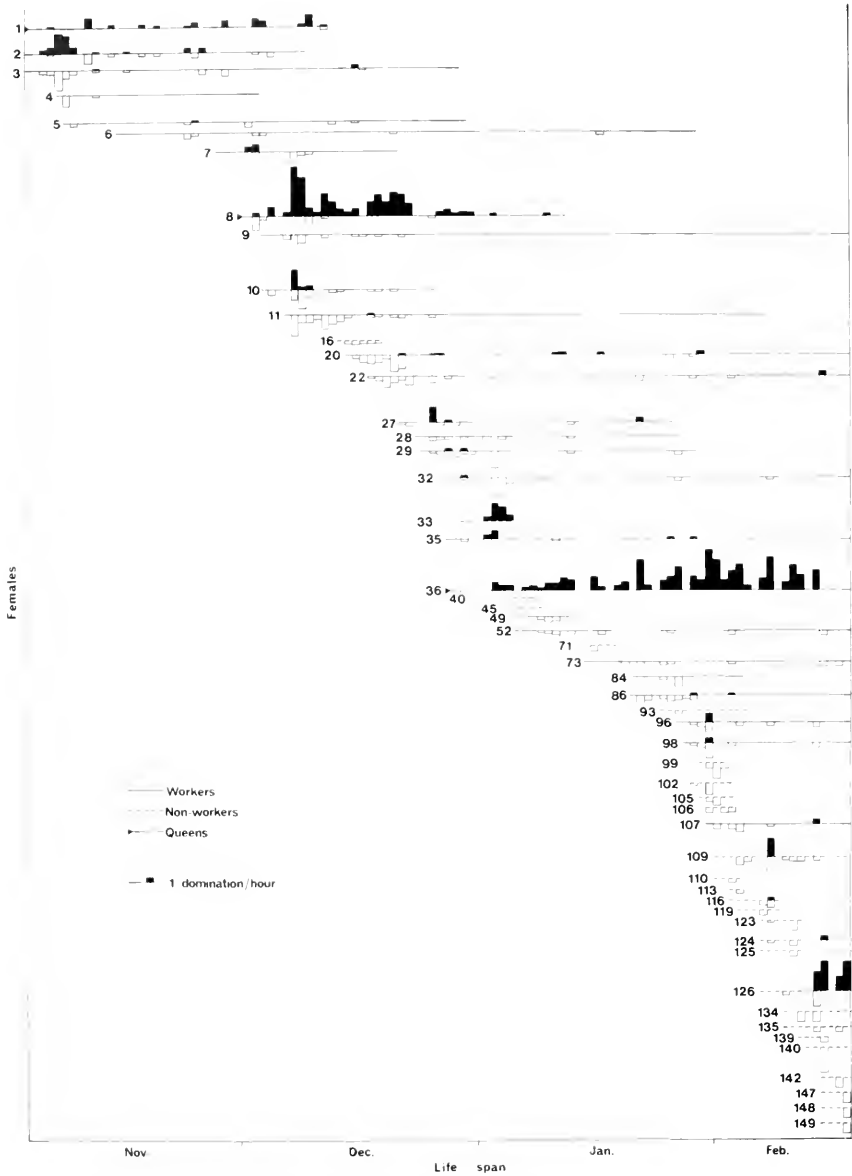

Figure 9. Domination and submission among females of colony 268. Each female is represented by a horizontal line extending from its date of emergence as an adult to its date of disappearance from the nest. The number of each female is given to the left of its line. They are given in order of emergence, from top to bottom. The rate at which each female dominated nestmates is given by a solid bar extending above her line for each day of her life. The rate at which each female was in turn dominated by nestmates is given by an open bar extending below the line. In the rare instances when the observation time was less than an hour, the rate was calculated as if observations had been made for an hour, to reduce unrealistically high rates owing to sampling error.

The 15 females who either disappeared after one day or were not involved in dominance interactions are omitted. Data extend from the emergence of the first female offspring to the end of observations, less than a week before the colony declined.

TABLE 15. Emergence of 12 ant queens and superseding queens in 12 colonies. The superseding rate in the development of a colony, like 174, was not observed at the peak, as the original queen was not superseded. It indicates that observations did not arrest the entire life of a superseding life of a queen. The superseding rate was calculated on the basis of the estimate of total eggs laid during a superseding life (see first column). Since this estimate is conservative, since it is likely that many ovipositions were not recorded in these records.

Colony No.	Queen No.	Emergence of superseding Y	Days to supersede	Days to supersede	Days to supersede	Days to supersede	Days to supersede	Days to supersede	Days to supersede	Fate
161	1	1	1	1	1	1	1	1	1	Superseded by no. 2
174	1	1	1	1	1	1	1	1	1	Superseded by no. 2
"	2	1	1	1	1	1	1	1	1	Superseded by no. 1
231	1	1	1	1	1	1	1	1	1	Superseded by no. 2
231	2	1	1	1	1	1	1	1	1	Superseded by no. 1
261	1	1	1	1	1	1	1	1	1	Superseded by no. 2
"	2	1	1	1	1	1	1	1	1	Superseded by no. 1
"	3	1	1	1	1	1	1	1	1	Superseded by no. 2
261	1	1	1	1	1	1	1	1	1	Disappeared
"	2	1	1	1	1	1	1	1	1	Superseded by no. 1
261	1	1	1	1	1	1	1	1	1	Superseded by no. 2
"	2	1	1	1	1	1	1	1	1	Superseded by no. 1
"	3	1	1	1	1	1	1	1	1	Superseded by no. 2
347	1	1	1	1	1	1	1	1	1	Superseded by no. 2

nies 231 and 310, for which observations were not complete enough to observe how or exactly when the changes occurred. In three of the cases of supersedure the total life span (from emergence to disappearance from the nest) of the ousted queen was recorded exactly. These averaged 60 days (range: 45-79 days). The average active egg-laying life of five ousted queens was 49 days (range: 36-69 days). A sixth ousted queen (no. 1 of colony 174) had an egg-laying life of at least 46 days.

3. Age of Superseding Queens

Table 15 gives the age of each queen at the time she was first observed to dominate a nestmate and to oviposit. The mean age for six queens was five days (range: 3-8 days). Nonqueens (workers and nonworkers), however, were first observed to dominate others at an average age of 8.5 days (range: 4-20) (29 individuals). The age of queens at the first observed oviposition

averaged 10 days (range: 9-15) (7 individuals).

4. Changing Rates of Oviposition

There was no apparent slowdown in rate of oviposition in the colonies toward the end of the egg-laying lives of superseded queens (Figs. 26D, 28D, 30D). In most cases, for a few days before the disappearance of the superseded queen, both old and new queens laid eggs, and during this interval the rate of oviposition of the old queen decreased to zero, but there was no indication that a decreasing rate of oviposition by the old queen might have been the cause of the subsequent supersedure. In the case of colony 174, when no. 26 finally ejected no. 1 she actually oviposited at a much lower rate than did no. 1 prior to supersedure (Fig. 30D), though at this time the colony was well into decline. On colony 342, no. 2 also had a very low initial rate of oviposition.

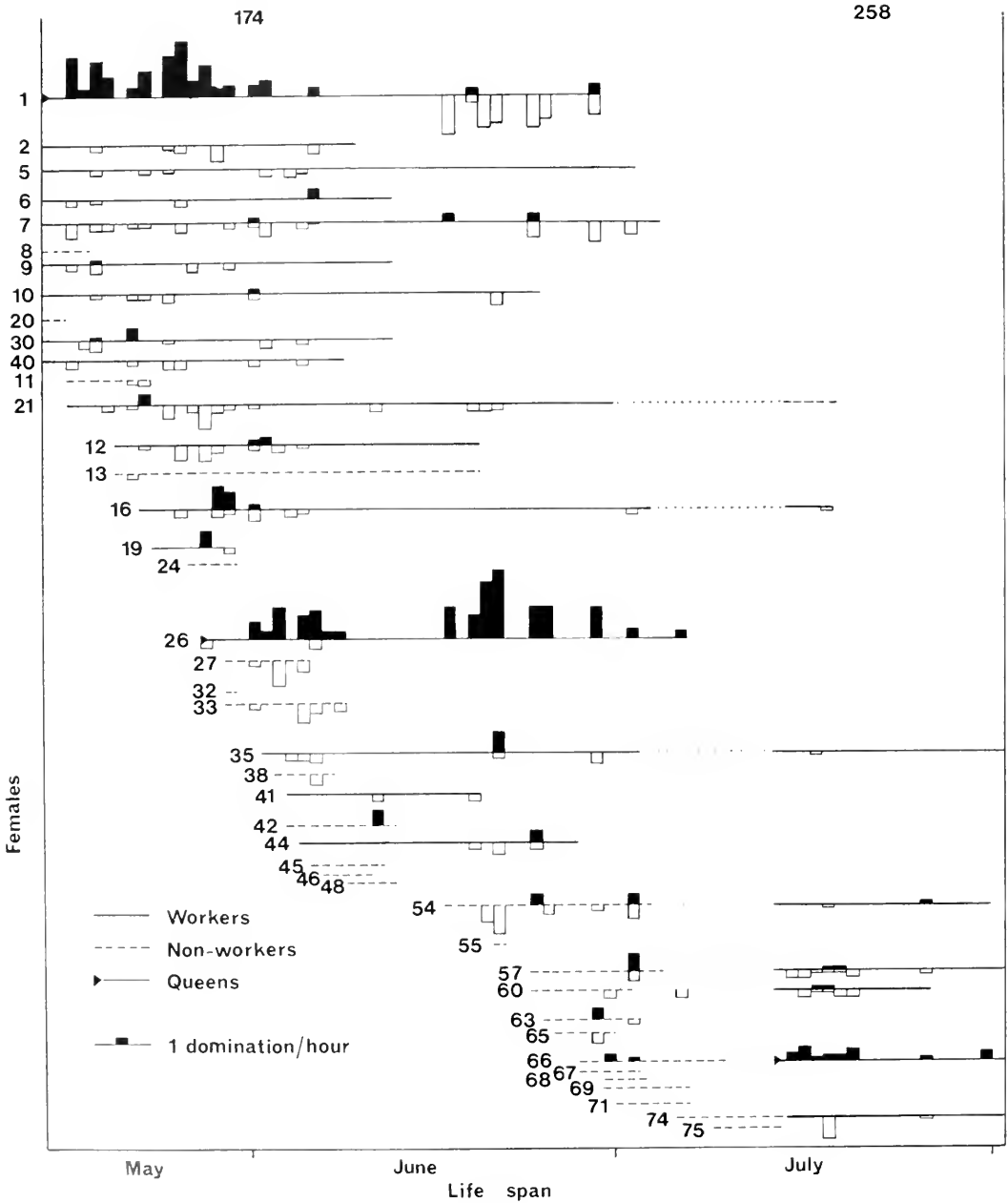

Figure 10. Domination and submission among females of colony 174 and its daughter colony, 258. (See Fig. 9 for explanation of presentation.) Data extend from the postemergence stage through decline of colony 174 and into the pre-emergence stage of colony 258. The interval between the disappearance of a female from colony 174 and its appearance as a co-foundress on 258 is represented by a dotted line.

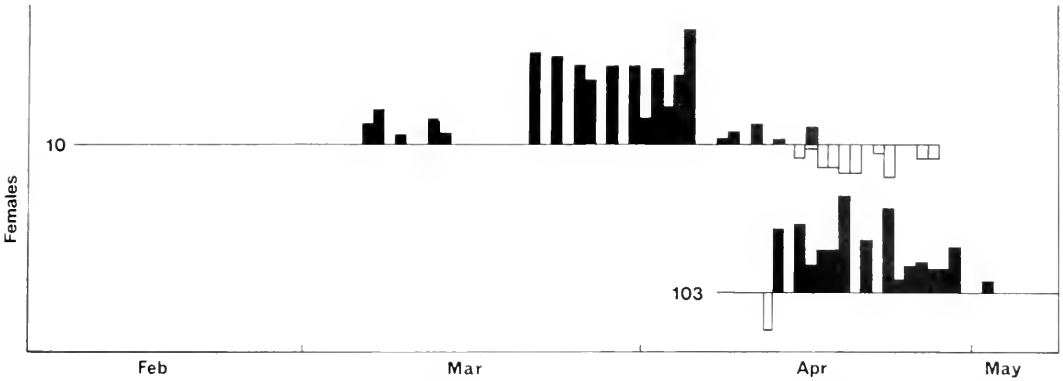

Figure 11. Domination and submission of queens 10 and 103 of colony 342. (See Fig. 9 for explanation of presentation.) The data span the passing of the queenship from 10 to 103.

5. Changing Rates of Domination

In all cases where observations were sufficiently regular to provide data for calculating rates of domination, the superseded queens were dominating at very low rates when they were ejected. This was true of no. 1 and no. 8 on colony 268 (Fig. 9), no. 1 on 174 (Fig. 10), and no. 10 on 342 (Fig. 11). The rate of domination of the superseding queen, on the other hand, was usually high at the time she ejected the old queen. This was especially true of no. 8 on 268 and no. 103 on 342 (Fig. 11), though less true of no. 36 of 268 (Fig. 9) and no. 26 of 174 (Fig. 10). Also, toward the end of a queen's reign, her younger offspring showed more dominance than did those who were young at the beginning of her term. This was especially clear during the reign of no. 8 on 268 and no. 1 on 174 (Figs. 9 and 10).

The rate of domination by no. 1, the foundress of 268, was much lower than that for superseding queens (Fig. 9). By the time she had offspring to dominate, she had put in five weeks of queen and worker duties combined and could well have been exhausted. If this low rate of domination is typical of foundresses, then this is evidence that no. 1 on 174 was not the foundress, since her rate of domination was as high as that for superseding queens

(Fig. 10). Indeed, by the time no. 1 was superseded by no. 26, colony 174 was about 130 days old, much more than the average life span of queens, so it is likely that no. 1 was at least the second queen.

6. Sex of the Offspring of Superseding Queens

Only three superseding queens took over early enough in the cycle of their colonies for their eggs to produce adult offspring. These were no. 8 on 268, and nos. 2 and 10 on 342. In all cases their offspring included females, proof that the superseding queens had been fecundated. Both males and females were among the offspring produced by the first eggs laid by these queens. Number 2 on colony 342 was queen for at least 48 days before any males emerged from the nest, yet the eggs she laid in this period produced adults of both sexes. Therefore, she must have mated with a male from another colony. The nearest known nest containing males at that time was 268, about 30 m away.

The situation that existed on colony 173 presents circumstantial evidence that a superseding queen need not be fecundated. When observations began on 16 May 1968 the colony was approximately 130 days old, yet it had only 38 cells. On that day there were five females and one male on the

nest. Over the next 57 days eggs were laid, the nest grew by cell addition, and then declined. Surprisingly, all of the 25 adults to emerge during this period were males, suggesting that the female who had laid these eggs was not fecundated. The fact that five females were present, though the nest was much older than the maximum age recorded for females, suggests that earlier there had been female offspring and that the original foundress was fecundated. The nest was unusually small for its age (in contrast, colony 174, of approximately the same age, had 115 cells), suggesting that it had undergone a long period of no growth. I suspect that the original queen was lost and there was no fecundated offspring to replace her. Unfortunately, it is not known whether the queen present on the nest during observations was fecundated, for the nest declined before any of her eggs produced adults. It is possible, however, that she was and that nest growth resumed only when she superseded the unfecundated egg-layer or egg-layers.

7. Discussion

As was seen above, the rate at which a queen dominates her nestmates generally decreases as she ages. Therefore, the offspring emerging later in her life as queen receive less domination on the average than those emerging earlier. Apparently, sooner or later one of these offspring does not receive enough domination to cause the inhibition of her ovarial development. As her ovaries develop she becomes increasingly dominant, and by her tenth day begins to oviposit. The old queen and the developing offspring co-exist on the nest for several days, both laying eggs. Eventually the offspring is able to challenge the queen, dominate her, and replace her as queen. Once the queen is superseded she does not merely regress in social status, but disappears from the nest altogether.

There is evidence that the amount of domination an offspring requires to force

it into a worker role varies greatly from one individual to another. Thus, no. 5 and no. 6 on colony 268 both assumed worker duties with a minimum of domination and did not dominate others at all (Fig. 9). This was in contrast to nos. 2 and 3 on the same nest. It may be that successful superseders are particularly robust individuals who happen to be on the scene at the time the reigning queen is weakening. Number 27 may have been a robust individual who challenged no. 8 as queen before no. 8 was sufficiently weak to be overthrown. Number 27 dominated no. 8 once on 25 December 1968, after which no. 8 bounced back and dominated no. 27 into submission (Fig. 9).

An obvious effect of supersedure is to maintain a vigorous, dominant queen in the colony. Though there is no direct evidence that superseded queens have a reduced reproductive capacity, the decreasing rate of dominance may be a sign of impending reproductive slowdown. Or, since domination plays a key role in caste determination and division of labor and is apparently necessary for the maintenance of the colony, the failure of the queen in this role alone may be cause enough for her replacement.

Eberhard (1969) stated that what she termed "queen substitution" may be a common occurrence in *Polistes canadensis* in Colombia. When she removed the queen from an active colony, cell addition stopped, but cell heightening continued during the subsequent period of conflict. When a new queen became established on the colony, cell addition resumed, forming a shelf of shallow cells distinct from the heightened cells initiated by the former queen. Since such "shelves" were common among abandoned nests, she concluded that regeneration of nest growth by "substitute queens" is a common occurrence. This phenomenon differs from queen supersedure in *M. dreuxeni* in that the old queen apparently first disappears, then there is a period of conflict among her

subordinates, during which there is no nest growth. When one of the subordinates is finally established as queen, nest growth resumes. In *M. drowseni* the conflict is directly between the old and the new queens, is very brief (a day or two), and usually has no visible effect on nest growth (though growth stopped temporarily on 26S when no. 36 took over) (Fig. 19).

The existence of queen supersedure in *M. drowseni* poses several questions. First, why has the colony cycle evolved such that it is several times longer than the reproductive cycle of a single queen? The answer to this may lie in a more complete understanding of the relationships of the wasps with their predators. If colonies are subject to a high rate of failure owing to destruction of brood by such predators as army ants, then it may be advantageous to have several short-lived queens that retain enough mobility and behavioral plasticity to begin a new colony at any time (Richards and Richards, 1951).

Another question is what determines whether a dominant young female with developing ovaries supersedes her mother (or older sibling) and stays on the parent nest as queen, or leaves the parent nest and founds a new colony. I suspect that the answer to this lies in an understanding of the colony cycle.

X. LIFE CYCLE OF THE COLONY AND ITS INDIVIDUALS

A. DURATION OF BROOD STAGES

1. Eggs

The phenomenon of egg-eating raises difficulties with attempts to determine the duration of the egg stage. Although accurate daily records were kept of the contents of each brood cell on each observation nest, no adequate method was found to determine with certainty when an egg had been eaten and replaced. The only sure ways of detecting that an egg had been eaten were either to observe the act

itself, or to observe the empty cell before it received a fresh egg. Noting the position of the egg in the cell was partially helpful, but often the new egg would be placed in the same position as the original one. Thus, brood development records often indicated that a given cell contained an egg for several weeks, with no information as to how many separate eggs were involved. Because of such uncertainties, it is not possible to compute average duration of the egg stage with accuracy.

An approximate figure for duration of the egg stage may be provided, however. The first few eggs laid in a newly founded nest, *i.e.*, those that produced the first workers, apparently were never eaten and replaced. I have observed neither such an egg being eaten, nor the cells containing these eggs empty. These eggs all developed within 10–13 days (average: 11.1). It is doubtful that the time of development of eggs varies as much as that of the larvae, since the development of the egg is not dependent upon receipt of food. Temperature probably plays the most important role. Thus, 11 days is probably a reasonably accurate approximation of the average duration of the egg stage.

Eberhard (1969) gave 17.1 days as the mean duration of the egg stage for *Polistes canadensis*, with the extremely wide range of 9–28 days. Isely (1922) gave 10–11 days as the incubation time for first eggs of *P. metricus*, and stated that later eggs do not require significantly longer.

2. Larvae

The problem of the detection of removal and replacement does not arise with larvae or with pupae. The duration of the larval stage varied considerably, depending on the stage of colony development. Figures 12B, 13B, and 14B plot the duration of the larval stage against age of the colony. The first larvae to eclose required the shortest time to develop. The variation in duration of larval stage probably reflects varying rates of feeding at different stages of

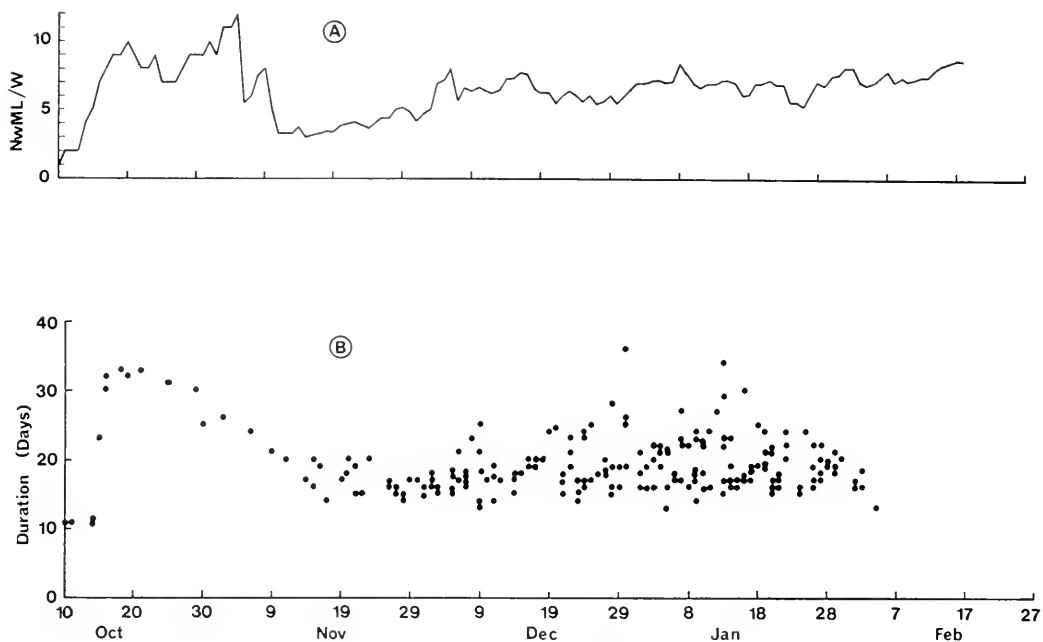

Figure 12. NwML/W ratio and larval duration, colony 268. A. NwML/W ratio. The ratio of nonworkers plus moles plus larvae/workers (ordinate) is plotted against time. B. Duration of the larval stage. Each point represents a single larva. Its date of eclosion is given on the abscissa, and the number of days it required to spin its cocoon is given on the ordinate. Larvae that did not survive to spin are not included.

colony development. This will be discussed further below (Colony Development, p. 119 and following). The minimum developmental time for first larvae was ten days (colony 421), though most required 11–12 days. Following this initial minimum, the curve of larval duration jumped to a maximum of from 30 to 40 days. The maximum recorded time required for a larva to develop was 60 days (colony 354). From this maximum the curve decreased to a second low of around 15 days. Then it rose gradually for the remainder of the colony cycle. The bulk of larvae that eclosed in the postemergence stage of colony development required 15–30 days to develop.

Table 16 gives the average development times for larvae for the entire colony cycle.

The developmental time for larvae of *Polistes canadensis* is 26.6 days (range: 14–53 days) (Eberhard, 1969).

TABLE 16. Duration of larval stages. The average duration of the larval stage is calculated only from the 111 colonies that were newly-founded colonies.

BOYS				
Average: 11.1 days				
LARVAE				
Colony	Age	S. D.	Range	Number
27	2.1	4.4	11–16	205
33	10.5	6.7	11–40	103
34	14.1	6.5	11–40	146
204	24.1	7.1	11–46	454
PIPAE				
Colony	Age	S. D.	Range	Number
27	1.1	1.2	1–16	164
33	14.5	1.6	14–16	54
34	14.1	0.5	13–15	129
204	14.5	0.5	13–16	347

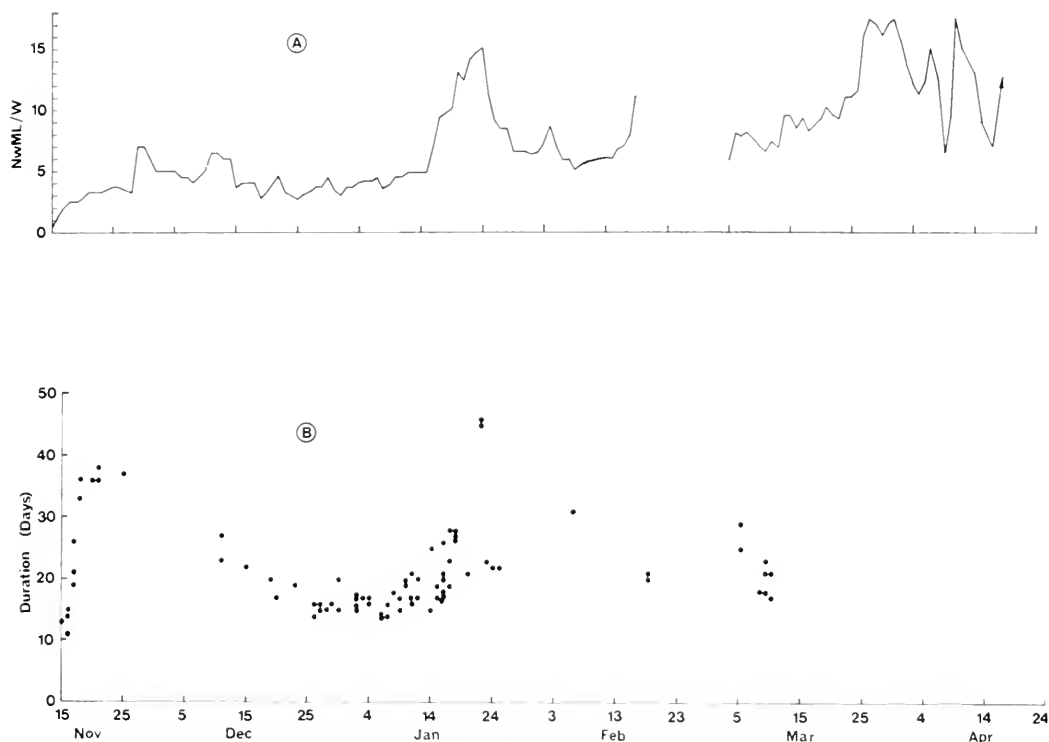

Figure 13. NwML/W ratio and larval duration, colony 310. A. NwML/W ratio. The ratio of nonworkers plus males plus larvae/workers (ordinate) is plotted against time. B. Duration of the larval stage. Each point represents a single larva. Its date of eclosion is given on the abscissa, and the number of days it required to spin its cocoon is given on the ordinate. Larvae that did not survive to spin are not included.

3. Pupae

Duration of the pupal stage varied much less widely than did that of the larval stage. Probably temperature plays an important role in determining rate of development of pupae (Eberhard, 1969). However, in colony 268 the first pupa required only 12 days and the next three only 13 days, while all subsequent pupae required 14–16 days. It was precisely these four individuals whose larval stage was extremely short (Fig. 12B). There was no evidence of a similar shortening of developmental time for the first pupae on either colony 310 or 342.

The overall average time for pupal development for all colonies was 14.8 ± 0.8 days (347 pupae) (Table 16).

There was no significant difference be-

tween the time taken for male pupae and female pupae to develop (71 males, 71 females, 3 degrees of freedom, $\chi^2 = 6.75$, $p > .05$).

Eberhard's data for duration of the pupal stage of *Polistes canadensis* show a much wider variation (7–32 days) than exists in *M. drewseni*. Likewise, Žikán (1951) stated that cells remained covered from 20 to 48 days in *M. scotophilus*. The reasons for this are not apparent. Isely (1922) found that pupae of *P. metricus* in the southeastern United States always required 18 days to develop.

B. SURVIVORSHIP OF ADULTS

Since the date on which each individual emerged as an adult was recorded and daily records were made of its presence on

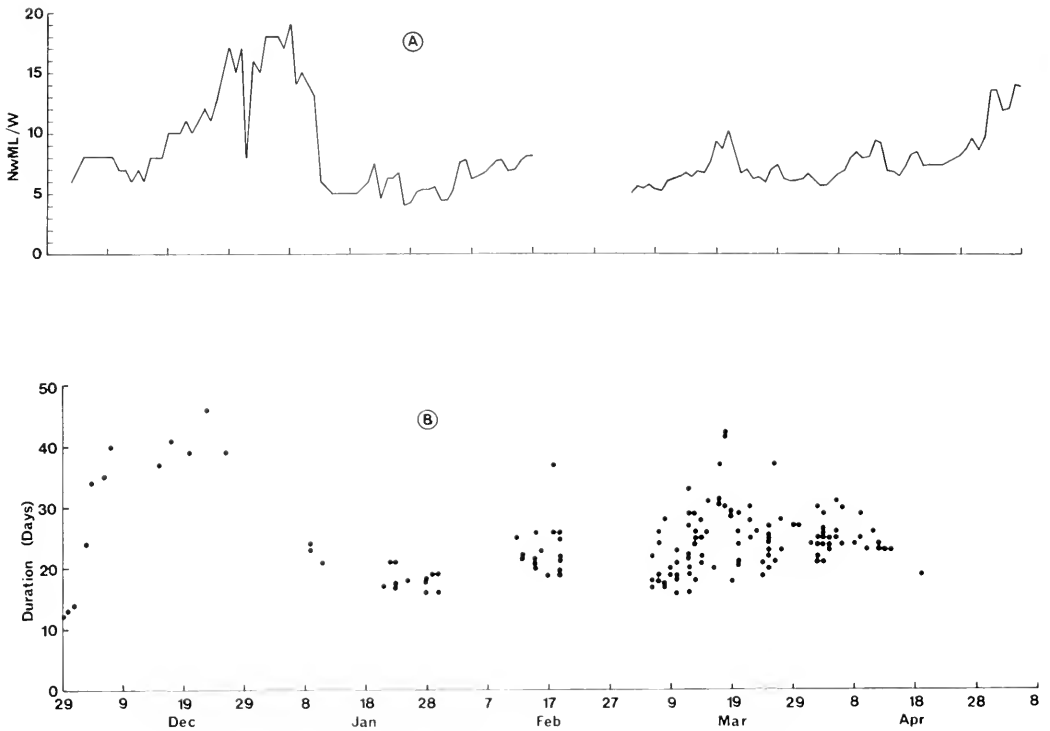

Figure 14. NwML/W ratio and larval duration, colony 342. A. NwML/W ratio. The ratio of nonworkers plus males plus larvae/workers (ordinate) is plotted against time. B. Duration of the larval stage. Each point represents a single larva. Its date of eclosion is given on the abscissa, and the number of days it required to spin its cocoon is given on the ordinate. Larvae that did not survive to spin are not included.

or absence from the nest, it is possible to construct life tables for the adult wasps. Several assumptions must first be made.

1) The term "life span" as used here is defined as the span of time (in days) an individual is recorded on the nest. Death is probably the reason most workers disappear from the nest, but the same assumption may not be valid for nonworkers and males, since these may leave the nest on mating flights, and some, at least, of the nonworkers may subsequently found new colonies.

2) There were a number of individuals that were not seen on the nest beyond their first or second day. In view of the fact that normally an adult did not leave the nest during its first two to three days, the

causes of such brief life spans are somewhat suspect. It is possible that these wasps were damaged in the process of marking, or by the paint mark itself. Or they may have been sick or weak individuals. Since there are no valid grounds for excluding them from the survivorship data, they are included.

3) Another problem arises with individuals whose entire period on the nest was not observed, either because they had already emerged when observations began or were still on the nest when observations ended. The average life span for such individuals was found not to be significantly different from the average for individuals whose entire life span was known; data from both groups were therefore pooled.

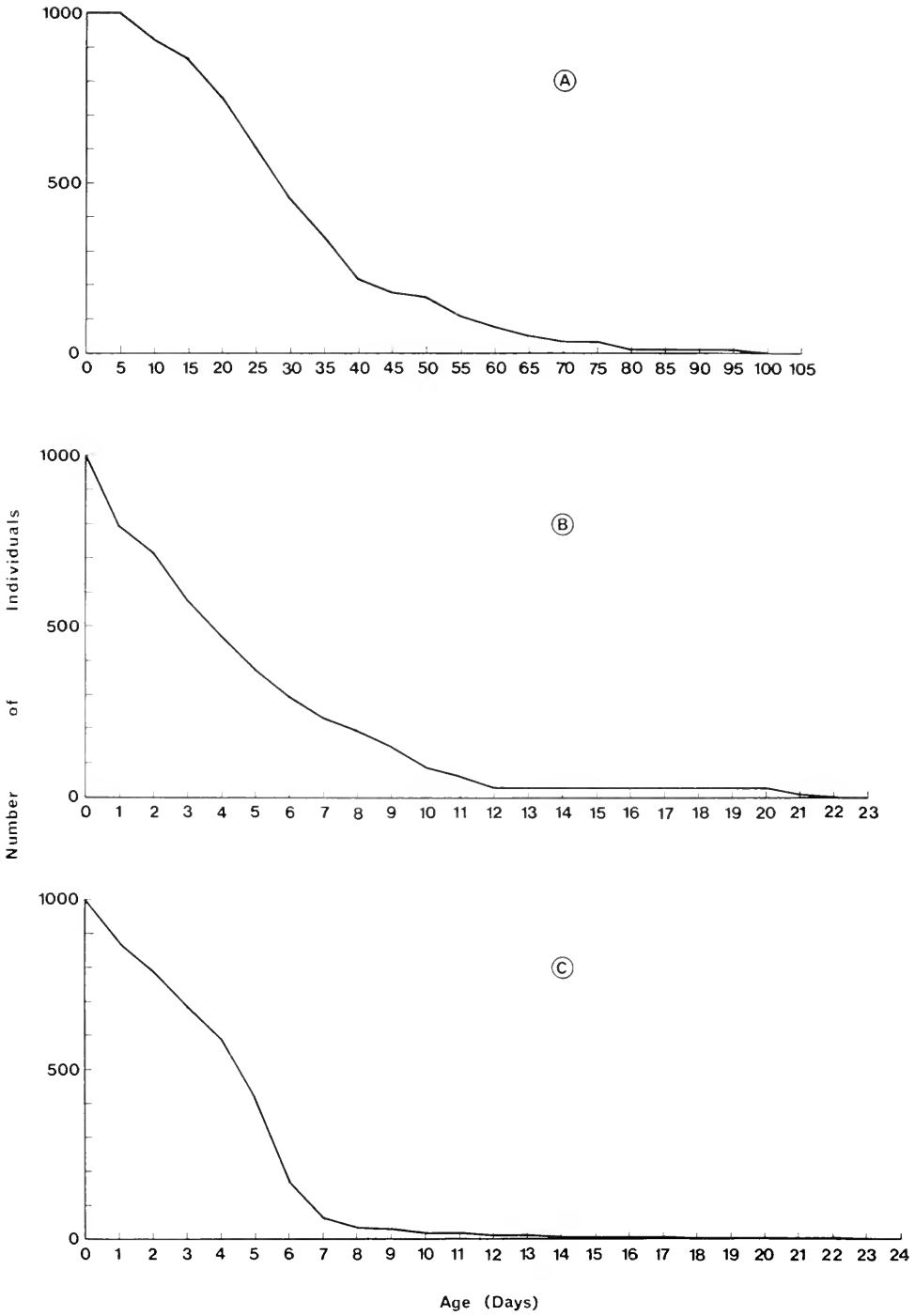

Figure 15. Survivorship of adults. A. Workers (148 individuals). B. Nonworkers (134 individuals). C. Males (323 individuals).

TABLE 17. AVERAGE LIFE SPANS OF ADULTS.

	Average life span (days)	S.D.	Range	No. individuals included
Queens	61	18.7	39-88	6
Workers	31	16.9	6-97	148
Nonworkers	5.0	3.5	1-22	134
Males	4.8	2.6	1-23	323

Survivorship curves for workers, males, and nonworkers (not including queens) are presented in Figure 15. The plateau of 100 percent survival in the first interval of the worker curve (Fig. 15A) is an artifact of the three-day period of "maturation" prior to the development of worker activities. Since for their first three days of adult life wasps remained more or less idle on the nest, it was not possible to determine whether a female was a worker or a nonworker until her third day or so. Thus, all workers had to stay on the nest at least four days, otherwise they could not be identified as workers and were grouped with nonworkers by default. The worker curve approaches Slobodkin's type I (Slobodkin, 1961) for the first 30 days, then approaches type III. Its form is similar to that published for worker honeybees (Sakagami and Fukuda, 1968) except that the change in death rate is not so sudden. The same sort of curve exists for males (Fig. 15C), while the nonworker curve is of type III throughout (Fig. 15B).

Average life spans for queens, workers, nonworkers, and males are presented in Table 17.

C. THE COLONY CYCLE

1. Colony Founding

A new colony may be founded either after the parent colony declines normally, or after it meets with some disaster that the adults escape. As can be seen in Table 18, there was generally a lag of only a few days between the time a foundress left her parent nest and the time she initiated her

own nest, though in one case a colony (353) was founded approximately 25 days before the parent colony (231) declined.

a. *Seasonal asynchrony of colony founding.* Table 18 gives dates of colony foundings for *M. drewseui*, estimated by extrapolation. Though data are not extensive enough to test statistically, there is no suggestion of seasonal synchronization of the colony cycle. The relatively greater number of foundings in the months of February, March, and April is probably attributable to the fact that these months were covered for two years; the low number of foundings in August and September is likewise probably due to there having been no observations during these months. Continuous observations during the course of a year at Taperinha (except for August and September), and spot checks during February, April, and October in Belém, revealed nests in all stages of development in all months. This agrees with Eberhard's conclusion of seasonal asynchrony of colony cycle in *Polistes canadensis* in Cali, Colombia (4°N) (Eberhard, 1969).

b. *Association of foundresses.* Twenty-nine colonies of *M. drewseui* were discovered while still in the pre-emergence stage. Of these, 20 (69 percent) were founded by a single female, 5 (17 percent) by two females, 1 (3.5 percent) by three, 2 (7 percent) by five, and 1 (3.5 percent) by eight. In the four cases where several previously marked females had associated to found a colony (180A, 258, 295 and 310), all co-foundresses on each nest had been marked on the same parent nest; that is, they were siblings. Daughter colonies were always founded within 30 meters of the parent colony, and usually much closer (Table 18).

In no case did I discover a multiple-foundress nest early enough to observe how the co-foundresses came together. I suspect, however, that such nests were initiated by one or two co-foundresses and that the others associated themselves with the venture over the course of several days.

TABLE 15. Estimated nests of foundresses of colonies of *M. drewseni*. Dates were estimated by extrapolation of pre-emergence colonies based on duration of arctic stages. A question mark indicates a colony which declined or was destroyed at about the time the presumed daughter colony was founded nearby, but that the absence of marks on the foundresses of the daughter colony did not permit their positive assignment to that parent colony. Asterisks indicate parent colonies that were destroyed.

Colony number	Estimated date of founding	Parent colony	Date of decline or destruction of parent colony	Approximate distance between parent and daughter nests (m)
258	February 1967	258*		0
259	February 1967	258*		0
274	17 February 1967	258*		0
282	17 March 1967	258*	17 March 1967	1
283	17 March 1967	258*		0
284	17 March 1967	258*		0
285	17 March 1967	258*		0
286	17 March 1967	258*	4 July 1967	1
287	17 March 1967	258*	12 Sept. 1967	1
288	17 March 1967	258*	14 October 1967	1
289	17 March 1967	258*	14 October 1967	1
290	17 March 1967	258*	14 October 1967	1
291	17 March 1967	258*	14 October 1967	1
292	17 March 1967	258*	14 October 1967	1
293	17 March 1967	258*	14 October 1967	1
294	17 March 1967	258*	14 October 1967	1
295	17 March 1967	258*	14 October 1967	1
296	17 March 1967	258*	14 October 1967	1
297	17 March 1967	258*	14 October 1967	1
298	17 March 1967	258*	14 October 1967	1
299	17 March 1967	258*	14 October 1967	1
300	17 March 1967	258*	14 October 1967	1
301	17 March 1967	258*	14 October 1967	1
302	17 March 1967	258*	14 October 1967	1
303	17 March 1967	258*	14 October 1967	1
304	17 March 1967	258*	14 October 1967	1
305	17 March 1967	258*	14 October 1967	1
306	17 March 1967	258*	14 October 1967	1
307	17 March 1967	258*	14 October 1967	1
308	17 March 1967	258*	14 October 1967	1
309	17 March 1967	258*	14 October 1967	1
310	17 March 1967	258*	14 October 1967	1
311	17 March 1967	258*	14 October 1967	1
312	17 March 1967	258*	14 October 1967	1
313	17 March 1967	258*	14 October 1967	1
314	17 March 1967	258*	14 October 1967	1
315	17 March 1967	258*	14 October 1967	1
316	17 March 1967	258*	14 October 1967	1
317	17 March 1967	258*	14 October 1967	1
318	17 March 1967	258*	14 October 1967	1
319	17 March 1967	258*	14 October 1967	1
320	17 March 1967	258*	14 October 1967	1
321	17 March 1967	258*	14 October 1967	1
322	17 March 1967	258*	14 October 1967	1
323	17 March 1967	258*	14 October 1967	1
324	17 March 1967	258*	14 October 1967	1
325	17 March 1967	258*	14 October 1967	1
326	17 March 1967	258*	14 October 1967	1
327	17 March 1967	258*	14 October 1967	1
328	17 March 1967	258*	14 October 1967	1
329	17 March 1967	258*	14 October 1967	1
330	17 March 1967	258*	14 October 1967	1
331	17 March 1967	258*	14 October 1967	1
332	17 March 1967	258*	14 October 1967	1
333	17 March 1967	258*	14 October 1967	1
334	17 March 1967	258*	14 October 1967	1
335	17 March 1967	258*	14 October 1967	1
336	17 March 1967	258*	14 October 1967	1
337	17 March 1967	258*	14 October 1967	1
338	17 March 1967	258*	14 October 1967	1
339	17 March 1967	258*	14 October 1967	1
340	17 March 1967	258*	14 October 1967	1
341	17 March 1967	258*	14 October 1967	1
342	17 March 1967	258*	14 October 1967	1
343	17 March 1967	258*	14 October 1967	1
344	17 March 1967	258*	14 October 1967	1
345	17 March 1967	258*	14 October 1967	1
346	17 March 1967	258*	14 October 1967	1
347	17 March 1967	258*	14 October 1967	1
348	17 March 1967	258*	14 October 1967	1
349	17 March 1967	258*	14 October 1967	1
350	17 March 1967	258*	14 October 1967	1
351	17 March 1967	258*	14 October 1967	1
352	17 March 1967	258*	14 October 1967	1
353	17 March 1967	258*	14 October 1967	1
354	17 March 1967	258*	14 October 1967	1
355	17 March 1967	258*	14 October 1967	1
356	17 March 1967	258*	14 October 1967	1
357	17 March 1967	258*	14 October 1967	1
358	17 March 1967	258*	14 October 1967	1
359	17 March 1967	258*	14 October 1967	1
360	17 March 1967	258*	14 October 1967	1
361	17 March 1967	258*	14 October 1967	1
362	17 March 1967	258*	14 October 1967	1
363	17 March 1967	258*	14 October 1967	1
364	17 March 1967	258*	14 October 1967	1
365	17 March 1967	258*	14 October 1967	1
366	17 March 1967	258*	14 October 1967	1
367	17 March 1967	258*	14 October 1967	1
368	17 March 1967	258*	14 October 1967	1
369	17 March 1967	258*	14 October 1967	1
370	17 March 1967	258*	14 October 1967	1
371	17 March 1967	258*	14 October 1967	1
372	17 March 1967	258*	14 October 1967	1
373	17 March 1967	258*	14 October 1967	1
374	17 March 1967	258*	14 October 1967	1
375	17 March 1967	258*	14 October 1967	1
376	17 March 1967	258*	14 October 1967	1
377	17 March 1967	258*	14 October 1967	1
378	17 March 1967	258*	14 October 1967	1
379	17 March 1967	258*	14 October 1967	1
380	17 March 1967	258*	14 October 1967	1
381	17 March 1967	258*	14 October 1967	1
382	17 March 1967	258*	14 October 1967	1
383	17 March 1967	258*	14 October 1967	1
384	17 March 1967	258*	14 October 1967	1
385	17 March 1967	258*	14 October 1967	1
386	17 March 1967	258*	14 October 1967	1
387	17 March 1967	258*	14 October 1967	1
388	17 March 1967	258*	14 October 1967	1
389	17 March 1967	258*	14 October 1967	1
390	17 March 1967	258*	14 October 1967	1
391	17 March 1967	258*	14 October 1967	1
392	17 March 1967	258*	14 October 1967	1
393	17 March 1967	258*	14 October 1967	1
394	17 March 1967	258*	14 October 1967	1
395	17 March 1967	258*	14 October 1967	1
396	17 March 1967	258*	14 October 1967	1
397	17 March 1967	258*	14 October 1967	1
398	17 March 1967	258*	14 October 1967	1
399	17 March 1967	258*	14 October 1967	1
400	17 March 1967	258*	14 October 1967	1

The subordinate co-foundresses of a daughter colony were among the last to leave the parent nest, and some were found on both nests for several days during the early stages of the daughter colony. Males, though present on the parent colonies while daughter colonies were being founded, were never seen on the daughter nests.

During the course of pre-emergence colony development, the number of co-foundresses gradually diminished. Colony 258, with a maximum of eight co-foundresses, had only four 24 days after founding. Of the five co-foundresses on colony 310,

only three remained at the emergence of the first offspring. Two weeks later none remained.

2. Colony Development

The progress of colony development from initiation through final decline can be traced in terms of brood population and nest size. When a nest is growing, virtually all cells are filled with brood, and new cells are supplied with eggs within a day or so after they are initiated. Consequently, the rate of addition of new cells is a good indicator of colony growth. When the nest is not being enlarged, the

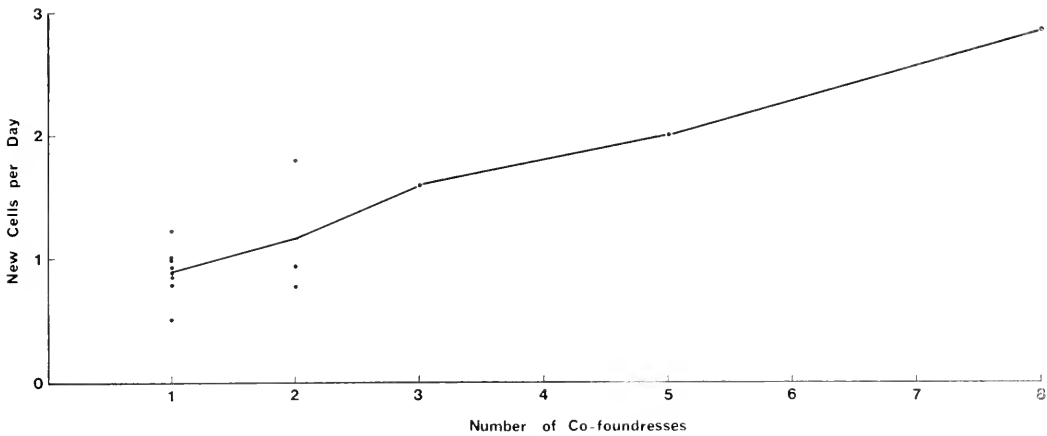

Figure 16. Change in rate of new cell construction with number of co-foundresses. Data are based on rate of nest growth (in new cells per day) before the first larva ecloses. Each dot represents a colony. The line connects average values.

size of the brood population may be either static or decreasing. When the brood is decreasing, cells are emptied of brood faster than they are filled with fresh eggs. Thus, the most convenient indicator of decreasing brood is an increase in the number of empty cells. Cells are emptied of brood in three ways: by the emergence of adults, by egg-eating, and by the abortion of brood. The termination of the colony cycle occurs when the brood decreases to zero and the number of empty cells equals the number of cells in the nest. This was observed in three colonies (173, 174, 310). The progress of colony development is normally one of growth until just before decline, though there may be temporary periods of no growth or even of decrease of brood population at any time. Data pertaining to colony development are most complete for seven colonies. Nest size (in number of cells) and number of empty cells for these colonies are plotted in Figures 17-23. Oviposition rates throughout colony development are presented in Figures 24D through 30D.

a. *The egg substage.* In the period from nest founding until the eclosion of the first larva the queen (or the queen and her co-foundresses) had three tasks: 1) to feed herself, 2) to initiate cells, and 3) to ovi-

posit. As soon as each cell was begun it was generally supplied with an egg, though occasionally a cell was left empty for as long as a day. Nests grew rapidly and steadily at an average rate of about 0.9 cell per day for single-foundress colonies; this rate increased by about 0.25 cell per day for each additional co-foundress (Fig. 16).

b. *The larval substage.* The first eggs took 11 to 12 days to hatch. With the appearance of the first larvae, the queen's duties changed. She ceased building new cells and turned her attention to feeding larvae and heightening the walls of their cells to keep up with their growth. The cessation of nest enlargement resulted in a "plateau" in nest size. The size of the nest at this point averaged 12 cells (range: 7-17) for eight single-foundress nests and increased with the number of co-foundresses (Table 19). The plateau was more distinct for single-foundress nests (Figs. 18 and 21) than for multiple-foundress nests (Figs. 17 and 20). Similar growth arrest occurs in *Polistes chinensis antennalis* in Japan (Morimoto, 1954a, b) and *P. gallicus* in Europe (Gervet, 1964b).

There was a slight decrease in oviposition rate during this substage (Figs. 25D and 27D). This agrees with what Gervet found for *Polistes gallicus* (Gervet,

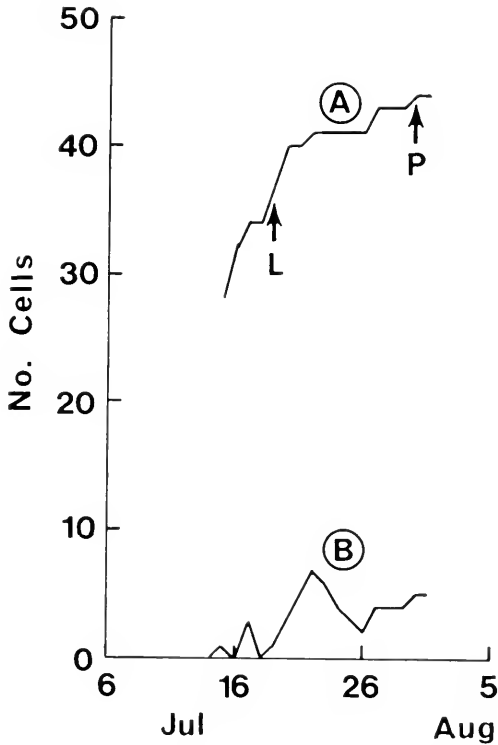

Figure 17. Nest growth, colony 258. A. Nest size in number of cells. L = date first larva eclosed. P = date first larva spun its cocoon. B. Number of empty cells.

1964b), though Morimoto (1954b) reported a complete cessation of egg-laying during the early larval stage in *P. chinensis antennalis*.

After the eclosion of the first larvae several of the eggs in peripheral cells were generally eaten. The rate of egg-eating was highest at the beginning of the larval substage, then tapered off within a few days (Figs. 24C, 25C, 27C). Since the rate of oviposition was reduced below the rate of egg-eating, the net result was a sudden rise in the numbers of empty cells at the beginning of the period (Figs. 17, 18, 20, 21). The number of empty cells then gradually declined as the rate of egg-eating dropped off and the empty cells were filled. This phenomenon occurred in both single- and multiple-foundress colonies. Though the eggs were ingested by

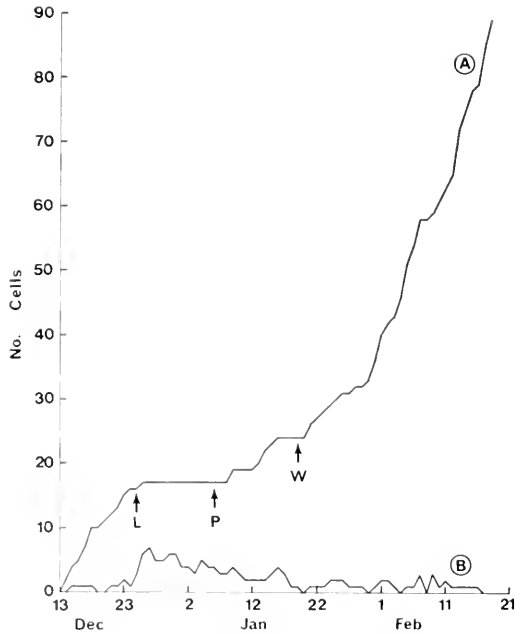

Figure 18. Nest growth, colony 347. A. Nest size in number of cells. L = date first larva eclosed. P = date first larva spun its cocoon. W = date first adult female emerged. B. Number of empty cells.

the ophagic individuals, observation suggests that the egg contents were regurgitated and fed to the larvae, *i.e.*, that they were used as "trophic eggs." Feeding eggs to larvae at this stage in colony development occurs in *P. chinensis antennalis* (Morimoto, 1954c) and in *P. gallicus* (Gervet, 1964a). It is possible that the diet of eggs is responsible for the rapid growth of the first larvae.

There were two other effects of the egg-eating that occurred at this time. First, since nest growth stopped, it enabled the queen to continue ovipositing by making cells available. Second was its effect on the timing of the brood. Since many of the eggs laid just prior to and during the early part of the larval substage were replaced with younger eggs toward the end of this period, the number of larvae in the nest at the beginning of the pupal substage was less than it would have been had the original eggs been left. The consequent lack of

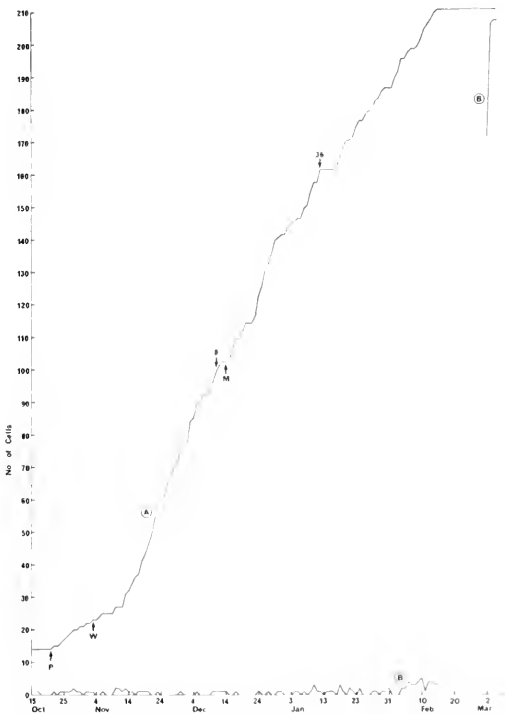

Figure 19. Nest growth, colony 268. A. Nest size in number of cells. P = date first larva spun its cocoon. W = date first adult female emerged. M = date first adult male emerged. 8 = date no. 8 become sole egg-layer. 36 = date no. 36 became sole egg-layer. B. Number of empty cells. Note that this curve continues after the 18 February–4 March break in observations.

eclosing larvae to replace those pupating led to a drop in the number of larvae at this time. This was seen especially clearly in colonies 347 and 310 (Figs. 32 and 34), and less clearly in colonies 268 and 342 (Figs. 33 and 35). The increase in eggs at the end of the larval substage resulted in a rise in number of larvae at about the time the first workers emerged (since eggs and pupae required roughly the same time to develop). Thus the increase in larvae requiring care is neatly synchronized with the increase in the worker force (Figs. 32–35). The drop in the number of pupae, beginning at about the time the first workers emerged, was due to the doubling or tripling of the duration of the larval stage

at this time. This initial periodicity of the brood was damped out completely after workers appeared.

The first two to four larvae to eclose, *i.e.*, those in the central (oldest) cells, grew rapidly, taking only 11–12 days to spin their cocoons (Figs. 12B, 13B, 14B). These formed the first pulse of worker offspring. The number in this first batch averaged 2.6 for single-foundress colonies. In single-foundress colonies the duration of the larval substage of these first workers was distinctly shorter than that for subsequent workers (Figs. 12B and 14B). In the case of multiple-foundress colonies, however, larval duration of the subsequent workers increased more gradually (Fig. 13B). As a result, the first batch of workers on such nests was less distinctly isolated in time of emergence from subsequent workers.

c. *Pupal substage.* Within 22–24 days after nest initiation the oldest larvae spun their cocoons. This, along with the egg-eating during the early larval substage, resulted in a reduction in the number of larvae at this time (Figs. 32, 34).

Beginning at about the time of the first pupation, rate of oviposition rose gradually (Figs. 25D, 26D, 27D). Gervet (1964b) reported a similar rise in *P. gallicus* and Morimoto (1954b) noticed it in *P. chinensis antennalis*. Brian and Brian (1948) noted a similar increase in oviposition rate with the appearance of pupae in *Bombus agrorum* and in *Myrmica laevinodis* and *M. ruginodis*. This rise in oviposition rate was coupled with a drop in the rate of egg-eating, so that cells that were left empty during the larval substage began to fill up.

Among the eggs laid during the pupal substage of colony development were those that gave rise to the first males. This agrees with what is reported for *P. gallicus* (Deleurance, 1948) and *P. canadensis* (Eberhard, 1969). This proves that some, if not all, male-producing eggs are laid by queens.

d. *Emergence of workers.* The first workers emerged 35–41 days after colony

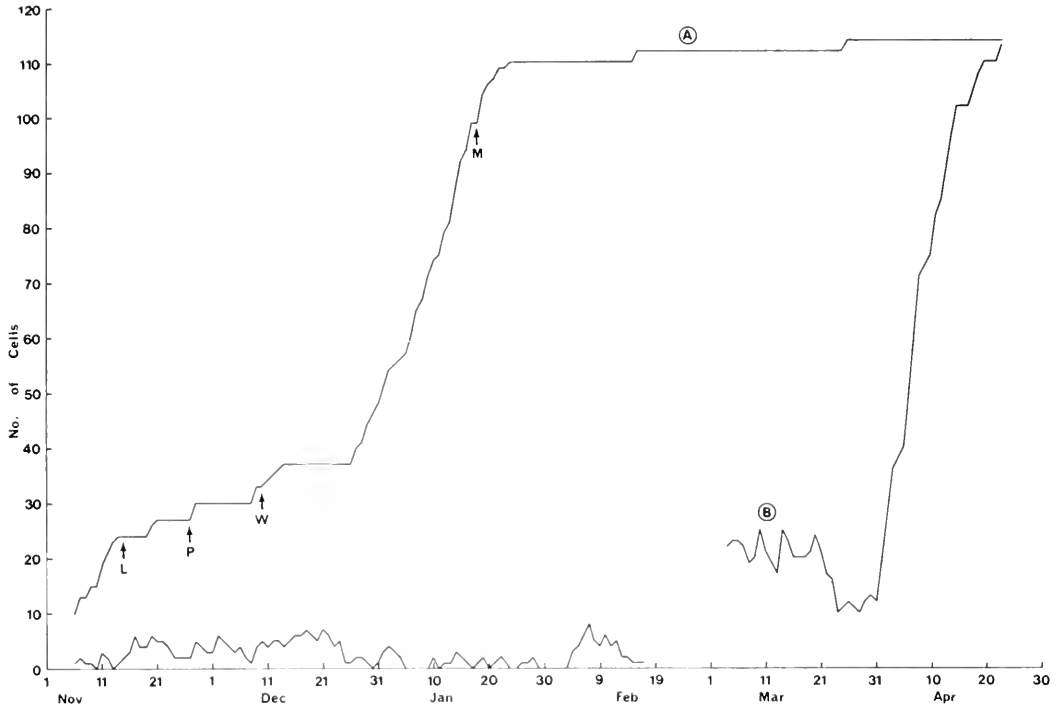

Figure 20. Nest growth, colony 310. A. Nest size in number of cells. L = date first larva eclosed. P = date first larva spun its cocoon. W = date of emergence of first adult female. M = date of emergence of first adult male. B. Number of empty cells.

initiation (Table 19 and Figs. 38–41). As these matured they began to assume worker duties. By this time there was an increase in the number of larvae, as the eggs laid at the beginning of the pupal period began to hatch. With the increase in the number of workers, the rate of nest growth increased (Figs. 18, 19) and the duration of the larval stage began to decrease (Figs. 12B, 13B, 14B). The reason for the gradual decrease is clear: larvae that eclosed early (*i.e.*, just after those comprising the first pulse) had proportionately more of their time on the nest before workers emerged and when rate of feeding was slow. Larvae eclosing later spent a greater proportion of their time as larvae when workers were present and feeding was faster.

e. *Emergence of males and nonworkers.* The first males began to emerge approxi-

mately six weeks after the first larvae pupated (Table 19; Figs. 19, 20, 21). At about this time nonworkers also began to make their appearance. On some nests several nonworkers appeared among the first workers, but these were always individuals who stayed on the nest only one or two days and could well have become workers but for an early disappearance. There was only one exception: no. 9 on colony 310 emerged 10 days before the first male, and stayed on the nest 10 days without being seen to perform worker tasks.

As males and nonworkers appeared and had to be fed by the workers, the rate of nest growth decreased. This was seen in colonies 268, 310, and 342 (Figs. 19, 20, 21). Morimoto (1954a) reported that with the appearance of males, nest growth stops altogether in *Polistes chinensis antennalis*.

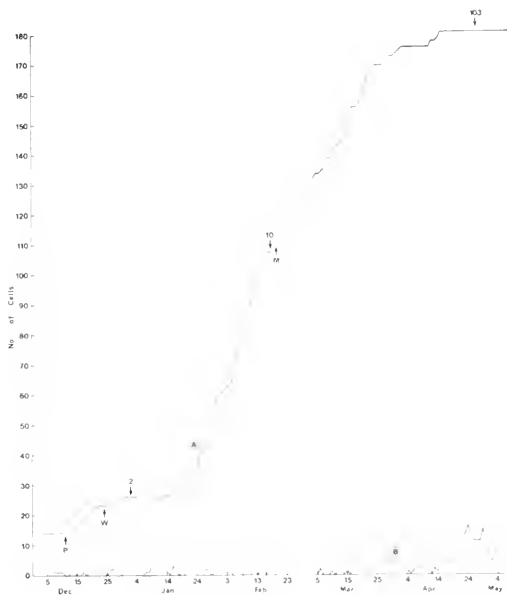

Figure 21. Nest growth, colony 342. A. Nest size in number of cells. P = date first larva spun its cocoon. W = date first adult female emerged. M = date first adult male emerged. 2 = date no. 2 became sole egg-layer. 10 = date no. 10 became sole egg-layer. 103 = date no. 103 became sole egg-layer. B. Number of empty cells.

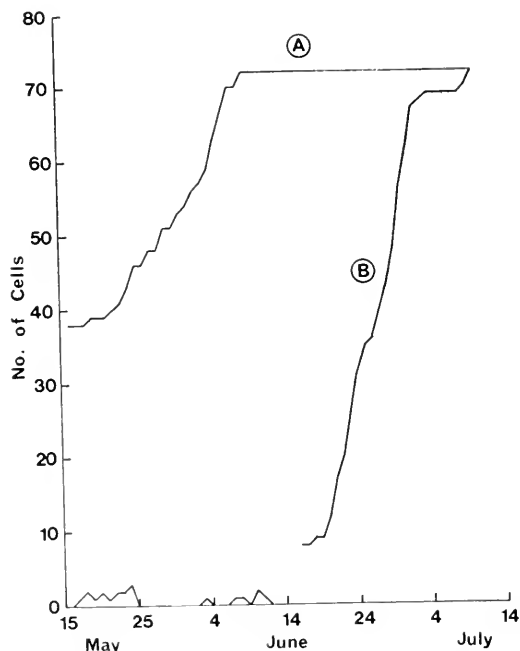

Figure 22. Nest growth, colony 173. A. Nest size in number of cells. B. Number of empty cells.

This occurred only on colony 310 (Fig. 20). There was a gradual increase in average duration of larval stage in the later postemergence period (Figs. 12B, 13B, 14B).

f. *Decline.* After about 10 weeks of male and nonworker production, adults on the nest began to abort the brood, eating larvae and pupae. Brood abortion began with the central cells and progressed outward. Brood was aborted by queens, workers, nonworkers, and males. When pupae were aborted, the caps of their cocoons were chewed away, and the pupae were pulled partway out of their cells and chewed. Smaller larvae were usually completely removed from their cells and chewed up in one piece. Usually several adults shared in the food. Females, after chewing a lump for several minutes, usually fed it to larvae, just as with solid food brought in from the field. Males, after ex-

tracting the juice, either dropped the remainder or passed it on to nestmates or to larvae. The guts of pupae were not eaten.

Queens usually continued to oviposit during decline (Figs. 27D, 29D, 30D), but not rapidly enough to keep cells filled as fast as they were emptied. As the brood decreased, the rate of emergence of adults dropped off; the number of adults (mostly nonworkers and males) on the nest diminished as they left and were not replaced. Ultimately, the brood was reduced virtually to zero, the last adults disappeared, and the colony cycle was complete.

Table 19 summarizes data on size and age of the several colonies at various points in their development. Though the final size of nests varied widely (72–210 cells, 8 colonies), the estimated age of colonies when growth stopped varied much less widely (119–147 days, 5 colonies). Likewise, the estimated ages at final decline showed relatively little variation (145–170 days for 5 colonies). A notable exception

TABLE 19. Colony development data. Age is measured in days from founding. Size is measured in cells. Non-workers include superseding queens. () indicates that an age is estimated (accurate to within 2 days). [] indicates that data for number of adults produced are incomplete because observations did not cover the entire colony cycle.

		Colony Number																			
		223	237	258	295	436	437	493	347	354	421	422	468	173	174	268	310	342	230	231	
A. NO. FOUNDESSES		2	3	8	2	1	1	1	1	1	2	1	1	1	2	1	5	1			
B. COLONY DEVELOPMENT																					
1) Size at first larva	13	22	37	10	7	11	8	17	11	24	13	8				14	24	14			
2) Size at first worker						24	14	36	14							23	34	23			
3) Age at first worker						34	(38)	(39)	(37)							(35)	(41)	(36)			
4) Size at first male																99	75				
5) Age at first male																(74)	(76)				
6) Workers before first male																15	13				
7) Size: termination of growth													124	72	137	210	114	180	193	118	
8) Age: termination of growth													(1.5)	(119)	(141)	(147)	(146)				
9) Age at final decline													(1.0)	(145)	(160)	(175)	169				
10) Days from termination of growth to final decline													33	26	19	29	>23	>21	>194		
C. ADULT PRODUCTION																					
11) No. workers													(12)	(0)	(6)	(25)	(17)	(43)	(7)	(4)	
12) No. non-workers													(11)	(0)	(25)	(45)	(14)	(21)	(22)	(19)	
13) No. males													(26)	(25)	(30)	(91)	(35)	(110)	(17)	(14)	
14) Total offspring													(49)	(25)	(61)	(161)*	(66)	(174)	(46)	(37)	
15) Males/female: total brood																1.30	1.13	1.72			
16) Males/female: females after first male													1.13	0.97	0.97	1.65	1.94	2.62	0.59	0.61	
17) No. adults produced by oldest cells																3	3	3	3	3	

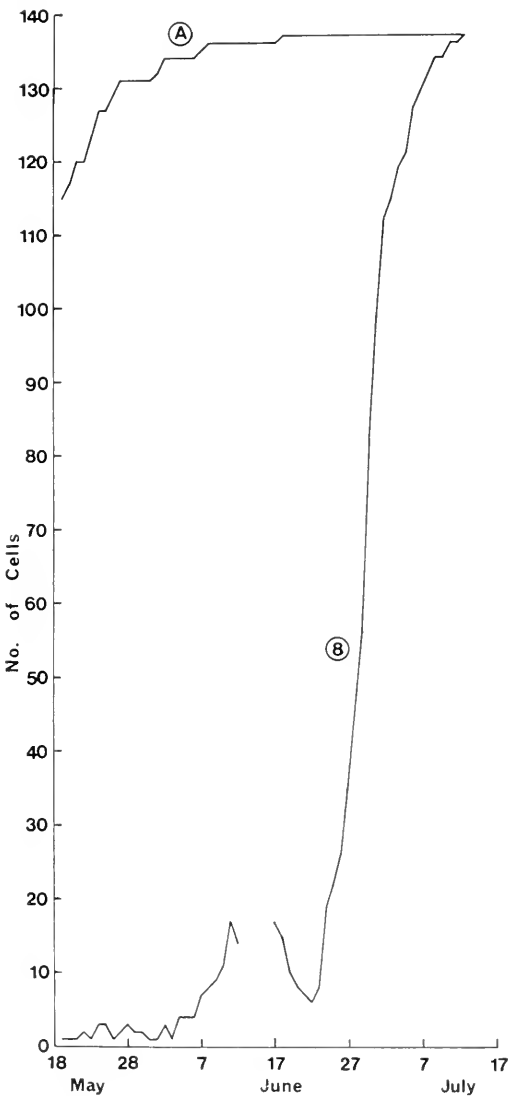

Figure 23. Nest growth, colony 174. A. Nest size in number of cells. B. Number of empty cells.

to this was colony 195 in Belém, which was active for at least 242 days (based on spot checks spanning 242 days).

Unless a colony was observed daily for its entire postemergence development, it was impossible to know the total number of offspring produced. Colony 310 was observed for its entire cycle, but with a

13-day gap during the postemergence period. During this gap 12 cells containing pupae were emptied. If they all produced adults the total production for the colony would have been 78 adults. Colony 268 declined during the same gap in observations. Though some of the 39 pupae present in the nest when observations ended may have been aborted, if they had all produced adults, the total adult production of the colony would have been 200. On the basis of these admittedly limited data, it would appear that the total productivity of a colony (in terms of adult offspring produced) bears little relation either to the number of foundresses or to the length of the colony cycle. It is probably more dependent upon the success with which it produces workers early in the postemergence stage.

No cell was observed to produce more than three adults throughout the entire colony cycle, though many of these contained larvae or even pupae of a fourth generation when the colony declined. This apparent constancy of the number of generations of brood produced by a colony is correlated with the relatively constant duration of colony development.

3. The Regulation of the Colony Cycle

Several attempts have been made to analyze the colony cycles of social wasps. Bodenheimer (1937) reviewed the literature pertaining to this problem. Richards and Richards (1951) have produced a mathematical description of the growth of colonies in terms of workers and brood. Lövgren (1958) has attempted a mathematical prediction of the optimal time for a colony to begin producing sexuals. Brian (1965) discussed a general model that shows the best population size or worker/queen ratio for sexual emission.

Ishay, Bytinski-Salz, and Shulov (1967) have proposed that the series of steps leading to decline of *Vespa orientalis* colonies is initiated by a decline in the supply of

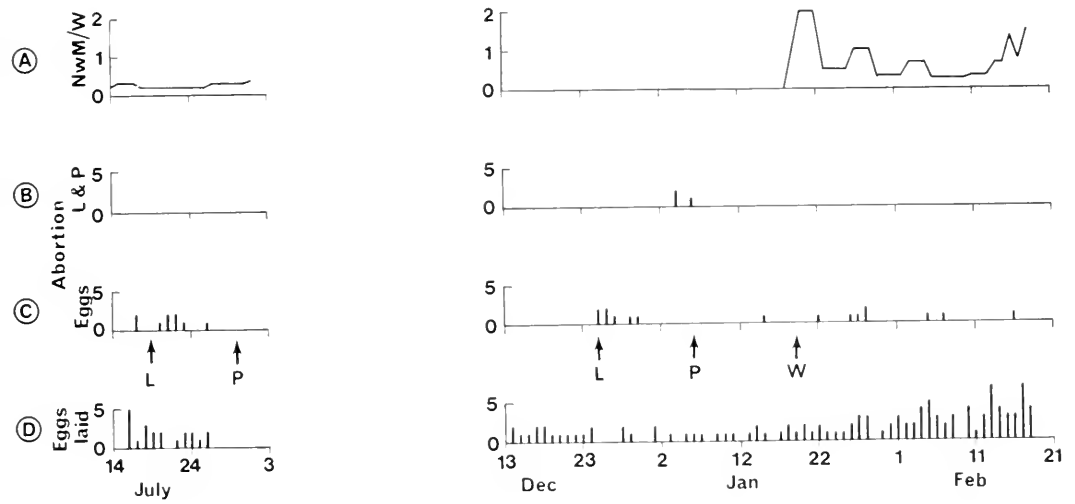

Figures 24 and 25. Fig. 24, left. NwM/W ratio and rates of abortion and oviposition, colony 258. Fig. 25, right. NwM/W ratio and rates of abortion and oviposition, colony 347. A. Ratio of nonworkers plus males/workers (NwM/W). B. Rate of abortion of larvae and pupae (larvae and pupae aborted per day). C. Rate of egg-eating (eggs eaten per day). L = date first larva eclosed. P = date first larva spun its cocoon. W = date first adult female emerged. D. Rate of oviposition (eggs laid per day).

nectar at the end of the season. Their hypothesis is speculative and I shall not go into the details of their argument; suffice it to say that I tend to doubt the validity of any hypothesis that attributes to environmental factors direct roles in the regulation of the colony cycle. In any case such "extrinsic" regulatory factors cannot be invoked to explain the quite regular and delimited cycles of tropical wasps such as *Mischocyttarus*. As has been seen, colonies of *M. drewseni* can be found in all stages of development at all times of the year. The absence of any climatic factors limiting the growth of colonies points necessarily to an intrinsic regulation of the colony cycle. It is probable that in temperate species the only response to environmental limits to growth has been evolutionary, i.e., intrinsic regulatory mechanisms have evolved such that the colony completes its cycle in the time available. Eberhard (1969) has brought forward evidence that the colony cycle in *Polistes canadensis* and *P. fuscatus* is controlled by the queen's reproductive cycle; she con-

cluded that a reproductively active (ovipositing and cell-initiating) female is required for normal colony development. In colonies she observed, disappearance of the queen or cessation of oviposition was associated with termination of cell addition, and brood decline usually followed. Several facts suggest that the queen's reproductive cycle does not regulate the entire colony cycle in *M. drewseni*; rather, the state of the colony seems to influence the behavior of the queen to a large degree. These facts are listed below:

- a) The fact that a colony normally went through several queens in the course of its development indicates that the colony cycle was relatively independent of the reproductive cycle of the queen.
- b) Oviposition rate generally increased with the age of the colony, regardless of the age of the egg-laying female (Figs. 26D, 27D, 28D). The average rate of oviposition of each superseding queen was greater than that of her predecessor (Fig. 42). This suggests that control of oviposition rate lies ultimately with the state

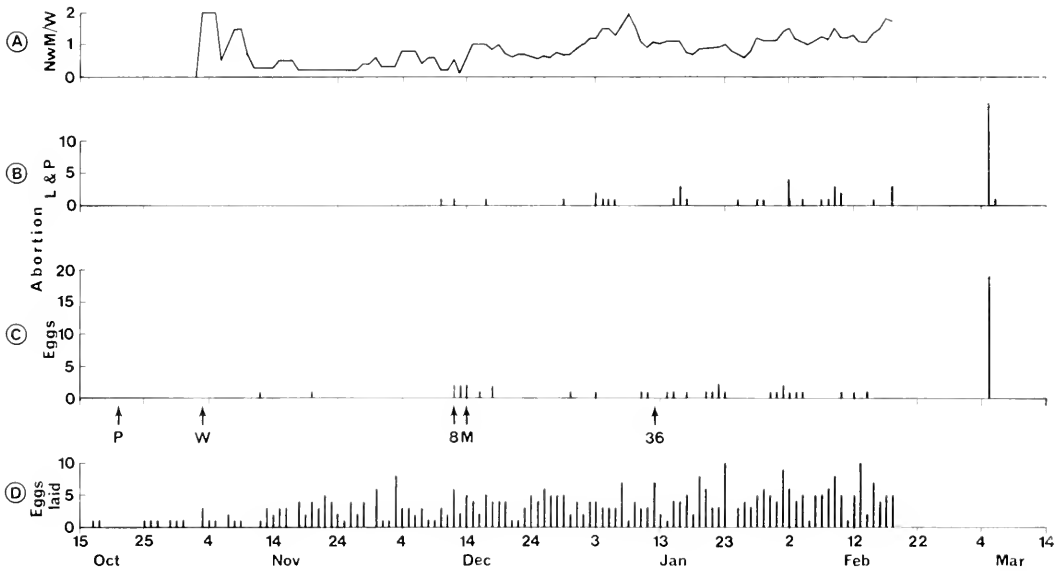

Figure 26. NwM/W ratio and rates of abortion and oviposition, colony 268. A. Ratio of nonworkers plus males/workers (NwM/W). B. Rate of abortion of larvae and pupae (larvae and pupae aborted per day). C. Rate of egg-eating (eggs eaten per day). P = date first larva spun its cocoon. W = date first adult female emerged. M = date first adult male emerged. 8 = date no. 8 became sole egg-layer. 36 = date no. 36 became sole egg-layer. D. Rate of oviposition (eggs laid per day).

of the colony and not with the absolute age or reproductive age of the queen.

c) The deposition of male eggs was dictated by the stage of the colony and not by the age of the queen. Male eggs were not laid before the first brood pupated, *i.e.*, when the founding queen had been laying for about 24 days, but superseding queens laid male and female eggs from the beginning of their reproductive lives, so that there was no interruption in the production of males by the colony.

d) Oviposition by the queens often continued well into colony decline. This suggests that colony decline was independent of the presence of a functioning queen.

e) Colony decline occurred in the presence of a queen of any age. Queen no. 10 had been ovipositing for at least 65 days and was 88 days old when colony 310 declined. At the other extreme, when colony 174 declined, no. 26 had been ovipositing for only 30 days and was only 39 days old. This suggests that the factors

triggering decline were independent of the reproductive age of the queen.

In the light of these facts, it seems impossible to conclude that the development of the colony cycle is solely a function of the queen's reproductive cycle. It is much more plausible that the queen, the workers, and certain properties of the colony as a whole all come into play in an interacting whole (Pardi, 1948a; Michener, 1964). The hypothetical steps in the regulation of colony development are proposed here in outline form and are then discussed.

a) The development of the colony up to the emergence of the first workers is a function of the queen and her responses to the stimuli provided by the state of the colony. Subordinates present on multiple-foundress colonies assume worker roles soon after colony founding.

b) As female offspring begin to appear, the queen dominates them and they assume worker roles, taking over the tasks of feeding the larvae and the queen.

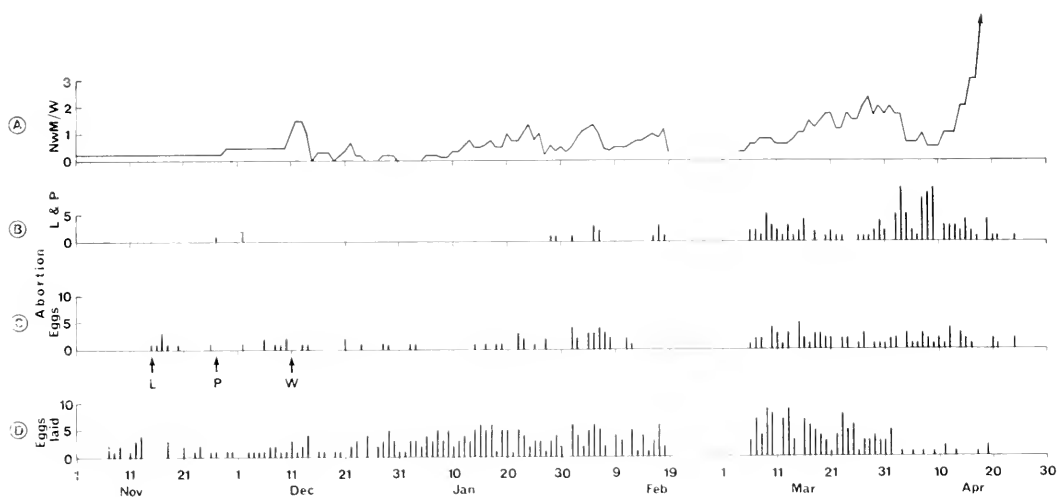

Figure 27. NwM/W ratio and rates of abortion and oviposition, colony 310. A. Ratio of nonworkers plus males/workers (NwM/W). B. Rate of abortion of larvae and pupae (larvae and pupae aborted per day). C. Rate of egg-eating (eggs eaten per day). L = date first larva eclosed. P = date first larva spun its cocoon. W = date first adult female emerged. D. Rate of oviposition (eggs laid per day).

c) As males and nonworkers begin to appear, their demand for food from the workers adds to the tasks the workers must carry out.

d) As the rate of emergence of adults increases with colony age, the amount of domination the queen is able to deliver to each female is reduced. This, along with the larger size of later-emerging females, causes fewer and fewer of the emerging females to assume worker roles.

e) The rapid buildup of nonworkers and males relative to the decreasing rate of replacement of workers results in a rise in the ratio of nonworkers and males to workers (NwM/W).

f) When this ratio reaches a certain point, the workers are no longer able to deliver enough food to the nest to feed the nonworkers and males, and brood (larvae and pupae) are aborted to feed the hungry adults.

g) If the NwM/W ratio remains high enough for long enough, all the brood are aborted, the adults disperse, and the colony declines.

a. *Pre-emergence growth.* The rate of cell initiation and oviposition during the egg substage is probably fixed within certain limits for each species. The size the nest has attained when the first larvae eclose depends upon this rate and upon the duration of the egg stage, which is probably also fixed.

There has been some controversy over whether oviposition rate determines rate of cell construction or vice versa (Deleurance, 1950; Morimoto, 1954b). The conclusion of Pardi (1948b) that "energy consumption dependent on intense work" contributes to the regression of ovaries in workers may be applicable to the queen during the pre-emergence stage, so that the normal reproductive development of the founding queen is regulated by the inhibitory effects of the work she is required to do. During the egg substage the queen has two tasks: (1) to construct new cells and (2) to oviposit. The presence of a ripe egg ready for oviposition may provide the stimulus to construct a new cell if an empty one is not present on the nest. The work involved in foraging for nest material

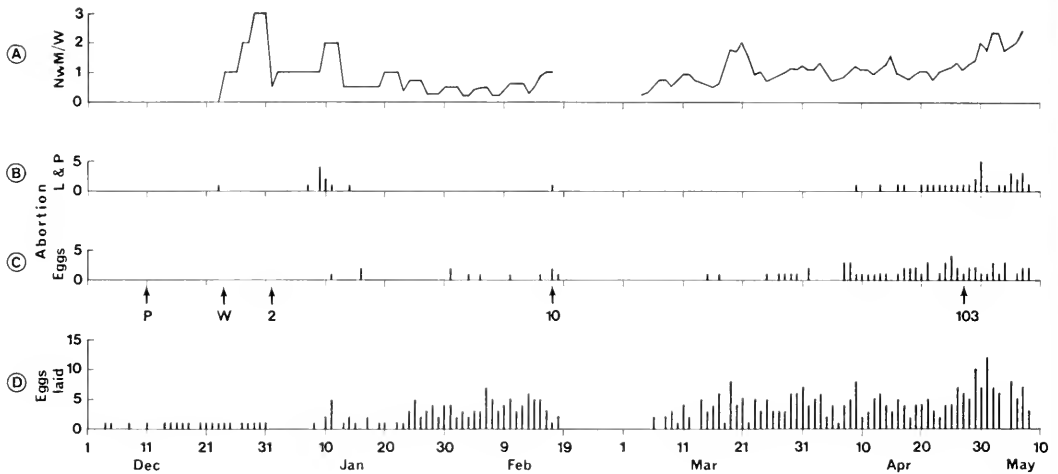

Figure 28. NwM/W ratio and rates of abortion and oviposition, colony 342. A. Ratio of nonworkers plus males/workers (NwM/W). B. Rate of abortion of larvae and pupae (larvae and pupae aborted per day). C. Rate of egg-eating (eggs eaten per day). P = date first larva spun its cocoon. W = date first adult female emerged. 2 = date no. 2 became sole egg-layer. 10 = date no. 10 became sole egg-layer. 103 = date no. 103 became sole egg-layer. D. Rate of oviposition (eggs laid per day).

and constructing such a cell may affect the queen's reproductive physiology in such a way that eggs ripen at a slower rate. Thus, the faster eggs ripen, the more work is required to provide cells for them, and the more work that is done, the slower eggs ripen. This sort of a double feedback mechanism between reproductive physiology and work output is in accord with Pardi's hypothesis.

On multiple-foundress colonies the task of cell initiation is taken over largely by the subordinates. The freeing of the queen from this task, plus the enhancing effects the domination of others has on ovarian development (Pardi, 1948b), could account for the increase in oviposition rate with number of co-foundresses.

When the first larvae eclose the queen must assume the added tasks of foraging food for them and heightening their cells as they grow. This increase in the amount of work the queen must do could have such an increased "castrating" effect on the queen that her rate of oviposition falls below the rate at which cells are emptied by egg-eating, and no new cells need be

constructed to accommodate the few eggs she lays. In effect, then, the queen becomes more workerlike during the larval substage than during the preceding egg substage.

In multiple-foundress colonies, this "work-erizing" effect on the queen is evidently less severe, since the tasks of feeding and cell heightening are largely taken over by her subordinates. They continue to construct new cells, albeit at a reduced rate, so the rate of nest growth slows during this substage, but does not stop altogether.

Once the first batch of rapidly growing larvae spin their cocoons, the queen apparently feeds the remaining larvae at a much reduced rate, for they develop much more slowly. This reduces her workload, resulting in an increased production of eggs and the resumption of new cell construction. The somewhat slower rate of nest growth during the pupal substage compared to the egg substage suggests that she does devote some energy to feeding the remaining larvae.

In multiple-foundress colonies there is a less distinct separation between the

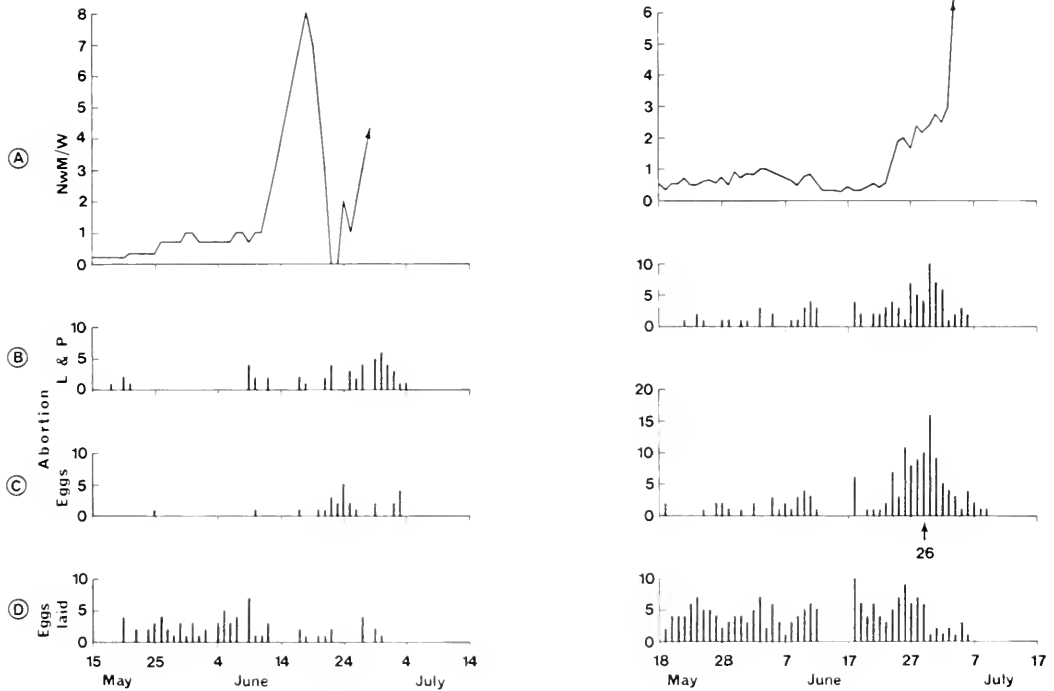

Figures 29 and 30. Fig. 29, left. NwM/W ratio and rates of abortion and oviposition, colony 173. Fig. 30, right. NwM/W ratio and rates of abortion and oviposition, colony 174. A. Ratio of nonworkers plus males workers (NwM/W). B. Rate of abortion of larvae and pupae (larvae and pupae aborted per day). C. Rate of egg-eating (eggs eaten per day). 26 = date no. 26 became sole egg-layer. D. Rate of oviposition (eggs laid per day).

duration of the larvae in the first batch and subsequent larvae, suggesting that the presence of co-foundresses results in a less strict division of tasks among the three substages, resulting in turn in a more even growth of brood population than occurs in single-foundress colonies.

b. *Postemergence growth and decline.* With the appearance of workers, the queen is largely freed from foraging and cell-constructing tasks. Her rate of oviposition increases gradually and the rate of nest growth increases.

Observations suggest that there is a hierarchy of priorities among the tasks the workers must perform in a mature colony. In order of priority, these are: 1) feed the queen, 2) feed the nonworkers and males, 3) feed the larvae, 4) heighten walls of larval cells.

That the queen, males, and nonworkers on the nest have priority over larvae for food is obvious from observation. If food is scarce, returning foragers are mobbed by males and females alike, and all but forced to yield up any nectar or solid food they have. In such situations the larvae get what is left, if any.

How far down the hierarchy of tasks the workers get depends on the balance between food supply (the amount of food the workers are able to bring in from the field) and the demand for food (the number of adults and the number of larvae). It can be assumed for convenience that the amount of food brought in is in direct proportion to the number of workers on the nest. (On single-foundress colonies, the queen is treated as a worker until the first female offspring begin working.) If sup-

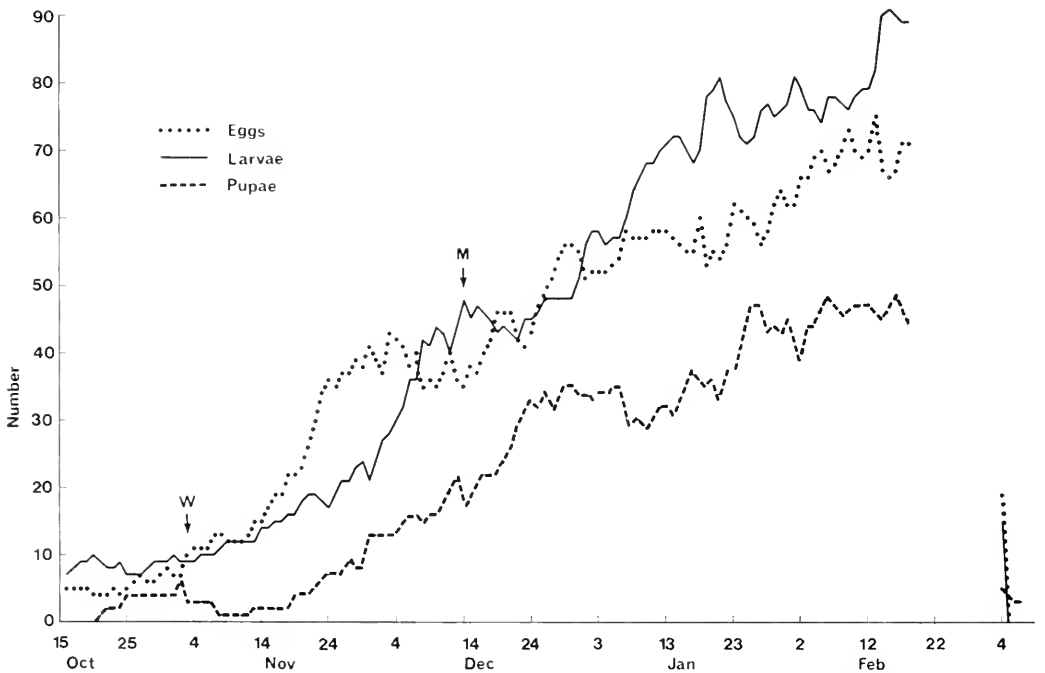
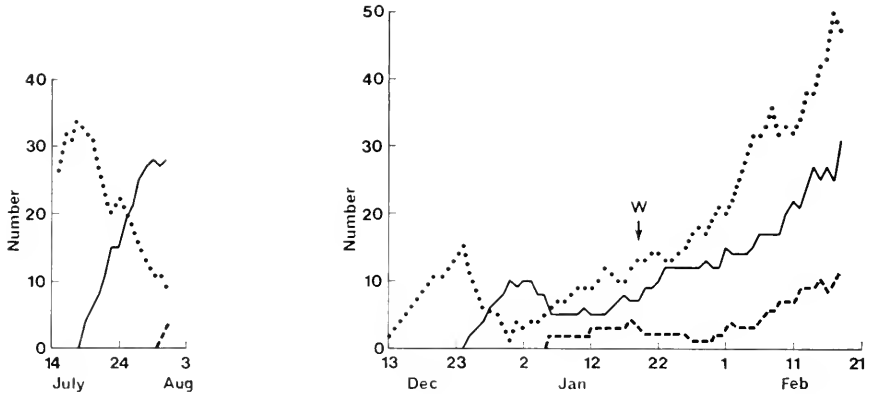

Figures 31, 32, 33. Fig. 31, above left. Brood populations, colony 258. Fig. 32, above right. Brood populations, colony 347. Fig. 33, below. Brood populations, colony 268. W = date first adult female emerged. M = date first adult male emerged.

ply is equal to demand, the adults are well fed and the larvae are fed and grow at a moderate rate. If demand surpasses supply, the larvae are first to feel the lack, and reflect it in increased length of the larval

development time. If supply drops still more, and the workers are not able to satisfy even the needs of the adults on the nest, some of the brood are aborted and eaten by the adults, and decline begins.

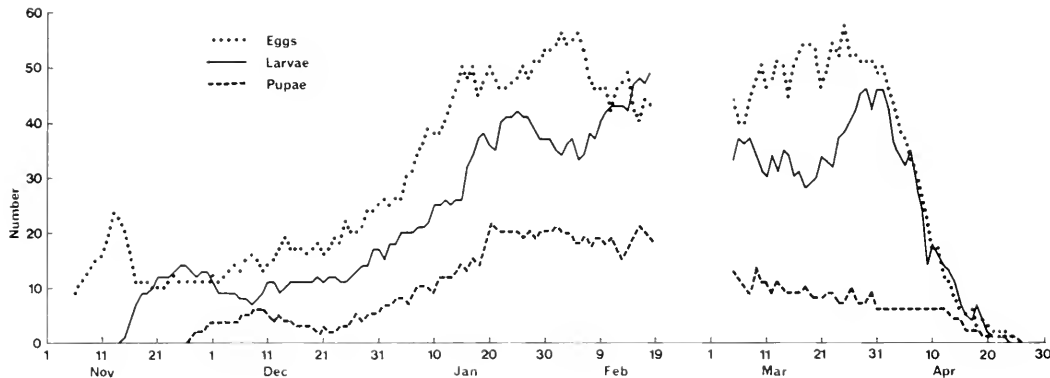

Figure 34. Brood populations, colony 310.

This interpretation of the causes of brood abortion prior to colony decline is in accordance with those of Zikán (1951) for *Mischocyttarus* and Roubaud (1916) for *Belonogaster*. Roubaud found that when mature (foraging) females were removed from a nest, the callows began eating larvae. He concluded that the foragers were necessary for maintenance of the colony and that colony decline was caused by "parasitism" by the abundant males on the mature nest. An experiment performed by Turner (1912) points to the same conclusion. He collected a post-emergence nest of *Polistes pallipes*, leaving the adults behind, and transplanted it to a cage. As offspring emerged he fed them with honey. In spite of these feedings, the adults soon began to eat larvae from the nest. From this point on the adults were provided with insects, and there was no further abortion of the larvae. The larvae were fed by the adults and many pupated and subsequently produced normal adults.

These experiments support the conclusion that brood abortion is initiated when adults are not provided with enough proteinaceous food.

c. *Role of the brood.* The larvae in nests from which the adults were removed survived for more than a week. In times of scarcity the larvae shrank markedly in size and presented a dried appearance. Presumably they maintained themselves at such times by drawing on their fat reserves.

Thus, the larvae can act as a buffer system for the colony during short periods of food shortage, absorbing the stress as an increase in the time spent in the larval stage. Maschwitz (1966a, b) has argued that the larval secretion serves as a "reservoir" of food for the adults during temporary periods of poor foraging. Presumably, even if the adults are not getting enough food via the foragers, they can survive for a short time on larval secretion.

Because the larvae are able to survive long periods without food, it is unlikely that there would be any advantage in reducing the size of the larval population through abortion when the larva/worker (L/W) ratio becomes large. Since the larvae receive food only after the adults are fed, the amount left over for them depends on the nonworker + male + larva/worker (NwML/W) ratio, and of this food allocated to the larvae, the average amount received by each one depends on the L/W ratio. Thus, the combination NwML/W gives an approximation of the average relative amount of food received by each larva. This ratio usually reaches its highest value during the early postemergence period, when there are no nonworkers and males on the nest. Thus, the value of NwML/W at this time is due entirely to

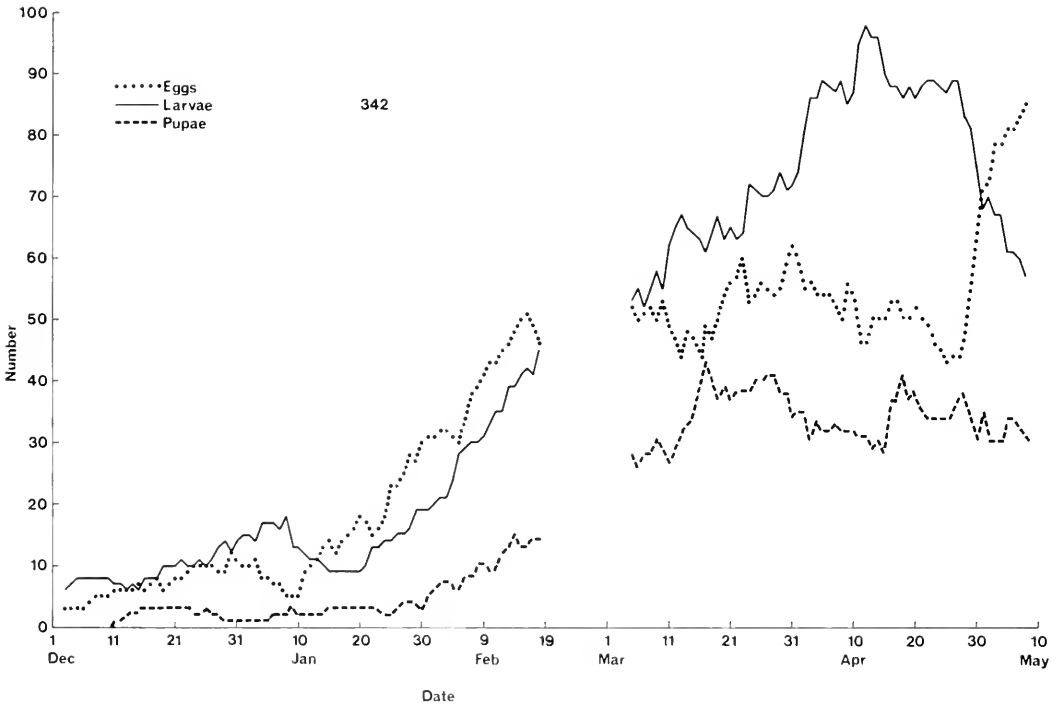

Figure 35. Brood populations, colony 342.

the high number of larvae per worker, yet there is no significant abortion of larvae during this period. (The brood aborted during the larval substage are virtually all eggs, which have no effect on the number of larvae until later.) On the other hand, the correlation between NwM/W and the number of days the larvae spend in the larval stage is quite good, lending support to the proposition that the amount of food the larvae are able to receive affects their rate of growth, but does not cause the workers to regulate larval numbers by abortion when this ratio becomes high (Figs. 12, 13, 14).

d. *Role of the nonworker-male/worker ratio (NwM/W).* Since larvae are fed only after the adults are fed, the amount of food the nonworking adults receive depends on the ratio of nonworkers (Nw) and males (M) to workers (W), and is independent of the number of larvae

present. Figures 36–41 show daily changes in population of workers, nonworkers, and males for six colonies. Figures 25A–30A plot the NwM/W ratios for the same six colonies.

According to the hypothesis, if the NwM/W ratio rises to the point where the workers can just barely feed themselves and the queen, nonworkers, and males, rate of nest growth is zero and the larvae are not fed. An examination of the data suggests that this critical ratio is around 1.4, though this varied from one colony to another. If the NwM/W ratio rises higher than this for more than a few days, the adults begin to go hungry and begin to eat brood. Unless the ratio drops, abortion continues until the brood is reduced essentially to zero, and the colony declines. This is borne out in the correlation between NwM/W ratio, rate of abortion, and the number of empty cells. Colony 174 showed

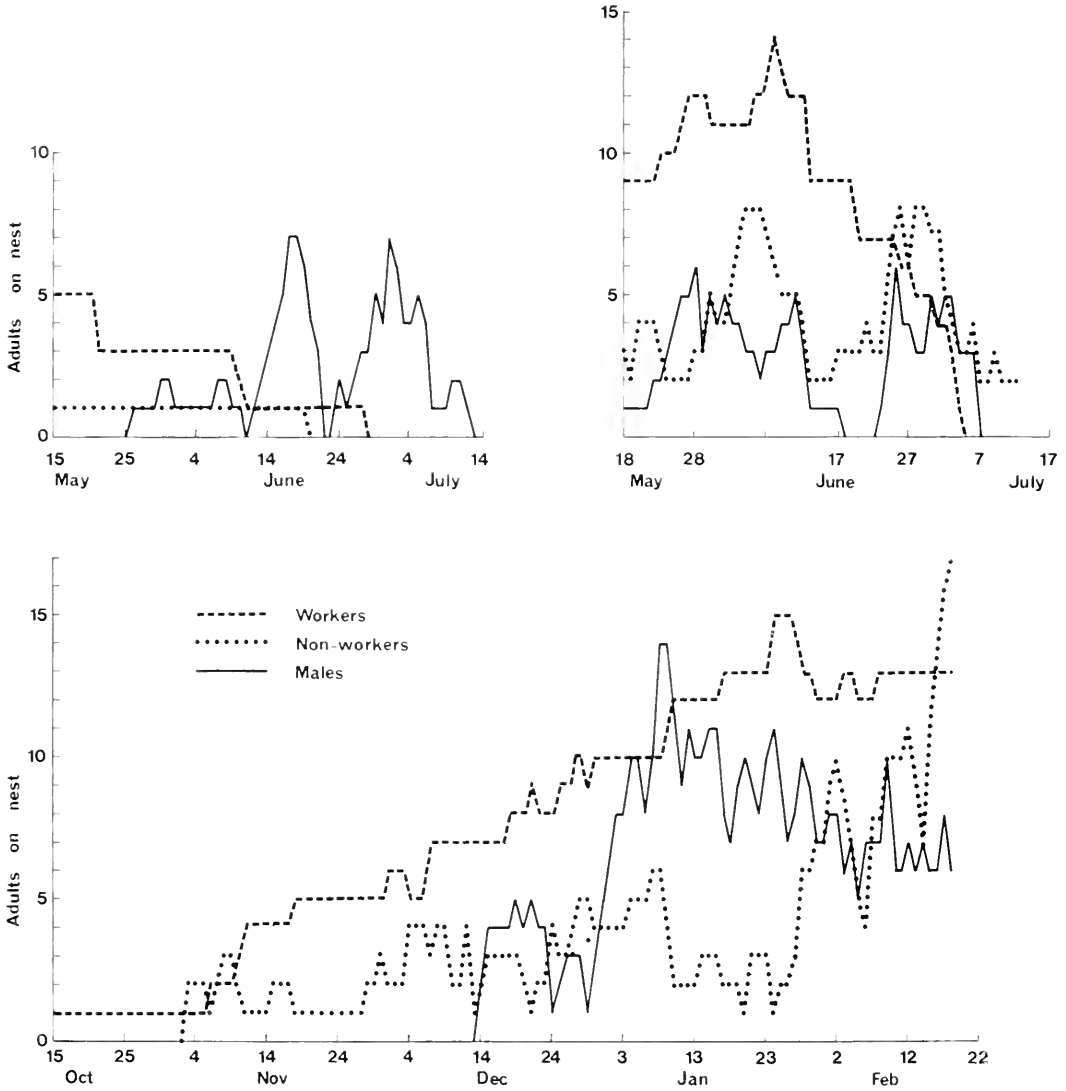

Figures 36, 37, 38. Fig. 36, above left. Adult populations, colony 173. Fig. 37, above right. Adult populations, colony 174. Fig. 38, below. Adult populations, colony 268.

this correlation clearly. During the period from 18 May to 11 June 1968, there was a relatively high NwM/W ratio, reaching 1.0 (Fig. 30A). This was accompanied by a rising rate of abortion of eggs and larvae (Fig. 30B, C) and a rise in the number of empty cells (Fig. 23). Then for the next ten days there was a relatively low NwM/W ratio (about 0.4–0.6) and rate of

abortion dropped below the rate of oviposition and the number of empty cells decreased. Then NwM/W rose sharply, ultimately to infinity as the last worker disappeared (Fig. 37), and during this period abortion rate was very high, causing a rapid emptying of all the cells in the nest (Fig. 23).

Colony 173 also demonstrated this cor-

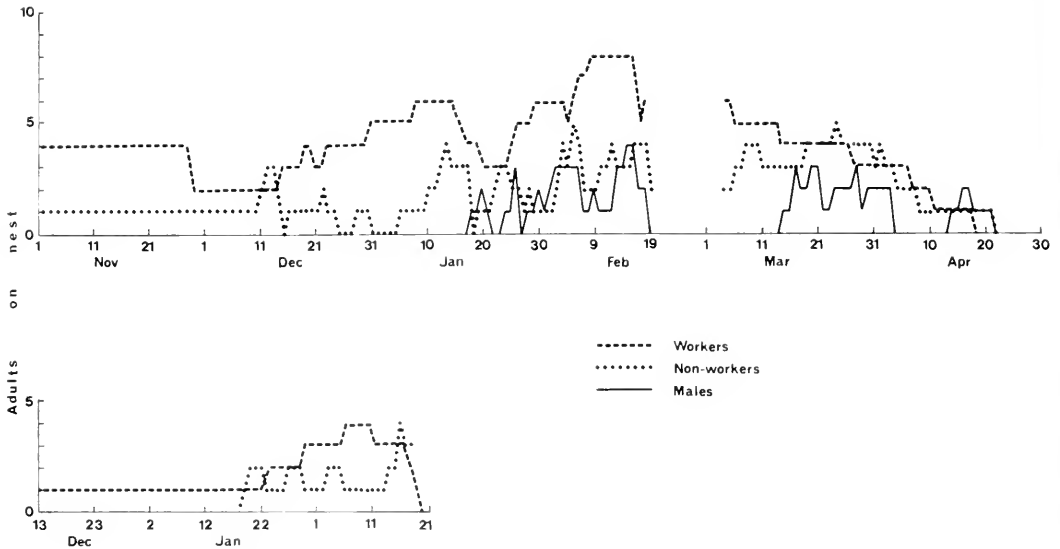

Figures 39 and 40. Fig. 39, above. Adult populations, colony 310. Fig. 40, below. Adult populations, colony 347.

relation between rise in NwM/W ratio and rise in abortion rate and number of empty cells at colony decline (Figs. 22 and 29).

Colony 310 also showed this, though less well. The increasing NwM/W ratio from 13 March to 3 April 1969 was accompanied by a rise in abortion rate toward the end of this period (Fig. 27). Apparently the low reduction in the ratio from 4 to 13 April was too brief and/or not low enough to have any significant effect on reducing abortion rate, and by 23 April the nest was empty (Fig. 20). The temporary rise in abortion rate and number of empty cells from 4 to 21 March would predict a high NwM/W ratio during the preceding ten days, when no observations were made.

Colony 268 underwent a gradual increase in NwM/W ratio over a period of weeks until 18 February, when a level of 1.8 was reached (Fig. 26A). As of this time there was still no significant increase in abortion rate or number of empty cells, though at this time the nest stopped growing (Fig. 19). During the interval from 18 February to 4 March, when no observations were made, abortion rate increased drastically, so that within a few days after

observations resumed on 4 March, the nest was nearly empty. It is unfortunate that data for this interval are not available.

Colony 342 stopped growing on 16 April, after a period of gradual increase in NwM/W . At about this time abortion of larvae began and gradually increased (Fig. 28). This was correlated with an increase in empty cells (Fig. 21). The subsequent decrease in number of empty cells, despite an increasing NwM/W ratio, seems to have been due to a higher rate of oviposition rather than to a drop in rate of abortion (Fig. 28B, D). The rise in oviposition rate was correlated with the takeover by no. 103 as queen. According to the hypothesis, no. 103 could have prolonged the life of the colony only by increasing the numbers of workers through heavy domination, and not by increasing the rate of oviposition.

e. *The initial high value of NwM/W .* Most colonies showed a high NwM/W ratio when the first offspring emerged (Figs. 25A, 26A, 27A, 28A). This was due to the fact that for their first three days adults did no work and were in effect nonworkers. In calculating NwM/W ratio,

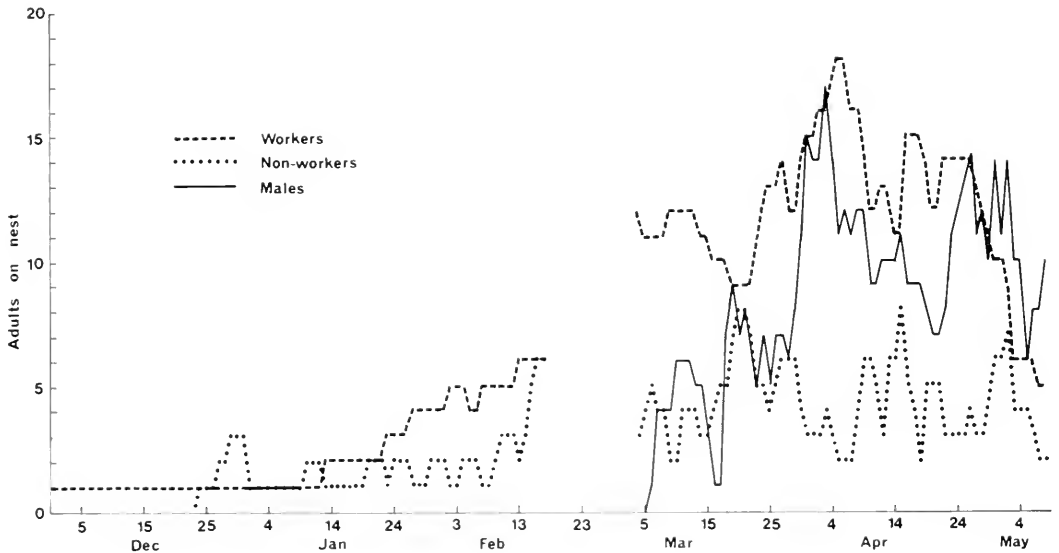

Figure 41. Adult populations, colony 342.

they were counted as such. On colony 268, for instance, NwM/W rose to 2.0 on 3 November 1968, when the first two offspring emerged (Fig. 26A). The queen was still the only "worker" from 3 to 5 November. After three days the ratio dropped then rose again as the next two workers emerged. As the number of workers on the nest increased, the effects of each newly emerging adult on the NwM/W ratio diminished. The same effect was seen in colonies 347 (Fig. 25A) and 310 (Fig. 27A). There was normally no brood abortion accompanying this period of high NwM/W ratio, probably because it was brief and larval secretion could make up for what the queen could not provide.

Colony 342, however, was somewhat unusual in that there was some abortion of larvae (a total of ten) and a rise in empty cells during this period (Fig. 21). This was apparently because the first two adults to emerge were nonworkers. This caused an unusually long period of high NwM/W ratio, long enough for the adults to require more food than the foragers could provide.

The effects of this showed up as a stoppage of nest growth for two weeks, which was unusual for this stage of colony development, and also as a higher peak and more gradual decline of the larval duration curve (Fig. 14B) as compared with those for colonies 268 (Fig. 12B) and 310 (Fig. 13B). This anomaly supports the hypothesis.

Thus there does appear to be a positive correlation between a rise in NwM/W ratio and an increase in abortion. The "critical ratio," or threshold, above which abortion begins probably depends on several factors, which vary from one colony to another. Intuitively, a high ratio would cause abortion to begin within a shorter time than a low ratio.

f. *Factors causing changes in the NwM/W ratio.* There are two immediate causes of change in NwM/W ratio: (1) change in rate of emergence of nonworkers and males relative to rate of emergence of workers, and, (2) since the average life span of workers is six times greater than that of nonworkers and males, a change in the overall emergence rate.

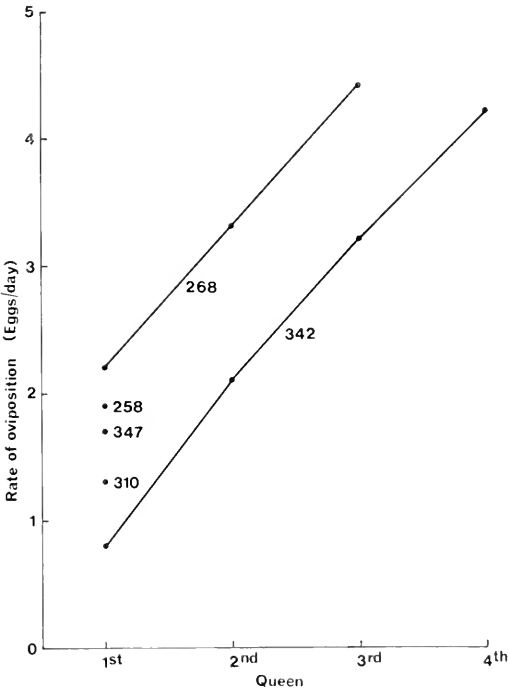

Figure 42. Rates of oviposition of successive queens. Each dot represents a queen. Numbers identify colonies. Abscissa gives the rank of the queen in the series of successive queens for that colony. Thus, "1st" is the foundress, "2nd" is the first superseding queen, etc. Rates of oviposition are estimates calculated by dividing the total observed ovipositions during the reign of a queen by the number of days she was queen.

Colony 268 seems to have been a "healthy" colony, experiencing a smooth growth with no major setbacks. Figure 43 gives the cumulative number of workers, nonworkers, and males to have emerged on this nest against time. Workers began to emerge on 3 November 1968 and continued at a fairly steady rate, averaging 0.2 per day, until 31 January, when the last worker emerged. During the period before any nonworkers or males appeared, the increasing number of workers (Fig. 38) caused a decrease in NwM/W (Fig. 26A).

On 30 November the first nonworker (no. 8) emerged. She challenged no. 1, the founding queen, and on 12 December superseded her as queen. Nonworkers con-

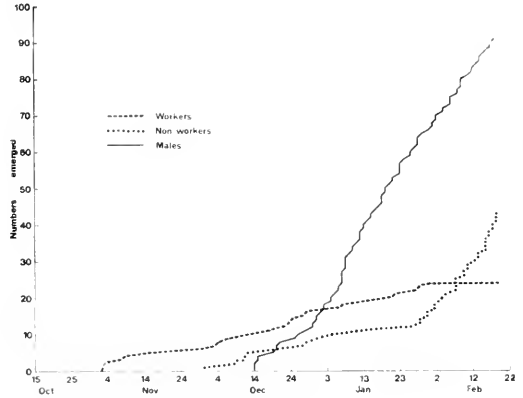

Figure 43. Adult emergence, colony 268. Curves give cumulative numbers of adults emerged.

tinued to emerge at a low rate (0.2 per day) until 25 January. During this same interval males emerged steadily at a rate of about 1.4 per day. Since the combined rate of emergence of nonworkers and males was greater than six times the rate of emergence of workers, the net rate of increase of nonworkers and males was greater (Fig. 38) and NwM/W gradually increased (Fig. 26A).

After 25 January nonworkers began to emerge at the increased rate of almost 1.3 per day (Fig. 43). Males continued to emerge at their high rate. At about this time the number of workers on the nest was at its maximum of 15 (Fig. 38). After 31 January no more workers emerged and their numbers began to decline (Fig. 38), causing the NwM/W ratio to begin to rise at a faster rate than before (Fig. 26A) and the colony to move toward decline (Fig. 19).

The eggs that produced the adults that emerged on 25 January, that is, at the beginning of the upsurge in emergence rate, were laid within a day or two of 12 December, the day no. 8 took over as queen. The rate at which no. 8 laid eggs during the 20 days following 12 December was 3.8 per day, while in the 20 days prior to this date no. 1 had laid only 2.8 per day. This increase corresponds approximately to

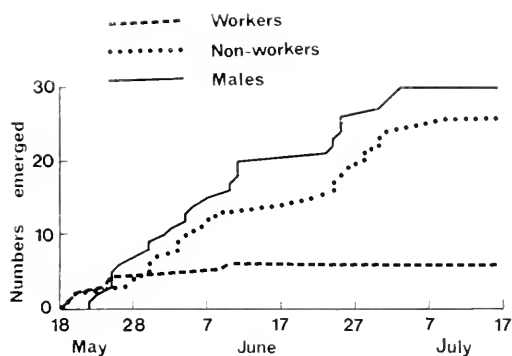

Figure 44. Adult emergence, colony 174. Curves give cumulative numbers of adults emerged.

the increase in rate of emergence ($1.3-0.2 = 1.1$).

It is interesting that with the change in queens the sex ratio changed. Of the last 50 offspring to develop from eggs unquestionably laid by no. 1, 15 (30 percent) were females and 35 (70 percent) were males. Of the first 50 offspring to arise from eggs unquestionably laid by no. 5, 25 (50 percent) were females and 25 (50 percent) were males. When no. 5 was subsequently replaced by no. 36 on 12 January, she was still producing males and females in a one-to-one ratio.

Colony 174 experienced a rapid rise in males and nonworkers, with relatively little increase in workers through 11 June (Fig. 44). This led to a rise in NwM:W ratio (Fig. 30A) and a slight increase in abortion rate (Fig. 30B, C). But during the next 11 days no males and only two nonworkers emerged, causing NwM:W to drop and abortion to decrease. The number of empty cells diminished, as the cells emptied by the earlier abortion were filled with eggs (Fig. 23). But the respite was short-lived, for the rate of emergence of males and nonworkers rose sharply around 25 June (Fig. 44). Since no new workers were produced, NwM:W ratio rose steeply (Fig. 30A). Rate of abortion again increased (Fig. 30B, C) and this time did not stop until the colony declined.

Colony 342 got off to a slow start because the first two offspring were not workers. The first (no. 2) superseded no. 1 as queen, and the second (no. 3) disappeared after five days. Workers were produced at a low rate (about 0.25 per day) until 19 March. Nonworkers emerged at an even lower rate (0.15 per day). After 19 March workers emerged at an increased rate of about 1.0 per day for about two weeks, then levelled off (Fig. 45). This increase in the number of workers (Fig. 41) caused a reduction in NwM:W ratio (Fig. 28A). The increase in workers seems to have been at the expense of nonworkers; that is, though the rate of emergence of female offspring remained more or less constant during this period, a greater proportion of them became workers. This was correlated with a period of heavy dominance by no. 10, the queen. This lends support to Pardi's hypothesis of psychophysiological caste determination. Sex ratio of emerging adults was 42 (28 percent) males to 110 (72 percent) females during the period of male emergence.

The low rate of nonworker emergence during the period of 19 February to 4 March, when no observations were made, is probably an artifact. Since the average life span of nonworkers was only five days, most of those to emerge in this interval would have been gone before they could have been counted on 4 March. This effect would not be as marked among workers, whose average life span was 30 days.

Colony 310 also experienced a slow initial development (Fig. 20). Again, the first two offspring did not remain on the nest long enough to become workers (Fig. 39). Workers were produced at a rate of about 0.23 per day until 16 February, after which only one emerged (Fig. 46). This was comparable to the rate of worker emergence in colonies 268 and 342. Nonworker emergence rate, at about 0.20, was also comparable to that of these colonies. However, the rate of male emergence, at 0.7 per day, was considerably lower than

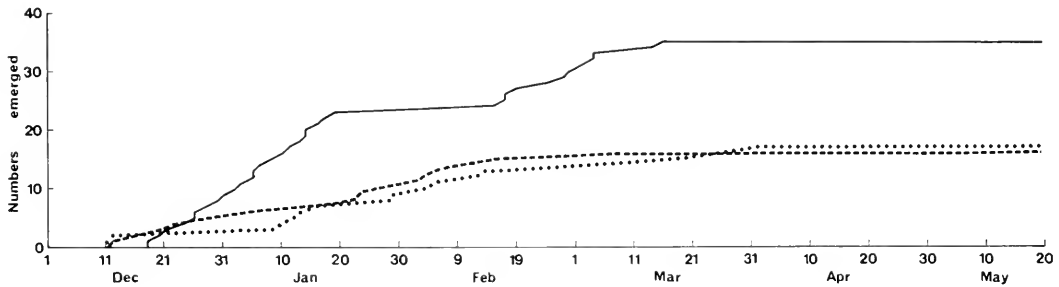
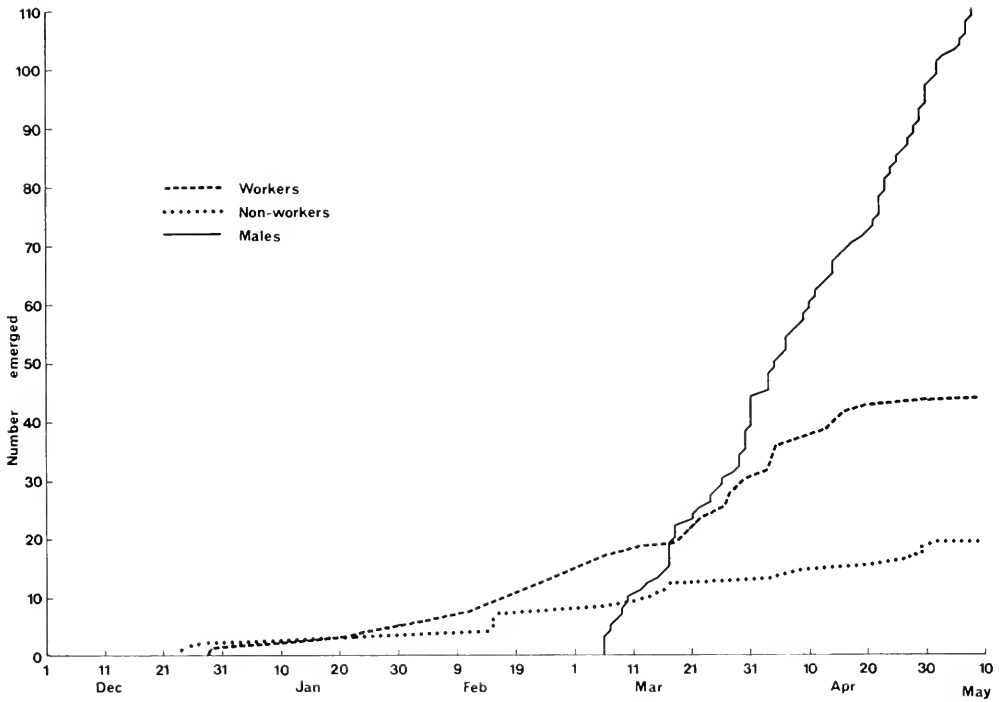

Figures 45 and 46. Fig. 45, above. Adult emergence, colony 342. Fig. 46, below. Adult emergence, colony 310. Curves give cumulative numbers of adults emerged.

those for the other colonies. The sex ratio was 10 (31 percent) females to 22 (69 percent) males during the 32-day period from beginning of male emergence until observations ended on 18 February. This was close to the ratio observed during the first part of colony 268's postmale emergence.

Again, the flat portion of the male and nonworker curves in the interval from 19 February to 4 March is probably an arti-

fact of the lack of observations during that period (Fig. 46).

The low rates of emergence of nonworkers and males throughout colony development apparently kept NwM/W high enough to limit nest growth, but too low to cause decline until the ratio was finally raised by the reduction in the number of workers (Fig. 27A).

Colony 173 produced only males during

the period of observation. The only females on the nest were the queen and five workers, already present when observations began (Fig. 36). The possible origin of such a situation is discussed above (Sex of the offspring of superseding queens, p. 111). As workers died off and were not replaced, NwM/W ratio increased (Fig. 29A). The nest contained only 72 cells when growth stopped. Despite the small size of the nest, and the presence of an ovipositing queen, the colony declined when NwM/W became high.

Thus the data presented here, though extremely limited, can reasonably be interpreted to support the proposed hypothesis. Much more data of this sort are needed to confirm the validity of the hypothesis.

ACKNOWLEDGMENTS

First words of gratitude must go to my advisor, Dr. Edward O. Wilson, for his continued support during every phase of the work. He was always ready with ideas, and rarely did I come away from a discussion with him without feeling a renewal of inspiration and self-confidence. His letters of advice and encouragement were of immeasurable value in seeing me through the long and often discouraging months of field work. He also patiently read the rough draft and offered advice during the preparation of the manuscript.

Dr. Paulo Vanzolini was instrumental in making the possibility of conducting the study in Brazil a reality. I am particularly indebted to him for arranging my stay at the Museu Paraense Emilio Goeldi in Belém and for easing my entry into a foreign culture. His unflinching support and encouragement throughout the study will always be appreciated.

The sisters Erica and Violeta Haggmann of Fazenda Taperinha accepted me practically sight unseen into their home as a guest for a full year, asking nothing but my company in return. Their assistance, patience, understanding, sympathy, en-

couragement, and hospitality were such as I have never experienced and shall not soon forget. To them and their family and employees I owe a special debt of gratitude.

Among those at the Museu Goeldi whose help was indispensable I must mention its director at that time, Dr. Daley Albuquerque and his successor, Dr. Luiz Miguel Scaff; also deserving acknowledgment are Dr. Roger Arlé, Dr. Fernando Novaes, and Dr. Paulo Cavalcante.

Special thanks must go to Tom and Mopsy Lovejoy, who on several occasions extended their warm hospitality to me while I was in Belém.

Dr. Warwick E. Kerr opened his home and made his laboratory available to me while I was in Ribeirão Preto. During a subsequent visit Dr. Ronaldo Zucchi provided facilities and instruction in his techniques of studying bee behavior.

At the bottom of a long list of those in Brazil indispensable to the cause stands "VASP" Airlines, which I patronized whenever possible for the inspiration it provided. I thank them for the superb job they did in keeping their planes together until I got to where I was going.

Mary Jane West Eberhard helped more than she knows. Conversations with her never failed to be both informative and productive of ideas. Her letters to me while I was in the field were always welcomed, for they always initiated new thinking and instilled new confidence. Her study of the social biology of *Polistes* I have always kept close at hand; it has served as a constant guide, standard, and source of inspiration from the beginning to the end of my own work.

Dr. Howard Evans has shown a continuing interest in the project and has facilitated it in every way possible. I am especially indebted to him for access to the entomological collections and reprint library of the MCZ, and for a critical reading of much of the manuscript in rough form.

Dr. Nancy Lind, David Woodruff, and

Dr. Bert Hölldobler all read parts of the manuscript and offered assistance of other kinds during the final stages of the preparation of the manuscript. Kathleen Horton typed the final manuscript and provided help in other ways too numerous to mention. Turid Hölldobler executed the drawings in Figures 2, 3, 4 and 6.

The work was carried out with financial support from the National Science Foundation in the form of several predoctoral fellowships, from Harvard University in the form of a Richmond Fellowship. This research has also been supported in part by grant number GB 3167 from the National Science Foundation, Reed C. Rollins, Harvard University, Principal Investigator. The cost of the artwork was covered with a grant from the Department of Biology at the University of Virginia.

Acknowledgment is gratefully made for permission to use the following copyrighted illustration:

R. L. Jeanne, Chemical defense of brood by a social wasp. *Science*, 165: 1465-1466, 19 June 1970. Copyright 1970 by the American Association for the Advancement of Science. Plate IV, fig. 7.

LIST OF REFERENCES

- ALVAREZ DEL TORO, M. 1950. A summer tanager, *Piranga rubra*, annihilates a wasp nest. *Auk*, **67**: 397.
- BEQUAERT, J. C. 1933. The Nearctic social wasps of the subfamily Polybiinae (Hymenoptera, Vespidae). *Entomologica Am.*, **13**(3): 87-150.
- BERTONI, A. DE W. 1911. Contribución á la biología de las avispas y abejas del Paraguay (Hymenoptera). *An. Mus. nac. Hist. nat. Buenos Aires*, **15**: 97-146.
- BODENHEIMER, F. S. 1937. Population problems of social insects. *Biol. Rev.*, **12**(4): 393-430.
- BRIAN, M. V. 1958. The evolution of queen control in the social Hymenoptera. *Proc. 10th Int. Congr. Ent.*, **2**: 497-502.
- . 1965. Caste differentiation in social insects. *Symp. zool. Soc. London*, **14**: 13-38.
- BRIAN, M. V., AND A. D. BRIAN. 1948. Regulation of oviposition in social Hymenoptera. *Nature (London)*, **161**(4100): 854.
- BUTLER, C. G. 1957. The process of queen super-
sedure in colonies of honeybees (*Apis mellifera* Linn.). *Insectes Soc.*, **4**(3): 211-223.
- DELEURANCE, E. P. 1948. Sur le cycle biologique de *Polistes* (Hyménoptères, Vespides). *C. r. hebd. Séanc. Acad. Sci. Paris*, **226**: 601-603.
- . 1950. Sur le mécanisme de la monogynie fonctionnelle chez les *Polistes* (Hyménoptères, Vespides). *C. r. hebd. Séanc. Acad. Sci. Paris*, **230**: 782-784.
- . 1957. Contribution à l'étude biologique des *Polistes*. I. L'activité de construction. *Annls Sci. nat. Zool.*, **19**(11): 91-222.
- . 1963. Sur le mécanisme de l'oophagie différentielle chez la guêpe, *Polistes gallicus* L. (Hyménoptère, Vespide). *C. r. hebd. Séanc. Acad. Sci. Paris*, **257**: 2339-2340.
- DUCKE, A. 1905. Sobre as vespidas sociaes do Pará. (1°. Supplemento). *Bolm. Mus. para. "Emilio Goeldi."*, **4**: 652-698.
- . 1907. Novas contribuições para o conhecimento das vespas (Vespidae sociaes) da região neotropical. *Bolm. Mus. para. "Emilio Goeldi."*, **5**: 152-199.
- . 1910. Révision des guêpes sociaes polygames d'Amérique. *Ann. Mus. nat. Hungarici*, **8**: 449-544.
- . 1914. Über Phylogenie und Klassifikation der sozialen Vespiden. *Zool. Jb. Abt. f. Syst.*, **36**: 303-330.
- EBERHARD, M. J. W. 1969. The social biology of polistine wasps. *Misc. Publ. Mus. Zool. Univ. Michigan*, No. 140, Ann Arbor, 101 pp., 23 figs.
- FIEBRIG, K. 1907. Eine Wespen zerstörende Ameise aus Paraguay. *Eciton vagans* Olivier. *Z. wiss. Insektbiol.*, **3**: 83-87.
- FLANDERS, S. E. 1945. Is caste differentiation in ants a function of the rate of egg deposition? *Science*, **101**: 245-246.
- . 1946. Control of sex and sex-limited polymorphism in the Hymenoptera. *Q. Rev. Biol.*, **21**: 135-143.
- . 1970. Cannibalistic infanticide in social Hymenoptera related to adult caste ratios. *Can. Ent.*, **102**: 898-905.
- GERVET, J. 1964a. Le comportement d'oophagie différentielle chez *Polistes gallicus* L. (Hymén., Vesp.). *Insectes Soc.*, **11**(4): 343-382.
- . 1964b. La ponte et sa régulation dans la société polygyne de *Polistes gallicus* L. (Hyménoptère, Vespide). *Annls Sci. nat., Zool.* 12^e Serie, **6**: 601-778.
- HAMAHER, J. I. 1936. Summer tanager (*Piranga rubra*) eating wasps. *Auk*, **53**: 220-221.
- HAMILTON, W. D. 1964a. The genetical evolution of social behaviour. I. *J. theor. Biol.*, **7**: 1-16.
- . 1964b. The genetical evolution of social behaviour. II. *J. theor. Biol.*, **7**: 17-52.

- HELDMANN, G. 1936. Über das Leben auf Waben mit mehreren überwinterten Weibchen von *Polistes gallica* L. Biol. Zbl., **56**: 389-400.
- HERING, H. VON. 1896. Zur Biologie der sozialen Wespen Brasiliens. Zool. Anz., **19**: 449-453.
- ISELY, D. 1922. Notes on nesting of *Polistes* (Hymenoptera, Vespidae). Kans. Univ. Sci. Bull., **14**(12): 341-343.
- ISHAY, J., H. BYTINSKI-SALZ, AND A. SHULOV. 1967. Contributions to the bionomics of the oriental hornet (*Vespa orientalis* Fab.). Israel J. Ent., **2**: 45-106.
- ISHAY, J., AND R. IKAN. 1968a. Gluconeogenesis in the oriental hornet *Vespa orientalis* F. Ecology, **49**(1): 169-171.
- . 1968b. Food exchange between adults and larvae in *Vespa orientalis* F. Anim. Behav., **16**(2-3): 298-303.
- JANET, C. 1903. Observations sur les guêpes. Paris, C. Naud. 85 pp.
- JEANNE, R. L. 1970a. Chemical defense of brood by a social wasp. Science, **168**: 1465-1466.
- . 1970b. Note on a bat (*Phylloderma stenops*) preying upon the brood of a social wasp. J. Mammal., **51**(3): 624-625.
- LÖVGREN, B. 1958. A mathematical treatment of the development of colonies of different kinds of social wasps. Bull. math. Biophys., **20**: 119-148.
- MASCHWITZ, U. 1966a. Larven als Nahrungsspeicher im Wespenvolk. Ein Beitrag zum Trophallaxisproblem. Verh. dt. zool. Ges. Jena 1965. Zool. Anz., **29**, Suppl.: 530-534.
- . 1966b. Das Speichelsekret der Wespenlarven und seine biologische Bedeutung. Z. vergl. Physiol., **53**: 228-252.
- MICHENER, C. D. 1964. Reproductive efficiency in relation to colony size in hymenopterous societies. Insectes Soc., **11**(4): 317-342.
- MORIMOTO, R. 1954a. On the nest development of *Polistes chinensis antennalis* Perez. I. (Studies on the social Hymenoptera of Japan. III). Sci. Bull. Fac. Agric. Kyushu Univ., **14**: 337-353.
- . 1954b. On the nest development of *Polistes chinensis antennalis* Perez. II. (Studies on the social Hymenoptera of Japan. IV). Sci. Bull. Fac. Agric. Kyushu Univ., **14**: 511-522.
- . 1954c. On the nest development of *Polistes chinensis antennalis* Perez. III. Relation between the removal of eggs and larvae from the nest and the oviposition of the founding female. (Studies on the social Hymenoptera of Japan. V). Sci. Bull. Fac. Agric. Kyushu Univ., **14**: 523-533.
- . 1960. Experimental study on the trophalactic behavior in *Polistes* (Hym., Vesp.). Acta hymenopt. Fukuoka, **1**(2): 99-103.
- . 1961a. On the dominance order in *Polistes* wasps I. (Studies on the social Hymenoptera in Japan. XII). Sci. Bull. Fac. Agric. Kyushu Univ., **18**(4): 339-351.
- . 1961b. On the dominance order in *Polistes* wasps II. (Studies on the social Hymenoptera of Japan. XIII). Sci. Bull. Fac. Agric. Kyushu Univ., **19**(1): 1-17.
- MYERS, J. G. 1929. The nesting together of birds, wasps, and ants. Proc. ent. Soc. London, **4**: 80-90.
- PARDI, L. 1940. Ricerche sui Polistini. I. Poliginia vera e apparente in *Polistes gallicus* (L.). Atti Soc. tosc. Sci. Nat. Pisa, **49**(4): 3-9.
- . 1942. Ricerche sui Polistini. V. La poliginia iniziale di *Polistes gallicus* (L.). Boll. Ist. Ent. Univ. Bologna, **14**: 1-106.
- . 1946. Ricerche sui Polistini. VII. La "dominazione" e il ciclo ovarico annuale in *Polistes gallicus* (L.). Boll. Ist. Ent. Univ. Bologna, **15**: 25-84.
- . 1947. Beobachtungen über das interindividuelle Verhalten bei *Polistes gallicus* (Untersuchungen über die Polistini, No. 10). Behaviour, **1**: 138-172.
- . 1948a. Ricerche sui Polistini. XI. Sulla durata della permanenza delle femmine nel nido e sull'accrescimento della società in *Polistes gallicus* (L.). Atti Soc. tosc. Sci. Nat. Pisa, **55**(B): 3-15.
- . 1948b. Dominance order in *Polistes* wasps. Physiol. Zool., **21**(1): 1-13.
- . 1951. Ricerche sui Polistini. XII. Studio della attività e della divisione di lavoro in una società di *Polistes gallicus* (L.) dopo la comparsa delle operaie. Arch. zool. ital., **36**: 363-431.
- PARDI, L., AND M. CAVALCANTI. 1951. Esperienze sul meccanismo della monoginia funzionale in *Polistes gallicus* (L.) (Hymenopt. Vesp.). Boll. Zool., **18**: 247-252.
- RAU, P. 1928a. The honey-gathering habits of *Polistes* wasps. Biol. Bull. mar. biol. Lab., Woods Hole, **54**: 503-519.
- . 1928b. Trophallaxis in *Polistes pallipes*. Psyche, Cambridge, **35**: 153-156.
- . 1930. Ecological and behavior notes on *Polistes pallipes*. Can. Ent., **62**: 143-147.
- . 1933. The jungle bees and wasps of Barro Colorado Island (with notes on other insects). Phil. Rau, Kirkwood, Mo., 324 pp.
- . 1935. Studies in the ecology and behavior of *Polistes* wasps. Bull. Brooklyn ent. Soc., **33**(5): 224-235.
- . 1939. Studies in the ecology and behavior of *Polistes* wasps. Bull. Brooklyn ent. Soc., **34**(1): 36-44.

- . 1940. The nesting habits of several species of Mexican social wasps. *Ann. ent. Soc. Am.*, **33**(1): 81–93.
- . 1941a. Observations on certain lepidopterous and hymenopterous parasites of *Polistes* wasps. *Ann. ent. Soc. Am.*, **34**: 355–366.
- . 1941b. Birds as enemies of *Polistes* wasps. *Can. Ent.*, **73**: 196.
- REED, W. W. 1941. The climates of the world. U. S. Dep. Agr. Yearbook, 1941: 665–684.
- REID, J. A. 1942. On the classification of the larvae of the Vespidae (Hymenoptera). *Trans. R. ent. Soc. London*, **92**: 285–331.
- RICHARDS, O. W. 1945. A revision of the genus *Mischocyttarus* de Saussure. *Trans. R. ent. Soc. London*, **95**: 295–462.
- . 1962. A revisional study of the masarid wasps (Hym., Vesp.). *British Museum (N. H.)*, London, 291 pp.
- RICHARDS, O. W., AND M. J. RICHARDS. 1951. Observations on the social wasps of South America (Hymenoptera, Vespidae). *Trans. R. ent. Soc. London*, **102**: 1–170.
- RODRIGUES, V. M. 1968. Estudo sobre vespas sociais do Brasil (Hymenoptera, Vespidae). Doctoral Dissertation, Faculdade de Filosofia, Ciências e Letras de Rio Claro, Universidade de Campinas, Brasil, 113 pp.
- ROUBAUD, E. 1916. Recherches biologiques sur les guêpes solitaires et sociales d'Afrique. La genèse de la vie sociale et l'évolution de l'instinct maternal chez les Vespides. *Annls Sci. nat. Zool.*, 10^e Série, **1**: 1–160.
- SAKAGAMI, SH. F., AND H. FUKUDA. 1968. Life tables for worker honeybees. *Res. Popul. Ecol.*, **10**: 127–139.
- SALT, G., AND J. BEQUAERT. 1929. Stylopedized Vespidae. *Psyche*, Cambridge, **36**: 249–282.
- SCHWARZ, H. F. 1929. Honey wasps. *Natur. Hist.*, New York, **29**(4): 421–426.
- . 1931. The nest habits of the diplopterous wasp *Polybia occidentalis* variety *scutellaris* (White) as observed at Barro Colorado, Canal Zone. *Am. Mus. Novitates*, No. 471: 1–27.
- SLOBODKIN, L. B. 1961. Growth and regulation of animal populations. New York, Holt, Rinehart and Winston, viii + 184 pp.
- SNELLING, R. R. 1953. Notes on the hibernation and nesting of the wasp *Mischocyttarus flavitarsis* (de Saussure) (Hym., Vesp.). *J. Kans. ent. Soc.*, **26**: 143–145.
- SWEZEY, O. 1910. The feeding habits of Hawaiian Lepidoptera. *Proc. Hawaii. ent. Soc.*, **2**(3): 131–193.
- TURNER, C. H. 1912. An orphan colony of *Polistes pallipes* Lepel. *Psyche*, Cambridge, **19**: 184–190.
- VEEHT, J. VAN DER. 1966. The geographical distribution of the social wasps (Hymenoptera, Vespidae). *Proc. 12th Int. Congr. ent. London*, 1964(1965): 440–441.
- . 1968. The terminal gastral sternite of female and worker social wasps (Hymenoptera, Vespidae). *Proc. K. ned. Akad. Wet., Sect. C*, **71**(1): 411–422.
- VESEY-FITZGERALD, D. 1938. Social wasps (Hym. Vespidae) from Trinidad, with a note on the genus *Trypoxylon* Latreille. *Trans. R. ent. Soc. London*, **87**: 181–191.
- WEST, M. J. 1967. Foundress associations in polistine wasps: dominance hierarchies and the evolution of social behavior. *Science*, **157**: 1584–1585.
- WHEELER, W. M. 1925. The finding of the queen of the army ant *Eciton hamatum* Fabricius. *Biol. Bull. mar. biol. Lab.*, Woods Hole, **49**: 139–149.
- WILLIAMS, F. X. 1928. Studies in tropical wasps—their hosts and associates (with descriptions of new species). *Bull. Exp. Stn Hawaii. Sug. Pls Assoc., Ent. Ser.* No. 19, 179 pp.
- WILLINK, A. 1953. Las especies argentinas de *Mischocyttarus* de Saussure (Hym. Vespidae). *Acta zool. Lilloana*, **14**: 317–340.
- WILSON, E. O. 1953. On Flanders' hypothesis of caste determination in ants. *Psyche*, Cambridge, **60**: 15–20.
- YOSHIKAWA, K. 1955. A polistine colony usurped by a foreign queen. *Ecological studies of Polistes wasps*. II. *Insectes Soc.*, **2**(3): 255–260.
- . 1962. Introductory studies on the life economy of polistine wasps. I. Scope of problems and consideration on the solitary stage. *Bull. Osaka Mus. nat. Hist.*, **15**: 3–27.
- . 1963a. Introductory studies on the life economy of polistine wasps. II. Superindividual stage. 3. Dominance order and territory. *J. Biol. Osaka Cy Univ.*, **14**: 55–61.
- . 1963b. Introductory studies on the life economy of polistine wasps. III. Social stage. *J. Biol. Osaka Cy Univ.*, **14**: 63–66.
- ZIKÁN, J. F. 1935. Die sozialen Wespen der Gattung *Mischocyttarus* Sauss., nebst Beschreibung von 27 neuen Arten (Hym., Vespidae). *Archos. Inst. Biol. veg.*, Rio de Janeiro, **1**: 143–203.
- . 1949. O género *Mischocyttarus* Saussure (Hym., Vespidae), com a descrição de 82 espécies novas. *Parque Nacional do Itatiaia, Bol. Nr.* 1: 1–251.
- . 1951. Polymorphismus und Ethologie der sozialen Faltenwespen (Vespidae, Diploptera). *Acta zool. Lilloana*, **11**: 5–51.



Plate 1. Fig. 1. Study site, Belém. The area is poorly drained, with a cover of tall grass and occasional clumps of low trees. Nests of *M. drowseni* were found under the eaves and window lintels of the house just to the left of the center of the picture. Fig. 2. Study site, Taperinha. In the foreground is "terra firme," covered in grass and other low vegetation. *M. drowseni* foraged here, and for short distances out over the varzea vegetation of the middle ground. At the time the picture was taken (May), the varzea was submerged by the annual flooding of the Amazon. The bush in the lower righthand corner of the picture was the site of nest 349.



Plate II. Fig. 3. Nesting sites, Toperinho. Nests of *M. drewseni* were common under the edge of the gallery (just above the top of the ladder). Fig. 4. Nesting sites, Toperinho. *M. drewseni* nested on the meteorological shacks in the foreground, under the tiles stocked behind the shacks, and under the eaves of the house in the background.

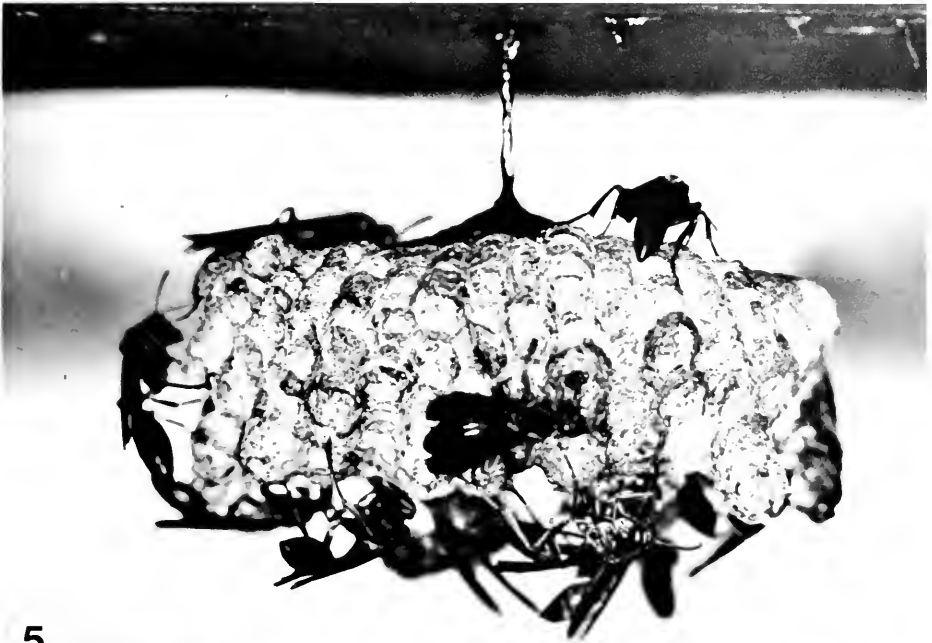

5

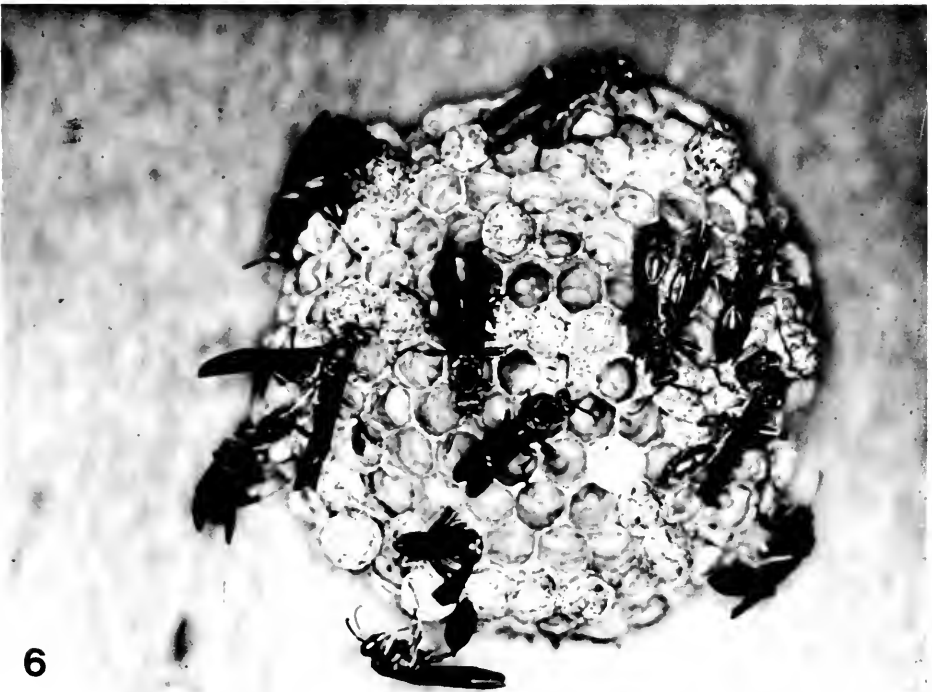

6

Plate III. Fig. 5. Postemergence nest of *M. drewseni*, side view. About $1\frac{1}{2}$ times natural size. Fig. 6. Postemergence nest of *M. drewseni* from below, showing the nest face. The light-colored pupal cap to the lower right of the center of the nest was recently spun by the larva and has not yet had pulp applied to it. Larvae are visible in some of the open cells. Slightly larger than natural size.



Plate IV. Fig. 7. A female applying the ant repellent secretion by rubbing the tuft of hair on the terminal gastral sternite against the surface of the nest stem (from Jeanne, 1970a). Fig. 8. Alarm response to movement of a large object below the nest. The wasps have spread their wings and are facing the disturbance.

INDEX

- Abdominal vibration, 83, 85–86, 97–98
 Abortion of brood, 68, 124, 126, 129, 132–133, 134, 135, 136, 137, 139
 Aggressiveness, 91
 Alarm, 90–91
 Alvarez del Toro, M., 88
 Ant repellent secretion, 86, 89–90, 96
 Ants, 77, 87, 89–90, 92
 Association of nest foundresses, 118–119
- Beatty, J. A., 88
 Bees, 107, 122
Belonogaster, 103, 133; *juncus*, 80, 81, 84, 86, 87
 Bequaert, J. C., 65, 81, 89
 Bertoni, A. de W., 88
 Bodenheimer, F. S., 126
Brachygastra lecheguana, 84; *mellifica*, 84
 Brian, A. D., 122
 Brian, M. V., 105, 122, 126
 Butler, C. G., 107
 Bytinski-Salz, H., 126
- C. II cleaning, 92
 Colony cycle, 68, 69, 113, 118–126
 Colony cycle, duration, 69, 125
 Colony cycle, regulation, 126–141
 Colony development, 119–126
 Colony founding, 118–119
 Colony size, 125, 126
 Communication, 86, 90–91
 Cooling the nest, 94, 95
- Defense, 89–91, 91
 Deleurance, E. P., 95, 104, 105, 122, 129
 Distribution, 66
 Division of labor, 91–96
 Dominance hierarchy, 100, 102–103, 105, 106
 Dominant behavior, 92, 93, 96–103, 105, 107, 108, 110–111, 114
 Duce, A., 65, 69, 89
- Eberhard, M. J. W., 69, 72, 74, 91, 92, 93, 95, 99, 102, 103, 104, 105, 106, 112, 113, 114, 115, 118, 122, 127
 Egg-eating, 68, 104–105, 113, 120, 121, 134
 Eggs, development time, 113
 Exchange of nectar, 83
- Fiebrig, K., 86
 Flanders, S. E., 105
 Foraging, distance, 76
 Foraging, flight, 76
 Foraging, nectar, 76, 81–82, 92, 93, 94, 95
 Foraging, nest material, 72–73, 76, 92, 93, 95
 Foraging, prey, 76–77, 92, 93, 95
 Fukuda, H., 118
- Gervet, J., 104, 105, 120, 121, 122
- Habitat, 69–71
 Hamaker, J. I., 88
 Hamilton, W. D., 103
- Ihering, H. von, 65
 Ikan, R., 85
 Isely, D., 113, 115
 Ishay, J., 84, 126
- Janet, C., 74, 84
 Jeanne, R. L., 88, 89
- Kerr, W. E., 67
- Larvae, 118–120, 133–134
 Larvae, abdominal lobes, 80
 Larvae, development time, 113–114
 Larvae, feeding, 79–81, 83–85
 Lövgren, B., 126
- Males, 80, 81, 82, 83, 84, 86, 94, 95, 98–99, 111, 112, 117, 118, 119, 122, 123–124, 128, 129, 133
 Maschwitz, U., 84, 85, 133
 Mating, 111, 116
Metapolybia, 84
 Michener, C. D., 128
Mischocyttarus, 65, 66, 133; *ater*, 84; *basimacula*, 88; *collarellus*, 73, 74, 84, 87, 88; *fitzgeraldi*, 73, 74; *flavitaris*, 81, 89; *injuvundus*, 75, 76, 84; *labiatus*, 76, 78, 87, 89; *lecoitei*, 75, 76, 84, 87, 88; *scotophilus*, 115; *surinamensis*, 75, 76, 88, 89
 Morimoto, R., 81, 84, 103, 120, 121, 122, 123, 129
 Mouthing, 75–76, 94, 95–96
 Myers, J. G., 87
- Nectar, 76, 81–84, 94
 Nectar, distribution to larvae, 83–84
 Nectar, exchange with nestmates, 82–83
 Nectar, foraging, 76, 81–82, 92, 93, 94, 95
 Nectar, sources, 81–82
 Nectar, storage, 76, 83–84
 Nest architecture, 72, 90
 Nest construction, 73–74, 92, 93, 130
 Nest construction secretion, 73, 75–76, 95
 Nest, dimensions, 72
 Nest material, 72
 Nest site, 70–72
 Nest stem, 75–76
 Nonworkers, 69, 80, 82, 94–95, 101, 102, 106, 117, 123–124, 129
- Ontogeny of behavior, 99–102, 103, 105–106, 107–109
 Oviposition, 92, 104, 105, 106, 109, 120–121, 124, 127, 128, 129, 130
- Parachartergus apicalis*, 81
 Parasites, 88–89, 90–91
 Pardi, L., 92, 96, 98, 99, 101, 102, 103, 104, 128, 129, 130

- Pecking, 86, 87
 Pheromones, 91
 Pires, M., 81
 Plants, as food, 81-82
 Plants, as nesting material, 72
 Plants, as nest site, 70-71
Polistes, 65, 66, 90, 104, 105, 107; *antennalis*, 81; *canadensis*, 71, 72, 78, 88, 92, 93, 102, 112, 113, 114, 115, 118, 119, 127; *chinensis*, 84, 120, 121, 122, 123; *fadwigae*, 80, 81, 88; *fuscatus*, 91, 92, 93, 106, 127; *gallicus*, 80, 81, 84, 87, 92, 96, 98, 99, 101, 102, 103, 120, 121, 122; *metricus*, 113, 115; *pallipes*, 81, 83, 84, 86, 87, 133; *variatus*, 81, 91
 Polistinae, 66
Polybia occidentalis, 78, 84, 88; *rejecta*, 84, 88; *sericea*, 76, 78
 Predators, 87-88, 113
 Prey, 78
 Prey capture, 76-78
 Prey, distribution to larvae, 79-80
 Prey, distribution to nestmates, 78-79
 Prey, foraging, 76-77, 92, 93, 95
 Prey, size, 77
Pseudopolybia vespiceps, 81
 Pulp, addition to pupal cocoons, 74-75
 Pulp, foraging, 72-73, 76, 92, 93, 95
 Pupae, 122
 Pupae, development time, 114
 Queen determination, 103-106, 139
 Queens, 69, 80, 82, 91-94, 102, 104, 106-113, 117, 118, 127-131
 Queens, age, 109, 112
 Queen substitution, 112
 Queen superscedure, 106-113, 135
 Rattling, *see* Abdominal vibration
 Rau, P., 65, 81, 83, 84, 86, 87, 88, 91
 Reed, W. W., 67
 Reid, J. A., 66, 80
 Richards, M. J., 65, 113, 126
 Richards, O. W., 65, 66, 67, 70, 88, 89, 113, 121
 Rodrigues, V. M., 103
 Roubaud, E., 80, 81, 84, 86, 103, 133
 Rubbing, 86, 87, 92, 93, 94, 96
 Sakagami, Sh. F., 118
 Salt, G., 89
 Schwarz, H. F., 84, 87
 Shulov, A., 126
 Slobodkin, L. B., 118
 Snelling, R. R., 65, 81
 Social parasitism, 89
 Solicitation, 78, 83, 98-99, 100
 Spiders, 77, 78, 88
Stelopolybia testacea, 81
Stenogaster depressigaster, 78
 Stenogastrinae, 66
 Sting, 91, 98
 Submissive behavior, 96-97, 99-102
 Subordinates, 69, 96-98, 103, 104, 105
 Swezey, O., 88
 Tarsal lobes, asymmetry of, 66, 77-78
 Trophallaxis, 83, 84-85, 86, 87, 95
 Trophic exchange, 78-81, 82-83, 94, 98-99, 103, 104
 Turner, C. H., 133
 Vecht, J. van der, 65, 89
 Vesey-Fitzgerald, D., 65, 75, 84, 87, 88, 89
Vespa, 84; *orientalis*, 85, 126
 Vespidae, 66
 Water, 72, 76, 95
 West, M. J., *see* Eberhard (M. J. West)
 Wheeler, W. M., 87
 Williams, D. J., 81
 Williams, F. X., 65, 78, 81
 Willink, A., 66
 Wilson, E. O., 87, 106
 Workers, 69, 91-94, 95, 99-101, 102, 104, 117, 118, 122, 128
 Yoshikawa, K., 68, 80, 81, 98, 103, 107
 Zikán, J. F., 65, 66, 88, 89, 115, 133

Bulletin OF THE
Museum of
Comparative
Zoology

Studies in the Milliped Order Chordeumida
(Diplopoda): A Revision of the Family
Cleidogonidae and a Reclassification of
the Order Chordeumida in the New World

WILLIAM A. SHEAR

HARVARD UNIVERSITY
CAMBRIDGE, MASSACHUSETTS, U.S.A.

VOLUME 144, NUMBER 4
26 OCTOBER 1972

PUBLICATIONS ISSUED
OR DISTRIBUTED BY THE
MUSEUM OF COMPARATIVE ZOOLOGY
HARVARD UNIVERSITY

BULLETIN 1863-
BREVIORA 1952-
MEMOIRS 1864-1938
JOHNSONIA, Department of Mollusks, 1941-
OCCASIONAL PAPERS ON MOLLUSKS, 1945-

Other Publications.

- Bigelow, H. B., and W. C. Schroeder, 1953. Fishes of the Gulf of Maine. Reprint. \$13.00 cloth.
- Brues, C. T., A. L. Melander, and F. M. Carpenter, 1954. Classification of Insects. \$15.00 cloth.
- Creighton, W. S., 1950. The Ants of North America. Reprint, \$15.00 cloth.
- Lyman, C. P., and A. R. Dawe (eds.), 1960. Symposium on Natural Mammalian Hibernation. \$5.00 paper.
- Peters' Check-list of Birds of the World, vols. 2-7, 9, 10, 12-15. (Price list on request.)
- Turner, R. D., 1966. A Survey and Illustrated Catalogue of the Teredinidae (Mollusca: Bivalvia). \$5.00 cloth.
- Whittington, H. B., and W. D. I. Rolfe (eds.), 1963. Phylogeny and Evolution of Crustacea. \$6.75 cloth.
- Proceedings of the New England Zoological Club 1899-1948. (Complete sets only.)
- Publications of the Boston Society of Natural History.

Authors preparing manuscripts for the *Bulletin of the Museum of Comparative Zoology* or *Breviora* should send for the current Information and Instruction Sheet, available from Ms Penelope Packard, Editor, Publications Office, Museum of Comparative Zoology, Harvard University, Cambridge, Massachusetts 02138, U.S.A.

STUDIES IN THE MILLIPED ORDER CHORDEUMIDA (DIPLOPODA): A REVISION OF THE FAMILY CLEIDOGONIDAE AND A RECLASSIFICATION OF THE ORDER CHORDEUMIDA IN THE NEW WORLD

WILLIAM A. SHEAR¹

TABLE OF CONTENTS

Abstract	151	Characters useful for delimiting taxa	249
General Introduction	152	Key to superfamilies and families	255
Acknowledgments	153	Superfamily Striarioidea	256
Part I. A Revision of the Family Cleidogonidae	154	Family Striariidae	257
Introduction	154	Family Caseyidae	258
Methods and Materials	154	Family Urochordeumidae	260
Family Cleidogonidae	156	Family Rhiscosomididae	261
Species not included in revision	157	Superfamily Brannerioidea	263
Evolution and Zoogeography of the Genera of Cleidogonidae	159	Family Tingupidae	264
Key to genera	162	Family Branneriidae	266
Genus <i>Pseudotremia</i>	162	Superfamily Heterochordeumatoidea	267
Key to species	168	Family Conotylidae	268
Genus <i>Solaenogona</i>	193	Family Adritylidae	273
Key to species	193	Superfamily Cleidogonoidea	274
Genus <i>Cleidogona</i>	195	Family Cleidogonidae	274
Key to Mexican and Central American species	206	Family Trichopetalidae	274
Key to North American species	222	Literature Cited	281
Genus <i>Tiganogona</i>	240	Index	349
Genus <i>Dybasia</i>	243		
Key to species	244		
Part II. A Reclassification of the Order Chordeumida in the New World	247		
Introduction	247		
Families not included	247		
The history of chordeumid studies	248		

¹Department of Biology, Concord College, Athens, West Virginia 24712.

ABSTRACT. This study of North American chordeumid millipeds is in two parts: a revision of the large family Cleidogonidae and a reclassification of the Order Chordeumida in the New World. In part one, the zoogeography and possible evolution of the Cleidogonidae are discussed. The family probably originated in the highlands of central and southern Mexico and subsequently spread north and south, enduring several waves of extinction that left behind numerous peculiar relict forms. The family names Dybasiidae Loomis, Bactropidae Chamberlin and Hoffman, and Bactropodellidae Jeekel are considered here as synonyms of Cleidogonidae Cook for the first time. *Dearolfia* Loomis is placed in the synonymy

of *Pseudotremia* Cope; *Mexiceuma* Verhoeff, *Rhabdarona* Chamberlin and Mulaik, *Cavota* Chamberlin, *Hirsutogona* Kraus, *Mecistopus* Loomis, *Acakandra* Loomis, and *Costarcia* Loomis are placed in the synonymy of *Cleidogona* Cook; *Bactropus* Cook and Collins (preoccupied), *Bactropodellus* Jeekel, *Ofcookogona* Causey and *Ozarkogona* Causey are synonyms of *Tiganogona* Chamberlin; *Ogkomus* Loomis and *Solemia* Loomis are synonyms of *Dybasia* Loomis.

The following new synonymies at the species level are recognized (valid name given first): *Pseudotremia carterensis* Packard = *P. sodalis* Loomis; *Cleidogona maculata* (Verhoeff) = *C. leona* Chamberlin, *C. propria* Causey; *C. bacillipus* (Chamberlin and Mulaik) = *Mecistopus varicornis* Loomis; *C. celerita* Williams and Hefner = *C. inflata* Causey; *C. cascioannulata* (Wood) = *C. exaspera* Williams and Hefner; *C. laminata* Cook and Collins = *C. aspera* Causey. The following species are described as new: *Pseudotremia stupefactor*, *P. lethe*, *P. acheron*, *P. cocythus*, *P. cottus*, *P. soco*, *P. momus*, *P. arnesi*, *P. nefanda*, *P. alecto*, *P. amphiorax*, *P. tsuga*, *P. scrutorum*, *P. merops*, *P. spira*, *P. nyx*, *P. cercops*, *P. lietor*, *P. aeacus*, *P. unca*, *P. minos*, *P. deprehendor*, *Solaeonogoua chiapas*, *Cleidogona accretis*, *C. fidelitor*, *C. georgia*, *C. lachesis*, *C. hoffmani*, *C. steno*, *C. tallapoosa*, *C. grenada*, *C. nantahala*, *C. atropos*, *C. laquinta*, *C. conotyloides*, *C. forficula*, *C. chontala*, *C. tizoc*, *C. xolotl*, *C. tequila*, *C. hauatla*, *C. baroqua*, *C. crystallina*, *C. peeki*, *C. gucumatz*, *C. mixteca*, *C. decurva*, *C. mayapee*, *C. camazotz*, *C. chacmool*, *C. zapoteca*, *C. totonaca*.

In part two, the known families of New World chordeumids are arranged into superfamilies. Superfamily Striarioidea Cook includes the families Striariidae Cook, Caseyidae Verhoeff, Rhiscosomididae Silvestri, and Urochordeumidae Silvestri; the new superfamily Heterochordeumidea includes the families Conotylidae Cook and Adritylidae Shear (as well as a few families not found in the New World); the new superfamily Cleidogonoidea includes the families Cleidogonidae Cook and Trichopetalidae Verhoeff; the new superfamily Brannerioidea includes the families Branneriidae Cook and Tingupidae Loomis. The possible relationships of the families are briefly discussed, and useful characters are assessed.

The family Idagonidae Buckett and Gardner is placed for the first time in the synonymy of the family Conotylidae Cook. The genera *Zygonopus* Ryder, *Tynopus* Chamberlin and *Flagellopetalum* Causey are treated as synonyms of *Trichopetalum* Harger. *Tingupa monterea* Chamberlin is transferred to the genus *Rhiscosomides*. The following species are described as new: *Rhiscosomides acovescor*, *Trichopetalum syntheticum*, *Scoterpes ventus* and *Mexiterpes metallicus*.

GENERAL INTRODUCTION

The milliped Order Chordeumida is a large assemblage of species belonging to the Subclass Chilognatha and having in common a number of very basic features: the sterna are free from the pleurotergites of the diplosegments, and the pleurotergites are not fused in the middorsal line; the anal segment bears two small spinnerets; segment numbers are constant within species and are either 26, 28, 30, or 32; the mentum of the gnathochilarium separates the lingual laminae and is sometimes divided; repugnatorial glands are absent. Beyond this basic similarity is a bewildering array of adaptive types, ranging from species normally active at or near the freezing point of water, to inhabitants of leaf litter of the tropical rain forest, and from nearly transparent troglobites to heavily armored burrowers. They range in size from 3 mm to nearly 40 mm.

Biological studies on this group (and millipeds in general) have been inhibited by the primitive state of milliped taxonomy. Less than a fourth of the species of millipeds inhabiting the United States have been described, as I judge from my own collecting experiences in several areas. In the past, only a few workers have made any attempt to gather together collections of millipeds and study them in a systematic way. Papers describing a miscellany of new species have been the rule, rather than revisions of genera and families (in the Chordeumida, *only one* revision of a genus, including four species, has appeared since 1895). Since 1955, a few exemplary studies of milliped families, such as R. L. Hoffman's ongoing revision of the very large family Nystodesmidae, and W. T. Keeton's complete study of the Spirobolidae, have appeared. The Order Chordeumida has been neglected.

This present study must be considered incomplete for a number of reasons. First, many additional species of the family Cleidogonidae remain to be discovered, as do additional genera and species of

other families briefly treated here. Second, a large collection in private hands, comprising several hundred vials of *Pseudotremia*, was not available for study, and a number of unique types of previously described species have either been lost or never found their way to their published repository.

ACKNOWLEDGMENTS

Dr. Herbert W. Levi of the Museum of Comparative Zoology has my thanks for his help, encouragement, and many kindnesses; he made possible my stay at Harvard and did much to expedite the completion of this study.

Dr. Richard L. Hoffman, Radford College, Radford, Virginia, foremost American authority on the Diplopoda, suggested the topic and provided many of the specimens used. Dr. Hoffman also made many valuable suggestions, and never failed to reply in detail to hastily written queries, despite his overloaded schedule.

Dr. Stewart Peck of the Museum of Comparative Zoology contributed a number of significant specimens, and, in numerous conversations in our shared office, helped clarify my thinking concerning the evolution of cave animals. Dr. Nell B. Cansy, Baton Rouge, Louisiana, loaned collections of branneriids and of Mexican cleidogonids. Further specimens were loaned or contributed by Michael R. Gardner, Davis, California; Dr. John Holsinger, Norfolk, Virginia; Dr. Thomas C. Barr and John and Martha Cooper, Lexington, Kentucky; Dr. J. A. Beatty, Carbondale, Ill.; Dr. F. A. Coyle, Cullowhee, N. C.; and, Dr. A. A. Weaver, Wooster, Ohio.

I thank the following museums and their curators for the loan of type specimens,

which often involved laborious searching: Museum of Comparative Zoology (Dr. H. W. Levi), American Museum of Natural History (Dr. J. A. L. Cooke), United States National Museum (Dr. Ralph E. Crabill, Jr.), University of Utah Zoology Museum (Mr. T. Lorenz), Illinois Natural History Survey (Dr. John Unzicker), Field Museum of Natural History (Mr. Henry Dybas), Philadelphia Academy of Sciences (Dr. N. Jago), The British Museum (Natural History) (Dr. J. G. Sheals and Mr. D. Clark), Senckenbergische Naturforschende Gesellschaft in Frankfurt (Dr. M. Grasshoff), Muséum d'Histoire Naturelle de Genève (Dr. B. Hauser), Zoologische Museum, Munich (Dr. W. Engelhardt and Dr. E. Popp).

I am also appreciative of the generous financial support of Harvard University, through the Committee on Evolutionary Biology (National Science Foundation Grant GB-7346), and through my tenure as a Richmond Fellow.

A number of friends and colleagues provided help through their hospitality during field studies; in particular Dr. and Mrs. Carl J. Chapman, Dr. and Mrs. Frederick A. Coyle, Dr. and Mrs. Jeremiah L. Blatt, and Mr. and Mrs. David R. Bard. The encouragement of the faculty and students of the Biology Department of Concord College, Athens, West Virginia, was also appreciated. Dr. Peter J. van Helsdingen helped with a number of tasks involved in completing the manuscript, and Prof. Frank Carpenter made several valuable suggestions.

The manuscript was typed by Wilmoth Peairs and Mrs. Sally Loth, who cheerfully put up with the hurriedly delivered fragments of typescript and constant changes and harassment.

Part I. A Revision of the Family Cleidogonidae

INTRODUCTION

Before the higher classification of any group of animals or plants can be established, thorough studies of the species, genera, and families involved are necessary. Such studies, as previously stated, have generally been lacking with regard to millipeds. In the Chordeumida, progress in studying the evolutionary relationships of the various forms has been hampered by the presence of several poorly known small families and a single large one, the Cleidogonidae, in which less than half the species have been described. Some of these smaller families are handled in more or less detail in the second part of this paper, and a moderate-sized family, the Conotylidae, has already been revised (Shear, 1971). The first section of this paper removes another of the obstacles listed above by revising the large family Cleidogonidae.

Because most of the species in the family Cleidogonidae remained undescribed, taxonomists having only a nodding acquaintance with the group set up numbers of superfluous genera and families (Verhoeff, 1936; Chamberlin and Hoffman, 1958; Kraus, 1954; Loomis, 1964, 1966; Causey, 1951b; etc., etc.). In the course of this study, intermediate species and genera were discovered that make most of these names obsolete.

Species of the family Cleidogonidae are among the commonest millipeds in two crucial biogeographic areas: the central Appalachian Mountains of North America and the highlands of Mexico. In both these areas, rapid and probably recent speciation in the genera *Cleidogona* and *Pseudotremia* have produced a confusing picture of highly localized distributions. Much work remains to be done in discovering the distributional details of most of the species. When this has been accomplished, perhaps the number of species can be reduced;

something of this kind has been necessary in this paper, though the discovery of new species has completely swamped the relatively small number of names placed in synonymy. In addition, some peculiar patterns are emerging. Along with highly localized species, there are others that, although seemingly not very different, are widely distributed. This problem is discussed in more detail later.

Little is known about the biology of the Cleidogonidae, and what additional information I have uncovered is treated both under the species involved, and, as it bears on collecting methods, in the section METHODS AND MATERIALS below.

METHODS AND MATERIALS

Approximately 2500 specimens of members of the family Cleidogonidae were examined during the course of this study. All were preserved in 70–85 percent ethanol. The majority of specimens came from the personal collections of Drs. Richard L. Hoffman and Nell B. Causey, and have been returned to them, with the exception of types of new species, all of which have been deposited in the Museum of Comparative Zoology. Nearly 200 specimens were taken by me in collecting seasons from 1962–1967 in Ohio, West Virginia, Virginia, and in Tennessee, North Carolina, Georgia and South Carolina during the collecting season of 1969. Some of these specimens, with the exception of types, are retained by me for the time being.

Collecting methods. Two collecting methods proved most successful in the search for cleidogonids. Since most epigeal species are dwellers in leaf-litter, scraping away the dry upper layer and sorting the moist, rotting duff underneath yielded many specimens. Tullgren funnel sampling was also successful, especially in collecting quantities of specimens of smaller species.

Hypogean species of *Pseudotremia* must be searched for in caves, where, in most instances, they are found on the floor, regardless of lighting conditions. The most important factor seems to be the presence of washed-in food, usually wood or other vegetable debris. Troglophilic species are frequently common in cave entrances. At Laurel Creek Cave, Greenville, West Virginia, a good sample of *Pseudotremia hobbsi* was taken beneath rocks and logs at the cave mouth where water dripped from the cliff above.

Some *Cleidogona* have a definite preference for dry conditions. For example, six adult males of *C. fustis* were taken at Athens, West Virginia, under stones in a sloping, south-facing pasture. *Cleidogona major* is common on West Virginia shale barrens, in a very warm and dry microclimate.

Upland oak forests and cove forests are the most productive Appalachian habitats for *Cleidogona*; coniferous forests in general support few millipeds. However, *Pseudotremia* is frequently taken in association with hemlock (*Tsuga canadensis*) or fir (*Abies fraseri*). On one occasion, two immature *Cleidogona* were collected in a fir forest near the summit of Mt. Mitchell, North Carolina.

The best collecting conditions occur from late March to early June, and again in October and November, depending on the latitude. Most individuals probably either estivate or burrow deeper into the soil and litter during the hot, dry summer months.

In Mexico species are commonly found in caves, and at somewhat higher altitudes than is usual in the United States. Some species have been collected in central Mexico as high as 14,000 feet (*ca.* 4500 m), but others may occur on the coastal plains. Again, broadleaf forests are most productive, particularly the so-called cloud forest.

Living specimens, especially of *Cleidogona*, are fragile and do not transport well. Unless they are specifically required in living condition, it is best to kill and pre-

serve them in 70–85 percent ethanol in the field. Specimens preserved in the lower concentrations of alcohol remain more flexible.

Dissecting methods. It is rarely possible to make adequate observations on the genitalia of the cleidogonids without dissection. This should be done with least damage to the specimen. I have found the following procedure useful. For tightly coiled males, it is usually necessary to break the body into two parts. This is best done with a pair of watchmaker's forceps between the seventh and eighth segments. The anterior and posterior gonopods will be exposed on one of the broken surfaces, and the tenth and eleventh legs on the other. The break can be made to occur neatly between the segments if gentle pressure and careful sawing movements of the forceps are used, so as to cut the muscles and do a minimum amount of damage to the cuticle. Next, the muscles attaching the tracheal apodemes of the gonopods to the body wall and to the preceding pair of legs should be severed by the use of a microscalpel made from a chip of razor blade. The gonopods can now be removed from the body with forceps or needles. Particular care must be taken to avoid damaging the anterior basal region during this part of the dissection. The anterior and posterior gonopods can be separated by using two needles to apply pressure gently in opposite directions, first at one lateral sternal angle, then at the other. Damage results when the separation is attempted from the middle of the sternum, owing to the weakness of this structure in the posterior gonopods.

Cleaning the muscular tissue from the anterior gonopods is sometimes useful. A number of methods involving corrosives or enzymes have been successful: soaking for twelve hours in cold 10 percent potassium hydroxide; one hour in saturated hydrogen peroxide; soaking twelve hours in a solution of the proteolytic enzyme trypsin at 90–95°F (40°C). The latter method is

preferred because it results in less distortion to the sclerotized parts.

Dissection of the female cyphopods is somewhat more difficult. These structures are located posterior to the coxae of the second legs. The best procedure seems to be to separate the head and collum from the rest of the body, then remove the second and third legs as a unit from the second thoracic segment. The third legs can then be carefully pried away from the cyphopods and second legs. Care must be taken to avoid damaging the postgenital plate, present immediately behind the cyphopods in most species of *Cleidogona*. It is rarely necessary to clean muscular tissue from the cyphopods, but if the need arises, the same methods can be used as mentioned above for the gonopods.

Many specimens had important morphological characters obscured by dirt, material from the digestive tract, or chemical deposits resulting from improper preservation. Cleaning this material, particularly from the delicate gonopods, with brushes and needles, may cause damage. Ultrasonic cleaning, however, removed almost every kind of debris in a few moments without damage to the most fragile structures (Shear and Levi, 1970). The machine used was a DiSon System 30 Ultrasonic generator, manufactured by Ultrasonic Industries, Engineer Hill, New York. Specimens to be cleaned were placed in a 17 × 60 mm glass vial of alcohol and immersed in the cleaning bath for from one to five minutes.

Illustrations. Illustrations were prepared at various magnifications, depending on the size of the structure to be drawn. Scale is clearly indicated for all illustrations. Drawings were first made in pencil with the use of ruled paper and an ocular grid; most were checked for details under higher magnification before being transferred in ink to heavier drawing paper. Measurements were made with an ocular micrometer and are accurate to 0.01 mm.

Family Cleidogonidae Cook, 1896

- Cleidogonidae Cook, 1896, *Brandtia*, 2: 8; Hoffman, 1950, *J. Washington Acad. Sci.*, 40: 87 (key to genera, list of species); Chamberlin and Hoffman, 1858, *Bull. U. S. Nat. Mus.*, 212: 89 (list of U. S. genera and species); Loomis, 1968, *U. S. Nat. Mus. Bull.*, 266: 66 (list of Mexican and Central American species).
 Entomobielziinae Verhoeff, 1909, *Zool. Anz.*, 34: 570 (in part, not including *Entomobielzia* Verhoeff).
 Mexiceumidae Verhoeff, 1926, *Zool. Anz.*, 68: 110.
 Pseudocleididae Attems, 1926, in *Kükenthal-Krumbach, Handbuch der Zoologie*, 4: 170 (in part, not including *Pseudoctis* Attems).
 Bactropidae Chamberlin and Hoffman, 1950, *Chicago Acad. Sci. Nat. Hist. Miscellany*, 71: 6. NEW SUBJECTIVE SYNONYMY.
 Dybasiidae Loomis, 1964, *Fieldiana*, 47: 100. NEW SUBJECTIVE SYNONYMY.
 Bactropodellidae Jeckel, 1969, *Entomol. Bericht*, 29: 88. New name for Bactropidae. NEW SUBJECTIVE SYNONYMY.

Type genera. Of Cleidogonidae, *Cleidogona* Cook and Collins, 1895; of Bactropidae, *Bactropus* Cook and Collins, 1895; of Mexiceumidae, *Mexiceuma* Verhoeff, 1926; of Dybasiidae, *Dybasia* Loomis, 1964.

Notes on synonymy. The Entomobielziinae of Verhoeff and Attems' Pseudocleididae were erected on European genera that superficially resemble cleidogonids, and those authors probably included the American genera for that reason, apparently not concerned that by doing so they were bringing Cook's earlier family name into the problem. *Mexiceuma* is a junior subjective synonym of *Cleidogona*. The family Bactropidae was based on the genus *Bactropus* by Chamberlin and Hoffman, because Cook and Collins (1895) stated in the original description that the promentum was "not distinct." Chamberlin and Hoffman (1950) took this to mean that the promentum was absent. The holotype of *B. conifer* was not examined by them or me and is presumed to be lost. However, a number of other species actually belonging to this genus have been described under a variety of generic names, and all have a separate promentum. The original mean-

ing of Cook and Collins' statement was probably that the promentum was difficult to see on the small holotype of *Bactropus conifer*. In any case, the generic name is preoccupied by *Bactropus* Barrande, 1872, a fossil crustacean of uncertain taxonomic position. The genera and species placed by Loomis in the family Dybasiidae do not differ in any important character from species of the Cleidogonidae, and indeed are related much more closely to *Cleidogona* than other genera traditionally placed in the Cleidogonidae.

Diagnosis. See the key to North American chordeumid families given in the second part of this paper.

Description. Thirty segments. Mentum divided. Antennae long to moderately short. Ocelli present, though in many cases reduced in number and depigmented. Body tapering gradually at either end, but more abruptly anteriorly in males, widest in males at seventh segment. Body segments smooth, cylindrical, or with pronounced thick shoulders, or with *Conotyla*-like paranota; in one genus (*Pseudotremia*) with coarse knobs or rugae dorsally and with lateral striations. Segmental setae present, prominent, or small and spatulate. Pregonopodal legs of males: legs 1 and 2 of normal size or slightly smaller, 6-segmented. Legs 3 through 7 enlarged, crassate, 7-segmented. Anterior gonopods: sternum usually well sclerotized, lateral sternal sclerites more or less set off by suture in region of spiracle. Coxae separate or fused, usually with setae. Colpocoxites fused to coxae or separated by a suture, with 1 or 2 branches; if 2, then lateral branch with a gland channel. Telopodites simple, much reduced, 1-segmented or absent, fused to each other, but sometimes movable with respect to coxae. Posterior gonopods: without colpocoxites, coxae always largest segments, 2- to 6-segmented, claw present in all but a few species. Tenth and eleventh legs with coxal glands, frequently with other modifications on the coxae that may be constant or variable

within genera. Twelfth sternum with or without an anterior projection. Following legs unmodified. Cyphopods: receptacle large (*Pseudotremia*) or reduced in size (*Cleidogona*); two pairs of postreceptacular bars. Valves well sclerotized, sometimes (*Cleidogona*) with ornate modifications. Postgenital plate present in *Cleidogona* and *Solaenogona*.

Distribution. Panama, Costa Rica, El Salvador, Guatemala, southern and eastern Mexico, southern Texas, United States east of the Mississippi River and south of the Great Lakes.

Species Not Included in the Revision

The following species could not be included in the revision because, for one reason or another, it was impossible to study the type material, the only known specimens.

Types of the following species could not be located at the published repository, the American Museum of Natural History:

Cleidogona saripa Causey

Cleidogona saripa Causey, 1961, Florida Entomol. 44: 36, figs. 1, 2, ♂. Male holotype from Savannah River Plant, Aiken Co., South Carolina.

Cleidogona arkansana Causey

Cleidogona arkansana Causey, 1954, Tulane Stud. Zool., 2: 66, figs. 6-9, ♂. Male holotype from 4 mi. east of Princeton, Dallas Co., Arkansas. Probably a synonym of *C. unita* Causey.

Cleidogona moderata Causey

Cleidogona moderata Causey, 1957, J. Kansas Entomol. Soc., 30: 115, figs. 6, 7, ♂. Male holotype from 18 mi. south of Tamazunchale, San Luis Potosí, Mexico. A member of the *maculata*-group of *Cleidogona*.

Cleidogona secreta Causey

Cleidogona secreta Causey, 1957, J. Kansas Entomol. Soc., 30: 119, fig. 16, ♀. Female holotype from Oaxaca City, Oaxaca, Mexico.

Tiganogona levis (Causey) NEW
COMBINATION

Ozarkogona levis Causey, 1959, J. Kansas Entomol. Soc., 32: 143, figs. 1, 2, ♂. Male holotype from Richmond Creek, Greene Co., Indiana. Probably a synonym of *Tiganogona conifer* (Cook and Collins).

Tiganogona ladymani (Causey) NEW
COMBINATION

Ozarkogona ladymani Causey, Proc. Biol. Soc. Washington, 65: 114, figs. 8, 9, ♂. Male holotype from Rector, Clay Co., Arkansas.

Types of the following species could not be located at the published repository, the United States National Museum.

Cleidogona forceps Cook and Collins

Cleidogona forceps Cook and Collins, 1895, Ann. New York Acad. Sci., 9: 49, figs. 159, 163, ♂. Type locality not specified, no localities known for this species.

Cleidogona australis Loomis

Cleidogona australis Loomis, 1966, Proc. Biol. Soc. Washington, 79: 226, figs. 8–10, ♂. Male holotype from Highlands Hammock State Park, Sebring, Florida.

Cleidogona curvipes (Loomis) NEW
COMBINATION

Costarcia curvipes Loomis, 1966, Proc. Biol. Soc. Washington, 79: 227, figs. 11–13, ♂. Male holotype from Cairo, Limon Prov., Costa Rica.

Tiganogona conifer (Cook and Collins)
NEW COMBINATION

Bactropus conifer Cook and Collins, 1895, Ann. New York Acad. Sci., 9: 54, figs. 172–176, ♂. Male holotype from Bloomington, Monroe Co., Indiana.

Types of the following species were sent by the Philadelphia Academy of Science and were apparently lost in the mails:

Tiganogona steuartae (Causey) NEW
COMBINATION

Ofcookogona steuartae Causey, 1951, Proc. Biol. Soc. Washington, 64: 121, fig. 13, ♂. Male holotype from Greenwood, Sebastian Co., Arkansas.

Cleidogona minima Causey

Cleidogona minima Causey, 1951, J. Washington Acad. Sci., 41: 80, figs. 10–13, ♂. Male holotype from Tuscaloosa, Tuscaloosa Co., Alabama.

The types of the following species could not be located in the University of Utah collection:

Cleidogona mandeli Chamberlin

Cleidogona mandeli Chamberlin, 1952, Great Basin Natur., 12: 13, figs. 4–7, ♂. Male holotype from Volcán Tajumulco, Guatemala.

Cleidogona punctifer Chamberlin

Cleidogona punctifer Chamberlin, 1952, Great Basin Natur., 12: 13, no figure. Female holotype from Chichivac, Guatemala.

Cleidogona tajmulco Chamberlin

Cleidogona tajmulco Chamberlin, 1952, Great Basin Natur., 12: 15, no figures. Female holotype from Volcán Tajumulco, Guatemala.

Cleidogona zempoala Chamberlin

Cleidogona zempoala Chamberlin, 1943, Bull. Univ. Utah, 34: 35, figs. 64, 65, ♂. Male holotype from Parque Nacional de Zempoala, Morelos, Mexico.

Pseudotremia hansonii Chamberlin

Pseudotremia hansonii Chamberlin, 1951, Great Basin Natur., 11: 25, no figures. Female holotype from Pineville, Kentucky.

Pseudotremia fracta Chamberlin

Pseudotremia fracta Chamberlin, 1951, Great Basin Natur., 11: 25, no figures. Female holotype from Catlinburg Cove, Catlinburg, Tennessee. This name might have been used for *P. cottus*, but *P. fracta* as described by Chamberlin seems to be smaller and has only 10 ocelli. Perhaps the female holotype was not mature.

The following species could not be studied in detail because the vials containing the types contained no gonopods:

Cleidogona austrina (Loomis) NEW
COMBINATION

Acakandra austrina Loomis, 1964, Fieldiana, 47: 99, figs. 9N–9Q, ♂. Male holotype from Cerro Punta, Chiriquí Prov., Panama, type deposited in Chicago Natural History Museum.

Cleidogona nueva Chamberlin

Cleidogona nueva Chamberlin, 1941, Entomol. News, 52: 250. Male holotype from Ojo de Agua, Sabinas Hidalgo, Nuevo León, Mexico, type deposited in collection of University of Utah. The holotype of the supposed subspecies *C. nueva michoacana*, deposited in the University of Utah collection, also lacked gonopods.

Evolution and Zoogeography of the Genera of Cleidogonidae

Hoffman (1969a, 1969b) made the first serious attempt in America to bring together information on the evolution and zoogeography of the Diplopoda. He did not include the chordeumids, however, because of the great confusion in their taxonomy. He concluded that with the exception of recent periods of rapid expansion and speciation in certain families, most of the events accounting for the present distribution of milliped orders, and perhaps the origins of the orders themselves, took place as early as the late Paleozoic. The fossil record (summarized in Hoffman, 1969b) is extremely skimpy, but forms not unlike those living today have been found in North American Upper Pennsylvanian sediments. A few forms are known from the Oligocene European Amber; they are members of families and possibly even genera found in Europe today.

Thus any attempt at historical zoogeography in millipeds must be highly speculative and must rely almost entirely on evidence from present distributions and analogies from groups with similar patterns.

In his discussion of other milliped orders, Hoffman (1969a) pointed out that there have been two major American centers of speciation and subsequent range expansion; the highlands of north central Mexico and the southern Appalachian Mountains. A third center may exist in the coastal ranges of the Pacific Northwest; too little is known about the fauna there to make a firm statement. My findings in the Cleidogonidae and other milliped families reinforce Hoffman's conclusions. In the following dis-

ussion, I have relied heavily on the information on paleogeography presented by Schuchert (1955) and Maldonado-Koerdell (1964), and the conceptual methods expounded by Darlington (1957, 1965).

In the second part of this paper, I have combined the families Cleidogonidae and Trichopetalidae under the new superfamily Cleidogonoidea; the reader is referred to that section for the evidence for this arrangement. Here I will only state that species of the genus *Mexiterpes* (Trichopetalidae) are quite intermediate in many respects between more typical trichopetalids and *Pseudotremia* (Cleidogonidae). The two families may have developed from a common stock beginning in the early Cretaceous, or even before.

In Map 1 the possible distribution of this early stock is shown. It may have been similar to *Mexiterpes* in many respects (dots show records of two species of *Mexiterpes*, both from caves), but probably had larger, more loosely articulated gonopod telopodites and lacked the obviously derived body form of the trichopetalids. The earliest differentiation of the two families, into a stock more closely resembling *Mexiterpes* and leading to the trichopetalids of North America, and a second line intermediate between *Mexiterpes* and *Pseudotremia*, from which the Cleidogonidae developed, may have taken place in the late Jurassic, when, except for submersion of coastal areas, the extent of the North American land mass was essentially as it is today (Schuchert, 1955). The more progressive proto-*Pseudotremia* stock expanded both northward and southward from an origin in the Mexican highlands, and may have limited the distribution of the early trichopetalids to the northern part of the continent by competition. Map 2 shows (dashed line) the present distribution of the Trichopetalidae in eastern North America. The heavy arrows indicate the possible invasion routes of the proto-*Pseudotremia* stock. The distribution and

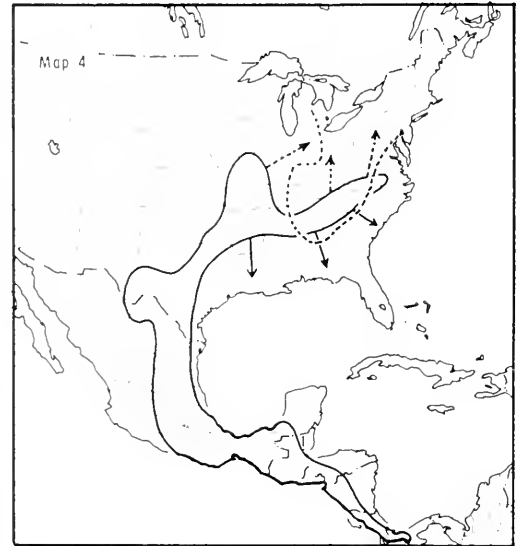
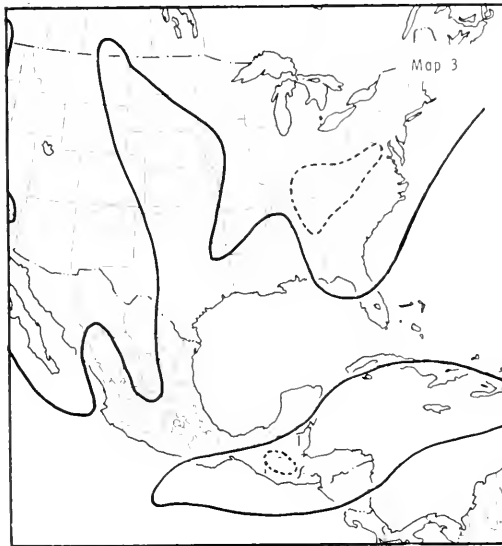
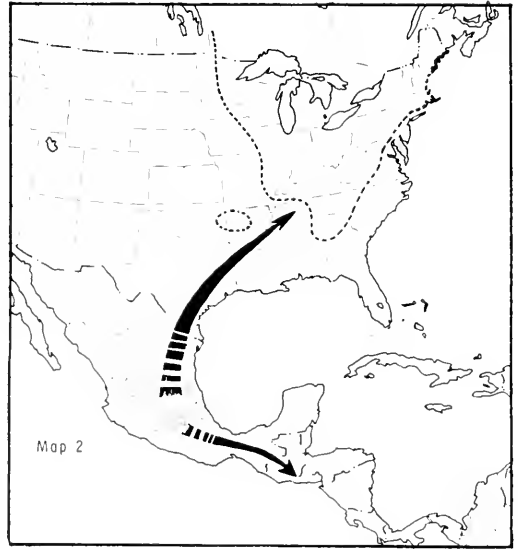
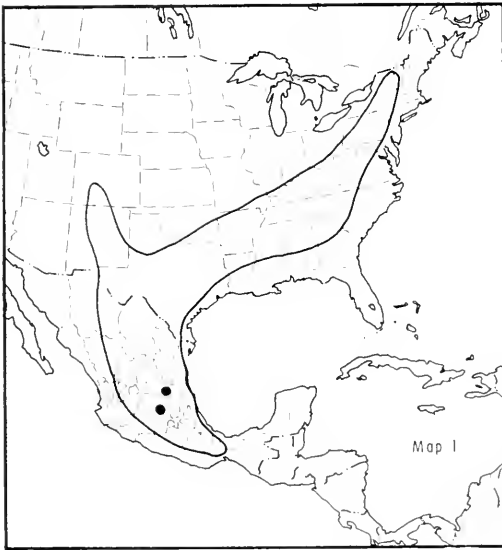

Maps 1-4. Speculations on historical zoogeography of the Cleidogonidae and Trichopetalidae. See text for explanations.

isolation of this stock into northern and southern elements took place perhaps during the Cretaceous. Map 3 (after Schuchert, 1955) shows the maximum extent of the seas of Cretaceous time (heavy line), and the present distributions (dashed lines) of the genera *Pseudotremia* and *Solaenogona*, which I believe to be

direct derivatives of the early proto-*Pseudotremia* stock. At some time during the Cenozoic, possibly as recently as the Miocene, ancestral *Cleidogona* originated from forms similar to the present-day *Solaenogona*. This very progressive, adaptable genus has since spread both northward and southward, though undoubtedly

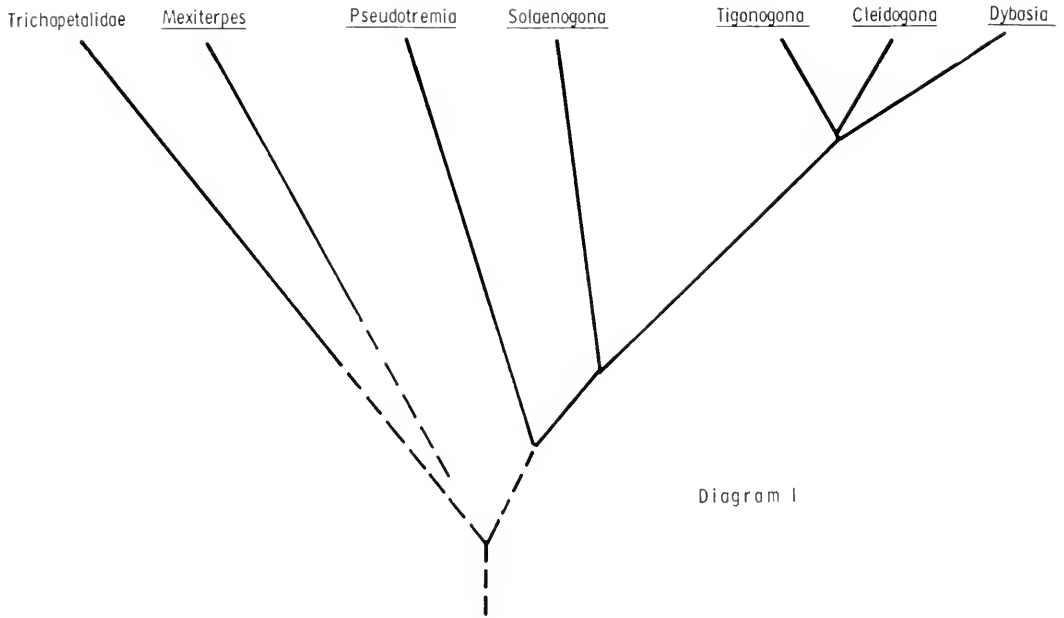

Diagram 1. Suggested phylogeny of genera of Cleidogonidae, showing relationship to the genus *Mexiterpes* and the family Trichopetalidae. Time scale not to be inferred.

there have been many intervening periods of recession and extinction (see the discussion under *Cleidogona*). Map 4 shows the speculative early distribution of *Cleidogona* (heavy line) and its satellite genera, *Tiganogona* and *Dybasia*. Solid arrows indicate movement southward from a secondary center in the southern Appalachians, and dashed arrows northward expansion. The dashed line represents speculation about the distribution of *Pseudotremia* at that time; since then it has been limited drastically from the north (compare Map 5) by glaciation, and by competition from *Cleidogona*.

Tiganogona is a small genus apparently adapted to somewhat drier climatic conditions than *Cleidogona*. It may have developed as a purely North American derivative of early Appalachian *Cleidogona*, or be most closely related to the Mexican species grouped around *C. maculata*. Specimens are rare and species limited in their distributions.

Dybasia occurs in Panama at the extreme southern limit of the distribution of the family. It is clearly a specialized stock of *Cleidogona*, and may not be worthy of generic recognition.

Members of the Cleidogonidae make up a predominately austral element of the North American milliped fauna, with some species of *Cleidogona* and members of the genus *Pseudotremia* secondarily adapted to boreal conditions. On the other hand, the family Trichopetalidae is distinctly boreal, with many species in the northern sections of North America adapted to activity in the winter. Other species are widespread in glaciated territory as far north as Newfoundland; *Mexiterpes* has two species in Mexican caves that are disjunct from the remainder of the family by more than 1000 miles.

These speculations are summarized in Maps 1-4 and Diagram 1. No time scale is to be inferred in reading Diagram 1.

KEY TO GENERA OF THE CLEIDOGONIDAE,
BASED ON MALES

- 1a. Dorsum with longitudinal rugae or several irregular series of small knobs; thick segmental shoulders usually well developed (Fig. 6), sides of segments longitudinally striate; anterior gonopod colpocoxites with a lateral branch bearing a gland channel (Figs. 1, 2). *Pseudotremia*
- 1b. Dorsum smooth; segments usually cylindrical, or with shoulders weakly developed, in a few species nearly horizontal paranota present (Fig. 274); anterior gonopod colpocoxites with gland channel obscure or absent 2
- 2a. Anterior gonopod colpocoxites with two large, subequal branches (Fig. 174), the anteriormost ornate and bearing a vague gland channel; Chiapas; Guatemala *Solaenogona*
- 2b. Anterior gonopod colpocoxites not as described above; usually with a single major branch (Figs. 184, 185) 3
- 3a. Anterior gonopod sterna with a pair of large projections (Fig. 416); most body segments with moderate paranota; Panama *Dybasia*
- 3b. Anterior gonopod sterna without processes, solidly joined to gonopod coxae (Figs. 184, 185) 4
- 4a. Posterior gonopod coxae elaborately lobed (Fig. 407), interlocking with simplified anterior gonopods; posterior gonopod sternum with a large knob (Fig. 402) *Tiganogona*
- 4b. Posterior gonopod coxae elongate, lobed (Fig. 199), but not to the extent as described above, not interlocking with anterior gonopods, which may be complex; posterior gonopod sternum without a knob (Fig. 199) *Cleidogona*

Genus *Pseudotremia* Cope

Pseudotremia Cope, 1869, Proc. Amer. Philos. Soc., 11: 179; Cook and Collins, 1895, Ann. New York Acad. Sci., 9: 34; Hoffman, 1950, J. Washington Acad. Sci., 40: 90; 1958, Proc. Biol. Soc. Washington, 71: 113-115; Chamberlin and Hoffman, 1958, Bull. U. S. Natl. Mus., 212: 94 (list of species).

Dearolfia Loomis, 1938, Bull. Mus. Comp. Zool., 86: 177.

Type species of *Pseudotremia*, *P. cavernarum* Cope, 1869, by monotypy; of *Dearolfia*, *D. lusciosa* Loomis, 1939, by monotypy. The meaning of the generic name *Pseudotremia* is apparently "false pore [*pseudo* + *trema* (pore, or hole)]" and may refer to Cope's mistaking the setal sockets for pores. The gender is feminine.

Diagnosis. The genus *Pseudotremia* is distinct from all but a few species of the Cleidogonidae in the tuberculate dorsum and the strong, rounded segmental shoulders on most species. The gonopods of the males bear a lateral branch on the colpocoxite, which carries a gland channel.

Description. Thirty segments. Mentum divided. Antennae long, article 3 or 5 the longest. Ocelli always present, though in many cases reduced in number (Figs. 36, 47), irregular in shape, and lacking pigment. Body fusiform, widest in males at segment 7, tapering evenly posteriorly. Segments with more or less prominent rounded shoulders (Fig. 6), sometimes raised above the level of the dorsum, usually most prominent on segments 7-15, divided by a diagonal depression. Surface of segments rarely smooth, variously rugose, knobbed or striate. Sides of segments with 5-15 lateral striations. Segmental setae not prominent, short and spatulate in troglolithic species, becoming prominent posteriorly in most other species. Pregonopodal legs of males: legs 1 and 2 6-segmented, reduced slightly in size, genital openings on coxae of second legs on slightly raised knobs. Legs 3 through 7 strongly crassate, prefemora and femora enlarged and slightly curved mesad, tarsi with special setae very prominent. Coxae of leg 7 especially enlarged, often with prominent posterior knobs. Anterior gonopods: highly modified (Figs. 1, 2). Sternum partially fused to coxae, extending between colpocoxites as weakly sclerotized membrane; deeply depressed laterally at spiracle. Coxae not fused in midline, cupped and setose laterally. Colpocoxites with two main branches; lateral branch thin, evenly curved, often divided, bearing gland channel; median branch thick anteriorly, bladelike posteriorly, posterior edge lacinate, sometimes with subapical spine. Telopodites fused at base to each other and to coxae, various median processes arising from base of telopodites and projecting between colpocoxites; telopodites usually mitten-shaped,

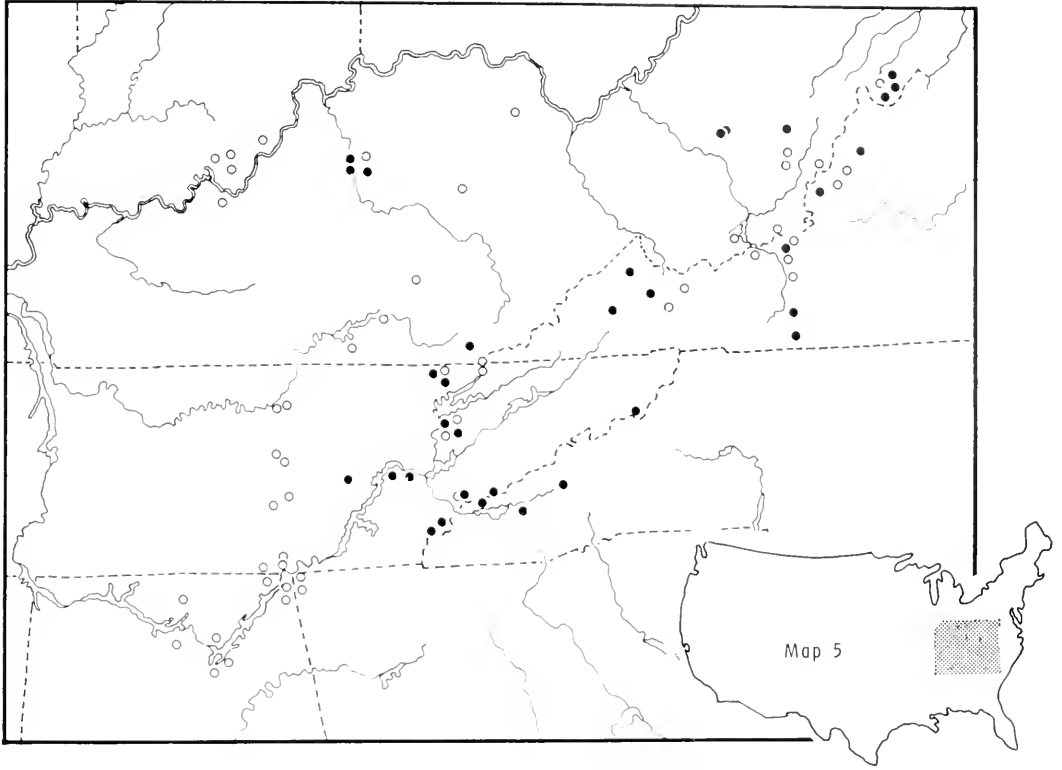

Map 5. Appalochian region, showing distribution of species of the genus *Pseudotremia*. Dots, epigeal records; circles, cave records. Only selected records for some species shown; some unidentifiable female and juvenile records also shown to give complete picture of distribution of genus.

curving anteroventrad. Posterior gonopods (Fig. 11): sternum bandlike, weakly sclerotized. Coxae enlarged, variously lobed; telopodites reduced, 4- to 2-segmented, claw always present. Tenth and eleventh legs with coxal glands. Tenth legs with more or less prominent knobs on coxal faces; eleventh legs with coxal knobs or hooks. Twelfth legs and sternum unmodified. Female cyphopods (Figs. 5, 16, 22) with valves flattened distally, fused proximally, often drawn out into processes and knobs, heavily setose. Postgenital plate always absent.

Distribution (See Map 5). Appalachian Mts. and interior foothills, frequently in caves, from southern Indiana through Tennessee to northeastern Alabama and northwestern Georgia, north through extreme

western North Carolina to western Virginia and Pendleton Co., West Virginia, west to central Kentucky. Reported once (Williams and Hefner, 1928) from Adams Co., Ohio.

Gonopod Anatomy of *Pseudotremia*

The gonopods of *Pseudotremia hobbsi* are typical of those found in other members of the genus *Pseudotremia*. The description below was prepared from material cleared in trypsin.

In anterior view (Fig. 1), a continuous sternal bar (*S*), strongly sclerotized, extends between the origins of the tracheal apodemes (*TA*). The gonopod coxae (*C*) are not fused to each other, nor are they in contact mesally; they articulate with the sternum by means of a clasplike mechanism (*A*, Fig. 4) into which a projection

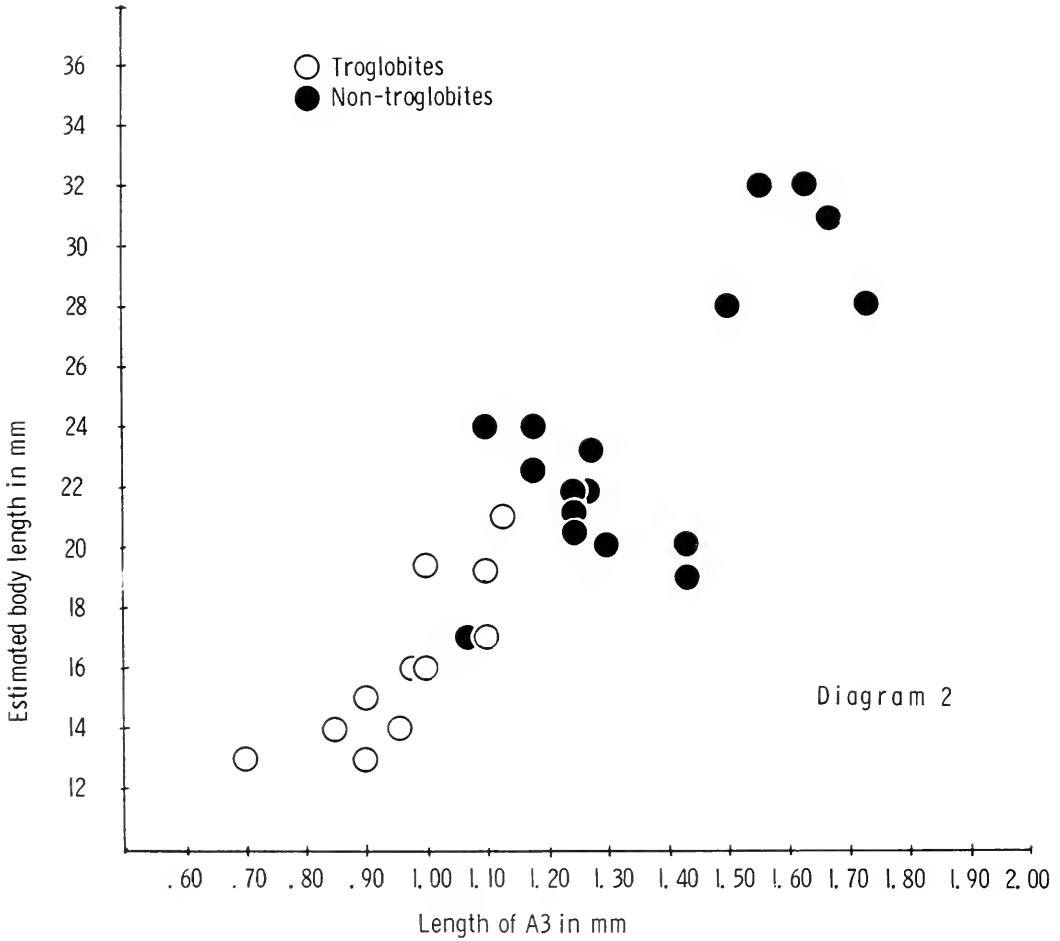

Diagram 2. Graph showing relationship between estimated body length and length of antennal segment three (A3) in holotypes of selected species of *Pseudotremia*.

from the sternum (*B*) inserts. Near the origin of the colpocoxites (*CC*) is an anteriorly projecting coxal knob (*CK*), which, as in *Cleidogona*, receives strong muscles from the tracheal apodeme of the opposite side. The colpocoxites (*CC*) are composed of a bladelike, curved lateral branch (*LB*) that in most species is forked, or bears a ventral tooth (*VB*). A gland channel (*G*) follows the dorsal part of the lateral branch. The mesal branch (*MB*) is thickened along the anterior margin, but tapers posteriorly to a thin, laciniate edge. Most species bear a subapical spine (*SA*),

which in *hobbsi* is unusually long, and extends straight ventrad. The origin of the intergonopodal sclerite (*IGS*) is obscure. In uncleared preparations, it is more or less solidly fused to the bases of the telopodites. In *P. hobbsi*, as in many other species, it bears a process that is of considerable taxonomic value. The telopodites (*T*) are fused basally and bear a large knob. In all known species but one, they are similarly mitten-shaped, though their size varies considerably. In posterior view (Fig. 2), little more is revealed. Here it can be seen that the sternum is incomplete posteriorly,

as in *Cleidogona*, but a lateral sternal sclerite is not definitely set off. Finally, in a slightly dorsal view of the base of a gonopod coxa (Fig. 3), the gland channel (GC) can be seen to begin in a definite internal pore (P).

There is surprisingly little variation in overall plan in the gonopods of species of *Pseudotremia*. In extreme troglobites (*P. cercops*, Fig. 81; *P. nodosa*, Fig. 70), everything is much simplified. In *P. sublevis* (Fig. 168), the ventral part of the lateral branch of the colpocoxite is very large, and the mesal branch reduced in size. In *P. stupefactor*, (Fig. 27), the telopodites are enormously enlarged and cover the remainder of the gonopods.

Cyphopod Anatomy of *Pseudotremia*

The cyphopods of female millipeds are cuticular specializations surrounding the pores of the oviducts, and are located posterior to the coxae of the second legs (Fig. 7). In *Pseudotremia hobbsi*, most features of taxonomic importance, especially the general shape of the organs, are visible without special treatment. After clearing in trypsin, however, several interesting structures come to light. The coxae (C) and sternum (S) of the second legs (Fig. 5) surround the cyphopods anteriorly. The coxae of the third legs are not strongly modified, but only shallowly excavate on their anterior faces. Each cyphopod is composed of four main parts. The valves are posteriormost and are fused dorsally, though in some cases (*P. letho*, Fig. 7) the fusion is nearly complete ventrally as well. The mesal valve (MV) is usually the longest, the lateral valve (LV) the broadest. In the groove between the valves, the sinuous seminal receptacle can be seen. Anteriorly, the unfused portions of the valves are capped by the receptacle (R), which in *P. hobbsi* bears a series of processes that may lock the subapical spine of the gonopod in place during copulation. Posterior to the receptacle and surrounding the actual oviduct pore (O) are two

pairs of sclerotized bars that cannot be seen in uncleared material. These post-receptacular bars (PB) were noticed by Buckett and Gardner (1967) in *Idagona westcotti*, but are not shown in any of the many European chordeumids illustrated by Bröleman (1935). In reality, the valves and receptacle of *Pseudotremia* cyphopods are heavily setose. These setae have been omitted for clarity in the drawings presented here, and in those that follow in the taxonomic part.

Species Characters and Evolution of Gonopods in *Pseudotremia*

It is difficult at this time to make any definite statements about the possible course of gonopod evolution in the genus *Pseudotremia*. Little is known of the functional significance of various features, and many species remain to be discovered and described. The present total of 36 species presents a complex array of gonopod types, some few of which (*P. stupefactor*, Fig. 28; *P. sublevis*, Fig. 169) seem quite unrelated to the others.

However, a few general statements can be made. The size of the gonopods is usually in keeping with the size of the animals—no small species have greatly enlarged gonopods and no large ones have unusually small gonopods. In general, the most complex kinds of gonopods are found in the largest (and usually) epigeal species; the smallest and simplest gonopods are to be found in the smallest and most highly specialized troglobites.

Some features of the gonopods seem more subject to variation than others. In *P. hobbsi*, three distinct forms of lateral branch of the colpocoxite are found in three different localities, but the variation is only in the relative sizes of the branches (Figs. 163–165). In most cases, the presence or absence of a division in the lateral branch of the colpocoxite is a good species character, but it is probably subject to varying selection pressures; in *P. carterensis* (Fig. 141) the ventral part is reduced

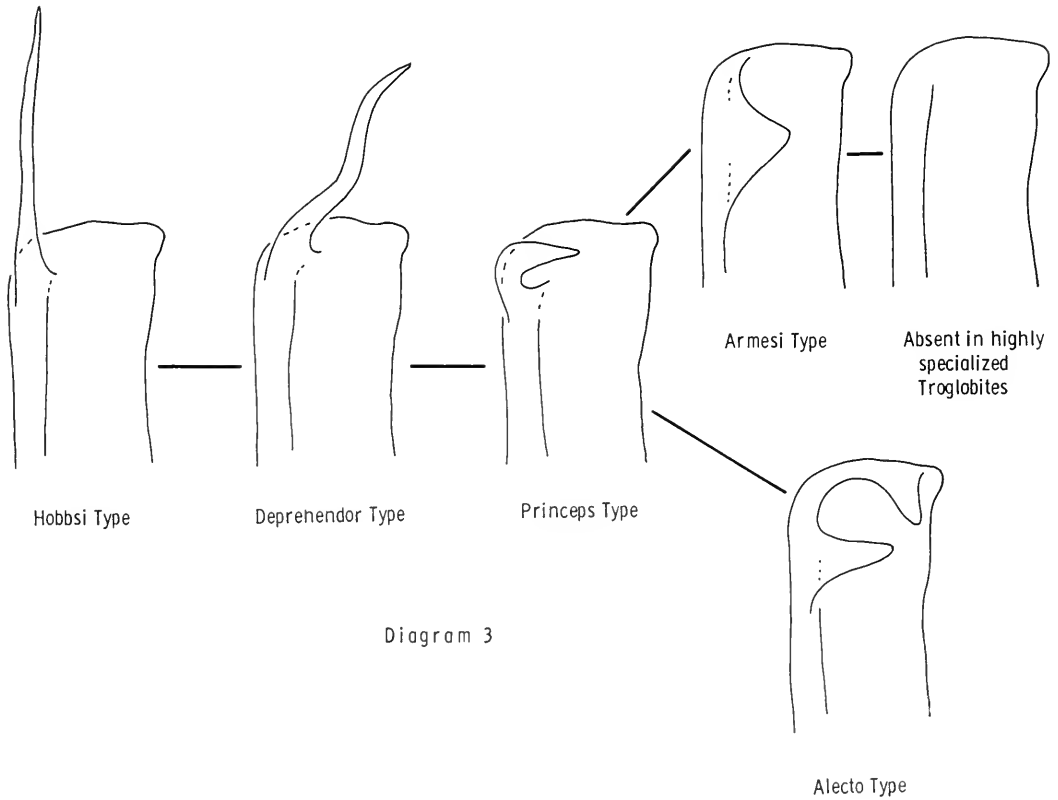

Diagram 3. Types of subapical spines on median colpocoxites of gonopods of *Pseudotremia* species. Heavy lines indicate hypothetical relationships but do not imply direction of evolution.

to a small tooth. There seems to be a tendency for branching to be suppressed. In trogllobites with simplified gonopods (*e. g.*, *P. lictor*, Fig. 86) the lateral branch of the colpocoxite is always simple. However, *P. sublevis* (Fig. 168) has the ventral branch of the lateral colpocoxite enormously enlarged.

The relative size of the telopodites in comparison with the colpocoxites is also variable, with a tendency for larger telopodites to occur in species in which the colpocoxites are less complex. *Pseudotremia stupefactor* (Figs. 27, 28) has the telopodites greatly expanded and curving over to cover the colpocoxites. I cannot even guess at the functional significance of this modification; the telopodites are not movable. But in general, the telopodites

do not provide many good taxonomic characters.

The subapical spine of the mesal colpocoxite is absent in trogllobites with simplified gonopods, but is also absent in many epigeic species with otherwise complicated gonopods. A number of types can be discerned in species where this spine is present. In *P. hobbsi* (Figs. 1, 2) the spine is extremely long and may be a locking device that fits into prongs on the cyphopod receptacle during mating. This *hobbsi* type grades into a form that is likewise long, but curved, that may be termed the *deprehendor* type (*P. depressendor*, Fig. 145). Most common is the *princeps* type, in which the spine is short and very distinctly bent mesad (*P. princeps*, Fig. 148); the *armesi* type, in

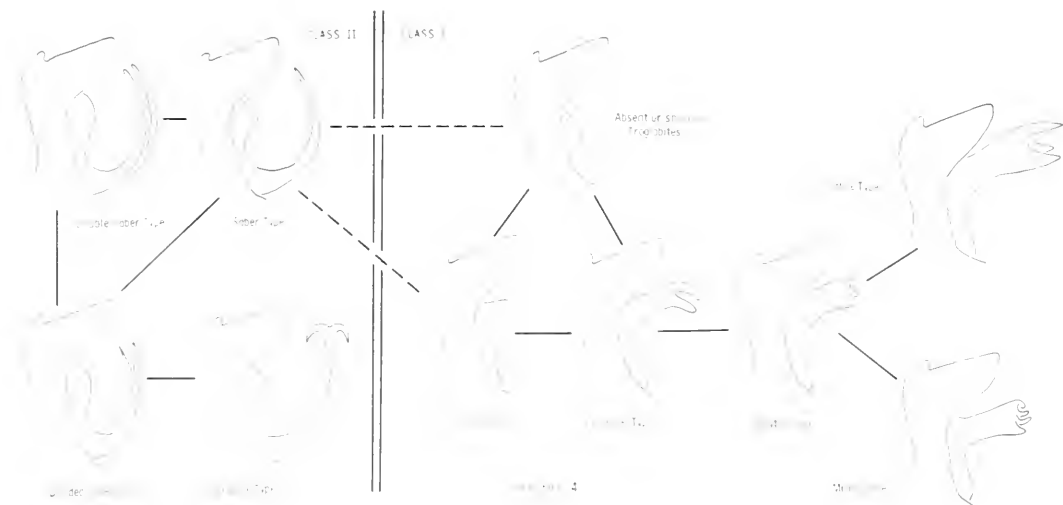

Diagram 4. Classes and types of telopodite processes of gonopods of *Pseudotremia* species. Heavy lines indicate hypothetical relationships, dashed lines more speculative ones; neither kind of line implies direction of evolution. Double line is artificial division between Classes I and II.

which the spine occurs only as a triangular lamella (*P. arnesi*, Fig. 118), and the *alecto* type (*P. alecto*, Figs. 122, 123), in which a distinct excavation above the spine gives the impression of a forcepslike apparatus, may be only subtypes of the *princeps* group. It is once again difficult to suggest in which direction this character is evolving, towards loss of the spine or towards its hypertrophy, but some possible relationships are summarized in Diagram 3. The absence of this spine, or its form when present, are good species characters.

The telopodite process is an extremely important taxonomic character, since it is rarely alike in two species. Once again, the process is absent in extreme trogllobites. There is some individual variation in species that are widespread enough to slow down or limit gene flow between populations; two forms (Figs. 103, 104) occur in *P. cottus*. Telopodite processes are divisible into two large categories. In the first class, the process arises from the bases of the telopodites and projects straight anteriorly from the notch between them (*Class I*, Diag. 4). In the second, the

process begins near the notch as a more or less well-developed knob, but then curves dorsad between the coxae (*Class II*, Diag. 4).

Five smaller groups can be recognized within the first class. The simple type consists of a short undivided knob or a broadly flattened lamella (*P. spira*, Fig. 44). In the *eburnea* type, the knob is divided at the apex (*P. rhadamanthus*, Fig. 54). In two types, the apical part of the process is divided into three branches; these branches are blunt in the *cocytus* type (*P. cocytus*, Fig. 99), and much larger and pointed in the *cottus* type (*P. cottus*, Fig. 103). The *minos* type occurs only in *P. minos* (Fig. 95) and seems to be a development from one of the two preceding kinds. Diagram 4 summarizes the forms of these processes and presents some ideas on their possible relationships. Geographically, with the exception of the two three-pronged kinds, the different ones seem at present to be distributed at random.

Under the second class, four basic types are clearly separable. In the *saber* type, the process is single and uniformly curved (*P. fulgida*, Fig. 135). The *divided saber*

type (*P. merops*, Fig. 31) is split at the tip, and the double saber type is completely divided (*P. deprehendor*, Fig. 145). The relationships of the grapple type are obscure (*P. indianae*, Fig. 18), but it probably represents a specialization of the divided saber type. The groups are not coherent geographically, but there is a tendency for the various types of Class II to occur in the northern part of the range of *Pseudotremia*. Diagram 4 represents a summary of the above information.

The trend in the evolution of the posterior gonopods is obvious; they are becoming progressively reduced in size and number of segments. In the simplest forms (*P. lictor*, Fig. 87), only two segments are movable with respect to each other; the apical three segments do not have joints between them. However, the claw is present in all species. The form of the posterior gonopods can be useful in separating species, but breaks down when species are closely related.

No particular evolutionary changes can be discerned at this time in the cyphopods. Because of their greater simplicity and variability (see Figs. 21–23, 106–109, 138–140), they are of less use than the gonopods in taxonomy. Females are not known for many previously described species, and thus I have not attempted to give names to females not associated with males.

Finally, an unusual feature of *Pseudotremia* among chordeumids is the usefulness of some nonsexual characters in separating species. The degree and pattern of dorsal tuberculation ranges from only a few low rugae to 40 or more well-defined nodules on each segment. The relative size of the segmental shoulders is also a good character; some species are more like *Cleidogona*, with low swellings, while others have the dorsum nearly flat, owing to the high shoulders. The shoulders generally become less prominent on posterior segments, and the point at which they are reduced to the level of the lateral striae is of taxonomic value. The number and dis-

tinctness of the lateral striae is of lesser importance.

Body length is of limited value, and difficult to measure consistently, owing to telescoping and/or coiling of the body. The lengths given for each species below are thus approximate. The length of the third antennal segment (A3) is correlated with body length (Diag. 2), and thus is given for the types of each species. Troglotic species (open symbols, Diag. 2) do not appear to have this segment longer in relation to body length than do epigeal ones.

KEY TO MALES OF *PSEUDOTREMIA* SPECIES

- 1a. Telopodites greatly enlarged, arching over and covering colpocoxites, nearly touching sternum in front (Figs. 27, 28); north-central Kentucky ... *stupefactor*
- 1b. Telopodites usually smaller than or subequal to colpocoxites 2
- 2a. Lateral branch of colpocoxite divided ... 3
- 2b. Lateral branch of colpocoxite not divided 21
- 3a. Subapical spine of median colpocoxite absent 4
- 3b. Subapical spine of median colpocoxite present, or a small triangular lamella present on mesal subapical edge of median branch 9
- 4a. Telopodite process absent or almost so; troglotic; Jackson Co., Tenn. *lethe*
- 4b. Telopodite process present, of various forms 5
- 5a. Telopodite process grapplelike; ventral branch of lateral colpocoxite very long (Fig. 110); Tazewell Co., Va. ... *tuberculata*
- 5b. Telopodite process not as above 6
- 6a. Telopodite process small, saberlike; ventral branch of lateral colpocoxite large, broad, L-shaped (Fig. 168); median colpocoxite reduced; Giles Co., Va. *sublevis*
- 6b. Telopodite process not as above 7
- 7a. Telopodite process blunt, apically cleft (Fig. 50); troglotic; Van Buren and Warren Cos., Tenn. *acheron*
- 7b. Telopodite process divided into three short branches (Figs. 99, 103, 104); not troglotic; large pigmented species 8
- 8a. Telopodite process relatively small (Fig. 99), branches blunt; Anderson Co., Tenn. *cocytus*
- 8b. Telopodite process very large (Fig. 104); branches pointed; several counties in east Tennessee (Map 7) *cottus*

- 9a. Telopodite process absent or a small knob 10
- 9b. Telopodite process present, or other than a knob 11
- 10a. Telopodite process absent; lateral branch of colpocoxite narrow (Fig. 59); about 14 ocelli; western North Carolina *soco*
- 10b. Telopodite process a small knob, lateral branch of colpocoxite broad (Fig. 148); about 20 ocelli; Pendleton Co., W. Va. *princeps*
- 11a. Telopodite process of the saberlike type, split at the tip (Fig. 9), single (Fig. 135) or double (Fig. 145), or grapplelike (Fig. 18) 12
- 11b. Telopodite process not of the saberlike form, blunt (Figs. 63, 89) 20
- 12a. Telopodite process grapplelike (Fig. 18) 13
- 12b. Telopodite process otherwise 15
- 13a. Median colpocoxites strongly decurved (Fig. 115); Smyth and Bland Cos., Va. *momus*
- 13b. Median colpocoxite erect 14
- 14a. Dorsum with numerous small, well-defined tubercles; 13-17 ocelli; usually not pigmented; caves in southern Indiana *indianae*
- 14b. Dorsum with several strong rugae; 19-21 ocelli; pigmented; Mercer Co., W. Va. *armesi*
- 15a. Telopodite process saberlike, apically divided 16
- 15b. Telopodite process saberlike, not divided 17
- 16a. About 12 ocelli; Clark Co., Ind. *nefanda*
- 16b. About 19-20 ocelli; Alleghany Co., Va. *alecto*
- 17a. Not pigmented; dorsum heavily knobbed; about 14 ocelli; Meade Co., Ky. *amphiorax*
- 17b. Pigmented; dorsum nearly smooth; ocelli usually more than 15 18
- 18a. 20-24 ocelli; body 30 mm long or longer 19
- 18b. 15-17 ocelli; body length rarely more than 25 mm *cavernarum*
- 19a. Smaller branch of lateral colpocoxite recurved (Fig. 152); Pocahontas Co., W. Va. *tsuga*
- 19b. Smaller branch of lateral colpocoxite not recurved (Figs. 163-165); eastern West Virginia and adjacent Virginia (Map 8) *hobbsi*
- 20a. Telopodite process with two blunt lobes (Figs. 63, 64); about 12 ocelli; tuberculation of dorsum weak; Dade Co., Ga. *eburnea*
- 20b. Telopodite process with three blunt lobes (Fig. 90); 25-30 ocelli; dorsum of each segment with 30-40 prominent tubercles; Scott Co., Tenn. *scrutorum*
- 21a. Subapical spine of median branch of colpocoxite absent 22
- 21b. Subapical spine of median branch of colpocoxite present, or a small triangular lamella present on mesal subapical margin of median branch 27
- 22a. Telopodite process a large, saberlike spine, single (Fig. 135) or double (Fig. 31), extending between coxae 23
- 22b. Telopodite process a blunt knob, or absent 24
- 23a. Telopodite process single (Fig. 135); body nearly smooth dorsally; 5-7 ocelli; Greenbriar Co., W. Va. *fulgida*
- 23b. Telopodite process double (Fig. 31); body with 30-40 strong dorsal knobs per segment; about 12 ocelli; Adair Co., Ky. *merops*
- 24a. Telopodite process knoblike; median colpocoxites sharply turned outward, lateral colpocoxites spiral in anterior view (Fig. 14); Pulaski Co., Ky. *spira*
- 24b. Telopodite process absent; colpocoxites short, simple 25
- 25a. About 12 ocelli; segmental shoulders very high, 4-5 strong knobs per segment on dorsum (Fig. 6); Marshall Co., Alabama *nyx*
- 25b. Less than 8 ocelli; segmental shoulders low 26
- 26a. Gonopods as in Fig. 81; dorsal tubercles inconspicuous; DeKalb Co., Tenn. *cercops*
- 26b. Gonopods as in Fig. 85; 12-15 large tubercles per segment; DeKalb Co., Tenn. *lictor*
- 27a. Subapical spine of median colpocoxite in the form of a triangular lamella (Fig. 66) 28
- 27b. Subapical spine of median colpocoxite in the form of an acuminate spine (Fig. 128) 29
- 28a. About 16 ocelli; segmental shoulders of moderate size; Dade Co., Georgia *acacus*
- 28b. Eight to 11 ocelli; segmental shoulders low; Claiborne Co., Tenn. *nodosa*
- 29a. Telopodite process absent 30
- 29b. Telopodite process of various forms 32
- 30a. Adult males less than 25 mm long 31
- 30b. Adult males 30 mm long or more *simulans*
- 31a. Pigmented animals, 20-22 ocelli; Claiborne Co., Tenn. *valga*
- 31b. Colorless animals, 7-9 ocelli; Rockcastle Co., Kentucky *unca*
- 32a. Telopodite process saberlike, single (Fig. 141) or double (Fig. 145) 33
- 32b. Telopodite process a knob with 4 short spines (Fig. 95); Jackson Co., Ala. *minos*

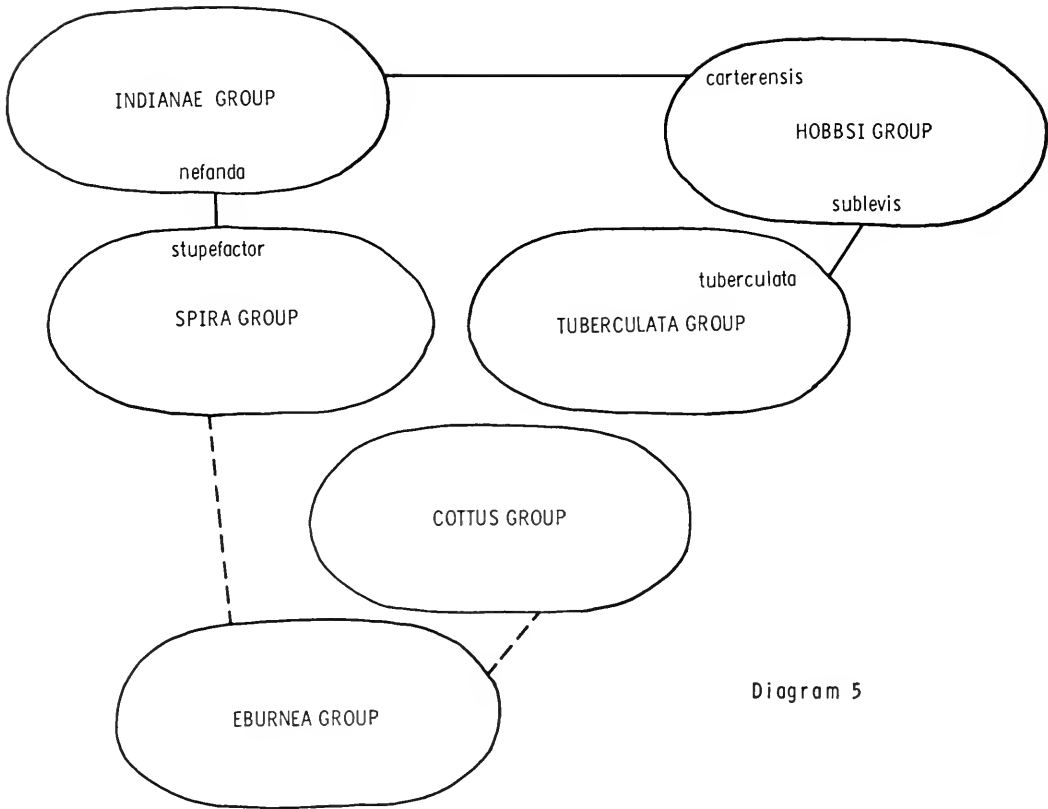

Diagram 5

Diagram 5. Possible relationships between species groups of *Pseudotremia*. Species that give good evidence for this arrangement are named close to lines connecting groups; lines do not imply direction of evolution. Species groups arranged in this diagram roughly as they are distributed geographically; compare Map 5.

- 33a. Telopodite process of the double saber type (Fig. 145); Anderson Co., Tenn. *deprehendor*
- 33b. Telopodite process a single saber 34
- 34a. Eighteen to 20 ocelli; gonopods as in Fig. 141; Carter Co., Ky. *carterensis*
- 34b. Five to 8 ocelli; gonopods as in Figs. 125, 126; Pendleton Co., W. Va. *lusciosa*

Species Groups in *Pseudotremia*

The arrangement of the species discussed here is admittedly a somewhat artificial one. As I have already mentioned, there are many species as yet undiscovered and undescribed; perhaps they will later fill gaps that will make possible more natural groupings. The species groups I propose are based on a combination of morpho-

logical evidence (mostly drawn from male gonopods) and geographical distribution. *Pseudotremia carterensis* and *P. depressendor*, for example, are placed in the *hobbsi*-group, but are widely separated from the other species of the group geographically.

The arrangement of species into groups that are more or less coherent geographically and perhaps phylogenetically related makes it possible to compare each species only with those closest to it in the species diagnoses given below.

The relationships between groups expressed in Diagram 5 is likewise speculative, and is based on evidence presented in the species descriptions below.

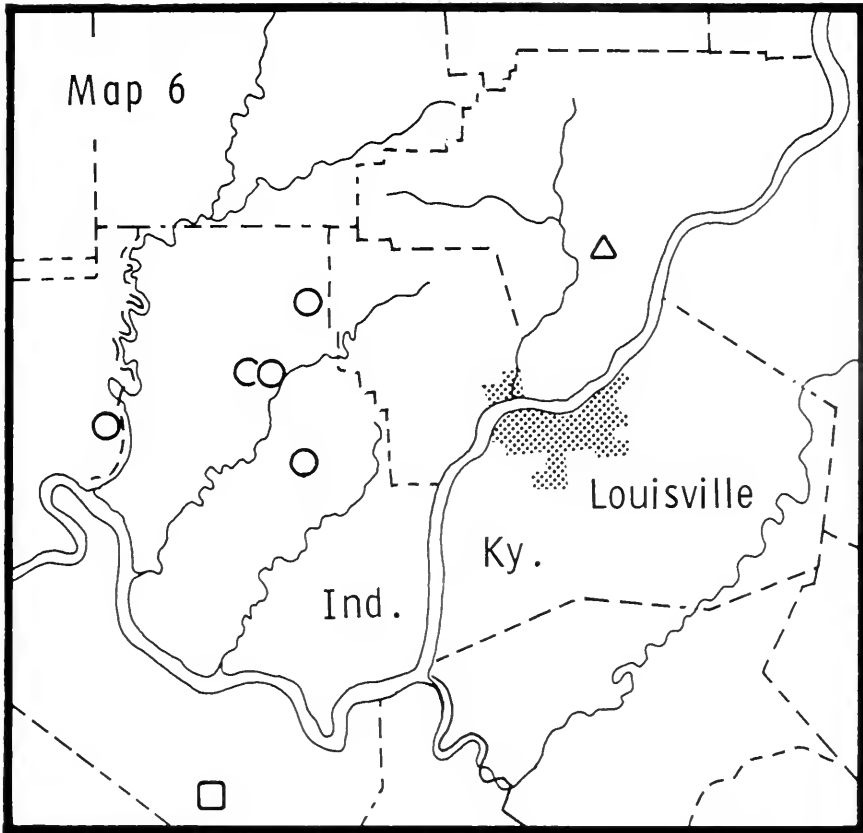

Map 6. Parts of Indiana and Kentucky, showing distribution of species of the genus *Pseudotremia*. Circles, *P. indianae*; triangle, *P. nefanda* type locality; square, *P. amphiorax* type locality

THE INDIANAE GROUP

The three species of this group occur in southern Indiana and adjacent Kentucky (Map 6). All have divided lateral colpocoxites and a spine on the median colpocoxite. The form of the telopodite process is variable. All lack pigment to some degree, with the ocelli reduced in number; they are known only from caves.

Pseudotremia nefanda n. sp.

Figures 8–12, Map 6

Types. Male holotype, female paratype and several other specimens of both sexes from Indian Cave, 0.7 mi. west of Charleston, Clark Co., Indiana, collected 26 Janu-

ary 1957, by T. C. Barr. The specific name is an adjective, meaning "confusing."

Diagnosis. Distinct from all other members of the *indianae*-group in the apically divided saberlike telopodite process, and in having slight pigmentation. The dorsum is not as knobby as in *P. amphiorax*, but slightly more so than in *P. indianae*.

Description of male holotype. Length, 15 mm, A3 = 1.08 mm. Ocelli irregular in shape and arrangement, 16 on either side, only partly pigmented. Coloration pale brown, vaguely marked darker purplish brown anteriorly. Segmental shoulders low, reduced to level of lateral striae about segment 15; dorsum moderately strongly tuberculate, rugae and knobs well defined

on posterior segments. Lateral striae prominent, 10–12 on midbody segments. Anterior gonopods: median colpocoxite with subapical spine (Figs. 8, 9), secondary spine projecting laterad from base of subapical spine; lateral colpocoxite short, simply curved, apically divided (Fig. 10), gland channel becoming obscure before division. Telopodite process short, curved dorsad, then slightly ventrad, apically cleft (Fig. 8). Telopodites as usual for the genus, but quite large, curving strongly anteriorly. Posterior gonopods: coxa deeply excavate (Fig. 11), second article as long as coxa, 3 distal articles as usual, not conspicuously reduced.

Description of female paratype. Length, 14 mm, $A_3 = 1.06$ mm. Other nonsexual characters as described for male. Cyphopods (Fig. 12): mesal valve narrow, elongate, lateral valve anteriorly lobed, wide; valves well separated.

Distribution. Known only from the type locality.

Pseudotremia amphiorax n. sp.

Figures 13–16, Map 6

Types. Male holotype, female paratype and several other specimens of both sexes from Sig Shacklett's Cave, 3 mi. north of Big Spring, 1.25 mi. north of Maples Corner, Meade Co., Indiana, collected 13 July 1957 by T. C. Barr. The specific name is a noun in apposition, the name of an argonaut and soothsayer.

Diagnosis. Distinct from the other species of the *indianae*-group in the short, undivided saberlike form of the telopodite process and the extremely rough dorsum. The posterior gonopods are also much smaller than in the other species.

Description of male holotype. Length, 15 mm, $A_3 = 0.90$ mm. Ocelli irregular in shape and distribution, not pigmented, 14 on left side, 15 on right side. Body lacking pigment. Segmental shoulders moderately high, reduced to level of lateral striae by segments 12–14; dorsum extremely rough, especially on posterior segments, about 30

prominent discrete tubercles on each midbody segment. Lateral striae strong, 9–10. Anterior gonopods: median colpocoxite with sharply recurved subapical spine (Fig. 15) broad at base, not branching from median colpocoxite until about one-half length of median colpocoxite, branches diverging at nearly right angles, ventral branch curved ventrad, then mesad, gland channel following shorter dorsal branch. Telopodite process short, curved, acuminate. Telopodites (Fig. 14) large, fused for most of their length, slightly curved anteriorly. Posterior gonopods (Fig. 15): small, coxae deeply excavate mesally and lobed, second article somewhat longer than coxae, 3 apical articles greatly reduced.

Description of female paratype. Length, 15 mm, $A_3 = 0.93$ mm. Nonsexual characters as in male. Cyphopods (Fig. 16) with lateral valve small, unmodified; median valve with distal processes.

Distribution. Known only from the type locality.

Pseudotremia indianae Chamberlin and Hoffman

Figures 17–24, Map 6

Pseudotremia cavernarum, Cook and Collins, 1895, *Ann. New York Acad. Sci.*, 9: 36–39, figs. 2–7, ♂. Not *P. cavernarum* Cope.

Pseudotremia indianae Chamberlin and Hoffman, 1958, *Bull. U. S. Nat. Mus.*, 212: 95. New name for Cook and Collins' specimens of *P. cavernarum*.

Types. According to Chamberlin and Hoffman (1958) the types of *P. indianae* are in the U. S. National Museum. They could not be located. The specimens described below were compared to a series of badly preserved specimens in the MCZ, collected at the type locality (Wyandotte Cave, Crawford Co., Indiana) by E. D. Cope in 1885, and found to be conspecific with them.

Description of male from King's Cave. Length, 17 mm, $A_3 = 1.05$ mm. Ocelli 15 on both sides, irregularly arranged, not pigmented. Body not pigmented. Segmental shoulders strong, reduced to level

of lateral striae on segments 20–22; dorsum heavily tuberculate, about 25 low knobs per midbody segment; lateral striae 10–13. Anterior gonopods: median colpocoxite (Fig. 18) with subapical spine directed sharply dorsad and anteriorly; lateral colpocoxite (Figs. 18, 19) divided, branches diverging at less than right angle, path of gland channel becoming obscure near branching point. Telopodite process (Figs. 17, 18) extremely large, curving in an arc of a circle between, then above, colpocoxites of each side, divided apically, divisions recurved, forming a grapplelike structure. Telopodites (Fig. 17) of moderate size. Posterior gonopods (Fig. 20) similar to those of *nefanda*.

Description of female from King's Cave. Length, 17.5 mm. A3 = 1.00 mm. Non-sexual characters as in male, but most females have slightly more (17–20) ocelli. Cyphopods (Fig. 21) similar to those of *nefanda*.

Distribution. Southern Indiana, in caves (Map 6). The following specimens were examined: INDIANA: *Crawford Co.*, Wyandotte Cave, E. D. Cope, 1855, ♂♂ ♀♀; *Harrison Co.*, Byrnes Cave, 1 mi. east of New Salisbury, T. C. Barr, 4 August 1957, ♂♂, juveniles; Steersetter Cave, 0.5 mi. east of Salisbury, T. C. Barr, 4 August 1957, ♂♂ ♀♀; Bevin Cave, 1 mi. north of Byrnesville, T. C. Barr, 4 August 1957, ♂♂ ♀♀; King's Cave, 3.5 mi. east of Corydon, 17 August 1957, T. C. Barr, ♂♂ ♀♀; L. Hubricht, 12 August 1957, ♂♂ ♀♀.

Notes. The number of ocelli in males varies from 14–19, average 15; females have 17–20 ocelli, average 19. There is little discernible variation in the male gonopods from the localities listed above, but the female cyphopods are somewhat variable; compare Figures 21–23. The confusion of Cook and Collins (1895) as to the identity of *Pseudotremia* from Indiana caves was engendered by Cope and Packard, who labelled all troglobitic specimens of *Pseudotremia* as *cavernarum*. Cope's original collection of *cavernarum* from Er-

harts Cave, Montgomery County, Virginia, was not available to Cook and Collins, but Hoffman (1958) showed that the species found at the type locality of *cavernarum* is not the same as the species in Wyandotte Cave, Indiana, source of Cook and Collins' material. See further discussions under *P. cavernarum* and *P. carterensis*.

THE SPIRA GROUP

This group of troglobitic, troglomorphic and epigeic species occurs in both the Bluegrass and Cumberland Rim karst regions. Morphologically, the group is a heterogeneous one, including species with and without subapical spines on the median colpocoxites, and with divided and entire lateral colpocoxites. The telopodite process is either absent, present as a small knob, or as a divided saber. The affinities of the group are clearly with the *indianae*-group, and I think that when the list of species included is more complete, the groups may be combined. *Pseudotremia merops* has a divided saberlike telopodite process like that of *P. nefanda* of the *indianae*-group. The larger-than-normal telopodites of *nefanda* and *amphiorax* of the *indianae*-group may indicate affinities with the peculiar *P. stupefactor* of the *spira*-group.

Species of the *spira*-group resemble each other only in general gonopod morphology and geographic distribution; this group may prove to be the most unnatural of all.

Pseudotremia valga Loomis

Figures 24–26

Pseudotremia valga Loomis, 1943, Bull. Mus. Comp. Zool., 92: 377–378, figs. 2a–c, ♂.

Types. Male holotype from King Solomon's Cave, Cumberland Gap, Claiborne Co., Tennessee, collected 26 July 1924 by G. P. Englehardt, in MCZ, examined. King Solomon's Cave is not listed in *Caves of Tennessee* (Barr, 1961). *Caves of Virginia* (Douglas, 1964: 318) states

that Cudjo's Cave, Cumberland Gap, Virginia, was at one time known as King Solomon's Cave. The town of Cumberland Gap is in Virginia. Thus I believe the type locality is probably Cudjo's Cave, Cumberland Gap, Lee Co., Virginia. The specific name is a Latin adjective, meaning "bow-legged."

Diagnosis. The median colpocoxites are widely separated at the base and curve sharply mesad; in all other species of the *spira*-group they are nearly parallel.

Description of male holotype. Length, 22 mm, A3 = 1.14 mm. Ocelli regular in size, pigmented, 20 on left side, 22 on right, in 6 rows forming triangular eye-patch. Coloration medium brown, marked darker purplish brown, especially on anterior segments. Segmental shoulders strong, reduced to level of lateral striae about segments 20–23; dorsum nearly smooth anteriorly, weakly rugose on midbody segments, posterior segments with posterior rows of 6–8 moderate tubercles; lateral striae prominent, 10–13. Anterior gonopods: median colpocoxite (Fig. 24) with strong subapical spine directed mesad; lateral colpocoxite (Fig. 25) broad, divided at apex, divisions subequal, curved mesad, meeting those of other side in midline. Telopodite process absent. Telopodites (Figs. 24, 25) broad, slightly curved. Posterior gonopods (Fig. 26) with second segment slightly longer than coxa, 3 apical segments as usual in larger species.

Distribution. Known only from the type locality, but undoubtedly occurs in other caves in the vicinity. The limestone stratum in which the type cave is located extends unbroken northward to the head of the Powell River valley and southwestward from there to near Sunbright, Va. (Douglas, 1964: 319).

Notes. Loomis (1943) had females available when the species was described, but their present whereabouts are unknown. In addition to the holotype, I examined a male collected at the type locality by T. C. Barr, 5 July 1958.

Pseudotremia stupefactor n. sp.

Figures 27–30

Types. Male holotype from cedar woods at Camp Nelson, Jessamine Co., Kentucky, collected 30 May 1958 by Leslie Hubricht; female paratype from Bowen Cave, 1 mi. northeast of Slade, Powell Co., Kentucky, collected with a male and other females 31 August 1957 by Leslie Hubricht. The specific name is a Latin noun in apposition, meaning "one who astonishes."

Diagnosis. Easily separated from any other known species of *Pseudotremia* by the enormous telopodites of the gonopods, which curve antieriad to cover the colpocoxites. Females have the median valve of the cyphopods very long.

Description of male holotype. Length, 21 mm, A3 = 1.17 mm. Twenty ocelli on both sides of head in 5 regular rows forming triangular ocellarium. Body gray-brown, weakly marked darker brown. Segmental shoulders moderate, reduced to level of lateral striae on segments 26; dorsum nearly smooth, with few weak rugae; lateral striae moderate, 9–14. Anterior gonopods: median colpocoxite with subapical spine directed antieriad (Fig. 27); lateral colpocoxite simple, evenly curved, not divided (Fig. 28). Telopodite process (Fig. 28) a small knob. Telopodites (Figs. 27, 28) enormously enlarged, curved sharply antieriad at an acute angle, covering colpocoxites, slightly recurved at tips, apparently not movable. Posterior gonopods (Fig. 29) typical, but coxae rather slender.

Description of female paratype. Length 22 mm, A3 = 1.19 mm. Nonsexual characters as in male. Cyphopods (Fig. 30) with median valve greatly elongated, almost acuminate posteriorly.

Distribution. In addition to the type and paratype localities, I examined the following specimens: KENTUCKY: *Anderson Co.*, Kentucky R. bluffs north of Tyrone, collector and date not given, ♀♀; *Mercer Co.*, Kentucky R. bluffs north and east of Shakertown, collector and date not given, ♀.

Pseudotremia merops n. sp.

Figures 31–35

Types. Male holotype and female paratype from Saltpetre Cave, 1 mi. northeast of Breeding, Adair Co., Kentucky, collected 3 August 1957 by L. Hubricht. The specific name is a noun in apposition, the name of a famous seer and soothsayer.

Diagnosis. No other *Pseudotremia* species has a divided saber-type telopodite process and colpocoxites without modification (Figs. 31, 32).

Description of male holotype. Length, 24 mm, A3 = 1.26 mm. Ocelli 12 on either side of head, irregularly arranged, weakly pigmented. Coloration typical purplish gray-brown, marked darker. Segmental shoulders large and prominent, reduced to level of lateral striae about segment 20; dorsum strongly knobbed, about 30 well-defined tubercles per segment; lateral striae vague, about 12 per segment on each side. Anterior gonopods: median colpocoxite (Fig. 31) large, upright, without subapical spine; lateral colpocoxite much shorter (Figs. 31, 32), evenly curved, entire. Telopodite process (Figs. 31, 33) short, curved ventrad, divided saber type. Telopodites (Fig. 31) widely diverging, smaller than colpocoxites. Posterior gonopods (Fig. 35) as usual.

Description of female paratype. Length, 25 mm, A3 = 1.25 mm. Nonsexual characters as in male. Cyphopods (Fig. 34) with lateral valve the largest, broadened and ventrally flattened.

Distribution. Known only from type locality.

Pseudotremia unca n. sp.

Figures 36–43

Types. Male holotype, female paratype and a second female from Great Saltpetre Cave, 4.6 mi. north of Livingston, Rockcastle Co., Kentucky, collected 15 December 1956 by T. C. Barr. The specific name is a Latin adjective, meaning "elbowed."

Diagnosis. Differs from *P. valga* in hav-

ing undivided lateral colpocoxites; from the other species of the group in the sharp distal bend in the median colpocoxites and the small telopodites.

Description of male holotype. Length, 14 mm, A3 = 0.85 mm. Ocelli 7 on left side, 8 on right side (Fig. 36), irregular in shape and arrangement, without pigment. Body colorless. Segmental shoulders weak, body nearly cylindrical, shoulders reduced to level of lateral striae on segments 18–20; dorsal tubercles low, but distinct, about 20 per midbody segment; lateral striae moderate, 10–12. Body setae of anterior segments (Fig. 40) strongly clavate, becoming longer on posterior segments (Fig. 41). Anterior gonopods: median colpocoxites widely separated, gradually curving mesad, then sharply elbowed laterad, subapical spine attached to posterior margin instead of anterior (Fig. 37); lateral colpocoxites long, thin, entire (Figs. 37, 38). Telopodite process absent. Telopodites (Fig. 37) small. Posterior gonopods (Fig. 39) small, coxae deeply excavate and lobed, second articles enlarged distally, 3 distal articles reduced and fused.

Description of female paratype. Length, 14 mm, A3 = 0.87 mm. Nonsexual characters as in male. Cyphopods (Figs. 42, 43) with median valve deeply notched, lateral valve bearing a variously developed knobby bifid process.

Distribution. Known only from type locality.

Pseudotremia spira n. sp.

Figures 44–48

Types. Male holotype, female paratype, and other specimens of both sexes from Wind Cave, 5 mi. southeast of Somerset, Pulaski Co., Kentucky, collected 16 December 1956 by T. C. Barr. The specific name is an adjective meaning "spiraled."

Diagnosis. No other species in the group has the lateral colpocoxites spiraled outward in anterior view (Fig. 44).

Description of male holotype. Length, 14 mm, A3 = 1.10 mm. Ocelli 10 on each

side, irregular in size, shape and arrangement (Fig. 47). Color in alcohol light brown, but probably white in life. Segmental shoulders high, angular, reduced to level of lateral striae about segment 24; dorsum nearly smooth, weak rugae beginning about segment 20, becoming stronger posteriad; lateral striae about 10. Anterior gonopods: median colpocoxite much as in *P. unca*, but lacking subapical spine (Fig. 44); lateral colpocoxites short, quite thin, spiraled in anterior view (Figs. 44, 45), entire. Telopodite process (Fig. 44) a flattened knob. Telopodites closely appressed (Fig. 44), of moderate size. Posterior gonopods (Fig. 46): similar to those of *unca*, but somewhat larger, basal knob more prominent.

Description of female paratype. Length 14–15 mm (all female specimens in fragments), $A_3 = 1.10$ mm. Nonsexual characters as in male. Cyphopods (Fig. 48) with valves obviously fused, each valve drawn out posteriad in a pointed process.

Distribution. Known only from the type locality.

THE *EBURNEA* GROUP

This is a group of troglobites, troglaphiles, and epigean species extending in a broad arc from Claiborne County, Tennessee, to adjacent parts of Alabama and Georgia and north to the Soco Gap region of North Carolina. The epigean and troglaphilic species are fairly uniform; all have subapical spines on the median colpocoxites, divided lateral colpocoxites and a blunt, two-pronged telopodite process. The majority of troglobitic species of *Pseudotremia* falls in this group, primarily for reasons of geography, though in a series of species running from *P. acheron* to *P. nyx* the gonopod features named above are successively lost and the gonopods become very simple. Possibly the species of this group occurring in central Tennessee can be removed to a group of their own when more is known about the epigean species of the region, but for the time being, I believe they are best kept here.

Pseudotremia acheron n. sp.

Figures 49–52

Types. Male holotype and female paratype from Higgenbotham Cave, 8 mi. south of McMinnville, Warren Co., Tennessee, collected 23 June 1957 by L. Hubricht. The specific name is a noun in apposition, the name of one of the five rivers of Hades.

Diagnosis. Distinct from the other unpigmented troglobites of the group in having a bifurcate telopodite process, and from the troglaphilic and epigean species in having a reduced number of ocelli and in lacking pigment.

Description of male holotype. Length, 16 mm. $A_3 = 1.00$ mm. Ocelli 19 on both sides of head, irregular, unpigmented. Body without pigment. Segmental shoulders moderately strong, reduced to level of lateral striae about segment 23; dorsum smooth except for row of 8–10 strong knobs across posterior margin of each segment; lateral striae unusually prominent, 12–14. Anterior gonopods: median colpocoxite erect, simple (Fig. 48), subapical spine lacking; lateral colpocoxite (Figs. 48, 49) sigmoidally curved, divided, dorsal branch recurved, crossing over ventral, ventral branch long, sharply acuminate. Telopodite process (Fig. 48) curved slightly dorsad, deeply notched apically. Telopodites moderately large (Fig. 48), evenly rounded. Posterior gonopod (Fig. 51) typical.

Description of female paratype. Length, 18 mm, $A_3 = 1.04$ mm. Nonsexual characters as in male. Cyphopod (Fig. 52) simple, median valve elongate, lateral valve distally widened.

Distribution. In addition to the type locality, the species is known from a male collected in McElroy Cave, 1.5 mi. north-east of Bone Cave Post Office, Van Buren Co., Tennessee, by L. Hubricht, 23 June 1957.

Pseudotremia rhadamanthus n. sp.

Figures 53–57

Types. Male holotype, female paratype, and many other specimens of both sexes

from Terrill Cave, 5 mi. northeast of Guntersville, Marshall Co., Alabama, collected 2 September 1968 by S. B. Peck. The specific name is a noun in apposition, the name of one of the three judges of Hades.

Diagnosis. Differs from the other pigmented species of the group in the very large, two-pronged telopodite process and the relatively basal position of the subapical spine of the median colpocoxite.

Description of male holotype. Length, 20 mm, A3 = 1.44 mm. Ocelli 12 on each side of head, in 3 rows, regular in size and shape and well pigmented. Body pigmented as usual, light brown marked darker purplish brown. Segmental shoulders moderate, persisting to segment 25; dorsum nearly smooth on anterior segments, posterior segments with few weak rugae; lateral striae weak, 8–10. Anterior gonopods: median colpocoxite with subapical spine set about halfway in its length (Fig. 52); lateral colpocoxite curved mesad, then sharply ventrad, apically divided, divisions subequal (Figs. 52, 54). Telopodite process (Fig. 54) broad, prominent, with two widely diverging dorsally curved apices. Telopodites (Fig. 52) as usual. Posterior gonopods (Fig. 55) typical of larger pigmented species, coxae and second articles subequal, 3 apical articles of nearly equal length.

Description of female paratype. Length, 19 mm, A3 = 1.40 mm. Nonsexual characters as in male. Cyphopods (Fig. 56) ornate, lateral valve lobed, both valves with posterior processes.

Distribution. In addition to the type locality, this species is represented by specimens of both sexes from Monteagle Saltpetre Cave, southeast of Monteagle, Marion Co., Tennessee, collected by S. B. Peck, 28 August 1968. This is a considerable range for a troglobitic species of *Pseudotremia*. Caves in the intervening area should be carefully examined for this species.

Notes. The cyphopods of females from

Monteagle Saltpetre Cave are slightly different from those of the paratype female (Fig. 57).

Pseudotremia soco n. sp.

Figures 58–62

Types. Male holotype from Soco Gap Falls, Jackson Co., North Carolina, collected 19 May 1956 by L. Hubricht. The specific name is a noun referring to the type locality.

Diagnosis. No other epigeal species that is well pigmented has so few ocelli (14, Fig. 58). The median colpocoxites are somewhat reminiscent of *P. valga*, but bear a sinuous subapical spine.

Description of male holotype. Length, 26 mm, A3 = 1.10 mm. Ocelli 14 on each side, in 3 irregular rows (Fig. 58). Body bleached by preservation, but other specimens pigmented as usual for epigeal species. Segmental shoulders very large and strong, dorsum nearly flat, reduced to level of lateral striae about segment 24; lateral striae moderately strong, 9–11. Anterior gonopods: median colpocoxites (Fig. 59) curving inward, then sharply outward, subapical spine long, slightly sinuous; lateral colpocoxites (Fig. 59, 61) extending straight ventrad, then curved sharply posteriad, divided, ventral branch the longest. Telopodite process (Fig. 60) a small knob. Telopodites as usual. Posterior gonopods (Fig. 62) typical, but apical segment somewhat elongate.

Female unknown.

Distribution. Known also from a single male collected along Rt. 197 at the Bumcombe Co. line (4300 ft. elev.), North Carolina, 30 June 1955, by A. Van Pelt.

Pseudotremia eburnea Loomis

Figures 63–65

Pseudotremia eburnea Loomis, 1939, Bull. Mus. Comp. Zool., 86: 174–175, figs. 5a–c, ♂.

Types. Male holotype from Cricket Cave, Rising Fawn, Dade Co., Georgia, collected 30 August 1935 by K. Dearolf, in MCZ, examined. During a recent faunal

survey of Georgia caves (S. Peck, personal communication) this cave could not be located. The specific name means "white as ivory."

Diagnosis. The telopodite process is two-parted, but small and blunt. Closest to *P. soco*, but in the holotype and most other specimens, the dorsal branch of the lateral colpocoxite is longest, and passes posterior of the telopodites (Fig. 63), while in *soco* the ventral branch is much longer.

Description of male holotype. Length, 19 mm, A3 = 1.12 mm. Ocelli 13 on left side, 12 on right side, unpigmented, irregular in size, shape, and arrangement. Body pale tan, but fresh specimens white to pale lavender. Segmental shoulders weak, not continuing beyond segment 17; dorsum with 6–8 vague rugae, more prominent on posterior segments; lateral striae 10–12, prominent. Anterior gonopods: median colpocoxites (Fig. 63) slightly diverging, subapical spine short and stout; lateral colpocoxite divided (Figs. 63, 64), branches diverging at an obtuse angle, both curved sharply mesad. Telopodite process (Fig. 63) short, blunt, notched at distal end. Telopodites (Fig. 63) larger than usual, partly covering colpocoxites. Posterior gonopods (Fig. 65) similar to those of *P. soco*, but coxae not as prominently lobed.

Females unknown.

Distribution. GEORGIA: Case Caverns, at Trenton, Cloudland Canyon State Park, Dade Co., 30 September 1967, T. Iles, ♂♂. TENNESSEE: Nickajack Cave, Marion Co., 11 November 1967, J. Holsinger, ♂.

Pseudotremia aeacus n. sp.

Figures 66–69

Types. Male holotype and female paratype from Hurricane Cave, near Rising Fawn, Dade Co., Georgia, collected 22 October 1967 by T. Iles. The specific name is the name of one of the three judges of Hades.

Diagnosis. Close to *P. nodosa* in bearing a triangular lamella in place of the sub-

apical spine of the median colpocoxite, but has much larger lateral colpocoxites than that species.

Description of male holotype. Length, 21 mm, A3 = 1.12 mm. Ocelli 16 on both sides, regular in shape, but irregularly arranged in 3 or 4 series. Body unpigmented. Segmental shoulders strong, high on anterior segments, dorsum nearly flat, shoulders reduced to level of lateral striae about segment 20–22; dorsum of each segment with 10–13 moderate tubercles, becoming on posterior segments row of 8 strong knobs across posterior segment margins; lateral striae weak, 7–8. Anterior gonopods: of the simplified troglobite type, median colpocoxite (Fig. 66) with a curved triangular lamella in place of subapical spine, lateral colpocoxites (Figs. 66, 67) larger than medians, entire, simply curved. Telopodite process (Fig. 67) a large, laterally flattened knob. Telopodites (Fig. 65) of moderate size. Posterior gonopods (Fig. 68) slightly reduced from those of *P. eburnea*, but similar in shape.

Description of female paratype. Length, 20 mm, A3 = 1.10 mm. Nonsexual characters as in male. Cyphopods (Fig. 69) large, obviously fused posteriorly, valves elongate.

Distribution. In addition to the type locality, known also from a single male collected in Byers Cave, 0.5 miles southwest of Hurricane Cave, 3 December 1967, by T. Iles. Hurricane Cave and Byers Cave are part of the same cave system (S. Peck, personal communication).

Pseudotremia nodosa Loomis

Figures 70–73

Pseudotremia nodosa Loomis, 1939, Bull. Mus. Comp. Zool., 86: 175–177, figs. 6a–d, ♂.

Types. Male holotype from English Cave, 0.9 mi. south of Hamilton School, Powell River, Claiborne Co., Tennessee, collected 2 July 1937 by K. Dearolf, in MCZ, examined. The specific name, meaning "knobby," is an adjective.

Diagnosis. Separated geographically from

the remainder of the group, but most closely resembles *P. aeacus*, and can be separated from it by the characters mentioned under that species.

Description of male holotype. Length, about 15 mm (holotype in fragments), $A_3 = 0.82$ mm. Ocelli 10 on right side, 11 on left side, irregular in shape and arrangement, not pigmented. Body not pigmented. Lateral shoulders almost absent, body nearly cylindrical; dorsum of each segment with 10–12 large, prominent nodules along posterior segmental margin; lateral striae weak, about 4–5 on midbody segments only. Anterior gonopods: very much simplified, median colpocoxites (Fig. 70) short, with subtriangular lamella replacing spine, lateral colpocoxites (Figs. 70–71) very short, simple, slightly curved. Telopodite process not easily observed, extending between median colpocoxites, similar in form to that of *P. aeacus*. Telopodites (Fig. 71) moderately large, curved anteriorly. Right posterior gonopod (Fig. 72) similar to that of *aeacus*, but second article somewhat shorter. Left posterior gonopod missing from holotype, but Loomis (1939) shows the 3 distal articles as nearly normal for walking legs.

Description of female from English Cave. Length, 16 mm, $A_3 = 0.85$ mm. Non-sexual characters as in male. Cyphopods (Fig. 73) with lateral valve reduced in size, median valve expanded laterad posterior to lateral valve.

Distribution. Known also from Knopper Cave, 3.3 mi. southeast of Rose Hill, Lee Co., Virginia, J. Holsinger, collector, 14 April 1968, ♂♂ ♀♀.

Notes. Except the holotype, all males examined by me had the posterior gonopods symmetrical, rather than asymmetrical, as Loomis (1939) described for the holotype.

Pseudotremia nyx n. sp.

Figures 6, 74–77

Types. Male holotype, female paratype and many other specimens of both sexes

from Cathedral Caverns, 3.5 mi. north of Grant, Marshall Co., Alabama, collected 18 June 1957 by L. Hubricht. The specific name is a noun in apposition, the Greek name of the personification of darkness.

Diagnosis. The gonopods of this species resemble those of both *P. cercops* and *P. lictor*, but *P. nyx* differs from them in having 12 or more ocelli, as opposed to less than 8. In addition, *P. cercops* is almost smooth dorsally, and *P. lictor* has 12–15 strong tubercles. *Pseudotremia nyx* has 4–6 large knobs on the dorsum of each segment (Fig. 6).

Description of male holotype. Length, 19 mm, $A_3 = 1.00$ mm. Ocelli 12 on each side, in three series, lightly pigmented. Body lacking pigment. Segmental shoulders highest in genus, raised nearly above level of dorsum, reduced to level of lateral striae on segment 28; dorsum with 4–5 strong knobs on posterior segmental margins, most median knobs raised along dorsal suture as median crest found in juveniles of most other *Pseudotremia* spp. (Fig. 6); lateral striae moderate, 6–7 per side per segment. Anterior gonopods: median colpocoxites (Fig. 74) widely separated, diverging, simple; lateral colpocoxite (Figs. 74, 75) short, simple, curved slightly ventrad. Telopodite process absent. Telopodites (Fig. 74) subequal to colpocoxites. Posterior gonopods (Fig. 75) with distal article much reduced, coxa with a large distal swelling.

Description of female paratype. Length, 19 mm; $A_3 = 1.00$ mm. Nonsexual characters as in male, but segmental shoulders not quite so large, body more nearly cylindrical. Cyphopods (Fig. 77) extremely large for size of animal, valves swollen anteriorly, greatly drawn out and obviously fused posteriorly.

Distribution. Known only from type locality.

Pseudotremia lethe n. sp.

Figures 7, 78–80

Types. Male holotype, female paratype and a second female from Carter Cave, 3.3

mi. southwest of Flynn's Lick, Jackson Co., Tennessee, collected 21 September 1968 by J. and M. Cooper. The specific name is a noun in apposition, the name of one of the five rivers of Hades.

Diagnosis. Differing from the other highly specialized troglolithic species in the group in having the lateral colpocoxites of the gonopods branched.

Description of male holotype. Length, 13 mm, A3 = 0.70 mm. Ocelli 4 on left side, 6 on right side, irregular in shape, size and arrangement, not pigmented, barely visible. Body without pigment. Segmental shoulders moderate, reduced to level of lateral striae by segment 15; dorsum with 10–12 large, prominent tubercles on anterior segments, posterior segments with row of 12 tubercles along posterior margins; lateral striae moderate, 8 per side per segment. Anterior gonopods: median colpocoxite (Fig. 78) simple, upright, lacking a spine; lateral colpocoxite (Fig. 78) thin, extending nearly straight ventrad, branched, ventral branch much the smallest. Telopodite process absent. Telopodites (Fig. 78) moderately large. Posterior gonopods (Fig. 79) similar to those of *P. nodosa* and *P. aeacus*.

Description of female paratype. Length, 14 mm, A3 = 0.72 mm. Nonsexual characters as in male. Cyphopods (Fig. 80) like those of *P. nodosa*, but median valve more truncate, longer.

Distribution. Known only from the type locality.

Pseudotremia cercops n. sp.

Figures 81–84

Types. Male holotype from Jim Cave, 3.5 mi. east of Dowelltown, DeKalb Co., Tennessee, collected 23 December 1956 by L. Hubricht; female paratype and other females from Hill Cave, 3 mi. east of Dowelltown, collected 23 December 1956 by L. Hubricht. The specific name is a noun in apposition, the name of a kind of

thieving, subterranean gnome of ancient Lydia.

Diagnosis. The male gonopods are almost indistinguishable from those of *P. lictor*, but *P. cercops* has much less prominent dorsal knobs than *P. lictor*, and the cyphopods are quite different.

Description of male holotype. Length, 13 mm, A3 = 0.90 mm. Ocelli 5 on either side, totally lacking in pigment, cuticular lenses very difficult to see. Body lacking pigment. Segmental shoulders low, reduced to level of lateral striae about segment 10; dorsum of each segment with 10–20 low, weak tubercles; lateral striae indistinct, about 10. Anterior gonopods: simplest of the genus, median colpocoxites (Fig. 81) large, erect, slightly flared, spine lacking; lateral colpocoxites (Figs. 81–82) short, entire, thin, less than half length of medians. Telopodite process absent. Telopodites (Figs. 81, 82) of moderate size. Posterior gonopods (Fig. 83) greatly reduced, coxae swollen dorsally, four distal segments all fused, reflexed dorsad; the general effect is almost that of the posterior gonopods of a species of Trichopetalidae.

Description of female paratype. Length, 13 mm, A3 = 0.92 mm. Nonsexual characters as in male. Cyphopods (Fig. 84) enormous for size of animal, greatly elongate, each valve with a short posterior process.

Distribution. In addition to the type localities, females were collected in Grant Cave, 1 mi. east of Dowelltown, DeKalb Co., Tennessee, by L. Hubricht on 23 December 1956.

Notes. It seems likely to me that *P. cercops* and *P. lictor* (described below) are descended from the same ancestor, and that this ancestor was likewise a troglolithic. Assuming a roughly equal rate of evolution in the troglolithic members of *Pseudotremia*, these two species, which show the most reduction from the epigeal forms, are perhaps the oldest troglolithes.

Pseudotremia lictor n. sp.

Figures 85–88

Types. Male holotype, female paratype, and several other specimens of both sexes from Avant Cave, 2 mi. east of Dowelltown, DeKalb Co., Tennessee, collected 23 December 1956 by L. Hubricht. The specific name is a noun in apposition, and refers to a Roman soldier armed with a mace, suggested by the form of the posterior gonopods.

Diagnosis. Closest to *P. cercops*, but distinct from that species by the characters given under the discussion above.

Description of male holotype. Length, 14 mm, A3 = 0.95 mm. Ocelli 5 on left side, about 7 or 8 on right side, totally unpigmented, cuticular lenses hard to see. Body lacking pigment. Segmental shoulders practically absent, body roughly cylindrical; dorsum with 12–15 large, strong tubercles per segment; lateral striae moderate, 11–12. Anterior gonopods: highly simplified, much as described for *P. cercops* (Figs. S5, S6). Posterior gonopods (Fig. S7) slightly less reduced than those of *P. cercops*, but coxae much more enlarged distally.

Description of female paratype. Length, 15 mm, A3 = 0.95 mm. Nonsexual characters as in male. Cyphopods (Fig. S8) like those of *P. cercops*, but smaller, not as elongate.

Distribution. Known only from the type locality.

THE *COTTUS* GROUP

Except for *P. minos*, this group is one of the more coherent species assemblages in the genus *Pseudotremia*. All except *P. minos* are large, epigean or troglomorphic species occurring in the Great Smoky Mountains, and through the foothills to the west to the area of the confluence of the Clinch and French Broad rivers. The most distinctive character linking them is the tripartite telopodite process. I think that *P. cottus*, *P. scrutorum*, and *P. cocytus*

are definitely closely related. *Pseudotremia minos*, on the other hand, is not closely related to the other three species, but it is somewhat modified for a troglobitic existence. The form of the telopodite process (Fig. 95) is unique, but is closest to this group. The area intervening between the distribution of the three closely related species and *P. minos* has not been well collected, and perhaps other species bridging the gap between *P. minos* and the others will be found to exist there. Among the other groups, the *cottus*-group is probably most closely related to the *eburnea*-group.

Pseudotremia scrutorum n. sp.

Figures 89–92

Types. Male holotype from trash dump, 1.7 mi. north-northeast of Winfield, Scott Co., Tennessee, collected 30 May 1958 by Leslie Hubricht. The specific name is a Latin genitive, meaning "of trash," and refers to the type locality.

Diagnosis. The lateral colpocoxites of this species are thinner than those of the others in the group (Fig. S9), and they differ further from the other two Tennessee species in the subapical spine of the median colpocoxites (Fig. S9).

Description of male holotype. Length, 28 mm, A3 = 1.45 mm. Ocelli 21 on both sides, in 5 series, regular in shape and arrangement, black. Body typically pigmented for epigean species, medium tan marked darker lavender-brown. Segmental shoulders high and prominent except on first segment and last 2 or 3 segments; dorsum with 30–40 well-defined small tubercles per segment; 8–10 moderate lateral striae. Anterior gonopods: median colpocoxites (Fig. S9) with slightly decurved subapical spine; lateral colpocoxites (Figs. S9, 90) divided, ventral branch extending straight ventrad, dorsal branch curved mesad, gland channel follows dorsal branch. Telopodite process (Fig. 90) small, bluntly 3-segmented. Telopodites (Fig. 91) as usual. Posterior gonopods

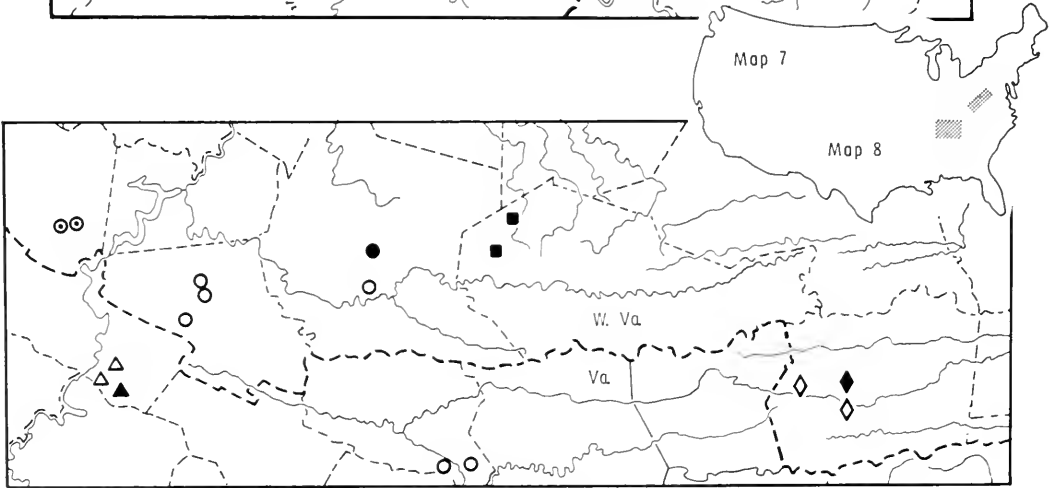
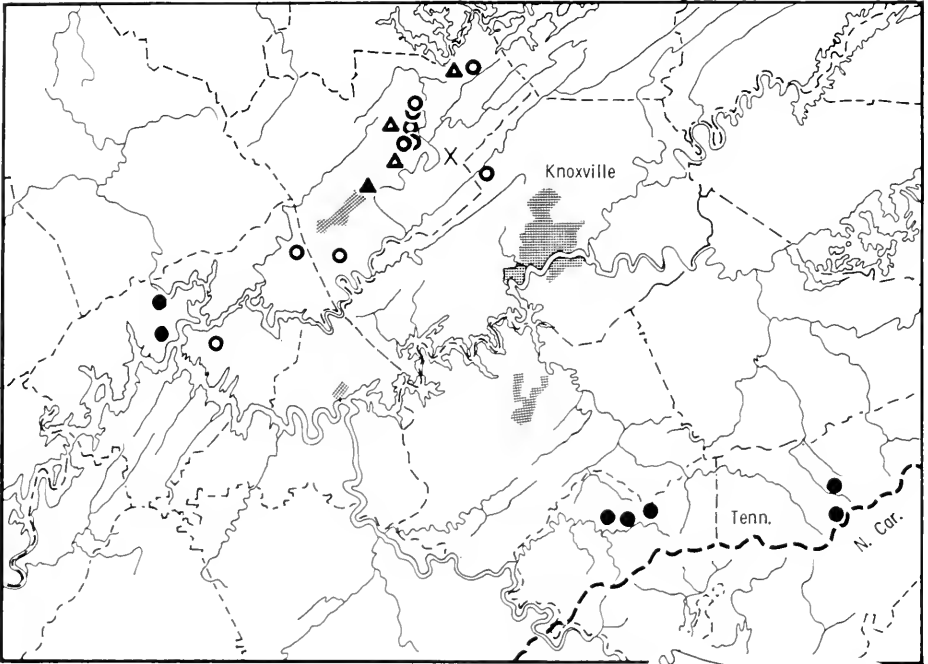

Map 7. Southwestern Tennessee, showing distribution of species of *Pseudotremia*. Solid symbols, epigeal records; open symbols, cave records. Dots and circles, *P. cottus*; triangles, *P. cocytus*; cross, type locality of *P. deprehendor*.

Map 8. Eastern West Virginia and adjacent Virginia (North is to the right) showing distribution of species of *Pseudotremia*. Solid symbols, epigeal records; open symbols, cave records. Dots and circles, *P. hobbsi*; circles with center dots, *P. arnesi*; triangles, *P. sublevis*; squares, *P. tsuga*; diamonds, *P. simulans*.

(Fig. 92) typical of epigeal species, coxa with subquadrate basal knob.

Female unknown.

Distribution. Known only from the type locality.

Pseudotremia minus n. sp.

Figures 93–97

Types. Male holotype, female paratype and other females from Russell Cave, Russell Cave National Monument, Jackson Co.,

Alabama, collected 10 August 1957 by D. F. Black. The specific name is the name of one of the three judges of Hades.

Diagnosis. The telopodite process is quite unique (Fig. 9); *P. minos* also differs from other species in the group in being unpigmented.

Description of male holotype. Length, 19 mm, A3 = 1.10 mm. Ocelli 21 on either side, regularly arranged in 5 series, but not pigmented. Body without pigment. Segmental shoulders high, strong, angular, dorsum nearly flat; 20–25 strong knobs and rugae per segment; 12–14 lateral striae per segment per side. Anterior gonopods: median colpocoxites (Fig. 93) with subapical spine at very tip; lateral colpocoxites very broad (Figs. 93, 94), diverging from medians high up from origin of colpocoxites, entire, evenly curved mesad. Telopodite process (Figs. 93, 95) blunt knob with 4 projections, of which central 2 are curved ventrad; median colpocoxites held *in situ* between outer and inner prongs (Fig. 94). Telopodites (Figs. 93, 94) as usual. Posterior gonopods (Fig. 96) like those of *P. scrutorum*, but basal coxal knob not as prominent.

Description of female paratype. Length 19 mm, A3 = 1.10 mm. Nonsexual characters as in male. Cyphopods (Fig. 97) with valves fused, but lateral valve recurved and overlapping central groove.

Distribution. Known only from the type locality.

Pseudotremia cocytus n. sp.

Figures 98–100, Map 7

Types. Male holotype from wooded hillside, 1.4 mi. east of Dossett, Anderson Co., Tennessee, collected 20 May 1961 by L. Hubricht. The specific name is the name of one of the five rivers of Hades.

Diagnosis. Differs from *P. scrutorum* in lacking a subapical spine on the median colpocoxite, and from *P. cottus* in the smaller, blunt telopodite process.

Description of male holotype. Length, 31 mm, A3 = 1.71 mm. Ocelli 21, regularly arranged in 5 series. Pigmentation typical of epigeane species. Segmental shoulders large, strong, reduced to level of lateral striae about segment 23; dorsal tuberculation of rather weak rugae; lateral striae moderate, 9–11. Anterior gonopods: median colpocoxite (Fig. 99) short, simple, subapical spine lacking; lateral colpocoxite large, broad (Figs. 98, 99), divided, branches diverging at about a right angle (Fig. 98), sharply curved mesad, gland channel follows dorsal branch. Telopodite process (Fig. 99), like that of *P. scrutorum*, blunt, tripartite. Telopodites (Fig. 99) as usual. Posterior gonopods (Fig. 100) large, all segments apparently movable.

Females unknown.

Distribution. Besides the type locality, the following (Map 7): TENNESSEE: Anderson Co., Norris Dam Cave, 2 mi. north of Norris, on logs 200 ft. from entry, 16 April 1965, J. Payne, ♂; Offutt's Cave, 2 mi. north of Clinton, 10 April 1965, J. Payne, ♂♂; 26 March 1965, J. Payne, ♂; Martin's Cave, 4 mi. southwest of Clinton, 17 April 1965, J. Payne, ♂♂, juveniles.

Note. The juvenile specimens from Martin's Cave are as follows: pigmentation light, ocelli poorly pigmented, segmental shoulders not well developed, dorsum with posterior row of large knobs on each segment, many smaller knobs anterior to these, margins of dorsal suture raised to form dorsal crest.

Pseudotremia cottus n. sp.

Figures 101–109, Map 7

Types. Male holotype and female paratype from The Sinks, Cades Cove, Blount Co., Tennessee, collected 25 May 1962 by L. Hubricht. The specific name is the name of one of the Hectanocheires, hundred-handed giants of mythology.

Diagnosis. Like *P. cocytus*, a large species, but with fewer ocelli than *P. cocytus* and with a much larger telopodite process.

Description of male holotype. Length, 30 mm, A3 = 1.72 mm. Ocelli 19 on either side, somewhat irregular in arrangement, but well pigmented. Body very dark, darker than any other species, purplish gray with darker brown markings. Segmental shoulders large, strong, reduced to level of lateral striae by segments 21–23; dorsum of each segment with 14–16 weak, elongate rugae; lateral striae prominent, 10–12 per side per segment. Anterior gonopods: median colpocoxites (Fig. 101) strong, upright, lacking subapical spine; lateral colpocoxites (Fig. 101, 102) broad, divided, gland channel follows ventral branch. Telopodite process (Figs. 103, 104) very large, tripartite, the lateral branches the largest, median colpocoxite held *in situ* between lateral branches and median projection. Telopodites normal. Posterior gonopods (Fig. 105) large, as usual for larger epigeic species.

Description of female paratype. Length, 32 mm, A3 = 1.75 mm. Nonsexual characters as in male. Cyphopods (Fig. 106) with median valve slightly longer than lateral, lateral valve with broad indentation laterally.

Distribution. In addition to the type locality, the following (Map 7): TENNESSEE: *Blount Co.*, Big Poplar Trail, Cades Cove, 23 May 1962, L. Hubricht, ♂♂; near Gregory's Cave, Cades Cove, 25 May 1962, L. Hubricht, ♂; *Anderson Co.*, Marie's Cave, 1 mi. north of Andersonville, 29 May 1965, J. Payne, ♂♂, juv.; Bee Hole Cave, 4 mi. north of Clinton, 30 May 1965, J. Payne, ♂; Carden's Cave, 1 mi. northeast of Clinton, 25 January 1965, J. Payne, ♂♀♀; Wright's Cave, 2 mi. northeast of Clinton, 18 April 1965, J. Payne, ♂; Quarry No. 1 Cave, 1 mi. north of Andersonville, 29 May 1965, J. Payne, ♂♂♀; Wallace's Cave, 5 mi. north of Clinton, 4 April 1965, J. Payne, ♂♂♀♀; Melton Hill Cave, 3 mi. south of Oak Ridge, 11 April 1965, J. Payne, ♂♀♀; Community Center Cave, Norris, 16 July 1965, J. Payne, ♂♂; Spring

Hill Cave, 5 mi. south of Spring Hill Community, 17 December 1965, J. Payne, ♂; *Knox Co.*, Rock Hill Cave, 2 mi. south of Heiskill, 12 June 1965, E. Mehinnick, ♂; *Roane Co.*, Eblen's Cave, near Kingston, 1 August 1955, S. Auerbach, ♂; wooded hillside 1.3 mi. southwest of Pine Grove, 1963, L. Hubricht, ♀♀; Obed River bluff at Harri-man, 21 May 1961, L. Hubricht, ♀; *Sevier Co.*, west side of Indian Gap (5000 ft. elev.) 4 August 1958, R. Hoffman, ♀; between Gatlinburg and Newfound Gap, 25 May 1962, L. Hubricht, ♂.

Notes. The male gonopods show some variation. The telopodite process is much larger (Fig. 103) in the populations from Blount County, and the foothills of the Great Smoky Mountains. In the Anderson County specimens, the lateral arms are smaller (Fig. 104) and not as diverging. Among the females, there is considerable variation in cyphopod shape; the approximate range of this variation is shown in Figures 106–109.

THE TUBERCULATA GROUP

This group is composed of four troglomorphic and epigeic species from the Allegheny Plateau rim and the mountain ridges just east of it. All have divided lateral colpocoxites and a grapplelike, or divided saber type of telopodite process. There is variation, however, in the form of the subapical spine. It is absent in *P. tuberculata*, and found only as a triangular lamella in *P. armesi*. The group is closely related to the *hobbsi*-group, and the discovery of intermediate species may eventually place all *Pseudotremia* species of the northern Appalachian Valley together.

Pseudotremia tuberculata Loomis Figures 110–113

Pseudotremia tuberculata Loomis, 1939, Bull. Mus. Comp. Zool., 86: 171–172, figs. 3a, b, ♂.

Types. Male holotype from Cassel Farm Cave, Burkes Garden, Tazewell Co., Virginia, collected 3 July 1937 by K. Dearolf,

in MCZ, examined. The specific name refers to the body texture.

Diagnosis. The extremely long ventral branch of the divided lateral colpocoxite (Fig. 110) sets *P. tuberculata* off from any other species.

Description of male from type locality. Since the holotype is in poor condition, a male collected at the type locality by R. L. Hoffman, 27 June 1947, is described here. Length, 29 mm, A3 = 1.35 mm. Ocelli 18 on both sides of head, somewhat irregular in form and arrangement, not fully pigmented. Coloration as usual, light tan-brown marked darker purplish brown. Segmental shoulders moderate, reduced to level of lateral striae about segment 21–23; dorsal tuberculation very strong, large, discrete tubercles densely scattered over midbody segments; lateral striae very strong, 12–14. Anterior gonopods: median colpocoxites (Figs. 110, 111) divided, ventral branch much the longest and thinnest, arching straight ventrad. Telopodite process (Fig. 110) grapplelike, base shaped like a gear wheel. Telopodites (Figs. 110, 111) of moderate size. Posterior gonopods (Fig. 112) typical of larger species.

Description of female from type locality. Length, 30 mm, A3 = 1.37 mm. Nonsexual characters as in male. Cyphopods (Fig. 113) large, valves thick, median valve the longest.

Distribution. Known only from the type locality.

Pseudotremia momus n. sp.

Figures 114–117

Types. Male holotype, female paratype and other specimens of both sexes from Spence Cave, between Saltville and Chattham, Smyth Co., Virginia, collected 3 January 1956 by R. L. Hoffman. The specific name is the name of the Roman god of ridicule, suggested by the peculiar form of the median colpocoxites.

Diagnosis. The form of the median colpocoxites in lateral view (Fig. 115) is distinctive.

Description of male holotype. Length, 23 mm, A3 = 1.26 mm. Ocelli 17 on both sides, in 4 or 5 series, regular in shape, black. Pigmentation typical of epigean and large troglomorphic species. Segmental shoulders strong on every segment but penultimate and anal; dorsum of each segment with a few low rugae, becoming posterior row of 10–12 moderate tubercles on posterior segments; lateral striae moderate, 10–12. Anterior gonopods: median colpocoxites broad in anterior view (Fig. 114), subapical spine hooklike, in lateral view median colpocoxite (Fig. 115) sharply decurved, almost forming a circle; lateral colpocoxites small (Fig. 115) short, divided at apex. Telopodite process (Fig. 114) grapplelike, base swollen and resembling a gear wheel. Telopodites as usual. Posterior gonopods (Fig. 116) normal for epigean or troglomorphic species.

Description of female paratype. Length, 25 mm, A3 = 1.25 mm. Nonsexual characters as in male. Cyphopods (Fig. 117) smaller than in *P. tuberculata*, lateral valves with a few vague lobes.

Distribution. Besides the type locality, a male was collected on the crest of Big Walker Mt., 4 mi. south of Ceres, Wythe and Bland Co., Virginia, 1 June 1969, by R. L. Hoffman.

Pseudotremia armesi n. sp.

Figures 118–121, Map 8

Types. Male holotype, female paratype, and other specimens of both sexes from Neely Farm Cave,¹ Athens, Mercer Co., West Virginia, collected 13 February 1966 by W. Shear and B. W. Armes. The specific name is in memory of my friend and student, B. W. Armes, who helped in the collection of the type series, and whose promising scientific career was cut short in Viet Nam.

¹ This cave has been variously known as Barrett Cave, Bear Cave, Theta Xi Cave, etc., but will appear under this name in the forthcoming *Caves of West Virginia* (J. Holsinger, personal communication).

Diagnosis. The triangular lamella in place of a subapical spine of the median colpocoxites distinguishes this species from any others of the group.

Description of male holotype. Length, 22 mm, A3 = 1.26 mm. Ocelli 19 on either side, slightly irregular in size, irregular in arrangement, poorly pigmented. Body pale brown, vaguely marked darker, especially on anterior segments. Segmental shoulders moderate, reduced to level of lateral striae about segment 25; dorsum of each segment with a few moderately prominent rugae; lateral striae weak, about 8 per side per segment. Anterior gonopods: median colpocoxites upright, triangular lamella in place of subapical spine (Fig. 118); lateral colpocoxites divided (Figs. 118, 119), ventral branch sharply curved dorsad. Telopodite process (Fig. 118) grapplelike, lacking gear-wheel base seen in *P. tuberculata* and *P. momus*. Telopodites as usual. Posterior gonopods (Fig. 120) with second article slightly longer than coxae.

Description of female paratype. Length, 23 mm, A3 = 1.22 mm. Nonssexual characters as in male. Cyphopods (Fig. 121) as in *P. momus*, but median valve somewhat longer in comparison to lateral.

Distribution (See Map 8). Besides the type locality, three females were collected near Brush Creek Falls, 3 mi. northeast of Princeton, Mercer Co., West Virginia, 15 June 1967, by W. A. Shear. The type locality is a small cave in a thin band of Hinton limestone, and is isolated by about 20 miles from any other caves.

Pseudotremia alecto n. sp.

Figures 122–124

Types. Male holotype and a second male from Griffith, Alleghany Co., Virginia, collected 6 May 1950 by R. Hoffman and L. Hubricht. The specific name is the name of one of the Furies of Greek mythology.

Diagnosis. The unusual clasplike form of the median colpocoxites (Fig. 122) is found only in *P. simulans* and *P. alecto*; *simulans* occurs in Pendleton Co., W. Va.

and is much larger (ca. 30 mm) than *alecto* (ca. 25 mm).

Description of male holotype. Length, 26 mm, A3 = 1.17 mm. Ocelli 19 on both sides of head, arranged in 5 series, pigmented. Coloration typical of epigean species. Segmental shoulders moderately high, reduced to level of lateral striae about segment 20–22; dorsal tuberculation very well developed, nearly 50 small but distinct tubercles on dorsum of each midbody segment; lateral striae prominent, 16–18. Anterior gonopods: median colpocoxites (Fig. 122) somewhat resembling those of *P. valga* and *P. socio*, but subapical spine forming forcepslike arrangement with a projection from the tip of median colpocoxite; lateral colpocoxites (Figs. 122, 123) broad, evenly curved, apically divided. Telopodite process (Fig. 123) short, thin, apically notched. Telopodites as usual. Posterior gonopods (Fig. 124) typical of larger species.

Females unknown.

Distribution. Known only from the type locality.

THE HOBBSI GROUP

This is a large, complex, heterogeneous group of epigean and troglomorphic species (*P. fulgida* and *P. lusciosa*, included here, are the only troglomorphs) from the northern part of the range of *Pseudotremia*, though *P. deprehendor* is found far to the south in Tennessee. The absence of records from southwestern Virginia precludes any statement about the relationship of *P. deprehendor* to the rest of the group; a large collection from the area exists, but was not available for this study. The parts of West Virginia and Kentucky intervening between the distribution of most species of the group and *P. carterensis* are difficult to get to and have not been well collected. There are two large female specimens of an undescribed species from Clay County, West Virginia (Map 5). The group seems related to the *tuberculata*-group, but also has affinities with the similarly northern *indiana*-group. Most of the species in-

cluded in the *hobbsi*-group have a subapical spine on the median colpocoxite. The lateral colpocoxite may be divided or not, and the telopodite process, when present, is of the saberlike type.

Pseudotremia lusciosa (Loomis)

Figures 125–127

Dearolfia lusciosa Loomis, 1939, Bull. Mus. Comp. Zool., 86: 178–179, figs. 7a–f, ♂.

Types. Male holotype from Seneca Caverns, 3 mi. northeast of Riverton, Pendleton Co., West Virginia, collected 1 June 1935 by K. Dearolf, in MCZ, examined. The specific name is a Latin adjective, meaning “partly blind.”

Diagnosis. The median colpocoxites are fused together for a considerable distance from their bases (Fig. 125); the gonopods of no other *Pseudotremia* species are known to be of this form. The superficial resemblance to species of *Cleidogona* led Loomis (1939) to erect the supposedly intermediate genus *Dearolfia*.

Description of male holotype. Length, 17 mm, A3 = 1.25 mm. Ocelli 7 on right side, 5 on left, small and unpigmented. Body without pigment. Segmental shoulders moderate, reduced to level of lateral striae about 17–19; dorsum nearly smooth, only a few vague rugae on midbody segments; lateral striae strong, 7–8 per side per segment. Anterior gonopods: median colpocoxites (Fig. 125) fused to each other for more than half their length, subapical spine erect; lateral colpocoxites (Fig. 126) long, thin, entire, evenly curved. Telopodite process not visible in figures, but of short saberlike form. Telopodites (Figs. 125, 126) smaller than usual. Posterior gonopods (Fig. 127) more reduced than in other members of the group, with deeply excavate coxae.

Females unknown. Loomis (1939) reported having a female, but it could not be located.

Distribution. Known only from the type locality.

Pseudotremia simulans Loomis

Figures 128–134, Map 8

Pseudotremia simulans Loomis, 1939, Bull. Mus. Comp. Zool., 86: 170–171, figs. 2a–b, ♂.

Types. Male holotype from Simmons Cave, near Cave Post Office, Pendleton Co., West Virginia, collected 5 July 1937 by K. Dearolf, in MCZ, examined. The specific means “simulating,” or “imitating,” and refers to the resemblance of this species to *P. princeps*, of the same region.

Diagnosis. The forcepslike arrangement at the apex of the median colpocoxite separates this species from all *Pseudotremia* except *P. alecto*, which is a smaller species.

Description of male from Trout Cave, 3 mi. south of Franklin. The description is taken from this specimen, which I compared with the type, since the holotype is in poor condition. Length, 32 mm, A3 = 1.60 mm. Ocelli 20, in 5 series, black. Pigmentation typical of larger species. Segmental shoulders strong, dorsum nearly flat, shoulders obvious to penultimate segment; dorsum with a few weak rugae, mostly on posterior margins of midbody segments; lateral striae moderate, 12–14. Anterior gonopods (Fig. 129): median colpocoxites with subapical spine; lateral colpocoxites (Fig. 132) simple, entire, curved abruptly ventrad. Telopodite process absent. Telopodites somewhat larger than usual. Posterior gonopods (Fig. 131) somewhat more complexly knobbed at base of coxae than in other large species.

Description of female from Trout Cave. Length, 31 mm, A3 = 1.60 mm. Nonsexual characters as in male. Cyphopods (Fig. 134) with lateral valve much the largest, broader than long.

Distribution. In addition to the type locality, the following (Map 8): WEST VIRGINIA: *Pendleton Co.*, Trout Cave, 3 mi. south of Franklin, 15 October 1950, R. Johnson, ♂♂ ♀♀; marsh 3 mi. west of Franklin, 22 May 1958, L. Hubricht, ♂.

Notes. The male from 3 mi. west of

Franklin differs in the general appearance of the gonopods, and has more ocelli (24) than the male holotype or males from Trout Cave. Because of these differences, the gonopods of the specimen are fully illustrated in Figures 128–130. This specimen may represent an undescribed species close to *P. simulans*, but because of the many similarities, I am reluctant to describe it as such from a single male.

Pseudotremia fulgida Loomis
Figures 135–140, Map 8

Pseudotremia fulgida, Loomis, 1943, Bull. Mus. Comp. Zool., 92: 378–380, figs. 3a–d, ♂.

Types. Male holotype from Higgenbotham Cave, 1.5 miles northwest of Frankford, Greenbriar Co., West Virginia, collected 24 August 1939 by L. Hubricht. The specific name is a Latin adjective meaning “shining.”

Diagnosis. No other species has such a large, prominent, saberlike telopodite process (Figs. 135, 136).

Description of male holotype. Length, 18 mm, A3 = 1.05 mm. Ocelli 7 on either side, irregularly arranged, lightly pigmented. Body without pigmentation. Segmental shoulders moderate, reduced to level of lateral striae by segment 15–17; dorsum nearly smooth, only posterior segments with few low rugae; lateral striae 8–10, moderate. Anterior gonopods: median colpocoxite (Fig. 135) simple, bladellike, erect, lacking subapical spine; lateral colpocoxites (Figs. 135, 136) broad, simple, entire, evenly curved. Telopodite process (Figs. 135, 136) very large, saberlike, curved in two-thirds of a circle between colpocoxites. Telopodites (Fig. 136) somewhat smaller than usual. Posterior gonopods (Fig. 137) somewhat like those of larger, epigeal species, but coxa more swollen distally.

Description of female from type locality. Length, 19 mm, A3 = 1.08 mm. Nonsexual characters as in male. Cyphopods (Figs. 138–140) showing some variation in specimens from type locality, but generally with

lateral valve subquadrate, median valve slightly elongated, distally flattened.

Distribution. In addition to the type locality, the following: WEST VIRGINIA: *Greenbriar Co.*, Hayes Cave, 5 mi. north of Lewisburg, 12 August 1939, L. Hubricht, ♀; Coffman Cave, near Frankford, 11 April 1967, T. C. Barr, ♂♂♀♀; Poor Farm Cave, 1.5 mi. east of Williamsburg, 27 September 1969, J. Holsinger, ♂.

Notes. Coffman Cave is part of the Higgenbotham Cave System, which includes three caves under the name Higgenbotham Cave (numbered one to three; Davies, 1949). *Pseudotremia hobbsi* also occurs in or near this cave system.

Pseudotremia carterensis Packard
Figures 141–144

Pseudotremia cavernarum carterensis Packard, 1883, Proc. Amer. Philos. Soc., 21: 186.

Pseudotremia carterensis, Cook and Collins, 1895, Ann. New York Acad. Sci., 9: 40, figs. 8–10, ♂.

Pseudotremia sodalis Loomis, 1939, Bull. Mus. Comp. Zool., 86: 173–174, figs. 4a–d, ♂. NEW SYNONYMY.

Types. Syntypes of *P. carterensis* from Bat Cave, Carter's Cave, Zwingell's Cave and X Cave, Carter Caves, Carter Co., Kentucky. Zwingell's Cave specimens collected 13 September 1874 by T. Sanborne, others without date or collector's name, in MCZ, examined; male holotype of *P. sodalis* from Bat Cave, Carter Caves, Carter Co., Kentucky, collected 25 June 1937 by K. Dearolf, in MCZ, examined; gonopods missing from vial.

Diagnosis. The small size of the subapical spine and the presence of a small tooth on the lateral colpocoxite (Fig. 141) are distinctive.

Description of male from Bat Cave. Length, 18 mm, A3 = 1.07 mm. Ocelli 20 on both sides, in 4 series, regular and well pigmented. Body pigmented as usual for epigeal and troglomorphic species. Segmental shoulders low to moderate; reduced to level of lateral striae on segments 20–22; dorsum nearly smooth anteriorly, with a few low rugae on midbody segments, be-

coming moderately well-defined elongate tubercles on posterior body segments; lateral striae moderately strong, 10–12. Anterior gonopods: median colpocoxite (Fig. 141) with subapical spine small but distinct; lateral colpocoxite (Fig. 141, 142) not divided, short, broad, evenly curved, with a small ventral tooth in most specimens. Telopodite process (Fig. 141) short, of the saberlike type. Telopodites (Fig. 141) quite large, curving forward. Posterior gonopods (Fig. 143) with coxal base somewhat more knobby than usual.

Description of female from Bat Cave. Length, 19.5 mm. A3 = 1.10 mm. Non-sexual characters as in male. Cyphopods (Fig. 144) with lateral valve bearing an anterior flange, both valves elongate, median valve slightly longer.

Distribution. Known only from the caves listed above, Carter Co., Kentucky. The record of a female from a rotted stump in Adams Co., Ohio (Williams and Heffner, 1928), has not been confirmed.

Notes. This species has been the subject of considerable confusion. Though Packard (1883) did not formally designate types, a series of specimens from the same caves he listed was found in the general collection in the MCZ, with labels in handwriting similar to that on the labels of other Packard specimens, and marked as "paratypes."¹ Included was a single male, labelled as being from Carter's Cave. The holotype male of *P. sodalis* Loomis, from Bat Cave, lacks gonopods. I compared the male from the Packard series with a collection of three males made in Bat Cave by T. C. Barr on 27 May 1957, and found agreement in all respects, except that the Packard specimen had each subapical spine double. In the absence of any other such specimen, I prefer to regard this as an anomaly.

The confusion is deepened by Cook and Collins' (1895) statement that their description of *P. carterensis*, which fits

Packard's specimens quite well, was drawn from material collected in Wyandotte Cave, Indiana, where only *P. indianae* Chamberlin and Hoffman is known to occur. It was implied that C. H. Bollman collected this material. It seems likely that it was mislabelled; nothing like *P. carterensis* has been collected in Indiana since.

Pseudotremia deprehendor n. sp.

Figures 145–147, Map 7

Types. Male holotype and a second male collected in Feather's Cave, 4 mi. east of Clinton, 2 August 1965 by J. Payne. The specific name is a noun in apposition and means "one who takes by surprise."

Diagnosis. The telopodite process is a long, double saber (Fig. 145), which also occurs in *P. merops*, but *merops* has only 12 ocelli while *P. deprehendor* has 20 or more.

Description of male holotype. Length, 21 mm, A3 = 1.25 mm. Ocelli 21 in 4 or 5 irregular series, well pigmented. Body pigmented as usual, light brown marked darker purplish brown. Segmental shoulders low, reduced to level of lateral striae about segment 23; dorsum with numerous low, elongate tubercles; lateral striae prominent, 10–12. Anterior gonopods: median colpocoxite (Fig. 145) with very long, slightly sinuous subapical spine; lateral colpocoxites (Figs. 145, 146) thin, rather small, spirally curved when seen in anterior view (Fig. 145) but curved inward, not outward as in *P. spira*. Telopodite process (Fig. 145) long, curved double saber type, curved through about one half of a circle. Telopodites small. Posterior gonopod (Fig. 147) with coxa quite flattened, two prominent mesal notches, second article expanded distally.

Female unknown.

Distribution. Known only from the type locality (Map 7). The occurrence of this species in Anderson Co., Tennessee, in the midst of the distributions of *P. cottus* and *P. cocytus*, two species that are closely related to each other but not at all to *P.*

¹ These may have been so marked by R. V. Chamberlin.

deprehendor, is remarkable. *P. depressendor* also shows some affinities with the *spira*-group.

Pseudotremia princeps Loomis
Figures 148–151

Pseudotremia princeps Loomis, 1939, Bull. Mus. Comp. Zool., 86: 168–170, figs. 1a–c, ♂.

Types. Male holotype from Eagle Cave, West Virginia, collected 22 April 1935 by K. Dearolf, in MCZ, examined.

The only Eagle Cave listed in *Caverns of West Virginia* (Davies, 1949: 163) is in Monongalia County, about 100 miles northwest of all other known localities for *P. princeps*, and is developed in the Greenbriar Limestone (Mississippian). The other localities are all in the Coeymans Limestone (Ordovician-Silurian) in Pendleton County. Neither Loomis (1939) nor Dearolf (1937) gives any details about the location of "Eagle Cave," and it seems likely to me that this name actually refers to an unlisted cave in Pendleton County. There is an Eagle Rock in Pendleton County. Such a wide distribution of a *Pseudotremia* species would be unique. The specific name means "largest" or "principal."

Diagnosis. A very large (30–36 mm long) species, *P. princeps* can be distinguished from its closest relatives (*P. simulans* and *P. tsuga*) by the basally very broad lateral colpocoxites (Fig. 146) divided into two large branches.

Description of male from Mystic Cave. Length, 32 mm, A3 = 1.70 mm. Ocelli 22 on both sides, in 5 or 6 series, well pigmented. Body with pigmentation typical of large epigeal species. Segmental shoulders strong, dorsum of anterior segments nearly flat, reduced to level of lateral striae by segment 20–22; dorsum with a few weak rugae on midbody segments; lateral striae 14–17, moderate. Anterior gonopods: median colpocoxites (Fig. 148) rather small, subapical spine short, straight; lateral colpocoxites (Figs. 148, 149) very broad at the base, divided, branches un-

equal, dorsal branch much the longest. Telopodite process (Fig. 149) a low, flattened swelling. Telopodites (Fig. 148) large and broad. Posterior gonopods (Fig. 150) as usual.

Description of female from Mystic Cave. Length, 37 mm, A3 = 1.72 mm. Nonsexual characters as in male. Cyphopods (Fig. 151) simple, valves distally flattened, lateral valve broader, shorter, than median valve.

Distribution. In addition to the type locality the following: WEST VIRGINIA: *Pendleton Co.*, Smoke Hole Cave, 1.1 mi. south of Branch, Pendleton Co., 20 April 1935, K. Dearolf, ♂♂ (Loomis, 1939); *Mystic Cave*, 0.4 mi. southwest of Teterton, 30 May 1952, L. Hubricht, ♂♀; east side of North Fork, 3.5 mi. southeast of Riverton, 22 May 1958, L. Hubricht, ♂.

Pseudotremia tsuga n. sp.
Figures 152–156, Map 8

Types. Male holotype and another male from Cranberry Glades Natural Area, near Mill Point, Monongahela National Forest, Pocahontas Co., West Virginia, collected 20 May 1967 by W. A. Shear and Paul Vogel; female paratype and another female from a marsh, Mill Point, Pocahontas Co., West Virginia, collected 23 May 1958 by L. Hubricht. The specific name is the generic name of the hemlock, and refers to the habitat of the holotype, a dense bog forest of hemlock.

Diagnosis. The small, recurved, ventral branch of the lateral colpocoxites (Fig. 150) and the short, saberlike telopodite process sets this species apart from the others of the group.

Description of male holotype. Length, 35 mm, A3 = 1.53 mm. Ocelli 25 in 6 series, well pigmented. Body pigmentation as usual in large epigeal species. Segmental shoulders strong, high, similar to those of *P. princeps*; dorsum with a few weak, elongate tubercles strongest on midbody segments; lateral striae 9–12, moderate. Anterior gonopods: median colpocoxites

(Fig. 152) short, slightly divergent, subapical spine curved dorsad; lateral colpocoxites (Figs. 152, 153) divided, ventral branch short, slender, recurved. Telopodite process (Fig. 153) of the short saberlike type. Telopodites (Fig. 154) slightly smaller than in *P. princeps*. Posterior gonopods (Fig. 155) similar to those of *P. princeps*, but slightly smaller.

Description of female paratype. Length, 30 mm, A3 = 1.50 mm. Nonsexual characters as in male. Cyphopods (Fig. 156) somewhat like those of *P. princeps*, but more irregular in outline.

Distribution. Known only from type localities (Map 8). Core (1955) has described the unusual relict area of Cranberry Glades. Barr (1967) found a species of the otherwise troglobitic carabid beetle genus *Pseudanophthalmus* on the surface at Cranberry Glades, many miles from any cavernous limestone. I have collected the boreal xystodesmid milliped *Semoniellus placidus* (Wood) nearby, the only West Virginia record; Hoffman (1969a) reports that *S. placidus* occurs primarily in the northern midwest, with a relict population in Virginia on high mountains.

Pseudotremia cavernarum Cope

Figures 157–160

Pseudotremia cavernarum Cope, 1869 (not Cook and Collins, 1895), Proc. Amer. Philos. Soc., 11: 179; Hoffman, 1958, Proc. Biol. Soc. Washington, 71: 113–118, figs. 1, 2, ♂.

Types. Type specimens collected by E. D. Cope in Erhart's Cave, 3 mi. southeast of Blacksburg, Montgomery Co., Virginia, believed destroyed.

Diagnosis. Distinguished from *P. hobbsi* by the much shorter subapical spines of the median colpocoxites in *P. cavernarum* (Fig. 157).

Description of male from Erhart's Cave. Length, 20 mm, A3 = 1.05 mm. Ocelli 15, irregularly arranged, weakly pigmented. Body light translucent brown. Segmental shoulders weak, body nearly cylindrical; dorsal surface smooth on anterior seg-

ments, posterior segments with row of small tubercles on posterior margins; lateral striae prominent, 12–14. Anterior gonopods: median colpocoxites erect (Fig. 157), divided, ventral branch much the longest. Telopodite process (Fig. 158) of the short saberlike type. Telopodites (Fig. 157) large. Posterior gonopods (Fig. 159) as usual.

Description of female from Erhart's Cave. Length, 21 mm, A3 = 1.00 mm. Nonsexual characters as in male. Cyphopods as in Figure 160.

Distribution. Known only from the type locality.

Notes. Before genitalic characters were widely used to distinguish species of millipeds, *Pseudotremia* was considered to contain only the single species, *P. cavernarum*; thus pre-1939 published records of this species are not reliable. Cook and Collins (1895) wrote their description of *P. cavernarum* from specimens collected in Wyandotte Cave, Indiana; Chamberlin and Hoffman (1958) provided the new name *P. indianae* for this material. It was not until 1958 that R. L. Hoffman published a detailed description of specimens collected at the type locality, the only place where *P. cavernarum* is known to occur. I visited the type locality in April, 1969, in company with Hoffman. Quarrying operations had blocked off the cave about 30 m from the entrance, and have since probably destroyed it completely.

Pseudotremia hobbsi Hoffman

Figures 1–5, 161–167, Map 8

Pseudotremia hobbsi Hoffman, 1950, J. Washington Acad. Sci., 40: 90–91, figs. 5, 6, ♂.

Types. Male holotype and many paratypes of both sexes from Chestnut Ridge Cave, 2 mi. north of Clifton Forge, Alleghany Co., Virginia, collected 31 March 1947 by R. L. Hoffman, in USNM, examined.

Diagnosis. Distinct from all other species of *Pseudotremia* in the unusually long sub-

apical spine of the median colpocoxite (Figs. 161, 162).

Description of male holotype. Length, 30 mm, A3 = 1.47 mm. Ocelli 19 on left side, 20 on right side, arranged in 5 series, pigmented. Body with typical pigmentation. Segmental shoulders strong, reduced to level of lateral striae about segment 20; dorsum moderately rough, 12–20 elongate tubercles on posterior portions of midbody segments; lateral striae rather weak, 14–16. Anterior gonopods: median colpocoxite (Fig. 159) with subapical spine as long as colpocoxite, erect; lateral colpocoxite not divided or with a small tooth (Fig. 160). Telopodite process of the saber type, moderately long (Fig. 161). Telopodites as usual. Posterior gonopods (Fig. 164) typical of larger species.

Description of female paratype. Length, 30 mm, A3 = 1.45 mm. Nonsexual characters as in male. Cyphopods (Fig. 167) similar to those of *P. cavernarum*.

Distribution. In addition to the type locality, the following (Map 8): VIRGINIA: *Alleghany Co.*, Quarry Cave at Lowmoor, 3 March 1948, R. Hoffman, ♂; Warm Springs Mountain, elev. 3600 ft., no date, L. Hubricht, ♂; *Montgomery Co.*, Slusser's Chapel Cave, 2 mi. northeast of Slusser's Chapel, 21 April 1968, J. Holsinger, ♂. WEST VIRGINIA: *Greenbriar Co.*, near Coffman Cave, 1.7 mi. west-southwest of Frankford, 11 April 1957, T. C. Barr, ♂ ♀ ♀; Higgenbotham Cave, 1.3 mi. west of Frankford, 11 April 1957, T. C. Barr, ♂ ♂; Dry Run Cave, 1.5 mi. west-northwest of Sunlight, 27 January 1968, J. Holsinger and R. Baroody, ♂; *Monroe Co.*, Greenville Saltpetre Cave, 0.4 mi. northeast of Greenville, 10 April 1969, W. A. Shear, L. Bayless, and N. Tuggle, ♂ ♂ ♀ ♀; Laurel Creek Cave, 1.5 mi. northeast of Greenville, 10 April 1969, W. A. Shear, L. Bayless, and N. Tuggle, ♂ ♂ ♀ ♀; Rock Camp Cave, 1.9 mi. southeast of Rock Camp, 1 July 1968, T. C. Barr, ♂ ♂.

Notes. Both this species and *P. cottus* have the most extensive known ranges of

epigean and troglomorphic species of *Pseudotremia*, and as in *P. cottus*, there is variability in the gonopods of *P. hobbsi*. Figures 163–165 show the variation in branching of the lateral colpocoxite in West Virginia (Greenbriar Valley) specimens. Virginia (James River drainage) specimens, and the types, have the colpocoxite unbranched (Figs. 161, 162). A detailed study of the variation awaits the collection of large samples from localities throughout the range of the species.

Pseudotremia sublevis Loomis

Figures 168–172, Map 8

Pseudotremia sublevis Loomis, 1944, *Psyche*, 51: 167–168, figs. 1A–C, ♂.

Types. Male holotype from Tony's (Tawney's) Cave, 8 mi. east of Pearisburg, Giles Co., Virginia, collected 9 May 1943 by H. W. Jackson, in MCZ, examined. The specific name means "lifted" or "supported."

Diagnosis. The small median colpocoxites in combination with the very large, L-shaped ventral branches of the lateral colpocoxites (Fig. 168) are unique.

Description of male holotype. Length, 28 mm. A3 = 1.45 mm. Ocelli 19, in 6 series, well pigmented. Body with the usual pigmentation. Segmental shoulders moderate, reduced to level of lateral striae about segment 20–22; dorsum as in *P. cavernarum*, nearly smooth; lateral striae 15–17, prominent. Anterior gonopods: median colpocoxites (Figs. 168, 169) small, short, simple, subapical spine lacking; lateral colpocoxites divided (Fig. 168), ventral branch enlarged, L-shaped, extending straight ventrad, gland channel following dorsal branch, which curves evenly mesad. Telopodite process (Fig. 168) of the short, saberlike type, with a large knob at the base. Telopodites as usual. Posterior gonopods (Fig. 170) typical of larger species.

Females unknown.

Distribution. In addition to the type locality, the following: VIRGINIA: *Giles Co.*,

Spruce Run Mountain Cave, 0.5 mi. south of Maybrook (Hoffman, 1958); sinkhole 5 mi. west of Newport, 16 June 1962, R. Hoffman. ♂: *Montgomery Co.*, Dry Run, 5 mi. east of Blacksburg, 10 April 1969, W. Shear, R. Hoffman, L. Knight, ♂.

Notes. The specimen from the sinkhole near Newport differs from the holotype in the form of the ventral branch of the lateral colpocoxite; compare Figures 171 and 172.

Genus *Solaenogona* Hoffman

Solaenogona Hoffman, 1950, *J. Washington Acad. Sci.*, 40: 91; Loomis, 1968, *U. S. Nat. Mus. Bull.*, 266: 69 (list).

Type species. *Solaenogona guatemalana* Hoffman, by original designation. The generic name is a feminine Latin neologism, and indicates relationship to the genus *Cleidogona*, and the grooved branch (solenomerite) of the gonopods.

Diagnosis. The enormous processes developed from the posterior surfaces of the colpocoxites of the anterior gonopods and the much reduced telopodites distinguish this genus from the others of the Cleidogonidae.

Description. Thirty segments. Mentum divided. Antennae moderately long, shorter than in *Pseudotremia*. Ocelli always present. Body fusiform, evenly tapering posteriorly in males from segment 7. Segments cylindrical, segmental setae short, acuminate. Surface of segments smooth, without lateral striations. Pregonopodal legs of males: legs 1 and 2 6-segmented, reduced slightly in size. Legs 3 through 7 much enlarged, crassate, tarsi with special setae. Anterior gonopods (Figs. 173, 177): very large and prominent, colpocoxites apically complex, with lateral emarginations and several apical processes, posteriorly with a large, heavy process curving ventrad to meet tip of colpocoxite. Telopodites basally fused, not movable, small. Posterior gonopods (Fig. 175): sternum bandlike, weakly sclerotized. Usually with 5 or 6 segments,

coxae enlarged, not conspicuously lobed, remnants of coxal sacs near base of coxae; second segment sometimes not distinctly set off from coxa. elongate, roughly cylindrical; third segment similar to second, always distinct; 3 distal segments usually fused; claw present or absent. Cyphopods (Figs. 176, 180): typical of the family, postgenital plate present, of various forms.

Distribution. Highlands of western Guatemala and adjacent Chiapas, Mexico; Map 9.

Notes. This genus is a particularly significant one from an evolutionary standpoint, since it combines some of the characters of *Pseudotremia* and *Cleidogona*. The present limited range of *Solaenogona* near the southern periphery of the range of the family seems to indicate a less progressive, perhaps primitive form now restricted in its distribution by competition from the more highly adapted species of *Cleidogona* occurring in southern Mexico. It seems likely that *Solaenogona* was derived from the same ancestral stock as *Pseudotremia*, but at a slightly later time, when some changes toward a *Cleidogona*-like form had already taken place. See the section above on generic relationships.

There are analogies (homologies?) in the gonopods of *Solaenogona* and *Pseudotremia*. The grooved colpocoxite of *Solaenogona* may correspond to the lateral colpocoxite of *Pseudotremia*, and *Solaenogona*'s massive posterior colpocoxite process, which has a fringed tip and probably functions in spermatophore transfer, may be homologous to the median colpocoxite of *Pseudotremia*.

KEY TO SPECIES OF *SOLAENOGONA*

- 1a. Apical spine of colpocoxite of gonopods (Fig. 173) acuminate; postgenital plate of females without a median shieldlike part (Fig. 176) *guatemalana*
- 1b. Apical spine of colpocoxite of gonopods (Fig. 177) with an expanded plate at the tip; postgenital plate of females with a median shield (Fig. 180) *chiapas*

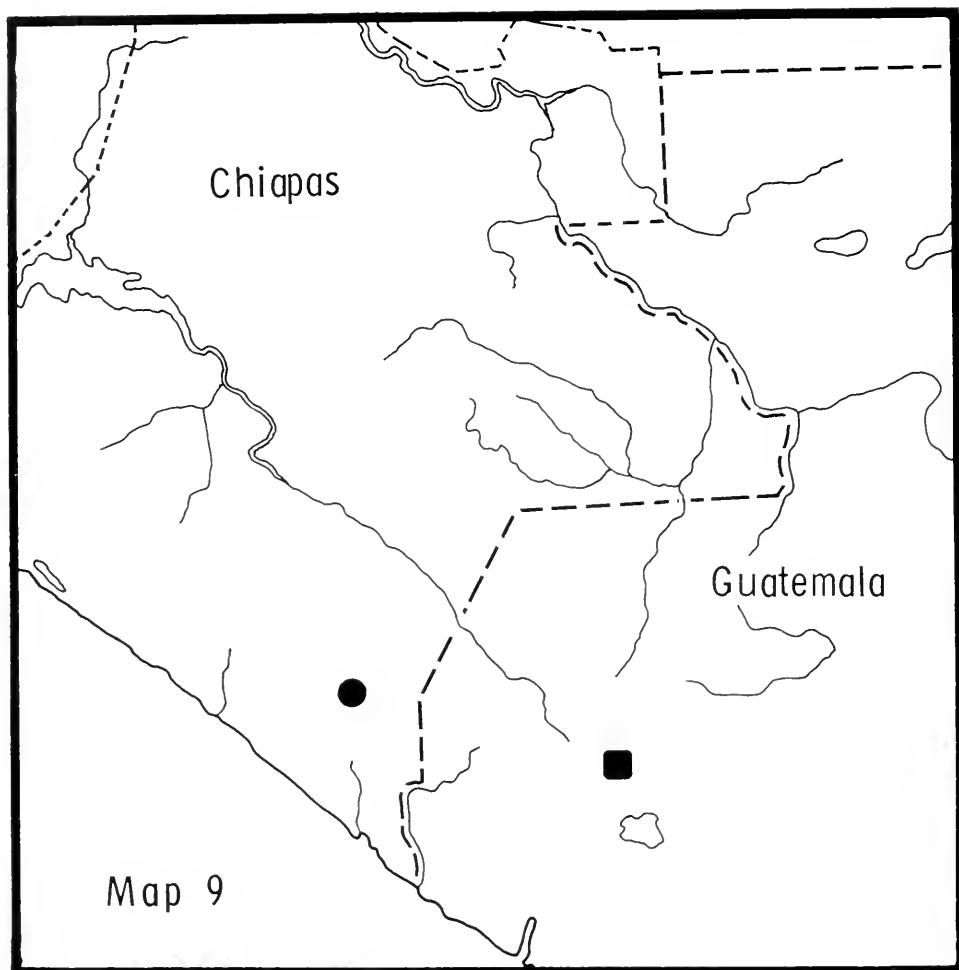

Map 9. Chiapas, Mexico, and western Guatemala, showing distribution of species of the genus *Salaenogona*. Dot, type locality of *S. chiapas*; square, type locality of *S. guatemalana*.

Solaenogona guatemalana Hoffman
 Figures 173–176

Solaenogona guatemalana Hoffman, 1950, *J. Washington Acad. Sci.*, 40: 91–92, figs. 1, 2, 4, ♂; 3, ♀.

Types. Male holotype, female paratype, and many other specimens from between Santa Cruz del Quiché and Totonicapán (“Santa Cruz Quiché” and “Totonicapam” in original description), collected 16 May 1906 by O. F. Cook, deposited in USNM (No. 1883), examined.

Diagnosis. Distinct from *S. chiapas*, the only other known species, as indicated in the above key.

Description of male holotype. Length, 22.5 mm, A3 = 1.15 mm. Ocelli 28 on both sides, in 7 regular series. Pigmentation as usual in *Cleidogona*, olive-brown with segmental muscle scars pale brown to white. Anterior gonopods: sternum produced into notched extension between coxae; colpocoxites massive, well sclerotized (Fig. 173), in anterior view with a depression in frontal area, lateral emargination poorly de-

veloped; subapical and apical spines both narrow and acuminate. In lateral view (Fig. 174), posterior process of colpocoxite massive, rounded, narrowest near attachment to colpocoxite, distally cupped and fringed. Telopodites small, pointed, abruptly angular, basally fused. Posterior gonopods (Fig. 175): coxa with vestigial gland opening prominent near base, second and third segments subequal, second segment slightly clavate; distal three segments fused, indistinct, claw present. Legs 10: coxae elongate, sinuous, depressed, bearing glands, lacking knobs or plates. Legs 11: similar to legs 10. Sternum 12: median process bulbous, with small distal hook.

Description of female paratype. Length, 21 mm, A3 = 1.15 mm. Nonsexual characters as in male. Cyphopods (Fig. 176): similar to those of *Cleidogona*, quite distinct from those of species of *Pseudotremia*; valves basally fused, lateral valves the broadest; postgenital plate low, weakly sclerotized, without a median shield.

Distribution. Known only from the type locality.

Solaenogona chiapas n. sp.

Figures 177–180

Types. Male holotype, female paratype, and several other specimens of both sexes from 33.7 mi. north of Huixtla, Chiapas, Mexico, elev. 6000 ft., collected 26 February 1966 by G. Ball and D. Whitehead. The specific name is a noun in apposition and refers to the type locality.

Diagnosis. Distinct from *S. guatemalana* in the characters mentioned in the key, and other details of the gonopods.

Description of male holotype. Length, 23 mm, A3 = 1.17 mm. Ocelli 28 on each side, in 6 series, plus single ocellus. Coloration like that of *S. guatemalana*. Anterior gonopods: stemum subquadrate (Fig. 177), not produced between coxae as in *S. guatemalana*; colpocoxites very elaborate, lateral emargination deep, subtended by curved, transparent plate with serrate margins; subapical spine with 2 branches, anterior-

most evenly curved laterad, posteriormost extending posteriad, then sharply ventrad and evenly curved anteriad; apical spine ending in small plate. Posterior process larger, more robust than in *S. guatemalana*, broader at point of attachment. Telopodites small, irregular, basally fused, embracing posterior processes of colpocoxites and fitting into special recesses on posterior processes (Fig. 178). Posterior gonopods: suture between coxa and second segment indistinct (Fig. 179). 3 apical segments fused, claw absent. Legs 10 and 11: as described for *S. guatemalana*.

Description of female paratype. Length, 23 mm, A3 = 1.15 mm. Nonsexual characters as in male. Cyphopods: valves distinctly overlapping (Fig. 180); postgenital plate with large, heavily sclerotized median shield.

Distribution. Known only from type locality.

Genus *Cleidogona* Cook

Cryptotrichus Packard, 1883, Proc. Amer. Philos. Soc., 21: 189; preoccupied by *Cryptotrichus* Schaufuss 1865 (Coleoptera).

Campodes, Bollman, 1893, U. S. Nat. Mus. Bull., 46: 120. Not *Campodes* C. L. Koch.

Cleidogona Cook, 1895, in Cook and Collins, 1895, J. New York Acad. Sci., 9: 3; new name to replace *Cryptotrichus* Packard. Cook and Collins, 1895, Ann. New York Acad. Sci., 9: 41; Hoffman, 1950, J. Washington Acad. Sci., 40: 88–89 (key and list of species); Chamberlin and Hoffman, 1958, U. S. Nat. Mus. Bull., 212: 89–92 (list of species); Loomis, 1968, U. S. Nat. Mus. Bull., 266: 66–68 (list of species).

Mexiceuma Verhoeff, 1926, Zool. Anz., 68: 112; Hoffman, 1950, J. Washington Acad. Sci., 40: 90 (key and list of species); Loomis, 1968, U. S. Nat. Mus. Bull., 266: 68 (list of species). NEW SUBJECTIVE SYNONYMY.

Rhabdarona Chamberlin and Mulaik, 1941, J. New York Entomol. Soc., 49: 60; Hoffman, 1950, J. Washington Acad. Sci., 40: 91 (key and list of species); Chamberlin and Hoffman, 1958, U. S. Nat. Mus. Bull., 212: 96 (list of species). NEW SUBJECTIVE SYNONYMY.

Cavota Chamberlin, 1942, Bull. Univ. Utah, 33: 8; Hoffman, 1950, J. Washington Acad. Sci., 40: 89 (key and list of species); Loomis, 1968, U. S. Nat. Mus. Bull., 266: 66 (list of species). NEW SUBJECTIVE SYNONYMY.

Hirsutogona Kraus, 1954, *Senck. Biol.*, 35: 329; Loomis, 1968, *U. S. Nat. Mus. Bull.*, 266: 68 (list of species). NEW SUBJECTIVE SYNONYMY.

Mecistopus Loomis, 1959, *J. Washington Acad. Sci.*, 49: 162. NEW SUBJECTIVE SYNONYMY.

Acakandra Loomis, 1964, *Fieldiana*, 47: 99; 1968, *U. S. Nat. Mus. Bull.*, 266: 66 (list of species). NEW SUBJECTIVE SYNONYMY.

Costaricia Loomis, 1966, *Proc. Biol. Soc. Washington*, 79: 226; 1968, *U. S. Nat. Mus. Bull.*, 266: 66 (list of species). NEW SUBJECTIVE SYNONYMY.

Type species. Of *Cleidogona*, *Spirostrephon caesioannulatus* Wood, by original designation; of *Mexiceuma*, *M. maculata* Verhoeff, by monotypy; of *Rhabdarona*, *R. bacillipus* Chamberlin and Mulaik, by monotypy; of *Cavota*, *C. crucis* Chamberlin, by monotypy; of *Hirsutogona*, *H. minutissima* Kraus, by original designation; of *Mecistopus*, *M. varicornis* Loomis (= *Cleidogona bacillipus* Chamberlin and Mulaik), by monotypy; of *Costaricia*, *C. curvipes* Loomis, by monotypy; of *Acakandra*, *A. austrina* Loomis, by monotypy.

Loomis (1966) correctly interpreted the proposal of the generic name *Cleidogona*. Cook proposed the name in an introductory note to the revision of the North American Craspedosomatidae published by Cook and Collins (1895). In a footnote, Cook clearly states that the name is to replace the pre-occupied *Cryptotrichus* Packard; as the type species of *Cryptotrichus* was *Spirostrephon caesioannulatus* Wood, *caesioannulatus* must be the type species of *Cleidogona* as well. Most later authors have followed Cook and Collins (1895) in considering *C. major* the type of *Cleidogona*, a proposal they (Cook and Collins) made with the expectation that *C. major* would eventually fall as a synonym of *C. caesioannulata*, a peculiar idea, since they had the correct concept of *caesioannulata* to begin with. The gender of the name *Cleidogona* is feminine; the meaning is obscure.

Notes on synonymy. The genus *Mexiceuma* was erected by Verhoeff on *M.*

maculata in 1926, and was made the type genus of the family Mexiceumidae. This is yet another example of Verhoeff's astonishing tendency to publish a bewildering series of names without examining related material. *Mexiceuma maculata* is a perfectly typical species of *Cleidogona*, and in fact has been described under new names in that genus twice since Verhoeff's original account. *Rhabdarona bacillipus*, type species of *Rhabdarona*, and *Mecistopus varicornis*, type species of *Mecistopus*, are synonyms. The species is a typical *Cleidogona*, northernmost representative of the Mexican group centering around *C. maculata*. Both genera were based primarily on characters of the posterior gonopods now known to be common to many species of *Cleidogona*. Likewise, *Cavota*, with its single species *C. crucis*, was set up because Chamberlin (1942) considered the presence of an extra segment in the posterior gonopods a generic character; it is not. *Hirsutogona* cannot be differentiated from *Cleidogona* on the characters given by Kraus (1954); the species listed by Kraus as belonging here are members of several different species groups of *Cleidogona*, and the type species, *H. minutissima*, has some of the characters of *Dybasia*. *Costaricia* was diagnosed by the cleft tip of the twelfth sternal process; this is not a generic character, and is found in other *Cleidogona* species. Unfortunately, the unique male holotype of *Acakandra austrina* had no gonopods with it, but the great similarity between that species and *Cleidogona atoyaca* of the species group near *C. minutissima* precludes recognizing the genus as distinct.

Diagnosis. Distinct from *Pseudotremia* and *Solaenogona* in lacking a colpocoxite branch bearing a gland channel; from *Dybasia* in having the sternite of the anterior gonopods completely fused to the coxae; and from *Tiganogona* in the greater complexity of the anterior gonopods and lesser complexity of the posterior gonopod coxae.

Description. Thirty segments. Mentum divided (Fig. 181). Antennae long, article 3 the longest. Ocelli always present, infrequently reduced in number and pigmentation. Body fusiform, widest in males at segment 7, tapering evenly posteriad. Majority of species with nearly cylindrical body segments (Fig. 382), segmental setae on very low tubercles, but some species with 2 outer segmental setae on prominent tubercles (Fig. 274) resembling *Conotyia* (Conotylidae). Surface of segments always smooth, dorsum evenly rounded. Segmental setae small to quite prominent, never spatulate, even in troglobitic species. Sides of segments without prominent lateral striations. Pregonopodal legs of males: legs 1 and 2 slender, 6-segmented, genital openings on second coxae not prominent. Legs 3 through 7 (Fig. 182) strongly crassate, prefemora and femora enlarged and strongly curved mesad. Coxae of legs 7 usually with prominent posterior knobs. Anterior gonopods: highly modified (Figs. 184, 185). Sternum fused to base of coxae, usually extending between colpocoxites for half their length as weakly sclerotized, depressed area. Strong lateral suture from spiracle setting off lateral sternal sclerites. Coxae small, irregular, not fused to one another, extending about half the length of colpocoxites laterally, drawn out anteriorly into prominent knob at juncture of sternum and colpocoxites, usually with lateral patch of setae. Colpocoxites large, variously complex, or simple and falcate, with at least part of posterior margin finely lacinate, fused narrowly to each other in proximal midline. Telopodites sometimes nearly absent, reduced to small knobs at posterior base of coxae, but usually at least one-third length of colpocoxites, sometimes fused basally, but muscularized and movable, simple in shape, usually clavate or spatulate. Posterior gonopods: sternum weak, bandlike. Coxae enlarged, variously lobed; telopodites reduced, 5- to 2-segmented, claw always present. Tenth and

eleventh legs with coxae much elongate, sigmoid, bearing coxal glands. Tenth coxae (Fig. 304) sometimes with prominent coxal knob distal to gland opening; eleventh coxae (Fig. 313) usually with sclerotized shelf distal and posterior to gland opening. Twelfth sternite (Fig. 314) usually with anterior peg extending between coxae of tenth and eleventh legs, of various forms. Twelfth coxae somewhat enlarged. Female cyphopods: valves subglobular, but frequently with serrate laminae posteriorly (Fig. 216), moderately setose. Postgenital plate (Fig. 186) usually present, of various forms.

Distribution (See Maps 10, 11). Highlands of Panama, Costa Rica, El Salvador, Honduras, Guatemala: Chiapas Plateau in Mexico north through Central Highlands to southern San Luis Potosí, and in Sierra Madre Oriental to Sierra de el Abra in Tamaulipas (troglobitic species); coastal Oaxaca, Veracruz, Volcán de Colima in Jalisco; from northern Nuevo León to Big Bend region in Texas; North American coastal plain from Mississippi to central Florida north to Virginia, Appalachian Mts. from west central Pennsylvania to Alabama; interior foothills and plains west to Illinois, Missouri, and Arkansas.

Gonopod Anatomy of *Cleidogona*

The gonopods of *Cleidogona major* are typical of those species of *Cleidogona* in which the telopodites are large and movable. The description below is based on material cleared in trypsin.

In an anterior view (Fig. 184), the thin, bandlike portion of the sternum (*S*) is readily apparent. The arms that extend laterad of the origin of the tracheal apodemes (*TA*) are slightly forked, and fused to the lateral sternal sclerites (*S*) by an immovable, or only slightly movable, joint. The gonopod coxae (*C*) articulate with the lateral sternal sclerites by means of a basal coxal bar (*CB*). The membranous front plate (*FP*) of the sternum is also attached

to the coxae, strongly so near the anterior coxal knobs (*CK*). In uncleared preparations, a large deltoid muscle inserts on the inner surface of this knob, originating on the tracheal apodeme of the opposite side. The colpocoxites (*CC*) are not movable at their joint with the coxae. They are contiguous in the midline and in uncleared preparations often give the impression of being fused there. In posterior view (Fig. 185), it can be seen that the sternum is incomplete posteriorly, the two lateral sternal selerites (*LSS*) being connected by a membrane. Two posterior coxal arms (*CA*) meet in the midline. The telopodites (*T*) are basally fused, and are inserted through a membrane connecting the mesal faces of the coxae with the posterior faces of the colpocoxites (*CC*). The proximal portions of the telopodites turn sharply distad, and receive strong muscles both from the tracheal apodemes (*TA*) and coxae. They are freely movable in cleared preparations. The colpocoxites (*CC*) have a sub-apical lacinate lobe, on which, in freshly killed animals, masses of sperm are sometimes entangled.

There are many additional modifications in other species, but the same basic plan is followed throughout the genus *Cleidogona*, the coxae being particularly similar from species to species. As already seen, in some members of the *major*-group, the apical part of the coxa is drawn out into a process situated about halfway in the length of the colpocoxite. In members of the *caesioannulata*-group (*Cleidogona caesioannulata*, Fig. 380) this process forms a fairly large plate. In members of the genus *Solaenogona* (*Solaenogona chiapas*, Fig. 178) the coxal process is enormous, and is the largest part of the anterior gonopods. In *Cleidogona celerita* (Fig. 374) the colpocoxites are very much expanded posteriorly. In *C. fustis* (Fig. 398) they are reflexed anteriorly and deeply notched. In many Mexican species (*C. baroqua*, Fig. 197) they are extremely complex, with numerous spines and knobs. The telopodites vary greatly in

size, from almost equal to the colpocoxites (*C. fustis*, Fig. 398), to practically absent (*C. stolli*, Fig. 276). There is no trace of the telopodites in *C. atoyaca* (Fig. 282). In the peculiar *C. forficula* (Figs. 190, 191) the telopodites are as large as the colpocoxites and are wrapped around them.

Cyphopod Anatomy of *Cleidogona*

The cyphopods of members of the genus *Cleidogona* differ in a number of ways from those of *Pseudotremia* species. In *Cleidogona major*, most of the typical features are well developed. In Figure 186, the cyphopod complex and associated leg coxae are seen in posterior view. The coxae of the second legs (*C*) extend lateral to the cyphopods. The coxae of the third legs are not strongly modified, but are slightly excavate to receive the cyphopod valves when they are not extended. As in *Pseudotremia hobbsi*, each cyphopod is composed of four main parts, seen to greater advantage in Figure 183, a ventral view of a single cyphopod. The lateral and mesal valves (*LV*, *MV*) are fused posteriorly, and the mesal valve is the largest (compare Fig. 186). The seminal receptacle, seen between the valves in Figure 186, consists of a group of teardrop-shaped sacs. The receptacle (*R*, Fig. 183) is much smaller than in *P. hobbsi*. The oviduct pore (*O*) is surrounded by two pairs of post-receptacular bars (*PB*). Unique to many species of *Cleidogona* is the postgenital plate (*PP*, Fig. 186), bearing ventral extensions of various shapes. This structure probably develops from the posterior parts of the second leg coxae, and is extremely useful in taxonomy.

Other Taxonomic Characters

The modifications of coxae 10 and 11 and sternum 12 of males are often of value. Size, as in *Pseudotremia*, is best estimated by the length of the third antennal article (see Diag. 6).

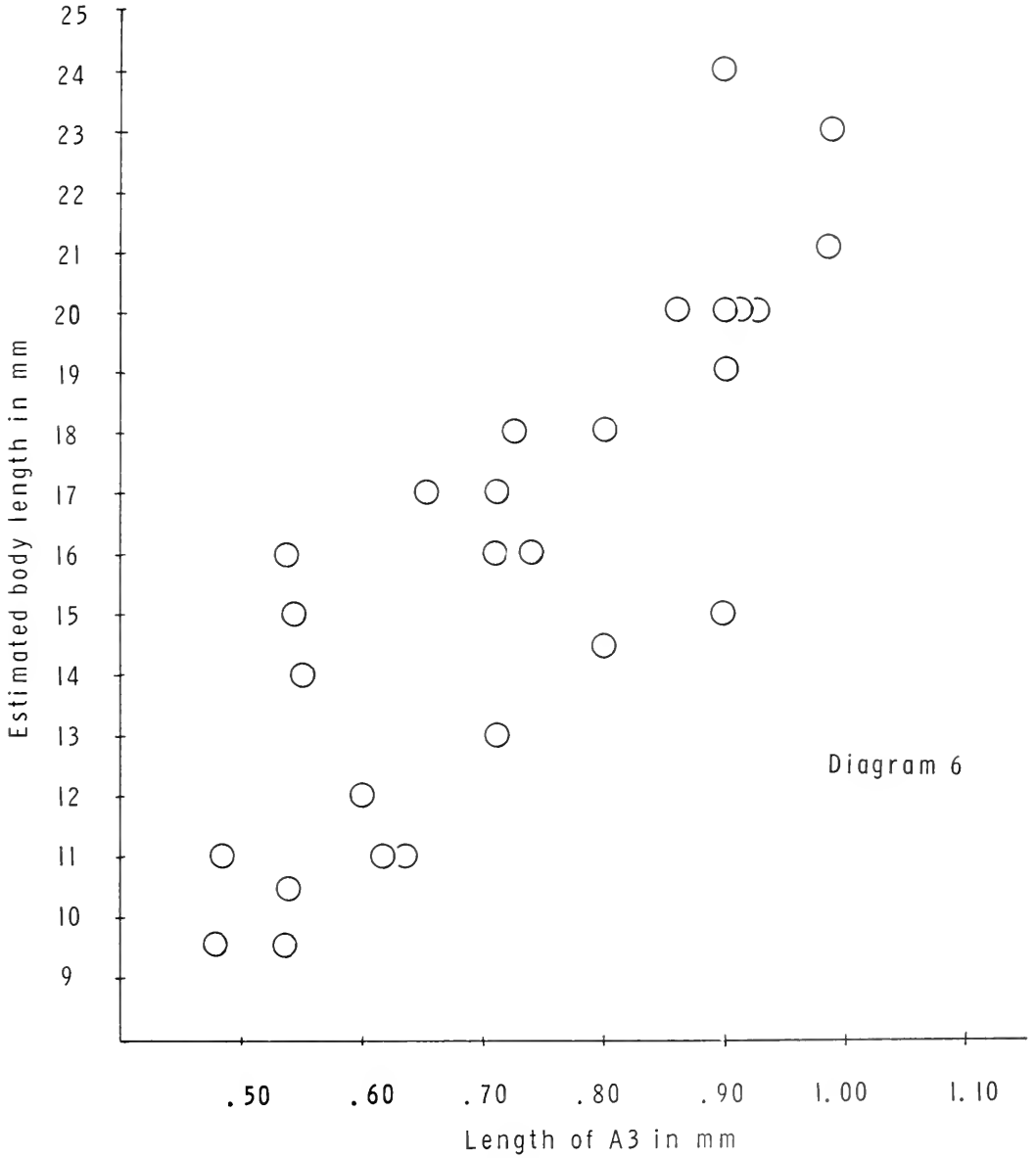
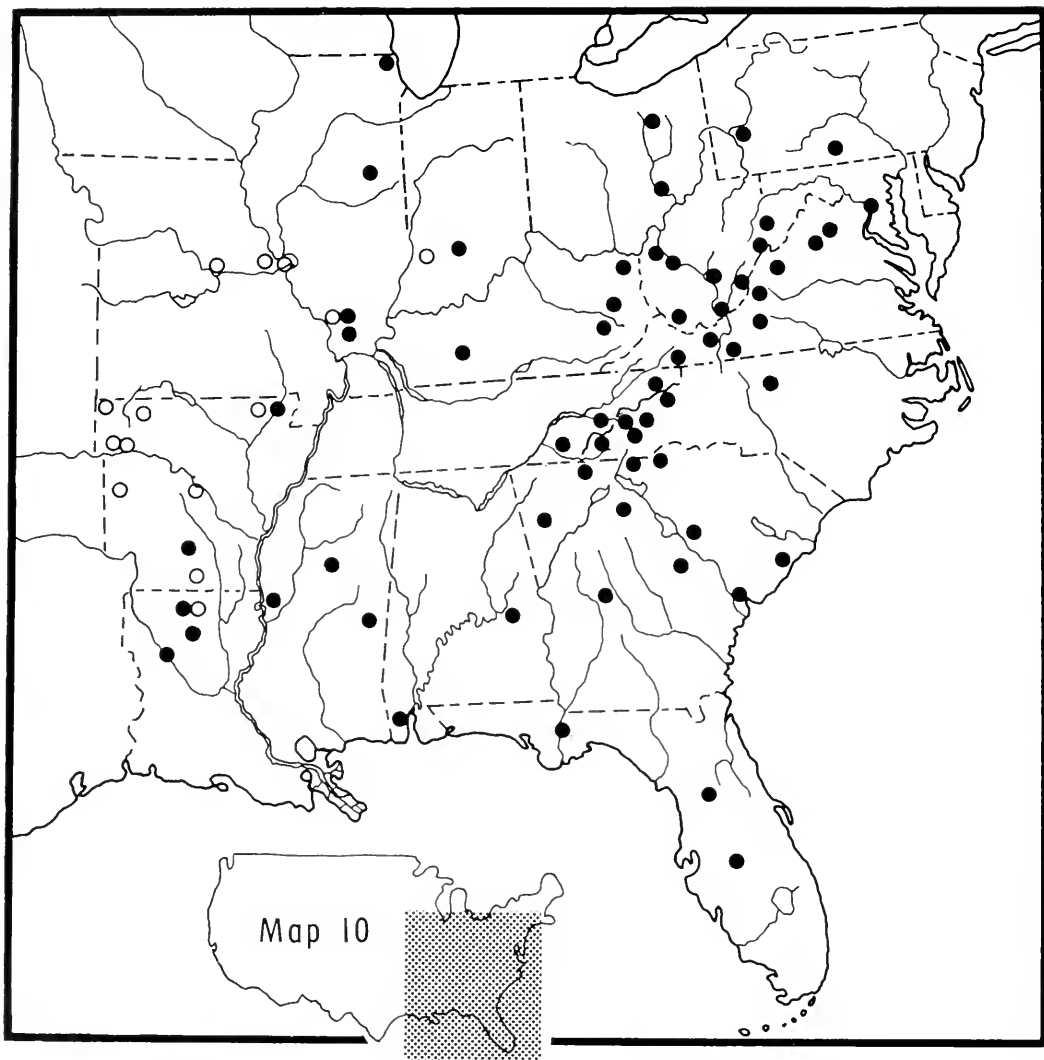

Diagram 6. Graph showing relationship between estimated body length and length of antennal segment three (A3) in holotypes of 27 species of *Cleidogona*.

Evolution, Zoogeography and Species Groups in *Cleidogona*

The evolution of the genus *Cleidogona* is much more difficult to deal with than it is in the genus *Pseudotremia*; there are

many more species of *Cleidogona*, and the range of the genus is enormously larger. There are also a few species that seem more or less unrelated to the genus as a whole, and which, applying past standards,



Map 10. Eastern United States, showing distribution of species of *Cleidogona* (dots) and *Tigonogona* (circles).

might even be considered as representing separate genera. In view of these difficulties, the following discussion is presented piecemeal, each species group being taken up in turn, under the larger geographical headings of Mexican and North American species. The species groups are not well defined; they consist of species that appear to be related through gonopod anatomy and geographical distribution, but I think

they are more natural than the species groups of *Pseudotremia*.

The Mexican Species

Having already indicated in the discussion of the evolution and zoogeography of the family Cleidogonidae given above that I believe the genus *Cleidogona* to have originated in the southern Mexican highlands, it seems most appropriate to

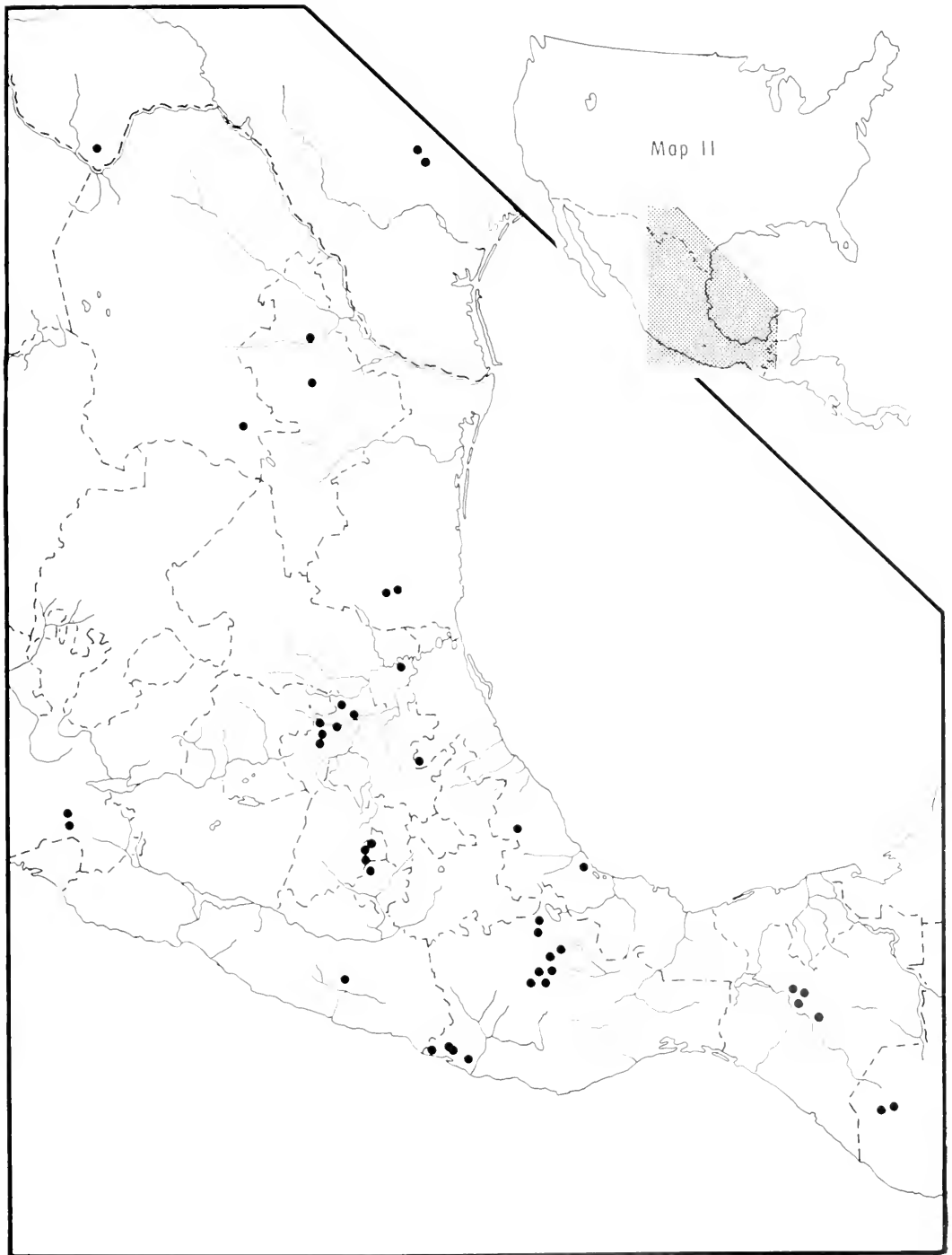

Map 11. Central Mexico and western Guatemala, showing distribution of *Cleidagana* species (dots). The genus also occurs in Honduras, El Salvador, Costa Rica, and Panama.

begin the discussion of *Cleidogona* with the Mexican species groups that appear to be most primitive, i.e., most like *Solaenogona* and *Pseudotremia*.

Ceibana Group. This group contains the single species, *C. ceibana*, unique in many ways. In an anterior view of the gonopods (Fig. 188), a groove can be seen that recalls the gland channel of *Solaenogona*, and the colpocoxites as a whole are complex. The telopodites apparently curve around the colpocoxites, but they are broken off in the unique type. Until more species are discovered in this group, its relationship to the rest of the genus is obscure.

Crucis Group. As in *Solaenogona*, the colpocoxites are extremely complex but, unlike that genus, the telopodites of this group are large and movable. The distribution of the group, with many distinct species in the highlands of Oaxaca and extending northward into Veracruz, needs clarification. I think only about half of the species have been described. The posterior gonopods assume a variety of forms and the females have the cyphopod complex more or less elaborate. The evidence of gonopod morphology and distribution indicates that this portion of the genus is most closely related to *Solaenogona*, possibly excepting *C. ceibana*. I believe the complexity of the gonopods is a primitive character, not an advanced one.

Crystallina Group. The two species of this group occur in caves in the Sierra de el Abra region of Tamaulipas and are intermediate in gonopod structure between the *crucis*-group and the *maculata*-group. The colpocoxites are somewhat simplified, and the telopodites are still large and movable. The occurrence of this group in caves, with some troglotic modifications, may indicate that the *maculata*-group (see below) differentiated in the Pleistocene, since climatic events of that epoch are generally believed responsible for cave relict populations (Mitchell, 1969). I believe the group to be derived from the *crucis*-group,

and possibly ancestral to the *maculata*-group.

Maculata Group. In this large group, the colpocoxites are simple, bladelike, and have a nearly right-angled bend in the apical third. The telopodites are of moderate size or reduced, and are usually movable. The group occurs with the greatest variety of species in the Mexican Central Highlands, in the states of Querétaro and the Mexican Federal District, extending northward into Coahuila, San Luis Potosí and into south Texas in the United States. The great number of species and the extension of the range northward indicate that this is a progressive, rapidly speciating group of recent origin. The *maculata*-group is related to the more primitive *crucis*-group through the intermediate *crystallina*-group.

The evidence from gonopod morphology and distribution shows that the North American members of the genus (and likewise the species of *Tiganogona*) are probably descended from a stock near the dividing point between the *crystallina*- and *maculata*-groups (Diag. 7). The present hiatus in the distribution of the genus in the Great Plains may point to a pre-Pliocene date for this movement into North America.

Godmani Group. The *godmani*-group, occurring in Oaxaca and Veracruz, with one species in Querétaro, is a minor offshoot from the *crucis*-group. There are some resemblances to species of the *maculata*-group, but these may be due to convergence. Species of the *godmani*-group are smaller, and the gonopods lack the right-angled bend found in those of the species of the *maculata*-group.

Forficula Group. The very peculiar *C. forficula* may be a development from the *godmani*-group. The gonopods are unique in the Cleidogonidae (Figs. 190, 191).

Rafaella Group. This group represents a parallel development with the *maculata*-group, arising from the *crucis*-group. The gonopod colpocoxites are simple, but very

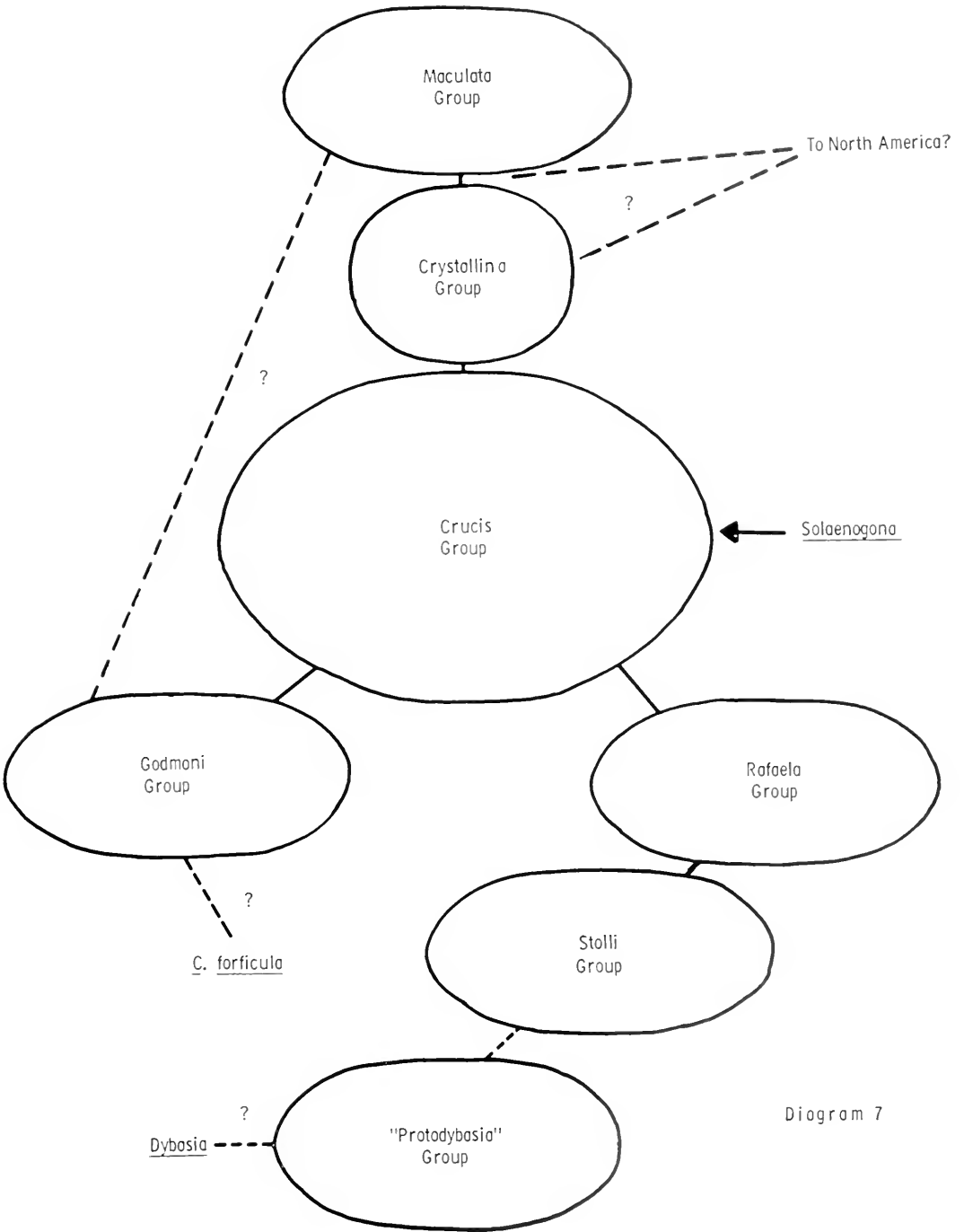

Diagram 7

Diagram 7. Possible relationships between species groups of Mexican and Central American *Cleidogana* and *Dybasia*. Lines do not imply direction of evolution unless tipped with an arrowhead. Species groups arranged roughly as they are distributed geographically.

broad in lateral view, and are not bent at a right angle. The telopodites are moderate to small in size. The group as a whole is distributed to the south of the *crucis*-group, in Chiapas and Oaxaca. While the development of the *maculata*-group line has led to the North American species, it seems likely that the *rafaela* line of development has spread southward along the mountain spine of Central America and has given rise to the genus *Dybasia* at its southernmost extension (Diag. 7).

Stolli Group; Proto-Dybasia Group. Both of these groups occur in Chiapas and Guatemala, and represent offshoots from the *rafaela*-group that are intermediate between *Cleidogona* and *Dybasia*. The small, simple colpocoxites, greatly reduced telopodites, and, in the *Proto-dybasia*-group, the sternal processes, all indicate a relationship with *Dybasia* species of Panama, the southernmost representatives of the family.

Summary of discussion of Mexican species. Diagram 7 graphically summarizes the relationships of the various groups of Mexican species. The ovals representing species groups are roughly positioned in the geographical relationship that exists in nature. The *crucis*-group is central to the scheme and is considered the most primitive because of its similarity to the species of *Solaenogona*. Historically, all that can now be said with some assurance is that the genus *Cleidogona* originated from *Solaenogona*-like ancestors and distributed northward through the highlands and mountain ranges of Chiapas, Oaxaca, and Veracruz, gradually differentiating into the *maculata* line in the north, and progressing more slowly southward to differentiate eventually into *Dybasia*. This process has doubtless taken a very long period of time, with many intervening periods of rapid speciation and expansion and of extinction and contraction, these latter resulting in enigmatic single-species remnants like *C. ceibana* and *C. forficula*.

The North American Species

The North American species of *Cleidogona* are probably derived from a Mexican stock close to the present *crystallina*- and *maculata*-groups. The evidence for this is indirect, but there are a few species in Mexico that somewhat resemble species of the *major*-group in North America. With the exception of *C. chisosi*, the North American species form a compact series difficult to separate into species groups.

Chisosi Group. This group contains the single species, *C. chisosi*. It appears to be quite unrelated to any other species of *Cleidogona*, and may later require a separate generic name.

Major Group. This is a very large group of species that has its center of diversity in the south-central Appalachians. The apex of the colpocoxite is divided, and the anterior division may be shieldlike. The coxae bear a posterior projection. The telopodites are large and movable, but not distally clasplike. I consider this group to be derived from Mexican ancestors closely related to the *crystallina*-group, that is, branching off the main line of *Cleidogona* before the trend toward simplification of the gonopods had gone as far as in the species of the *maculata*-group. There has obviously been a great deal of speciation in the Appalachians in the *major*-group, much of it perhaps as recently as the Pleistocene, producing a very close-knit group of similar species. A similar situation exists in several other milliped genera (Hoffman, 1969a). With the possible exception of the species assigned in this study to the genus *Tiganogona*, all of the other North American species groups of *Cleidogona* are satellites of the *major*-group.

Caesioannulata Group. The distribution of the species of this group overlaps with that of species of the *major*-group in western Virginia and North Carolina, and extends westward to Illinois and north to Pennsylvania. The divided tip of the colpocoxite is bent sharply at a right angle, and the coxal projection is large, subquadrate,

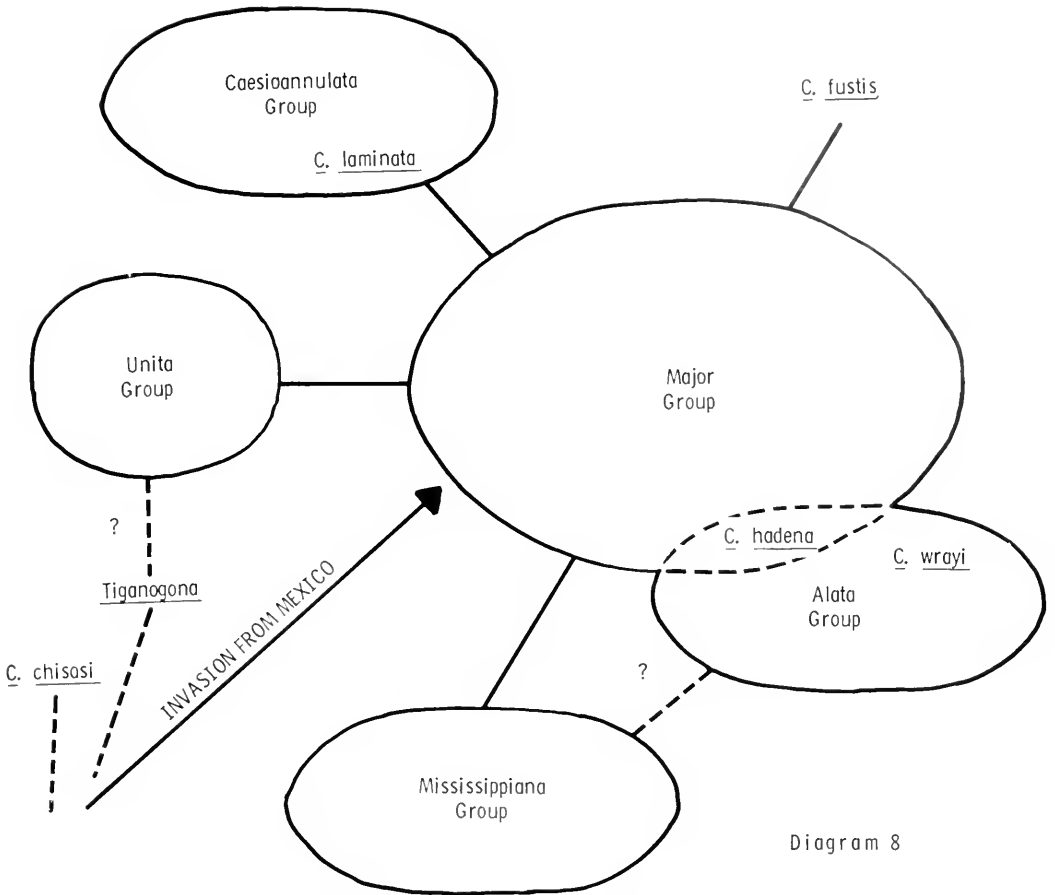

Diagram 8

Diagram 8. Possible relationships between species groups of North American *Cleidogona* and *Tiganogona*. Lines do not imply direction of evolution unless tipped with an arrowhead. Species groups are arranged roughly as they are distributed geographically; compare Map 10.

or much inflated (*C. celerita*). The telopodites are clublike or very small. There has been a great deal of confusion about species names in the *caesioannulata*-group.

Unita Group. This small group of two species is a western and southern extension of the *major*-group. The gonopods and the animals themselves are smaller, more simplified, and the colpocoxites are fused at their bases. Too little is known about the distribution of the group to make any confident statements about its origin, except that it definitely is a derivative of the

major-group and may possibly be related to the species of *Tiganogona*.

Mississippiana Group; *Alata Group*. The majority of species in these two groups occurs on the Gulf Coastal Plain, Atlantic Coastal Plain, and south into peninsular Florida. They are highly specialized derivatives of the *major* stock; species of the *alata*-group form a series difficult to separate from those of the *major*-group, but the species most similar to *C. major*, *C. hadena*, occurs in Florida. The gonopod colpocoxites of both groups are thinner,

more rodlike, than those of species of the *major*-group. In the *mississippiana*-group, composed of three or four very closely related species, the anterior branch of the divided colpocoxite tip has become a complex process. The telopodites are large, clasplike, and freely movable. The distribution of species of these groups around the Atlantic and Gulf of Mexico Coastal Plains suggests an invasion from the southern Appalachian centers of the *major*-group.

Fustis Group. *Cleidogona fustis* is a peculiar but apparently very successful northern and western derivative of the *major*-group that has a wide distribution. It has been reported from Indiana and Ohio, and is common in West Virginia and eastern Virginia. The colpocoxites resemble those of *C. major*, but are smaller and lack the coxal projection. The telopodites are much larger in comparison to the colpocoxites than in any other North American species. Cook and Collins' (1895) lost species *C. forceps* may be related to *C. fustis*.

Summary of discussion of North American species. Diagram 8 summarizes the above information. I believe the North American species to be derived from a Mexican stock near the *crystallina*-group, and to have their main center of speciation in the southern Appalachians. Derivatives of the dominant *major*-group have colonized northward, westward, and southward.

It might be mentioned here that two species at the northern extremity of the range of *Cleidogona*, *C. major* and *C. caesioannulata*, have very large ranges, and are not, in the northern parts of these ranges, sympatric with any other species. Perhaps these two species became adapted to cooler average climatic conditions during the Pleistocene, and when glaciation removed any possible competitors to the north, rapidly expanded in that direction. There is some evidence that this range extension is still continuing; females and immature specimens belonging to *Cleidogona* have been taken in Connecticut and on Cape

Cod, the only records of the family from glaciated territory.

The Mexican and Central American Species of *Cleidogona*

Since only a single species, *C. bacillipus*, occurs both north and south of the Rio Grande, and in view of the large number of species of *Cleidogona* to be discussed, it seems most efficient to divide the following species accounts and keys between the Mexican and Central American species and the species occurring in the United States. *Cleidogona bacillipus* appears in both keys, but is discussed below with its Mexican relatives.

KEY TO MALES OF MEXICAN AND CENTRAL AMERICAN *CLEIDOGONA* SPECIES

Males of *C. mexicana* are not known, and that species is not included in this key; for others not included, see section above on species not included in revision.

- 1a. Body with definite *Conotyla*-like paranota (Fig. 274) on at least anterior segments 2
- 1b. Segments without paranota, usually cylindrical, or with outermost setae on low rounded swelling 3
- 2a. Paranota persisting to around segment 17, posterior segments more or less cylindrical; Chiapas *laquinta*
- 2b. Paranota persisting past segment 17; Chiapas *conotylloides*
- 3a. Process of sternum 12 apically cleft; Honduras *ceibana*
- 3b. Process absent or not apically cleft 4
- 4a. Anterior gonopods (Figs. 190, 191) with telopodites and colpocoxites nearly equal in size, telopodites curving around colpocoxites; Chiapas *forficula*
- 4b. Gonopods not as above 5
- 5a. Anterior gonopod colpocoxites with a deep, semicircular lateral cleft armed with sharp teeth (Fig. 205); Oaxaca *chontala*
- 5b. Gonopods not as above 6
- 6a. Anterior gonopod coxae with acuminate process from posterior part of setose region (Fig. 230); Querétaro *tizoc*
- 6b. Gonopods without such a process 7
- 7a. Anterior gonopod telopodites very thin, curved nearly in a circle, apically divided (Fig. 242); Hidalgo *xolotl*

- 7b. Anterior gonopod telopodites not as above 8
- 8a. Posterior gonopod coxae with long mesal spatulate process (Fig. 251); Veracruz *tequila*
- 8b. Posterior gonopod coxae without such a process 9
- 9a. Anterior gonopod colpocoxites apically pointed (Fig. 254); Oaxaca *hauatla*
- 9b. Anterior gonopod colpocoxites not as above 10
- 10a. Body not pigmented, chalky white or pale gray 11
- 10b. Body normally pigmented 14
- 11a. Ten to 15 ocelli, ocelli not pigmented; caves in Veracruz *crucis*
- 11b. More than 20 ocelli, usually pigmented 12
- 12a. More than 25 ocelli; gonopods (Figs. 197, 198) elaborate; Sótano de San Agustín, Oaxaca *baroqua*
- 12b. Less than 22 ocelli (usually 20); gonopods simpler (Figs. 221, 217); caves in Sierra de el Abra region, Tamaulipas 13
- 13a. Gonopods as in Fig. 217 *crystallina*
- 13b. Gonopods as in Fig. 221 *pecki*
- 14a. Anterior gonopod colpocoxites with transparent, small lateral teeth (Figs. 201, 209) 15
- 14b. Colpocoxites lacking such teeth 17
- 15a. Anterior gonopod colpocoxites with a subapical retrorse rod (Fig. 202); Oaxaca *gucumatz*
- 15b. Anterior gonopod colpocoxites lacking such a rod 16
- 16a. Sternum with triangular anterior processes (Fig. 284); El Salvador *minutissima*
- 16b. Sternum lacking such processes, gonopods as in Fig. 209; Oaxaca *mixteca*
- 17a. Anterior gonopod colpocoxites with rugae or corrugations on anterior basal part (Figs. 278, 244, 226) 18
- 17b. Colpocoxites without such corrugations 22
- 18a. Corrugations extending all across anterior basal surface of colpocoxite, not limited by heavy lateral or mesal ridge (Fig. 226); region of Mexico City *maculata*
- 18b. Corrugations limited laterally by a heavy ridge (Figs. 278, 244, 236) 19
- 19a. Telopodites of anterior gonopods short, decurved (Fig. 278); Chiapas *decurva*
- 19b. Telopodites long or short, upright, not decurved 20
- 20a. Body less than 10 mm long; Querétaro *mayapec*
- 20b. Body more than 16 mm long 21
- 21a. Gonopods as in Fig. 236; Oaxaca *camazotz*
- 21b. Gonopods as in Fig. 244; Texas, Coahuila, Nuevo León *bacillipus*
- 22a. Telopodites of anterior gonopods absent (Fig. 282); Veracruz *atoyaca*
- 22b. Telopodites present 23
- 23a. Telopodites very short, decurved (Figs. 276, 286) 24
- 23b. Telopodites not as above 25
- 24a. Gonopods as in Fig. 276; Guatemala *stolli*
- 24b. Gonopods as in Fig. 286; El Salvador *mirabilis*
- 25a. Anterior gonopod colpocoxites with denticulate subapical process (Figs. 213, 214); Oaxaca *chacmool*
- 25b. Anterior gonopod colpocoxites without such a process 26
- 26a. Anterior gonopod colpocoxites in lateral view less than one-fourth as broad as long (Figs. 260, 264) 27
- 26b. Anterior gonopod colpocoxites in lateral view more than one-sixth as broad as long (Figs. 248, 257) 28
- 27a. Anterior gonopod colpocoxites with oblique ridge in anterior view (Fig. 263); Mexico City area *rafaela*
- 27b. Gonopods not as above, oblique ridge absent; Oaxaca *zapoteca*
- 28a. Colpocoxites of anterior gonopods strongly diverging (Fig. 257); Querétaro *totonaca*
- 28b. Colpocoxites not strongly diverging 29
- 29a. Gonopods as in Fig. 248; Guatemala *godmani*
- 29b. Gonopods as in Figs. 232-233; Hidalgo *zimapaniensis*

Cleidogona mexicana (Humbert and Saussure)**Figure 187**

Craspedosoma mexicanum Humbert and Saussure, 1869, Rev. Mag. Zool. (2), 21: 153.

Cleidogona mexicana, Cook and Collins, 1895, Ann. New York Acad. Sci., 9: 52; Loomis, 1968, U. S. Nat. Mus. Bull., 266: 67.

Types. Female holotype from "Eastern Cordillera," Mexico, deposited in Natural History Museum of Geneva, Switzerland, examined.

Diagnosis. In the absence of males, no diagnostic characters can be described.

Description of female holotype. Length, about 20 mm: A3 = 0.90 mm. About 28 ocelli in the usual arrangement. Cyphopods (Fig. 187) simple, valves unmodified; postgenital plate narrowly quadrate, apex irregular.

Notes. In the absence of males and definite locality records, little can be said

about this species. The holotype is completely bleached, making some characters (ocelli number, coloration) difficult to observe.

Cleidogona ceibana Chamberlin

Figures 188, 189

Cleidogona ceibana Chamberlin, 1922, Proc. U. S. Nat. Mus., 60: 11, plate 6, figs. 1-6, ♂.

Hirsutogona ceibana, Kraus, 1954, Senck. Biol., 35: 329 (placed in *Hirsutogona* with doubt).

Types. Male holotype from La Ceiba, Honduras, in USNM, Type No. 822, examined.

Diagnosis. Completely distinct in the form of the gonopods from any other species of *Cleidogona*; the posterior fimbriate portion of the anterior gonopod (Fig. 189) is especially diagnostic.

Description of male holotype. Length, about 14 mm. A3 = 0.55 mm. Ocelli 21 on both sides of head, in 5 rows plus single ocellus. Coloration light, but typical, fulvous brown with darker markings around points of muscle attachment. Anterior gonopods: in anterior view (Fig. 188), sternum broad, extending between coxae, deep groove in median portion. Coxae rounded, densely setose; colpocoxites complex apically and with vaguely indicated groove on anterior face lying in depression. In lateral view (Fig. 189) lateral sternal sclerite large; colpocoxite with posterior fimbriate area. Telopodites broken off (?) in type, with a large wing basally, rodlike branch curving lateral of colpocoxites. Posterior gonopods: not found in vial with holotype, described by Chamberlin (1922) as follows: "... first joint is nearly as long as the second; it is thick proximally and bends a little and narrows just distad of the middle . . . process on base small. The second joint is strongly clavate. . . ." Coxa 10 elongate, not knobbed, gland on long petiole. Coxa 11 with sharp, spike-shaped branch above gland. Twelfth sternum with large, apically cleft process.

Female unknown.

Distribution. Known only from the type locality.

Notes. This species resembles species of *Solaenogona* in certain respects and links that genus with *Cleidogona*. Loomis (1966) overlooked the illustrations and description of Chamberlin (1922) when he set up the genus *Costaricia* for *C. curvipes* on the basis of the cleft twelfth sternal process in that species. Kraus (1954) had not seen specimens, and assigned *C. ceibana* to *Hirsutogona* with doubt.

THE FORFICULA GROUP

Cleidogona forficula n. sp.

Figures 190-192

Types. Male holotype from San Cristobal de las Casas, Chiapas, Mexico, collected 14-16 July 1950 by C. and M. Goodnight. The specific name, an adjective, refers to pincerlike gonopods.

Diagnosis. The subequal, interlocking telopodites and colpocoxites of this species distinguish it from all other species of *Cleidogona*.

Description of male holotype. Length, 16 mm; antennae missing. Ocelli 24 on left side, 25 on right side, in 4 rows plus single ocellus. Coloration typical. Segmental shoulders moderately developed as rounded knobs around lateralmost seta on each segment. Anterior gonopods: in anterior view (Fig. 190) sternum transverse, extending between coxae; coxae flattened, with few setae. Colpocoxites upright, rodlike; telopodites visible, curving anterior of colpocoxites about midlength, thin, laminate, edges sinuous. In posterior view (Fig. 191), colpocoxites apically divided, posterior branch densely fimbriate, anterior branch platelike; telopodites in contact basally; coxae extending nearly to midline. Posterior gonopods: coxa with large knob bearing vestigial gland aperture (Fig. 192) otherwise typical. Legs 10 and 11 absent from holotype. Sternal process of twelfth sternum small, subtriangular lamella or ridge.

Female unknown.

Distribution. Known only from the type locality.

Notes. The relationships of this species are very obscure. No other Mexican species of *Cleidogona* even remotely resembles it in gonopod anatomy. If additional species are discovered, a separate generic name may be justified.

THE CRUCIS GROUP

The species of this group have elaborate modifications of the apical part of the colpocoxites of the anterior gonopods, and in this way resemble species of *Solaenogona* and *Cleidogona ceibana*. The telopodites are well developed and are distally expanded. The female genitalia are simple, with few elaborations of the valves and a subquadrate or bluntly triangular postgenital plate.

Cleidogona crucis (Chamberlin)

NEW COMBINATION

Figures 193–196

Cavota crucis Chamberlin, 1942, Bull. Univ. Utah, 33: 8, figs. 3–7, ♂.

Types. Male holotype from Cueva de Atoyac, Veracruz, type said to have been deposited in Escuela Nacional, Mexico City (Chamberlin, 1942), not seen. The specific name probably makes reference to the state of Veracruz. "True Cross."

Diagnosis. The only species of the group lacking pigment and having less than 20 ocelli.

Description of male from type locality. Length. 15 mm; A3 = 0.65 mm. Ocelli 10, colorless, irregularly arranged in about 3 rows. Totally without pigment. Body segments cylindrical. Anterior gonopods: in anterior view (Fig. 193), sternum broad; coxae with group of 4–5 setae. Colpocoxites with subterminal lateral branch divided apically into 4 small lobes. In lateral view (Fig. 194), telopodite large, cupped ventrad, posterior division with

serrate lamella. Posterior gonopods: coxa rather slender, without conspicuous lobes; otherwise typical (Fig. 195). Coxa 10 elongate, cylindrical, gland on short chitinous petiole. Coxa 11 with acuminate process above gland, thin chitinous piece extending basally behind gland. Sternal process 12 typical, acuminate ventrally, dorsal portion of tip thickened, of moderate length.

Description of female from type locality. Length, 14 mm; A3 = 0.62 mm. Nonsexual characters as described for male. Cyphopods: lateral valves of cyphopods much thicker than median valves in posterior view (Fig. 196); postgenital plate broad, transparent, with vague radiating ridges from thickened midline.

Distribution. In addition to the type locality, also known from: VERACRUZ: Cueva de Ojo de Agua Grande, near Cordoba, 4.5 mi. north of Potrero Viejo and 6 mi. northwest of Paraje Nueva, 3 August 1967, J. Reddell, ♂; 7 August 1969, S. Peck, ♂♂. A large collection of both males and females was taken from the type locality by S. and J. Peck, 6 August 1969.

Notes. Cueva de Atoyac and Cueva de Ojo de Agua Grande are separated by about 10 miles (S. Peck, personal communication). The description given by Chamberlin (1942) differs from the above in a few details; the holotype is said to have 14 ocelli in four rows. The posterior gonopods are shown with six segments. In all males examined by me, a rather weak suture, but not a joint, was visible near the basal part of the posterior gonopod coxae (Fig. 195), and Chamberlin may have mistaken this for an actual articulation. This species is a true troglobite.

Cleidogona baroqua n. sp.

Figures 197–200

Types. Male holotype, female paratype types from Sótano de San Agustín, Hauatla de Jiménez, Oaxaca, collected 28 December 1966 by T. Raines. The species

name refers to the elaborate appearance of the anterior gonopods.

Diagnosis. Unlike any other species of the group, the apical part of the anterior gonopod colpocoxites are developed into a curved lamella with a denticulate margin; the animals are depigmented but have normal ocelli.

Description of male holotype. Length, 27 mm, A3 = 1.53 mm. Ocelli, 27 on each side in 6 rows plus single ocellus, regular in size and lightly pigmented. Body lacking pigment. Segments cylindrical. Anterior gonopods: in anterior view (Fig. 197) sternum extending high up between colpocoxites, broad, with 2 slight depressions near midline. Coxae elongate, densely setose; colpocoxites with apical curved lamella with denticulate margin curving around rodlike mesal subapical branch. In lateral view (Fig. 198), colpocoxite lamella narrowed in midlength, at right angle to body of colpocoxite; telopodite short, stout, pressed against rounded chitinous mass occupying center of posterior portion of colpocoxites, with short apical hook. Posterior gonopods: coxa (Fig. 199) with complex basal lobes, including long rodlike lobe nearest base (vestigial gland?); widest part of second segment near middle of length. Remaining segments reduced, typical. Coxae 10 not strongly modified, glands sessile or nearly so. Coxae 11 with prominent chitinous plates above glands. Sternal process 12 as usual, as described for *C. crucis*.

Description of female paratype. Length, 25 mm, A3 = 1.50 mm. Nonsexual characters as described for male. Cyphopods: coxae of legs 2 with prominent rugose knobs posteriorly; valves not ornamented (Fig. 200); postgenital plate low, rounded.

Distribution. Known only from type locality.

Notes. Though the three individuals comprising the type collection lack pigment except around the ocelli, this species may not be a true troglobite. It is the largest Mexican *Cleidogona*.

Cleidogona gucumatz n. sp.

Figures 201–204

Types. Male holotype, female paratype and other specimens from 1.5 mi. northeast of El Punto, on road to Ixtlán de Juárez, Oaxaca, elev. 7500 ft., collected 3 September 1961 by R. M. Bogert. The species name is a noun in apposition, the name of the hero of the Mayan epic, *Popol Vuh*.

Diagnosis. The coxae are low and do not extend laterally along the colpocoxites; the telopodites are rodlike, rather than cupped and apically expanded as in the preceding two species.

Description of male holotype. Length, 17 mm, A3 = 0.80 mm. Ocelli 28, in 7 rows. Coloration typical. Segments cylindrical. Anterior gonopods: colpocoxites and sternum apparently completely fused in anterior view (Fig. 201); colpocoxites with retrorse corrugated rod extending basally from upper anterior part, laterally with series of small, transparent teeth. In lateral view (Fig. 202), telopodite more rodlike than in preceding two species. Coxa with only two setae. Posterior gonopods: typical of genus (Fig. 203), coxa with basal lobe, narrowed near middle; second segment with broadest point below distal end. Coxa 10 elongate, curved, gland with petiole. Coxa 11 with short plate above gland. Process of sternum 12 acuminate-triangular, shorter than in preceding species.

Description of female paratype. Length, 15.5 mm, A3 = 0.80 mm. Nonsexual characters as in male. Cyphopods: lateral valves (Fig. 204) with broad flanges; postgenital plate narrowly triangular.

Distribution. Known only from the type locality.

Cleidogona chontala n. sp.

Figures 205–208

Types. Male holotype and four female paratypes from 27.5 mi. south of Valle Nacional, Oaxaca, elev. 5600 ft., collected 15–16 August 1965 by G. Ball and D. Whitehead. The specific name is an ad-

jective referring to the Chontal Indians of Oaxaca.

Diagnosis. The deep, denticulate cleft on the lateral margins of the anterior gonopods distinguishes this species from any other.

Description of male holotype. Length, 16 mm, $A_3 = ?$ (antennae missing from all specimens). Ocelli 27, in 6 rows. Coloration typical. Segments cylindrical. Anterior gonopods: in anterior view (Fig. 205), sternum low, subtriangular between gonopod coxae, coxal knobs prominent, coxae without setae, solidly fused to colpocoxites; with deep lateral excavation with basal margin denticulate, distal margin drawn out into long acuminate process. Colpocoxites bluntly quadrate, posteriorly bladelike, thin posterior portion with tooth visible in lateral view (Fig. 206) near midlength. Telopodites curved, not apically expanded. Posterior gonopods: similar to those of *C. gucumatz*, but with widest part of second segment near midlength, not at apical end (Fig. 207).

Description of female paratype. Length, 16 mm, antennae missing. Nonsexual characters as in male. Cyphopods: (Fig. 208) both lateral and median valves with carinae, postgenital plate broad, transparent.

Distribution. Known only from the type locality.

Cleidogona mixteca n. sp.

Figures 209–212

Types. Male holotype, female paratype and other males and females from 54.1 mi. south of Valle Nacional, Oaxaca, elev. 8300 ft., collected 3 May 1966 by G. Ball and D. Whitehead. The species name, an adjective, refers to the Mixtec culture of pre-Columbian Mexico.

Diagnosis. The apical part of the anterior gonopod colpocoxites is corrugated, rather than smooth, as it is in *C. chontala*; the small, transparent lateral teeth are much more numerous than in *C. gucumatz*.

Description of male holotype. Length,

16 mm, $A_3 = 0.83$ mm. Ocelli 26 in 5 rows. Coloration typical, somewhat darker than usual. Segments cylindrical. Anterior gonopods: in anterior view (Fig. 209), sternum broadly expanded between colpocoxites, lightly depressed; only coxal knobs visible in anterior view; coxae without setae. Colpocoxites with series of lateral transparent teeth, mesoapical region finely corrugated. In lateral view (Fig. 210), apical part of colpocoxite hoodlike, blade portion concealed, with a few weak ridges laterally. Telopodite curved, rodlike. Posterior gonopods: coxa typical (Fig. 211); second joint not as broadly expanded as in preceding 2 species. Coxa 10 elongate. Coxa 11 with a small plate distal to gland. Process of sternum 12 typical.

Description of female paratype. Length, 15.5 mm, $A_3 = 0.80$ mm. Nonsexual characters as in male. Cyphopods (Fig. 212): similar to those of *C. gucumatz*, postgenital plate somewhat narrower.

Distribution. Besides the type locality, the following: OAXACA: 30.2 mi. south of Valle Nacional, 8300 ft. elev., 16 August 1965, G. Ball and D. Whitehead, ♂; 88.5 mi. south of Valle Nacional, 4100 ft. elev., G. Ball and D. Whitehead, ♂ ♀ ♀.

Notes. *Cleidogona mixteca* is clearly related to *C. gucumatz*.

Cleidogona chacmool n. sp.

Figures 213–216

Types. Male holotype, female paratype and another female from 60.6 mi. south of Valle Nacional, Oaxaca, 7500 ft. elev., collected 18 August 1965 by G. Ball and D. Whitehead. The species name is a noun in apposition, and refers to the Aztec death god.

Diagnosis. The subapical branch of the anterior gonopod colpocoxite pointing distad (Fig. 214) is diagnostic.

Description of male holotype. Length, 25 mm, $A_3 = 1.10$ mm. Ocelli 28 in 7 rows. Coloration typical. Segments cylindrical. Anterior gonopods: in anterior view (Fig. 213), sternum and colpocoxites appear

fused, sternum not extending far between colpocoxites. Both apical branches of colpocoxite with small teeth; coxae with only 2 setae. In lateral view (Fig. 214), branches of colpocoxite unequal, anterior subapical branch rodlike, posterior branch broad, with posterior bladelike portion obviously finely fimbriate along posterior margin. Telopodite broadly expanded, posterior portion longest, rugose area in cup between prongs. Posterior gonopods (Fig. 215): coxa narrower than in other species of group; second segment broadly and evenly expanded, widest part just distad of midlength. Coxae 10 and 11 are as described for *C. mixteca*. Process of sternum 12 as usual.

Description of female paratype. Length, 23 mm, A3 = 1.08 mm. Nonsexual characters as described for male. Cyphopods (Fig. 216): similar to those of two preceding species, but knobs of coxae 2 somewhat larger, lateral carinae of lateral valves corrugated.

Distribution. In addition to the type locality, the following: OAXACA: Llano de las Flores, Sierra Juarez, 9300 ft. elev., 17 September 1961. M. R. Bogert, ♂ ♀.

THE CRYSTALLINA GROUP

Members of this group have gonopods simpler than those of the preceding group, but the colpocoxites are not bent at a right angle as in the *maculata*-group. They occur in caves in the Sierra de el Abra of southern Tamaulipas, but do not appear to be genuine trogllobites.

Cleidogona crystallina n. sp.

Figures 217–220

Types. Male holotype, female paratype and many other specimens from Cueva Chica de la Perra, 6 mi. northwest of Gómez Farias, Tamaulipas, elev. 7000 ft., collected 2 July 1969 by S. Peck and R. Norton. The species name refers to this species' occurrence in nearby Crystal Cave.

Diagnosis. Distinct from the related *C.*

pecki in the less acutely angled colpocoxites of the anterior gonopods and the form of the telopodites (Fig. 218). The basal segment of the posterior gonopods (Fig. 219) has a definite articulation about one-third its length from the basal end. The female cyphopods lack the high posterior carinae on the valves found in *C. pecki*.

Description of male holotype. Length, 15 mm, A3 = 0.90 mm. Ocelli 21, somewhat irregular in arrangement, not pigmented. Body not pigmented, or dirty gray in color, blotched darker. Segments cylindrical. Anterior gonopods: in anterior view (Fig. 217), basal part of sternum subquadrate, extending narrowly between colpocoxites; coxae large, setose. Colpocoxites with 2 rounded ridges on anterior side, with lateral projection and subterminal process. In lateral view (Fig. 218), lateral projection with 2 teeth, colpocoxite bent at obtuse angle, bladelike posterior part deeply laciniate. Telopodite with median winglike process. Posterior gonopods (Fig. 219) 6-segmented; second (third?) segment not much broadened. Coxae 10 and 11 as usual; process of sternum 12 of moderate size.

Description of female paratype. Length, 15 mm, A3 = 0.92 mm. Nonsexual characters as in male. Cyphopods (Fig. 220): lateral valves with moderate lateral carinae; postgenital plate much reduced, possibly absent.

Distribution. In addition to the type locality, the following: TAMAULIPAS: Crystal Cave, Rancho de Cielo, near Gómez Farias, no date or collector, ♂; Salamander Cave, 6 mi. northwest of Gómez Farias, 4 July 1969, S. and J. Peck, ♂; Cueva Capilla de la Perra, 8 mi. northwest of Gómez Farias, 2 July 1969, S. Peck and R. Norton, ♂ ♂ ♀ ♀.

Notes. This species may be a troglophile; it has not been collected on the surface. However, the animals are not completely depigmented and have a nearly normal number of ocelli.

Cleidogona pecki n. sp.

Figures 221–225

Types. Male holotype, female paratype and many other specimens from Cueva de la Mina, 6 mi. northwest of Gómez Farias, Tamaulipas, elev. 5000 ft., collected 1 July 1969 by S. and J. Peck. The name honors my friend, Dr. Stewart B. Peck, who collected the type series, and helped in this study in many other ways.

Diagnosis. Closely related to *C. crystallina*, but distinct in the characters given in the diagnosis of that species.

Description of male holotype. Length, 21 mm, A3 = 1.08 mm. Twenty ocelli in about 5 rows, darkly pigmented in some specimens, not pigmented in others. Body not pigmented, chalk white, or slate gray blotched darker (possibly artifact of preservation). Segments cylindrical. Anterior gonopods: in anterior view (Fig. 221), similar in general form to those of *C. crystallina*, but larger, lacking lateral projection and subterminal process; tip of colpocoxites with small cleft. In lateral view (Fig. 222), telopodite curved, apically expanded, drawn out into long process on anterior edge of expanded tip. Posterior gonopods (Fig. 223): 5-segmented, typical of the genus. Coxae 10 and 11 and process of sternum 12 as in *C. crystallina*.

Description of female paratype. Length, 20 mm, A3 = 1.05 mm. Nonsexual characters as in male. Cyphopods (Figs. 224, 225): valves with high posterior carinae (Fig. 225); postgenital plate low, rounded (Fig. 224).

Distribution. Known only from the type locality. Many specimens have been collected by S. B. Peck, R. Mitchell, and others.

Notes. There is some variation in the pigmentation and number of ocelli. A few individuals have as few as 16 ocelli, irregular and not pigmented. Other specimens have about 20, regularly arranged and darkly pigmented; thus this species may be in the process of making the first morphological adaptations to a troglitic

existence. It has not been collected on the surface, though it has been searched for (S. Peck, personal communication). The type locality, Cueva de la Mina, has a remarkably diverse fauna of troglitic arthropods for a tropical cave; there are two other millipeds (a cambalid and a glomerid), a scorpion, two pseudoscorpions, a mite, a campodean, a thysanuran, three beetles, a spider and an isopod (Mitchell, 1968).

THE *MACULATA* GROUP

In this large group, the colpocoxites are generally simple, long, and sharply bent posteriad about midlength. The telopodites are variable. Most species occur in the central highlands of Mexico and in the transverse volcanic belt.

Cleidogona maculata (Verhoeff)

NEW COMBINATION

Figures 226–228

Mexicuma maculatum Verhoeff, 1926, Zool. Anz., 68: 112, figs. 12–15, ♂.

Cleidogona leona Chamberlin, 1943, Bull. Univ. Utah, 34: 34, figs. 69–72, ♂. NEW SYNONYMY.

Cleidogona propia Causey, 1957, J. Kansas Entomol. Soc., 30: 119, figs. 13–14, ♂, 15, ♀. NEW SYNONYMY.

Types. Male holotype of *M. maculata* from Desierto de los Leones, near Mexico City, D. F., collected 20 July 1924 by Professor Dampf, in Zoologische Museum Munich, examined; male holotype of *C. leona* from Desierto de los Leones, in the University of Utah collection, examined; male holotype of *C. propia* from Puerto las Peras, on Highway 15, Michoacán, collected 15 June 1955 by D. Causey, in AMNH, examined. Puerto las Peras is not on any map seen by me and is not listed in Gazetteer 15 (Mexico), Official Standard Names approved by the United States Board on Geographic Names (1956).

Diagnosis. Distinct from other species of the group in the extent of the corrugations or rugae on the posterior face of

the basal portion of the anterior gonopod colpocoxite (Fig. 226).

Description of male from type locality. Length, 15 mm. A3 = 0.80 mm. Ocelli 26, in 6 rows. Coloration typical. Segments cylindrical. Anterior gonopods (Figs. 226, 227): basal part of colpocoxites with numerous rugae or corrugations on anterior face, extending across entire width of gonopod. Coxae without projections, setose. Telopodites (Fig. 227) long, freely movable, apically divided, branches widely divergent. Colpocoxite in lateral view (Fig. 227) bent at slightly more than a right angle just beyond midlength. Posterior gonopods (Fig. 228): typical of genus; widest part of second segment just distal of midlength. Coxa 10 elongate, gland on long pedicel. Coxa 11 slightly enlarged above gland opening, lacking spine or plate. Process of sternum 12 typical.

Females have been collected, but none could be located for this study. The illustration by Causey (1957, fig. 15) shows the cyphopods to be very similar to those of *C. chontala* (Fig. 208).

Distribution. In addition to the type localities given for the various synonyms, the following: MICHOACÁN: Puerta Garnica, ca. 30 mi. east of Morelia, elev. 9200 ft., 30 July 1966, G. Ball and D. Whitehead, ♂.

Notes. Verhoeff's original illustration of the posterior gonopod does not agree with that of the type specimen. It is possible that he drew a regenerated appendage from another specimen. Chamberlin (1943) did not mention *C. maculata* in describing *C. leona*; Causey (1957) compared the specimens she described as *C. propia* to *C. nueva* Chamberlin.

Cleidogona tizoc n. sp.

Figures 229–231

Types. Male holotype from Delina, Pinal de Amoles, Querétaro, collected 10 July 1967 by J. Reddell. The species name is a noun in apposition, the name of an Aztec king, ca. 1481.

Diagnosis. Distinct from all other members of the *maculata*-group in having a prominent process on the anterior gonopod coxa (Fig. 230).

Description of male holotype. Length, 16 mm, A3 = 0.82 mm. Ocelli 25, in 6 rows plus single ocellus. Color typical. Segments cylindrical. Anterior gonopods: in anterior view (Fig. 229), coxal knobs prominent; subapical process of colpocoxite extending distad from point of flexure. In lateral view (Fig. 230), coxa with acuminate, slightly curved process, setose. Apex of colpocoxite with a series of branches and processes, not simple as in *C. maculata* (compare Fig. 227); telopodites short. Posterior gonopods: coxa with a basal knob, small pointed process above knob (Fig. 231); second segment not much enlarged. Coxa 10 elongate; gland petiolate. Coxa 11 with small process above gland. Process of sternum 12 as usual.

Female unknown.

Distribution. In addition to the type locality: QUÉRETARO: 17.8 mi. east of Landa de Matamoros, 5300 ft. elev., S. and J. Peck, 4 July 1969, ♂♂.

Cleidogona zimapaniensis Causey

Figures 232–235

Cleidogona zimapaniensis Causey, 1957, J. Kansas Entomol. Soc., 30: 117, pl. 2, figs. 9–12, ♂♀.

Types. Male holotype and female paratype from 14 mi. north of Zimapán, Hidalgo, collected 23 June 1954 by N. Causey, in AMNH, examined.

Diagnosis. Distinct from all but *C. tizoc* in having a subapical process on the anterior part of the anterior gonopod colpocoxite, but differing from that species in lacking a coxal process.

Description of male holotype. In poor condition, broken into many pieces, A3 = 0.54 mm. Ocelli 27, in 6 rows. Coloration typical. Segments cylindrical. Anterior gonopods: in poor condition, basal parts destroyed, apparently cleared at one time, covered with sticky deposits partly cleaned away by ultrasonics. Only a line drawing

can be presented here (Figs. 232–233), owing to the poor condition of the gonopods. Posterior gonopods: similar in form to those of *C. tizoc*, but basal process longer, with tiny knobs (Fig. 234); second segment wider than in *C. tizoc*. Coxa 10 elongate, gland on petiole. Coxa 11 with moderate lobes above gland. Process of sternum 12 short, rounded, with small thorn on basal part of ventral side.

Description of female paratype. Length, 15.5 mm, A3 = 0.80 mm. Nonsexual characters as in male. Cyphopods (Fig. 235): postgenital plate a narrow rod, somewhat expanded apically.

Distribution. Known only from the type locality.

Cleidogona camazotz n. sp.

Figures 236–238

Type. Male holotype and female paratype from 3 mi. west of Guerrero border, Guerrero, on Mexico Route 200, collected 14 July 1963 by J. Beatty and F. Coyle. The species name, a noun in apposition, refers to the bat monster of Mexican mythology.

Diagnosis. Like *C. maculata* and *C. bacillipus*, *C. camazotz* has prominent corrugations on the anterior basal part of the anterior gonopod colpocoxites (Fig. 236), but differs from *C. maculata* in having the corrugations less extensive (compare Fig. 226) and from *C. bacillipus* in the broader, more strongly curved colpocoxites.

Description of male holotype. Length, 21 mm, A3 = 0.80 mm. Ocelli 25 in 5 rows. Coloration typical, somewhat darker than usual. Segments cylindrical. Anterior gonopods: in anterior view (Fig. 236), sternum broad, with short central fovea; colpocoxites with prominent outer ridge, corrugations limited to inner surfaces mesad of ridge. In lateral view, colpocoxite bent at right angle near midlength (Fig. 237), telopodite similar to that of *C. maculata*. Coxae 10 and 11 elongate, glands on petioles, knobs and processes absent. Process on sternum 12 typical.

Description of female paratype. Length,

19 mm, A3 = 0.80 mm. Nonsexual characters as in male. Cyphopods (Fig. 238): postgenital plate broadly triangular, apex rounded; valves lobed.

Distribution. In addition to the type locality: OAXACA: 22.2 mi. south of San Pedro Juchatengo, near Pinotepa Nacional, 22 July 1966, G. Ball and D. Whitehead, ♂ ♀.

Cleidogona mayapec n. sp.

Figures 239–241

Types. Male holotype from 1 mi. south of Río Blanco, Querétaro, collected 8 July 1967 by J. Reddell. The species name is a noun in apposition, the name of the Lightning Dog of Mexican mythology.

Diagnosis. Lacks the corrugations present in the anterior gonopods of *C. maculata*, *C. camazotz* and *C. bacillipus*; differs from *C. tizoc* in lacking a coxal process.

Description of male holotype. Length, 9 mm, A3 = 0.47 mm. Ocelli 25 in 6 rows. Coloration typical. Segments cylindrical. Anterior gonopods: in anterior view (Fig. 239), colpocoxites with ridge on median side. In lateral view (Fig. 240), colpocoxite bent at less than a right angle, nearly nearly touching telopodite. Posterior gonopods (Fig. 241): coxae with basal process long; second segment with widest part at midlength, almost subtriangular. Coxae 10 and 11 and sternal process 12 as described for *C. camazotz*.

Female unknown.

Distribution. In addition to the type locality, the following: (QUERÉTARO: Cueva del Judío, 1 mi. south of Pinal de Amoles, 10 July 1967, J. Reddell, ♂.

Cleidogona xolotl n. sp.

Figures 242, 243

Types. Male holotype from 23.8 mi. northeast of Jacala, Hidalgo, elev. 5100 ft., collected 13 November 1965 by G. Ball and D. Whitehead. The species name (pronounced show-lotl) is a noun in apposition, the name of the brother of Quetzalcoatl.

Diagnosis. The unique form of the

telopodites (Fig. 242) immediately distinguishes this species from all others of the group.

Description of male holotype. Length, 20 mm, antennae missing. Ocelli 27 in 6 rows. Coloration typical. Segments cylindrical. Anterior gonopods (Fig. 242): colpocoxites bent at nearly a right angle, posterior side with acuminate, slightly curved process just distad to point of flexure, lateral apical margin drawn out, shieldlike. Telopodites small, weak, curved in nearly a circle, apex divided, branches widely diverging, small. Posterior gonopods (Fig. 243) with narrow basal processes on coxae; widest part of second segment distad of midlength. Coxae 10 typical. Coxae 11 with a large, thick plate projecting distad to gland. Process of sternum 12 typical, basally subglobose, apically pointed.

Female unknown.

Distribution. Known only from the type locality.

Cleidogona bacillipus (Chamberlin and Mulaik) NEW COMBINATION

Figures 244–247

Rhabdarona bacillipus Chamberlin and Mulaik, 1941, *J. New York Entomol. Soc.*, 49: 60, no figures.

Mecistopus varicornis Loomis, 1959, *J. Washington Acad. Sci.*, 49: 162, figs. 10–14, ♂. NEW SYNONYMY.

Types. Male holotype of *R. bacillipus* from Raven Ranch, Kerr Co., Texas, in University of Utah collection, examined; male holotype of *M. varicornis* from along Highway 16 between Kerrville and Medina, Texas, in USNM, examined.

Description of male holotype. Length, 18 mm, $A_3 = 0.75$ mm. Ocelli 26 in 6 rows. Coloration typical. Segments cylindrical, lateralmost setae of segments on slightly raised knobs. Anterior gonopods: in anterior view (Fig. 244), colpocoxites narrow, upright, with lateral ridge limiting mesal corrugated or rugose area, apex of each colpocoxite turned slightly laterad;

coxal knobs prominent. In lateral view (Fig. 245), colpocoxite bent at nearly a right angle beyond midlength, apex without complex processes; telopodite small, not apically divided. Posterior gonopods: coxa broadest at base, with large process slightly rugose distally; second segment clavate, widest at distal end; apical segment with a weak suture. Posterior gonopods giving the impression of being 4-segmented. Coxae 10 and 11 typical. Process of sternum 12 short, slightly decurved.

Description of female from near type locality. Length, 17 mm, $A_3 = 0.72$ mm. Nonsexual characters as in male. Cyphopods (Fig. 247): postgenital plate with two projections.

Distribution. In addition to the type locality: UNITED STATES. TEXAS: (reported by Loomis, 1967) *Kerr-Bandera Cos.*, along road between Kerrville and Medina, 26 December 1958, H. and J. Loomis, ♂♂♀♀; *Comal Co.*, Landa Park, New Braunfels, 29 December 1958, H. and J. Loomis, ♂; *Kendall Co.*, 5 mi. southwest of Boerne, 31 January 1959, J. Loomis, ♂. MEXICO. NUEVO LEÓN: Monterrey, Chipinque Mesa, forest litter, elev. 5400 ft., 24 June 1969, S. and J. Peck, ♂♂♀♀; COAHUILA: 8.6 mi. east of San Antonio de las Alazanas, elev. 8200 ft., 21 October 1965, G. Ball and D. Whitehead, ♂♂♀♀.

Notes. The illustrations given by Loomis do not match the types of *M. varicornis* in several respects. In Loomis' figure 12 (Loomis, 1959) the gonopod telopodites are omitted; figure 13 shows an extra articulation above the coxal process of the posterior gonopod. Both *Rhabdarona* and *Mecistopus* were based mainly on the structure of the posterior gonopod, which, as can be seen in my Figure 246, is not very different from those of others in the *maculata*-group. This species has a wide distribution, the widest of any Mexican species. Perhaps it is more adapted to arid conditions than those found further south and has spread into areas in which it has no competition from congeners.

THE GODMANI GROUP

This group may not be a very natural one; part of it may be derived directly from the *crucis*-group, and another species may be more closely related to the *maculata*-group. The anterior gonopod colpocoxites of these species are simple, and some, like those of the species of the *maculata*-group, are abruptly bent about midlength, but in other species they are narrower, rodlike, and evenly curved. The telopodites are usually simple and unbranched. Species are found in Oaxaca, Veracruz, Guerrero, and Querétaro.

Cleidogona godmani Pocock

Figure 248

Cleidogona godmani Pocock, 1903. Biologia Centrali-Americana, Zoologia, Chilopoda and Diplopoda, p. 52, pl. 5, figs. 8a-c. ♂.

Hirsutogona godmani, Kraus, 1954, Senck. Biol., 35: 329.

Types. Male holotype from Omilteme (north of Zimpango), Guerrero, deposited in British Museum (Natural History), examined.

Diagnosis. The colpocoxites and telopodites (Fig. 248) of the anterior gonopods are the simplest of any species of the group, and the most sharply bent.

Description of male holotype. In poor condition; originally pinned and preserved dry, now in alcohol, bleached and stained green by corrosion from pin, all legs missing. Length, 17 mm, A3 = 0.65 mm. Ocelli 28, in 7 rows. Segments cylindrical. Anterior gonopods (Fig. 248): in anterior view, sternum broad at base, triangular, extending between colpocoxites. In lateral view, colpocoxite rodlike, apically expanded, bent at right angle; telopodite simple. Posterior gonopods: missing from holotype. Coxa 10 as usual. Coxa 11 with small, rounded cone distad of gland. Process of sternum 12 a short, triangular ridge.

Female unknown.

Distribution. Known only from the type locality.

Cleidogona tequila n. sp.

Figures 249-252

Types. Male holotype, female paratype and other specimens from Tequila (18° 44' N, 97° 04' W), Veracruz, collected 7 August 1967 by J. Reddell. The species name is a noun in apposition referring to the type locality.

Diagnosis. The long spatulate process on the coxae of the posterior gonopods (Fig. 251) resembles that of *C. totonaca* but lacks additional knobs.

Description of male holotype. Length, 11 mm, A3 = 0.63 mm. Ocelli 26, in 5 rows. Coloration typical. Segments cylindrical. Anterior gonopods: in anterior view (Fig. 249), sternum extending between coxae and colpocoxites, coxal knobs prominent; colpocoxites with mesal ridge. In lateral view (Fig. 250), colpocoxite simple, evenly curved; telopodite with large, subterminal process. Posterior gonopods (Fig. 251) typical, but with long spatulate process from base of coxae. Coxae 10 and 11 and sternal process 12 as usual.

Description of female paratype. Length, 12 mm, A3 = 0.62 mm. Nonsexual characters as in male. Cyphopods (Fig. 252): valves with carinae, postgenital plate small.

Distribution. Known only from type locality.

Cleidogona hauatla n. sp.

Figures 253-256

Types. Male holotype and female paratype from 20 mi. west of Hauatla, Oaxaca, collected 10 August 1967 by J. Reddell, J. Fish, and T. Evans.

Diagnosis. The attenuate tip of the anterior gonopod colpocoxites is diagnostic (Fig. 254), as is the complexity of the posterior gonopod coxae (Fig. 255).

Description of male holotype. Length, 24 mm, A3 = 0.90 mm. Ocelli 26, in 5 rows plus single ocellus. Coloration typical. Segments cylindrical. Anterior gonopods: in anterior view (Fig. 253), colpocoxites with definite lateral shoulders, as in *C. godmani*

(compare Fig. 248); sternum broad, extending between colpocoxites, slightly depressed, with prominent anterior knobs. In lateral view (Fig. 254), colpocoxite narrow, evenly curved, tip acuminate. Telopodite apically broadened, bladelike. Posterior gonopods (Fig. 255) typical, but coxa with complex series of knobs, including vestigial gland opening on basal part, rugose area on distal part; widest part of second segment at distal end. Coxae 10 and 11 elongate, not otherwise modified. Process of sternum 12 a long rod.

Description of female paratype. Length, 24.5 mm, A3 = 0.90 mm. Nonsexual characters as in male. Cyphopods (Fig. 256): valves unmodified; postgenital plate broad, nearly square, transparent, with triangular teeth laterad to main plate.

Distribution. Known only from the type locality.

Cleidogona totonaca n. sp.

Figures 257-259

Types. Male holotype and other males from 17.8 mi. east of Landa de Matamoros, Querétaro, elev. 5300 ft., collected 18 November 1965 by G. Ball and D. Whitehead. The specific name is an adjective referring to the Totonac civilization of pre-Columbian Mexico.

Diagnosis. Closely related to *C. tequila*, but distinct in the form of the posterior gonopods (Fig. 295, compare Fig. 251).

Description of male holotype. Length, 20 mm, A3 = 0.90 mm. Ocelli 25 in 6 rows. Coloration typical. Segments cylindrical. Anterior gonopods: in anterior view (Fig. 258), resembling those of *C. tequila*, but colpocoxites more divergent, ridge along midline rather than on mesal edge. In lateral view (Fig. 257), colpocoxite less curved; telopodite simpler than in *C. tequila*. Posterior gonopods as in Figure 259, apparently 6-segmented. Coxae 10 and 11 and process of sternum 12 all of typical form.

Female unknown.

Distribution. In addition to the type

locality: QUERÉTARO: Sótano del Gobernador, 1 mi. south of Pinal de Amoles, 10 July 1967, J. Reddell, ♂.

THE *RAFAELA* GROUP

This group is clearly related to the *maculata*-group, but the colpocoxites are shorter, and, seen in lateral view, much broader in proportion to their length. The telopodites are generally simple and the posterior gonopods typical of the genus. *Cleidogona conotyloides* is a somewhat discordant element in this group, and may serve to relate the *rafaela*- and *godmani*-groups. Species of the *rafaela*-group occur in Chiapas, Oaxaca, and the vicinity of the Mexican Federal District.

Cleidogona rafaela Chamberlin

Figures 260-262

Cleidogona rafaela Chamberlin, 1943, Bull. Univ. Utah, 34: 35, figs. 73-75, ♂.

Types. Male holotype from San Rafael, "D. F.," deposited in University of Utah collection, examined. There seems to be no San Rafael in the Mexican Federal District; there is a San Rafael in Mexico State and San Rafael Zaragoza is in nearby Morelos.

Diagnosis. Distinct in details of the anterior gonopods (Fig. 260) from other species of the group.

Description of male holotype. Length, 15 mm, A3 = 0.54 mm. Ocelli 28 in 6 rows. Coloration typical. Segments cylindrical. Anterior gonopods (Fig. 260): broad in lateral view, posterior bladelike part of colpocoxite deeply indented near apex, margin concave; coxae setose; telopodite with small, lateral, subterminal tooth. Posterior gonopod: coxa elongate, with basal lobe, distal rugose area; widest part of second segment just beyond midlength. Coxa 10 elongate, gland nearly sessile. Coxa 11 with large chitinous plate above gland opening. Process of sternum 12 a small triangular ridge.

Description of female from type locality. Length, 15 mm, A3 = 0.57 mm. Nonsexual characters as in male. Cyphopods: valves

with inner margins deeply sinuate (Fig. 262); postgenital plate apparently absent.

Distribution. Known only from the type locality.

Cleidogona zapoteca n. sp.

Figures 263–265

Types. Male holotype from San Pedro Juchatengo, near Pinotepa Nacional, Oaxaca, elev. 7100 ft., collected 23 March 1966 by G. Ball and D. Whitehead. The specific name refers to the Zapotec culture of pre-Columbian Mexico.

Diagnosis. Closest to *C. rafaela*, but distinct from that species in the oblique ridge across the anterior face of the anterior gonopod colpocoxites (Fig. 263) and the form of the anterior gonopod telopodite (Fig. 264, compare Fig. 260).

Description of male holotype. Length, 15 mm, $A_3 = 0.74$ mm. Ocelli 26 in 5 rows plus single ocellus. Coloration typical. Segments cylindrical. Anterior gonopods: in anterior view (Fig. 263), sternum not extending far between colpocoxites; coxae without setae. Colpocoxites with oblique ridge about midlength. In lateral view (Fig. 264) resembling gonopods of *C. rafaela*, but bladelike portion of colpocoxite with posterior margin convex, not concave; telopodite simple, pointed, not much curved. Posterior gonopods: typical of genus (Fig. 265). Coxae 10 and 11 and process of sternum 12 typical.

Female unknown.

Distribution. Known only from the type locality.

Cleidogona laquinta n. sp.

Figures 266–268

Types. Male holotype from 3 mi. east of San Cristóbal de las Casas, on road to La Quinta, Chiapas, collected 17 July 1956 by Bell and Van Horn. The species name refers to the type locality, and is a noun in apposition.

Diagnosis. This species resembles *C. conotyloides* in having moderately developed lateral shoulders, or paranota,

though they are not as distinct as in that species. The gonopods are quite different, and more greatly resemble those of *C. zapoteca*, from which *C. laquinta* can be separated by its larger anterior gonopod telopodites (Fig. 268, compare Fig. 264).

Description of male holotype. Length, 9.5 mm, $A_3 = 0.47$ mm. Ocelli 22 in 5 rows. Specimen bleached, but coloration probably as usual in fresh material. Segments with moderate paranota, somewhat less developed than those of *C. conotyloides* (Fig. 274), segments posterior of segment 17 roughly cylindrical. Anterior gonopods: in anterior view (Fig. 267), sternum extending between colpocoxites, coxae with only 2 setae; colpocoxites with a pronounced mesal ridge at the base, sharply curved apically. In lateral view (Fig. 268) resembling gonopods of *C. zapoteca*, but telopodites bulkier, anterior margin of telopodite irregular. Posterior gonopods: typical (Fig. 266) but lacking a claw. Coxae 10 and 11 as usual, but coxae 11 without knobs; process of sternum 12 typical.

Female unknown.

Distribution. Known only from type locality.

Notes. This species, because of the moderate development of paranota, may serve to link the rest of the group with *C. conotyloides* (below), and through that species, with the *godmani*-group.

Cleidogona conotyloides n. sp.

Figures 269–274

Types. Male holotype from 8.6 mi. east of San Cristóbal de las Casas, Chiapas, 8500–9000 ft., collected 30 April 1966 by G. Ball and D. Whitehead; female paratype from 11.6 mi. north of Pueblo Nuevo, Chiapas, 5200 ft., collected 26 April 1966 by Ball and Whitehead.

Diagnosis. The very well-developed, *Conotylo*-like paranota distinguish this species from any other of *Cleidogona*.

Description of male holotype. Length, 16 mm, $A_3 = 0.54$ mm. Ocelli 25 in 5 rows

plus single ocellus. Coloration: paranota light, row of dark spots down midline of dorsum. Segments with well-developed paranota, similar to those found in members of the genus *Conotyta* (Conotylidae), 2 lateralmost setae of each side on paranota (Fig. 274). Anterior gonopods: in anterior view (Fig. 269), coxal knobs evident, colpocoxites closely appressed basally, simple, with mesal ridge. In lateral view (Fig. 270), colpocoxites simple, bladelike, slightly curved; telopodite apically expanded and sharply curved anteriorly. Posterior gonopods: bulkier than is usual in genus, coxae with basal knob (Fig. 271). Coxae 10 and 11 elongate, with glands, not otherwise modified. Process of sternum 12 apically divided into 2 curved branches of equal length (Fig. 272).

Description of female paratype. Length, 15.5 mm, A3 = 0.50 mm. Nonsexual characters as in male. Cyphopods as in Figure 273.

Distribution. In addition to the type localities, an immature specimen from 5 mi. west of San Cristóbal de las Casas, Chiapas, 7200 ft., can probably be assigned to this species.

Notes. While the gonopods of this species are typical of *Cleidogona*, the strong paranota on the segments create a superficial resemblance to members of the family Conotylidae, not definitely known to occur south of Chihuahua. The cleft process of the twelfth sternum again demonstrates that this character is not of generic value, as Loomis (1966) supposed.

THE STOLLI GROUP

This small group of two species is intermediate between members of the preceding group and the Proto-*dybasia*-group, described below. The anterior gonopod colpocoxites give the impression of being small, blunt, and curved at a right angle. The telopodites are small (almost absent in *C. stolli*) and curved sharply dorsad. *Cleidogona mirabilis* is included in this group, despite the somewhat different appearance of the gonopod colpocoxites; it

may belong to the Proto-*dybasia*-group, but the basal region of the anterior gonopods was evidently damaged during the original dissection. Species of the *stolli*-group occur in Chiapas, Mexico, and in Guatemala and El Salvador.

Cleidogona stolli Pocock

Figures 275-277

Cleidogona stolli Pocock, 1903, *Biologia Centrali-Americana, Zoologia, Diplopoda et Chilopoda*, p. 52, pl. 5, fig. 7a-e, ♂.

Hirsutogona stolli, Kraus, 1954, *Senck. Biol.*, 35: 329.

Types. Male holotype and other specimens from Volcán de Agua, Guatemala, deposited in British Museum (Natural History), examined.

Diagnosis. The telopodites are the smallest of any *Cleidogona* species (Fig. 276), except *C. atoyaca*, in which they are absent.

Description of male holotype. Length, about 15 mm, all specimens in poor condition, originally pinned and dried; antennae and legs mostly missing. Ocelli 25, with no regular arrangement. Specimen bleached and stained green. Segments cylindrical. Anterior gonopods: in anterior view (Fig. 275), sternum broad, not extending much between colpocoxites, coxal knobs prominent. Colpocoxites stout and simple. In lateral view (Fig. 276), colpocoxites curved at nearly a right angle, with shelflike apophysis above insertion of short, curved telopodites. Posterior gonopods absent from specimen. Coxae 10 with large, knobby cones above gland apertures. Coxae 11 as usual, chitinous shelves distad to glands. Process of sternum 12 typical.

Description of female from type locality. Length, about 15 mm, antennae missing. Cyphopods as in Figure 277, possibly distorted by drying and rehydration.

Distribution. Known only from the type locality.

Notes. This species is clearly related to *C. decurva*, and to *C. atoyaca* of the Proto-*dybasia*-group.

Cleidogona decurva n. sp.

Figures 278–280

Types. Male holotype from surface near Sumidero de Camino (a sumidero is a sink-hole with a stream running into it), 10 mi. northwest of Comitán, Chiapas, collected 22 August 1967 by J. Reddell.

Diagnosis. The anterior faces of the anterior gonopod colpocoxites are corrugated, as in some species of the *maculata*-group, but the short, decurved telopodites are distinctive.

Description of male holotype. Length, 12 mm, A3 = 0.61 mm. Ocelli 25 in 6 rows. Coloration typical. Segments cylindrical. Anterior gonopods: in anterior view (Fig. 278) sternum not extending between colpocoxites, colpocoxites with prominent ridge, corrugated area mesal to ridge; colpocoxites apically expanded. In lateral view (Fig. 279), coxae large, with setae, extending around base of telopodites posteriorly; telopodites short, decurved, with two nearly right angles. Posterior gonopods: coxae complex, with series of basal lobes (Fig. 280); second joint very narrow at base, widest part just beyond midlength; apical joint rather longer than usual. Coxa 10 with cylindrical process above gland aperture. Coxa 11 typical. Process of sternum 12 suppressed, small elongate ridge.

Female unknown.

Distribution. In addition to the type locality: CHIAPAS: pine forest along Rt. 190, 8.5 mi. southeast of San Cristóbal de las Casas, 23 July 1956, R. T. Bell, ♂ ♂.

Cleidogona mirabilis (Kraus)

NEW COMBINATION

Figures 286, 287

Hirsutogona mirabilis Kraus, 1954, Senck. Biol., 35: 329, figs. 62–65, ♂.

Types. Male holotype and immature female paratype from Monte Cristo, Metapán Mts., Dept. Santa Ana, El Salvador, deposited in Senckenburg Museum, Frankfurt, examined.

Diagnosis. The details of the gonopods, in particular the rather thin colpocoxites, separate this species from others of the group.

Description of male holotype. Length, 18 mm, A3 = 0.86 mm. Ocelli 28 in 6 rows. Coloration typical. Segments cylindrical, segmental setae unusually stiff and short. Anterior gonopods: see Figure 286. The gonopods have been permanently mounted on microscope slides, so I can do little more here than present line drawings made with the aid of a microscope projecting device (Bioscope). The basal part of the gonopod has been destroyed, but the curved short telopodites indicate a relationship to *C. decurva* and *C. stolli*. Posterior gonopods: typical of the genus (Fig. 287), coxae with large basal knob, widest part of second segment near midlength; apical segment apparently divided, perhaps folded when mounted on slide. Coxae 10 and 11 and sternal process 12 as usual.

Distribution. Known only from the type locality.

THE PROTO-DYBASIA GROUP

I refer to this group as the Proto-*Dybasia*-group rather than by the name of one of the included species, in order to emphasize its relationship to the genus *Dybasia*, of Panama. The two species belonging to this group are distinguished by the large knobs projecting from the sternum of the anterior gonopod. In species of *Dybasia*, these projections are usually free, and the sternum does not extend between the colpocoxites as it does in most species of *Cleidogona*. Showing further affinity with *Dybasia*, at least one species of this group has the telopodites reduced (a good observation of the telopodites was not possible in *C. minutissima*).

Cleidogona atoyaca Chamberlin

Figures 281–283

Cleidogona atoyaca Chamberlin, 1943, Bull. Univ. Utah, 34: 34, figs. 66–68, ♂.

Types. Male holotype from Atoyac, Veracruz, in University of Utah collection, examined.

Diagnosis. The only species of *Cleidogona* except *C. austrina* of Panama (see section on species not included in revision) that completely lacks anterior gonopod telopodites.

Description of male holotype. Length, 11 mm, A3 = 0.46 mm. Ocelli 20, arrangement somewhat irregular. Specimen bleached by long preservation. Segments cylindrical. Anterior gonopods: in anterior view (Fig. 281), sternum with pair of subtriangular processes from portion between colpocoxites, depressed between processes; coxal knobs prominent, coxae setose; colpocoxites short, stout. In lateral view (Fig. 282), telopodites missing or reduced to small common knob at posterior bases of coxae. Posterior gonopods appearing 6-segmented, but apparent articulation just above coxal process may be artifact; coxal process long, with small knobs; widest part of second segment near midlength. Coxae 10 and 11 and process of sternum 12 as usual.

Female unknown.

Distribution. In addition to the type locality: VERACRUZ: Fortin de las Flores (as Fortin on most maps, near city of Orizaba), 26–30 June 1966, D. Whitehead, ♂.

Notes. This species has most of the characters used by Loomis (1964) to separate the genus *Acakandra* from *Cleidogona*. I have synonymized *Acakandra* under *Cleidogona*, but the only known male of *A. austrina*, the type and only species, lacks gonopods. The illustrations given by Loomis (1964) resemble *C. atoyaca*, but *C. austrina* occurs in Panama.

Cleidogona minutissima (Kraus)

NEW COMBINATION

Figures 284, 285

Hirsutogona minutissima Kraus, 1954, Senck. Biol., 35: 332, figs. 66–71, ♂.

Types. Male holotype from (shores of?) Laguna de las Ranas, Dept. Sonosante, El

Salvador, deposited in Senckenburg Museum, Frankfurt, examined.

Diagnosis. This species has sternal processes on the anterior gonopods like those found in *C. atoyaca*, but, according to the illustrations of Kraus (1954), has much larger telopodites and a series of small teeth along the lateral edges of the colpocoxites (Fig. 284).

Description of male holotype. Length, 11 mm, A3 = 0.50 mm. Ocelli 25 in 5 rows. Coloration typical. Segments cylindrical. Anterior gonopods: see Figure 284 and Kraus (1954). The gonopods were mounted on a permanent microscope slide, much cleared and distorted by compression. The figure given here was made using a projection device (Bioscope). Posterior gonopods: much like those of *C. atoyaca* (Fig. 285, compare Fig. 283). Coxae 10 and 11 and sternum 12 as usual.

Female unknown.

Distribution. Known only from the type locality.

The North American Species of *Cleidogona*

KEY TO MALES OF NORTH AMERICAN *CLEIDOGONA* SPECIES

For species not included, see section above on species not included in revision.

- 1a. Posterior gonopod with large, conical process at base of coxa, nearly as large as rest of coxa (Fig. 246); San Antonio area of Texas *bacillipus* (discussed under Mexican species)
- 1b. Posterior gonopod without such a process 2
- 2a. Anterior gonopod telopodites with large, winglike lateral process (Fig. 350); Georgia *alata*
- 2b. Such a process lacking 3
- 3a. Posterior part of anterior gonopod colpocoxites enormously swollen; telopodites much reduced (Fig. 374); Ohio, Illinois *celerita*
- 3b. Not as above 4
- 4a. Each anterior gonopod colpocoxite divided nearly to base, anterior branch cupped; posterior, longer branch rodlike (Figs. 288–290); Big Bend region of Texas *chisosi*
- 4b. Anterior gonopod colpocoxites not divided, or if so, then only at apex, apical

branches not longer than one-third length of gonopod	5	16a. Anterior branch of anterior gonopod colpocoxite apex redivided (Figs. 320–323, 368)	17
5a. Divisions of anterior gonopod colpocoxite turned anterior (Fig. 398); Indiana, Ohio to Kentucky, Virginia	<i>rustis</i>	16b. Anterior branch not redivided	18
5b. Divisions of anterior gonopod colpocoxites continuing line of colpocoxite, or curved posterior; or gonopod colpocoxites not divided	6	17a. Posterior gonopod with deep basal coxal notch (Fig. 365); Mississippi	<i>mississippiana</i>
6a. Anterior gonopod colpocoxites widely separated near base by sternum (Figs. 338, 342, 352, 359, 394)	7	17b. Posterior gonopod as in Fig. 324; Virginia, North Carolina	<i>hoffmani</i>
6b. Anterior gonopod colpocoxites not widely separated at or near base by sternum (Figs. 297, 310, 320, 316, 332, etc.)	11	18a. Apex of anterior gonopod telopodites deeply divided, clasping colpocoxites (Fig. 345); South Carolina	<i>steno</i>
7a. Body length less than 10 mm; anterior gonopods as in Figs. 394, 395; Mississippi	<i>accretis</i>	18b. Apex of telopodites clublike (Figs. 294, 333)	19
7b. Body length more than 10 mm; anterior gonopods not as in Figs. 394–395	8	19a. Coxal process of anterior gonopods wider at base than long (Fig. 333); Alabama	<i>tallapoosa</i>
8a. Anterior gonopod colpocoxites apically divided	9	19b. Coxal process of anterior gonopod not wider at base than long (Figs. 294, 298)	20
8b. Anterior gonopod colpocoxites not apically divided (Figs. 359, 360); North Carolina	<i>wrayi</i>	20a. Apical branches of anterior gonopod colpocoxite curved posterior (Fig. 298); Map 13	<i>inexpectata</i>
9a. Anterior gonopod telopodite with thornlike process below divided apex (Fig. 343); Virginia	<i>fidclitor</i>	20b. Branches not curved (Fig. 294); Map 12	<i>major</i>
9b. No such process	10	21a. Anterior apical branch of colpocoxite completely redivided (Fig. 364), or rodlike and turned laterad (Figs. 370, 371)	22
10a. Anterior gonopods as in Figs. 252, 253; Georgia	<i>georgia</i>	21b. Not as above	23
10b. Anterior gonopods as in Figs. 338, 339; North Carolina	<i>caroliniana</i>	22a. Anterior colpocoxite of anterior gonopod branch as in Fig. 364, Mississippi, Alabama	<i>grenada</i>
11a. Anterior gonopod coxa with posterior process (Figs. 294, 311, 321, 333, 345, 368, 378)	12	22b. Anterior colpocoxite branch of anterior gonopod as in Fig. 371; Louisiana	<i>sublettei</i>
11b. Anterior gonopod coxa lacking such a process (Figs. 302, 317, 329, 335, 364)	21	23a. Anterior gonopod colpocoxites not divided (Figs. 388–390); Illinois	<i>unita</i>
12a. Coxal process subtriangular, pointed (Figs. 311, 321, 368)	14	23b. Anterior gonopod colpocoxites apically divided	24
12b. Coxal process quadrate (Figs. 378–380, 386)	13	24a. Anterior gonopod telopodites with small winglike lateral process (Fig. 302); North Carolina	<i>nantahala</i>
13a. Posterior branch of anterior gonopod colpocoxite apex distally notched, branches straight (Fig. 386); Arkansas	<i>laminata</i>	24b. Such processes lacking	25
13b. Posterior colpocoxite branch not notched, apical branches curved posterior (Figs. 378–380); see Map 12	<i>caesioannulata</i>	25a. Anterior gonopod with anterior colpocoxite branch a toothed lamella (Fig. 328); Georgia	<i>atropos</i>
14a. Anterior colpocoxites not apically divided (Figs. 307, 308); North Carolina	<i>lachesis</i>	25b. Not as above	26
14b. Anterior gonopod colpocoxites apically divided	15	26a. Gonopods as in Figs. 335–337; Florida	<i>hadena</i>
15a. Posterior gonopod with large rodlike process on distal half of coxa (Fig. 312); North Carolina	<i>margarita</i>	26b. Gonopods as in Figs. 316–318; North and South Carolina	<i>jocassee</i>
15b. Posterior gonopod lacking such a process 16			

THE CHISOSI GROUP

Cleidogona chisosi Loomis
Figures 288–292*Cleidogona chisosi* Loomis, 1963, J. Kansas Entomol. Soc., 36: 121, figs. 5–7, ♂.

Types. Male holotype from Pulliam Ridge, elev. 5400 ft., near Panther Basin, Big Bend National Park, Texas; female paratype from Green Gulch, road to Panther Basin, Big Bend National Park, Texas, deposited in USNM, examined.

Diagnosis. The form of the anterior gonopods, with the two-branched colpocoxites (Figs. 288–290) is unique in the genus.

Description of male holotype. Length, 9 mm, A3 = 0.50 mm. Ocelli 24 in 5 rows. Coloration typical. Segments cylindrical. Anterior gonopods: in anterior view (Fig. 288), sternum with triangular extension between coxae; coxae with prominent lateral shoulders, setose. Colpocoxites with 2 branches, the anterior branch broad, mesally cupped, the posterior branch a long, flat lamella, longer than anterior branch and mesad to it (Fig. 289). In lateral view (Fig. 290), telopodite nearly half as long as posterior branch of colpocoxite, freely movable. Posterior gonopods: with three (four?) segments, resembling species of *Tiganogona*; coxa enlarged, depressed in median midline. Second segment not enlarged as is usual in *Cleidogona*; apical segments subglobose. Coxae 10 and 11 and sternal process 12 as usual in genus.

Description of female paratype. Length, 9 mm, A3 = 0.47 mm. Nonsexual characters as in male. Cyphopods (Figs. 292, 293): lateral valve extending posteriad of mesal valve (Fig. 293), curving mesad; postgenital plate (Fig. 292) low.

Distribution. Known only from the type localities.

Notes. Loomis' (1963) verbal description of the anterior gonopods is hard for me to follow, but he apparently did not recognize that the anterior gonopod colpocoxites of each side were divided into two branches. He may also have interpreted his figure of the gonopods in lateral view (Loomis, 1963, his fig. 6) while inadvertently reversing anterior and posterior. Loomis' figure 7 shows an extra articulation

in the distal segments of the posterior gonopod.

THE MAJOR GROUP

This is the largest species group of *Cleidogona* in number of species, and probably represents the most actively speciating line in the genus; most of the present species probably originated when Pleistocene glacial conditions created isolated habitats in the southern Appalachians. The gonopods are very similar in most species. The anterior gonopod colpocoxites are apically divided, and there is usually a coxal process, found only in *C. tizoc* among the Mexican species. The telopodites are usually large and freely movable. The postgenital plate of females is often divided, and in typical species, each division has two branches (Fig. 296). The species clustered around *C. caroliniana* (see below) form a distinct subgroup, especially when the female genitalia are considered. *Cleidogona major* occurs from North Carolina to northern Virginia, but most other species of the group are to be found in limited areas of the central and southern Appalachians (Maps 12, 13).

Cleidogona major Cook and Collins Figures 294–296, Map 12

Cleidogona major Cook and Collins, 1895, Ann. New York Acad. Sci., 9: 47, figs. 110–137, ♂.

Types. Male holotype from Washington, D. C., in USNM, examined.

Diagnosis. Most closely related to *C. inexpectata*, but distinct from that species in the form of the coxal process and in the lesser apical curvature of the gonopod colpocoxites in *C. major* (compare Fig. 294, *C. major*, and Fig. 298, *C. inexpectata*).

Description of male holotype. Length, 20 mm, A3 = 0.95 mm. Ocelli 27 in 6 rows. Coloration typical. Segments cylindrical. Anterior gonopods: in lateral view, coxa swollen, coxal process squared off at tip, not curved; colpocoxites (Fig. 294) apically divided, branches subequal, neither branch shieldlike. Telopodites basally rodlike,

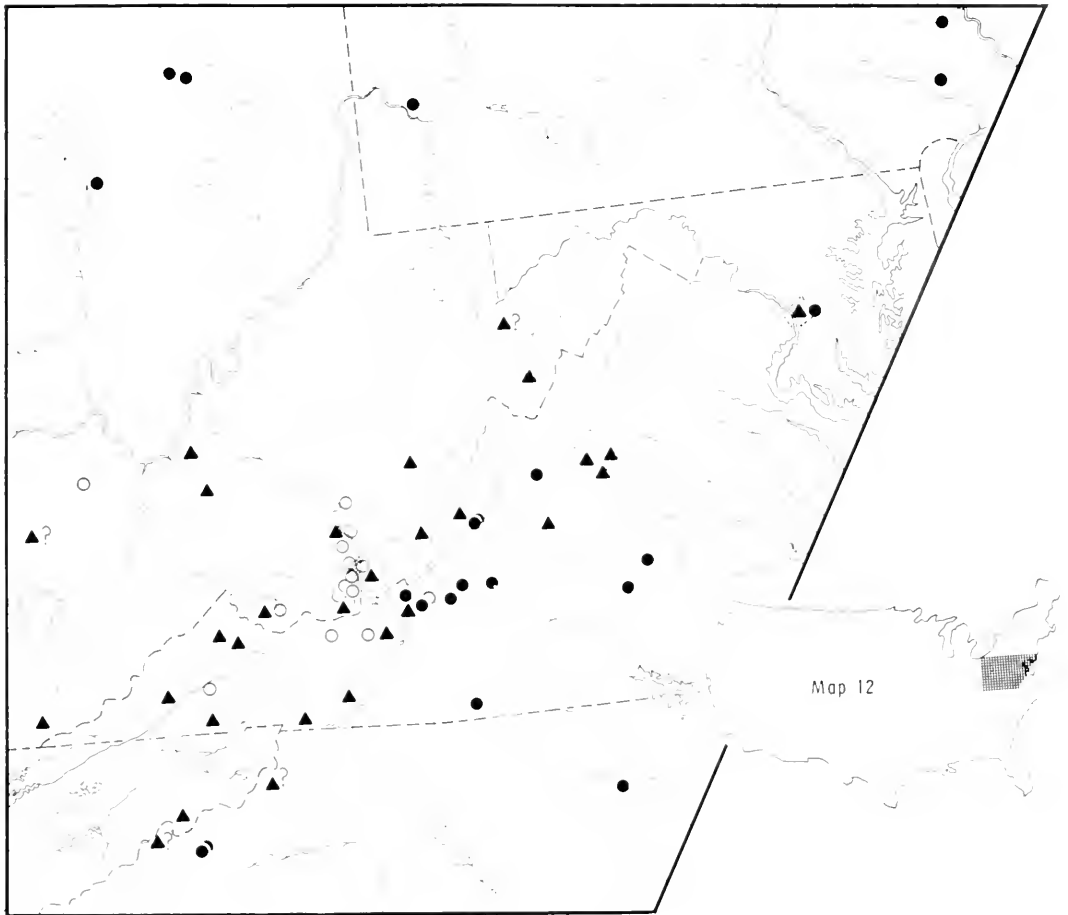

Map 12. West Virginia and parts of adjacent states, showing distribution of species of *Cleidogona*. Dots, *C. caesiannulata*; circles, *C. fustis*; triangles, *C. major*. *Cleidogona fustis* has also been reported from Indiana and Ohio.

broadly expanded apically, large and movable. Posterior gonopods (Fig. 295): typical of group, basal knob of coxa low, rounded; widest part of second segment just beyond midlength. Coxa 10 and 11 and sternal process 12 as usual.

Description of female from type locality. Length, 22 mm, A3 = 1.00 mm. Nonsexual characters as in male. Cyphopods: valves not modified; postgenital plate (Fig. 296) divided, each division with two branches, mesal branch longest and apically expanded, lateral branch broader at base, tapered, shorter.

Distribution (Map 12). KENTUCKY: *Bell*

Co., Pine Mt. State Park, 22 June 1950, R. Hoffman, ♂ ♀; *Powell Co.*, Natural Bridge State Park, 9 July 1966, B. Branson, ♂ ♀. NORTH CAROLINA: (Dubious records, females only, may apply to *C. margarita*). *Madison Co.*, near Hot Springs, 6 July 1968, R. Hoffman, ♀; *Watauga Co.*, 6 mi. from Boone, 17 June 1948, M. Wright, ♀. TENNESSEE: *Carter Co.*, 4.5 mi. north of Shell Creek (3500 ft.), 17 July 1964, R. Hoffman, ♂. VIRGINIA: *Albemarle Co.*, Stony Point, 30 October 1948, R. Hoffman, ♂ ♂ ♀ ♀; Saddle Hollow, March 1948, R. Hoffman, ♀; Charlottesville, November 1948, R. Hoffman, ♂ ♀; *Alleghany Co.*, 2

mi. northwest of Clifton Forge, 23 August 1947, R. Hoffman, ♂ ♀; *Buchanan Co.*, Grimleysville, 30 June 1951, R. Hoffman, ♂ ♀; 8 mi. southwest of Vansant, 1 July 1951, R. Hoffman, ♂; *Carroll Co.*, 9 mi. north of Fries, 10 June 1962, R. Hoffman, ♂; *Giles Co.*, 5 mi. west of Newport, 16 June 1962, R. Hoffman, ♂ ♀ ♀; *Grayson Co.*, west of Independence, 18 June 1950, R. Hoffman, ♀ ♀; *Pulaski Co.*, 10 mi. northeast of Pulaski, July 1963, D. Stapleton, ♂ ♂ ♀ ♀; *Rockbridge Co.*, Blue Ridge Parkway, Rocky Mount, 24 August 1949, R. Hoffman, ♂; *Scott Co.*, 3.5 mi. northeast of Dungannon, 31 July 1965, R. Hoffman, ♂; *Washington Co.*, 3 mi. northeast of Mendota, 31 July 1965, R. Hoffman, ♂ ♂. WEST VIRGINIA: *Cabell Co.*, 2.5 mi. southeast of Ona, 12 August 1938, MacMillan and Richmond, ♂; *Greenbriar Co.*, Kate's Mt., above White Sulphur Springs, 5 April 1967, W. Shear, ♂ ♂; *Lincoln Co.*, Myra, 15 August 1948, Richmond, ♀; *McDowell Co.*, 5 July 1947, H. Hobbs, ♂; *Monroe Co.*, 2 mi. north of Ballard, 14 September 1962, R. Hoffman, ♀; *Mercer Co.*, Bluefield, 25 June 1966, R. Hoffman, ♂ ♂; *Pendleton Co.*, 3 mi. northeast of Franklin, 22 August 1958, L. Hubricht, ♂; *Raleigh Co.*, Grandview State Park, 14 September 1962, R. Hoffman, ♀; *Tucker Co.*, Parsons, Pernow Experimental Forest, 17 October 1965, J. and M. Cooper, ♀; *Webster Co.*, 5 mi. southwest of Three Forks, 18 June 1963, R. Hoffman, ♂ ♀.

Notes. Despite the wide range, there is little variation in this species, especially in the form of the gonopods. Cook and Collins (1895) suggested that this species might be the original of *C. caesioannulata*, even though they had just redescribed that species correctly.

Cleidogona inexpectata Hoffman

Figures 297–300, Map 13

Cleidogona inexpectata Hoffman, 1950, J. Elisha Mitchell Sci. Soc., 66: 22, figs. 23–25, ♂.

Types. Male holotype from Chimneys Camp Ground, Great Smoky Mountains

National Park, Sevier Co., Tennessee, in USNM (Type No. 1878), examined.

Diagnosis. Closely related to *C. major*, but distinct from that species in the form of the coxal process of the anterior gonopods (Fig. 298) and the greater curvature in *inexpectata* of the apical part of the colpocoxites. The females of the two species may be separated by reference to Figure 296 (*C. major*) and Figure 300 (*C. inexpectata*).

Description of male from type locality. Length, 23 mm, A3 = 1.08 mm. Ocelli 30, in 7 rows plus single ocellus. Coloration normal. Segments cylindrical. Anterior gonopods: in anterior view (Fig. 297), sternum extending well between colpocoxites, fused to colpocoxites; coxae setose, coxal knobs prominent. In lateral view (Fig. 298), colpocoxite apically divided, branches curved, posterior branch somewhat larger in lateral view, shieldlike; coxal process pointed, slightly curved; coxa depressed, not swollen as in *C. major*, depression limited by an anterior ridge. Telopodite similar to that of *C. major*. Posterior gonopods (Fig. 299): like those of *C. major*, but basal coxal process larger; second segment more evenly rounded on mesal edge. Coxa 10 elongate, gland on petiole. Coxa 11 with large shelf distad to gland opening. Process of sternum 12 a long rod, but of typical form.

Description of female from type locality. Length, 24.5 mm, A3 = 1.10 mm. Ocelli 29 in 7 rows on left side, like male on right side. Nonsexual characters as in male. Cyphopods: postgenital plate divided (Fig. 300), lateral branch of each division much reduced, mesal branch long, apically enlarged and lobed.

Distribution (Map 13). TENNESSEE: *Blount Co.*, Cades Cove Camp Ground, Great Smoky Mountains National Park, 29 August 1961, N. Causey, ♂ ♂ ♀ ♀; *Hamilton Co.*, Signal Mtn., 18 August 1956, R. Hoffman, ♂ ♂ ♀ ♀; *Sequatchie Co.*, 5 mi. southeast of Dunlap, 20 August 1956, R. Hoffman, ♂.

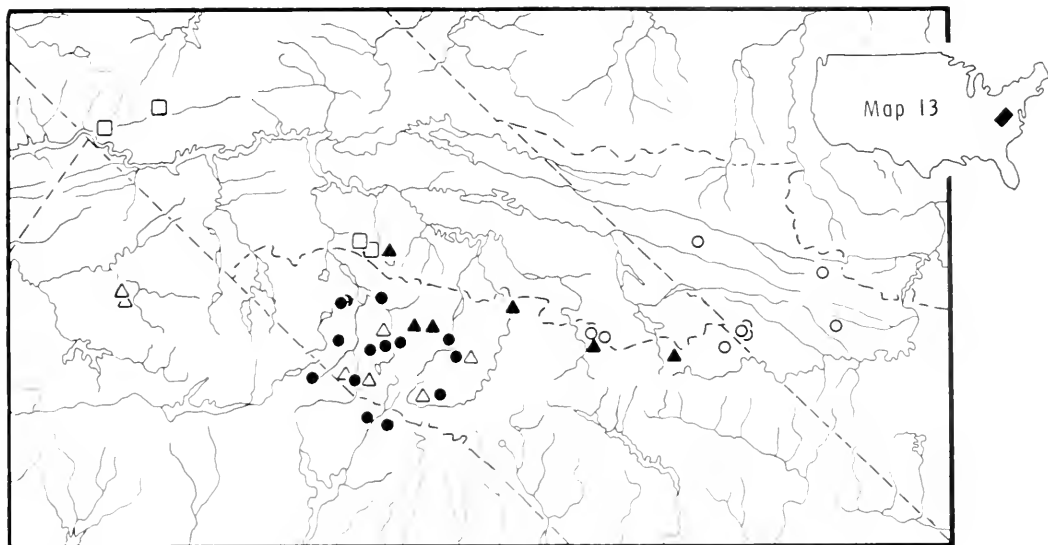

Map 13. Parts of Tennessee, North Carolina, Virginia, and Georgia, showing distribution of *Cleidogona* species. Dots, *C. jocassee*; circles, *C. hallmani*; squares, *C. inexpectata*; open triangles, *C. nantahala*; solid triangles, *C. margarita*.

Notes. This species and *C. major* are very closely related and probably had a common ancestor in the recent past (late Pleistocene?). *Cleidogona inexpectata* is distributed to the south of *C. major* and has extended its range into the western Tennessee foothills. Undoubtedly many further localities for this species remain to be discovered.

Cleidogona nantahala n. sp.
 Figures 301–306, Map 13

Types. Male holotype, female paratype, and other specimens from Mt. Pisgah, elev. 5000 ft., Haywood Co., North Carolina, collected 7 April 1949 by D. L. Wray. The specific name refers to the Nantahala National Forest.

Diagnosis. Related to *C. margarita*, *C. lachesis*, and *C. jocassee*, but distinct from those species in lacking a coxal process on the anterior gonopods (Fig. 302, compare Figs. 308, 311, and 317); females of *C. nantahala* do not have the postgenital plate divided as in *C. margarita* and *C. jocassee*, and the valves are modified. Females of *C. lachesis* are unknown.

Description of male holotype. Length, 17 mm, A3 = 0.72 mm. Ocelli 26 in 6 rows. Coloration pale, but typical, segments cylindrical. Anterior gonopods: in anterior view (Fig. 301), sternum broadly extended between coxae and colpocoxites, coxae elongate, with obvious knobs. In lateral view (Fig. 302), coxal process suppressed; colpocoxite apically divided, inner (posterior) branch bladelike, finely hirsute posteriorly, lateral (anterior) branch, expanded, shieldlike. Telopodite with short wing near midlength, slightly expanded apically, sharply curved. Coxa (Fig. 304) with swollen rugose area above gland aperture (note spermatophore on tip of extruded gland) on mesal side, blunt process on lateral side. Coxa 11 with small plate distal to gland. Process of sternum 12 (Fig. 305) typical, slightly larger distally than usual.

Description of female paratype. Length, 17 mm, A3 = 0.70 mm. Nonsexual characters as in male. Cyphopods (Fig. 306) with large, transparent, apically irregular processes posterior on lateral valves; post-

genital plate not divided, flared broadly at tip, transparent.

Distribution (Map 13). NORTH CAROLINA: *Jackson Co.*, Western Carolina University Preserve, Cullowhee, 25 October 1969, W. Shear, ♂ ♀ ♀; *Macon Co.*, 5 mi. west of Highlands, 26 October 1969, W. Shear, ♂ ♂; Highlands, 16 November 1961, R. Hoffman, ♂ ♂ ♀ ♀; *Transylvania Co.*, Balsam Grove, 16 October 1965, R. Hoffman, ♂ ♂.

The following specimens are females that conform to Figure 306, but in the absence of males, I am reluctant to assign them for certain to *C. nantahala*. They are indicated on Map 13. GEORGIA: *Pickens Co.*, 2 mi. south of Marble Hill, 8 April 1961, L. Hubricht, ♀; 4 mi. north of Jasper, 6 November 1960, L. Hubricht, ♀.

Notes. The female genitalia of this species resemble those of species of the *alata*-group, to which it may be related; this interpretation is reinforced by the small "wing" on the anterior gonopod telopodite. *Cleidogona nantahala* is limited to the southern Blue Ridge.

Cleidogona lachesis n. sp.

Figures 307–309

Types. Male holotype from Linville Falls, Avery Co., North Carolina, 7 April 1949 by D. L. Wray. The species name, a noun in apposition, is the name of one of the three fates, and was suggested by the hooded appearance of the anterior gonopod colpocoxites.

Diagnosis. Related to *C. jocassee* and *C. margarita*, but distinct in having the inner (posterior) branch of the anterior gonopod colpocoxites suppressed and not visible in lateral view (Fig. 308). The posterior gonopods resemble those of *C. margarita*, but the apical process of the coxa is smaller.

Description of male holotype. Length, 19 mm, A3 = 0.90 mm. Ocelli 28–30 in 6 rows. Coloration typical. Segments cylindrical. Anterior gonopods: in anterior view (Fig. 307), coxae without pronounced

knobs, sternum extending between colpocoxites and fused to them. In lateral view (Fig. 308), coxa with rugose area below setae, coxal process pointed; colpocoxite with only outer branch visible, outer branch hoodlike, smooth, telopodites upright, expanded apically, not much curved. Posterior gonopods (Fig. 309): basal process of coxa small, subapical process rounded, of moderate size; widest part of expanded second joint just distad of mid-length. Coxae 10 and 11 as usual. Process of sternum 12 short, pointed, not reaching beyond coxae 11.

Female unknown.

Distribution. In addition to the type locality: NORTH CAROLINA: *Avery Co.*, east side of Grandfather Mountain, 1 June 1954, R. L. Hoffman, ♂.

Cleidogona margarita Hoffman

Figures 310–315, Map 13

Cleidogona margarita Hoffman, 1950, J. Elisha Mitchell Sci. Soc., 66: 21, figs. 19–22, ♂ ♀.

Types. Male holotype and female paratype from Chimneys Camp Ground, Great Smoky Mountains National Park, Sevier Co., Tennessee, in USNM, examined.

Diagnosis. Closely related to *C. jocassee*, but distinct in the larger coxal process on the anterior gonopods (Fig. 311) and the presence of a long subapical rod on the coxae of the posterior gonopods (Fig. 312).

Description of male from Soco Gap. Length, 18 mm, A3 = 0.80 mm. Ocelli 31–33 in 6 rows. Coloration typical. Segments cylindrical. Anterior gonopods: in anterior view (Fig. 310), with sternum extending between colpocoxites and expanded between them; coxal knobs prominent; anterior branch of colpocoxite shieldlike, concealing base of posterior branch. In lateral view (Fig. 311), coxal process large, quadrate, telopodite evenly and slightly curved, not much expanded apically. Posterior gonopods (Fig. 312), coxa with abortive gland knob basally, long rod subapically; second segment more evenly curved mesally than in other species.

widest part near midline. Coxae 10 and 11 and sternal process 12 as described for *C. inexpectata* (Figs. 313, 314).

Description of female from Soco Gap. Length, 19 mm, A3 = 0.82 mm. Nonsexual characters as in male. Cyphopods (Fig. 315): postgenital plate poorly sclerotized, with two upright rods.

Distribution (Map 13). NORTH CAROLINA: *Haywood Co.*, Soco Gap, 23 September 1961, R. Hoffman, ♂♂♀♀; *Jackson Co.*, Soco Gap Falls, 20 May 1959, R. Hoffman, ♀; *Madison Co.*, Hot Springs area, 6 July 1968, R. Hoffman, ♂♀; *Mitchell Co.*, 3 mi. south of Bakersville on N. C. Rt. 226, 12 July 1962, R. Hoffman, ♂; *Watauga Co.*, 4 mi. north of Vilas on US 421, 11 July 1962, R. Hoffman, ♂♀. See also North Carolina records of *C. major*.

Cleidogona jocassee Hoffman

Figures 316–319, Map 13

Cleidogona jocassee Hoffman, 1950, J. Elisha Mitchell Sci. Soc., 66: 19, figs. 15–18, ♂♀.

Types. Male holotype and female paratype from Jocassee, Oconee Co., South Carolina, in USNM (Type No. 1876), examined.

Diagnosis. The general appearance of the anterior gonopods is very much like that of *C. margarita*, but the coxal process is much suppressed (Fig. 317).

Description of male holotype. Length, 21 mm, A3 = 1.00 mm. Ocelli 27 in 6 rows plus single ocellus. Coloration typical. Segments cylindrical. Anterior gonopods (Figs. 316, 317): as in *C. margarita*, but coxal process suppressed, reduced to low rounded swelling; telopodites more abruptly expanded apically, not as curved as in *C. margarita*. Posterior gonopods (Fig. 318): typical of genus; widest part of second segment subapical. Coxae 10 and 11 and sternum 12 typical.

Description of female paratype. Length, 22.5 mm, A3 = 1.00 mm. Nonsexual characters as in male. Cyphopods: typical of group, postgenital plate divided (Fig. 319),

with branches not as deeply separated as in *C. inexpectata* or *C. major*.

Distribution (Map 13). GEORGIA: *Rabun Co.*, Glade Mtn., 27 July 1949, R. Hoffman, ♀♀. NORTH CAROLINA: *Haywood Co.*, Lake Junaluska, 6 July 1959, H. Weems, ♂♀; Mt. Pisgah, 4000–5000 ft., 4 July 1959, H. Weems, ♂♂♀♀; *Jackson Co.*, Cullowhee, 25 October 1969, W. Shear, ♀♀; Balsam, 3 August 1949, R. Hoffman, ♂; Chatooga River Gorge, 1 August 1958, R. Hoffman, ♂♀; *Macon Co.*, Wayah Bald, 5335 ft., 13 June 1953, R. Hoffman, ♂♂♀♀; 5 mi. north-northwest of Highlands, 9 July 1958, R. Hoffman, ♂♂♀♀; *Swain Co.*, base of Cliff Ridge at Nantahala, 6 May 1951, L. Hubricht, ♂♂♀♀; 3.3 mi. northeast of Nantahala, 16 May 1961, L. Hubricht, ♂♀; Birdtown, 6 May 1961, L. Hubricht, ♂♂♀♀; *Transylvania Co.*, Pink Beds Recreation Area, 8 mi. north of Brevard, 28–30 July 1958, R. Hoffman, ♂♂♀♀. SOUTH CAROLINA: *Oconee Co.*, Chatooga River, 2 mi. north of Mountain Rest, 22 July 1958, R. Hoffman, ♂.

Cleidogona hoffmani n. sp.

Figures 320–327, Map 13

Types. Male holotype, female paratype and other specimens from Roan Mt., below Carvers Gap, Mitchell Co., North Carolina, collected 23 September 1950 by Leslie Hubricht. The species name honors Dr. Richard L. Hoffman, in recognition of his many contributions to North American diplopod taxonomy, and his indispensable help with this study.

Diagnosis. Related to *C. margarita*, *C. jocassee*, etc., but differing in having the posterior branch of the apex of the anterior gonopod colpocoxite subdivided (Figs. 321–323).

Description of male holotype. Length, 18 mm, A3 = 0.75 mm. Ocelli 23–25 in 6 rows. Coloration typical. Segments cylindrical. Anterior gonopods: in anterior view (Fig. 320), sternum extending between colpocoxites, fused to them; coxal knobs moderate. Anterior faces of colpocoxites

with 2 ridges, mesal and lateral. In lateral view (Fig. 321) coxal process slightly curved, nearly triangular. Posterior branch of apex of colpocoxite flattened, posteriorly finely lacinate; anterior branch divided, lateralmost division rodlike, curved, mesal division somewhat flattened. Telopodite apically expanded and cupped, curved anteriorly about two-thirds from base. Posterior gonopods (Fig. 324): not as highly modified as others in group. Coxae 10 as usual. Coxa 11 (Fig. 325) with small lamina distad to gland. Process of sternum 12 as usual, posterior ridge of sternum with two small knobs.

Description of female paratype. Length, 18 mm, A3 = 0.72 mm. Nonsexual characters as in male. Cyphopods (Figs. 326, 327): valves modified, with thin lamina ventrally (Fig. 327); postgenital plate typical of genus, much like that of *C. jocassee*, but mesal branch of each division longer, divisions not so deeply divided.

Distribution. All collections by R. Hoffman. NORTH CAROLINA: *Ashe Co.*, 3 mi. northwest of Lansing, 13 October 1963, ♂♂♀♀. TENNESSEE: *Carter Co.*, top of Roan Mt., 22 June 1950, ♂♀. VIRGINIA: *Bland Co.*, Hamilton Cave, 3 mi. northeast of Mechanicsburg, 9 September 1956, ♂; *Grayson Co.*, Mt. Rogers, 4500 ft., 12 and 27 September 1962, ♂♂♀♀; Helton Creek, east side of Mt. Rogers, 1 June 1950, ♂; south slope of Mt. Rogers, 20 October 1963, ♂♂♀♀; *Russell Co.*, 1 mi. northwest of Lynn Springs, 20 April 1962, ♂; *Tazewell Co.*, north side of Beartown Mtn., 25 August 1969, ♂♂♀♀; East River Mtn., 11 September 1955, ♂♀; *Wythe Co.*, Reed Creek at Carter Wayside, Ft. Chiswell, 4 October 1969, ♂♂.

Notes. This species has been collected in beech woods and on the muddy banks of a stream. There is some variation in the male gonopods; a male from Beartown Mountain (Fig. 323) has the posterior branch of the gonopod apex less curved. Specimens from Mt. Rogers, Virginia, have the colpocoxites shorter beyond the coxal

process (Fig. 322), and differ slightly in the tip of the colpocoxite as well.

Cleidogona atropos n. sp.

Figures 328–331

Types. Male holotype and female paratype from 1 mi. south of Munnerlynn Swamp, Burke Co., Georgia, collected 24 October 1959, by L. Hubricht. The specific name is a noun in apposition, the name of one of the three fates.

Diagnosis. The details of the gonopods (Figs. 328–329) distinguish this species from others of its group. The female genitalia resemble those of *C. nantahala* and *C. steno*, but can be separated by reference to the figures.

Description of male holotype. Length, 10.5 mm, A3 = 0.54 mm. Ocelli 24 in 6 rows plus single ocellus. Coloration probably typical in fresh material, types bleached by preservation. Segments cylindrical. Anterior gonopods: tips of colpocoxites in anterior view (Fig. 328) with posterior branches thin plates, marginally dentate, the teeth irregular, posterior branches sinuously curved. In lateral view (Fig. 329), coxa without a process, setae in two groups; colpocoxite with posterior apical branch heavily lacinated along posterior margin. Telopodite sigmoidally curved, apically swollen. Posterior gonopods (Fig. 330) typical. Coxae 10 as usual. Process of coxa 11 reduced in size. Process of sternum 12 as usual.

Description of female paratype. Length, 11 mm, A3 = 0.55 mm. Nonsexual characters as in male. Cyphopods (Fig. 331): valves with posterior carinae; postgenital plate slightly narrowed at base, rounded distally, but with sharp corners.

Distribution. Known only from the type locality.

Notes. This species, *C. nantahala*, *C. steno*, *C. caroliniana*, *C. georgia* and possibly *C. tallapoosa* and *C. fidelitor* form a subgroup within the *major*-group connecting the species more typical of the group to the species of the *alata*- and *missis-*

sippiana-groups. It is difficult to place species either in this subgroup or in the *alata*-group; the female genitalia indicate an affinity with the *alata*-group.

Cleidogona tallapoosa n. sp.

Figures 332–334

Types. Male holotype and several other males from 4 mi. south of Perryville, Tallapoosa Co., Alabama, collected 24 July 1960 by L. Hubricht. The specific name refers to the type locality.

Diagnosis. A rather typical species of the *major*-group, despite its far southern distribution. A comparison of the figures of the anterior gonopods is necessary to distinguish this species from the group of species near *C. margarita*.

Description of male holotype. Length, 20 mm. A3 = 0.90 mm. Ocelli 30 in 7 rows. Coloration typical, slightly paler than usual, yellow-white marked medium tan to brown. Segments typical. Anterior gonopods: in anterior view (Fig. 332), sternum extending between coxae, rounded above, deep fissure in midline; coxal knobs prominent. In lateral view (Fig. 333), coxal process triangular, not curved; apical branches of colpocoxite with posterior branch flattened, lacinate, anterior branch shieldlike, twisted mesad. Telopodite not curved, upright, apically enlarged. Coxae 10 typical, glands on short pedicels. Coxae 11 as usual; process of sternum 12 shaped as usual, but somewhat longer, extending more ventrad than in other species.

Female unknown.

Distribution. Known only from the type locality.

Cleidogona hadena Causey

Figures 335–337

Cleidogona hadena Causey, 1961, Florida Entomol., 44: 38, figs. 3, 4, ♂.

Types. Male holotype from Juniper Springs, Marion Co., Florida, in AMNH, examined. The species name may be an acronym for H. A. Denmark.

Diagnosis. The anterior prong of the bifid tip of the anterior gonopod colpocoxite is reduced; the dividing notch between the two branches is not deep (Fig. 335). This is the only species of the *major*-group occurring in Florida.

Description of male holotype. Length, about 16 mm, A3 = 0.70 mm. Ocelli 24 in 6 rows. Coloration typical. Segments cylindrical. Anterior gonopods: probably had been cleared in corrosives or enzymes, basal portion could not be studied in detail. An anterior view of colpocoxite tip (Fig. 336) shows relationship of two branches of apex. In lateral view, distal parts of gonopod (Fig. 335) show coxal process below insertion of telopodite, telopodite distally bifid, sigmoidally curved. Posterior gonopods (Fig. 337) typical of family. Coxae 10 and 11 as usual. Sternal process 12 shorter than usual, with a small dorsal hook.

Female unknown.

Distribution. Known only from the type locality.

Cleidogona caroliniana Causey

Figures 338–340

Cleidogona caroliniana Causey, 1957, J. Kansas Entomol. Soc., 30: 115, figs. 4, 5, ♂.

Types. Male holotype from Fayetteville, Cumberland Co., North Carolina, in AMNH, examined.

Diagnosis. Differs from others of the *major*-group in lacking a coxal process (Fig. 339) and in having the telopodite apically divided, the branches widely diverging. The similar *C. fidelitor* (Fig. 343) has a small subterminal tooth on the anterior gonopod colpocoxites. *Cleidogona steno* (Fig. 345) has a coxal process.

Description of male holotype. Length, 10.5 mm, A3 = 0.60 mm. Ocelli 25 in 6 rows. Coloration typical. Segments cylindrical. Anterior gonopods: in anterior view (Fig. 338), colpocoxites widely separated at base by extension of sternum; processes from basal articulations of telopodites clearly visible; coxal knobs prominent. In

lateral view (Fig. 339), coxa without process; colpocoxites apically divided, anterior branch shieldlike. Telopodites sigmoidally curved, apically divided, branches curved and widely diverging, clasplike. Posterior gonopods (Fig. 340): typical of genus. Coxae 10 and 11 as usual; sternal process 12 as described for *C. hadena*.

Female unknown.

Distribution. Besides the type locality: SOUTH CAROLINA: Sumter Co., 2 mi. south of Edgefield, 22 November 1959, L. Hubricht, ♂.

Notes. The above record and type locality suggest a wide distribution for this species.

Cleidogona fidelitor n. sp.

Figures 341–343

Types. Male holotype from Mt. Tory Furnace, Lyndhurst, road to Sherando, Augusta Co., Virginia, collected 27 November 1965 by K. Brownell. The name is a noun in apposition, meaning "loyalist" and refers to the type locality.

Diagnosis. In anterior view, the anterior gonopods resemble those of *C. caroliniana*, in having basal processes from the telopodites visible (Fig. 342); however, *C. fidelitor* has much larger telopodites with a small subterminal tooth (Fig. 343). The segments also have moderately developed shoulders.

Description of male holotype. Length, 11 mm, A3 = 0.63 mm. Ocelli 26 in 5 rows. Coloration pale, typical pattern seen only on anterior segments. Segments with moderately developed shoulders bearing outer setae. Anterior gonopods: in anterior view (Fig. 342), sternum broad, widely separating colpocoxites, between which protrude processes from bases of telopodites; coxal knobs prominent. In lateral view (Fig. 343), coxa lacking process, setose; anterior branch of divided colpocoxite apex shieldlike, turned laterad; posterior branch heavily laciniate on posterior margin. Telopodite very large, curving anteriorly, with subterminal tooth, terminal divisions of

telopodite cupped around posterior colpocoxite branch. Posterior gonopods (Fig. 341): typical of genus. Coxa 10 with gland not on a petiole. Coxa 11 with small plate above gland opening. Process of sternum 12 typical.

Female unknown.

Distribution. In addition to the type locality: VIRGINIA: Bedford Co., Peaks of Otter, October 1960, R. Hoffman, ♂.

Cleidogona steno n. sp.

Figures 344–348

Types. Male holotype, female paratype, and a second female from Burnt Mountain, Pickens Co., Georgia, collected 6 November 1960 by L. Hubricht. The species name, a noun in apposition, is the name of one of the three gorgons.

Diagnosis. This species somewhat resembles *C. fidelitor* when the gonopods are seen in lateral view (Fig. 345), but there is a coxal process in *C. steno*, and in anterior view (Fig. 344) no basal telopodite process is seen.

Description of male holotype. Length, 14.5 mm, A3 = 0.80 mm. Ocelli 27 in 5 rows plus a single ocellus. Coloration pale but typical, specimens may be bleached by preservative. Segments cylindrical. Anterior gonopods: in anterior view (Fig. 344), coxal knobs very prominent; sternum not much extended between colpocoxites; colpocoxites with anterior apical branch shieldlike, posterior branch with process at base visible only in anterior view. In lateral view (Fig. 345), coxa with large, blunt process, telopodites sharply sigmoidally curved, embracing posterior colpocoxite branch as in *C. fidelitor*. Posterior gonopods (Fig. 346) typical of genus. Coxa 10 (Fig. 347) with rugose knob just above gland opening, lateral knob near apex. Coxa 11 as usual. Sternal process 12 typical, somewhat shorter than in other species of the group.

Description of female paratype. Length, 14 mm, A3 = 0.80 mm. Nonsexual characters as in male. Cyphopods (Fig. 348):

typical of subgroup (see *Notes* under *C. atropos*); lateral valves with very large, irregularly serrate posterior lamella; post-genital plate broadly expanded apically, deeply notched, transparent.

Distribution. Known only from the type locality.

THE ALATA GROUP

This group is difficult to separate from the last few species discussed under the *major*-group, and they probably represent a continuation of the same series of evolutionary trends. However, as a rule, the anterior gonopod colpocoxites of species of the *alata*-group are thinner in lateral view than those of the *major*-group, and the apical division of the colpocoxites is not so pronounced. The telopodites are large and freely movable, and usually curved. Females are known only for *C. georgia*, and the genitalia resemble those of *C. steno* and others (see above). Species of this group occur in the Piedmont and Atlantic Coastal Plain.

Cleidogona alata Causey

Figures 349–351

Cleidogona alata Causey, 1961, Florida Entomol., 44: 38–39, figs. 5–7, ♂.

Types. Male holotype from 1 mi. south of Ila, Madison Co., Georgia, in AMNH, examined. The species name probably refers to the winglike processes on the anterior gonopod telopodites.

Diagnosis. This species may be separated from all others by the upright, rod-like anterior gonopod colpocoxites and the large telopodites, with lateral flaring lamellae (Fig. 350).

Description of male holotype. Length, about 17.5 mm (data from Causey, 1961, holotype vial does not contain complete specimen), A3 = 0.72 mm. Ocelli 27, somewhat irregular in arrangement, about 6 rows. Coloration light, but typical. Segments cylindrical. Anterior gonopods: in anterior view (Fig. 349), sternum extending between colpocoxites; coxal knobs

prominent; colpocoxites with anterior apical branch, small, lamellate, sometimes toothed. In lateral view (Fig. 350), coxa without process; colpocoxite upright, rod-like, only slightly curved, posterior apical part very heavily laciniate. Telopodite large, bulky, readily movable, apically divided, but branches not widely diverging, with broad lateral winglike lamellae on lateral side of each telopodite. Posterior gonopods nearly exactly like those of *C. wrayi* (Fig. 361). Coxa 10 with gland not on pedicel, rugose knob above gland, lateral knob as a thick shelf. Coxa 11 as usual. Process of sternum 12 as in Figure 356.

Female unknown.

Distribution. Known only from the type locality.

Notes. Only the anterior portions of the holotype are to be found in the vial so labelled; the posterior segments in the vial are much larger and obviously belong to another species; the total segment number of the two fragments is more than 30.

Cleidogona georgia n. sp.

Figures 352–358

Types. Male holotype, female paratype and another female from 4.2 mi. southeast of Cochran, Bleckley Co., Georgia, collected 5 December 1959 by L. Hubricht. The species name refers to the type locality and is a noun in apposition.

Diagnosis. Distinct from *C. alata* in lacking the lateral lamellae on the anterior gonopod telopodites, and from *C. wrayi* in having the colpocoxites apically divided.

Description of male holotype. Length, 13 mm. A3 = 0.72 mm. Ocelli 22–23 in 5 rows. Coloration probably typical in fresh material, specimen bleached by preservation. Segments cylindrical. Anterior gonopods: in anterior view (Fig. 352) with colpocoxites touching near bases, but slightly divergent distally; coxal knobs prominent; sternum with two large lateral lobes. Anterior apical branches of colpocoxites shieldlike. In lateral view (Fig.

353), coxa without process; posterior apical branch of colpocoxite with laciniate part on a knob; telopodite sigmoidally curved, smaller than in *C. alata*, apically divided, without lateral processes. Posterior gonopods: typical of genus (Fig. 354). Coxa 10 as in Figure 355; coxa 11 as in Figure 356. Process of sternum 12 typical in shape, but shorter and stouter than usual in genus (Fig. 357).

Description of female paratype. Length, 13.5 mm, A3 = 0.75 mm. Nonsexual characters as in male. Cyphopods (Fig. 358): valves with posterior lamellae with irregular edges; postgenital plate as in related species, but not notched as in *C. steno*.

Distribution. Known only from the type locality.

Cleidogona wrayi Causey

Figures 359–361

Cleidogona wrayi Causey, 1957, *J. Kansas Entomol. Soc.*, 30: 114, figs. 1–3, ♂.

Types. Holotype male from Acre, Beaufort Co., North Carolina, in AMNH, examined.

Diagnosis. Distinct from other species of the group in having the anterior gonopod colpocoxites not divided apically.

Description of male holotype. Length, probably about 17–18 mm (specimen fragmented), antennae missing. Ocelli 28 in 6 rows. Coloration as usual. Segments cylindrical. Anterior gonopods: in anterior view (Fig. 359), colpocoxites broadly separated by sternal extension, processes from bases of telopodites just visible in gap; coxal knobs prominent. In lateral view (Fig. 360), apex of colpocoxite not divided, sigmoidally curved, slightly expanded; telopodite sigmoidally curved, small subapical process present. Posterior gonopods (Fig. 361) as usual. Coxae of legs 10 and 11 as usual; sternal process 12 typical.

Females unknown.

Distribution. Known only from the type locality.

THE MISSISSIPPIANA GROUP

Species of this group are distinct from the *major*-group and *alata*-group in that the anterior branch of the apex of the anterior gonopod colpocoxites is elaborated into a process, sometimes with branches itself, that curve laterad and dorsad when the gonopod is *in situ*. The telopodites are generally large and apically expanded. Species of the group are found in extreme southern Alabama, northern Louisiana, and central Mississippi. They may be most closely related to the *caesioannulata*-group.

Cleidogona grenada n. sp.

Figures 362–367, 369

Types. Male holotype and female paratype, with several other specimens, from 3.4 mi. east of Grenada, Grenada Co., Mississippi, collected 21 August 1960 by L. Hubricht. The species name refers to the type locality.

Diagnosis. *Cleidogona sublettei* has only a single branch developed from the anterior part of the colpocoxite apex (Fig. 371); *C. mississippiana* (Fig. 368) has a coxal process, but otherwise is close to *C. grenada*.

Description of male holotype. Length, 16 mm, A3 = 0.74 mm. Ocelli 29 in 6 rows. Coloration typical. Segments cylindrical. Anterior gonopods: in anterior view (Fig. 362), sternum broad, fused to colpocoxites; coxal knobs not prominent. Anterior branch of colpocoxite apex extending nearly at right angles to body of colpocoxite. In lateral view (Figs. 363, 364), colpocoxite apex with posterior branch rod-like, laciniate (Fig. 364), anterior branch subdivided into 2 or 3 parts, one extending laterally, a second apically and a third ventrally (compare Fig. 363); telopodite large, apically expanded, not divided; coxal process absent. Posterior gonopods: coxa with acuminate basal process below a notch, distal face of notch rugose; second segments not much swollen, widest part just beyond midlength. Coxa 10 as usual. Coxa 11 as in Figure 366 (note spermat-

phore on extruded gland). Sternal process 12 as in Figure 367, typical.

Description of female paratype. Length, 14 mm, A3 = 0.72 mm. Nonsexual characters as in male. Cyphopods with postgenital plate divided (Fig. 369), margins irregularly toothed.

Distribution. In addition to the type locality: ALABAMA: *Mobile Co.*, Mobile, 11 September 1959, W. Suter, ♂♂ ♀♀.

Notes. The ventrally pointing part of the anterior colpocoxite branch is easily broken off (compare Figs. 363, 364, drawn from two different specimens from the type locality). In all features, this species is nearly identical to *C. mississippiana*, but the presence of a coxal process in *C. mississippiana* separates the two species. There are also some differences in the apex of the anterior gonopod colpocoxites (compare Figs. 364 and 368). However, it is clear that these two species are very closely related, and they may have to be synonymized if intermediate specimens are collected.

Cleidogona mississippiana Chamberlin
Figure 368

Cleidogona mississippiana Chamberlin, 1942, Bull. Univ. Utah, 32: 3, figs. 4-6, ♂.

Types. Male holotype from 8 mi. east of Vicksburg, Warren Co., Mississippi, in University of Utah Collection, examined.

Diagnosis. Closely related to *C. grenada*, but differs in that *C. mississippiana* (Fig. 368) bears a coxal process on the anterior gonopods.

Description of male holotype. Length, 20 mm, A3 = 0.90 mm. Ocelli 29 in 6 rows. Coloration typical. Segments cylindrical. Anterior gonopods: almost exactly as in *C. grenada*, but differing in having a coxal process and in the details of the apical branches, as shown in Figure 368. Posterior gonopod: exactly as in *C. grenada* (Fig. 365). Coxae 10 and 11 and sternal process 12 as usual.

Females have been collected but none could be obtained for study.

Distribution. As reported by Chamberlin (1942): MISSISSIPPI: *Rankin Co.*, Roosevelt State Park, 20 August 1940, S. Mulaik, ♂♀; *Forest Co.*, 14 mi. west of Forest, 26 August 1940, S. Mulaik, ♂.

Notes. See *Notes* section under *C. grenada*.

Cleidogona sublettei Causey
Figures 370-373

Cleidogona sublettei Causey, 1954, Tulane Stud. Zool., 2: 66, figs. 4, 5, ♂.

Types. Male holotype from Grand Ecore, Natchitoches Parish, Louisiana, in AMNH, could not be located.

Diagnosis. Distinct from both *C. grenada* and *C. mississippiana* in the shorter anterior gonopod telopodites and simple anterior apical colpocoxite branch (Fig. 371).

Description of male from Natchitoches, La. Length, 19 mm, A3 = 0.80 mm. Ocelli 29 in 7 rows. Coloration typical. Segments cylindrical. Anterior gonopods: in anterior view (Fig. 370), much as in *C. grenada*, sternum not as broad as in *C. grenada*. In lateral view (Fig. 371), coxal process absent; colpocoxite anterior apical branch single, turned laterad; posterior branch rodlike. Telopodite shorter than in *C. grenada*, apically swollen and truncate. Posterior gonopods (Fig. 372) similar to *C. grenada* and *C. mississippiana*, but basal coxal knob smaller. Coxae 10 and 11 and sternal process 12 as usual.

Description of female from Natchitoches, La. Length, 20 mm, A3 = 0.84 mm. Nonsexual characters as in male. Cyphopods (Fig. 373): valves with large anterior hooks; postgenital plate divided, much like that of *C. grenada* (Fig. 369).

Distribution. In addition to the type locality: LOUISIANA: *Natchitoches Par.*, Natchitoches, 26 October 1954, C. Sublette, ♂♀.

THE CAESIOANNULLATA GROUP

This northern and western offshoot from the *major*-group is characterized by having

the coxal process of the anterior gonopods developed into a more or less broad plate, or having the posterior faces of the colpocoxites and coxae greatly swollen. The telopodites are moderately large to very small (in *C. celerita*). The female genitalia resemble those of species of the *major*-group very closely. Species of the *caesioannulata*-group are found in the northcentral Appalachians north to Pennsylvania, west to Ohio and Illinois, and south to Arkansas.

Cleidogona celerita Williams and Hefner

Figures 374–377

Cleidogona celerita Williams and Hefner, 1928, Bull. Ohio Biol. Surv., 18: 117, fig. 14c, ♂.

Cleidogona inflata Causey, 1951, J. Washington Acad. Sci., 41: 90, figs. 14–19, ♂. NEW SYNONYMY.

Types. Male holotype of *C. celerita* from "Ohio," in USNM (Type No. 2271), examined; male holotype of *C. inflata* from Starved Rock State Park, Putnam Co., Illinois, in Illinois Natural History Survey Collection, examined.

Diagnosis. The swollen appearance of the anterior gonopods (Fig. 374) differentiates this species from any other occurring in North America.

Description of male holotype. Length, 18 mm, A3 = 1.00 mm. Ocelli 28 in 6 rows. Coloration typical. Segments cylindrical. Anterior gonopods: in anterior view (Fig. 375), sternum broad, extending between colpocoxites as a quadrate piece; coxal knobs not obvious, coxae setose, wrinkled. Colpocoxites with subapical corrugations and subapical process, colpocoxite tip divided. In lateral view (Fig. 374), colpocoxite and coxa enormously swollen posteriorly, anterior branch of colpocoxite apex rodlike, posterior branch broad, curved, lacinate on posterior surface. Telopodite small, thin. Posterior gonopods (Fig. 376): reminiscent of those of species of *mississippiana*-group, basal process cylindrical, notch absent, apical coxal process with small knobs. Coxae 10 and 11 and sternal process 12 as usual.

Description of female from Urbana, Ill. Length, 20 mm, A3 = 1.05 mm. Ocelli 29 in 6 rows plus single ocellus. Nonsexual characters as in male. Cyphopods (Fig. 377): valves not ornamented; postgenital plate low and irregular.

Distribution. Williams and Hefner (1928) report this species as "general throughout Ohio." I have not seen any Ohio specimens except the holotype. ILLINOIS: *Lake Co.*, Volvo Bog, Volvo, D. F. Reichle, 22 July 1962, ♂♂; *Champaign Co.*, Champaign, 11 July 1921, A. Wcese, ♂♂♀ (MCZ); Urbana, no date or collector's name, ♂♀ (MCZ).

Cleidogona caesioannulata (Wood)

Figures 378–384

Spirostrephon caesioannulatus Wood, 1865, Trans. Amer. Philos. Soc., 13: 194, no figures.

Cleidogona caesioannulata, Cook and Collins, 1895, Ann. New York Acad. Sci., 9: 43–47, figs. 138, 139, 145–148, 150, ♂; Chamberlin and Hoffman, 1958, U. S. Nat. Mus. Bull., 212: 90 (notes on synonymy); *not* Williams and Hefner, 1928, see *C. fustis*.

Cleidogona exaspera Williams and Hefner, 1928, Bull. Ohio Biol. Surv., 18: 117, new name for *C. caesioannulata* as described by Cook and Collins (1895). NEW SYNONYMY.

Types. Female holotype of *S. caesioannulatus* from "Western Pennsylvania," in Acad. Nat. Sci., Philadelphia (No. 11202), examined; male holotype of *C. exaspera* from Delaware Co., Ohio, in USNM (Type No. 2270), examined.

Diagnosis. Differs from the most closely related species, *C. laminata*, in the form of the coxal process of the anterior gonopods.

Description of male from Wooster, Ohio. Length, 20 mm, A3 = 0.80 mm. Ocelli 27 in 6 rows. Coloration as usual. Segments (Fig. 382) cylindrical. Anterior gonopods: in lateral view (Fig. 378), coxae broad at base, setose, with subquadrate coxal process; colpocoxites with small lateral tooth above coxal process, apex divided and bent at right angle to body of colpocoxite, posterior branch the longest. Telopodites slender basally, apically swollen, of mod-

erate size. Posterior gonopod (Fig. 383): similar to *C. celerita* and to some members of the *mississippiana*-group. Coxae 10 and 11 and sternal process 12 as usual (Fig. 382).

Description of female from Wooster, Ohio. Length, 21 mm, A3 = 0.82 mm. Nonsexual characters as in male. Cyphopods (Fig. 384): median valves with median carinae; postgenital plate divided, with two upright arms.

Distribution. It should be noted that most of the many records of this species in the early literature apply to other, then undescribed, species. Until 1895, *caesioannulata* was thought to be the only species of its genus. See Map 12. INDIANA: *Monroe Co.*, reported by Cook and Collins (1895). NORTH CAROLINA: *Durham Co.*, Duke Forest, 6–25 November 1952, A. S. Pearse, ♂♂♀♀; *Yancey Co.*, Mt. Mitchell, 29 November 1950, N. Causey, ♂♂; Mt. Mitchell summit (6600 ft.), balsam forest, 30 October 1969, W. Shear, ♂. OHIO: *Delaware Co.*, reported by Williams and Hefner (1928); *Wayne Co.*, Highland Park, Wooster, May 1959, A. Weaver, ♂♂; Funk's Hollow, 10 May 1962, A. MacDougall, ♀. PENNSYLVANIA: *Montgomery Co.*, Bryn Mawr, October 1952, R. Stuart, ♂♂♀♀; *Monroe Co.*, Stroudsburg, 15 May 1962, F. B. Busser, ♀♀. VIRGINIA: *Alleghany Co.*, Lowmoor, 2 mi. west of Clifton Forge, 4 October 1949, R. Hoffman, ♂♂; Clifton Forge, 20 October 1956, R. Hoffman, ♂♂♀♀; 3 mi. northwest of Clifton Forge, 15 September 1947, R. Hoffman, ♂; *Appomattox Co.*, 1.5 mi. northeast of Vera, 5 October 1952, R. Hoffman, ♂♀; *Augusta Co.*, Elliott's knob (4470 ft.), 26 September 1949, R. Hoffman, ♂♀♀; *Bedford Co.*, Peaks of Otter, October 1960, R. Hoffman, ♂♂♀♀; *Campbell Co.*, Long Mt., 1 mi. northwest of Rustburg, 5 October 1962, L. Hubricht, ♂♂; *Giles Co.*, Mountain Lake, 2–8 August 1948, H. K. Wallace, ♂♂♀♀; *Henry Co.*, Ridgeway, 27 November 1961, R. Hoffman, ♂; *Montgomery Co.*, Roanoke River bluff, 1 mi. east of Shawsville, 22

April 1956, R. Hoffman, ♂♂♀♀; Blacksburg, 28 October 1956, R. Hoffman, ♂♂♀♀; *Roanoke Co.*, Poor Mt., 15 October 1956, R. Hoffman, ♂♂.

Notes. Williams and Hefner (1928) confused this species with *C. fustis*, illustrating *C. fustis* as *C. caesioannulata*, and true *C. caesioannulata* under the name *C. exaspera*, which they proposed for Cook and Collins' (1895) concept of *C. caesioannulata*. Williams and Hefner (1928) based their assumption on data from McNeill (1887), who had specimens from Indiana, and which, judging by his illustrations, were either *C. caesioannulata* or *C. laminata*. The earlier reports of Packard and Bollman are treated in Cook and Collins (1895); it is enough to say here that Packard's material from Alabama and Mississippi and Bollman's from east Tennessee are not *C. caesioannulata*.

The female holotype was said to be from Alleghany County, Pennsylvania, by Chamberlin and Hoffman (1958), but is only labelled "Western Pennsylvania." It is in poor condition, but clearly identifiable as to species by the shape of the postgenital plate (see Fig. 384). Thus Cook and Collins' (1895) prediction that *C. major* would eventually be proved a synonym of *C. caesioannulata* is rejected (compare Fig. 296). The two species are sympatric at Washington, D. C., and throughout much of Virginia.

There is some variation in the gonopods of this widespread species. Figure 379 represents a lateral view of the apical part of the anterior gonopod of a specimen from Peaks of Otter, Bedford County, Virginia; the main difference from Ohio specimens is in the form of the coxal process. Specimens from Campbell County, Virginia, conform to this figure as well. The apex of an anterior gonopod of a specimen from Mt. Mitchell, Yancey County, North Carolina, is shown in Figure 380; the distal corner of the coxal process is drawn out, and the anterior apical branch of the colpocoxite is shorter than in the Ohio material.

Specimens from Henry County, Virginia, also resemble this figure. Figure 381 shows the tip of the colpocoxite of a male from Clifton Forge, Alleghany County, Virginia; the coxal process of this specimen is as in the Ohio specimens. Specimens from Montgomery, Roanoke and Augusta counties, Virginia, are similar, but intergrade with the type of colpocoxite apex seen in Figure 379.

Cleidogona laminata Cook and Collins

Figures 385–387

Cleidogona laminata Cook and Collins, 1895, Ann. New York Acad. Sci., 9: 48, figs. 164–171, ♂. *Cleidogona aspera* Causey, 1951, J. Washington Acad. Sci., 41: 78, figs. 1–4, ♂. NEW SYNONYMY.

Types. Male holotype of *C. laminata* “probably from Indiana (Cook and Collins, 1895)” but probably not, see below, in USNM (No. 427), examined; male holotype and female paratype of *C. aspera* from 6 mi. east of Imboden, Lawrence Co., Arkansas, deposited in Philadelphia Academy of Sciences, but subsequently lost in mail.

Diagnosis. Very close to *C. caesioannulata*, but distinct in not having the apex of the gonopod colpocoxites turned over at right angles to the body of the gonopod (Fig. 386, compare Fig. 378).

Description of male from Pocahontas, Arkansas. Length, 19 mm, A3 = 0.90 mm. Ocelli 29 in 7 rows. Coloration typical. Segments cylindrical. Anterior gonopods: as in Figures 385, 386, almost identical to those of *C. caesioannulata*; apex of colpocoxite not bent, posterior branch with 2 small terminal branches. Posterior gonopod (Fig. 387) more closely resembles those of species of the *mississippiana*-group than does that of *C. caesioannulata*, differing from that species in the lesser expansion of the second segment. Coxae 10 and 11 and sternal process 12 all as in *C. caesioannulata*.

Females have been collected, but none were available for this study.

Distribution. ARKANSAS: *Clay Co.*, Poca-

hontas, 22 March 1950, N. Causey, ♂; reported by Causey (1951a) from *Randolph Co.*, Pocahontas, and from *Dallas Co.*, Carthage. LOUISIANA: *Jackson Par.*, 7 mi. east of Ruston, 29 October 1954, W. Stevens, ♂.

Notes. The male holotype of Cook and Collins' species was unlabelled, but as it probably came from the Bollman collection, they assumed that it had been collected in Indiana, where Bollman did most of his work. However, it seems now that it is much more likely that the specimen originated in Arkansas, a region from which Bollman also received material from time to time. I compared the holotype of *C. laminata* with specimens of *C. aspera* labelled as such by Causey and found no differences; thus as first reviser, I designate the type locality of *C. aspera* (6 mi. east of Imboden, Lawrence Co., Arkansas) as the type locality of *C. laminata*.

This species represents a southern offshoot of the *C. caesioannulata* stock, and clearly connects the *caesioannulata*-group with the *mississippiana*-group.

THE *UNITA* GROUP

This group is probably derived from the *major*-group, but at the same time resembles species of *Tiganogona* in the simplicity of the anterior gonopods. Besides the species discussed in detail below, *C. arkansana* and *C. minima* Causey (see section on species not included in revision) also belong to this group. Species of the *unita*-group occur in the Midwest from Illinois and Kentucky to Arkansas and Alabama.

Cleidogona unita Causey

Figures 388–393

Cleidogona unita Causey, 1951, J. Washington Acad. Sci., 41: 78, figs. 5–9, ♂.

Types. Male holotype and female paratypes from Giant City State Park, Union

Co., Illinois, deposited in collection of Illinois Natural History Survey, examined.

Diagnosis. Distinguished from *C. accretis* (Fig. 395) in the narrower colpocoxites of the anterior gonopod in lateral view (Fig. 389). This species cannot profitably be compared to *C. arkansana* and *C. minima* in the absence of specimens of those species.

Description of male holotype. Length, 15 mm, A3 = 0.60 mm. Ocelli 26 in 5 rows plus single ocellus. Coloration typical. Segments cylindrical. Anterior gonopods: in anterior view (Fig. 388), sternum broadly triangular between colpocoxites, coxal knobs rather small; colpocoxites short and curved, not divided. In lateral view (Fig. 389), coxa without process, colpocoxite basally broad, distal part set off by distinct notch, distal part bladelike, with few broad ridges on anterior ventral surface. Telopodites rodlike, S-shaped. Posterior gonopods (Fig. 391): details reduced from *C. caesioannulata* type; broadest part of second segment just beyond midlength. Coxae 10 and 11 and sternal process 12 as usual for genus.

Description of female paratype. Length, 15.5 mm, A3 = 0.62 mm. Nonsexual characters as in male. Cyphopods (Fig. 393): valves with processes and laminae; post-genital plate (Fig. 392) not divided, margin regular.

Distribution. In addition to the type locality, the following: ILLINOIS: *Jackson Co.*, Grand Tower, Pine Hills, off Rt. 3, 23 October 1966, F. Schmidt, ♂; *Union Co.*, Pine Hills, 23 October 1926, J. Beatty, ♂; 8 mi. south-southwest of Carbondale, 22 October 1966, J. M. Nelson, ♂; reported by Causey (1951) from *Pope Co.*, Dixon Springs. KENTUCKY: *Edmonson Co.*, Mammoth Cave Hollow, Mammoth Cave National Park, 25 November 1960, D. Reichle, ♂.

Notes. The apex of the anterior gonopods of specimen from Mammoth Cave National Park, Kentucky, is shown in Figure 390.

Cleidogona accretis n. sp.

Figures 394–396

Types. Male holotype and other males from 2 mi. southwest of Increase, near Little Creek, Lauderdale Co., Mississippi, collected by L. Hubricht, 3 December 1961. The species name refers to the type locality.

Diagnosis. Distinct from *C. unita* (Fig. 389) in the shorter colpocoxites of the anterior gonopods (Fig. 395).

Description of male holotype. Length, 9.5 mm, A3 = 0.54 mm. Ocelli 26 in 5 rows. Coloration pale, but typical. Segments cylindrical. Anterior gonopods: in anterior view (Fig. 394), colpocoxites well separated by sternum, sternum with longitudinal fovea in midline, oblique wrinkles; coxal knobs prominent. In lateral view (Fig. 395), coxa with blunt process near apical part; colpocoxite short, hoodlike; telopodites rodlike, evenly curved. Posterior gonopods (Fig. 396): somewhat reduced, coxae without processes; second segment not much enlarged. Coxae 10 and 11 and sternal process 12 as usual for genus.

Female unknown.

Distribution. Known only from the type locality.

THE *FUSTIS* GROUP

Cleidogona fustis Cook and Collins

Figures 397–400

Cleidogona fustis Cook and Collins, 1895, Ann. New York Acad. Sci., 9: 49, figs. 151–153, ♂.

Cleidogona caesioannulata, Williams and Hefner, 1928, Bull. Ohio Biol. Surv., 18: 116, fig. 14A, ♂; not *C. caesioannulata* (Wood), 1865, or Cook and Collins, 1895; see discussion in *Notes* under *C. caesioannulata*.

Types. Male holotype from "Indiana," deposited in USNM (No. 446), not examined, presumed lost. Number 446 is not a diplopod, according to the curator (R. Crabill, in litt.).

Diagnosis. The thin colpocoxites of the anterior gonopods, with two subequal apical branches turned anteriorly (Fig. 398), distinguish this species from all others.

Description of male from Athens, West Virginia. Length, 16 mm, A3 = 0.60 mm. Ocelli 27 in 6 rows. Coloration typical. Segments cylindrical. Anterior gonopods: in posterior view (Fig. 397), telopodites thin, rodlike, fused at base; anterior colpocoxite branch broadly lamellate, transparent, posterior branch rodlike, posterior faces finely lacinate. In lateral view (Fig. 398), coxa without process, apical divisions of colpocoxite turned anteriorly; telopodites with small subterminal teeth. Posterior gonopod (Fig. 399): resembling *C. caesioannulata*. Coxae 10 and 11 and sternum 12 as usual.

Description of female from Athens, West Virginia. Length, 16 mm, A3 = 0.65 mm. Nonsexual characters as in male. Cyphopods: valves (Fig. 400) with long posterior rodlike lamellae; postgenital plate nearly diamond-shaped, similar to those of species of *alata*-group.

Distribution. INDIANA: *Montgomery Co.*, reported by Chamberlin and Hoffman (1958); *Jefferson Co.*, Clifty Falls State Park, near Madison, reported by Williams and Hefner (1928). KENTUCKY: *Carter Co.*, 3 mi. east of Grayson, 19 April 1961, R. L. Hoffman, ♂. VIRGINIA: *Montgomery Co.*, 5 mi. northeast of Blacksburg, R. Hoffman and W. Shear, 10 April 1969, ♂; *Pulaski Co.*, Draper Mt. above Pulaski, 4 October 1959, R. Hoffman, ♂; *Russell Co.*, 1 mi. north of Lynn Spring, 20 April 1962, R. Hoffman, ♂; *Tazewell Co.*, Burkes Garden, top of Clinch Mt., 14 November 1965, Radford College Biology Club, ♂. WEST VIRGINIA: *Fayette Co.*, Babcock State Park, 2 April 1967, W. Shear, ♂ ♀; *McDowell Co.*, Kimball, 19 May 1966, S. Romeo, ♂; *Mercer Co.*, Athens, 22 October 1966, W. Shear, 30 March 1967, R. Wertheim, 23 March 1968, N. Price, ♂ ♂ ♀ ♀; 2 mi. south of Athens on Rt. 20, 16 October 1966, W. Shear, ♂; Camp Creek State Forest, 20 February 1966, 26 March 1967, W. Shear, ♂ ♂ ♀; Brush Creek Falls, 10 November 1966, L. Bayless, ♂; *Raleigh Co.*, Grandview State Park, 6 May 1967, W.

Shear, ♀; 5 mi. east of Shady Spring, 14 December 1965, R. Hoffman, ♂ ♂ ♀ ♀; *Summers Co.*, Bluestone State Park, 27 March 1968, W. Shear, ♀ ♀; Bull Falls Recreation Area (Bluestone Reservoir), 7 April 1967, W. Shear, ♂ ♀; 4.2 mi. southeast of Bellepoint, 12 December 1965, R. Hoffman, ♀ ♀.

Notes. See notes section under *C. caesioannulata* for an explanation of Williams and Hefner's (1928) confusion between *C. fustis* and that species. *Cleidogona fustis* is related to the *major*- and *caesioannulata*-groups.

Genus *Tiganogona* Chamberlin

Bactropus Cook and Collins, 1895, Ann. New York Acad. Sci., 9: 53. Preoccupied by *Bactropus* Barrande, 1872, fossil Crustacea.

Tiganogona Chamberlin, 1928, Entomol. News, 39: 154; Chamberlin and Hoffman, 1958, U. S. Nat. Mus. Bull., 212: 96-97 (list of species).

Ofcookogona Causey, 1951, Proc. Biol. Soc. Washington, 64: 120; Chamberlin and Hoffman, 1958, U. S. Nat. Mus. Bull., 212: 93 (list of species). NEW SUBJECTIVE SYNONYMY.

Ozarkogona Causey, 1951, J. Washington Acad. Sci., 41: 82; Chamberlin and Hoffman, 1958, U. S. Nat. Mus. Bull., 212: 93 (list of species). NEW SUBJECTIVE SYNONYMY.

Bactropodellus Jeekel, 1969, Entomol. Bericht., 29: 88 (new name to replace *Bactropus* Cook and Collins). NEW SUBJECTIVE SYNONYMY.

Type species. Of *Bactropus* and *Bactropodellus*, *B. conifer* Cook and Collins, by monotypy; of *Tiganogona*, *T. brownae* Chamberlin, by original designation; of *Ofcookogona*, *O. steuartae* Causey, by original designation; of *Ozarkogona*, *O. glebosa* Causey, by original designation.

Notes on synonymy. The unique holotype of *Bactropus conifer*, type species of *Bactropodellus* (*Bactropus*) has been lost, but the illustrations presented by Cook and Collins (1895, figs. 172-176) leave no doubt that *B. conifer* is congeneric with *Tiganogona brownae*. In particular, the high shoulders of the lateral sternal sclerites, the simple anterior gonopod colpocoxites and the form of the posterior gonopods place *B. conifer* here. The distin-

guishing characters of *Ofcookogona* and *Ozarkogona* are minor differences in the lobation of coxae of the posterior gonopods and the number of telopodite segments. These differences are hardly of species importance.

Jeekel (1969) first pointed out that the generic name *Bactropus* was preoccupied, but did not attempt to determine if any other names might be available for the genus. Thus he proposed the new name *Bactropodellus*. The gender of the name *Tiganogona* is believed to be feminine.

Diagnosis. Distinct from *Pseudotremia* and *Solaenogona* in lacking a colpocoxite branch bearing a gland channel; from *Dybasia* in having the sternite of the anterior gonopods completely fused to the coxae; and from *Cleidogona* in the simplicity of the anterior gonopods and the form of the posterior gonopod coxae.

Description. Thirty segments. Mentum divided (Fig. 181). Antennae long, article 3 the longest. Ocelli always present. Body fusiform, widest in males at segment 7, tapering evenly posteriad. Body segments more or less cylindrical, surface of segments smooth, sides of segments without prominent lateral striations. Pregonopodal legs of males: as described for *Cleidogona*. Anterior gonopods: basic construction as in *Cleidogona*, but lateral sternal sclerite usually much larger, with high angular shoulders (Fig. 401). Coxae and colpocoxites more solidly fused than usual in *Cleidogona*: coxal region with setae, colpocoxite region usually simple and bladeliike. Telopodites simple. Posterior gonopods: coxae bearing series of complex lobes (Fig. 413), or with a single curved lobe (Fig. 402); *in situ*, telopodites of anterior gonopods locking around lobes (Fig. 407). Telopodites much reduced, 3-segmented to 1-segmented (Figs. 402, 408, 411, 413). Postgonopodal legs: coxa 10 with gland sessile (Fig. 403), large rugose apical knob. Coxa 11 with gland sessile, not modified; prefemur 11 with mesal plate about midlength (Fig. 404). Sternum 12

not modified. Female cyphopods: postgenital plate usually absent, see Figures 405, 409, 414.

Distribution. See Map 10, open symbols. Indiana, Missouri, Arkansas, and Louisiana.

Identifications. Half of the species assigned to this genus are known only from unique type specimens that could not be located; thus it seems futile to present a key to the remaining half of the genus, discussed species by species below.

Tiganogona brownae Chamberlin
Figures 401–405

Tiganogona brownae Chamberlin, 1928, Entomol. News, 39: 154; Causey, 1951, Proc. Biol. Soc. Washington, 64: 124, figs. 17, 18, ♂.

Types. Male holotype and female paratype from St. Charles, St. Louis Co., Missouri, in University of Utah collection, examined.

Diagnosis. Closest to *T. moesta* and *T. alia*: differs from *T. moesta* in the larger anterior gonopod telopodites (compare Figs. 401 and 406) and from *T. alia* in the 2-segmented posterior gonopod telopodites (Fig. 402).

Description of male holotype. Length, 12 mm, A3 = 0.54 mm. Ocelli 28 in 6 rows. Coloration typical, as in species of *Cleidogona*. Segments cylindrical. Anterior gonopods: in lateral view (Fig. 401), lateral sternal sclerite triangular, well set off. Colpocoxite simple, bladeliike, apex with three teeth. Telopodite long, as long as colpocoxite, rodlike, with distal hook. Blunt process from base of colpocoxites. Posterior gonopods: sternum broad, not well sclerotized (Fig. 402), with large median knob rugose. Gonopod coxae elongated mesally to form lobe as long as rest of gonopod; telopodites with two segments and claw, first telopodite segment cylindrical, second globose. Coxae 10 and 11 (Figs. 403, 404) as described for genus.

Description of female paratype. Length, 12 mm, A3 = 0.52 mm. Ocelli ca. 27, head crushed. Nonsexual characters as in male.

Cyphopods (Fig. 405) with median valve high, knobby; postgenital plate absent, but coxae 2 much extended ventrolaterally.

Distribution. Known definitely only from type locality, but reported by Causey (in litt.) from "most of Missouri."

Tiganogona moesta Causey

Figures 406–409

Tiganogona moesta Causey, 1951, J. Washington Acad. Sci., 41: 82, figs. 22, 23, ♂.

Types. Male holotype from Blue Spring, Carroll Co., Arkansas, in Philadelphia Academy of Sciences, apparently lost in mails, not seen.

Diagnosis. Distinct from *T. brownae* in the characters given under that species. The anterior gonopods (Fig. 406) resemble those of *T. steuartae*, as illustrated by Causey (1951a, fig. 13), but apparently differ in having teeth on the apical part of the colpocoxites.

Description of male from Cave Creek Valley, Arkansas. Length, about 12 mm, A3 = 0.57 mm. Ocelli 27–28 in 6 rows. Coloration typical. Segments cylindrical. Anterior gonopods: in lateral view (Fig. 406), lateral sternal sclerite squared off, anterior sternal sclerite with triangular lateral projection. Coxal area with only 2 setae; colpocoxite as in *T. brownae*, but with more apical posterior teeth. Telopodite much shorter than colpocoxite, rodlike, slightly curved, pointed at tip. Posterior gonopods (Fig. 408): as in *T. brownae*, but telopodites 3-segmented, apical segment small, cylindrical. Coxae 10 and 11 as described for *T. brownae*.

Description of female from Cave Creek Valley, Arkansas. Length, about 12–15 mm, A3 = 0.54 mm. Nonsexual characters as in male. Cyphopods much like those of *T. brownae*; mesal valves somewhat larger (Fig. 409).

Distribution. In addition to the type locality: ARKANSAS: *Washington Co.*, Cave (Cove?) Creek Valley, 10 November 1955, collector's name illegible, ♂ ♀.

Tiganogona alia (Causey) NEW

COMBINATION

Figures 410, 411

Ofcookogona alia Causey, 1951, Proc. Biol. Soc. Washington, 64: 121, figs. 14–16, ♂.

Types. Male holotype from Junction City, Union Co., Arkansas, in Philadelphia Academy of Sciences, evidently lost in mails, not seen.

Diagnosis. Distinct from the other species illustrated here in the single-segmented posterior gonopod telopodite (Fig. 411), which is short and globose, rather than elongate and clavate as in *T. glebosa* (Fig. 413).

Description of male from Ruston, Lincoln Co., Louisiana. Length, about 12 mm, A3 = 0.53 mm. Ocelli 24–25 in 5 rows. Coloration typical. Segments cylindrical. Anterior gonopods: in lateral view (Fig. 410), with lateral sternal sclerite extending far posteriad, triangular in shape, covering bases of coxal setae. Colpocoxites simple, somewhat flattened anteroposteriorly, with large blunt, curved process at base; telopodites small, simple, curved, acuminate. Posterior gonopods (Fig. 411): sternum poorly sclerotized, with long, thin knob on midline, laterally cupping posterior gonopod coxae; coxae large, lobed as in Figure 411; telopodite a single globular segment with small, reduced claw. Coxae 10 and 11 as described for *T. brownae*.

Female unknown.

Distribution. In addition to the type locality: ARKANSAS: *Washington Co.*, December 1958, G. Ogden, ♂♂. LOUISIANA: *Lincoln Co.*, Ruston, 18 March 1955, W. J. Harman, ♂♂.

Tiganogona glebosa (Causey)

NEW COMBINATION

Figures 412–414

Ozarkogona glebosa Causey, 1951, J. Washington Acad. Sci., 41: 82, figs. 20, 21, ♂.

Types. Male holotype from Fayetteville, Washington Co., Arkansas, in Philadelphia Academy of Natural Sciences, evidently lost in mails, not seen.

Diagnosis. See diagnosis of *T. alia*.

Description of male from Clear Creek, Washington Co., Arkansas. Length, 14 mm, A3 = 0.63 mm. Ocelli 2S in 6 rows. Coloration typical. Segments cylindrical. Anterior gonopods: in lateral view (Fig. 412) with lateral sternal sclerite smaller than other members of genus illustrated here, not extending posteriad of coxae. Coxal portion heavily setose; colpocoxite simple, sharply curved near tip to form a hook. Telopodite nearly as large as colpocoxite, bulky, much enlarged apically, slightly curved anteriorly. Posterior gonopods (Fig. 413): sternum weak, median sternal knob much reduced. Coxae large, swollen, complexly lobed as shown; telopodite single-segmented, as long as coxae, clubshaped, 1 or 2 vaguely indicated sutures near distal end; claw pointed, but small. Coxae 10 and 11 as described for *T. brownae*.

Description of female from Clear Creek, Washington Co., Arkansas. Length, 15 mm, A3 = 0.65 mm. Nonsexual characters as in male. Cyphopods as in Figure 414.

Distribution. In addition to the type locality: ARKANSAS: Washington Co., Clear Creek, 14 February 1955, J. Hastings, ♂♂ ♀♀.

Genus *Dybasia* Loomis

Dybasia Loomis, 1964, Fieldiana, 47: 100.

Ogkomus Loomis, 1964, Fieldiana, 47: 102. NEW SUBJECTIVE SYNONYMY.

Solemia Loomis, 1964, Fieldiana, 47: 104. NEW SUBJECTIVE SYNONYMY.

Types. Of *Dybasia*, *D. humerosa* Loomis; of *Ogkomus*, *O. divergens* Loomis; of *Solemia*, *S. chiriquia* Loomis; all by monotypy and original designation. The gender of the generic name is feminine.

Notes on synonymy. The three monotypic genera combined here in *Dybasia* were proposed by Loomis (1964) in the same paper. As first reviser, I select *Dybasia* as the generic name. Though Loomis considered these species as constituting a distinct family (Dybasiidae) related to the cleidogonids, an examination

of the specimens has convinced me that such a placement is at this time unjustified; indeed it may eventually prove necessary to include these species in *Cleidogona*. Unfortunately, the similarity between *Dybasia divergens* and *Cleidogona minutissima* could not be explored because of a lack of material. For the time being I prefer to recognize the genus on the basis of the peculiarities of the sternum of the anterior gonopods, the segmental paranota, the form of the posterior gonopods, and their zoogeographic distinctness, all characters which mark the species in *Dybasia* as a uniform group. The other characters given by Loomis (1964) as diagnostic for the family Dybasiidae and the three genera included in it are to be found in numerous species of *Cleidogona*. In particular, his statement that the anterior gonopod sternum is "very small or lacking" in the Cleidogonidae is obviously in error.

Diagnosis. Closely related to *Cleidogona*, but differing primarily in the sternum of the anterior gonopods, which in *Dybasia* is free from the anterior median faces of the coxae and drawn out ventrad into a pair of more or less prominent processes, longest in *D. humerosa*, but much shorter in *D. divergens*.

Description. Thirty segments. Mentum divided. Antennae of moderate length, shorter than in *Cleidogona* and *Pseudotremia*. Ocelli always present. Body fusiform, most body segments with prominent paranota, somewhat resembling members of the family Conotylidae. Surface of segments smooth. Segmental setae prominent, never spatulate. Sides of segments without lateral striations. Pregonopodal legs of males: as described for *Cleidogona*. Anterior gonopods: sternum broad, well sclerotized, not fused firmly to gonopod coxae, bearing pair of anterior processes. Lateral sternal sclerite distinct. Coxae large, irregular, setae sometimes lacking. Colpocoxites simple, with large angular shoulders at coxal junction, evenly curved, usually cupped posteriad. Telopodites re-

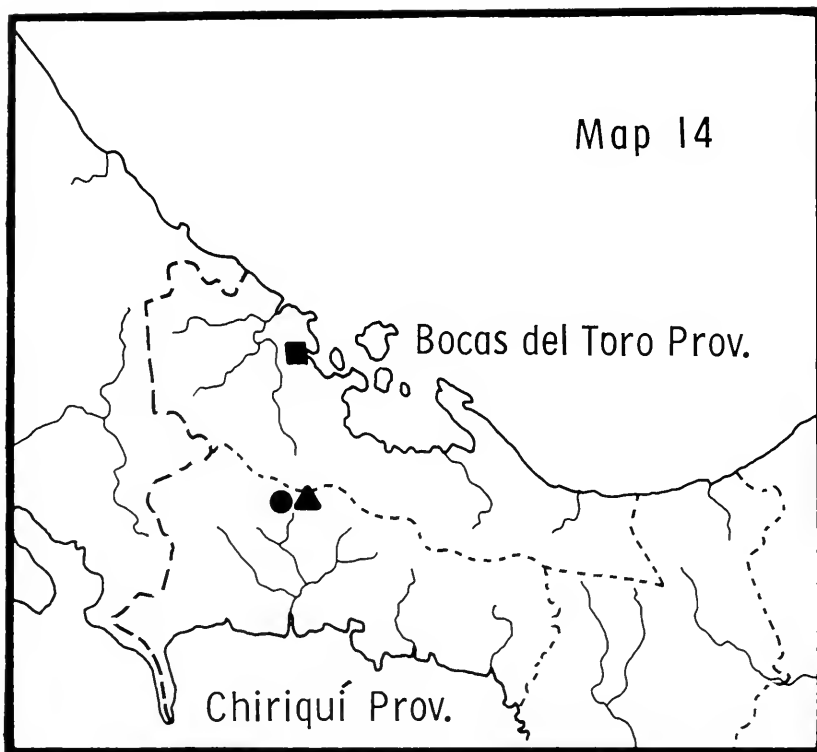

Map 14. Northern Panama, showing distribution of the genus *Dybasia*. Dot, *D. humerosa*; triangle, *D. chiriquia*; square, *D. divergens*.

duced, nearly absent in some species. Posterior gonopods: 4-segmented, coxae variously modified. Tenth and eleventh coxae and twelfth sternum as described for *Cleidogona*. Female cyphopods: valves keeled, postgenital plate absent.

Distribution. Northern Panama. See Map 14.

KEY TO MALES OF SPECIES OF *DYBASIA*

- 1a. Sternal processes of anterior gonopods short, diverging, not meeting in midline (Fig. 419) *divergens*
- 1b. Sternal processes of male gonopods more or less elongate, meeting in midline (Figs. 416, 423) 2
- 2a. Coxae of posterior gonopods of male shorter than second segment, with single process (Fig. 424) *chiriquia*
- 2b. Coxae of posterior gonopods of male longer than second segment, with two processes (Fig. 415) *humerosa*

Dybasia humerosa Loomis
 Figures 415–418, Map 14

Dybasia humerosa Loomis, 1964, Fieldiana, 47: 101, figs. 10A–I, ♂.

Types. Male holotype from “Casita Alta,” Finca Lerida, near Boquete, Chiriquí Province, Panama, collected 18 March 1959 by H. S. Dybas, deposited in Field Museum of Natural History, examined. The specific name probably refers to the shoulders on each segment.

Diagnosis. As in the above key.

Description of male holotype. Length, 10 mm, A3 = 0.50 mm. Ocelli 23 on left side, 25 on right side, in subtriangular patch. Coloration typical of *Cleidogona*, midbody segments with raised shoulders, but dorsum not flat, shoulders about one-fourth body width, body segments beyond

23–24 cylindrical. Anterior gonopods: in anterior view (Fig. 416), sternum broad, well sclerotized; sternal processes translucent, joined basally at midline, somewhat enlarged apically, anterior apical face of each process rugose. Coxae with high, thick shoulders: basal knob projecting anteriorly. Colpocoxites thin, cupped posteriorly, lateral margin (Fig. 417) sinuate. Telopodites nearly obsolete, fused into small knob at posterior coxal bases. Posterior gonopods: 5-segmented. Coxae largest and longest segments, with blunt basal processes, more acute midapical processes rugose and set with stiff setae. Second segments cylindrical, apical 3 segments reduced in size (Fig. 415). Coxae of legs 10 and 11 with gland petiolate, each with prominent mesal knob above gland opening. Sternum 12 with long typical process as in *Cleidogona*, reaching to sternum 10.

Description of female paratype. Length, 11 mm, A3 = 0.52 mm. Nonsexual characters as in male, but segmental shoulders not so prominent on anterior segments. Cyphopods (Fig. 418) with completely fused, keeled valves. Postgenital plate absent.

Distribution (from Loomis, 1964). PANAMA. *Chiriquí Province*, "Casita Alta," Finca Lerida, near Boquete, from forest floor litter. 5650 ft., 6900 ft., 7750 ft., 7800 ft., 14–18 March 1949, H. Dybas; Cerro Punta, 6900 ft., 7 March 1959, H. Dybas. All of these records are based on females and immature specimens. *Dybasia humerosa* is syntopic or nearly so with *D. chiriquia* at Finca Lerida, and I am unable to distinguish females and young of the two species. None of the females of *D. chiriquia* reported by Loomis (1964) are mature.

Notes. Loomis shows the posterior gonopod (Loomis, 1964: 103, fig. 10–H) with the coxa divided into two segments and the apical three reduced to two. In Loomis' figure 10–I, the sternal processes of the anterior gonopods are shown as fused nearly up to their distal ends.

Dybasia divergens (Loomis)

NEW COMBINATION

Figures 419–421, Map 13

Ogkomus divergens Loomis, 1964, Fieldiana, 47: 102; figs. 10J–L.

Types. Male holotype and three female paratypes from Almirante, Bocas del Toro Province, Panama, collected from forest floor litter by H. S. Dybas, 1 April 1959, deposited in Field Museum of Natural History, examined. The specific name probably refers to the diverging sternal processes.

Diagnosis. Distinct from the other two species of the genus in the details of the gonopods, and the characters given in the above key.

Description of male holotype. Length, 11.5 mm, A3 = 0.55 mm. Ocelli 26 on both sides of head. Coloration typical. Segments similar to those of *D. humerosa*, shoulders somewhat less pronounced. Anterior gonopods: sternum (Fig. 419) broad, well sclerotized, slightly depressed at base of sternal processes; sternal processes short, diverging. Coxae and lateral sternal sclerites with pronounced shoulders. Colpocoxites right-angled in lateral view (Fig. 420), with apical lateral hooklike process. Telopodites small, knoblike, fused basally but distinct distally. Posterior gonopods (Fig. 421): intermediate between those of *D. humerosa* and *D. chiriquia*: coxae and second segments subequal in length, coxae with proximal and distal lobes. Tenth and eleventh legs with coxae essentially unmodified. Twelfth sternum as described for *D. humerosa*, but process shorter.

Mature females that can be assigned with certainty to this species have not been collected.

Distribution. Known only from the type locality.

Notes. I did not see the basal pore in coxa of the posterior gonopod illustrated by Loomis (1964: 103, fig. 10–L). None of the females from the type locality (designated by Loomis as paratypes) are mature.

Dybasia chiriquia (Loomis)

NEW COMBINATION

Figures 422–424, Map 13

Solemia chiriquia Loomis, 1964, Fieldiana, 47: 105; figs. 10M–P, ♂.

Types. Male holotype from Finca Lerida, near Boquete, Chiriquí Province, Panama, elev. 5600 ft., collected 12 March 1959 by H. S. Dybas, female and juvenile paratypes from same locality, deposited in Field Museum of Natural History, examined. The specific name refers to Chiriquí Province.

Diagnosis. Distinct in the details of the gonopods, and the characters given in the key.

Description of male holotype. Length, 12 mm, A3 = 0.55 mm. Ocelli 26 on left side of head, 27 on right side. Coloration typical. Segments as in *D. humerosa*. Anterior gonopods: sternum (Fig. 422) low, more poorly sclerotized than in preceding 2 species; sternal processes thin but broad, abruptly diverging, anterior faces slightly rugose. Coxae with shoulders less promi-

nent than in *D. humerosa*. Colpocoxites (Fig. 423) broad, cupped, resembling *D. humerosa*, but edges not sinuate; posterior margin with small subapical hook. Telopodites largest in genus, distinctly separate, recurved. Posterior gonopods (Fig. 424): coxae shorter than second segments, bearing long knobs basally. Second segments and apical 3 segments typical.

Females that can be assigned to this species with certainty have not been collected. See *Notes* below.

Distribution. Known only from the type locality. A few females and young collected by G. A. Solem, 7 March 1959, at 6700 ft. and 7000 ft. on Cerro Punto, Chiriquí Province, Panama, have been assigned to *D. chiriquia* by Loomis (1964).

Notes. I cannot, with certainty, distinguish between females of this species and the syntopic *D. humerosa*. For this reason, I hesitate to assign the specimen to one or the other of the species, and have arbitrarily described the females under *D. humerosa*.

Part II. A Reclassification of the Order Chordeumida in the New World

INTRODUCTION

In an excellent discussion of the zoogeography of North American millipeds, Hoffman (1969a) was unable to include the Order Chordeumida because of the chaotic state of its taxonomy. An investigation of the literature reveals that little or no revisionary work has been done on this order in America since 1895. Even the most recently published papers concern themselves with either describing new species in poorly defined genera and families, thus perpetuating past errors, or with setting up superfluous new higher categories. Some of these new genera and families were based on a few specimens of single species, or, worse, on misleading literature, the author of the new name never having seen actual specimens.

In the course of revising the Family Cleidogonidae, the largest and commonest North American chordeumid family, I had occasion to examine type specimens or newly collected material of all but one North American chordeumid family, and the great majority of genera and species. Some of these observations have already been reported in the form of a revision of the family Conotyliidae (Shear, 1971a) and a synopsis of the genera of North American cave millipeds, most of which are chordeumids (Shear, 1969).

It soon became apparent that the North American families I consider valid fall into four large, seemingly natural groups. Since three of these groups are exclusively North American (the third has some Asian, Australian, and South American members), I feel that no damage is done to the stability of nomenclature by recognizing them as superfamilies. Past efforts at subdividing the North American members of the Chordeumida have failed (see historical review below), usually because the taxonomists involved failed to examine specimens; thus only one of the superfamilies

proposed below takes an earlier name from the superfamily level.

Following the historical review and discussion of useful characters, I present some artificial keys to the superfamilies and the included families.

Families Not Included¹

The family Ergethidae Chamberlin, 1947, is not included here, since I have shown it to be a polydesmid rather than a chordeumid (Shear, 1971b). The family Apterouridae Loomis, 1966, cannot be treated in detail because the unique types of the only species, *Apterourus horizontalis* Loomis, have been lost. They were to have been deposited in the USNM, which has no record of having received them. This family can be treated in detail if the types are found, or if new material is collected.

¹ Following completion of this paper, and while it was in press, I became aware of two papers making important changes in the arrangement of families and genera in the Chordeumida:

Loomis, H. F., and R. Schmitt. 1971. The ecology, distribution, and taxonomy of the millipeds of Montana west of the continental divide. *Northwest Sci.*, 45: 107-131.

Causey, N. B. 1969. New trichopetalid (Chordeumidea: Chordeumida) millipeds from caves in North and Central America. *Louisiana Acad. Sci.*, 32: 43-49.

In the first, Loomis and Schmitt (1971) describe several new species and genera, as well as a new family of chordeumids from Montana. Several of these names are synonyms of older, well-established ones (i. e., *Brunsonia complexipes* Loomis and Schmitt = *Conotyia albertana* Chamberlin, etc.). Some of the species are described in the wrong families. The new family Macromastidae Loomis and Schmitt appears to be valid at this time, but I have not yet examined specimens.

Causey (1969) describes the new genus *Poterpes*, which is an obvious synonym of *Mexiterpes*. The two species *P. egea* and *P. fishi* are closely related to *Mexiterpes metallicus*, described as new below. *Flagellopetalum appropinquu* is described, but no comparison with *F. quadratum* Loomis, from a nearby locality, is made, and *F. appropinquu* may be a synonym of *F. quadratum*.

THE HISTORY OF CHORDEUMID STUDIES

The history of the study of North American diplopods is brief, and has been summarized by Underwood (1893) and Chamberlin and Hoffman (1958). In the following review I emphasize the study of chordeumid millipeds in North America.

In 1805, Latreille first recognized the millipeds and centipeds as distinct from the Insecta, and set them apart in his "Legion" Myriapoda. Later, in 1814, Leach called this group the Class Myriapoda, encompassing the same animals. There followed, from 1833 to 1872, a progressive subdivision of this class as the complexity and heterogeneity of Latreille's and Leach's original concepts became obvious. These changes are summarized in Chamberlin and Hoffman (1958). Chamberlin and Hoffman finally established ordinal names in the Diplopoda in an authoritative manner. Their system has gained almost universal acceptance.

Though Palisot de Beauvois (1805) had described *Julus americanae-borealis* (the animal now called *Narceus americanus*), the first American naturalist to describe several millipeds in a recognizable way was the eccentric C. S. Rafinesque (1820). His work was long neglected, but in 1953, Hoffman and Crabill indicated that they could recognize Rafinesque's names and reestablished three of his milliped generic names: *Narceus* (Spirobolidae), *Abacion* (Schizopetalidae) and *Pleurolooma* (Xystodesmidae). These names have been adopted and are now in general use for some of our commonest millipeds. Rafinesque apparently described no chordeumids.

In 1821, only a year after Rafinesque's *Annals of Nature*, Thomas Say published an account of the "Myriapodae" of the

United States, but mentioned no chordeumids. H. C. Wood summarized his own findings on the fauna of the eastern United States in 1865, describing *Spirostrephon caesioannulatus* (now called *Cleidogona caesioannulata*), the first North American member of the Chordeumida to be described. E. D. Cope described a second species, *Pseudotremia cavernarum*, in 1869. In the years immediately following several authors described species of chordeumids, many of which have remained unrecognizable.

The real foundation for systematic studies in North American millipeds was laid by C. H. Bollman, who, before his death in 1889 at the age of 21, published 14 papers (11 more appeared posthumously) on the rich Appalachian fauna. A collection of Bollman's papers, including 11 previously unpublished ones, appeared in 1893, under the editorship of Underwood. This important work contained a catalog (p. 117) giving Bollman's summary of the American fauna. It contains 15 species of chordeumids, all under the family Craspedosomatidae (a group apparently equivalent to the present Order Chordeumida). Five genera were listed.

The next significant contribution on North American chordeumids appeared in 1895 — Cook and Collins' "Craspedosomatidae of North America," which set a standard of excellence in descriptions that has not yet been surpassed. They followed their European contemporaries in using genitalic characters and in presenting profuse illustrations of surprising accuracy. Cook and Collins took a conservative view of generic names, with the result that all 10 genera they recognized are still valid. Included were 25 species.

O. F. Cook, by training a botanist and palm specialist, established his peculiar and short-lived journal *Brandtia* in 1895. It lasted for only two years, and published Cook's own articles on Diplopoda and other arthropods. In "On recent diplopod names," Cook (1895) divided his Order

In any case, Causey's illustrations greatly strengthen the case for making both *Flagellopetalum* and *Zygonopus* synonyms of *Trichopetalum*.

I will treat this and other material in more detail in a forthcoming supplement to the present paper.

Coelochaeta into three suborders, the Lysioptaloidea, Chordeumatoidea, and Striarioidea. The 10 genera and 25 species listed earlier that year in Cook and Collins (1895) were distributed in four families.

In 1910, K. W. Verhoeff began a lamentable practice of European diplopod taxonomists, that of ignoring Cook's work and attempting to place North American species in his own taxonomic system without examining specimens. As a result he duplicated some of Cook's family names, and placed other species in unrelated European families. American diplopod taxonomists either were not aware of or ignored much of Verhoeff's work. In 1932, for example, Verhoeff set up the family Trichopetalidae for *Trichopetalum*, and this was not noticed in the United States until 29 years later (Hoffman, 1961). Since Cook and Collins' paper, no revisionary work has been done on the Order Chordeumida in North America, with the result that when Chamberlin and Hoffman (1958) compiled their checklist of the United States fauna, they could list more than 100 species in 31 genera and 9 families. Five of these families contained only a single genus each and 16 of the 31 genera were monotypic. Since 1958, Verhoeff's name Trichopetalidae has been rediscovered, and three more families have been described, two of which are based on single species. The only recent extensive reworking of chordeumid higher classification has been the posthumous publication of a re-arrangement of the world fauna by Attems (1959). This classification is so absurd with regard to the North American species and in its disregard for the rules of priority that it merits no further consideration here. The reader is referred to Chamberlin and Hoffman (1958) for a summary of their classification. The three post-1958 families are added to Chamberlin and Hoffman's key by Buckett and Gardner (1967). Only one other change in the 1958 system has been made up to the present time; I have shown (Shear, 1971b) that *Ergethus perditus*

Chamberlin, on which the family Ergethidae was based, is not a chordeumid, but a polydesmid.

However, in the following sections, I propose several changes at the family level and numerous generic synonymies, based on studies of specimens of nearly all genera in all known North American chordeumid families, except for the families Caseyidae and Striariidae, currently being revised by other taxonomists. I have also grouped the North American families into superfamilies, and provided names for these taxa. New names were needed because none of these categories are coextensive with previously proposed ones, and do not include any families found outside North America, except in one case. The striking gap between the North American fauna and the very rich European one may be considerably reduced when some of the confusion in names of European chordeumids is cleared up, and it may be possible then to include a few European families in the superfamilies named here, or to use older European names for the superfamilies.

CHARACTERS USEFUL FOR DELIMITING TAXA BELONGING TO HIGHER CATEGORIES IN THE ORDER CHORDEUMIDA

This subject has previously been discussed by Brölemann (1918, 1935), Verhoeff (1906, 1909, 1935), Attems (1959) and Cook and Collins (1895). Only Cook and Collins treated the North American forms in a meaningful way (with specimens on hand), and of the European authors, Brölemann's ideas have best stood the test of time. It is not my purpose here to point out all of the differences and similarities in the various systems, but to evaluate, with respect to the neglected North American fauna, the characters that American taxonomists have used in the past. I want to evaluate these characters according to two main criteria: their possible phylogenetic significance and their applicability in prac-

tical taxonomy. For my views on the formation of taxa of higher categories, see the summary below.

NONSEXUAL CHARACTERS

Segment Number

The term segment must be defined for use in the following discussion. In the Diplopoda in general, most trunk segments consist of fused pairs of metameres. According to Manton (1953), this gives maximum body flexibility, pushing power, and tergal area for muscle insertion. However, the first three segments of chilognath millipedes are single metameres. Thus the term segment, as used below and in the taxonomic literature in general, refers to the obvious gross divisions of the trunk and not to the actual derivatives of one metamere. It has been suggested that the term "ring" be applied (Kaestner, 1968), but I think this gives the mistaken impression that all diplosegmental sclerites are fused to form complete body rings, whereas this is really the case only in the Polydesmida. Thus I will continue to use the term segment in this way, with the understanding that it refers to the obvious, usually uniform, divisions of the trunk whether they are actually derived from single metameres or two metameres (diplosegments).

The number of trunk segments is fixed within adults of species in the Order Chordeumida as here considered, as opposed to a variable number within species in the related Order Callipodida. Fixity of adult segment number is probably an advanced character, though Manton (1953) presents some arguments to the contrary for the chordeumids and polydesmids. But fixity of segment number within species is found in all of the more specialized milliped groups, and clearly indicates greater degree of genetic control of development. The actual number of segments present is variable from species to species, and is most likely a function of size, the lesser numbers being an adaptation to small size.

Members of the genus *Branneria* have the fewest segments of any chordeumids (26, a number shared with the European *Chaemosoma*). They are also only 3–4 mm long, the smallest North American chilognaths. Some species of the Trichopetalidae and Tingupidae have only 28 segments, and in the case of some species of *Tingupa*, the males have 28 and the females 30 segments. In all cases of reduction from the basic segment number (30, though some primitive heterochordeumatoids have 32) the animals are small, usually less than 10 mm long, frequently troglobitic, and often have from two to four legless segments at the posterior end of the body, which probably indicates that further reduction is in progress.

Segment number alone as a generic criterion must be used with caution. Brölemann (1918) called the tendency towards a reduced number of segments tachygenesis, and pointed out that Verhoeff's (1913) group Trachyzona, based on genera with reduced segment numbers, was a hodge-podge of unrelated phylogenetic lines that had adapted to small size. *Trichopetalum* (Trichopetalidae) has long been separated from other genera of its family primarily because of a reduced number of segments (28) rather than on characters less subject to adaptive differences, although other genera whose species clearly belong to it have been kept apart from *Trichopetalum*. The presence in some species of *Tingupa* (Tingupidae) of 28-segmented males and 30-segmented females argues strongly against the use of segment number alone as a generic character. *Branneria carinata* (Branneriidae) can be clearly distinguished by gonopod anatomy and secondary sexual modifications as well as its unique segment number; other members of the genus may be found with more, or fewer segments.

I have used segment number as an additional character to group species that are otherwise similar, but have not used it alone.

Troglobitic Adaptations

Adaptations for cave life include loss of pigment, reduction or loss of ocelli, hypertrophy of tactile and chemical sense organs (primarily the antennae), reduction of cuticle sclerotization, hypertrophy (or reduction, in *Pseudotremia*) of segmental setae, and increased length of leg segments. Numerous behavioral and physiological adaptations are also implied. Most taxonomists who work in groups that have troglobitic members agree that these adaptations are not in themselves sufficient to justify lumping troglobites into taxa of higher categories. But in some cases (as in the beetle *Glacivicola*; see Westcott, 1968) the adaptations are so unique that doubt exists as to which family or genus the animal belongs to, and new families or genera are sometimes described. I know of no such cases in chordeumid millipeds, except possibly the conotylid *Idagona westcotti* Buckett and Gardner, but it is not highly adapted to cave life, and the unusual features are to be found only in the male gonopods. In *Pseudotremia* (Cleidogonidae) there is a series of species, from some having adaptations for leaf-litter surface life to others that are highly adapted troglobites. Without the strong similarities in more stable characters, such as gonopods, the extreme adaptations of the troglobitic species might well lead taxonomists into describing them as belonging to new genera and families.

Troglobitic adaptations are thus not very useful in delimiting families and genera. Perhaps the same might be said of any modification of sense organs (ocelli number, antennal length, etc.), no matter how extreme.

Subdivision of the Mentum

In the past division of the mentum of the gnathochilarium into promentum and mentum in some Chordeumida was considered an important phylogenetic character. Brölemann (1935) used this as one character

to distinguish suborders within the order Chordeumida (he considered Callipodida a suborder of Chordeumida, and divided the present Chordeumida into two more suborders on the form of the mentum and characters of the gonopods). The adaptive significance of having the mentum divided or not is obscure. A divided mentum is presumably more flexible. The division is usually on the level of the bases of the lingual laminae. In small forms this division is not at all easy to see, and if the undivided mentum is truncate, the membranous space anterior to it is often mistaken for a promentum.

The absence or presence of this division has been used carelessly. In all keys and other references since 1920 (see especially Chamberlin and Hoffinan, 1958), members of the family Trichopetalidae have been characterized as having an undivided mentum, and on this basis have been placed near, or as a subfamily of, the Conotylidae. Cook and Collins (1895) described the promentum in each trichopetalid species they discussed, and all the species examined by me in this study had a divided mentum. I have used this as additional evidence in placing the Trichopetalidae in the Superfamily Cleidogonoidea. Chamberlin and Hoffman (1950) raised the genus *Bactropus* to family status because Cook and Collins described the promentum as "not distinct." The type specimen of *Bactropus conifer* was not examined by Chamberlin and Hoffman, and is apparently lost or destroyed. Likewise, the type specimen of *Conotylo leibergeri* probably has the mentum undivided; Cook and Collins (1895) stated that it was divided, and on this alone, Chamberlin (1941b) erected the genus *Cookella*.

This character is clearly not of great adaptive significance. Even if the placements discussed immediately above were based on correct observations, genera and families should not be established on a single character. However, the undivided mentum can be used as a key character to

separate species of the Superfamily Heterochordeumatoidea from any other North American chordeumids. Thus the divided mentum is useful at a superfamily level.

Pectinate Lamellae of the Mandible

This character has not been adequately studied. Dissection of the mandibles requires virtual destruction of the head capsule, and so is not advisable on unique specimens. The rows of spines making up the lamellae are difficult to see, even in preparations mounted on microscope slides and examined with phase contrast. I have found the number of lamellae constant within species in those species examined. Smaller species have fewer lamellae. The adaptive significance of the number of lamellae is obscure, and as they are difficult to see and count, I think they are not of much taxonomic utility.

GENITALIA AND SECONDARY SEXUAL MODIFICATIONS

Eversible Coxal Glands

Members of the Order Callipodida and all Colobognatha have eversible coxal sacs on all or most of the legs, for imbibing water from the substrate. In the Chordeumida, these sacs are greatly reduced in number and are found on one or two pairs of legs immediately posterior to the gonopods. They are used not for taking up water, but for receiving the seminal fluid from the genital openings on the coxae of the second legs (Schubart, 1934; Verhoeff, 1910). Secretions presumably formed by the sacs aid in the manufacture of spermatophores, and the tips of the functional gonopods are usually near or actually inserted in these glands. Many preserved specimens have the glands extruded, and often capped with spermatophores. In all the North American chordeumids, the sacs occur on either legs 10 alone, or on legs 10 and 11.¹ This ar-

angement is consistent within families delimited by other characters, and thus I think distribution of coxal sacs is a conservative character in the Chordeumida that can be very useful in showing relationships.

Postgonopodal and Pregonopodal Leg Modifications

In some chordeumids, from one to all of the seven pairs of pregonopodal legs of the males are modified for grasping the female during mating. The modifications are in the form of enlargement of the legs, sometimes the geniculate form of certain leg segments, and sometimes knobs on the legs. In *Urochordeuma porona* the modifications are quite bizarre. Modifications also occur, primarily in the Cleidogonidae and Conotylidae, in postgonopodal legs. The function of these changes might be to support and make rigid the gonopod complex, and they usually involve the basal articles of the legs and their sternites.

For some reason, it has often been assumed that these modifications are of greater significance than those of the anterior gonopods, and they are frequently mentioned in generic diagnoses (Chamberlin, 1941b; Loomis, 1963). In my revision of the large family Conotylidae, within the genus *Conotyla* I found the differences in pregonopodal leg modifications to be of only species significance; apparently they evolved many times. But in *Austrotyla*, these modifications are uniform in all species of a genus; here I considered them supporting evidence for uniting a group of species, but not as a justification for generic splitting. I have since found that there is a good deal of individual variation in some *Conotyla* species in the distribution of knobs on the pregonopodal legs. In the Trichopetalidae there is variation within a genus in such modifications, but the en-

¹I have been unable to verify the observations of Causey (1963a, 1963b) of small coxal glands on the posterior gonopods (ninth legs) of some

Trichopetalidae and Caseyidae, though rudimentary, closed glands occur there in some species of *Cleidogona*.

largement of the pregonopodal legs is most marked in larger species that are not troglitic, so perhaps there are some relationships between this modification and size. The smallest known *Conotyla* species has the pregonopodal legs completely unmodified.

Loomis (1966) described the genus *Costaricia* (Cleidogonidae), whose species differ hardly at all from those of *Cleidogona*. The distinguishing character used was the apically cleft process of the twelfth sternite. This character does not seem to be of great significance; I believe that species should be lumped in genera based on similarities, rather than differences used for splitting, since genera contain related species. The postgonopodal leg modifications are sometimes of use in separating species of *Cleidogona*, sometimes not. They are uniform in all species of *Pseudotremia*.

I do not think the pregonopodal and postgonopodal leg modifications are of particular use in separating families, though they are sometimes useful characters at the level of genus and species.

Posterior Gonopods

In the Chordeumida, the posterior gonopods are the ninth legpair of adult males, usually modified in some way. Verhoeff (1936) and Attems (1959) thought these structures to be of primary importance in establishing higher categories. The number of articles in the posterior gonopods has been used extensively (see especially Hoffman, 1950a) to delimit genera in the Cleidogonidae, and to a lesser extent in the Trichopetalidae (Causey, 1960a). Buckett and Gardner (1967) considered the absence of posterior gonopod telopodite segments justification for erecting the family Idagonidae for *Idagona westcotti*.

An examination of a series of species of *Cleidogona* or of *Pseudotremia* that are otherwise close indicates that this is a specialized character, perhaps degenerative, permitting a hypertrophy of the anterior gonopods and keeping (in this case)

the apparently functionless posterior gonopods out of the way during mating. In some European forms, the posterior gonopods are almost absent. On the other hand, the posterior gonopods, or at least their colpocoxites, function in spermatophore transfer in at least some species of the North American family Conotylidae. But the telopodite articles are reflexed dorsad, out of the way of the colpocoxites. As mentioned above, they are entirely lacking in *Idagona*, and there is a possibility that conotylids with more than two telopodite articles on the posterior gonopods exist.

I think the number of articles in the posterior gonopod telopodites is of only limited value in indicating phylogenetic relationships, but it is of considerable significance which gonopod pair, anterior or posterior, function in spermatophore transfer. The presence or absence of a functional colpocoxite is of particular importance. In some families (Caseyidae, Urochordeumidae), processes occur on the posterior gonopod coxae, but it is not known if they are functional in spermatophore transfer. It is likely that colpocoxites have evolved several times, and there is evidence that originally functional colpocoxites may be displaced in their function by the anterior gonopods (Adritylidae, some species of Conotylidae; see discussion of these families below).

Anterior Gonopods

Unlike Verhoeff and Attems, Brölemann (1935) emphasized the overall morphology of the anterior gonopods, and arrived at a much more satisfactory classification of the European chordeumids. Only recently has the value of the anterior gonopods in grouping species and genera been recognized in the United States (Hoffman, 1961). Of great importance is the degree to which the anterior gonopods have departed from their original leglike form through the fusion of articles of the individual legs and through the bilateral fusion of the primitive eighth legpair. Hoffman (1963) studied

some species of the family Heterochordeumatidae in detail. The anterior gonopods are extremely leglike, though reduced in size, and the posterior gonopods bear colpocoxites remarkably like those found in the family Conotylidae. The gonopod morphology of species of the Heterochordeumatidae is the most leglike, and thus the most primitive, yet discovered among the Chordeumida.

In most families that occur in Europe, the anterior gonopods are completely fused to each other, and show few traces of segmentation. Median structures of obscure derivation are common. In many species, extreme reduction in the number of articles in the legs immediately anterior and posterior to the gonopods has also taken place. Few North American species are so highly specialized. In species of the Trichopetalidae, the coxae of the anterior gonopods are free from the sternite, and the telopodites, though single-articled, are articulated, not fused, with the coxae. Conotylids belong to the group of families in which the colpocoxites of the posterior gonopods are functional—the anterior gonopods are reduced to single articles but are free from the sternite. In one species (*Achemenides pectinatus*) the anterior gonopod coxae are fused bilaterally.

In species of the Cleidogonidae, the anterior gonopods are much modified, but coxal and telopodite regions can still easily be distinguished, especially if homologies with gonopods of species of the Trichopetalidae are recognized; the posterior gonopods are not functional. In members of the superfamily Brannerioidea, for example *Branneria*, a great amount of fusion has taken place, and there are median structures. Some others in that superfamily, however, have still-discernable coxal and telopodite regions (Tingupidae). In the species of the family Adritylidae, though the basic conotyloid morphology is present, cheirites, formed from the complete fusion of gonopod, sternite, and tracheal apodeme, occur. The posterior gonopod is

possibly not functional, and the tenth pair of legs is modified to form a supporting structure.

Gonopod morphology of all the North American families is discussed in more detail in another section. But as can be seen by the preceding discussion, the gonopod anatomy is of great phylogenetic and therefore taxonomic importance. The structure must be studied in detail when new taxa are proposed, since superficial similarities in body form and other characters have led to unnatural placements in the past.

Female Genitalia

The cuticular specializations around the openings of the oviducts have been termed *cyphopods*. Their origin was at first the subject of some debate; without any real evidence, Verhoeff (1909) claimed that these valvelike structures were the reduced posterior leg pair of the third segment. Brölemann and Lichtenstein (1919) demonstrated that they were merely specialized regions of integument developed around the oviduct pores and connected to the coxae of the second pair of legs; they showed that the same is true of the so-called penes found in male millipeds in the same position. The third segment is a single metamere. Wood (1865) used the shape of the cyphopods as a species character in the family Parajulidae, and later Brölemann (1922) studied them in detail and found an abundance of differences between species. Keeton (1960) found them useful in the family Spirobolidae. In the chordeumids, their usefulness varies. Brölemann used them extensively in his treatment of the Order Chordeumida in *Faune de France* (1935), but frequently depended on small details that might prove unreliable when large series of specimens are studied. In the Conotylidae, I found the cyphopods too variable within species to be useful as a species character (Shear, 1971a), but in *Cleidogona* and *Pseudotremia* (Cleidogonidae) they are extremely useful.

However, the general plan is too similar in all millipeds to be of much utility in separating families and genera.

SUMMARY

From the brief discussion above, and the more detailed descriptive material to be found in the section on superfamilies, the following points are clear.

1. The gross morphology of the gonopods, particularly the degree of segmentation in the anterior gonopods, and the functional distinction between anterior and posterior gonopods, are of paramount importance in placing species in the proper genera and families, and in relating families to each other.

2. Other characters should be used in connection with the gonopod morphology, but with caution, and with the understanding that many of them are subject to convergent evolution because of their obvious adaptiveness.

3. *Genera and families are composed of similar species grouped together to emphasize that similarity.* Monotypic higher taxa are logically justifiable, however, if it can be shown that the included species would make other genera and families in which they might be placed obviously polyphyletic, or if the included species can be demonstrated to be the end of a separate phyletic line. Both of the above criteria rely primarily on inference from taxonomic information.

It is not inconsistent to have within the same major group very large, presumably recent, actively speciating taxa (*e. g.*, *Cleidogona*) and probably very old, nearly extinct, monotypic ones (*e. g.*, *Adritylidae*). The genus is not an objective category, but neither should it be arbitrary, in composition or size.

KEYS TO SUPERFAMILIES AND FAMILIES OF NORTH AMERICAN CHORDEUMIDA

KEY TO SUPERFAMILIES

- 1a. Mentum not divided
..... HETEROCHORDEUMATOIDEA

- 1b. Mentum divided (Fig. 181) 2
2a. Both coxae 10 and 11 of males with gland openings CLEIDOGONOIDEA
2b. Coxa 10 only with gland opening 3
3a. Coxae of male anterior gonopods with articulated flagelliform branch (Fig. 429); posterior gonopods 2-segmented, apical segment flattened (Fig. 430) STRIARIOIDEA
3b. Coxae of male anterior gonopods without such a branch, telopodites (Fig. 465) flagelliform; posterior gonopod 3-4-segmented, apical segment not flattened (Fig. 472) BRANNERIOIDEA

KEY TO FAMILIES OF HETEROCHORDEUMATOIDEA

- 1a. Leg 10 of males of normal size
..... CONOTYLIDAE
1b. Leg 10 of males reduced (Fig. 496)
..... ADRITYLIDAE

KEY TO FAMILIES OF CLEIDOGONOIDEA

- 1a. Posterior gonopods of males clavate distally (Fig. 507) TRICHOPETALIDAE
1b. Posterior gonopods of males attenuate distally (Figs. 387, 413) CLEIDOGONIDAE

KEY TO FAMILIES OF STRIARIOIDEA

- 1a. Collum partially covering head 2
1b. Collum not covering head 3
2a. Body segments with prominent paranota (Fig. 452) RHISCOSOMIDIDAE
2b. Body segments without paranota; 10-12 longitudinal ridges on each segment (Fig. 425) STRIARIIDAE
3a. Body segments with prominent paranota (Fig. 446) UROCHORDEUMIDAE
3b. Body segments cylindrical CASEYIDAE

KEY TO FAMILIES OF BRANNERIOIDEA

- 1a. Adults with 26 segments BRANNERIIDAE
1b. Adults with 28 or 30 segments
..... TINGUPIDAE

ARTIFICIAL KEY TO FAMILIES OF THE ORDER CHORDEUMIDA IN NORTH AMERICA

I have attempted to base the following key on nonsexual characters, but in some cases, this was not possible. In such instances, gonopod characters that can easily be observed under low magnification have been used.

- 1a. 26 postcephalic segments BRANNERIIDAE
1b. 28-30 postcephalic segments 2

- 2a. Body segments with series of heavy, longitudinal, linear carina (Fig. 425), but otherwise circular in cross section; males with prominent spines on the labral angles STRIARIIDAE
- 2b. Body without such carina, or not circular in cross section, with enlarged lateral tubercles (Fig. 6) or polydesmidlike paranota (Fig. 446); males without labral spines 3
- 3a. Mentum divided into mentum and pro-mentum (Fig. 181) 4
- 3b. Mentum not divided 9
- 4a. Body segments with rather broad, flat polydesmidlike paranota; dorsal surface with various kinds of sculpturing, but never smooth 5
- 4b. Body segments cylindrical, or with more or less prominent enlarged lateral tubercles, but not polydesmidlike paranota; dorsal surface usually smooth, but sometimes (*Pseudotremia*) with coarse knobs (Fig. 6) between the lateral tubercles 7
- 5a. Collum broader than the head; dorsal body surface with closely set, sharp-pointed tubercles (Fig. 452) RHISCOSOMIDIDAE
- 5b. Collum narrower than head; dorsal surface otherwise 6
- 6a. Anal segment trilobed; paranota (Fig. 446) broad, thin, not curved ventrally, lateral-most seta in a midmarginal notch on paranota; adults *ca.* 16–20 mm long UROCHORDEUMIDAE
- 6b. Anal segment not trilobed; paranota (Fig. 460) narrowed distally, thick, curved ventrally, lateralmost seta on posterior side of paranota; adults less than 10 mm long TINGUPIDAE
- 7a. Posterior gonopods of males (Fig. 444) 2-segmented, basal segment (coxa) with a strong mesal process (coxite) CASEYIDAE
- 7b. Posterior gonopods of males 2–6-segmented (Figs. 387, 413, 504), but 2-segmented gonopods lacking a coxite 8
- 8a. Posterior gonopods 2-segmented (Fig. 504), distal (telopodite) segment enlarged; small animals (less than 10 mm long); antennae usually clavate TRICHOPETALIDAE
- 8b. Posterior gonopods (Figs. 387, 413) more than 2-segmented, distal segments smaller than basal; larger animals (usually more than 10 mm long); antennae long, not clavate CLEIDOGONIDAE
- 9a. Tenth legs of males (Fig. 496) with coxae enlarged, telopodite greatly reduced ADRITYLIDAE
- 9b. Tenth leg telopodites normal, coxae sometimes slightly enlarged CONOTYLIDAE

Superfamily STRIARIOIDEA Cook, NEW STATUS

Striarioidea Cook, 1889, Proc. U. S. Natl. Mus., 21: 670.

Chordeumid millipedes with 30 segments; mentum divided. Anterior gonopods complex, with two or more distinct coxal branches, at least one of which is flagelliform and may be movable. Telopodites lobelike, usually not fused to coxae. Posterior gonopods with sternum broad, coxae with or without processes, two or three telopodite segments, expanded and flattened. Coxae of legs 10 with glands. North America.

Included families. Striariidae Bollman, 1888; Caseyidae Verhoeff, 1909; Rhiscosomididae Silvestri, 1909; Urochordeumidae Silvestri, 1909.

Discussion. The name Striarioidea was used by Cook (1899) as a subordinal name under his Order Coelochaeta, though the spelling now conforms to superfamily names, which covered our present orders Chordeumida and Callipodida. It originally contained only the family Striariidae, and this arrangement was long accepted by milliped taxonomists, on the basis of the peculiar body form (the collum is hoodlike, the anal segment trilobed, the metazonites, with prominent ridges, and apparently lacking the usual segmental setae; sexual dimorphism is pronounced), but Causey (1963a) examined the gonopods and found the subordinal designation unwarranted. I agree, if the category Striarioidea, at whatever level, includes only the family Striariidae. However, Causey's statement was based on an erroneous interpretation of the anterior gonopods, discussed under the Family Caseyidae below. The Caseyidae and Striariidae are related, but not for the reasons Causey (1963a) puts forth. A detailed examination of material of two other poorly known families, Rhiscosomididae and Urochordeumidae, makes it possible to include them in this assemblage. The main points of similarity are covered in the characteriza-

tion above, but to reinforce this new status of the name Striarioidea, some further discussion of the similarities of the striariids to the other families is needed.

The members of the family Rhiscosomidae are heavily sclerotized, and have the collum wider than, and partly concealing, the head—in these characters they resemble the species of *Striaria*. In *Urochordeuma* (Urochordeumidae) the anal segment is trilobed as it is in the striariids, and the body is moderately heavily sclerotized. Urochordeumids resemble rhiscosomidids in the broad, thin paranota; but like the species of the family Caseyidae, the head is free from the collum and there are lateral striations. Thus a number of the characters previously thought of as unique to the Striariidae have their analogues in other related families. The ridges of the dorsum and the labral spines and modified mandibles of male striariids remain as unique characters of that family. Though none of the specimens of *Striaria* I have examined have detectable segmental setae, *Speostriaria shastae* has them long and prominent.

The distribution of the superfamily as it is now known is primarily western. The several genera of Caseyidae are found on the Pacific coast, with a single genus (*Underwoodia*) in New England and Newfoundland. *Urochordeuma* has two possible species in the region of Mt. Tacoma, Washington. The three known species of *Rhiscosomides* are found in southern Oregon and the San Francisco Bay area of California. Species of the Striariidae are known from both the Pacific coast and the Appalachian Mountains, from northern Virginia and southern Indiana to Georgia. It must be emphasized that this section of the Order Chordeumida is in the greatest need of critical study, but the scarcity of specimens will postpone such work for some years.

The relationships of the superfamily Striarioidea are very obscure. The caseyids are similar to the cleidogonids in general

body form. However, the development of coxal processes on the posterior gonopods of some species may indicate a relationship with the Heterochordeumatoidea. The complexity and anatomy of the anterior gonopods suggest a relationship with the Brannerioidea. Whichever of the other three North American superfamilies the group is related to, it is clear they have had a long separate history.

Family STRIARIIDAE Bollman

Striariidae Bollman, 1893, Bull. U. S. Nat. Mus., 46: 158; Cook, 1899, Proc. U. S. Nat. Mus., 21: 668; Causey, 1958, Proc. Biol. Soc. Washington, 71: 179 (key to genera).

Type genus. *Striaria* Bollman, 1888.

Included genera. *Striaria*, *Amplaria*, *Vaferia*, *Speostriaria*.

Range. California, Oregon, Indiana, Appalachian Mts. from Virginia to Georgia.

Diagnosis. This family is set apart from all other North American chordeumids by the hoodlike collum and peculiar sculpture of the tergites (Fig. 425).

Description. Antennae of moderate length (Fig. 425), not clavate. Ocelli present, usually less than 12, irregularly arranged. Mentum divided. Segments 30, metazonites with 10–12 sharply elevated longitudinal ridges, the lateralmost pair at ventral segment margin, areas between ridges with small tubercles. Collum broad, expanded, wider than head, hoodlike, partly covering head (Fig. 425). Anal segment trilobed. Segmental setae present or absent. Males usually with long, immovable spines at labral margins. Anterior gonopods: sternum broad, well sclerotized, expanded and flaring laterally (Figs. 426, 427). Coxae divided into two or three branches, anteriormost rodlike (Fig. 428), posteriormost forming sheath for flagelliform branch (Fig. 429); telopodites irregular, globular, distally with minute scales. Posterior gonopods: 2-articled, distal article expanded and flattened (Fig. 430), sternum broad, with platelike posterior process. Pregonopodal legs thickened,

crassate, curiously flattened. Third coxae with large, flasklike anterior projections. Coxae 10 with glands, but not much enlarged.

Discussion. This family may be quite large in number of species (R. L. Hoffman, personal communication), but because of the humus-dwelling habits and a definite tendency to occur in drier habitats where millipeds are not usually searched for, species of the family *Striariidae* are rare in collections. The family *Striariidae* is currently being revised by Dr. J. P. Mauries. The criteria by which genera have been separated are, as a rule, unreliable. Causey (1958) pointed out that the presence of 12 crests on the collum is not diagnostic of *Amplaria*, as Chamberlin (1941b) stated in describing that genus. Causey continues to recognize *Amplaria*, however, on the basis of its fewer ocelli and a deep transverse furrow on the collum. I have not seen specimens of this genus. *Vaferia* (Causey, 1958) is separated on the basis of the anterior flattening of the body, and the lack of labral spines on the males. Causey also described *Speostriaria* (Causey, 1960) for the very large, troglobitic species *Speostriaria shastae*. Except for the matter of greater sexual dimorphism, all the characters mentioned as diagnostic of *Speostriaria* are due to troglobitic adaptations. The small gonopod differences do not seem to justify generic distinction.

I examined the gonopods of three Appalachian species in detail. It appears to be impossible at this time to assign names to these forms, but I have illustrated a male from Shenandoah National Park that is probably referable to *Striaria columbiana* Cook.

In lateral view (Fig. 427), the heavily sclerotized sternum (S) bears a lateral projection that is set off by a suture and conceals the tracheal spiracle. The anterior coxite (Fig. 428) is complexly branched; the details of this branching appear to be of value in distinguishing species. The transverse ridges seen on this branch in

anterior view (Fig. 426) are characteristic of the species of *Striaria* I examined. The posterior branch, seen in Figure 429 in mesal view, is articulated basally with a movable flagelliform branch (F). The number of flagella appears to be variable. Distally, this posterior coxite forms a curved sheath. The telopodites (T, Figs. 426, 427) are lobelike and curve posteriorly and dorsad, where they are closely set with minute scales. The anterior portion of the telopodite (T, Fig. 426) may actually be the body of the coxa. It is muscularized directly from the tracheal apodemes.

Family CASEYIDAE Verhoeff

Caseyidae Verhoeff, 1909, *Zool. Anz.*, 34: 567;
Causey, 1963, *Wasmann J. Biol.*, 21: 193.
Underwoodiidae Verhoeff, 1909, *Zool. Anz.*, 34: 568.

Type genus. *Caseya* Cook and Collins 1895.

Included genera. *Caseya*, *Oponia*, *Placerna*, *Speoseya*, *Vasingtona*, *Zantona*, *Underwoodia*.

Range (Map 15). Newfoundland, Long Island, northern New York State, (*Underwoodia*); northern California, Oregon, Washington, British Columbia. Two species of *Underwoodia* were described by Chamberlin from Utah (*U. hespera* and *U. tida*). The female holotype of *hespera* was recently found in the collection of the MCZ; it is an immature female and is probably not an *Underwoodia*. The type of *U. tida* is also a female.

Diagnosis. The body segments are cylindrical and have lateral striations, but are dorsally smooth. The collum does not cover the head.

Description. Antennae of moderate length, not clavate. Ocelli present or absent. Mentum divided. Segments 30, prominent carinae or tubercles lacking, body cylindrical, segments with prominent lateral striations. Anterior gonopods (Figs. 431–433); sternum distinct, well sclerotized. Coxae separate, subglobular; coxites extremely complex, usually with 2–4 dis-

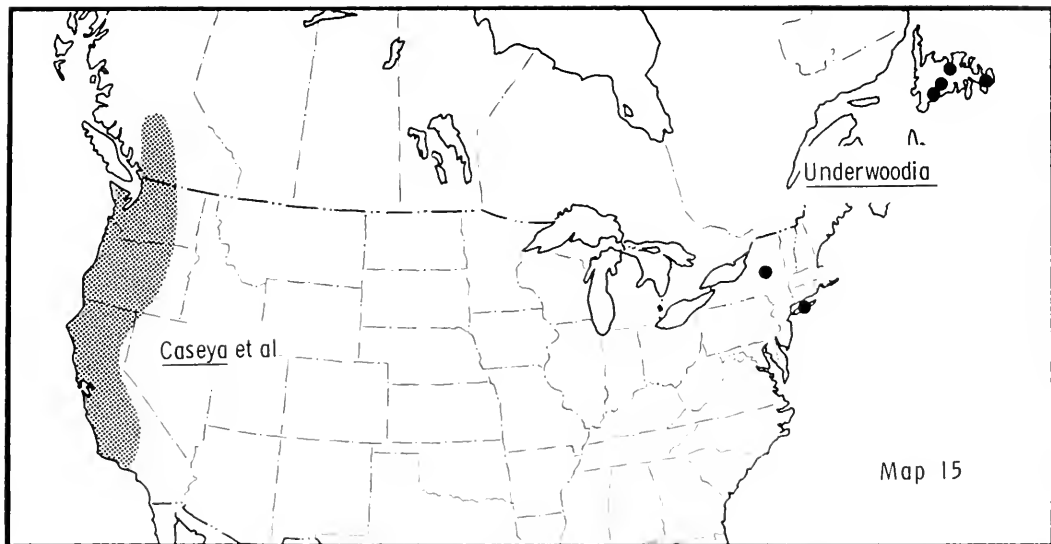

Map 15. Central North America, showing distribution of western genera of Caseyidae (Caseya et al., hatched area) and the genus *Underwoodia* (dots).

tinct divisions. Flagella usually present; telopodite simple or with a rudimentary suture. Posterior gonopods (Fig. 434) 2-articled; telopodite article enlarged, coxa with prominent coxite and sometimes a small gland. Modifications of pregonopodal legs various, but usually with coxal projections on legs 2 and 3, coxae of legs 7 enlarged, lobed, posteriorly excavate. Coxae of legs 10 enlarged, lobed, with large gland.

Discussion. This family, very probably a large one in number of species, is the most poorly known of abundant North American milliped families. It is currently the subject of a revision being carried out by Mr. Michael Gardner, Davis, California, and for that reason, I am limiting the present discussion to the gonopod structure of *Caseya heteropus* Cook and Collins, and some past misconceptions regarding the Caseyidae.

Verhoeff (1909) probably did not have specimens when he set up separate families for Cook and Collins' (1895) genera *Underwoodia* and *Caseya*. Causey (1963a) suggested that there was no reason for

keeping the two families separate, an opinion with which I concur, despite the fact that the extreme rarity of *Underwoodia* males has not allowed me to examine their gonopod anatomy; the sex ratio in *U. polygama* (= *U. iuloides*?) is about 40:1 in favor of females (Cook and Collins, 1895; Palmén, 1952), and the animals themselves are uncommon, and boreal and hygrophilous in habit. The holotypes of both *U. polygama* Cook and Collins and *U. iuloides* (Harger) have been lost.

However, I cannot find any evidence in *Caseya heteropus* to support Causey's (1963a) interpretation of the gonopods of *Opiona* and *Speoseya*, which she extends to the whole Family Caseyidae, and by implication to the family Striariidae. Briefly, she asserts that what are here referred to as the anterior gonopods actually represent both anterior and posterior gonopods, closely appressed, and that what are here called posterior gonopods are actually the tenth legs. Causey presents no sound evidence for this view, but I suspect that the tiny coxal gland on the posterior gonopods of *Speoseya grahami*

and *Opiona siliquae* strongly influenced Causey's interpretation. But an examination of Palmén's (1952) excellent figures of *Underwoodia polygama* rules out such an interpretation of the gonopods of that species; thus to propose for caseyids such an unusual gonopod structure, in fact a unique one, and at the same time combine the family with *Underwoodia* is inconsistent.

I examined the gonopods of *Caseya heteropus* in detail, and found no evidence that two pairs of legs are involved in the anterior gonopods. In fact, the musculature and structure of the sternites militates against such a view. If indeed the "posterior gonopods (of Causey)" are closely appressed and fused with the "anterior gonopods," they have lost all independent muscularization as well as their sternite and tracheal apodemes. I have not known such a development to have occurred anywhere in the Diplopoda. I must then assume that Causey considered the telopodites of the anterior gonopods (Fig. 431, *T*) to be "posterior gonopods"; this is an understandable error in view of the complexity of the anterior gonopod coxites (Fig. 432, *C*).

The complex pre- and postgonopodal leg modifications have been described in detail for this species by Cook and Collins (1895) and need no further attention. They have been the basis for division of the family into genera, which may have to be re-aligned after detailed study of the various species involved. The affinities of this family are very obscure, but relationship with the Striariidae is clear. There may be a distant kinship to the trichopetalid-cleidogonid complex, but much more must be learned about the gonopods and their function before this can be settled with any certainty.

Family UROCHORDEUMIDAE Silvestri

Urochordeumidae Silvestri, 1909, Rend. R. Accad. Lincei, 5: 229; 1913, Boll. Lab. Zool. Gen. Agr. Portici, 7: 303; Chamberlin and Hoffman, 1958, U. S. Nat. Mus. Bull., 212: 107.

Type genus. *Urochordeuma* Silvestri, 1909; family monobasic.

Range. Vicinity of Mt. Ranier, Pierce and King counties, Washington.

Diagnosis. The head is wider than the collum, not narrower, as it is in the Rhiscosomididae; the paranota (Fig. 446) separate this family from the Caseyidae.

Description. Antennae long, slightly clavate. Ocelli present, in trapeziform group. Mentum divided. Segments 30, most with prominent, polydesmidlike paranota (Fig. 446) that more than double body width; prominent lateral striations. Anal segment trilobed. Body surface with scattered, prominent tubercles; posterior margins of midbody segments with row of strong rugae. Gonopods: anterior gonopods (Figs. 447, 448) with a separate, well-sclerotized sternum (Silvestri, 1913); gonopods not bilaterally fused but apparently without clear separation of coxa and telopodite. Flagellum present. Posterior gonopods (Fig. 445) 2-articled; telopodite article enlarged, coxa with process. Modifications of pregonopodal legs as described for *Urochordeuma*. Coxae of legs 10 with coxal gland; coxae of legs 11 enlarged, shallowly excavate on anterior surface.

Discussion. This unusual family has been a source of confusion since its description. Most recently, Attems (1959) separated it from all other chordeumid families because Silvestri's (1913) drawings show the vas deferens opening separately anterior to the second coxae. This was a mistaken observation on the part of Silvestri, one which he also repeated in the same paper for *Rhiscosomides mineri*.¹ The body form is very similar to that of *Diplomaragna* (Attems, 1898; Murakami and Paik, 1968), but the gonopods point to a relationship with the Caseyidae.

Only two species are known, *Urochordeuma bumpusi* Silvestri, 1909, and *U.*

¹ Actually, since it is not indicated whether the view given by Silvestri is anterior or posterior, it would be impossible to say that the openings were anterior to the coxae.

porona Chamberlin, 1941. Both are from the vicinity of Mt. Ranier, Washington, and are so similar in description that they may very well represent the same species, but I will not combine them without examining specimens of *U. bumpusi*; the types have apparently been lost. The gonopods of *U. porona* could not be studied in detail from the unique holotype. During the original dissection, the basal region of the anterior gonopods was damaged. The left gonopod was missing altogether. The labels on Figures 447 and 448 are thus speculative, based on the obvious similarity to the gonopods of *Caseya*. The coxites (*C*, Figs. 447, 448) are complex and folded to enclose a single flagellum arising from the anterior margin. The telopodite (*T*, Fig. 448) is simple and partly fused along its anterior edge to the coxite. The basal region of the coxa bears a prominent group of setae. The peculiar modifications of the anterior legs have been described by Chamberlin (1941). The second legs have long processes on the third segments (Fig. 449), and the third legs have long knobs arising from the coxae (Fig. 450), similar to the processes found in *Striaria*. The seventh coxae have lobes similar to those found in *Caseya*.

Family RHISCOSOMIDIDAE Silvestri

Rhiscosomididae Silvestri, 1909, Rend. R. Accad. Lincei, 18: 232; 1913, Boll. Lab. Zool. Portici, 7: 307.

Type genus. *Rhiscosomides* Silvestri, 1909.

Diagnosis. The only chordeumid milliped family in North America other than the Striariidae with the collum wider than the head; the dorsum bears densely scattered sharp-tipped tubercles, rather than the longitudinal ridges of the Striariidae.

Description. Thirty segments. Mentum divided. Head narrower than collum (Fig. 451). Antennae short, clavate. Ocelli present, in an irregular single or double row. Postcollum segments (Fig. 452) with

broad, almost polydesmidlike paranota; dorsum with dense scattering of sharp-tipped tubercles. Pregonopodal legs of males enlarged, not otherwise modified. Anterior gonopods (Figs. 453–456): sternum strongly sclerotized, laterally expanded. Coxae with 2 groups of coxal processes, the anteriormost sometimes fused to form a plate, the posteriormost with flagelliform processes and scalelike setae. Telopodites simple, lobelike. Posterior gonopods (Figs. 457, 458): sternum bandlike, strong, laterally rugose. Coxae large, expanded, rugose. Telopodite article lobelike. Coxae of legs 10 with glands. Twelfth sternum and legs normal.

Distribution. Pacific coast of North America (Map 16).

Discussion. Very little is known about this family. Silvestri (1913) described *Rhiscosomides mineri* from Lebanon, Linn County, Oregon. I have seen a female from Santa Cruz County, California, and a collection of immature males from Loon Lake, Douglas County, Oregon. The second species of the family known from males is described here as *R. acovescor*, from Marin County, California. The collecting labels on all specimens I have seen indicate that the animals live in conifer duff. The Rhiscosomididae and Striariidae seem more closely related to each other than to the Caseyidae; but I hesitate to combine them, with so little known about the eventual extent of the families.

Each described species is discussed in more detail below.

Genus *Rhiscosomides* Silvestri

Rhiscosomides Silvestri, 1909, Rend. R. Accad. Lincei, 18: 232.

Type species. *Rhiscosomides mineri*, by monotypy. The gender of the generic name is neuter.

Rhiscosomides mineri Silvestri

Rhiscosomides mineri Silvestri, 1913, Boll. Lab. Zool. Portici, 7: 308, figs. 4–7, ♂.

Types. Male holotype from a rotting tree, Lebanon, about 30 mi. south-southwest of Salem, Linn Co., Oregon; whereabouts of types unknown.

Discussion. Loomis (1966) reported that Silvestri had sent him a syntype, but it could not be located. Silvestri's 1913 figures of *Urochordeuma bumpusi*, described in the same paper, are reasonably accurate, but *R. mineri* is a much smaller form, and the figures of the gonopods do not much resemble those of *R. acovescor* presented here. The immature males mentioned above from nearby Loon Lake, Douglas County, Oregon, are probably *R. mineri*, since they all have five ocelli. A redescription of this species from males is badly needed.

Rhiscosomides josephi Chamberlin

Rhiscosomides josephi Chamberlin, 1941, Bull. Univ. Utah Biol. Ser., 6: 16-17.

Types. Female holotype from John Day Creek, Douglas Co., Oregon, collected 18 November 1941 by J. C. Chamberlin, deposited in University of Utah collection, examined.

Discussion. The "differences" between this species and *R. mineri* given by Chamberlin in his extremely brief description are quite useless — for example, the coloration is described as "brown rather than chestnut." However, the type has seven ocelli as opposed to five in *R. mineri*, and ocelli number may be a good species character in *Rhiscosomides*; a large collection of immature males I have assigned to *R. mineri* all have five ocelli on both sides of the head.

Rhiscosomides monterea (Chamberlin)

NEW COMBINATION

Tingupa monterea Chamberlin, 1910, Ann. Ent. Soc. Amer., 3: 240-241, figs. 3-5, probably ♀.

Type. Holotype of unspecified sex from Pacific Grove, California, coll. June, 1902, lost, presumed destroyed.

Discussion. It is clear from several points

in the discussion of nonsexual characters of this species given by Chamberlin (1910) that it belongs in *Rhiscosomides* and not *Tingupa*. In particular, the sharp-tipped dorsal tubercles, denticulate paranota, and light spots around the bases of the segmental setae place it here; the type was also reported as having eight ocelli. A female *Tingupa* from Marin County, California, has 13 ocelli, but female *Rhiscosomides* from San Mateo County have only eight, and I have assigned these latter specimens to *R. monterea*.

Rhiscosomides acovescor n. sp.

Figures 451-458

Types. Male holotype, a second male, and females and immature specimens from *Sequoia* duff, S. P. Taylor State Park, Marin Co., California, collected 7 January 1962 by C. W. O'Brien. The specific epithet is a Latin noun in apposition and means "needle-eater," in reference to the species' habitat.

Diagnosis. Distinct from *R. josephi* and *R. monterea* in ocelli number; and from *R. mineri* in details of the gonopods.

Description of male holotype. Length, 5.8 mm, width 1.3 mm. Five ocelli in 2 rows of 3 and 2. Head (Fig. 451) broadly rounded, depressed in anterior midline and with two supra-antennal swellings. Antennae strongly clavate, antennal segment 5 longest and thickest. Midbody segments (Fig. 452) typical for genus. Coxae of leg 7 enlarged, pregonopodal legs slightly more crassate than other legs. Anterior gonopods: sternum (S, Fig. 453) bandlike, laterally expanded, tracheal spiracles mesal, below corresponding prongs on gonopod coxite. Coxae with two groups of coxites; the anteriormost (C, Fig. 453) fused along midline to form thin anterior plate, with strongly projecting anterior hooks that fit into sockets at tracheal spiracles. Posterior side of plate gives rise to paired, flattened flagellae formed from fusion of numerous sclerotized fibers. Posterior coxite (C, Fig. 456) basally lobe-

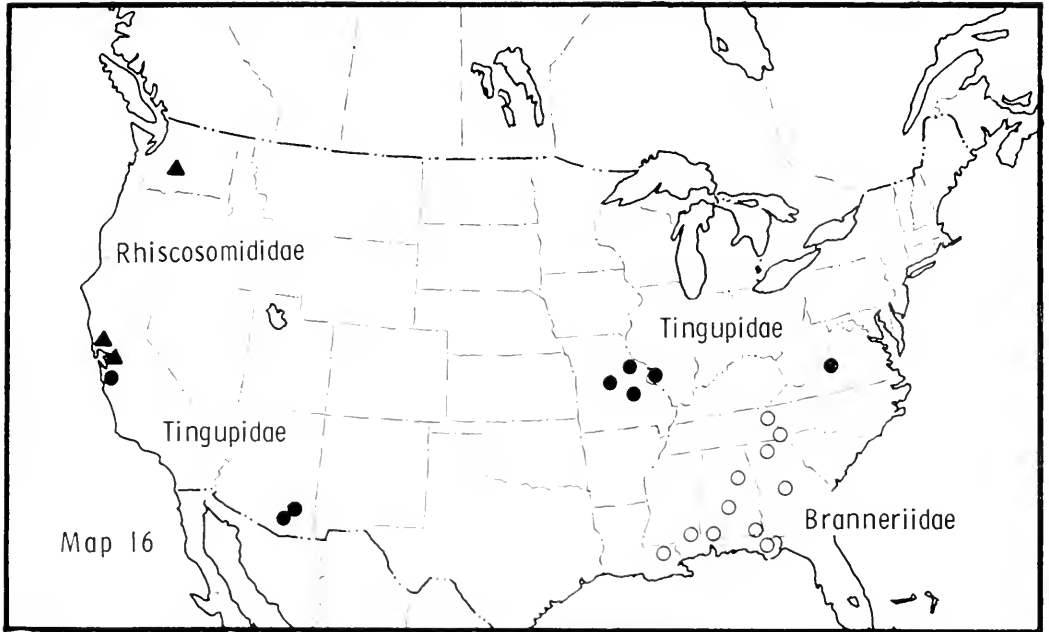

Map 16. United States, showing distribution of the families Tingupidae (dots), Rhiscosomididae (triangles), and Branneriidae (circles).

like, with scalelike setae and a posterior flagelliform branch. Telopodites (*T.* Fig. 454) simple, lobelike, well muscularized from tracheal apodeme and coxae. Coxae of legs 10 enlarged, with glands. Posterior gonopods: as described for genus (Figs. 457, 458).

Notes. The gonopods of *R. acovescor* do not agree well with Silvestri's figures of *R. mineri*, but these figures are difficult to interpret. It is possible that more than one genus is involved in *Rhiscosomides*.

Superfamily BRANNERIOIDEA Cook, NEW STATUS

Chordeumid millipeds with 26–30 segments; mentum divided. Anterior gonopods complex, of various forms, but always with one or more prominent colpocoxites and a distinct, posterior telopodite region. Posterior gonopods with reduced number of segments, but without colpocoxites. Coxae of legs 10 and 11 with glands, or

with the front faces excavate (*Branneria*). North America.

Included families. Branneriidae Cook, 1896; Tingupidae Loomis, 1966.

Discussion. It is questionable whether this superfamily really represents a monophyletic line, despite the similar gonopod plans. The similarities of the included families may be the result of convergent evolution from several lines and due to adaptation to small size. But they are incompletely known, both with regard to the numbers of genera and species involved and their respective distributions. *Branneria* (Branneriidae), for example, has only been reported in the literature once since its description, but actually it is widespread in the southeastern United States (Map 16), and extremely common at certain localities. Most species of *Tingupa* (Tingupidae) are known only from the type locality, though *T. pallida* is known from several localities in Missouri and Illinois (Map 16).

The fact that the two included families both lack posterior gonopod colpocoxites, have glands on coxae 10 and 11, and have the mentum divided, may eventually relate them to the Cleidogonoidea, but it is obvious that these families have had a long separate history.

There are a few European genera that superficially resemble the North American families grouped here, especially in the complexity of their gonopods and their small size. I have been able to study specimens of some of these genera, through exchange collections placed in the MCZ by Verhoeff and Attems. *Chaemosoma* (specimen examined) and *Acrochordum* (Strasser, 1942; Attems, 1898) have anterior gonopods superficially like those of *Rhiscosomides* and *Tingupa*, respectively, but also have more or less complex colpocoxites on the posterior gonopods. The gonopod construction of *Halleinosoma* (Schubart, 1934) is quite close to that of *Branneria*. But *Branneria* has 26 segments, as opposed to *Halleinosoma's* 30, and the tenth and eleventh legs of *Branneria* are much more reduced than those of *Halleinosoma*. These differences may be only of generic importance, and if this is so, *Halleinosoma* should be transferred to the family Branneriidae.

The literature on the European fauna is in too great a state of confusion, owing mostly to complete disregard on the part of the prolific K. W. Verhoeff for the rules of priority in nomenclature, for any statement to be made about their position in the system proposed here until a new, complete and detailed study of specimens is carried out.

Family TINGUPIDAE Loomis

Tingupidae Loomis, 1966, Proc. Biol. Soc. Washington, 79: 227.

Type genus. *Tingupa* Chamberlin, 1910. The family is monobasic.

Diagnosis. Distinct from the Branneriidae in having 28 or 30 segments as opposed to 26, and from the Rhiscosomididae

in having the collum much narrower than the head.

Description. Twenty-eight or 30 segments. Mentum divided. Head wider than collum. Antennae short, markedly clavate (Fig. 459). Ocelli present, but reduced in some species. Postcollum segments with thick paranota (Fig. 460); dorsum with heavy sculpturing of short, sharp-edged ridges. Pregonopodal legs of male not modified, sometimes slightly more crassate than other legs. Anterior gonopods (Figs. 461, 465): sternum small, bandlike; coxae with mesal and lateral coxites touching to form an anterior plate; coxites with spinose processes distally; telopodites with 2 flagelliform branches. Posterior gonopods (Figs. 464, 472): usually 4-segmented, fourth segment minute. Coxae of tenth and eleventh legs with coxal glands. Twelfth legs and sternum not modified.

Distribution (Map 16). North America, primarily southern half of United States — California, Utah, Arizona, Missouri, Illinois; Virginia? Florida?

Discussion. The family contains the single genus, *Tingupa*. There may be other genera, however; immature 28-segmented females that greatly resemble *Tingupa* in general appearance have been collected in Montgomery County, Virginia. They are minute (3 mm long), totally without pigment and blind. Loomis (personal communication) has collected immature and female tingupids in Florida,¹ and I have seen immature *Tingupa* from Marin County, California. The distribution of the family (Map 16) is incompletely known. None of the species have ever had their gonopods adequately illustrated, thus each of the three described species is discussed in more detail below. *Tingupa monterea* Chamberlin (1910) is, judging by the description, obviously not a *Tingupa* but a *Rhiscosomides*; the type has been lost.

¹New evidence indicates these specimens probably belong to *Branneria*.

Genus *Tingupa* Chamberlin

Tingupa Chamberlin, 1910, Ann. Entomol. Soc. Amer., 3: 238.

Type species. *T. utahensis*, by original designation. The gender is believed to be feminine.

KEY TO SPECIES OF *TINGUPA*

- 1a. Males with 30 segments; caves in Missouri and Illinois *pallida*
 1b. Males with 28 segments; (females with 30) 2
 2a. Gonopods as in Figs. 465–467; ocelli 10–17; Arizona *arizonica*
 2b. Gonopods as in Figs. 459–464; ocelli about 20; Utah *utahensis*

***Tingupa utahensis* Chamberlin**

Figures 459–464

Tingupa utahensis Chamberlin, 1910, Ann. Entomol. Soc. Amer., 3: 238, pl. 33, figs. 3–8 (sex not indicated).

Types. Sex of holotype and paratypes not specified, from Mill Creek Canyon, Salt Lake Co., Utah; presumed lost. I studied a series of specimens collected at the type locality 25 May 1924 by R. V. Chamberlin, and identified by him as *T. utahensis*. Specimens deposited in MCZ.

Discussion. Chamberlin (1910) accurately and in great detail described the anatomy of *T. utahensis*, probably from a female. The nonsexual characters of the males are nearly identical to those of the female, but males are somewhat smaller (6–7 mm long, 0.9 mm wide) and have only 28 segments. Both sexes are uniform dark brown after long preservation, and are heavily sclerotized. Loomis (1966) assumed that *T. utahensis* males were 30-segmented, reasoning from *T. pallida*. *Tingupa utahensis* is very close to *T. arizonica*, there being only minor differences in the gonopods. Chamberlin (1925) gave the name *T. utahensis australis* to a female specimen from “the canyon,” Cedar City, Iron County, Utah (holotype in MCZ, examined). The status of this form is not clear in the absence of males. I think it is

likely that *T. utahensis* and *T. arizonica* are parts of a widely distributed polytypic species. *Austrotyla coloradensis* (Conotylidae) has a distribution nearly as wide.

***Tingupa arizonica* Loomis**

Figures 465–468

Tingupa arizonica Loomis, 1966, Proc. Biol. Soc. Washington, 79: 228–229, figs. 14–16, ♂.

Types. Male holotype from Mt. Lemmon (8,000 ft.), Santa Catalina Mts., Pima Co., Arizona, in USNM, not seen.

Discussion. I have studied, and illustrate here (Figs. 465–467), males from the type locality collected by J. A. Beatty, 12 November 1960. Loomis (1966) briefly described the nonsexual characters of the species and gave two illustrations of the gonopods. They serve to identify the species as a *Tingupa*, but are otherwise too sketchy to be useful. Loomis did not observe the joint between the basal and second segments of the posterior gonopods; thus his reference to the rudimentary third segment is actually to the fourth segment, which may indeed only be a reduced claw.

***Tingupa pallida* Loomis**

Figures 469–472

Tingupa pallida Loomis, 1939, Bull. Mus. Comp. Zool., 86: 185, figs. 12a–12c, ♂; 1943, Bull. Mus. Comp. Zool., 92: 387, fig. 7, ♂; Shear, 1969, Psyche, 76: 141, Fig. 9, ♂.

Types. Male holotype from River Cave, Hahatunka, Camden Co., Missouri, in MCZ, examined.

Discussion. This species is common in caves in Missouri and Illinois, and has been reported once (Causey, 1951b) from leaf litter, at Collinsville, Illinois. It is colorless and the number and size of the ocelli are reduced. The gonopods (Figs. 469–472) show some differences from the two western species, and the males have 30 segments. A complete description of the nonsexual characters and details of the distribution are given by Loomis (1939, 1943).

Family BRANNERIIDAE Cook

Branneriidae Cook, 1896, *Brandtia*, 2: 8.

Type genus. *Branneria* Bollman, 1893.

Diagnosis. The only North American chordeumid with 26 segments.

Description. Twenty-six segments. Mentum divided. Head wider than collum. Antennae short, markedly clavate (Fig. 473). Postcollum segments with thick paranotal swellings (Fig. 474) similar to some species of *Pseudotremia*; dorsum with heavy rugae. Pregonopodal legs of male unmodified. Anterior gonopods: complex, coxae enveloping basal region of telopodite, colpocoxites fused mesally, sharply elbowed. Telopodite (?) with 2 branches, 1 flagelliform. Posterior gonopods: sternum broad, excavate. Coxae flattened, lobed. Telopodite with 2 articles. Tenth legs with coxae enlarged, folded, with glands. Telopodite reduced, 2-segmented. Twelfth sternum and legs normal.

Discussion. *Branneria carinata* (Bollman) is the only known species. No original descriptive material on this species has been published since 1895, when Cook and Collins treated it briefly in their monograph. The original description (Bollman, 1888) contains little concrete information, and the gonopods have never been illustrated. The relationships of this minute, humicolous form are equally obscure, though it is clearly related to the Tingupidae. The gonopods are so tiny and transparent that they must be mounted on a microscope slide and observed under a phase contrast microscope; even then, it is difficult to distinguish the various regions. Probably many of the peculiarities of *B. carinata* are adaptations to small size, and to living in crevices in the soil. I present below for the first time a detailed description of the gonopods.

Genus *Branneria* Bollman

Branneria Bollman, 1893, U. S. Nat. Mus. Bull., 46: 158.

Type species. *Craspedosoma carinata* Bollman, by monotypy. The gender of the generic name is feminine.

***Branneria carinata* (Bollman)**

Figures 473–478

Craspedosoma carinatum Bollman, 1888, Ann. New York Acad. Sci., 10: 108.

Branneria carinata, Cook and Collins, 1895, Ann. New York Acad. Sci., 9: 33–34, fig. 1, ♂.

Types. Syntypes from Beaver Creek, Jefferson Co., Tenn., about 2 mi. NE of Strawberry Plains, Tenn.; syntypes deposited in USNM, could not be located.

Description. Male from Torreya Park, Fla.; length, 4.2 mm, width, 0.35 mm. Ocelli 9 on both sides, in 2 irregular rows plus single ocellus. Head rounded (Fig. 473), subspherical, antennae short, clavate, third segment longest, fifth segment widest. Midbody segments (Fig. 474) as described for family. Epiproct rugose and shallowly emarginate. Head dark purplish brown, with irregular lighter markings, antennae lighter, body segments yellowish white, marked purplish brown as shown in Figure 474. Pregonopodal legs not modified, but coxae of seventh legs slightly enlarged and rugose on posterior surface. Anterior gonopods: in anterior view (Fig. 475), sternum handlike, weak. Coxae subglobose at base, colpocoxites elbowed, truncate; 5 setae in lateral group, 3 in mesal group, strong single seta near apex of each colpocoxite. In posterior view (Fig. 476), telopodites with flagelliform basal branch curving between apical branch of telopodite and colpocoxite, crossing in front of coxae (Fig. 475). Distal telopodite branch longer than colpocoxites, truncate, with prominent knobby projection midway in its length. Acuminate median structure possibly derived from fusion of telopodites basally (see discussion of gonopods of *Pseudotremia*, Cleidogonidae). Posterior gonopods: 3-segmented (Fig. 477); sternum broad, strong, excavated. Distal segment subglobose. Tenth legs (Fig. 478) with enlarged, lobed coxae with glands,

telopodite 2-segmented. Eleventh legs with coxae slightly enlarged, shallowly excavated on anterior face (gland remnant?).

Discussion. My study is based on literally hundreds of individuals, about half of them mature males, collected in Florida by Dr. Stewart Peck in Berlese samples of logs and leaf litter. A series of 20 males from this collection ranged in length from 3.95 to 4.26 mm, averaging 4.11 ± 0.12 mm. Ocelli number in this same series varied from seven to ten on each side of the head, with nine the most common number. With the exception of the type locality and the Florida specimens, all the records listed below are based on material kindly loaned by Dr. N. B. Causey. I give these records (see also Map 16) to establish the range of the species.

Records. ALABAMA: *Franklin Co.*, The Dismals; *Talladega Co.*, Sylacauga; *Mobile Co.*, Mobile; *Blount Co.*, near Bangor Cave; *Marshall Co.*, near Guffey Cave. FLORIDA: *Jackson Co.*, Florida Caverns State Park, Marianna; *Liberty Co.*, Torreya State Park, Bristol. GEORGIA: *Rabun Co.*, Mountain City. MISSISSIPPI: *Forrest Co.*; *Wayne Co.*, bank of Buckatunna Riv. on Hwy. 84. NORTH CAROLINA: *Transylvania Co.*, Brevard; *Macon Co.*, Cullasaja Riv. gorge.

Superfamily HETEROCHORDEUMATOIDEA Pocock, NEW STATUS

Chordeumid millipeds with 28–32 segments; mentum not divided. Anterior gonopods of various forms: blunt, leglike, 4–5-segmented (Heterochordeumatidae); single segment free from sternite (Conotylidae, Diplomaragnidae, probably Metapidiotrichidae); or a cheirite, formed from complete fusion of gonopod, sternite, and tracheal apodeme (Adritylidae). Posterior gonopods with more or less complex colpocoxites that function in spermatophore transfer, telopodite 2-segmented, or rarely absent (*Idagona*, Conotylidae). Coxal sacs on legs 10 only. Circum-Pacific in distribution.

Included families. Conotylidae Cook,

1896; Adritylidae Shear, 1970; Diplomaragnidae Attems, 1907; Heterochordeumatidae Pocock, 1894; Metapidiotrichidae Attems, 1907; Japanosomidae Verhoeff, 1926.

Discussion. This group of families clearly presents a monophyletic line, one of the few such groups in the Diplopoda whose common descent cannot be doubted. Included are the Heterochordeumatidae, considered by Hoffman (1963) as the most primitive of all chordeumids, and the Adritylidae, one of the most highly specialized North American families (Causey, 1961; Shear, 1971a). I have not studied specimens of the Asian families Heterochordeumatidae, Diplomaragnidae, and Metapidiotrichidae, but it seems that they establish, with the North American Conotylidae and Adritylidae, an easily-delimited group.

The Heterochordeumatidae (Hoffman, 1963) are a supposedly primitive group. They have 32 segments, and occur in Burma and Sumatra. The anterior gonopods are more leglike than in any other chordeumids, being cylindrical and with four to five definite segments. It is unlikely that they play any role in spermatophore transfer. The posterior gonopods are like those of *Adrityla*: the colpocoxite is divided into two unequal branches. But there are also specialized characters: the body segments bear broad paranota. They are so broad that Hoffman (1963) doubted if it would be possible to tell a headless female heterochordeumatid from a platydesmid! Also, the telopodites of the tenth legs are reduced, as in *Adrityla*. Hoffman speculated that *Heterochordeuma* may represent an early offshoot from a common platydesmid-chordeumid ancestor.

The Diplomaragnidae are found in eastern Siberia, Korea (*Diplomaragna*), and Japan (*Syntelopodeuma*). Species have been described by Attems (1898) and by Verhoeff (1914, 1936). These forms also have 32 segments. In *Diplomaragna terricolor* (Attems) (Attems, 1898) and *Synte-*

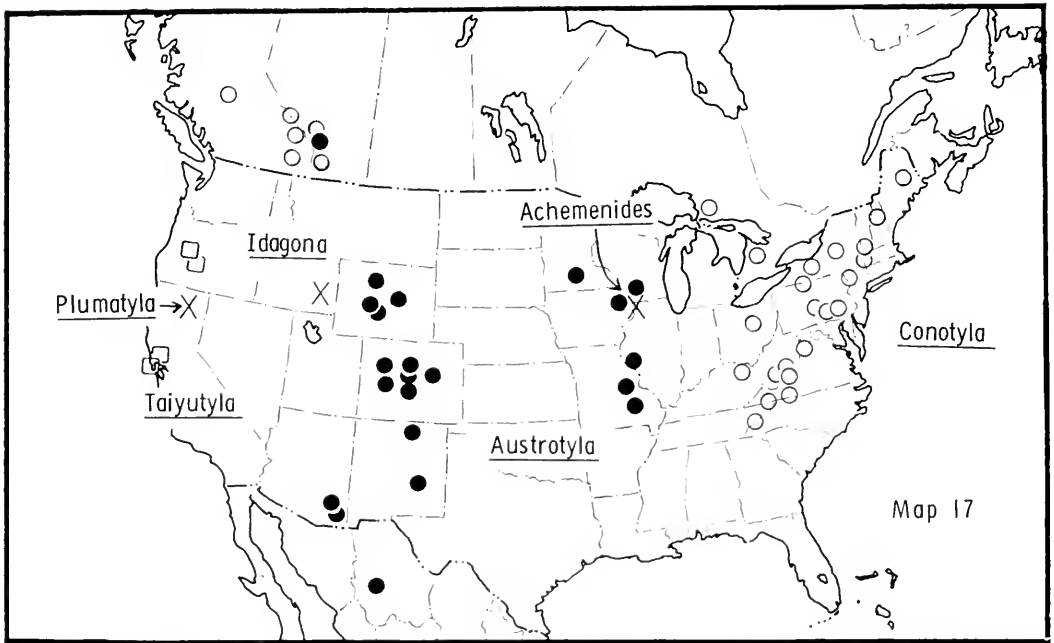

Map 17. United States, showing distribution of the genera of the family Conotylidae. Dots, *Austrotyla*; circles, *Conotyla*; squares, *Taiyutyla*; crosses, localities of other genera as indicated.

lopodeuma gracilipes Verhoeff (Verhoeff, 1914) the posterior gonopods are much like those of *Heterochordeuma*, but both anterior gonopods are fused together into a complex structure called a *syntelopodite*, which interlocks with the colpocoxites of the posterior gonopods. The tenth legs are reduced in *Diplomaragna*, and of normal size in *Syntelopodeuma*.

The Metapidiotrichidae are not easy to define. According to Attems (1907) the family includes *Metapidiotrix* (Java), *Eudigona*, *Apodigona* (Chile), and *Schedotrigona* (New Zealand). *Apodigona* has 30 segments, the others 32 (Silvestri, 1903; Attems, 1907); both *Apodigona* and *Eudigona* have gonopods like those in the North American Conotylidae, and Verhoeff (1914) placed *Eudigona* in that family, though his placement of *Apodigona* in the Trichopetalidae is erroneous. *Metapidiotrix* has segmented anterior gonopods that clasp the colpocoxites of the posterior

gonopods in the conotylid manner, and reduced tenth and eleventh legs (Attems, 1907). This family is closest to the Conotylidae, and a detailed study of specimens belonging to this family is urgently needed.

The North American families are treated below in greater detail.

Family CONOTYLIDAE Cook

Conotylidae Cook, 1896, *Brandtia*, 2: 8; Verhoeff, 1932, *Zool. Jahrb. Abt. Syst.*, 62: 500; Hoffman, 1961, *Trans. Amer. Entomol. Soc.*, 87: 263; Shear, 1971, *Bull. Mus. Comp. Zool.*, 141 (2): 58.

Idagonidae Buckett and Gardner, 1967, *Michigan Entomol.*, 1: 117; Shear, 1969, *Psyche*, 76: 137.
NEW SUBJECTIVE SYNONYMY.

Type genus. Of Conotylidae, *Conotyla* Cook and Collins, 1895; of Idagonidae, *Idagona* Buckett and Gardner, 1967.

Included North American genera. *Conotyla*, *Austrotyla*, *Taiyutyla*, *Plumatyla*, *Achemenides*, *Idagona*.

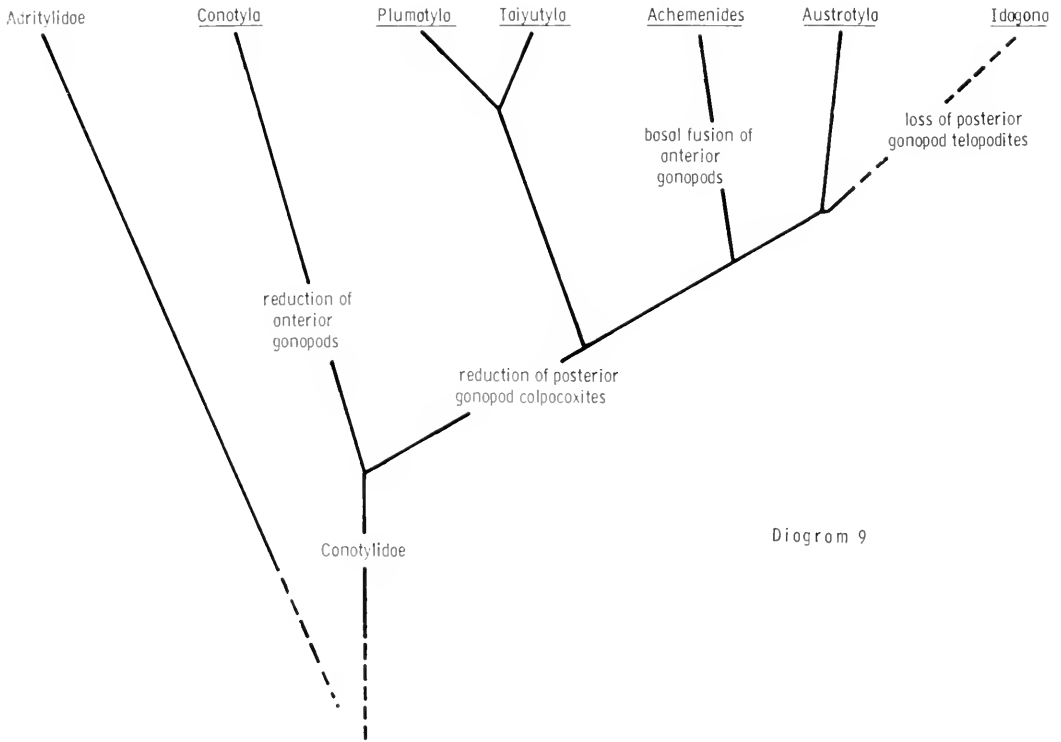

Diagram 9

Diagram 9. Hypothetical cladogram of the genera of Conotylidae and the Family Adritylidae. Time scale not to be inferred.

Diagnosis. Distinct from all North American families except Adritylidae in having the mentum not divided, and bearing apparently functional colpocoxites on the posterior gonopods; distinct from the Adritylidae in not having the anterior gonopods fused to their sternites.

Description. Thirty segments. Mentum undivided. Head wider than collum. Antennae long, slender, not clavate. Ocelli always present, usually in a triangular patch, but sometimes reduced in number and size. Postcollum segments with prominent rounded knobs at the bases of the outer segmental setae. Pregonopodal legs of males frequently with modifications, usually consisting of mesal knobs on 1 or 2 segments. Anterior gonopods: single-articled; free from sternites; curving around colpocoxites of posterior gonopods, or flattened, platelike. Posterior gonopods:

coxae free from sternites, with prominent sclerotized colpocoxites; telopodites absent (*Idagono*), or 2-segmented, distal article swollen, turned dorsal, both articles without significant muscles. Coxae of tenth legs enlarged, with coxal glands. Coxae and prefemur of eleventh legs sometimes modified, but coxae without glands. Twelfth legs and sternum normal.

Distribution. North America (Map 17) (Japan?).

Discussion. A more detailed discussion of the biology and gonopod morphology is in my recent revision (Shear, 1971a). The dubious taxonomic status of the generic names *Zygotyla*, *Cookella*, and *Bollmanella* are also discussed there. The relationships of the genera to one another are discussed separately below; a hypothetical cladogram based on this evidence is presented in Diagram 9.

KEY TO GENERA OF CONOTYLIDAE IN
NORTH AMERICA

- 1a. Anterior gonopods much larger than posterior (Figs. 479, 481); telopodites of posterior gonopods absent; Idaho caves *Idagona* 2
- 1b. Anterior gonopods not larger than posterior (including telopodites); telopodites of posterior gonopods 2-segmented (Fig. 483) 2
- 2a. Anterior gonopod sternum divided; anterior gonopods fused to each other at base, much larger than colpocoxites of posterior gonopods (Figs. 485, 486); northern Illinois, northeastern Iowa, southwestern Wisconsin *Achemenides* 3
- 2b. Anterior gonopod sternum not divided; anterior gonopods not fused to each other, though they may be closely appressed (Figs. 487, 492), smaller or larger than colpocoxites of posterior gonopods 3
- 3a. Anterior gonopods flattened, platelike, often appressed in the midline (Figs. 487, 492), larger than or subequal to colpocoxites of posterior gonopods 4
- 3b. Anterior gonopods not flattened, often with complex or plumose branches (Figs. 482, 490), smaller than or subequal to colpocoxites of posterior gonopods 5
- 4a. Anterior gonopod sternum with lateral processes partially fused to lateral sides of gonopods (Fig. 487); gonopods complex on posterior surface (Fig. 488); colpocoxites of posterior gonopods small, cupped anteriorly; Illinois and Missouri, and Rocky Mountains from Alberta to Chihuahua *Austrotyla*
- 4b. Anterior gonopod sternum without such processes, heavily sclerotized, completely surrounding bases of gonopods (Fig. 492); colpocoxites of posterior gonopods subequal to anterior gonopods, frequently complex and branched, never cupped anteriorly (Fig. 493); Pacific coast from central Oregon to San Francisco Bay region *Taiyutyla*
- 5a. Anterior gonopod sternum with lateral process partially fused to lateral edge of gonopod; gonopod 2-branched, mesal edge of major branch lacinate (Fig. 490); colpocoxite of posterior gonopod 2-branched; caves in northern California and southern Oregon *Plumatyla*
- 5b. Anterior gonopod sternum simple and bandlike (Fig. 482), gonopod with one or two small branches; colpocoxites of posterior gonopods with complex posterior surface, but not 2-branched; eastern North America from Maine to North Carolina, Rocky Mts. of Alberta and British Co-

Genus *Idagona* Buckett and Gardner

lumbia, Sierra Nevada of California *Conotyla*

Idagona Buckett and Gardner, 1967, Michigan Entomol., 1: 120.

Type species. Idagona westcotti Buckett and Gardner, by monotypy and original designation.

Diagnosis. Distinct from all other Conotylidae in the comparatively greater size of the anterior gonopods and the absence of telopodites from the greatly reduced posterior gonopods. Coxae of legs 10 are enlarged and lobed; those of leg 11 slightly so, but lacking a gland.

Discussion. This genus is the type of the family Idagonidae, described by Buckett and Gardner (1967) at the same time as the genus. In order to make Conotylidae a meaningful family, Idagonidae, with its only included genus, is considered synonymous. *Idagona* falls well within the Conotylidae, though Idagonidae may have to be considered a subfamily when the western conotylids are more completely known. The drawings presented by Buckett and Gardner (1967) are adequate for recognition of the species. However, some of the details of the gonopod structure, in particular the tracheal apodemes, are shown here for the first time. The large anterior gonopods (Figs. 479, 480) are separate from the sternum. The posterior gonopod sternum (Fig. 479) is much reduced, being mainly membranous mesally but well sclerotized around the spiracles. Despite the specializations, which may have resulted in a reversal of the usual functional roles of the gonopods in conotylids, *Idagona* retains some fairly primitive features. The coxal region of the anterior gonopods (Fig. 481) is more clearly set off here than in any other genus of the Conotylidae, and the presence of setae on the anterior gonopod sternum (Fig. 480) may also be primitive.

Idagona is related to the *Austrotyla-Taiyutyla* line within the Conotylidae.

Genus *Conotyla* Cook and Collins

Conotyla Cook and Collins, 1895, Ann. New York Acad. Sci., 9: 70-71; Shear, 1971, Bull. Mus. Comp. Zool., 141(2): 64.
Proconotyla Verhoeff, 1932, Zool. Jahrb. Abt. Syst., 62: 501.

Type species. Of *Conotyla*, *C. fischeri* Cook and Collins, 1895, by original designation; of *Proconotyla*, *P. blakei* Verhoeff, 1932, by monotypy.

Diagnosis. Diagnostic characters are given in the above key.

Discussion. My recent revision (Shear, 1971a) has a key to species. In *Conotyla*, the anterior gonopods (Figs. 482, 484) are free from the sternum, but are fused into a single article, usually passing laterad to the colpocoxites of the posterior gonopods in a distinct plumose region. The posterior gonopod telopodites are 2-articled, enlarged, and turned dorsad (Fig. 483). The colpocoxites of the posterior gonopods are variable. In some species they are quite simple and acuminate, while in others they bear a complex of rodlike and plumose branches. There is good evidence in this genus of spermatophore transfer by the colpocoxites of the posterior gonopods, since spermatophores have been found on both the extruded tenth coxal glands and the tips of the colpocoxites. The exact mechanism of transfer is unknown.

Distribution. *Conotyla* is quite widespread for a milliped genus. The present distribution (Map 17) is probably a relict of an earlier, more continuous distribution. There is a considerable morphological gap between species of the *atrolineata* group in Alberta and British Columbia and the several species groups in the Appalachians. It is interesting that species in the highly dissected Rocky Mountain habitats are more widespread than species in the Appalachians, which are often extremely limited in their distribution. However, the western species all appear to be limited to coniferous forests at high altitudes, and these forests may be more or less continuous for many miles. Possibly the advance

and retreat of the Pleistocene glaciers, much more pronounced in the east, divided the Appalachian habitat into small habitable areas, from which the eastern species of *Conotyla* spread to their present distributions. Probably the major part of the speciation process took place when populations were isolated in valleys during glacial maxima and became adapted to low temperatures (Shear, 1971a). Most species of *Conotyla* now occur at higher elevations and are active mainly in late fall and very early spring.

Two species (*Conotyla blakei*, *C. fischeri*) are common in glaciated territory. *C. blakei* also occurring to the south in caves. *Conotyla blakei* has the widest range of any eastern conotylid, presenting an example of a milliped not much different from many of its congeners but somehow capable of much greater dispersal and successful colonization. It is closely related to *C. hollmani*, a species primarily of caves in Indiana, but is not related to the majority of Appalachian species. *Conotyla fischeri* occurs throughout central New York state, and is closely related to *C. personata* of northern Ohio; both these species are derived from Appalachian forms. At the extreme southern end of the range of the genus in North Carolina and Tennessee, species of *Conotyla* are rare and localized, occurring mostly in coniferous zones on the tops of the highest mountains.

Another factor limiting the distribution of the genus in the southern Appalachians may be competition with many species of *Pseudotremia*, which have a similar niche and are more common.

Genus *Achemenides* Shear

Achemenides Shear, 1971, Bull. Mus. Comp. Zool., 141(2): 84.

Type species. *Conotyla pectinata* Causey, 1952, by monotypy and original designation.

Diagnosis. Distinct from all other cono-

tylid genera in that the anterior gonopods are joined at the base and drawn out anteriorly into a curved knob; also in having knobs on 2 segments of the last pregonopodal leg.

Discussion. The gonopod anatomy of *A. pectinatus* (Figs. 485, 486) departs somewhat from the usual conotyloid pattern. While the anterior gonopods (Fig. 485) are roughly similar to those of *Austrotyla*, as are the reduced colpocoxites of the posterior gonopods (Fig. 486), the anterior sternum is bandlike, as in *Conotyta*, though it is also divided bilaterally. I do not think this division is primitive, but believe it to be a secondary development to accommodate the anterior knob of the basally fused anterior gonopods.

The fusion of the bases of the anterior gonopods recalls *Syntelopodeuma* (Diplomaragnidae) of Japan, but there are no other similarities. I think *Achemenides* has evolved from conotyloid stock in North America.

Distribution. The species is known only from caves and mines in the adjacent areas of Illinois, Iowa, and Wisconsin. I have earlier speculated (1971a) that the troglomorphic habit of the species may be due to the climatic severity of the Wisconsinian glaciation. The area in which the species occurs is the so-called driftless area, an area assumed to have been free of ice and in which species may have survived the glaciation in caves (see Frye, 1965; Cushing, 1965, for a more complete discussion). The glaciers would have wiped out surface populations of the driftless area by lowering beyond their tolerance the minimum annual temperature. Cave temperatures, however, generally approximate the local average temperature the year 'round. Thus a cold-adapted animal could survive such conditions in caves.

Genus *Taiyutyla* Chamberlin

Taiyutyla Chamberlin, 1952, Nat. Hist. Misc. Chicago Acad. Sci., No. 113: 1; Shear, 1971, Bull. Mus. Comp. Zool., 141(2): 86.

Type species. *Taiyutyla corvallis* Chamberlin, 1952, by original designation.

Diagnosis. The characters given in the key serve to diagnose this genus, particularly the size and shape of the colpocoxites (Fig. 493), which are similar to those of *Conotyta*, while the anterior gonopods (Fig. 492) are similar to those of *Austrotyla*. My revision (Shear, 1971a) has a key to the described species.

Discussion. Little can be said about this genus. Only a few specimens of mature males are known, probably owing to a lack of suitable collecting methods in the Coast Ranges of the Pacific Northwest, where the three known species occur. *T. francisca* was collected in pine duff. There are doubtless many undescribed species.

Genus *Austrotyla* Causey

Austrotyla Causey, 1961, Proc. Biol. Soc. Washington, 74: 260; Shear, 1971, Bull. Mus. Comp. Zool., 141(2): 89.

Type species. *Conotyta specus* Loomis, 1939, by original designation.

Diagnosis. In addition to the characters given in the key, all species have the male pregonopodal legs modified the same way: femoral knobs on legs 3 and 4. In some of the species, anterior knobs appear on the coxae of legs 10 and 11. Shear (1971a) has a key to described species.

Discussion. This large, primarily western genus forms a compact group with *Taiyutyla* and *Plumatyla*, and it is likely that they are actually closely related. The gonopods differ considerably from those of *Conotyta*. In *Austrotyla*, the anterior gonopods are much larger than the colpocoxites of the posterior gonopods (Figs. 487, 488) and are platelike and contiguous in the midline. The colpocoxites of the posterior gonopods are small and inconspicuous (Fig. 77). This structural reversal may be evidence that the functional roles of the gonopods are reversed in this genus, and in *Achemenides* and *Idagona*. The mating of living *Austrotyla* has not been studied. Within the genus, species are remarkably

similar, considering the great geographical separation between them. *Austrotyla borealis*, of the Rocky Mountains of Alberta, is quite similar to *A. specus* of Missouri and Illinois; *A. coloradensis* (Colorado) is very close to *A. chihuahua* (Chihuahua, Mexico).

Distribution. The genus is primarily a Rocky Mountain group, with isolated species in caves and a few surface localities in Missouri and Illinois. There are other such distributions known for soil-dwelling arthropods: the spider genus *Atypoides* (Coyle, 1968) and the milliped family Nearectodesmidae (Hoffman, 1962) are good examples. Such distributions are relicts of previously more continuous ones, and it seems possible that when the droughts of the Pliocene brought the Great Plains into being, large areas became inhospitable to conotylids and divided *Austrotyla's* range. Glacial advance and retreat during the Pleistocene can perhaps be used to explain in part the cave populations of *A. specus*.

In the Rocky Mountains, species of *Austrotyla* are quite boreal in habitat. Extensive collections by H. W. Levi of *A. coloradensis* are mostly from forests about 7000 ft. (2500 m) in elevation; the most southerly species, *A. chihuahua*, is from the Sierra Madre Occidental, at an elevation of 6500–7000 ft. (2250–2500 m).

Genus *Plumatyla* Shear

Plumatyla Shear, 1971, Bull. Mus. Comp. Zool., 141(2): 94.

Type species. *Conotyla humerosa* Loomis, 1943, by monotypy and original designation.

Diagnosis. Besides the distinctive gonopods mentioned in the key, *P. humerosa* is without pigment and has reduced, irregularly arranged ocelli (about 10); no other conotylid is as strongly modified for cave life.

Discussion. The gonopods (Figs. 490, 491) show certain intermediate characters between those of *Taiyutyla* and *Austrotyla*,

and may be similar to a possible common ancestor of these two genera. Little else can be said, owing, as usual, to a lack of mature specimens. It would be remarkable if this were the only species to occur throughout the lava flow regions of northern California; we might expect additional species in other neighboring caves.

Family ADRITYLIDAE Shear

Adritylidae Shear, 1971, Bull. Mus. Comp. Zool., 141(2): 57.

Type genus. *Adrityla* Causey, 1961. The family contains only one genus with a single species, *Conotyla deseretae* Chamberlin, 1910.

Diagnosis. *Adrityla deseretae*, Figures 494–496, is the only North American species with the anterior gonopods each of a single piece, formed from a fusion of the gonopod, with its sternite, and the tracheal apodeme. The coxae of the posterior gonopods and tenth legs are also fused to their respective sterna. This is also the largest (ca. 25–30 mm) North American species.

Description. Thirty segments. Mentum undivided. Head wider than collum. Antennae long, slender, not clavate. Ocelli in a triangular patch. Pregonopodal legs with femoral knobs. Anterior gonopods: 1-segmented, fused with sternites and tracheal apodemes (Fig. 494). Posterior gonopods: colpocoxite divided into two branches, telopodite 2-segmented (Fig. 495). Coxae of tenth legs enlarged, lobed, with gland, telopodites much reduced (Fig. 496). Coxae of eleventh legs without coxal glands. Twelfth legs and sternum normal.

Distribution. The single known species of this family is found in the Wasatch Mts. of northeastern Utah, where it is common in canyons. F. A. Coyle collected specimens near Timpanogos Cave National Monument at about 7000 ft. elevation, in ponderosa pine parkland on canyon slopes (Coyle, personal communication). There may be other species in the Rocky Mts. to the north and south, but these mountains have been very poorly collected.

Discussion. While highly specialized, the anterior gonopods are derived from a conotylidlike form. As in *Achemenides* (Conotylidae), the divided sternum is probably not primitive. The large colpocoxites might indicate that this family began to diverge from the basic conotylid stock before the reduction of colpocoxites that gave rise to the *Austrotyla* line. The reduction of the telopodites of leg 10 is undoubtedly parallel evolution with some of the Asian genera of the superfamily, rather than a primitive condition.

Superfamily CLEIDOGONOIDEA Cook, NEW STATUS

Chordeumid millipeds with 28 or 30 segments; mentum divided. Anterior gonopods with prominent colpocoxites sometimes divided into two branches, but always lacking flagella. Telopodites fused at their bases (Cleidotgonidae) or free (most Trichopetalidae), sometimes with accessory lacinate branches (Trichopetalidae), not fused to coxae. Posterior gonopods with sternum narrow, sometimes with processes; coxae of posterior gonopods lacking colpocoxites, but often with lobes or knobs; telopodites reduced, 4- to 1-segmented. Coxae of legs 10 and 11 with glands. Panama to Newfoundland.

Included families. Cleidotgonidae Cook 1895; Trichopetalidae Verhoeff 1932.

Discussion. For many years, taxonomists assumed a relationship between the Trichopetalidae and Conotylidae (Cook, 1895; Causey, 1960a; Hoffman, 1961; Shear, 1971a), based mainly on the similarity in body form and the reduction of the posterior gonopods. A thorough study of the gonopods and other characters reveals, however, that the family Trichopetalidae is very close to the Cleidotgonidae; species of *Mexiterpes* (Trichopetalidae) combine features of both families. Cleidotgonidae are predominantly an austral group, while the Trichopetalidae are boreal in distribution, occurring well into glaciated territory, on high mountains and in caves.

This superfamily seems to be exclusively North American and not closely related to any other chordeumid group.

Family CLEIDOGONIDAE Cook

The preceding detailed revision of the Cleidotgonidae furnishes all the necessary information on this family.

Family TRICHOPETALIDAE Verhoeff

Trichopetalidae Verhoeff, 1932, Zool. Jahrb. Abt. Syst., 62: 485; Hoffman, 1961, Trans. Amer. Ent. Soc., 87: 262; Causey, 1963, Psyche, 70: 237 (key to genera).

Type genus. *Trichopetalum* Harger, 1872.

Diagnosis. Distinct from the Cleidotgonidae in having extremely long segmental setae, the telopodites of the anterior gonopods not fused (except in *Mexiterpes*) and with an anterior lacinate branch or area. In all cleidotgonid genera except *Tiganozona*, the posterior gonopods are 4- to 6-segmented, while in the species of Trichopetalidae, they are 2- or 3-segmented. Only a few Mexican species of Cleidotgonidae have the prominent paranota found in all trichopetalids.

Description. Twenty-eight or 30 segments. Mentum divided, but often hard to see because of weak sclerotization. Ocelli few or absent; if present arranged in single row or lunate patch. Trunk segments with prominent paranota and long, strong segmental setae, often with mucous droplets. Anterior gonopods: sternum broad, sclerotized, often expanded in front for muscle attachment. Coxae distinct, but sometimes fused to each other in midline, with 1- to 3-branched colpocoxites of various forms, setose. Telopodite 1-segmented, usually lobelike, not fused to coxae, usually not fused to one another (except in *Mexiterpes*), with anterior plumose branch or area. Posterior gonopods: sternum weakly sclerotized, gonopod coxae usually widely separated, musculature weak, coxae usually without lobes or processes; telopodites 1- or 2-segmented, additional segments some-

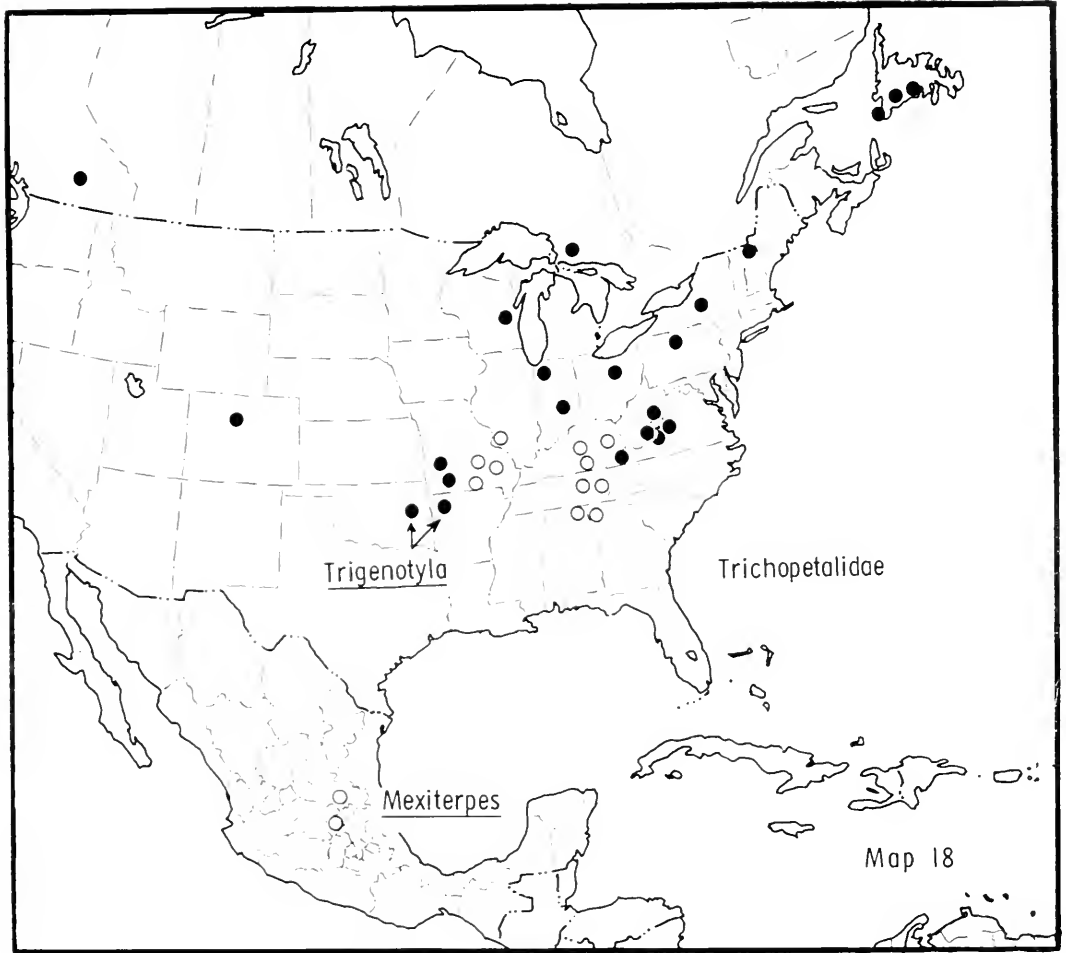

Map 18. North America, showing distribution of genera of the family Trichopetalidae. Dots, *Trigenotyla* (as indicated), and *Trichopetalum*; circles, *Scaterpes* and (as indicated) *Mexiterpes*.

times indicated by vague sutures, with or without claw. Coxae of legs 10 and 11 with coxal glands, slightly enlarged. Females lacking postgenital plate.

Included genera. *Trichopetalum*, *Scaterpes*, *Mexiterpes*, *Trigenotyla*.

Distribution (Map 18). Georgia west to Missouri, north to Newfoundland; British Columbia? Colorado? Caves in San Luis Potosí and Querétaro, Mexico.

Discussion. The form of the gonopods, the divided mentum, and the presence of coxal glands on legs 10 and 11 ally this

family to the Family Cleidogonidae. In addition, *Mexiterpes metallicus* (new species, described below) has several characters in common with *Pseudotremia* spp.; the anterior gonopod telopodites are basally fused and are not lobelike, and there are median structures developed from this fused base. Like the Cleidogonidae, this family probably had its origin in the Mexican highlands and spread north, differentiating into two major stocks from a proto-*Mexiterpes* ancestor. The most successful of these is represented by *Tricho-*

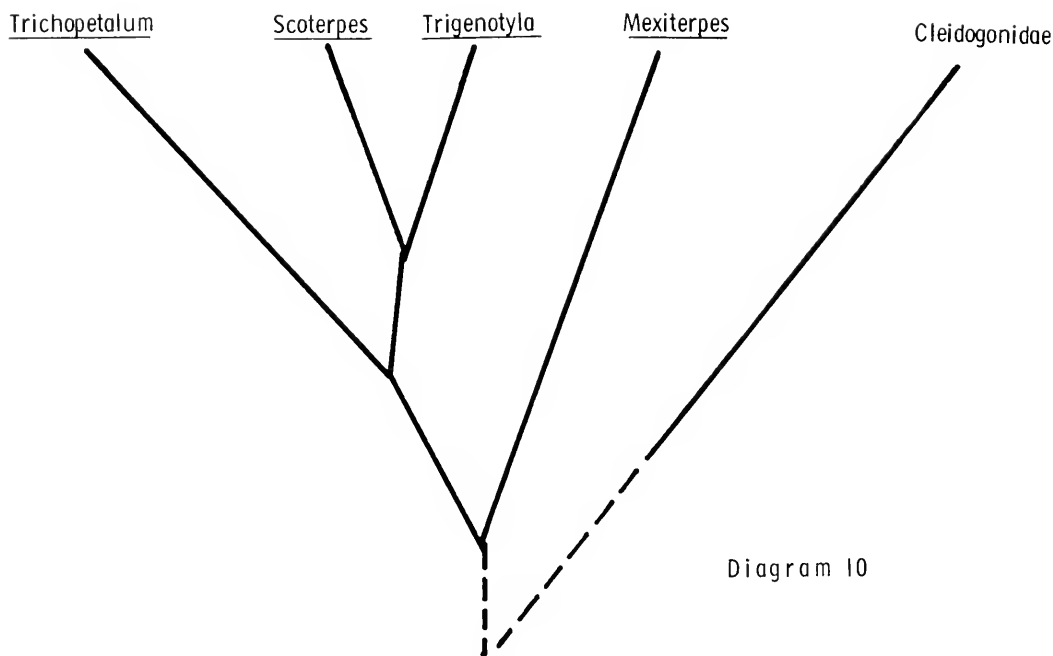

Diagram 10

Diagram 10. Hypothetical cladogram of genera of Trichopetalidae, showing relationship to the family Cleidogonidae (compare Diagram 1). Time scale not to be inferred.

petalum, a widespread genus occurring in most of eastern North America inland of the Fall Line on the Atlantic Piedmont. A second stock is represented by two genera: *Trigenotyla*, an Ozarkian relict, and *Scoterpes*, now limited to Appalachian and Ozark caves. The two species of *Mexiterpes* occurring in Mexican caves are apparently the most primitive trichopetalids, but are also quite specialized in their resemblance to cleidogonids. A hypothetical cladogram is presented in Diagram 10. The group is badly in need of revisionary studies at the generic level, as the extensive synonymies presented below indicate.

KEY TO GENERA OF TRICHOPE TALIDAE,
BASED ON MALES

- 1a. Anterior gonopod telopodites basally fused, not lobelike, decurved dorsad (Fig. 537); San Luis Potosí, Querétaro, in caves *Mexiterpes*
- 1b. Anterior gonopod telopodites not fused, lobelike (Figs. 523, 503) 2

- 2a. Laciniate branch of anterior gonopod with base visible in posterior view, not concealed by body of telopodite (Figs. 523, 528); colpocoxites with two or three branches 3
- 2b. Laciniate branch of anterior gonopod with base concealed in posterior view (Figs. 500, 503); colpocoxites with one or two branches, often with an anterior patch of small scales *Trichopetalum*
- 3a. Pigmented, with ocelli; northwestern Arkansas *Trigenotyla*
- 3b. Not pigmented, ocelli absent; caves in Illinois, Missouri, and Appalachian region from Kentucky to Alabama and Georgia *Scoterpes*

Genus *Trichopetalum* Harger

Trichopetalum Harger, 1872, Amer. J. Arts Sci., 4: 117; Cook and Collins, 1895, Ann. New York Acad. Sci., 9: 62; Chamberlin and Hoffman, 1958, U. S. Nat. Mus. Bull., 212: 102 (list of species); Causey, 1967, Proc. Biol. Soc. Washington, 80: 117 (key to species).
Zygonopus Ryder, 1881, Proc. U. S. Nat. Mus., 3: 527; Cook and Collins, 1895, Ann. New York Acad. Sci., 9: 59; Chamberlin and Hoffman, 1958, U. S. Nat. Mus. Bull., 212: 103

(list of species); Causey, 1960, J. New York Entomol. Soc., 67: 70 (key to species). NEW SUBJECTIVE SYNONYMY.

Tynopus Chamberlin, 1940, Canadian Entomol., 72: 57. NEW SUBJECTIVE SYNONYMY.

Flagellopetalum Causey, 1951, Proc. Biol. Soc. Washington, 64: 119; Loomis, 1966, Proc. Biol. Soc. Washington, 79: 229. NEW SUBJECTIVE SYNONYMY.

Types. Of *Trichopetalum*, *T. lunatum* Harger, by subsequent designation of Cook and Collins, 1895; of *Zygonopus*, *Z. whitei* Ryder by monotypy; of *Tynopus*, *T. dux* Chamberlin by monotypy; of *Flagellopetalum*, *F. stannardi* Causey, by monotypy.

Notes on synonymy. The synonymies given above will doubtless prove controversial. However, when segment number and troglobitic adaptations are not considered to be, by themselves, clear evidence of generic groupings, the species included in the genera listed above form a natural group. Careful comparison of the gonopod illustrations presented here will confirm this. *Zygonopus* has been separated from *Trichopetalum* on the basis of a higher segment number, troglobitic adaptations, and pregonopodal leg modifications. But as I have pointed out above, in the section on characters, reduced segment number is an adaptation to small size and not a taxonomic character of great importance. *Trichopetalum syntheticum* (new species, described below) has 28 segments and is eyeless and depigmented. Pregonopodal leg modifications vary within genera, see description of *Scoterpes ventus* below. *Tynopus dux* is a typical species of *Trichopetalum*, as Hoffman (1961) suggested. Unfortunately, the types of *Flagellopetalum stannardi* Causey and *F. quadratum* Loomis are not available for study and are the only known material of the genus. The museums where they were to have been deposited (Illinois Nat. Hist. Surv. and USNM, respectively) have no record of ever having received them. However, from the information presented in the descriptions of these two species, I do not

hesitate to synonymize the genus under *Trichopetalum*.

Diagnosis. Most epigean members of the genus have 28 segments; *Trigenotyta parca* has 30. Troglobitic species may be separated from *Scoterpes* by a comparison of the figures of the gonopods given below.

I have examined and here illustrate the following species of *Trichopetalum*.

Trichopetalum lunatum Harger

Figures 497–499

Trichopetalum lunatum Harger, 1872, Amer. J. Arts Sci., 4: 118. Causey, 1967, Proc. Biol. Soc. Washington, 80: fig. 1, ♂.

Trichopetalum album Cook and Collins, 1895, Ann. New York Acad. Sci., 9: 64, figs. 22–29, 36–45, ♂.

Types. Male holotype of *T. lunatum* from New Haven, Connecticut, whereabouts unknown; of *T. album*, from Syracuse, Onondaga Co., New York, in USNM, not examined.

Notes. Causey (1967) reports this species from Pennsylvania, Wisconsin, New York, and Connecticut. I have collected it in West Virginia: Palmén (1952) reported it as fairly common in Newfoundland. Specimens labelled as being from the Pinnacle Mountains of British Columbia are in the MCZ. Figure 497 is based on material from the Connecticut Lakes region of northern New Hampshire. Variation is concentrated in the form of the tip of the colpocoxite (West Virginia specimen, Fig. 499; British Columbia (?) specimen, Fig. 498).

Trichopetalum unicum Cook and Collins

Figures 500, 501

Trichopetalum unicum Cook and Collins, 1895, J. New York Acad. Sci., 9: 66, fig. 51, ♂; Causey, 1967, Proc. Biol. Soc. Washington, 80: 119 (records).

Types. Male holotype from Bloomington, Monroe Co., Indiana, reported to be in USNM, not examined.

Notes. Chamberlin and Hoffman (1958) give the distribution as "Indiana and Illi-

nois, south to Arkansas." Causey (1967) has recently recorded it from Missouri, Oklahoma, and Kentucky. My illustrations (Figs. 500, 501) are based on material from a cave in Stone County, Missouri. Some of the individuals in this collection lacked ocelli, while others had only four poorly pigmented ones.

Trichopetalum dux (Chamberlin)

NEW COMBINATION

Figures 502–504

Tynopus dux Chamberlin, Canadian Entomol., 72: 57.

Types. Male holotype collected in Duke Forest, Durham Co., North Carolina, 10 December, 1939 by N. B. Causey, in R. V. Chamberlin collection, University of Utah, Salt Lake City, Utah; examined.

Notes. The male holotype is about 4.5 mm long, has five ocelli in a single curved row with a single ocellus just below the center of the row. The pregonopodal legs are enlarged and crassate. The gonopods have never been illustrated, and are shown in Figures 502–504. The anterior gonopods resemble those of *T. unicum* in some details, but the colpocoxites are smaller, and the telopodites have a definite apical lamella not present in *T. unicum*.

Trichopetalum syntheticum n. sp.

Figures 505–510

Types. Male holotype and two immature specimens from Crossings Cave, 1.5 miles north of Paint Rock, Jackson Co., Alabama, collected 23 December 1967 by W. Torode. The specific epithet, a Latin adjective, refers to the combination of characters in this species previously considered of generic importance in separating *Trichopetalum* and *Zygonopus*.

Diagnosis. Not closely related to other species of *Trichopetalum*, except possibly *T. subterraneum*. The short coxites and concealed plumose branch of the telopodite are distinctive.

Description of male holotype. Length,

5.5 mm. Twenty-eight segments. Segmental setae long, as in *Scoterpes*. Ocelli absent, body unpigmented. Pregonopodal legs unmodified. Anterior gonopods (Figs. 507–509) simplified; sternum as in *T. cornutum*, but lacking swollen frontal areas. Coxae subglobular, meeting in midline along most of their length, mesal group of three setae near base, lateral setae group diffuse over anterior surface; coxite short, thin, truncate, about one-third length of coxa. Telopodites large, basally depressed, roughly triangular in posterior view; lacinate branch hidden on anterobasal surface. Posterior gonopods (Fig. 510) typical, 3-articled, without a claw.

Notes. This species greatly resembles a small *Scoterpes*, but has 28 segments and materially different gonopods. The antennae (Fig. 505) are short; compare Figures 525 and 531. The gonopods lack the swollen areas usually found in *Trichopetalum*, but the species is obviously a troglobite, and this may be a reduced character.

Trichopetalum cornutum Cook and Collins

Figures 511–513

Trichopetalum cornutum Cook and Collins, 1895, Ann. New York Acad. Soc., 9: 66, figs. 46–49, ♂.

Types. Male holotype from Bloomington, Indiana, in USNM, not examined.

Notes. Causey (1967) examined specimens from Indiana, Michigan, Kentucky, and Tennessee. Figures 511–513 are based on material from Highlands, Macon Co., North Carolina, collected from a Berlese sample of *Rhododendron* litter.

Trichopetalum packardi (Causey)

NEW COMBINATION

Figures 514, 515

Zygonopus packardi Causey, 1960, J. New York Entomol. Soc., 68: 77–79, figs. 8, 9, ♂.

Types. Male holotype and female paratype from Luray Cave, Page Co., Virginia, deposited in the American Museum of Natural History, not examined.

Notes. Figures 513 and 514 were drawn from specimens collected by John Holsinger in Slussers Chapel Cave, Montgomery Co., Virginia. Comparison with the preceding figures of species traditionally placed in the genus *Trichopetalum* should prove convincing as regards the synonymy of *Zygonopus* with that genus. All of the species previously assigned to *Zygonopus* are troglobites from the adjacent regions of Virginia and West Virginia.

Genus *Scoterpes* Cope

Scoterpes Cope, 1872, Amer. Nat., 6: 414; Chamberlin and Hoffman, 1958, U. S. Nat. Mus. Bull., 212: 101 (list of species).

Type species. *Spirostrephon copei* Packard, by original designation.

Diagnosis. Can be confused with 30-segmented troglobitic members of *Trichopetalum*, but the gonopods are very different in form; the colpocoxites bear a roughly T-shaped apical branch (Fig. 518). Species of *Scoterpes* are nowhere sympatric with 30-segmented troglobitic species of *Trichopetalum*.

Notes. Species of this exclusively troglobitic genus are known from caves in Kentucky, Tennessee, Alabama, Georgia, Missouri, and Illinois. When all species are described, the total number may rise to 30. *Scoterpes* is closely related to *Trigenotyia*, and the two genera may someday have to be combined. This fact, and the distribution of *S. dendropus* in Missouri and Illinois, indicates that *Scoterpes* is a more primitive genus than the possibly derived *Trichopetalum*, and not the reverse, as Causey has suggested (Causey, 1967). The Appalachian species seem to be divisible into at least two species groups, one including species similar to *S. austrinus* Loomis, with simple, T-shaped colpocoxites, and another group near *S. copei* and *S. ventus* (new species, described below) resembling *S. dendropus* of Missouri in the more complex, branched colpocoxites. As with most chordeumid genera, a thorough revision is badly needed, par-

ticularly considering the large number of undescribed taxa. I examined, and illustrate, the following species:

Scoterpes copei (Packard)

Figures 516, 517

Spirostrephon (Pseudotremia) copei Packard, 1871, Amer. Nat., 5: 748.

Scoterpes copei, Cook and Collins, 1895, Ann. New York Acad. Sci., 9: 55, figs. 12, 13, ♂.

Types. Male paratype from Poynter's Cave in Mammoth Cave region, Edmonson Co., Kentucky, in MCZ, examined.

Notes. Chamberlin and Hoffman (1958) are certainly in error when they give the range of this species as extending south from the type locality to Georgia. *Scoterpes copei* has gonopods (Figs. 516, 517) intermediate in complexity between those of *S. dendropus* and *S. austrinus* (Fig. 519).

Scoterpes austrinus Loomis

Figures 518–520

Scoterpes austrinus Loomis, 1943, Bull. Mus. Comp. Zool., 92: 386, fig. 6, pl. 1, figs. 1, 2, ♂.

Types. Male holotype from Manitou Cave, 1 mi. south of Fort Payne, De Kalb Co., Alabama, in MCZ, examined.

Notes. Chamberlin (1946) described a subspecies, *S. austrinus nudus*, which he claimed differed in lacking a claw on the posterior gonopods. Individuals from the same cave often differ in this character, so I do not think that it is of any importance; the question is whether or not *S. austrinus nudus* is a separate species or a synonym of *S. austrinus*. I have not examined the types of *nudus*. The illustrations presented here (Figs. 519–520) of *S. austrinus* are of material from White River Cave, Floyd County, Georgia, which I compared with the holotype.

Scoterpes ventus n. sp.

Figures 521–526

Types. Male holotype and paratype from Blowing Cave, Sequatchie, Marion Co., Tennessee, collected 29 August 1968

by S. B. Peck. The specific epithet is a Latin noun in apposition, "wind," and refers to the name of the type locality.

Diagnosis. Close to *S. copei* and *S. dendropus*. Distinct from *S. dendropus* in the modification of legpair 6, and from *S. copei* in the much greater complexity of the anterior gonopod coxae.

Description of male holotype. Length, 10 mm. Ocelli absent. Legs 3–7 of male much enlarged, crassate, legs 6 and 7 longer than legs 3–5; leg 6 (Fig. 525) with fourth article swollen, irregular knob at mesobasal side; leg 7 somewhat more slender than leg 6, longer. Anterior gonopods (Figs. 521–523) similar to those of *S. dendropus*, with lateral and medial setae groups, depressed. Coxites 3; lateral coxites short, rounded, with crown of chitinous hooks solidly fused to coxite, not with sockets. Middle coxite the longest, slightly sinuous, with irregular bumps on apical fourth. Mesal coxite simple, acuminate. Telopodites complexly lobed, large lacinate branch proximad of apex. Posterior gonopods (Fig. 524) simple, 2-articled, with small knob (pointed like claw in paratype), setose.

Notes. Causey (1960a) separated *Zygonopus* from *Scoterpes* on the basis of the enlarged and bowed sixth leg of *Zygonopus* contrasted with the unmodified pregonopodal legs of *Scoterpes*. Causey's statements must have been based on *S. dendropus*, since Loomis (1939) illustrates the crassate sixth leg of *S. copei*. There is considerable variation in pregonopodal leg modifications in *Scoterpes*, and thus it is not a reliable diagnostic character.

Genus *Trigenotyla* Causey

Trigenotyla Causey, 1951, Proc. Biol. Soc. Washington, 64: 118.

Type species. *Trigenotyla parca* Causey, by monotypy.

Diagnosis. Differs from all other 30-segmented epigean trichopetalids in the

very large lacinate portion of the anterior gonopod telopodite.

Notes. *Trigenotyla* is clearly related to *Scoterpes*, and may at some future time be placed as a synonym of *Scoterpes*, but more must be found out about *Scoterpes* species first. Though not a troglobite, *T. parca* is frequently found in caves in Arkansas. The strong, swordlike setae on the anterior face of the anterior gonopod colpocoxite (Fig. 527) are unusual, as are the large telopodites (Fig. 528). The posterior gonopod coxae are prolonged beyond the insertion of the telopodite segment. The specimen illustrated here was collected in Granny Dean Cave, 10 mi. southeast of Fayetteville, Washington County, Arkansas, by S. B. Peck, 9 June 1969.

Genus *Mexiterpes* Causey

Mexiterpes Causey, 1963, Psyche, 70: 235.

Type species. *Mexiterpes sabinus* Causey, by monotypy.

Diagnosis. The fused telopodites of the posterior gonopods, which are not lobelike and lack a lacinate or plunose branch, distinguish this genus from other trichopetalids.

Notes. This genus links the family Trichopetalidae with the family Cleidogonidae. The gonopods of *Mexiterpes metallicus* closely resemble those of *Pseudotremia* species (Cleidogonidae); even if this resemblance is due to convergent evolution, the basic morphology of the gonopods is quite similar: the large, curved colpocoxites, fused telopodites and median structures derived from the fused telopodite bases. The body form and posterior gonopods are typical of trichopetalids, however. In the original generic diagnosis, Causey (1963b) stated that the genus contains only eyeless species. This is true of the type species, *M. sabinus*, but *M. metallicus* has a few poorly pigmented ocelli. The posterior gonopods of *M. metallicus* also differ somewhat from those illustrated by Causey for *M. sabinus*, but see below.

Mexiterpes sabinus Causey

Figures 529–531

Mexiterpes sabinus Causey, 1963. Psyche, 70: 235, figs. 1–3, ♂.

Types. Male holotype from Sotano del Arroyo, 8 mi. north of Valles, San Luis Potosí, Mexico, in MCZ, examined.

Notes. I examined the type specimen in detail and found Causey's (1963b) illustrations misleading. The drawings presented here (Figs. 529–531) were made from the gonopods of the holotype, under high magnification; details were confirmed by temporarily mounting the gonopods in glycerine on a microscope slide and examining them under phase contrast. The posterior gonopods are permanently mounted on a slide and cleared almost to transparency. I found a definite gap between the posterior gonopod coxae in the midline; Causey (1963b) described them as fused. I could not find the gland opening illustrated by Causey, nor the joints between the "third and fourth" segments of the telopodite. The right posterior gonopod has a definite claw, the left does not.

Mexiterpes metallicus n. sp.

Figures 532–538

Types. Male holotype and four female paratypes from 1.2 miles east of Pinal de Amoles, Querétaro, Mexico, in an iron mine at roadside, collected 17 August 1969 by S. B. and J. Peck. The specific name is a noun in apposition: "a miner of metals."

Diagnosis. Distinct in details of the gonopods from *M. sabinus*, and in having 4 poorly pigmented ocelli.

Description of male holotype. Length, 9.7 mm. Ocelli 4, in single row (Fig. 532). Other nonsexual characters as described by Causey (1963b) for *M. sabinus*. Anterior gonopods: sternum large, well sclerotized, raised lateral lobes articulating with fused bases of coxae; coxae fused basomedially (Fig. 533), coxites elongate, gradually narrowed, sharply elbowed posteriorly, basal setae strong, numerous, setose area well

defined. Coxae extending posteriorly (Fig. 537) as a lobed basal cup, firmly articulated with lateral parts of sternum. Telopodites (Figs. 534, 536) basally fused, with common basal lacinate area with deeply excavate lateral lobes; posteriorly produced into large, rugose mass. Distal part of telopodites separated, curved dorsad, sinuous. Posterior gonopods: as in Figure 535.

Description of female paratype. Nonsexual characters as described for male. Cyphopods (Fig. 538) large, protruding, similar to those of *Pseudotremia* spp.; receptacle simple, cupped, margined. Valves anteriorly fused, groove rimmed and setose; median valve of each side drawn out as heavily sclerotized hook. Sternum 3 flattened but not otherwise modified.

Notes. Though the holotype and paratype were collected in a mine, there are numerous limestone caves in the area, which should be thoroughly searched for this species. There may be epigeal species of *Mexiterpes*; a female from Querétaro was tentatively assigned to *Austrotyla* (Conotylidae) when I examined it before seeing specimens of *Mexiterpes metallicus* (Shear, 1971).

LITERATURE CITED

- ATIEMS, C. 1898. Neues über paläarktische Myriapoden. Zool. Jarb., Abt. Syst., **12**: 286–336.
- . 1907. Javanische Myriapoden gesammelt von Direktor K. Kraepelin im Jahre 1903. Ann. Naturhist. Mus. Wien, **24**: 78–138.
- . 1959. Die Myriapoden der Höhlen Balkanhalbinsel nach dem Material der "Biospeologica balkana." Ann. Naturh. Mus. Wien, **63**: 345–351.
- BARR, T. C. 1961. Caves of Tennessee. Tennessee Dept. Conserv. Comm., Div. Geol., Bull. **64**: 1–567.
- . 1967. A new *Pseudanophthalmus* from an epigeal environment in West Virginia. Psyche, **74**: 166–172.
- BOLLEMAN, C. H. 1888. Notes upon a collection of myriapoda from east Tennessee, with description of a new genus and six new species. Ann. New York Acad. Sci., **10**: 106–112.
- . 1893. The Myriapoda of the United States. U. S. Nat. Mus. Bull., **43**: 1–210.
- BRÖLEMANN, H. W. 1918. Quelques indices

- d'évolution chez les Myriapodes. Tr. Inst. Zool. Univ. Montpellier, **28**: 1-33.
- . 1922. Notes on female paraiulids. Ann. Entomol. Soc. America, **15**: 281-307.
- . 1935. Myriapodes diplopodes (Chilognathes I). In Faune de France, 29: 1-369.
- , AND J. L. LICHTENSTEIN. 1919. Les vulves des diplopodes (memoire preliminaire). Arch. Zool. Exper. Gen., **58**: 173-218.
- BUCKETT, J. S., AND M. R. GARDNER. 1967. A new family of cavernicolous millipedes with the description of a new genus and species from Idaho (Diplopoda: Chordeumida: Chordeumidia). Michigan Entomol., **1**: 117-126.
- CAUSEY, N. B. 1951a. New cleidogonid millipedes (Chordeumoidea). J. Washington Acad. Sci., **41**: 78-83.
- . 1951b. New genera and species of chordeumoid millipedes in the United States, and notes on some established species. Proc. Biol. Soc. Washington, **64**: 117-124.
- . 1952. Four new chordeumoid millipedes from the United States. Proc. Biol. Soc. Washington, **65**: 111-118.
- . 1954. Three new species and new records of southern millipedes. Tulane Stud. Zool., **2**: 63-68.
- . 1957. New records and descriptions of millipedes of the family Cleidogonidae. J. Kansas Entomol. Soc., **30**: 114-120.
- . 1958. New records and descriptions of a new genus and a new species of milliped of the family Striariidae. Proc. Biol. Soc. Washington, **71**: 179-184.
- . 1959. A new species of *Ozarkogona* from Indiana. J. Kansas Entomol. Soc., **32**: 141-144.
- . 1960a. The troglobitic milliped genus *Zygonopus*. J. New York Entomol. Soc., **68**: 69-80.
- . 1960b. *Speostriaria*, new genus. Proc. Biol. Soc. Washington, **73**: 25-28.
- . 1961. Three new millipedes of the genus *Cleidogona* (Cleidogonidae: Chordeumida) from the southern states. Florida Entomol., **44**: 35-39.
- . 1963a. Two new caseyid millipedes from California caves. Wasmann J. Biol., **21**: 193-198.
- . 1963b. *Mexiterpes sabinus*, new genus and new species, a Mexican troglobite. Psyche, **70**: 235-239.
- . 1967. *Trichopetalum subterraneum*, new species from Kentucky, new records and a key to the genus. Proc. Biol. Soc. Washington, **80**: 117-122.
- CHAMBERLIN, R. V. 1910. Diplopoda from the western states. Ann. Entomol. Soc. America, **3**: 233-262.
- . 1922. The millipedes of Central America. Proc. U. S. Nat. Mus., **60**: 1-75.
- . 1925. Notes on some centipeds and millipeds from Utah. Pan-Pacific Entomol., **2**: 55-63.
- . 1940. On some chilopods and diplopods from North Carolina. Canadian Entomol., **72**: 56-59.
- . 1941a. Seven new millipedes from Mexico. Entomol. News, **52**: 250-255.
- . 1941b. New southern millipedes. Bull. Univ. Utah, **32**: 1-19.
- . 1942. On centipeds and millipedes from Mexican Caves. Bull. Univ. Utah, **33**: 1-19.
- . 1943. On Mexican millipedes. Bull. Univ. Utah, **34**: 1-103.
- . 1946. On some millipedes of Georgia. Entomol. News, **57**: 149-153.
- . 1949. A new family in the diplopod Order Chordeumida. Proc. Biol. Soc. Washington, **62**: 7-8.
- . 1952. Further records and descriptions of American millipedes. Great Basin Nat., **12**: 13-34.
- , AND R. L. HOFFMAN. 1950. On some genera and families of North American diplopods. Nat. Hist. Misc., No. 71: 1-7.
- , AND ———. 1958. Checklist of the millipedes of North America. U. S. Nat. Mus. Bull., **212**: 1-236.
- , AND S. MULAİK. 1941. On a collection of millipedes from Texas and New Mexico. J. New York Entomol. Soc., **49**: 60-64.
- COOK, O. F. 1895. On recent diplopod names. Brandtia, **2**: 5-8.
- . 1899. The diplopod family Striariidae. Proc. U. S. Nat. Mus., **21**: 667-676.
- , AND C. N. COLLINS. 1895. The Craspedosomatidae of North America. Ann. New York Acad. Sci., **9**: 1-100.
- COPE, E. D. 1869. Synopsis of the extinct Mammalia . . . with observations on some Myriapoda. . . . Proc. Amer. Philos. Soc., **11**: 171-192.
- CORE, E. L. 1955. Cranberry Glades Natural Area. Wild Flower, **31**: 65-81.
- COYLE, F. A. 1968. The mygalomorph spider genus *Atypoides* (Araneae: Antrodiaetidae). Psyche, **75**: 157-194.
- DARLINGTON, P. J., JR. 1957. Zoogeography: The Geographical Distribution of Animals. New York, John Wiley & Sons. 675 pp.
- . 1965. Biogeography of the Southern End of the World. Cambridge, Harvard Univ. Press. 236 pp.

- DAVIES, W. K. 1949. Caverns of West Virginia. West Virginia Geol. Surv. Report, 19: 1-353.
- DEAROLF, K. 1937. The invertebrates of 75 caves in the United States. Pennsylvania Acad. Sci., **37**: 225-241.
- DOUGLAS, H. H. 1964. Caves of Virginia. Falls Church, Virginia Cave Survey. 761 pp.
- FRYE, J. C., H. B. WILLMAN, AND R. F. BLACK. 1965. Outline of the glacial geology of Illinois and Wisconsin. In H. E. Wright, Jr. and D. G. Frey (eds.), The Quaternary of the United States. Princeton, N. J., Princeton University Press, pp. 43-61.
- HOFFMAN, R. L. 1950a. A preliminary list of the cleidogonid millipeds, with descriptions of a new genus from Guatemala and a new species from Virginia. J. Washington Acad. Sci., **40**: 87-92.
- . 1950b. Systematic notes on some Central American millipeds. Proc. Biol. Soc. Washington, **63**: 69-72.
- . 1950c. Records and descriptions of diplopods from the southern Appalachians. J. Elisha Mitchell Sci. Soc., **66**: 11-33.
- . 1958. On the identity of *Pseudotremia cavernarum* Cope, a poorly known American chordeumoid diplopod. Proc. Biol. Soc. Washington, **71**: 113-118.
- . 1961. Systematic and morphological notes on North American conotyloid diplopods. Trans. Amer. Entomol. Soc., **87**: 259-272.
- . 1962. A new genus and species in the diplopod family Nearctodesmidae from Illinois (Polydesmida). American Midl. Nat., **68**: 192-198.
- . 1963. Notes on the structure and classification of the diplopod family Heterochor-denmatidae. Ann. Mag. Nat. Hist., **6**: 129-135.
- . 1969a. The origin and affinities of the southern Appalachian diplopod fauna. In P. C. Holt (ed.), The distributional history of the biota of the southern Appalachians, Part I, Invertebrates. Virginia Polytech. Inst. Res. Monogr., 1. 295 pp.
- . 1969b. Myriapoda, exclusive of Insecta, pp. R572-R606. In R. C. Moore (ed.), Treatise on Invertebrate Paleontology, Part R, Arthr. 4, Vol. 2. Lawrence, Kansas, Geological Society of America. Pp. R400-R659.
- , AND R. E. CRABILL. 1953. C. S. Rafinesque as the real father of American myriapodology: an analysis of his hitherto unrecognized species. Florida Entomol., **36**: 73-82.
- JEEKEL, C. A. 1969. Two new generic names in the diplopod order Craspedosomatida. Entomol. Bericht., **29**: 88.
- KAESTNER, A. 1968. Invertebrate Zoology, vol. 2, translated and adapted by H. W. and L. R. Levi. New York, Wiley-Interscience. 472 pp.
- KEETON, W. T. 1960. A taxonomic study of the milliped family Spirobolidae. Mem. American Entomol. Soc., **17**: 1-146.
- KRAUS, O. 1954. Myriapoden aus El Salvador. Senck. Biol., **35**: 293-349.
- LOOMIS, H. F. 1939. The millipeds collected in Appalachian Caves by Mr. Kenneth Dearolf. Bull. Mus. Comp. Zool., **86**: 165-193.
- . 1943. New cave and epigeal millipeds. Bull. Mus. Comp. Zool., **92**: 373-410.
- . 1944. Millipeds principally collected by Professor V. E. Shelford in the eastern and southeastern states. Psyche, **51**: 166-177.
- . 1959. Millipeds collected en route from Florida to San Antonio, Texas. J. Washington Acad. Sci., **49**: 157-163.
- . 1963. Millipeds from states immediately north and south of the Mexican boundary. J. Kansas Entomol. Soc., **36**: 118-126.
- . 1964. The millipeds of Panama (Diplopoda). Fieldiana (Zool.), **47**: 5-136.
- . 1966. Two new families and other North American Diplopoda of the order Chordeumida. Proc. Biol. Soc. Washington, **79**: 221-230.
- . 1968. A checklist of the millipeds of Mexico and Central America. U. S. Nat. Mus. Bull., **266**: 1-137.
- MCNEILL, J. 1887. Descriptions of twelve new species of Myriapoda, chiefly from Indiana. Proc. U. S. Nat. Mus., **10**: 328-334.
- MALDONADO-KOERFELL, M. 1964. Geohistory and paleogeography of middle America. In R. C. West (ed.), Handbook of Middle American Indians, Vol. I. Austin, Univ. of Texas Press. 570 pp.
- MANTON, S. M. 1953. The evolution of arthropodan locomotory mechanisms — Part 4. The structure, habits and evolution of the Diplopoda. J. Linnean Soc., **42**: 299-368.
- MITCHELL, R. W. 1968. *Typhlochactas*, a new genus of eyeless cave scorpion from Mexico. Ann. Speleol., **23**: 753-777.
- . 1969. A comparison of temperate and tropical cave communities. Southwestern Nat. **14**: 73-88.
- MURAKAMI, Y., AND K. Y. PAIK. 1968. Results of the speological survey in South Korea, 1966. XI. Cave-dwelling myriapods from the southern part of Korea. Bull. Nat. Sci. Mus. (Tokyo), **11**: 363-384.
- PACKARD, A. S. 1883. A revision of the Lysiopetalidae, a family of Chilognath Myriapoda, with

- a notice of the genus *Cambala*. Proc. Amer. Philos. Soc., **21**: 177-197.
- PALISOT DE BEAUVOIS, A. M. 1805. Insectes . . . Aptères: 1-276 (original not seen, as reported in Hoffman and Crabill, 1953).
- PALMIÉN, E. 1952. Survey of the Diplopoda of Newfoundland. Ann. Zool. Soc. 'Vanamo,' **15**: 1-31.
- RAFINESQUE, C. S. 1820. Annals of Nature. . . . First Annual Number for 1820. 20 pp. (original not seen, as reported in Hoffman and Crabill, 1953).
- SAY, T. 1821. Description of the Myriapoda of the United States. J. Acad. Nat. Sci. Philadelphia, **2**: 102-114.
- SCHUBART, O. 1934. Tausendfüßler oder Myriapoda, I: Diplopoda. In F. Dahl (ed.), Die Tierwelt Deutschlands. Vol. 28. 318 pp.
- SCHUCHERT, C. 1955. Atlas of Palaeogeographic Maps of North America. New York, John Wiley and Sons. 177 pp.
- SILVESTRI, F. 1903. Note diplopodologiche. I. Nuovi diplopodi del Chile. Boll. Mus. Torino, **18**: 1-12.
- . 1913. Illustrazione di due famiglie di Chordeumoidea (Diplopoda) del Nord America. Boll. Lab. Zool. (Portici), **7**: 303-316.
- SHEAR, W. A. 1969. A synopsis of the cave millipedes of the United States, with an illustrated key to genera. Psyche, **76**: 126-143.
- . 1971a. A taxonomic revision of the milliped family Conotylidae in North America, with a description of the new family Adritylidae (Diplopoda: Chordeumida). Bull. Mus. Comp. Zool., **141**(2): 55-96.
- . 1971b. The taxonomic position of the milliped *Ergethus perditus* (Polydesmida, Paradoxosomatidae). Proc. Biol. Soc. Washington, **83**(39): 455-458.
- , AND H. W. LEVI. 1970. Cleaning museum specimens of Arachnida and Myriapoda with ultrasonics. Bull. Brit. Arachn. Soc., **1**: 1-17.
- STRASSER, K. 1942. Diplopoden aus dem Julischen Karst. Zool. Anz., **133**: 15-234.
- UNDERWOOD, L. M. 1893. A review of the literature of the North American Myriapoda. In C. H. Bollman, the Myriapoda of North America. U. S. Nat. Mus. Bull., **46**: 9-18.
- VERHOEFF, K. W. 1906. Über Diplopoden 5. (24) Aufsatz. Arch. Naturg., **72**: 107-226.
- . 1909. Neues System der Diplopoden — AscospERMOPHORA. Zool. Anz., **34**: 566-572.
- . 1910. Über Diplopoden. 11-15 Aufsatz (31-35). Nov. Act. Abb. Kaiserl. Leop.-Carol. Deutsch. Akad. Naturforsch., **92**: 144-146.
- . 1913. Zwei neue Gattungen der Trachyzona superfam. der AscospERMOPHORA. Zool. Anz., **43**: 125-143.
- . 1914. AscospERMOPHOREN aus Japan. (Über Diplopoden 69. Aufsatz.). Zool. Anz., **43**: 342-370.
- . 1932. Diplopoden-Beiträge. Zool. Jahrb., Abt. Syst., **62**: 459-524.
- . 1935. Neues ostasiatische Diplopoden. Zool. Anz., **107**: 62-73.
- . 1936. Ueber Diplopoden aus Japan, gesammelt von Herrn Y. Takakuwa (139. Diplopoden-Aufsatz). Trans. Sapporo Nat. Hist. Soc., **14**: 148-171.
- WESTCOTT, R. 1968. A new subfamily of blind beetles from Idaho ice caves. . . . Contr. Sci. Los Angeles County Mus. Nat. Hist., **141**: 1-14.
- WILLIAMS, S. R., AND R. A. HEFNER. 1928. Millipedes and centipedes of Ohio. Ohio Biol. Surv. Bull., **28**: 93-146.
- WOOD, H. C. 1865. The Myriapoda of North America. Trans. American Philos. Soc., **13**: 137-248.

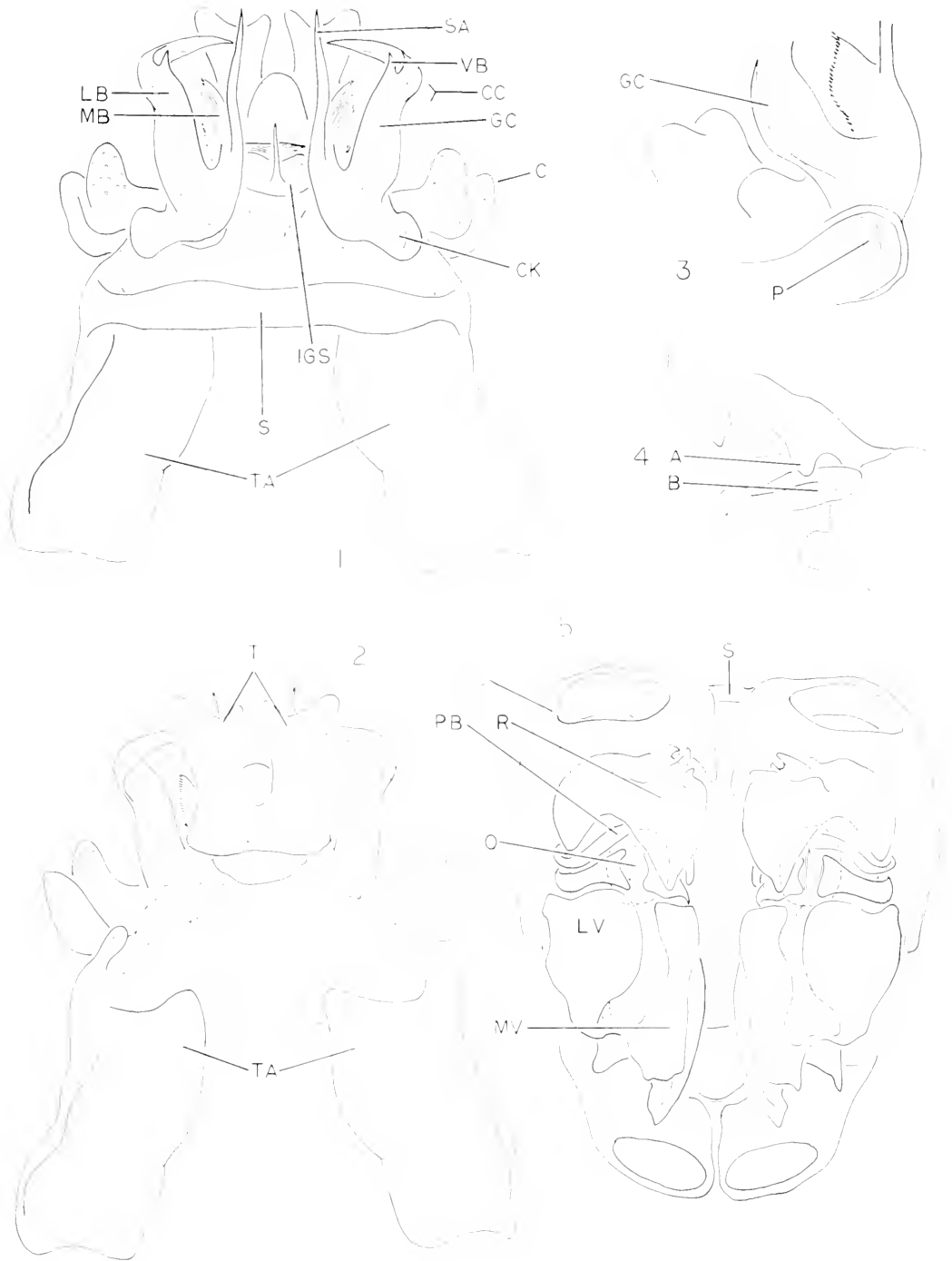

Figures 1-5. Anatomy of genitalia of *Pseudotremia hobbsi*. Fig. 1. Gonopods, anterior view. Fig. 2. Gonopods, posterior view. Fig. 3. Base of gonopod coxo, subdorsal view. Fig. 4. Articulation of gonopod sternum and coxo, lateral view. Fig. 5. Cyphopods and associated leg coxae, ventral view.

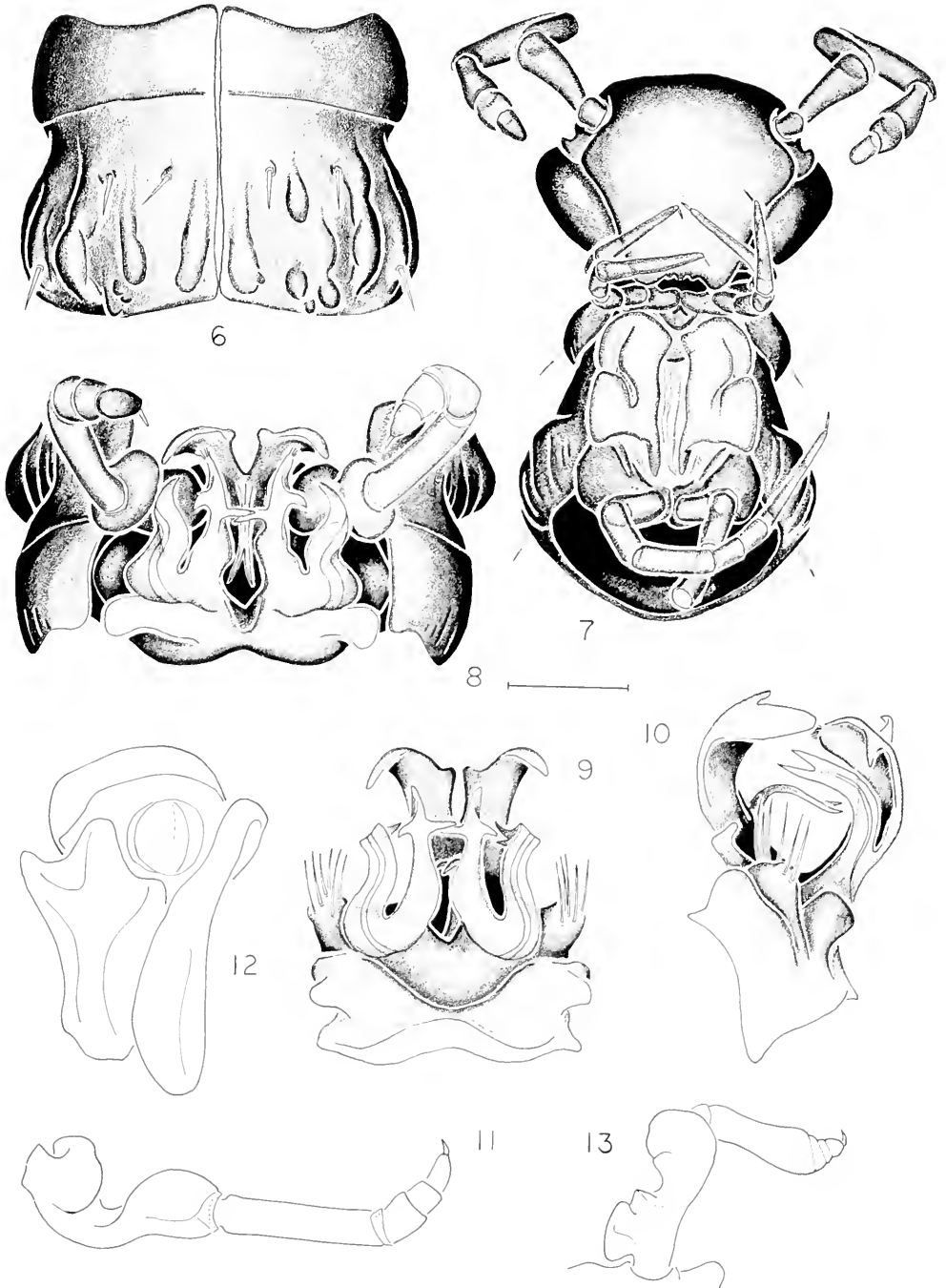

Figures 6-13. Anatomy of *Pseudotremia* species. Fig. 6. Tenth segment of *P. nyx*, dorsal view. Fig. 7. Anterior end of female *P. lethe*, ventral view. Fig. 8. Seventh segment of male *P. nefanda*, ventral view. Figs. 9-12. *P. nefanda*. Fig. 9. Gonopods, anterior view. Fig. 10. Left gonopod, lateral view. Fig. 11. Right posterior gonopod, anterior view. Fig. 12. Right cyphopod, ventral view. Fig. 13. Right posterior gonopod of *P. amphiorax*, anterior view. Scale lines = 0.5 mm for Figs. 6-11, 13; 0.25 mm for Fig. 12.

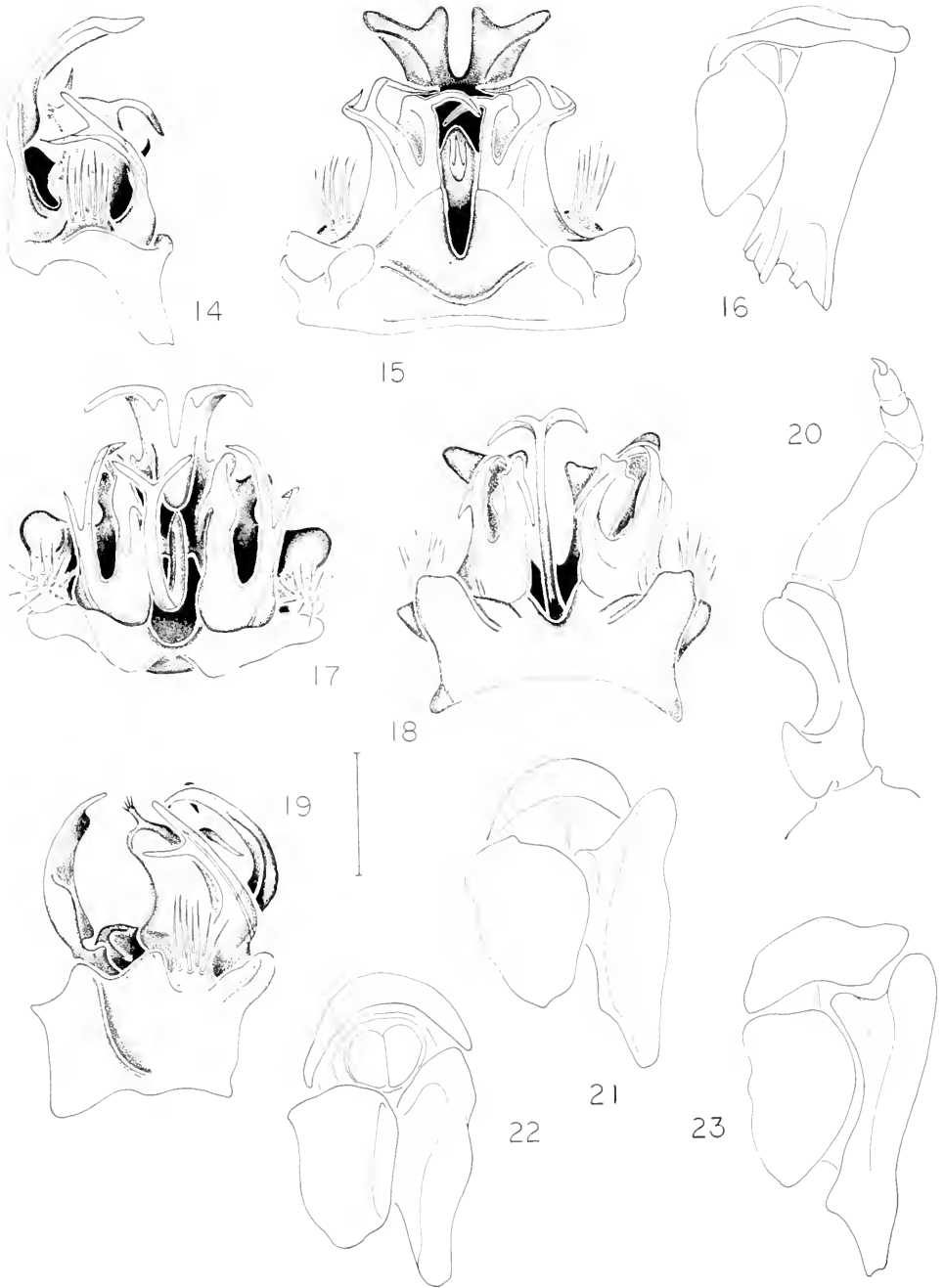

Figures 14–23. Anatomy of *Pseudotremia* spp. Figs. 14–16. *P. amphiorax*. Fig. 14. Left gonopods, lateral view. Fig. 15. Gonopods, anterior view. Fig. 16. Right cyphopod, ventral view. Figs. 17–23. *P. indianae*. Fig. 17. Gonopods, ventral view. Fig. 18. Gonopods, anterior view. Fig. 19. Left gonopod, lateral view. Fig. 20. Right posterior gonopod, anterior view. Figs. 21–23. Right cyphopods, ventral view. Fig. 21. Specimen from King's Cove. Fig. 22. Specimen from Mayfield's Cave. Fig. 23. Specimen from Wyandotte Cave. Scale lines = 0.5 mm for anterior and posterior gonopods, 0.25 mm for cyphopods.

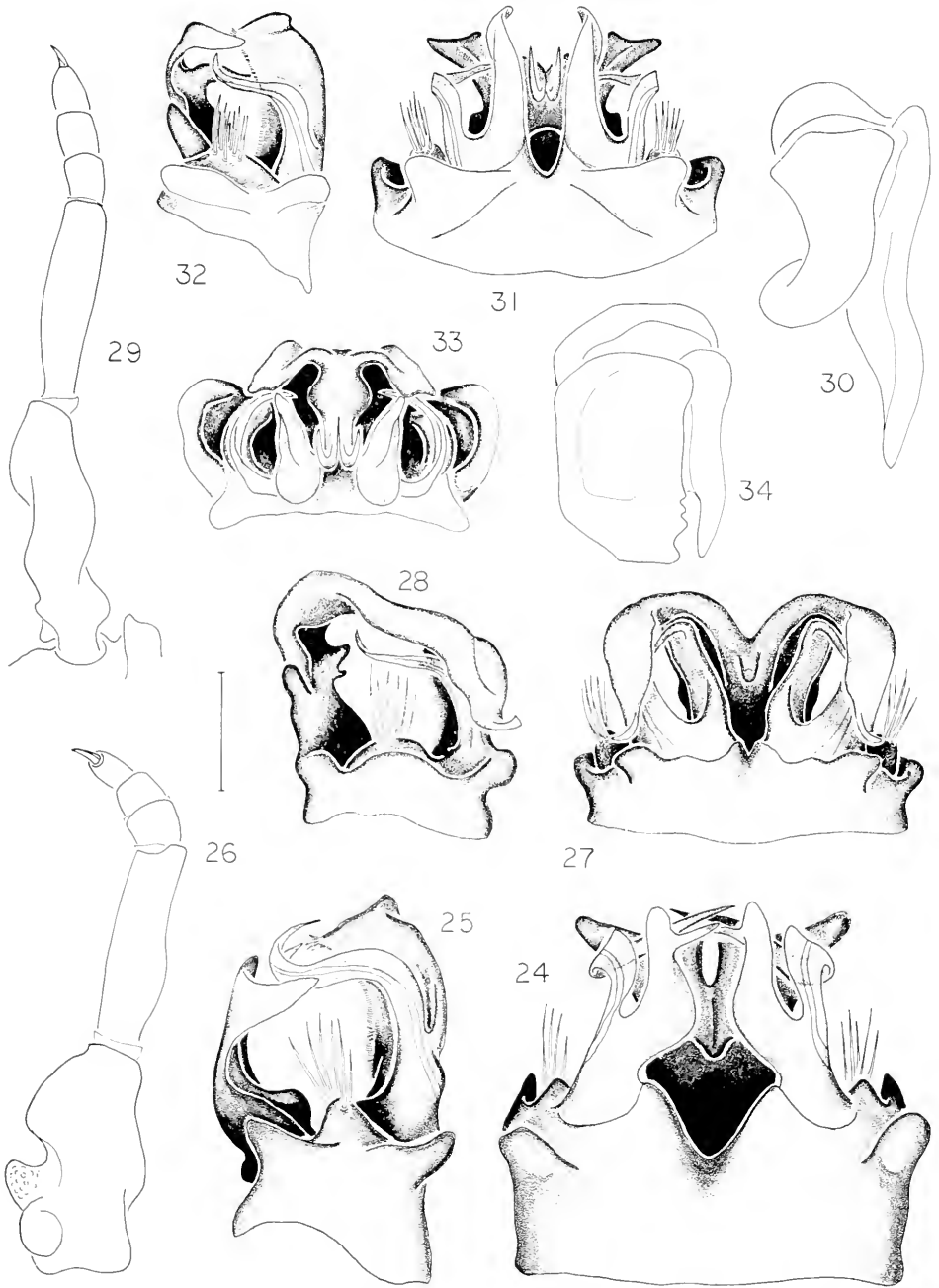

Figures 24–34. Anatomy of *Pseudotremia* spp. Figs. 24–26. *P. valgo*. Fig. 24. Anterior gonopods, anterior view. Fig. 25. Left anterior gonopods, lateral view. Fig. 26. Right posterior gonopod, anterior view. Figs. 27–30. *P. stupefactor*. Fig. 27. Anterior gonopods, anterior view. Fig. 28. Left anterior gonopod, lateral view. Fig. 29. Right posterior gonopod, anterior view. Fig. 30. Right cyphopod, ventral view. Figs. 31–34. *P. merops*. Fig. 31. Anterior gonopods, anterior view. Fig. 32. Left anterior gonopod, lateral view. Fig. 33. Anterior gonopods, ventral view. Fig. 34. Right cyphopod, ventral view. Scale lines = 0.5 mm for anterior and posterior gonopods, 0.25 mm for cyphopods.

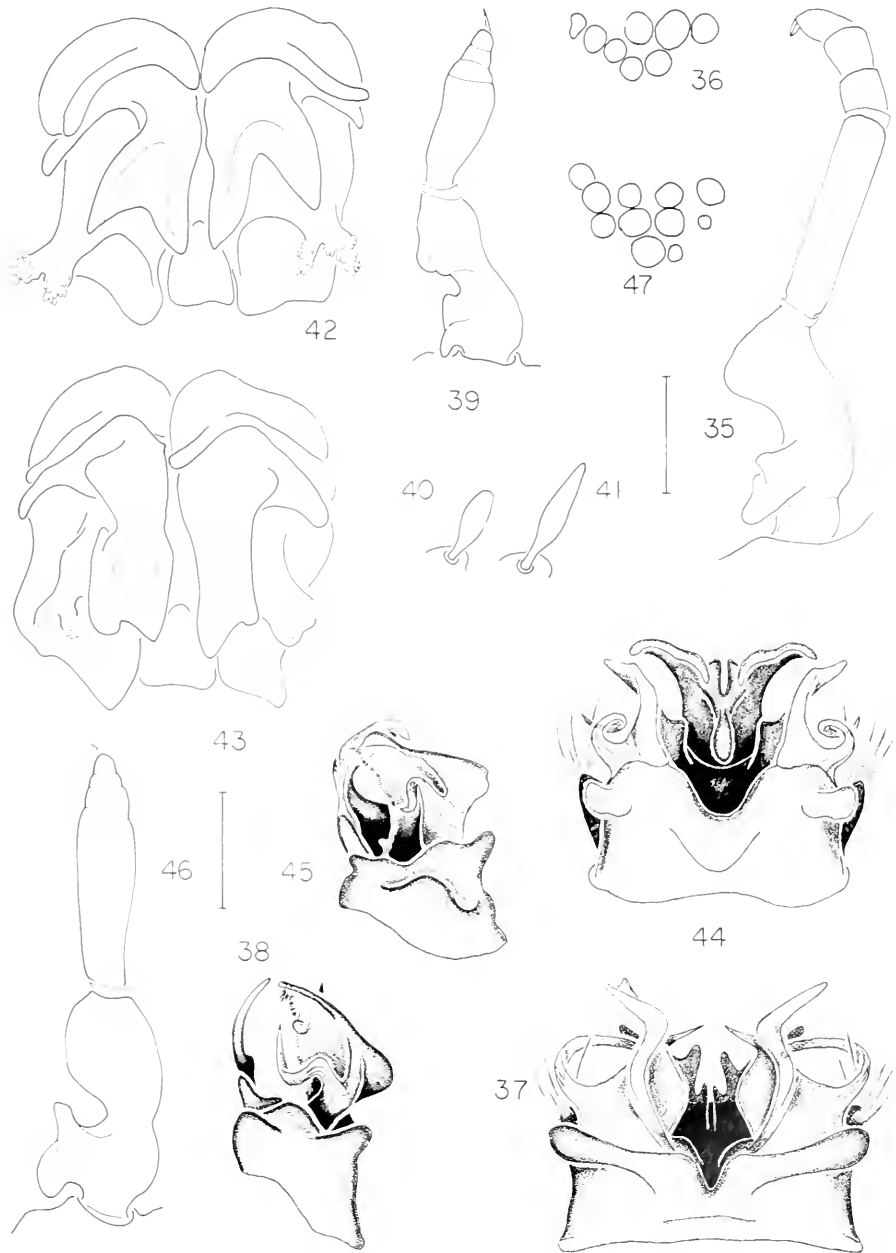

Figures 35-47. Anatomy of *Pseudotrema* spp. Fig. 35. Right posterior gonopod of *P. merops*, anterior view. Figs. 36-43. *P. unco*. Fig. 36. Left eyepatch, lateral view. Fig. 37. Anterior gonopods, anterior view. Fig. 38. Left anterior gonopod, setae omitted, lateral view. Fig. 39. Right posterior gonopod, anterior view. Fig. 40. Outer segmental seta from segment five. Fig. 41. Outer segmental seta from segment 21. Fig. 42. Cyphopods, ventral view. Fig. 43. Cyphopods of another specimen from the same locality, ventral view. Figs. 44-47. *P. spira*. Fig. 44. Anterior gonopods, anterior view. Fig. 45. Left anterior gonopod, setae omitted, lateral view. Fig. 46. Right posterior gonopod, anterior view. Fig. 47. Left eyepatch, lateral view. Scale lines = 0.5 mm for anterior and posterior gonopods, 0.25 mm for cyphopods.

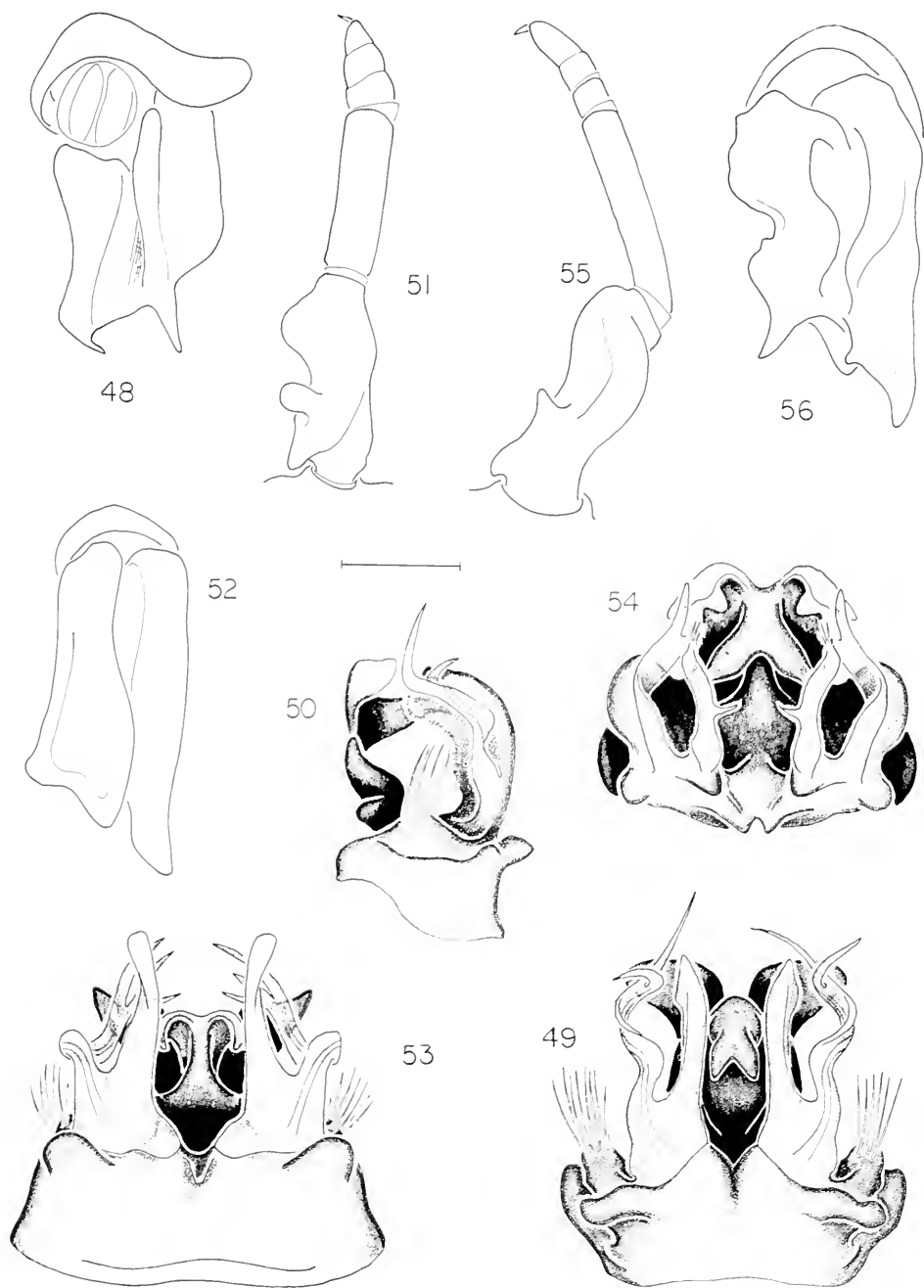

Figures 48–56. Anatomy of *Pseudotremia* spp. Fig. 48. Right cyphopod of *P. spira*, ventral view. Figs. 49–52. *P. ocheron*. Fig. 49. Anterior gonopods, anterior view. Fig. 50. Left anterior gonopod, lateral view. Fig. 51. Right posterior gonopod, anterior view. Fig. 52. Right cyphopod, ventral view. Figs. 53–56. *P. rhadamanthus*. Fig. 53. Anterior gonopods, anterior view. Fig. 54. Anterior gonopods, ventral view. Fig. 55. Right posterior gonopod, anterior view. Fig. 56. Right cyphopod of specimen from Terrill's Cove, ventral view. Scale lines = 0.5 mm for anterior and posterior gonopods, 0.25 mm for cyphopods.

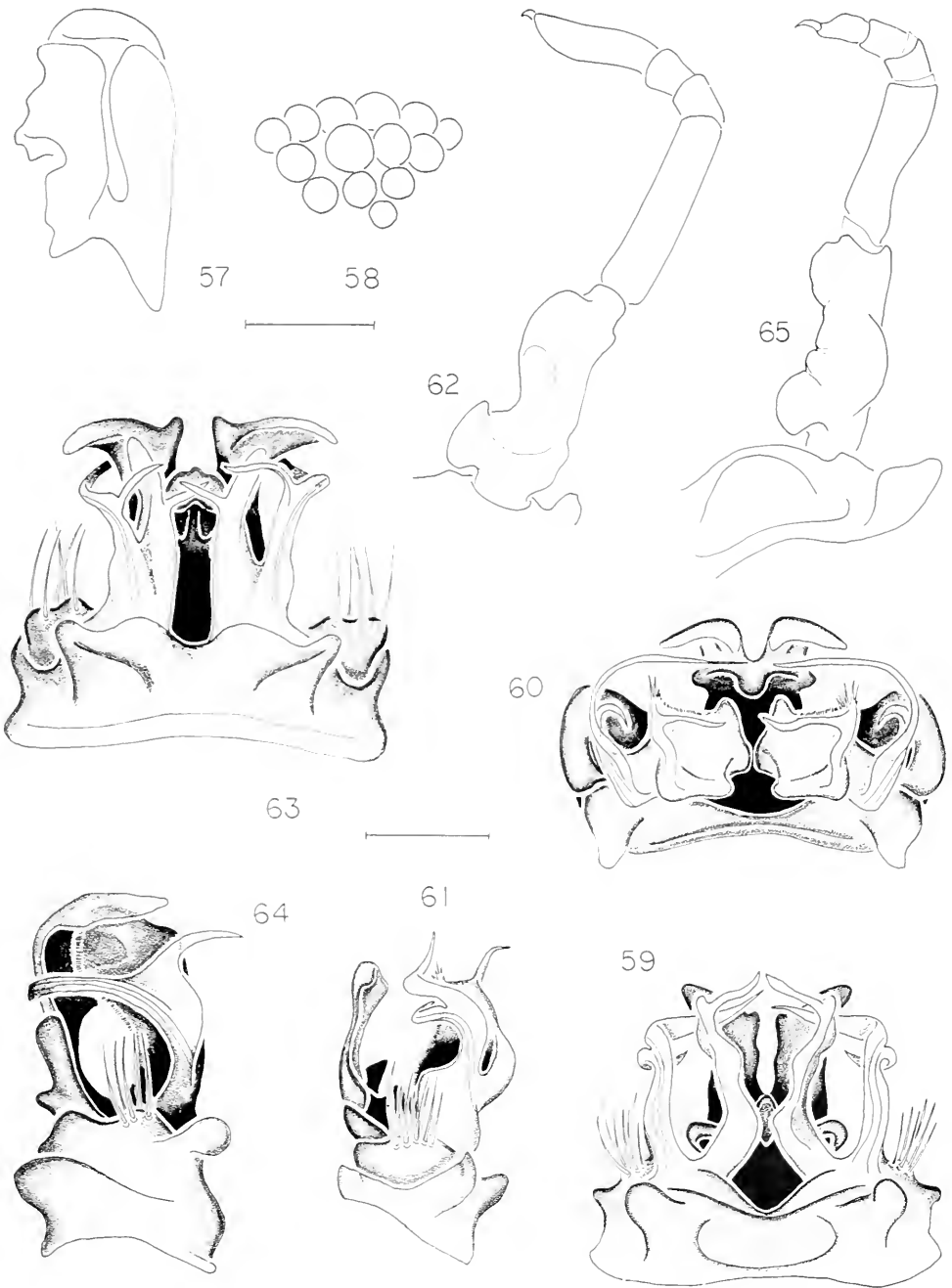

Figures 57-65. Anatomy of *Pseudotremia* spp. Fig. 57. Right cyphopod of *P. rhadamanthus* from Monteagle Saltpetre Cave, ventral view. Figs. 58-62. *P. sacco*. Fig. 58. Right eyepatch, lateral view. Fig. 59. Anterior gonopods, anterior view. Fig. 60. Anterior gonopods, ventral view. Fig. 61. Left anterior gonopod, lateral view. Fig. 62. Right posterior gonopod, anterior view. Figs. 63-65. *P. eburnea*. Fig. 63. Anterior gonopods, anterior view. Fig. 64. Left anterior gonopod, lateral view. Fig. 65. Right posterior gonopod and part of sternum, anterior view. Scale lines = 0.5 mm for anterior and posterior gonopods, 0.25 mm for cyphopods.

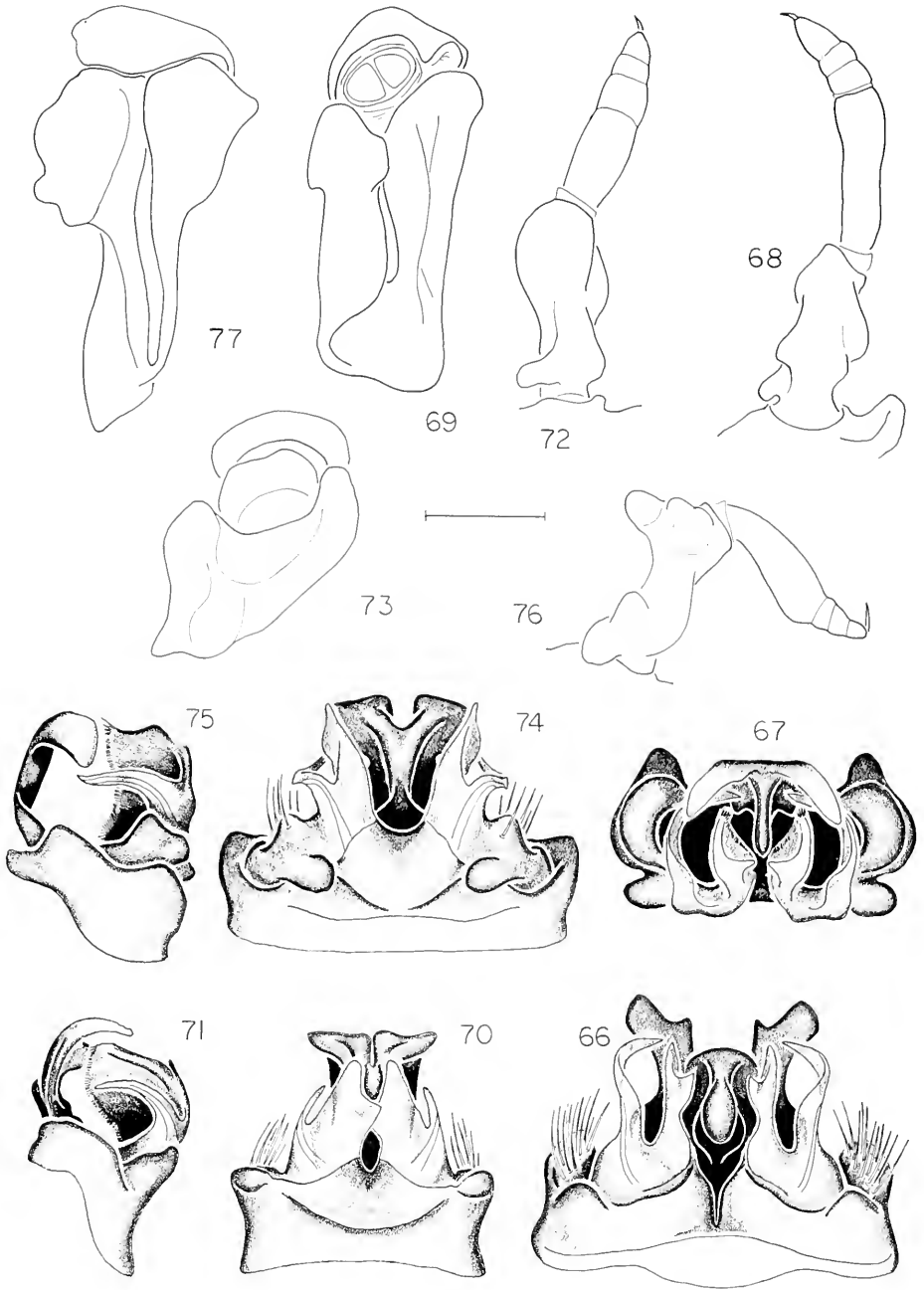

Figures 66-77. Anatomy of *Pseudotremia* spp. Figs. 66-69. *P. aeacus*. Fig. 66. Anterior gonopods, anterior view. Fig. 67. Anterior gonopods, ventral view. Fig. 68. Right posterior gonopod, anterior view. Fig. 69. Right cyphopod, ventral view. Figs. 70-73. *P. nodosa*. Fig. 70. Anterior gonopods, anterior view. Fig. 71. Left anterior gonopod, setae omitted, lateral view. Fig. 72. Right posterior gonopod, anterior view. Fig. 73. Right cyphopod, ventral view. Figs. 74-77. *P. nyx*. Fig. 74. Anterior gonopods, anterior view. Fig. 75. Left anterior gonopod, setae omitted, lateral view. Fig. 76. Right posterior gonopod, anterior view. Fig. 77. Right cyphopod, ventral view. Scale lines = 0.5 mm for anterior and posterior gonopods, 0.25 mm for cyphopods.

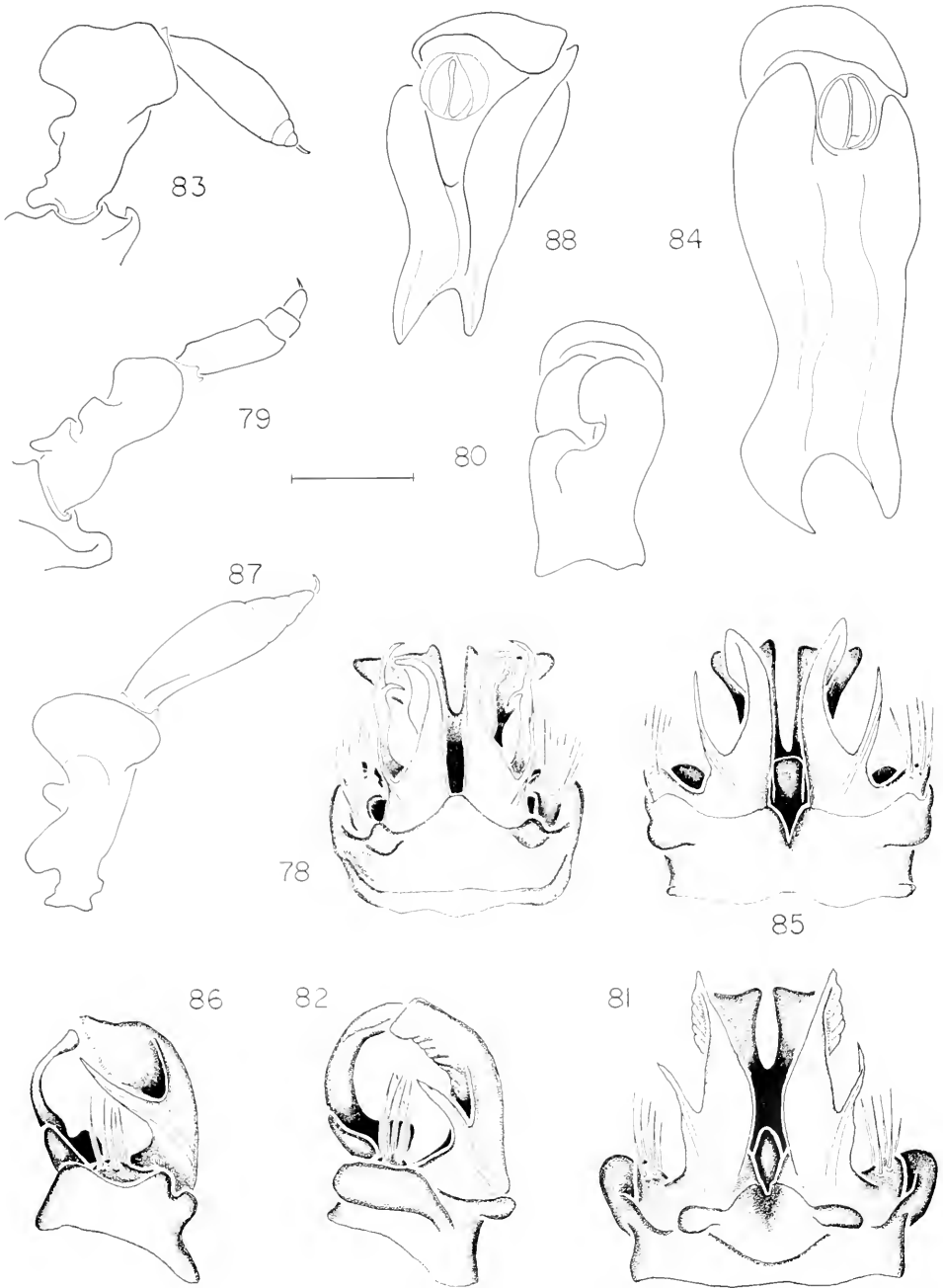

Figures 78-88. Anatomy of *Pseudatreimia* spp. Figs. 78-80. *P. lethe*. Fig. 78. Anterior gonopods, anterior view. Fig. 79. Right posterior gonopod, anterior view. Fig. 80. Right cyphopod, ventral view. Figs. 81-84. *P. cercops*. Fig. 81. Anterior gonopods, anterior view. Fig. 82. Left anterior gonopod, lateral view. Fig. 83. Right posterior gonopod, anterior view. Fig. 84. Right cyphopod, ventral view. Figs. 85-88. *P. lictor*. Fig. 85. Anterior gonopods, anterior view. Fig. 86. Left anterior gonopod, lateral view. Fig. 87. Right posterior gonopod, anterior view. Fig. 88. Right cyphopod, ventral view. Scale lines = 0.5 mm for anterior and posterior gonopods, 0.25 mm for cyphopods.

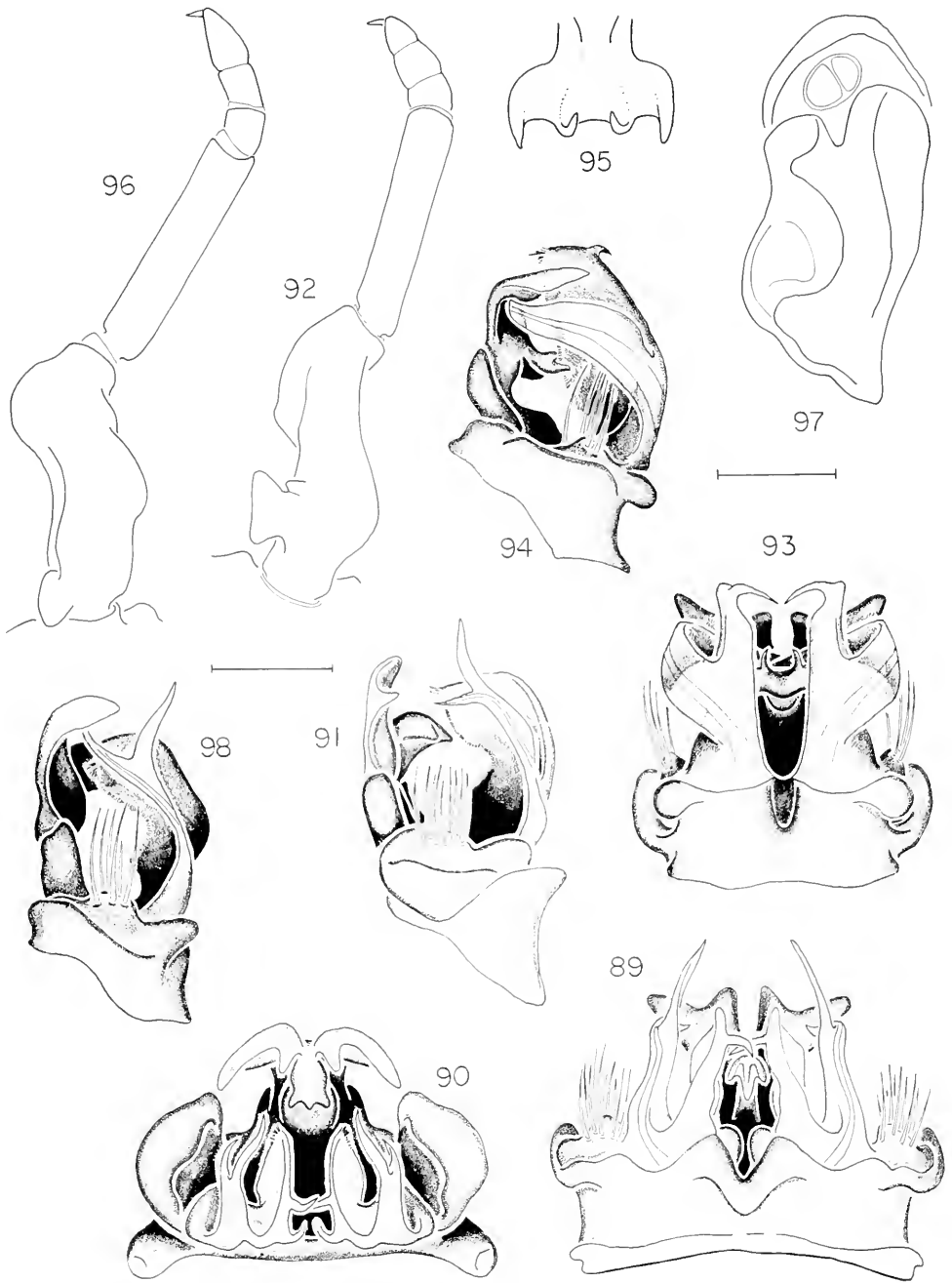

Figures 89–98. Anatomy of *Pseudatrema* spp. Figs. 89–92. *P. scrutarum*. Fig. 89. Anterior gonopods, anterior view. Fig. 90. Anterior gonopods, ventral view. Fig. 91. Left anterior gonopod, lateral view. Fig. 92. Right posterior gonopod, anterior view. Figs. 93–97. *P. minos*. Fig. 93. Anterior gonopods, anterior view. Fig. 94. Left anterior gonopod, lateral view. Fig. 95. Telopodite process of gonopods, ventral view. Fig. 96. Right posterior gonopod, anterior view. Fig. 97. Right cyphopod, ventral view. Fig. 98. Left anterior gonopod of *P. cacytus*, lateral view. Scale lines = 0.5 mm for anterior and posterior gonopods, 0.25 mm for cyphopods.

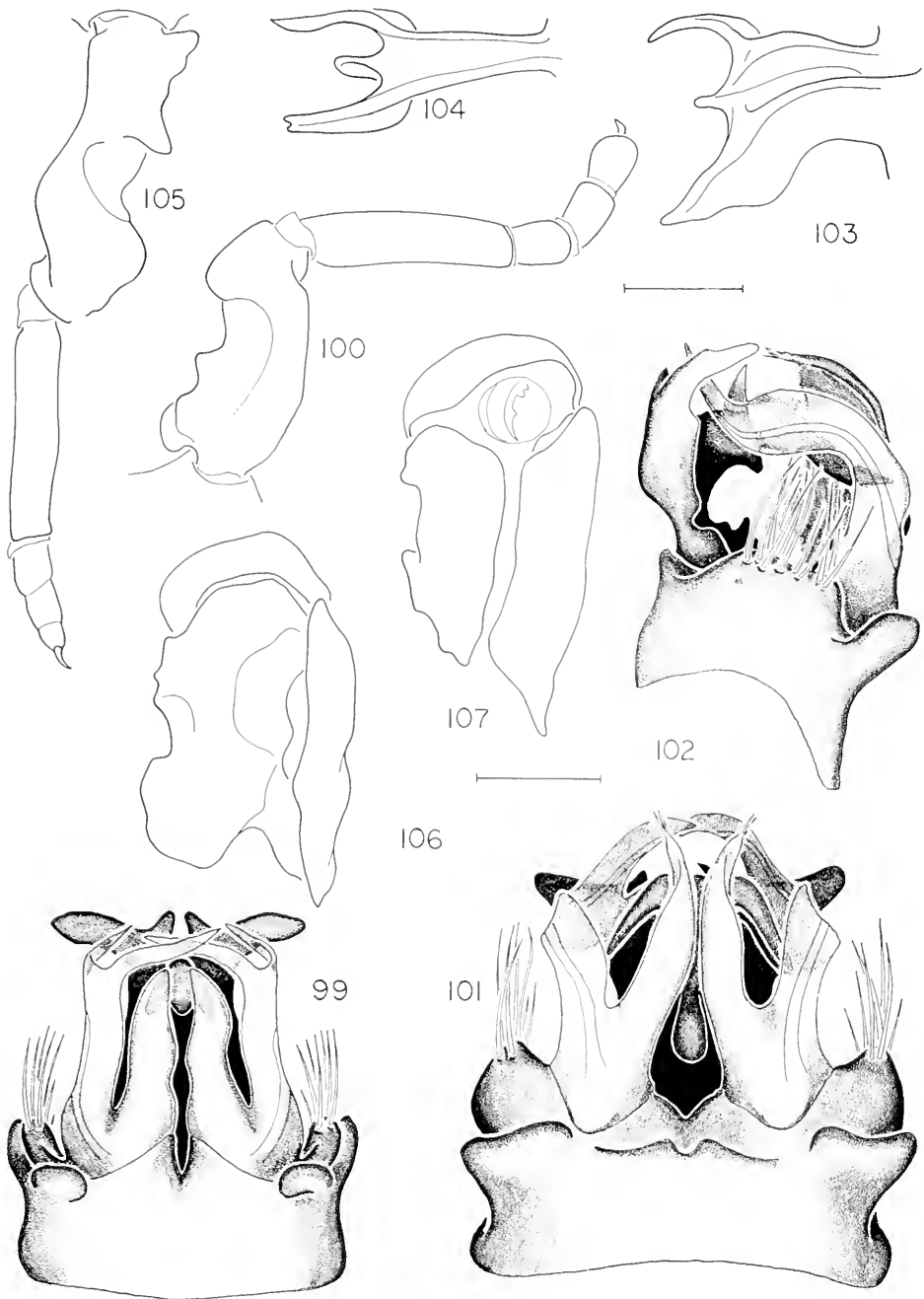

Figures 99–107. Anatomy of *Pseudotremia* spp. Figs. 99–100. *P. cocytus*. Fig. 99. Anterior gonopods, anterior view. Fig. 100. Right posterior gonopod, anterior view. Figs. 101–107. *P. cottus*. Fig. 101. Anterior gonopods, anterior view. Fig. 102. Left anterior gonopod, lateral view. Figs. 103–104. Telopodite processes of gonopods, ventrolateral views. Fig. 103. Specimen from Cade's Cove. Fig. 104. Specimen from Corden Cave. Fig. 105. Right posterior gonopod, anterior view. Figs. 106–107. Right cyphopods, ventral views. Fig. 106. Specimen from Cade's Cove. Fig. 107. Specimen from Walker's Cave. Scale lines = 0.5 mm for anterior and posterior gonopods, 0.25 mm for cyphopods.

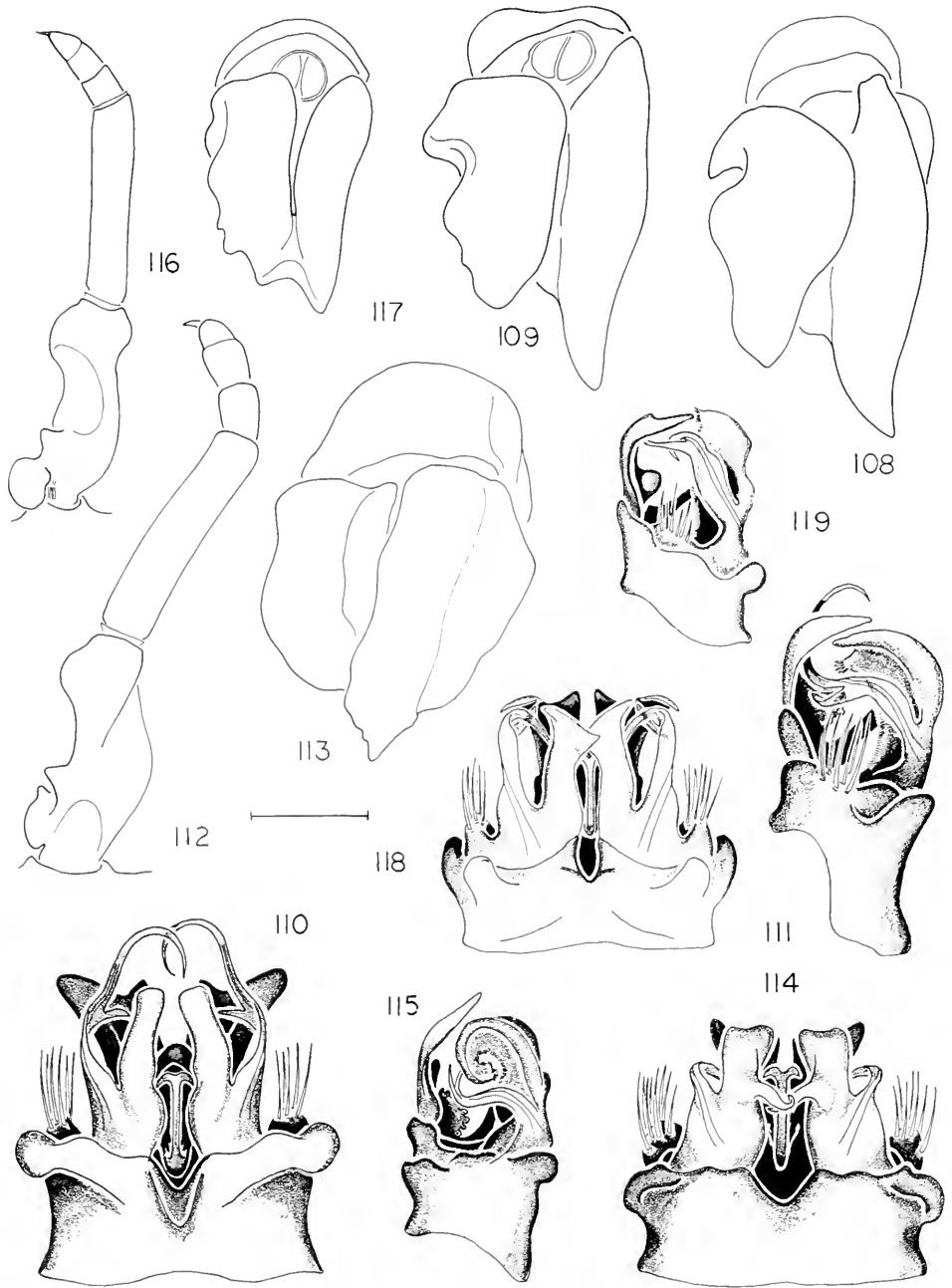

Figures 108–119. Anatomy of *Pseudotrema* spp. Figs. 108–109. *P. cottus*, right cyphopods, ventral views. Fig. 108. Specimen from Carden's Cove. Fig. 109. Specimen from Quarry Cove #1. Figs. 110–113. *P. tuberculata*. Fig. 110. Anterior gonopods, anterior view. Fig. 111. Left anterior gonopod, lateral view. Fig. 112. Right posterior gonopod, anterior view. Fig. 113. Right cyphopod, ventral view. Figs. 114–117. *P. momus*. Fig. 114. Anterior gonopods, anterior view. Fig. 115. Left anterior gonopod, setae omitted, lateral view. Fig. 116. Right posterior gonopod, anterior view. Fig. 117. Right cyphopod, ventral view. Figs. 118–119. *P. armesi*. Fig. 118. Anterior gonopod, anterior view. Fig. 119. Left anterior gonopod, lateral view. Scale lines = 0.5 mm for anterior and posterior gonopods, 0.25 mm for cyphopods.

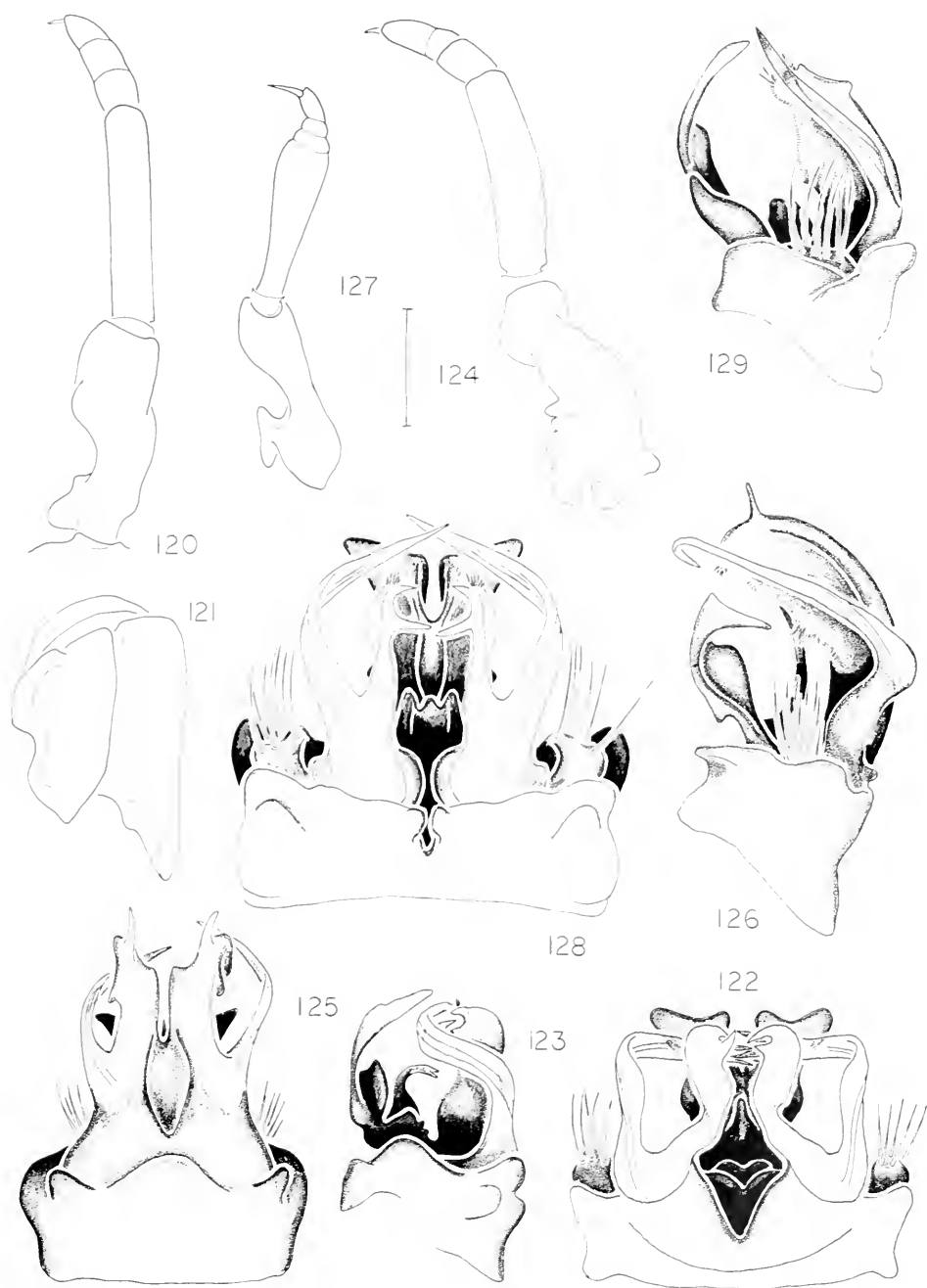

Figures 120–129. Anatomy of *Pseudotremia* spp. Figs. 120–121. *P. ormesi*. Fig. 120. Right posterior gonopod, anterior view. Fig. 121. Right cyphopod, ventral view. Figs. 122–124. *P. alecto*. Fig. 122. Anterior gonopods, anterior view. Fig. 123. Left anterior gonopod, setae omitted, lateral view. Fig. 124. Right posterior gonopod, anterior view. Figs. 125–127. *P. lusciosa*. Fig. 125. Anterior gonopods, anterior view. Fig. 126. Left anterior gonopod, lateral view. Fig. 127. Right posterior gonopod, anterior view. Figs. 128–129. *P. simulans*, specimen from marsh near Franklin, W. Va. Fig. 128. Anterior gonopods, anterior view. Fig. 129. Left anterior gonopod, lateral view. Scale lines = 0.5 mm for anterior and posterior gonopods, 0.25 mm for cyphopods.

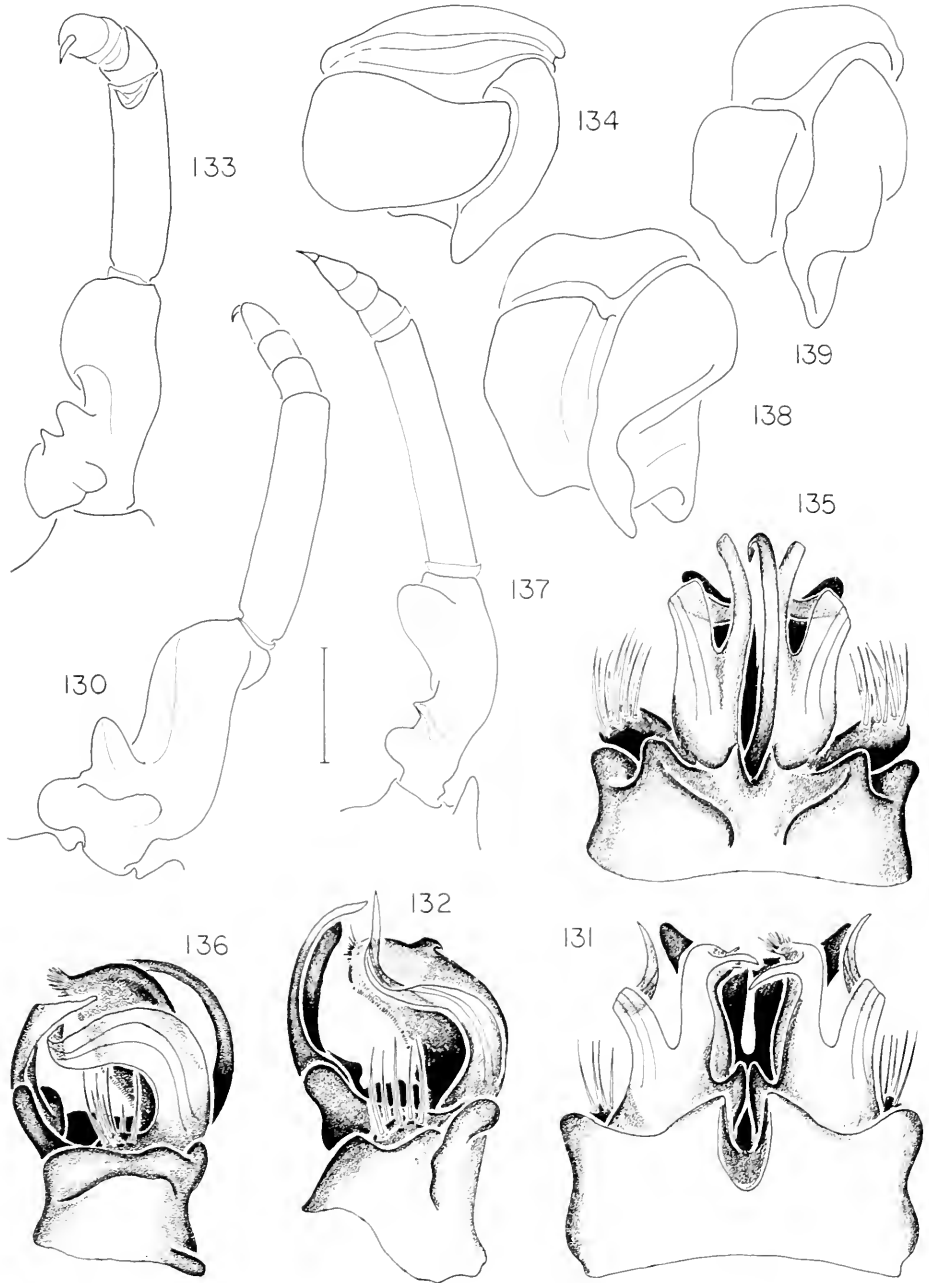

Figures 130–139. Anatomy of *Pseudotremia* spp. Fig. 130. Right posterior gonopod of *P. simulans* from marsh near Franklin, W. Va., anterior view. Figs. 131–134. *P. simulans*, holotype. Fig. 131. Anterior gonopods, anterior view. Fig. 132. Left anterior gonopod, lateral view. Fig. 133. Right posterior gonopod, anterior view. Fig. 134. Right cyphopod, paratype, ventral view. Figs. 135–139. *P. fulgida*. Fig. 135. Anterior gonopods, anterior view. Fig. 136. Left anterior gonopod, lateral view. Fig. 137. Right posterior gonopod, anterior view. Fig. 138. Right cyphopod, ventral view. Fig. 139. Right cyphopod of another specimen from the same locality, ventral view. Scale lines = 0.5 mm for anterior and posterior gonopods, 0.25 mm for cyphopods.

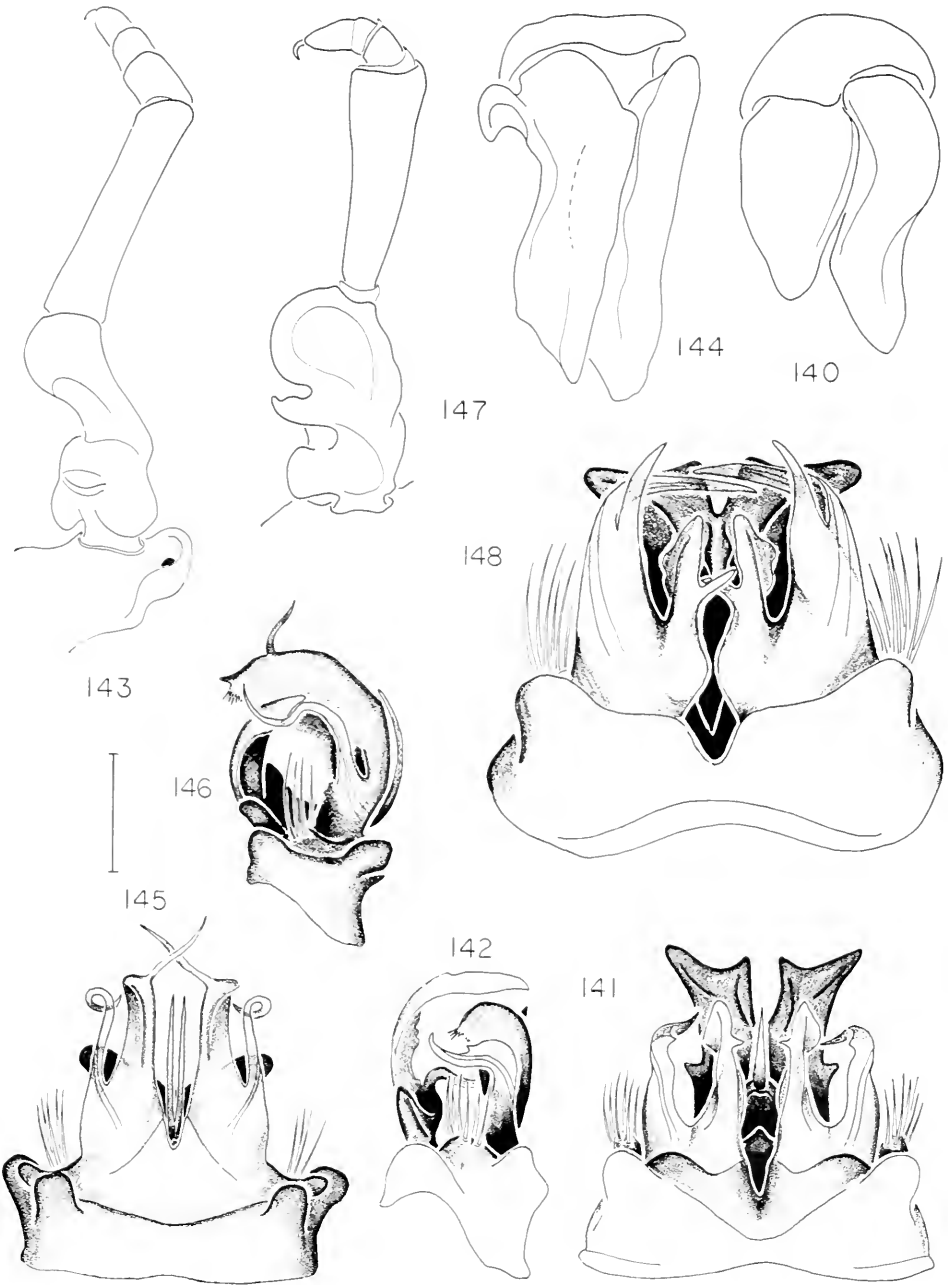

Figures 140-148. Anatomy of *Pseudotremia* spp. Fig. 140. Right cyphopod of specimen of *P. fulgida* from some locality as those shown in Figs. 138 and 139, ventral view. Figs. 141-144. *P. carterensis*. Fig. 141. Anterior gonopods, anterior view. Fig. 142. Left anterior gonopod, lateral view. Fig. 143. Right posterior gonopod, anterior view. Fig. 144. Right cyphopod, ventral view. Figs. 145-147. *P. deprehendar*. Fig. 145. Anterior gonopods, anterior view. Fig. 146. Left anterior gonopod, lateral view. Fig. 147. Right posterior gonopod, anterior view. Fig. 148. Anterior gonopods, of *P. princeps*, anterior view. Scale lines = 0.5 mm for anterior and posterior gonopods, 0.25 mm for cyphopods.

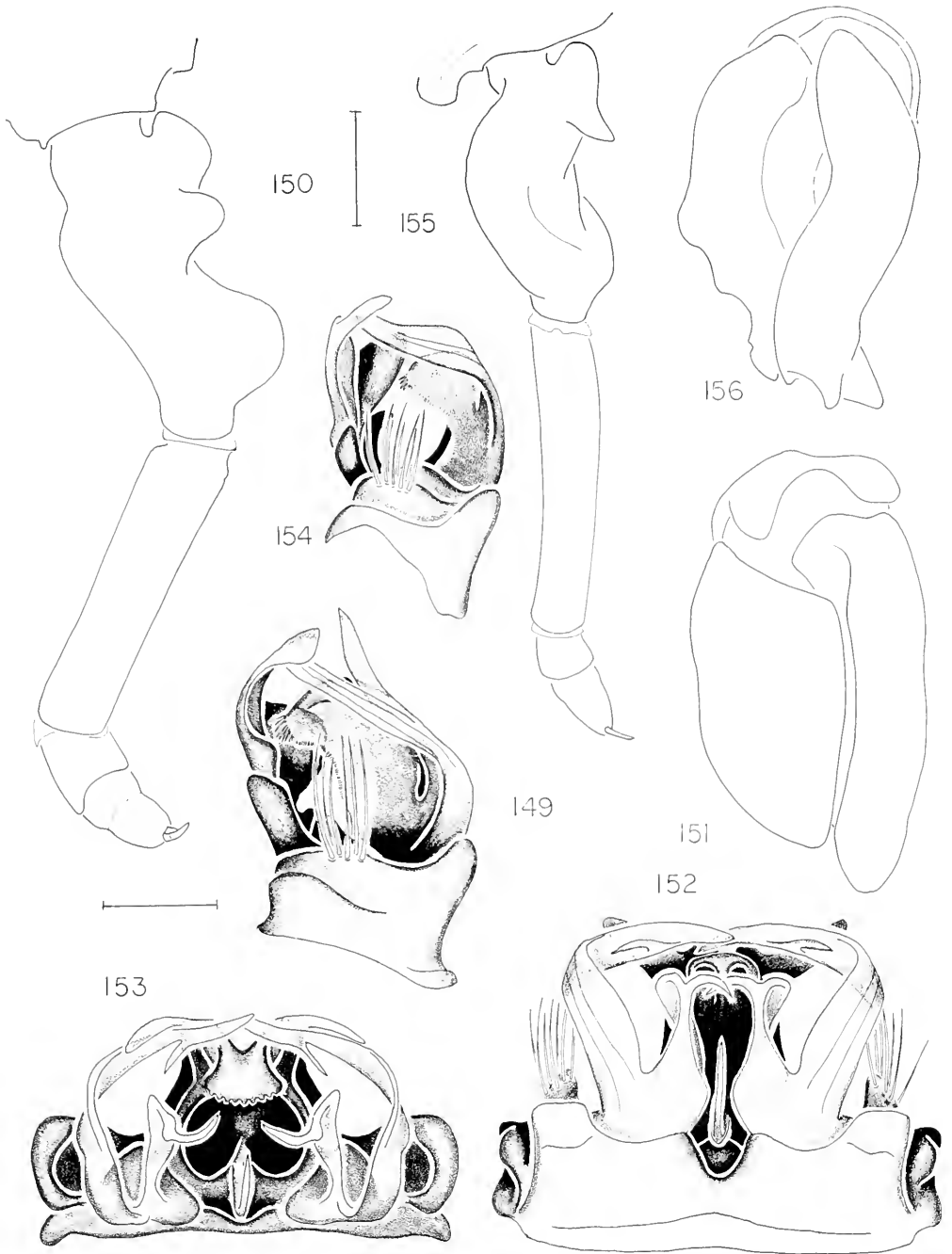

Figures 149–156. Anatomy of *Pseudotremia* spp. Figs. 149–151. *P. princeps*. Fig. 149. Left anterior gonopod, lateral view. Fig. 150. Right posterior gonopod, anterior view. Fig. 151. Right cyphopod, ventral view. Figs. 152–156. *P. tsuga*. Fig. 152. Anterior gonopods, anterior view. Fig. 153. Anterior gonopods, ventral view. Fig. 154. Left anterior gonopod, lateral view. Fig. 155. Right posterior gonopod, anterior view. Fig. 156. Right cyphopod, ventral view. Scale lines = 0.5 mm for anterior and posterior gonopods, 0.25 mm for cyphopods.

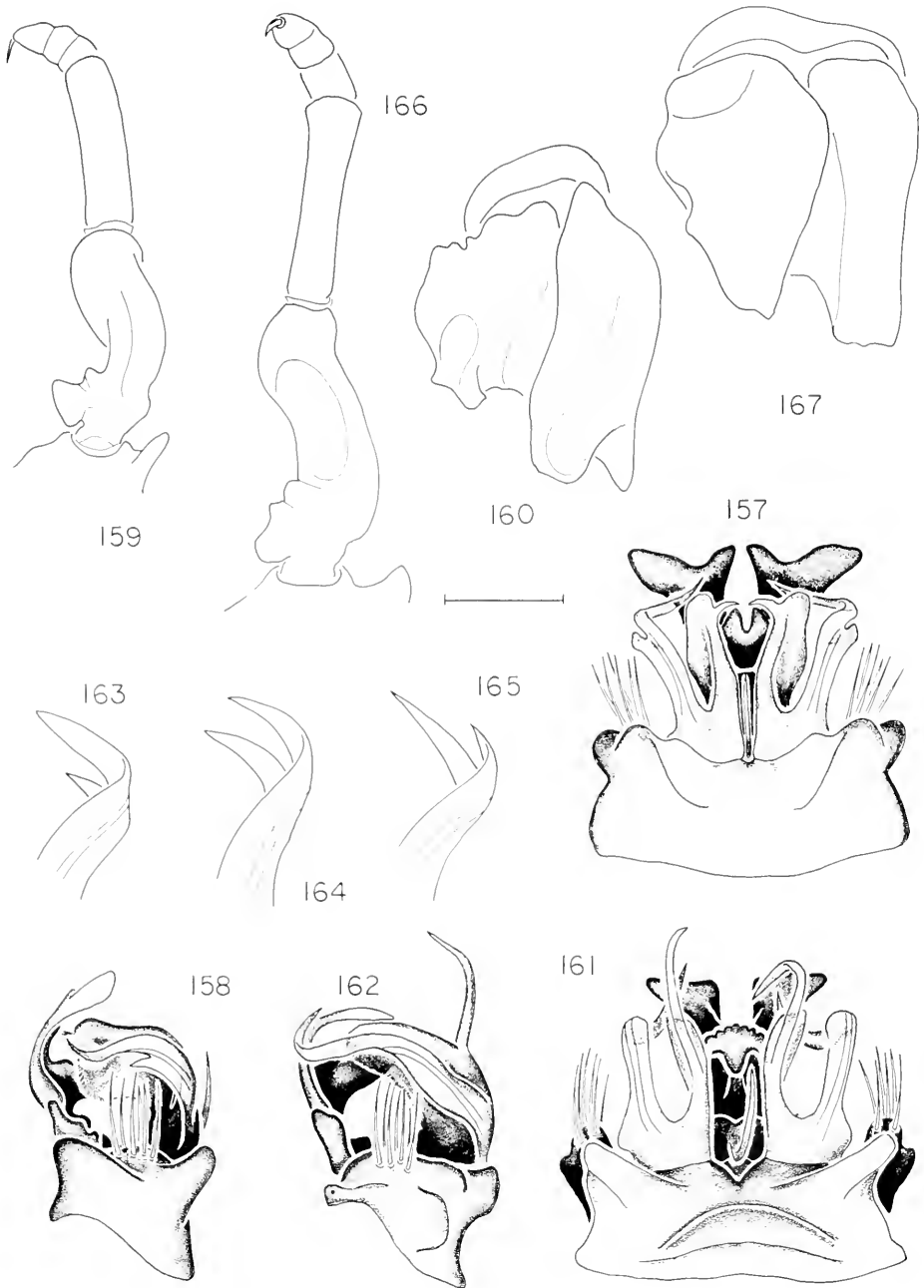

Figures 157-167. Anatomy of *Pseudotremia* spp. Figs. 157-160. *P. cavernarum*. Fig. 157. Anterior gonopods, anterior view. Fig. 158. Left anterior gonopod, lateral view. Fig. 159. Right posterior gonopod, anterior view. Fig. 160. Right cyphopod, ventral view. Figs. 161-167. *P. hobbsi*. Fig. 161. Anterior gonopods, anterior view. Fig. 162. Left anterior gonopod, lateral view. Figs. 163-165. Tips of lateral colpocoxites of gonopods, lateral view. Fig. 163. Specimen from Higgenbotham Cove. Fig. 164. Specimen from Rock Camp Cave. Fig. 165. Specimen from Laurel Creek Cave system. Fig. 166. Right posterior gonopod, anterior view. Fig. 167. Right cyphopod of specimen from Warm Springs Mtn., ventral view. Scale lines = 0.5 mm for anterior and posterior gonopods, 0.25 mm for cyphopods.

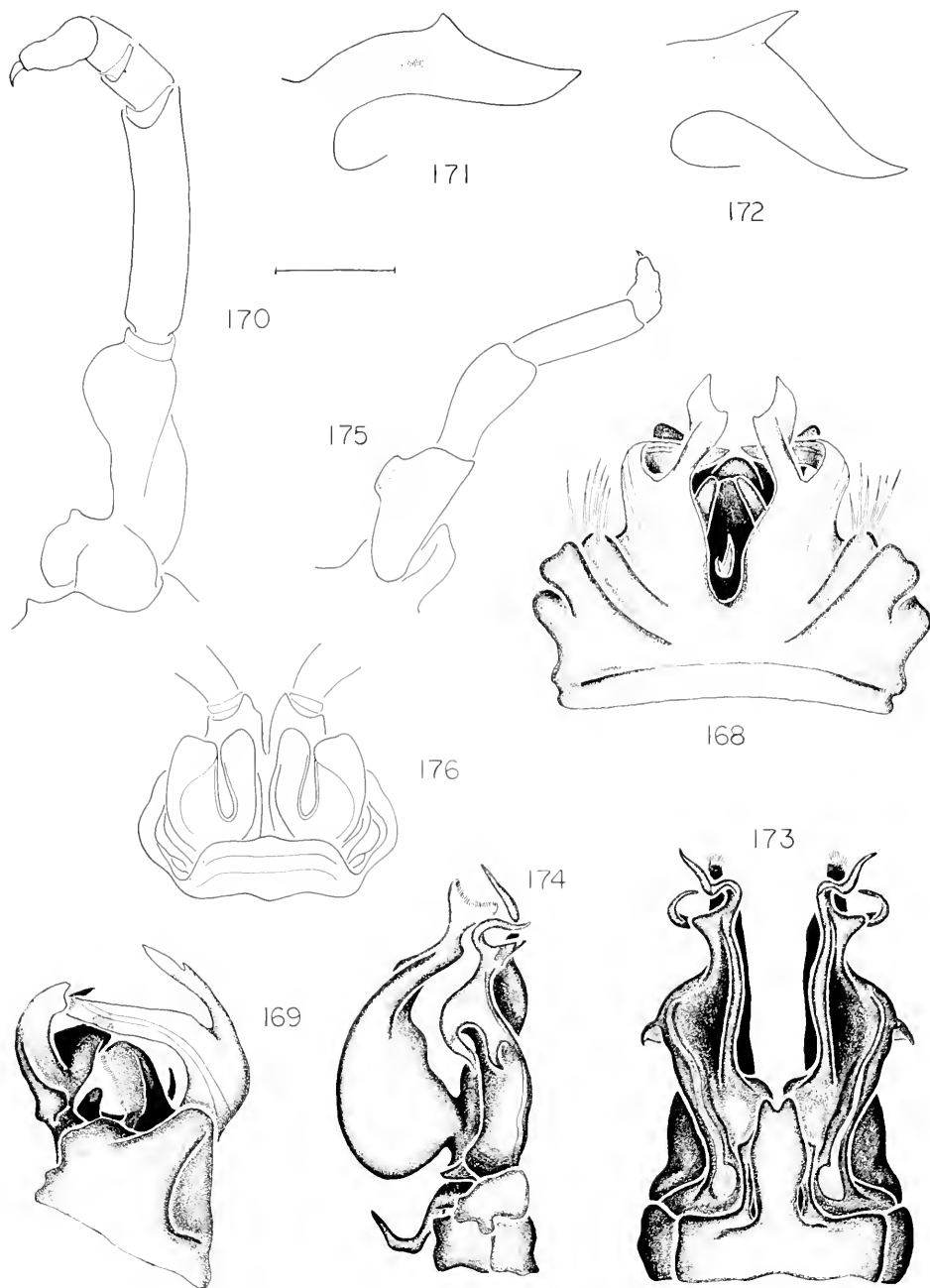

Figures 168–176. Anatomy of *Pseudotremia* and *Salaenogana* spp. Figs. 168–170. *Pseudotremia sublevis*. Fig. 168. Anterior gonopods, anterior view. Fig. 169. Left anterior gonopod, lateral view. Fig. 170. Right posterior gonopod, anterior view. Figs. 171–172. Ventral branches of lateral calpacoxites of gonopods. Fig. 171. Halotype. Fig. 172. Specimen from near Newport, Va. Figs. 173–176. *Salaenogana guatemalana*. Fig. 173. Anterior gonopods, anterior view. Fig. 174. Left anterior gonopod, lateral view. Fig. 175. Right posterior gonopod, anterior view. Fig. 176. Cyphopads, posterior view. Scale lines = 0.5 mm for anterior and posterior gonopods, 0.25 mm for cyphopads.

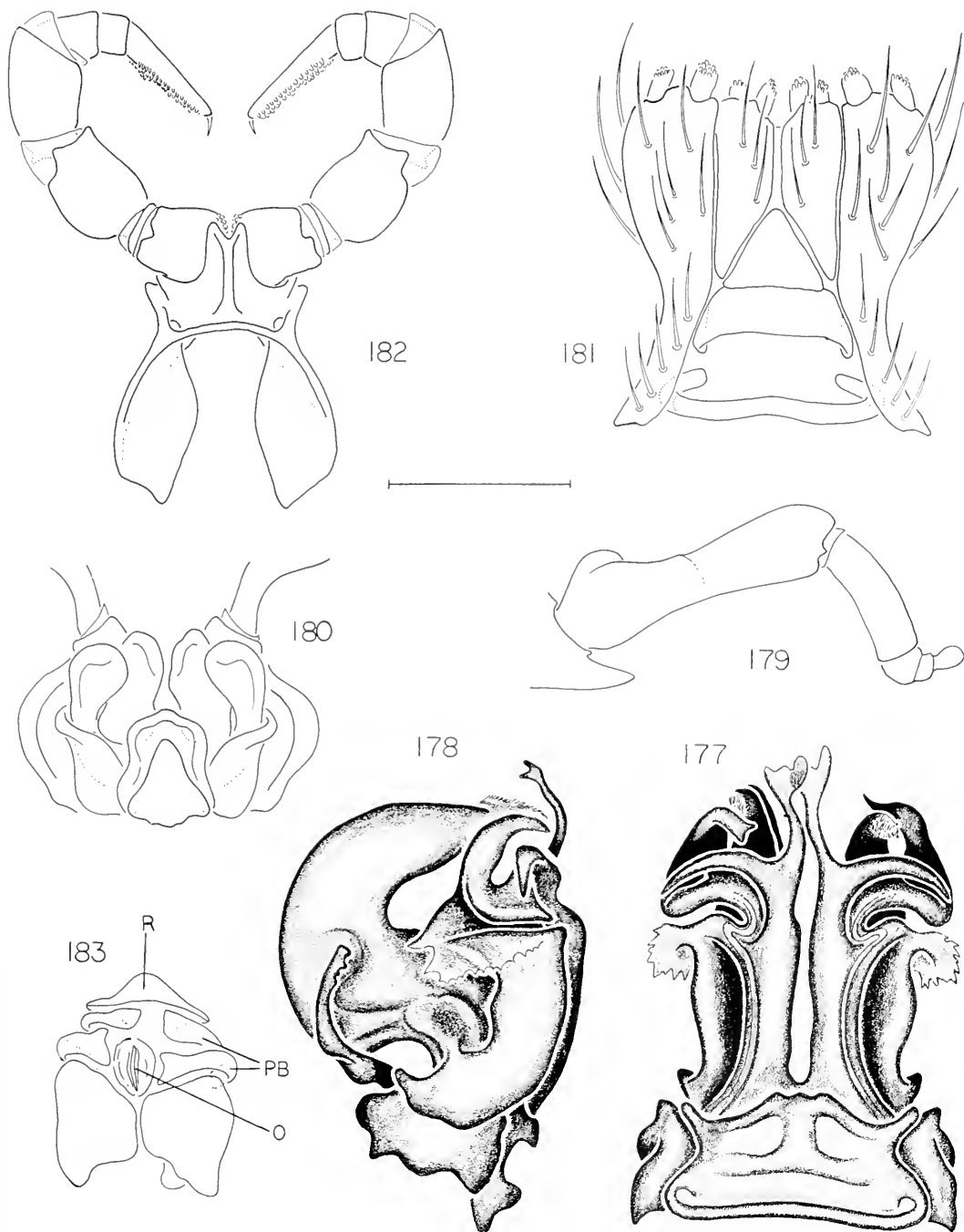

Figures 177-183. Anatomy of *Solænogona* and *Cleidogona* spp. Figs. 177-180. *Solænogona chiopos*. Fig. 177. Anterior gonopods, anterior view. Fig. 178. Left anterior gonopod, lateral view. Fig. 179. Right posterior gonopod, anterior view. Fig. 180. Cyphopods, posterior view. Figs. 181-183. *Cleidogona major*. Fig. 181. Gnathochilarium, ventral view. Fig. 182. Legpair seven, anterior view. Fig. 183. Left cyphopods, ventral view. Scale line = 1.00 mm for Figs. 177-179, 182, 0.50 mm for Figs. 180, 181, 183.

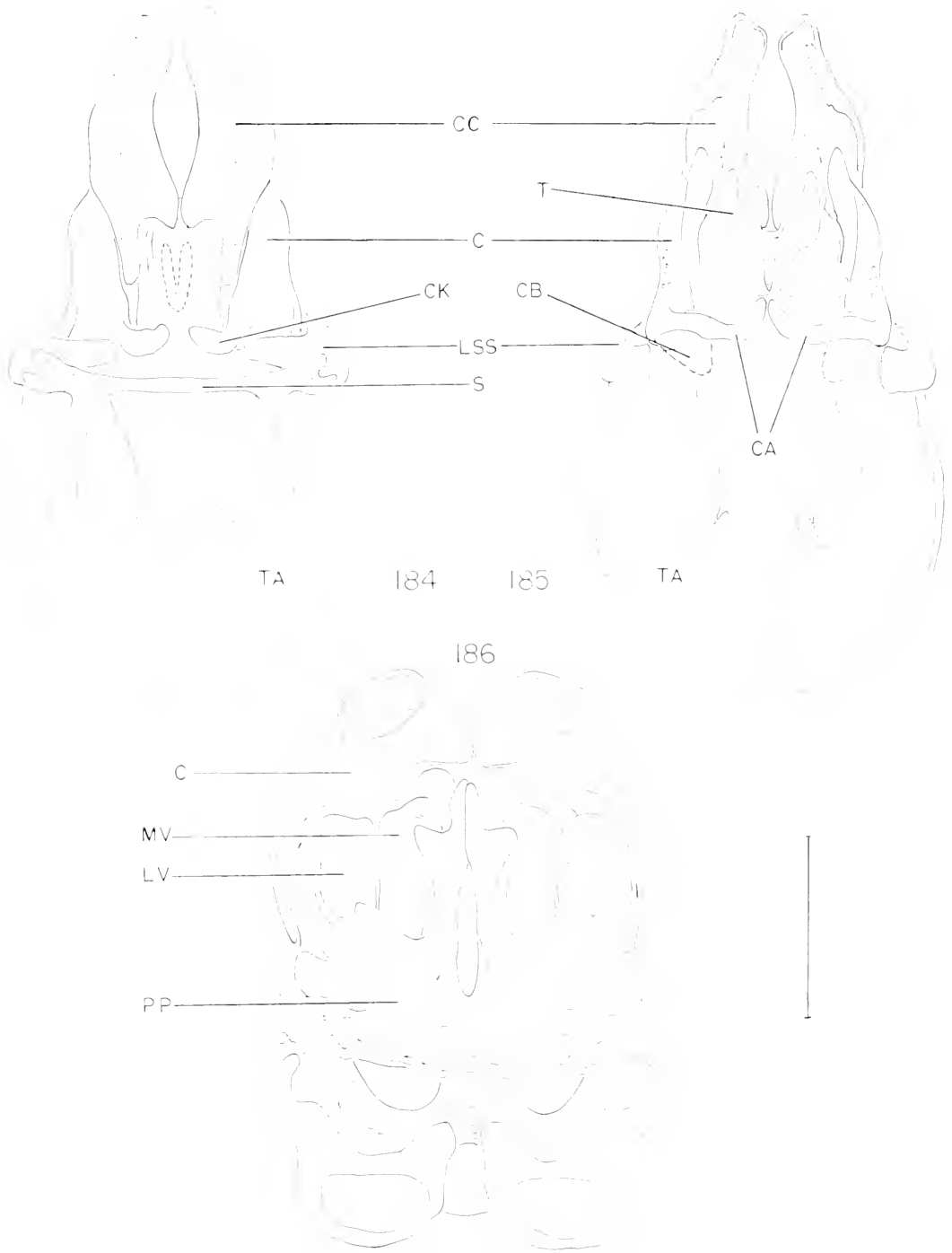

Figures 184-186. Anatomy of *Cleidegona major*. Fig. 184. Anterior gonopods, anterior view. Fig. 185. Anterior gonopods, posterior view. Fig. 186. Cyphopods, ventroposterior view. Scale line = 0.5 mm.

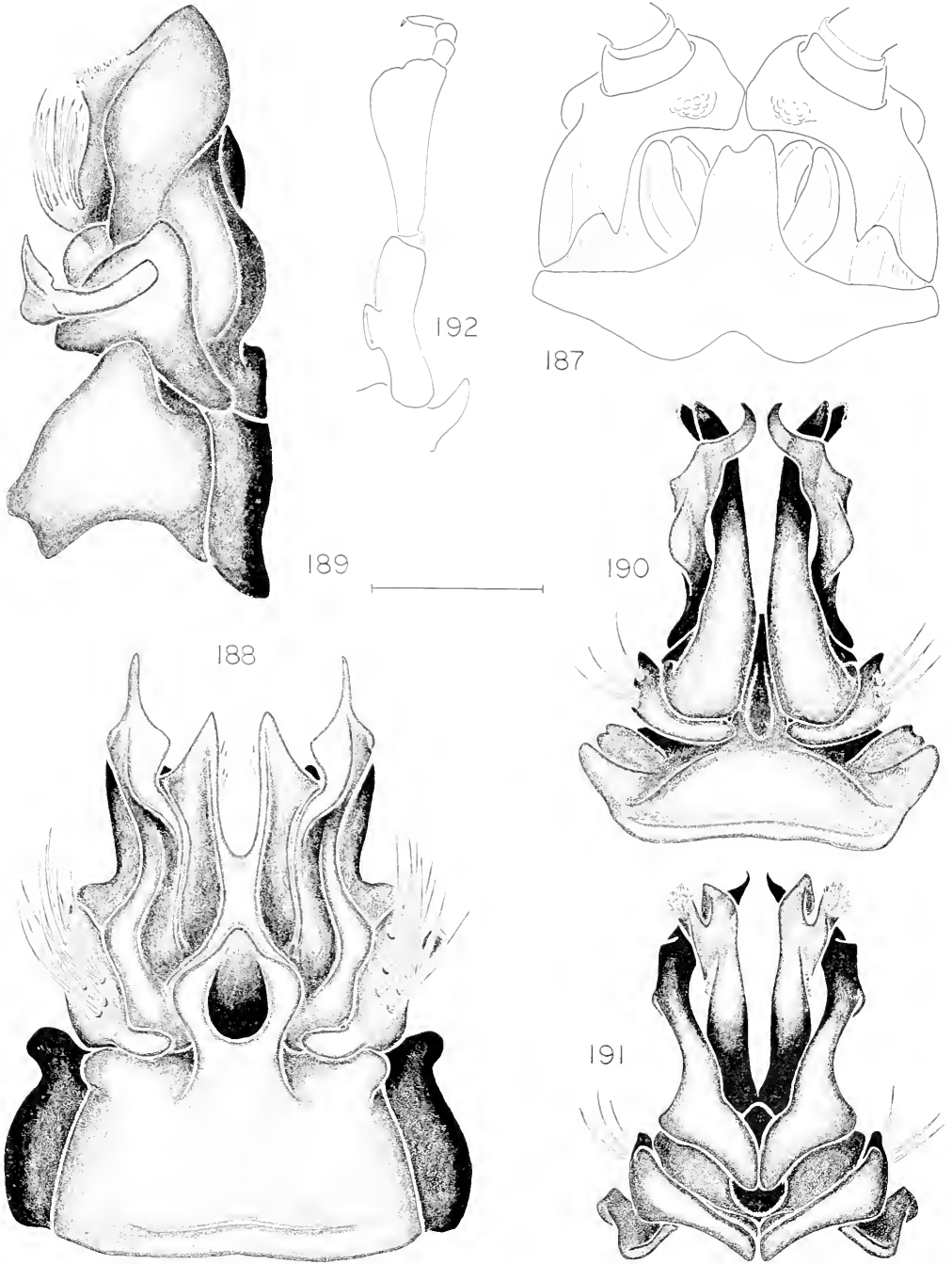

Figures 187-192. Anatomy of *Cleidogona* spp. Fig. 187. *C. mexicana*, cyphopods, posterior view. Figs. 188-189. *C. ceibana*. Fig. 188. Anterior gonopods, anterior view. Fig. 189. Left anterior gonopod, lateral view. Figs. 190-192. *C. forficula*. Fig. 190. Anterior gonopods, anterior view. Fig. 191. Anterior gonopods, posterior view. Fig. 192. Right posterior gonopod, anterior view. Scale line = 0.25 mm for Figs. 188, 189; 0.45 mm for Figs. 190, 191; 0.75 mm for Fig. 192; 0.35 mm for Fig. 187.

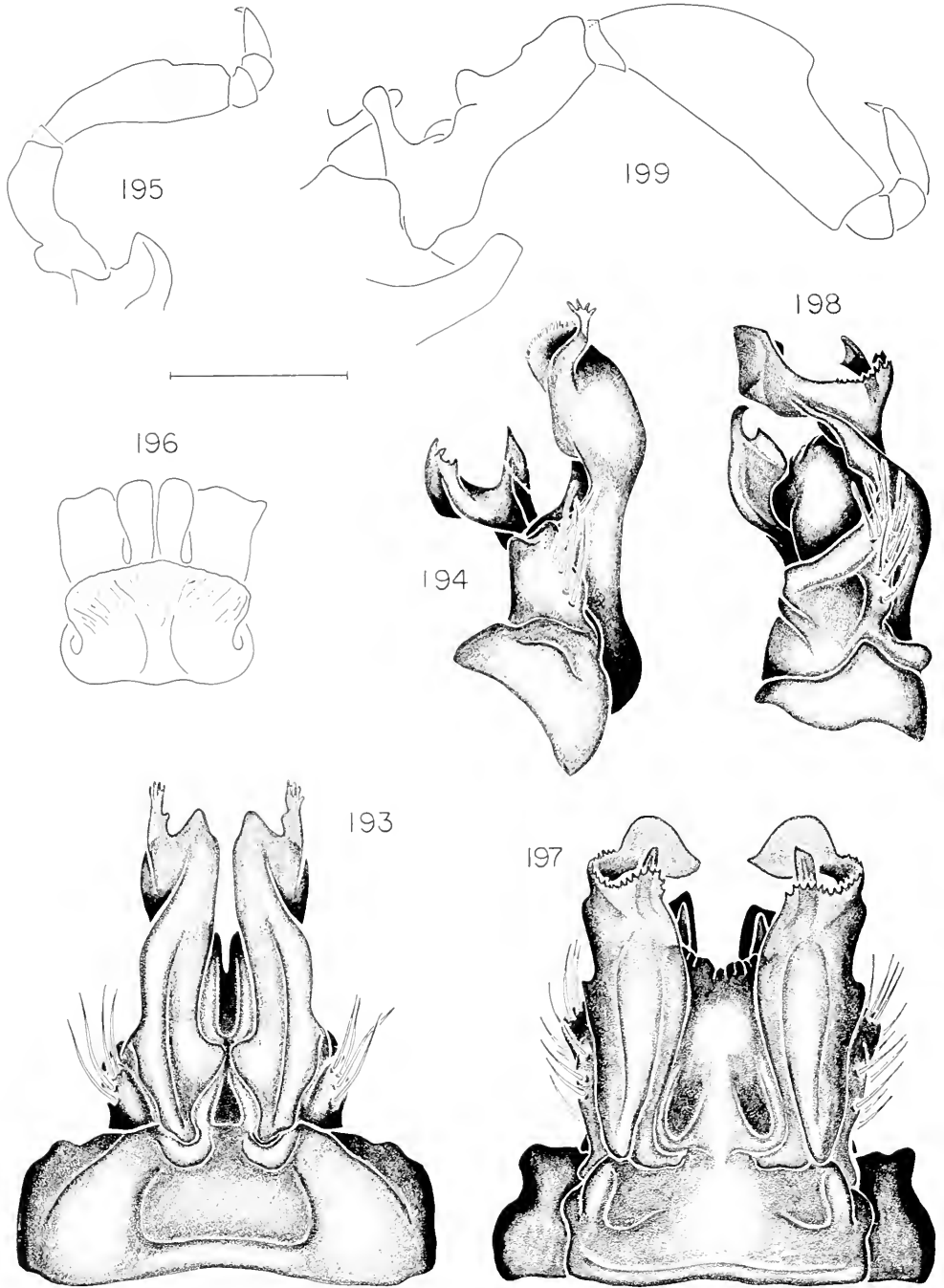

Figures 193–199. Anatomy of *Cleidogona* spp. Figs. 193–196. *C. crucis*. Fig. 193. Anterior gonopods, anterior view. Fig. 194. Left anterior gonopod, lateral view. Fig. 195. Right posterior gonopod, anterior view. Fig. 196. Cyphopods, posterior view. Figs. 197–199. *C. baroqua*. Fig. 197. Anterior gonopods, anterior view. Fig. 198. Left anterior gonopod, lateral view. Fig. 199. Right posterior gonopod, anterior view. Scale line = 0.50 mm for Figs. 193, 194; 0.35 mm for Fig. 196; 0.90 mm for Figs. 195, 197–199.

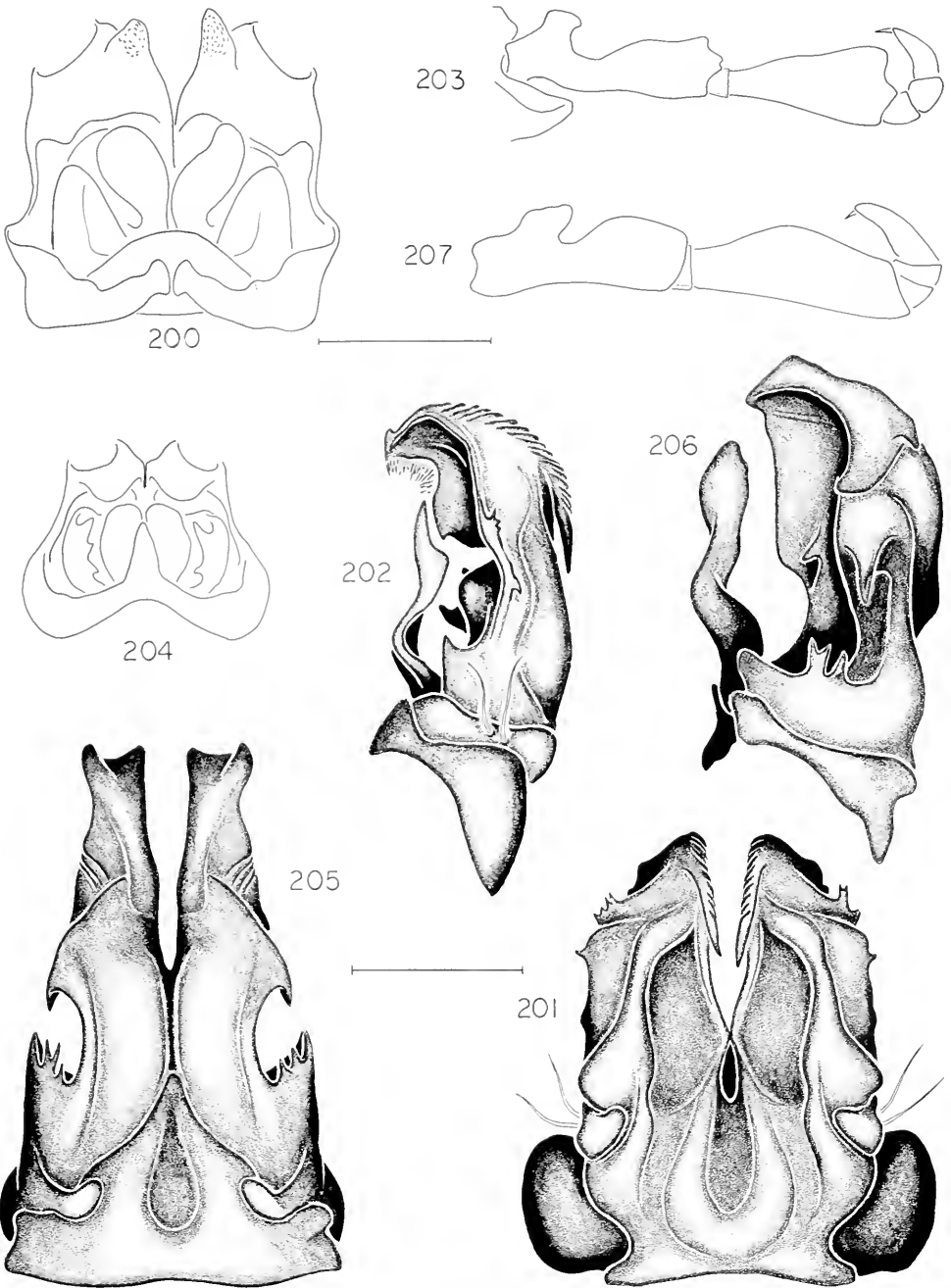

Figures 200–207. Anatomy of *Cleidogana* spp. Fig. 200. *C. boroqua*. Cyphopods, posterior view. Figs. 201–204. *C. gucumatz*. Fig. 201. Anterior gonopods, anterior view. Fig. 202. Left anterior gonopod, lateral view. Fig. 203. Right posterior gonopod, anterior view. Fig. 204. Cyphopods, posterior view. Figs. 205–207. *C. chantala*. Fig. 205. Anterior gonopods, anterior view. Fig. 206. Left anterior gonopod, anterior view. Fig. 207. Right posterior gonopod, anterior view. Scale line = 0.90 mm for Figs. 200, 204; 0.50 mm for Figs. 201, 202, 205, 206; 0.75 mm for Figs. 203, 207.

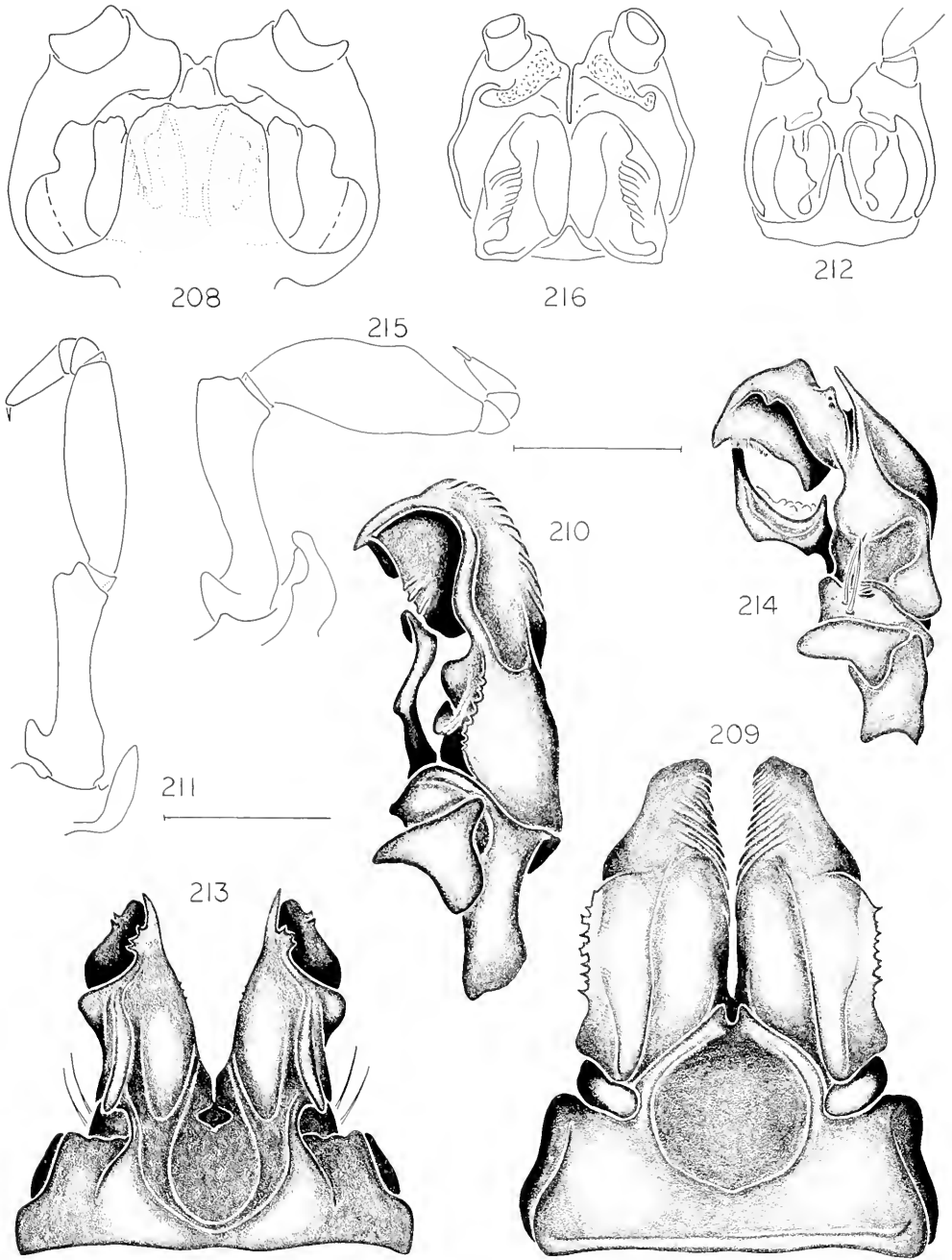

Figures 208–216. Anatomy of *Cleidogono* spp. Fig. 208. *C. chonta'a*, cyphopods, posterior view. Figs. 209–212. *C. mixteca*. Fig. 209. Anterior gonopods, anterior view. Fig. 210. Left anterior gonopod, lateral view. Fig. 211. Right posterior gonopod, anterior view. Fig. 212. Cyphopods, posterior view. Figs. 213–216. *C. chacmool*. Fig. 213. Anterior gonopods, anterior view. Fig. 214. Left anterior gonopod, lateral view. Fig. 215. Right posterior gonopod, anterior view. Fig. 216. Cyphopods, ventral view. Scale line = 0.90 mm for Figs. 213, 214, 216; 0.75 mm for Figs. 211, 212, 215; 0.45 mm for Figs. 208–210.

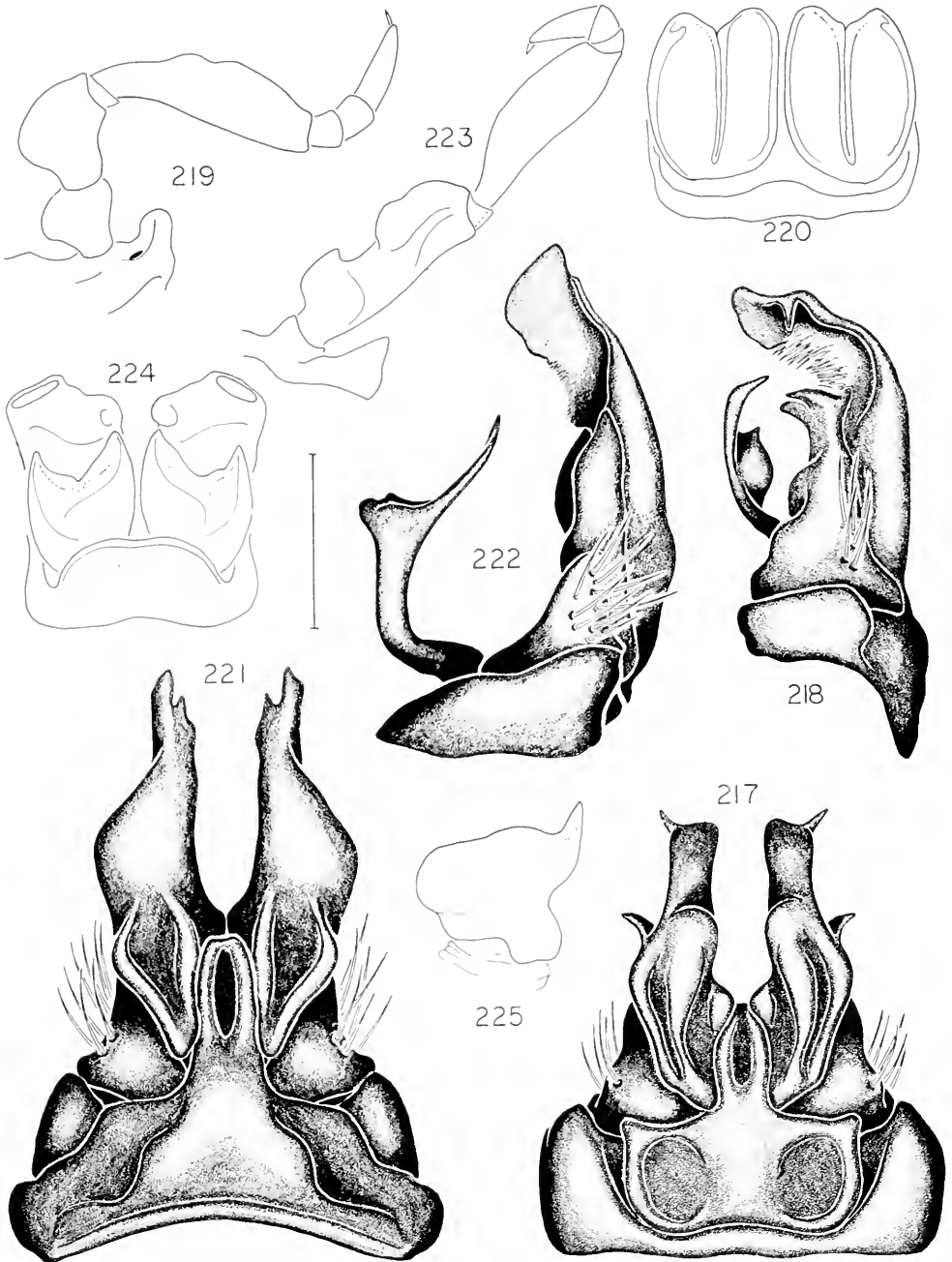

Figures 217-225. Anatomy of *Cleidogona* spp. Figs. 217-220. *C. crystallina*. Fig. 217. Anterior gonopods, anterior view. Fig. 218. Left anterior gonopod, lateral view. Fig. 219. Right posterior gonopod, anterior view. Fig. 220. Cyphopods, posterior view. Figs. 221-225. *C. pecki*. Fig. 221. Anterior gonopods, anterior view. Fig. 222. Left anterior gonopod, lateral view. Fig. 223. Right posterior gonopod, anterior view. Fig. 224. Cyphopods, posterior view. Fig. 225. Lateral valve of right cyphopod, lateral view. Scale line = 0.50 mm for anterior gonopods, 0.90 mm for posterior gonopods, 0.35 mm for cyphopods.

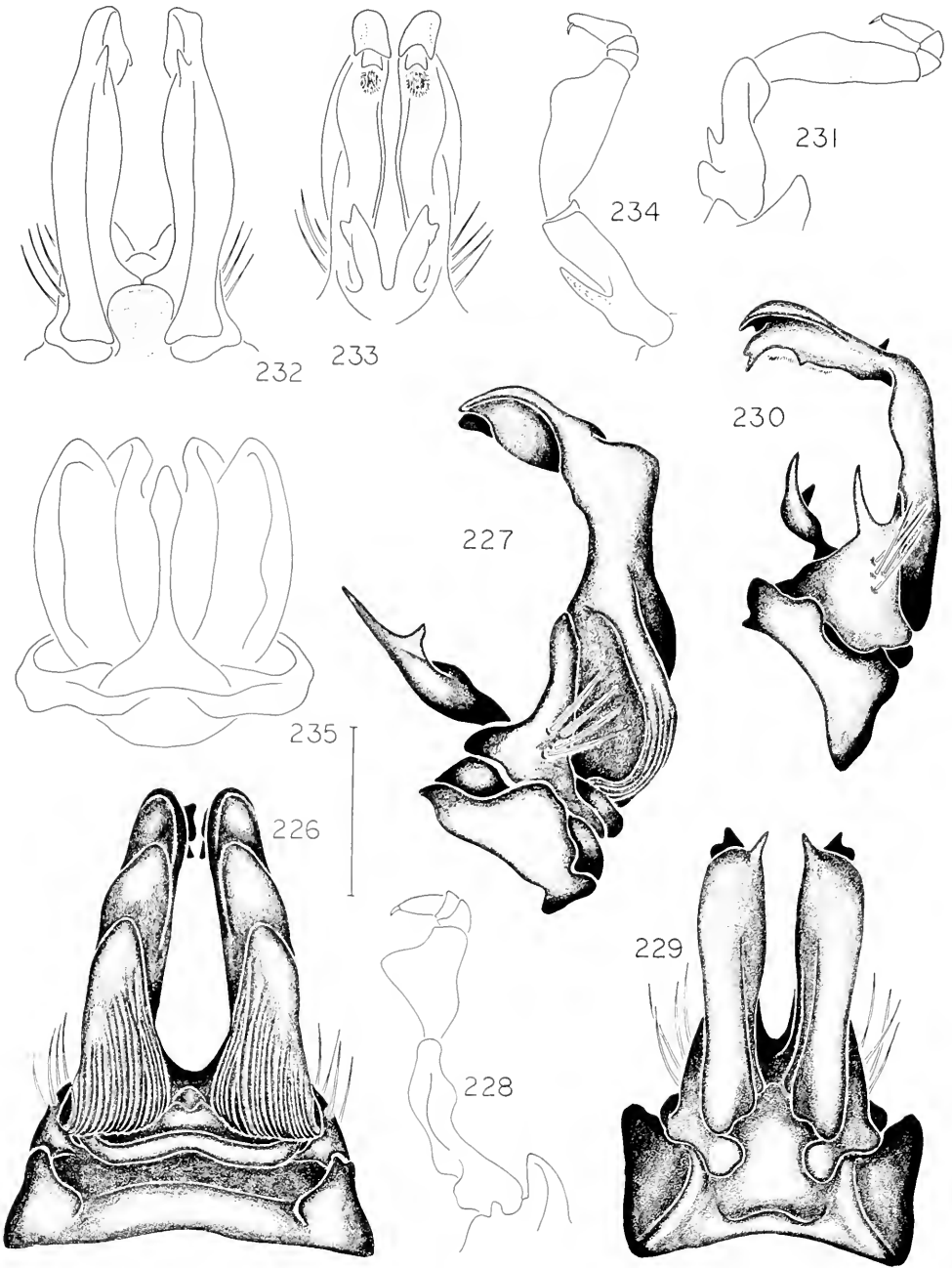

Figures 226–235. Anatomy of *Cleidogana* spp. Figs. 226–228. *C. maculata*. Fig. 226. Anterior gonopods, anterior view. Fig. 227. Left anterior gonopod, lateral view. Fig. 228. Right posterior gonopod, anterior view. Figs. 229–231. *C. tizac*. Fig. 229. Anterior gonopods, lateral view. Fig. 230. Left anterior gonopod, lateral view. Fig. 231. Posterior gonopod, anterior view. Figs. 232–235. *C. zimopaniensis*. Fig. 232. Anterior gonopods, anterior view. Fig. 233. Anterior gonopods, posterior view. Fig. 234. Right posterior gonopod, anterior view. Fig. 235. Cyphopods, posterior view. Scale line = 0.50 mm for Figs. 226–230; 0.90 mm for Fig. 231; 0.45 mm for Figs. 232–235.

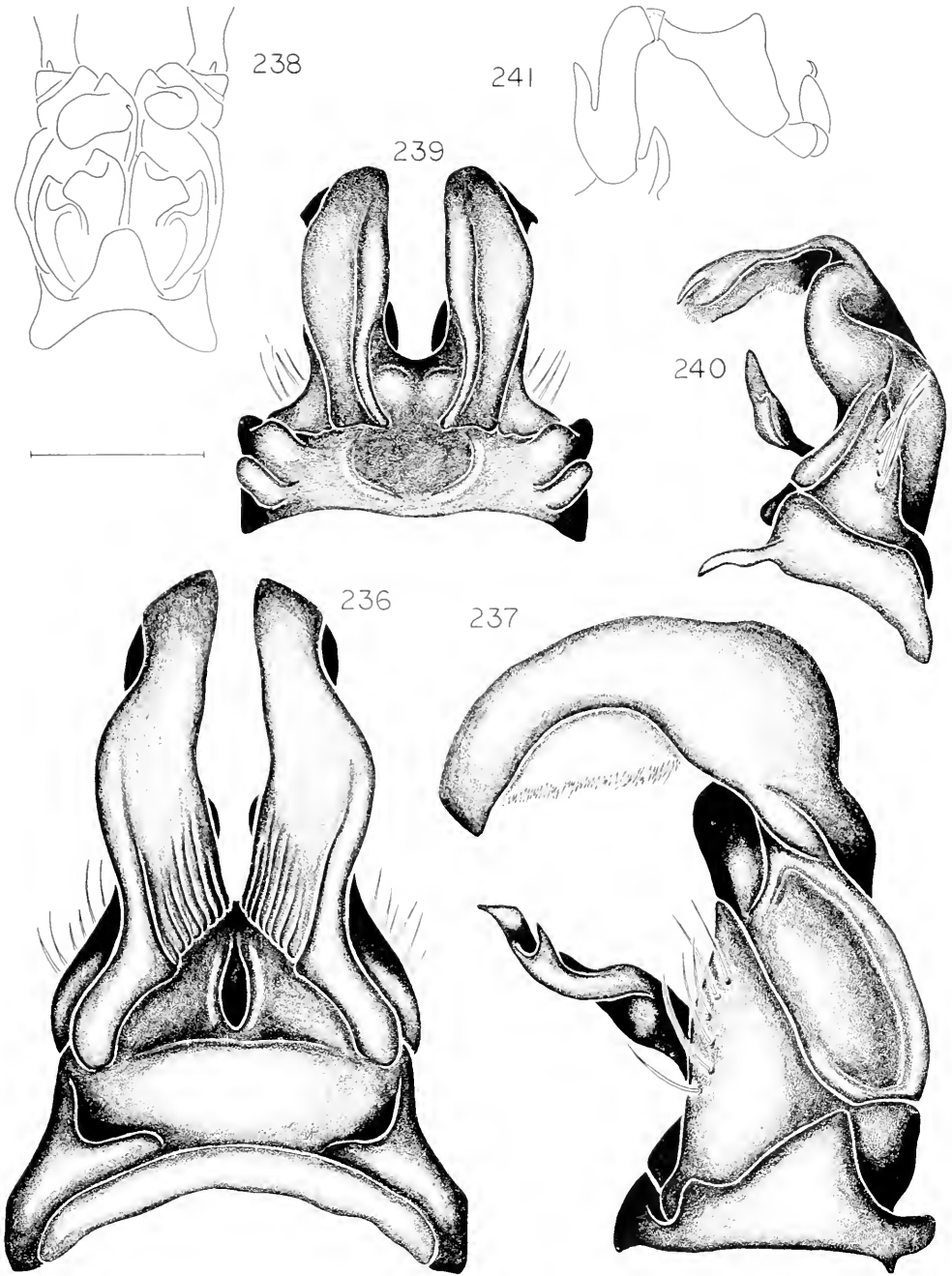

Figures 236-241. Anatomy of *Cleidogona* spp. Figs. 236-238. *C. camazotz*. Fig. 236. Anterior gonopods, anterior view. Fig. 237. Left anterior gonopod, lateral view. Fig. 238. Cyphopods, posterior view. Figs. 239-241. *C. mayapec*. Fig. 239. Anterior gonopods, anterior view. Fig. 240. Left anterior gonopod, lateral view. Fig. 241. Right posterior gonopod, anterior view. Scale line = 0.50 mm for Figs. 236, 237; 1.00 mm for Fig. 238; 0.45 mm for Figs. 239, 240; 0.90 mm for Fig. 241.

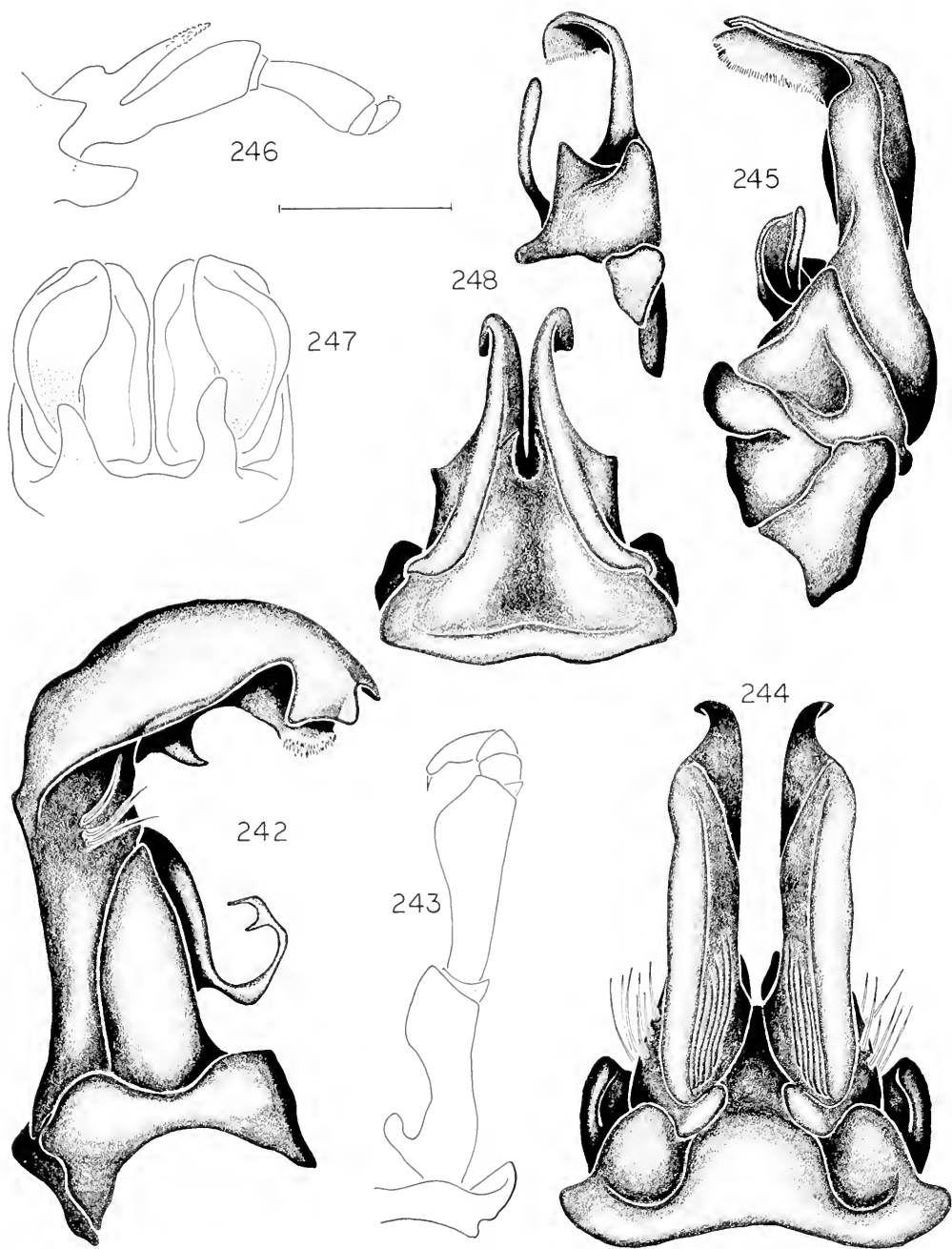

Figures 242-248. Anatomy of *Cleidagona* spp. Figs. 242-243. *C. xolotl*. Fig. 242. Right anterior gonopod, lateral view. Fig. 243. Right posterior gonopod, anterior view. Figs. 244-247. *C. bacillipus*. Fig. 244. Anterior gonopods, anterior view. Fig. 245. Left anterior gonopod, lateral view. Fig. 246. Right posterior gonopod, anterior view. Fig. 247. Cyphopads, posterior view. Fig. 248. Anterior gonopods of *C. gadmani*, anterior view below, lateral view of left gonopod above. Scale line = 0.25 mm for all anterior gonopods; 0.75 mm for Fig. 246; 0.45 mm for Fig. 243; 0.35 mm for Fig. 247.

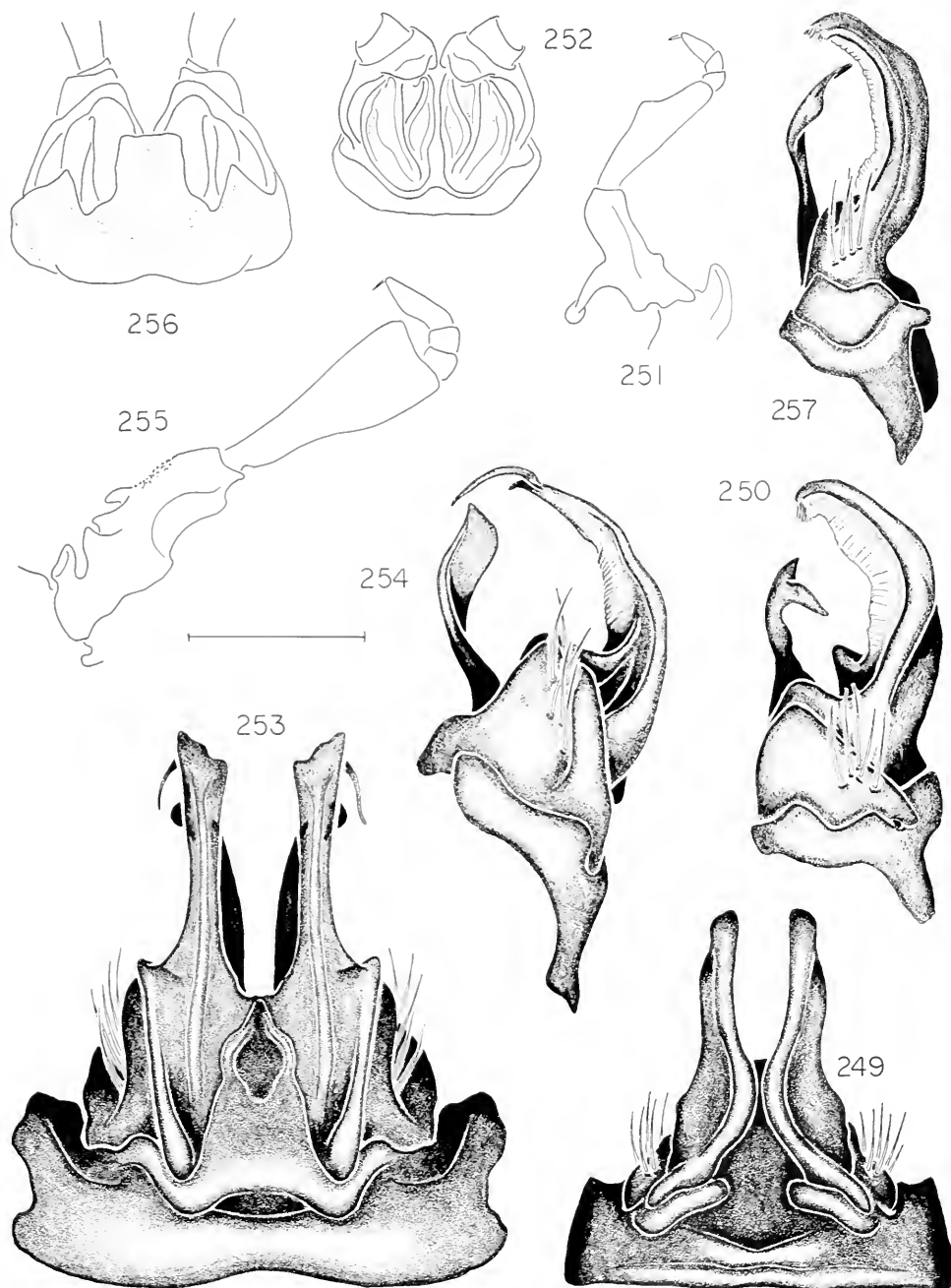

Figures 249–257. Anatomy of *Cleidogona* spp. Figs. 249–252. *C. tequila*. Fig. 249. Anterior gonopods, anterior view. Fig. 250. Left anterior gonopod, lateral view. Fig. 251. Right posterior gonopod, anterior view. Fig. 252. Cyphopods, ventral view. Figs. 253–256. *C. hauatla*. Fig. 253. Anterior gonopods, anterior view. Fig. 254. Left anterior gonopod, lateral view. Fig. 255. Right posterior gonopod, anterior view. Fig. 256. Cyphopods, posterior view. Fig. 257. *C. totonaca*, left anterior gonopod, lateral view. Scale line = 0.50 mm for Figs. 253, 254, 257; 0.45 mm for Figs. 249, 250; 0.90 mm for posterior gonopods and cyphopods.

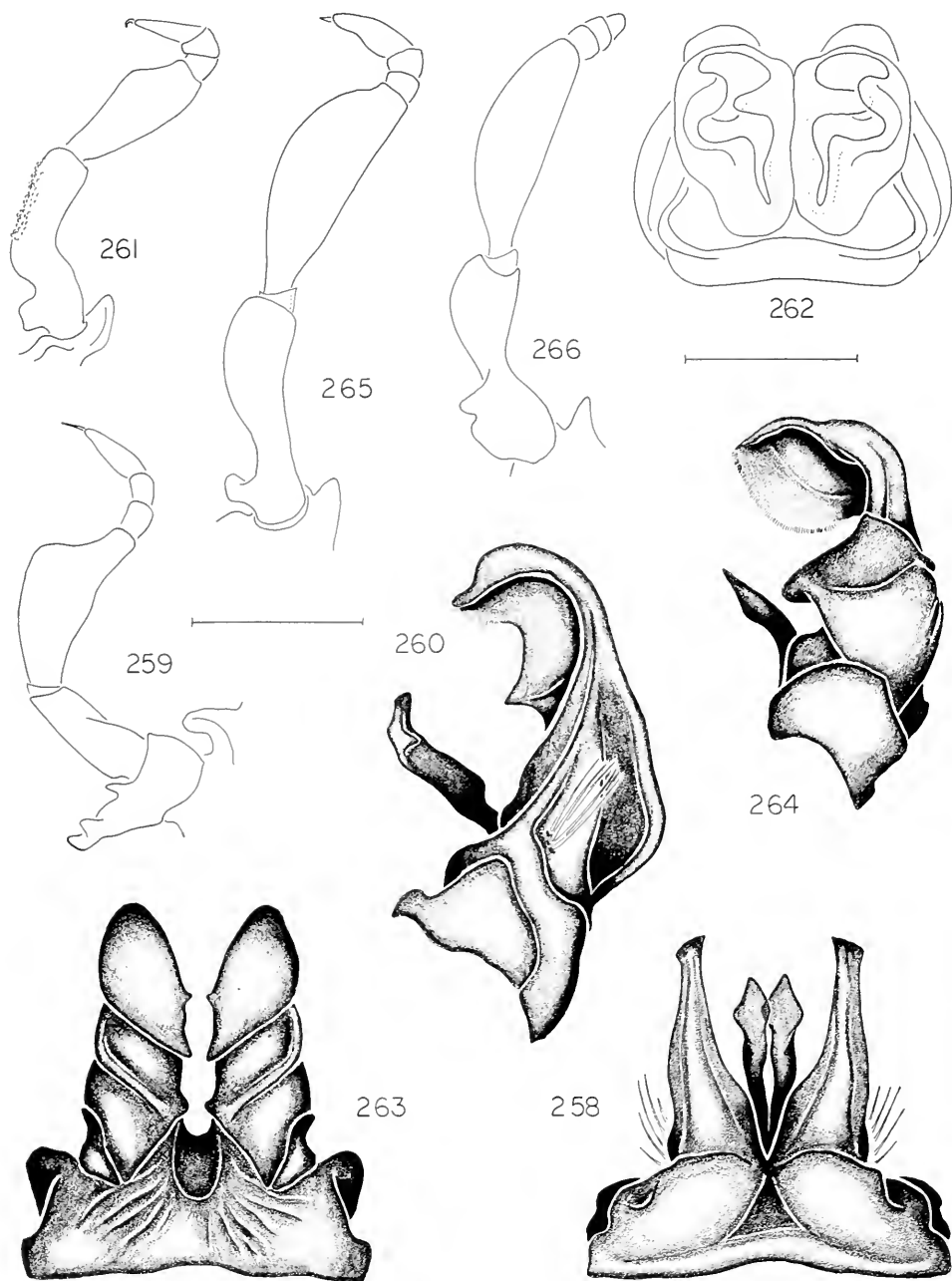

Figures 258–266. Anatomy of *Cleidogona* spp. Figs. 258–259. *C. totonaca*. Fig. 258. Anterior gonopods, anterior view. Fig. 259. Right posterior gonopod, anterior view. Figs. 260–262. *C. rafaella*. Fig. 260. Left anterior gonopod, lateral view. Fig. 261. Right posterior gonopod, anterior view. Fig. 262. Cyphopods, posterior-ventral view. Figs. 263–265. *C. zapoteca*. Fig. 263. Anterior gonopods, anterior view. Fig. 264. Left anterior gonopod, lateral view. Fig. 265. Right posterior gonopod, anterior view. Fig. 266. *C. laquinta*, right posterior gonopod, anterior view. Scale lines = 0.45 mm for Figs. 262–264; 0.75 mm for posterior gonopods; 0.50 mm for Fig. 258; 0.35 mm for Fig. 260.

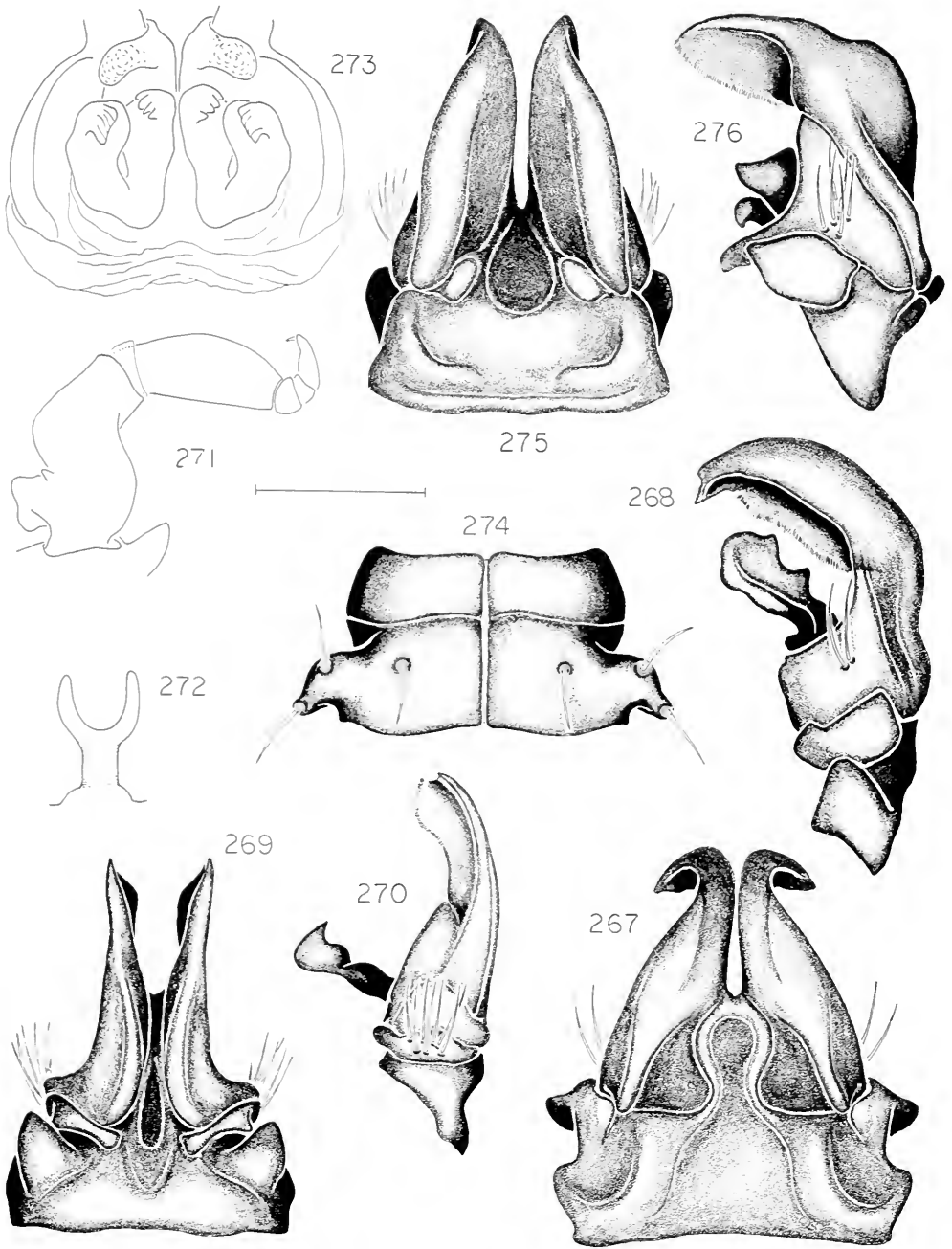

Figures 267-276. Anatomy of *Cleidogona* spp. Figs. 267-268. *C. laquinta*. Fig. 267. Anterior gonopods, anterior view. Fig. 268. Left anterior gonopod, lateral view. Figs. 269-274. *C. canatyloides*. Fig. 269. Anterior gonopods, anterior view. Fig. 270. Left anterior gonopod, lateral view. Fig. 271. Right posterior gonopod, anterior view. Fig. 272. Process of sternum 12, ventral view. Fig. 273. Cyphopods, ventral view. Fig. 274. Segment 15, dorsal view. Figs. 275-276. *C. stollii*. Fig. 275. Anterior gonopods, anterior view. Fig. 276. Left anterior gonopod, lateral view. Scale line = 0.75 mm for Fig. 274; 0.25 mm for Figs. 267, 268, 271-273; 0.45 mm for Figs. 269, 270, 275, 276.

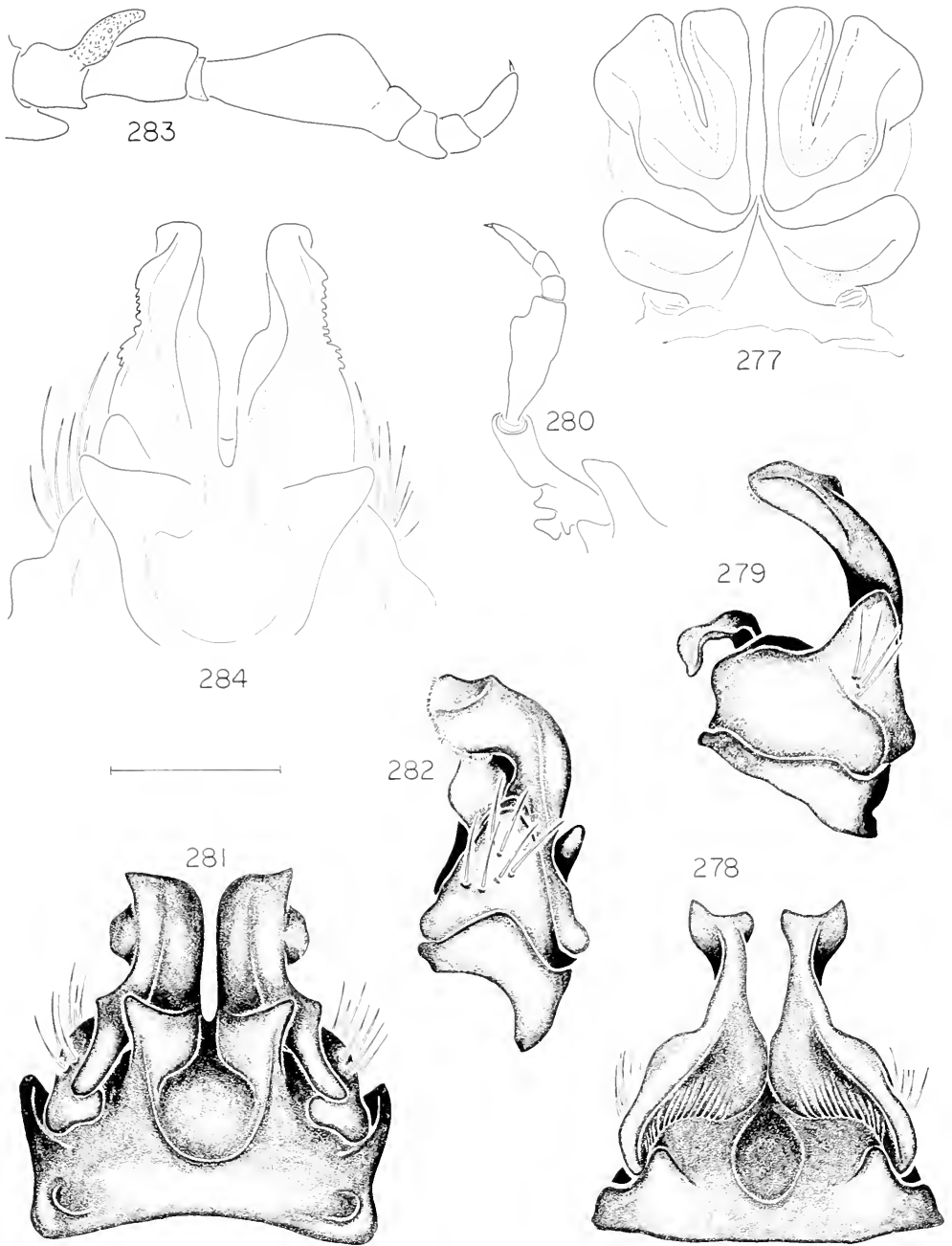

Figures 277-284. Anatomy of *Cleidogona* spp. Fig. 277. *C. stalli*, cyphopods, posterior view. Figs. 278-280. *C. decurva*. Fig. 278. Anterior gonopods, anterior view. Fig. 279. Left anterior gonopod, lateral view. Fig. 280. Right posterior gonopod, anterior view. Figs. 281-283. *C. atoyaca*. Fig. 281. Anterior gonopods, anterior view. Fig. 282. Left anterior gonopod, lateral view. Fig. 283. Right posterior gonopod, anterior view. Fig. 284. *C. minutissima*, anterior gonopods, anterior view. Scale line = 0.25 mm for Figs. 277, 281, 282; 0.45 mm for Figs. 278-280; 0.35 mm for Fig. 283; 0.10 mm for Fig. 284.

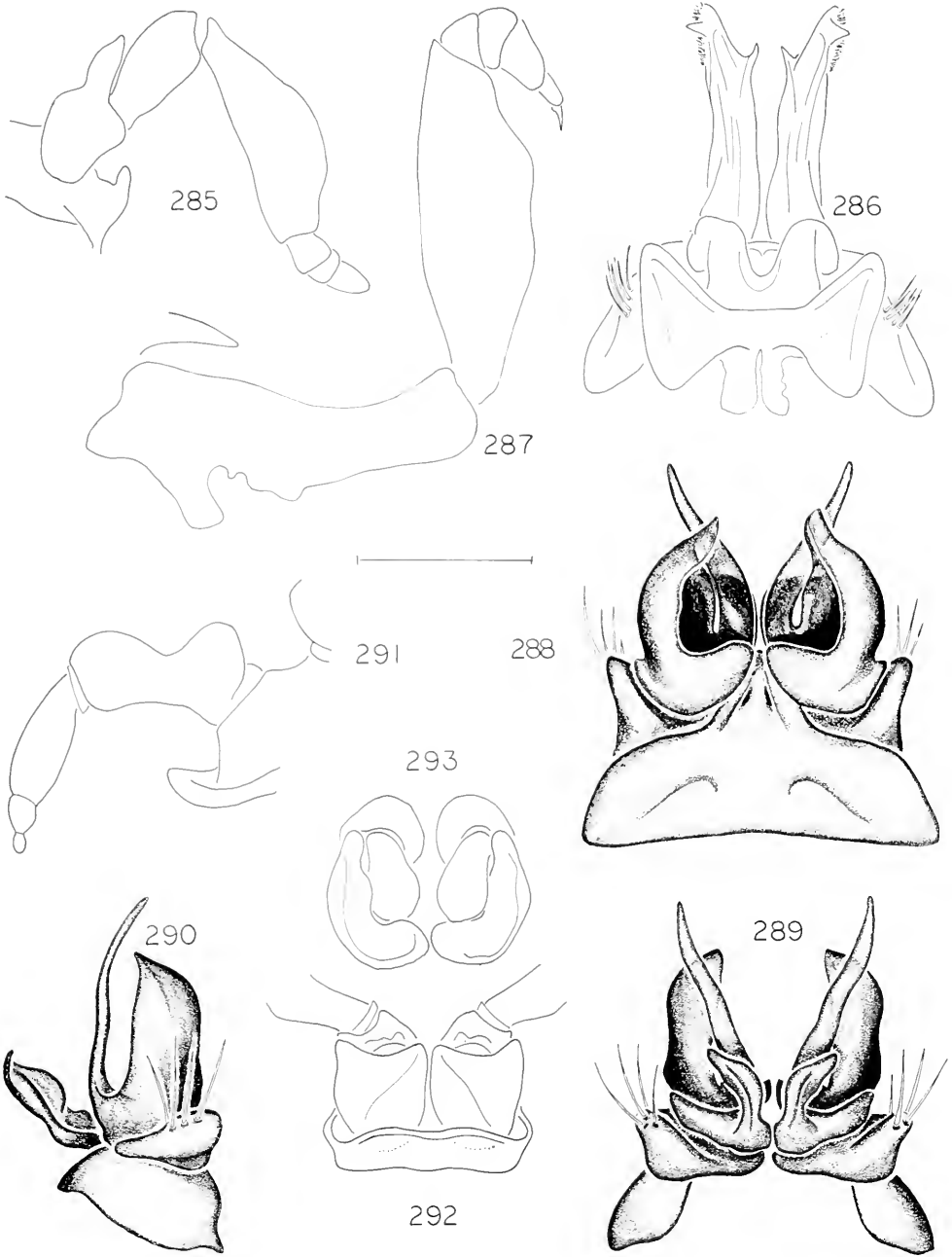

Figures 285–293. Anatomy of *Cleidogona* spp. Fig. 285. *C. minutissima*, right posterior gonopod, anterior view. Figs. 286–287. *C. mirabilis*. Fig. 286. Anterior gonopods, posterior (?) view. Fig. 287. Left posterior gonopod, anterior view. Figs. 288–293. *C. chisosi*. Fig. 288. Anterior gonopods, anterior view. Fig. 289. Anterior gonopods, posterior view. Fig. 290. Left anterior gonopod, lateral view. Fig. 291. Left posterior gonopod, anterior view. Fig. 292. Cyphopods, posterior view. Fig. 293. Cyphopods, ventral view. Scale line = 0.10 mm for Figs. 285–287, 0.25 mm for Figs. 288–293.

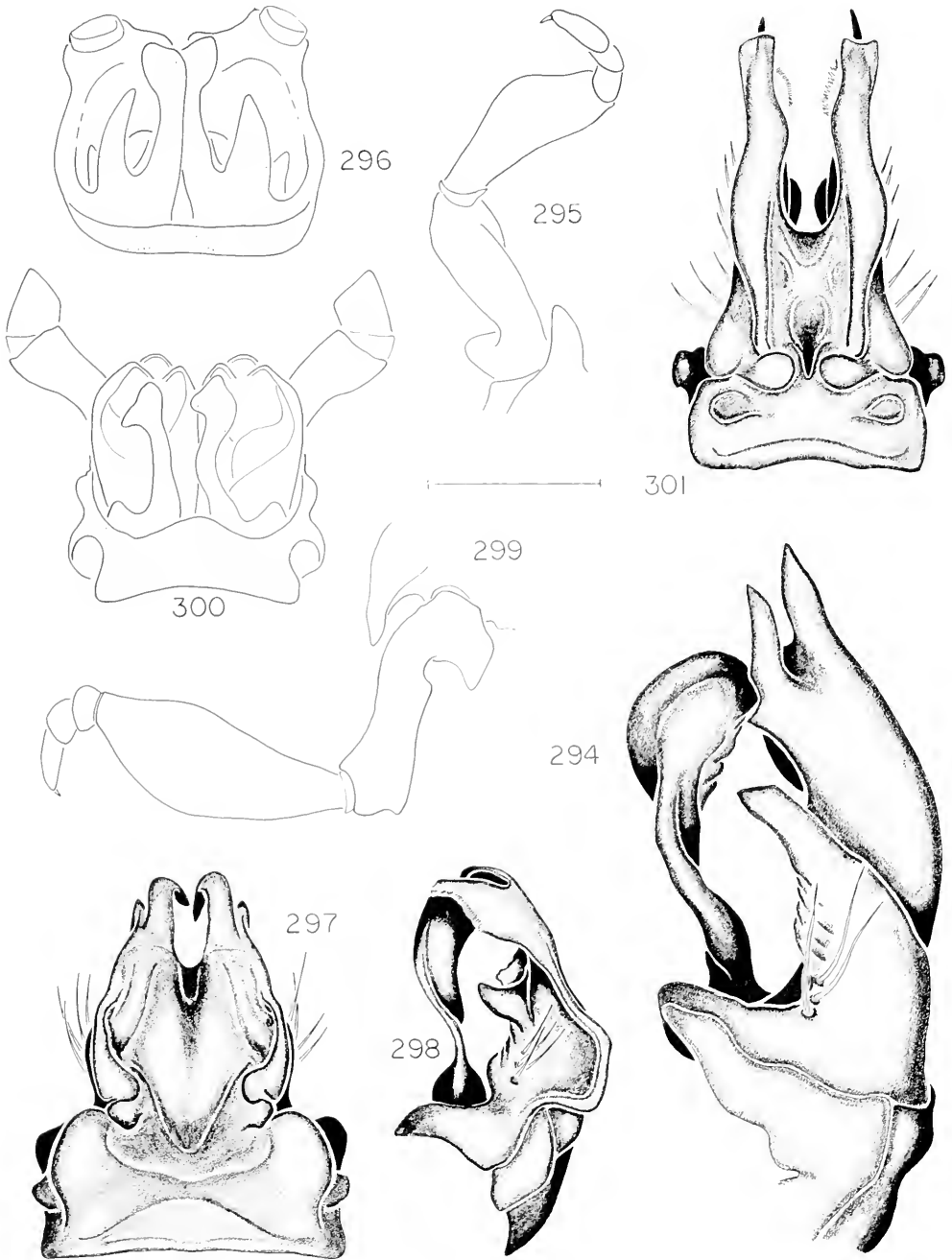

Figures 294-301. Anatomy of *Cleidogona* spp. Figs. 294-296. *C. major*. Fig. 294. Left anterior gonopod, lateral view. Fig. 295. Right posterior gonopod, anterior view. Fig. 296. Cyphopods, posterior view. Figs. 297-300. *C. inexpectata*. Fig. 297. Anterior gonopods, anterior view. Fig. 298. Left anterior gonopod, lateral view. Fig. 299. Right posterior gonopod, anterior view. Fig. 300. Cyphopods, posterior view. Fig. 301. *C. nantahala*, anterior gonopods, anterior view. Scale line = 0.75 mm for Figs. 297, 298; 0.45 mm for Fig. 294; 0.90 mm for posterior gonopods; 0.35 mm for cyphopods; 0.35 mm for Fig. 301.

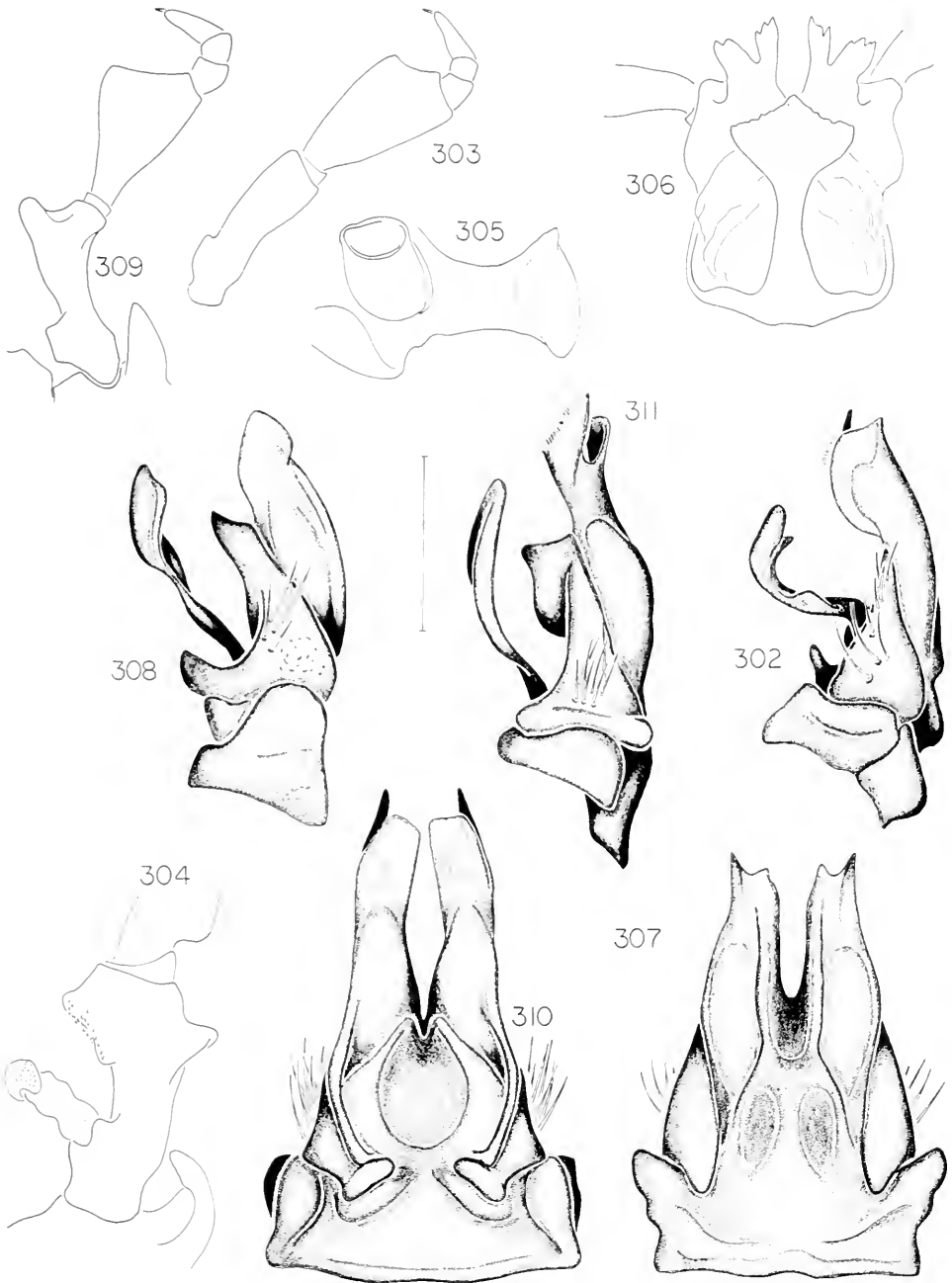

Figures 302-311. Anatomy of *Cleidogana* spp. Figs. 302-306. *C. nantahala*. Fig. 302. Left anterior gonopod, lateral view. Fig. 303. Right posterior gonopod, anterior view. Fig. 304. Right coxa 10, anterior view. Fig. 305. Process of sternum 12, lateral view. Fig. 306. Cyphopods, posterior view. Figs. 307-309. *C. lachesis*. Fig. 307. Anterior gonopods, anterior view. Fig. 308. Left anterior gonopod, lateral view. Fig. 309. Right posterior gonopod, anterior view. Figs. 310-311. *C. margarita*. Fig. 310. Anterior gonopods, anterior view. Fig. 311. Left anterior gonopod, lateral view. Scale line = 0.45 mm for anterior gonopods; 0.75 mm for posterior gonopods; 0.35 mm for Figs. 304-306.

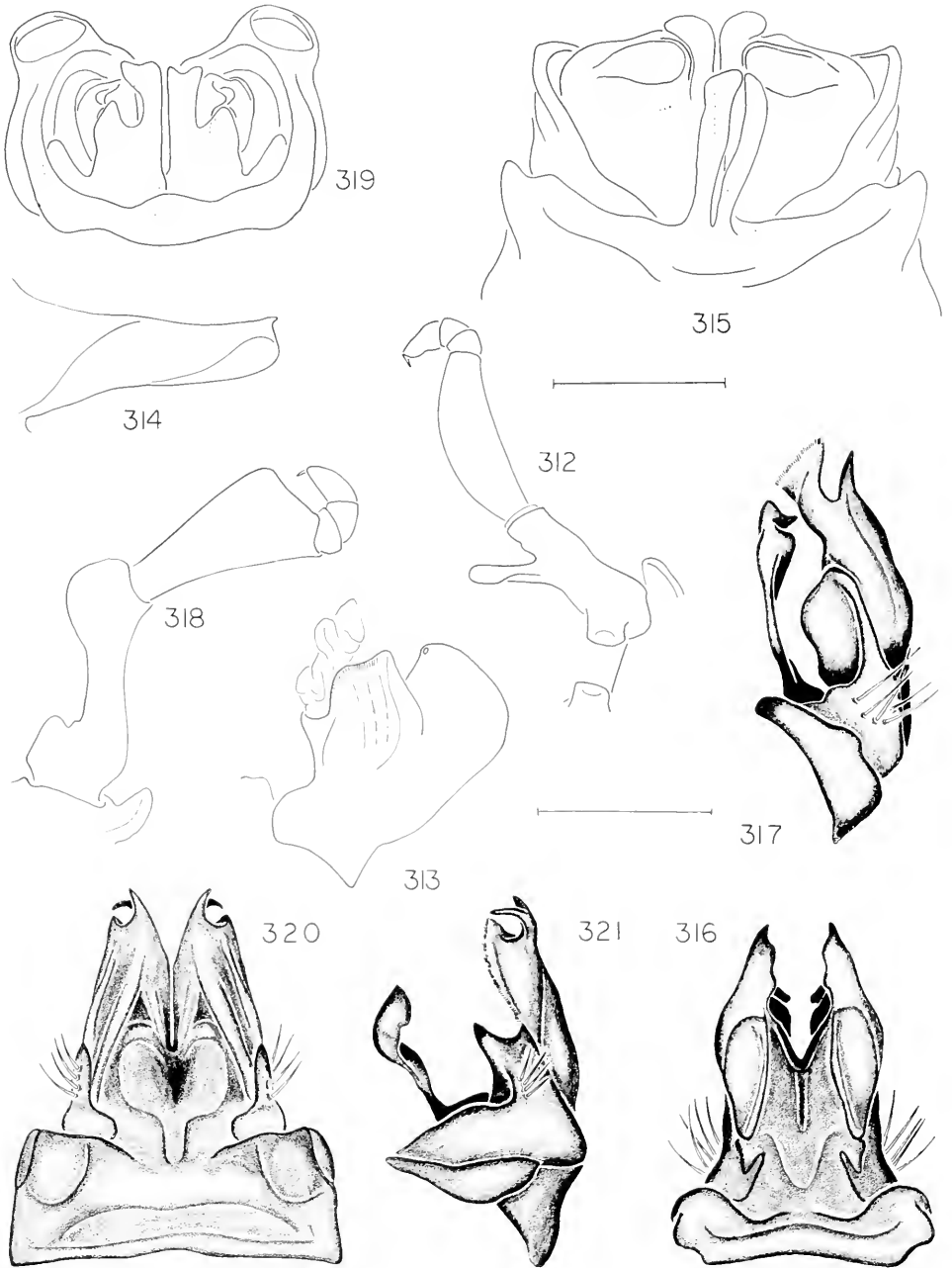

Figures 312-321. Anatomy of *Cleidogona* spp. Figs. 312-315. *C. margarita*. Fig. 312. Right posterior gonopod, anterior view. Fig. 313. Left coxa 11, posterior view. Fig. 314. Process of sternum 12, lateral view. Fig. 315. Cyphopods, posterior view. Figs 316-319. *C. jocassee*. Fig. 316. Anterior gonopods, anterior view. Fig. 317. Left anterior gonopod, lateral view. Fig. 318. Right posterior gonopod, anterior view. Fig. 319. Cyphopods, posterior view. Figs. 320-321. *C. hoffmani*. Fig. 320. Anterior gonopods, anterior view. Fig. 321. Left anterior gonopod, lateral view. Scale lines = 0.75 mm for Figs. 312, 318; 0.35 mm for Figs. 313, 314, 319; 0.25 mm for Figs. 315; 0.60 mm for Figs. 316, 317; 0.45 mm for Figs. 320, 321.

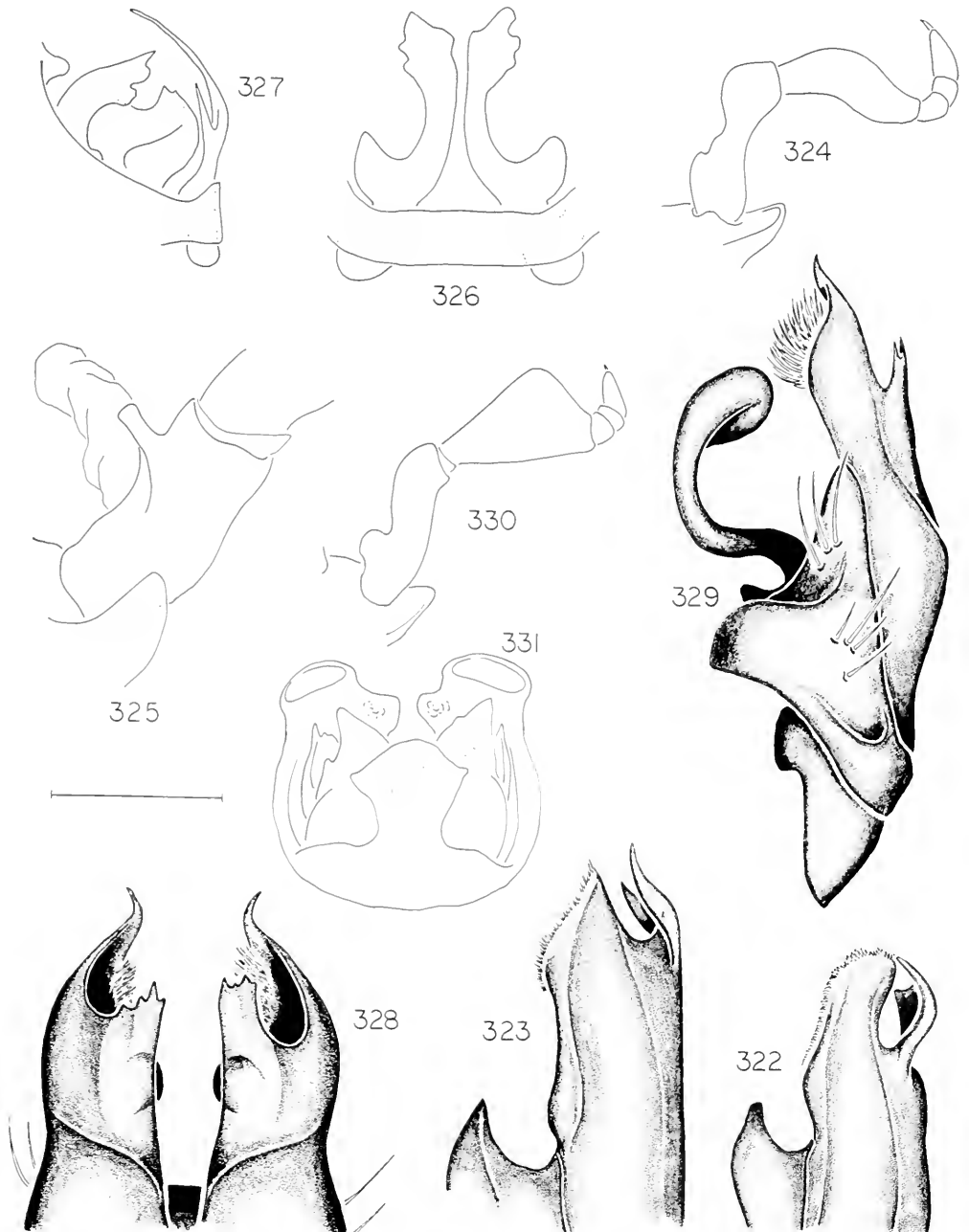

Figures 322-331. Anatomy of *Cleidogona* spp. Figs. 322-327. *C. hoffmani*. Figs. 322-323. Tips of anterior gonopod colpocoxites. Fig. 322. Specimen from Mt. Rogers, Va. Fig. 323. Specimen from Beartown Mt., Va. Fig. 324. Right posterior gonopod, anterior view. Fig. 325. Left coxa 11, posterior view. Fig. 326. Postgenital plate, posterior view. Fig. 327. Right cyphopods, lateral view. Figs. 328-331. *C. otropos*. Fig. 328. Apical part of anterior gonopod colpocoxites, anterior view. Fig. 329. Left anterior gonopod, lateral view. Fig. 330. Right posterior gonopod, anterior view. Fig. 331. Cyphopods, posterior view. Scale line = 0.25 mm for anterior gonopods; 0.75 mm for posterior gonopods; 0.35 mm for coxa and cyphopods.

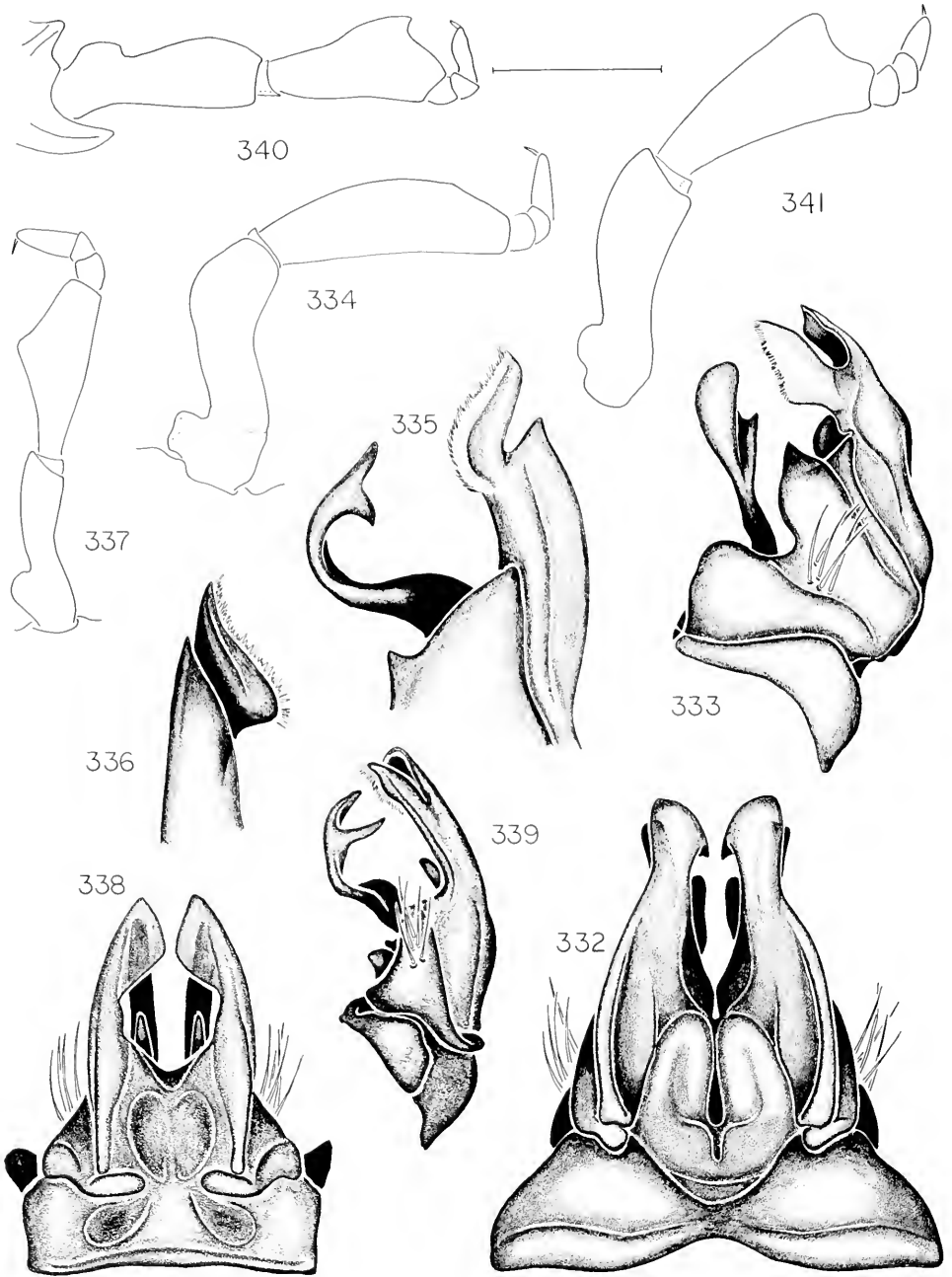

Figures 332–341. Anatomy of *Cleidogona* spp. Figs. 332–334. *C. tallapoosa*. Fig. 332. Anterior gonopods, anterior view. Fig. 333. Left anterior gonopod, lateral view. Fig. 334. Right posterior gonopod, anterior view. Figs. 335–337. *C. hadena*. Fig. 335. Left anterior gonopod, lateral view. Fig. 336. Left anterior gonopod colpocoxite tip, anterior view. Fig. 337. Right posterior gonopod, anterior view. Figs. 338–340. *C. caroliniana*. Fig. 338. Anterior gonopods, anterior view. Fig. 339. Left anterior gonopod, lateral view. Fig. 340. Right posterior gonopod, anterior view. Fig. 341. *C. fidelitor*, right posterior gonopod, anterior view. Scale line = 0.45 mm for Figs. 332, 333, 338, 339; 0.25 mm for Figs. 335, 336; 0.75 mm for Figs. 337, 340; 0.35 mm for Fig. 341.

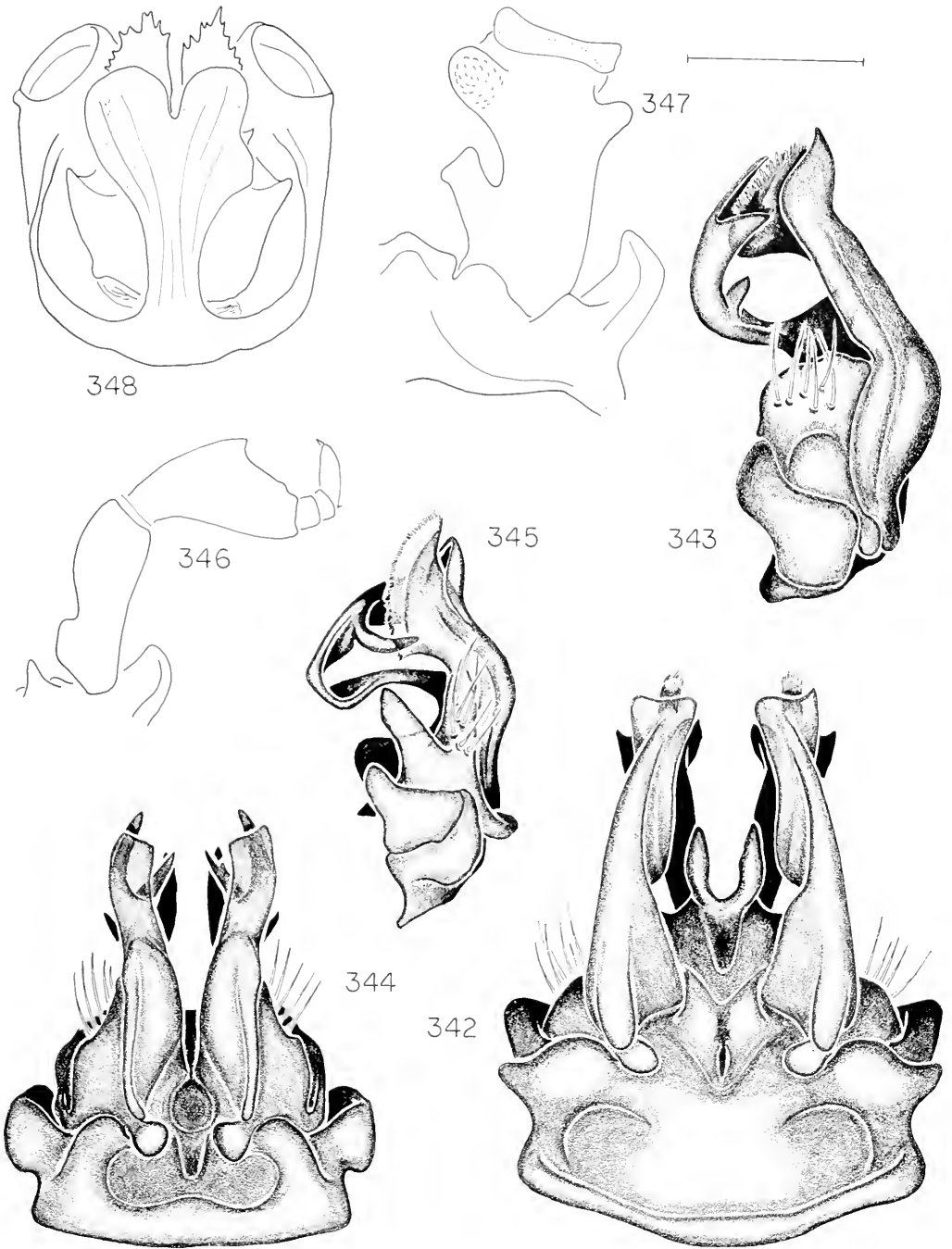

Figures 342-348. Anatomy of *Cleidogona* spp. Figs. 342-343. *C. fidelitor*. Fig. 342. Anterior gonopods, anterior view. Fig. 343. Left anterior gonopod, lateral view. Figs. 344-348. *C. steno*. Fig. 344. Anterior gonopods, anterior view. Fig. 345. Left anterior gonopod, lateral view. Fig. 346. Right posterior gonopod, anterior view. Fig. 347. Right coxo 10, anterior view. Fig. 348. Cyphopods, posterior view. Scale line = 0.45 mm for Figs. 344-346; 0.25 mm for Figs. 342, 343, 347, 348.

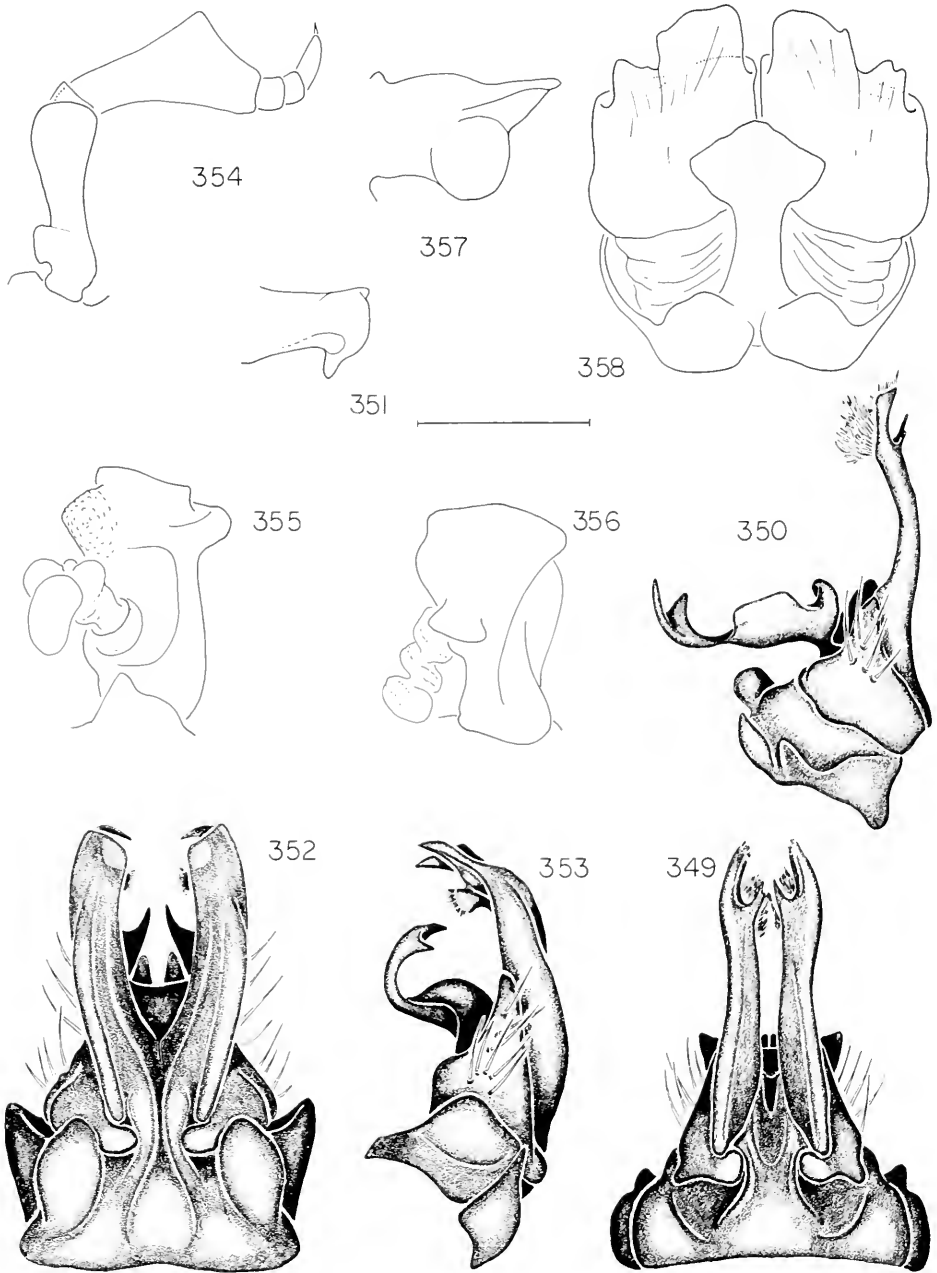

Figures 349–358. Anatomy of *Cleidogona* spp. Figs. 349–351. *C. alata*. Fig. 349. Anterior gonopods, anterior view. Fig. 350. Left anterior gonopod, lateral view. Fig. 351. Process of sternum 12, lateral view. Figs. 352–358. *C. georgica*. Fig. 352. Anterior gonopods, anterior view. Fig. 353. Left anterior gonopod, lateral view. Fig. 354. Right posterior gonopod, anterior view. Fig. 355. Right coxa 10, anterior view. Fig. 356. Left coxa 11, posterior view. Fig. 357. Process of sternum 12, lateral view. Fig. 358. Cyphopods, posterior view. Scale line = 0.45 mm for anterior gonopods, 0.35 mm for Figs. 355, 356; 0.25 mm for Figs. 351, 358; 0.75 mm for Fig. 354.

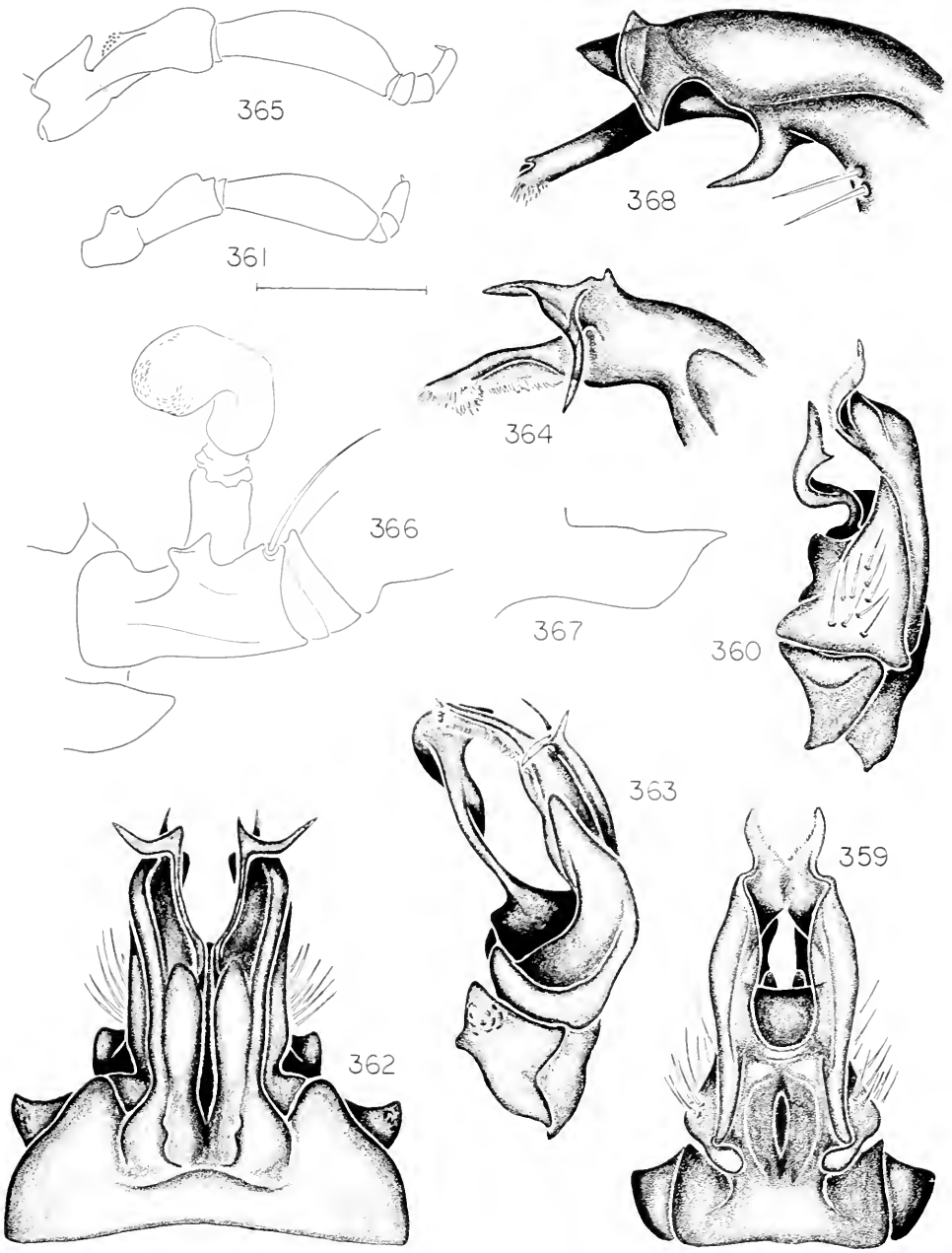

Figures 359-368. Anatomy of *Cleidogono* spp. Figs. 359-361. *C. wrayi*. Fig. 359. Anterior gonopods, anterior view. Fig. 360. Left anterior gonopod, lateral view. Fig. 361. Right posterior gonopod, anterior view. Figs. 362-367. *C. grenada*. Fig. 362. Anterior gonopods, anterior view. Fig. 363. Left anterior gonopod, lateral view. Fig. 364. Tip of left anterior gonopod colpocoxite, lateral view. Fig. 365. Right posterior gonopod, anterior view. Fig. 366. Left coxo 11, posterior view. Fig. 367. Process of sternum 12, lateral view. Fig. 368. *C. mississippiana*, tip of colpocoxite of left anterior gonopod, lateral view. Scale line = 0.45 mm for Figs. 359, 360, 362, 363; 0.25 mm for Figs. 364, 366-368; 0.75 mm for posterior gonopods.

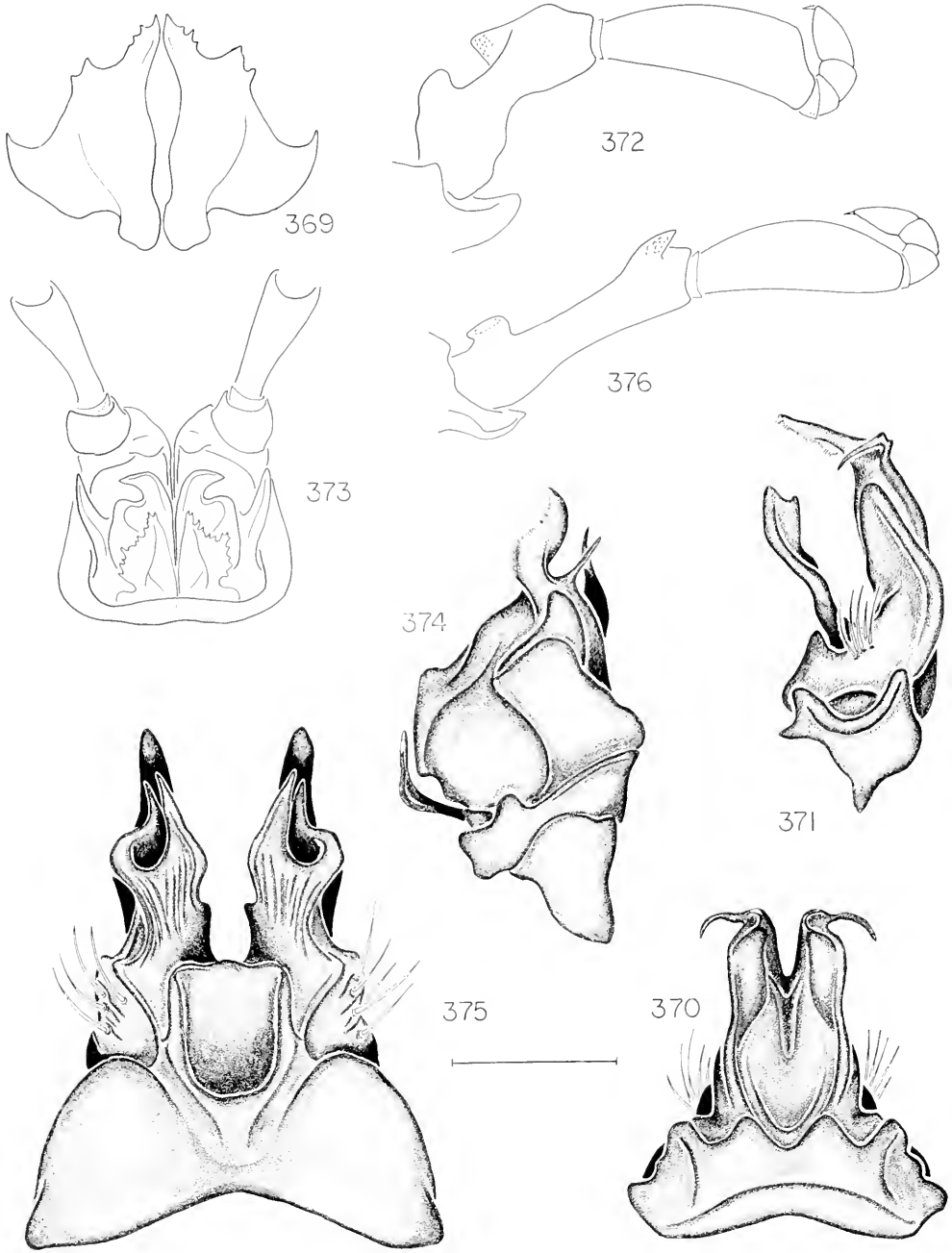

Figures 369–376. Anatomy of *Cleidogona* spp. Fig. 369. *C. grenada*, postgenital plate, posterior view. Figs. 370–373. *C. sublettei*. Fig. 370. Anterior gonopods, anterior view. Fig. 371. Left anterior gonopod, lateral view. Fig. 372. Right posterior gonopod, anterior view. Fig. 373. Cyphopods, posterior view. Figs. 374–376. *C. celerita*. Fig. 374. Left anterior gonopod, lateral view. Fig. 375. Anterior gonopods, anterior view. Fig. 376. Right posterior gonopod, anterior view. Scale line = 0.60 mm for Figs. 370, 371; 0.75 mm for Figs. 373–375; 0.90 mm for Figs. 372, 376; 0.25 mm for Fig. 369.

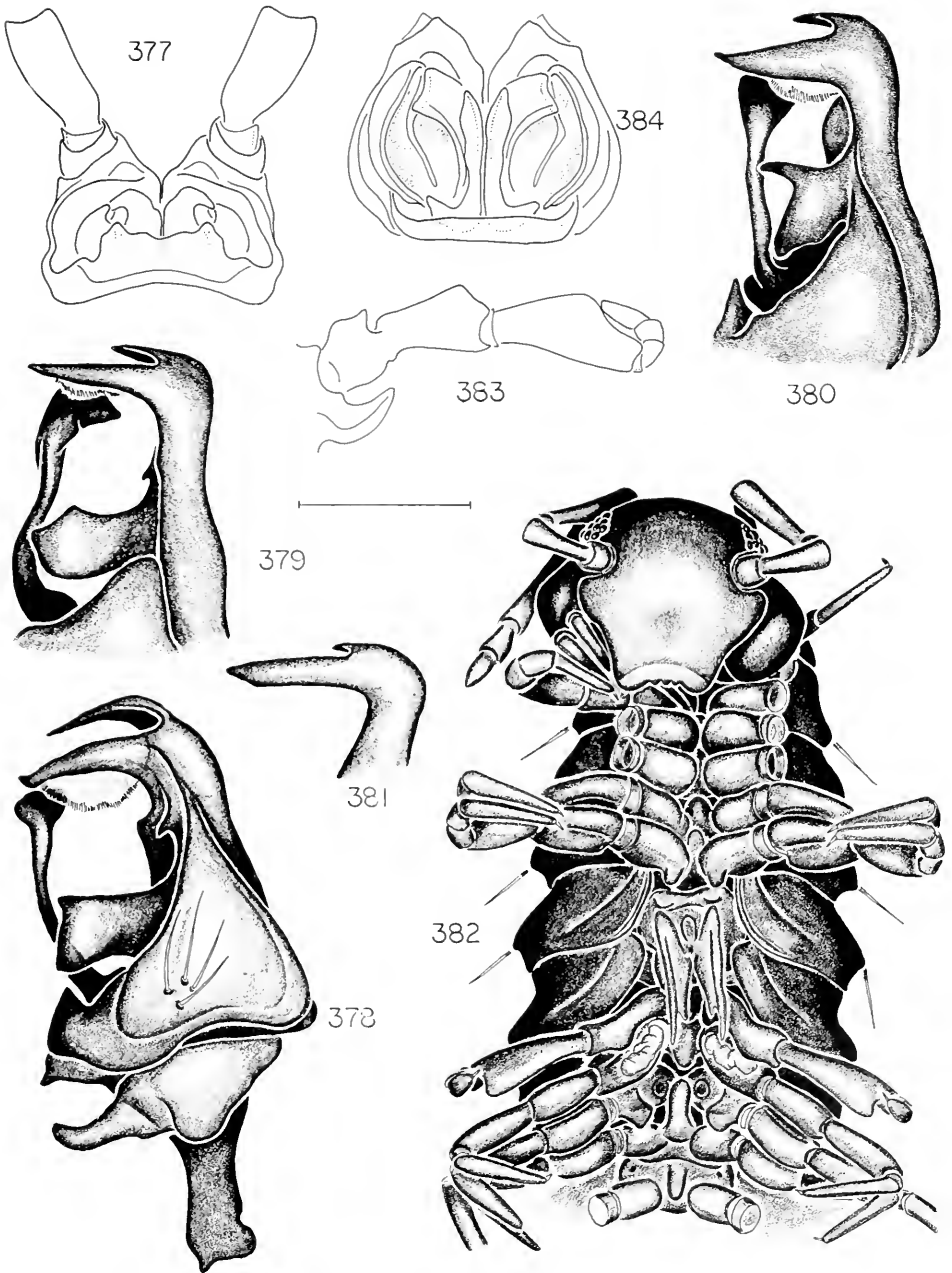

Figures 377-384. Anatomy of *Cleidogona* spp. Fig. 377. *C. celerita*, cyphopods, posterior view. Figs. 378-384. *C. caesioannulata*. Fig. 378. Left anterior gonopod, lateral view, specimen from Wooster, Ohio. Figs. 379-381. Tips of left anterior gonopod colpocoxites. Fig. 379. Specimen from Peaks of Otter, Va. Fig. 380. Specimen from Mt. Mitchell, N. Car. Fig. 381. Specimen from Clifton Forge, Va. Fig. 382. Anterior end of body of male, ventral view. Fig. 383. Right posterior gonopod, anterior view. Fig. 384. Cyphopods, posterior view [specimen from Wooster, Ohio, compared with female holotype]. Scale line = 0.50 mm for Figs. 378-381; 0.90 mm for Fig. 382; 1.00 mm for Fig. 383; 0.75 mm for Figs. 377, 384.

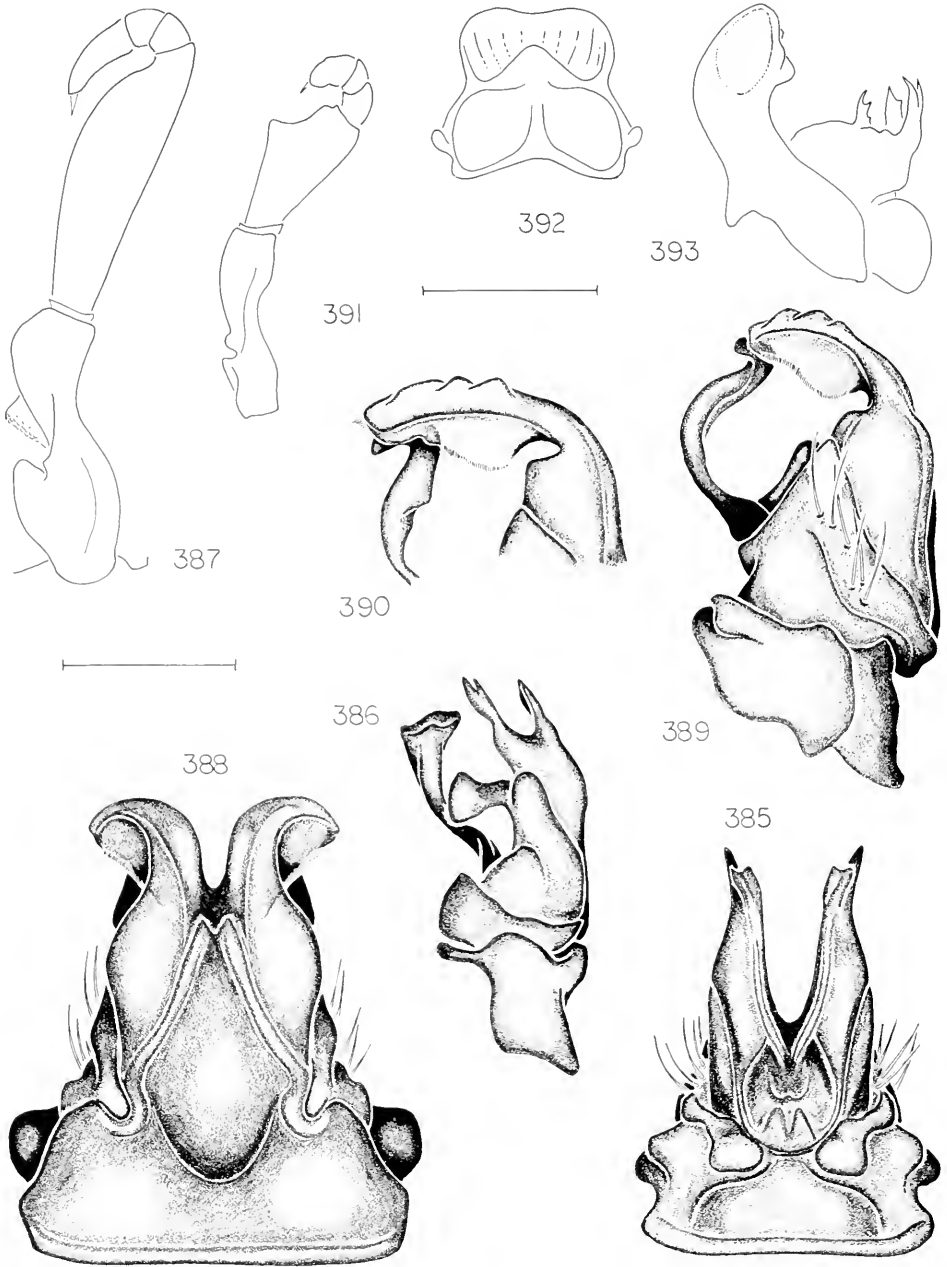

Figures 385-393. Anatomy of *Cleidogona* spp. Figs. 385-387. *C. laminata*. Fig. 385. Anterior gonopods, anterior view. Fig. 386. Left anterior gonopod, lateral view. Fig. 387. Right posterior gonopod, anterior view. Figs. 388-393. *C. unita*. Fig. 388. Anterior gonopods, anterior view. Fig. 389. Left anterior gonopod, lateral view. Fig. 390. Tip of colpocoxite of left anterior gonopod of specimen from Mammoth Cave National Park, Ky., lateral view. Fig. 391. Right posterior gonopod, anterior view. Fig. 392. Postgenital plate, posterior view. Fig. 393. Right cyphopods and coxa 2, lateral view. Scale lines = 0.35 mm for Figs. 388-390; 0.60 mm for Figs. 385-387; 0.75 mm for Fig. 381; 0.35 mm for Figs. 392, 393.

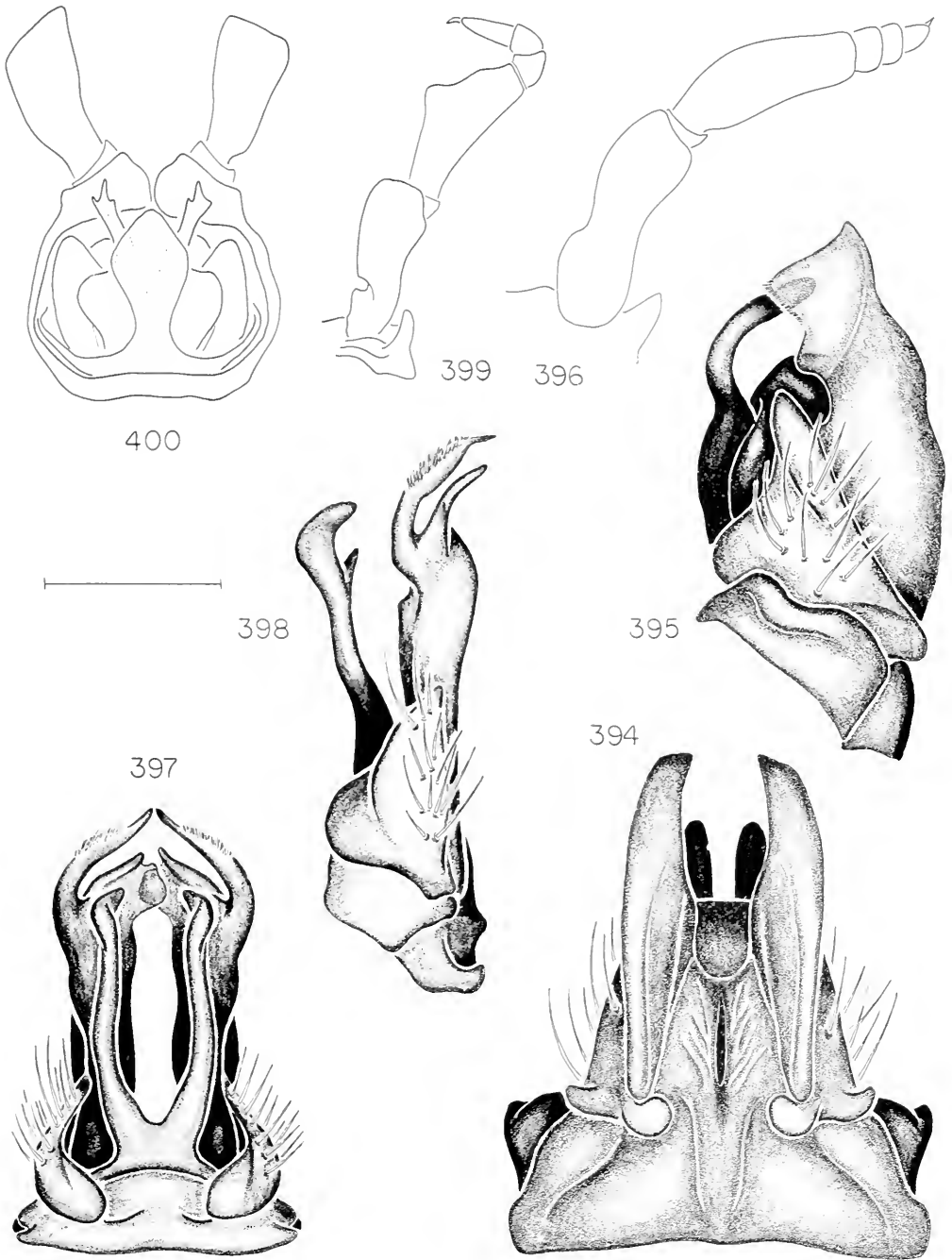

Figures 394-400. Anatomy of *Cleidogono* spp. Figs. 394-396. *C. accretis*. Fig. 394. Anterior gonopods, anterior view. Fig. 395. Left anterior gonopod, lateral view. Fig. 396. Right posterior gonopod, anterior view. Figs. 397-400. *C. fustis*. Fig. 397. Anterior gonopods, posterior view. Fig. 398. Left anterior gonopod, lateral view. Fig. 399. Right posterior gonopod, anterior view. Fig. 400. Cyphopods, anterior view. Scale line = 0.50 mm for Figs. 397, 398, 400; 0.25 mm for Figs. 394-395; 0.35 mm for Fig. 396; 0.90 mm for Fig. 399.

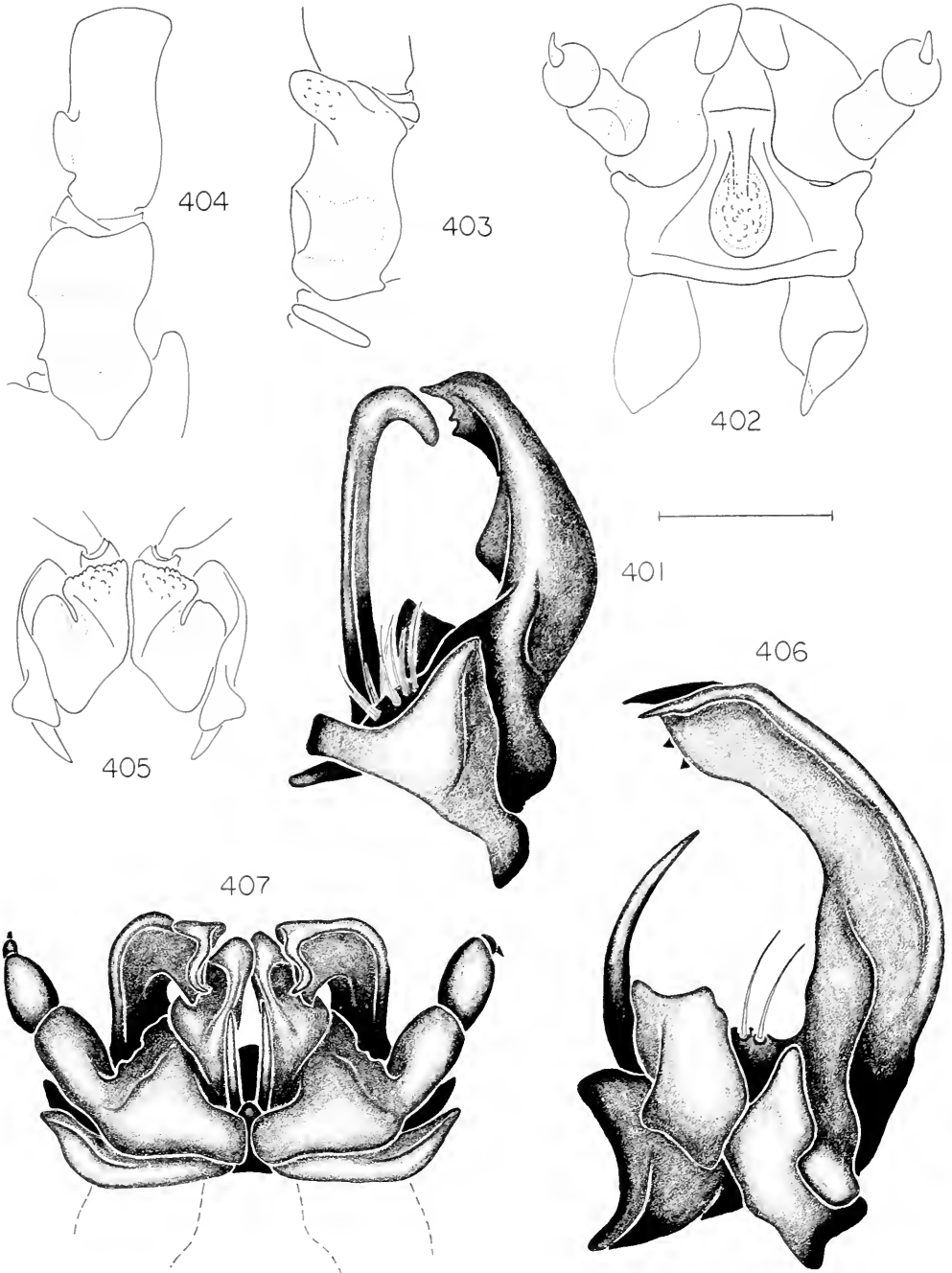

Figures 401–407. Anatomy of *Tigonogono* spp. Figs. 401–405. *T. brownae*. Fig. 401. Left anterior gonopod, anterior view. Fig. 402. Posterior gonopods, anterior view. Fig. 403. Right coxa 10, anterior view. Fig. 404. Right coxa, trochanter, and prefemur 11, anterior view. Fig. 405. Cyphopods, posterior view. Figs. 406–407. *T. moesta*. Fig. 406. Left anterior gonopod, anterior view. Fig. 407. Anterior and posterior gonopods *in situ*, posterior view. Scale line = 0.75 mm for Fig. 405; 0.35 mm for Figs. 401–404, 406, 407.

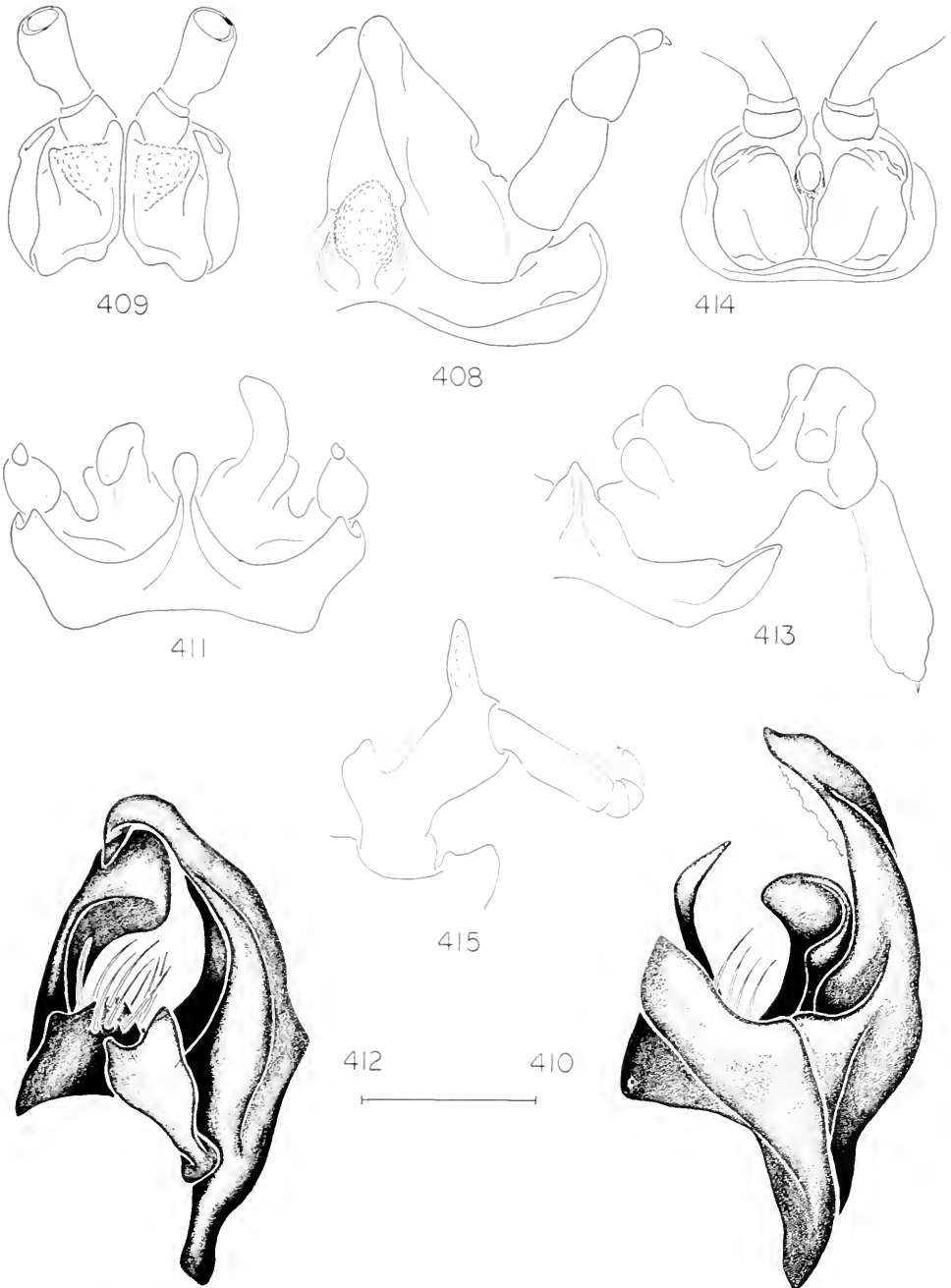

Figures 408-415. Anatomy of *Tiganogona* and *Dybasia* spp. Figs. 408-409. *Tiganogona moesta*. Fig. 408. Right posterior gonopod, anterior view. Fig. 409. Cyphopods, posterior view. Figs. 410-411. *T. alia*. Fig. 410. Left anterior gonopod, lateral view. Fig. 411. Posterior gonopods, anterior view. Figs. 412-414. *T. glebosa*. Fig. 412. Left anterior gonopod, lateral view. Fig. 413. Right posterior gonopod, anterior view. Fig. 414. Cyphopods, posterior view. Fig. 415. *Dybasia humerosa*, right posterior gonopod, anterior view. Scale line = 0.35 mm for anterior and posterior gonopods, 0.75 mm for cyphopods.

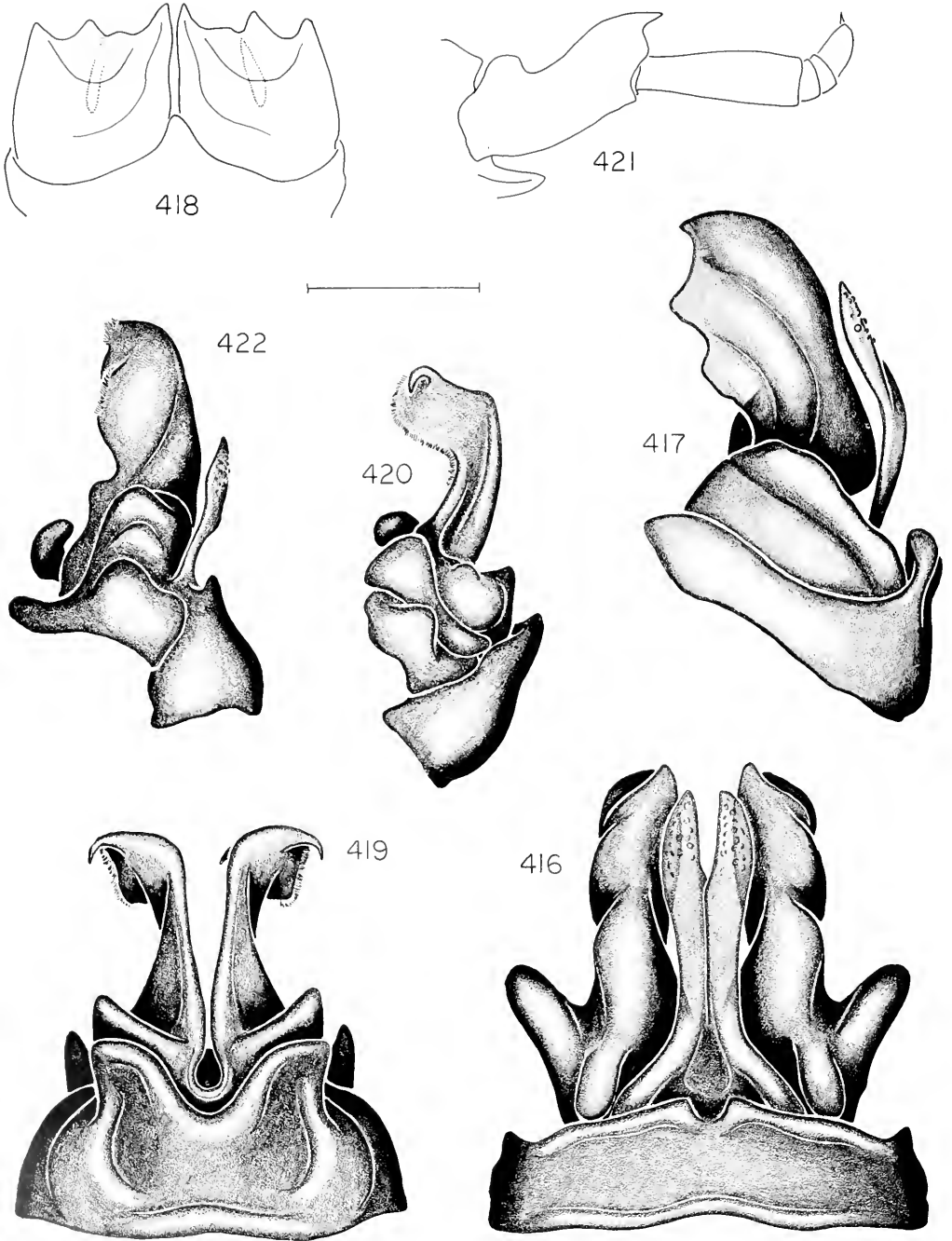

Figures 416–422. Anatomy of *Dybasia* spp. Figs. 416–418. *D. humerosa*. Fig. 416. Anterior gonopods, anterior view. Fig. 417. Left anterior gonopod, lateral view. Fig. 418. Cyphopods, posterior view. Figs. 419–421. *D. divergens*. Fig. 419. Anterior gonopods, anterior view. Fig. 420. Left anterior gonopod, lateral view. Fig. 421. Right posterior gonopod, anterior view. Fig. 422. *D. chiriquia*, left anterior gonopod, lateral view. Scale lines = 0.35 mm for Fig. 421, 0.25 mm for Figs. 416–420, 422.

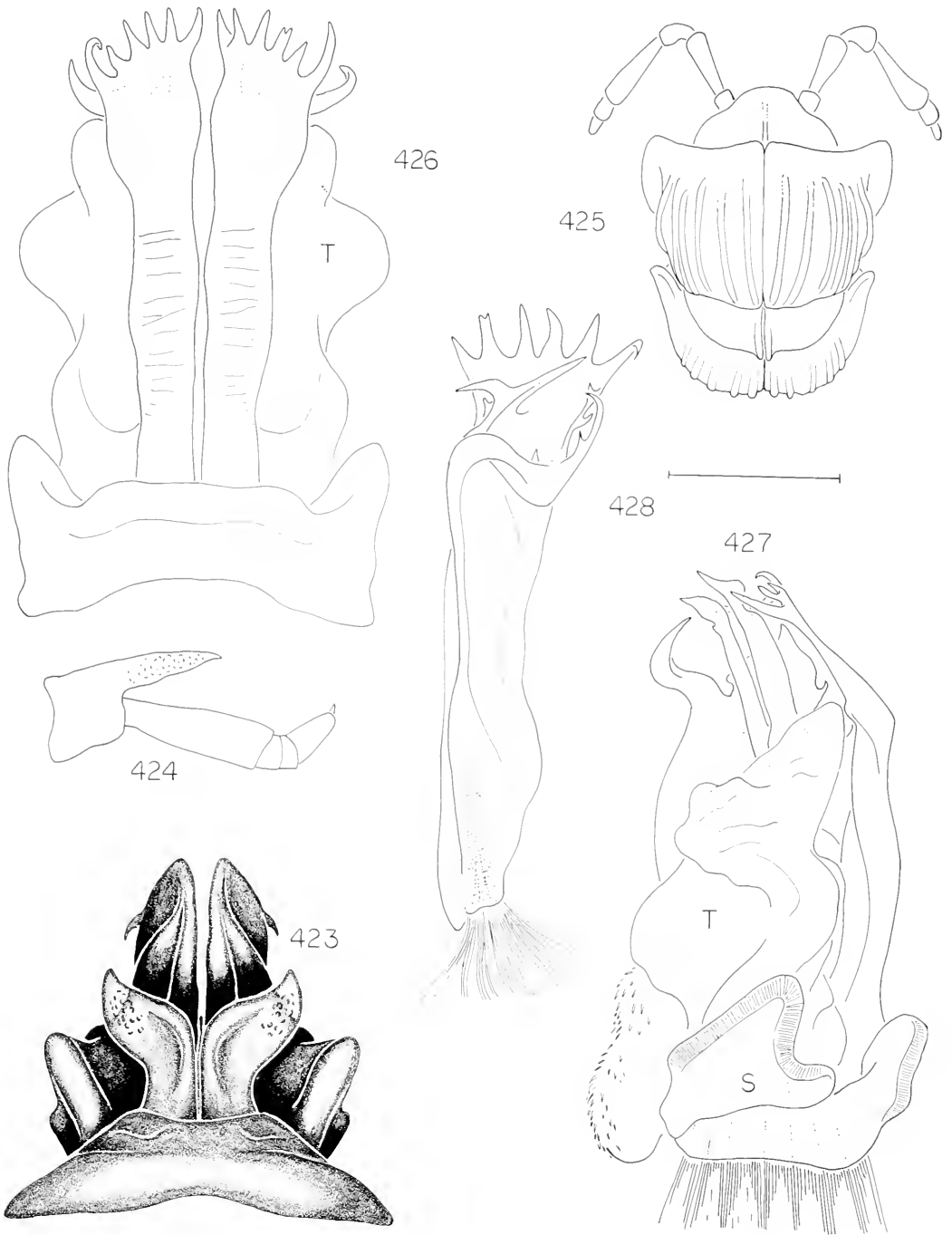

Figures 423-428. Anatomy of *Dybasia* and *Striaria* spp. Figs. 423-424. *Dybasia chiriquia*. Fig. 423. Anterior gonopods, anterior view. Fig. 424. Right posterior gonopod, anterior view. Figs. 425-428. *Striaria* sp. Fig. 425. Anterior end of body, dorsal view. Fig. 426. Anterior gonopods, anterior view. Fig. 427. Left anterior gonopod, lateral view. Fig. 428. Left anterior gonopod, anterior colpocoxite, posterior view. Scale line = 0.25 mm for Figs. 423, 424; 0.90 mm for Fig. 425; 0.10 mm for Figs. 426-428.



Figures 429–445. Anatomy of *Striaria* sp., *Caseyia heteropus*, and *Urochordeuma porona*. Figs. 429–430. *Striaria* sp. Fig. 429. Posterior calpocoxite of left anterior gonopod, mesal view. Fig. 430. Posterior gonopods, anterior view. Figs. 431–444. *Caseyia heteropus*. Fig. 431. Anterior gonopods, posterior view. Fig. 432. Left anterior gonopod, lateral view. Fig. 433. Left anterior gonopod, mesal view. Fig. 444. Posterior gonopods, posterior view. Fig. 445. *Urochordeuma porona*, posterior gonopods, posterior view. Scale lines = 0.09 mm for Fig. 429; 0.75 mm for Figs. 431–444; 0.60 mm for Fig. 445; 0.35 mm for Fig. 430.

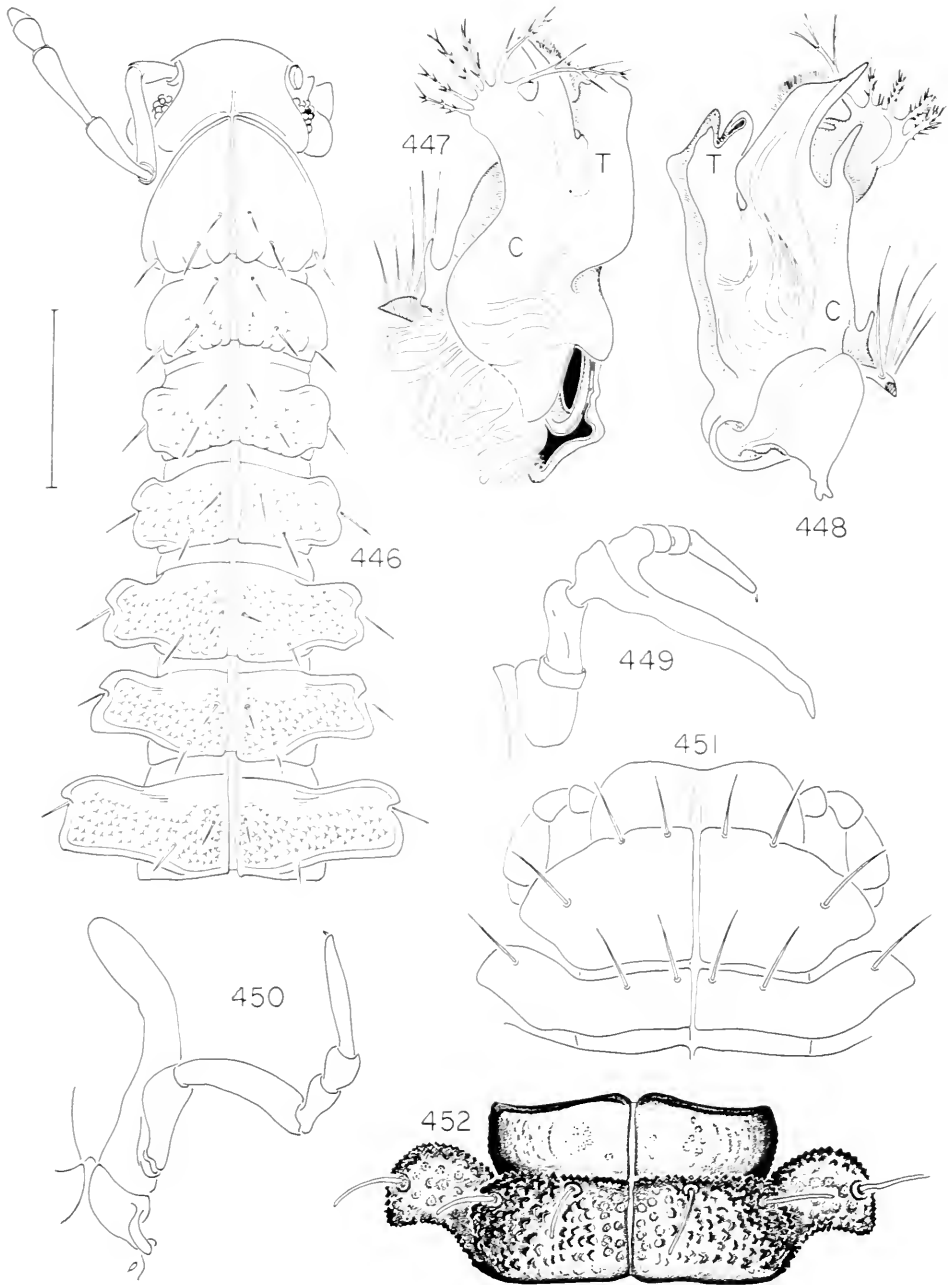

Figures 446–452. Anatomy of *Urochordeuma porona* and *Rhiscosomides acovescor*. Figs. 446–450. *Urochordeuma porona*. Fig. 446. Anterior end of body, dorsal view. Fig. 447. Left anterior gonopod, mesol view. Fig. 448. Left anterior gonopod, lateral view. Fig. 449. Right leg 1, posterior view. Fig. 450. Right leg 3, anterior view. Figs. 451–452. *Rhiscosomides acovescor*. Fig. 451. Anterior end of body, dorsal view, tergal sculpture omitted. Fig. 452. Segment 12, dorsal view. Scale line = 0.90 mm for Fig. 446; 0.60 mm for Figs. 447, 448; 0.75 mm for Figs. 449, 450; 0.45 mm for Figs. 451, 452.

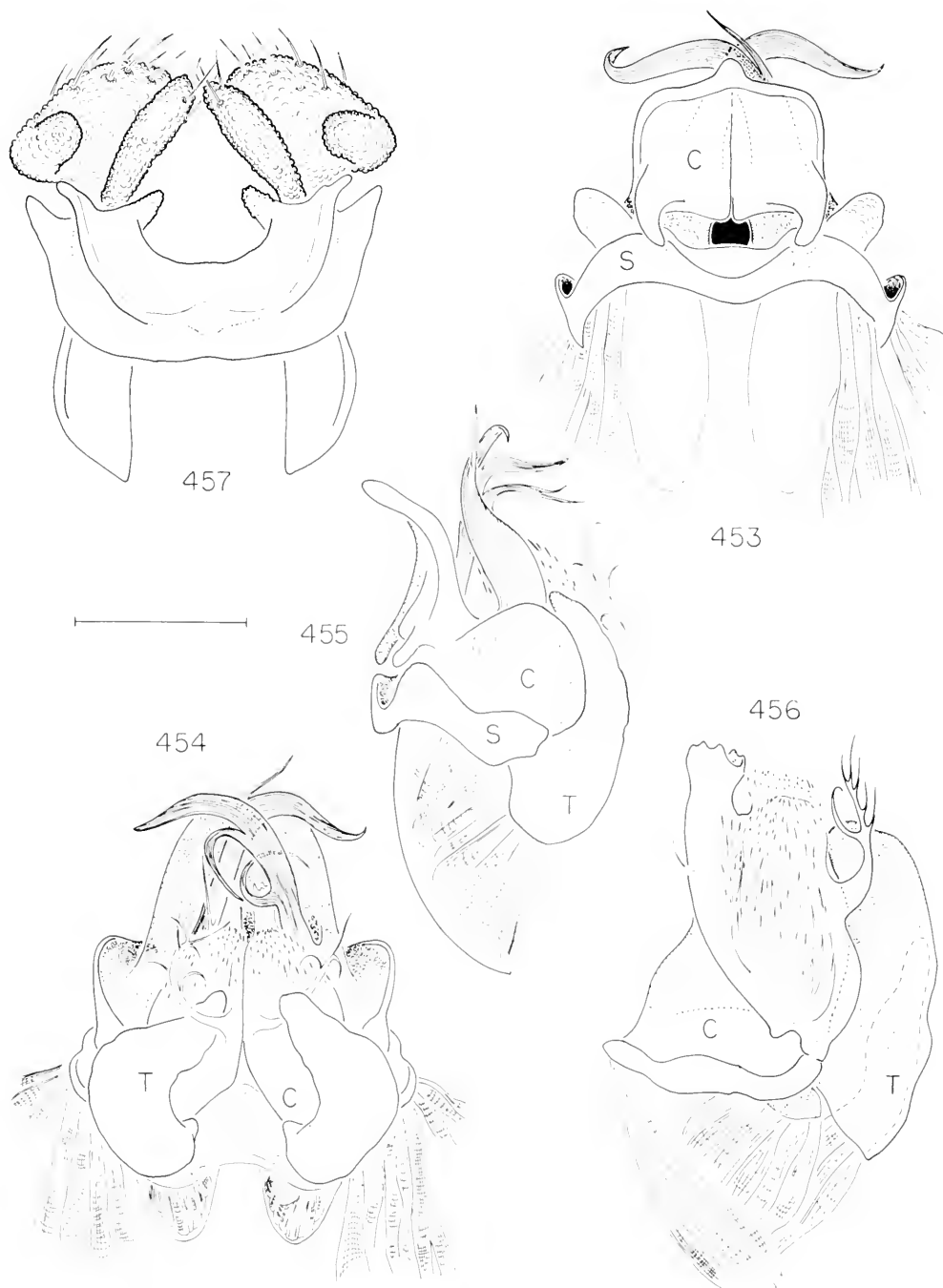

Figures 453–457. Anatomy of *Rhiscosomides ocovescor*. Fig. 453. Anterior gonopods, anterior view. Fig. 454. Anterior gonopods, posterior view. Fig. 455. Anterior gonopods, lateral view. Fig. 456. Left posterior colpocoxite and telopodite of anterior gonopods, mesal view. Fig. 457. Posterior gonopods, posterior view. Scale line = 0.40 mm for Figs. 453–455; 0.20 mm for Figs. 456; 0.25 mm for Figs. 457.

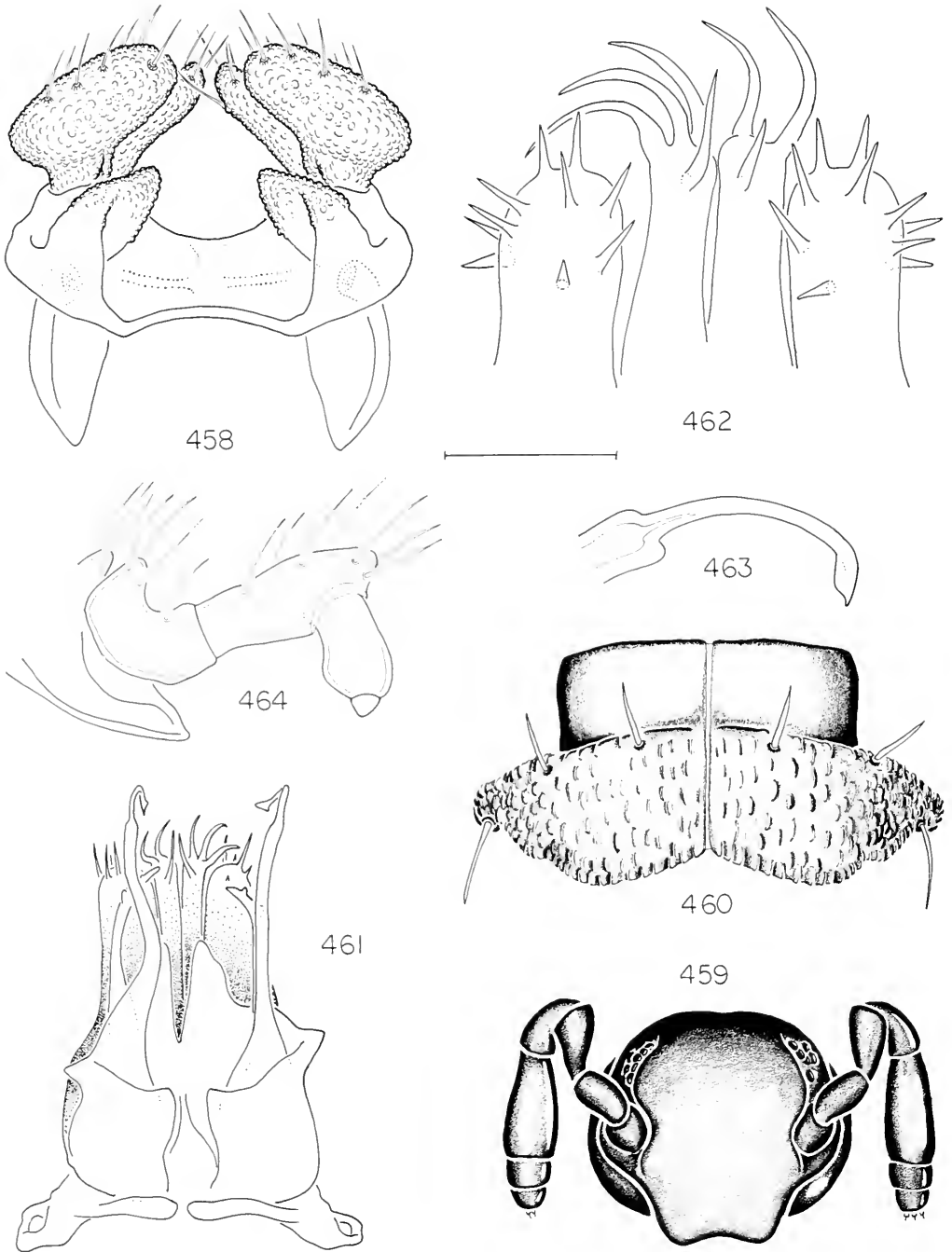

Figures 458-464. Anatomy of *Rhiscosomides acovescor* and *Tingupa utahensis*. Fig. 458. *Rhiscosomides acovescor*, posterior gonopods, anterior view. Figs. 459-463. *Tingupa utahensis*. Fig. 459. Head, anterior view. Fig. 460. Segment 12, dorsal view. Fig. 461. Anterior gonopods, posterior view. Fig. 462. Tips of anterior gonopod coxal processes, posterior view. Fig. 463. Tip of longest telopodite process of anterior gonopod, lateral view. Fig. 464. Right posterior gonopod, anterior view. Scale line = 0.25 mm for Figs. 458, 461, 464; 0.35 mm for Figs. 459, 460; 0.05 mm for Figs. 462, 463.

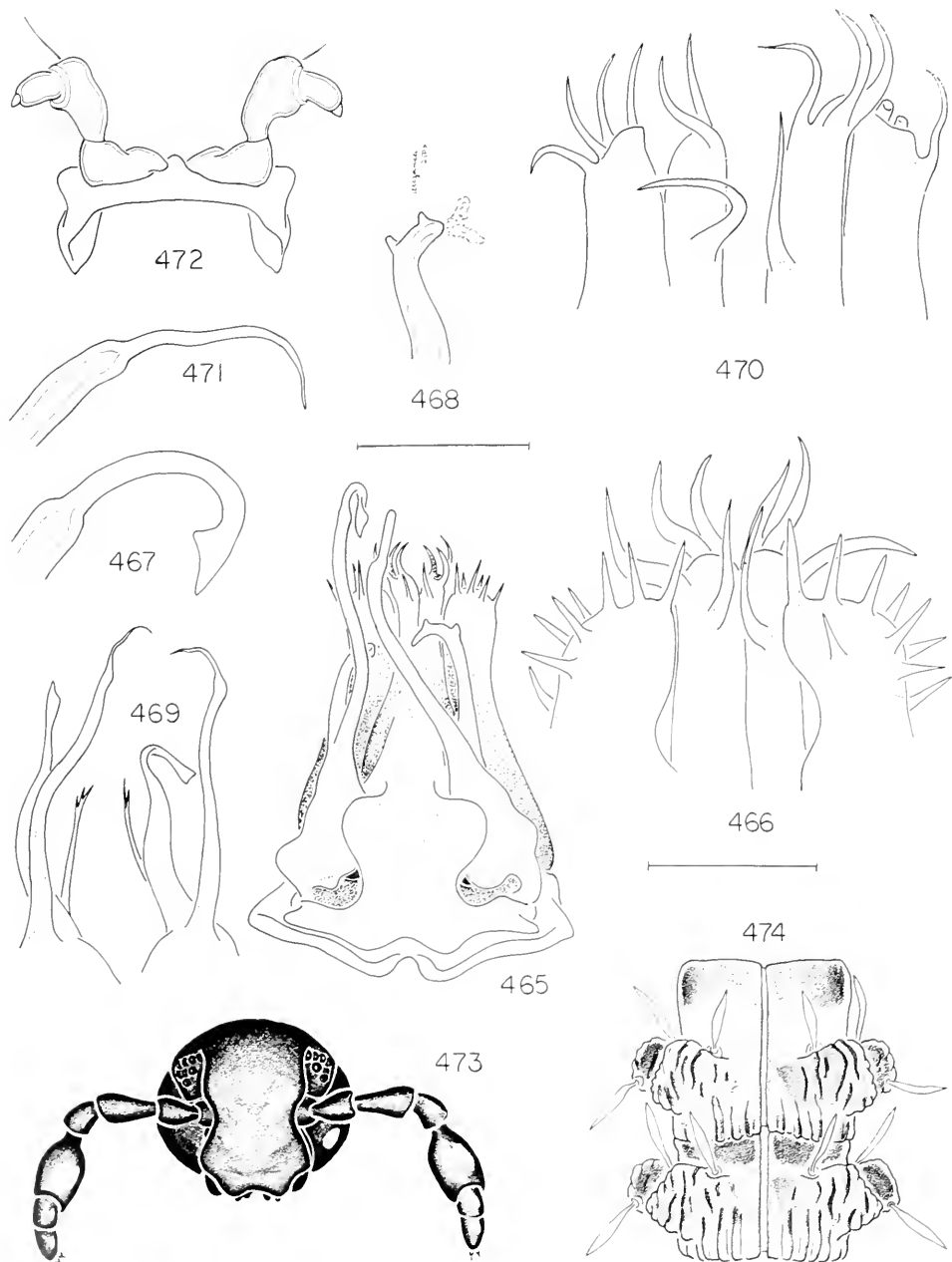

Figures 465-474. Anatomy of *Tingupa* spp. and *Branneria carinata*. Figs. 465-468. *Tingupa arizonica*. Fig. 465. Anterior gonopods, posterior view. Fig. 466. Tips of anterior gonopod coxal processes, posterior view. Fig. 467. Tip of longest telopodite process of anterior gonopod, lateral view. Fig. 468. Tip of shorter anterior gonopod telopodite process, lateral view. Figs. 469-472. *T. pallida*. Fig. 469. Telopodites of anterior gonopods, posterior view. Fig. 470. Tips of anterior gonopod coxal processes, posterior view. Fig. 471. Tip of longest anterior gonopod telopodite process, lateral view. Fig. 472. Posterior gonopods, anterior view. Figs. 473-474. *Branneria carinata*. Fig. 473. Head, anterior view. Fig. 474. Segments 12, 13, dorsolateral view. Scale line = 0.25 mm for Figs. 465, 469; 0.35 mm for Figs. 473, 474; 0.05 mm for Figs. 466-468, 470, 471; 0.50 mm for Fig. 472.

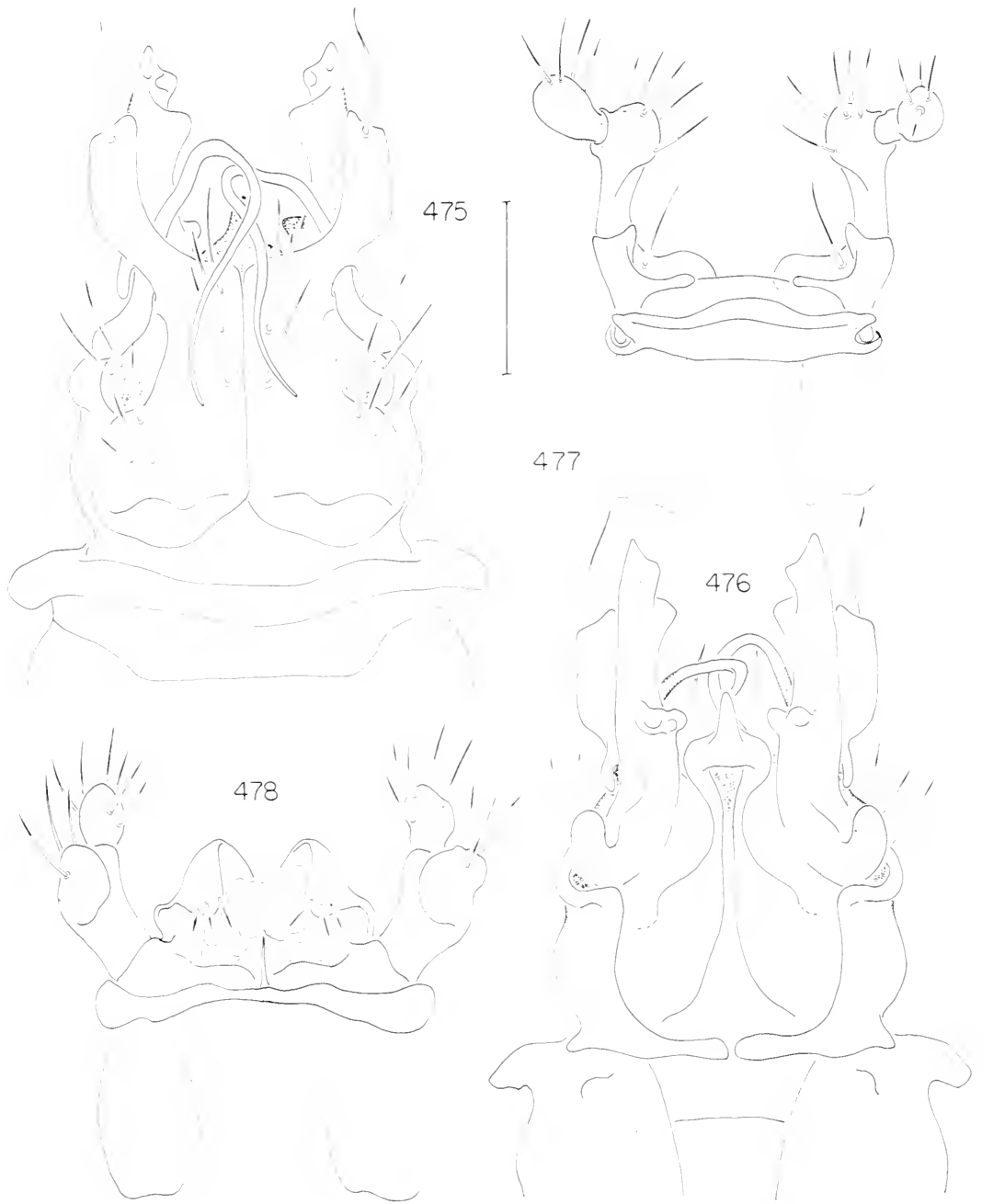

Figures 475–478. Anatomy of *Bronnerio carinata*. Fig. 475. Anterior gonopods, anterior view. Fig. 476. Anterior gonopods, posterior view. Fig. 477. Posterior gonopods, anterior view. Fig. 478. Legpair 10, anterior view. Scale line = 0.05 mm for Figs. 475, 476; 0.09 mm for Figs. 477, 478.

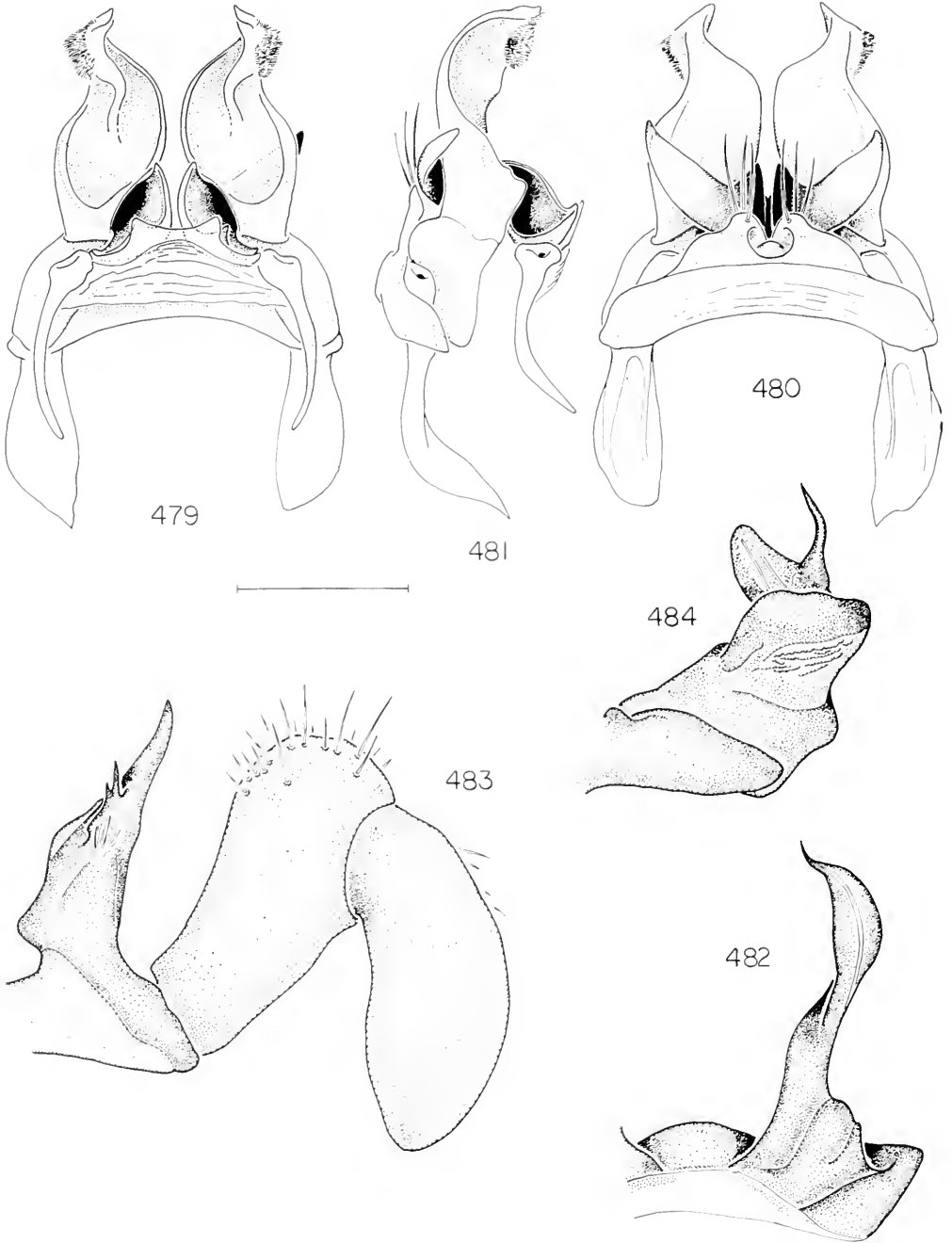

Figures 479-484. Anatomy of species of Conotylidae. Figs. 479-481. *Idagona westcotti*. Fig. 479. Gonopods, posterior view. Fig. 480. Gonopods, anterior view. Fig. 481. Right gonopods, lateral view. Figs. 482-483. *Conotyla blakei*. Fig. 482. Left anterior gonopod, posterior view. Fig. 483. Right posterior gonopod, anterior view. Fig. 484. *Conotyla albertana*, right anterior gonopod, anterior view. Scale line = 0.35 mm for Figs. 482-484; 0.50 mm for Figs. 479-481.

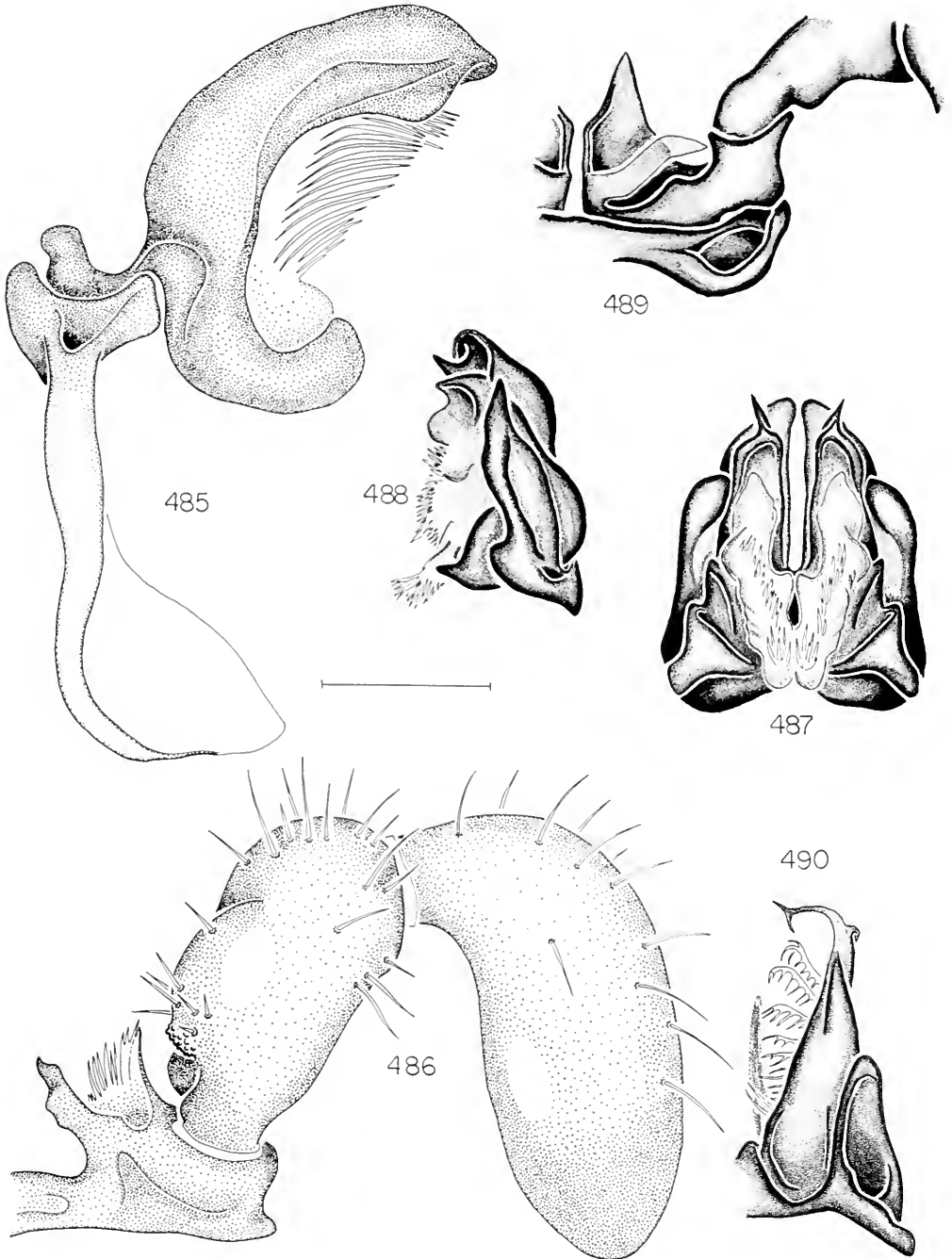

Figures 485-490. Anatomy of species of Conotylidae. Figs. 485-486. *Achemenides pectinatus*. Fig. 485. Right anterior gonopod, lateral view. Fig. 486. Right posterior gonopod, anterior view. Figs. 487-489. *Austrotyla chihuahua*. Fig. 487. Anterior gonopods, posterior view. Fig. 488. Left anterior gonopod, lateral view. Fig. 489. Right posterior gonopod, anterior view. Fig. 490. *Plumotyla humerosa*, right anterior gonopod, anterior view. Scale line = 0.35 mm.

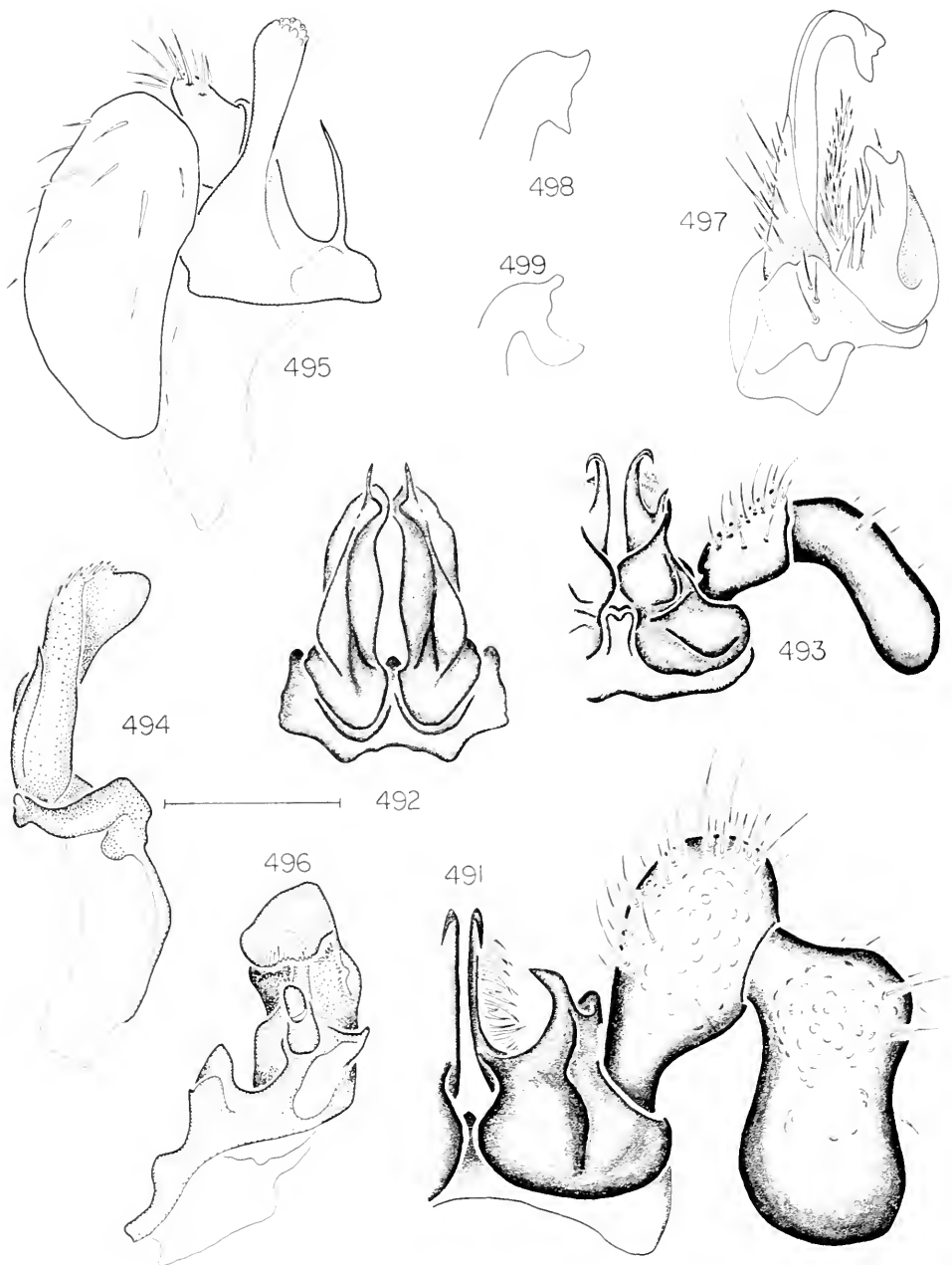

Figures 491-499. Anatomy of *Adityla deseretae*, species of Conatylidae, and *Trichopetalum lunatum*. Fig. 491. *Plumatyla humerosa*, left posterior gonopod, posterior view. Figs. 492-493. *Taiyutyla corvallis*. Fig. 492. Anterior gonopods, posterior view. Fig. 493. Left posterior gonopod, posterior view. Figs. 494-496. *Adityla deseretae*. Fig. 494. Right anterior gonopod, lateral view. Fig. 495. Left posterior gonopod, anterior view. Fig. 496. Left leg 10, anterior view. Figs. 497-499. *Trichopetalum lunatum*. Fig. 497. Right anterior gonopod, lateral view. Fig. 498. Colpocoxite tip of specimen from British Columbia. Fig. 499. Colpocoxite tip of specimen from West Virginia. Scale line = 0.35 mm for Figs. 491-493; 0.60 mm for Figs. 495-496; 0.10 mm for Fig. 497; 0.05 mm for Figs. 498-499.

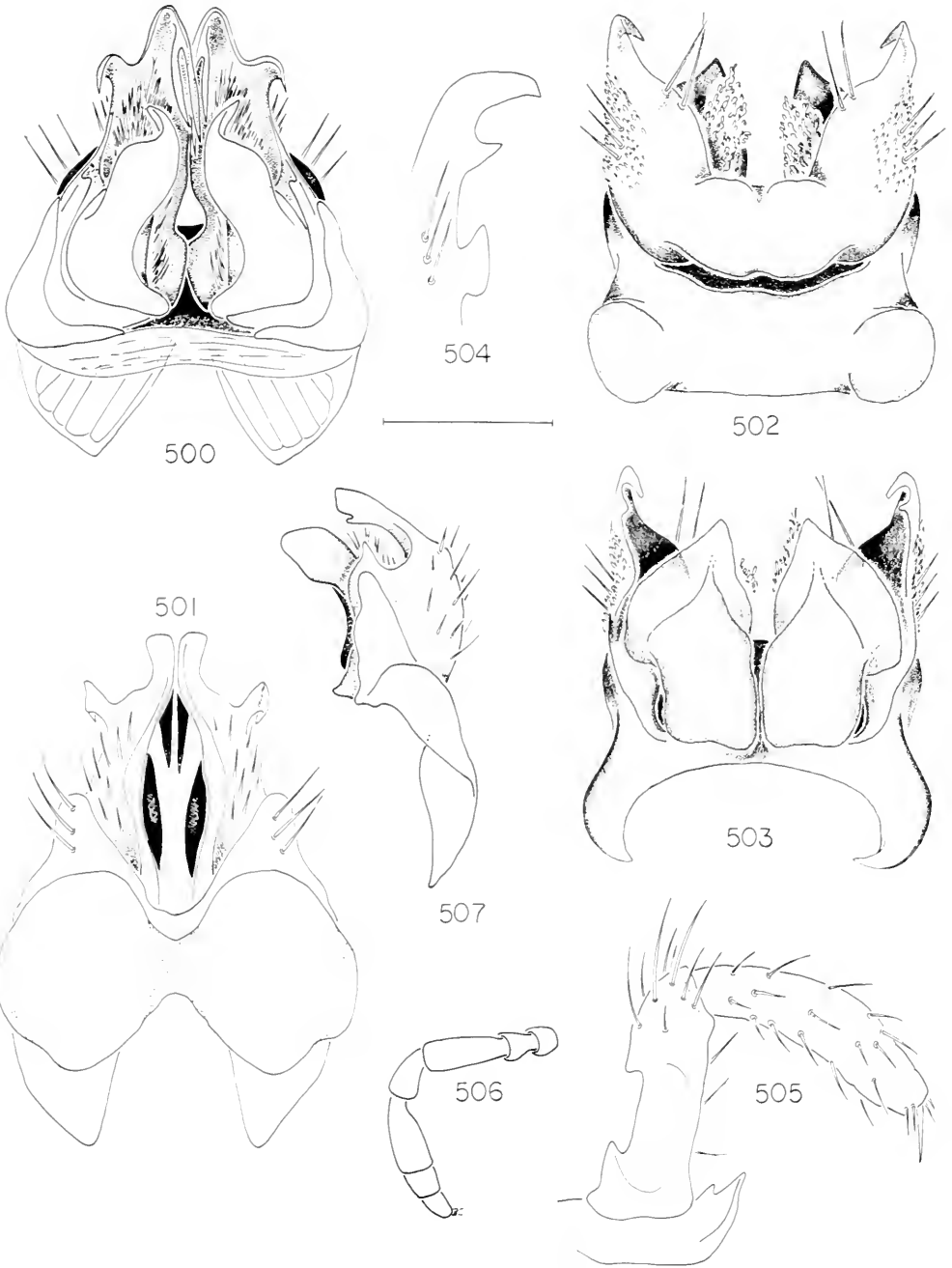

Figures 500-507. Anatomy of *Trichopetalum* spp. Figs. 500-501. *T. unicum*. Fig. 500. Anterior gonopods, posterior view. Fig. 501. Anterior gonopods, anterior view. Figs. 502-505. *T. dux*. Fig. 502. Anterior gonopods, posterior view. Fig. 503. Anterior gonopods, posterior view. Fig. 504. Tip of left anterior gonopod colpocoxite, lateral view. Fig. 505. Right posterior gonopod, anterior view. Figs. 506-507. *T. syntheticum*. Fig. 506. Right antenna, anterior view. Fig. 507. Left anterior gonopod, lateral view. Scale line = 0.10 mm for Figs. 500-503, 505, 507; 0.25 mm for Fig. 506; 0.05 mm for Fig. 504.

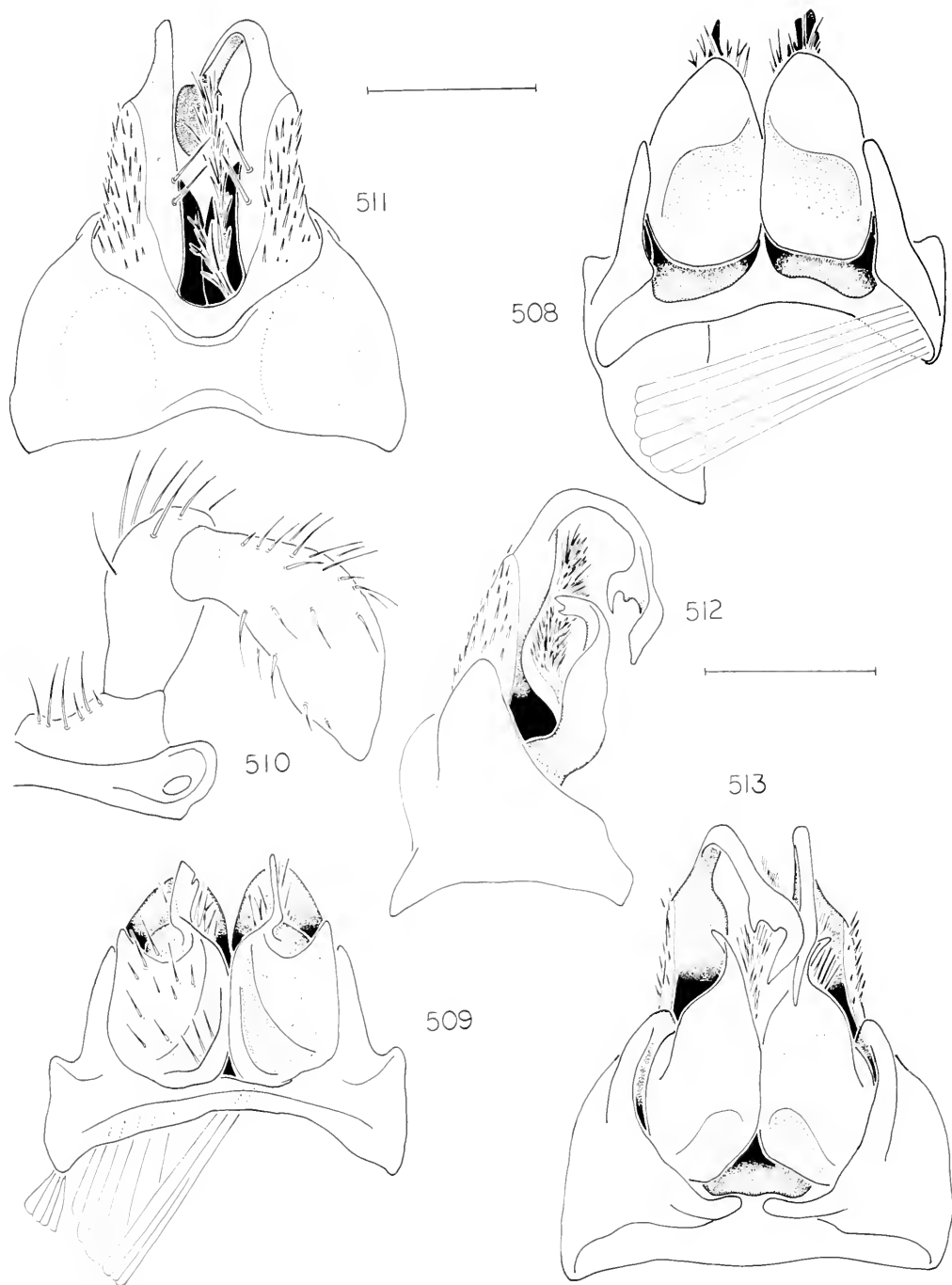

Figures 508-513. Anatomy of *Trichopetalum* spp. Figs. 508-510. *T. syntheticum*. Fig. 508. Anterior gonopods, posterior view. Fig. 509. Anterior gonopods, anterior view. Fig. 510. Right posterior gonopod, anterior view. Figs. 511-513. *T. cornutum*. Fig. 511. Anterior gonopods, anterior view. Fig. 512. Anterior gonopods, lateral view. Fig. 513. Anterior gonopods, posterior view. Scale line = 0.10 mm.

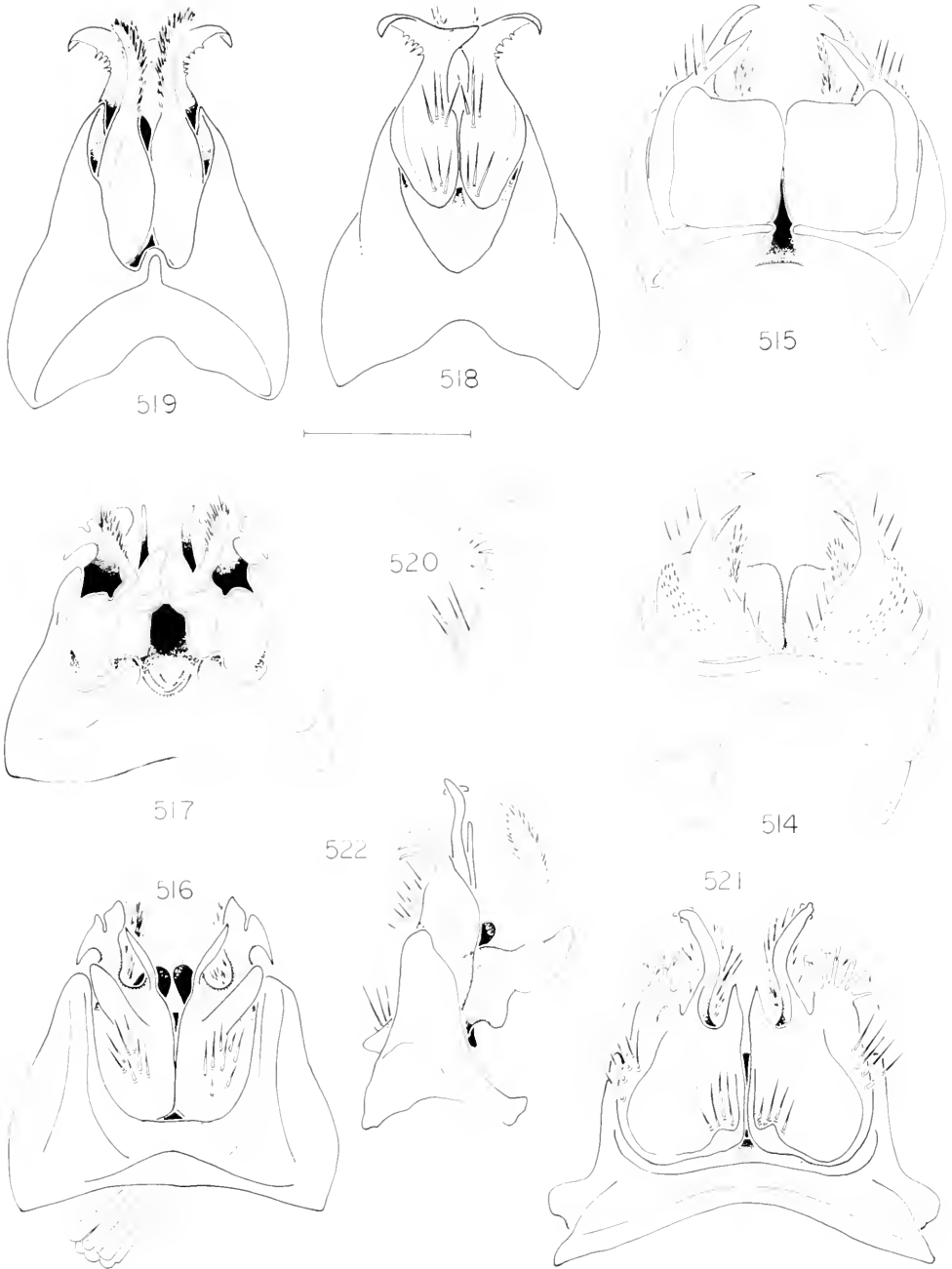

Figures 514-522. Anatomy of *Trichopetalum* and *Scoterpes* spp. Figs. 514-515. *T. packardi*. Fig. 514. Anterior gonopods, anterior view. Fig. 515. Anterior gonopods, posterior view. Figs. 516-517. *S. copei*. Fig. 516. Anterior gonopods, anterior view. Fig. 517. Anterior gonopods, posterior view. Figs. 518-520. *S. austrinus*. Fig. 518. Anterior gonopods, anterior view. Fig. 519. Anterior gonopods, posterior view. Fig. 520. Tip of right anterior gonopod colpocoxite, lateral view. Figs. 521-522. *S. ventus*. Fig. 521. Anterior gonopods, anterior view. Fig. 522. Right anterior gonopod, lateral view. Scale line = 0.10 mm for Figs. 514-519, 521, 522; 0.07 mm for Fig. 520.

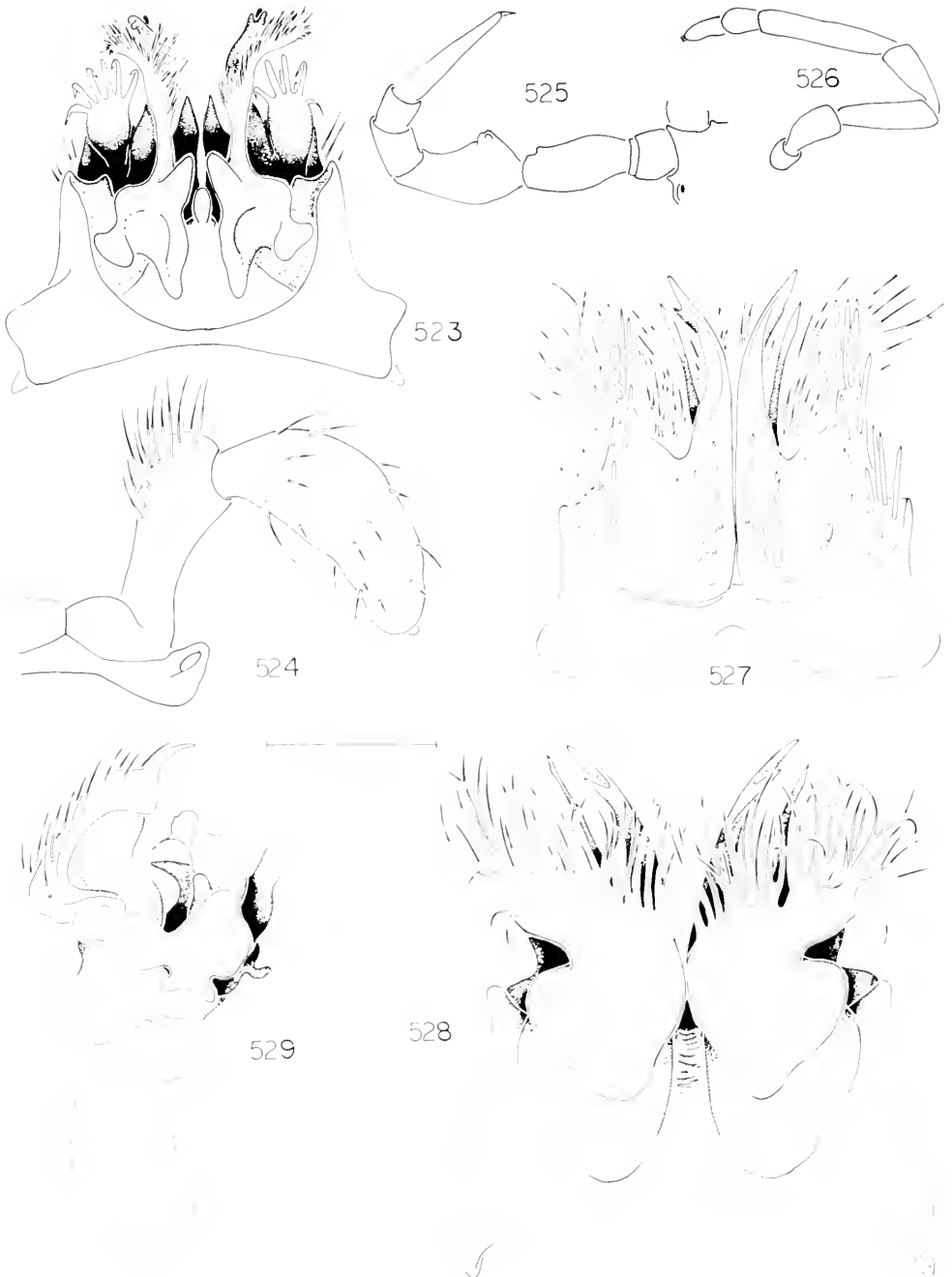

Figures 523–529. Anatomy of *Scoterpes ventus* and *Trigenotylo parca*. Figs. 523–526. *S. ventus*. Fig. 523. Anterior gonopods, posterior view. Fig. 524. Right posterior gonopod, anterior view. Fig. 525. Right leg 6, posterior view. Fig. 526. Antenna, anterior view. Figs. 527–528. *T. parca*. Fig. 527. Anterior gonopods, anterior view. Fig. 528. Anterior gonopods, posterior view. Fig. 529. *Mexiterpes sabinus*, right anterior gonopod, lateral view. Scale line = 0.10 mm for Figs. 523, 524, 527–529; 0.75 mm for Figs. 525, 526.

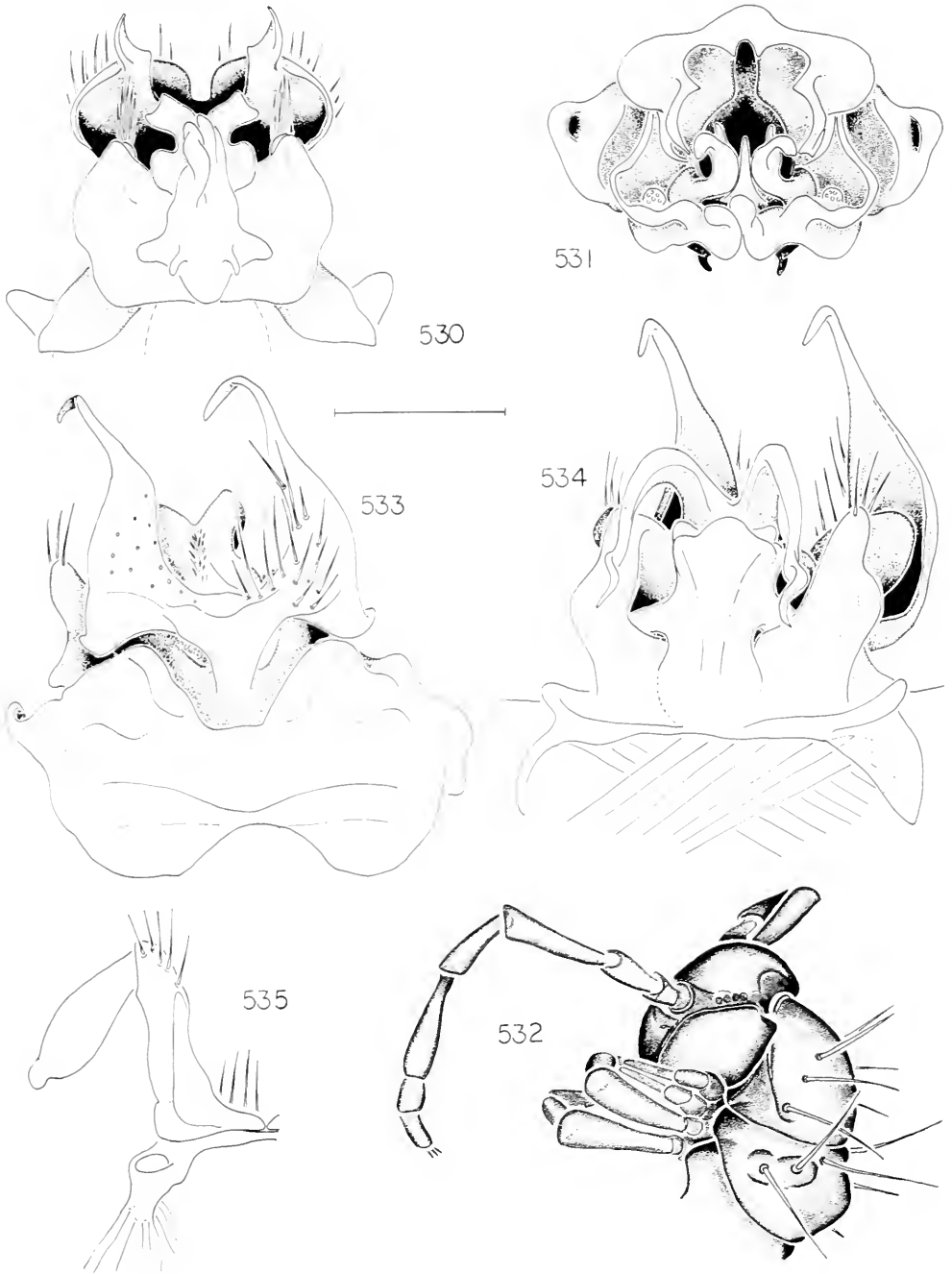

Figures 530-535. Anatomy of *Mexiterpes* spp. Figs. 530-531. *M. sabinus*. Fig. 530. Anterior ganapads, posterior view. Fig. 531. Anterior ganapads, ventral view. Figs. 532-535. *M. metallicus*. Fig. 532. Anterior end of body, lateral view. Fig. 533. Anterior ganapads, view slightly lateral of anterior. Fig. 534. Anterior ganapads, view slightly lateral of posterior. Fig. 535. Left posterior ganopod, anterior view. Scale line = 0.10 mm for Figs. 530, 531, 533-535; 0.75 mm for Fig. 532.

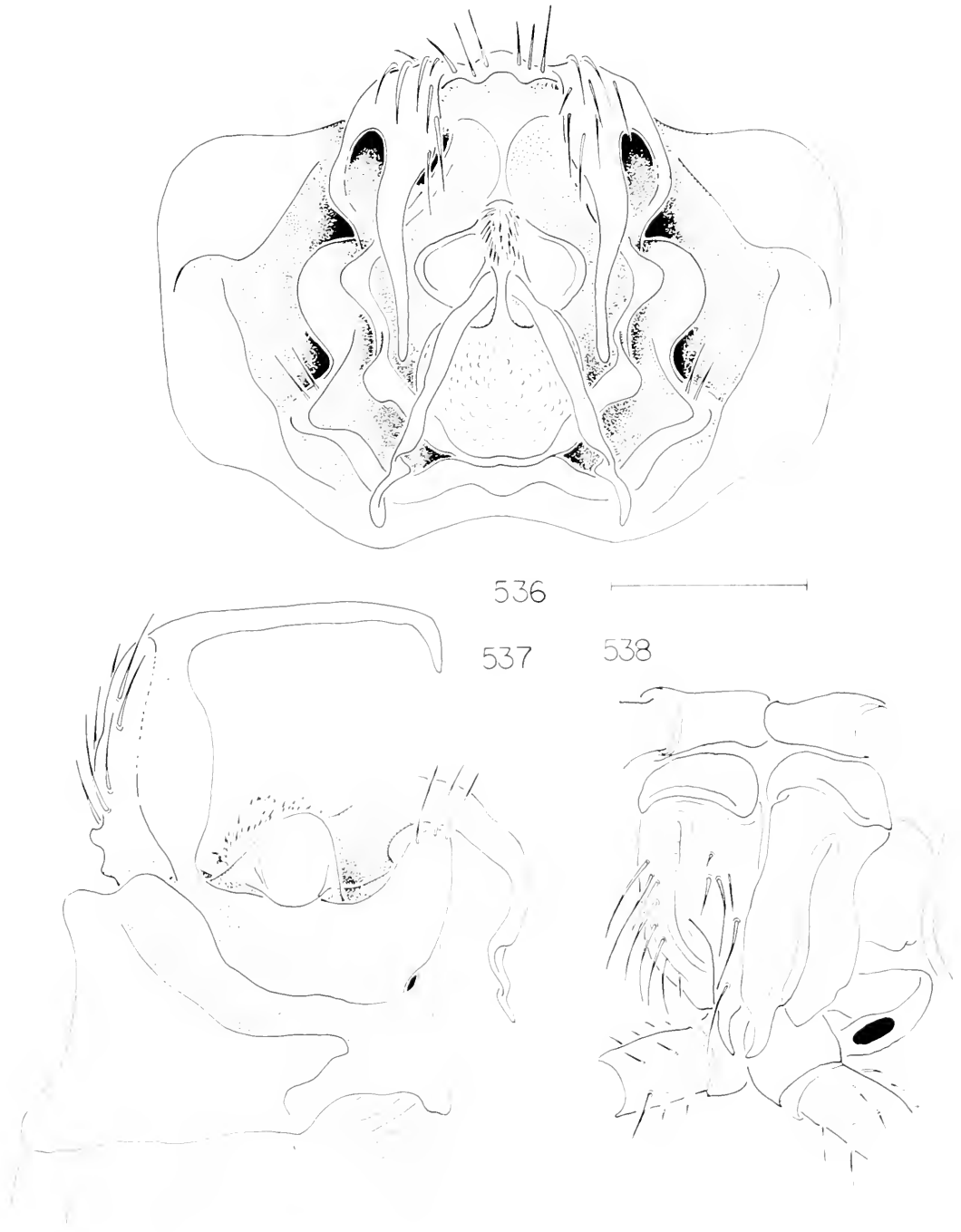

Figures 536–538. Anatomy of *Mexiterpes metallicus*. Fig. 536. Anterior gonopods, ventral view. Fig. 537. Anterior gonopods, lateral view. Fig. 538. Cyphopods, lateral view. Scale line = 0.10 mm for Figs. 536, 537; 0.15 mm for Fig. 538.

INDEX

Valid generic names and species combinations in italics.

- Acakandra 196
accretis, *Cleidogona* 239
Achemenides 271
acheron, *Pseudotremia* 176
acorescor, *Rhiscosomides* 262
Acrochordum 264
Adrityla 273
 Adritylidae 273
acacus, *Pseudotremia* 178
alata, *Cleidogona* 233
 Alata species group of *Cleidogona* 232
album, *Trichopetalum* 277
alecto, *Pseudotremia* 186
 alia, *Ofcoogogona* 242
alia, *Tiganogona* 242
amphiorax, *Pseudotremia* 171
Amplaria 257
Apodigona 268
 Apterouridae 247
Apterourus 247
arizonica, *Tingupa* 265
arkansana, *Cleidogona* 157
armesi, *Pseudotremia* 185
aspera, *Cleidogona* 238
atoyaca, *Cleidogona* 221
atrolincata, *Conotyta* 271
atropos, *Cleidogona* 230
australis, *Cleidogona* 158
austrina, *Acakandra* 158
austrina, *Cleidogona* 158
austrinus nudus, *Scoterpes* 279
austrinus, *Scoterpes* 279
Austrotyla 272

bacillipus, *Cleidogona* 216
bacillipus, *Rhabdarona* 216
 Bactropidae 156
 Bactropodellidae 156
Bactropodellus 240
Bactropus 240
baroqua, *Cleidogona* 209
blakei, *Conotyta* 271
bollmani, *Conotyta* 271
borealis, *Austrotyla* 273
Branneria 266
 Branneriidae 266
 Brannerioidea 262
 Key to families 255
brownae, *Tiganogona* 241
bumpusi, *Urochordeuma* 261

caesioannulata, *Cleidogona* 236
 Caesioannulata species group of *Cleidogona* 236
camazotz, *Cleidogona* 215
 Campodes 195
carinata, *Branneria* 266
caroliniana, *Cleidogona* 231
carterensis, *Pseudotremia* 188
Caseya 258
 Caseyidae 258
cavernarum, *Pseudotremia* 191
 Cavota 195
ceibana, *Cleidogona* 208
ceibana, *Hirsutogona* 208
celerita, *Cleidogona* 236
cercops, *Pseudotremia* 180
chacmool, *Cleidogona* 211
Chaemosoma 264
chiapas, *Solacogona* 195
chihuahua, *Austrotyla* 273
chiriquia, *Dybasia* 246
chiriquia, *Solemia* 246
chisosi, *Cleidogona* 222
chontala, *Cleidogona* 210
 Chordeumida, key to superfamilies 255
Cleidogona 195
 Key to Mexican and Central American species 206
 Key to U. S. species 222
 Cleidogonidae 157
 Key to genera 162
 Cleidogonoidea 274
 Key to families 255
cocytus, *Pseudotremia* 183
 Collecting methods 154
coloradensis, *Austrotyla* 273
columbiana, *Striaria* 258
conifer, *Bactropus* 158
conifer, *Tiganogona* 158
Conotyta 271
 Conotyliidae 268
 Key to genera 270
conotyloides, *Cleidogona* 219
copei, *Scoterpes* 279
cornutum, *Trichopetalum* 278
corvallis, *Taiyutyla* 272
 Costaricia 196
cottus, *Pseudotremia* 183
 Cottus species group of *Pseudotremia* 181
 Coxal glands as a taxonomic character 252
crucis, *Cavota* 209
crucis, *Cleidogona* 209
 Crucis species group of *Cleidogona* 209
 Cryptotrichus 195
crystallina, *Cleidogona* 212
 Crystallina species group of *Cleidogona* 212

- curvipes*, *Cleidogona* 158
curvipes, *Costarcia* 158
- decurva*, *Cleidogona* 221
dendropus, *Scoterpes* 280
deprehendor, *Pseudotremia* 189
deseretae, *Adrityla* 273
deseretae, *Conotyla* 273
Diplomaragnidae 267
Dissection methods 155
divergens, *Dybasia* 245
divergens, *Ogkomus* 245
dux, *Trichopetalum* 278
dux, *Tynopus* 278
Dybasia 243
 Key to species 244
Dybasiidae 156
- eburnea*, *Pseudotremia* 177
Eburnea species group of *Pseudotremia* 176
Entomobielziinae 156
Ergethidae 247
Ergethus 249
Endigona 268
exaspera, *Cleidogona* 236
- fidelitor*, *Cleidogona* 232
Flagellopetalum 277
forceps, *Cleidogona* 158
forficula, *Cleidogona* 208
fracta, *Pseudotremia* 158
fulgida, *Pseudotremia* 188
fustis, *Cleidogona* 239
- georgia*, *Cleidogona* 233
glebosa, *Ozarkogona* 242
glebosa, *Tiganogona* 242
godmani, *Cleidogona* 217
Godmani species group of *Cleidogona* 217
Conopods as sources of taxonomic characters 253
gruada, *Cleidogona* 234
guatemalana, *Solaenogona* 194
gucumatz, *Cleidogona* 210
- hadena*, *Cleidogona* 231
Halleinosoma 264
hansonii, *Pseudotremia* 158
hautla, *Cleidogona* 217
hespera, *Underwoodia* 258
Heterochordematidae 267
Heterochordematoidea 267
 Key to families 255
heteropus, *Cascya* 259
Hirsutogona 196
hobbsi, *Pseudotremia* 191
Hobbsi species group of *Pseudotremia* 186
hoffmani, *Cleidogona* 229
horizontalis, *Apterourus* 247
- humerosa*, *Dybasia* 244
humerosa, *Plumatyla* 273
- Idagone* 270
Idagonidae 268
indianae, *Pseudotremia* 172
Indianae species group of *Pseudotremia* 170
inexpectata, *Cleidogona* 226
inflata, *Cleidogona* 236
inuloides, *Underwoodia* 259
- Japanosomidae 267
jocasseae, *Cleidogona* 229
josephi, *Rhiscosomides* 262
- lachesis*, *Cleidogona* 228
ladymani, *Ozarkogona* 158
ladymani, *Tiganogona* 158
laminata, *Cleidogona* 238
laquinta, *Cleidogona* 219
leona, *Cleidogona* 213
lethe, *Pseudotremia* 179
levis, *Ozarkogona* 158
levis, *Tiganogona* 158
liCTOR, *Pseudotremia* 181
lunatum, *Trichopetalum* 277
lusciosa, *Dearolfia* 187
lusciosa, *Pseudotremia* 187
- maculata*, *Cleidogona* 213
Maculata species group of *Cleidogona* 213
maculatum, *Mexiceuma* 213
major, *Cleidogona* 224
Major species group of *Cleidogona* 224
mandeli, *Cleidogona* 158
mandible, pectinate lamellae of,
 as taxonomic character 252
margarita, *Cleidogona* 228
mayapev, *Cleidogona* 215
Mecistopus 196
Mentum, subdivision of, as
 taxonomic character 251
microps, *Pseudotremia* 175
metallicus, *Mexiterpes* 281
Metapidiotrichidae 267, 268
mexicana, *Cleidogona* 207
mexicanum, *Craspedosoma* 207
Mexiceuma 195
Mexiceumidae 156
Mexiterpes 280
mineri, *Rhiscosomides* 261
minima, *Cleidogona* 158
minos, *Pseudotremia* 182
minutissima, *Cleidogona* 222
minutissima, *Hirsutogona* 222
mirabilis, *Cleidogona* 221
mirabilis, *Hirsutogona* 221
mississippiana, *Cleidogona* 235
Mississippiana species group of *Cleidogona* 234

- mixteca*, *Cleidogona* 211
moderata, *Cleidogona* 157
moesta, *Tiganogona* 242
momus, *Pseudotremia* 185
monterea, *Rhiscosomides* 262
monterea, *Tingupa* 262
- nantahala*, *Cleidogona* 227
uefanda, *Pseudotremia* 170
nodosa, *Pseudotremia* 178
nuera, *Cleidogona* 158
nuera michoacana, *Cleidogona* 158
nyx, *Pseudotremia* 179
- Ofcookogona 240
 Ogkomus 243
 Opiona 258
 Ozarkogona 240
- packardi*, *Trichopetalum* 278
packardi, *Zygonopus* 278
pallida, *Tingupa* 265
parca, *Triguotyla* 280
pecki, *Cleidogona* 213
pectinata, *Achemenides* 272
pectinata, *Conotyla* 272
perditus, *Ergethus* 249
personata, *Conotyla* 271
Placema 258
Plumatyla 273
polygama, *Underwoodia* 259
porona, *Urochordeuma* 260
princeps, *Pseudotremia* 190
Proconotyla 271
propria, *Cleidogona* 213
 Proto-Dybasia species group of *Cleidogona* 221
Pseudocleididae 156
Pseudotremia 162
 Key to species 168
punctifer, *Cleidogona* 158
- rafaela*, *Cleidogona* 218
Rafaela species group of *Cleidogona* 218
Rhabdarona 195
rhadamanthus, *Pseudotremia* 176
Rhiscosomides 261
Rhiscosomididae 261
- sabimus*, *Mexiterpes* 281
saripa, *Cleidogona* 157
Schedotrigona 268
Scoterpes 279
scrutorum, *Pseudotremia* 181
 Secondary sexual modifications
 as taxonomic characters 252
secreta, *Cleidogona* 157
 Segment number as a taxonomic character 250
shastae, *Speostriaria* 258
simulans, *Pseudotremia* 187
- soco*, *Pseudotremia* 177
sodalis, *Pseudotremia* 188
Solaenogona 193
 Key to species 193
Solemia 243
specus, *Austrityla* 272, 273
Speoseya 258
Speostriaria 257
spira, *Pseudotremia* 175
Spira species group of *Pseudotremia* 173
steno, *Cleidogona* 232
stewartae, *Ofcookogona* 158
stewartae, *Tiganogona* 158
stolli, *Cleidogona* 220
stolli, *Hirsutogona* 220
Stolli species group of *Cleidogona* 220
Striaria 257
Striariidae 257
Striarioidea 255
 Key to families 255
stupefactor, *Pseudotremia* 174
sublettei, *Cleidogona* 235
sublevis, *Pseudotremia* 192
Syntelopodeuma 267, 268
syntheticum, *Trichopetalum* 278
- Taiyutyla* 272
tajmulco, *Cleidogona* 158
tallapoosa, *Cleidogona* 231
tequila, *Cleidogona* 217
Tiganogona 240
Tingupa 265
 Key to species 265
Tingupidae 264
tizoc, *Cleidogona* 214
tonoaca, *Cleidogona* 218
Trichopetalidae 274
 Key to genera 276
Trichopetalum 276
Triguotyla 280
 Troglolite adaptations as taxonomic characters 251
tsuga, *Pseudotremia* 190
tuberculata, *Pseudotremia* 184
Tuberculata species group of *Pseudotremia* 184
Tynopus 277
- unca*, *Pseudotremia* 175
uncum, *Trichopetalum* 277
Underwoodia 258
Underwoodiidae 258
unita, *Cleidogona* 238
Unita species group of *Cleidogona* 238
Urochordeuma 260
Urochordeumidae 260
utahensis australis, *Tingupa* 265
utahensis, *Tingupa* 265
- Vaferia* 257
valga, *Pseudotremia* 173

varicornis, *Mecistopus* 216

Vasingtona 258

ventus, *Scoterpes* 279

westcotti, *Idagona* 270

wrayi, *Cleidogona* 234

xolotl, *Cleidogona* 215

Zautona 258

zapoteca, *Cleidogona* 219

zempoala, *Cleidogona* 158

zimapaniensis, *Cleidogona* 214

Zygonopus 276

Bulletin OF THE
Museum of
Comparative
Zoology

Romeriid Reptiles from the
Lower Permian

JOHN CLARK AND ROBERT L. CARROLL

PUBLICATIONS ISSUED
OR DISTRIBUTED BY THE
MUSEUM OF COMPARATIVE ZOOLOGY
HARVARD UNIVERSITY

BULLETIN 1863-
BREVIORA 1952-
MEMOIRS 1864-1938
JOHNSONIA, Department of Mollusks, 1941-
OCCASIONAL PAPERS ON MOLLUSKS, 1945-

Other Publications.

- Bigelow, H. B., and W. C. Schroeder, 1953. Fishes of the Gulf of Maine.
- Brues, C. T., A. L. Melander, and F. M. Carpenter, 1954. Classification of Insects.
- Creighton, W. S., 1950. The Ants of North America.
- Lyman, C. P., and A. R. Dawe (eds.), 1960. Symposium on Natural Mammalian Hibernation.
- Peters' Check-list of Birds of the World, vols. 2-7, 9, 10, 12-15.
- Turner, R. D., 1966. A Survey and Illustrated Catalogue of the Teredinidae (Mollusca: Bivalvia).
- Whittington, H. B., and W. D. I. Rolfe (eds.), 1963. Phylogeny and Evolution of Crustacea.
- Proceedings of the New England Zoological Club 1899-1948. (Complete sets only.)
- Publications of the Boston Society of Natural History.

Authors preparing manuscripts for the *Bulletin of the Museum of Comparative Zoology* or *Breviora* should send for the current Information and Instruction Sheet, available from Editor, Publications Office, Museum of Comparative Zoology, Harvard University, Cambridge, Massachusetts 02138, U.S.A.

ROMERIID REPTILES FROM THE LOWER PERMIAN

JOHN CLARK¹ AND ROBERT L. CARROLL²

ABSTRACT. The Family Romeriidae, ancestral to most major reptilian groups, is represented by numerous specimens in the Lower Permian of Texas, West Virginia, and Oklahoma. Two lineages can be recognized. One, characterized by the genus *Protorothyris archeri*, is a continuation of the main Pennsylvanian stock in which the upper tooth row is horizontal. A species from West Virginia, originally placed in a distinct genus, *Melanothyris morani*, is here considered as only specifically distinct from *P. archeri*. A second group, in which the premaxilla is hooked, is typified by *Romeria texana*. Within this group, a new species, *Romeria prinus*, and a new genus, *Protocaptorhinus pricei*, are named. A sequence of forms within this group demonstrates an almost complete transition between the families Romeriidae and Captorhinidae. The Captorhinidae can be differentiated from the Romeriidae by the conspicuous lateral expansion of the cheek region. In the late Belle Plains and Clyde Formations of Texas, captorhinids are represented by a genus closely resembling *Captorhinus*, but having only a single marginal tooth row. In Texas, *Captorhinus aguti* is not known with assurance prior to the Arroyo Formation. A primitive antecedent of *Labidosaurus hamatus* is known from the Clyde Formation, an indication that this genus evolved directly from the romeriids, rather than from the immediate ancestor of *Captorhinus aguti*. The following groups must have evolved from romeriids prior to the Permian: pelycosaurs, mesosaurs, *Bolosaur*, araeoscelids, and eosuchians. Turtles may have evolved from Lower Permian romeriids. Procolophonoids probably diverged from the ancestral reptilian stock separately from romeriids, as did limnoscelids.

¹ John Clark began this work in the early 1950's, but died before the paper was completed.

² Redpath Museum, McGill University, Montreal, Quebec.

Introductory note. Much of the careful and thorough preparation of the romeriids described in this paper was accomplished by John Clark while he was a graduate student at Harvard between 1948 and 1954. He also made many preliminary drawings of the specimens and had begun description of several species as a basis for his Ph.D thesis. This work was continued by Mr. Clark at Marietta College where he taught for a number of years. Study of these specimens was interrupted by Mr. Clark's death in 1967. In 1968, Dr. Romer asked me to prepare this material for publication. In general, the scope of this paper corresponds with that of John Clark's preliminary work. Because research on the origin of reptiles and the anatomy of Pennsylvanian romeriids has been published by other authors since the initiation of Mr. Clark's thesis, some of the broader phylogenetic problems that he was considering are not discussed in this paper. Nevertheless, his extensive work with this material fully justifies his recognition as senior author.

Robert L. Carroll

CONTENTS

Introduction	354
Acknowledgments	354
Systematic Descriptions	357
<i>Protorothyris archeri</i> Price	357
<i>Protorothyris morani</i> (Romer), new combination	367
<i>Romeria prinus</i> new species	371
<i>Romeria texana</i> Price	375
<i>Protocaptorhinus pricei</i> new species	379
<i>Pleuristion brachycoelus</i> Case	386
Abbreviations	360
Changes in the Skull Structure of Lower Permian Romeriids	387
The Origin of the Family Captorhinidae	389
Relationships of Romeriids with other Reptiles	400
Literature Cited	405

INTRODUCTION

The earliest known reptiles and the ancestors of most, if not all, advanced members of the class are included within the Family Romeriidae. This family was first recognized by L. I. Price (1937) in his description of skulls from the Lower Permian of Texas. Other specimens, also discovered by Price, were assigned to this group by Watson (1954). Subsequently, a number of species from the Pennsylvanian have been described as members of this family (Carroll, 1964, 1969a; Carroll and Baird, 1972). Despite their great taxonomic significance, the Permian romeriids have never been thoroughly described. The palates and postcranial skeletons have never been illustrated and their relationships to contemporary and derivative groups have been considered only in a cursory manner. The excellent preservation of these specimens enables very detailed illustrations and descriptions to be made, and these in turn provide a basis for specific comparisons with other groups of primitive reptiles.

The Lower Permian romeriids are the youngest known members of a family that can be traced back to the early Pennsylvanian. Although several lineages of Pennsylvanian romeriids can be recognized, the genera described in this paper appear to have a common ancestry within the Permian. This, together with the fact that most are represented primarily by very well-preserved skulls, makes it practical to discuss them separately from the Pennsylvanian members of the family.

Among the material collected by Price, two lineages may be recognized. The more conservative, represented by *Protorothyris*, is a continuation of the main Pennsylvanian lineage of *Hylonomus* from the Westphalian B and *Paleothyris* from the Westphalian D. The number of marginal teeth is large, the upper tooth row is horizontal and there are two pairs of "canines" near the front of the maxilla. The other assemblage is first recognized in the Moran Formation (see Figs.

21 and 22 for stratigraphic position of the specimens), contemporary with *Protorothyris*. It is represented by one specimen from that horizon, *Romeria texana* from the Putnam, and others from the Admiral and Belle Plains. This stock demonstrates a transition toward the Family Captorhinidae. The premaxilla is hooked, the tooth row becomes progressively shorter and the canines less pronounced.

The Texas Redbeds, from which most of these specimens have come, represent an area of essentially continuous deposition over some 15 million years of the Lower Permian. The predominant environment is deltaic, but with many subenvironments representing rivers, streams, swamps, and small lakes. It is apparent that few really upland forms are preserved. Reptiles are relatively rare in the early beds, but attain complete dominance by the end of the sequence.

Although individuals are rare, the known romeriids apparently represent quite well the total range of diversity of the group; at least, all the specimens can be fitted into a simple and consistent phylogenetic pattern. Despite the diversity and numerical dominance of their descendants, the romeriids themselves were apparently very rare elements of the Lower Permian fauna, in contrast with their local abundance in the Pennsylvanian.

The species will be described in taxonomic and stratigraphic sequence, beginning with the more primitive of the two genera from the Moran Formation.

ACKNOWLEDGMENTS

We wish to thank Dr. Romer for encouraging us to study these members of the Family Romeriidae and for setting a high standard by his own work with other groups of Paleozoic vertebrates. Dr. Romer further contributed to this paper by preparing the map and stratigraphic section showing the geographical and geological distribution of the specimens described.

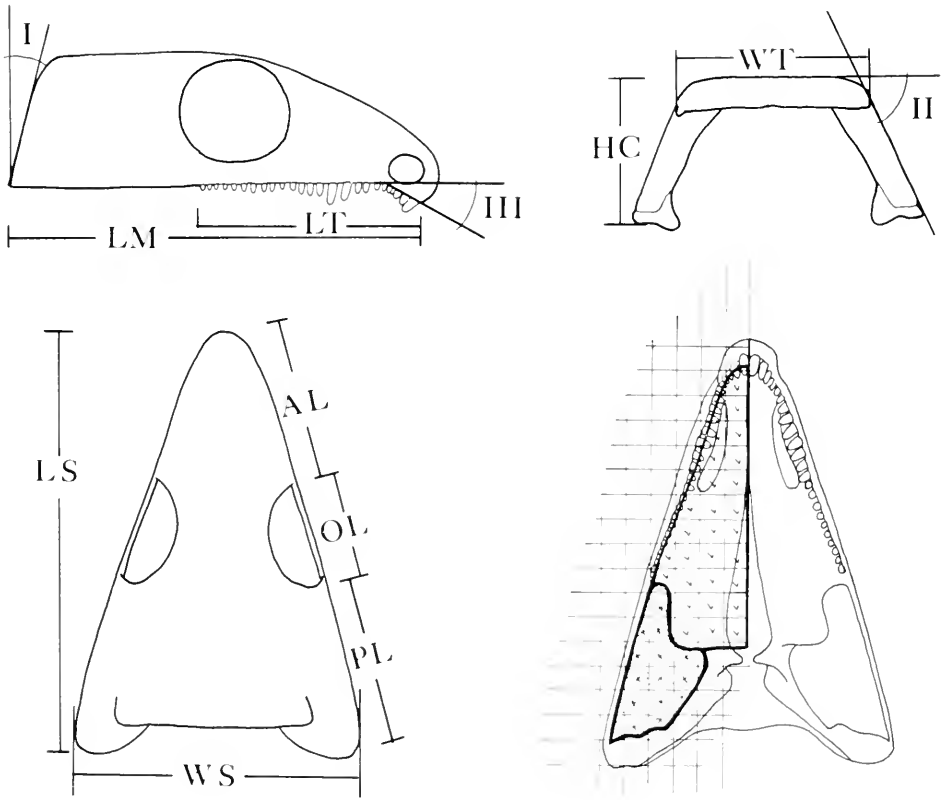

Figure 1. Sketches of romeriid skull showing position of measurements given in Table I. LS—length of skull; WS—width of skull; HC—height of cheek; WT—width of skull table; LM—length of skull margin; LT—length of tooth row; LO—length of orbit; PL—postorbital length; AL—antorbital length; I—angle of posterior margin of cheek; II—angle between cheek and skull table; III—angle of premaxillary teeth row. Area with heavy lines indicated by checks and crosses is measured as total palatal area. Shaded portion is measured as cross section of subtemporal fossa.

In addition to the material from the Harvard collections, specimens were loaned by Dr. Zangerl of the Field Museum, Chicago; Dr. Langston of the University of Texas, Austin; Dr. Dawson, Carnegie Museum, Pittsburgh; and Dr. Russell, Natural History Museum, Ottawa; for this help we are grateful. Dr. Olson has contributed much information on the romeriids and captorhinids from Oklahoma. Special credit should be given to Mr. L. I. Price, whose keen vision enabled him to discover nearly all of the Lower Permian romeriids from Texas. The illustrations were made by Mrs. Pamela Gaskill; without her careful work, several

more years would have been necessary before this paper could have been completed. Mrs. D. Alison assisted with many technical aspects of the preparation of this paper. This work was supported by grants from the National Research Council of Canada.

Specimens described in this paper are identified by the following museum abbreviations: CM, Carnegie Museum, Pittsburgh; MCZ, Museum of Comparative Zoology, Harvard; UC-CNHM, Field Museum of Natural History, Chicago, including specimens from the University of Chicago; UT, University of Texas, Austin.

TABLE I. MEASUREMENTS OF THE SKULL OF ROMERIDS AND CAPTORHINIDS, MADE PRIMARILY ON THE BASIS OF THE RESTORATIONS. POSITIONS OF MEASUREMENTS INDICATED ON FIGURE 1. MEASUREMENTS IN MILLIMETERS.

	Length of skull	Width of skull	Height of skull	Length of skull	Width of skull	Length of skull	Ratio of tooth to skull margin	Length of orbit	Auto-oral length	Postorbital length	Ratio of orbit length to skull length	Angle of posterior margin of cheek	Angle between cheek and skull table	Angle of premaxillary tooth row	Proportion of palate occupied by subtemporal fenestrae	Area of lower jaws as a proportion of palatal area	
<i>Protocaptorhinus archeri</i>	56	31	20	21	56	37	66%	16	22	18	28%	17	67°	0	27%	45%	
<i>Protocaptorhinus morani</i>	35	21	13	13	35	21	60%	13	12	10	37%	8°	68°	0	—	—	
<i>Romeria primus</i>	57	38	22	24	53	29	51%	17	17	22	30%	5	70°	26	31%	43%	
<i>Romeria texana</i> type	58	38	19	25	55	31	56%	15	20	23	26%	11	66	25°	33%	—	
<i>Romeria texana</i> juvenile	33	21	12	16	32	15	47%	9	11	13	27%	13	68°	—	—	—	
<i>Protocaptorhinus pricei</i> type	52	37	15	24	49	29	59%	14	17	19	27%	2	61	19	37%	60%	
<i>Protocaptorhinus pricei</i> MCZ 1160	57	38	17	24	57	28	49%	13	17	26	23%	5	61°	19°	—	—	
Type of "Parotiticus taliceps"	69	58	20	31	72	38	55%	19	24	29	28%	4	56	—	38%	60%	
Clypeus																	
"Labidosaurus"																	
CNHM-UC 183	121	79	38	42	122	62	51%	26	47	52	21%	14	61°	34°	—	—	—

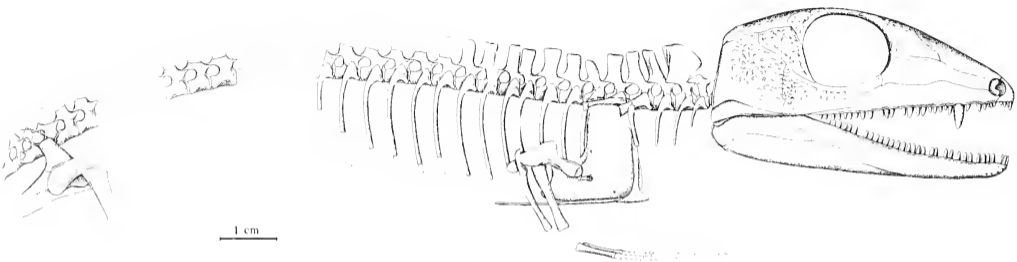

(Fold out) Restoration of the skeleton of *Eumecurus echen*, based primarily on the type, N 112

SYSTEMATIC DESCRIPTIONS

Class REPTILIA

Subclass ANAPSIDA

Order Cotylosauria

Suborder Captorhinomorpha

Family ROMERIIDAE

Genus *Protorothyris* Price 1937Type species *Protorothyris archeri* Price*Melanothyris* Romer, 1952: 92.

Revised generic diagnosis. Large romeriid captorhinomorph. Primitive pattern of bones of skull roof. Both tabular and supratemporal retained. Bones marked by uniformly distributed shallow pits. Posterior margin of the parietal deeply embayed for postparietal and tabular. Postorbital does not extend onto skull roof. Premaxilla not down-turned. Primitive marginal dentition. Twenty-four to 30 maxillary teeth, two pairs of enlarged "canines." The ventral margin of the transverse flange of the pterygoid bears a row of large denticles. Ectopterygoid present. Ossified portion of the opisthotic does not reach squamosal. No retroarticular process. Axis intercentrum not a separate ossification. Skull equal in length to 12 to 14 trunk vertebrae. Neural spines tall and narrow, not sculptured. Two sacral vertebrae. Humerus lacking supinator process and entepicondylar ridge. Scapulocoracoid ossified as a single unit. Two species known, *P. archeri* from the Lower Permian of Texas and *P. morani* from the Dunkard of West Virginia.

Protorothyris archeri Price

Figures 2–6 and fold-out

Protorothyris archeri Price, 1937: 98.

Specific diagnosis. Same as for genus, except that there are 29 to 30 maxillary teeth. The length of the teeth increases behind the canines but none in this series is especially larger than those immediately adjacent. Jugal is wide beneath orbit. There are apparently no denticles on the parasphenoid.

Horizon and locality. Moran Formation, Wichita Group, Lower Permian, Cottonwood Creek, Archer County, Texas, about 50 feet below the Sedwick limestone equivalent.

Holotype. MCZ 1532—skull and anterior portion of postcranial skeleton. Referred specimens: MCZ 2149—laterally compressed skull. MCZ 2148—laterally compressed skull lacking snout region. Pectoral girdle and anterior vertebrae. MCZ 2150—dorsoventrally compressed skull and postcranial elements. MCZ 2147—dorsoventrally compressed skull; this specimen could not be located during this study.

Protorothyris archeri is represented by five specimens, all from a single locality in the Moran Formation, Lower Permian of Texas. All were collected by L. I. Price, who described the first specimen in 1937 as a member of a new family, Protorothyridae. One specimen (MCZ 2150) is very poorly preserved and has been only partially prepared. The description of the species is based primarily on the remaining animals. Two skulls are compressed laterally and two dorsoventrally. All are substantially the same size. The restoration is based primarily on the type, with details contributed from the other specimens.

Skull. The skull, like those of *Hylonomus* and *Paleothyris*, is long and narrow. The significance of this feature will become more evident when the lineage including the genus *Romeria* is discussed. The height of the cheek region is roughly equal to the width of the skull table. The width at the quadrates is approximately 50 percent greater than that of the skull table. The total length of the type skull is 56 mm, the width at the quadrates, 31 mm. The orbits are situated slightly posterior to the middle of the skull. The cheek region and skull roof are uniformly sculptured with a pattern of evenly distributed pits and grooves. The pattern is more pronounced than in any of the Pennsylvanian romeriids. The anterior portions of the nasal and the lacrimal, as well as the maxilla and premaxilla, are

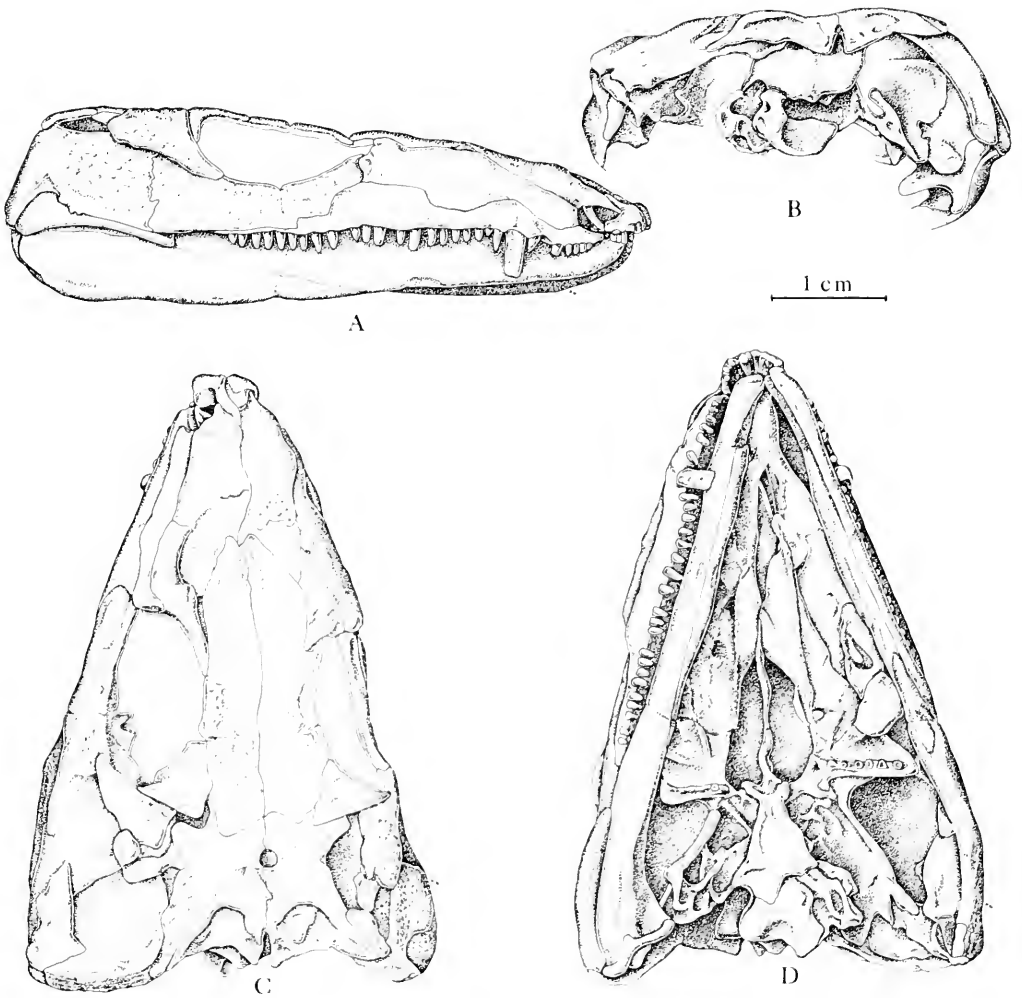

Figure 2. *Prorathyrus archeri*. Skull is A, lateral; B, occipital; C, dorsal; and D, palatal views. Type MCZ 1532. $\times 1\frac{1}{2}$.

nearly smooth. The pattern of the bones of the skull roof is very similar to that noted in *Paleothyris* and *Brouffia*. The configuration of the individual elements is somewhat different, however. The parietals are very deeply embayed posteriorly for the postparietals, with the dorsal surface of the bone extending posterolaterally as a narrow process to the corner of the skull table. The parietal embayment is presumably developed to accommodate a forward extension of the axial musculature.

The tabulars and postparietals are themselves insubstantial bones of little structural significance. For most, if not all, of their extent they are underlain by the parietals. The postparietals are thin sheets of bone that are readily displaced. The tabular has no connection with the braincase, nor does it serve to strengthen the attachment of the skull roof to the cheek region. It appears to be little more than a relict from an earlier stage of evolution. The supratemporal is a narrow strip of bone, supported dorsally

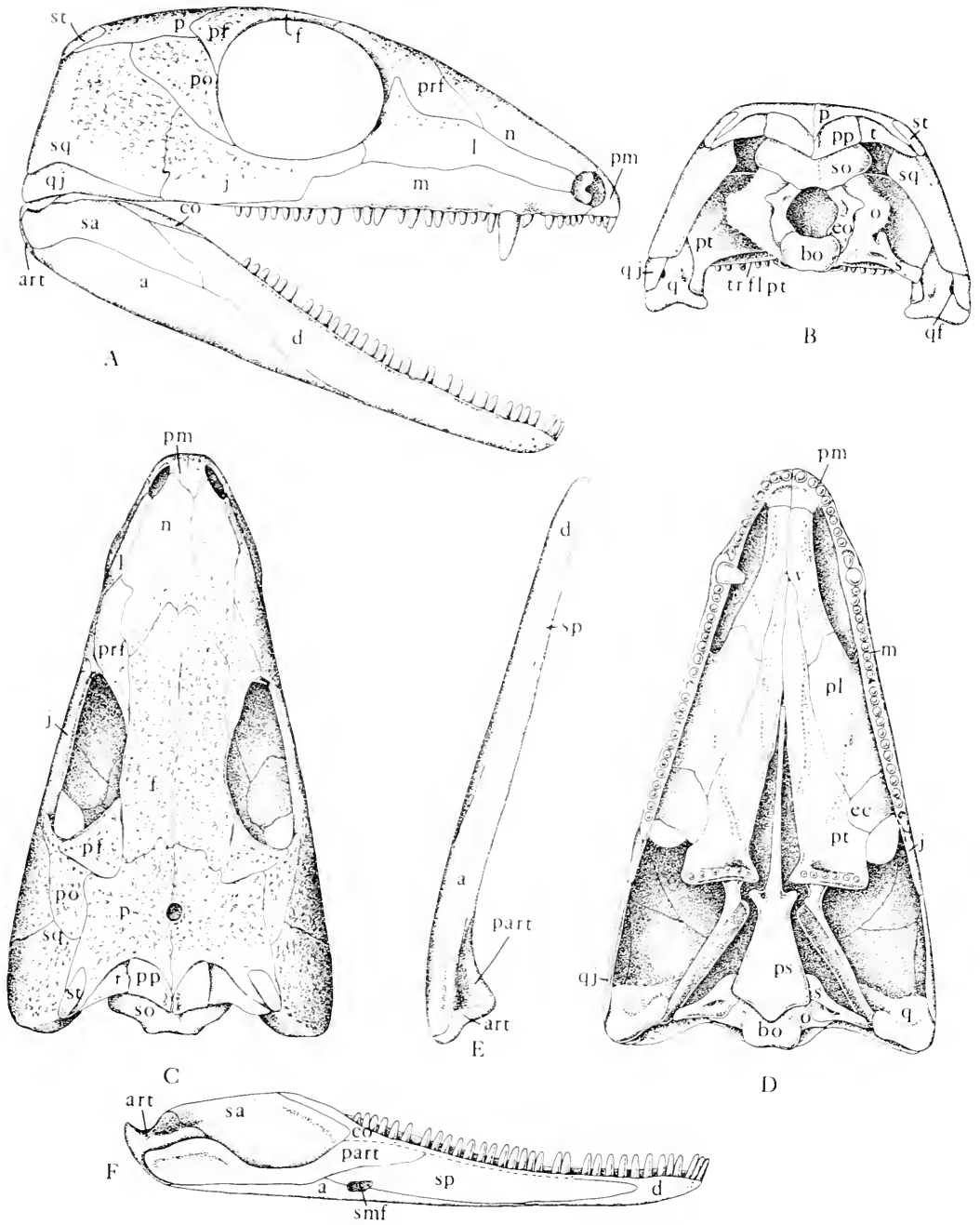

Figure 3. *Protorothyris archeri*. Restoration of skull, based primarily on the type. A, lateral; B, occipital; C, dorsal; and D, palatal views of the skull. E and F, ventral and medial views of lower jaw. $\times 1\frac{1}{2}$. Abbreviations indicated on page 360.

by the posterolateral extension of the parietal and extending ventrally to the squamosal.

The parietal overlaps the dorsal margin of the postorbital and squamosal. Some movement was probably possible between the cheek region and skull roof in the living animal. The posterior margin of the squamosal is no more than 17 degrees from the vertical. The bone extends a considerable distance medially to surround the posterodorsal portion of the quadrate. The posterior margin of the quadrate ramus of the pterygoid underlies the occipital portion of the squamosal. There is no particular area of the squamosal that gives evidence of having supported the tympanum.

The superficial extent of the quadratojugal differs from skull to skull as a result of the variable preservation of the thin overlapping ventral margin of the squamosal. Except posteriorly, the superficial exposure is quite limited and shows little, if any, sculpturing. It reaches to the posterior margin of the jugal.

The jugal differs from that of all Pennsylvanian romeriids in the relatively greater width beneath the orbit. This is related to the absolutely larger skull size of *Protorthyris* and the relatively smaller size of the orbit. The bone also extends further anteriorly than in the smaller forms. As in the Pennsylvanian genera, the postorbital is restricted to the cheek region and is overlapped by, but not suturally attached to, the parietal. In other Permian genera, the postorbital extends onto the skull roof to establish a somewhat firmer union between it and the cheek.

The maxilla is distinctive in having a very narrow superficial exposure beneath the posterior half of the orbit. At the level of the sixth tooth from the rear, the width of the bone suddenly increases. There are five small teeth at the front of the maxilla, two much larger "canines," and room for 23 "cheek teeth"; the length of these teeth is greatest in the middle of the series and decreases gradually, anteriorly and posteriorly. This

is particularly noticeable in MCZ 2149 (Fig. 4A). The immediate post-canine tooth is as long as those in the middle of the series. The teeth are simple cones, bluntly pointed at the tip. The tooth row continues in a horizontal plane onto the premaxilla; this bone is not down-turned, as in more specialized Lower Permian romeriids. There are four premaxillary teeth, the anteriormost being the largest. The length decreases toward the maxilla, with the length of the

ABBREVIATIONS

a	angular
aa	atlas arch
acf	anterior coracoid foramen
ap	atlas pleurocentrum
art	articular
axa	axis arch
bo	basioccipital
cf	coracoid foramen
co	coronoid
d	dentary
ec	ectopterygoid
eo	exoccipital
f	frontal
j	jugal
l	lacrimal
m	maxilla
n	nasal
o	opisthotic
p	parietal
part	prearticular
pf	postfrontal
pl	palatine
pm	premaxilla
po	postorbital
pp	postparietal
prf	prefrontal
proa	proatlas
ps	parasphenoid
pt	pterygoid
q	quadrate
qf	quadrate foramen
qj	quadratojugal
s	stapes
sa	surangular
sgf	supraglenoid foramen
smf	submeckelian fossa
sp	splénial
sq	squamosal
SR	sacral rib
st	supratemporal
t	tabular
tr fl pt	transverse flange of pterygoid
v	vomer

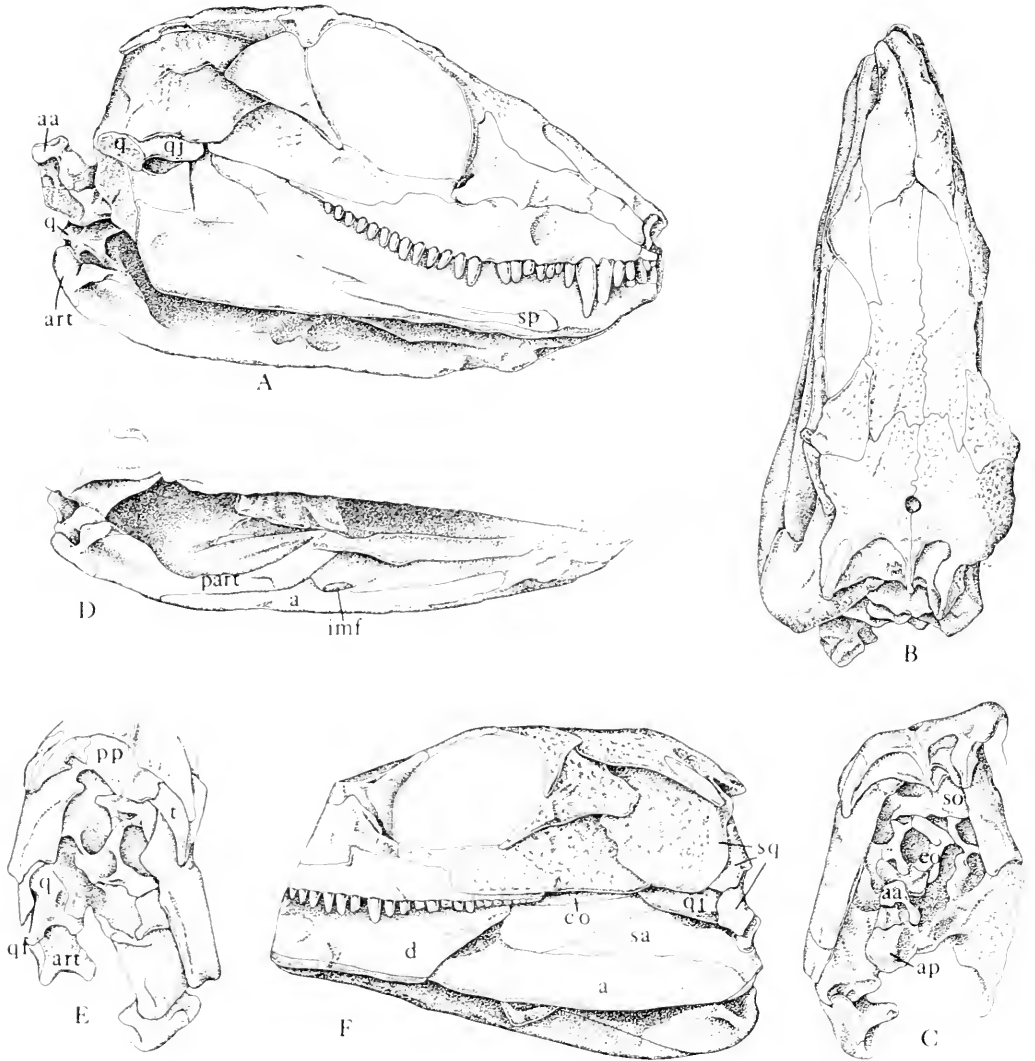

Figure 4. *Protarathrys archeri*. A-D, lateral, dorsal, and occipital views of skull and medial view of lower jaw, MCZ 2149. E and F, occipital and lateral views of skull, MCZ 2148. $\times 1\frac{1}{2}$.

anterior maxillary teeth increasing toward the rear.

The palate is well exposed in the type. Unlike the condition in *Captorhinus*, a distinct oval ectopterygoid is retained. The transverse flange of the pterygoid bears a row of large teeth. Finer rows of denticles extend from the basicranial articulation obliquely laterally toward and onto the

palatine. A second row runs anteriorly, near the midline toward the vomers. The vomers carry a continuation of this row and a further row along the margin of the internal nares. There are narrowly triangular interpterygoid vacuities which extend for one-half of the length of the pterygoids. Anteriorly, the portion of the pterygoid medial to the longitudinal row of denticles extends

dorsally at a slight angle. The ends of the pterygoids come to a point, separating the vomers for half of their length. The quadrate ramus of the pterygoid continues as a broad vertical plate to support the medial surface of the quadrate and makes contact with the squamosal posteriorly. The parasphenoid resembles that of other romeriids in its proportions. Neither the body nor the cultriform process bears any denticles. The internal nares are long oval openings that extend posteriorly to the level of the 14th maxillary tooth.

The occiput and posterior portion of the braincase are distorted in all of the specimens but can be readily reconstructed. The supraoccipital is a wide, thin plate of bone incised ventrally for the foramen magnum. The ossified portion extends laterally beyond the limits of the postparietals, but does not make contact with either the tabular or squamosal. There are large, but ill-defined posttemporal fossae. In contrast with the known Pennsylvanian romeriids, the otic capsules are at least partially ossified. They appear incomplete laterally. They extend toward the squamosal, but there is no evidence that they reached the cheek region. Ventrally, the opisthotic forms the posterior margin of a large fenestra ovalis. Neither the proötic nor epipterygoid can be seen in these specimens.

The exoccipitals are narrow bones, each bearing a facet for the proatlas. They are almost indistinguishably fused to the basioccipital. The stapes follow the typical pattern in early reptiles, with a broad footplate fitting into the large fenestra ovalis and braced by the parasphenoid ventrally. There is an oblong stapedial foramen just proximal to the dorsal process. The stem extends as a stout rod toward the quadrate.

The quadrate, like that of other romeriids, has a broad articular surface, separated into a large lateral condyle and a transversely elongate oval medial knob. The anterior portion of the surface is obscured in all the specimens. Dorsally, the bone narrows to a thin blade that extends nearly to

the top of the squamosal. The lateral margin is notched, adjacent to the quadratojugal, for the quadrate foramen. Medially the bone has a broad depression, opposite the end of the stapes. A narrow process of the pterygoid extends ventrally, just anterior to this depression.

The lower jaws are clenched shut in all specimens, but most significant features can be seen. No specimen shows all the teeth in place, but a count of 35 would agree closely with that in the upper jaw. The articular is visible posteriorly and laterally at the margin of the angular and surangular but there is no retroarticular process. The medial extension of the articular provides space ventrally, where this bone is sheathed by the prearticular, for the insertion of the pterygoideus musculature. The prearticular extends anteriorly to approximately the level of the eighth tooth from the rear. Much of the inside surface of the jaw is formed by the splenial. At the junction of this bone with the angular is the small inframeckelian fossa. The coronoid area is not clearly visible in any specimen, except laterally, where the posterior element makes up the margin of a very low coronoid process. The external surface of the lower jaw is not sculptured. The suture between the angular and surangular is very difficult to see and so its course can only be approximated in the restoration. The splenial is not exposed laterally.

The skull of *Protorothyris archeri* differs from that of Pennsylvanian romeriids primarily by its greater size (compare with Table I in Carroll and Baird, 1972). The greater extent of the jugal beneath the orbit is a consequence of the relatively smaller size of the orbit. The deep posterior embayment of the parietals for the greater anterior extent of the axial musculature is a further distinguishing characteristic. On the basis of the current fossil record, this genus is the last known member of this particular romeriid lineage.

Postcranial skeleton. Postcranial elements are known for three specimens of *Protoro-*

thyris archeri: the type, MCZ 2149, and MCZ 2150. Much of the skeleton is represented, except for the feet and the tail. The anterior 18 vertebrae are preserved in the type, as well as a series of three from the more posterior trunk region and two from immediately anterior to the sacrals. The minimum number of 23 presacrals may well be too short. The column is restored as having 29, the number in the largest of the Pennsylvanian romeriids, *Coelostegus*. As was noted in the earlier members of the family, the ratio of head to trunk increases in proportion to the total body size. In *Protorothyris* the head was approximately 50 percent the length of the presacral column.

The basic structure of the vertebrae resembles that of *Paleothyris*. Neither the proatlas nor the atlas intercentrum is visible, but the remainder of the atlas-axis complex is typical of romeriids. The left atlas arch in the type is crushed down on the axis arch. The posterior portion of the right is present in MCZ 2149, atop a broken pleurocentrum. Although not well preserved, these elements can be restored according to the pattern in other romeriids. The axis is well shown in the type. The spine is a large, hatchet-shaped structure, very similar in configuration to that of the pelycosaur *Ophiacodon*. The anterior margin overhangs the atlas arch. The posterior edge tips slightly posteriorly from the vertical and shows a series of grooves for attachment of the interspinous ligaments. The arch is indistinguishably fused to the centrum. As can be seen in dorsal view (Fig. 5), the transverse processes of the axis and other anterior vertebrae are very long. Their total lateral extent is nearly twice the width of the zygapophyses. All of the preserved trunk vertebrae have much longer neural spines than those of other romeriids. They are not expanded anteroposteriorly as in *Anthracodromeus*, however.

The elongation of the anterior spines can be associated with the need for additional support of the disproportionately large

skull. The spine of the sixth vertebra in the type is shorter and rounded dorsally, rather than having a constant width. This modification would have allowed greater dorsal flexure of the neck. Such specialization is noted in other romeriids as well, but may affect different vertebrae (e.g., the third in *Anthracodromeus*). In MCZ 2148, the atlas and axis are not preserved. Judging from the configuration of the ribs, the first vertebra preserved in the third. The spine is almost nonexistent. This may be a peculiarity of this particular specimen, or indicate a range of variability in which one of the cervical vertebrae is specialized to allow flexure. None of the more posterior cervicals in this specimen is so modified.

The length of the transverse processes decreases posteriorly. Throughout the column the arches and centra are firmly attached without evidence of suture. Small crescentic intercentra are in place throughout the column.

Several vertebrae are associated with the pelvic girdle. The two presacrals are badly crushed, obscuring the structure of the neural spines. The sacrals resemble those of *Paleothyris*, in that the more anterior bears the principal sacral rib and the second has a smaller supporting role. These vertebrae in *Protorothyris archeri* are too poorly preserved to distinguish them from those of the trunk region. Two poorly preserved vertebrae are present behind the sacrum. The spine of the first is apparently complete but is half the length of those in the cervical region. As in most romeriids, the major portion of the tail is missing.

All the ribs have clearly separated heads. This is particularly conspicuous in the cervicals, in which the transverse processes are particularly long. The first three ribs have narrow shafts that probably extended ventrolaterally, as do those in pelycosaurs, although their original orientation is difficult to reconstruct from the crushed specimens. The fourth and fifth ribs have wide shafts and definitely extended posterolaterally to form extensive supports for the endo-

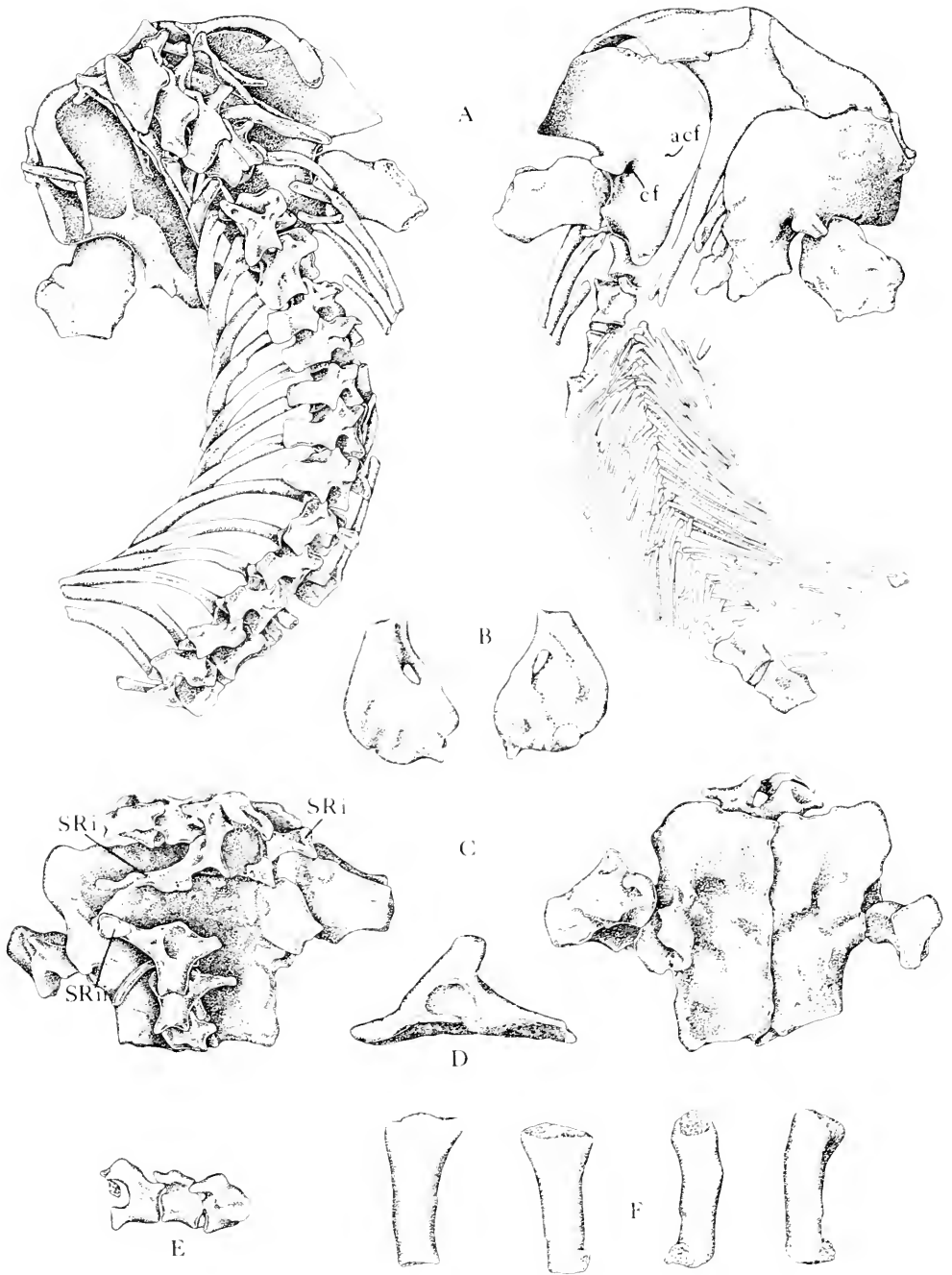

Figure 5. *Pratorothyris archeri*. Postcranial elements of type, MCZ 1532. A, shoulder girdle and anterior axial skeleton in dorsal and ventral views. B, dorsal and ventral views of distal end of left humerus. C, dorsal and ventral views of sacral vertebrae and pelvis. D, lateral view of left side of pelvic girdle. E, three posterior trunk vertebrae. F, left tibia in anterior, posterior, medial, and lateral views. $\times 11\frac{1}{2}$.

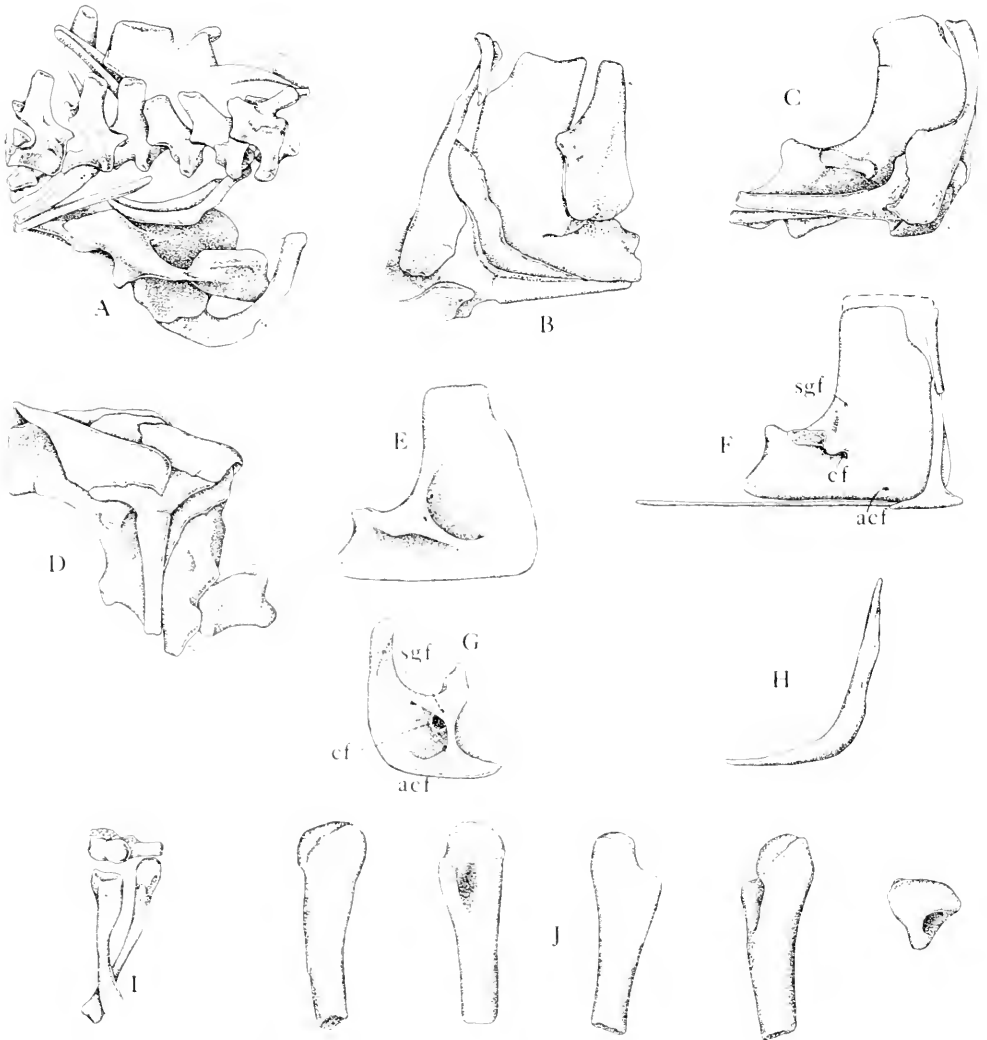

Figure 6. *Protorothyris orcheri*. Postcranial elements. A, B, C, and D, various views of shoulder girdle, MCZ 2148. E and F, restoration of shoulder girdle in medial and lateral views. G, obliquely anterodorsal view of the scapulocoracoid showing position of foramina on medial surface. H, anterior view of left clavicle. I, ventral view of distal end of humerus, ulna, and radius, MCZ 2150. J, dorsal, ventral, anterior, posterior, and proximal views of femur, MCZ 2150. $\times 1\frac{1}{2}$.

chondral shoulder girdle. Most, if not all, of the ribs in the trunk region are incomplete distally. The pattern shown in the skeletal restoration is based on the maximum length of the ribs preserved. No ribs are present between the eighteenth trunk vertebra and the sacrum. The pattern of the sacral ribs is evidently similar to that described in *Paleothyris*, although the preservation here

is too poor for further elaboration. No caudal ribs are preserved.

The shoulder girdle is superbly shown in the type and MCZ 2149 (Figs. 5 and 6). It does not differ substantially from that of *Paleothyris*, but some details are more clearly shown. The cleithrum is a simple, compressed rod of bone fitting into a well-defined groove at the anterolateral margin

of the clavicular stem. It was not attached to the scapula, as that bone is ossified in these specimens. The lateral margin is gently rounded throughout its length. The clavicle is somewhat simpler than in earlier romeriids and pelycosaurs in that the posterior margin of the shaft does not swell out to form a superficial flange for the attachment of the clavicular portion of the deltoid muscle. The entire shaft is very narrow anteroposteriorly. It is not noticeably grooved posteriorly to accommodate the scapula, but lies entirely lateral to that bone. The blade is slightly sculptured. The anterior margin of the blade extends anteriorly at about a 15° angle from the transverse plane. Posteriorly the blade expands to about six times the width of the very narrow stem. The interclavicle has a very wide, diamond-shaped plate, recessed anteriorly for the clavicles, except for a narrow isthmus at the midline. The stem is long, narrow, and forked at the tip.

The scapulocoracoid is ossified as a single element, without the slightest trace of sutures separating the scapula and the coracoid(s). The dorsal margin of the scapula as preserved was probably continued for a short distance dorsally in cartilage, but this portion of the endochondral girdle remains much shorter than its counterpart in any pelycosaur. As ossified, the anterodorsal margin of the blade is recessed behind the cleithrum. The posterior margin is essentially vertical. Anteroventrally, the coracoid portion bulges beyond the clavicular stem. The coracoid regions curve strongly medially from each side to approach each other at the midline, at least anteriorly. The glenoid is short, with the anterior margin slightly below the posterior, but otherwise similar to that of other romeriids and pelycosaurs. Behind it there is a prominent process for the attachment of the coronoid head of the triceps. This structure is common in pelycosaurs, but not reported in other romeriids. The supraglenoid foramen opens just anterior to the supraglenoid buttress, near its apex.

In addition to the coracoid foramen opening (for the supracoracoid nerve and blood vessels) beneath the anterior buttress of the glenoid, there is a second, smaller opening on the more ventral and anterior portion of the anterior coracoid region. As in ophiacodont pelycosaurs, there is an area of unfinished bone at the posteroventral corner of the posterior coracoid that would have been continued in cartilage.

The medial surface of the scapulocoracoid is marked by two prominent ridges. One, as in pelycosaurs, extends vertically, medial to the supraglenoid buttress. The second diverges from the base of the first and runs anteroventrally toward the middle of the anterior coracoid region. It is sharply demarcated from the more ventral and posterior coracoid area. Dorsally, the ridge is deeply undercut for the subcoracoseapular fossa. The coracoid foramen opens into this area just anterior to the vertical ridge.

A further, small foramen can be seen near the apex of the ridge, just anterior to the divergence from the vertical support. A small opening for the anterior coracoid foramen can be seen at the base of the dorsal surface of the anteriorly directed ridge, just posterior to where it merges with the flat anterior coracoid region.

In the type and MCZ 2149, the proximal ends of the humeri are in place in the glenoid. They resemble the general pattern of romeriids and *Captorhinus*. The middle of this shaft is not preserved. The distal end is present in the type and in MCZ 2150. There is apparently neither an ectepicondylar ridge nor a supinator process. In lacking these features the humerus resembles that of *Hylonomus* rather than *Paleothyris* or *Captorhinus*. The preservation is not good in either specimen, however.

The ulna and radius in MCZ 2150 are very lightly built, but not well enough preserved for detailed comparison with other romeriids. The olecranon is ossified and the distal articulating surface is narrow. The carpals are not preserved. Judging

from other romeriids, they were probably ossified, but no evidence is afforded by these specimens. Metacarpals and/or proximal phalanges are preserved in MCZ 2150, but their specific identity cannot be established.

Except for the iliac blades, the entire pelvic girdle is preserved in the type. The basic pattern resembles that of *Hylonomus*, *Paleothyris*, and *Brouffia*, but few surface details are evident. The base of the iliac blade is narrow, but there is no indication of its normal length. The badly crushed heads of both femora are present in each acetabulum. Details can be seen much more readily in MCZ 2150. It resembles closely that of *Paleothyris*. The distal end is not known. The isolated proximal end of a tibia is associated with the type. The general configuration of the femur and tibia suggests that the proportions of the rear limbs were similar to those of *Paleothyris*. Neither tarsals nor any elements of the rear foot are known.

A great many ventral scales are preserved in more or less their natural association in the type. They have the usual open lattice, chevron pattern of primitive reptiles. The proximal end of the medial scales is expanded to overlap with the scale from the opposite side. Each scale is very long and narrow. Two or three ranks are visible posteriorly.

Discussion. *Protorothis archeri* is the last known member of a conservative romeriid stock going back to the Lower Pennsylvanian. Except for a slight increase in size, it shows a continuation of the basic pattern established by *Hylonomus* and *Paleothyris* in the Lower and Middle Pennsylvanian. The conservative skull proportions and the nature of the dentition indicate a similar diet and manner of catching and consuming the prey throughout this entire period of time. Throughout the skeleton there are sufficient differences to recognize a series of genera, but the basic way of life must have remained nearly constant. The larger body size is the culmination of

a general trend to increased size within the family as a whole. Judging from the body proportions of Pennsylvanian species, the disproportionately large head to trunk ratio is a direct consequence of the overall size increase. Despite the considerable longevity of the lineage, it does not seem to have survived past the earliest Permian. Fossils of a wide range of reptiles and amphibians are common in the later Redbeds of Texas, but no survivors of this particular lineage have been described. Romeriids and their successors are known throughout the Lower Permian but the primitive central stock apparently become extinct prior to the deposition of the Putnam Formation.

Although lepidosaurs and archosaurs probably arose from this particular lineage, these groups apparently evolved from genera of a slightly more primitive morphology than the known Permian forms.

Protorothis morani (Romer), new combination

Figure 7

Melanothyris morani Romer, 1952: 92.

In a preliminary report, Romer (1952) described a new species of romeriid from the Dunkard Group of West Virginia, *Melanothyris morani*, based on a number of small skulls. No illustrations were included, but he compared the form to the Texas genus *Romeria*. Preparation of this material indicates that the skulls are no more than specifically distinct from *Protorothis archeri*.

Specific diagnosis. *Protorothis morani* resembles the type species, *P. archeri*, except for the smaller number of maxillary teeth (24–26 rather than 29–30) and the presence of two teeth noticeably larger than the remainder in the series posterior to the canines. The cultriform process bears a row of small denticles, apparently not present in the type species. All known specimens are small (the skull length ranging from 31 to 34 mm), and are apparently immature. The jugal is narrow beneath the orbit, but

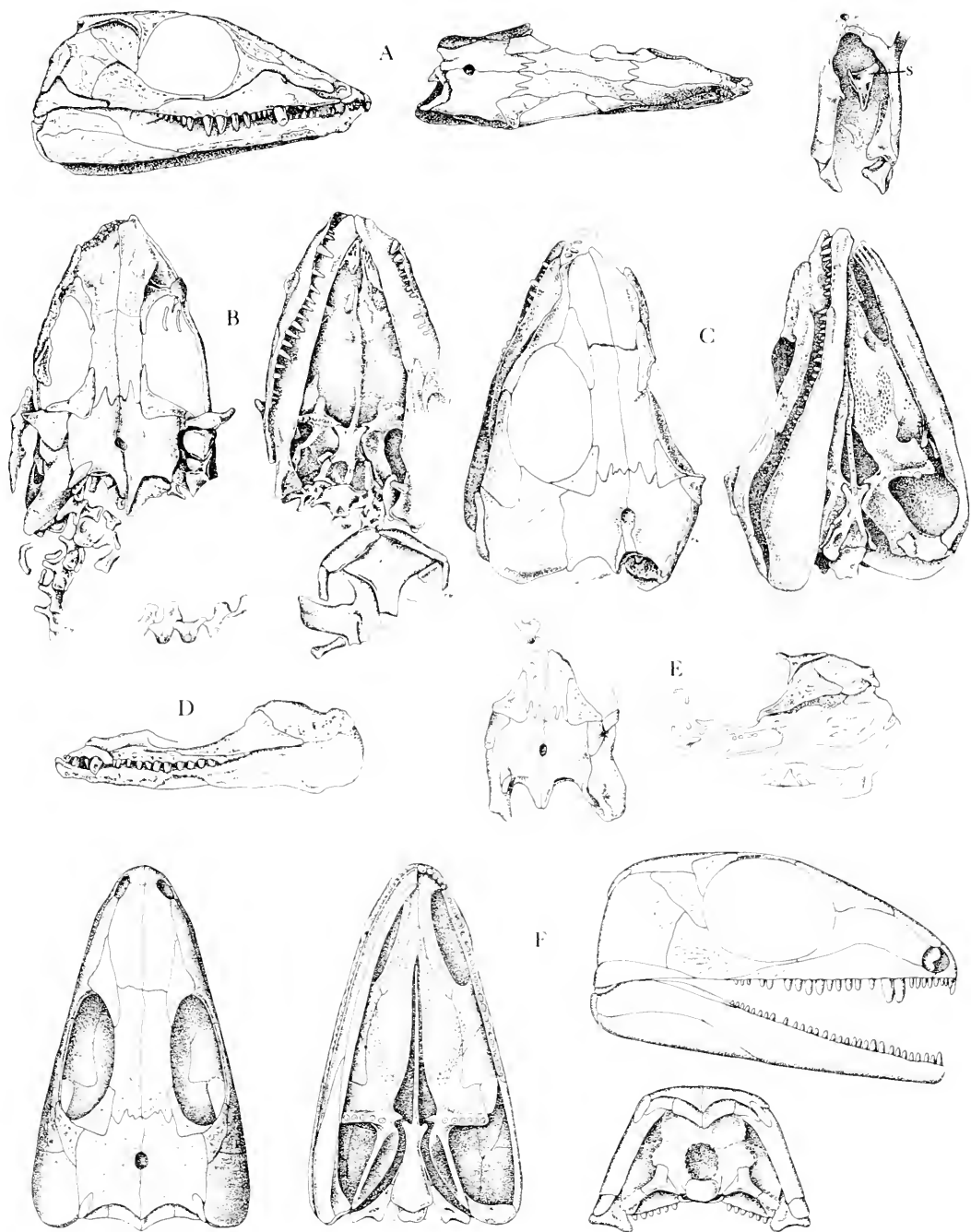

Figure 7. *Prorathyrus morani*. A, type, CM 8617, skull in lateral, dorsal, and occipital views. B, MCZ 2151, skull in dorsal and palatal views with associated postcranial elements, anterior neural arches in lateral view. C, MCZ 2152, skull in dorsal and palatal views. D, MCZ 4111, crushed skull. E, MCZ 4110, back of skull in dorsal view and portion of left cheek region. F, restoration of skull, dorsal, palatal, lateral, and occipital views. $\times 1\frac{1}{2}$.

this may be a result of immaturity and not a distinguishing feature from *P. archeri* in the adult.

Locality and horizon. Dunkard locality 9 (see Romer, 1952) near Blacksville, West Virginia. Equivalent to the lower Wichita Group of Texas.

Type. CM 8617. Skull, laterally compressed.

Referred specimens. MCZ 2151, dorsoventrally compressed skull and associated postcranial material. MCZ 2152, well-preserved skull. MCZ 4110, posterior portion of skull roof and left cheek region. MCZ 4111, badly crushed skull. MCZ 4112, dorsoventrally crushed skull. MCZ 4113, incomplete skull associated with MCZ 2151. Other specimens in the collection of the Carnegie Museum.

The Dunkard species is represented by seven skulls, ranging from 31 to 34 mm in length. All are substantially smaller than the adult specimens of other Permian romeriids. The skulls show some evidence of immaturity (see subsequent discussion), but the adults may have been small as well.

Important similarities seen in *Protorothis archeri* and the Dunkard form, but not shared with other Permian romeriids, include: tooth-bearing margin of the premaxilla in same plane as that of maxilla. Similar pattern of sculpturing. Canines very prominent. Second peak in length of maxillary teeth behind canine. Ectopterygoid retained. Long teeth on ventral margin of transverse flange of pterygoid. Tabulars present and parietals deeply embayed for reception of postparietals and tabulars. Only the last feature distinguishes *P. archeri* from such Pennsylvanian romeriids as *Paleothyris* and *Brouffia*.

Were the skulls not so well preserved, or had they come from Texas rather than West Virginia, it would be difficult to justify even specific differentiation from *P. archeri*.

Except for the small size and slightly different proportions, the skull is basically similar to that of the type species of *Protorothis*. One clear-cut difference is the con-

TABLE II. DENTITION OF ROMERIIDS AND CAPTORIINIDS. A-D, *PROTOROTHYRIS MORAXI*—SIMPLIFIED DRAWINGS OF DENTITION TO SHOW POSITION OF TEETH BEING REPLACED (X) AND RELATIVE LENGTH OF TEETH IN DIFFERENT REGIONS OF THE JAW. BRACKETS INDICATE POSITION OF CANINES, ARROW INDICATES ANTERIOR END OF JAW. A, MAXILLA AND PREMAXILLA OF CM 8617; B, MAXILLA OF MCZ 2151; C, MAXILLA AND DENTARY OF MCZ 2152; D, MAXILLA OF MCZ 4111. ×2.

	No. of premaxillary teeth	No. of maxillary teeth	Position of canine(s)
<i>Paleothyris acadiana</i>	6	35	8 & 9
<i>Protorothis archeri</i>	4	29-30	6 & 7
<i>Protorothis morani</i>	3	24-26	6 & 7
<i>Romeria primus</i>	4	26	26 & 7
<i>Romeria texana</i>	3	20	3 & 6
<i>Protocantorhinus pricei</i> 1478	3	22	3
<i>Protocantorhinus pricei</i> 1160	4	18	4
" <i>Parioticus laticeps</i> " type	4	16	4
UC 181 Clyd. " <i>Labidosaurus</i> "	4	20	6

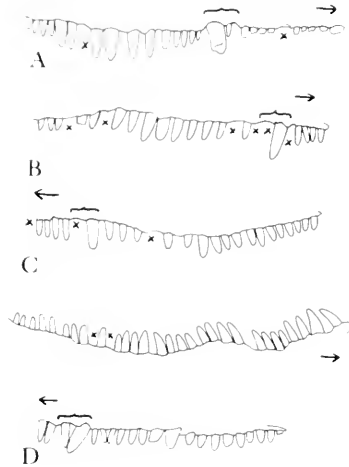

sistently smaller number of maxillary teeth (see Table II). This is not simply a result of immaturity, since the small skull of *Romeria texana* has only one less tooth than does the adult, although the size difference is equivalent to that between the Dunkard skulls and *Protorothis archeri*. Another

difference between the Dunkard skulls and *Protorothyris archeri* is the relatively narrower exposure of the jugal beneath the orbit in the former. This difference is certainly related to size, with all of the circumorbital bones being small in the Dunkard species. Larger individuals might well resemble the Texas species in this feature. *Protorothyris morani* has denticles extending along the cultriform process of the parasphenoid. These are missing on the Texas species, but are present in *Paleothyris* and also in some individuals of *Captorhinus*.

Mechanical preparation of the Dunkard specimens has resulted in the loss of much of the very thin bone from the surface of the skulls. Except on the occipital surface, this has not greatly interfered with determination of the extent of the bones. Although quite delicate, the pattern of sculpturing resembles that of the Texas species. Except for the accommodation of the relatively large orbits, the configuration of the skull bones is very similar to that of *Protorothyris archeri*. The skull table extends posteriorly almost to the level of the back of the jaw articulation. As Parrington (1959) has pointed out, the greater posterior extent of the cheek region in larger forms is probably a result of allometric adjustment during growth.

Since the dentition is the one feature that distinguishes this species from the genotype, it will be described in detail. The marginal dentition of this species is basically similar to that of *P. archeri*. There are apparently five rather than four premaxillary teeth, although the end of the snout is damaged in all specimens and a lower count cannot be ruled out. The most anterior premaxillary tooth is conspicuously larger than the remainder. The first five maxillary teeth are also of small size. These are followed by two very large canines. In most specimens, one or the other is either absent or represented by a very small, immature tooth. The length of the teeth gradually increases behind the canines, to reach a maximum in the area of the sixth to ninth tooth. Two teeth

in this series are noticeably larger in diameter than those adjacent. Such distinctive teeth are not seen in *P. archeri*. The length gradually decreases to the end of the tooth row. The tooth count, the position of gaps in the tooth row, and the position of the longest teeth is shown in Table II. The complete complement of postcanine teeth apparently varies from 17 to 19; the total of maxillary teeth from 24 to 26. This is four to six teeth less than in *Protorothyris archeri*. All of the teeth are cylindrical, with conical, sharply pointed tips.

In only a single specimen, MCZ 2152, is the dentition of the lower jaw well exposed. Twenty-nine teeth are in place; there is room for two additional teeth. As in the upper jaw, the length of teeth is variable. Although there are none as long as the canines, and the overall differentiation is not as clear, peaks are noted at the very front of the jaw, at the ninth and tenth teeth, and to a lesser extent in the area of the 16th and 22nd.

Fragments of at least six vertebrae are in place behind the skull of MCZ 2151. They are badly crushed and too delicate for complete preparation. The neural spines of the third and fourth are tall and narrow, as in the type species, and the transverse processes extend a considerable distance laterally. The total length of the four most completely preserved vertebrae in natural articulation is 10.5 mm from the anterior end of the anterior zygapophyses to the posterior end of the posterior zygapophyses. The skull is thus equal in length to approximately 12 trunk vertebrae. In *Protorothyris archeri* the skull is equal in length to almost 14 complete vertebrae. The measurement of only four vertebrae is probably not sufficient to stress this possible proportional difference, however.

Much of the shoulder girdle is preserved in MCZ 2151. The dermal elements differ from those of the type species only in their smaller size and generally imperfect preservation. The margins of the scapulocoracoid are broken or obscured by other

bones. The glenoid area resembles that of *P. archeri* in indicating only a single area of ossification. The supraglenoid and coracoid foramina are in the same relative position. Although the dorsal margin of the scapular blade was probably extended in cartilage, its relative height is as great as in *P. archeri*. Only an uninformative fragment of the humerus is present. Nothing is known of the more posterior portion of the skeleton.

Discussion. The chief problem in dealing with *Protorothyris morani* is in determining whether the small size is indicative of immaturity, or whether the specimens represent adults.

Fortunately, a standard of comparison is provided by another romeriid species in which both an adult and a juvenile are known. Only two specimens of the species *Romeria texana* are known; both are figured and described in a subsequent section of this paper. The type is presumably an adult, very similar in size to the several specimens of *Protorothyris archeri*. The second specimen, from a different locality but the same horizon in Texas, has a skull that is only 57 percent the length of the type. Except for the absence of the postparietals, the braincase, and the lower jaw in the type, the skulls are very similar in structure, including the number of teeth in the upper jaw. The smaller skull has relatively larger orbits and a more rounded snout, but no other significant differences. Although incompletely exposed, the endochondral shoulder girdle of the small specimen is ossified as a single unit, in contrast to the obviously juvenile romeriids from the Pennsylvanian, *Cephalerpeton ventriarmatum*, *Brouffia orientalis*, and *Coelostegus*, that show multiple centers of ossification of the endochondral shoulder girdle. The stem of the stapes of the smaller skull of *Romeria texana* is as fully ossified as that of the mature specimens of *Protorothyris archeri*.

Although the skulls of *Protorothyris morani* are as large or larger than that of the

juvenile *Romeria texana*, the orbits are significantly larger, both absolutely and relatively. This feature might be accentuated in a form with a small-sized adult, although it is not noted in *Paleothyris acadiana*. As in the juvenile *Romeria texana*, the scapulo-coracoid of *P. morani* is ossified as a unit. In contrast with that specimen, the stem of the stapes is incompletely ossified. This feature suggests that the specimens of *Protorothyris morani* are at least as immature as the juvenile *Romeria texana* and that the adult might be as large as the adult of that species.

Romeria Price

Type species *Romeria texana* Price, 1937: 97.

Revised generic diagnosis. Large Lower Permian romeriid. Premaxillary tooth row inclined at an angle from the maxillary tooth row. Four to five premaxillary teeth. Twenty to twenty-five maxillary teeth. Fifth and sixth teeth slightly larger than remainder. No tabular, no ectopterygoid. No retroarticular process. Opisthotic incompletely ossified and not extending to squamosal. Check region forming an angle of more than 65° with the skull roof. Parietal deeply embayed for postparietals. Where known, short denticles scattered on anterior face of transverse flange of pterygoid rather than long denticles on ventral margin. Low neural spines on anterior vertebrae. Two species are known, *R. texana* from the Putnam Formation and *R. primus* from the underlying Moran Formation, Lower Permian of Texas.

Romeria primus, new species

Figures 8, 9, and 10

From the same locality as the five specimens of *Protorothyris* has come a single skull (MCZ 1963) of a distinct genus that indicates the initiation of a new trend in the evolution of romeriid reptiles—one that culminates in the origin of the distinct family Captorhinidae and may even presage the evolution of turtles. Whereas the tooth

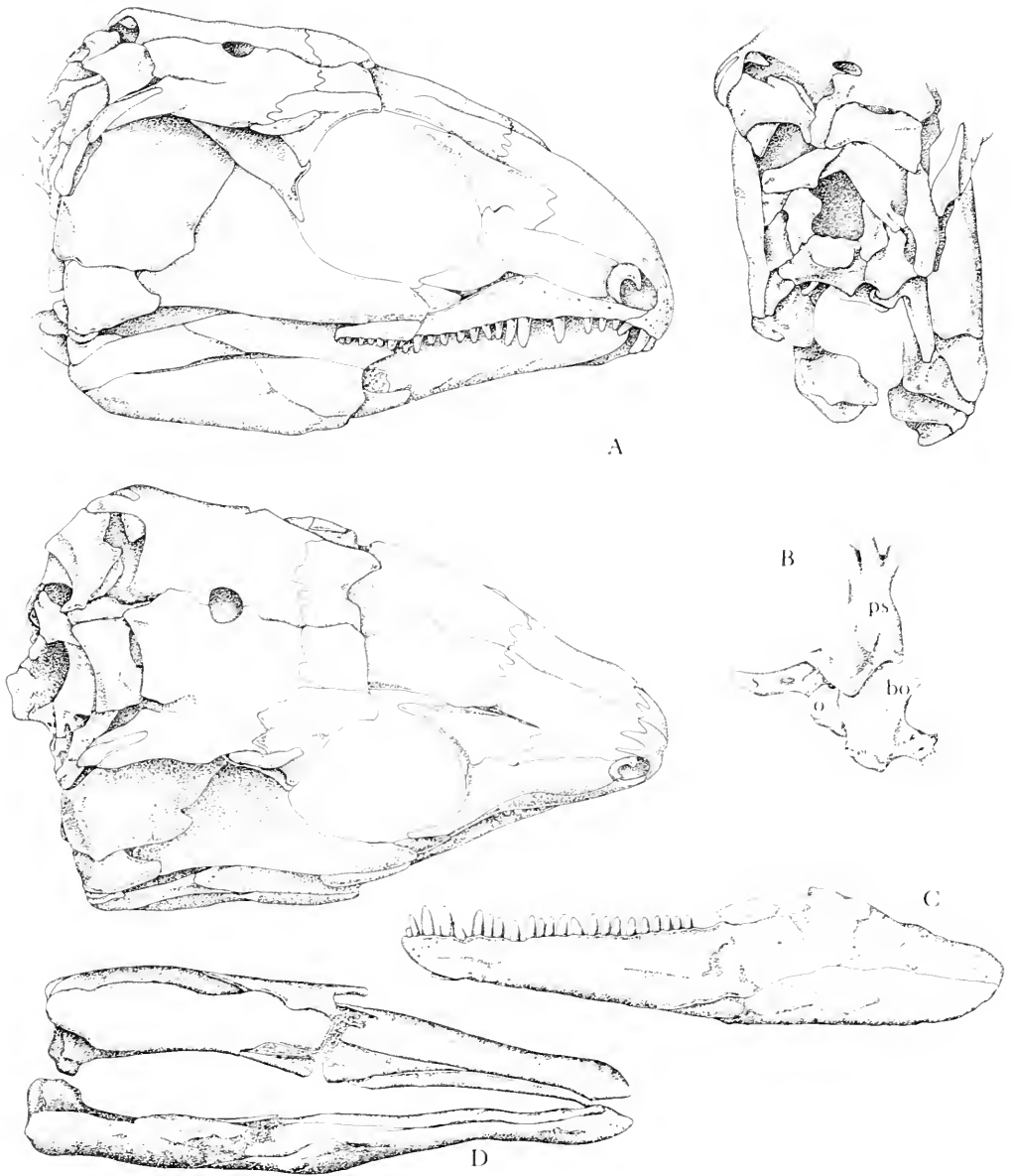

Figure 8. *Rameria primus*, n. sp. Type, MCZ 1963. A, skull in lateral, dorsal, and occipital views. B, braincase in ventral view. C, left lower jaw in lateral view. D, lower jaws in ventral view. $\times 1\frac{1}{2}$.

row in all Pennsylvanian romeriids and *Protorothyris* is straight, the premaxilla of this species and subsequent members of this lineage is down-turned to form a "beak." The canines are less emphasized

and the entire tooth row becomes relatively shorter. The size of the skull remains essentially the same. The changes in dentition indicate that the appearance of this genus was related to a change in prey spe-

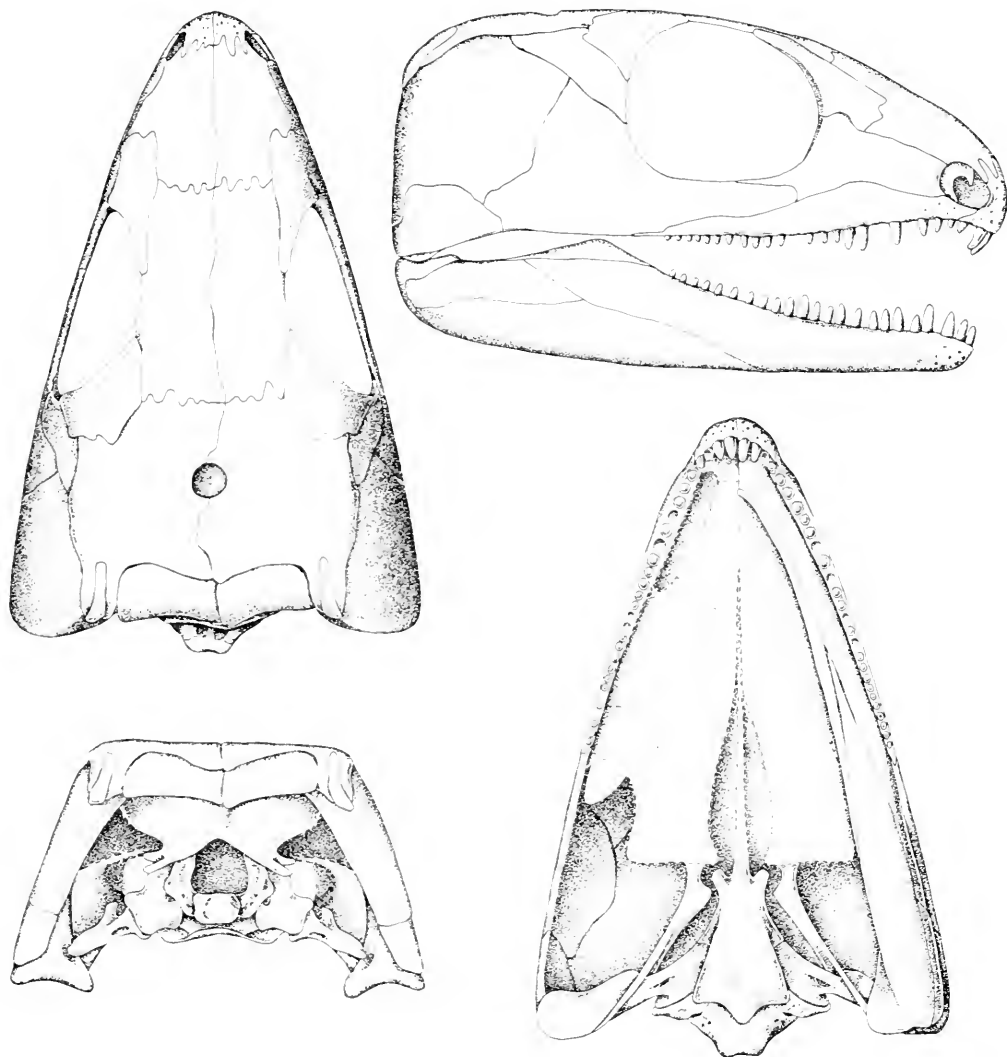

Figure 9. Type of *Romeria primus*, n. sp., MCZ 1963. Restoration of skull in dorsal, lateral, occipital, and palatal views. Smooth appearance of skull roof is not natural. Sculpturing was removed during preparation. Tabulars are missing. There is no evidence for ectopterygoid. $\times 1^{1/2}$.

cies and or a shift in the way prey was captured and ingested.

The specimen from the Moran is clearly closely related to *Romeria texana* from the overlying Putnam Formation. Although we are limited to comparisons of only one adult specimen from each horizon, the difference in age and dentition seems sufficient to recognize two species. Despite the taxonomic

priority, the new species will be described prior to a redescription of the type species in order to emphasize the phylogenetic and taxonomic sequence of the specimens.

Specific diagnosis. Similar to type species, *R. texana*, except for having five rather than four premaxillary teeth and 23–25 rather than 20 maxillary teeth.

Horizon and locality. Cottonwood Creek,

Archer County, Texas. Moran Formation, Wichita Group, Lower Permian.

Type. MCZ 1963, skull and associated postcranial material. This is the only specimen known. The specific name is given to indicate that this form is the first known member of a new lineage.

Description. The single known skull of *Romeria primus* is crushed laterally, with the lower jaws covering almost all of the palate. In general, the skull resembles that of more primitive romeriids but there are certain important differences. The premaxilla is tilted ventrally so that the end of the tooth row forms a hooked "beak." The number of teeth is reduced to four in the premaxilla and to 23–25 in the maxilla, and the tooth row is shortened relative to the total length of the skull. The longest maxillary tooth, nominally a canine, is the seventh on the right side. One of the teeth being replaced, the fourth or sixth, may have been longer but apparently none of the teeth in this area is as conspicuous as the canines in *Protorothyris*. The length of the teeth diminishes gradually on either side of the "canine" but increases again posteriorly to reach a maximum at the level of the eighth tooth from the rear. The difference in the dentition of these two genera seems relative to the position at which the prey could be most efficiently held. In *Protorothyris* and its Pennsylvanian antecedents, the canines would serve to block the escape of the prey anteriorly. The center of the prey held crossways in the mouth would have been about half way between the anterior margin of the orbit and the external nares. A shallow notch in the tooth row is also evident directly beneath the external nares with the anterior premaxillary teeth elongate to block the egress. The efficiency of this trap is greatly improved in *Romeria primus* by the down-turning of the entire premaxilla. The relative position of the canines now becomes more posterior and would serve as the posterior barrier for the main insect trap and the anterior barrier of a less well-developed notch beneath

the anterior margin of the orbit. One might suppose that the nearer the front of the mouth the animal could grip the prey, the more likely it would be successfully caught. The same general type of dentition is retained into the early captorhinids, in which additional tooth rows are added. The length of the teeth in the lower jaw of *R. primus* alternates with that in the upper jaw.

As illustrated, the skull is very smooth. This is almost certainly the result of mechanical preparation, and does not indicate a lack of sculpturing in the living animal. Although it is difficult to restore the angle between the skull table and cheek region accurately without more information concerning the palate than is available from the skull as preserved, the whole back of the skull appears wider than in *Protorothyris* and earlier romeriids. There are a few additional differences in the configuration of the individual bones. The parietals are still embayed, but the postparietals do not extend anterior to the supratemporals. The postorbital extends onto the dorsal surface of the skull roof to bind the table more firmly to the cheek region. The tabulars are lost and the postparietals extend laterally toward the squamosals. The quadratojugal appears shorter and higher than that of *Protorothyris*, but this is probably not an important point of distinction. The orbits are relatively further forward. The pineal opening is considerably larger.

The crushing of the skull and the presence of lower jaws obscures most of the palate. The posterior portion of the braincase, the parasphenoid, and stapes can be seen at an oblique angle between the jaws (Fig. SB). This area is substantially similar to that of both other romeriids and *Captorhinus*.

In occipital view, the opisthotics can be seen to be more fully ossified than in *Protorothyris*, but the exposure of the ventrolateral portion of the supraoccipital suggests that the otic capsule was still not completely ossified. The supraoccipital is a broad plate of bone, possibly reaching as far as the squamosal laterally, restricting the

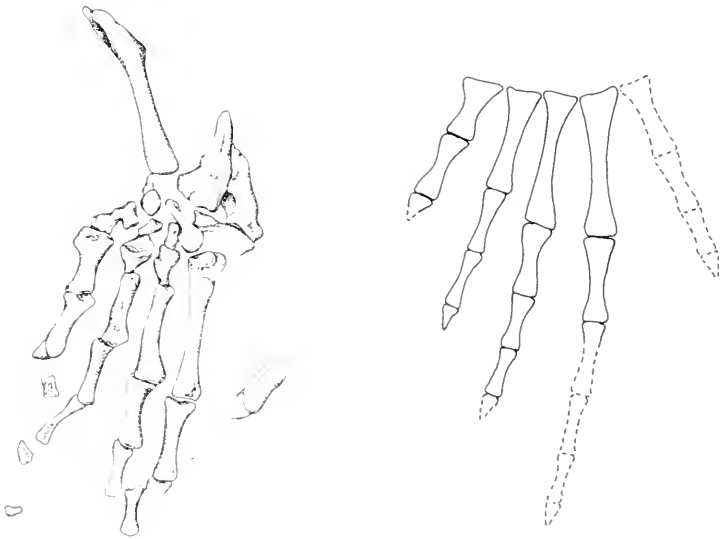

Figure 10. *Romeria primus*, n. sp., type, MCZ 1963. Hand as preserved and as restored. $\times 1\frac{1}{2}$.

size of the posttemporal fenestrae. The basicranial tubera for the insertion of axial musculature are readily seen at the back of the parasphenoid, beneath the otic capsule. The relationship and configuration of the quadrate is as in other romeriids. As restored, the lower jaws resemble in general those of *Protorothyris archeri*, although the splenial extends further forward, and the entire jaw is thicker, relative to its length. Jumbled postcranial remains accompany the skull. The anterior vertebrae have low neural spines, quite unlike those of *Protorothyris*, but more or less similar to those of *Captorhinus*. They are not well enough preserved for further description. Broken and incomplete bones of the forelimb are present, but give very little evidence of their original structure or even proportions. The carpals are broken and jumbled, but were evidently well ossified. Their specific configuration cannot be restored. The proximal portions of the first four digits are present in nearly their normal position. The configuration is obviously reptilian and the proportions similar to those of the better known Pennsylvanian romeriids. The claws are short and pointed. Nothing is known

of the posterior portion of the vertebral column or the rear limb.

Discussion. *Romeria primus* clearly evolved from the main romeriid stock. Since the two species are contemporary, it could not have evolved from *Protorothyris archeri* itself, but it may have evolved from a very similar antecedent form. The cranial differences are clear cut, but may not have required much time to develop.

Romeria texana Price

Figures 11, 12, and 13

Specific diagnosis. The same as for genus. This species may be distinguished from *R. primus* by the smaller number of maxillary teeth and the greater number of premaxillary teeth.

Horizon and locality. Archer City Bone Bed, Archer County, Texas. Putnam Formation, Wichita Group, Lower Permian of Texas.

Holotype. MCZ 1480, skull lacking braincase, lower jaws, and postparietals.

Referred specimen. UT 40001-4, skeleton of juvenile individual from Zott Pasture, southwest corner, section 55, block 3, Clark

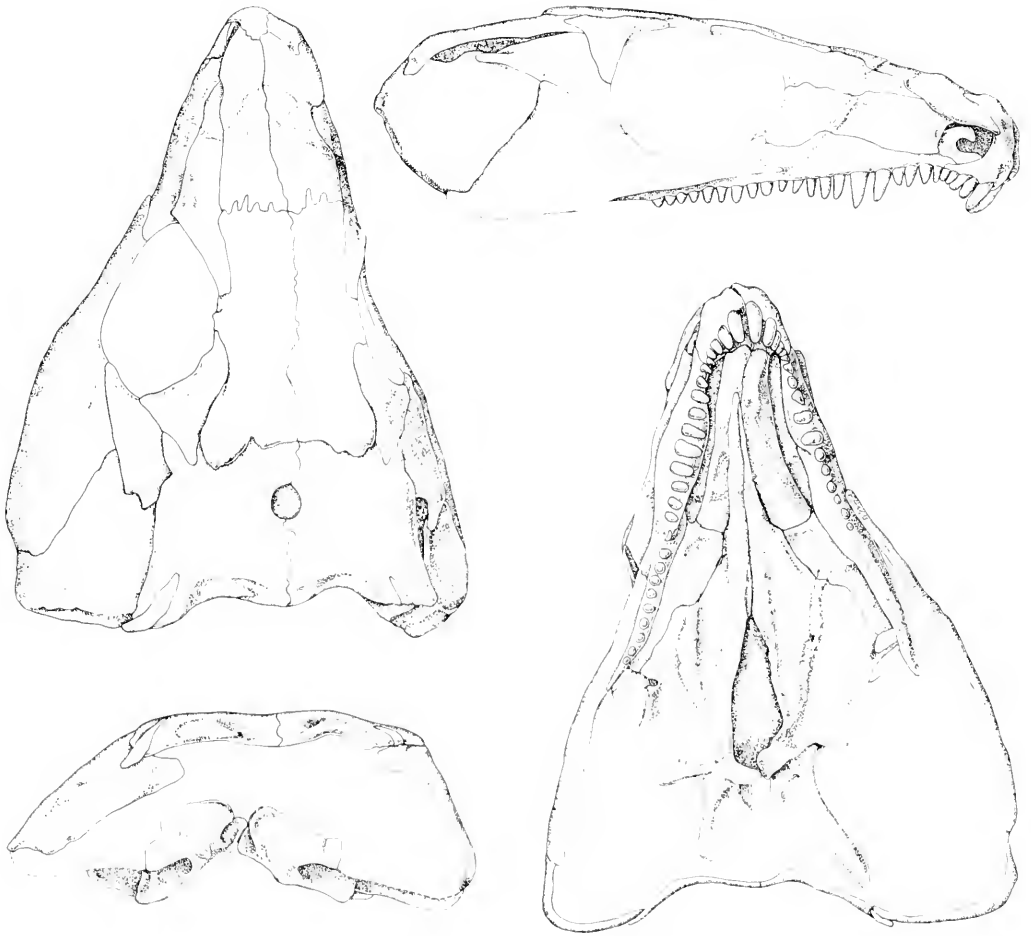

Figure 11. *Romeria texana*. Type, MCZ 1480, in dorsal, lateral, accipital, and palatal views. Braincase, lower jaws, and postparietals are missing. $\times 1\frac{1}{2}$.

and Plumb Survey, 3 miles north of Windthorst, Archer County, Texas, Putnam Formation.

Description. Price based the family Romeriidae on a single specimen of the species *Romeria texana*. Only the skull, minus the lower jaws, braincase, and postparietals is preserved. The original description was based on the skull roof alone, but the palate has since been exposed.

The general pattern of the skull roof follows that of other romeriids. The specimen shows almost no sculpturing of the dermal bones. This is almost certainly the result of

polishing in the course of mechanical preparation. A pattern of shallow, scattered pits can be dimly perceived in the remaining bone surface. The pineal opening of this species, like that of *Romeria primus* and the next species to be described, is relatively and absolutely larger than in other romeriids. The postparietals are missing from the skull but their position and relative width can be judged from the emargination of the parietals. Although readily perceived, this emargination is not as marked as that of *Protorothyris*. As can be seen in the second, juvenile skull of *Romeria texana*,

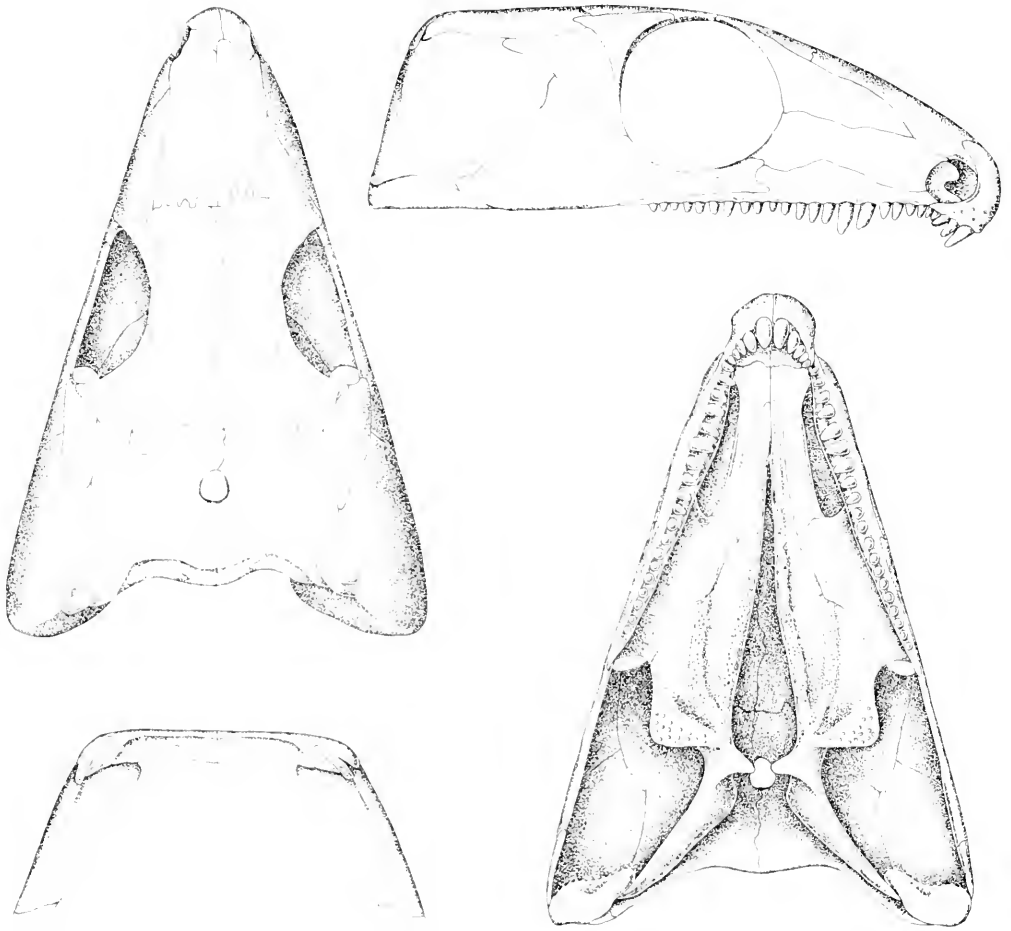

Figure 12. *Romeria texana*. Type, MCZ 1480. Restoration of skull in dorsal, lateral, occipital, and palatal views. Post-parietals and braincase are missing. There is no ectopterygoid. Smooth appearance of skull roof is an artifact, sculpturing was removed during preparation. $\times 1\frac{1}{2}$.

there is no tabular. The postorbital extends very slightly onto the dorsal surface of the skull roof to strengthen its attachment to the cheek region.

The lateral exposure of the portion of the maxilla extending beneath the orbit is very narrow. There are twenty teeth in the right maxilla, with no empty sockets. The posterior portion of the left maxilla has been damaged, precluding determination of the exact tooth count. The anterior 12 teeth are all in place. The fifth and sixth teeth are sufficiently longer than the remainder to

be designated "canines." The next five teeth are progressively shorter. The length of the next three teeth increases slightly and the remainder are all short. The tooth-bearing surface of the premaxilla is at an angle of 25° to the maxillary tooth row. The most anterior of the premaxillary teeth are the longest, roughly equal to the canines. The more posterior are progressively shorter.

Since the lower jaws are missing the palate is well exposed. The surface detail has, unfortunately, been blunted by mechanical

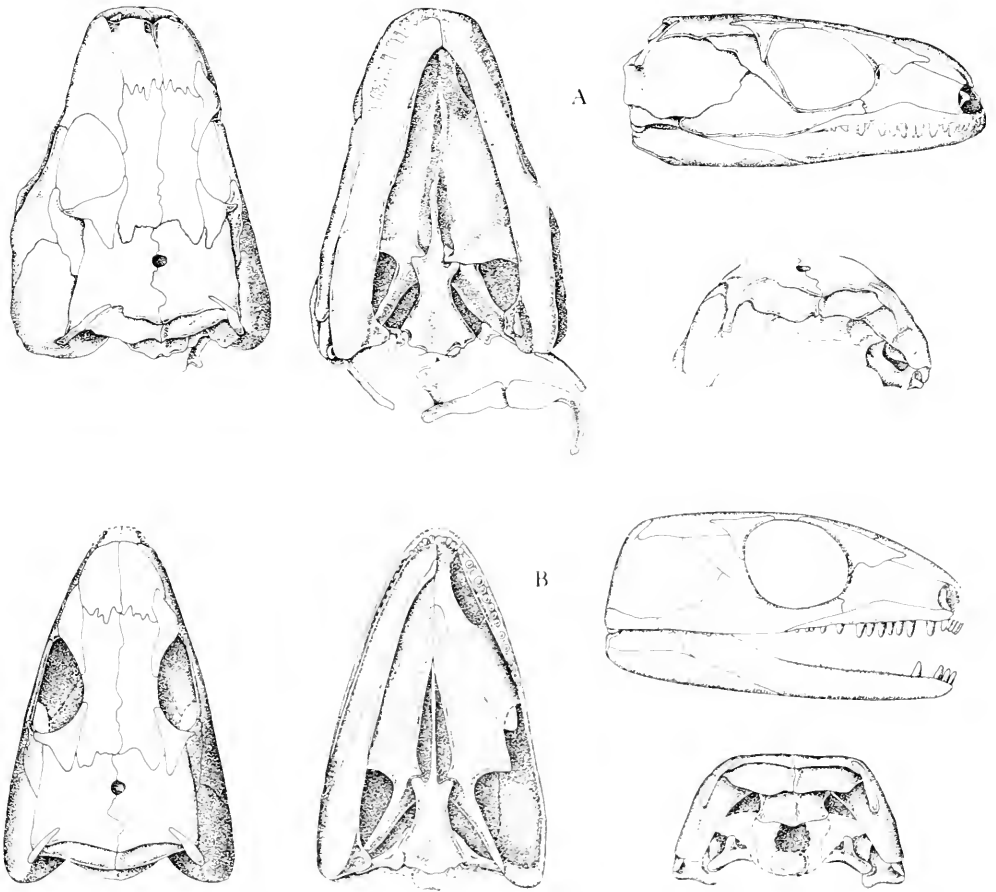

Figure 13. *Romeria texana*. Immature specimen, UT 40001-4. A, skull as preserved in dorsal, ventral, lateral, and occipital views. B, restoration of skull in similar views. $\times 1\frac{1}{2}$.

preparation. There is apparently no ectopterygoid. The palatine extends from the internal nares to the subtemporal fossa. The transverse flange of the pterygoid apparently does not have a row of large teeth on its margin, but rather a scattering of smaller denticles along its anterior face. Two ridges, certainly bearing denticles, extend along the palatal ramus of the pterygoid, one along the medial margin and the other obliquely laterally toward the palatine. Another ridge, possibly topped with denticles, borders the lateral margin of the vomer. The pterygoids extend between the vomers, nearly to the premaxillae. In occipital view, the squamosal can be seen to

extend medially to underlie the postparietals. The quadrates and the posterior portion of the quadratojugal are missing.

In addition to the type skull, *Romeria texana* is represented by a second, juvenile specimen, from the University of Texas collection UT 40001-4. It was collected together with a great deal of material of the microsaur *Pantylus*. This locality is in the Putnam Formation as is that from which the type was collected. Except for the smaller size and slight difference in proportions, the juvenile skull is very similar to the type. It is more complete in retaining the postparietals and the braincase in their natural positions. The presence of the post-

parietals makes this skull appear more similar to that of *Romeria primus* than does the type. Between the juvenile and the adult of this species the relative size of the parietal opening increases, the snout becomes more elongate, the portion of the skull anterior to the orbits becomes relatively longer and the canine teeth become more pronounced. The orbit becomes relatively smaller and the tooth row relatively longer (See Table I). There is room for five teeth in the premaxilla and 19 in the maxilla. This suggests that the number of teeth does not change substantially during ontogeny.

Unfortunately the specimen was preserved in a very resistant ironstone matrix. The surface of the bone was almost completely destroyed during preliminary preparation with acid (?hydrochloric). The occipital area is preserved but little preparation is possible without severely damaging the specimen. It is clear that there are broad postparietals that extend just short of the supratemporals. There are no tabular bones. The supraoccipital is about one-third the width of the skull. The posttemporal fossae open between it and the medial portion of the squamosal. The opisthotic appears quite well ossified and must have extended nearly to the squamosal. The stapes are small but of essentially adult proportions, unlike that of the juvenile specimen of *Coelostegus* (Carroll and Baird, 1972) or *Protorothyris morani*. The stem is long and abuts against the quadrate. The lower jaw shows no retroarticular process.

Much of the postcranial skeleton is preserved in a nodule behind the skull. Unfortunately, the extremely small size and fragility of the bones combined with the hardness of the matrix render it impractical to prepare the remainder of the specimen at the present time. It is hoped that techniques will be developed which will make this preparation practical. Elements that are exposed include a series of neural arches that are broad and show little development of a spine. A series of three arches extends for 9 mm. The elements of the shoul-

der girdle are generally similar to those of *Protorothyris*. The scapulocoracoid, although small, is clearly ossified as a single unit.

Protocaptorhinus, new genus

Figures 14, 15, 16, and 17

Type species *Protocaptorhinus pricei*, new species

Only a single romeriid specimen (MCZ 1478) has been discovered in the Admiral Formation that overlies the Putnam. It consists of a well-preserved skull and the anterior portion of the postcranial skeleton. Although generally similar to *Romeria*, it approaches the captorhinid condition more closely in several respects. It was included in the species *Captorhinus aguti* by Seltin (1959) but the presence of only a single row of marginal teeth definitely precludes this assignment.

Generic diagnosis. Large romeriid captorhinomorph. Skull roof deeply sculptured with uniformly distributed oval pits. Tabulars lost. Posterior margin of parietals shallowly concave. Supratemporal extending down along top half of the posterior margin of the squamosal. Posterior margin of the squamosal nearly vertical. Postorbital large and extending onto skull roof. Pineal opening large. Premaxilla down-turned. Four to five teeth in premaxilla, 18 to 22 in maxilla; fourth or fifth is enlarged "canine." No evidence of more than a single tooth row. Ossified portion of opisthotic not reaching squamosal. Supraoccipital constricted laterally to form margins of large posttemporal fenestrae. Very slight retroarticular process. Neural arches in trunk region approaching configuration noted in *Captorhinus*. Zygapophyses nearly horizontal.

Protocaptorhinus pricei, new species

Specific diagnosis. Same as for genus.

The specific name honours Mr. L. I. Price, who found this and most of the other

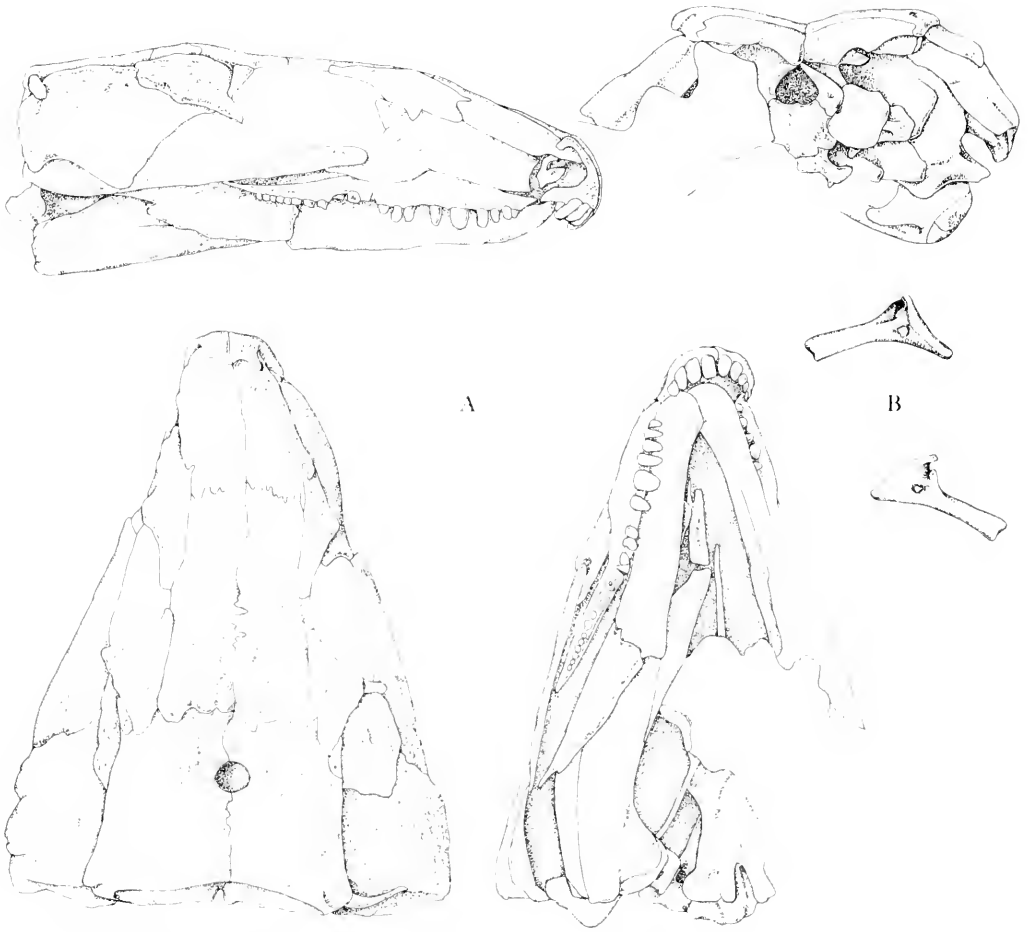

Figure 14. *Protacaptorhinus pricei*, n. gen. and n. sp. Type, MCZ 1478. A, skull in lateral, occipital, dorsal, and ventral views. White areas show position of overlying postcranial elements that appear in a different plane than the skull. B, left stapes in posterior and anterior views. $\times 1\frac{1}{2}$.

romeriid specimens from the Lower Permian of Texas.

Horizon and locality. Rattlesnake Canyon, Archer County, Texas. Uppermost Admiral Formation, Wichita Group, Lower Permian.

Holotype. MCZ 1478. Skull and associated elements of anterior postcranial skeleton.

Questionably referred specimen, MCZ 1160. Badly crushed skull from the Belle Plains Formation.

Description. The size and general con-

figuration of the skull resemble those of the previous genus. The surface is deeply pitted, more like *Captorhinus* than earlier romeriids, although the individual pits are noticeably wider than in that genus. The pincal foramen, as in *Romeria*, is larger than in most Lower Permian reptiles. The posterior margin of the two parietals is shallowly concave; unlike the condition in *Romeria*, these bones are shortest at the midline. The postparietals are thin, narrow bones, exposed primarily in occipital rather than dorsal view. The supratempo-

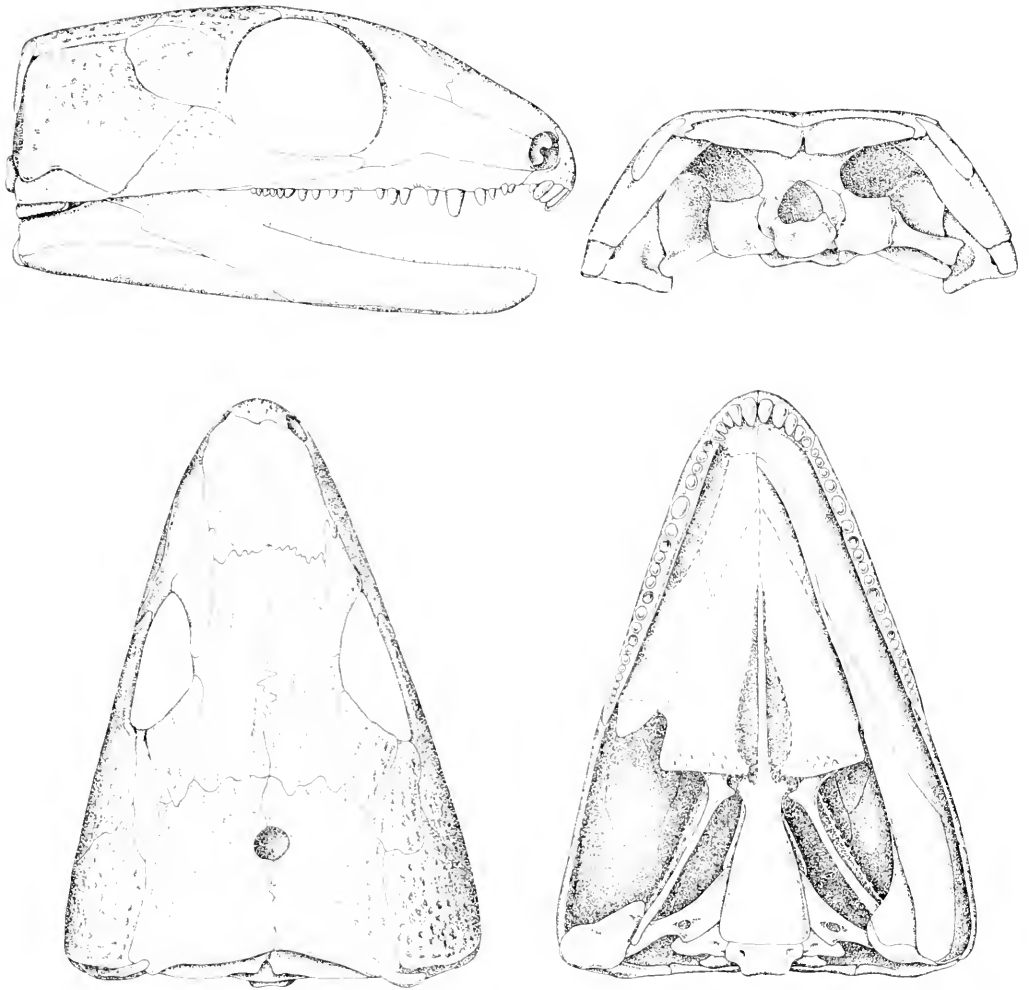

Figure 15. *Protocaptarhinus pricei*, n. gen and n. sp. Restoration of type, MCZ 1478. Skull in lateral, occipital, dorsal, and ventral views. $\times 1\frac{1}{2}$.

als are supported dorsally by very shallow notches in the parietals. Distally, they extend ventrolaterally over the dorsal half of the posterior margin of the squamosal. The posterior margin of the squamosal is nearly vertical. The dorsal margin of the post-orbital extends onto the skull roof.

The dentition resembles that of *Romeria*. The premaxilla is tilted down from the horizontal and bears five teeth; the anterior one is the largest and the length of the remaining teeth decreases gradually.

The most anterior maxillary teeth are also short. The length increases rapidly to the sixth, which may be considered a canine although it is not as prominent as the canines in earlier romeriids. Only a single tooth can be so designated on each side, in contrast with the condition in *Romeria*, *Protorothyris*, and the Pennsylvanian genera that always have two pairs of canines. The length of the teeth decreases steadily behind the canines. On the right side, 14 teeth are in place in this area, with room for three

more. Although the tips of the teeth have been damaged slightly, all appear to be simple pegs with bluntly pointed, conical tips. Unfortunately, it is not possible to determine the extent of wear. Although the lower jaws are clenched into place against the palate, enough of the ventral margin of the maxilla is exposed to be certain that there is only a single row of marginal teeth.

Most of the lateral and anterior portion of the palate is covered by the lower jaws. Only the cultriform process and a small portion of the transverse flange of the pterygoid can be seen anterior to the basi-cranial articulation. The posterior portion of the parasphenoid and the ventral surface of the otic-occipital region resemble closely their counterparts in other romeriids.

The occipital surface demonstrates several differences from earlier romeriids. The supraoccipital is noticeably more narrow, so that very large posttemporal fenestrae are formed. Just beneath the skull roof, the dorsolateral corners of the supraoccipital are extended as cylindrical processes, exactly as in *Captorhinus*. The opisthotic is more completely ossified than in earlier romeriids. It extends laterally to cover much of the dorsal process of the stapes. It is separated from the squamosal by a wide gap, however. The extent of the occipital portion of the squamosal is nearly parallel with the lateral margin of the cheek. The exoccipitals bear well-developed facets for articulation with the proatlas and are indistinguishably fused to the basi-occipital. The cheek region meets the skull roof at an angle of 61° .

The right stapes is in place, but much of the stem has been lost. The left stapes has fallen out of the skull and lies adjacent to the cervical vertebrae. Although it cannot be removed completely without damage to the adjacent bones, it can be drawn from several angles to disclose the most important structures. In its large relative size and in most structural details it resembles the stapes of other romeriids and *Captorhinus*. There is a large oval footplate, set

at an angle of approximately 55° to the longitudinal axis of the shaft. The posterior end of the footplate rests against the margin of the fenestra ovalis formed by the opisthotic. Ventrally it is supported and held loosely in place by the parasphenoid. Anteriorly it abuts the proötic. As seen ventrally, the shaft extends posteriorly at an angle of approximately 18° from the transverse plane toward the quadrate. As seen in occipital view, the stem extends ventrally at an angle of 20° from the horizontal. The dorsal process is approximately as long as the shaft is thick and extends medially at an angle of approximately 45° . At the base of the dorsal process is the stapedia foramen, which extends anterodorsally from the rear. The shaft is 1.5 mm in diameter just distal to the dorsal process and thickens to a diameter of 3 mm at its distal end. This portion of the shaft is 6 mm in length. The distal end is in the form of a roughened concavity. Presumably it was continued in cartilage. The configuration of the quadrate resembles that of other romeriids.

The lower jaws are considerably thicker than in *Protorothyris*, continuing the trend seen in *Romeria*. The posterior margin of the articular extends slightly behind the angular and surangular as an abbreviated retroarticular process. The ventral surface of the articular and supporting prearticular are extended medially to provide a large area for the insertion of the pterygoideus jaw musculature that originates on the back of the transverse flange of the pterygoid. The splenial extends forward to the symphysis. The tooth-bearing margin of the lower jaw is completely covered by the skull roof. In contrast with *Protorothyris*, the dentary is lightly sculptured.

Postcranial skeleton. Accompanying the skull are a series of seven anterior vertebrae, ribs, much of the shoulder girdle, and the right forelimb. The elements of the atlas-axis complex resemble in general those of *Paleothyris* and *Protorothyris*, but the relative proportions of the bones differ widely

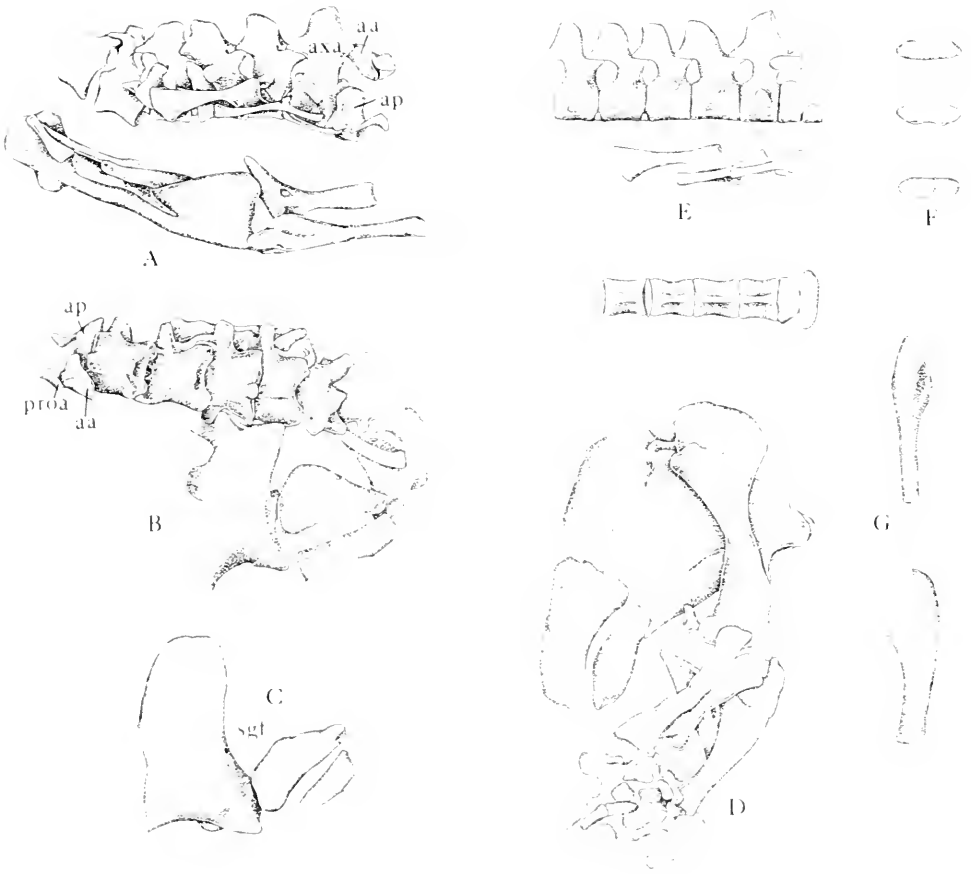

Figure 16. *Protocaptorhinus pricei*, n. gen and n. sp. Type, MCZ 1478. Postcranial elements. A, anterior vertebrae in lateral view, humerus, ulna, and stapes. B, anterior vertebrae in dorsal view, scapula and proximal end of left humerus. C, left scapula and broken proximal end of humerus. D, shoulder girdle and right forelimb. E, restoration of anterior vertebrae in lateral and ventral views, cervical ribs. F, atlas intercentrum in anterior, dorsal, and ventral views. G, right ulna in posterior and medial views. $\times 1\frac{1}{2}$.

in the three genera. A piece of the oval proaltas may be seen emerging from the left posttemporal fenestra. The posterior portion is flattened ventrally and rounded dorsally. The atlas intercentrum has fallen from its normal position and lies below the other cervicals. It is a wide crescent, marked ventrally by a longitudinal ridge. It presumably bore the capitulum of the first rib, but the facet for its articulation is not visible. The atlas arch is a small, paired structure without a neural spine. It is loosely articulated with a short, cylindrical

pleurocentrum that is notched dorsally for the nerve cord. There is no separate axis intercentrum; presumably it is indistinguishably fused to the base of the atlas pleurocentrum. The axis centrum is only slightly longer than the atlas centrum and not appreciably larger than the remaining cervicals. It is indistinguishably fused to the arch. The axis neural spine is broken anteriorly, but was clearly larger than those of the other cervicals; presumably, as in other romeriids, the anterior margin overhanging the atlas arch. The spine is much

shorter than that of *Protorothyris archeri*, but resembles that of *Captorhinus*. The length of the axis centrum is relatively much shorter than that of *Paleothyris*.

Surprisingly, there is no intercentrum for the third or fourth vertebra. The ventral lip of these centra is extended anteriorly to underlie the posterior margin of the more anterior vertebrae. The cervical region in *Captorhinus* has not been described in sufficient detail to permit more specific comparison with this form. Normal intercentra are present anterior to the fifth and sixth centra and both margins of the pleurocentra are bevelled for their reception. All the centra in the cervical region bear a rounded keel. In lateral view, the neural arches in *Protocaptorhinus* resemble those of *Paleothyris*. When viewed dorsally, however, it can be seen that they are expanded laterally in much the same way as those in *Captorhinus*. The zygapophyses extend far beyond the width of the centra, to form the "typical" cotylosaur swollen neural arch. The transverse processes extend laterally beyond the zygapophyses. The alternation in spine height noted in *Captorhinus* by Vaughn (1970) is not evident in this short series.

Several cervical ribs are present. Those associated with the first three vertebrae are shown in Figure 16. They have clearly separated heads to bridge the wide gap between the anterior transverse process and the base of the centra, and spatulate shafts that evidently extended posteriorly alongside the column, rather than ventrally.

The shoulder girdle is badly jumbled, but most of the elements are present. Their preservation is such that no more than general similarities with other romeriids can be noted. The humerus, ulna, and radius are all somewhat distorted and broken. They resemble their counterparts in *Captorhinus* in being considerably more stoutly built than those of earlier romeriids. In as much as the preservation permits comparison, the humerus in particular is nearly identical with that of *Captorhinus*. The

carpals and distal phalanges are jumbled together and do not permit restoration.

A further specimen that is clearly closely related to MCZ 1478 is an isolated skull, MCZ 1160, collected by Price from the lower Belle Plains Formation, one and a half miles northwest of Woodrum House. Superficially it appears almost indistinguishable from the type of *Protocaptorhinus pricei*. The fact that it comes from a later formation and has been cited by Seltin (1959) and Fox and Bowman (1966) as belonging to the genus *Captorhinus* makes it deserving of special notice. Unfortunately, the skull is not well preserved. The skull roof is badly cracked and much of the palate and braincase is missing. The bone is softer than the matrix and delicate preparation is not possible. Although the superficial surface of the skull roof has been removed in earlier preparation, the pattern of the individual bones is very easily seen as a result of their slight disarticulation. The outline of the skull and the configuration of the bones is very similar to those of MCZ 1478. Although the individual teeth are poorly preserved, the general dental pattern can be readily discerned. There are four teeth in each premaxilla, as in most specimens of *Captorhinus aguti*, but one less than the count in the type of *Protocaptorhinus pricei*. There is definitely only a single row of maxillary teeth. In *Captorhinus* the fourth maxillary tooth is usually the largest and the terminal member of the first diagonal row. The next tooth is smaller and clearly more medial in position. In MCZ 1478 the fifth tooth is the largest, but those more posterior are clearly in the same row. In MCZ 1160 the fourth tooth is the largest, but again, all of the marginal teeth are in a single, straight row. Neither maxilla is sufficiently well preserved to establish the tooth count accurately. There are approximately 18 teeth, intermediate between the number of marginal teeth in MCZ 1478 (22) and *Captorhinus* (approximately 16). A further factor in which MCZ 1160 resembles the type of *Protocaptorhinus*

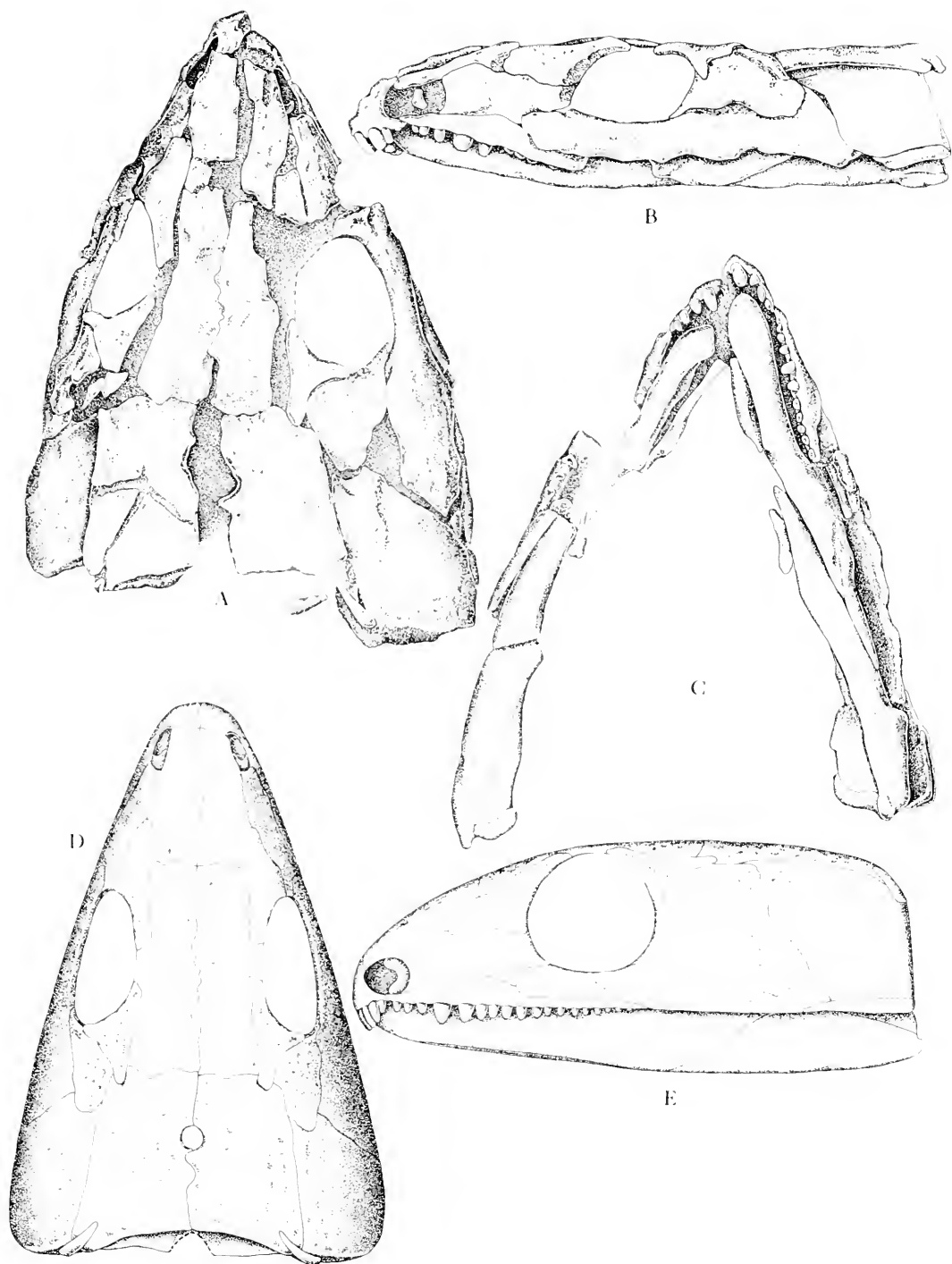

Figure 17. *Protocaptorhinus pricei*. MCZ 1160. Skull as preserved in A, dorsal, B, lateral, and C, ventral views. Restoration of skull in D, dorsal and E, lateral views. $\times 1\frac{1}{2}$.

pricei is the presence of only a very short retroarticular process. It more closely approaches the condition of *Captorhinus* in the extension of the jugal anterior to the orbit and the relatively anterior position of the orbit, but can be unequivocally distinguished from that genus by the relatively narrower cheek region. In MCZ 1160, as in all romeriids, the skull margin is nearly straight between the external nares and the quadrate. Although this specimen differs from the type of *Protocaptorhinus pricei* in the number of teeth and in other minor respects, it will be included here in the species.

Pleuristion brachycoelous Case

Brief mention should be made of an additional, recently described specimen that might be included in the family Romeriidae. In 1970, Olson described a skull from the Wellington Formation of Oklahoma and assigned it to Case's species *Pleuristion brachycoelous*, originally based on vertebrae from that formation. Olson included the species within the Captorhinidae. He noted that it was distinguishable from *Captorhinus* primarily on the basis of the dentition. The skull clearly has only a single row of teeth in both the maxilla and the dentary and the tips of the teeth were pointed rather than chisel-shaped or blunted with wear as in *Labidosaurus hamatus* or *Captorhinus aguti*. As will become clear in the subsequent section on the ancestry of the Captorhinidae, there is an almost complete transition between that family and the Romeriidae. One distinction that can be maintained is the different configuration of the cheek region. The skull of *Pleuristion brachycoelous* described by Olson resembles that of the romeriids in having an essentially straight margin between the posterior edge of the premaxilla and the quadrate, as determined by the structure of the left lower jaw. Because of the large mass of the jaw muscle, the common captorhinid genera *Captorhinus* and *Labidosaurus* have

expanded the cheek region laterally so that the ventrolateral margin of the skull is distinctly concave between the premaxilla and the quadrate. There are no features in the skull described by Olson that are definitely those of captorhinids as distinct from romeriids. The individual teeth resemble those of romeriids more than captorhinids in having sharply pointed rather than chisel-shaped tips and in the presence of two pairs of "canines." The premaxilla is not preserved. Olson has restored this bone as being hooked in the manner of *Romeria* and *Captorhinus*. The small number of marginal teeth, as well as the configuration of the posterior margin of the skull roof, suggests that it is advanced over the *Protorothyris* pattern and so might be expected to have a specialized premaxilla as well.

Although it is not illustrated by Olson, the posterior portion of the skull roof is well preserved. It resembles that of *Protocaptorhinus* and *Captorhinus* in that the posterior margin of the parietals forms a shallowly concave recess. The postparietals face entirely posteriorly and there are only very shallow notches in the parietals for the supratemporals. In these features the skull is definitely advanced over the level of *Romeria*. The presence of two pairs of fairly conspicuous canines distinguishes it from *Protocaptorhinus* and *Captorhinus*, however, as does the very narrow lower jaw. The peculiar distribution of the palatine denticles is a further feature distinguishing it from *Captorhinus* and *Romeria*. The palate is not exposed in either of the specimens of *Protocaptorhinus*.

Apparently *Pleuristion* represents a lineage that has evolved in parallel with the *Romeria-Captorhinus* group. No other members of this lineage are known. The exact age equivalence between the Wellington Formation and the Texas sequence has not been determined. It has been equated with both the Belle Plains and the Arroyo. In either case, *Pleuristion* is one of the latest romeriids.

CHANGES IN THE SKULL STRUCTURE OF LOWER PERMIAN ROMERIIDS

In contrast with the Pennsylvanian romeriids, in which the postcranial skeleton of most genera is known in considerable detail, our current knowledge of the Lower Permian members of the family is based primarily on a series of excellently preserved skulls. These skulls show progressive changes in the palate, jaws, and dentition that culminate in the origin of the family Captorhinidae.

The significance of the changes in the structure of the jaws and their musculature in the origin of reptiles has recently been emphasized (Carroll, 1969b). The basic pattern achieved by the early romeriids is retained in the primitive members of many advanced reptilian lineages, notably lepidosaurs and archosaurs. All of the Pennsylvanian romeriids retain the primitive configuration in which the tooth-bearing margin of the skull is in a single plane and the canines are very conspicuous. Except for *Cephalerpeton*, the remaining maxillary teeth are small and numerous.

The entire jaw apparatus in small, primitive reptiles was probably evolved to capture, hold, and ingest small insects. In most Pennsylvanian romeriids, the skull is small and the marginal teeth are typically small so that they would serve primarily to hold the prey. The larger teeth in *Cephalerpeton* may have been more efficient in piercing. The canine teeth in the typical genera, *Hylonomus* and *Paleothyris*, may have served to pierce the prey as well, but more likely their primary function was to keep small fusiform insects from escaping at the front of the mouth. They would be most effective if the prey were held crossways in the jaws, as may be observed in living lizards. The canines are approximately midway between the anterior margin of the orbits and the posterior margin of the external nares. The longer anterior premaxillary teeth would have served a similar function, but there is little space between them

and the canines to accommodate any but the smallest prey.

The two species of *Protorothyris* from the Lower Permian continue the pattern established by *Hylonomus* and *Paleothyris*. *Romeria* and *Protocaptorhinus* initiate a distinct departure that culminates in the specialized dentition of the family Captorhinidae. The trend is first recognizable in *Romeria primus* from the Moran Formation. This species resembles more primitive romeriids in many respects, but the tooth-bearing margin of the premaxilla bends ventrally at an angle of 26° to the horizontal. The tooth count is reduced to 25 in the maxilla and four in each premaxilla. The canines shift to a slightly more posterior position. This results in the formation of a very effective insect trap anterior to the canines, just beneath the external nares. This is significantly further forward than the primary trap in *Protorothyris*. The canines are less conspicuously larger than the remaining cheek teeth, although they remain easily recognizable in this genus. The shorter teeth behind the canines form a secondary food trap. The teeth in the lower jaw also contribute to the effectiveness of the system. In both *Protorothyris* and *Romeria primus* the length of the dentary teeth alternates with that of the premaxillary teeth. A basically similar pattern is seen in *Protocaptorhinus*.

Although it is of obvious advantage in capturing prey to have the holding surface as close as possible to the end of the jaws, this places the lever system of the jaw at a considerable mechanical disadvantage. More force must be applied by the muscles the further the prey is from the fulcrum. Not surprisingly, the change in tooth and jaw structure seen in the sequence *Protorothyris-Romeria-Protocaptorhinus* is accompanied by a progressive enlargement of the subtemporal fenestrae and the width of the lower jaw (see Table I). The areas in question were measured by the use of a grid, with squares being counted as zero if less than half was covered and as one if



Figure 18. A, lateral view of skull of the earliest identifiable captorhinid, MCZ 1483, from the middle of the Belle Plains Formation. Cheek region is expanded and posterior teeth have chisel-shaped tips. There is only a single row of marginal teeth. B, occiput of *Captorhinus pattern*, UC 1119, Wichita River, near Vernon Crossing, Clyde Formation. $\times 1\frac{1}{2}$.

more than half was covered. These measures are not meant to correspond strictly to functional units, but simply to give a standard for discussing the relative size of the areas available for jaw musculature. In *Protorothyris archeri*, the subtemporal fenestrae occupy approximately 27 percent of the palatal surface, in *Romeria primus* 31 percent, *Romeria texana* 33 percent, and *Protocaptorhinus pricei* 37 percent. Other measurements demonstrate a similar widening of the lower jaws to accommodate a greater mass of the adductor musculature. These changes set the stage for a second, even more radical organization of the dentition which occurred in the origin of the Captorhinidae (see subsequent section).

A further series of changes, occurring simultaneously with those noted in the lower jaw, are seen in the occiput. One, which has no immediately obvious structural or functional advantage, is the ossification of the otic capsule. This structure is only questionably recognizable in the Pennsylvanian members of the group. In *Paleothyris* the exoccipital appears to have

occupied some of the area later recognized as opisthotic. In *Protorothyris* the exoccipital is clearly recognized, but little is evident of the opisthotic. In *Romeria primus* the medial and ventral portions of the otic capsule are ossified, but the dorsal and lateral areas were apparently cartilaginous. In *Protocaptorhinus* all of the medial part is ossified, but the distal ends stop short of the squamosals. In *Captorhinus* the capsule extends to the cheek. This changed pattern of ossification seems to have little significance within the romeriids, but may be very important in the evolution of at least one group of advanced reptiles. Of more obvious significance is the change in the overall proportion of the occiput. As may be noted in Table I, the Permian romeriids show a progressive widening of the skull so that the height-width ratio changes from 1:1.5 to 1:2.5 from *Protorothyris* to *Protocaptorhinus*. The length of the skull is essentially unchanged and the height is only slightly reduced. One reason for the relative increase in the width of the cheek region is to accommodate the increased jaw

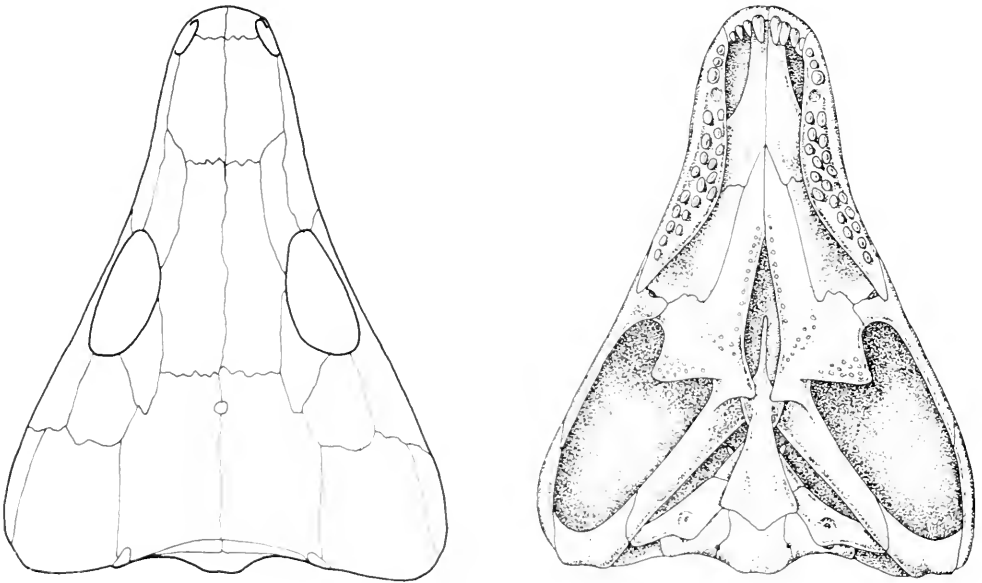

Figure 19. *Captorhinus aguti*. Skull, in dorsal and palatal views. Approximately $\times 1$.

musculature. The widening of the occiput also results in a reorganization of the cervical musculature and the direction of the major forces that move the skull. The occipital condyle forms a fulcrum that allows movement in both the vertical and horizontal planes. The degree of control and mobility in each species is dependent on the placement and orientation of the major muscles. Judging from modern lizards, the muscles moving the skull of *Protorothyris* were probably located in an arc above the occipital condyle extending no more than about 15 degrees from the vertical. Control of the head would have been primarily in a vertical plane. In *Protocaptorhinus* the muscles could occupy much more lateral positions, enabling greater force to be applied in moving the skull from side to side. In modern lizards much of the force in crushing the prey is achieved by pushing the jaw along the ground on one side or the other. This would be facilitated by the distribution of muscles seen in the advanced romeriids. As a result of the lateral shift of the cervical musculature, the postparietal

extends laterally to usurp the position occupied by the tabular in *Protorothyris* and other primitive romeriids. The supratemporal narrows to give a greater surface for the attachment of the spinalis capitis muscles, attaching to the margin of the post-temporal fossa.

THE ORIGIN OF THE FAMILY CAPTORHINIDAE

As Watson (1954) and others have observed and as has been further demonstrated in this paper, the Lower Permian romeriid lineage including the genus *Romeria* forms a more or less continuous transition from the primitive romeriid pattern to that of the Captorhinidae. If these two families are to be distinguished taxonomically, it is necessary to determine the specific phylogenetic relationship between them and establish what significant morphological features can be used to differentiate the assigned species.

Among captorhinids, only the genera *Captorhinus* and *Labidosaurus* need concern us here. The many genera described

by Olson (1970 and references therein) and the newly discovered African form (Taquet, 1969), all with multiple tooth rows and other evidence of considerable specialization, certainly evolved from *Captorhinus* and/or *Labidosaurus*, rather than directly from any romeriids.

Published accounts of *Captorhinus* by Price (1935), Romer (1956), Seltin (1959), and Fox and Bowman (1966) are all based essentially, if not entirely, on specimens from the Arroyo Formation, Clear Fork Group in Texas, or from the Fort Sill locality in Oklahoma of apparently equivalent age. These specimens can be differentiated from romeriids by significant differences in the dentition.

Both the maxilla and dentary bear multiple rows of teeth. The teeth are aligned in three or four (depending on the maturity of the specimen) overlapping rows, roughly parallel to each other, but set at a slight angle to the long axis of the jaw. The presence of more than a single row of teeth can be determined even in specimens with the jaws closely clenched because the "marginal" tooth row is not straight, but "stepped" where one tooth row is succeeded by the next.

In well-preserved and carefully prepared specimens, the rear teeth can be distinguished from those in typical romeriids by the lateral compression of the tips and their termination in a flat, chisel edge, in contrast to a sharpish point. Except for recently erupted teeth, most show considerable wear.

In dorsal view, the skulls of the Arroyo *Captorhinus* can be distinguished from those of any romeriids by the lateral expansion of the cheek region. A line drawn along the skull margin and extending back to the quadrate is distinctly concave out-

wards, whereas in all described romeriids the skull margin from the back of the premaxilla to the quadrate is nearly straight. The expansion of the cheek region is obviously associated with an increase in the adductor jaw musculature. This, in turn, may be related to the change in dentition. The jugal extends a process medially, behind the maxilla, to reach the pterygoid. The lower jaw has a conspicuous retroarticular process.

Other features distinguishing the Arroyo *Captorhinus* from the romeriids can be seen in occipital view. The paroccipital process of the otic capsule extends as a narrowing rod anterior to an extensive occipital flange of the squamosal. In romeriids, the paroccipital process of the otic capsule is not fully ossified, and the occipital portion of the squamosal is not as extensive [compare Fig. 15 of *Protocaptorhinus pricei* and Romer's fig. 36F (1956) of *Captorhinus*]. In association with the expansion of the jaw musculature, the angle between the skull roof and the cheek region decreases substantially (from approximately 70° to 60°). Although these specimens of *Captorhinus* can readily be derived from the known romeriids, particularly *Protocaptorhinus pricei*, there is no problem of differentiating the two groups or of accepting the familial distinction. The latter is further justified by the considerable subsequent differentiation of the known captorhinids.

In addition to the specimens from the Arroyo, *Captorhinus* has been recognized in diminishing numbers from as early as the Admiral or Belle Plains Formation. According to Seltin (1959) and Fox and Bowman (1966) all of the earlier members of the genus can be included in the same species, *C. aguti*, as the Arroyo form. Since they were placed in the same species, one

Figure 20. Pictorial phylogeny illustrating the origin of the Captorhinidae from Permian romeriids. A, *Protorathyrus orcheri*, $\times 1$; B, *Romeria primus*, $\times 1$; C, *Romeria texana*, $\times 1$; D and E, two specimens of *Protacaptorhinus pricei*, $\times 1$; F, type of "*Parioticus laticeps*," a possible ancestor of *Captorhinus aguti*, $\times 1$; G, UC 183, possible ancestor of *Labidosaurus hamatus*, $\times \frac{2}{3}$.

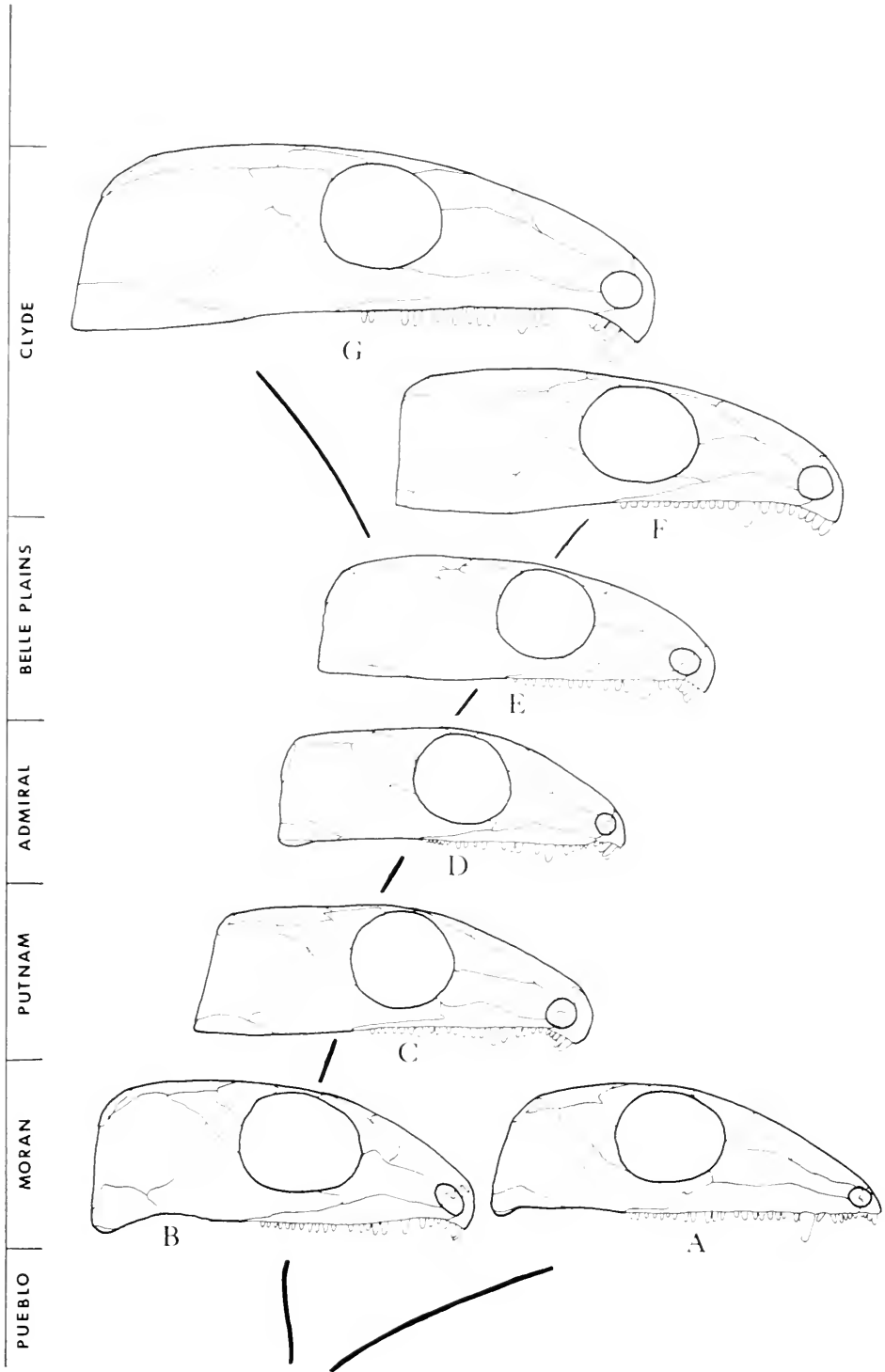

would assume from the literature that all these specimens had multiple tooth rows, and that this character had either developed abruptly from the romeriid condition, or that gradual evolution of the characteristic had occurred in some other area at an earlier time.

In an effort to determine more accurately the time of evolution of *Captorhinus* from romeriids, a number of specimens from below the Arroyo that had been attributed to *C. aguti* were examined:

Belle Plains Formation

MCZ 1483. Skull with lower jaws. *Trematops* locality, west of Williams Ranch, J. Gibbs Survey A-566, southeast of Fulda, Baylor County, Texas.

Clyde Formation

UC 196. Anterior part of skull and lower jaws. Mitchell Creek, near Wichita River, Baylor County, Texas.

UC 1043. Skull with lower jaws. Mitchell Creek, below Mabelle, Baylor County, Texas.

UC 642. Type of *Parioticus laticeps* (see Plate I). Complete skeleton. Mitchell Creek, Baylor County, Texas.

UC 1119. Occiput. Wichita River, near Vernon Crossing, Baylor County, Texas.

MCZ 1740. Skull with lower jaws. Weiss locality, Red Pasture Line House, sec. 7, block 5, H. and T.C.R.R., Willbarger County, Texas.

MCZ 2804. Skull with lower jaws. 1 mile south of Electra, H.T. & B.R.R., survey A-137, about middle of North Section lines, Wichita County, Texas.

No specimens have been described from the Lueders, a predominantly marine formation between the Belle Plains and the Arroyo.

All these specimens showed one or more of the attributes of the specimens of *Captorhinus* from the Arroyo, *but in no case were multiple tooth rows discovered*. Admittedly,

it has not been possible to prepare both the maxillae and the dentaries from their occlusal surface and some might show initial development of medial tooth rows, but in no case has this feature reached the stage of development typified by the Arroyo forms. The marginal teeth form a single, straight row.

In UC 1043, UC 642, MCZ 1740, and MCZ 1483, the cheek region was expanded. The occiput of UC 1119 (Fig. 18) showed an angle of approximately 60° with the cheek region, and the relationship between the squamosal and braincase is as in *Captorhinus*.

Although much more remains to be done in preparing and illustrating the material, it definitely demonstrates a long and gradual evolution of the typical captorhinid features from the romeriid pattern. This transition may be visualized as occurring in the following sequence:

Development of the overhanging premaxilla and loss of the tabulars—achieved in the Moran Formation.

Straightening of the posterior margin of the skull roof—initiated in the Moran, achieved by the Belle Plains.

Lateral compression of the cheek teeth—achieved in the Belle Plains.

Expansion of the cheek region—achieved by the Upper Belle Plains.

Extension of the jugal to the pterygoid—not observed until the Clyde.

Ossification of the lateral portion of the otic capsule and medial expansion of the squamosal—not known to be achieved until the late Clyde.

Development of multiple tooth rows—not observed until the Arroyo.

From the standpoint of evolution, this makes a very logical sequence, suggesting a change in feeding habits with gradual morphological specialization. From the taxonomic standpoint such a continuous series of morphological changes creates a number of problems, the most serious of which is determining a practical point of

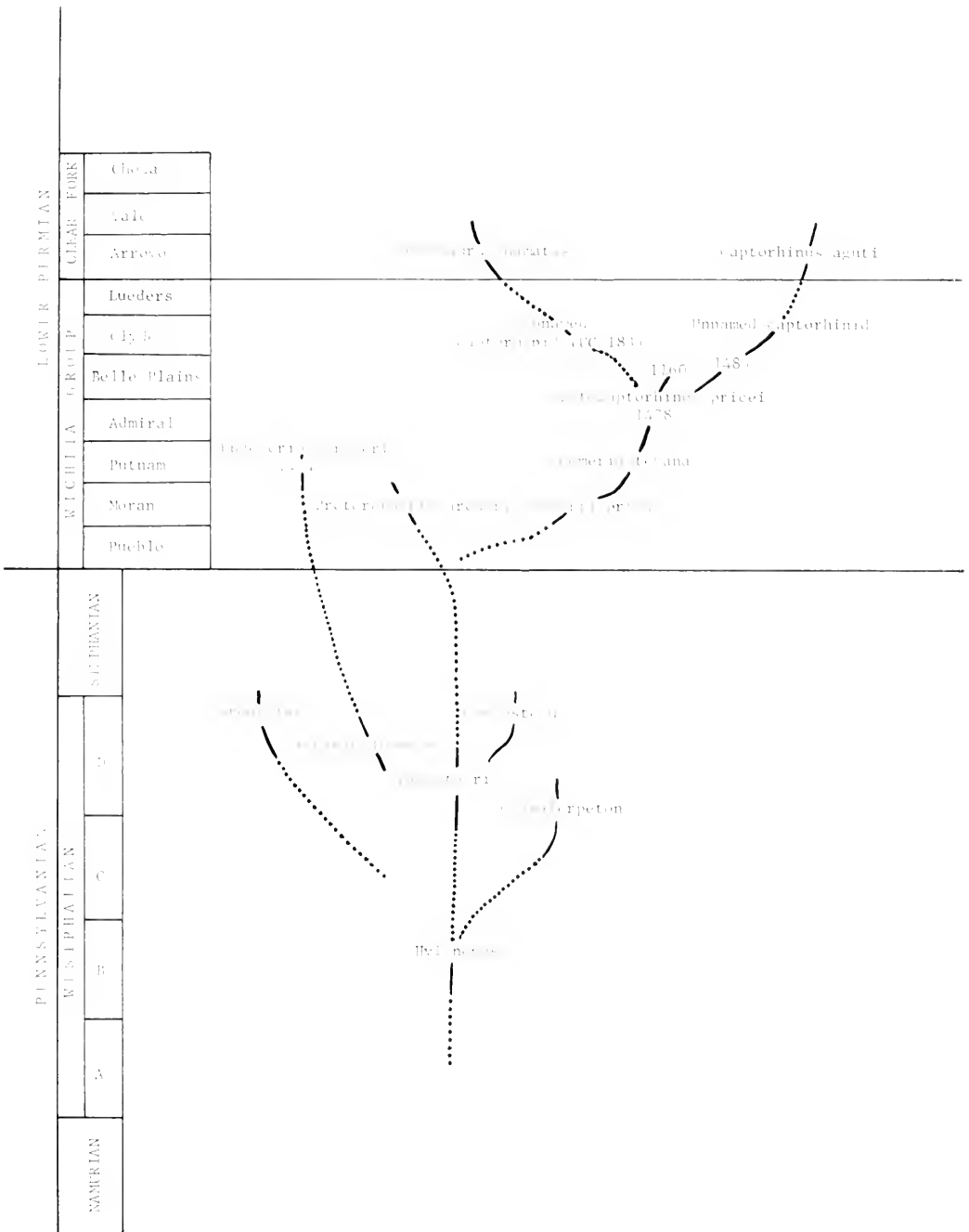

Figure 21. Phylogeny of romeriids. 1160, 1483, 1478, and 1474 are MCZ numbers.

division between the families Romeriidae and Captorhinidae. A second problem is the taxonomic status of the forms from the Belle Plains and Clyde Formations that resemble *Captorhinus aguti*, but have only a single row of marginal teeth.

The specimens from the Belle Plains and Clyde Formations that are intermediate between the romeriid *Protocaptorhinus pricei* and *Captorhinus aguti* should be differentiated taxonomically from both of these species as well as from *Labidosaurus* (see below). A formal definition should await more complete descriptive work than is possible in this paper. The specific name *laticeps* is available for this taxon since the type specimen of *Parioticus laticeps* (UC 642) is included within this group. Williston's original generic name is not appropriate, however, since it was originally applied to a gymarthrid microsauro (AMNH 432S, see Gregory, Peabody, and Price, 1956). The name *Captorhinus laticeps* might be used, but the morphological and developmental significance of the evolution of multiple tooth rows should probably be emphasized by establishing a generic distinction between these forms and *Captorhinus aguti*. Formal designation awaits further preparation of the presumptive type and other related forms.

This newly recognized genus, with the general appearance of *Captorhinus aguti* but only a single row of marginal teeth, can conveniently be included in the Captorhinidae since the expansion of the cheek region makes it separable from romeriids by casual examination. In Texas, the earliest known specimen in which the cheek region is expanded is MCZ 1483 (Fig. 18), from the Upper Belle Plains Formation. Although it is very poorly preserved and badly damaged by acid preparation, it illustrates the first occurrence of the family Captorhinidae in Texas. The posterior cheek

teeth are laterally compressed, like those of *Captorhinus aguti*, and the orbits are located at some distance anterior to the middle of the length of the skull. There is, however, but a single row of marginal teeth. They number approximately sixteen.

In Texas, at least, the romeriid-captorhinomorph transition appears to be represented by a single lineage, with little or no overlap in time. True romeriids give way to forms with a swollen cheek region but with only a single tooth row in the Upper Belle Plains, and these in turn are succeeded by typical *Captorhinus aguti* with multiple tooth rows by the Arroyo. In Oklahoma the succession is more complicated. According to Olson (1970) *Pleuristion*, here considered a romeriid, occurs in the Wellington Formation with a typical member of the species *Captorhinus aguti* having multiple tooth rows. This is the same formation from which Seltin (1959) described *Labidosaurus oklahomensis*, with an expanded cheek region but only a single row of marginal teeth. It is as if the entire Texas succession were telescoped into a single formation. The occurrence of these diverse forms in a single formation is demonstrated by the fossil record. The only question is the age of the occurrence. According to Seltin the Wellington is equivalent to the Arroyo or Vale Formation in Texas. If this estimate were correct, *Pleuristion* would be the last surviving romeriid. The captorhinid with a single tooth row would also be a relict, as is the similar form from the Fort Sill deposit. Olson, on the hand, suggests that the Wellington Formation is considerably older, equivalent to the Belle Plains of Texas. The occurrence of *Pleuristion* at this level is not surprising, nor is that of a captorhinid with a single tooth row. The presence of a form with multiple tooth rows is very surprising, however. It suggests that this feature developed some two

→

CAVIRIIDAE

ROMERIIDAE

			LUEDERS	
			Galpa limestone	
	1941-1942; 1944; 1945; 1946; 1947; 1948; 1949	X	Mitchell Creek and Vernon Cr. in	⑤
			CLYDE	
	IX-1944	X	S. Electro	⑧
	IX-1944	X	Weiss locality: The Lueders Lighthouse	⑦
			High Mountain limestone, Highburg	
	IX-1944	X	Trinity locality	⑥
			BELLE PLAINS	
	IX-1944	X	Northwest corner	⑤
	IX-1944	X	Highburg limestone with Highburg fauna	④
			ADMIRAL	
	IX-1944	X	Admiral locality: Highburg Archer City locality	③
	IX-1944	X	Admiral locality	②
			PUTNAM	
	All material referred to the Archer and Highburg localities	X	Putnam locality: Cottonwood Grove	①
			MORAN	
			East Colorado horizon	
	No romeriids		PUEBLO	
			Sadie Creek horizon	

formations earlier in Oklahoma than in Texas. This is possible, but it would be surprising that the more primitive forms survived so much longer in Texas, with so far no substantiated reports of *C. aguti* before the Arroyo.

Olson admits that the stratigraphic basis for assigning any particular age to the Wellington is still very weak. His faunal arguments for comparison with the earlier beds of Texas are reasonable, but are subject to other interpretations. The significance of the occurrence of these three captorhinomorphs in the Wellington Formation cannot be established until the age of the beds can be determined with greater accuracy.

Captorhinus aguti has also been reported from the Abo Formation in New Mexico (Seltin, 1959). The specimen on which this identification was based, UC 735, does not include the skull, however, and so there is no evidence for distinguishing it from a romeriid such as *Romeria* or *Protocaptorhinus*.

Whatever the evidence from Oklahoma, the evolutionary picture in Texas is quite clear. Through the transition to captorhinids, the romeriids dwindle in importance. In terms of both numbers and taxonomic diversity, romeriids are much less important than they were in the Pennsylvanian. With the development of a laterally expanded check region, the early captorhinids of the Clyde quickly became much more common, and in the Arroyo started to differentiate taxonomically. It would appear that some change had occurred that provided a great selective advantage for this group. Although the evidence is limited, there do not appear to be any fundamental modifications in the postcranial skeleton between *Protorothyris* and *Captorhinus*. Modification in the vertebral struc-

ture and limb proportion evidenced by *Protocaptorhinus* indicates that the *Captorhinus* pattern had been achieved within the romeriids. As with the earlier romeriid dichotomy in the lowermost Permian, the final phase in the romeriid-captorhinomorph transition is best explained by consideration of the jaw mechanism and dentition. A notable feature in all well-preserved and carefully prepared specimens of *Captorhinus aguti*, and the captorhinid jaws with a single tooth row from Fort Sill, is the severe wear of the teeth. The crowns are flattened and even chipped, apparently as the result of force from the occlusal surface. There is a variety of possible causes for the great amount of wear observed in these teeth. The animals may have been crushing hard-shelled molluscs, arthropods, or annelids; they may have eaten tough plant food; or eaten either plant or animal food dug from the ground and ingested with a great deal of soil grit. Whatever the food source or sources, it was apparently very plentiful to provide for the enormous number of individuals recorded from the Fort Sill locality. Judging from the proliferation of other captorhinid genera with multiple tooth rows, it would appear that the facility to have evolved extra crushing surfaces was of considerable survival value.

Interestingly enough, the success of the captorhinids was initiated (in Texas at least) prior to the development of the extra rows of teeth. A genus with a single row is already fairly common in the Clyde. The romeriid genera *Romeria* and *Protocaptorhinus* show a preadaptation for the development of multiple tooth rows as a result of changes in the lower jaws. Because of the mechanical disadvantages of holding and crushing prey near the anterior end of the jaws in this lineage, the mass of jaw

Figure 23. Geological map of North Central Texas showing geographic position of specimens described in this paper. Drafted from a map prepared by Dr. Romer. Relative stratigraphic positions of numbered localities shown in Figure 22. Hoppersville in Uppermost Pennsylvanian. Conspicuous "islands" in Pueblo, Moran, Putnam, and Admiral formations are outliers from overlying formations.

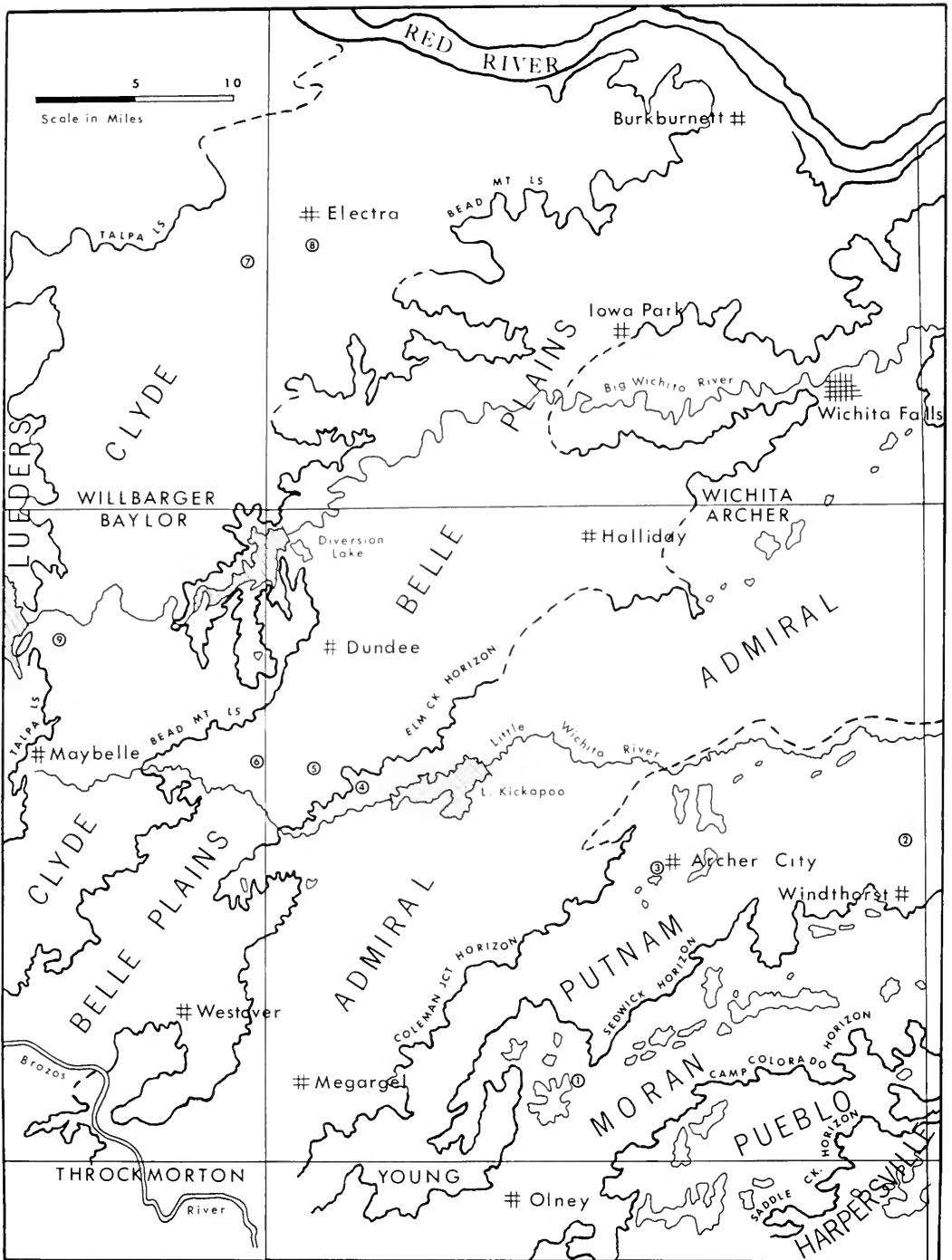

musculature must increase. This placed a selective advantage on widening the posterior portion of the jaw for the insertion of both the vertical adductor muscles and the pterygoideus.

Although we have no knowledge of the system of genetic control, it is quite possible that selection, acting to increase the width of the posterior portion of the jaw, would also lead to an increase in the width of the tooth-bearing area. As this occurred, it would be possible for more than one generation of teeth to be functional at one time. On the assumption that there had already been a dietary shift in the immediate ancestors of *Captorhinus aguti* that led to rapid wear of the teeth, any disruption of the developmental pattern that led to the premature eruption of replacement teeth would have a selective advantage. Because of the initially greater width of the dentary, this feature would be expected to appear first in the lower jaw, and later be manifest in the maxilla. A great deal more study is necessary before the exact pattern of tooth replacement and its relationship to the expression of the tooth rows in *Captorhinus aguti* are determined. This is certainly possible from the wealth of material available from the Fort Sill fissure deposit. It is evident from a casual examination of this material that all teeth are continuously replaced, with gaps in the tooth pattern approximately as common as in romeriids, and that all tooth positions can show extensive wear. The functional pattern remains essentially unchanged from very small to very large specimens.

The phylogenetic position of *Labidosaurus* must also be evaluated in order to define the Captorhinidae. Like *Captorhinus*, the definitive form of this genus is from the Lower Clear Fork. The type species, *L. hamatus*, was described by Cope (1896) from the Arroyo Formation. The skulls of the type species are commonly approximately twice the size of those of *Captorhinus aguti* (see Seltin, 1959: 502), have an even more conspicuously expanded

cheek region and a down-turned premaxilla, but only a single row of marginal teeth. The jugal apparently does not extend medially to reach the pterygoid. The similarities in the morphology of the individual teeth and the pattern of the skull roof are adequate to unite this genus in the same family as *Captorhinus*, despite the difference in the dental pattern. It is generally assumed that the two genera have a common ancestor, already specialized above the level of typical romeriids.

The situation has been confused taxonomically by the extension of the term *Labidosaurus* to forms with a skull size and shape similar to *Captorhinus aguti*, but with only a single tooth row, e.g., *Labidosaurus oklahomensis*, described by Seltin (1959) from the Wellington Formation, and numerous *Captorhinus*-sized jaws from Fort Sill, Oklahoma, generally considered equivalent in age to the Arroyo of Texas. Seltin suggested that *L. oklahomensis* was a morphological intermediate between *Captorhinus aguti* and *Labidosaurus hamatus*, and structurally antecedent to the former, although he cited the Wellington Formation as equivalent to the Arroyo or even Vale. The term *Labidosaurus* has hence come to be applied to two or possibly three different categories: both large and small forms from the Arroyo or later formations and small forms hypothesized to have existed in earlier formations that were true antecedents of *Captorhinus aguti*. In order to define more clearly the taxonomic boundary between romeriids and captorhinids, it is necessary to separate these different usages of the term *Labidosaurus*. Re-examination of the large Arroyo forms makes it evident that they can be readily segregated from any *Captorhinus*-sized species. In particular, the great increase in the width of the back of the skull has necessitated a complete reorganization in the manner of support for the braincase. The braincase is, relatively, much smaller in *Labidosaurus hamatus*. The paroccipital process does not extend to the middle of the squamosal, but rather is supported by

the posterolateral margin of the parietal (see Case, 1911, plate 12, fig. 2). The par-occipital process and the stapes both have very much longer stems than is the case in *Captorhinus*. Since these features are primarily an adjustment to the greater size of this particular species, it is clear that it would not occur in smaller forms. The increase in size, together with the necessary adjustment of the braincase, seems sufficient to separate *Labidosaurus hamatus* generically from currently known animals the size of all known specimens of *Captorhinus aguti*.

The necessity of differentiating between the ancestors of *Captorhinus aguti* and *Labidosaurus hamatus* is emphasized by the anatomy of an additional specimen from the Clyde Formation. With one exception, all the specimens that have been assigned to *Labidosaurus hamatus* have come from the Arroyo Formation. One skull, attributed to this species by Seltin, CNHM-UC 183, comes from the earlier Clyde Formation of Mitchell Creek, Texas. This skull (Plate 1) is smaller than those of most described specimens of *Labidosaurus hamatus*, but far larger than any described for *Captorhinus aguti*. Its general anatomy suggests that it is a reasonable antecedent for the Arroyo specimens of *Labidosaurus hamatus*, although it differs in several respects.

This skull has a single tooth row, with four premaxillary teeth and twenty in the maxilla, the sixth of which is considerably larger. The posterior cheek teeth are not laterally compressed, but show considerable wear. Detailed comparison with *Labidosaurus hamatus* would require extensive preparation and description of that species that is beyond the scope of this work. Some general features can be noted, however, based on the published descriptions and CNHM-UR 161, illustrated by Seltin (1959). The tooth count and position of the "canine" are identical. The distance between the orbits is relatively greater in the more primitive skull; the snout is considerably

less acuminate anteriorly. The cheek region may be somewhat expanded, but not as much as in the Clyde specimens that resemble *Captorhinus aguti*. The cheek and skull table meet at a sharp angle. The configuration and nature of support for the braincase appear like that of advanced romeriids, rather than having the peculiarities of *Labidosaurus hamatus*. The skull roof is notably shorter than the posterior margin of the cheek. Except for this last feature, these characteristics resemble those of *Protocaptorhinus pricei*. The relatively narrow cheek region, noncompression of the posterior cheek teeth, and absence of a medial extension of the jugal suggest that this specimen evolved directly from romeriids such as *Protocaptorhinus*, possibly in the late Admiral or during the Belle Plains, rather than from the immediate ancestor of *Captorhinus aguti*. This specimen may reasonably be placed in a species distinct from *Labidosaurus hamatus*, but formal description must await further work on that species.

The establishment of an almost continuous sequence between romeriids and captorhinids complicates the definition of both groups. Since both names are widely used in the literature and encompass the approximate bounds of two distinct patterns of morphological and taxonomic diversification, it is of obvious advantage to retain the accepted usage as closely as possible. Phylogenetically, the most practical point of division would be at the dichotomy between the typical romeriids, such as *Paleothyris* and *Protorothyris* that have a straight tooth row, and the Lower Permian genera that have evolved a hooked premaxilla. The two lineages are readily separable morphologically and presumably had adapted to different manners of feeding. This point of division has, however, the lamentable taxonomic implication of removing the type genus from the family Romeriidae. Since the name Romeriidae has long been associated with the phylogenetically most important family of Paleozoic reptiles and also

honours one of this century's greatest contributors to vertebrate paleontology, an alternative point of separation should be considered. In order to include the common ancestors of both *Captorhinus aguti* and *Labidosaurus hamatus* within the Captorhinidae, the division must be made below the Clyde. On the basis of the presently available material it is fairly easy to differentiate the romeriid *Protocaptorhinus pricei* from the ancestors of *Captorhinus* by the configuration of the cheek region and from the ancestors of *Labidosaurus* on the basis of size. From an evolutionary standpoint this is a logical point of division, since the taxonomic diversification and numerical success of the Captorhinidae both occur subsequent to this division.

RELATIONSHIPS OF ROMERIIDS WITH OTHER REPTILES

Although much of this paper has been devoted to the close relationship between a particular group of Lower Permian romeriids and the family Captorhinidae, the additional information on romeriids provides a basis for discussing the origin of other reptilian groups as well. During the past ten years, all of the specimens that might be included in the Family Romeriidae have been studied. Two or three incomplete specimens from the Lower Permian of Texas remain to be described, but they do not substantially alter the picture provided by the descriptions already published.

Of all known groups of Paleozoic reptiles only romeriids are sufficiently generalized to be ancestral to any of the subsequent lineages. All of the members of this family that have been described conform to a single, basic morphological pattern, showing progressive modification of a series of skeletal features, but within rather narrow limits. On the assumption that the known record is representative of the total differentiation of the family, it is possible to specify both the time and particular phylogenetic position of the derivation of a

large proportion of the advanced reptilian orders. The position of several groups has been discussed in previous papers (Carroll, 1969a; Carroll and Gaskill, 1971; Carroll and Baird, 1972), primarily on the basis of the Pennsylvanian romeriids. The progressive evolution of all known members of the family in the Lower Permian places an apparent upper limit on the derivation of some groups whose earliest known appearance might otherwise have allowed derivation in the earliest Permian.

Pelycosaurus. On the basis of both their early appearance and generalized morphology, pelycosaurids have long been accepted as diverging from the main reptilian stock at a very early stage. Evidence of pelycosaurids from the Westphalian B of Joggins, Nova Scotia (Carroll, 1964), and the Westphalian D of Florence, Nova Scotia (Reisz, 1972), emphasizes the close relationship of pelycosaurids and romeriids and indicates that the two groups diverged from one another shortly before the appearance of the earliest member of either lineage in the Lower Pennsylvanian. The definition of the family Romeriidae could easily be extended to include the earliest Pennsylvanian and/or the latest Mississippian forms that were ancestral to both known romeriids and pelycosaurids. Such forms would, in fact, be barely distinguishable from *Hylonomus lyelli*.

Mesosaurus. The mesosaurids are also certainly direct romeriid derivatives. Members of this group are known only from the Pennsylvanian-Permian boundary, by which time they are already highly specialized in their cranial anatomy. Their postcranial skeleton is less specialized and suggests derivation from romeriids at about the level of development exemplified by *Paleothyris* in the Westphalian D.

Aclisterhinus, *Batropetes*, *Bolosaurus*, and *Eunosaurus*. Although many details of the anatomy of the genera *Aclisterhinus* (Daly, 1969), *Batropetes* (Carroll and Gaskill, 1971), and *Bolosaurus* (Watson, 1954; Carroll and Gaskill, 1971) remain to be

studied and their interrelationships are not firmly established, these forms have a number of peculiarities in common. All may have evolved from rather primitive romeriids in the early Pennsylvanian or from one or more persistently primitive lineages in the middle or late Pennsylvanian. The primitive expression of a single pair of sacral ribs and the reduced number of vertebrae make *Eunotosaurus* a possible member of this ill-defined assemblage. As emphasized by Cox (1969), it is clearly a derivative of the primitive captorhinomorph assemblage.

Araeoscelidae. The Araeoscelidae (Vaughn, 1955), known from the North American genus *Araeoscelis* and the European *Kadalisaurus*, resemble most closely *Paleothyris* among known romeriids and presumably evolved from forms of approximately that level of development, in the middle part of the Pennsylvanian.

Lepidosaur. The ancestry of the lepidosaurs can be closely associated with the romeriids. Watson (1957) made a very plausible case for accepting the millerosaurs as ancestors for the typical eosuchians, including younginids and prolacertids, themselves ancestral to the living lepidosaur orders. Although Watson suggested that the millerosaurs had evolved from a group other than the captorhinomorphs, Parrington (1958) demonstrated the overwhelming similarities between millerosaurs, romeriids, and pelycosaurs. The known millerosaurs are all from the middle and late Permian and suggest that both the lateral and dorsal temporal openings appeared fairly late in the evolution of this group. Both the skull and the posterianal anatomy of the millerosaurs indicate derivation from romeriids in the middle to late Pennsylvanian, prior to the evolution of the cranial specialization seen in *Coelostegus*, *Protorothyris*, or the *Romeria-Captorhinus* lineage. The skull is noticeably small relative to the length of the trunk region. The tabular remains large and the paroccipital process does not extend to the squamosal.

An alternate ancestry for the typical eosuchians was suggested by Peabody (1952) in his description of *Petrolacosaurus* from the Upper Pennsylvanian of Kansas. He claimed that this animal had two temporal openings and so was ancestral to later diapsids, despite the primitive nature of the remainder of the skeleton. The presence of two temporal openings has been disputed by other workers and Stovall *et al.* (1966) suggested that this genus was an edaphosaur pelycosaur. Additional material of *Petrolacosaurus*, discovered by Peabody and Eaton, is currently being studied by Eaton and Reisz. These specimens show that there are indeed two temporal openings. The remainder of the cranial anatomy resembles that of primitive romeriids, while the girdles and limbs bear marked resemblance to those of the araeoscelids. The region of the quadrate and otic capsule are not well preserved, but there is no compelling evidence of the tympanum being supported by the quadrate in the manner of both millerosaurs and typical eosuchians.

Whether advanced lepidosaurs evolved from millerosaurs or from *Petrolacosaurus* or some other, as yet undetermined, intermediate forms, their ultimate derivation evidently lies with Middle Pennsylvanian romeriids such as *Paleothyris*.

Archosaurs. Our current knowledge of the romeriids adds little to our understanding of the ancestry of archosaurs. The earliest known members of that group, from the uppermost Permian, are already far advanced in most aspects of their skeletal anatomy from the primitive reptilian pattern. Clearly, the ancestors of these forms originally arose from romeriids, but whether via primitive eosuchians (Watson, 1957), varanopsid pelycosaurs (Reig, 1970), or some group as yet unreported (Romer, 1967), cannot be determined. Among romeriids, the greatest similarity to archosaurs is found in *Protorothyris*. This is mainly due to the large size of the skull and the large skull to trunk ratio. Although

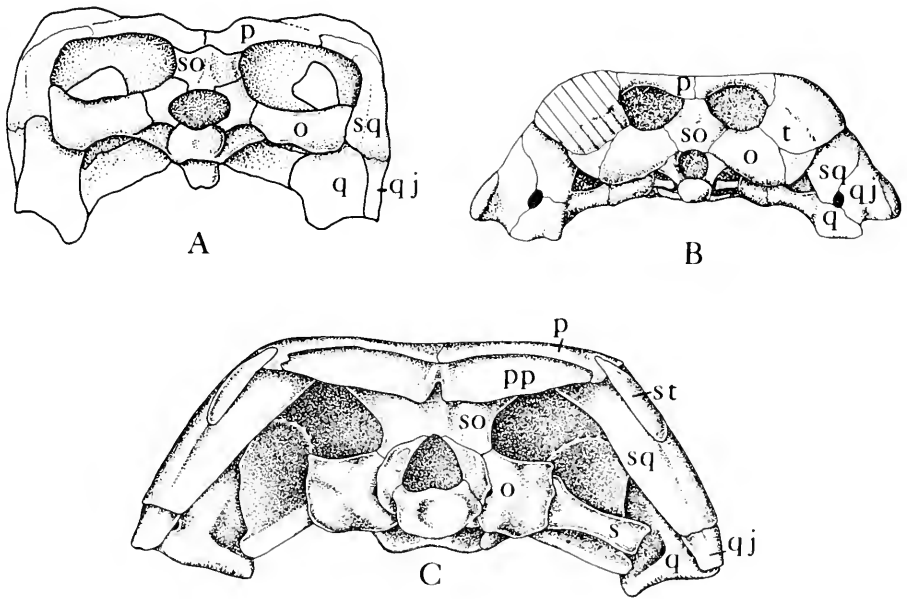

Figure 24. A, occiput of the Triassic turtle, *Proganochelys*, sketch based on photographs in Parsons and Williams (1961). B, occiput of *Procolophon*. C, occiput of *Protocaptorhinus pricei*.

this genus might be slightly closer to archosaurs than are other known romeriids, the similarities are not even close enough to differentiate between romeriids and pelycosaurs as potential archosaur ancestors. At present it does not seem appropriate to specify romeriids as any more than the *ultimate* ancestors of archosaurs.

Chelonian ancestry. The ancestry of turtles remains one of the greatest unsolved problems in reptilian phylogeny. Since they lack lateral or dorsal temporal openings, it can be safely assumed that they did not evolve from any of the advanced reptilian groups with synapsid, diapsid or parapsid skull configurations. If phylogenetically reptilian, they could have evolved only from primitive anapsid forms. Although no real intermediate forms are known, relationship with various "cotylosaurs" has been suggested: pareiasaurs (Gregory, 1946); diadectids (Olson, 1947); and procolophonoids (Romer, 1964 and 1966). The interrelationship of these groups and their phylogenetic position relative to other

primitive reptiles is subject to continuing dispute. None seem to have evolved from romeriids as such. If turtles had evolved from any of these groups, they would be only distantly related to the remaining reptilian subclasses, all of which may be reasonably traced to the romeriids.

In working with *Protocaptorhinus* and *Captorhinus*, one is struck by the similarities in the occiput to the primitive chelonian *Proganochelys* (Fig. 24). In both the captorhinomorphs and the turtle there are large posttemporal fossae, separated by a narrow supraoccipital. The paroccipital processes extend laterally toward the squamosal and are braced against this bone in *Captorhinus*. The tabular is missing.

The significance of the occipital structure is apparent if one considers the nature of the jaw musculature in turtles. As Gaffney (1971) has emphasized, the specialized jaw musculature in turtles is nearly as significant as the armor in differentiating this group from other reptiles. The main adductor muscle extends posteriorly from the

normal reptilian subtemporal fossa over the otic capsule (or a special process of the pterygoid in pleurodires) in the fashion of a pulley, and inserts on the supraoccipital. In both groups of turtles and their common ancestor, a strong union between the paroccipital process and the cheek region is necessary. This is already established in *Proganochelys*. This relationship between the paroccipital process and the cheek region is also developed in both lepidosaurs and archosaurs, in association with the development of an otic notch in the quadrate and the establishment of temporal openings. The only anapsid groups in which there are large posttemporal fossae above the paroccipital process are the advanced romeriids and captorhinids.

Pareiasaurs and procolophonoids seem particularly inappropriate ancestors for turtles because they have a totally different configuration of the occiput. Comparison of procolophonoids with both *Proganochelys* and early captorhinomorphs is relatively simple since they are of similar size (Fig. 24). The paroccipital processes of the braincase in procolophonoids are directed dorsolaterally toward the *tabulars*, as in anthracosaurs and the primitive genus *Limnoscelis* (Carroll, 1970). In the well known primitive genus *Procolophon*, the attachment of the braincase to the skull roof is loose, and the two are easily separated. The quadrate ramus of the pterygoid retains a primitive configuration, effectively separating the jaw musculature from the occipital surface. The main adductor musculature is essentially vertical in orientation and the posterior margin of the orbit is emarginated in order to provide a larger area for its expansion.

Although *Procolophon* is not the most primitive of procolophonoids, the primitive features of the jaw musculature that it exhibits would effectively bar both it and its immediate ancestors from giving rise to turtles. Consideration of pareiasaurs is difficult because of the great size and corresponding modification of the skull in all the

described genera. As in procolophonoids, the jaw musculature is effectively separated from the occipital surface by the quadrate ramus of the pterygoid and the quadrate itself. The paroccipital processes are oriented dorsolaterally, effectively preventing their attachment to the squamosal or the development of large posttemporal fossae.

It is certainly more difficult to envision the development of chelonian jaw musculature from pareiasaurs, procolophonoids, or their immediate ancestors than from advanced romeriids. Such a derivation for turtles has the aesthetic advantage of relating them to the main stream of reptilian evolution, although at a much later point of derivation than has typically been assumed.

One can argue that many of the factors involved in the origin of the chelonian jaw musculature are comparable with the changes that occurred in the origin of *Captorhinus* from romeriids. In both cases some factor in the relative abundance or nature of the food supply placed a premium on the development of a greater amount of, and more efficient use of, the jaw musculature. From a basic romeriid skull configuration, the cross-sectional area of the subtemporal fossa has increased, resulting in a lateral expansion of the cheek region. Some time between the Lower Permian and the Upper Triassic the jaw musculature of the ancestors of turtles expanded medially and posteriorly over the quadrate ramus of the pterygoid and took origin on the margins of the posttemporal fossae—on the upper surface of the paroccipital process and the lateral face of the supraoccipital. This is easily conceived from an advanced romeriid or a primitive captorhinid pattern.

The relatively short cheek region in *Proganochelys* and presumably its ancestors would have placed a premium on the evolution of some compensatory change in the jaw musculature. The posterior prolongation of the squamosal and supraoccipital would have provided for an even larger amount of jaw musculature than

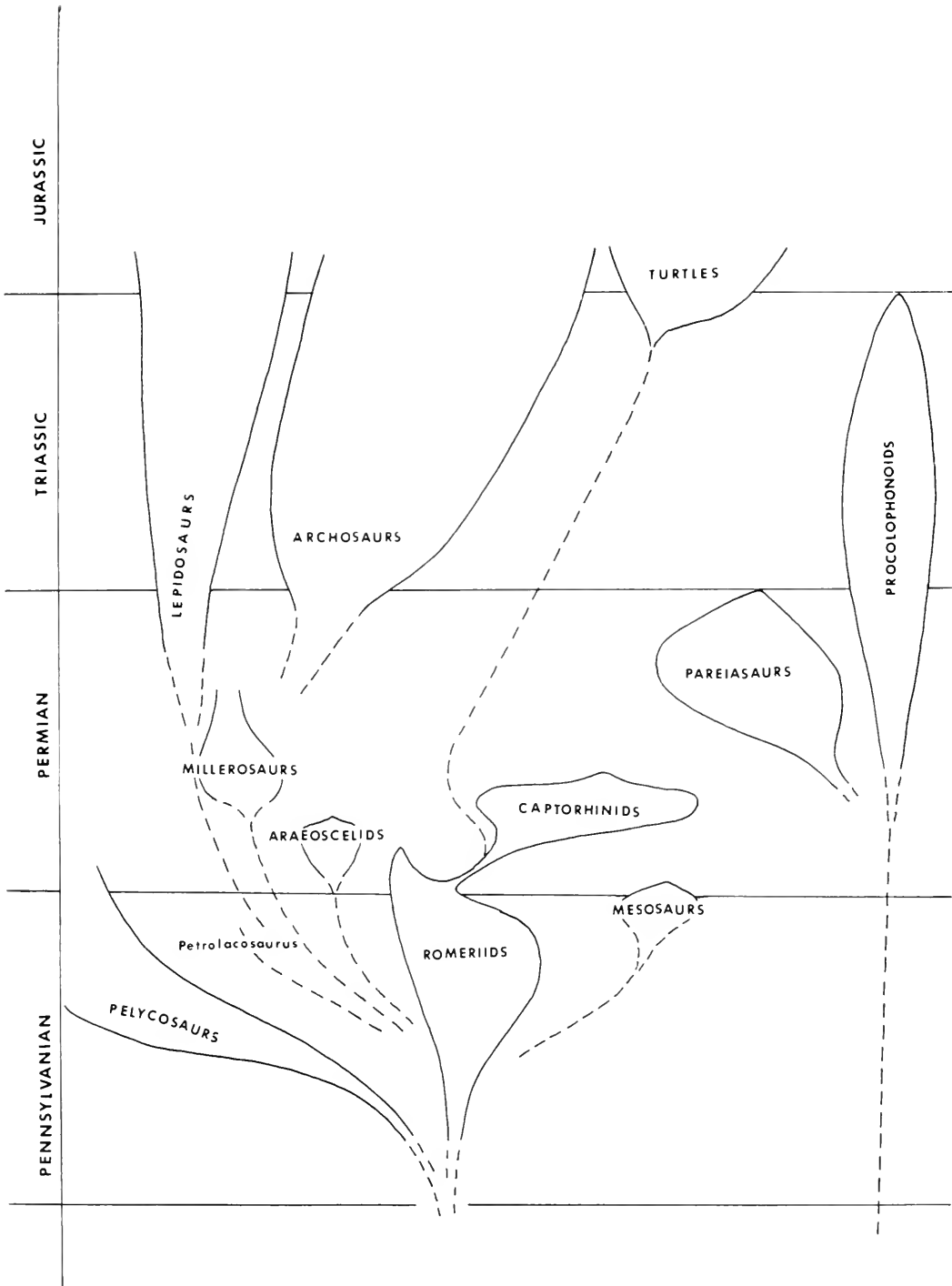

Figure 25. Phylogeny of romeriid descendants.

could be present in a captorhinomorph with a much longer cheek region. Presumably the otic notch, little developed in *Proganocheilus*, evolved secondarily beneath this process.

Ichthyopterygia and Euryapsida. Unfortunately, elucidation of the anatomy of the Lower Permian romeriids casts little light on the origin of the specialized aquatic reptilian subclasses Ichthyopterygia and Euryapsida. We would prefer to accept Romer's (1971) assumption that they share a common ancestry with other reptilian subclasses, rather than Kuhn-Schnyder's (1967) suggestion of multiple, separate origins from amphibians, but an obvious point of departure of any of these forms from the romeriids cannot yet be established.

Procolophonoids and pareiasaurs. Further groups that are usually considered to be among the reptiles should be discussed in connection with the romeriids. Despite the apparently primitively anapsid condition shared by procolophonoids and pareiasaurs, neither group can be readily derived from any romeriids. Although restricted to the Middle and Upper Permian, all known pareiasaurs are large, highly specialized animals. The specializations of the skull, in association with their large size, preclude simple comparison with any of the groups of small, primitive reptiles. It is generally accepted that they are most closely related to the procolophonoids, but the similarities are primarily confined to the common absence of temporal openings and the presence of other strictly primitive features. The dorsolateral orientation of the opisthotic, common to the pareiasaurs, may, as in *Labidosaurus hamatus*, be a result of the great lateral extent of the cheek region and may not be a primitive trait. If so, this eliminates one of the few bases of comparison with procolophonoids, without providing any evidence of other possible relationships.

Because of their small size, procolophonoids are more readily compared with romeriids. As was mentioned recently in a

separate paper (Carroll and Gaskill, 1971), the configuration of the occipital region in procolophonoids is distinctly more primitive than is that of romeriids or their immediate derivatives. In this characteristic they more closely resemble *Limnoscelis* and the anthracosaurian ancestors of romeriids. Unless it can be shown that the procolophonoid condition can be derived from that observed in the romeriids, it must be assumed that the two groups have a separate ancestry, prior to the appearance of the earliest known romeriids. The highly specialized nature of the pareiasaurs make it more difficult to preclude the possibility of romeriid ancestry, but at present it cannot be established.

LITERATURE CITED

- CARROLL, R. L. 1964. The earliest reptiles. *Jour. Linnean Soc. (Zool.)*, **45**: 61-83.
- . 1969a. A Middle Pennsylvanian captorhinomorph, and the interrelationships of primitive reptiles. *Jour. Paleontology*, **43**: 151-170.
- . 1969b. Problems of the origin of reptiles. *Biol. Rev.*, **44**: 393-432.
- . 1970. Quantitative aspects of the amphibian-reptilian transition. *Forma et Functio*, **3**: 165-178.
- , AND D. BAIRD. 1972. Carboniferous stem reptiles of the Family Romeriidae. *Bull. Mus. Comp. Zool.*, **143**(5): 321-364.
- , AND P. GASKILL. 1971. A captorhinomorph reptile from the Lower Permian of Europe. *Jour. Paleontology*, **45**: 450-463.
- CASE, E. C. 1911. A revision of the Cotylosauria of North America. *Publ. Carn. Inst. Wash.*, No. 145: 1-122.
- COPE, E. D. 1896. The reptilian order Cotylosauria. *Proc. Am. Phil. Soc.*, XXXIV: 436-456.
- COX, C. B. 1969. The problematic Permian reptile *Eunotosaurus*. *Bull. Geol. Brit. Mus. Nat. Hist.*, **18**: 167-198.
- DALY, E. 1969. A new procolophonoid reptile from the Lower Permian of Oklahoma. *Jour. Paleontology*, **43**: 676-687.
- FOX, R. C., AND M. C. BOWMAN. 1966. Osteology and relationships of *Captorhinus aguti* (Cope) (Reptilia: Captorhinomorpha). *Paleont. Contr. Univ. Kansas. Vertebrata*, Art. 11: 1-79.
- GAFFNEY, E. 1971. Chelonia. *In* McGraw-Hill Yearbook of Science and Technology. New York: McGraw-Hill, Inc., pp. 140-142.

- GREGORY, J. T., F. E. PEABODY, AND L. I. PRICE. 1956. Revision of the Gymnarthridae, American Permian microsaur. Bull. Peabody Mus., **10**: 1-77.
- GREGORY, W. K. 1946. Pareiasaurs versus placodonts as near ancestors to the turtles. Bull. Am. Mus. Nat. Hist., **86**: 279-326.
- KUHN-SCHNYDER, E. 1967. Das Problem der Euryapsida. Problèmes actuels de Paléontologie, Paris, No. 163: 335-348.
- OLSON, E. C. 1947. The family Diadectidae and its bearing on the classification of reptiles. Fieldiana, Geol., **11**: 1-53.
- . 1970. New and little known genera and species of vertebrates from the Lower Permian of Oklahoma. Fieldiana, Geol., **18**: 359-434.
- PARSONS, T. S., AND E. E. WILLIAMS. 1961. Two Jurassic turtle skulls: a morphological study. Bull. Mus. Comp. Zool., **125**: 43-107.
- PARRINGTON, F. R. 1958. The problem of the classification of reptiles. Jour. Linnæan Soc. (Zool.), **44**: 99-115.
- . 1959. A note on the Labyrinthodont middle ear. Ann. Mag. Nat. Hist., ser. 13, **2**: 24-28.
- PEABODY, F. E. 1952. *Petrolacosaurus kansensis* Lane, a Pennsylvanian reptile from Kansas. Paleont. Contr. Univ. Kansas, Vertebrata, Art. 1: 1-41.
- PRICE, L. I. 1935. Notes on the braincase of *Captorhinus*. Proc. Boston Soc. Nat. Hist., **40**: 377-386.
- . 1937. Two new cotylosaurs from the Permian of Texas. Proc. New England Zool. Club, **16**: 97-102.
- REIG, O. A. 1970. The Proterosuchia and the early evolution of the archosaurs: an essay about the origin of a major taxon. Bull. Mus. Comp. Zool., **139**: 229-292.
- REISZ, R. 1972. Pelycosaurian reptiles from the Middle Pennsylvanian of North America. Bull. Mus. Comp. Zool., **144**: 27-62.
- ROMER, A. S. 1952. Late Pennsylvanian and early Permian vertebrates of the Pittsburgh-West Virginia region. Ann. Carn. Mus., **33**, Art. 2: 47-110.
- . 1956. Osteology of the Reptiles. Chicago: Chicago Univ. Press, xxi + 772 pp., 248 text-figs.
- . 1964. *Diadectes*, an amphibian. Copeia, No. 4: 718-719.
- . 1966. Vertebrate Paleontology. v + 468 pp., 443 text-figs.
- . 1967. Early reptilian evolution reviewed. Evolution, **21**: 821-833.
- . 1971. Unorthodoxies in Reptilian phylogeny. Evolution, **25**: 103-112.
- SELFIN, R. J. 1959. A review of the Family Captorhinidae. Fieldiana, Geol., **10**: 461-509.
- STOVALL, J. W., L. I. PRICE, AND A. S. ROMER. 1966. The postcranial skeleton of the giant Permian pelycosaur *Cotylorhynchus romeri*. Bull. Mus. Comp. Zool., **135**: 1-30.
- TAOUCET, P. 1969. Première découverte en Afrique d'un Reptile Captorhinomorphe (*Cotylosaurien*). C.R. Acad. Sc. Paris, **268**: 779-781.
- VAUGHN, P. P. 1955. The Permian Reptile *Aracoseclis* restudied. Bull. Mus. Comp. Zool., **113**: 305-467.
- . 1970. Alternation of neural spine height in certain early Permian tetrapods. Bull. Southern Cal. Acad. Sci., **69**: 80-86.
- WATSON, D. M. S. 1954. On *Bolosaurus* and the origin and classification of reptiles. Bull. Mus. Comp. Zool., **111**: 297-449.
- . 1957. On *Millerosaurus* and the early history of the sauropsid reptiles. Roy. Soc. London, Phil. Trans. (B.), **240**: 325-400.

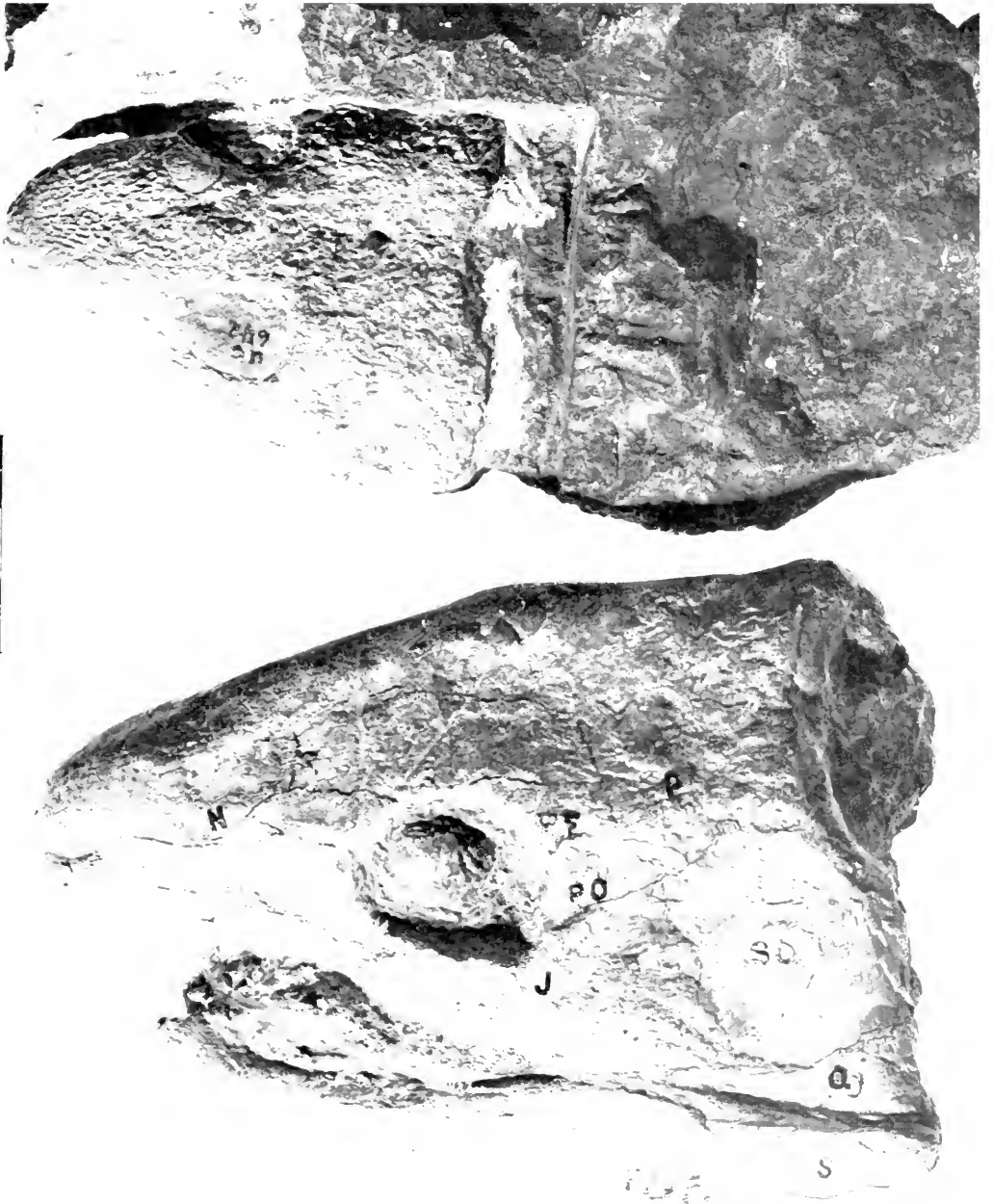

Plate I. Captorhinids from the Clyde Formation. Above, type of *Pariaticus laticeps* Williston, UC 642. Below, a possible antecedent of *Labidosaurus hamatus*, UC 183. Both $\times 1$.

Bulletin of the
Museum of
Comparative
Zoology

Beutlieni Cephalopods from the Tithonian
Upper Permian, Northwest Iran

CURT TEichert AND FERDINAND KUMMER

PUBLICATIONS ISSUED
OR DISTRIBUTED BY THE
MUSEUM OF COMPARATIVE ZOOLOGY
HARVARD UNIVERSITY

BULLETIN 1863-
BREVIOIRA 1952-
MEMOIRS 1864-1938
JOHNSONIA, Department of Mollusks, 1941-
OCCASIONAL PAPERS ON MOLLUSKS, 1945-

Other Publications.

- Bigelow, H. B., and W. C. Schroeder, 1953. Fishes of the Gulf of Maine.
Brues, C. T., A. L. Melander, and F. M. Carpenter, 1954. Classification of
Insects.
Creighton, W. S., 1950. The Ants of North America.
Lyman, C. P., and A. R. Dawe (eds.), 1960. Symposium on Natural Mam-
malian Hibernation.
Peters' Check-list of Birds of the World, vols. 2-7, 9, 10, 12-15.
Turner, R. D., 1966. A Survey and Illustrated Catalogue of the Teredinidae
(Mollusca: Bivalvia).
Whittington, H. B., and W. D. I. Rolfe (eds.), 1963. Phylogeny and Evolution
of Crustacea.
Proceedings of the New England Zoological Club 1899-1948. (Complete sets
only.)
Publications of the Boston Society of Natural History.

Authors preparing manuscripts for the *Bulletin of the Museum of Comparative Zoology* or *Breviiora* should send for the current Information and Instruction Sheet, available from Editor, Publications Office, Museum of Comparative Zoology, Harvard University, Cambridge, Massachusetts 02138, U.S.A.

NAUTILOID CEPHALOPODS FROM THE JULFA BEDS, UPPER PERMIAN, NORTHWEST IRAN

CURT TEICHERT¹ AND BERNHARD KUMMEL²

ABSTRACT. Seventeen species of nautiloid cephalopods, from the Upper Permian Julfa Beds of northwestern Iran are described and discussed. They belong to twelve genera. Eight of the species are assigned to, or compared with, previously described species; the remainder is left unnamed. This appears to be one of the richest nautiloid faunas known from beds of very Late Permian age.

INTRODUCTION

Nautiloids of Late Permian age are extremely uncommon. In connection with our study of the Ali Bashi Formation³ at Kuh-e-Ali Bashi near Julfa, northwestern Iran (Teichert, Kummel, and Sweet, in press; Kummel and Teichert, 1971, and in press), we were able to collect a fairly large fauna of nautiloids from the underlying Julfa Beds. This report is a description and discussion of this fauna.

We wish to acknowledge assistance received from Victoria Kohler, at Harvard University, and William L. Fisher, at the University of Kansas. The material was collected in 1968, during field work supported by National Science Foundation Grant GA-996.

PREVIOUS WORK

The first record of nautiloids from the Late Permian of the Transcaucasus was by

Abich (1878), who described the following species from the Araks (Araxes) Gorge west of Soviet Dzhulfa (the modern generic assignment is placed in parentheses):

Nautilus excentricus Eichwald
(*Permonutilus*)

Nautilus propinquus Abich
(*Liroceras*)

Nautilus parallelus Abich
(*Domatoceras*)

Nautilus convergens Abich
(*Stenopoceras*)

Nautilus concavus Sowerby
(*Liroceras*)

Nautilus dolerius Abich
(*Domatoceras*)

Nautilus dorsoarmatus Abich
(*Metacoceras*)

Nautilus pichleri v. Hauer
(*Pleuronautilus*)

Nautilus incertus Abich
(*Pleuronautilus*)

Nautilus tubercularis Abich
(*Pleuronautilus*)

Nautilus dorsoplicatus Abich
(*Tainoceras*)

Nautilus armeniacus Abich
(*Pseudotitanoceras*)

Nautilus cornutus Golovinski
(*Permonutilus*)

Orthoceras annulatum Sowerby
(?*Neocycloceras*)

Orthoceras cribrosum Geinitz
(?)

¹ University of Kansas.

² Harvard University.

³ This formation is being described by Teichert, Kummel, and Sweet (in press). It corresponds essentially to the "Transition beds" plus "*Paratirolites* beds" of Stepanov *et al.* (1969).

Orthoceras transversum Abich
(?)
Orthoceras bicinctum Abich
(?)
Orthoceras margaritatum Abich
(? *Neocycloceras*)
Orthoceras turritellum Abich
(?)

Regardless of whether or not the species are narrowly defined, for a late Paleozoic fauna this an impressively diverse list. In a restudy of the Soviet Dzhulfian fauna Arthaber (*in* Frech and Arthaber, 1900) introduced only one new species, namely, *Pleuro-nautilus verae* Arthaber. Even the review of the stratigraphy and paleontology of these beds by Stoyanow (1910) resulted in only two new species of nautiloids—*Orthoceras lopingense* Stoyanow and *Nautilus hunicus* Diener. In fact these are the only nautiloids described by Stoyanow in that report.

In the comprehensive monograph on the Permo-Triassic formations of Soviet Dzhulfa, edited by V. E. Ruzhentsev and T. G. Sarycheva (1965), the nautiloids were studied by Shimanskiy, who recognized the following species from the *Araxoceras* and *Vedioceras* beds:

***Tainoceras dorsoplicatum* (Abich)
***Metacoceras dorsoarmatum* (Abich)
Metacoceras sp. 1 (ex. gr. *dorsoarmatum* Abich)
***Pseudotemnocheilus* sp.
***Foordiceras* sp. 1
***Foordiceras* cf. *grypocerooides* (Reed)
***Foordiceras* cf. *flemingianum* (Koninck)
***Tirolonutilus* sp.
**? *Hexagonites* sp.
***Pleuronautilus incertus* (Abich)
Pleuronautilus cf. *incertus* (Abich)
Pleuronautilus verae (Arthaber)
***Pleuronautilus tubercularis* (Abich)
**Pleuronautilus dzhulfensis* Shimanskiy
**Pleuronautilus costalis* Shimanskiy
Pleuronautilus sp.
**? *Phaedrysmocheilus* sp.
***Domatoceras convergens* (Abich)

**Domatoceras atypicum* Shimanskiy
***Domatoceras hunicum* (Diener)
**Domatoceras gracile* Shimanskiy
***Domatoceras parallelum* (Abich)
Domatoceras cf. *gracile* Shimanskiy
***Domatoceras* sp. 1
**Pseudotitanoceras armeniacum* (Abich)
Permonautilus abichi (Kruglov)
Permonautilus sp.
**? *Stearoceras* sp.
***Paranautilus peregrinus* (Waagen)
**Styrionautilus* sp.
***Neocycloceras obliqueannulatum* (Waagen)
**? *Neocycloceras* cf. *cyclophorum* (Waagen)
**? *Neocycloceras margaritatum* (Abich)
? *Neocycloceras* cf. *margaritatum* (Abich)
***Lopingoceras lopingense* (Stoyanow)
Lopingoceras cf. *lopingense* (Stoyanow)
***Cycloceras bicinctum* (Abich)

Only six of these species were completely described and illustrated in the text. These are indicated by a single asterisk in the above list. A number of species were illustrated on plates but were not described in the text, and these are indicated in the above list by a double asterisk. A few general comments on this impressive list of species are in order. *Pseudotemnocheilus* we regard as a synonym of *Temnocheilus*. The illustration by Shimanskiy (*in* Ruzhentsev and Sarycheva, 1965, pl. 14, fig. 7) of a specimen of *Pseudotemnocheilus* is very poor, but it seems to be possibly conspecific with what we describe here as *Temnocheilus* sp. indet. The illustrations of the various species of *Foordiceras* appear to be similar to specimens we assign to *Pleuronautilus* sp. indet. 2. *Tirolonutilus* sp. and *Hexagonites* sp. were both based on single, very fragmentary specimens. On the basis of the illustrations of these specimens, we do not believe that they are generically identifiable. The generic identification of *Phaedrysmocheilus* and *Stearoceras* were

questioned by Shimanskiy, and, on the basis of the illustrations he presented, we agree that these identifications are doubtful. Excluding the orthocerids it appears that this nautiloid fauna of Soviet Dzhulfa includes nine genera, which, as late Paleozoic nautiloid faunas go, is a large number.

PRESENT INVESTIGATIONS

The specimens described in the present paper were collected by us from that part of the section which Stepanov *et al.* (1969) called Julfa Beds. These correspond to the Dzhulfian Stage (Dzhulfinskiy Yarus) of Arakelyan, Grunt, and Shevyrev (*in Ruzhentsev and Sarycheva, 1965: 23*). All collections were obtained in a small side valley, parallel to the main access valley to Kuh-e-Ali Bashi, about 8 km west of Julfa and about 200–300 m upstream from our Ali Bashi locality 4 (Teichert, Kummel, and Sweet, *in press*). Our collections contain the following genera and species:

- Lopingoceras lopingense* (Stoyanow)
- Lopingoceras* sp. cf. *L. lopingense* (Stoyanow)
- Neocycloceras* sp. cf. *N. obliquannulatum* (Waagen)
- Tainoceras* sp. indet.
- Metacoceras dorashamense* Shimanskiy
- Metacoceras dorsoarmatum* (Abich)
- Pleuromutilus* sp. indet. 1
- Pleuromutilus* sp. indet. 2
- Tainionutilus* sp. indet.
- Temnocheilus* sp. indet.
- Domatoceras hunicum* (Diener)
- Domatoceras parallelum* (Abich)
- Domatoceras* sp. indet.
- Stenopoceras* sp. indet.
- Titanoceras* sp. indet.
- Pseudotitanoceras armeniacum* (Abich)
- Liroceras* sp. indet.

This fauna is essentially the same as that from the corresponding beds at Soviet Dzhulfa except for the presence of *Temnocheilus*, *Tainionutilus*, and *Titanoceras*. At the same time the Kuh-e-Ali Bashi fauna

does not include *Permonutilus*, *Paranutilus*, and *Styrionutilus*.

In an analysis of the nautiloid fauna of the Julfa Beds it is important to consider the fauna of the overlying Ali Bashi Formation. It is these strata that are of prime importance in consideration of the Permian-Triassic boundary of this region. Shimanskiy (*in Ruzhentsev and Sarycheva, 1965: 41*) listed the following species from the equivalents of the Ali Bashi Formation at Soviet Dzhulfa (*Phisonites* beds plus beds 1–4 of the "Induan stage"):

- Tainoceras* sp. 1 (ex. gr. *changlingpuense* Chao)
- Tainoceras* sp. 2 (ex. gr. *changlingpuense* Chao)
- Tainoceras* sp. 3
- Metacoceras* sp. 2 (ex. gr. *dorsoarmatum* Abich)
- ?*Foordiceras* sp. 2
- Pleuromutilus* sp. (ex. gr. *dieneri* v. Krafft)
- ?*Pleuromutilus* sp.
- Tainionutilus* sp.
- Domatoceras* sp. 2
- ?*Syringonutilus vagus* Shimanskiy
- ?*Paranutilus* sp.
- ?*Neocycloceras* sp.

Only ?*Syringonutilus vagus* Shimanskiy was described and illustrated (*in Ruzhentsev and Sarycheva, 1965: 163, pl. 16, fig. 9*). Most of the remaining species were illustrated by photographs, unaccompanied by descriptions. The specimen assigned to ?*Syringonutilus*, to judge from the illustration, appears to be more likely to represent a species of *Stearoceras*.

Teichert, Kummel, and Sweet (*in press*) describe the following species of nautiloids from the Ali Bashi Formation at Kuh-e-Ali Bashi:

- ?*Dolorthoceras* sp.
- Neocycloceras* sp.
- Lopingoceras* sp.
- Tainoceras* sp. indet.
- Metacoceras* sp. indet.

TABLE I
DISTRIBUTION OF NAUTILOID GENERA IN JULFA
BEDS AND ALI BASHI FORMATION

	Julfa Beds	Ali Bashi Form.
? <i>Dolorthoceras</i>		×
<i>Neocycloceras</i>	×	×
<i>Lopingoceras</i>	×	×
<i>Tainoceras</i>	×	×
<i>Metacoceras</i>	×	×
<i>Pleuromutilus</i>	×	×
<i>Tainionutilus</i>	×	×
<i>Temnocheilus</i>	×	×
<i>Domatoceras</i>	×	×
<i>Pseudotitanoceras</i>	×	
? <i>Stearoceras</i>	×	×
<i>Stenopoceras</i>	×	×
<i>Titanoceras</i>	×	
<i>Styrionutilus</i>	×	
<i>Liroceras</i>	×	×
<i>Paranutilus</i>	×	×
<i>Permonutilus</i>	×	

Pleuromutilus sp. indet.

Temnocheilus sp. indet.

Domatoceras sp. indet.

Liroceras sp. indet.

Paranutilus sp. indet.

It can readily be seen that this fauna is essentially the same as that described by Shimanskiy from Soviet Dzhulfa and that these faunas contain elements of those of the underlying Julfa Beds. The stratigraphic distribution of the nautiloids now known from the Julfa Beds and the Ali Bashi Formation at Kuh-e-Ali Bashi and Soviet Dzhulfa is shown in Table 1.

In the controversy as to whether the Ali Bashi Formation is Permian or Triassic in age, nautiloids are not helpful. A comprehensive review of the relationship of Permian and Triassic nautiloids has been presented by Kummel (1953) and restated by the same author in the *Treatise on Invertebrate Paleontology*, Part K (Teichert *et al.*, 1964). The situation has been summarized as follows: "Evolution of the nautiloids in the Triassic is mostly one of culminating patterns and modes started in the late Paleozoic" (Kummel, 1953: 1). The relationships of

late Paleozoic and Triassic nautiloid genera are shown in Figure 1. The nautiloid fauna of the Julfa Beds includes most of the genera that are present in Late Permian and Early Triassic rocks. This further emphasizes the continuity of evolution of the nautiloids across the Permian-Triassic boundary, in contrast to the history of extinction and radiation displayed by the ammonoids at this boundary.

SYSTEMATIC PALEONTOLOGY

Class **CEPHALOPODA** Cuvier, 1798

Order **ORTHO CERIDA** Kuhn, 1940

Family and superfamily uncertain

About 30 fragments of shells of orthoconic nautiloids in our collections are assigned by us to the genera *Neocycloceras* Flower and Caster and *Lopingoceras* Shimanskiy. Both genera have been placed in the Pseudorthoceratidae with more or less confidence by Shimanskiy and by Sweet (see references below). Since the siphuncle structures of the type species of both genera are not well known, we conclude that *Neocycloceras* and *Lopingoceras* are of uncertain family affinities.

Genus *Lopingoceras* Shimanskiy,
in Ruzhentsev, 1962

Type species, *Orthoceras lopingense*
Stoyanow, 1910

This genus was described by Shimanskiy (*in Ruzhentsev, 1962: 90*) as follows (transl. from Russian): "Conch with transverse rings [which are] angular in section. Sutures situated in the intervals between rings, parallel to them and perpendicular or slightly inclined to the longitudinal axis of the conch. Siphuncle segments longitudinally ellipsoidal." The type species was described by Stoyanow (1910: 70) from the Upper Permian of Dzhulfa, and Shimanskiy (*in Ruzhentsev, 1962*) mentioned occurrences of the genus in Yugoslavia, Tirol, and China, but gave no references to published descriptions. Barskov (1963)

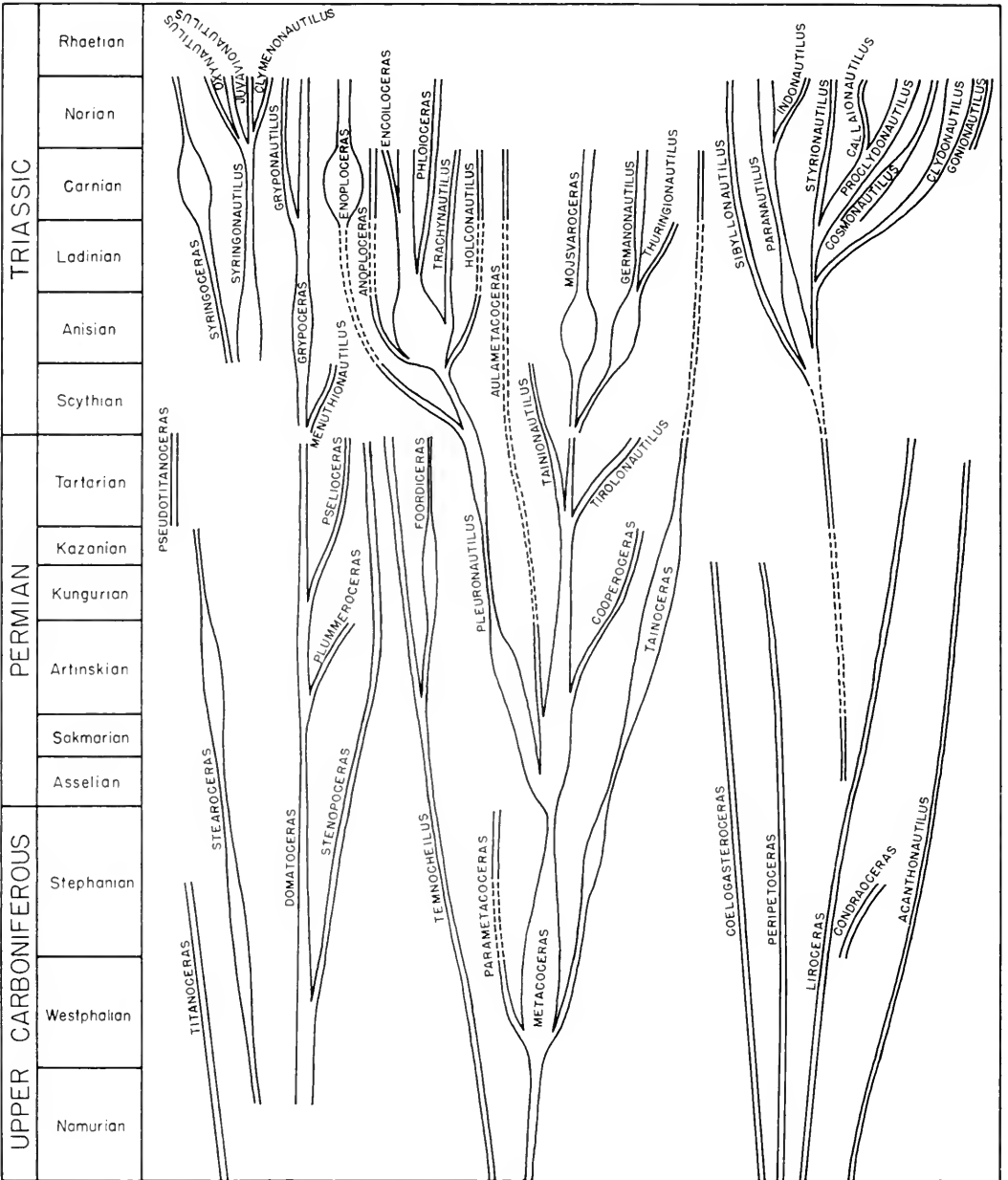

Figure 1. Diagram showing inferred phylogeny and geologic distribution of late Paleozoic and Triassic coiled nautiloids. (Adapted from Kummel, 1953.)

placed *Lopingoceras* in his newly established family, Pseudocycloceratidae, without stating reasons.

Lopingoceras lopingense (Stoyanow)

Plate 4, figures 9, 11

Orthoceras lopingense Stoyanow, 1910: 70, pl. 7, figs. 2, 3.

Lopingoceras lopingense (Stoyanow), - Shimanskiy, in Ruzhentsev and Sarycheva, 1965: 41, 42, pl. 16, fig. 10.

Description. Our collections contain at least four fragmentary specimens that we assign to *Lopingoceras lopingense*. When he established this species, Stoyanow (1910: 70) cited angularity of outline of the annulations as its most important distinguishing feature, but did not really give a formal description of it. Since the species is known only from fragmentary phragmocones and living chambers, a complete description is difficult to give.

Obviously, the conch is longiconic and straight. The sutures are straight and the chambers quite short, each chamber bearing one annulation that thus runs parallel to the sutures. The specimen figured on Plate 4, figure 11, is a fragmentary phragmocone consisting of three entire and two fragmentary chambers. Of the three entire chambers two are short and one is long. Their lengths are 2.8, 3.0, and 5.6 mm. Thus, the third chamber is about twice as long as each of the first two and it carries two rings, instead of one. Apparently, we are here concerned with one of the rare cases where construction of a septum was skipped. Teichert (in Teichert *et al.*, 1964: K31, K52) has cited from the literature some previously described cases of this kind.

Remarks. Stoyanow (1910: 103) listed *Orthoceras lopingense* from a bed he called "Cephalopoda-zone," 11 to 14 m above the base of his Dzhulfia section. Shimanskiy (in Ruzhentsev and Sarycheva, 1965: 42) listed the species only from the *Araxoceras* Zone, the lowest of the Dzhulfian zones.

Repository. MCZ 9774 (Pl. 4, fig. 9),

MCZ 9776 (Pl. 4, fig. 11), unfigured specimens KU 34435.

Lopingoceras sp. cf. *L. lopingense*
(Stoyanow)

Plate 4, figures 13, 14

Description. Our collections contain at least four fragments of phragmocones that are similar to those here placed in *Lopingoceras lopingense*, except that the number of annulations per chamber is normally two. In addition the conch tends to be compressed in cross section rather than circular. On the more narrowly rounded sides the annulations form narrow lobes, while the sutures remain straight (Pl. 4, fig. 14). The length of the chambers is 2.8 to 3.0 mm, or about the same as the length of normal chambers of *L. lopingense*. In one piece, which consists of five camerae, or parts thereof, and of the basal part of the living chamber, the length of four of the chambers is 2.8 mm, but that of the last camera is 2.0 mm, and it bears only one ring.

Remarks. A character which these specimens share with typical *Lopingoceras lopingense* is the angularity in perpendicular section of the annulations. No similar forms are as yet known from the Dzhulfian beds near Soviet Dzhulfia.

Repository. MCZ 9775 (Pl. 4, figs. 13, 14), unfigured specimen KU 34431.

Genus *Neocycloceras* Flower & Caster 1935

Type species, *Neocycloceras obliquum*
Flower and Caster, 1935

Flower and Caster (1935: 15) stated that this genus was separated from "other annulated forms by the oblique sinuous sutures and the eccentric nummuloidal siphuncle." It is further characterized by "large, sinuous and slightly oblique annulations." Flower and Caster placed the genus questionably in the family Orthoceratidae Hyatt. Flower (1939: 309) placed it equally questionably in the Pseudorthoceratidae, and maintained this position in subsequent publications (Flower, 1941:

475; 1943: 107; 1945: 685), whereas Flower and Kummel (1950: 610) included the genus without query in that family. Both Shimanskiy (*in* Ruzhentsev and Sarycheva, 1965) and Sweet (*in* Teichert *et al.*, 1964) placed *Neocycloceras* in the family Pseudorthoceratidae. Sweet, however, with reservations.

The range of the genus is stated to be Upper Devonian to Lower Carboniferous by Sweet (*in* Teichert *et al.*, 1964), and Devonian to Lower Carboniferous and Upper Permian by Shimanskiy (*in* Ruzhentsev, 1962).

Neocycloceras sp. cf. *N. obliqueannulatum*
(Waagen)

Plate 4, figures 10, 12

cf. *Orthoceras obliqueannulatum* Waagen, 1879:
69, 70, pl. 6, figs. 9, 10.

Description. A number of fragmentary conch parts, ranging from about 4 mm to about 20 mm in conch diameter, are almost certainly assignable to the genus *Neocycloceras* and may be related to the species described by Waagen as *Orthoceras obliqueannulatum*. All our specimens are more or less fragmentary living chambers and two of them have parts of camerae attached to their bottom.

The largest specimen (Pl. 4, fig. 12) is a living chamber that is probably complete, with one camera attached at the bottom. The camera is 6.5 mm long and about 18 mm wide and it seems to bear one annulation. However, only one-half of the outside of the camera is preserved. The living chamber is 24 mm long. The aperture has an elliptical outline, having diameters of 19 and 14 mm respectively. The living chamber bears five annulations, the last one situated close to the apertural margin. The annulations are strong, rising at least 1 mm above the depressions between them, and these are wider than the annulations. The annulations cross one of the broad sides of the shell in a low arch, slope adapically across the two narrow sides, and

cross the opposite broad side of the shell almost horizontally. Only one-half of the last suture of the phragmocone is preserved; it slopes in the same direction as the annulations.

We have three additional fragments of living chambers of comparable size, but of poorer preservation. As far as one can judge, their features are essentially the same as those of the living chamber described above.

In addition, our collections contain five fragments of considerably smaller living chambers with oblique annulations, the largest of these having long and short shell diameters of 10.5 and 9.5 mm respectively. Two of these have fragments of camerae attached to them which allow one to observe that the sutures are oblique. In all specimens the cross section of the shell is more or less elliptical. Whether or not these smaller specimens belong to the same species as the larger ones described above could presumably be decided on the basis of a larger sample.

The siphuncle cannot be observed in any of the specimens.

Remarks. The reason for our uncertainty in the proper taxonomic assignment of the Julfa specimens lies in the deficiencies of Waagen's description of the type material, which came from the Chhidru Formation ("upper Productus limestone") of the Salt Range of West Pakistan. Waagen (1879: 69) himself admitted that his few fragments "seem barely sufficient for the foundation of a species," although the oblique annulations seemed to him such a characteristic feature that he did in fact establish the species. Unfortunately, he seemed to be unable to observe the sutures, for he does not mention them.

Miller and Unklesbay (1942) referred Waagen's species questionably to the genus *Brachycycloceras*. However, the annulations in that genus are not oblique.

The species has been recorded and in part illustrated from the Dzhulfian beds near Dzhulfa (Arthaber, *in* Frech and

Arthaber, 1900: 210; Shimanskiy, in Ruzhentsev and Sarycheva, 1965: 41), from Loping in Kiangsi, China (Frech, 1911: 108), and from the Aghil Mountains in Tibet (Renz, 1940: 67).

Repository. KU 34411 (Pl. 4, fig. 10), MCZ 9777 (Pl. 4, fig. 12), unfigured specimens MCZ 9778, KU 34412.

Order **NAUTILIDA** Agassiz, 1847

Superfamily **TAINOCERATA**CEAE

Hyatt, 1883

Family **TAINOCERATIDAE** Hyatt, 1883

Genus *Tainoceras* Hyatt, 1883

Type species, *Nautilus quadrangulus*

McChesney, 1860

Tainoceras sp. indet.

Plate 4, figures 1, 2

Discussion. This record is based on a fairly well-preserved phragmocone 74 mm in diameter. The width of the most adoral camera is 51.5 mm and the height 36 mm. The conch is moderately involute with an oval whorl section. The venter is broadly rounded with a prominent median furrow. The ventrolateral shoulders are broadly rounded, merging imperceptibly into convex lateral areas. The umbilical shoulders are more abruptly rounded and the umbilical wall steep; the umbilicus has a diameter of approximately 22 mm. The ornament consists of a row of nodes on the venter adjoining each side of the ventral furrow and another row of nodes on the ventrolateral shoulder. The nodes are generally located on the adoral part of each camera. The suture consists of a deep ventral lobe in the ventral furrow and a shallow lateral lobe on the flanks.

Shimanskiy (in Ruzhentsev and Sarycheva, 1965: 41) lists *Tainoceras dorsoplicatum* (Abich) from the *Araxoceras* beds of Soviet Dzhulfa. His table indicates that he had three specimens, but no formal description was given and only one specimen, a small fragment of phragmocone, was illustrated. Specific identification of

this fragment does not seem justified. The illustrations and descriptions of *Nautilus dorsoplicatus* Abich (1878: 23, pl. 2, fig. 6; pl. 3, fig. 1; pl. 4, fig. 8) are most unsatisfactory. The specimen illustrated by Abich on his plate 4, figure 8 does show marked similarities to that in our collection. Even so it seems unwise to assign a specific name to our specimen. Shimanskiy also listed four specimens assigned to three indeterminate species of *Tainoceras* from the Ali Bashi Formation of Soviet Dzhulfa. Two of these forms were illustrated but not described. The illustrations clearly show the specimens to be species of *Tainoceras*, but the incompleteness of the specimens and their poor preservation make specific identification impossible. Our collections from the Ali Bashi Formation at Kuh-e-Ali Bashi contain one fragmentary specimen of *Tainoceras*.

In a review of the genus *Tainoceras*, Kummel (1953: 24) recorded 23 species assignable to the genus. It has a range from Middle Pennsylvanian to Late Permian in age and one species, *Trematodiscus klipsteini* Mojsisovics (1882) from the Karnian of the Alps, is also included in this genus.

Repository. MCZ 9752 (Pl. 4, figs. 1, 2).

Genus **Metacoceras** Hyatt, 1883

Type species, *Nautilus (Discus) sangamonensis* Meek and Worthen, 1861

Metacoceras dorashamense Shimanskiy

Plate 4, figures 5, 6

Metacoceras dorashamense Shimanskiy, in Ruzhentsev and Sarycheva, 1965: 157, pl. 14, fig. 3.

Discussion. Our collections contain nine specimens mainly of poor preservation. The only complete specimen (Pl. 4, figs. 5, 6) is a phragmocone measuring 39 mm in diameter, 23 mm for the width of the adoral whorl, and 17 mm for the height. Shimanskiy distinguished his species primarily on the presence of nodes on both the ventrolateral and umbilical shoulders, the latter being very small, and on ribs between the

nodes increasing in prominence toward the ventrolateral node. The umbilical nodes are not apparent on the one illustration Shimanskiy (*in* Ruzhentsev and Sarycheva, 1965, pl. 14, fig. 3b) published. The ventrolateral nodes are very conspicuous and the so-called ribs are lateral extensions from these nodes. This is the general nature of the ornament pattern in our specimens.

In a general review of the genus *Metacoceras*, Kummel (1953) noted that: "The high degree of variation and few or poorly preserved specimens prevent a thorough understanding of most of the species. There are more than twice as many species of *Metacoceras* (50) as of any other Pennsylvanian and Permian nautiloid." Shimanskiy had only two specimens of his new species and the illustrated type is surely the phragmocone of a juvenile. Our specimens are of limited help in broadening the understanding of this species because of their fragmentary nature and generally poor preservation. As there are no data on the range of variation in ornament for any species of *Metacoceras*, direct comparison of species is meaningless. The only significance of the large number of species assigned to this genus is an indication of the widespread distribution and general abundance of *Metacoceras* in marine seaways of Pennsylvanian and Permian age.

In addition to *Metacoceras dorashamense*, Shimanskiy's fauna also includes *Metacoceras dorsoarmatum* (Abich). The latter species was said to differ in having only ventrolateral nodes. Our collections also contain specimens assignable to *M. dorsoarmatum*, but the really significant difference from *M. dorashamense* is in the more or less quadrate whorl section. Our collections from the overlying Ali Bashi Formation contain one fragment of a phragmocone, which, on the basis of its depressed whorl section, appears to be a representative of *M. dorashamense*. In Soviet Dzhulfia Shimanskiy listed from the beds with *Phisonites* one specimen attributed to *Metacoceras* sp. 2 (ex. gr. *dorsoarmatum* Abich).

Repository. MCZ 9753 (Pl. 4, figs. 5, 6), unfigured specimens MCZ 9754.

***Metacoceras dorsoarmatum* (Abich)**
Plate 3, figures 5, 6

Nautilus dorsoarmatus Abich, 1878: 20, pl. 4, figs. 1, 1a.

Metacoceras dorsoarmatum, – Shimanskiy, *in* Ruzhentsev and Sarycheva, 1965: 41, pl. 14, fig. 5.

Discussion. This species differs from *Metacoceras dorashamense* in having a more subquadrate whorl section rather than a depressed whorl section. Likewise there are no nodes on the umbilical shoulder. The prominent ventrolateral nodes taper off up the lateral areas, giving the appearance of incipient ribs. The largest specimen in our collection (Pl. 3, figs. 5, 6) is a phragmocone 37.5 mm in diameter; the most adoral whorl has a width of 17.7 mm and a height of 16 mm. The remaining six specimens are fragments of phragmocone. General comments on the genus *Metacoceras* and the species from the Julfa Beds are offered in the preceding section.

Repository. MCZ 9755 (Pl. 3, figs. 5, 6), unfigured specimens MCZ 9756.

Genus *Pleuromutilus* Mojsisovics, 1882
Type species, *Pleuromutilus trinodosus*
Mojsisovics, 1882

Discussion. This is another of the most common genera of nautiloids in the Julfa Beds. The relative abundance of specimens and the fact that they are ornamented have led to a proliferation of species names, as is generally the case. Abich (1878) described three species that can readily be assigned to this genus, e. g., *Nautilus tubercularis* Abich, *N. pichleri* Hauer, and *N. incertus* Abich. Shimanskiy (*in* Ruzhentsev and Sarycheva, 1965: 41) recognized five species from the Dzhulfian beds of Soviet Dzhulfia, e. g., *Pleuromutilus incertus* (Abich), *P. verae* (Arthaber), *P. tubercularis* (Abich), *P. dzhulfensis* Shimanskiy, and *P. costalis* Shimanskiy. In addition, Shimanskiy listed three distinct intermediate

species of *Pleuronautilus*. The differences between these species are stated to be primarily in ornament pattern. However, it needs to be emphasized that all are based on relatively few and generally fragmentary specimens. The significance of the differences in ornament pattern is completely unknown. Kummel (1953), in a review of the genus *Pleuronautilus*, recorded 24 Permian species and 34 Triassic species. Most of these are likewise based on very few specimens. Because most species of pleuronautilids have been narrowly conceived, especially those from the Julfa Beds, we conclude it is inadvisable to assign specific names to our specimens.

Within our collection we have two distinct forms: the first, consisting of only one specimen, has a more compressed whorl section and the whorls increase in dimensions slowly; the second form includes 15 specimens and is characterized by a robust, depressed whorl section.

Our collections from the overlying Ali Bashi Formation contain two fragmentary specimens which resemble the specimens described here as *Pleuronautilus* sp. indet. 2, and they are possibly conspecific.

Pleuronautilus sp. indet. 1

Plate 1, figures 3, 4

Discussion. Among the 16 specimens of pleuronautilids in our collection one is distinctly different from all the others. This specimen is all phragmocone, 59 mm in diameter, 17 mm in width of adoral whorl, and 19.2 mm in height. The umbilicus is 25 mm in diameter. Both the venter and the lateral areas are slightly convex. The ventrolateral shoulders are sharply rounded, the umbilical shoulders more broadly so, and the umbilical wall slopes to the umbilical seam at an angle of about 45 degrees. The suture has a shallow ventral lobe and a broad lateral lobe occupying the whole flank. The lateral areas bear prominent radial ribs that extend from the umbilical shoulder to the ventrolateral shoulder where they terminate in a node.

Among the various species of this genus recognized by Shimanskiy from the Julfa Beds, our specimen most resembles *Pleuronautilus costalis* Shimanskiy. The resemblance is largely confined to the general shape and proportions of the whorl section. Our specimen lacks the additional rows of nodes on the ribs which are said to characterize *P. costalis*. However, as mentioned above, the significance of these differences in ornament is not known. Our specimen is also very similar to *P. verae* Arthaber (*in* Frech and Arthaber, 1900, pl. 18, fig.4). All other pleuronautilids from the Julfa Beds display a more rapid growth or inflation of the whorls, and, at the diameter of this specimen, already have robust, depressed whorl sections. In addition, the ornament pattern is highly variable.

Repository. KU 34384.

Pleuronautilus sp. indet. 2

Plate 4, figures 3, 4, 7, 8

Discussion. The remaining specimens of pleuronautilids in our collection are grouped under this heading. Most specimens are fragments, but two are fairly complete. The most characteristic feature is the depressed whorl section. The lateral areas bear ribs, and in this feature there is much variation. The large specimen of Plate 4, figures 3, 4 has ribs that originate on a low node on the ventrolateral shoulder, decrease in strength, and completely disappear across the mid-area of the flanks. In other specimens the ribs extend fully to the umbilical shoulder. There is likewise much variation in general prominence of the ribs, that is, in some specimens they are very weakly expressed and in others they are very noticeable.

The specimen of Plate 4, figures 3, 4 has the following dimensions: diameter 87 mm, height of adoral whorl section 31.5 mm, width of adoral whorl section 40 mm, diameter of umbilicus 28.5 mm. These proportions are typical of all the remaining fragments included here.

It is possible to match one or more of our fragments with *Pleuronautilus tubercularis*

(Abieh), *P. incertus* (Abieh), or *P. dzhul-fensis* Shimanskiy. However, as mentioned above, all these species are very incompletely known because they are based on few and generally poorly preserved specimens. Study of our suite of mainly fragmentary specimens leads us to conclude that this is nothing more than a single, somewhat variable species. It seems doubtful that there are possibly more than two species of *Pleuromutilus* in the Julfa Beds' fauna.

Repository. MCZ 9757 (Pl. 4, figs. 3, 4), MCZ 9758 (Pl. 4, figs. 7, 8), unfigured specimens MCZ 9759, KU 34389, 34414, 34415, 34419, 34427, 34428.

Genus *Tainionutilus* Mojsisovics, 1902

Type species, *Nautilus transitorius*
Waagen, 1879

Tainionutilus sp. indet.
Plate 3, figures 9, 10

Discussion. This identification is made on a single fragment of phragmocone consisting of only one-third revolution. The whorl section is depressed, subquadrate, measuring 41 mm in width and approximately 30 mm in height. The flanks are flattened and converge slightly toward the venter. The venter is broad and flattened. Both the ventrolateral and umbilical shoulders are sharply rounded. The venter bears a conspicuous, smooth, deep median furrow aligned on both sides by broad diagonal ribs that extend to the ventrolateral shoulder. The lateral areas do not appear to bear ribs, but this is uncertain because of poor preservation. The suture forms a deep ventral lobe on the venter and a broad rounded lobe on the lateral area.

Only five species have been referred to this genus, *Tainionutilus fugax* Mojsisovics, from the Bellerophon Limestone, the type species *T. transitorius* (Waagen), *T. cynnei* (Waagen), *T. multicostatus* (Reed), and *T.* sp. Reed from the Chhidru Formation of the Salt Range, West Pakistan. *Tainio-*

nautilus trachyceras Frech from the Mianwali Formation of the Salt Range also has been included in this genus. Our specimen is most similar to the type species, *T. transitorius*, but whether it is conspecific cannot be determined because of its fragmentary nature.

Shimanskiy (*in* Ruzhentsev and Sarycheva, 1965: 158, pl. 15, figs. 8a, b) identified one specimen from the Dzhulfian strata at Baisal as *Tainionutilus* sp. The specimen is small (34 mm diameter) and has conspicuous forward-projecting lateral ribs. The precise relationship of this specimen with ours is obscure because of poor preservation and the fragmentary nature of our specimen.

Repository. MCZ 9760, unfigured specimens KU 34391, 34413.

Family KONINCKIOCERATIDAE Hyatt,
in Zittel, 1900

Genus *Temnocheilus* McCoy, 1844

Type species, *Nautilus (Temnocheilus)*
coronatus McCoy, 1844

Temnocheilus sp. indet.
Plate 3, figures 1-4, 7, 8

Discussion. This very distinctive late Paleozoic genus is represented in our collection by one nearly complete phragmocone and six fragments. The best specimen (Pl. 3, figs. 3, 4) has a diameter of 61 mm, an adoral whorl width of 27 mm (measured on the nodes), and a whorl height of 15.5 mm. The umbilicus has a diameter of 30.5 mm. The whorl cross section is subtrapezoidal with a broad, only slightly convex venter, rounded ventrolateral shoulders, and convex lateral areas that converge toward the dorsum. The ventrolateral area bears prominent nodes spaced about the width of one camera apart. The suture has a broad shallow ventral lobe and a similar lobe on the lateral areas. A smaller fragment with a whorl width of 17 mm is illustrated on Plate 3, figures 7, 8. Three of the remaining fragmentary specimens are portions

of larger individuals. One specimen is a fragment of body chamber and measures 39 mm in width and 27.5 mm in height. Another fragment is a phragmocone consisting of four camerae that measures 43 mm in width and 21.5 mm in height. The larger fragments have the same whorl shape, ornament pattern, and suture as the more complete specimen of Plate 3, figures 3, 4.

Tenuocheilus is fairly common in the Pennsylvanian and Permian. Kummel (1953: 18), in a general review of the genus, listed 23 described species from the U.S.A. and Eurasia. Within the family Koninckioceratidae *Tenuocheilus* is a long-ranging genus that appears to have given rise to only one other form—*Foordiceras*. This is in sharp contrast to *Metacoceras*, which gave rise to a number of late Paleozoic genera (Kummel, 1953). What is of interest is that the two genera represent parallel evolutionary lines.

Shimanskiy (in Ruzhentsev and Sarycheva, 1965: 41) lists *Pseudotenuocheilus* from the *Araxoceras* and *Vedioceras* beds in Soviet Dzhulfa; however, he neither discribed nor illustrated these specimens. Kummel (in Teichert *et al.*, 1964) placed *Pseudotenuocheilus* in the synonymy of *Tenuocheilus*. It would thus appear that this Soviet region includes in its nautiloid fauna a tenuocheilid possibly similar to that of Kuh-e-Ali Bashi.

Repository. MCZ 9761 (Pl. 3, figs. 1, 2), MCZ 9762 (Pl. 3, figs. 3, 4), KU 34394 (Pl. 3, figs. 7, 8), unfigured specimens MCZ 9763.

Superfamily TRIGONOCERATACEAE Hyatt, 1884

Family GRYPOCERATIDAE Hyatt, in Zittel, 1900

Genus *Domatoceras* Hyatt, 1891

Type species, *Domatoceras umbilicatum*
Hyatt, 1891

Discussion. The predominant coiled nautiloids in our collections from the Julfa Beds

at Kuh-e-Ali Bashi are species of the genus *Domatoceras*. We have 35 specimens of which only a few are essentially complete. The same predominance prevails in correlative strata of Soviet Dzhulfa where Shimanskiy (in Ruzhentsev and Sarycheva, 1965: 41) reported 36 specimens. In addition to being represented by large numbers of specimens, there is also a great diversity in form. The differences in form are expressed primarily in the shape of the whorl section. Shimanskiy recognized from the *Araxoceras* beds the following species: *D. convergens* (Abich), *D. atypicum* Shimanskiy, *D. hunicum* (Diener), *D. gracile* Shimanskiy, and *D. parallelum* (Abich). In the overlying *Vedioceras* beds Shimanskiy records *D. cf. gracile* and *D. sp. 1*, and in the equivalents of the Ali Bashi Formation, *D. sp. 2*.

Nautilus convergens Abich we believe to be a species of *Stenopoceras* rather than *Domatoceras*. *Domatoceras atypicum* Shimanskiy is an inflated form with a narrow concave venter and convergent convex flanks; our collections include two specimens of this species. We believe that *D. gracile* Shimanskiy is a synonym of *D. parallelum* (Abich); our collections contain eight specimens of this species. The most abundant species, represented by 23 specimens, is *D. hunicum* (Diener), which has a subrectangular whorl section. Finally, our collections contain a fragmentary specimen consisting of one camera and a portion of body chamber, making up one-quarter of a volution of conch, and this seems to represent a very unique new genus of domatoceratid. The primary feature is a fastigate venter with a smooth sharp midline and the remaining ventral area convexly curving to merge with smooth flanks. To the best of our knowledge no other domatoceratid has such a whorl section. The presence of this form emphasizes the statement regarding the diversity of the domatoceratids in the Julfa Beds. Because our specimen is so fragmentary we refrain from introducing a new generic name, but that it

represents a new genus we have no question.

Domatoceras hunicum (Diener)

Plate 1, figures 7, 8; Plate 2, figures 3, 4

Nautilus (*Domatoceras*?) *hunicus* Diener, 1903: 5, pl. 1, figs. 1a-c.

Grypoceras (*Domatoceras*) *hunicum*, – Kummel, 1953: 55.

Domatoceras hunicum, – Shimanskiy, in Ruzhentsev and Sarycheva, 1965: 41, pl. 15, fig. 12.

Discussion. This species is represented in our collections by 24 fragmentary specimens, most of which are body chambers. The species is characterized by an evolute, smooth conch with a subquadrate whorl section. The illustrated body chamber (Pl. 2, figs. 3, 4) has a whorl height of 27 mm and a width of 23 mm. The venter is flattened and the flanks are only slightly convex, converging gently toward the venter. The ventrolateral and umbilical shoulders are rounded. The siphuncle is central. The suture has a ventral lobe that occupies most of the venter and a lateral lobe that occupies nearly all of the flanks.

This species differs from the associated species in the fauna primarily in the shape of the whorl section. *Domatoceras parallelum* has a much more compressed whorl section and *D. atypicum* a more inflated whorl section with a relatively narrow venter.

Repository. MCZ 9764 (Pl. 2, figs. 3, 4), MCZ 9765 (Pl. 1, figs. 7, 8), unfigured specimens MCZ 9766, KU 34393, 34395, 34429, 34430.

Domatoceras parallelum (Abich)

Plate 2, figures 1, 2, 9, 10

Nautilus parallelus Abich, 1878: 17, pl. 3, fig. 2. *Grypoceras* (*Domatoceras*) *parallelus*, – Kummel, 1953: 55.

Domatoceras parallelus, – Shimanskiy, in Ruzhentsev and Sarycheva, 1965: 41, pl. 15, fig. 10.

Domatoceras gracile Shimanskiy, in Ruzhentsev and Sarycheva, 1965: 160, pl. 16, fig. 1.

Discussion. This is the compressed form among species of *Domatoceras* in the

Dzhulfian fauna. The specimen of *Domatoceras gracile* illustrated by Shimanskiy (in Ruzhentsev and Sarycheva, 1965, pl. 16, fig. 1) is identical to our specimen illustrated on Plate 2, figures 9, 10. We believe these specimens to be juvenile forms; a mature phragmocone is that illustrated on Plate 2, figures 1, 2. In the more mature whorls the flanks are more parallel than in the immature whorls. Another difference is that the ventrolateral and umbilical shoulders of immature whorls are sharply rounded, though much less so than those of mature whorls. In conjunction with this change the venter on the inner whorls is flat but becomes slightly convex on the outer whorls. Our collections contain nine specimens of this compressed form, but we conclude that *D. gracile* is a synonym of *D. parallelum* (Abich).

Repository. MCZ 9767 (Pl. 2, figs. 9, 10), KU 34387 (Pl. 2, figs. 1, 2), unfigured specimens MCZ 9768.

Domatoceras sp. indet.

Plate 2, figures 7, 8

Discussion. This species is represented by two fragments of phragmocone. The illustrated specimen (Pl. 2, figs. 7, 8) has a whorl height of approximately 28.5 mm and a width of 34.5 mm. The venter is slightly concave and has a width of 15 mm. The ventrolateral shoulders are rounded and the flanks broadly convex, diverging markedly toward the dorsum. The width of the whorl at the umbilical shoulder is nearly twice the width of the venter. The umbilical shoulders are sharply rounded. The suture has a ventral lobe occupying the venter and a lateral lobe occupying most of the flank.

These specimens are considerably different from any domatoceratid described or illustrated by Shimanskiy from Soviet Dzhulfia. It most resembles *Domatoceras atypicum* Shimanskiy. However, in that species the whorls are said to be higher than wide and the sutures to be straight

across the venter. The venter was described as narrow but is convex rather than concave. The shape of the whorl section of our specimens is unique among domatoceratids described to date. Unfortunately, the specimens are too incomplete for complete analysis.

Repository. MCZ 9769 (Pl. 2, figs. 7, 8), unfigured specimen MCZ 9770.

Domatoceratid n. gen., n. sp.

Plate 2, figures 5, 6

Discussion. One specimen in our collection is unique and clearly belongs to an undescribed new genus of domatoceratids. However, it consists of only one camera and a small portion of phragmocone. It is clearly too incomplete to be made the type of a new genus. The unique feature of the specimen is the acute venter with arching ventral shoulders blending smoothly with the lateral flanks. The suture begins with a pointed saddle on the acute venter, followed by a shallow concave lobe occupying all of the ventral shoulder, then an acute saddle followed by a broad concave lobe occupying the whole flank.

The acute venter and the suture clearly indicate that this specimen represents a unique, as yet undescribed new genus related to *Domatoceras*.

Repository. MCZ 9773 (Pl. 2, figs. 5, 6).

Genus *Pseudotitanoceras* Shimanskiy, in Ruzhentsev and Sarycheva, 1965

Type species, *Nautilus armeniacus* Abich, 1878

Discussion. When he established the genus *Pseudotitanoceras*, Shimanskiy (in Ruzhentsev and Sarycheva, 1965: 162) gave the following diagnosis (translated from Russian):

Shell large, evolute, discoidal, whorl section trapezoidal; height of whorls almost equal to width. Ventral side concave, lateral sides flat, diverging considerably towards the umbilical

shoulder. Ventral shoulder protrudes and is carimate, umbilical shoulder almost rectangular. Sculpture consists of oval tubercles stretched out along the ventral shoulder and of sparse oval tubercles on the umbilical shoulder. Sutures broad, with deep lateral and ventral lobes and a smaller and narrower dorsal one. A very small lobe occurs on the umbonal wall.

Shimanskiy further stated that (translated):

On the basis of the general shape of the shell, the concavity of the ventral side and the presence of oval tubercles along the ventral shoulder the new genus resembles *Titanoceras* Hyatt. The shape of the cross section is a distinguishing feature (being trapezoidal in our genus and having convex lateral sides in *Titanoceras*), and also the occurrence of pre-umbonal tubercles in *Pseudotitanoceras*.

In spite of this resemblance Shimanskiy concluded that the two genera were unrelated homeomorphs and that *Pseudotitanoceras* might belong to the family Mosquoceratidae.

***Pseudotitanoceras armeniacum* (Abich)**

Plate 1, figures 5, 6

Nautilus armeniacus Abich, 1878: 24, pl. 2, fig. 5.

Pseudotitanoceras armeniacum, - Shimanskiy, in Ruzhentsev and Sarycheva, 1965: 162, pl. 16, figs. 5, 6.

Discussion. Our collections include one specimen that can readily be assigned to this species. It is a large fragment of phragmocone of one-third volution. Only the venter and one lateral side are preserved. The most adoral part of the specimen most probably preserves a portion of the living chamber. Our specimen has a length of 120 mm; we estimate the total diameter is in excess of 200 mm. The ventral area is wide and markedly concave. The ventrolateral shoulders are acutely rounded and aligned by elongate, low nodes. The lateral sides

converge strongly toward the ventrolateral shoulders and are flattened except near the ventrolateral shoulder where they become slightly concave. The camerae are 12 mm high measured along the venter except the most adoral two camerae, which are 9 mm and 10 mm high. The suture has a deep V-shaped ventral lobe, a narrowly rounded saddle centered on the ventrolateral shoulder, and a broad, deep, rounded lateral lobe occupying the whole lateral area.

Our specimen is approximately twice the size of the largest recorded by Shimanskiy from Soviet Dzhulfia, but there is no reason to doubt that they are conspecific. This is the only species assigned as yet to *Pseudotitanoceras* and is known only from the Dzhulfian strata in the vicinity of the Aras River. Even here, however, it is rare, as Shimanskiy had only four specimens and we managed to collect only one.

Repository. KU 34392 (Pl. 1, figs. 5, 6).

Genus *Stenopoceras* Hyatt, 1893

Type species, *Phacoceras dumblei* Hyatt, 1891

Stenopoceras sp. indet.

Plate 1, figures 9, 10

Discussion. This record is based on a single fragmentary phragmocone of one-third revolution of only moderate preservation. The whorl cross section and suture are the key features in this identification. The whorls are compressed, lateral areas convex and converging to a narrowly rounded venter. The suture has a narrow, acute ventral saddle and a broad deep lateral lobe. These are the diagnostic features of the genus *Stenopoceras*.

Kummel (1953) reviewed the taxonomic and evolutionary data on *Stenopoceras* and listed eight species of the genus. Most of the species are known from Upper Carboniferous and Permian formations of the United States. One species, *S. rouillieri* (de Koninck) occurs in the Upper Carboniferous of central Russia. Our specimen is

too incomplete for meaningful comparison with the known species of the genus. Again it should be pointed out that all species are known from very few, often fragmentary specimens.

Stenopoceras is a compressed involute evolutionary offshoot of *Domatoceras*. In the Triassic, *Grypoceras* is the direct lineal descendant of *Domatoceras* and itself gave off a compressed involute line, *Gryponautilus*.

Repository. KU 34434 (Pl. 1, figs. 9, 10).

Genus *Titanoceras* Hyatt, 1884

Type species, *Nautilus ponderosus* Meek, 1872

Titanoceras sp. indet.

Plate 1, figures 1, 2

Discussion. Our collections contain one large specimen that represents an indeterminate species of this genus. The specimen is all phragmocone, consisting of one-third revolution. The specimen had a diameter of at least 140 mm. The adoral camerae have a height of 59 mm and a width of approximately 68 mm. The venter is broadly convex with rounded ventrolateral shoulders, broad flattened lateral areas, and rounded umbilical shoulder. The specimen is slightly crushed, but the whorl cross section appears to have been subquadratic with the whorl sides converging slightly toward the dorsum. The ventrolateral shoulders bear distant, large, low nodes spaced about 15 mm apart. The suture is nearly straight across the venter, but the lateral area is occupied by a broad lateral lobe. The camerae along the ventrolateral shoulder in the adoral portion of the phragmocone are 15 mm in width; in the two adoral camerae it is 4 mm.

Titanoceras is not a particularly common late Paleozoic nautiloid. Previously it has been reported only from Upper Carboniferous and Lower Permian formations of Nebraska and western Australia. There is no reason to doubt the generic assignment of our specimen, but specific comparison

with previously described species is of limited value because of its incompleteness.
Repository. MCZ 9771 (Pl. 1, figs. 1, 2).

Superfamily CLYDONAUTILACEAE Hyatt, in Zittel, 1900

Family LIROCERATIDAE Miller and Youngquist, 1949

Genus *Liroceras* Teichert, 1940

Type species, *Coloceras liratum* Girty, 1911

Liroceras sp. indet.

Plate 3, figures 11, 12

Discussion. This is one of the more common nautiloid genera in the Julfa Beds at Kuh-e-Ali Bashi. Our collections contain 16 specimens, most of which are fragmentary and slightly crushed. The largest specimen, consisting of a phragmocone, had a diameter of at least 100 mm.

Liroceras is one of the simplest of late Paleozoic nautiloids. It is characterized by a smooth, globular, involute conch with a depressed whorl section and an essentially straight suture. Even with well-preserved material specific identification is most difficult. Our material is not well enough preserved for this.

In view of the relative abundance of *Liroceras* in our collections, it is of interest that the genus is not listed by Shimanskiy (in Ruzhentsev and Sarycheva, 1965: 41) as a member of the nautiloid fauna in Soviet Dzshulfa. At the same time the specimens Abich (1878) described and illustrated as *Nautilus concavus* and *Nautilus propinquus* Abich appear to be conspecific with our forms. Our collections from the overlying Ali Bashi Formation contain two specimens of *Liroceras* for which there is no reason to believe that they are not conspecific with those recorded here from the Julfa Beds.

Repository. KU 34386 (Pl. 3, figs. 11, 12); unfigured specimens MCZ 9772 (10 specimens), KU 34418, 34385, 34420, 34424, 34426.

REFERENCES

- ABICH, H. W. 1878. Geologische Forschungen in den kaukasischen Ländern. Th. 1, Eine Bergkalkfauna aus der Araxesenge bei Djoulfa in Armenien. Wien: Alfred Hölder. 126 pp.
- BARSKOV, I. S. 1963. Sistema i filogeniya psevdortotseratid. Byull., Moskov. Obshch. Ispytat. Prirodi, N.S., Vol. 68, Otdel Geol., **38**(4): 149-150.
- DIENER, C. 1903. Permian fossils of the Central Himalayas. Paleont. Indica, Ser. 15, **1**(5): 1-204.
- FLOWER, R. H. 1939. Study of the Pseudorthoceratidae. Palaeontographica Amer., **2**: 245-460, 9 pls.
- . 1941. Revision and internal structures of *Leurocyloceras*. Amer. Jour. Sci., **239**: 469-488, 3 pls.
- . 1943. Studies of Paleozoic Nautiloidea. VII. Annulated orthoceraconic genera of Paleozoic nautiloids. Bull. Amer. Paleont., **28** (109): 102-140.
- . 1945. Classification of Devonian nautiloids. Amer. Midland Naturalist, **33**: 675-724, 5 pls.
- , AND K. E. CASTER. 1935. The stratigraphy and paleontology of northwestern Pennsylvania. Part II, Paleontology. Section A. The cephalopod fauna of the Conewang Series of the Upper Devonian in New York and Pennsylvania. Bull. Amer. Paleont., **22** (75): 1-74, 8 pls.
- , AND B. KUMMEL. 1950. A classification of the Nautiloidea. Jour. Paleont., **24**: 604-616.
- FRECH, F. 1911. Abschliessende paläontologische Bearbeitung der Sammlungen F. von Richthofens, die Untersuchung weiterer fossiler Reste aus den von ihm bereisten Provinzen sowie ein Entwurf einer erdgeschichtlichen Uebersicht Chinas. In Richthofen, F. F. von, 1877-1912, China. Berlin: Dietrich Reimer, Vol. 5: 1-289.
- , AND G. VON ARTHABER. 1900. Über das Paläozoicum in Hocharmenien und Persien mit einem Anhang über die Kreide von Sirab in Persien. Beitr. Paläont. Geol. Öst.-Ung. Orient., **12**: 161-308.
- GIRTY, G. H. 1911. The fauna of the Moorefield shale of Arkansas. Bull. U. S. Geol. Surv., **439**: 1-148.
- HYATT, A. 1883. Genera of fossil cephalopods. Proc. Boston Soc. Nat. Hist., **22**: 253-272.
- . 1884. Genera of fossil cephalopods. Proc. Boston Soc. Nat. Hist., **22**: 273-338.
- . 1891. Carboniferous cephalopods. Ann. Rept. Texas Geol. Surv., No. 2: 327-356.
- . 1893. Carboniferous cephalopods, se-

- cond paper. Ann. Rept. Texas Geol. Surv., No. 4 (1892): 377-474.
- KUMMEL, B. 1953. American Triassic coiled nautiloids. U. S. Geol. Surv., Prof. Paper 250: 1-104, 19 pls.
- , AND C. TEICHERT. 1971. Permian-Triassic boundary beds in middle Tethys (Abst.). Int. Permian-Triassic Conference, Calgary, 1971, Program with Abstracts. Univ. Calgary, Geol. Surv. Canada, Bull. Canad. Petrol. Geol., **19**(2): 336-337.
- , AND ———. Permian-Triassic boundary beds in middle Tethys. Can. Sci. Jour. (in press).
- McCLESNEY, J. H. 1860 (1859). Descriptions of new species of fossils from the Paleozoic rocks of the western states. Chicago, pp. 1-76.
- McCoy, F. 1844. A synopsis of the characters of the Carboniferous Limestone fossils of Ireland. Dublin: Univ. Press, 207 pp., 29 pls.
- MEEK, F. B. 1872. Report on the paleontology of eastern Nebraska with some remarks on the Carboniferous rocks of that district. In F. V. Hayden, Final report of the United States Geological Survey of Nebraska. Final Rept., Pt. 2, Paleont., pp. 83-239, pls. 1-11.
- , AND A. H. WORTHEN. 1861. Descriptions of new Carboniferous fossils from Illinois and other western states. Proc. Acad. Nat. Sci., Philadelphia, **1860**: 147-172.
- MILLER, A. M., AND A. C. UNKLESBAY. 1912. Permian nautiloids from western United States. Jour. Paleont., **16**: 719-738.
- MOJSISOVICS, E. VON. 1882. Die Cephalopoden der mediterranen Triasprovinz. Abhandl. Geol. Reichsanst. Wien, **10**: 1-322.
- . 1902. Das Gebirge um Hallstatt. Abhandl. Geol. Reichsanst. Wien, Suppl. H., **6**: 175-356.
- RENZ, C. 1940. Die palaeozoischen Faunen von 1929-30. Wissensch. Ergebnisse der Niederländischen Expedition in dem Karakorum, vol. 3, pt. 1, Geologie, Abt. 1. Leiden, pp. 9-68.
- RUZHENTSEV, V. E. (ed.) 1962. Osnovy Paleontologii. Molluski-Golovonogie I. Izdatel. Akad. Nauk SSSR, Moscow, 438 pp.
- , AND T. G. SARYCHEVA. 1965. Razvitie i smena morskikh organizmov na rubezhe Paleozoya i Mezozoya. (Development and change of marine organisms at the Paleozoic-Mesozoic boundary.) Trudy Paleont. Inst. Akad. Nauk SSSR, **108**: 1-431.
- STEPANOV, D. L., F. GOLSHANI, AND J. STÖCKLIN. 1969. Upper Permian and Permian-Triassic boundary in North Iran. Geol. Surv. Iran, Rept. No. 12: 1-72.
- STOYANOW, A. A. 1910. On the character of the boundary of Paleozoic and Mesozoic near Djulfa. Verhandl. Russ.-Kaiserl. Mineral. Gesell., St. Petersburg, Ser. 2, **17**: 61-135, pls. 6-9.
- TEICHERT, C. 1910. Actinosiphonate cephalopods (Cyrtoceroidea) from the Devonian of Australia. Jour. Royal Soc. W. Australia, **26**: 59-75, 4 pls., 2 figs.
- . *et al.* 1961. Cephalopoda—general features, Endoceratoidea-Actinoceratoidea-Nautiloidea, Bactritoidea. In Moore, R. C. (ed.), Treatise on Invertebrate Paleontology, Pt. K, Mollusca 3. Geol. Soc. Amer., Univ. Kansas Press, 519 pp., 361 figs.
- , B. KUMMEL, AND W. SWEET. Permian-Triassic strata. Kuh-e-Ali Bashi, northwestern Iran. Bull. Mus. Comp. Zool. (in press).
- WAAGEN, W. 1879. Salt Range fossils: *Productus* limestone fossils. Mem. India Geol. Surv., Paleont. Indica, Ser. 13, **1**(1): 1-72.

PLATE 1. TITANOCERAS, PLEURONAUTILUS, PSEUDOTITANOCERAS, DOMATOCERAS, STENOPOCERAS

Figures	Page
1, 2. <i>Titanoceras</i> sp. indet., MCZ 9771. $\times 0.5$.	423
3, 4. <i>Pleuronautilus</i> sp. indet. 1, KU 34384. $\times 1$.	418
5, 6. <i>Pseudotitanoceras armeniacum</i> (Abich), KU 34392. $\times 0.5$.	422
7, 8. <i>Domatoceras hunicum</i> (Diener), MCZ 9765. $\times 0.5$.	421
9, 10. <i>Stenopoceros</i> sp. indet., KU 34434. 9, $\times 1$; 10, $\times 2$.	423



1



2



3



5

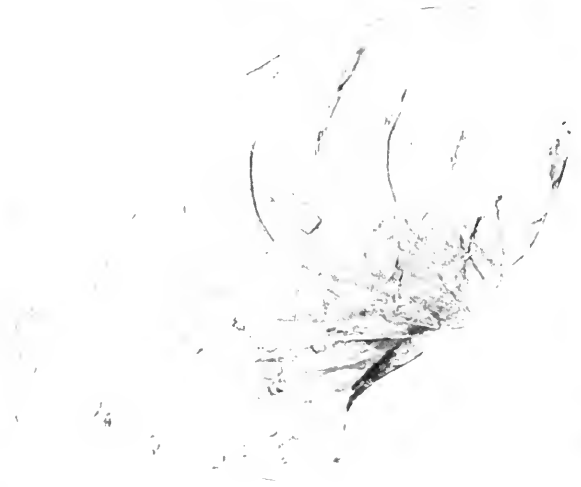

9



4



6



7



8



10

PLATE 2. DOMATOCERAS

Figures	Page
1, 2. <i>Domatoceras parallelum</i> (Abich), KU 34387. $\times 1$.	421
3, 4. <i>Domatoceras hunicum</i> (Abich), MCZ 9764. $\times 1$.	421
5, 6. Domotoceratid, n. gen., n. sp., MCZ 9773. $\times 1$.	422
7, 8. <i>Domatoceras</i> sp. indet., MCZ 9769. $\times 1$.	421
9, 10. <i>Domatoceras parallelum</i> (Abich), MCZ 9767. $\times 1$.	421



PLATE 3. TEMNOCHEILUS, METACOCERAS, TAINIONAUTILUS, LIROCERAS

Figures

	Page
1, 2. <i>Temnocheilus</i> sp. indet., MCZ 9761. $\times 1$.	419
3, 4. <i>Temnocheilus</i> sp. indet., MCZ 9762. $\times 1$.	419
5, 6. <i>Metacoceras darsaarmatum</i> (Abich), MCZ 9755. $\times 1$.	417
7, 8. <i>Temnocheilus</i> sp. indet., KU 34394. $\times 1$.	419
9, 10. <i>Tainionautilus</i> sp. indet., MCZ 9760. $\times 1$.	419
11, 12. <i>Liroceras</i> sp. indet., KU 34386. $\times 1$.	424



1



2



3



4



9



6



5



8



7

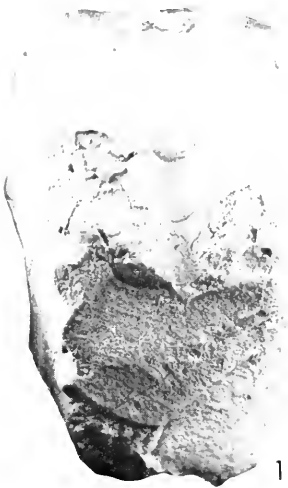

10



11

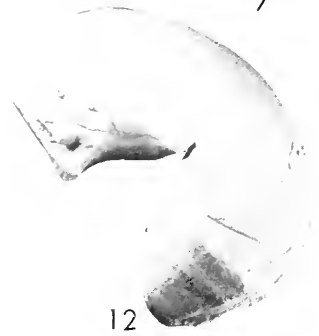

12

PLATE 4. TAINOCERAS, PLEURONAUTILUS, METACOCERAS, LOPINGOCERAS, NEOCYCLOCERAS

Figures	Page
1, 2. <i>Tainoceras</i> sp. indet., MCZ 9752. $\times 1$.	416
3, 4. <i>Pleuonautilus</i> sp. indet. 2, MCZ 9757. $\times 2$.	418
5, 6. <i>Metacoceras dorashamense</i> Shimanskiy, MCZ 9753. $\times 1$.	416
7, 8. <i>Pleuonautilus</i> sp. indet. 2, MCZ 9758. $\times 1$.	418
9. <i>Lopingoceras lopingense</i> (Stoyanow), MCZ 9774. $\times 1.5$.	414
10. <i>Neocycloceras</i> sp. cf. <i>N. obliqueannulatum</i> (Waagen), KU 34411. $\times 1$.	415
11. <i>Lopingoceras lopingense</i> (Stoyanow), MCZ 9776. $\times 2$.	414
12. <i>Neocycloceras</i> sp. cf. <i>N. obliqueannulatum</i> (Waagen), MCZ 9777. $\times 1$.	415
13, 14. <i>Lopingoceras</i> sp. cf. <i>L. lopingense</i> (Stoyanow), MCZ 9775. $\times 1.5$.	414

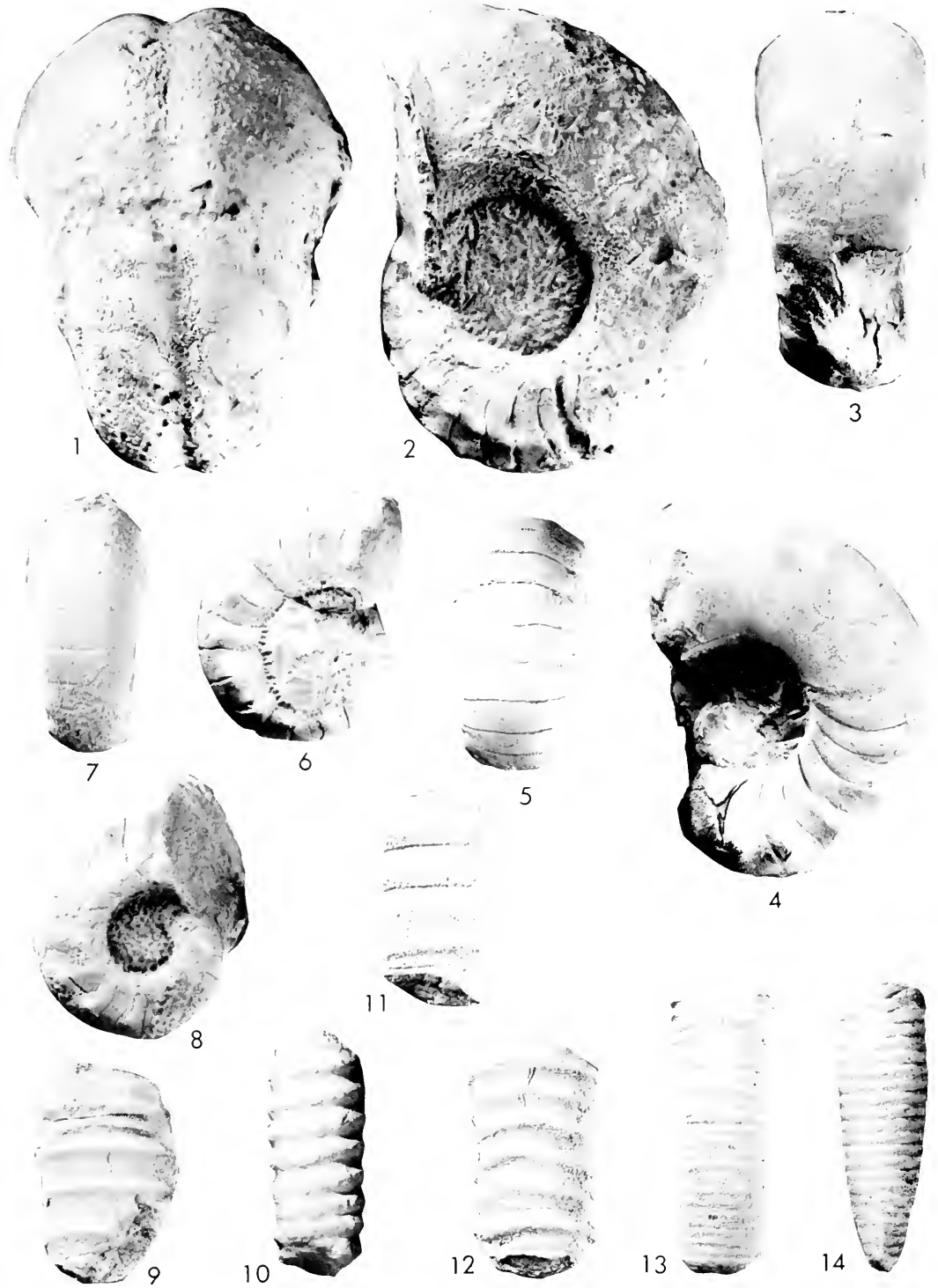

Bulletin of the
Museum of
Comparative
Zoology

The Nearctic Species of the
Genus *Dolomedes* (Araneae: Pisauridae)

JAMES EDWIN CARICO

PUBLICATIONS ISSUED
OR DISTRIBUTED BY THE
MUSEUM OF COMPARATIVE ZOOLOGY
HARVARD UNIVERSITY

BULLETIN 1863-
BREVIOIRA 1952-
MEMOIRS 1864-1938
JOHNSONIA, Department of Mollusks, 1941-
OCCASIONAL PAPERS ON MOLLUSKS, 1945-

Other Publications.

- Bigelow, H. B., and W. C. Schroeder, 1953. Fishes of the Gulf of Maine. Reprint.
- Brues, C. T., A. L. Melander, and F. M. Carpenter, 1954. Classification of Insects.
- Creighton, W. S., 1950. The Ants of North America. Reprint.
- Lyman, C. P., and A. R. Dawe (eds.), 1960. Symposium on Natural Mammalian Hibernation.
- Peters' Check-list of Birds of the World, vols. 2-7, 9, 10, 12-15. (Price list on request.)
- Turner, R. D., 1966. A Survey and Illustrated Catalogue of the Teredinidae (Mollusca: Bivalvia).
- Whittington, H. B., and W. D. I. Rolfe (eds.), 1963. Phylogeny and Evolution of Crustacea.
- Proceedings of the New England Zoological Club 1899-1948. (Complete sets only.)
- Publications of the Boston Society of Natural History.

Authors preparing manuscripts for the *Bulletin of the Museum of Comparative Zoology* or *Breviiora* should send for the current Information and Instruction Sheet available from Editor, Publications Office, Museum of Comparative Zoology, Harvard University, Cambridge, Massachusetts 02138, U.S.A.

THE NEARCTIC SPECIES OF THE GENUS *DOLOMEDES* (ARANEAE: PISAURIDAE)¹

JAMES EDWIN CARICO²

ABSTRACT. Of 34 names given in the literature for nearctic species of *Dolomedes*, only seven have validity: *D. tenebrosus* Hentz, *D. okfino-kensis* Bishop, *D. albivus* Hentz, *D. scriptus* Hentz, *D. vittatus* Walekenaer, *D. striatus* Giebel, and *D. triton* (Walekenaer). Two new species are described, *D. gertschi* and *D. holti*. Four new synonyms are recognized.

An effort is made to fully characterize each species in terms of habitat, affinities, geographic distribution, behavior, and morphological variation. New taxonomic characters are described, many of which are measurable. A characteristic array of color pattern zones in nearctic *Dolomedes* is described.

Pleistocene geographical isolation is proposed as the probable cause of evolutionary divergence in three species-pairs.

INTRODUCTION

Approximately forty-nine years ago Sherman Bishop (1924) published his revision of the Pisauridae of the United States which, for its time, stood as a classic among works on the taxonomy of spiders. The genus *Dolomedes* was given comprehensive treatment and most of the North American species were included. Although it is rather unusual for a particular

spider group to be revised twice within the same half-century, the present study was undertaken for three reasons: (1) additional collecting of familiar species since 1924 provides a better knowledge of their ranges; (2) new forms have been found since then; (3) new techniques and concepts in taxonomy, when applied to *Dolomedes*, bring about interpretations different from those of Bishop.

Thirty-four specific names have been applied to nearctic spiders of the genus *Dolomedes*. Here only seven of these names are regarded as valid, 14 have been synonymized, either in this paper or previously, and 13 are *nomina nuda, inquirenda*, or do not apply to species of *Dolomedes*. Among the major reasons for this proliferation of names is an apparent lack among previous workers of an appreciation or knowledge of variability within the group. Bishop did much to stabilize the nomenclature of well-known species of *Dolomedes*, but at the same time he introduced some new names which were based merely upon variants of other species. Since Bishop's work, Chamberlin and Ivie introduced new names and revived old ones which were applied to what I consider to be intraspecific variants. The problems of interpretation seem to arise from the variability of color pattern and certain parts of the genitalia which occurs in a number of the species. With this in mind I have attempted to gather

¹From a dissertation submitted to the faculty of Virginia Polytechnic Institute and State University in partial fulfillment of the requirements for the degree of Doctor of Philosophy.

²Department of Biology, Lynchburg College, Lynchburg, Virginia 24504. Research Fellow in Arachnology, Museum of Comparative Zoology, Harvard University, 1972.

some objective data on the extent of intra-specific variability involved in the species under investigation.

The primary objectives of this revision, however, are to redefine known species and describe new ones, compile information pertaining to their biology, and speculate upon factors of evolution in the genus.

Acknowledgments. Materials for this study were loaned by Dr. W. J. Gertsch (American Museum of Natural History), Dr. H. W. Levi (Museum of Comparative Zoology), Dr. H. K. Wallace (University of Florida), Dr. C. D. Dondale (Canada Department of Agriculture), the late Mr. Wilton Ivie (American Museum of Natural History), Dr. Robin E. Leech (University of Alberta), Dr. Perry C. Holt (Virginia Polytechnic Institute and State University), Dr. Paul Arnaud (California Academy of Sciences), Dr. Nicholas D. Jago (The Academy of Natural Sciences of Philadelphia), Dr. Robert J. Snetsinger (Pennsylvania State University), Dr. R. Piechocki (Martin-Luther-Universität, Halle, DDR), Dr. J. E. H. Martin (Canada Department of Agriculture), and Dr. John D. Unzicker (Illinois Natural History Survey). I wish to thank these men for their help. Valuable advice and counsel were provided by Drs. Gertsch and Levi at various times during the study, and their generosity is greatly appreciated. Dr. Holt devoted many hours to a critical examination of the manuscript. To him I am greatly indebted for stimulating my interest in spiders, his encouragement and, not least of all, his patience. I also wish to thank Dr. Herbert W. Levi, Dr. H. K. Wallace, Dr. Michael Kosztarab, Dr. Richard L. Hoffman, and Dr. John P. Hubbard for many helpful criticisms of the text.

Financial support was obtained from Grant-in-Aid No. NSF-G-4977 through the Highlands Biological Station, a Lynchburg College Faculty Improvement Grant supported by The Fund for the Advancement of Education (a Ford Foundation Pro-

gram), and the Biology Department of Lynchburg College. The Department of Biology of Virginia Polytechnic Institute and State University has contributed to the costs of publication.

BIOLOGY OF *DOLOMEDES*

Generally speaking, the members of the genus *Dolomedes* are large, rather robust spiders, with the length of the body in one species ranging to about 35 mm. They are usually encountered near permanent bodies of fresh water, over the surface of which they can run with surprising agility, apparently kept afloat by hairs coated with hydrophobic substances on the ventral surface of the body. These spiders utilize this ability to run on the water's surface to escape predation and to capture prey. In the latter case, they use the surface film as if it were a web, because they sit at the edge of the water and pursue insects that accidentally fall upon the water and are trapped by the surface tension. Thus, these spiders occupy the neuston community.

Prey capture. Detection of prey trapped by surface tension is probably by two means: eyesight and tactile stimuli from the surface of the water. Frequently, the spiders will be encountered resting upon a solid object floating on or emerging from the water with the anterior two pairs of legs resting upon the surface of the water itself. Apparently the ripples caused by an insect provide the stimulus for the predatory response and possibly also provide information as to the location of the prey. No data are available about visual acuity, and there is nothing to indicate that it is any greater or less than in any other member of the Lycosoidea.

Spiders of the genus *Dolomedes* are rather easy to capture by hand because they rarely give a flight response, even if the slowly moving pursuer is but a few inches away. Whether this is due to poor eyesight or to a peculiar behavioral pattern is not known.

Another unusual behavioral trait of *Dolomedes* is the ability to dive into the water either to escape predation or to prey upon aquatic organisms. Submergence beneath the surface film is accomplished only with considerable force, such as jumping off a high object or launching from a relatively stationary object at water level. During submergence, an envelope of air surrounds the body with the tips of the longest hairs and spines determining the thickness of the air space. Duration of submergence may be considerable. Bishop (1924) records ". . . one-half an hour or longer . . ." for *D. triton*, an observation which I have confirmed with other species as well. The mechanism must be similar to the plastron breathing of various aquatic insects in which the air bubble functions as an accessory lung to furnish dissolved oxygen and dissipate carbon dioxide. Spraying the spider with alcohol before submergence results in inability to produce an air envelope and subsequently the animal will remain underwater for only a few seconds. Whether this quick return to the surface of the water is due mainly to the influence of the alcohol or to the lack of sufficient oxygen is not known.

Prey taken underwater seems to be limited to fish. Barbour (1921) observed three spiders in southern Florida (which he believed to be *D. tenebrosus*), each involved in consuming a small fish. Considering the locations, the spiders were probably *D. okefinokensis*. McCook (1889) fancifully figured a spider riding the back of a relatively huge fish. Davis (1891) stated that while watching one of a number of specimens of *D. triton* on the surface of a small pond ". . . it suddenly made a rapid motion and seized a little silvery fish over an inch in length. It held it firmly and remained as stationary as it had been before the capture." *Dolomedes triton* has been known to cause considerable damage in fish hatcheries (Mechan, 1934). In such cases, these spiders were observed to

have a standard method of attack which was with the ". . . mandibles sunk in the prey at the base of the head and the legs clasping the body in a straddling position." Several other accounts of fish capture, apparently by *Dolomedes*, may be found in articles by Spring (1859), Peters (1876), Gudger (1922, 1925, 1931), and Adams (1927). More recently, a striking photograph was published in *Turtlox News* (Mohrhardt, 1963) which showed a specimen of *D. scriptus* consuming a small fish along a Michigan stream. The only such case I have observed was of a female *D. scriptus* feeding upon a small darter. It is reasonable to believe that aquatic invertebrates, especially insects, would also fall prey to *Dolomedes*, but no cases have been reported nor have I observed any. On the basis of present information, it is difficult to say whether or not fish are the preferred underwater prey.

Habitat relationships. Considerable field observation has shown that the species of *Dolomedes* have fairly well-defined habitats, especially wherever several species are found together in the same stream system. The majority of nearctic species are confined to the eastern United States, approximately east of the one-hundredth parallel, and in almost any stream system in this area a number of species will occupy essentially different microhabitats. Descriptions of the microhabitats must be understood to be rather general and there are frequent invasions of microhabitats by other species. Habitat specificity seems to be related primarily to size and type of the body of water and to the vegetation. It is difficult, in the latter case, to determine whether the type of vegetation or the amount of shade is more important.

Three common species in the midatlantic states, *D. scriptus*, *D. vittatus* and *D. triton*, have been studied most closely. In this region many stream systems are occupied by all three species. *Dolomedes triton* is usually found among emergent vegetation

in ponds, lakes, and slow moving streams which are characterized by relatively quiet water. *Dolomedes scriptus* is usually common along large, moderately swift streams where there are rocks, boulders, and entangled rubbish emerging from or bordering the water. These larger streams typically are open to the sun because of the wide separation of tall, woody vegetation on the banks. *Dolomedes vittatus* is most often encountered along smaller, moderately swift streams with most of the sunlight shut out because of a rather continuous cover of tall, woody vegetation overhead. Several streams have been studied, and two examples will demonstrate the habitat relationships of these three species.

The first example is the relatively undisturbed upper parts of the Cullasaja River system near Highlands, North Carolina. Two small, artificial lakes, located near the town at the headwaters of Mill Creek, Lake Ravenel, and Harris Lake, have rather stable vegetation composed of water lilies and sedges. The chief spider occupant of these lakes is *D. triton*. However, the small streams that drain these lakes are well shaded by tall vegetation and are inhabited chiefly by *D. vittatus*. Further downstream, in the Cullasaja River proper, *D. scriptus* is the species most often encountered. The stream here is rather rapid and possesses many emergent boulders but is not shaded by a continuous canopy.

The other example is from the Toxaway River drainage of Transylvania County, North Carolina. The specific area studied is the part of the river near Bearwallow Creek and the creek itself. The river is wide, open and contains many rocks, boulders, and much rubbish, while the creek is small, closed overhead and also contains rubbish and rocks. *D. scriptus* is the main occupant of the river and *D. vittatus* is the chief occupant of the creek. The general area of the creek mouth is a transition zone where some *D. scriptus* are found part way up the creek, and *D. vittatus* is found under

clumps of grass and in other dark areas along the banks of the river.

The above-mentioned species are protectively colored for their respective habitats. *Dolomedes triton* usually varies from greenish to light tan in color and blends with the aquatic green herbaceous vegetation, sometimes covered with mud, among which it is typically associated. *Dolomedes scriptus* is gray with distinct light and dark markings which make it blend well with the gray rocks and weathered, sun-bleached rubbish with which it is found. *Dolomedes vittatus* ranges from light to dark brown (in males) to almost entirely dark brown (in females), and approximates the brownish hues of rotting, unbleached, woody rubbish and dead leaves found in and around the water.

Protective coloration suggests predation by visual predators. Pompilid and sphecoid wasps, which hunt primarily by sight, and although more properly called parasites, apparently take their toll of *Dolomedes*. This assumption is based on the collection of a large paralyzed female *D. tenebrosus*. Vertebrate predation is known only from a collection from Florida which contains 32 *D. triton* adults and juveniles taken from the gut of an immature little blue heron, *Florida caerulea caerulea*.

In the southern coastal plain of the United States, there are at least three different species typical of the streams of the region. Observations have been made on parts of the Waccamaw River, in Horry County, and the Santee River, in Georgetown County, South Carolina. In many of these slow-moving streams *Dolomedes* is found on cypress and other trees as well as herbaceous vegetation emerging from the water. *Dolomedes triton* is found among the herbaceous vegetation and occasionally at the waterline on small bushes and trees. *Dolomedes albineus*, a light gray species, is found higher up the trunks of trees, lying flat against the bark about three to six feet above the waterline, while *D. tenebrosus*, another gray species, remains usually within

two feet of the waterline. Both *D. albineus* and *D. tenebrosus* blend well into the gray bark background. A similar relationship among these species has been observed in a small stream in Leon County, Texas.

In the Okefinokee Swamp, Georgia, a similar situation exists. This area is also characterized by a mixture of vegetation such as cypress trees and other woody plants, along with various herbaceous plants. Here the same species as those named above exist, with the exception that *D. tenebrosus* is replaced by its close relative *D. okefinokensis*, which occupies a similar habitat. These three species are found throughout peninsular Florida and probably occupy their respective microhabitats wherever they coexist.

Sexual biology. In experiments, Kaston (1936) showed the presence of substances that could elicit a mating response from spiders even in the absence of other spiders. One of the spiders he used was *D. scriptus*. Other experiments by Hegdekar and Dondale (1969) have shown the specific nature of sexual pheromones in interspecific mating in the closely related lycosids. This evidence seems to indicate a major role played by chemotactic stimuli in the mating process.

My observations of the mating of two species of *Dolomedes* suggest that visual stimuli play a relatively minor role. These observations were made upon *D. scriptus* (two complete matings) and upon an unusual case in which an adult male and a penultimate female *D. vittatus* were displaying preliminary mating behavior. In all these observations there was a preliminary period of "palpation," consisting of leg waving and touching, beginning with contact with the tarsi and proceeding to contact with the tibiae as the pair gradually moved closer together. The contact was primarily between leg pair I and, to some degree, leg pair II. This stage required about thirty minutes, and the majority of the time the animals were unable to see more than each other's legs waving in the air because they were on opposite sides

of small rock ledges or flat pieces of wood. In one case the initial parts of this preliminary period were begun while the female was unable to see its partner at all because the contact was made while her legs were flexed over the edge of the rock. Whenever complete mating occurred, the contact was made between the femora. The male faced the anterior end of the female during the preliminary period, moved about 180° around the stationary female, and then advanced backward over the female, which had, during this time, assumed a posture with the legs I and II extended forward while she stood high off the ground on the tips of the tarsi III and IV, with the femora almost vertical. As the body of the male crossed over the female, he settled down upon her, reached around the body between legs III and IV, and placed the palpal organ against the epigynum, apparently immediately releasing the sperm into a bursa copulatrix. After this first contact with the palpal organ, the female appeared to quickly throw off the male. The male approached a second time, with the preliminary palpation period lasting but a few seconds, and the other palpal organ was then emptied. The male approached a third time and possibly as much as a fourth, but each time the female rejected him and the two subsequently parted. The two observations of complete *D. scriptus* matings were made 29 August 1961, and 3 September 1961, in mountainous streams of southwestern North Carolina. In both cases the females were gravid at the time of mating. These observations of mating in the natural habitat are quite similar to observations made in the laboratory by Kaston (1936).

In other groups of spiders the embolus of the male palpal organ is frequently broken off during mating and remains embedded within the bursa copulatrix of the female. Notable in this sense is the Theridiidae (Levi, 1959) and the Lycosidae (Hegdekar and Dondale, 1969). Some specimens of *D. scriptus*, *D. triton*, and *D. vittatus* in the collections I have studied each had

one embolus still inserted. No palpal organ studied was without an embolus. It appears that breaking of the embolus in *Dolomedes* is infrequent.

EVOLUTION IN NEARCTIC DOLOMEDES

It is with hesitation that I attempt to speculate upon the evolution of a group whose biology and systematics are so poorly known. However, underlying any similar venture in any group, there is at least an unarticulated understanding that what is said is subject to future revision. Such speculations, then, are useful at any stage of knowledge in giving direction and focus to further work.

I wish to comment chiefly upon the recent evolution of three species-pairs of *Dolomedes*. This effort was prompted by observations upon the known distributional patterns and upon apparent evolutionary relationships that are based upon structure and ecology. But first, consideration must be given to some basic biological factors involved in spider evolution.

General considerations. Apparently, the chief event that precedes speciation is geographic isolation. Therefore, an understanding of how a population can be isolated is directly related to knowledge of the dispersal mechanisms of that species. Two known important mechanisms of dispersal in *Dolomedes* could be classified as *passive* and *active*.

The *passive* means of dispersal is the process referred to as "ballooning." This is the well-known mechanism involving the dispersal of spiders by wind currents. Our knowledge is incomplete, not only about which species balloon, but also which families balloon. Additionally, we have inadequate information about the importance of ballooning in colonization and therefore what part it plays in geographic isolation.

Whether ballooning is a generic characteristic of *Dolomedes* is unknown, but there is some evidence that certain species

are capable of this practice to some degree. The nursery web is typically placed high in weeds, higher than where these animals usually stay at other times in their respective habitats. Perched at this height, the spiderlings at least have an increased opportunity for successful ballooning even though there is no available evidence that the nursery is a specific adaptation to this function. I have not observed ballooning, but Emerton (1908) reported finding evidence of considerable fall ballooning in *D. triton*.

If we conclude that some species of *Dolomedes* do balloon as a general rule, then we must consider the degree of their capability, and further, the relationship of this capability to the ability to colonize new areas across wide barriers. Some indirect evidence is available to suggest that their ballooning capability is not as great as in many other spiders.

First, these spiders are quite dependent upon water. With the exception of *D. tenebrosus*, which may be found in moist basements of houses or woods, they are not found far from bodies of water. Experience with culturing them in the laboratory shows that they are much more susceptible to fatal desiccation than are most other spiders. Their dependency upon water therefore suggests difficulty in surviving long-distance transport in the air. It is unlikely that any but very small immatures would balloon great distances because of the relatively large size of these animals. If only the immatures are able to balloon, then they would be faced with the problems of encountering a suitably moist habitat and surviving there for up to about two years until reaching sexual maturity. If a spider somehow survives to reproductive age then it must encounter a spider of opposite sex, also at the reproductive stage at the same time. These factors of chance tend to raise doubts about the probability of successful long-distance transport and colonization when compared with well-known ballooners.

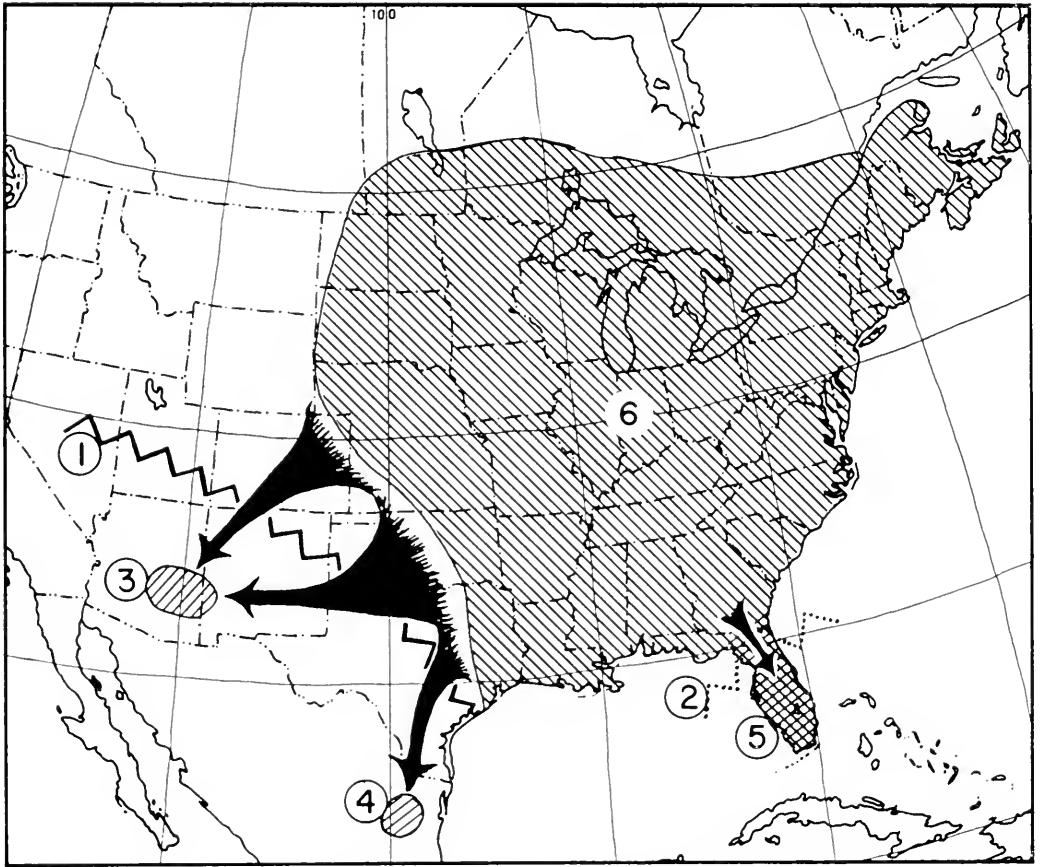

Map 1. Speciation among six nearctic species of the genus *Dolomedes*. The diagonally hatched area (6) represents the combined distributions of the widely distributed eastern species: *Dolomedes scriptus*, *D. vittatus*, and *D. tenebrosus*. The isolated populations of *D. gertschi* (3) and *D. holti* (4) are separated from the eastern populations (6) by a xeric barrier (1) which probably became established in the Pleistocene. The Florida species, *D. okefinokensis* (5), was probably isolated from the eastern populations (6) by a sea barrier (2) also at some time during the Pleistocene. The black arrows show probable dispersal routes into the isolated areas from the eastern populations.

Another kind of passive dispersal is transportation by flowing water in streams. This would not be of interest in terms of geographic isolation because freshwater connections would potentially provide continuous connections between populations, and similarly between their gene pools. Many changes in streams which affect the distribution of strictly aquatic animals (e.g., stream capture and fishes) would not apply to *Dolomedes*.

Active means of dispersal is here meant to include primarily directional movements

of the spider by walking. Again, as stated before, water dependency seems to restrict *Dolomedes* to a wet, or at least a moist environment; therefore, species of *Dolomedes* are not found walking in arid areas, and are probably not capable of living in such conditions for very long. Within a drainage system, however, these animals might be expected to move long distances relatively quickly.

Areas of ocean water are also a barrier to dispersal. The apparent absence of *Dolomedes* from most islands off the coast of

southeastern U.S.A. may provide indirect evidence for this, because suitable habitats apparently exist there.

Temperature generally seems not to be a very important limiting factor to dispersal. Some species of *Dolomedes* are distributed over wide geographical areas that include widely diversified and extreme temperature characteristics. Overwintering seems to occur in most, if not all, stages of the life cycle.

Speciation in certain species pairs. Below, some particular species of the genus *Dolomedes* are treated in terms of their probable evolution. For the sake of further discussion, it is assumed that the proposed barriers to dispersal are effective against active and passive means.

Dolomedes scriptus-Dolomedes gertschi. These two species, which are clearly allopatric, seem to represent a rather closely related monophyletic species-pair. *Dolomedes scriptus* is widely distributed in eastern North America (Map 5), while *D. gertschi* is restricted to the mesic parts of the Gila River drainage in Arizona and New Mexico (Map 6). Invasion of each other's ranges by active means is apparently prevented by the broad xeric barrier separating the two distributions in these southwestern states. There is no indication that there is any invasion by passive means or that this is even very probable (Map 1).

If one assumes that these two species represent evolved fragments of a single ancestral species, then the time of emergence of the dispersal barrier between the fragments may indicate time of gene-pool isolation. That the xeric conditions of the southwest were caused primarily by the emergence of the Rocky Mountains and the Coastal Ranges is well established. It is not certain when the xeric conditions emerged, but they appear to have been at least post-Miocene. Well-documented evidence shows that during the Pleistocene this region experienced fluctuations in climate that caused expansions and contractions of mesic areas. We may postulate then, (1)

that the parent species had a continuous distribution from the East into the Gila River drainage, and therefore isolation occurred when xeric conditions between these areas became severe enough to block dispersal and gene flow (perhaps in the Pliocene or early Pleistocene), or alternatively that (2) no populations of the parent species existed in the Gila Basin until they were introduced into the area during a Pleistocene pluvial period (mesic period) followed by disjunction and differentiation in an interglacial (xeric) period. The Pleistocene may be the most likely time of differentiation.

Dolomedes vittatus-Dolomedes holti. These two species are probably more closely related than are any other two in North America. *Dolomedes vittatus* is relatively widely distributed in the eastern United States with the range extending westward into eastern Texas (Map 7). *Dolomedes holti* is known only from the drainage of the upper San Juan River, a Mexican tributary of the Rio Grande (Map 8). There is a lack of congenial habitats between the lower reaches of the tributaries of the Rio Grande and the streams of the eastern United States. Therefore, if the geographic range of the parent species included the ranges of the present species, then *D. holti* could have been derived from populations separated by this xeric barrier (Map 1). If, however, the parent species did not originally extend into the Rio Grande before the barrier developed, it is possible that the Mexican species emerged from a population that invaded the Rio Grande drainage during a Pleistocene pluvial stage. Following the invasion, when contraction of mesic conditions occurred, the populations at lower elevations moved into the cooler, wetter canyons in the mountains. The same geological events were apparently involved here as in the first species-pair mentioned.

Dolomedes tenebrosus-Dolomedes okefinokensis. Again, these represent a closely related species-pair, but the probable

factors relating to their origin are quite different from those described for the previous pairs. Both are eastern North American species, with *D. tenebrosus* distributed from Canada to western Florida (Map 2) and the apparently allopatric *D. okefino-kensis* chiefly limited to peninsular Florida (Map 3). The most outstanding feature of the southern Coastal Plain that has probable relevance to *Dolomedes* speciation, is the occurrence of islands in peninsular Florida during interglacial periods of the Pleistocene (Map 1). That these islands were formed in the Aftonian, Yarmouth, and Sangamon interglacial periods is well established, and the geological evidence will not be reviewed here (see Flint, 1940; MacNeil, 1950; King, 1965).

The Pleistocene islands of Florida have previously been proposed as important factors in the differentiation of other groups, such as reptiles (Auffenberg and Milstead, 1965). Of greater significance for this discussion is the excellent work of McCrone (1963) in which he gives convincing evidence for Pleistocene speciation in *Geolycosa* owing to isolation on these islands during Pleistocene interglacial times. If one assumes that these islands (1) had a hospitable environment, (2) existed long enough for speciation to occur, and (3) were inhabited by a disjunct population of the parent species, then one might be able to date with some accuracy from geological data the origin of *D. okefino-kensis*.

The present distribution of these species can be explained on the basis of interaction between them. *Dolomedes okefino-kensis* apparently became better adapted to relatively warmer climatic conditions, and eventually a zone of demarcation between their respective ranges became established. There is no obvious difference in other aspects of the habitats, so the allopatry may be now maintained by competition.

In each of the foregoing species-pairs, there is one representative that has a wide eastern distribution and another that has

a restricted and allopatric one. All three of the former species are largely sympatric in the East.

Taking an overview of the species ranges under consideration, in reference to geological events, it seems that the large, eastern ranges are found in relatively undisturbed portions of North America, while the smaller allopatric distributions are isolated in areas that are known to have had more Pleistocene climatic (at least in terms of arid-versus-mesic considerations) and geographical disruption. It seems reasonable, then, to conclude that Pleistocene events were the major causes of speciation owing to geographic isolation in these areas.

Not enough evidence is available to arrive at any conclusions about the evolution of the three remaining nearctic species: *D. albineus*, *D. striatus*, and *D. triton*. It is worthwhile, however, to note the geographic distributions of these species which would undoubtedly play a significant part in any conclusions about their evolution. *Dolomedes albineus* (Map 4) is primarily found in the eastern Coastal Plain and geologic events in this region may have influenced the origin of this species. *Dolomedes striatus* (Map 9) is almost entirely limited to the glaciated region of eastern North America. *Dolomedes triton* (Map 10) is very widespread in the Nearctic Region, more so than any other species of *Dolomedes*, and one might expect some differentiation to be evident in the various populations represented in the collections. Most of the collections from outside the eastern United States contained immatures and the few adults available showed no clear evidence of differentiation. Further collecting in these areas may eventually lead to the discovery of new forms.

A summary of probable evolutionary relationships is diagrammed in Table 1. The basis for the construction of this dendrogram of nearctic *Dolomedes* is the structure of the male palpus. Features such as the fundamental configuration of the median apophysis and tibial apophysis

TABLE 1. DENDROGRAM OF THE NEARCTIC SPECIES OF *DOLOMEDES*. THE "DEGREES" OF RELATIONSHIP DO NOT REPRESENT ANY EXACT POINT IN TIME, AND THE DISTANCE BETWEEN EACH "DEGREE" ON THE DENDROGRAM IS THEREFORE NOT DRAWN TO ANY CHRONOLOGICAL SCALE.

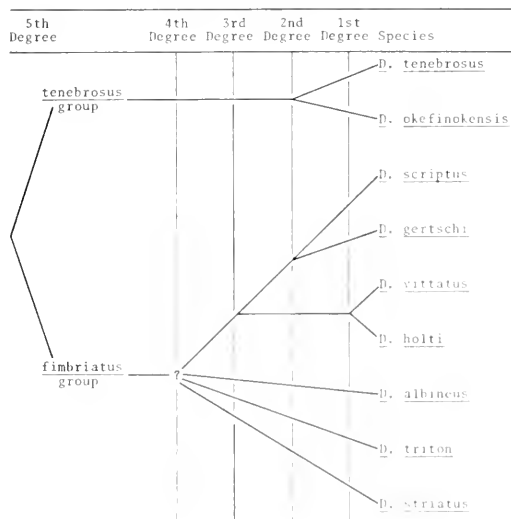

appear to be rather sensitive indicators of degree of relationship. Also helpful are configuration of the tegulum and the relative lengths of the cymbium and tibia.

METHODS

All drawings of genitalia were made to the same size to emphasize *form* rather than *size* because of extreme variation in the latter. Dorsal color patterns were photographed and drawings made from the photographs.

For purposes of illustration the right male palpus was dismembered at the joint between patella and tibia. The female genitalia were removed and dissected according to the methods described by Carico and Holt (1964).

A zoom stereomicroscope was used in the measuring of all characters. An ocular micrometer was employed in a 10× wide-field ocular and the system was calibrated by a stage micrometer. The two magnifications used were approximately 10× and

50×; the latter was obtained with 2× accessory lens. All measurements were made by myself.

A large number of characters were measured on small samples and only those that seemed to be of practical diagnostic value were utilized on all specimens. Many measurements, ratios, and characters used herein are unique to this study, and an explanation of abbreviations used in both text and illustrations is found in the following list, except that ratios are indicated in the form of a fraction (e.g., EW/EL).

A—atrium; AB—accessory bulb; AE—the four eyes of the anterior row; BC—bursa copulatrix; C—cymbium; CL—length of the carapace; CON—conductor; CW—carapace width; CYL—length of the cymbium as measured from the prolateral side (Fig. 39); E—epigynum; EF—epigastric furrow; EL—maximum length of the epigynum (Figs. 49–50); EMB—embolus; EW—maximum width of the epigynum (Figs. 49–50); FT—fertilization tube; FUL—fulcrum; GP—gonopore; LE—lateral elevation; MA—median apophysis; MAT—muscle attachments (found on all mature female specimens but illustrated only when of diagnostic value); MB—medial borders of lateral elevations; MC—median concavity; ME—median elevation; MEW—width of the middle elevation of the epigynum as measured by the maximum distance between the medial edges of the lateral lobes, used *only* in *fimbriatus* group (Fig. 50); OV—oviduct; PAP—point on the proximal end of male palpal tibia that articulates directly with the patella (Fig. 38); PE—the four eyes of the posterior row; PEL—length of the posterior part of the epigynum as measured from the narrowest point of the median elevation to the most posterior margin, used *only* in *tenebrosus* group (Fig. 49); PL—post-valvar ligaments; PTL—length of the posterior part of the tibia between the proximal articulation point (PAP and the axilla of the tibial apophysis base (Fig. 38); S—spermatheca; SV—seminal valve; SVH—

maximum height of the seminal valve as measured between the apical tip of the seminal valve and the posterior extreme of the epigynum (Fig. 59); SW—maximum width of the spermathecae (Fig. 59); T—tibia; TA—tibial apophysis; TEG—tegulum; TL—length of the male palpal tibia between proximal articulation point (PAP) and distal apex (Fig. 3S).

The length of the carapace is used as an index to the length of the animal instead of total length because the softer abdomen is subject to wider variation as a result of sex, gravidity, feeding, and age. The abdomen is about equal to the length of the carapace in males and about 1.3 the length of the carapace in females.

All statistical data were computed with an IBM 1401 computer through the Fortran IV language. The computations are compiled into modified Dice-Leraas diagrams (Diag. 1).

Specimens were collected during the day or night by hand or net. Because of the vagabond nature of these spiders, sweeping is not effective and it is necessary to find each individual animal by sight alone. Some animals were collected in 3 percent formalin and 80 percent ethanol, which tend to maintain the color patterns more distinctly. Storage of all collections is in 80 percent ethanol.

Some locality data for each species are included in the thesis (Carico, 1970) from which this paper has been taken. A list of additional locality records obtained since the writing of the thesis is deposited in the author's files.

TAXONOMIC CHARACTERS

Since early names were given to specimens because of differences in color patterns, attention is given herein to this character. Emphasis is placed upon the relative intensity of coloration of a particular specimen and no attempt is made to describe precise hue because of the less permanent nature of the latter.

During a study of the color patterns of species of *Dolomedes* the existence of a definable common array of pattern components distinctive of *Dolomedes* was found. Not all species share the same assortment of variations of components, but all species have *some* assortment which is usually species specific. This situation, I believe, is further proof of the close phylogenetic relationship of the species. Furthermore, one may derive a common pattern "motif" from the species of a genus and speculate upon its value as a generic character by comparing it with the "motifs" of related genera.

In Table 2 I have indicated diagrammatically those "zones" of the color pattern "motif" which lend themselves to analysis because of their relative distinctness and therefore ease of interpretation. There are several other less distinct features that are not analyzed. The zones analyzed are subject to some intraspecific and intrasexual variation as is indicated in the descriptions, but only the most significant variations are treated. The table is intended primarily for comparative purposes, but it might be used as a supplement to the species descriptions and as an aid to the identification of immatures.

Certain zones may be considered as being "primitive." Specifically, zones 6, 9, and 10 appear to be present in all species, at least at some period of development (with the exception of *D. striatus*, of which I have not seen older spiderlings). Additionally, very similar markings are seen in some species of lycosids, an indication that these markings are not confined to *Dolomedes*. They coincide with the hypothesized primitive segmentation of the body, especially those on the carapace, and therefore may be related directly to this segmentation ontogenetically.

The male palpal organ is remarkably similar among the species within a species group and there is no attempt to give full descriptions of it in each species. Instead, references are made to species-group de-

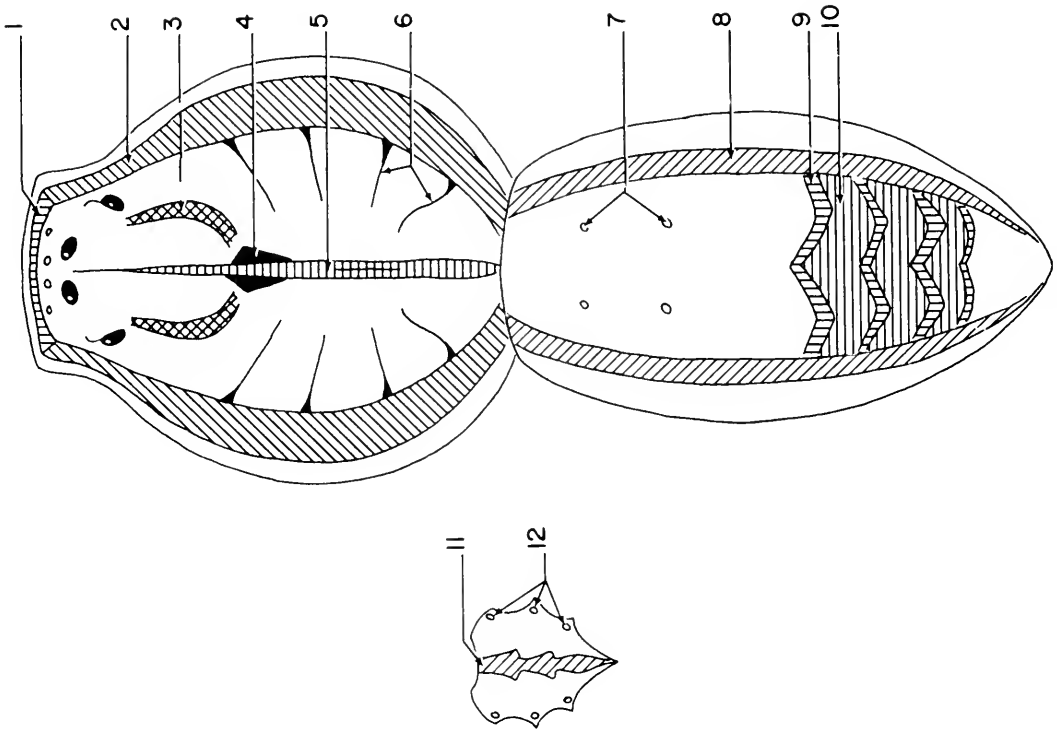

TABLE 2. VARIATION OF STANDARD COLOR ZONES IN NEARCTIC SPECIES OF *DOLOMEDES*. THE ACCOMPANYING FIGURE SHOWS THE LOCATION OF THESE COLOR ZONES. SEE TEXT FOR FURTHER DISCUSSION.

	<i>Dolomedes tenebrosus</i>	<i>Dolomedes okefinoekensis</i>	<i>Dolomedes albinus</i>	<i>Dolomedes scriptus</i>	<i>Dolomedes acritschii</i>	<i>Dolomedes vittatus</i>	<i>Dolomedes holti</i>	<i>Dolomedes striatus</i>	<i>Dolomedes triflorus</i>
1 TRANSVERSE LIGHT BAND	Median Spot	Median Spot	Median Spot	Present	Median Spot	Absent	Present or Absent	Absent	Median Spot
2 SUBMARGINAL LIGHT BAND	♂ Present ♀ Series of light areas	♂ Present ♀ Series of light areas	Absent	♂ Series of light areas to bands ♀ Series of light areas to absent	♂ Series of light areas to bands ♀ Series of light areas to absent	♂ Bands ♀ Absent	Present or Absent	Present	Present
3 LIGHT BAND	Present	Present	Absent	Present	Present	♂ Present ♀ Absent	Present or obscure	Absent	Present
4 DARK SPOTS	Present	Present	Indistinct	Present	Present to obscure	Present	Present	Absent	Indistinct
5 LIGHT BAND	Present	Present	Absent	Present	Between III and thoracic groove	obscure to Absent	Present	Absent	Absent
6 DARK LINES	Present	Present	Present	Present	Present	Present	Present	obscure	Present
7 LIGHT BAND	Absent	Absent	Absent	♂ obscure or absent ♀ Absent	Absent	♂ Present ♀ Absent	♂ Present or absent ♀ present or absent	Present	Absent
8 LIGHT SPOTS	Absent	Absent	Absent	Absent	Absent	Absent	Absent	Present or obscure	Present
9 LIGHT BANDS	Present	Present	Present	Present	Present	obscure in young and lighter adults	Present or absent	Lateral Spots or spots obscure	Present
10 DARK BANDS	Light laterally	Light laterally	Present	Present	Present	♂ lateral lines continuous with #7 ♀ lateral spots	Lateral lines continuous with #7 or lateral spots	Absent	Obscure only in spiderlings
11 LIGHT BAND	Present	Present	Absent	Present	Present	♂ Present ♀ Absent	Present or Absent	Dark on light background	Absent
12 DARK SPOTS ON LIGHT BACKGROUND	Absent	Absent	Absent	Absent	Absent	Absent	Absent	Present	Present & sometimes coalesced

scriptions, and only significant distinctions are noted when present. A detailed description of the anatomy of the male palpus may be found in Comstock (1940) and Bishop (1924). Refer to Figures 28 and 38-39 for a review of the anatomy. The basic shape of the tibial apophysis in many cases proved to be diagnostic. Ratios of various parts of the male pedipalp were very helpful in distinguishing species, and these data are presented in Dice-Leraas diagrams. Refer to the list of abbreviations for an explanation of the characters that were measured.

Female genitalia also are basically very similar within a species-group, but any important diagnostic differences that do exist are noted with the use of the terminology of Carico and Holt (1964). A detailed account of the anatomy of the genitalia is found in Carico and Holt and no description is given herein except for a brief review in Figures 2 and 16. Ratios of various parts of the female genitalia also proved to be helpful in distinguishing species, and these data are also presented in Dice-Leraas diagrams. Refer to the list of abbreviations for an explanation of the characters that were measured.

Dolomedes Latreille

Dolomedes Latreille, 1804, Dictionnaire (Nouveau) d'Histoire Naturelle, 24: 135. Type, by subsequent designation, *Araneus fimbriatus* Clerck (see discussion below for explanation).—Walckenaer, 1805, Tableau des Aranéides, pp. 16, 17.

Teippus Chamberlin, 1924, Proc. United States Nat. Mus., 63(13): 28. Type, by monotypy, *Teippus lamprus* Chamberlin. First synonymized by Gertsch, 1934, American Mus. Novitates, No. 726: 11.

Description. Carapace: rather uniform in shape, longer than broad, moderately high, slightly indented to entire at posterior edge, thoracic groove distinct. *Eyes:* two transverse rows, anterior row much narrower than posterior; anterior eyes subequal, smaller than posterior, in a straight line or

slightly procurved; posterior eyes subequal, in a greatly procurved line; median ocular area much wider behind. *Sternum:* lanceolate, truncated anteriorly, acute posteriorly. *Chelicerae:* basal segment robust; retro-margin of fang furrow with four equidistant teeth of equal size; promargin with three teeth, distal smallest, middle largest, proximal intermediate in size. *Pedipalp:* dorsal surface of femur with 7 spines (Fig. 37). *Legs:* typically IV-I-II-III; supplied with large, articulating spines; undersurface of distal segments clothed with long hairs curved at tips. *Abdomen:* robust; group of strong, curved hairs on anterior declivity. *Pedicel:* superior lorum composed of four sclerites, two median and two lateral. *Integument:* clothed in a variety of types of hairs including plumose hairs located primarily in white areas. **MALE:** *Pedipalps:* tibia with a lateral apophysis. *Bulb:* external tegulum, embolus distal and pointed ventrad, median apophysis ventral. **FEMALE:** *Epigynum:* three primary elevations, lateral two elevations with darkened medial borders. *Internal copulatory apparatus:* narrow and tapered bursae copulatrix, spermathecae thick-walled and ovoid, accessory bulbs each attached laterally to a spermatheca.

Discussion. Latreille (1804) erected the genus *Dolomedes* with only a reference to "Les *coureuses* de Walckenaer." Walckenaer (1805) used this generic name with *Araneus fimbriatus* Clerck, one of the two species he mentioned in a previous work and which Latreille apparently had in mind when he erected the genus. *Dolomedes fimbriatus* (Clerck), a common and well-known species of eastern Europe, is therefore the type of the genus. On the basis of a comparative study of female genitalia, Carico and Holt (1964) considered *D. fimbriatus* to be congeneric with the American taxa referred to *Dolomedes*, and this opinion has been confirmed by subsequent comparison of the palpal structures of the males.

Dolomedes is included in the family

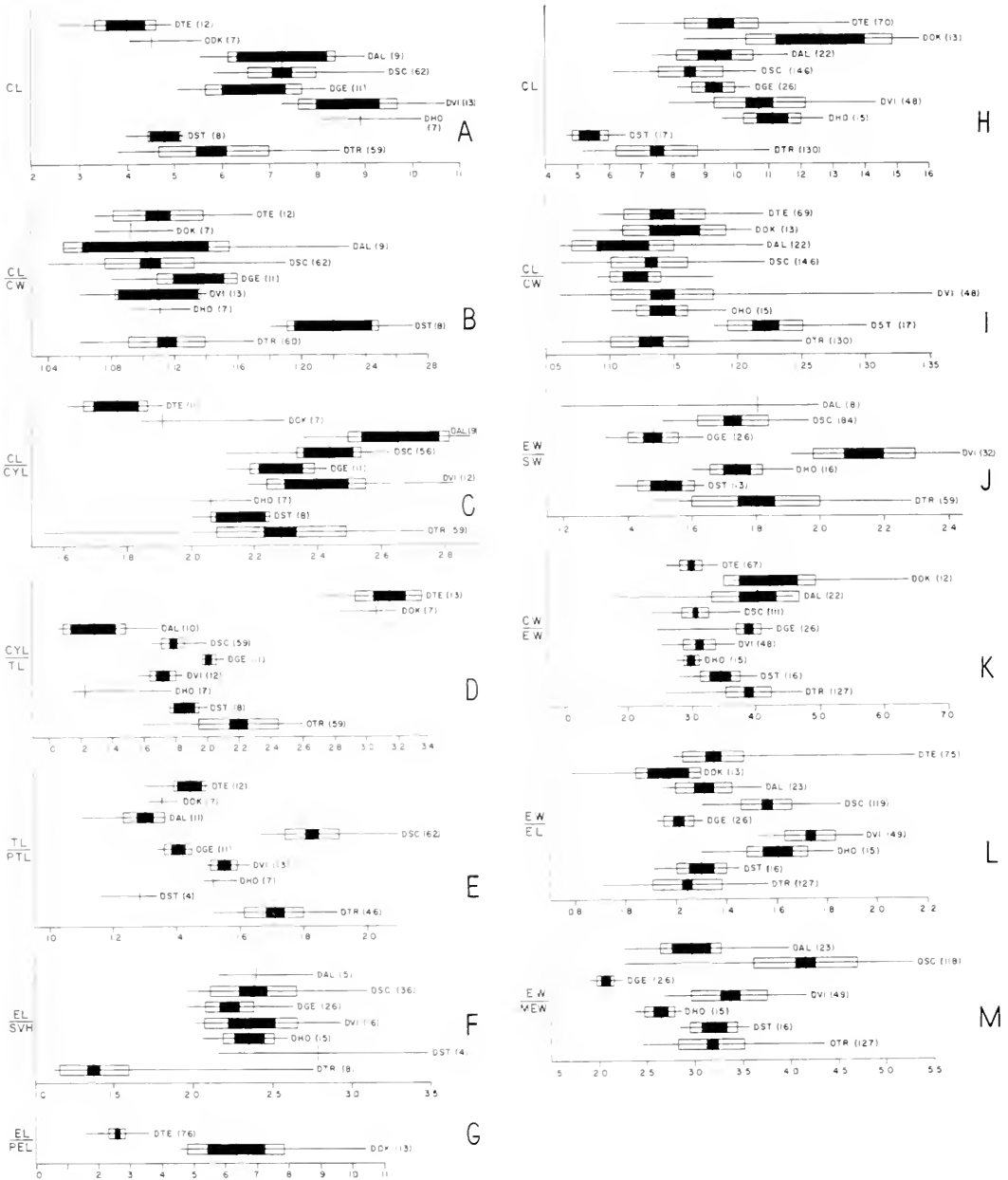

Diagram 1. Dice-Leraas diagrams (modified) of measurements and ratios in the nearctic species of *Dolomedes*. A-E Males. F-M Females. (Scales: A and H are in millimeters.)
 Explanation of diagrams. Vertical line = mean; horizontal line = observed range; open rectangle = standard deviation; black rectangle = 95% confidence interval for the mean; number in parentheses = number of specimens observed. DAL = *D. albineus*; DGE = *D. gertschi*; DHO = *D. halti*; DOK = *D. akefinakensis*; DSC = *D. scriptus*; DST = *D. striatus*; DTE = *D. tenebrarius*; DTR = *D. triton*; DVI = *D. vittatus*.

TABLE 3. A COMPARISON OF OLDER NOMENCLATURES FOR NEARCTIC SPECIES OF *DOLOMEDES* (BISHOP, 1924; BISHOP AND CROSBY, 1936; CHAMBERLIN AND IVIE, 1946) WITH THE NOMENCLATURE ADOPTED IN THIS PAPER.

Old Names	Change	Names used herein
<i>D. tenebrosus</i> (1924)	no change	<i>D. tenebrosus</i>
<i>D. olefinokensis</i> (1924)	no change	<i>D. kefinokensis</i>
<i>D. suspectus</i> (1946)	synonymized	<i>D. albineus</i>
<i>D. albineus</i> (1924)	no change	
<i>D. panicola</i>	1924	<i>D. scriptus</i>
<i>D. scriptus</i>	1936	
<i>D. albiclavus</i> (1924)	synonymized	<i>D. tritatus</i>
<i>D. t. tritatus</i> (1924)		
<i>D. t. sexpunctatus</i> (1924)		
<i>D. sexpunctatus</i> (1936)		
<i>D. scapularis</i> (Ivie, 1946)		
<i>D. spatulatus</i> (1936)	no change	<i>D. tritatus</i>
<i>D. triton</i> (1946)		
<i>D. striatus</i> (1924)	synonymized	<i>D. tritatus</i>
<i>D. fulvistrigatus</i> (1924)	synonymized	<i>D. tritatus</i>
<i>D. vittatus</i> (1924)	synonymized	<i>D. tritatus</i>
<i>D. urinator</i> (1924)		
	new species	<i>D. eritatus</i>
	new species	<i>D. albi</i>

Pisauridae (Simon, 1898), which is a spider family with a moderately large number of species. Bonnet (1956–1959) lists 53 genera and 350 species, while Roewer (1954) lists 64 genera and 538 species. In the New World, *Dolomedes* is primarily found in the Nearctic Region with only three doubtful species described from South America.

The pisaurids are cursorial spiders recorded from all continents. In the Nearctic Region, they are usually found in close relationship with freshwater or moist conditions. Some genera composed of relatively small-sized species such as *Pisaurina*, *Thanatidius*, and *Pelopatis* typically hunt in low herbaceous vegetation growing on the shores of, or emerging from, bodies of water, while the larger-sized species of *Dolomedes* or *Trechalea* characteristically are found among rocks and debris bordering or emerging from a body of water. Members of many of the latter species are quite pro-

ficient at walking on the surface of water or submerging beneath it for long periods.

Species-groups of Dolomedes. In a comparative study of females, Carico and Holt (1964) observed that there are two distinct types of female genitalia in the nearctic species of *Dolomedes*. This conclusion has been confirmed by females examined in the present study. Further, the taxonomic implications are strengthened by the discovery that there are also corresponding differences in the male genitalia. The conclusion is that there are two distinct divergent species-groups represented. The bases for this grouping of species, other than genitalia, are mainly the comparative sizes of males and females (using the length of the carapace as an index) and relative lengths of segments of the male pedipalp.

Nomenclature of nearctic species. The revision of the Pisauridae of the United States by Bishop (1924) brought considerable stability to the nomenclature of most nearctic species. Only two subsequent publications (Bishop and Crosby, 1936; Chamberlin and Ivie, 1946) have had any notable influence on the names in use since 1924. Since the nomenclature adopted in this paper varies considerably from the nomenclature of these authors, a summary of it has been tabulated (Table 3).

UNCERTAIN NAMES

- D. aeruginus* C. L. Koch, 1848, Die Arachniden, pp. 122–123, fig. 1357. Type lost.—I cannot identify this species. Bishop (1924) suggests that this species is not from the U. S. because Koch listed the locality as “Amerika.”
- D. audax* Marx, 1883, in Howard’s List of Invertebrate Fauna of South Carolina, p. 25.—This citation is from Bonnet (1956) who calls it a “*nomen nudum*.” I cannot find this in Marx 1883 nor in his “Catalogue” (1889).
- D. binotatus* C. L. Koch, 1848, Die Arachniden, pp. 121–122, fig. 1355. Type lost.—I cannot identify this species.
- D. convexus* Giebel, 1869, Z. gesam. Natur., 33: 252–253. Type perhaps in Halle, Germany. I cannot identify this species. From Giebel’s description it is clear that this is not a *Dolomedes*.
- D. fuscus* Franganillo-Balboa, 1931, Rev. del Col.

- de Belen, pp. 48, 286.—Described from Cuba. I cannot identify this species with certainty, but it may be *D. triton* or a similar species as is suggested from reading the sketchy description.
- D. hastulatus* Hentz, 1844, J. Boston Natur. Hist. Soc., 4: 395–396, pl. 19, fig. 9. Type destroyed.—I cannot identify this species, but Hentz states “found . . . in a web, like that of *Agelena*,” an indication that it is not a *Dolomedes*.
- D. lineatus* Walckenaer, 1837, Hist. Natur. Insectes, Aptères, 1: 347.—Walckenaer refers to Abbot's figures 51 (“variété jaune”) and 56 (“variété rouge”). Abbot's figures, the types, are probably of lycosids: *Lycosa rabida* Walck. and *L. punctulata* Hentz, respectively (Bishop, 1924, and Chamberlin and Ivie, 1944).
- D. marginatus* Marx, 1883, in Howard's List of Invertebrate Fauna of South Carolina, p. 25.—This citation is from Bonnet (1956), who calls it a “*nomen nudum*.” I cannot find this in Marx 1883 nor in his “Catalogue” (1889).
- D. marginellus* C. L. Koch, 1848, Die Arachniden, p. 120, fig. 1355. Type lost.—This species has been placed by others (Simon, 1895; Mello-Leitão, 1927; and Franganillo-Balboa, 1936) into *Thaumasia*, a conclusion I do not dispute.
- D. minor* Banks, 1898, Proc. California Acad. Sci., 1(7): 205–308, pl. 17, fig. 5. This species is described from Baja California. It is not a species of *Dolomedes* and is probably a junior synonym of *Tinus peregrinus* (Bishop, 1924).
- D. mirus* Walckenaer, 1837, Hist. Natur. Insectes, Aptères, 1: 357.—The type is Abbot's figure 321. This species has been regarded as the type of the genus *Pisaurina* (= *Dapanus*?), and is not a *Dolomedes*.
- D. oblongus* C. L. Koch, 1848, Die Arachniden, p. 114, fig. 1350.—This species has been transferred to the lycosid genus *Diapontia* by Petrunkevitch (1911). I do not dispute this conclusion.
- D. tenax* Hentz, 1844, J. Boston Natur. Hist. Soc., 4: 395, pl. 19, figs. 7–8. Type destroyed.—From the description and figures, I believe that this was probably an immature form of *D. albincus* Hentz.
- Aranca rufa* DeGeer, 1778, Mem. l'Hist. Insectes, 7: 319, pl. 39, fig. 6. Type lost.—I agree with Bishop (1924), who said that this description is unidentifiable and that the conclusions of Banks (1898) and Petrunkevitch (1911) are incorrect in saying that this species is synonymous with *D. albincus* Hentz, on the grounds that Pennsylvania is outside the range of the latter species.
- D. virgatus* Walckenaer, 1837, Hist. Natur. Insectes, Aptères, 1: 358.—The type is Abbot's figure 291. I agree with Bishop (1924) that this is probably a species of *Pisaurina* (*Dapanus*).

KEY TO THE ADULTS OF THE NEARCTIC SPECIES OF THE GENUS *Dolomedes*¹

MALES:

- Median apophysis distinctly widest in basal half, narrowed and sinuous apically (Figs. 25–26): CYL/TL > 2.7 (*tenebrosus* group)—2
Median apophysis not distinctly widest in basal half (Figs. 27–33): CYL/TL < 2.7 (*fimbriatus* group)—3
- Narrowed apex of median apophysis bent into an acute angle (Fig. 25) *D. tenebrosus*
Narrowed apex of median apophysis not bent into an acute angle (Fig. 26) *D. okefinokensis*
- Spiny tubercle or group of stiff spines subapically on femur IV 4
Spiny tubercle or group of stiff spines not present on femur IV 6
- Apex of tibial apophysis rounded and extending beyond distal end of tibia (Figs. 33, 48): spiny tubercle subapically on femur IV (Fig. 34) *D. triton*
Apex of tibial apophysis toothed and not extending beyond distal end of tibia; group of stiff spines subapically on femur IV (Figs. 35–36) 5
- CL CYL usually > 2.2; known only from the United States and Canada *D. vittatus*
CL CYL usually < 2.2; known only from Nuevo León, Mexico *D. holti*
- TL PTL > 1.5 *D. scriptus*
TL PTL < 1.5 7
- CYL, TL < 1.7 *D. albincus*
CYL, TL > 1.7 8
- CL, CW < 1.17: TL PTL > 1.32 *D. gertschi*
CL, CW > 1.17: TL PTL < 1.32 *D. striatus*

FEMALES:

- Middle lobe at anterior margin of epigynum; median concavity absent (Figs. 54–56) (*tenebrosus* group)—2
Middle lobe at posterior margin of epigynum; median concavity present (Fig. 60) (*fimbriatus* group)—3
- EL, PEL < 4.0: CW, EW < 3.5 *D. tenebrosus*
EL, PEL > 4.0: CW, EW > 3.5 *D. okefinokensis*
- Posterior median edge of epigynum curved dorsally and anteriorly, thus covering most of copulatory apparatus (Fig. 69); EL SVH usually < 1.9 *D. triton*

¹To identify immatures see key below.

- Posterior median edge of epigynum not curved dorsally and anteriorly, not covering much of copulatory apparatus; EL/SVH usually > 1.9 4
4. Distinct, continuous light submarginal bands on carapace 5
- Distinct, continuous light submarginal bands not present on carapace 6
5. CL < 8.0 ; northeastern United States and eastern Canada *D. striatus*
 CL > 8.0 ; Nuevo León, Mexico *D. holti*
6. Series of distinct light spots on the otherwise usually uniformly colored abdominal dorsum (Fig. 15) 7
- Series of distinct light spots not present on abdominal dorsum, which has a complex pattern 8
7. EW/SW > 1.9 ; known only from the United States and Canada *D. vittatus*
 EW/SW < 1.9 ; known only from Nuevo León, Mexico *D. holti*
8. EW/EL > 1.3 ; EW/MLW > 2.25 ; ventral loop of fertilization tube visible from dorsal view (Fig. 59); not known from Arizona or New Mexico *D. scriptus*
 EW/EL < 1.3 ; EW/MLW < 2.25 ; ventral loop of fertilization tube not visible from dorsal view (Fig. 59); known only from the Gila River drainage basin of Arizona and New Mexico *D. gertschi*
5. Distinct, circular light spots on abdominal dorsum, each often surrounded by ring of dark marks, no transverse "W-shaped" dark marks (Figs. 18-19) *D. triton*
- Distinct, circular light spots absent from abdomen, transverse "W-shaped" dark marks present 6
6. Found in Gila River drainage basin in Arizona and New Mexico
 (variation in males only) *D. gertschi*
- Not found in Gila River drainage basin in Arizona and New Mexico (Fig. 8)
 (variation in males only) *D. scriptus*
7. Light marks absent from submarginal area of carapace; distinct, light spots present on abdominal dorsum 8
- Light marks present in submarginal area of carapace, often rhomboid in shape and connected into an emarginate band (Figs. 22-24); no distinct light circular spots on dorsum of abdomen 9
8. Found north of Mexico (Fig. 15)
 (female) *D. vittatus*
- Found south of Texas
 (variation in females) *D. holti*
9. Found in Gila River drainage basin in Arizona and New Mexico (Figs. 12-13)
 *D. gertschi*
- Not found in Gila River drainage basin in Arizona and New Mexico 10
10. Cephalic area distinct and higher than thoracic area of carapace (Fig. 7)
 *D. albivens*
- Cephalic area less distinct and not higher than thoracic area of carapace (Fig. 10) 11
11. Light transverse abdominal bands between "W-shaped" dark bands continuous across dorsum (Figs. 8-9) *D. scriptus*
- Light transverse abdominal bands between "W-shaped" dark bands obscure medially, but laterally present as distinct, elongate pairs of light marks 12
12. Found north and west of peninsular Florida and southeastern Georgia (Figs. 1-2)
 *D. tenebrosus*
- Found in peninsular Florida and southeastern Georgia (Figs. 3-4)
 *D. okefinokensis*

KEY TO THE NEARCTIC SPECIES OF *Dolomedes* BASED CHIEFLY ON COLOR PATTERNS¹

1. Distinct, continuous, light submarginal carapacial bands with entire margins (Figs. 18-19) 2
- No submarginal bands present, or when present, margins are not entire 7
2. Distinct, light, longitudinal bands on abdomen continuous with light bands of carapace (Figs. 20-21) 3
- Distinct, light, longitudinal bands absent from abdomen 5
3. Short, light marks project medially from abdominal light bands (Fig. 14); abdomen without circular light dorsal spots 4
- Short, light marks as above absent; circular light spots frequently present on dark median band of abdominal dorsum (Figs. 20-21) *D. striatus*²
4. Found north of Mexico (Fig. 14) (male only) *D. vittatus*
- Found south of Texas (Figs. 16-17) *D. holti*
- Tenebrosus* GROUP
- Males much smaller than females, average female CL/average male CL = 2.25 (*D. tenebrosus*) and 2.75 (*D. okefinokensis*). MALES: tibia of pedipalp relatively shorter, CYL/TL = 3.15 (*D. tene-*

¹Applicable to later instars as well as adults.
²"Fulvitrionotatus" pattern not represented in this key.

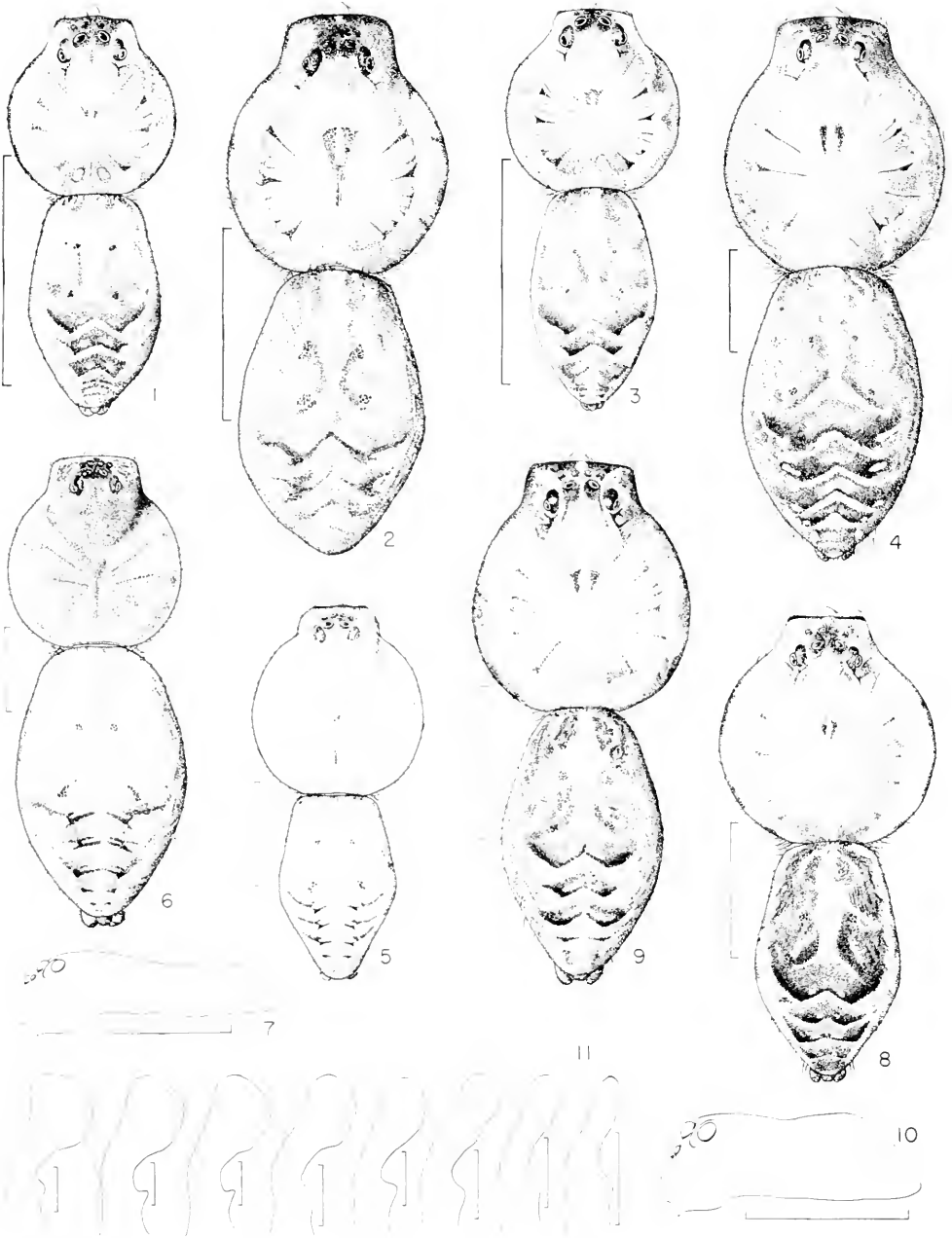

Figures 1-11. Color patterns of the dorsum. Figs. 1-2, *Dolomedes tenebrassus* Hentz. 1, Male. 2, Female. Figs. 3-4, *D. okefinokensis* Bishop. 3, Male. 4, Female. Figs. 5-6, *D. albineus* Hentz. 5, Male. 6, Female. Figs. 8-9, *D. scriptus* Hentz. 8, Male. 9, Female. Figs. 7, 10, Lateral aspects of carapaces. 7, *D. albineus* Hentz. 10, *D. scriptus* Hentz. Fig. 11, Tibial apophyses of the right palpi of a series of male *D. triton* (Walckenaer) from Kingston, Tennessee. Scales. Figs. 1-10, 5.0 mm. Fig. 11, 1.0 mm.

brosus) and 3.03 (*D. okefinokensis*); tibial apophysis broad, flat, wider distally than basally and wider than diameter of tibia, truncated at tip with small teeth; palpal bulb with median apophysis distinctly widest at basal half with distal half narrowed and sinuous; tegulum bulbous with rounded outer curvature which projects from ventral face of bulb (Figs. 25–26). No spiny tubercle or group of spines on femur IV. FEMALES: median elevation of epigynum at anterior border; lateral elevations broadly joined posteriorly at midline, atria large, rounded internally and conspicuous ventrally, no median concavity present (Figs. 54, 56); fertilization tubes about as long as bursae copulatrix and twisted in appearance, seminal valves wider than diameter of fertilization tubes and spatulate in shape (Figs. 53, 55).

Dolomedes tenebrosus Hentz
Figures 3–4, 25, 40, 53–54; Map 2

Dolomedes tenebrosus Hentz, 1843, J. Boston Natur. Hist. Soc., 4: 396, pl. 19, figs. 10–13. Male and female types from Carolina, Alabama, and Massachusetts, destroyed.—Emerton, 1902, Common Spiders of the United States, p. 87, figs. 213–214, ♀ (*D. scriptus*?).—Comstock, 1912, Spider Book, p. 608, figs. 694–696.—Bishop, 1924, Bull. New York State Mus., 252: 40–43, pl. 18, fig. 2; pls. 20, 21, ♂, ♀. Bishop and Crosby, 1936, Entomol. News, 47: 239, ♂.—Comstock, 1940, Spider Book, rev. ed., pp. 626–627, figs. 694, 695, ♀.—Chamberlin and Ivie, 1944, Bull. Univ. Utah, 35(9): 136, ♀.—Kaston, 1948, Bull. Connecticut State Geol. Natur. Hist. Surv., 70: 300, figs. 967–969, 993–994, ♂, ♀.—Roewer, 1954, Katalog der Araneae, 2(a): 135.—Bonnet, 1956, Bibliographia Araneorum, 2: 1540, 1541.—Carico and Holt, 1964, Virginia Agr. Exp. Sta., Tech. Bull., 172: 13, figs. 23, 24, ♀.

Dolomedes idoneus Montgomery, 1902, Proc. Acad. Natur. Sci. Philadelphia, 54: 588, pl. 30, fig. 51. Female syntypes from West Chester, Pennsylvania, in Museum of Natural Science of Philadelphia, examined.—Emerton, 1909, Trans. Connecticut Acad. Sci., 14: 211, pl. 7, fig. 8, ♀.—First synonymized by Banks, 1910, Bull. United States Nat. Mus., 72: 53.

Dolomedes vernalis Emerton, 1909, Trans. Connecticut Acad. Sci., pl. 7, fig. 7, ♂, ♀. Female holotype from Three Mile Island, Lake Winni-

pesaukee, New Hampshire, in the Museum of Comparative Zoology, examined.—First synonymized by Bishop, 1924, Bull. New York State Mus., 252: 42.

Diagnosis. *Dolomedes tenebrosus* (Figs. 1–2) is most closely related to *D. okefinokensis* and together they represent a distinct monophyletic group.

The two species of the *tenebrosus* group are indistinguishable except by means of sexual characters. The males differ primarily in the median apophysis of the palpal organ, which is acutely bent in *D. tenebrosus* (Fig. 25) and not acutely bent in *D. okefinokensis* (Fig. 26). The number of teeth on the distal edge of the male tibial apophysis of the pedipalp, although variable, does not overlap with those of *D. okefinokensis* in the samples examined. *D. tenebrosus* males have more teeth (mean 7) than those of *D. okefinokensis* (mean 4).

The epigynum of *D. tenebrosus* (Fig. 54) has the PEL distinctly longer than that of *D. okefinokensis* (Fig. 56). Internally the bursae copulatrix develop from the atria in different directions, i.e., in *D. tenebrosus* (Fig. 53) they run more nearly anteriorly than in *D. okefinokensis* (Fig. 55).

The color patterns of the largely allopatric *D. scriptus* (Figs. 8–9) and *D. tenebrosus* are similar, but the two species are easily distinguished by the genitalia (Figs. 28, 43, 59, 60).

Description. Average female CL/average male CL = 2.251.

Male (from Colleton County, South Carolina): On the *carapace*, ocular area, clypeus dark except for medial light spot on anterior edge; central disc dark gray, darkest near edge, with widening dark lines radiating from thoracic groove; irregular submarginal bands lateral to central disc, extend from clypeal dark area almost to posterior edge of carapace; extreme lateral edges dark gray, two pairs of light lines extend posteriorly from posterior eyes. *Sternum* gray at edges with median lanceolate mark. *Labium* about as long as wide,

color of central area gray with light area around anterior edges. Basal segments of *chelicerae* elongate, each marked with anterior, longitudinal, gray band. *Palpal endites* light, without distinct markings. Coxae of *legs* light ventrally with 1-2 indistinct maculae, other segments with irregular maculae, which sometimes coalesce into indistinct annular bands. Leg length order IV-(I-II)-III. *Abdominal* background color dorsally dark gray to brownish with light lanceolate cardiac area, two anterolateral longitudinal lines, 4 transverse "chevron-shaped" bands terminating laterally with 4 pairs of white spots. Sides dark, each with short incomplete dorsal band beginning anteriorly, becoming diffuse posteriorly. Venter light in color with dark lateral areas nearly converging just anterior to spinnerets. *Palpal organ* (Fig. 25) as for *tenebrosus* species-group. *Median apophysis* bent into acute angle, narrowed distally. Distal edge of *tibial apophysis* with 6-9 teeth (mean 7). For *measurements* see Diagram 1 for dimensions and ratios of the body and genitalia.

Female (from Horry County, South Carolina): On the *carapace* ocular area, clypeus dark with inverted "V-shaped" black mark beginning at AME extending to edge of clypeus, enclosing light spot on its anteromedial margin; general background color gray to reddish brown; central disc with widening dark lines radiating from thoracic groove, some terminating in white spots; two triangular dark spots anterior to thoracic groove; lateral submarginal areas marked with irregular reticulated light lines, extreme edges each marked with incomplete dark band; two pairs of light lines posterior to PLE and PME, medial light line extends from between PME to thoracic groove. General color of *sternum* light gray with medial longitudinal area. *Labium* about as long as wide, dark reddish brown, becoming lighter at anterior edge. *Palpal endites* dark reddish brown, becoming light at anterior edge. *Chelicerae* dark reddish brown, clothed anteriorly with long, erect, white

hairs. Coxae of *legs* light with few indistinct maculae; other segments with irregular maculae, some coalescing into indistinct annular bands. Leg length order IV-(I-II)-III. *Abdominal* background color gray to brownish. Dorsum anteriorly with light lanceolate cardiac area with two curved lateral longitudinal lines; posterior two-thirds with 4 transverse "chevron-shaped" dark bands terminated laterally by 4 pairs of elongate light spots; lateral margins of dorsum with reticulated light areas. Sides light anteriorly, each with reticulated lighter area that merges into dark area posteriorly. Venter dark gray to brownish with two irregular, indistinct light lines beginning at transverse groove posterior to book lungs, extending to spinnerets. The *epigynum* and *internal copulatory apparatus* is used as the standard for the *tenebrosus* species-group. PEL relatively long (see Fig. 54). *Bursae copulatrix* (Fig. 53) develop initially in anterior direction from atria. Internally, atria protrude posteriorly to origin of bursae copulatrix and are close together (Carico and Holt, 1964). For *measurements* see Diagram 1 for dimensions and ratios of the body and genitalia.

The immatures have essentially the same color pattern as do the adults.

Variation. The complex color pattern does not vary greatly through the wide geographic range of *D. tenebrosus*. Contrasting light and dark areas seem to intensify northward with the northernmost specimens often quite dark. In any part of the range there are differences in the relative extent of light and dark areas in the pattern. Typical of the latter point is the pattern of the submarginal bands which are occasionally solid light bands, frequently a series of disconnected light areas of various sizes and shapes, and occasionally solid gray or brownish similar to the color of the central disc. Also typical is the variation of the pattern of the sternum, which in some specimens is almost entirely gray with a white median longitudinal line

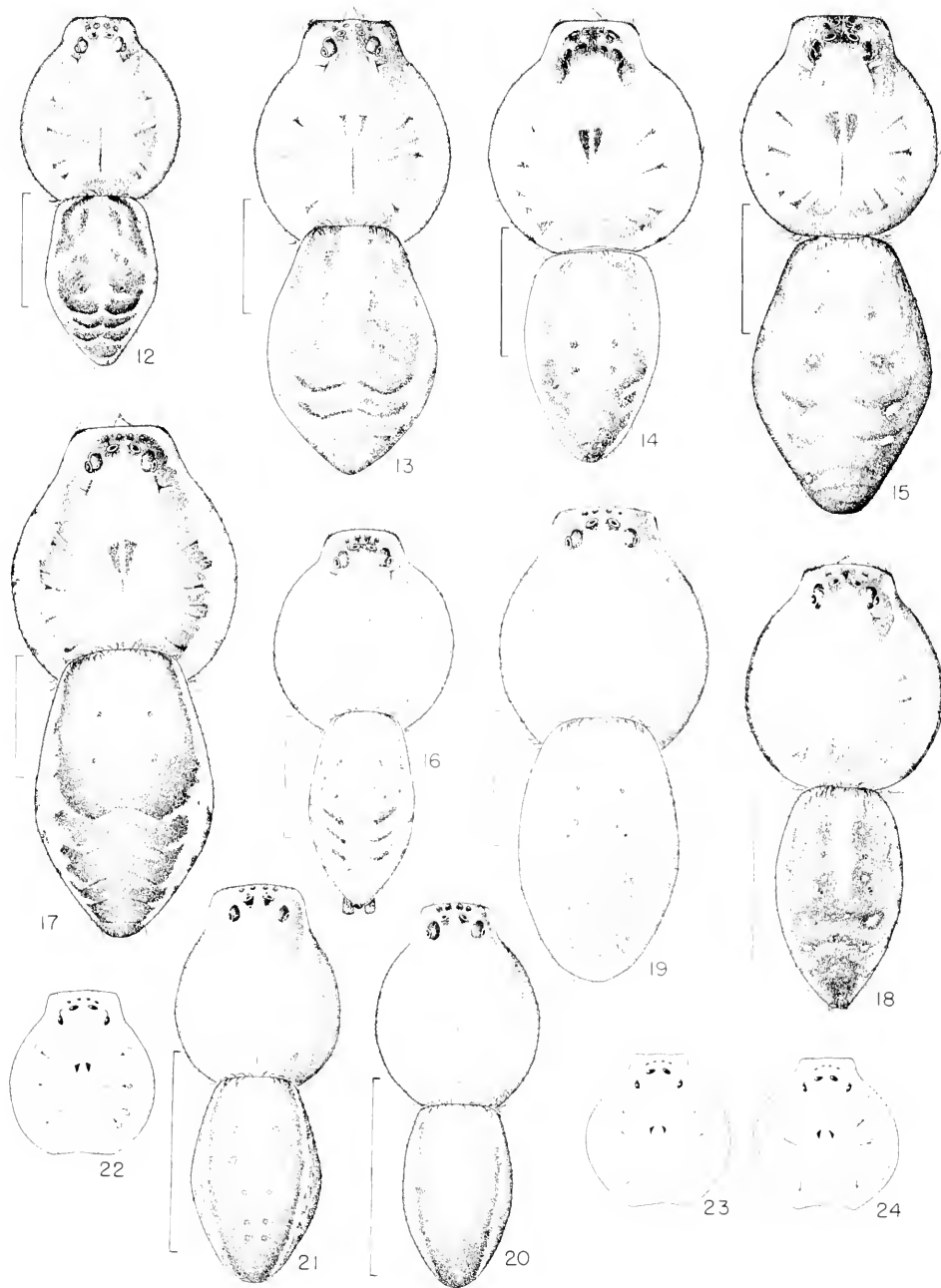

Figures 12-24. Color patterns of the dorsum. Figs. 12-13, *Dalamedes gertschi* n. sp. 12, Male. 13, Female. Figs. 14-15, *D. vittatus* Walckenaer. 14, Male. 15, Female. Figs. 16-17, *D. halti* n. sp. 16, Male. 17, Female. Figs. 18-19, *D. triton* (Walckenaer). 18, Male. 19, Female. Figs. 20-21, *D. striatus* Giebel. 20, Male. 21, Female. Figs. 22-24, Color patterns of carapaces of *D. scriptus* Hentz. 22, Female. 23-24, Male.

Scales. 5.0 mm.

and in others is almost entirely light with gray edges.

Natural history. The habitat of this species seems to be more variable than that of other members of the genus. Collection notes and personal observations show it to be commonly encountered in the environs of the swamps and ponds in the southern United States coastal plain and the lakes and ponds of the glaciated part of the range. Although little microhabitat data accompanied the northern collections, a large number of collections gave the name of a lake as part of the locality data. In the southern coastal plain I have collected *D. tenebrosus* primarily from the vertical trunks of trees and other objects emerging from slow-moving streams and ponds, a habitat that is shared with *D. okefinokensis*. Unlike other *Dolomedes*, this species was regularly collected a considerable distance from water. Data with specimens collected in Indiana and Pennsylvania state that they were found "on trunk of dead tree in beech maple forest" and on "dead trees in deep woods," respectively. In the mountainous regions of Virginia and North Carolina, I have never taken a mature specimen of *D. tenebrosus* near bodies of water (where I have done considerable collecting), but have encountered it infrequently in woods under logs and more often in association with houses. Although I have collected males and females in basements, most such specimens have been brought to me by excited homeowners who have also found them in basements, kitchens, and, in one case, the bedroom. Comments by Bishop (1924), Kaston (1948), and Gertsch (personal communication) confirm that the relative freedom from the aquatic habitat is a distinct feature of the natural history of this species.

A collection from Ottawa, Canada (11 July 1958) contained the following note: "numerous proctytropoid [*sic?*] parasites emerged from egg case."

Eight collections taken from 30 June to 14 August from the northern part of the

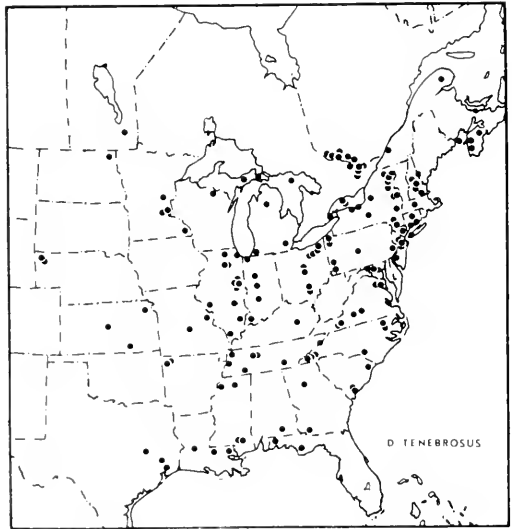

Map 2. Distribution of *Dolomedes tenebrosus* Hentz.

range (Ontario, Quebec, Nova Scotia, Michigan, and New York) contained egg sacs. The earliest and latest of these dates are from Quebec. Five females from the same general area with swollen abdomens (and presumably gravid) were taken from the first half of June to August. Kaston (1948) reported an egg sac as early as June 22 and stated that the number of eggs or spiderlings in three egg sacs ranged from 555 spiderlings to 1393 eggs. He also observed two females in their nursery webs on July 13 and September 10 respectively. No data are available on the reproduction of southern *D. tenebrosus*. Adult females are present virtually throughout the year but are probably inactive during cold months. Penultimate females hibernate in Connecticut according to Kaston (1948). Adult males are more prevalent in May but may be found earlier in the south and later in the north. Immatures in all sizes are present all year.

Fish-capturing observations were discussed in the section on biology of the genus.

Distribution. *D. tenebrosus* ranges from Newfoundland, southern Quebec, and Manitoba southward to the Florida Panhandle

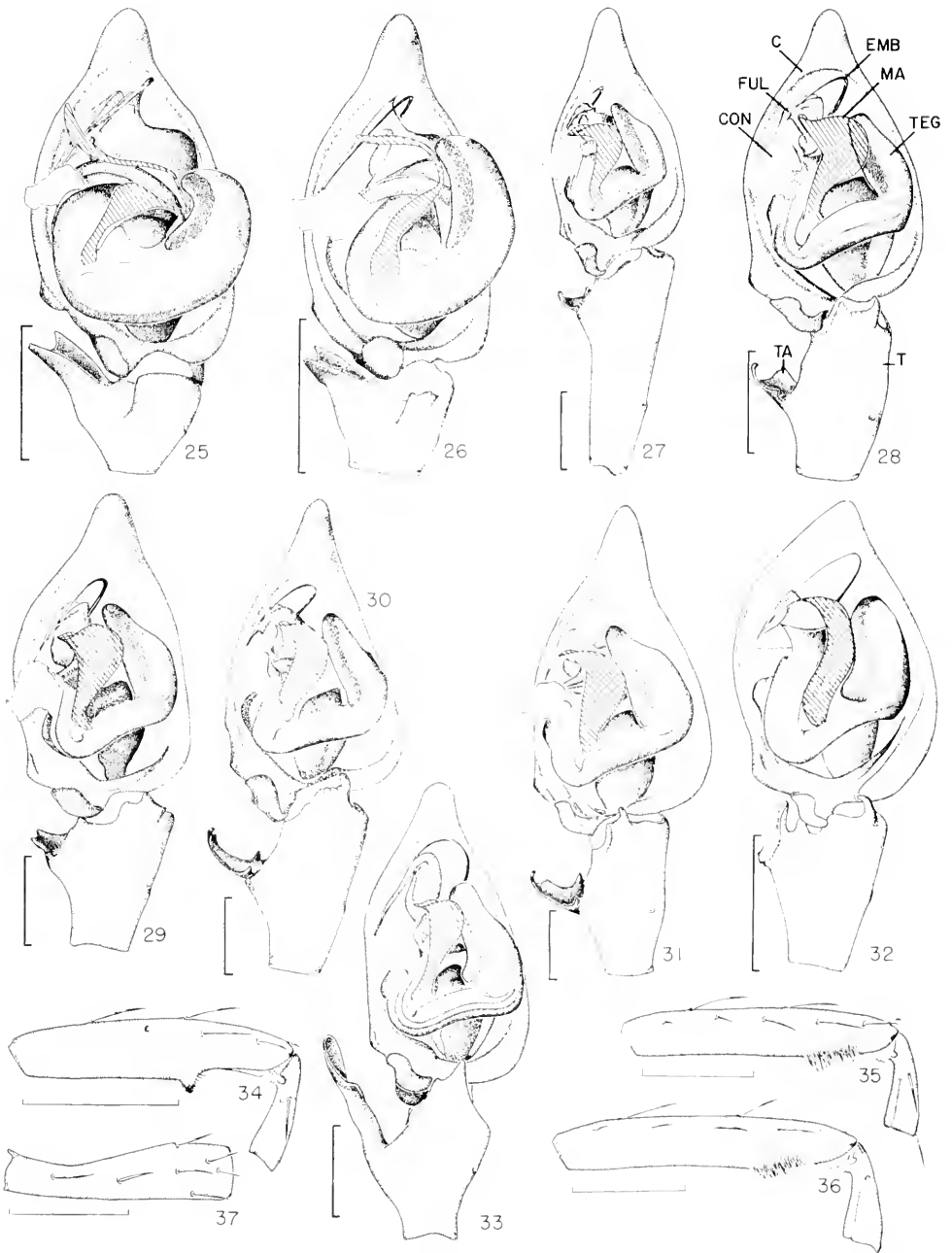

Figures 25-37. Figs. 25-33, Ventral views of right palpi of males. 25, *Dolomedes tenebrassus* Hentz. 26, *D. okefinokensis* Bishop. 27, *D. albineus* Hentz. 28, *D. scriptus* Hentz. 29, *D. gertschi* n. sp. 30, *D. vittatus* Walckenaer. 31, *D. holti* n. sp. 32, *D. striatus* Giebel. 33, *D. triton* (Walckenaer). Figs. 34-36, Retrolateral views of femurs and patellae of right male legs IV. 34, *D. triton* (Walckenaer). 35, *D. holti* n. sp. 36, *D. vittatus* Walckenaer. Fig. 37, Dorsal view of right female palpal tibio of *D. triton*. Scales. Figs. 25-36, 5.0 mm. Fig. 37, 2.0 mm.

and westward to eastern Texas, eastern Kansas, western Nebraska, and eastern North Dakota (Map 2). The ranges of *D. tenebrosus* and the closely related *D. okefinokeensis* do not seem to overlap. Because of the similarity of the color patterns of these two species, no immatures of the *tenebrosus* group are plotted in southern Mississippi, Alabama, Georgia, and all of Florida.

Bishop (1924) listed *D. tenebrosus* from the Okefinokee Swamp, Georgia, and from Archer, Florida, neither of which I have been able to confirm. He did not designate sex nor maturity, and therefore the observations may have been made upon immatures, a practice of dubious validity. His record from Yuma, Arizona, was apparently based upon erroneous collection data.

Material examined. Twenty-five male, 118 female, and 91 immature specimens.

Dolomedes okefinokeensis Bishop
 Figures 3-4, 26, 41, 55-56; Map 3

Dolomedes okefinokeensis Bishop, 1924, Bull. New York State Mus., 252: 38-40, pls. 17, 18, fig. 1; pl. 19, figs. 1, 2. Female holotype and allotype from Billy's Island, Okefinokee Swamp, Georgia, deposited in the New York State Museum. I have not been able to confirm the existence of the holotype and allotype, and the paratypes originally deposited at Cornell University were not in the spider collection on loan to the American Museum of Natural History in New York. I have collected adults of this species from the type locality.—Roewer, 1954, Katalog der Araneae, 2(a): 131.—Bonnet, 1956, Bibliographia Araneorum, 2: 1535.—Carico and Holt, 1964, Virginia Agr. Exp. Sta., Tech. Bull., 172: 13, ♀.

Diagnosis. *D. okefinokeensis* (Figs. 3-4) is quite similar to *D. tenebrosus* in coloration and can be distinguished with confidence only by examination of the genitalia (see above, Figs. 26, 41, 55-56).

Description. Average female CL/average male CL = 2.75.

Male (from Okefinokee Swamp, Georgia). On *carapace*, ocular area, clypeus dark except for medial light spot on anterior edge; central disc dark gray, darkest near

edge, with widening dark lines radiating from thoracic groove; irregular submarginal bands lateral to central disc extend from clypeal dark area to posterior edge of carapace; extreme lateral edges dark gray, one or two pairs of light lines extend posteriorly from PE. *Sternum* gray at edges with central irregular lanceolate mark. *Labium* about as wide as long, color of central area somewhat gray on light background around edges. Basal segments of *chelicerae* elongate, each marked with anterior, longitudinal gray band. *Palpal endites* light, without distinct markings. Coxae of *legs* light ventrally with 2-3 indistinct maculae, other segments with irregular maculae which sometimes coalesce into indistinct annular bands. Leg length order IV-(I-II)-III. *Abdominal* background color dark gray to brownish dorsally with light lanceolate cardiac area, two curved anterolateral longitudinal lines, posterior third with 4 transverse "chevron-shaped" bands terminating laterally with 4 pairs of white spots. Sides dark, each with incomplete dorsal band beginning anteriorly, becoming diffuse posteriad. Venter light in color with dark lateral areas nearly converging just anterior to spinnerets. *Palpal organ* (Fig. 26) as for *tenebrosus* group. Median apophysis curved into a "question-mark-shape," without acute angles, narrowed distally. Distal edge of *tibial apophysis* with 2-6 teeth (mean 4) (Fig. 41). For *measurements* see Diagram 1 for dimensions and ratios of the body and genitalia.

Female (from Okefinokee Swamp, Georgia). On the *carapace*, ocular area, clypeus dark with inverted "V-shaped" black mark beginning at AME, extending to edge of clypeus, enclosing light spot on its anteromedial margin; general background color gray to reddish brown; central disc with widening dark lines radiating from thoracic groove, some terminating in white spots; two elongate dark spots anterior to thoracic groove; lateral submarginal areas marked

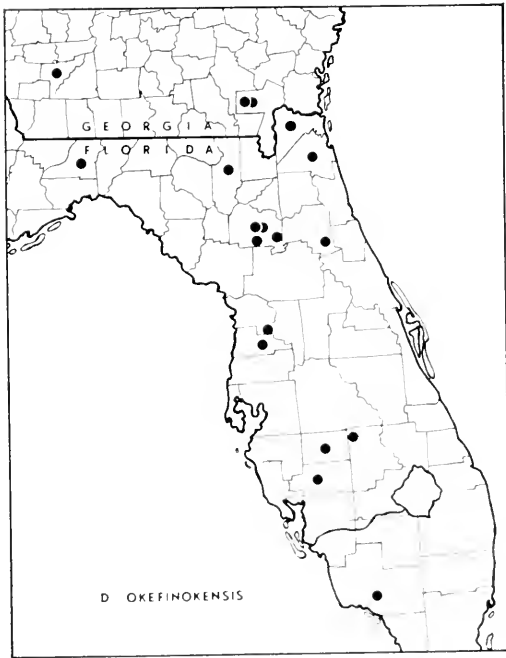

Map 3. Distribution of *Dolomedes okefinokensis* Bishop.

with irregular reticulated light lines, extreme edges each marked with black line; two pairs of light lines posterior to PLE and PME, medial light line extends from between PME to thoracic groove. Edges of *sternum* light gray, enclosing lighter medial area. *Labium* about as long as wide, dark reddish brown, becoming lighter at anterior edge. *Palpal endites* dark reddish brown, becoming light at anterior edge. *Chelicerae* robust, dark reddish brown, clothed with long, erect white hairs. Coxae of *legs* light with few indistinct maculae, other segments with irregular maculae, some of which coalesce into indistinct annular bands. Leg length order IV-(I-II)-III. Background color of *abdomen* dark gray to brownish. Dorsum with light lanceolate cardiac area with two curved lateral longitudinal lines anteriorly, posterior two-thirds with about 5 transverse "chevron-shaped" dark bands terminated laterally with 4 pairs of elongate white spots; lateral margins of dorsum with reticulated light

areas. Sides each light anteriorly with reticulated lighter area that merges into dark area posteriorly. Venter dark gray to brownish with two irregular light lines beginning at transverse groove posterior to book lungs, extending to spinnerets. *Epigynum*, *internal copulatory apparatus* as for *tenebrosus* group; PEL relatively short (Fig. 56); bursae copulatrix (Fig. 55) develop initially in anteromedial direction, atria internally do not protrude posteriorly, are well separated (Carico and Holt, 1964). For *measurements* see Diagram 1 for various dimensions and ratios of the body and genitalia.

Those immatures suspected of being of this species had essentially the same kind of pattern as the adults.

Variation. Color variation was not great in the few cases where more than one specimen was present in a single collection. Other variations may have been due to the differences in collecting date and preservative. The only significant variations were (1) in the intensity of color, (2) the extent of development of the submarginal bands of the carapace of the male and (3) the distinctness of the reticulations and light spots in the submarginal areas of the female carapace.

Natural history. According to data with the museum collections and personal observations at Okefinokee Swamp, Georgia, this species inhabits primarily swampy areas. Typically these spiders were seen flattened against vertical sides of cypress or other emergent trees in pools of water. They were also taken from other objects such as concrete bridges and docks. They are found above the water to about four feet. A female taken in Jacksonville, Florida, was found "under a log in a dried-up cypress swamp." The general habitat preference of *D. okefinokensis* does not differ in any obvious way from that of the southern *D. tenebrosus*.

A female taken 7 October 1949, on Lake Lochloosa, Alachua County, Florida, car-

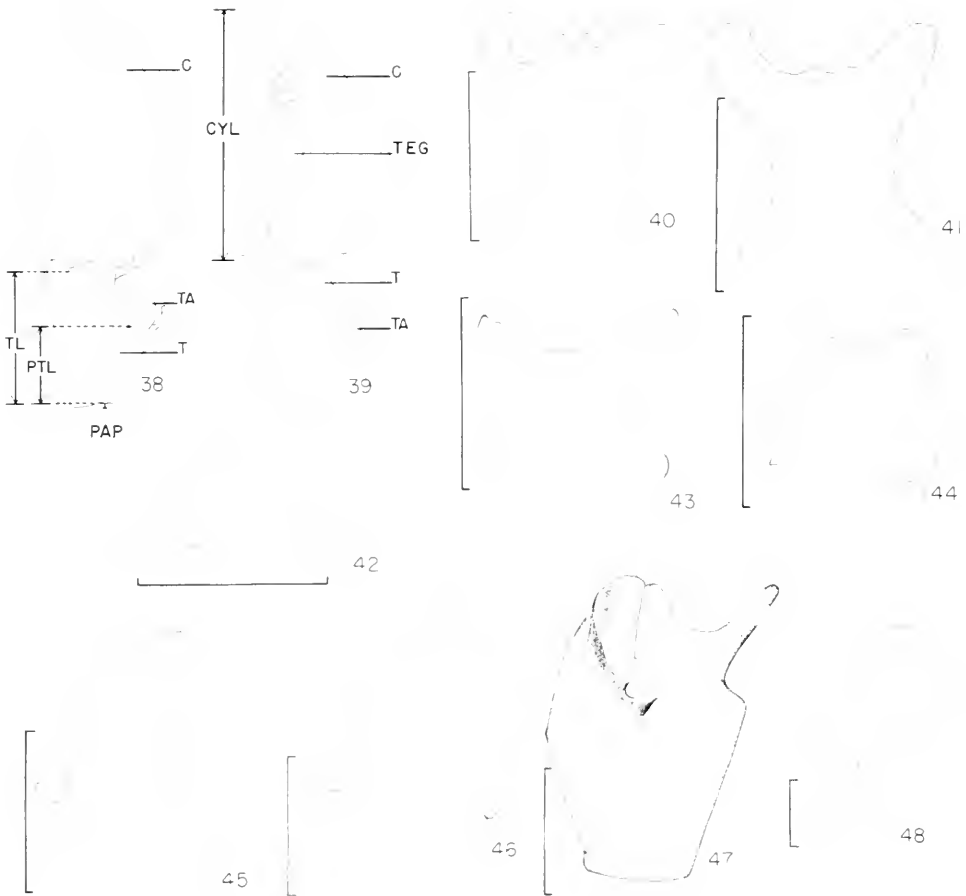

Figures 38-48. Figs. 38-39, Male palpi. 38, Dorsal view. 39, Prolateral view. Figs. 40-48, Tibial apophyses of right male palpi. 40, *Dalomedes tenebrosus* Hentz, retrolateral view. 41, *D. akelnakensis* Bishop, retrolateral view. 42, *D. albineus* Hentz, distal view. 43, *D. scriptus* Hentz, retrolateral view. 44, *D. gertschi* n. sp., distal view. 45, *D. vittatus* Walckenaer, retrolateral view. 46, *D. holti* n. sp., retrolateral view. 47, *D. striatus* Giebel, retrolateral view. 48, *D. tritan* (Walckenaer), retrolateral view.

Scales. Figs. 38-47, 0.5 mm. Fig. 48, 1.0 mm.

ried an egg sac that was whitish in color and covered with a fluffy layer of loose threads (which is different from that of other species). The contents of the egg sac included 140 fully developed spiderlings that were probably near emergence and 369 fully developed adult chalcidoid wasps still within the egg membranes.

Distribution. Peninsular Florida and southeastern Georgia (Map 3). Because of the difficulty of distinguishing immatures of *D. okefinoakensis* and *D. tenebrosus*, only

natures of the *tenebrosus* species-group were plotted in Florida and in the southern portions of the states of Mississippi, Alabama, Georgia, and South Carolina. Although I find little overlap of the geographic ranges of these two species, Bishop (1924) listed two localities for *D. okefinoakensis* in Alabama and in Louisiana. I have not located these collections, and it is possible that these data were based upon immatures of *D. tenebrosus*. Further discussion of the distribution of species of the

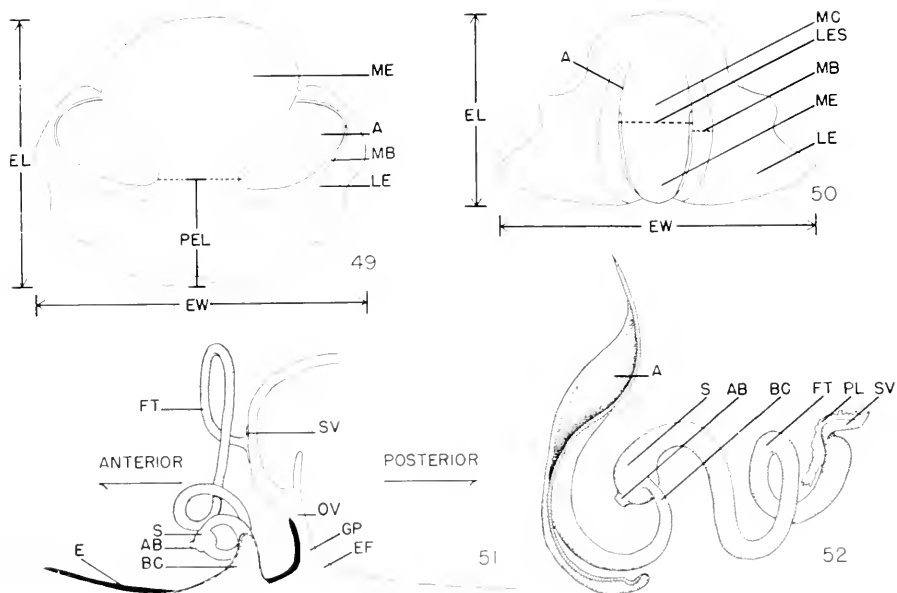

Figures 49-52. Epigyna. 49, *Tenebrassus* type. 50, *Fimbriatus* type. 51, Diagram of midsagittal section through capulatory apparatus. 52, Midsagittal section through expanded capulatory apparatus of *fimbriatus* type. (All adapted from Carica and Holt, 1964.)

tenebrosus group may be found above in the section on evolution.

Material examined. Seven male and 23 female specimens. Several immatures were examined from the apparent range of this species, but their identity is uncertain.

Fimbriatus GROUP

Males smaller than females, but size difference not as much as in *tenebrosus* group, average female CL average male CL = 1.35 (range 1.11-1.35) or less. MALES: tibia of pedipalp relatively longer, CYL TL = 2.20 (range 1.29-2.20) or less, tibial apophysis narrow, width less than diameter of tibia, bearing various types of projections, and usually not truncated; palpal bulb with median apophysis narrowed at basal half and widest at distal half or uniform in width, tegulum not as bulbous and outer curvature not as rounded, protruding less from within concavity of cymbium (Fig. 2S). Some species with spiny tubercle or group of spines on femur IV (Figs. 34-36).

FEMALES: median elevation of epigynum at posterior border, lateral elevations narrowly joined (if at all) posteriorly at midline with juncture usually obscured, atria small, flattened internally, inconspicuous ventrally, median concavity present posterior to median elevation (Fig. 60); fertilization tubes looped and/or coiled at least twice length of bursae copulatrix, seminal valves usually not wider than diameter of fertilization tubes, not spatulate in shape (Fig. 59).

Dolomedes albineus Hentz Figures 5-7, 42, 57-58; Map 4

Dolomedes rufus, Walckenaer (not DeGeer, 1778), 1837, *Hist. Natur. Insectes. Aptères*, 1: 351-352.
Dolomedes albineus Hentz, 1845, *J. Boston Natur. Hist. Soc.*, 5: 189-190, pl. 16, fig. 2. Female type from Alabama destroyed.—Comstock, 1912, *The Spider Book*, p. 609.—Bishop, 1924, *Bull. New York State Mus.*, 252: 33-36, pls. 12-13; pl. 14, figs. 1, 2, 3; pl. 15, ♂, ♀.—Bishop and Crosby, 1936, *Entomol. News*, 47: 239, 240, 244, ♂.—Comstock, 1940, *The Spider Book*, rev. ed., p. 627.—Chamberlin and Ivie,

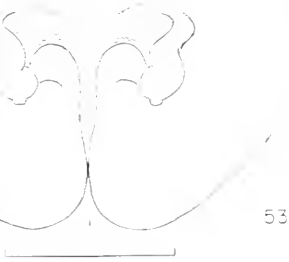

53



54



55

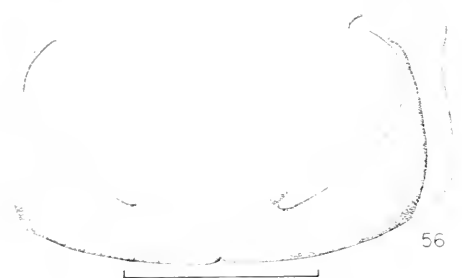

56

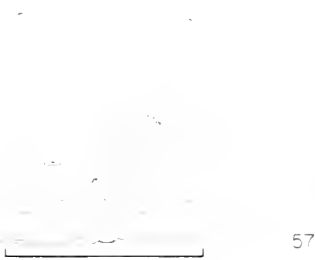

57

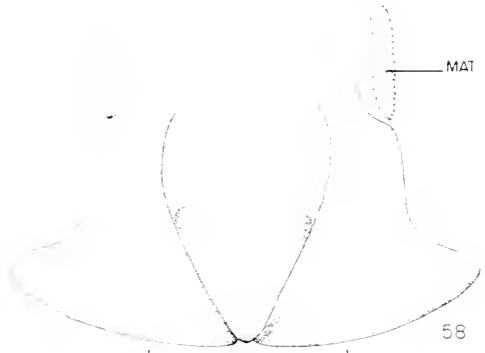

58

Figures 53–58. Epigyna. Figs. 53–54, *Dolomedes tenebrosus* Hentz. 53, Dorsal view. 54, Ventral view. Figs. 55–56, *D. okefinoensis* Bishop. 55, Dorsal view. 56, Ventral view. Figs. 57–58, *D. albineus* Hentz. 57, Dorsal view. 58, Ventral view. [Figs. 55–58 adapted from Carico and Holt, 1964.]

Scales. 1.0 mm.

1944, Bull. Univ. Utah, 35(9): 135, ♀—Roewer, 1954, Katalog der Araneae, 2(a): 134.—Bonnet, 1956, Bibliographia Araneorum, 2: 1525–1526.—Carico and Holt, 1964, Virginia Agr. Exp. Sta. Tech. Bull., 172: 12, figs. 15, 16, ♀.

Micrommata pinicola Hentz, 1850, J. Boston Natur. Hist. Soc., 6: 257, pl. 10, fig. 14. Immature holotype destroyed. NEW SYNONYMY.

Thaumasia pinicola. Banks, 1910, Bull. United

- States Nat. Mus., 72: 54.—Bryant, 1940, Bull. Mus. Comp. Zool., 86(7): 278.
- Dolomedes pinnicola*, Banks, 1904, Proc. Acad. Natur. Sci. Philadelphia, 56: 136.—Comstock, 1912, The Spider Book, p. 617.—Bishop, 1924, Bull. New York State Mus., 252: 60, 61, pl. 35, immature.—Bonnet, 1956, Bibliographia Araneorum, 2: 1535.
- Ticippus laurpus* Chamberlin, 1924, Proc. United States Nat. Mus., 63(13): 28. Immature holotype from Fallon, Louisiana, in the Museum of Comparative Zoology, examined. Synonymized to *D. pinnicola* by Gertsch, 1934, American Mus. Novitates, No. 726: 11.
- Ticippus pinnicola*, Chamberlin and Ivie, 1944, Bull. Univ. Utah, 35(9): 138, 139, ♀ (data from Walckenaer, 1837).—Roewer, 1954, Katalog der Araneae, 2(a): 140.
- Dolomedes suspectus*, Chamberlin and Ivie, 1946, Bull. Univ. Utah, 36(13): 6, 7, sex? [misidentification of *Lycosa tarantula suspecta* Walckenaer].

Diagnosis. The elevated cephalic area of the carapace (Fig. 7) and the color pattern of the abdomen (Figs. 5–6) are the most distinctive characters. In adult males the tibia of the pedipalp is comparatively long, making the CYL:TL ratio a distinctive feature when compared with males of sympatric species. The epigynum and internal copulatory apparatus are very similar to *D. scriptus*, but may usually be distinguished from the latter by the lack of complete sclerotization and dark coloration of the anterior edge of the epigynum, which causes the muscle attachments (MAT) to be distinct from the epigynum (Figs. 55, 60).

Description. Average female CL/average male CL = 1.29.

Male (from Alachua County, Florida): Background color of *carapace* light, covered with white hair; ocular area, clypeus dark with transverse band of white hairs on latter passing about midway between AME, clypeus margin; pair of dark, elongate, median marks anterior to thoracic groove; indistinct dark lines radiate from thoracic groove; marginal dark line present; cephalic area elevated above rest of carapace. *Sternum* light, slightly darker at margins. *Labium* about as long as wide, dark

reddish brown laterally, lighter medially, light at anterior margin. Basal segments of *chelicerae* elongate, each with dark background color, darker distally, covered anteriorly with long white hairs, thick patch of short, closely appressed white hairs laterally around boss, which extends subdistally. *Palpal endites* dark on lateral, medial margins, lighter centrally, light distally. All segments of *legs* light ventrally, slightly darker dorsally; femora with indistinct longitudinal dark dorsal marks. Leg length order I-II-IV-III. *Abdominal* background color light dorsally, covered with white hairs, darker lanceolate cardiac area, four transverse dark lines terminated laterally by light areas, indistinct lighter bands between darker ones. Sides light, each with dark band that extends obliquely, ventrally from anterodorsal end. Venter light with very light median longitudinal band, bordered laterally with somewhat darker bands. *Palpal organ* (Fig. 27) as for *fimbriatus* group. *Tibial apophysis* (Fig. 42) with three well-defined teeth, smallest ventral, largest central. For *measurements* see Diagram 1 for dimensions and ratios of the body and genitalia.

Female (from Alachua County, Florida): Background color of *carapace* reddish brown, covered with white hairs; ocular area, clypeus dark with transverse band of white hairs on latter passing about midway between AME, clypeus margin; obscure elongate marks anterior to thoracic groove; indistinct bands radiate from thoracic groove; marginal dark line present; submarginal areas broken into series of light areas; cephalic area elevated above rest of carapace (Fig. 7). *Sternum* medium reddish brown, slightly darker at margins. *Labium* dark reddish brown, light at anterior margin, with distinct transverse, central groove. Basal segments of *chelicerae* each very dark reddish brown, clothed anteriorly with long erect light hairs, thick patch of short white hairs laterally around boss, which extends almost to distal end.

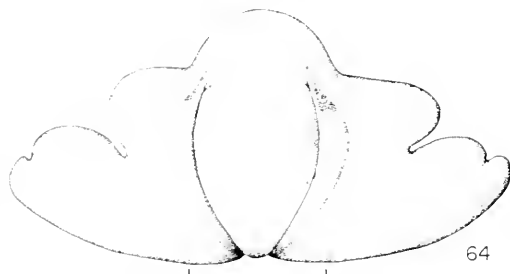
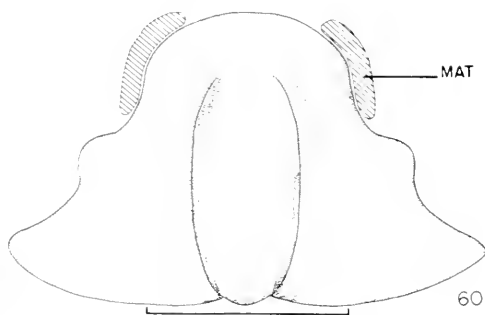
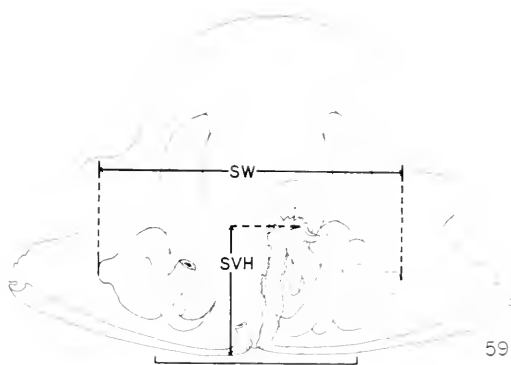

Figures 59–64. Epigyna. Figs. 59–60, *Dolomedes scriptus* Hentz. 59, Dorsal view. 60, Ventral view. Figs. 61–62, *D. gertschi* n. sp. 61, Dorsal view. 62, Ventral view. Figs. 63–64, *D. vittatus* Walckenaer. 63, Dorsal view. 64, Ventral view. (Figs. 59–60, 63–64 adapted from Carico and Holt, 1964.)

Scales. 1.0 mm.

Palpal endites dark reddish brown, light distally. Coxae of *legs* medium reddish brown ventrally, lighter medially; other segments medium reddish brown ventrally, covered with white hairs, dorsal surfaces with indistinct darker longitudinal areas.

Leg length order IV-I-II-III. *Abdominal* background color light, covered with patches of light hair; dark lanceolate cardiac area; five transverse dark lines preceded by a white line, terminated laterally by light areas, first, third lines longest; pair of

oblique dark lines join cardiac area with first transverse line. Sides each with central, anterior, irregular dark longitudinal band; remainder of area covered with small dark, white spots. Venter with median, light band narrowing from epigynum to tracheal spiracle, bordered laterally by pair of medium brown bands, each bordered in turn by series of dark spots. *Epigynum* (Fig. 58), *internal copulatory apparatus* (Fig. 57) as for *fimbriatus* group. Pair of anterolateral *muscle attachments* not entirely joined to epigynum, anterior edge of epigynum often appears incompletely sclerotized, indistinct in outline. *Fertilization tubes* each composed of one coil and two loops, seminal valves located in posterior half of dorso-epigynal area (Carico and Holt, 1964). For *measurements* see Diagram 1 for dimensions and ratios of the body and genitalia.

Immatures typically have a lighter background color with the color pattern somewhat more distinct and extensive than the adults. Perhaps the most distinctive feature is the carapace shape, which is depressed except for the noticeably elevated cephalic area.

In some immatures and adults the carapace has a distinctly maroon color in life.

Variation. No significant geographic variation could be ascertained from the limited sample that was examined. In general, the variation of the color pattern is limited to differences of distinctiveness. Some notably light-colored specimens are treated under the discussion of nomenclature below.

Natural history. Collection data with the specimens studied include no information about the biology of this species. Limited personal observations of it suggest that *D. albineus* is most common in swamps, ponds, and slow-moving streams, resting upon the vertical trunks of emergent trees with the head in a downward position. Bishop (1924) reported the same observations and also stated that if disturbed "... they rush into the water or dodge with surprising quickness to the opposite side of the tree,

after the manner of a squirrel." The manner of diving into the water is typical of the genus, but their manner of "... dodging..." to the other side of the tree is unique. Whereas Bishop seems to imply that these animals walk around to the opposite side of the tree, I have observed them to spring away from the surface of the tree in such a way as to "swing" quickly around the tree suspended by the dragline. This habit, in conjunction with their relative shyness and superb camouflage, makes them difficult to collect.

In his discussion of the "Habits" of *D. okefiokensis*, Bishop stated that members of that species "... were found on herbage and the prostrate trunks of trees and not usually in such close proximity to water as in the case of *Dolomedes albineus*..." On the contrary; where I have collected these two species together, *D. albineus* has been higher on the tree than *D. okefiokensis*. Walckenaer (1837) cited some biological notes made by Abbot which seem to agree with my observation. Abbot said (after Walckenaer, 1837), "Elle ne fait pas de toile, mais se retire dans le creux des arbres..." Perhaps the hiding places were merely shallow depressions on the tree surface in which the spider rested, the result being that the outline of the spider came into greater conformity with that of the tree. The latter situation I have observed.

Herring and Dowling (1947) made an observation upon *D. albineus* which seemed to be unique, at least for the genus. While collecting at night they discovered numerous adult members of this species assembled in a tree at Payne's Prairie in Alachua County, Florida. Although other trees were nearby, one particular tree was the only one that contained these spiders in great numbers, some of which were quite high above the water. They suggested, and reasonably so, that this phenomenon may have been related to sexual activity. If this were a spider version of a "mating swarm," it deserves greater attention because this kind

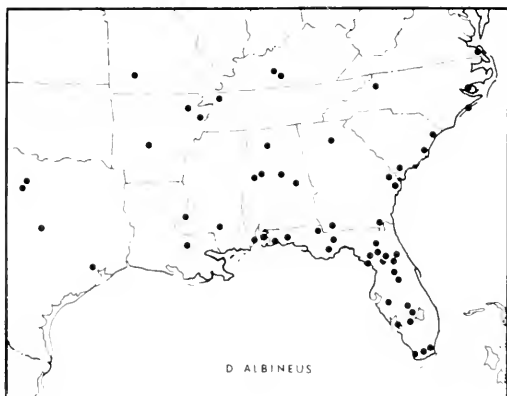

Map 4. Distribution of *Dolomedes albineus* Hentz.

of behavior does not seem to be common among spiders.

Distribution. Typically, *D. albineus* is associated with slow-moving streams, lakes, and ponds in the southern coastal plain as far north as Virginia and westward to about the 100° longitude in Texas. The range extends northward in the Mississippi River basin, and in some cases into the uplands of northern Alabama, the mid-section of Kentucky, the Ozarks of Missouri, and the Appalachians of North Carolina (Map 4).

Material examined. Thirteen male, 25 female, and 50 immature specimens.

Discussion. The survey of the literature on this species has been of nightmarish complexity and deserves some comment. I agree with Bishop (1924: 11) that *Aranea rufa* DeGeer is probably not *D. albineus* for at least one of the same reasons, i.e., that the reported locality, Pennsylvania, is far outside the apparent range of this species. Walckenaer (1837), however, believed that four figures of Abbot (numbers 1, 6, 16, and 281) are *Dolomedes rufus* (DeGeer) and described them as four "varieties" that may actually have represented various stages in development. His descriptions were apparently made from specimens, because he mentioned characters that cannot be viewed from the dorsal side, which was the only view that Abbot had

figured. The descriptions of color pattern and habitat match fairly well those of *D. albineus* Hentz, but only figure six can confidently be determined to be this species. DeGeer's name is therefore not retained (see Art. 49 in Rules of Zoological Nomenclature).

Hentz clearly described and figured *D. albineus* in 1845, but later (1850) he described and figured the synonymous *Micrommata pinicola*, which subsequently resulted in confusion in the literature. Hentz's specimen of *M. pinicola* has been destroyed and no other specimen was referred to this species until Bishop's (1924) revision of the Pisauridae. The species was transferred in the meanwhile to *Dolomedes* by Banks (1904) and Comstock (1912). Bishop (1924) examined an immature from Punta Gorda, Florida, collected by Banks, which resembled Hentz's drawing and description. I have studied this specimen and find that it is a small immature of *Dolomedes albineus*. It is indeed very light and devoid of many clear markings, but the shape of the carapace and the position of the markings that are present clearly indicate its identity. The series of dots on the venter of the abdomen mentioned in Hentz's description are merely points of muscle attachment which are present in all species, but are only noticeable against a light background. Because Bank's specimen resembles closely the figure of *Micrommata pinicola*, I have concluded that Hentz must have described an immature of *D. albineus*. One adult female that I examined from Florida (no other locality data) is also very light, but still shows distinct *D. albineus* sexual structures as well as other structural features.

Later (1936) Bishop and Crosby described and figured a mature male of *D. pinicola* from Edinburg, Texas. Although the coloration is very light as in Banks' specimen, the resemblance ends there. The shape of the carapace and position of the few faint markings do not resemble those of Banks' specimen at all. In fact, the

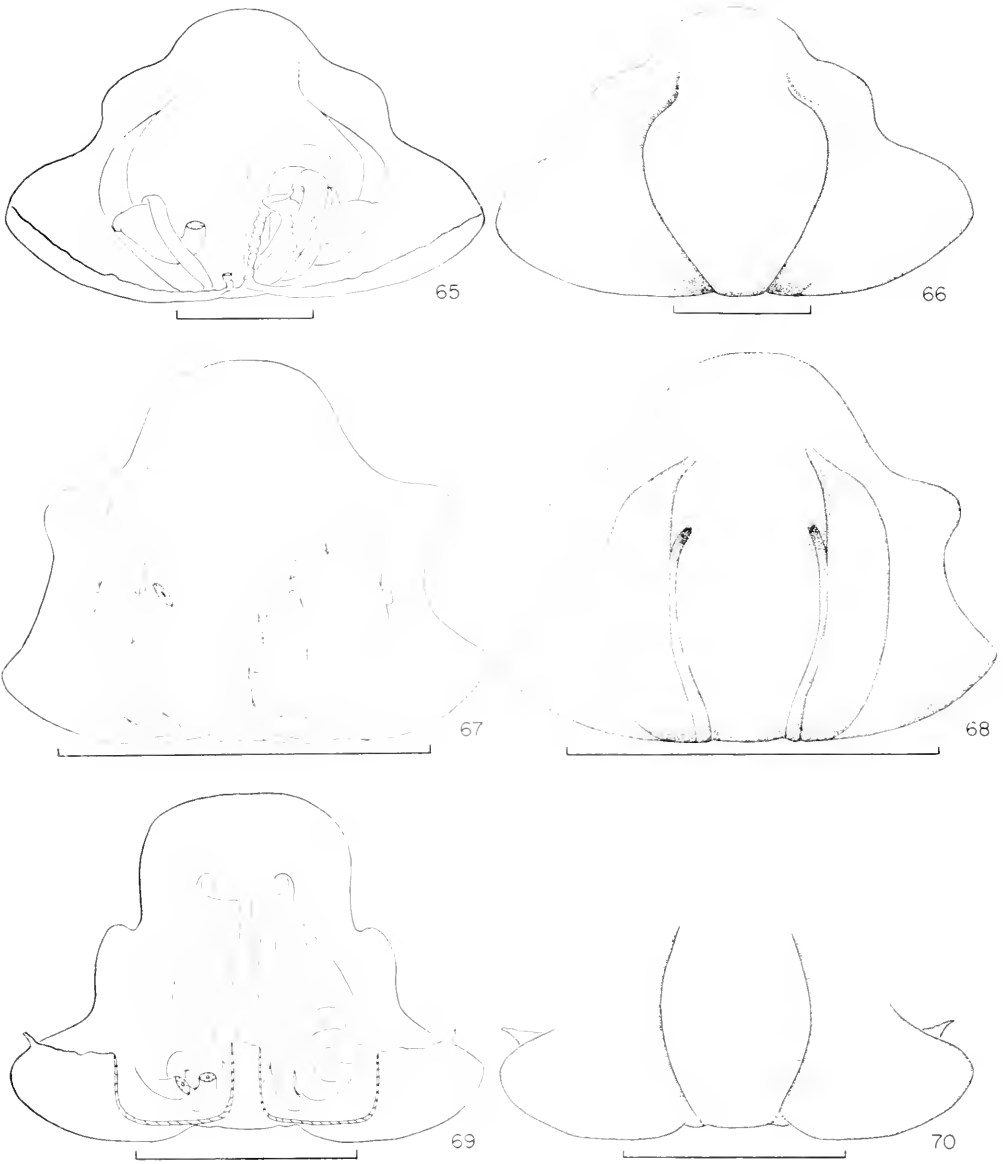

Figures 65–70. Epigyno. Figs. 65–66, *Dolamedes holti* n. sp. 65, Dorsal view. 66, Ventral view. Figs. 67–68, *D. striatus* Giebel. 67, Dorsal view. 68, Ventral view. Figs. 69–70, *D. triton* (Walckenaer). 69, Dorsal view. 70, Ventral view. (Figs. 67–68 adapted from Carico and Holt, 1964.)

Scales. 1.0 mm.

structure of the palpus and body appear to be almost identical in shape to that of the "typical" *D. scriptus*, the species into which it is here tentatively placed. Bishop, in his key, distinguished the tibial apophysis

of this male from *D. scriptus* upon the basis of the presence of a basal tooth. I have found this feature in both his species. This male, however, is distinctly smaller (CL = 5.0 mm) and much lighter than most males

of *D. scriptus*. It is also noteworthy that it was collected outside the known range of *D. scriptus* and, indeed, this is the only record of *D. scriptus* in all the Rio Grande drainage. I unsuccessfully attempted, in the summer of 1968, to collect specimens of *Dolomedes* in this location. It would be interesting to determine the significance of this unusual specimen, a task obviously requiring additional collecting.

Dolomedes scriptus Hentz

Figures 8–10, 22–24, 28, 43, 59–60; Map 5

Dolomedes scriptus Hentz, 1845, J. Boston Natur. Hist. Soc., 5: 189, pl. 16, fig. 1. Immature male (?) holotype from Alabama, lost.—Bishop, 1924, Bull. New York State Mus., 252: 44–47, pls. 22–23; pl. 24, figs. 1–2, ♂, ♀.—Bishop and Crosby, 1936, Entomol. News, 47: 239, 240, ♂.—Comstock, 1940, The Spider Book, rev. ed., W. J. Gertsch, p. 627, figs. 696–698, ♂, ♀.—Kaston, 1948, Bull. Connecticut State Geol. Natur. Hist. Surv., 70: 299, figs. 964–966, 992, 2061, 2062, ♂, ♀.—Roewer, 1954, Katalog der Araneae, 2(a): 135.—Bonnet, 1956, Bibliotheca Araneorum, 2: 1539.—Carico and Holt, 1961, Virginia Agr. Exp. Sta., Tech. Bull., 172: 12, figs. 13–14, ♀.

Dolomedes tenebrosus, Emerton, 1885, Trans. Connecticut Acad. Sci., 6: 501, pl. 49, fig. 9C, ♀.—Emerton, 1902, Common Spiders of the United States, pp. 57–58, figs. 213–214, ♀. [Mis-identifications.]

Dolomedes fontanus Emerton, 1885, Trans. Connecticut Acad. Sci., 6: 502, pl. 49, fig. 10. Female holotype from Dublin, New Hampshire, in the Museum of Comparative Zoology, examined.—Comstock, 1912, The Spider Book, p. 609, figs. 114–115, 116(3), 686, 696–698; *op. cit.*, rev. ed., 1940, figs. 114–115, 116(3), 686. First synonymized by Bishop, 1924, Bull. New York State Mus., 252: 45.

Dolomedes pinicola, Bishop and Crosby, 1936, Entomol. News, 47: 239–242, fig. 2, ♂. [Mis-identification.]

Diagnosis. *Dolomedes scriptus* and *D. gertschi* are apparently closely related. See "Diagnosis" under the latter species.

The females of *D. scriptus* are also very similar in pattern (Fig. 9) to the largely sympatric females of *D. tenebrosus*, but they are easily distinguished by characters of the genitalia (Figs. 28, 43, 59–60), which place them in different related species

groups. The relationship with *D. albivens* is discussed under "Diagnosis" of the latter species.

This species can usually be distinguished from other species by its abdominal dorsum, which has distinct "W-shaped" transverse bands.

Description. Average female CL average male CL = 1.17.

Male (from Transylvania County, North Carolina): On the *carapace* ocular area dark; clypens with transverse band of light hairs interrupted by irregular dark mottled area descending from ALE, marginal line interrupted medially with white spot; wide submarginal light bands continuous with clypeal band, extend to posterior edge of carapace, enclosing distinct medium gray central disc; irregular, narrow, dark marginal band widens posteriorly; curved light line extends posteriorly from each PLE, pair of indistinct triangular marks anterior to thoracic groove; narrow, medial, light band extends posteriorly from between thoracic triangular marks, surrounds thoracic groove; several dark lines of varying distinctness radiate from thoracic groove, each ending abruptly at edge of central disc, some widening at this terminus; pair of "Y-shaped" marks posterior to PME. **Sternum** dark gray laterally with irregular medial band extending from labium to posterior apex. **Labium** light, becoming medium reddish brown at laterobasal margins. Basal segments of *chelicerae* elongate, each marked anteriorly with longitudinal mottled gray band, anterior surfaces clothed with long light hairs. **Palpal endites** entirely light. All segments of *legs* light gray ventrally, darker dorsally; dorsal surfaces with indistinct gray longitudinal marks that appear to coalesce in some places into indistinct annular bands. Leg length order IV-I-II-III. **Abdomen** dorsally with medium gray lanceolate cardiac area bordered by pair of lateral narrow sinuous light bands; pair of oblique light marks that project posteriorly from posterior apex of cardiac area; two "W-shaped" transverse light

bands across posterior half of dorsum connected laterally to two narrow longitudinal light bands that extend from basal end; transverse light bands bordered anteriorly by similarly shaped black bands, posteriorly by dark gray areas; posterior apex with three transverse alternating black, dark gray bands. Sides medium gray that becomes lighter ventrally. Venter light with faint mottling that becomes darker towards sides; light spot just anterior to each anterior spinneret. *Palpal organ* (Fig. 28) as for *fimbriatus* group. *Tibial apophysis* (Fig. 43) with two large, broad, subequal teeth on end of truncated distal edge, small tooth at base on ventral margin. For *measurements* see Diagram 1 for dimensions and ratios of the genitalia and body.

Female (from Transylvania County, North Carolina): On the *carapace* ocular area dark only around each eye; clypeus with homogeneous medium gray area between AME and anterior edge except for median longitudinal white spot that begins at margin; mottled gray bands lateral to clypeal median gray area; lateral submarginal bands divided into series of discontinuous, light, elongate areas that enclose medium gray central disc; irregular, narrow, marginal bands widen posteriorly; curved light line extends posteriorly from each PLE, each of which is bordered laterally by short dark band; pair of triangular dark marks anterior to thoracic groove; light, median longitudinal band begins between PME, extends between triangular marks, widens around thoracic groove, continues to posterior margin of carapace; several lines of varying distinctness radiate from thoracic groove, end abruptly at edge of central disc; some lines become wider and truncated at this terminus, which joins submarginal light areas; "Y-shaped" dark mark posterior to each PME. *Sternum* medium gray laterally with broad irregular medial band extending from labium to posterior apex. *Labium* medium reddish brown, darkest laterally, lightest distally. Basal segments of *chelicerae* robust, me-

dium dark reddish brown in color; anterior surface clothed with long, light and dark hairs. *Palpal endites* light, becoming light reddish brown at base. Coxae of *legs* light ventrally; femora with light gray mottling ventrally which coalesces distally into annular bands on light background; other segments light gray with dorsal surfaces with distinct longitudinal gray marks that appear in some places to coalesce into annular bands. Leg length order IV-(II-I)-III. *Abdomen* dorsally with medium gray lanceolate cardiac area bordered by pair of curved light bands laterally; two pairs of light marks project obliquely, laterally from middle, posterior apex; four "W-shaped" transverse light bands across posterior half of dorsum connected laterally to mottled light areas; transverse light bands bordered anteriorly by similarly shaped black bands, posteriorly by dark gray bands separated by discontinuous narrow light marks. Sides medium gray, somewhat mottled, become homogeneously lighter ventrally. Venter light gray with indistinct longitudinal bands; light spot just anterior to each anterior spinneret. *Epigynum* (Fig. 60), *internal copulatory apparatus* (Fig. 59) as for *fimbriatus* group; pair of skeletal muscle attachments are anterolateral to epigynum, completely joined to it; epigynum completely sclerotized, distinct at anterior margin; fertilization tubes each composed of one coil, two loops; seminal valves found in posterior half of dorso-epigynal area (Carico and Holt, 1964). For measurements see Diagram 1 for dimensions and ratios of the genitalia and body.

Immatures have dorsal color patterns similar to the adults.

Variation. The rather complex color pattern varies considerably. The male described above possessed a wide, light, submarginal carapacial band. However, in some specimens, this band becomes broken into connected rhomboid light areas, while in others the light areas are reduced to a series of unconnected linear elongate light spots

(Figs. 23-24). Females show a similar type of variation of the carapacial band but they do not have the wide, uniform band of the male, and occasionally the light areas are almost obsolete (Fig. 22). Correlating with the decrease in light areas of the carapacial band is the decrease in light areas of the abdominal dorsum. Especially affected are the lateral light mottled areas of the female which may become a homogeneous medium gray. Likewise, the male shows a decrease in the width of the lateral light bands, but the transverse bands are always in evidence in both sexes. In older specimens the chelicerae, palpal endites, and labium may be quite dark.

In the north, the general color may be darker. The lateral parts of the "W-shaped" transverse abdominal bands are lighter and appear as distinct white marks.

An interesting light male variant from the Rio Grande Valley, previously called *D. pinicola*, was discussed in the "Variation" section of *D. albineus*.

Natural history. From personal observation and data from collections made by other collectors, it is clear that this species is most commonly found associated with moderate to fast moving streams. In the Appalachians they are very common among rocks and boulders located at the margins of or in the stream itself. They are also found among piles of dead sticks and leaves washed up along the stream margin. Their general grayish color and complex pattern blend quite well with the gray of rocks and weathered wood. *D. scriptus* is often found associated with *D. vittatus*, and their ecological relationship was discussed above in the section on the biology of the genus.

During the month of August and the first part of September, females with egg sacs are encountered and nurseries are common along stream banks. Occasionally females with egg sacs have been found either earlier (21 July, Pennsylvania) or later (22 October, New Jersey). Among four egg sacs opened, the number of eggs varied from 368 to 769. Gravid females

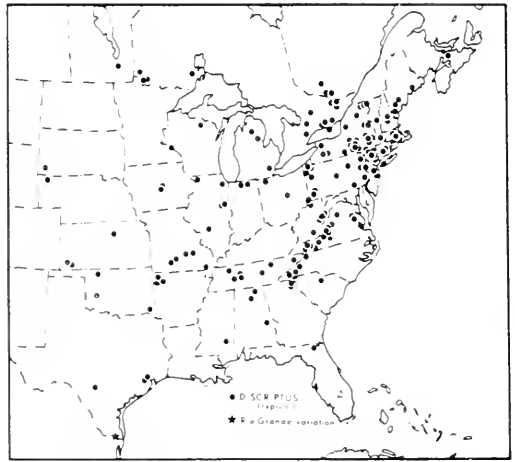

Map 5. Distribution of *Dolomedes scriptus* Hentz.

were found more often during July. Two females each had an embolus imbedded in the copulatory apparatus.

Distribution. Eastern United States and Canada from Nova Scotia, Southern Quebec, Ontario, and Manitoba southward to Texas, Alabama, Mississippi, Georgia, and east to the Atlantic coast. Westwardly, the range extends to western South Dakota, Nebraska, and Oklahoma (Map 5).

Bishop (1924) listed a locality as Arden, Florida, and another from Ft. Collins, Colorado, neither of which I have been able to confirm. He also referred to *D. scriptus* specimens from Hot Springs, Arizona; most likely these were *D. gertschi*.

Material examined. Eighty-two male, 157 female, and 157 immature specimens.

Dolomedes gertschi new species
Figures 12-13, 29, 44, 59-60; Map 6

Holotype. A female holotype and paratype series from Oak Creek Canyon, Coconino County, Arizona, 22 July 1949, collected by W. J. and J. W. Gertsch, in the American Museum of Natural History.

Etymology. It is my honor to name this species for Dr. Willis J. Gertsch for his encouragement and advice, and for calling to my attention that the species was undescribed.

Diagnosis. *Dolomedes gertschi* seems to be most closely related to *D. scriptus*, a conclusion based on basic similarities of their color patterns (Figs. 12–13) and shape of the tibial apophyses of the males (Fig. 44). The two species are clearly distinguishable by the CYL TL and TL PTL ratios of the males and the EW EL and EW MEW ratios of the females (see Dicke-Leraas diagrams for comparisons). Additionally, the median light band of the carapace is between PME and thoracic groove in *D. gertschi* (Figs. 12–13), whereas it is between PME and posterior edge of carapace in *D. scriptus* (Figs. 8–9).

Description. Average female CL average male CL = 1.38.

Male (from the type locality collected 4 July 1953, W. J. and J. W. Gertsch): On the *carapace* ocular area generally black, black areas around PE contiguous, black areas around AE discrete; clypeus medium gray with medial light spot extending from AME to edge; submarginal light bands extend from clypeal gray area to posterior edge of carapace and enclose distinct medium gray central disc; narrow marginal dark line present; curved light line extends posteriorly from each PLE; pair of indistinct elongate dark marks anterior to thoracic groove; narrow, median, light band extends between PME and elongate dark marks; several dark lines of varying distinctness radiate from thoracic groove, end abruptly at edge of central disc, some widening at this terminus. *Sternum* medium gray laterally with irregular median band extending from labium to posterior apex. *Labium* generally light, becoming dark reddish brown at latero-posterior margins. Basal segments of *chelicerae* elongate, each marked with anterior, longitudinal, indistinct gray band; anterior surface clothed with long light hairs. *Palpal endites* entirely light. All segments of *legs* light. Leg length order IV-I-II-III. *Abdomen* dorsally with light cardiac area bordered by pair of lateral sinuous light

bands, pair of oblique light marks that project posteriorly from posterior apex; three "W-shaped" transverse light bands across posterior half of dorsum connected laterally to two light bands that extend full length of dorsum; transverse light bands bordered anteriorly by similarly shaped black bands, posteriorly by dark gray areas; posterior apex with two transverse black bands separated by dark gray. Sides medium gray with dorsolateral longitudinal light bands punctuated by small dark spots. Venter with lighter mottling on light gray background. *Palpal organ* (Fig. 29) as for *fimbriatus* group. *Tibial apophysis* (Fig. 44) with two large broad subequal teeth on distal edge, small tooth at base on ventral margin; dorsal margin has low, broad, rounded projection, basal indentation. For *measurements* see Diagram 1 for dimensions and ratios of the genitalia and body of this species.

Female (holotype): General color of the carapace reddish brown; ocular area dark principally around each eye; clypeus with dark gray area between AME and anterior edge except for median longitudinal light spot between AME, anterior margin; mottled gray bands lateral to median gray clypeal area; lateral submarginal bands divided into series of discontinuous, light elongate areas that enclose medium reddish brown central disc; narrow, marginal dark bands widen posteriorly; curved light line extends posteriorly from each PLE, bordered laterally by tapered dark band; pair of triangular marks anterior to thoracic groove; light median longitudinal band begins between PME, extends to between triangular marks; several lines of varying distinctness radiate from thoracic groove, end abruptly at edge of central disc; some lines become wider and truncated at this terminus, which adjoins submarginal light areas; angular dark line posterior to each PME. *Sternum* dark reddish brown laterally with narrow irregular medial band extending from labium to posterior apex.

Labium dark reddish brown, light distally. Basal segments of *chelicerae* robust, dark reddish brown in color; anterior surface clothed with long light, dark hairs. *Palpal endites* dark reddish brown, light distally. Coxae of *legs* light ventrally with indistinct gray mottling; femora with extensive dark gray mottling on light background; other segments medium reddish brown, dorsal surfaces with distinct longitudinal dark marks that appear in some places to coalesce into annular bands. Leg length order IV-II-I-III. *Abdomen* dorsally with medium gray lanceolate cardiac area bordered by pair of curved light bands laterally, two pairs of light marks which project obliquely, laterad from middle, posterior apex; four "W-shaped" transverse light bands across posterior half of dorsum connected laterally to mottled light areas; transverse light bands bordered anteriorly by very dark bands, posteriorly by dark gray bands. Sides dark gray, becoming lighter ventrally. Venter medium gray. *Epigynum* (Fig. 60). *internal copulatory apparatus* (Fig. 59) as for *fimbriatus* group; fertilization tubes each composed of one coil, one loop not visible from dorsal view; seminal valves in posterior half of dorsoepigynal area. For *measurements* see Diagram 1 for dimensions and ratios of the genitalia and body.

The few immatures available have a color pattern much like that of the adults.

Variation. Within the limited sample studied, no significant variation was evident in the color pattern.

Natural history. The habitat of *D. gertschi* resembles that of *D. scriptus*, at least in a superficial way. I was quite impressed with the similarity of Oak Creek (the type locality) to mountain and piedmont streams of equivalent size of the eastern United States. Specifically, the stream has a rather open cover of vegetation and has intermittent riffles and pools among numerous boulders and rocks of various sizes.

Females collected on three dates carried

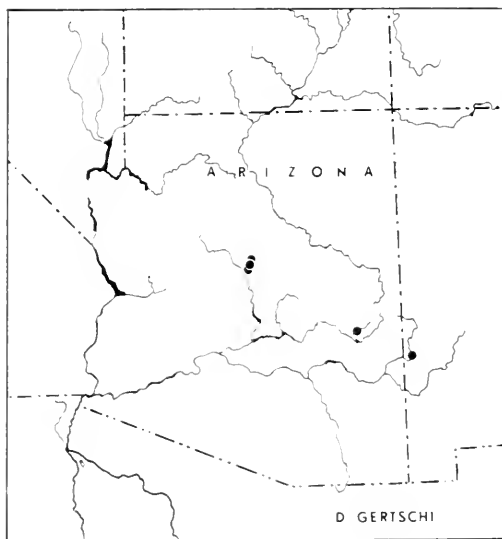

Map 6. Distribution of *Dolomedes gertschi* n. sp.

egg sacs: (1) 22 July 1949; 1.7cm dia. (453 spiderlings), 1.6cm dia., 1.5cm dia. (approx.); (2) 27 July 1950; 1.8cm dia. (1003 spiderlings); 1.7cm dia., 1.6cm dia.; (3) 8 July; 1.1cm dia. The egg sacs were typical of the genus and were light brown in color and spherical.

Distribution. The upper Gila River drainage in Arizona and New Mexico (Map 6).

Material examined. Twelve male, 25 female, and 15 immature specimens from the following localities.

Arizona. Coconino County: Oak Creek Canyon, 25 July 1952, 2 ♀ ♀, (M. Cazier, WJG, R. Schrammel) [AMNH]; 4 July 1953, 7 ♂ ♂ + 8 ♀ ♀ (W. J. & J. W. Gertsch) [AMNH]; 22 July 1949, ♂ + 4 ♀ ♀, (W. J. & J. W. Gertsch) [AMNH]; 27 July 1950, 2 ♂ ♂ + 5 ♀ ♀, (Mont A. Cazier) [AMNH]; (5128), 18 June 1935, ♀, (E. Saunder) [MCZ]; 17 m. NE White-river, 8 July, ♀, [AMNH]; 19 June 1966, ♂ + 3 ♀ ♀ (JEC) [JEC]. *New Mexico.* Whitewater Canyon, NE Glenwood, 4800', W108.54; N33.23, 18-19 August 1965, 2 ♀ ♀, (H. S. Fitch) [AMNH].

Dolomedes vittatus Walckenaer
 Figures 14–15, 30, 45, 63–64; Map 7

Dolomedes vittatus Walckenaer, 1837, Hist. Natur.

Insectes. Aptères, 1: 347. Immature male holotype is Abbot's figure No. 21, from Ogeechee River Swamp, Georgia.—Bishop, 1924, Bull. New York State Mus., 252: 47–50, pl. 24, fig. 1; pl. 25, ♂, ♀.—Bishop and Crosby, 1936, Entomol. News, 47: 238, ♂.—Comstock, 1940, The Spider Book, rev. ed., p. 630, ♂.—Chamberlin and Ivie, 1944, Bull. Univ. Utah, 35(9): 137, ♂, ♀.—Kaston, 1948, Bull. Connecticut State Geol. Natur. Hist. Surv., 70: 301–302, figs. 973–974, 995, ♂.—Roewer, 1954, Katalog der Araneae, 2(a): 135.—Bonnet, 1956, Bibliographia Araneorum, 2: 1543.

Dolomedes lanccolatus Hentz, 1845, J. Boston Natur. Hist. Soc., 5: 191, pl. 17, fig. 12. Male holotype from Massachusetts, North Carolina, South Carolina, or Alabama, destroyed.—First synonymized by Emerton, 1909, Trans. Connecticut Acad. Arts Sci., 14: 211, ♂.

Dolomedes urinator Hentz, 1845, J. Boston Natur. Hist. Soc., 5: 190–191, pl. 16, fig. 3. Female holotype, from North Carolina or Alabama, destroyed.—Banks, 1891, Entomol. News, 2: 86 (= *D. lanccolatus*).—Montgomery, 1904, Proc. Acad. Natur. Sci. Philadelphia, 56: 317–318, ♂, ♀.—Comstock, 1912, The Spider Book, p. 609, figs. 699–700, ♂, ♀.—Bishop, 1924, Bull. New York State Mus., 252: 36–38, pl. 33, fig. 3, ♀.—Comstock, 1940, The Spider Book, rev. ed., pp. 627–628, figs. 699–700, ♀.—Chamberlin and Ivie, 1944, Bull. Univ. Utah, 35(9): 137.—Kaston, 1948, Bull. Connecticut State Geol. Natur. Hist. Surv., 70: 302, figs. 975, 996, ♀.—Roewer, 1954, Katalog der Araneae, 2(a): 134.—Bonnet, 1956, Bibliographia Araneorum, 2: 1543.—Carico and Holt, 1964, Virginia Agr. Exp. Sta., Tech. Bull., 172: 12, figs. 17–18, ♀.

Diagnosis. *Dolomedes vittatus* and *D. holti* are the most closely related species-pair in the Neartic Region. See the diagnosis section under the latter species for further discussion. *Dolomedes vittatus* differs from other species by its deep chocolate brown background color and the distinctive pattern of light areas on the dorsum as in Figures 14–15.

The male is distinguished by the shape of the tibial apophysis, which is longer than wide and bears two teeth at the apical margin (Fig. 45), and by the presence of a patch of stiff spines on each femur IV

(Fig. 36). In the female the EW/SW and EW/EL ratios are usually distinctive but there is some overlap with other species (see Diag. 1).

Description. Average female CL/average male CL = 1.23.

Male (from Transylvania County, North Carolina): On the *carapace* ocular area dark; clypeus with wide transverse white band continuous laterally with submarginal white bands, and an anterior black margin; wide submarginal white bands continuous with clypeal band extend to posterior edge of carapace to enclose medium brown central disc; black marginal band present; indistinct curved light line extends posteriorly from each PLE; pair of very distinct black triangular marks anterior to thoracic groove; several dark lines of varying distinctness radiate from thoracic groove, end abruptly at edge of central disc, some widening at this terminus. *Sternum* light gray with indistinct, irregular median band of lighter color. *Labium* medium reddish brown, light at apical margin. Basal segments of *chelicerae* elongate, medium brown, each marked anteriorly with five longitudinal dark gray lines; anterior surfaces clothed with long, light hairs. *Palpal endites* medium reddish brown, light at apical margins. All femurs, coxae of *legs* light ventrally with indistinct light gray mottling, dorsal surfaces light with indistinct light brown longitudinal marks; other segments medium brown. Leg length order IV-I-II-III; femurs IV each have subapical patch of stiff spines retrolaterally on ventral side (Fig. 36). *Abdomen* dorsally with background color dark brown with distinct lateral, longitudinal light bands that extend from base, narrow towards apex; two pairs of alternating posterior light, dark, transverse lines extend medially from lateral light bands; pair of short, oblique basal light lines laterad from distinct cardiac area. Sides mottled with medium brown below longitudinal light bands becoming lighter ventrally. Venter light

brown, distinct from mottled brown areas of sides. *Palpal organ* (Fig. 30) as for *fimbriatus* group. *Tibial apophysis* (Fig. 45) about twice as long as wide, apical margin with two teeth, ventral one largest and curved; two other teeth located basally at anterior, posterior margins. For *measurements* see Diagram 1 for dimensions and ratios of the body and genitalia.

Female (from Transylvania County, North Carolina): General background color of the *carapace* dark brown with ocular area, clypeus dark; curved light line extends posteriorly from each PE; pair of triangular black marks anterior to thoracic groove; several lines of varying distinctiveness radiate from thoracic groove, and end abruptly at edge of indistinct central disc; some lines become wider and truncated at this terminus. *Sternum* dark brown. *Labium* dark reddish brown, becoming light at apical margin. *Chelicerae* dark reddish brown, with anterior surface clothed with mixture of long, light, dark hairs. *Palpal endites* dark reddish brown, becoming light at apical margins. General color of *legs* dark brown; ventral surfaces with indistinct gray mottling, dorsal surfaces with longitudinal gray marks that appear in some places to coalesce into annular bands. Leg length order IV-(II)-III. *Abdomen* dorsally dark brown in general background color; two pairs of small white spots in basal half with three pairs of larger white spots in apical half joined by indistinct transverse dark lines; indistinct lighter lanceolate cardiac area present. Sides dark brown. Venter dark brown, distinct from sides. *Epigynum* (Fig. 64), *internal copulatory apparatus* (Fig. 63) as for *fimbriatus* group; posterolateral edges of epigynum turned somewhat dorsally and anteriorly; fertilization tubes composed of one coil, two loops, seminal valves located in posterior half of dorso-epigynal area (Carico and Holt, 1964). For *measurements* see Diagram 1 for dimension and ratios of the genitalia and body.

The immatures have a color pattern very similar to that of the adults and therefore are relatively distinctive. Sexual dimorphism is evident, making sexual differentiation of the young easy. Frequently, a more complex pattern is apparent in very young or light specimens similar to the pattern of *D. scriptus*.

Variation. Generally, *D. vittatus* does not show any significant variation in the color pattern. The principal differences encountered in both sexes in most populations is the degree of darkness in the brown background color. When the background color is relatively light, a more complex pattern of dark lines and bands emerges which roughly resembles that of *D. scriptus*. A single male collected in Lynchburg, Virginia, has an atypical pattern that resembles the typical female pattern more than that of males.

Natural history. The range of *D. vittatus* overlaps that of *D. scriptus* for the most part, as do their habitats. Although they are frequently found together, *D. vittatus* is more prevalent in small, well-covered streams, whereas *D. scriptus* is more common in larger, open streams. The dark brown color may be protective because they inhabit shaded areas of streams among piles of woody debris, around rocks and boulders, and on trunks of trees.

I have seen two nurseries of this species and they are of typical *Dolomedes* construction. Egg sacs occur from late summer (26 July, Virginia) to early fall (11 September, N. Carolina). The number of eggs or spiderlings per sac is among the largest of the genus. Bishop (1924) and Kaston (1945) reported as many as 1457 and 1480 respectively. The maximum is 1134 among the material I have examined. One female collected in Whitfield County, Georgia, had the embolus embedded in the right side of the copulatory apparatus. A mature male and a penultimate female were observed to engage in preliminary mating

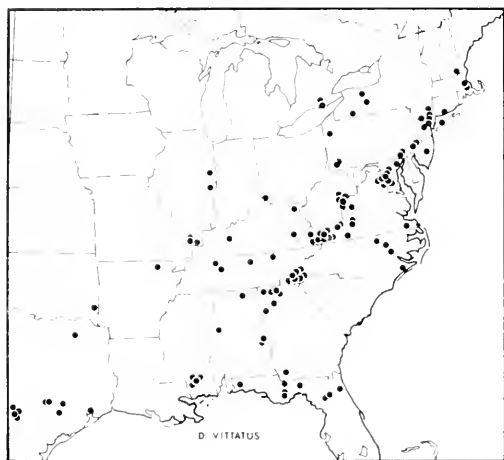

Map 7. Distribution of *Dolomedes vittatus* Walckenaer.

behavior for several hours in the laboratory but did not mate.

Distribution. Eastern United States and Canada from Ontario and New Hampshire southward to northern Florida and westward to Arkansas and the eastern parts of Oklahoma and Texas (Map 7). Bishop (1924) reported a male and female from Olney, Illinois.

Material examined. Fourteen male, 65 female, and 100 immature specimens.

Discussion. The striking sexual dimorphism in the color pattern of this species has resulted in considerable nomenclatural confusion, with males having been known generally as *D. vittatus* or *D. lanceolatus*, while the females have been known as *D. urinator*. Banks (1891), Montgomery (1904), and Comstock (1912) considered both sexes to be of the same species, though under different names. However, Bishop (1924: 49) “. . . found several [female] specimens which agree in size, color and markings to such an extent [with the male of *D. vittatus*] that it is impossible to reach any other conclusion than that *Dolomedes urinator* is distinct and known only from the female.” Additionally, he says (p. 50) of females of *D. vittatus*, “I have recently (June, 1923) found the fe-

males to be fairly common in a tamarack swamp near Voorheesville, N. Y.” I have not collected nor seen a female with the “male” pattern. This diversity of female patterns is not unlikely. I have observed similar pattern diversity in other species, notably the closely related *D. holti*.

No reference has been made to a male with the female pattern except that by Kaston (1948), who collected a penultimate specimen at Gainesville, Georgia. I have collected a mature male with the female pattern, as stated before, but the genitalia and tibial characters were typical of *D. vittatus*. This is not surprising, since the males are also variable in other species.

Dolomedes holti new species

Figures 16–17, 31, 35, 46, 65–66; Map 8

Holotype. A female holotype and paratype series from San Juan River west of Horsetail Falls, Nuevo León, Mexico, 1 August 1968, collected by James E. Carico, in the Museum of Comparative Zoology, Harvard University. One male and one female paratype are deposited in the American Museum of Natural History.

Etymology. This species is named for Dr. Perry C. Holt, who has encouraged and advised me in this project from its inception.

Diagnosis. *Dolomedes holti* and *D. vittatus* are the most closely related species-pair in the Nearctic Region. While the color patterns (Figs. 16–17) and genitalia (Figs. 65–66) of these two species show basic similarities, there are, however, certain characters that, at the same time, clearly indicate the distinctiveness of their gene pools.

As stated above in the section on variation, *D. holti* has a very variable color pattern. Some of the variations are very similar to the color patterns of *D. vittatus*; however, other variations are unknown for the latter species.

In males the CL:CYL ratio is a reliable

character with the CYL/TL (see Diag. 1) being a useful ratio but with some overlap between the two species. Females are clearly distinguished by the EW/SW (see Diag. 1) ratio while the EW/MEW ratio is generally a good character but having some overlap.

Description. Average female CL/average male CL = 1.24.

Male (paratype): Ocular area of *carapace* dark; clypeus with wide transverse white band continuous laterally with submarginal white bands, anterior black margin; wide submarginal white bands continuous with clypeal band extend to posterior edge of carapace to enclose a medium brown central disc; black marginal band present; distinct curved light line extends posteriorly from each PLIE; pair of dark triangular marks anterior to thoracic groove; several dark lines of varying distinctness radiate from thoracic groove, end abruptly at edge of central disc, some widening at this terminus. *Sternum* entirely light. *Labium* medium reddish brown, darker at basolateral margins, light apically. Basal segments of *chelicerae* elongate, medium brown, each marked anteriorly by reddish brown mottling; anterior surfaces clothed with long, light hairs. *Palpal endites* medium reddish brown, light at apical margins. All femurs, coxae of *legs* light ventrally, dorsal surfaces light with indistinct light brown longitudinal marks; other segments medium brown. Leg length order IV-I-II-III; femurs IV each with subapical patch of stiff spines retrolaterally on ventral side (Fig. 35). *Abdomen* dorsally with background color dark to medium brown with distinct lateral, longitudinal light bands that extend from base, narrow towards apex; three pairs of posterior light transverse lines extend medially from lateral light bands with dark transverse lines just posterior to each transverse light line; pair of obscure, short, oblique basal light lines present; cardiac area indistinct. Sides mot-

tled medium brown below longitudinal light bands that become lighter, obsolete ventrally. Venter light brown, not distinctly set off from mottled brown areas of sides. *Palpal organ* (Fig. 31) as for *fimbriatus* group. *Tibial apophysis* (Fig. 46) about twice as long as wide, apical margin with two teeth, the curved ventral one largest; two other teeth located basally at dorsal, ventral margins, with dorsal one much larger. For *measurements* see Diagram 1 for dimensions and ratios of the body and genitalia.

Female (holotype): General background color of *carapace* dark brown with ocular area darker; clypeus with wide transverse white band continuous laterally with submarginal white bands, black band at anterior margin; wide submarginal white bands continuous with clypeal band, extend to posterior edge of carapace, thus enclosing medium brown central disc; black irregular marginal band present; distinct curved light line extends posteriorly from each PLIE; pair of black triangular marks anterior to thoracic groove; several dark lines of varying distinctness radiate from thoracic groove, end abruptly at edge of central disc, some widening at this terminus. *Sternum* medium brown. *Labium* dark reddish brown, light at apical margin. *Chelicerae* dark reddish brown, with anterior surface clothed with long mixed light, dark hairs. *Palpal endites* dark reddish brown, light at apical margins. General color of *legs* medium to dark brown; coxae medium brown, femurs with dark gray mottling that appears to coalesce into annular bands; other segments dark brown with indistinct annular dark bands. Leg length order IV-II-I-III. *Abdomen* dorsally with general background color dark brown with distinct lateral, longitudinal light bands that extend from base, narrow towards apex; two pairs of posterior light transverse lines separated by dark extend medially from lateral light bands; margins

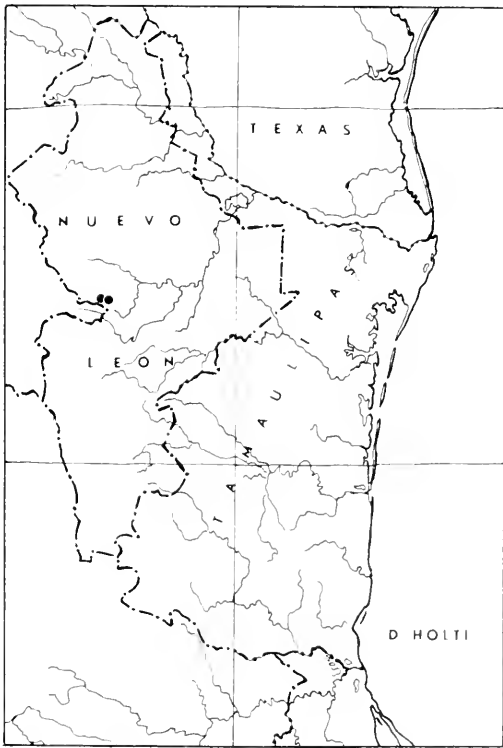

Map 8. Distribution of *Dolomedes holti* n. sp.

of lateral light bands undulated posterior to origin of transverse lines; two pairs of obscure light basal marks lateral to indistinct cardiac area. Sides mottled dark brown below longitudinal light bands, cuticle folded into several longitudinal grooves and ridges. Venter dark brown, not easily distinguished from sides. *Epigynum* (Fig. 66), *internal copulatory apparatus* (Fig. 65) as for *fimbriatus* group; fertilization tubes composed of one coil, two loops; seminal valves located in posterior half of dorsoepigynal area. For *measurements* see Diagram 1 for dimensions and ratios of the genitalia and body.

Immatures in the paratype series number thirteen and are in various stages of development. Generally they are lighter in color than the adults and are quite varied in pattern.

Variation. In the paratype series the males showed little significant variation among themselves, but one of the two males in another series from nearby Horsetail Falls is unusual in that it is very light and the longitudinal bands are obsolete.

Females of the paratype series were unusual in that there were two different color patterns represented. One variant is chocolate brown with white areas limited to white spots on the dorsum as in *D. vittatus* females. The other has very distinct longitudinal white bands on the carapace and abdomen (five of the 13 females in the type series), therefore showing a close resemblance to males of the same species and to the male of *D. vittatus*. In the Horsetail Falls series, the two females showed a complex pattern similar to *D. scriptus* because of the generally lighter background color.

Natural history. The paratype series was taken from the San Juan River, which is a generally shallow stream (approximately 25 ft. in width), with intermittent pools and riffles in an open, high-walled canyon. The spiders were found during the day under and around the bases of large boulders at the edges of, or emerging from, the stream. They were usually positioned on vertical faces with head down in typical *Dolomedes* fashion. Many of the females had distended abdomens and were apparently gravid.

Distribution. San Juan River drainage in the vicinity of Horsetail Falls, Nuevo León, Mexico (Map 8).

Material examined. Seven male, 16 female, and 19 immature specimens from the following localities.

MEXICO. *Nuevo León.* Horsetail Falls, 31 July 1968, 2 ♂♂ + 2 ♀♀ (JEC) [JEC]; 27 Nov. 1937, ♀ (L. Irby David & Bruce Brown) [AMNH]; at San Juan R. Canyon, 1 August 1968, 4 ♂♂ + 13 ♀♀ + 13 imm. (type series) (JEC) [JEC]; Villa De Santiago, 16, 18 June 1938, ♂ + 6 imm. (H. Hoogstraal) [MCZ].

Dolomedes striatus Giebel

Figures 20–21, 32, 47, 67–68; Map 9

Dolomedes striatus Giebel, 1869, Zeits. gesam. Naturw., 33: 252. Immature (?female) holotype from Illinois in Zoologisches Institut, Martin-Luther-Universität Halle-Wittenberg, Halle, DDR, examined.—Bishop, 1924, Bull. New York State Mus., 252: 57–59, pl. 33, fig. 1: pl. 34, fig. 2, ♀.—Bishop and Crosby, 1936, Entomol. News, 47: 242, ♂.—Kaston, 1948, Bull. Connecticut State Geol. Natur. Hist. Surv., 70: 301, 972, 982, ♂, ♀.—Roewer, 1954, Katalog der Araneae, 2(a): 135.—Bonnet, 1956, Bibliographia Araneorum, 2: 1540.—Carico and Holt, 1964, Virginia Agr. Expt. Sta., Tech. Bull., 172: 12, figs. 19–20, ♀.

Dolomedes fulvitreronotatus Bishop, 1924, Bull. New York State Mus., 252: 59–60, pl. 19, fig. 3: pl. 34, fig. 1. Female holotype from Pistakee, Illinois, in the Museum of Comparative Zoology, examined.—Roewer, 1954, Katalog der Araneae, 2(a): 134.—Bonnet, 1956, Bibliographia Araneorum, 2: 1532. NEW SYNONYMY.

Diagnosis. *Dolomedes striatus* is often confused with *D. triton* because of similarity of pattern. Both possess white bands on the carapace and abdomen, white spots on the abdomen, and dark spots on the sternum. The white abdominal bands of typical *D. striatus* are more dorsal, more distinct, and are solid colored, and the median dark band is darker at the edge adjacent to the white bands (Figs. 20–21).

The adults are easily distinguished by characteristics of the genitalia. Males of *D. striatus* have a very distinct earlike tibial apophysis (Fig. 47) that is obviously dissimilar to the long spatulate tibial apophysis of *D. triton* (Fig. 48). Also, *D. striatus* males have no spinous hump on femur IV. The epigynum of *D. striatus* has a wider middle lobe and wider medial border of the lateral lobes; also, the position of the seminal valve is located more posteriorly in the dorsoepigynal area (Fig. 67).

Description. Average female CL/average male CL = 1.11.

Male (from Ramsey, New Jersey): General background color of *carapace* medium brown, with ocular area dark only around each individual eye; clypeus with median

light spot between two obscure gray areas; rather straight submarginal white band extends from each anterolateral clypeal angle to posterior edge of carapace and encloses medium brown central disc; dark marginal bands present, several obscure lines of varying distinctness radiate from thoracic groove, end at edge of central disc. *Sternum* light with median, indistinct, longitudinal dark band; four pairs of coalesced dark spots laterally. *Labium* medium reddish brown, darker basolaterally, light distally. *Chelicerae* medium brown, anterior surface with indistinct gray lines, long, dark, light hairs. *Palpal endites* medium brown. *Legs* medium brown with obscure mottling on ventral sides of coxae, femurs; obscure longitudinal marks on dorsal surface of femurs. Leg length order (IV-I)-II-III. *Abdominal* background color medium to dark brown; dorsally two distinct, narrow, lateral, longitudinal white bands extending from base to apex enclosing wide brown median area that darkens apically, darkens laterally towards edge adjacent to white bands; three pairs of obscure light spots in apical half of median dark band. Sides with numerous parallel dark brown lines. Venter light brown with narrow dark brown lines laterally; median medium brown area widest at epigastric groove, narrows to spinnerets. *Palpal organ* (Fig. 32) as for *fimbriatus* group. *Tibial apophysis* (Fig. 47) closely appressed to tibia, earlike in shape with one or two small teeth. For *measurements* see Diagram 1 for dimensions and ratios of the body and genitalia.

Female (from Ramsey, New Jersey): General background color of *carapace* medium brown, ocular area dark only around each individual eye; clypeus with median light spot between two obscure gray areas; rather straight submarginal white band extends from each anterolateral clypeal angle to posterior edge of carapace, encloses medium brown central disc; dark marginal bands present, several obscure lines of varying distinctness radiate from tho-

racic groove, end at edge of central disc. *Sternum* light with median, indistinct, longitudinal dark band, four pairs of triangular distinct dark spots laterally. *Labium* medium reddish brown, darker basolaterally, light distally. *Chelicerae* medium brown; anterior surface with indistinct gray lines, long, mixed, light, dark hairs. *Palpal endites* medium brown. *Legs* medium brown, obscure mottling on ventral sides of coxae, femurs; obscure longitudinal marks on dorsal surfaces of femurs. Leg length order IV-(I-II)-III. *Abdominal* background color medium to dark brown; dorsally, two distinct, narrow, lateral longitudinal white bands extend from base to apex, enclose wide, brown, median area that darkens apically, darkens laterally towards edge adjacent to white bands, five pairs of small light spots in median dark band. Sides with numerous parallel dark brown lines. Venter light brown with narrow medium brown lines laterally, median medium brown area widest at epigastric groove, narrows to spinnerets. *Epigynum* (Fig. 65), *internal copulatory apparatus* (Fig. 67) as for *fimbriatus* group; fertilization tubes composed of one coil, two loops; seminal valves in posterior half of dorsoepigynal area (Carico and Holt, 1964). For *measurements* see Diagram 1 for dimensions and ratios of the genitalia and body.

The pattern of the immatures is like that of the adults, and may be distinguished from *D. triton* by the dark edge of the abdominal median band, which is adjacent to the distinct white bands.

Variation. There seem to be two rather different color patterns, one of which is much more common than the other. Most common is the pattern of the specimens herein described and figured, and there seems to be little significant variation within this form.

The least common variation is here referred to as the "fulviatronotatus" color pattern because it was described as a new

species under that specific name. It is distinguished by a pattern that is greatly diffused into a rather irregular and scattered array of dark spots and "blotches" over the body. Four adult female and two immature specimens with this pattern were examined and they all showed different degrees of diffusion of the pattern. Refer to Bishop's (1924) plate 34, figure 2 for an illustration of this variety.

Natural history. This is the only known North American species that I have not collected, even though such an effort was made in Illinois (and the type locality of *D. fulviatronotatus* Bishop), Michigan, and Ontario the summer of 1968. Therefore, I can only cite from literature, museum labels, and personal correspondence on the subject of natural history.

Kaston (1948) and Joseph A. Beatty (personal communication) both have collected *D. striatus* around small ponds and marshy areas. H. K. Wallace (personal communication) collected it in marshes and swamps in the E. S. George Reserve, Livingston County, Michigan, by sweeping and sifting, and with the aid of a headlight. Museum specimen labels often indicated the locality as a particular pond, but additional information is lacking except for two Canadian collections, which had comments such as "edge of sandy pool" and "under drift at high water mark."

Bishop reports observing a nursery in New York on 3 September which resembled the nursery of *D. triton* and contained an egg sac "about three-eighths inch" in diameter. Egg sacs were in collections from Michigan (26 June) and New Jersey (26 August). Mature males are found in the collections as early as 30 May (Connecticut) and as late as 3 January (Ontario) while mature females are from May (New York) to 24 September (New Jersey).

Distribution. Glaciated regions of the northeastern United States and Canada north of 40° latitude to Labrador, and west to Illinois and western Ontario (Map

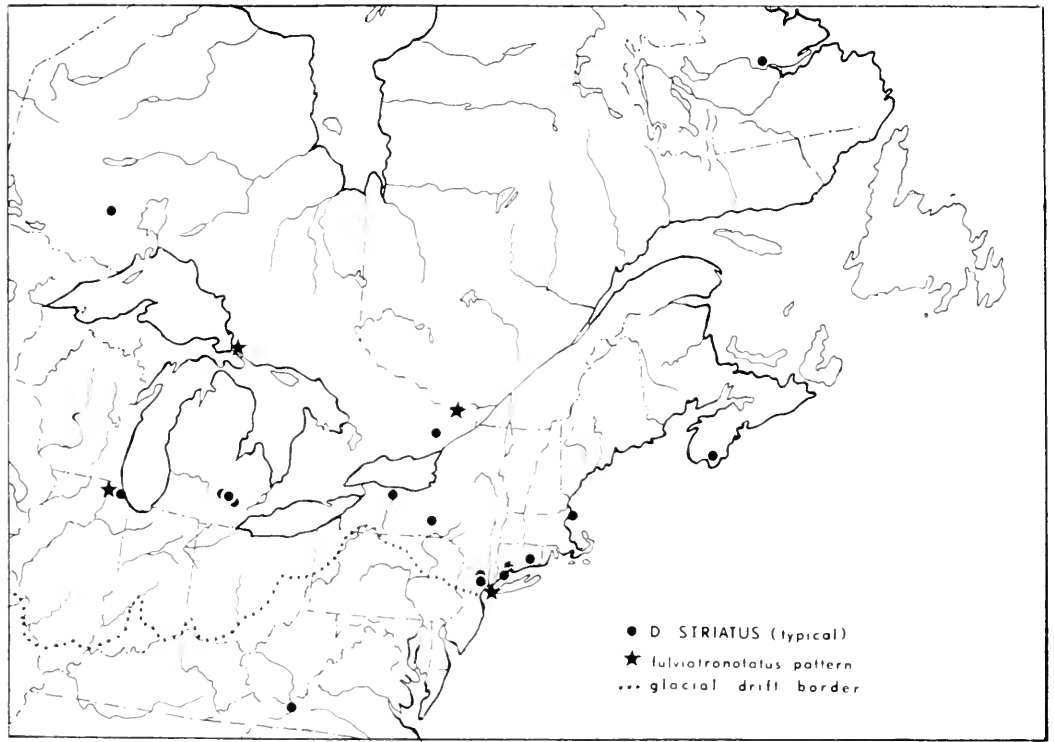

Map 9. Distribution of *Dolomedes striatus* Giebel.

9). A mature female from the H. K. Wallace collection found in Giles County, Virginia, extends the apparent range of this species considerably. It might be from a range extension that follows the Appalachian Mountains southward.

Material examined. Eleven male, 20 female, and 58 immature specimens were examined.

Discussion. Giebel's description has been considered (Bishop, 1924; Bishop and Crosby, 1936) to refer to the species herein described. An examination of his description leaves doubt as to whether he was describing the more common and widely distributed *D. triton*, which is quite similar. The only characters he mentioned are the features of the dorsal abdominal pattern, but the manner of describing some of them is not entirely clear, while other, more clearly described characters are possessed

by both species. The holotype, because of its shriveled and colorless condition, is of little help. Measurements of the carapace agree more with those of what is here considered *D. striatus* than those of *D. triton*. I believe that Bishop was therefore justified in resurrecting this name.

Because I have been unable to obtain specimens from the type-locality, Illinois, I have chosen to select specimens for descriptions from a series in good condition from New Jersey which are consistent in taxonomic characters with specimens from other areas of the range.

Dolomedes triton (Walckenaer)

Figures 11, 18-19, 33, 37, 48, 69-70; Map 10

Lycosa triton Walckenaer, 1837, Hist. Natur. Insectes, Aptères, 1: 340. Female holotype Abbot figure no. 91 from Georgia.

- Dolomedes sexpunctatus* Hentz, 1845, J. Boston Natur. Hist. Soc., 5: 191, pl. 16, figs. 5, 6. Female and immature male syntypes from North and South Carolina, Massachusetts, and Alabama, destroyed.—Emerton, 1902, Common Spiders of the United States, p. 85, figs. 210–212, ♀.—First synonymized to *D. triton* (Walekenaer) by Petrunkevitch, 1910, Ann. New York Acad. Sci., 19: 219–220.—Comstock, 1912, The Spider Book, p. 614–616, figs. 704–706, ♂, ♀.—Chamberlin and Ivie, 1946, Bull. Univ. Utah, 36(13): 5, fig. 4, ♂, ♀.
- Dolomedes scapularis* C. L. Koch, 1848, Die Arachniden, 14: 119–120, fig. 1358, immature (?).—First synonymized with *D. sexpunctatus* Hentz by Banks, 1901, New York Entomol. Soc., 9: 186.
- Dolomedes scopularis* [sic]—Chamberlin and Ivie, 1946, Bull. Univ. Utah, 36(13): 4, fig. 3, ♂, ♀.
- Dolomedes major* Banks, 1898, Proc. California Acad. Sci., 1: 276–277, pl. 17, fig. 5. Male and female syntypes from San José del Cabo and Sierra San Lazaro, Baja California, Territorio del Sur, Mexico, in Museum of Comparative Zoology, examined.—Roewer, 1954, Katalog der Araneae, 2(a): 133.—Bonnet, 1956, Bibliographia Araneorum, 2: 1534. NEW SYNONYMY.
- Dolomedes triton*.—Petrunkevitch, 1910, Ann. New York Acad. Sci., 19: 219–220.—Bishop and Crosby, 1936, Entomol. News, 47: 238, ♂.—Comstock, 1940, Spider Book (rev. ed.), p. 631, figs. 702–704, ♂, ♀.—Chamberlin and Ivie, 1944, Bull. Univ. Utah, 35(9): 136–137, ♂, ♀.—Chamberlin and Ivie, 1946, Bull. Univ. Utah, 36(13): 6, fig. 6, ♂, ♀.—Roewer, 1954, Katalog der Araneae, 2(a): 133–134.—Bonnet, 1956, Bibliographia Araneorum, 2: 1541–1542.—Carico and Holt, 1964, Virginia Agr. Exp. Sta., Tech. Bull., 172: 12–13, figs. 21–22, ♀.
- Dolomedes triton triton*.—Bishop, 1924, Bull. New York State Mus., 252: 50–55, pls. 27, 28, 30, figs. 1–4, ♂, ♀.
- Dolomedes triton sexpunctatus*.—Bishop, 1924, Bull. New York State Mus., 252: 52–55, pl. 29, figs. 1–2.—Kaston, 1948, Bull. Connecticut State. Geol. Natur. Hist. Surv., 70: 300–301, figs. 970–971, 979–981, ♂, ♀.
- Dolomedes albiclavius* Bishop, 1924, Bull. New York State Mus., 252: 56, pl. 32, pl. 33, fig. 4. Female holotype from Springfield, Missouri, in the Museum of Comparative Zoology, examined.—Chamberlin and Ivie, 1944, Bull. Univ. Utah, 35(9): 135.—Roewer, 1954, Katalog der Araneae, 2(a): 134.—Bonnet, 1956, Bibliographia Araneorum, 2: 1525. NEW SYNONYMY.
- Dolomedes spatulatus* Chamberlin and Ivie, 1946, Bull. Univ. Utah, 36(13): 6, fig. 5, ♂, ♀.
- Male holotype, female allotype from Kingston, Tennessee, in the University of Utah, not examined; paratypes from type locality in American Museum of Natural History, examined. NEW SYNONYMY.
- Diagnosis.* The relationship of *D. triton* to other species is obscure. It bears a superficial resemblance with *D. striatus* and is discussed further in the diagnosis section under the latter species. The pattern differs from other species in that it has three pairs of dark sternal spots, light submarginal carapacial bands, and a number of light spots on the abdominal dorsum (Figs. 18–19).
- Males are easily distinguished by the shape of the tibial apophysis, which is rounded and expanded apically and extends beyond the apex of the tibia (Fig. 33). The seminal valve of the female copulatory apparatus is located in the anterior half of the dorsoepigynal area, and the fertilization tubes are loosely wound and rather narrow (Fig. 69). The posterior edge of the epigynum is turned dorsally and anteriorly so as to cover part of the dorsoepigynal area (Fig. 69).
- Description.* Average female CL/average male CL = 1.28.
- Male* (from Charlton County, Georgia): General background color of *carapace* greenish gray to medium brown with ocular area dark; clypeus with median, light, submarginal area between two gray areas; submarginal white band extends from each anterolateral clypeal angle to posterior edge of carapace, encloses medium brown central disc; medium dark marginal bands present, curved light line extends posteriorly from each PLE; pair of indistinct, medium dark marks anterior to thoracic groove; narrow, median, light band extends from near PME to posterior edge of carapace; pair of short, medium dark bands encloses anterior end of median light band; several obscure lines of varying distinctness radiate from thoracic groove, end at edge of central disc. *Sternum* light with three distinct pairs of dark spots laterally. *La-*

bium medium reddish brown, light on apical margin. *Chelicerae* light, each with 2-3 longitudinal dark lines, long light hairs anteriorly. *Palpal endites* light reddish brown. All *leg* segments light ventrally with irregular longitudinal gray lines dorsally; femur IV with spiny tubercle apically on ventral side. Leg length order IV-I-II-III. *Abdominal* background color dark reddish brown to light brown. Dark brown color dorsally with a distinct light cardiac area; two pairs of anterior white spots lateral to cardiac area; posteriorly, four pairs of white spots lateral to three pairs of smaller white spots, with obscure transverse dark bands between more posterior pairs of white spots. Sides each with irregular white reticulated band dorsally adjacent to dark area of dorsum; ventrally, sides with irregular dark mottling. Venter light with longitudinal medium bands, with dark areas of sides nearly in contact just anterior to spinnerets. *Palpal organ* (Fig. 33) as for *fimbriatus* group. *Tibial apophysis* (Fig. 48) length usually more than twice its width at widest point, expanded, rounded, flattened apically; ventral blunt tooth about one-third distance from base. For *measurements* see Diagram I for dimensions and ratios of the body and genitalia.

Female (from Charlton County, Georgia): General background color of *carapace* greenish gray to medium brown, with ocular area dark only around each individual eye; clypeus with median, light spot between two gray areas; submarginal white band extends from each anterolateral clypeal angle to posterior edge of carapace, encloses medium brown central disc; dark marginal bands present, curved light line extends posteriorly from each PLE; pair of indistinct medium dark marks anterior to thoracic groove; narrow, median, light band extends from near PME to posterior edge of carapace; pair of short, medium dark bands encloses anterior end of median light band, several

obscure lines of varying distinctness radiate from thoracic groove, end at edge of central disc. *Sternum* light, with three distinct pairs of dark spots laterally. *Labium* dark reddish brown, light on apical margin. *Chelicerae* dark reddish brown, with anterior surface clothed with long, mixed light, dark hairs. *Palpal endites* medium reddish brown, lighter apically. All *leg* segments light ventrally with irregular gray lines dorsally. Leg length order IV-(I-II)-III. *Abdominal* background color dark reddish brown to light brown. Dorsally, color dark brown with distinct cardiac area; two pairs of anterior white spots lateral to cardiac area; four posterior pairs of white spots, each encircled by dark ring lateral to four pairs of smaller white spots. Sides each with irregular white reticulated band dorsally adjacent to dark area of dorsum; ventrally, sides have irregular dark mottling. Venter light with longitudinal obscure dark bands. *Epigynum* (Fig. 70), *internal copulatory apparatus* (Fig. 69) as for *fimbriatus* group; entire posterior edge of epigynum turned dorsally and anteriorly, overlaps much of internal parts of copulatory apparatus, pigmentation may be light, making edges obscure; fertilization tubes relatively slender, loosely looped in dorsoepigynal area, each composed of three loops; seminal valves found in anterior half of dorsoepigynal area (Carico and Holt, 1964). For *measurements* see Diagram I for dimensions and ratios of the body and genitalia.

Generally, the color pattern of immatures is very similar to that of the adults. *Dolomedes triton* immatures typically have a lighter and greener background color with the dark rings around the white abdominal spots usually quite distinctive. Very small spiderlings show a more diffuse pattern with some evidence of abdominal transverse markings.

Variation. *Dolomedes triton* is probably the most variable of all nearctic species.

The variation is both geographic and intrapopulation.

The populations in the eastern United States show variation in both the distinctiveness and distribution of the color pattern over the body. In females, I have noticed a definite deepening of color in the dark areas of the pattern to be associated with advanced age. While the lighter and younger individuals are greenish tan, the color of older individuals tends towards a deeper brown. On the abdominal dorsum, it seems as if the center for the darkening trend is the dark rings around the larger white spots. These dark rings may vary from narrow rings to broad and coalescing longitudinal dark bands.

Another eastern variation is the width of the carapace bands. The width of the bands may vary (with intermediates) from a narrow submarginal band to a wide band that nearly reaches the lateral margins of the carapace and continues across the clypeus. An attempt was made to measure and therefore quantify these bands because of their supposed taxonomic implications, but their irregularity defied this kind of objective analysis. The wider bands are less common than the narrower ones in any of the populations examined; the wider bands are found in the northeast and southeast, but more often in the latter. As one proceeds westward from the northeastern United States, the narrower carapace bands seem to shift position by becoming more medial and straighter. In the latter case, the carapace bands resemble those of *D. striatus*, which are, in some cases, sympatric with *D. triton* in this region.

Variation of sternal spotting seems to be more geographic. In the southeast these spots are distinct, but in the northeast and throughout the northwest, they usually coalesce to some degree into lateral bands. There appears to be a clinal change from south to north of this variation.

The only feature of the reproductive structures which shows mentionable variation is the male tibial apophysis. As can

be seen in Figure 11 the apex of the apophysis varies in the degree to which it is expanded. This expansion seems to be closely related to the overall size, with the greatest expansions present in the largest individuals. In a type of geographic variation, the plane of the expanded apophysis apex is turned so as to lie about 90° relative to the plane of the base. The northeastern and northwestern males generally have this latter variation.

The southern members of this species average larger in size than the northern representatives.

Natural history. *Dolomedes triton* is the species most clearly related to the standing or slow-water habitat. Typically, specimens are collected among the emergent aquatic vegetation at the margins of permanent lakes, ponds, or pools in a stream. They position themselves head-down near the waterline, or have the anterior legs on the water surface while the posterior legs are resting on a leaf or twig. When startled, they quickly dive to the underside of a lily pad or climb down the submerged portion of a vertical leaf. Some individuals have been observed feeding upon adult damselflies as well as other water-related insects. In this still-water habitat, *D. triton* may be found with *D. albineus*, *D. tenebrosus*, or *D. okefinokensis* wherever their respective geographic ranges overlap.

Probably adults of both sexes could be found all year, but in the North they are reported primarily from the warmer seasons. There are numerous collections of adults from Florida during the period December through April.

Egg sacs are found in Florida as early as April, but in the North they appear primarily from June to September. In the College Lake on the Lynchburg College campus, Lynchburg, Virginia, egg sacs annually occur in greatest frequency in nurseries during late August and early September. The nurseries at the latter locality typically occur from one to three feet above

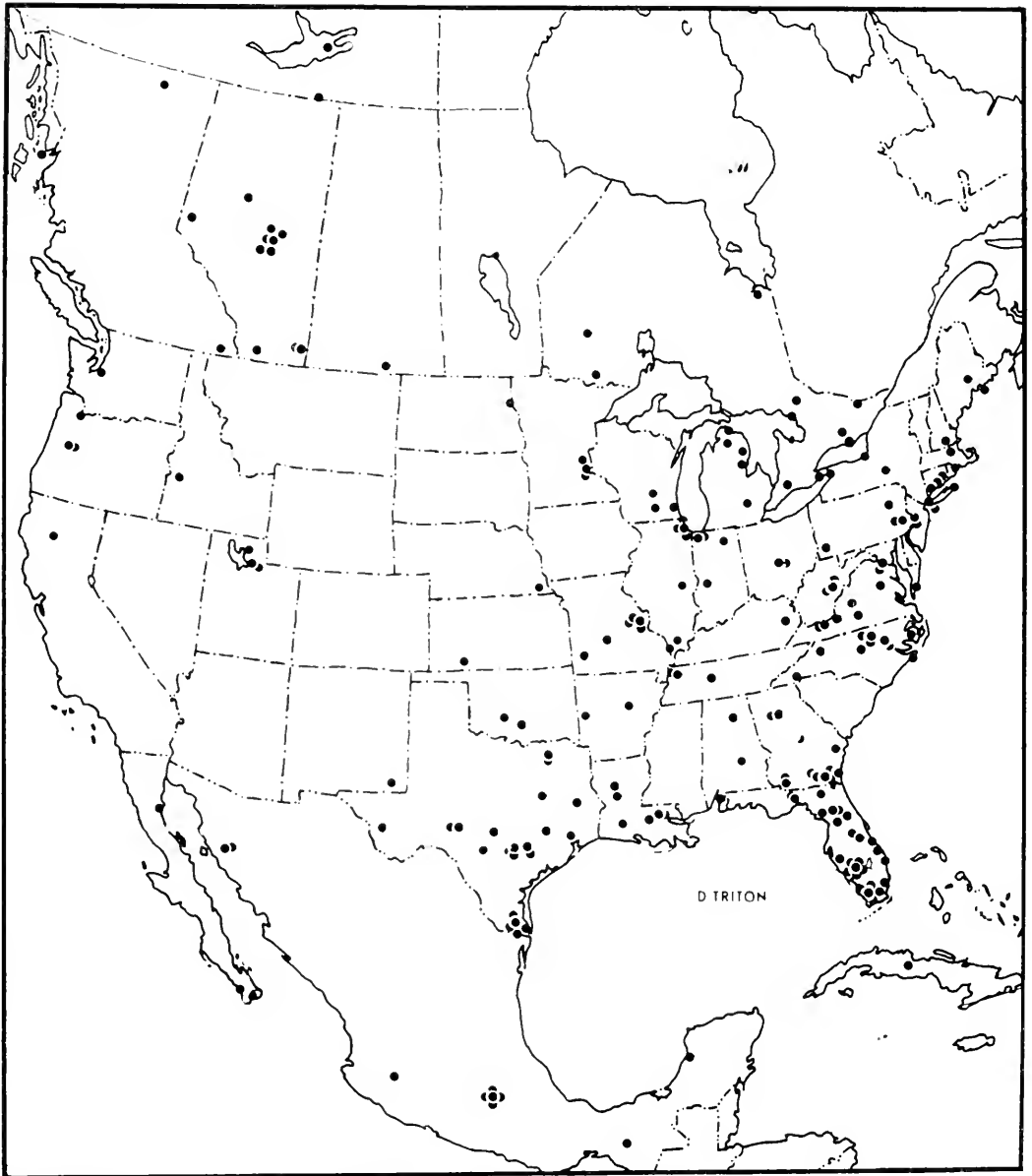

Map 10. Distribution of *Dolomedes triton* (Wolckenoer).

water in thick stands of *Sparganium* where tilted leaves cross each other.

Distribution. *Dolomedes triton* evidently has a wider distribution than any other nearctic species of *Dolomedes*. Its range extends from Ontario and Maine to southern

Florida and Texas, westward to the southern panhandle of Alaska and southward to Yucatan Peninsula and Chiapas, Mexico (Map 10). The southwestern states seem to be devoid of this species since these areas have been fairly well collected with-

out the occurrence of more than a single record of its being found.

Material examined. Eighty-two males, 219 females, and 287 immatures.

Discussion. The wide variability of this species, as well as its wide geographic range, has contributed to considerable misinterpretation resulting in nomenclatural fragmentation. I will attempt here to review and reinterpret the principal nomenclatural events.

Although Walckenaer clearly had this species in mind under his name *D. triton*, the name was forgotten, and Hentz's junior synonym, *D. sexpunctatus*, generally held sway from the time of its proposal until *D. triton* was revived by Bishop in his 1924 revision. Concerning the distribution of these two subspecies, Bishop said of *D. t. triton* that ". . . it apparently occurs only in the south.", and of *D. t. sexpunctatus* that it ". . . is the familiar form in the North [and] also occurs in all the South Atlantic States. . . ." Further, he said that he found chiefly the former subspecies ". . . from various localities in the Okefinokee swamp." Under "Distribution" of the latter subspecies Bishop also listed localities in the Okefinokee Swamp. From the information given in Bishop's revision itself, I am inclined to reject these subspecies *a priori*. One major element of the modern concept of a subspecies concerns its geographic allopatry with other related subspecies while retaining the apparent potential for interbreeding (Mayr, 1969). Therefore, since Bishop's data suggest sympatry of the two subspecies, I believe that his subspecies division is invalid. Additionally, studies of series from the northern and southern United States, including the Okefinokee Swamp, revealed that the characters used by Bishop were variable and showed intrapopulational intergrades, and that the characters of both subspecies were found in the North. The characters to which Bishop gave especial emphasis were the width of the carapace band and overall size difference of the males.

In the revision, Bishop also described *D. albiclavius* from three widely separated localities, i.e., "Springfield, Mo., Salt Lake, Utah, Billy's Island, Okefinokee Swamp, Ga." Under "remarks" he said: "This large and distinct species is evidently related to *Dolomedes triton* but differs from it in the structure of the epigynum, in its general darker color and lack of paired white spots on the dorsum of the abdomen. The legs are proportionally and actually longer in this species than in *D. triton* and the body more robust." Of the specimens he listed, I have examined only the holotype. This specimen is indeed dark, but can be considered at the extreme end of the range of a highly variable and therefore questionable character. The abdominal spots were indeed absent, but since the dorsum was well rubbed, the white hairs of these spots were removed long ago, and no evidence of their presence was left. The epigynum showed no unusual deviation from the range of variation of the epigynum of *D. triton*. The length of the legs and shape of the body fall within the range of variability of *D. triton*.

Bishop's concept of these various species has generally been followed to the present. Only one later change of Bishop's arrangement has been published. Chamberlin and Ivie, in a short and superficial treatment (1946), proposed recognition of four species in a kind of "triton group." The old and neglected name, *D. scopularis* Koch [sic] was resurrected and applied to males having the apex of the tibial apophysis turned and to those ". . . *Triton* and *sexpunctatus* north of 40 degrees. . . ." *D. sexpunctatus* Hentz was the only taxon for which a full description was given, but the apparent chief distinguishing character was the narrow apex of the tibial apophysis. *D. triton* (Walckenaer) was distinguished primarily by the intermediate expansion of the tibial apophysis. The only localities indicated for this species are in Georgia. Finally, *D. spatulatus* was described as a new species from Kingston, Tennessee (Cham-

berlin and Ivie, 1946). The very short description emphasized the broad expansion of the tibial apophysis. I have not examined the holotype, but I have examined a large series (AMNH) collected (according to the label) two days later at the same locality which may actually have been the intended paratypes designated by the authors. A study of the tibial apophyses of the fourteen males of this series showed a wide range of apical expansion from the very narrow to the very wide (Fig. 11) which was directly correlated with the overall body size. Indeed, the apophyses of three of Chamberlin and Ivie's species, *D. sexpunctatus* (narrow apophysis), *D. triton* (intermediate apophysis), and *D. spatulatus* (wide apophysis), were represented along with intergrades among all three. The *D. scopularis* type of apophysis was not represented in this series, but the species is obviously based on a highly variable and therefore unreliable character. For these reasons, I have concluded that the four species of *Dolomedes* mentioned above, which were defined by Chamberlin and Ivie (1946), are synonymous.

LITERATURE CITED

- ADAMS, W. 1927. (Note on a fishing spider). Bull. New York Zool. Soc., **30**: 77.
- AUFFENBERG, W., AND W. W. MILSTEAD. 1965. Reptiles in the Quaternary of North America. In H. E. Wright, and D. G. Frey (eds.), The Quaternary of the United States. Princeton: Princeton Univ. Press, pp. 557-567.
- BARBOUR, T. 1921. Spiders feeding on small cyprinodonts. Psyche, **28**(3): 131-132.
- BANKS, N. 1891. Notes on some spiders described by Hentz. Entomol. News, **2**: 84-87.
- . 1898. Concerning the names of some common spiders. Entomol. News, **9**: 141-142.
- . 1904. The Arachnida of Florida. Proc. Acad. Sci. Philadelphia, **56**: 120-147.
- BISHOP, S. C. 1924. A revision of the Pisauridae of the United States. Bull. New York State Mus., **252**: 1-140.
- , AND C. R. CROSBY. 1936. Notes on some spiders of the family Pisauridae (Araneae). Entomol. News, **47**: 238-244.
- BONNET, P. 1956-1959. Bibliographia Araneorum. Toulouse. Vol. 2, pp. 1-5058.
- CARICO, J. E. 1970. The nearctic species of the genus *Dolomedes* (Araneae: Pisauridae). Ph.D. Thesis, Virginia Poly. Inst. Ste. Univ.
- , AND P. C. HOLT. 1964. A comparative study of the female copulatory apparatus of certain species in the spider genus *Dolomedes* (Pisauridae: Araneae). Virginia Agr. Exp. Sta., Tech. Bull., **172**: 1-27.
- CHAMBERLIN, R. V., AND W. IVIE. 1944. Spiders of the Georgia Region of North America. Bull. Univ. Utah, **35**(9): 1-267.
- . 1946. On several new American spiders. Bull. Univ. Utah, **36**(13): 1-15.
- COMSTOCK, J. H. 1912. The Spider Book. Garden City: Doubleday, Page & Co. 721 pp., 770 figs.
- . 1940. The Spider Book (rev. ed., W. J. Gertsch). New York: Comstock Pub. Co. xi-729 pp., 770 figs.
- DAVIS, W. T. 1891. A spider fisherman. Entomol. News, **2**: 77.
- EMERTON, J. H. 1908. Autumn flights of spiders. Psyche, **11**: 40.
- FLINT, R. F. 1940. Pleistocene features of the Atlantic Coastal Plain. American J. Sci., **238**: 757-787.
- FRANGANILLO-BALBOA, P. 1936. Los Araenidos de Cuba Hasta 1936. La Habana. 183 pp.
- GUDDER, E. W. 1922. Spiders as fishermen. J. American Mus. Natur. Hist., **22**(6): 565-568.
- . 1925. Spiders as fishermen and hunters. J. American Mus. Natur. Hist., **25**: 261-275.
- . 1931. Some more spider fishermen. Natur. Hist., **31**(1): 58-61.
- HEGDEKAR, B. M., AND C. D. DONDALE. 1969. A contact pheromone and some response parameters in lycosid spiders. Canadian J. Zool., **47**(1): 1-4.
- HENTZ, N. M. 1845. Descriptions and figures of the Araneides of the United States. J. Boston Natur. Hist. Soc., **5**: 189-202.
- . 1850. Descriptions and figures of the Araneides of the United States. J. Boston Natur. Hist. Soc., **6**: 18-35.
- HERRING, J. L., AND H. DOWLING, JR. 1947. Observations on *Dolomedes albineus* Hentz. Florida Entomol., **30**(3): 42.
- KASTON, B. J. 1936. The senses involved in the courtship of some vagabond spiders. Entomol. American, **16**: 97-167.
- . 1948. Spiders of Connecticut. Bull. Connecticut State Geol. Natur. Hist. Surv., **70**: 1-874.
- KING, P. B. 1965. Tectonics of Quaternary time in middle North America. In H. E. Wright and D. G. Frey (eds.), The Quaternary of the United States. Princeton: Princeton Univ. Press. Pp. 831-870.

- LATREILLE, P. A. 1804. Tableau méthodique des Insectes. Dictionnaire (Nouveau) d'Histoire Naturelle. Vol. 24, pp. 127-200.
- LEVI, H. W. 1959. The spider genus *Latrodectus* (Araneae, Theridiidae). Trans. American Microscop. Soc., **78**: 7-43.
- MACNEIL, F. S. 1950. Pleistocene shorelines in Florida and Georgia. United States Geol. Surv. Prof. Pap., **221**(F): 95-107.
- MARX, G. 1889. Catalogue of the described Araneae of Temperate North America. Proc. United States Nat. Mus., **12**: 497-594.
- MAYR, E. 1969. Principles of Systematic Zoology. New York: McGraw-Hill. xi-428 pp.
- MCCOOK, H. C. 1889. American Spiders and Their Spinning-work. Vol. I. Philadelphia. 373 pp.
- MCCRONE, J. D. 1963. Taxonomic status and evolutionary history of the *Geolycosa pikei* complex in the southeastern U.S. (Araneae, Lycosidae). American Midland Natur., **70**(1): 47-73.
- MEEHEAN, O. L. 1934. Spiders that fish. Natur. Hist., **34**(6): 538-540.
- MELLO-LEITÃO, C. D. DE. 1927. Arachnidos de Santa Catharina (Brasil). Revista Museu Paulista, **15**: 395-418.
- MOHRHARDT, D. 1963. (Photograph of *Dolomedes scriptus* preying on minnow). Turtlox News, **41**(8): 197.
- MONTGOMERY, T. H. 1904. Description of North American Araneae of the families Lycosidae and Pisauridae. Proc. Acad. Natur. Sci. Philadelphia, **56**: 261-323.
- PETERS, T. M. 1876. A spider fisherman. American Natur., **10**: 688.
- PETRUNKEVITCH, A. 1911. A synonymic index-catalogue of spiders of North, Central and South America with all adjacent islands, etc. Bull. American Mus. Natur. Hist., **29**: 1-791.
- ROEWER, C. F. 1954. Katalog der Araneae. Vol. 2(a), pp. 1-923. Brussels.
- SIMON, E. 1898. Histoire Naturelle des Araignées. Vol. 2(2), pp. 193-380.
- SPRUNG, E. A. 1859. (Letter regarding a fish caught by a spider). Proc. Acad. Natur. Sci. Philadelphia, **11**: 255.
- WALCKENAER, C. A. 1805. Tableau des Araignées. . . , etc. Paris. xii-88 pp.
- . 1837. Histoire naturelle des Insectes. Aptères. Vol. I. Paris. 682 pp.

Bulletin OF THE
Museum of
Comparative
Zoology

The Glandulocaudine Characid Fishes
of the Guayas Basin in Western Ecuador

TYSON R. ROBERTS

HARVARD UNIVERSITY
CAMBRIDGE, MASSACHUSETTS, U.S.A.

VOLUME 144, NUMBER 8
13 MARCH 1973

END OF VOLUME

PUBLICATIONS ISSUED
OR DISTRIBUTED BY THE
MUSEUM OF COMPARATIVE ZOOLOGY
HARVARD UNIVERSITY

BULLETIN 1863-
BREVIORA 1952-
MEMOIRS 1864-1938
JOHNSONIA, Department of Mollusks, 1941-
OCCASIONAL PAPERS ON MOLLUSKS, 1945-

Other Publications.

- Bigelow, H. B., and W. C. Schroeder, 1953. Fishes of the Gulf of Maine. Reprint.
- Brues, C. T., A. L. Melander, and F. M. Carpenter, 1954. Classification of Insects.
- Creighton, W. S., 1950. The Ants of North America. Reprint.
- Lyman, C. P., and A. R. Dawe (eds.), 1960. Symposium on Natural Mammalian Hibernation.
- Peters' Check-list of Birds of the World, vols. 2-7, 9, 10, 12-15. (Price list on request.)
- Turner, R. D., 1966. A Survey and Illustrated Catalogue of the Teredinidae (Mollusca: Bivalvia).
- Whittington, H. B., and W. D. I. Rolfe (eds.), 1963. Phylogeny and Evolution of Crustacea.
- Proceedings of the New England Zoological Club 1899-1948. (Complete sets only.)
- Publications of the Boston Society of Natural History.

Authors preparing manuscripts for the *Bulletin of the Museum of Comparative Zoology* or *Breviora* should send for the current Information and Instruction Sheet available from Editor, Publications Office, Museum of Comparative Zoology, Harvard University, Cambridge, Massachusetts 02138, U.S.A.

THE GLANDULOCAUDINE CHARACID FISHES OF THE GUAYAS BASIN IN WESTERN ECUADOR

TYSON R. ROBERTS

ABSTRACT. The Guayas basin on the Pacific coast of Ecuador has a small but remarkable fauna of Characidae, which includes three endemic glandulocaudines: *Landonia latidens* Eigenmann and Henn, 1914; *Phenacobrycon henni* (Eigenmann, 1914); and *Iotabrycon praecox*, a new genus and species described in this paper. The osteology of these glandulocaudines is described and compared with that of other characids in the Guayas basin. An attempt to find specialized osteological characters shared by the three glandulocaudine genera was unsuccessful. The osteological characters they share also occur in *Bryconamericus*, *Astyanax*, and probably many other generalized characids. Some remarks are made concerning the hooks found on the fin rays of many neotropical characids.

INTRODUCTION

The Glandulocaudinae are New World Characidae characterized by males having a variety of specialized structures (so-called "caudal glands") on the caudal fin and its base. The behavioral significance of these structures and of other peculiar secondary sexual characters, such as the spectacularly modified humeral scales in *Pterobrycon* (Bussing and Roberts, 1971), is still largely conjectural, despite recent studies on glandulocaudine behavior by Nelson (1964a, b, c).

Three monotypic glandulocaudine genera are relatively isolated in the Guayas basin on the Pacific coast of Ecuador. While differing considerably among themselves in dentition, osteology, general features, body proportions, etc., they are probably

more closely related to each other than to any other glandulocaudines. They do not seem derived from the same stock as the geographically nearest trans-Andean glandulocaudines (*Pterobrycon*, *Gephyrocharax*, and *Argopleura*), which occur in the San Juan and Atrato drainages of Colombia, although a close relationship, especially to *Argopleura*, cannot be ruled out. No glandulocaudines occur on the Pacific coast of South America south of the Guayas basin, nor have any been found in the Esmeraldas, the large basin immediately north of the Guayas. One of the Guayas glandulocaudines (*Phenacobrycon*) has been reported from the Río Chone and the Río Puerto Viejo (Eigenmann *et al.*, 1914), small rivers in the intervening coastal plain. The only other Characidae in the Guayas basin are three or four distinctive species of *Brycon*, two species of *Bryconamericus*, *Astyanax festae*, and an endemic species of *Hyphessobrycon* (*H. ecuadoriensis* Eigenmann and Henn). Eigenmann (1922) gives an account of the freshwater fishes of the Pacific slope of northwestern South America and their distribution. The two papers by Myers and Böhlke (1956) and Böhlke (1958) together constitute a review of the glandulocaudine genera, excluding *Saccoliderma* and *Compsura*, which are placed in the Cheirodontinae, and *Brittanichthys*, subsequently described by Géry (1965).

Two of the Guayas glandulocaudines,

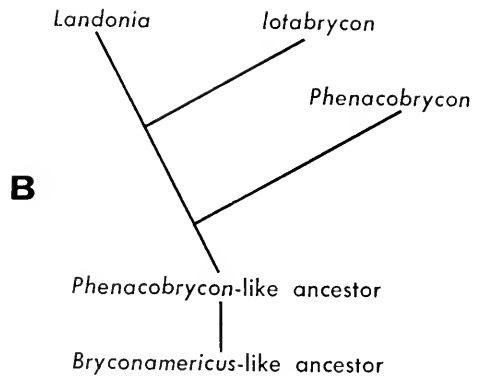
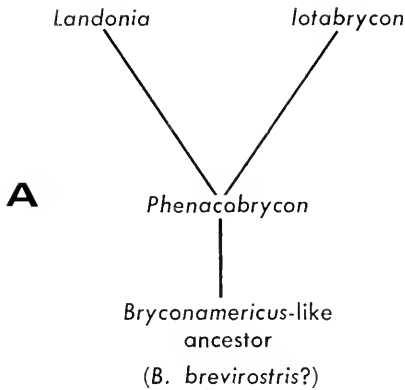

Landonia Eigenmann and Henn, 1914 (in Eigenmann *et al.*, 1914) and *Phenacobrycon* Eigenmann, 1922, are already described. The third (*Iotabrycon*), which has the most specialized caudal gland of the three, is described here for the first time. An osteological study of these three genera was undertaken for the following reasons: 1) to permit a more precise diagnosis of the new genus; 2) to characterize more fully *Phenacobrycon* and *Landonia*, thus permitting their comparison with other characids; 3) to provide information about variation of osteological characters in Characidae, as background for other studies; and 4) to help in judging the utility of osteological comparisons for determining relationships among Characidae at the generic level.

The hypothesis is here investigated that the Guayas glanduloceudines are an autochthonous monophyletic lineage and had *Bryconamericus*-like ancestors, possibly similar to *Bryconamericus brevirostris* now inhabiting the Guayas basin. Diagram A represents one possible interpretation of their relationships. Another possible interpretation is shown in Diagram B.

The specimens upon which this paper is based were obtained during a survey to identify the principal freshwater food fishes of Ecuador for the International Center for Aquaculture of Auburn University, in October-December of 1971.

Collections in the Guayas basin were made by Sr. Fausto Silva M., Chief Fisheries Officer, and Sr. Gerinaldo Morales, both of the Departamento de Piscicultura of the Ministerio de la Produccion of Ecuador; Mr. Ronnie J. Gilbert of Auburn University; and myself.

I wish to thank Dr. Stanley H. Weitzman, Division of Fishes, Smithsonian Institution, for helpful comments on the manuscript.

Note. Standard lengths are used throughout this paper, and all proportional measurements are expressed as times in standard length. All gill raker counts are made from alizarin preparations. It is practically impossible to make consistent gill raker counts in whole unstained specimens, and difficult to remove the first gill arch without leaving rakers behind. Also, rakers at the ends of the arch often show a sharp decrease in size, and the smallest rakers are often so small as to pass undetected unless stained by alizarin. Many published counts, especially for medium- and small-sized characids, err in giving too few rakers.

SYSTEMATIC ACCOUNT

PHENACOBRYCON Eigenmann, 1922

Phenacobrycon henni (Eigenmann)

Bryconamericus henni Eigenmann, 1914: 6 (in Eigenmann *et al.*, 1914; type locality = Vinces).
Phenacobrycon henni Eigenmann, 1922: 147

(*Bryconamericus henni* designated type species of monotypic new genus *Phenacobrycon*).—Eigenmann, 1927: 350–51 (synonymy, list of specimens, description), pl. 84, figs. 2, 3 (structures on caudal and anal fins of male); pl. 86, figs. 1–5 (full lateral view of male and female; dentition); pl. 97, fig. 7 (radiograph).

Material examined. MCZ 48660, 97 specimens, 21.4–33.0 mm, Río Vinces at Vinces, 5 November 1971; MCZ 48661, 56 specimens, 22.8–29.9 mm, isolated dry-season pool in Río Nuevo where it flows into left side of Río Vinces, one kilometer upstream from the town of Vinces, 5 November 1971; MCZ 48662, 9 specimens, 20.5–29.0 mm, Río Cristal 16 km E of Babahoyo, Los Ríos Province, 6 November 1971.

LANDONIA Eigenmann and Henn, 1914

Landonia latidens Eigenmann and Henn

Landonia latidens Eigenmann and Henn, 1914: 1 (in Eigenmann *et al.*, 1914: type locality = Vinces; *L. latidens* type of monotypic new genus *Landonia* by original designation).—Eigenmann, 1927: 400–401 (synonymy, list of specimens, description), pl. 77, figs. 1, 2, 4 (dentition); pl. 90, figs. 1, 2 (full lateral view of male and female).

Material examined. MCZ 48663, 14 specimens, 25.3–53.2 mm, Río Vinces at Vinces, 5 November 1971; MCZ 48664, 24 specimens, 23.9–42.1 mm, Río Cristal 16 km E of Babahoyo, Los Ríos Province, 6 November 1971.

IOTABRYCON new genus

Type species. *Iotabrycon praecox*, new species.

Diagnosis. Slender, minute glandulocaudine characids, body transparent in life except for opaque white peritoneum and sparsely distributed melanophores. Humeral spot absent. A small black spot at base of caudal fin present only in females. Dorsal fin ii, 7. Anal fin iii, 21 to v, 23. Pelvic fin 7. Adipose fin absent. Predorsum naked, body otherwise completely scaled. Anal fin scaleless. Lateral line incomplete, pore-bearing canals re-

stricted to the first few scales in the lateral series. Pseudotympanum absent. Premaxillary and dentary with a row of large conical teeth. Maxillary toothless. Caudal pouch of males supported by a single (?) large and characteristically modified scale on base of caudal fin, and a muscle not covered by scales extending over basal half of upper caudal fin lobe. A posteriorly directed process (indicated by an arrow in Fig. 3) appears to be separately ossified and may represent a second, highly modified, scale. Number of procurrent caudal rays equal in males and females; lower procurrent rays of males enlarged but otherwise unmodified. Hooks in males restricted to elongate anterior rays of anal fin and inner margin of pelvic fin rays. Rhinosphenoid bone present. Only three circumorbital bones. Vertebrae (precaudal + caudal exclusive of hypural complex) 17 + 18–19 = 35 or 36.

Remarks. *Iotabrycon* is readily distinguished from *Phenacobrycon* and *Landonia* (which are probably its closest relatives) by its small size at maturity, caudal pouch structure, conical dentition, naked predorsum, absence of adipose fin, and fin ray counts. (See Table 1 and comparisons below.) There are several other minute or small glandulocaudines, but these are more deep-bodied, silvery with bluish reflections or brightly colored instead of transparent, and with completely different dentition. None of the described genera can be confused with *Iotabrycon*, although some share with it such characters as lack of adipose fin (*Pterobrycon landoni*, *Corynopoma*, undescribed *Tytocharax* from Ecuadorean Amazon), incomplete lateral line (*Glandulocauda*, *Mimagoniates*), incomplete circumorbital series (*Tytocharax*), presence of rhinosphenoid bone (*Tytocharax*). A single row of conical teeth on premaxillary and dentary is found in *Brittanichthys*, but its teeth are minute and relatively numerous. A “naked” muscle extending well onto the upper caudal fin lobe in males apparently occurs only in *Iotabrycon*.

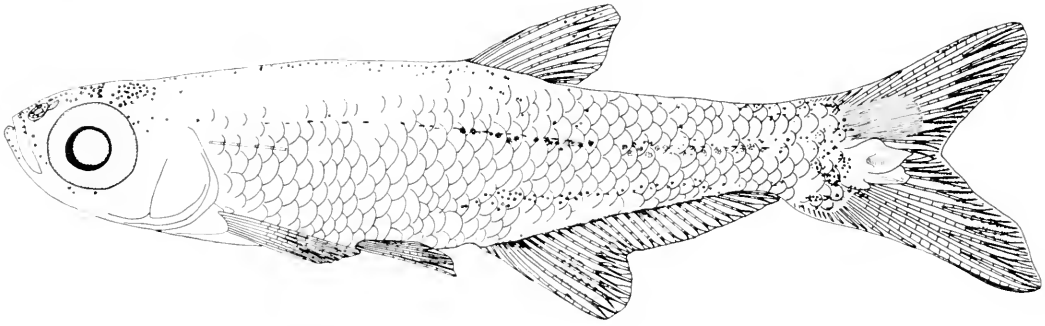

Figure 1. *lotabrycon praecox*, new genus and new species, MCZ 48659, 17.9-mm ♂ paratype (hooks on anal fin based on alizarin preparation of 18.8-mm ♂ paratype).

lotabrycon praecox new species

Figures 1–4

Holotype. MCZ 48658, a male 18.6 mm, from an isolated dry season pool in Río Nuevo where it flows into left side of Río Vices, one kilometer upstream from the town of Vices, 5 November 1971.

Paratypes. MCZ 48659, 5 females or immatures 16.2–19.9 mm and 12 males 17.2–18.8 mm, collected with the holotype.

General features. Largest specimen, a female, 19.9 mm. Largest male 18.8 mm. Males as small as 17.4 mm sexually mature (as indicated by full development of caudal gland and hooks on anal and pelvic fins). Body elongate, slender. Eye large. Adipose eyelid absent. Mouth moderately superior, lower jaw slightly projecting. Maxillary extending to anterior border of eye but not beyond, exposed (not slipping under first infraorbital, which is greatly reduced); leading edge of maxillary convex. Premaxillary with a row of 5 or 6 conical teeth; maxillary toothless; dentary with a row of 6 teeth, first four somewhat larger than those on premaxillary, last two reduced; first tooth on dentary pointed into mouth, second tooth pointed outwards (Fig. 11). First gill arch with 5 or 6 + 12 moderately long, edentulous, widely spaced gill rakers (Fig. 19). Pseudotympanum absent, area normally occupied by pseudotympanum with orangish fat deposits. Belly rounded. No membranous

ventral keel between pelvic fins and anal fin origin (often present in minute or larval characids at comparable sizes).

Proportional measurements. The measurements of the holotype are given first, followed in parentheses by the ranges in the type series. Body depth 4.4(4.1–4.8). Depth caudal peduncle 9.3(9.3–11.3). Predorsal length 1.8(1.7–1.9). Preanal length 1.7(1.7–1.8). Prepelvic length 2.3(2.2–2.5). Length anal base 3.4(3.2–3.6). Height dorsal fin 5.3(4.3–5.4). Height anal fin 5.6(4.5–6.2). Length pectoral fin 5.3(5.0–6.3). Length pelvic fin 7.2(6.9–9.7). Length upper caudal fin lobe 3.6(3.4–4.4). Length lower caudal fin lobe 3.3(3.1–4.0). Head length 4.1(3.9–4.3). Length of orbit 10.3(9.5–11.2).

Fins. Dorsal fin rays ii, 7 (ii, 6 in one specimen). Anal fin rays iv, 21 to v, 23 (one specimen with iv, 24 has an abnormally thin 23rd ray). Principal caudal fin rays 10 + 9. Procurrent caudal rays: 13 upper + 12 lower (18.8-mm ♂); 13 + 13 (17.4-mm ♀); 11 + 11 (16.2-mm immature). Pectoral fin rays usually 9 or 10. Pelvic fin rays 7. Adipose fin absent.

Dorsal fin origin slightly in front of a vertical line through anal fin origin, and predorsal length shorter than preanal length, in all specimens with ii, 7 dorsal fin rays. In unique specimen with ii, 6 dorsal fin rays, the dorsal fin origin slightly posterior to anal fin origin; its predorsal



Figure 2. Caudal gland of 17.9-mm ♂ *Iatabrycon praecox*.

length (1.75) slightly greater than its preanal length (1.8). Tip of pectoral fin extends beyond pelvic fin origin. Caudal fin relatively large, lower lobe slightly larger than upper lobe, possibly less so in females. Fins scaleless, except for modified scale on base of caudal fin in sexually mature males.

Squamation. Nape and predorsal region naked, scaleless area corresponding to two-three full scale rows on either side (Fig. 1). Scales in a lateral series 35–40. Scale counts difficult to make. In four specimens stained with Delafield's hematoxylin, which makes scale pockets show up well, scale counts 38(2) and 39(2). Lateral line incomplete, only 3–6 anteriormost scales in lateral series bearing pores. A 16.8-mm

specimen has 4 weakly developed pores. In a 16.4-mm specimen pores undeveloped. Smallest specimen, 16.2-mm, stained in alizarin, with 5 scales bearing pores.

Sexual dimorphism. Mature males readily distinguished from immature specimens and females by specialized structures on caudal fin, described below. Caudal fin larger in males; length of upper caudal lobe 3.4–3.7 (average 3.6) in males, 3.5–4.4 (average 3.9) in females; length of lower caudal lobe 3.1–3.5 (average 3.3) in males, 3.3–3.9 (average 3.6) in females. In both sexes lower caudal lobe about ten percent longer than upper. Lower procurent caudal rays relatively larger in males, giving lower margin of caudal base a keel-like structure. In males caudal peduncle

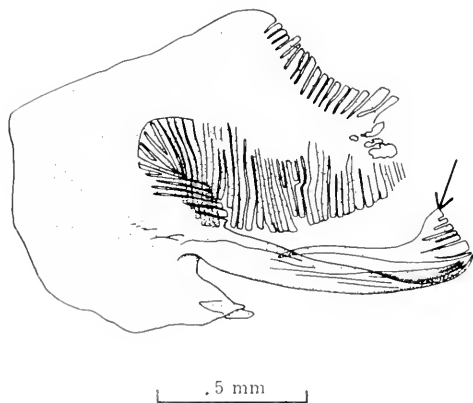

Figure 3. Modified scale in caudal gland of 18.8-mm ♂ *Iotabrycon praecox* (drawn from an alizarin preparation). Arrow points to separately ossified process which may represent a second modified scale.

depth (range 9.3–10.8, average 9.9) tends to be greater than in females and immature specimens (range 9.4–11.3, average 10.5). In males the first eight or nine segmented anal fin rays bear hooks and form a distinct lobe; pelvic fins relatively longer and bearing hooks; pelvic fin length 6.9–8.0, (average 7.4). In females anal and pelvic fins hookless; pelvic length 8.5–9.7, average 9.0. No other evident differences in proportional measurements between sexes.

Of 12 male specimens in the type series, the six largest individuals range from 18.0–18.8 mm standard length, whereas out of only 8 females and immatures, the largest female, at 19.9 mm, is considerably larger.

Modified caudal structures in males (Figs. 1–3). Twelve of the 20 specimens in the type series are identified as males because they bear well-developed hooks on the anal and pelvic fins and have a “caudal gland.” In *Iotabrycon* the caudal modifications consist of a highly modified scale supporting a large caudal pouch and a muscle with extensive attachments to the proximal half of the upper caudal lobe. The modified scales on opposite sides of the caudal fin are mirror images. It is questionable whether the posteriorly directed process indicated by an arrow in

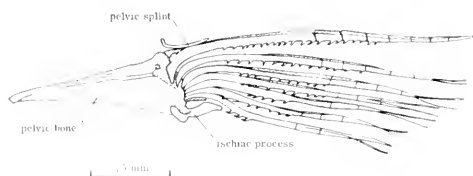

Figure 4. Left pelvic fin and girdle of 18.8-mm ♂ *Iotabrycon praecox*, showing distribution of hooks on fin rays (ventral view).

Figure 3 represents a separate scale. They are well developed and of similar morphology in all the males in the type series. The principal caudal rays are unmodified, except in size, the caudal fin being somewhat larger in males than in females. The upper procurrent caudal rays in males are unmodified but the lower procurrent rays are considerably enlarged, giving the lower margin of the male caudal fin a keel-like appearance.

Comparisons with *Phenacobrycon* and *Landonia* (Table 1)

Some comparisons between *Iotabrycon*, *Phenacobrycon*, and *Landonia* appear in Table 1. The smallest *Phenacobrycon* examined, 20.5–24.0 mm, are readily distinguished from *Iotabrycon* by their coloration; deeper body (depth of body normally 3.1–3.3; body depth of 20.5-mm specimen 3.8, but it is emaciated); adipose fin; higher dorsal, anal, and pelvic fin ray counts; dentition; and lack of sexual dimorphism. Most of these differences should also serve to differentiate specimens of *Phenacobrycon* of the same size as *Iotabrycon*. Very young *Landonia* should be readily distinguished by their higher scale and fin ray counts, adipose fin, and lack of sexual dimorphism.

Coloration. Live *Phenacobrycon* and *Landonia* have the same coloration: silvery overall, with bluish reflections; no humeral spot; upper lobe of caudal fin pale lemon yellow with its distal margin black, lower lobe of caudal usually clear; dorsal fin dusky, especially near tip; other fins clear.

In some specimens of *Phenacobrycon* the lower caudal lobe is also yellow and tipped with black, but the coloration is always more intense on the upper lobe. Preserved specimens exhibit a small oblong spot in the middle of the caudal fin base; fine melanophores occur on the tip of the dorsal fin, paralleling the anal fin base and the posterior half of the horizontal septum, and scattered on the dorsum. In live *Iotabrycon* the body is translucent except for the opaque white peritoneum; the "caudal gland" area of males is less translucent than the corresponding area in females. None of the Guayas glandulocaudines has a lateral silvery band, although all have a concentration of melanophores forming a thin black line along the posterior two-thirds of the horizontal septum. A broad, sharply demarcated, silver lateral band is a constant character of *Argopleura*.

Dentition. In *Phenacobrycon* (Fig. 5) the premaxillary bears two rows of sharp-pointed multicuspoid teeth in which the central cusp is enlarged; the external premaxillary row of three tricuspid teeth, the

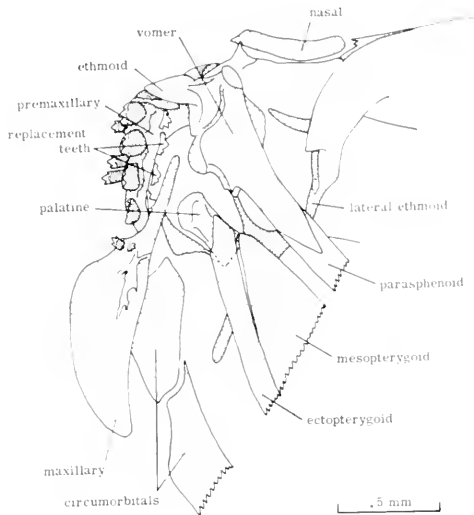

Figure 5. *Phenacobrycon henni*. Upper jaw (left side removed), and anterior portion of palate (ventral-oblique view of 25.6-mm specimen).

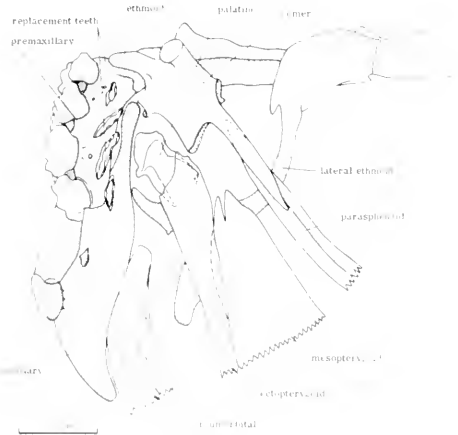

Figure 6. *Landonia latidens*. Upper jaw (left side removed), and anterior portion of palate (ventral-oblique view of 32.1-mm specimen).

internal row of four teeth each with four or five cusps. The dentary bears a single row of four large quinquicuspid teeth with enlarged central cusp followed by two very small conical teeth. The maxillary bears a single small tricuspid tooth.

In *Landonia* (Fig. 6) the premaxillary bears two irregular rows of multicuspoid teeth in which the cusps are about equal in size and have rounded crowns even in newly formed teeth. The external row has three tricuspid teeth, the internal row four quinquicuspid teeth. The dentary bears five or six teeth, the first two or three each with five rounded cusps, the last two or three with a straight cutting edge without any trace of cusps. The maxillary bears two or three large elongate subrectangular teeth with straight cutting edges similar to the posteriormost two dentary teeth. Alizarin preparations of the replacement teeth of the maxillary fail to reveal separately formed cusps or fusion of conical elements in their formation. No other genus of Characidae has teeth similar to *Landonia*.

Caudal glands. In *Landonia* the caudal pouch is membranous; the terminal scale in the pored lateral line series (Fig. 26) is dorsoventrally expanded but does not

TABLE 1. SOME MORPHOLOGICAL AND OSTEOLOGICAL CHARACTERS IN *LOTABRYCON*, *PHENACOBRYCON*, AND *LANONIA*. *P* = PRIMITIVE, *R* = REDUCTIVE, *L* = LABILE, *S* = SPECIALIZED; SEE TEXT FOR EXPLANATION.

	<i>Lotabrycon</i>	<i>Phenacobrycon</i>	<i>Landonia</i>
1. Dorsal fin	ii, 7 <i>R</i> , <i>L</i>	ii, 8 <i>P</i>	ii, 8 <i>P</i>
2. Adipose fin	absent <i>R</i>	present <i>P</i>	present <i>P</i>
3. Anal fin	iii, 21 to v, 23 <i>L</i>	v, 27 to vi, 29 <i>L</i>	v, 29 to vi, 30 <i>L</i>
4. Pectoral fin	8 or 9 (16.2 mm) 10 (18.8 mm) <i>R</i> , <i>L</i>	11 or 12 <i>P</i>	11 <i>P</i>
5. Postcleithra	2, 3 <i>R</i> 3 slender for its entire length <i>R</i>	1, 2, 3 <i>P</i> 1 and 2 widely separated, 3 with a proximal laminar portion <i>P</i>	1, 2, 3 <i>P</i> 1 and 2 widely separated, 3 with a proximal laminar portion <i>P</i>
6. Pelvic fin	7 <i>S</i> , <i>R</i>	8 <i>P</i>	8 <i>P</i>
7. Procurent caudal rays	11 + 11 (16.2 mm) 13 + 12 (18.8 mm) 13 + 13 (17.4 mm) lower procurent rays enlarged in males, producing a keel <i>S</i> , <i>L</i>	9 + 8 (27.1 and 27.7 mm) 10 + 8 (25.5 mm) lower procurent rays not enlarged in males? <i>P</i>	12 + 10 (25.6 mm) 13 + 10 (31.0 mm) 13 + 12 (30.4 mm) 14 + 11 (42.1 mm) 14 + 12 (32.1 mm) lower procurent rays not enlarged in males <i>P</i>
8. Caudal pouch	supported internally by highly modified caudal scale <i>S</i>	membranous <i>S</i> , <i>L</i> ?	membranous <i>S</i> , <i>L</i> ?
9. Extensive muscle to upper lobe of caudal fin in males	present <i>S</i>	absent <i>P</i>	absent <i>P</i>
10. Epirals	2 <i>P</i> , <i>L</i>	2 <i>P</i> , <i>L</i>	2 <i>P</i> , <i>L</i>
11. Lateral line scale count	38-40 <i>L</i>	37-38 <i>L</i>	45-50 <i>L</i>
12. Pored lateral line scales	3-6 anteriormost scales only <i>R</i>	complete <i>P</i>	complete <i>P</i>
13. Extent of squamation on body	predorsal area naked, rest of body completely scaled <i>R</i>	body completely scaled <i>P</i>	body completely scaled <i>P</i>

TABLE 1. (Continued)

	<i>Iatropogon</i>	<i>Phenacogobion</i>	<i>Lanthonia</i>
14. Scales on anal fin	anal fin naked <i>R</i>	base of anal fin with a row of scales for its entire length <i>L</i>	only anterior one-third of anal base with a row of scales <i>L</i>
15. Teeth on premaxillary	single row of 5-6 conical teeth <i>R</i>	outer row of 3 and inner row of 4 tricuspid teeth with sharp points <i>P</i>	outer row of 3 and inner row of 1 tricuspid teeth with points somewhat rounded <i>S</i>
16. Teeth on maxillary	none <i>R</i>	a single small tricuspid tooth at juncture with premaxillary <i>L</i>	two large straight-edged teeth forming a continuous cutting edge for two-thirds of distal portion of maxillary <i>S</i>
17. Teeth on dentary	single row of 6 conical teeth (last 2 teeth reduced in size) <i>S?</i> , <i>R</i>	single row of 3 large quinquenspid teeth with sharp points and 2 small (conical?) teeth <i>P</i>	single row of 2 or 3 multicuspid (quinquenspid?) teeth with rounded points and 2 or 3 large straight-edged teeth <i>S</i>
18. Mode of tooth replacement	at seemingly irregular intervals along tooth rows <i>R</i>	alternating replacement from one side of jaws to the other <i>P</i>	"simultaneous" replacement of all jaw teeth at once <i>S</i>
19. Gill rakers	3 or 4 + 11 (16.2 mm) 5 + 11 or 12 (18.8 mm) <i>R</i> , <i>L</i>	11 or 12 + 17 13 + 21 <i>P</i> , <i>L</i>	9 + 19 (42.1 mm) 10 + 18 (25.6 mm) 12 + 18 (32.1 mm) <i>P</i> , <i>L</i>
20. Number of basibranchials	4 <i>P</i>	4 <i>P</i>	4 <i>P</i>
21. Supraorbital	absent <i>R</i>	absent <i>R</i>	absent <i>R</i>
22. Circumorbitals	1, 2, 3 <i>R</i>	1, 2, 3, 1, 5, 6 <i>P</i>	1 + 2, 3 + 4, 5, 6 <i>S</i>
23. Rhinosphenoid	present <i>L?</i>	absent <i>R?</i>	absent <i>R?</i>
24. Posterior portion of parasphenoid	weakly developed <i>R</i>	strongly developed <i>P</i>	strongly developed <i>P</i>
25. Supraacurals	5-6 <i>P</i>	6-7 <i>P</i>	6 <i>P</i>
26. Vertebrae	17 + 18 - 19 <i>P?</i> , <i>L?</i>	16 + 18 <i>P?</i> , <i>L?</i>	16 + 19 - 20 <i>P</i> , <i>L?</i>

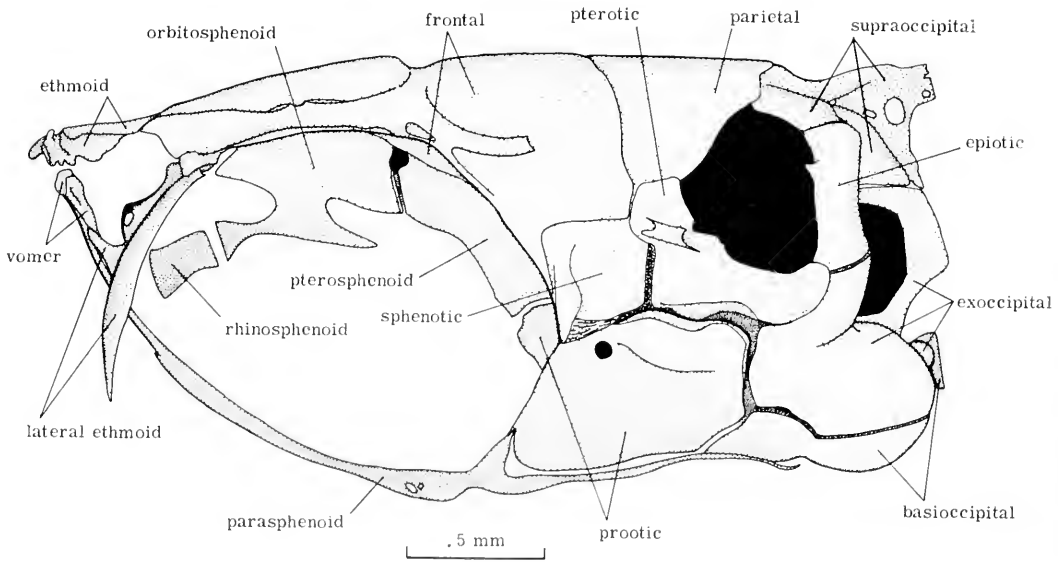

Figure 7. *Iatabrycon praecox*. Lateral view of cranium (18.8-mm specimen).

enter into the construction of the pouch (Eigenmann, 1927, pl. 84, fig. 2; Nelson, 1964a, fig. 46 on p. 72). *Phenacobrycon* (Nelson, 1964a, fig. 36 on p. 71) has a membranous pouch perhaps less well developed than in *Landonia*, and some slightly modified scales on the ventral half of the caudal base. The last pored scale in the lateral line is the same size as the ones preceding (i.e., it is not expanded).

Distribution of hooks on anal and pelvic fin rays. In the Guayas glandulocaudines the hooks characteristic of mature males occur on the anal and pelvic fins (most if not all glandulocaudines have hooks on the anal fin; many also have hooks on the caudal fin; and some may lack hooks on the pelvis).

In *Phenacobrycon* hooks occur on the rays in the anterior and posterior portions of the anal fin but not on the rays in between. According to Eigenmann (1927: 401) the first ten and the last ten "developed" rays of the anal fin of males bear hooks. In the single male specimen collected in November 1971 (MCZ 48660, 28.2 mm), the anterior portion of the anal fin

has two rudimentary hooks on the last unbranched ray, one hook on the first and second branched rays, two hooks on the third branched ray, one hook on the fourth branched ray, and two hooks on the fifth to eighth branched rays. The posterior portion of the anal fin has two hooks on the 23rd, 24th, and 26th to 28th branched rays and three hooks on the 25th. The ninth through 22nd branched rays are without hooks. In *Landonia*, as in *Iatabrycon*, hooks are restricted to the anterior portion of the anal fin. Eigenmann (1927: 350) reported *Landonia* with several "tubercles" on the second, third and fourth rays and a large retrorse hook on the fifth through ninth rays. In all male *Landonia* collected in November 1971, the hooks are likewise restricted to the anterior portion of the anal fin. In the specimen with the greatest development of hooks (MCZ 48664, 38.8 mm) the last undivided ray and first branched ray bear two hooks and the second through sixth branched rays bear a single hook.

The distribution of hooks on the pelvic fin rays differs in the three genera. In



Figure 8. *Phenacobrycon henni*. Lateral view of cranium (27.7-mm specimen).

Iotabrycon hooks occur on all of the pelvic rays but are medially directed and restricted to the inner edge of each ray (Fig. 4). In *Phenacobrycon* and *Landonia* the outermost pelvic ray has no hooks. In *Landonia* the hooks are medially directed and restricted to the inner edge of each ray as in *Iotabrycon*, but in *Phenacobrycon* the hooks are dorsally directed and occur on all branches of each ray, as in *Brycon-americus scleroparius*.

Replacement teeth and tooth replacement. In *Iotabrycon*, as in other minute characins with conical teeth, the replacement teeth are in varying stages of development. In adults of *Phenacobrycon* and *Landonia*, as in other characids with multicuspid teeth, all of the replacement teeth on one side of both the upper and lower jaws are always in the same stage of formation, and at least in *Phenacobrycon* all the teeth on one side of the jaws are probably replaced in one continuous process; in other words there is nearly simultaneous replacement of one-half of the entire dentition, first on one side, then on the other side of the jaws, as occurs in

Brycon and other characids with multicuspid teeth (Roberts, 1967). In a population sample of 97 *Phenacobrycon* (MCZ 48660) are 85 specimens in which all of the teeth are in functional position on both sides of the jaws, and 12 specimens in which the teeth on only one side of the jaws are in the process of replacement.

In *Iotabrycon* the replacement teeth in both jaws lie in the gum just inside the row of functional teeth. In *Phenacobrycon* the replacement teeth for the internal row of teeth on the premaxillary and for the single small tooth on the maxillary lie simply in the gum (Fig. 5), but the replacement teeth for the external premaxillary tooth row are entirely enclosed within the premaxillary bone, and the replacement teeth for the lower jaw are almost entirely enclosed in the dentary, that is, they lie in a deep trench in the medial face of the dentary—as in *Alestes* (Roberts, 1967, fig. 3 on p. 246). In *Landonia* only the internal row of replacement teeth on the premaxillary lies superficially in the gum; the replacement teeth for the external row on the premaxillary, for the maxillary, and

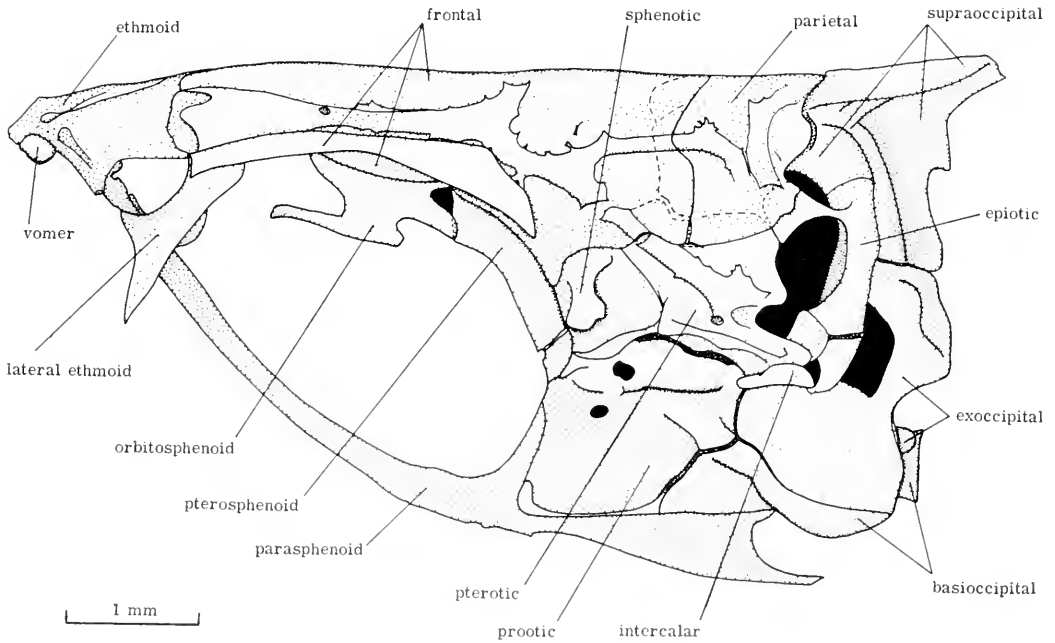

Figure 9. *Landonia latidens*. Lateral view of cranium (42.1-mm specimen).

for the dentary are entirely enclosed within these bones (Figs. 6, 15).

In the multicuspid teeth of *Phenacobrycon* and *Landonia* each cusp represents a separately formed conical element. In the formation of the peculiar straight-edged teeth of *Landonia*, however, there is no sign of separate conical elements, at least not in alizarin preparations. When these teeth first show signs of ossification they have already acquired a perfectly straight-edged crown.

After examining five alizarin preparations of *Landonia*, I am inclined to think that all of the teeth on both sides of its jaws are replaced in one continuous and relatively rapid ("simultaneous") act. The reasons are: 1) in none of the specimens does there appear to be differential wear of the teeth on one side of the jaws, nor do the teeth on one side of the jaws differ in any other way (such as coloration, density of alizarin uptake) from those on the other side, as one would expect to find

in a characid with replacement alternating from side to side; 2) in four of the five specimens the replacement teeth (note: the replacement teeth enclosed in their respective bones are visible through the bone, and the replacement teeth for the internal row on the premaxillary lie exposed in the gum) on both sides of the jaw are in the same stage of formation; and 3) in the remaining specimen, 31.0 mm, there are no ossified replacement teeth on either side of the jaws and the functional teeth appear unworn and newly arrived in position. Finally, in a population sample of 24 *Landonia* (MCZ 48664), there are 23 specimens in which all of the teeth on both sides of the jaws are firmly in functional position, and one specimen in which the gums are uniformly soft and swollen, and the teeth, which are easily movable in the soft tissue, are in the process of coming into functional position on both sides of the jaws.

Size. Eigenmann *et al.* (1914) and

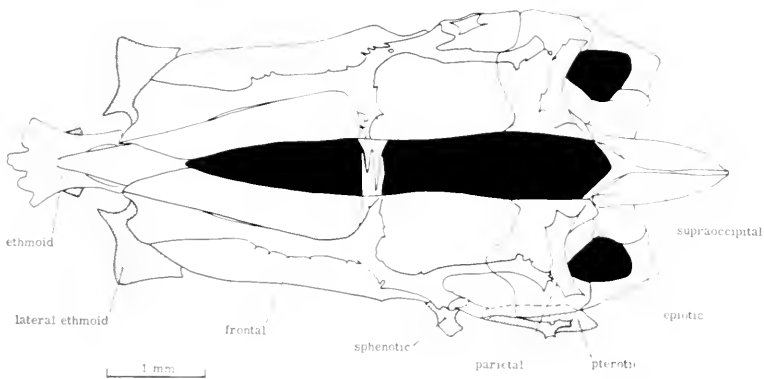

Figure 10. *Landonia latidens*. Dorsal view of cranium (42.1-mm specimen).

Eigenmann (1922) reported *Phenacobrycon henni* from 46 to 53 mm and *Landonia latidens* from 28 to 59 mm (total length?). In the material collected by Silva, Gilbert, and myself in 1971 *Phenacobrycon* are from 20.5 to 33.0 mm in standard length, and the *Landonia* significantly larger, from 23.9 to 53.2 mm in standard length. In both *Phenacobrycon* and *Landonia* (and probably in *Iotabrycon*) the largest specimens in a population are females. Males with sexually dimorphic characters fully developed are known from 28.2 mm (MCZ 48660) to 50 mm (total length?) in

Phenacobrycon and from 36.1–42.1 mm (MCZ 48664) to 50 mm (total length?) in *Landonia*. It may be recalled that the largest specimen of *Iotabrycon* is a 19.9-mm female, the males ranging from 17.2 to 18.8 mm.

ECOLOGY

Habitat. *Iotabrycon* was found in a single locality: a large, isolated dry-season pool in the Río Nuevo a few hundred yards from where it flows into the Río Vinces. A shaded arm of this pool, about 5 meters

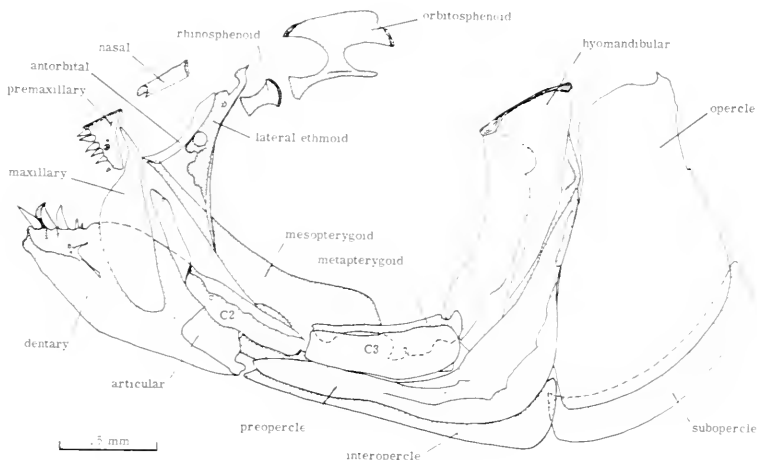

Figure 11. *Iotabrycon praecox*. Lateral view of jaws, suspensorium, and facial bones (17.4-mm specimen; teeth in lower jaw drawn from 18.8-mm specimen).

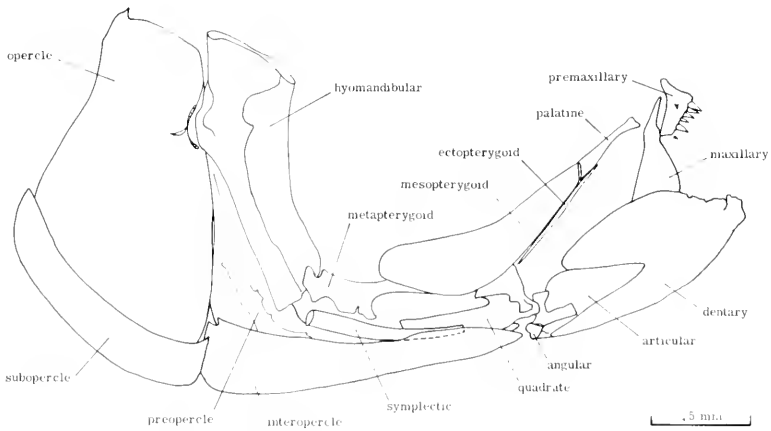

Figure 12. *Iotabrycon praecox*. Internal view of jaws, suspensorium, and facial bones (circumorbitals removed; teeth in lower jaw inadvertently dislodged) (17.4-mm specimen).

wide, 50 meters long, and no more than a meter deep, was rotenoned in the late afternoon on 5 November 1971, at which time the water temperature in the pool was 78°F. It contained a good proportion of the species found in all but the deepest and swiftest waters of the nearby Río Vinces, including: *Ilopias microlepis*, *Lebiasina bimaculata*, *Astyanax festae*, *Brycon alburnus*, *Bryconamericus brevisrostris*, *Phenacobrycon henni*, young *Rhoadsia altipinna*,

Leporinus ecuadoriensis, *Curimatorbis trotscheli*, *Ichthyoclephas humeralis*, a large *Sternopygus macrurus*, *Pimelodella*, young *Plecostomus spinosissimus*, *Pseudopocilia*, *Aequidens rivulatus*, and *Cichlaurus festae*. *Landonia* was found only in backwaters of the Río Vinces and Río Cristal, where they are respectively perhaps 100 meters and 50 meters wide. *Phenacobrycon* were taken at the same localities, and also in the isolated pool with *Iotabrycon*.

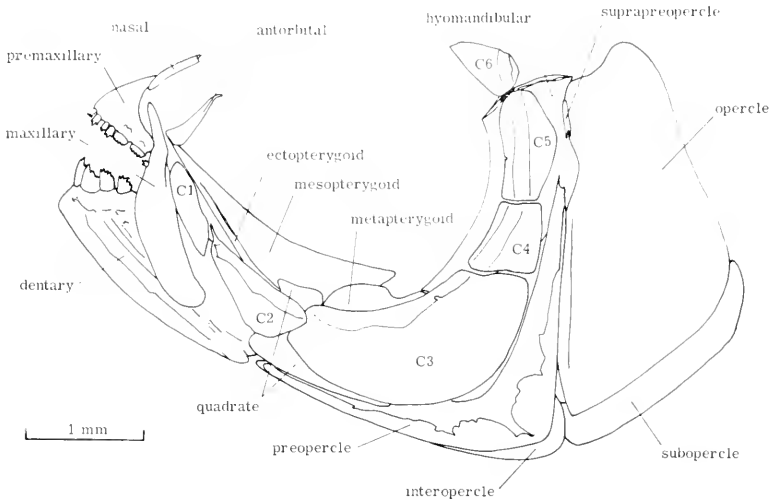

Figure 13. *Phenacobrycon henni*. Lateral view of jaws, suspensorium, and facial bones (27.1-mm specimen).

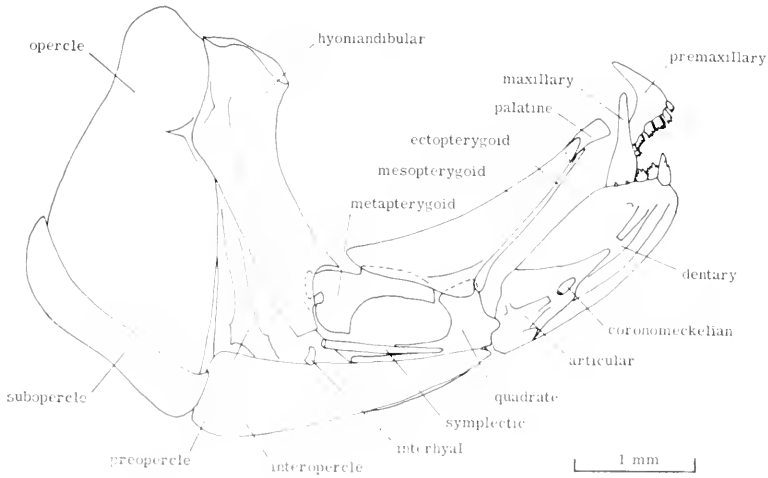

Figure 14. *Phenacobrycon henni*. Internal view of jaws, suspensorium, and facial bones (27.1-mm specimen).

Relative abundance. During our field-work in 1971 glandulocaudines were found only in large, low gradient streams of the Guayas basin, unlike the ubiquitous and more common *Bryconamericus brevisrostris* and *Astyanax festae*. Of the three glandulocaudine genera, *Phenacobrycon* is by far the commonest in our samples. A preponderance of *Phenacobrycon* over *Landonia* also is found in the only other two recorded collections: the Festa collection from the Río Vinces, made sometime before

1895, contains 67 *Phenacobrycon* and 5 *Landonia* (reported in Tortonese, 1941-42). In 1913 Hemm obtained 15 *Landonia* and more than 40 *Phenacobrycon* at Vinces, and 22 *Landonia* and "many" *Phenacobrycon* at Colimes on the Río Daule (Eigemann, 1927).

Feeding habits. The specimens of *Iotabrycon*, *Phenacobrycon*, and *Landonia* taken near Vinces in November 1971 appear to be well fed, in contrast to *Bryconamericus brevisrostris* and *Astyanax*

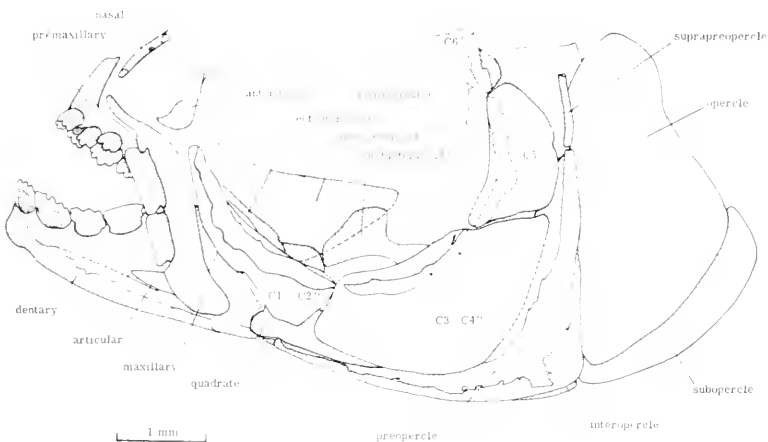

Figure 15. *Landonia latidens*. Lateral view of jaws, suspensorium, and facial bones (32.1-mm specimen).

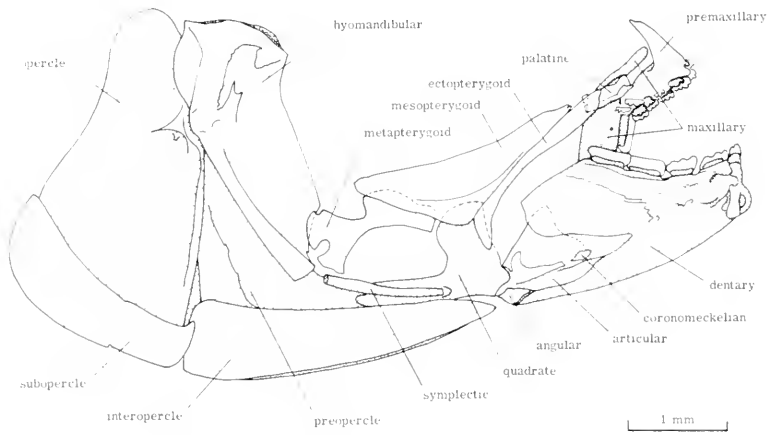

Figure 16. *Landania latidens*. Internal view of jaws, suspensorium, and facial bones (32.1-mm specimen).

festae, many of which were taken in starved condition. Many specimens of *Bryconamericus* have guts full of mud. Several *Landonia* had empty guts. A 36.1-mm *Landonia* had a well-formed bolus of segmented fin rays, perhaps from a characid, and nothing else. The stomach of a 42.0-mm specimen contained a packet of about 24 characid scales from 1.7 to 3.0 mm in their longest dimension, including some 2.2-mm scales which appear identical to scales on a 53-mm *Astyanax festae* from the same collection. Its own scales are 1.2 mm in their longest dimension. A 31.5-mm specimen contained a few scales and a few strands of what looked like a filamentous alga. None of the *Landonia* examined had ingested insects or sand and soil particles.

In contrast to *Landonia*, *Phenacobrycon* feed largely on an assortment of Arthropoda. A list of the arthropod stomach contents of ten *Phenacobrycon* from the Río Vinces (MCZ 48660) was kindly prepared by Dr. John Lawrence:

Araneida	2
Acarina	1
Collembola	20+
Orthoptera	
Tridactylidae	2
Hemiptera	
Gerridae	14+

Diptera	
3 kinds of larvae	7+
Hymenoptera	1
Colcoptera	
Staphylinidae	1
Limnichidae	1

The waterstriders, almost certainly taken alive at the surface, and the springtails, possibly taken at the surface, are the predominant food items. The waterstriders constitute the item with greatest biomass among the stomach contents. The Tridactylidae are minute mole crickets which tend to live in damp soil at or near the water's edge. The staphylinid beetle, mite (a terrestrial form), hymenopteran, and perhaps the spiders are likely to have been taken while floating or sinking after falling onto the water's surface. The dipteran larvae are almost certainly taken at the bottom. Along with the arthropods one finds sand and soil particles, usually held together in a flocculent mass, presumably ingested from the bottom, and a quantity of very small, brown oval objects that might be seeds, but no fish scales or fin rays.

Ten *Phenacobrycon* from this same population sample had tooth replacement in progress. The stomachs of several of

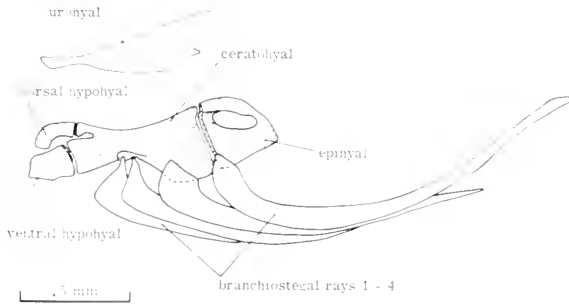

Figure 17. *Iotabrycon praecox*. Lateral view of left half of hyoid arch (minus basihyal and interhyal) and urohyal [offset] (18.8-mm specimen).

these specimens are relatively empty, an indication that they had stopped feeding.

The stomach contents of *Iotabrycon* have not been investigated, in order to conserve specimens.

OSTEOLOGY

Figures 4–26; Tables 1, 2

Osteological study material. This account is based on the following material:

Iotabrycon praecox: MCZ 48659, 3 paratypes: 16.2-mm immature; 17.4-mm female; 18.8-mm male.

Phenacobrycon hemi: MCZ 48661, 3 specimens, 25.6–27.7 mm.

Landonia latidens: MCZ 48664, 5 specimens, 25.6–42.1 mm.

Bryconamericus brevisrostris: MCZ 48665, 2 specimens, 51.7 and 60.5 mm. Rio Vinces at Vinces, 5 November 1971.

Bryconamericus scleroparius: MCZ 48666, 5 specimens, 31.9–39.7 mm. Arroyo Campo Triste, tributary to Rio Blanco, Esmeraldas basin, 27 km NW of town of Santo Domingo, 20 October 1971.

Astyanax festae: MCZ 48667, 3 specimens, 34.5–46.5 mm, Rio Vinces at Vinces, 5 November 1971.

Brycon dentex: MCZ 48668, 2 specimens, 79.0 and 82.0 mm, Rio Esmeraldas 35 km upstream from city of Esmeraldas, 21 October 1971.

Cranium (Figs. 7–10). Crania of *Phenacobrycon* (Fig. 8) and *Landonia* (Figs. 9, 10) are similar to each other except in the ethmoid region. Both lack rhinosphenoids and the strong ventroposteriorly directed pterotic process found in *Brycon*, but otherwise differ little from that genus. The

posterior half of the cranium of *Landonia* is slightly foreshortened and deeper, as evidenced in the shapes of the parietal, pterotic, and prootic bones, and in the approximation of the parietal branch of the frontal laterosensory canal to the parietal laterosensory canal. In *Phenacobrycon* the ethmoid region is similar to that in *Brycon* in that the vomer remains separate from the ethmoid, and the vomerine process of the lateral ethmoid is in intimate contact with the vomer. In *Landonia* ethmoid and vomer are fused but the vomerine processes of the lateral ethmoids are weakly developed and fail to contact the vomer. The lateral portion of the lateral ethmoid also is relatively smaller in *Landonia*.

Dorsal cranial fontanel and epiphyseal bar well developed in all three genera. In *Iotabrycon* posterior portion of cranial fontanel about 1½ times as long as anterior portion, anterior portion slightly wider than posterior portion. In *Phenacobrycon* posterior and anterior portions of cranial fontanel about equal in length and width. In *Landonia* anterior portion slightly shorter and narrower than posterior portion (Fig. 10). Despite these slight differences in proportion between the anterior and posterior portions, the shape of the cranial fontanel is very similar in the three genera.

The cranium of *Iotabrycon* (Fig. 7) differs most notably from crania of

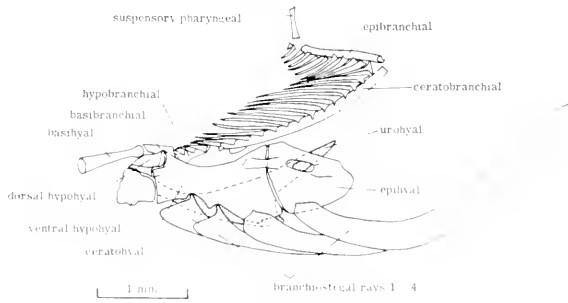

Figure 18. *Landonia latidens*. Lateral view of left half of hyoid (minus interhyal) and first gill arches (32.1-mm specimen).

Phenacobrycon and *Landonia* in possessing a well-developed rhinosphenoid. The relationships of ethmoid, vomer, and lateral ethmoid are as in *Phenacobrycon*. In *Landonia* and *Phenacobrycon* the posteriormost part of the parasphenoid provides a strong, ventrally directed, keel-like structure on the base of the cranium; in *Iotabrycon* the posterior part of the parasphenoid is weakly developed, flattened from side to side, and fails to form a strong ventral keel.

In *Iotabrycon* only the frontal and

pteroic branches of the cephalic laterosensory system develop bony canals. The pterotic canal is short, and the frontal canal fails to develop a parietal branch. Parietal canal absent.

In all three genera the ventral part of the orbitosphenoid has a posteriorly directed process. This process is relatively weak in *Landonia*.

In *Phenacobrycon* and *Iotabrycon* the vertical laminar portion of the supraoccipital is fenestrated.

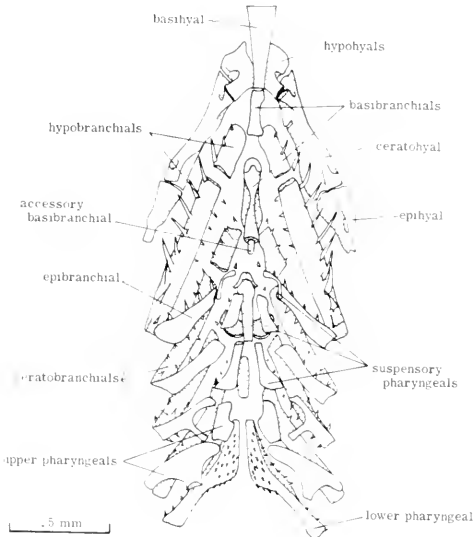

Figure 19. *Iotabrycon praecax*. Dorsal view of hyoid (minus interhyal) and gill arches (branchiostegal rays removed) (18.8-mm specimen).

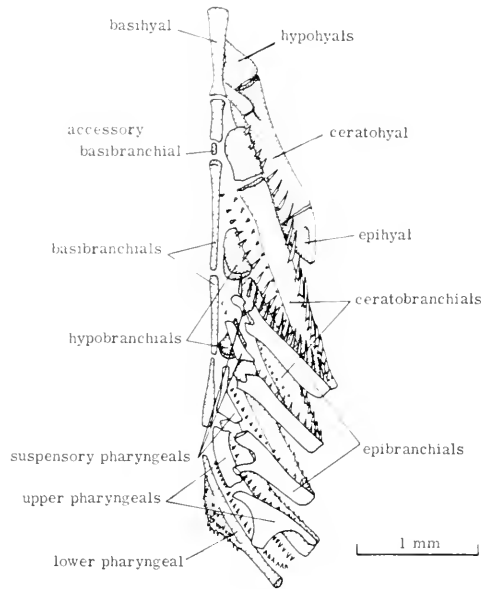

Figure 20. *Phenacobrycon henni*. Dorsal view of right half of hyoid (minus interhyal) and gill arches (branchiostegal rays removed) (25.6-mm specimen).

TABLE 2. SOME OSTEOLOGICAL CHARACTERS IN *PHENACOBRYCON*, *BRYCONAMERICUS*, *ASTYANAX*, AND *BRYCON*. P = PRIMITIVE, R = REDUCTIVE, L = LAME, S = SPECIALIZED; SEE TEXT FOR EXPLANATION.

	<i>Phenacobrycon</i> (<i>P. lucini</i>)	<i>Bryconamericus</i> and <i>Astyanax</i> (<i>B. brevicestris</i> , <i>B. scleroperlus</i> ; <i>A. festae</i>)	<i>Brycon</i> (<i>B. meeki</i> , after Weitzman, 1962; <i>B. dentex</i>)
1. Supraorbital	absent R	absent R	present P
2. Circumorbitals	I, 2, 3, I, 5, 6 P	I, 2, 3, I, 5, 6 P	I, 2, 3, I, 5, 6 P
3. Rhinosphenoid	absent L	absent L	present P?
1. Posteriorly directed ventral process on orbitosphenoid	strongly developed R?	weakly developed L	absent P?
5. Posteriorly directed ventral pterotic process	absent R	weak R	strong P, L
6. Epiotic bridge	relatively narrow R	relatively narrow R	relatively wide P?
7. Number of tooth rows on premaxillary	2 P	2 P	3 or 1 (irregular rows) S
8. Teeth on maxillary	a single small tricuspid tooth at junction with premaxillary R, L	absent (<i>Astyanax</i>); two small tricuspid teeth at junction with premaxillary (<i>Bryconamericus</i>) R, L	13-15 tricuspid teeth extending entire length of descending limb P?, L
9. An internal row of two teeth near symphysis of lower jaw (one tooth on each dentary)	absent R?	absent R?	present P?, L
10. Mode of tooth replacement	alternating from side to side of the jaws P	alternating from side to side of the jaws P	alternating from side to side of the jaws P
11. Ossified basibranchials	4 P, L?	4 P, L	3 L, P
12. Postcleithra	I, 2, 3; I and 2 widely separated; 3 with proximal laminar portion P	I, 2, 3; I and 2 widely separated; 3 with proximal laminar portion P	I, 2, 3; I and 2 in contact (<i>B. meeki</i>) or only slightly separated (<i>B. dentex</i>); 3 striplike, without laminar portion P
13. Supraneurals	6-7 R	5-6 R	10 (<i>B. meeki</i>), 11 (<i>B. dentex</i>) S?
14. Epurals	2 P	2 P	2 (<i>B. dentex</i>), 3 (<i>B. meeki</i>) P, L
15. Vertebrae	16 + 18 L	16-17 + 17 (<i>Astyanax</i>); 17 + 18-19, 18 + 18 (<i>Bryconamericus</i>) L	22-23 + 23 S?

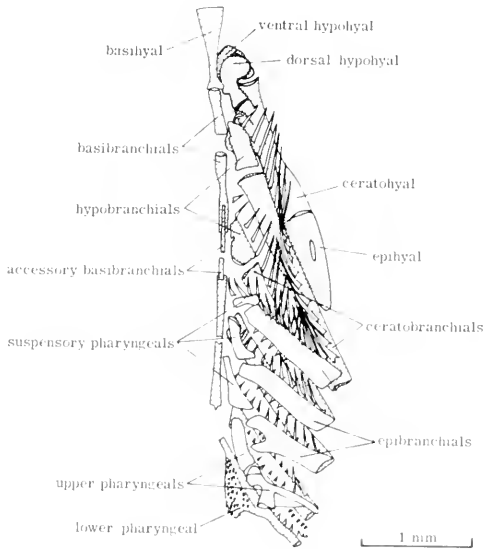

Figure 21. *Landonia latidens*. Dorsal view of right half of hyoid (minus interhyal) and gill arches (branchiostegal rays removed) (32.1-mm specimen).

In all three genera the lateral foramen of the exoccipital is unusually large.

Jaws (Figs. 5, 6, 11-16). The jaws of *Phenacobrycon* (Figs. 5, 13, 14) are similar to the jaws of *Bryconamericus* and *Astyanax*. The dorsal surface of the distal end of the premaxillary is notched to receive the ventral edge of the maxillary's ascending process. This notch is a relatively constant feature in many Tetragonopterinae and other characids with multicuspid teeth. It is present in such generalized forms as *Brycon*, *Salminus*, and the African genus *Alestes*. In these forms the lateral wall of the notch in the premaxillary bone lies external to the ascending maxillary limb (as in Fig. 13 of *Phenacobrycon*). In *Landonia* the notch is absent, and the entire ascending limb of the maxillary lies external to the premaxillary. This can be seen in Figure 15, a lateral view of *Landonia*, but it is more apparent when the jawbones are viewed from above (not figured).

A second marked peculiarity of the maxillary in *Landonia* is the shape of its

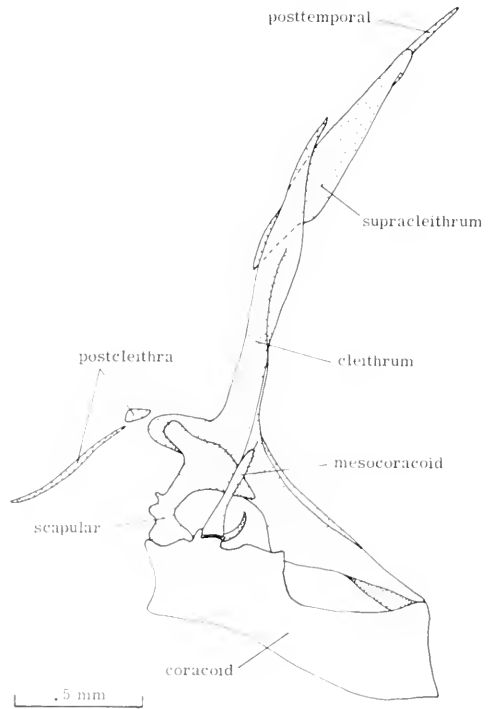

Figure 22. *Iotabrycon proecox*. Internal view of left half of pectoral girdle (17.4-mm specimen).

distal end, the trailing edge of which is curved outwards. From manipulation of the alizarin preparations the impression is gained that these peculiarities of the maxillary in *Landonia* are functionally significant in aligning the straight-edged teeth of the maxillary with those on the dentary close enough that their shearing or scissor-like action can be effected. This action possibly could be further enhanced by dilation of the rami of the lower jaws; in *Landonia*, as in *Phenacobrycon* and many other characins, the two halves of the lower jaw are movably joined at the symphysis by a symphyseal hinge joint.

In *Phenacobrycon* the maxillary is moderately long and slender, with a slightly convex ventral margin, similar in shape to the maxillary of *Bryconamericus*. The maxillary of *Astyanax* is relatively short, with its distal end expanded. It may be

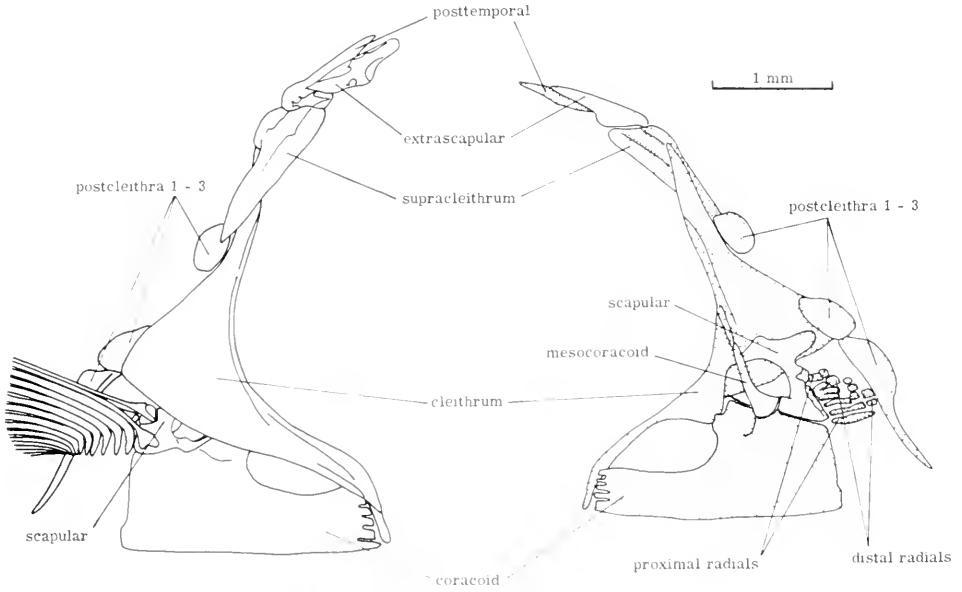

Figure 23. *Phenacobrycon henni*. Lateral and internal views of right half of pectoral girdle (25.6-mm specimen).

noted that the dentary of *Landonia* is relatively elongate, and in this respect more similar to the dentary of *Bryconamericus* than to that of *Astyanax*.

Facial bones (Figs. 11–16). All three genera lack the supraorbital and have a tubular nasal bone and an antorbital bone similar in shape and position to the nasal

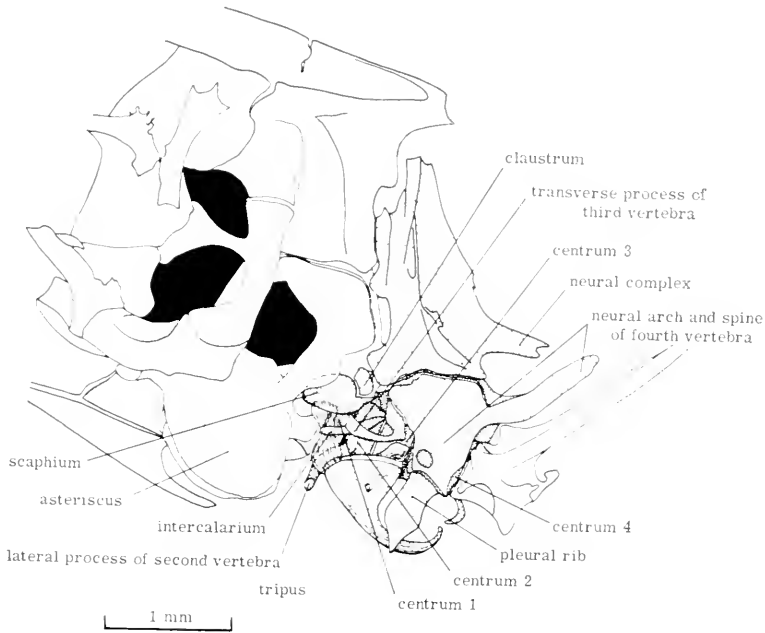

Figure 24. *Landonia latidens*. Lateral oblique view of Weberian apparatus (42.1-mm specimen).

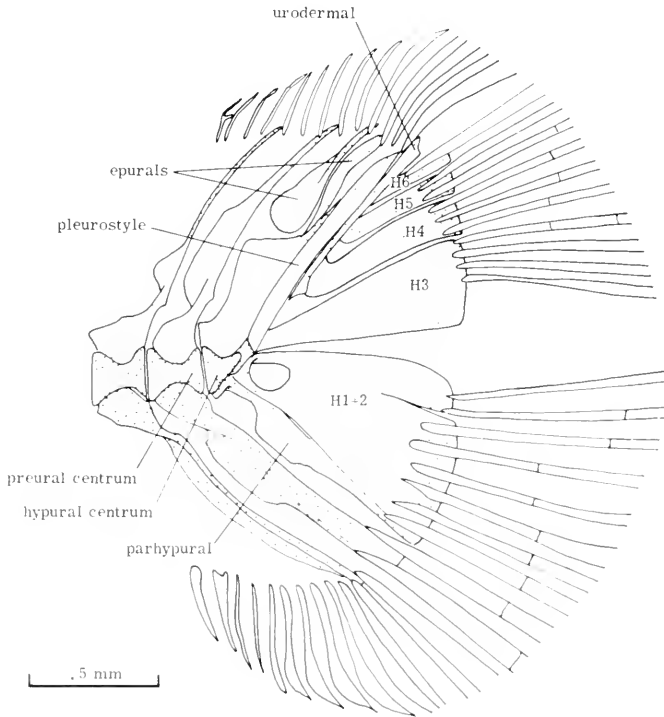

Figure 25. *Iotabrycon praecox*. Lateral view of caudal skeleton (18.8-mm ♂). Note enlarged lower procurrent caudal roys.

and antorbital in *Bryconamericus* and *Astyanax*. *Phenacobrycon* has six infraorbitals, the shape and size of each similar to the corresponding elements in *Bryconamericus* and *Astyanax* (Fig. 13). *Landonia* has but four separate infraorbitals (Fig. 15). The first separate element (= fused first and second infraorbitals?) is elongate; its leading edge is indented, thus permitting the flared distal end of maxillary bone to lie uncovered by it when mouth is closed. The second separate element (= fused third and fourth?) is slightly enlarged compared to corresponding elements in *Phenacobrycon* and *Bryconamericus*. The number and relative sizes of the circumorbitals is the same in all five specimens of *Landonia*. *Iotabrycon* has only three circumorbitals (Fig. 11), the number and relative size the same in the three specimens examined.

The opercle, subopercle, interopercle, and preopercle are similar in size and shape in all three genera and are much as in *Bryconamericus* and *Astyanax*. In *Phenacobrycon* and *Landonia* the dorsal-most part of the preopercular branch of the laterosensory canal system is enclosed in a separate, tubular, bony supra-preopercle.

Visceral arches (Figs. 17-21). The visceral arches are similar in all three genera, the principal difference lying in the numbers of gill rakers. All have a well-ossified fourth basibranchial, thus agreeing with *Bryconamericus* and *Astyanax* but differing from *Brycon*, which has only three ossified basibranchials (excluding "accessory" ossifications).

Pectoral girdle (Figs. 22, 23). The pectoral girdles are virtually identical in *Phenacobrycon* and *Landonia*. The dis-

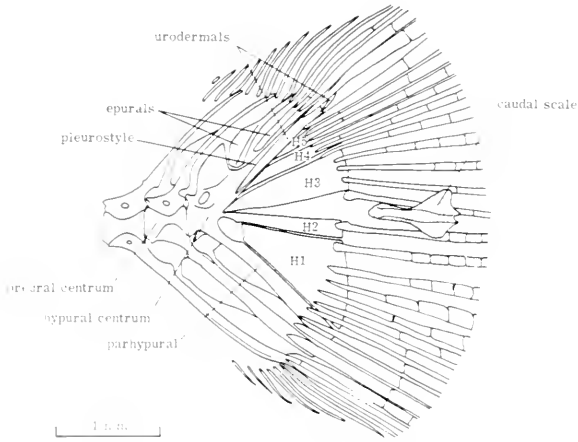

Figure 26. *Landonia latidens*. Lateral view of caudal skeleton and modified terminal scale of pored lateral line series (32.1-mm specimen).

position of the three postcleithra differs from that in *Brycon*: in *Brycon*, the first and second postcleithra are in contact, and the third postcleithrum is strut-like. In *Phenacobrycon* and *Landonia* the first and second postcleithra are widely separated and the proximal half of the third postcleithrum is laminar. *Iotabrycon* differs from *Phenacobrycon* and *Landonia* chiefly in that the first postcleithrum is absent, the second greatly reduced, and the third an elongate strut with no lamellar portion.

In *Iotabrycon* the posttemporal is a simple shaft (absence of lower limb correlated with absence of intercalar). In *Phenacobrycon* the lower limb of posttemporal is short and weakly developed (in one specimen) or absent (in two specimens, including the one on which Fig. 23 is based). In *Landonia* (pectoral girdle not figured) the lower posttemporal limb is moderately well developed.

Pelvic girdle (Fig. 4). The pelvic girdle is similar in all three genera, and like that in other characids which have a generalized pelvic girdle. *Phenacobrycon* and *Landonia* have eight pelvic rays, as have *Bryconamericus* and *Astyanax*. *Iotabrycon* has only seven. The distribution of hooks on the pelvic fin rays in males differs in the three genera, as discussed above.

Weberian apparatus (Fig. 24). The Weberian apparatus is similar in all three genera and like that of other generalized characids. The scaphium is relatively large in *Iotabrycon*, as is usual in characids of greatly reduced size.

Caudal skeleton (Figs. 25, 26). The caudal skeleton is similar in all three genera, and very much like the caudal skeleton in *Bryconamericus* and *Astyanax*.

Vertebral counts. The total vertebral and precandal-caudal vertebral counts are very close in the three genera. *Phenacobrycon* has 34 vertebrae (excluding hypural), *Landonia* 35 or 36, and *Iotabrycon* 35 or 36. Frequencies of precandal and caudal vertebrae were observed as follows: *Phenacobrycon*, 16 + 18 (3 specimens); *Landonia*, 16 + 19 (3) and 16 + 20 (2); and *Iotabrycon*, 17 + 18 (1) and 17 + 19 (2). The similarity of these counts is evidence for relationship, but it must be borne in mind that *Astyanax* and *Bryconamericus* also have vertebral counts similar to these.

DISCUSSION

An attempt has been made in Tables 1 and 2 to evaluate systematic characters according to whether they are primitive,

labile, reductive, or specialized with regard to Tetragonopterinae or generalized characids. Primitive characters (*P*) cannot be used to show relationships when they are common to many forms outside the group being considered. Labile characters (*L*) change readily, often show a mosaic distribution, and are of limited use in determining relationships. Reductive characters (*R*), including loss characters, occur commonly and independently, especially in forms with greatly reduced body size, and are likewise of limited utility. Specialized characters (*S*) are those that are most important in determining relationships. Ideally, specialized characters originate only once, i.e., are incapable of having originated independently. We may note in passing that the generic classification in *The American Characidae* is based largely on reductive and labile characters.

The osteology of what will doubtless prove to be the great majority of species in the subfamily Tetragonopterinae and in the subfamilies derived from it is relatively uniform. This is not difficult to believe when one considers the sameness in habitus and dentition in literally hundreds of species belonging to large genera and groups of genera such as *Astyanax*, *Bryconamericus*, *Moenkhausia*, *Hyphessobrycon*, and *Hemigrammus*. A worker might assume that two characids are closely related because they share osteological features that are truly similar, not realizing that these characters are very widespread. One must use as many osteological characters as possible and even then the results may prove inconclusive. In the present instance I have not been able to find any specialized osteological characters which would serve to identify *Iotabrycon*, *Phenacobrycon*, and *Landonia* as a closely related group. The osteological characters they share are all generalized and can be found in many other characids, including the non-glandulo-caudines *Bryconamericus* and *Astyanax* from the same basin. Thus the osteological characters shared by *Phenacobrycon* and

Bryconamericus do not prove a close relationship. Most of the osteological differences between *Phenacobrycon*, *Landonia*, and *Iotabrycon* and between them and such generalized American characids as *Brycon* (Weitzman, 1962), *Bryconamericus*, or *Astyanax*, are related to either 1) modifications of the jaws and jaw teeth or 2) differences in the extent of ossification which are correlated with body size. *Phenacobrycon* and *Landonia* are similar osteologically except for differences in their jaw dentition, ethmoid regions, and circumorbitals.

Of the three Guayas glandulo-caudines, *Phenacobrycon* is more generalized than either *Iotabrycon* or *Landonia* in its dentition and possession of six separate circumorbital bones. Compared to *Iotabrycon*, *Phenacobrycon* is also more generalized in its retention of an adipose fin, complete squamation, and complete lateral line. With respect to *Landonia*, it is also more generalized in its jaw morphology and perhaps in having fewer scales. The similarity in coloration of live specimens reported here may be taken as additional evidence that *Landonia* and *Phenacobrycon* are closely related, as first suggested by Myers (Eigenmann and Myers, 1929: 4). On the other hand, the morphology of the maxillary bone and circumorbital series, complete enclosure of all but the internal premaxillary row of replacement teeth within the jaw bones, and probably the mode of tooth replacement of *Landonia* indicate considerable divergence from its presumed *Phenacobrycon*-like or *Bryconamericus*-like ancestors. *Landonia* is immediately distinguished from all other characids by the morphology of its teeth. The small size of scales in *Landonia* may be an adaptation to lessen autopredation on scales; small scale size and more adherent scales are characteristic of all the characoid genera that are highly specialized as scale-eaters: they tend to feed on fishes with scales much larger than their own (Roberts, 1970). On the

other hand, the dentition of *Landonia* is probably primarily adapted to some other kind of food, and the gut contents of specimens taken during the dry season are probably different from what one would find in the wet season.

Overall, *Iotabrycon* looks modified in a reductive way with unique specialization in the caudal gland. The presence of a rhinosphenoid is a surprise, since all other osteological differences between *Iotabrycon* and *Phenacobrycon* and *Landonia* seem to be those commonly associated with extreme size reduction in Characidae, i.e., failure of the epiotic bone to form a bridge across posttemporal fossa; reduction of circum-orbital series; absence of intercalar; conical dentition; and reduction of bony canals enclosing cephalic laterosensory system. The rhinosphenoid occurs in many South American genera of Characidae, and also in Hemiodontidae and Cynodontidae. There is some indication that it has a mosaic distribution. Thus the rhinosphenoid is absent in *Astyanax festae* but present in *Astyanax fasciatus* (MCZ 46756 from the coast of Ceará). The presence or absence of the rhinosphenoid may in some degree be dependent on development of the orbitosphenoid. The series *Bryconamericus*-*Landonia*-*Phenacobrycon*-*Iotabrycon* shows a progressively more developed orbitosphenoid. In larval *Brycon dentex* the orbitosphenoid is well developed and ossified before there is any indication of the rhinosphenoid.

Some comments concerning the hooks on the fin rays in males of many New World Characidae are in order. The hooks differ from pearl organs and breeding tubercles in being osseous structures invariably associated with segmented rays rather than keratinous structures of widespread occurrence on the body and fins. The earliest reference to the hooks of Characidae is probably by Jenyns (1842: 126), who distinguished *Tetragonopterus* (= *Astyanax*) *scabripinnis* from other species by the anal fin rays "being set with

asperities, which communicate a scabrous harsh feel to the touch, when the finger is passed along them from the base upwards." He also mentioned the scabrous condition of the anal fin in one specimen of *Tetragonopterus* (= *Cheirodon*) *interruptus* (*op. cit.*, p. 128), and suggested that this may be a sexual character common to several species. The occurrence of hooks was recorded for many species in *The American Characidae* (Eigenmann, 1917-1927; Eigenmann and Myers, 1929). More recent records are reviewed by Wiley and Collette (1970: 164-165). Nelson's remark that "the presence of caudal and even dorsal fin hooks in the male *Acrobrycon* certainly suggests that in that genus fertilization is internal" (Nelson, 1964a: 129) should be questioned. The hooks, which perhaps hook onto the unarmed rays in the female when the fins of a mating pair come in contact, presumably would facilitate spawning accompanied by external fertilization. This is especially so if the action takes place in swift current, as it presumably does in *Bryconamericus* sp. undet. (MCZ 48669), in which well-developed hooks are present on all of the fin rays in all of the fins, including the dorsal and pectorals. One specimen of this form was collected in the Río Toachi, Río Esmeraldas drainage, about 15 km E of Santo Domingo, altitude approximately 900 meters, on 19 October 1971. In this region the river is very swift, and even in the pools, which are scarce, there tends to be considerable current. Böhlke (1958: 12) reported that adult males of *Bryconamericus peruanus* have hooks on all fins supported by rays, but did not indicate locality or habitat whence the specimens came. In lowland populations of *Bryconamericus "peruanus"* (= *Bryconamericus scleroparius*) that we sampled the hooks occur only on the anal and pelvic fins. There is no reason to believe that internal fertilization occurs in more than a small proportion of characids having hooks. On the other hand, hooks are probably preadaptive to the evolution of

internal fertilization. At the present time it is premature to state that internal fertilization occurs in all glandulocaudines (see Bussing and Roberts, 1971).

LITERATURE CITED

- BÖHLKE, J. 1958. Studies on fishes of the family Characidae—No. 14. A report on several extensive recent collections from Ecuador. *Proc. Acad. Nat. Sci. Philadelphia*, **110**: 1–121.
- BUSSING, W. A., AND T. R. ROBERTS. 1971. Rediscovery of the glandulocaudine fish *Pterobrycon* and hypothetical significance of its spectacular humeral scales (Pisces: Characidae). *Copeia*, **1971**(1): 179–181.
- EIGENMANN, C. H. 1917–27. The American Characidae. *Mem. Mus. Comp. Zool., Harvard*, vol. 43, pt. 1, pp. 1–102, 16 pls. (1917); pt. 2, pp. 103–208, 22 pls. (1918); pt. 3, pp. 209–310, 28 pls. (1921); pt. 4, pp. 311–428, 24 pls. (1927).
- . 1922. The Fishes of Western South America. Part I. *Mem. Carnegie Mus.*, vol. 10, no. 1, pp. 1–346, 35 pls., 1 map.
- , A. HENN, AND C. WILSON. 1914. New fishes from Western Colombia, Ecuador, and Peru. *Indiana Univ. Studies* no. 19, 15 pp.
- , AND G. S. MYERS. 1929. The American Characidae. *Mem. Mus. Comp. Zool., Harvard*, vol. 43, pt. 5, pp. 429–574, 11 pls.
- CÉRY, J. 1965. A new genus from Brazil—*Brittanichthys*—a new, sexually-dimorphic characid genus with peculiar caudal ornament, from the Rio Negro, Brazil, with a discussion of cheirodontin genera and a description of two new species, *B. axelrodi* and *B. myersi*. *Tropical Fish Hobbyist*, February, 1965: 13–14, 18, 20–24, 61–65, 67–69.
- JENYNS, REV. LEONARD. 1842. The Zoology of the Voyage of H.M.S. BEAGLE. Part IV. Fish, xvi + 172 pp., 29 pls.
- MYERS, G. S., AND J. BÖHLKE. 1956. The Xenobryconini, a group of minute South American characid fishes with teeth outside the mouth. *Stanford Ichth. Bull.*, **7**(2): 6–12.
- NELSON, K. 1964a. Behavior and morphology in the glandulocaudine fishes (Ostariophysi, Characidae). *Univ. California Publ. Zool.*, **75**(2): 59–152.
- . 1964b. The temporal patterning of courtship behaviour in the glandulocaudine fishes (Ostariophysi, Characidae). *Behaviour*, **24**(pts. 1–2): 90–146.
- . 1964c. The evolution of a pattern of sound production associated with courtship in the characid fish, *Glandulocauda inequalis*. *Evolution*, **18**(4): 526–540.
- ROBERTS, T. R. 1967. Tooth formation and replacement in characid fishes. *Stanford Ichth. Bull.*, **8**(4): 231–247.
- . 1970. Scale-eating American characid fishes, with special reference to *Probolodus heterostomus*. *Proc. California Acad. Sci.*, ser. 4, **38**(20): 383–390.
- TORTONESE, E. 1941–42. Ricerche ed osservazioni sui Caracidi delle sottofamiglie Tetragonopterinae, Glandulocaudinae e Stethaprioninae (Teleostei Plectospondyli). *Boll. Mus. Zool. Anat. Comp. R. Univ. Torino*, **49**(ser. 4, no. 117): 11–86, 5 pls.
- WELTZMAN, S. H. 1962. The osteology of *Brycon meeki*, a generalized characid fish, with an osteological definition of the family. *Stanford Ichth. Bull.*, **8**(1): 1–77.
- WILEY, M. L., AND B. B. COLLETTE. 1970. Breeding tubercles and contact organs in fishes: their occurrence, structure, and significance. *Bull. Amer. Mus. Nat. Hist.*, **143**(3): 143–216.

Harvard MCZ Library



3 2044 066 304 189

Date Due

Date Due	
1987	
2004	
NOV 09 2004	

