

32313

SCOPE OF THE COLLECTIONS OF THE DIVISION OF ENGINEERING.

SMITHSONIAN INSTITUTION  
UNITED STATES NATIONAL MUSEUM  
BULLETIN 173

---

CATALOG OF THE MECHANICAL COLLECTIONS  
OF THE DIVISION OF ENGINEERING  
UNITED STATES NATIONAL MUSEUM

BY  
FRANK A. TAYLOR



UNITED STATES  
GOVERNMENT PRINTING OFFICE  
WASHINGTON : 1939

## ADVERTISEMENT

The scientific publications of the National Museum include two series, known, respectively, as *Proceedings* and *Bulletin*.

The *Proceedings* series, begun in 1878, is intended primarily as a medium for the publication of original papers, based on the collections of the National Museum, that set forth newly acquired facts in biology, anthropology, and geology, with descriptions of new forms and revisions of limited groups. Copies of each paper, in pamphlet form, are distributed as published to libraries and scientific organizations and to specialists and others interested in the different subjects. The dates at which these separate papers are published are recorded in the table of contents of each of the volumes.

The series of *Bulletins*, the first of which was issued in 1875, contains separate publications comprising monographs of large zoological groups and other general systematic treatises (occasionally in several volumes), faunal works, reports of expeditions, catalogs of type specimens and special collections, and other material of similar nature. The majority of the volumes are octavo in size, but a quarto size has been adopted in a few instances in which large plates were regarded as indispensable. In the *Bulletin* series appear volumes under the heading *Contributions from the United States National Herbarium*, in octavo form, published by the National Museum since 1902, which contain papers relating to the botanical collections of the Museum.

The present work forms No. 173 of the *Bulletin* series.

ALEXANDER WETMORE,  
*Assistant Secretary, Smithsonian Institution.*

WASHINGTON, D. C., *December 12, 1938.*



## CONTENTS

---

	Page
Preface.....	vii
Introduction.....	1
Mechanical elements.....	2
Animal power.....	4
Power from the wind.....	7
Water power.....	14
The steam engine.....	24
Rotary steam engines.....	55
Steam-engine valves and valve gears.....	60
Inventions of George H. Corliss.....	71
Engine governors.....	80
Condensers.....	86
Engine indicators.....	89
Miscellaneous steam-engine accessories.....	95
Air and hydraulic engines.....	100
Mechanical transmission of power.....	102
Steam boilers.....	103
Steam-boiler accessories and burners.....	119
Boiler feed-water pumps and injectors.....	125
Steam pumps.....	133
Fire engines.....	139
Miscellaneous pumps.....	142
Internal-combustion engines.....	143
Carburetors.....	165
Internal-combustion engine accessories.....	173
Caloric, or hot-air, engines.....	175
Air-and-steam ("aerator") engines.....	182
Refrigerating machines.....	183
Selected bibliography.....	186
Index.....	191

## ILLUSTRATIONS

### PLATES

1. Scope of the collections of the Division of Engineering.....	Frontispiece Facing page
2. Mechanical elements.....	4
(1) Roller, lever, and inclined plane.	
(2) Chinese windlass.	
(3) Differential chain hoist.	
3. Treadmills.....	5
(1) Human treadmill, c. 1588.	
(2) Dog-powered treadmill, 1878.	
4. Windmills.....	8
(1) Smock windmill, c. 1826.	
(2) Post windmill, c. 1826.	
(3) Grist windmills on Long Island, c. 1874.	
5. Windmills.....	9
(1) Monitor windmill, 1881.	
(2) Moses G. Farmer wind-electric generator, 1880.	
6. Water wheels.....	16
(1) Vertical water mill, c. 1588.	
(2) Burden Iron Co.'s water wheel, 1851.	
7. Wooden water-mill gearing, c. 1870.....	17
(1) Spur gears.	
(2) Pinwheels.	
8. Pelton water-wheel buckets, 1901-1912.....	22
9. Conowingo hydroelectric generating station, 1928.....	23
10. Early steam engines.....	28
(1) Heron's turbine, c. 150 A. D.	
(2) Watt pumping engine, "Old Bess," 1777.	
11. Newcomen pumping engine, c. 1717.....	29
12. Early steam engines in America.....	40
(1) Half cylinder of the first steam engine in America, 1755.	
(2) John Stevens steamboat engine, 1804.	
13. Steam engines, 1864-1875.....	41
(1) Horizontal steam engine, 1864.	
(2) Thompson and Hunt steam engine, c. 1875.	
14. Small multicylinder steam engines.....	54
(1) First Stanley steam automobile engine, 1897.	
(2) Westinghouse Junior automatic engine, c. 1900.	
15. Three-stage steam turbine, 1926-1930.....	55
16. Adjustable cut-off valve gears.....	66
(1) Sickels drop cut-off valve gear, 1841.	
(2) Allen adjustable cut-off valve gear, 1841.	
17. Adjustable cut-off valve gears.....	67
(1) Francis B. Stevens cut-off, 1861.	
(2) Corliss drop cut-off valve gear, 1849.	

	Facing page
18. Corliss beam engines.....	78
(1) Corliss compound beam pumping engine, 1870.	
(2) Corliss Centennial steam engine, 1876.	
19. Steam-engine governors.....	79
(1) Porter weighted engine governor, 1858.	
(2) Thompson and Hunt shaft governor, 1878.	
20. Engine indicators.....	94
(1) McNaught, c. 1835-1842.	
(2) Richards, c. 1867.	
(3) Crosby, 1879.	
(4) Indicator with continuous card attachment, 1930.	
21. Engine accessories.....	95
(1) Multiple hydrostatic lubricator.	
(2) Hewitt piston-rod packing.	
22. Early steam boilers.....	110
(1) Wooden steam boiler, 1801-1815.	
(2) Stevens water-tube boiler, 1803-1825.	
23. National water-tube boiler, 1885.....	111
24. Sectional boilers.....	116
(1) Babcock and Wilcox steam generator, 1867.	
(2) Sinuous boiler headers, 1867-1926.	
25. Double-deck inclined-tube boiler, 1929.....	117
26. Boiler accessories.....	124
(1) Stevens safety valve, 1825.	
(2) Mechanical oil burner, 1929.	
27. Feed-water injectors.....	125
(1) Giffard injector, 1860.	
(2) Exhaust feed-water heater injector, 1925.	
28. Steam pumps.....	134
(1) Worthington direct-acting steam pump, 1855.	
(2) Cameron pump valves, 1874.	
29. Steam pumps.....	135
(1) Knowles steam pump, 1879.	
(2) Frost steam-pump valve, 1890.	
30. Internal-combustion engines.....	148
(1) Perry gas or vapor engine, 1844.	
(2) Drake gas engine, 1855.	
31. Internal-combustion engines.....	149
(1) Otto and Langen gas engine, 1867.	
(2) Brayton oil engine, 1874.	
32. Internal-combustion engines.....	154
(1) Otto 4-stroke cycle engine, 1877.	
(2) Otto gas engine, 1882.	
33. Internal-combustion engines.....	155
(1) Hornsby-Akroyd oil engine, 1893-1895.	
(2) Manly radial engine, 1901.	
34. Carburetors.....	174
(1) Duryea carburetor, 1893.	
(2) Dyke float-feed carburetor, 1900.	
(3) Carburetor of the Manly engine, 1901.	

	Facing page
35. Hot-air engines-----	175
(1) Ericsson hot-air engine, 1855.	
(2) Rider hot-air engine, 1871.	
36. Ericsson hot-air pumping engine, 1906 .....	182
37. Refrigerating machines-----	183
(1) Audiffren refrigerating machine, 1913.	
(2) Frost-Maker domestic refrigerating unit, c. 1914.	

## PREFACE

OBJECTS illustrating the development of the mechanical arts and sciences have been collected and preserved by the Smithsonian Institution from the earliest period of its existence. For years this activity was continued incidentally to the work of the ethnological sections of the Institution in the United States National Museum. In 1884, however, acquisitions from the Centennial Exposition of 1876 had increased the collections so greatly, particularly in the field of transportation, that a section of transportation was created in the Museum. This section has in time grown in scope and size into the present Department of Engineering and Industries and includes collections and exhibits in nearly every branch of engineering and industry.

The Department of Engineering and Industries is now, in effect, the national museum of engineering and industry of the United States, and in size, scope, and merit of collections and in numbers of visitors to its exhibits it compares favorably with the national museums of science and industry abroad. This comparison could readily be made more favorable were it not for the fact that the collections at present are crowded in antiquated and inadequate buildings that prevent exhibition of the material in the most appealing and instructive manner. It is anticipated that in due time modern housing for these important collections will be provided.

The division of engineering, one of the four divisions of the Department, collects, preserves, and exhibits material illustrative of the progress in all fields of engineering and the physical sciences, including such diversified subjects as transportation, aeronautics, mining, communications, tools and crafts, timekeeping, office machines, and many others. The collections described in this catalog, compiled by Frank A. Taylor, curator of engineering in the United States National Museum, are in the group roughly designated as prime movers or power-producing devices and their accessories and auxiliaries. It includes such machines as windmills, water wheels, steam, oil, and gas engines, and steam boilers, and it will serve as a typical example of what has been done in recording, by relics, the progress made in a fundamentally important engineering field in America.

It is intended that this catalog will prove a useful guide to the collections, particularly for those who cannot visit the Museum. At the same time, it will illustrate the deficiencies of the collections and, it is hoped, enlist the aid of all who can offer information, sug-

gestions, or material for expansion and improvement. It is also anticipated that individuals, trade associations, and professional groups who are in a position to assist will be encouraged to consider seriously what aid or influence they might lend to the further development of an adequate national museum of engineering and industry for the United States, under the direction of the Smithsonian Institution.

C. W. MITMAN, *Head Curator,*  
*Department of Engineering and Industries.*

# CATALOG OF THE MECHANICAL COLLECTIONS OF THE DIVISION OF ENGINEERING, UNITED STATES NATIONAL MUSEUM

---

By FRANK A. TAYLOR

---

## INTRODUCTION

THROUGHOUT history the changing pattern of society has been determined to a large degree by the progress made in exploiting the natural energy resources of the world and the manner in which the fruits of this energy have been distributed. When the only harnessable energy source was the muscular effort of men, the sole pools of power were in groups of men, and the leaders who sought to build wealth, culture, and government beyond the immediate primitive needs of the individual had to command the obedience of slaves. When engines and machines were developed to convert the potential energy of beasts, wind, water, and fuels into useful work, the individual was able to produce more with their help than his immediate needs required; to pay his part of the costs of government, research, and art; and with his surplus to purchase freedom from incessant work or struggle. More recently the effort of the individual has become such a small part of the total energy applied to production that the questions of how little effort a man should expend and how much he should receive in return for his work have produced an unrest that today is changing nations and threatening the very society that power has so largely built.

A few bare relics of the progress of power devices in a museum cannot display their effects upon people or answer the sociological questions their use has produced. They do, however, indicate the slow and systematic work of scientists, engineers, and mechanics to produce the most for the least expenditure of human effort and also suggest that solutions for the question of the proper distribution of returns have been found in the past, often by virtue of further developments within the very field. They should suggest, too, that improvement and advance in engineering methods and devices are the natural and inevitable course and that an increasingly higher standard of living is both the permanent result and the solution of increasing producing power, in spite of temporary difficulties of adjustment.

The material in the National Museum that illustrates the development of mechanical power-producing devices is described in the catalog that follows. The arrangement of the description is roughly chronological by groups as indicated in the table of contents. The brief and general summary of the development preceding each group of descriptions is condensed and fabricated principally from the published works listed in the bibliography.

## MECHANICAL ELEMENTS

Engineering methods and equipment began with the first uses of the so-called mechanical powers. These are the devices that, through the interrelation of force, distance, and time, accomplish the more convenient or the more effective application of effort. Usually included in the term are the lever, the inclined plane, the roller, the pulley, the wheel and axle, and the screw. Originally employed to apply the muscular effort of animals and men, these simple devices are today the elements of the complex combinations or machines that harness resources of natural energy vastly greater than the combined muscular energy of all the men and animals that have lived.

It would be of interest to point to the invention of each of these and trace its development to the present, but this is not possible. It has been observed that a young wild orang will use a stick as a lever to move stones, and that all these devices, including a semblance of the screw, were known independently to one or another of the primitive races around the world. It is supposed therefore that the mechanical powers were used by man earlier than the limits of our historical or archeological knowledge.

The lever, the roller, and the inclined plane occur in nature and were probably the first mechanical powers used by man. The rowing oar, which is a simple application of the lever, is shown in Egyptian drawings of 3000 B. C.; Aristotle (B. C. 384-322) discussed the laws of levers; Archytas (fl. 400 B. C.) wrote of the screw and pulley; and Archimedes (B. C. 287?-212) is said to have used a screw as a jack or as a pulling device to launch a ship for Herot.

Practically all manual labor is still applied through the medium of simple mechanical powers, and the total manual or muscular energy expended through them is greater today than ever before. Spoons, faucet levers, tool handles, gear shift levers, steering wheels, typewriter keys, golf clubs, doors, and controller handles are all common examples of simple mechanical powers.



## MODELS OF MECHANICAL POWERS

U.S.N.M. nos. 307593-307599; 307913-307919; 307942-307946; 308030-308043; 308121-308122; 308227-308232; 308324-308327, all inclusive; 45 models; made in the Museum; not illustrated.

These models are exhibited to illustrate the mechanical powers and their simpler combinations in man-powered machines.

There are about 45 models illustrating the various orders of levers, including straight, bent, and rotary levers, and their applications to such simple machines as cranks and windlasses; the inclined plane and its application to ramps, wedges, screws, and jacks; and rollers in the forms of axles, load rollers, pulley blocks, and wheels.

## ROLLER, LEVER, AND INCLINED PLANE

## PLATE 2, FIGURE 1

U.S.N.M. no. 181251; model; made in the Museum; photograph no. 39008.

This model shows a group of men moving a block of stone along a ramp with the aid of rollers and a crowbar. It illustrates a present every-day use of three mechanical powers in their simplest forms.

## CHINESE WINDLASS

## PLATE 2, FIGURE 2

U.S.N.M. no. 307599; model; made in the Museum; photograph no. 24926C.

This elementary form of the differential hoist (see below) is said to have been in use in China for many centuries.

The windlass drum is made of two sections of different diameters, which turn together as one piece. The rope is so attached that it winds upon one section of the drum as it unwinds from the other, the net lifting or lowering effect being the difference between the length of rope wound upon the drum and that unwound. By making the sections nearly alike in diameter a large mechanical advantage is secured without making the drum too slender for strength or the crank too long for convenience.

## HAND HOISTS, 1928

## PLATE 2, FIGURE 3

U.S.N.M. nos. 309507-309510; originals; gift of the Yale & Towne Manufacturing Co.; photograph no. 6232A.

Three complete hoists and a sectioned operating one are exhibited in the Museum to illustrate the principles of the modern differential pulley block, the screw-gearred block, and the planetary spur-gear hoist.

The differential hoist is a modern form of the old Chinese windlass (see above). It was first suggested in this form by Thomas A. Weston about 1858. It is the least efficient of the three hand hoists exhibited, but with it one man pulling 77 pounds can lift 810 pounds through 19 inches in one-half minute.

With the screw-gearred block, which has a mechanical efficiency of about 40 percent, one man pulling 77 pounds lifts 1,600 pounds 12.8 inches in one-half minute.

The ball-bearing spur-gear block is the most efficient of the three (80-85 percent). With it one man pulling 77 pounds lifts 1 ton 26 inches in one-half minute.

#### ADDITIONAL MODELS IN THE COLLECTION, NOT DESCRIBED

Apparatus for raising and lowering weights (chain hoist), Patent Office model, Patent no. 99231, January 25, 1870, issued to J. Pickering. U.S.N.M. no. 308807.

Apparatus for raising and lowering weights (chain hoist), Patent Office model, Patent no. 119527, October 3, 1871, issued to Thomas Moore. U.S.N.M. no. 308801.

Chain hoist, Patent Office model, not identified. U.S.N.M. no. 308800.

Speed governor and friction brake (chain windlass), Patent Office model, Patent no. 212339, February 18, 1879, issued to T. A. Weston. U.S.N.M. no. 308830.

Friction brake and clutch for hoisting drum, Patent Office model, Patent no. 212338, February 18, 1879, T. A. Weston. U.S.N.M. no. 308829.

Chain hoist, Patent Office model, not identified. U.S.N.M. no. 308851.

Ship steam windlass, models presented by the American Ship Windlass Co. U.S.N.M. no. 160186.

Hand windlass, 1876, invented and presented by T. S. Allen. U.S.N.M. no. 160185.

Hand windlass, 1880, invented and presented by T. S. Allen. U.S.N.M. no. 160324.

Capstan, Patent Office model, not identified, U.S.N.M. no. 308539.

"Providence" steam windlass and capstan, 1886, gift of American Ship Windlass Co. U.S.N.M. no. 57053.

Hoisting pulley and worm gear apparatus (chain hoist), Patent Office model, Patent no. 218223, issued to A. Box, August 5, 1879. Transfer from the United States Patent Office. U.S.N.M. no. 311179.

Converting reciprocating motion to rotary motion, Patent Office model, not identified. Transfer from the United States Patent Office. U.S.N.M. no. 311180.

Pawl and ratchet, Patent Office model, Patent no. 464838, issued to Thomas Johnson, December 8, 1891. Transfer from the United States Patent Office. U.S.N.M. no. 308844.

#### ANIMAL POWER

Dogs and horses were domesticated and used for transport and burden as long ago as the New Stone Age, 12,500 to 6,000 years before Christ, and other animals as they came under man's dominion were trained to pull and carry. It is not until about 200 B. C., however, that any mention is made of animals used for power purposes. Though the ancients knew all the elements of later-day machines



3909B

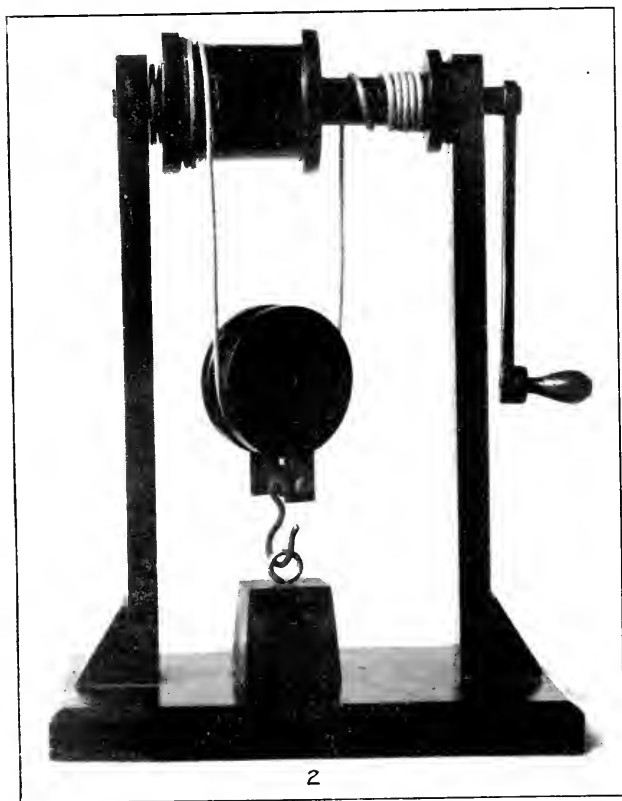

24926C

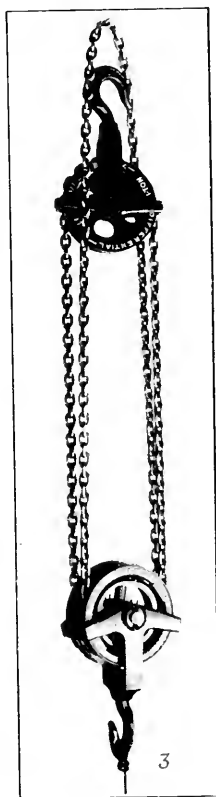

6232A

MECHANICAL ELEMENTS.

1. Roller, lever, and inclined plane (model; U.S.N.M. no. 181251). See p. 3.
2. Chinese windlass (model; U.S.N.M. no. 307599). See p. 3.
3. Differential chain hoist (U.S.N.M. no. 309509). See p. 4.

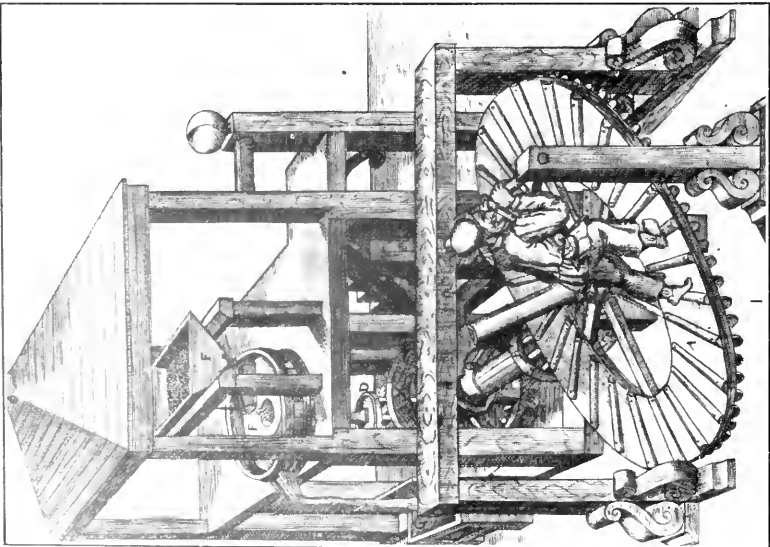

31694B

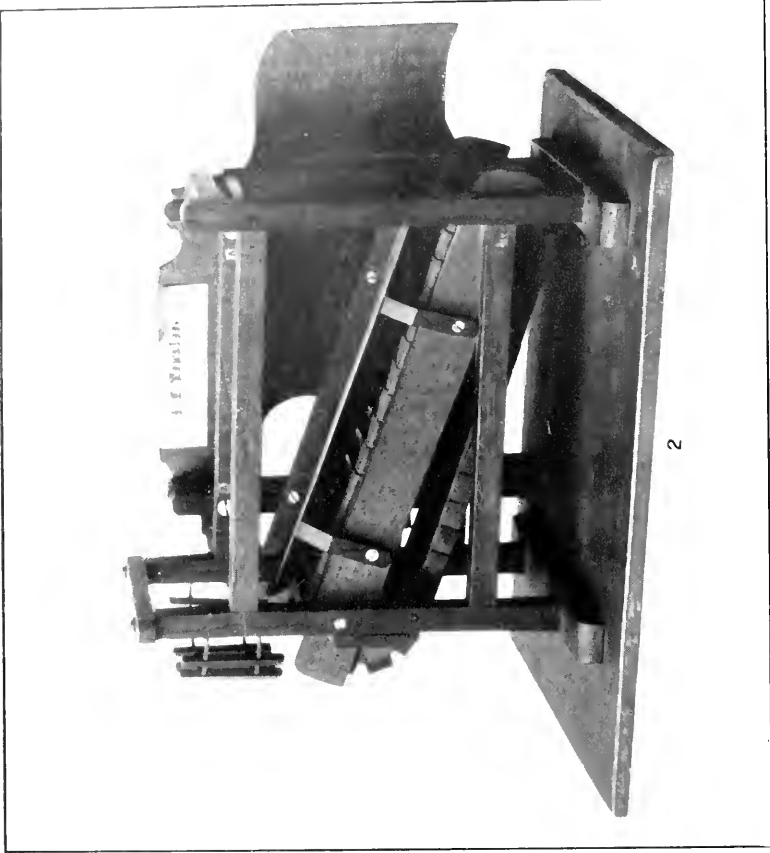

19978A

TREADMILLS.

1. Human treadmill, c. 1588; from Ramelli's *Le Dicerie et Artificiose Machine*, pl. cxviii.  
 2. Dog-powered treadmill, 1878 (model; U.S.N.M. no. 309199). See p. 7.

and had many simple machine combinations, these were all designed to be operated by human muscular power, applied in most instances with a reciprocating motion. Before it was possible to apply the pulling effort of a beast to a machine it was necessary to develop a continuous motion as an essential feature of the machine. Water-raising wheels and rotary grain mills were the first devices to have this essential feature, and a rotary mill turned by asses, mentioned by Cato the Elder (232-149 B. C.), is the earliest known application of animal power to a machine. It was not until the abolishment of slavery in the fourth century in Rome that cattle mills, which were not unlike the slave mills, were generally used, and the use of the geared animal mill, as it is known today, came after the development of the geared water mills and windmills some time between the isolated mention of one in 16 B. C. and their general use after 1200 A. D. "Throughout medieval times a horse mill was practically identical in construction with wind or water mills. The simple driving gear placed in the lower story of the building comprised an upward shaft revolved by the traction of one or more asses or horses harnessed to shafts: attached to the shaft and near the ceiling, a large horizontal toothed wheel actuated one or more spindle wheels connected with the stones, which were placed above" (Bennett and Elton, *History of Corn Milling*).

A horse, walking around and turning a vertical shaft geared to a chain drum, was used as late as 1928 to raise boats on a fairly large marine railway at St. Michaels, Md., and the clay for the hand-made brick used in the restoration of the Washington Birthplace at Wakefield, Va., was tempered in a horse-powered pugmill erected there for the purpose in 1931.

Treadmills operated by the feet of men date back to water-raising tread wheels of about the time of Christ, and they continue to be used as penal devices today. No mention is found of the use of animals on treadmills until a much later date. A donkey walking on the inside of a large wooden wheel, first built in 1588, was used to raise water from a well at Carlsbrooke Castle on the Isle of Wight as late as 1919. Turnspit dogs running in wheels were early used to revolve roasting spits, while dog-driven butter churns are still used to some slight extent in this country.

The *unit* of power that is most widely used to rate every source of power (waterfalls, windmills, and all engines included) is based on the effort of an animal. This unit, the *horsepower*, was determined by James Watt to be the equivalent of 33,000 foot-pounds of work performed per minute. One foot-pound is the work required to raise a weight of 1 pound through a vertical distance of 1 foot, or the work required to raise one-half pound 2 feet. Similarly 1 horsepower is the equivalent of 33,000 pounds raised a foot every minute,

or 1 pound raised 33,000 feet every minute. The work of later investigators (Poncelet, Morin, Rankine, and others) demonstrated that the rate of 33,000 foot-pounds a minute can be maintained by a horse only under the most favorable conditions. The power of a horse operating a horse gin varies from 17,700 foot-pounds to 26,000 foot-pounds a minute.

#### JOHN STEVENS HORSE-POWERED FERRYBOAT, 1813

U.S.N.M. no. 160402; model; made in the Museum; not illustrated.

Col. John Stevens, of Hoboken, built a horse-powered ferryboat to establish a ferry service between Hoboken and New York, in the face of the monopoly on steam navigation that had been granted to Fulton and Livingston. Six horses, harnessed singly to six sweeps, walked in a circle, revolving a vertical shaft to which the sweeps were attached. Bevel gearing transmitted the motion of this shaft to a horizontal shaft upon which a single paddle wheel was mounted. The engine was "reversible" as the horses were turned around and made to walk in the opposite direction when the boat was backed away from its slip.

Boats powered by horses were used until the Fulton-Livingston privilege was declared unconstitutional in February 1824.

#### HUMAN TREADMILL

U.S.N.M. no. 308352; model; made in the Museum; not illustrated.

This model (1/40 size) illustrates the use of the horizontal circular platform treadmill. Men standing on the platform gripping handle bars, and moving their feet as if walking forward, would cause the platform to move back under them. The vertical post, turning with the platform, carries a horizontal cogwheel that meshes with a rundle wheel on the windlass shaft and causes the windlass drum to turn. Two human figures are shown on the treadmill platform. The windlass is erected over a mine shaft and is employed in raising buckets of ore. The model was suggested by an illustration in Agricola's *De Re Metallica*, c. 1550.

#### HORSEPOWER LOCOMOTIVE, THE "FLYING DUTCHMAN", 1830

U.S.N.M. no. 181086; model; made in the Museum; not illustrated.

In 1829 the South Carolina Railroad Co. offered a premium of \$500 for the best locomotive operated by horsepower. This premium was awarded to C. E. Detmold, who invented one that worked by an endless-chain platform, or treadmill.

When this horsepower locomotive was completed and tested upon the road in 1830 it carried 12 passengers at the rate of 12 miles an hour. It was propelled by one horse walking on the treadmill, which was connected by gearing to the car-wheel axles.

## DOG-POWERED TREADMILL, 1878

## PLATE 3, FIGURE 2

U.S.N.M. no. 309199; original patent model; transferred from the United States Patent Office; photograph no. 19978A.

This model was submitted with the application for the patent issued to F. K. Traxler, April 23, 1878, no. 202679.

The treadmill represented consists of an endless track of wooden cleats on a flexible belt, carried over two rollers held in a rigid frame. The frame pivots about the shaft of the upper roller so that the lower end of the frame may be raised or lowered to give any desired angle of inclination to the track. A power take-off shaft is geared to the shaft of the upper track roller.

## WARREN SPRING MOTOR, 1880

U.S.N.M. no. 308835; original patent model, transferred from the United States Patent Office; not illustrated.

This model was submitted with the application for the patent issued to John Warren, of Detroit, Mich., April 20, 1880, no. 226813.

The motor represented is of the class intended to operate light machinery such as a phonograph but differs from most of the class in that it employs a spiral spring instead of the usual coil spring. It converts the rectilinear motion of the spring into rotary motion and equalizes the varying tension of the spring.

The free end of the spring carries a nut that engages in a spiral-grooved motor shaft, which revolves at the axis of the spring. A hand crank, worm, and worm wheel are used to compress the spring by turning the shaft in the reverse direction. The power is taken from a bevel gear on the shaft. A ball nut, which employs a ball to follow in the groove of the shaft, is used because an ordinary nut would not work in the groove of varying pitch. The varying pitch is used to compensate for the varying tension of the spring.

## ADDITIONAL MODELS IN THE COLLECTION, NOT DESCRIBED

Motor by foot power (treadle), Patent Office model. Patent no. 197759, December 4, 1877, issued to E. E. G. Bozerian. U.S.N.M. no. 308821.

Hand and foot motor (treadle and levers), Patent Office model, Patent no. 229739, July 6, 1880, issued to D. W. Mott. U.S.N.M. no. 309200.

Animal power (treadmill), Patent Office model, Patent no. 266844, October 31, 1882, issued to W. C. Knox. U.S.N.M. no. 309691.

## POWER FROM THE WIND

It is now generally believed that boats were propelled by sails on the Nile as early as 6000 B. C., but the first use of the wind to drive machines and to do mechanical work came much later. Wind *wheels*, such as prayer wheels upon which were inscribed prayers, deemed

efficacious when the wheels were turned by the wind, were in use in Tibet and Mongolia in very early times, and Heron of Alexandria (*Treatise on Pneumatics*, c. 150 A. D.) described a light, wind-driven organ pump. That the wind *mill* originated in the East and was introduced into Europe by the Crusaders returning from the East is now generally accepted. This theory is supported to some extent by the fact that windmills were known in Persia in the tenth century and in England and France in the twelfth century. The earliest authenticated record of a windmill in the West is of one at Haberdon in England in 1191. Records following this show that within the next 50 years windmills were erected very generally in Europe.

The details of construction of the first windmills are purely conjectural. The first records are of mills that were complete in the essential elements of a horizontal shaft carrying sails at the outer end, a downward or vertical shaft that carried the millstone at its lower end, and some crude gearing (at the upper end of the vertical shaft and the inner end of the horizontal shaft) to transmit the motion of the sail shaft to the vertical shaft. Though not shown in the earliest drawings, it is assumed that the first mills also had a means of raising or lowering the millstone to vary the grain size of the meal being ground. To these elements no improvements are known to have been added until the fifteenth century. A heavy beam pressed against the sail shaft was used as a brake in the first part of the sixteenth century, and by the end of the century the curved brake band of pliable wood applied to the rim of the driving wheel (suggested by da Vinci about 1500) was used. The improvement of setting the sail shaft at a slight angle to the horizontal was suggested about 1557 by Dardan, and the internal features of the mill were practically complete by the end of the sixteenth century.

Externally the construction of the windmill has been determined by the necessity of housing the mill material equipment and operators and at the same time permitting the mill to be faced in the direction of the wind from any quarter. Some presume that the original windmill was built upon a boat in order that it might be turned about easily to meet the wind, but the earliest windmills alluded to were on land, and it is believed that the problem of facing the mill about was solved before the first was built. The most primitive mill consisted of a light boxlike house built upon a central post, which was supported by a timber tripod base that rested upon the ground and could be turned round, base and all, to face the wind. Later, in the fourteenth century, the central post was let into the ground and fixed, and the mill turned upon the post. Following this the turret-post mill was constructed in which the boxlike structure was erected upon a masonry tower, in which larger milling facilities could be housed



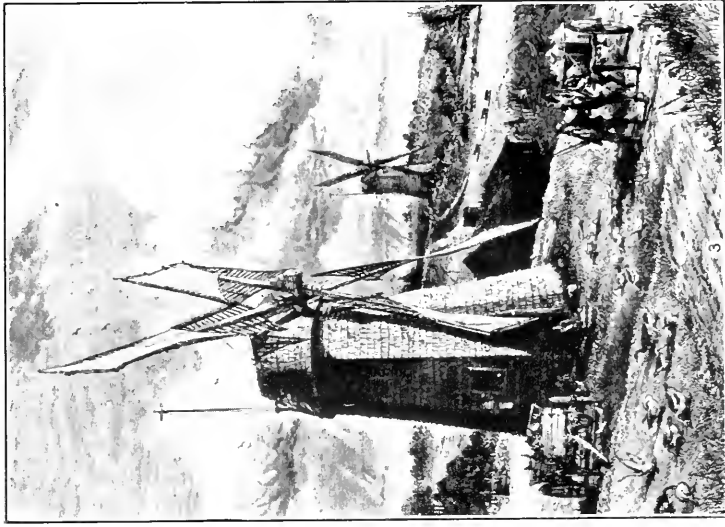

3337D

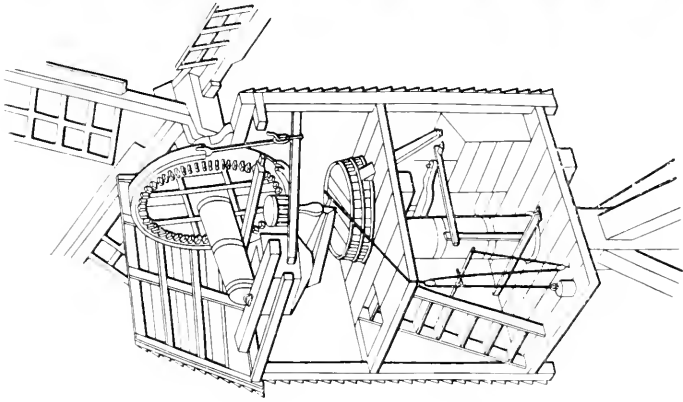

3169A

WINDMILLS.

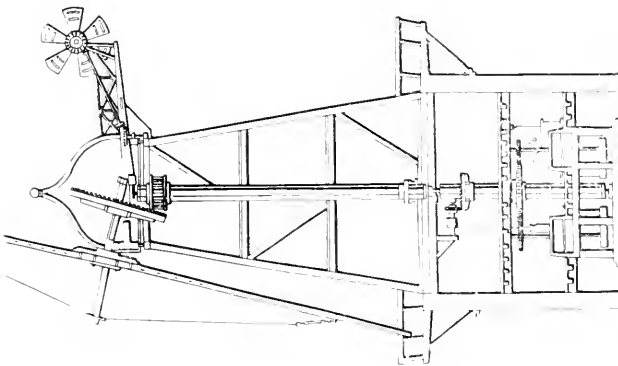

- 1. Smeck windmill, c. 1826; from Nicholson's *The Operative Mechanic*, pl. 12. See p. 8.
- 2. Post windmill, c. 1826; from Nicholson's *The Operative Mechanic*, pl. 12. See p. 8.
- 3. Crist windmills at East Hampton, L. I., c. 1874; from William Cullen Bryant's *Picturesque America*, vol. 1. See p. 10.

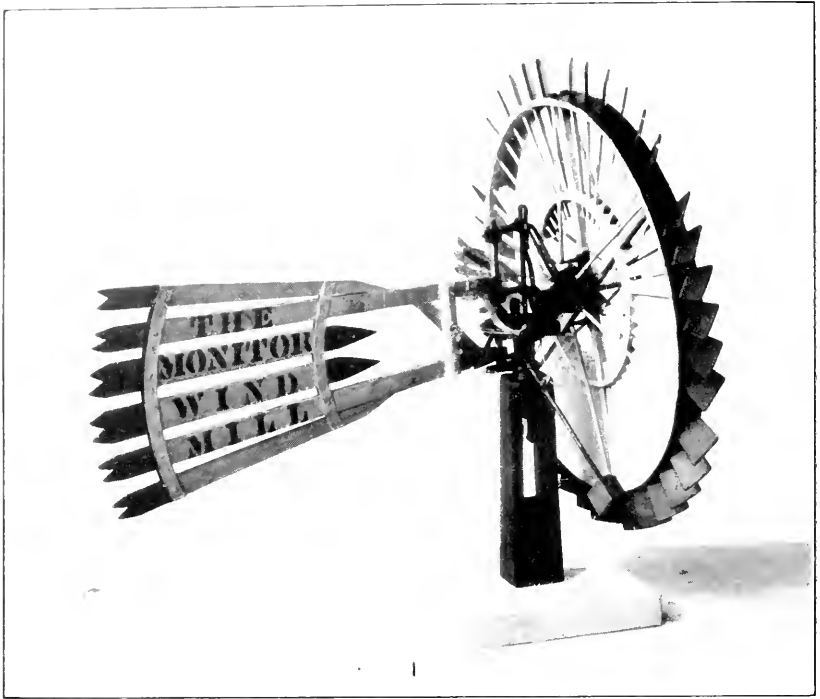

18219A

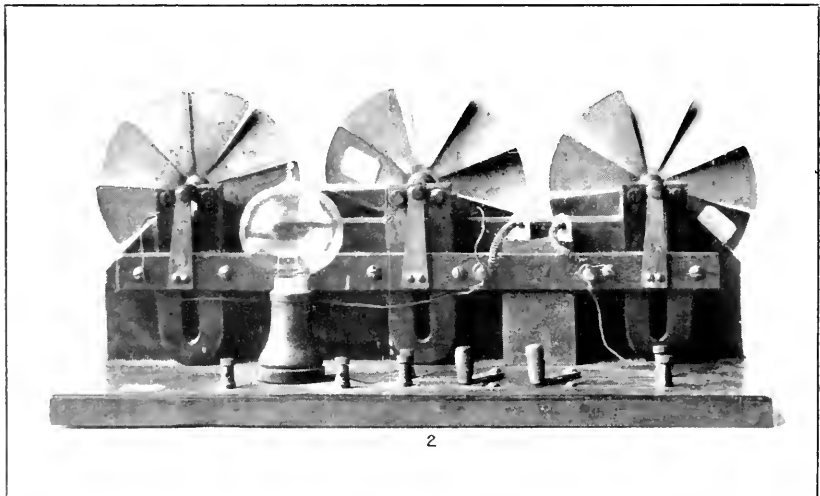

2

WINDMILLS.

18234

1. Monitor windmill, 1881 (model; U.S.N.M. no. 309687). See p. 11.
2. Moses G. Farmer wind-electric generator, 1880 (model; U.S.N.M. no. 181985). See p. 13

without adding to the bulk or weight of the portion that had to be faced about. The final development in this direction was the tower, or "smock", mill familiarly known as the Holland windmill, which was a Flemish invention of the early sixteenth century. In this the roof portion or cap carrying the sails and main shaft is the only part turned (see below).

The earliest post mills were provided with a long sweep or beam by which the miller walking on the ground and pushing upon the beam could turn the mill about. This method was employed in turning the movable parts of the turret and tower mills and was for many years the feature that limited the height to which mills could be built. In the tower mills balconies were provided around the tower so that it was not necessary to extend the beam to the ground, but the first real improvement was the "pulley-winder", consisting of a cogwheel fastened to the cap and meshed with a ring gear that ran around the upper rim of the tower. The cogwheel was turned by a pulley and endless rope that hung around the pulley and down outside the tower so that the miller pulling on the rope turned the cogwheel, causing it to travel in the gear around the tower, pulling the cap with it. The final improvement in this direction was the automatic winder, which consists of a small set of sails placed at right angles to the main sails of the mill so that when the wind was directly into the main sails the small set was edgewise to the wind and at rest, but should the direction of the wind change it would cause the small set to revolve and turn a cogwheel that acted as in the pulley winder to bring the main sails into the wind. Automatic winders came into use early in the eighteenth century.

None of the early windmills had means of governing the speed other than by turning the sails away from the wind or by applying the brake. Later the large sails were made up of swiveled slats connected to a bar as in Venetian blinds, so that the angle of the slats could be varied, opening or closing the surface of the sail to present more or less surface to the wind. They were also made up of small fabric elements wound on separate rollers so that the fabric might be rolled up to present less surface. These operated against the pull of springs that served to unroll the elements. These arrangements permitted the governing of the speed of the mill without turning the heavy cap, and before the end of the eighteenth century they were being used in connection with centrifugal ball governors to effect full automatic regulation of the mill.

*American types of windmill.*—Many windmills of the Dutch, or tower, type have been erected in the United States, some at very early dates. The stone tower at Newport, R. I. (the Viking tower of tradition), is believed to be the ruin of a "stone-built windmill" mentioned

in the will of Governor Benedict Arnold (1677) and is said to have been preceded by a wooden one, of still earlier date, blown down in 1675. Another of popular interest is the windmill erected at Orient, L. I., in 1760 by Amos Tabor for Noah Tuthill (restored 1810), which was removed to an amusement park on Glen Island about 1900. Others that were standing within the past few years were erected at Detroit, Mich., Lawrence, Kans., and East Hampton, L. I., N. Y.

The type of windmill that has come into general use in the United States, however, has little resemblance to the European tower mill. In place of the few large sails of the Dutch mill, the American mill has a small compact wind wheel made up of many small slats or blades, and instead of the stone or shingled building that supported the machinery of the mill and sometimes housed the miller and his family, the American type of mill is supported on a skeleton tower of wood or steel framework, and the machinery driven by it, if housed at all, is usually protected by a small shed at the base of the tower. The wind wheel is mounted upon a pivot at the top of the tower and is faced into the wind by a simple rudderlike vane or sometimes merely by the pressure of the wind upon the back of the wheel itself. Governing devices maintain uniform speeds of the wheels and prevent injury from runaways by automatically turning the wheels away from the wind or in others by changing the pitch of the blades in the wheels.

The earliest mills of this type had wheels with rigid wooden vanes and were without governing or safety devices. L. H. Wheeler, an Indian missionary, in Wisconsin, used solid wheel windmills to pump water and grind corn as early as 1841, and some time thereafter he perfected a means of automatically controlling their speed. His patent of 1867 (no. 68674) was the first of the solid wheel mills mounted upon a pivot and equipped with hinged tail vane and weights that operated to change the position of the wheel in relation to the direction of the wind so that a constant speed was held in spite of varying winds or load, and the mill was automatically turned edgewise to the wind in dangerous squalls and gales. This type of governing and safety device has been used with modifications in the greatest number of windmills built in the United States (Eclipse, Monitor, and others) and is employed in connection with the steel-vane mills made today.

In 1854 Daniel Halladay and John P. Burnham perfected the first form of a wind wheel in which control of the speed was obtained by varying the pitch of the vanes in the wheel (Halladay's patent, no. 11629). Burnham (who is sometimes called "the father of the American type of windmill") and Halladay manufactured and improved the windmill thereafter for many years. In 1883 at the laboratory of the Halladay Co., then located at Batavia, Ill., Thomas O. Perry

carried forward a series of experiments that led to the perfection of the solid wheel mill with curved steel blades. This type of wind wheel was not Perry's invention, but his design (the aerometer) was far in advance of all others, with an efficiency of 25 percent, about 80 percent better than any prior windmill. Perry is said to have done for the windmill what Poncelet did for the water wheel.

Recent developments in windmill design have had to do principally with the application of aerodynamic principles to the design of wind-wheel vanes. The airplane-propeller type wind wheel is used in some of the direct-connected wind-electric sets, while the Kumme system employs a wind wheel of a few very large vanes or sails similar in design and construction to an airplane wing. In these latter ones the blade is free to move about the arm that carries it, and its pitch is regulated by the wind itself. The most radical in appearance of all the modern windmills are those that employ the rotor principle or "Magnus effect" for their operation. These may have a wind wheel made up of a few arms supporting small light rotor cylinders or may consist only of one large vertical cylinder rising directly from the ground and designed to be used upon the top of some wind-swept hill.

By far the greatest number of windmills in the United States have been used for pumping water, a service to which the windmill is well suited because large quantities of water may be pumped and stored during periods of steady winds, to be drawn upon and used at any time regardless of the wind. An analogous service in which the windmill is now successfully applied is that of generating electric power, which, like water, may be stored (in batteries) during steady winds to be used when needed. Wind-electric generator sets are now used extensively in the lighting of isolated airway beacons and farms. A very early suggestion of this use of wind power is shown (below) in the model of a wind-electric system made by Moses G. Farmer as early as 1880.

#### MONITOR WINDMILL, 1881

##### PLATE 5, FIGURE 1

U.S.N.M. no. 300687; original patent model; transferred from the United States Patent Office; photograph no. 18219A.

This model was submitted with the application for the patent issued to L. H. Sparks, August 30, 1881, no. 246247.

This is one of several similar designs that constitute the bulk of the windmills in use in this country. The mill has the solid type of wind wheel (in which the slats are rigidly fixed), a rudder vane for holding the wind wheel in the direction of the wind, and a governor for maintaining a uniform speed of the mill in varying winds. The governor consists of a safety vane normal to the direction of the wind and

located just behind the wind wheel, which tends to throw the wheel out of the wind as the wind pressure increases, and a weighted lever so connected to the hinged rudder vane and the wheel bracket that it opposes the action of the safety vane. The resulting action of the governor is to turn the wheel away from the direct force of the wind as the wind velocity increases and to turn it back as the wind decreases.

#### PRAIRIE WINDMILL

U.S.N.M. no. 309688; model; made in the Museum; not illustrated.

The model represents a horizontal paddle-wheel windmill of the type used to some extent on the prairies of the United States. The model shows the windmill set up to pump water to an irrigation flume. The axle of the wind wheel is mounted on bearings supported on the top of a board fence that encloses the lower part of the paddle wheel.

Paddle-wheel windmills differ from the sail-wheel mills in that the paddles move in the direction of the wind rather than across the wind, and it is necessary to make the paddle-wheel feathering or shield part of it so as to prevent the wind from striking the paddles that are moving in the direction opposite to that of the wind. The axis of the paddle-wheel type may be either horizontal or vertical. The use of the horizontal type is limited by the fact that it operates only when the wind is in the direction nearly perpendicular to the axis of the wheel.

#### VERTICAL WINDMILL, 1879

U.S.N.M. no. 309690; original patent model; transferred from the United States Patent Office; not illustrated.

This model was submitted with the application for the patent issued to W. A. Wheeler, July 1, 1879, no. 217053.

A vertical-axis paddle-wheel windmill in which the wheel consists of an upper and a lower horizontal rim between which are many vertical, narrow, wooden-slat sails. The slats are pivoted in the rims and are connected to a centrifugal ball governor, which regulates the speed of the mill by changing the angle of the slats. A hand lever connected to the collar of the governor permits the operator to stop the wheel by turning the slats so far that they present a continuous closed cylindrical surface to the wind. Stationary guide vanes direct the wind to the sails of the wheel.

Vertical paddle-wheel windmills have a slightly wider application than the horizontal ones. They can be built to receive the wind from all directions and are comparatively easy to regulate and govern. They have been built in sizes from 4 to 24 feet in diameter and are usually placed on low buildings. Many have been used successfully for grinding wheat.

## WINDMILL, 1879

U.S.N.M. no. 309131; original patent model; transferred from the United States Patent Office; not illustrated.

This model was submitted with the application for the patent issued to J. and F. M. Cottle, October 21, 1879, no. 220751.

This mill has a double-rimmed steel wind wheel made up of small wedge-shaped vanes, which are removable to permit regulation of the power of the mill. The wind wheel cannot be swung out of its position, but the shaft is carried in sliding bearings so that the gear on the shaft can be disengaged to let the wheel run free. It is equipped with a selective gear transmission. The model shows the mill attached to the bucket chain of a well.

## WINDMILL, 1880

U.S.N.M. no. 309201; original patent model; transferred from the United States Patent Office; not illustrated.

This model was submitted with the application for the patent issued to H. H. Bevil, April 6, 1880, no. 226625.

This specimen illustrates all the parts of the present-day "American" type of windmill. It has the multivaned wind wheel, the pivot, the brake, the rudder vane, the governor, the pull-out, and the pump pole.

## FARMER WIND-ELECTRIC GENERATOR, 1880

## PLATE 5, FIGURE 2

U.S.N.M. no. 181985; original model; gift of Sarah J. Farmer; photograph no. 18234.

Three solid wind wheels drive the armatures of three dynamos, which are in circuit with a small storage battery, an incandescent electric lamp, and switches. This model, constructed by Moses G. Farmer, electrical pioneer, about 1880, is probably the earliest suggestion of the use of wind power through the medium of the electric generator and storage battery.

Much of the objection to the use of the windmill as a source of power is due to the intermittent nature of its operation. It was thought that it was suited only for pumping water or similar operations where the energy or work produced by the windmill could be stored during periods of useful wind velocities to be used as needed. Now considerable work has been done on the use of the wind-driven electric generator to charge storage batteries from which electrical energy can be drawn as needed. At present the use of the windmill as the prime mover for small domestic or farm electric sets offers interesting possibilities.

## ADDITIONAL WINDMILLS IN THE COLLECTION, NOT DESCRIBED

Windmill, Patent Office model, Patent no. 208208, issued to Elijah H. Smith, September 17, 1878. U.S.N.M. no. 309137.

Windmill, Patent Office model, Patent no. 209583, issued to Jesse Benson, November 12, 1878. U.S.N.M. no. 309133.

Wind engine, Patent Office model, Patent no. 209862, issued to John Cook, November 12, 1878. U.S.N.M. no. 309135.

Windmill, Patent Office model, Patent no. 222340, issued to H. M. Wood, December 2, 1879. U.S.N.M. no. 309136.

## WATER POWER

*Water wheels.*—Flowing and falling water was utilized to drive simple machines many centuries ago. The *novia*, a wheel turned by the current of a stream and employed to raise water from the stream by means of jars attached to the rim of the wheel, was the earliest water-powered machine and probably the first machine to be driven by any power other than the muscular power of men and beasts. The first water wheel in history is one discussed by Philo of Byzantium, a Greek writer of the second or third century B. C. He apparently described a then existing water wheel driving a chain of buckets for raising water. The first mention of a particular water wheel was given by Strabo (63 B. C.—21 A. D.) of a water mill set up in Asia Minor in 88 B. C. for Mithridates VI, king of Pontus. This is also the first mention of a water *mill*. It is assumed that this first mill was of the simplest type, consisting of a vertical shaft of wood with a horizontal wheel formed of a series of warped wooden blades at its lower end with a horizontal rotary millstone attached to the upper end. Falling water was directed onto the blades of the wheel in a direction parallel to the vertical shaft. This type of mill has been definitely identified in the fifth century and was in general use throughout Europe in the Middle Ages. It has become known as the Greek or Norse mill in distinction from the Roman mill, which was first suggested by Vitruvius (first century B. C.) about 16 B. C. In the Roman mill the vertical shaft of the millstone was connected by gearing to the horizontal shaft of a vertical current wheel, essentially as in the mills with undershot wheels of recent date. There is no evidence of the use of this type of mill before the fourth century, and it was not in general use much before the twelfth century. As indicated before, the first vertical water wheel was the current wheel, a large wooden wheel with boardlike vanes or paddles attached radially to the wheel with the surface of each paddle in a plane through the axle of the wheel. The wheel was so mounted that the paddles dipped into the stream and presented their broad surfaces to the flow of the current, which forced the wheel around. The unconfined current headed up against the paddles and escaped past



the edges, with the result that only a small portion of the energy of the stream was used. The improvement of confining the channel of the stream so that all the flow was caused to pass within the vanes of the wheel was probably first made about the fourth century. After this, little change was made in the form of the undershot wheel until 1824, when M. Poncelet of France introduced the wheel now known by his name. The Poncelet wheel had backwardly curved vanes designed to receive the water without shock or disturbance and to discharge it promptly with little final velocity or residual energy in the water. The best of these wheels had an efficiency of about 75 percent, as compared to the 30 percent efficiency of the simple undershot wheel.

When the overshot wheel, which takes the water at the top rather than at the bottom and can utilize the weight of the water as well as the energy of the current, was first used is not known. It is possible that the Romans who brought water to their mills through aqueducts may have used the overshot wheel, but it has not been identified before the fourteenth century, and the undershot wheel continued in most general use to the sixteenth century. The overshot wheel has since been the most widely used water wheel. Its efficiency, when well constructed and properly used, is equal to that of the best turbine, and it has the added advantage that it maintains its efficiency when the water supply is less than the normal designed rate. It is capable of an efficiency of about 90 percent.

Between the undershot and overshot wheel in principle and efficiency is the breast wheel, which turns inward to the fall and onto the periphery of which water is laid at any height up to the height of the axle of the wheel. The breast wheel uses the current of the stream as in the undershot wheel and the weight of the water to a lesser extent than the overshot wheel. It is able to employ the weight of the water where the vertical fall is less than the diameter of the wheel, as is necessary for the overshot wheel.

*Turbines.*—The hydraulic turbine differs from water wheels in that guide vanes or nozzles direct the water into the rotating wheel, the vanes of which change the magnitude and direction of the velocity of the water, the force exerted to turn the rotor being equal to the force required to change the velocity of the water. Most turbines are now built with horizontal rotors upon vertical shafts, and because of this the early Greek or Norse mills (mentioned above) are often called the first hydraulic turbines. This early form of water wheel, however, was generally abandoned with the perfection of the water wheel, and the development of the turbine is directly traced to the simple reaction turbine proposed by Dr. Barker about 1743. This consisted essentially of a wide vertical tube closed at the bottom and free to turn on a bearing at its base with two straight horizontal tubes closed

at the ends (but provided with orifices) extending from the vertical tube. When the vertical tube was filled with water, the water escaped through orifices in the arms in tangential jets, which by their reaction caused the tube to rotate. This simple turbine had a maximum efficiency of about 66 percent. Its principal defect was the requirement of a vertical tube of a height equal to the head of water, containing a mass of water that was rotated as so much useless weight. This design was improved by curving the horizontal arms, and many such turbines, known as Scotch mills, were put in use. The number of arms was gradually increased until the turbine took the form of a complete wheel. In 1826-27 Benoit Fourneyron constructed a turbine in which stationary guide vanes at the center of the wheel directed water into vanes in the rim of the wheel. This was the first radial outward-flow turbine. The next turbine (1841) was that of Nicolas Jonval. This was an axial-flow turbine in which the water moved parallel to the shaft. It consisted of a horizontal wheel with vanes set radially in the rim. A ring of stationary guide vanes above the rotor directed the water against the moving vanes. In 1826 Poncelet proposed an inward-flow turbine the opposite of the Fourneyron.

*American developments in water wheels.*—Water mills were among the first permanent structures built by the early settlers in the American colonies. As early as 1646 Massachusetts granted a patent to Joseph Jenks, an iron worker, "for making the engines for mills to go by water," an indication that water mills were in use some time before this. By 1700 every settlement had its mills employed in a great variety of work, grinding grain, rags, plaster, malt, chocolate, and tobacco; breaking leather; fulling cloth; boring gun barrels; slitting iron; and sawing wood. Many relics of these old mills remain in every part of the original colonies, some in a state of more or less complete preservation.

Though the mills on the Delaware and the Chesapeake prior to the Revolution were considered the equal of any in the world, their excellence was due to the flexibility and completeness of their gearing rather than to the efficiency of their water wheels. Practically all the American mills used the *undershot* wheels, which were capable of converting only a small fraction of the power of the streams. After the Revolution the great water powers of the New England and Middle Atlantic States were extensively developed, and very complete systems of dams, reservoirs, and canals were constructed to permit the recovery of every possible bit of energy from the streams. In most of these mills the wooden pitchback wheel, which turned inward to the fall, was used. The water struck just short of its highest point, the power being produced by the weight of the water, which was retained in the buckets until it reached the bottom by a

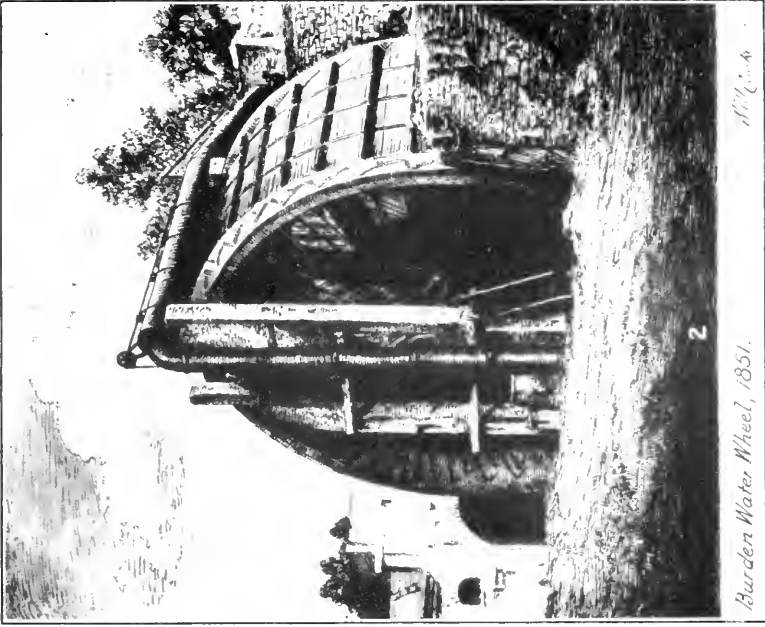

*Burden Water Wheel, 1851.*

*M. C. A.*

32651

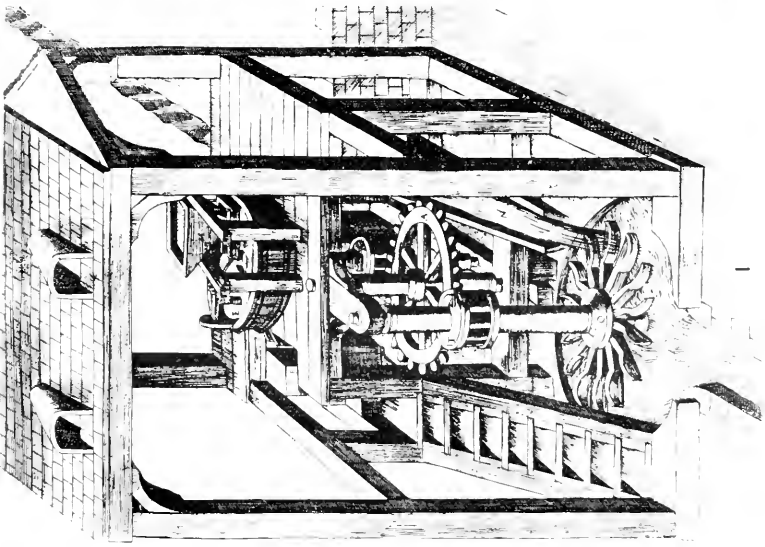

31609

WATER WHEELS.

- 1. Vertical water mill, c. 1588; from Ramelli's *Le Diverse et Artificiose Machine*, pl. cxv.
- 2. Burden from Co.'s water wheel, Troy, N. Y., 1851. Diameter, 60 feet; width, 23 feet; horsepower, 500.

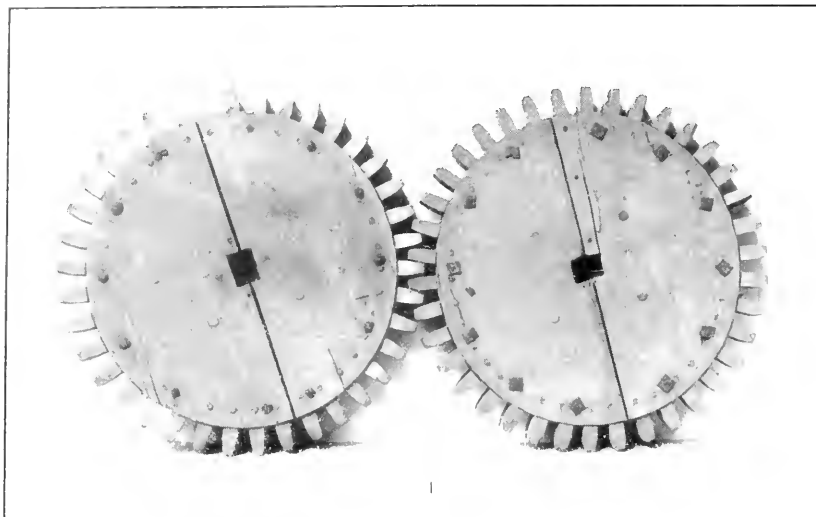

31705A

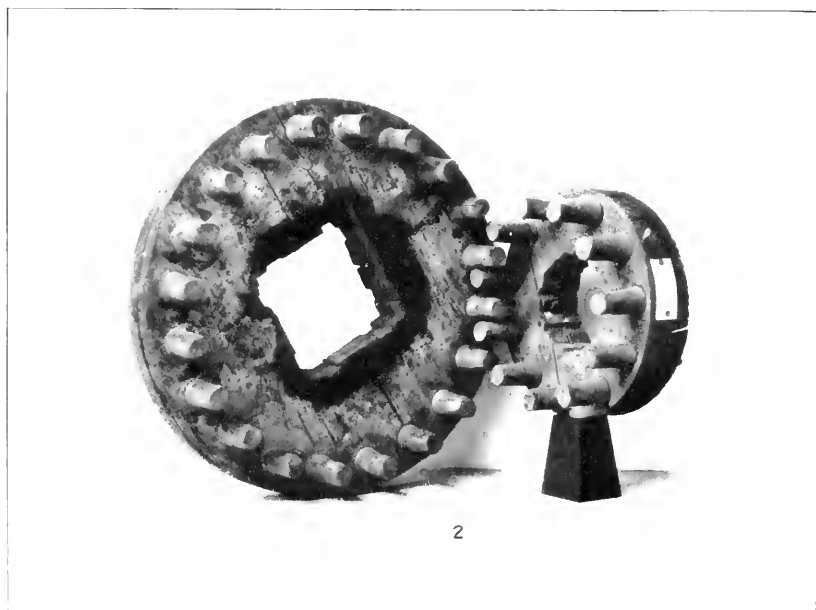

2

31705B

WOODEN WATER-MILL GEARING C. 1870

1. Spur gears (U.S.N.M. no. 310538). See p. 20.
2. Pinwheels (U.S.N.M. no. 310539). See p. 20.

stationary apron fitting as closely as practicable to the circumference. The best of these wheels was about 75 percent efficient. One installation, that of the Merrimac Co., consisted of eight wheels, each 30 feet in diameter and 12 feet wide. Until 1840 this type of wheel was practically the only one used and may be said to have reached the period of its greatest application then. Subsequent to 1840 the hydraulic turbine began to replace the water wheel in the American mills.

*Hydraulic turbines in the United States.*—Accounts tell of the use of a hydraulic turbine in Massachusetts as early as 1790, though with no practical or permanent success. The continuous development of the turbine in the United States begins about 1843, when the work of Fourneyron in France was made known to engineers by a series of tests of turbines of the Fourneyron type conducted by Ellwood Morris, engineer, at Philadelphia. His results indicated that a maximum efficiency of 75 percent, equal to that of the best water wheels in use, was possible with the turbine. The natural advantages of the turbine over the water wheel then caused mill owners to consider its use. In the same year George Kilburn, of New Hampshire, built and installed the first turbine to be used practically in New England at the print works of Robeson & Sons, Fall River, Mass. In 1844 Uriah Boyden designed a turbine of 75 horsepower for the Appleton Co. at Lowell, and two years later three more of 190 horsepower each for the same company. "These wheels were of the Fourneyron type with certain improvements effected by Boyden, including diffusers (Patent no. 5090) and other peculiar devices." An efficiency of 88 percent was claimed for the early Boyden-Fourneyron turbines, which led to the installation of turbines in every new mill in New England and in the old mills as rapidly as the water wheels wore out. In the meantime a purely American development in turbines was taking place in the perfection of the inward-flow and mixed-flow turbines. Jonval of France suggested the inward-flow turbine in 1829, but the first of the type was built by Samuel B. Howd, of Geneva, N. Y., who obtained a patent in 1838 (Patent no. 861). The runner of the Howd turbine was made of a ring of shallow curved buckets around the periphery of a light wheel. The sides of the buckets were vertical, and the water flowing through the buckets radially toward the center was confined to a horizontal path until it left the inner rim of the wheel, when it began to fall, running off parallel to the vertical shaft. The water was directed into the runner by straight stationary guide vanes. The Howd turbine was simple and cheap, and many were installed in small mills where they gave the advantages of the turbine at small initial cost. About 1849 James B. Francis designed an inward-flow turbine under the Howd patent in which the vanes were shaped to deflect the water downward before it left the vanes

so that the path of the water in the buckets was a combination of radial and axial flow. Francis conducted accurate tests of his turbine, analyzed and published the results, and formulated rules for turbine runner design, with the result that his name is now used to identify the whole class of inward-flow, mixed-flow turbines of which his was the first. The first installation of the Francis turbine was of two at the Booth Cotton Mills at Lowell. The rapid and general adoption of the Francis turbine led to a great many similar designs. A. M. Swain (Patent no. 28314, 1860) designed the turbine known by his name in 1859. About 1860 James Leffel made the greatest departure from the Francis type with his double-runner turbine (see below). In this the upper half of the runner is designed for radial flow and the lower half for radial admission and axial discharge. The subsequent development of large inward-flow reaction turbines has been made possible by the inventions among others of the conical draft tube, the spiral casing, the spreading draft tube (L. F. Moody), the hydracone (W. M. White), movable guide vanes, the Kingsbury thrust bearing, and the use of rubber seal rings (for high heads). The 54,000 horsepower I. P. Morris turbine of the Conowingo (Md.) Station of the Philadelphia Electric Co., 89-foot head (see below), and the San Francisco No. 2 plant of the City of Los Angeles, 20,500 horsepower at 515-foot head are indications of the advance. The Oak Grove plant of the Portland Railway Light & Power Co., 35,000 horsepower at 850-foot head holds the record (1930) for high head application of a turbine of the Francis type.

*Impulse turbines and tangential water wheels.*—Parallel with the improvement of the reaction or pressure turbine was the development of the impulse or velocity turbine, also called the tangential water wheel. An impulse turbine is one driven entirely by the force of the weight of the water acting through its velocity. The wheel buckets are open to the atmosphere, and the discharge is unrestricted so that none of the energy of the flow of water is utilized as pressure energy. The first current wheel was an impulse turbine of the simplest form. The Poncelet water wheel, with the stream confined and directed fully upon curved buckets and with the discharge above the tail water, was the beginning of the modern development. In the present-day wheels of the most common type the flow of water is wholly confined and is directed upon the wheel from one or two adjustable nozzles. The buckets are highly developed combinations of curved surfaces.

The first departure from the undershot wheel, in impulse turbines, was that of Jearum Atkins, of Vermont and Illinois, well-known inventor of agricultural machinery. Atkins' turbine consisted of a horizontal rotor having buckets curved as semicircles in the radial

direction, straight sided in the axial direction, and open to the atmosphere above and below. The water entered the wheel from a scroll casing surrounding it. Flat guide vanes within the casing directed the water into the buckets in smooth continuous streams at several points around the periphery. The speed of the rotor was such that the water reached the inner edge of the bucket with little velocity in the radial direction, and discharged by falling through the lower side of the bucket space. Atkins applied for a patent in 1853, about the time that Girard in England was perfecting his turbine of similar design. This type of turbine has been popular abroad, but it has never been widely used in the United States, where the impulse turbine most generally used is the tangential water wheel.

The simplest form of the tangential water wheel was the "hurdy-gurdy," a large wooden wheel carrying buckets of angular boxlike construction into which water was directed from one or two fixed nozzles located near the bottom of the wheel. These wheels were widely used in the mountain settlements of the Pacific coast where high-head water powers were developed for mining operations. The wheels were developed there experimentally, and various stories are told of this development. The first wheels are said to have been wagon wheels with flat floats or box buckets bolted to the rims of the wheels. The wagon wheels gave way to wooden centers, wide-rimmed wooden wheels, and, later, iron wheels. The buckets then were made as curved bowls with cut-out lips to aid discharge (Knight, 1870), and the split bucket is said to have been the result of an accident in which a wheel slipped sideways on its shaft so that the jet struck the edge of the bowl instead of the center, with the result that the speed of the wheel increased. J. Moore, 1874, and L. A. Pelton, about 1877, designed split buckets, and Pelton after some success in selling and installing wheels of his design, including the installation of the first impulse turbine-electric generating unit at Aspen, Colo., in 1885, sold his business to the founders of the Pelton Water Wheel Co. in 1887. Experiments conducted by Ralph T. Brown and Professor Hesse at the University of California resulted in the design from theoretical analysis of a bucket similar to Pelton's, and the report of these experiments, published in 1883, was the first literature on the subject of the design of impulse water wheels. The buckets subsequently developed in form through the work of Hesse, Abner Doble (1889), Dodd (1889), and Hug (1897). The present type has ellipsoidal back and face surfaces, central spitter edge, and notched lip, substantially as developed by Doble by 1899 (see below) and has the chain type of attaching-lug developed about 1907 by the Pelton Water Wheel Co. The method of controlling the jets, at first merely by gate valves, was developed through butterfly valves, tongue nozzles in which one side of rectangular nozzles was hinged like a tongue,

needle nozzles that varied the size of the jets (1899–1903), deflecting nozzles (1899), and, finally (1903), the stream deflectors, which deflect the jets independently of the nozzles. Later developments have been in methods of securing automatic control of the wheels and in improving designs to facilitate replacements and repairs.

### WATER-MILL GEARING

#### PLATE 7

U.S.N.M. nos. 310538 and 310539; originals; gift of Charles H. Estes, photograph nos. 31705A and B.

Two pairs of wooden spur gears and cogwheels from the Estes Mill at Sperryville, Va. Estimated to have been made about 1870; collected in 1932.

The spur gears (U.S.N.M. no. 310538, photograph no. 31705A) are each 24-inch, 38-tooth gears, made up of two solid oak disks held together with iron rods riveted over hand-cut square washers. The teeth are of black locust held between the disks and secured with wooden pegs. (Pl. 7, fig. 1.)

The cogwheels (U.S.N.M. no. 310539, photograph no. 31705B) are a pair of one 18-inch, 20-tooth wheel and one 10-inch, 11-tooth wheel. The disks are red oak, held together with black-locust dowels spread with yellow-pine wedges. The teeth are dogwood, secured by black-locust pegs, which bear on hickory plugs. (Pl. 7, fig. 2.)

### DOMESTIC WATER MOTOR, 1878

U.S.N.M. no. 309203; original patent model; transferred from the United States Patent Office; not illustrated.

This model was submitted with the application for the patent issued to John Haworth, of Philadelphia, Pa., April 30, 1878, no. 203035.

The model represents a water motor having a vertical cylindrical water chute, within the lower end of which a small parallel-flow reaction turbine wheel is located. The wheel is carried on a shaft that passes through the water chute and a stuffing box at its opposite end to carry a worm gear from which the power of the motor is supplied. The motor is designed to operate a sewing machine, and the drive shaft carries a 2-bladed propeller fan for fanning the machine operator.

Motors of this type operating from the faucet pressure of city water systems were in use up to a few years ago to drive sewing machines, fans, and washing machines. Their use was discontinued with the development of the small electric motor, cheap electric current, and the practice of installing individual meters in municipal water systems.



## WATER MOTOR, 1879

U.S.N.M. no. 309204; original patent model; transferred from the United States Patent Office; not illustrated.

This model was submitted with the application for the patent issued to W. F. Eyster, of Chambersburg, Pa., November 4, 1879, no. 221225.

The model represents a vertical cylindrical water tube having a vertical slot in one side through which the rim of a vertical water wheel extends into the tube. The water wheel is supported and inclosed in a flat circular chamber, which bolts to the side of the water tube. A nozzle within the tube at the top directs the water downward against the buckets of the wheel at about the height of the center of the wheel. A plug cock at the top of the tube controls the flow of water, and a funnel-shaped flange below the cock drains any leakage into the water tube. One feature of the motor is that the part of the water tube that carries the water wheel is free to revolve about its vertical axis, so that the bulky part of the motor can be put in the position most convenient to the machine operator.

## BROOKS WATER WHEEL, 1880

U.S.N.M. no. 3096S9; original patent model; transferred from the United States Patent Office; not illustrated.

This model was submitted with the application for the patent issued to Edgar B. Brooks, of La Porte, Ind., February 10, 1880; no. 224270.

This is a nicely made brass model of an inward-flow reaction turbine having the register type of adjustable feed chutes or guide vanes and a cylinder water gate. The combination relieves the guide vanes of the function of cutting off the water when the wheel is to be stopped and makes it unnecessary that the guide vanes close perfectly, so that any looseness developed in them by wear is immaterial.

## LEUCHSENRING ROTARY WATER ENGINE, 1880

U.S.N.M. no. 308709; original patent model; transferred from the United States Patent Office; not illustrated.

This model was submitted with the application for the patent issued to Robert Leuchsenring, of New Bedford, Mass., March 9, 1880, no. 225226.

This is a form of engine in which a drum-shaped rotor turns in a casing, which is eccentric to the center of the drum, so that the drum runs against one part of the casing and a crescent-shaped annular space is formed between the casing and the drum. Water is admitted tangentially to the drum to one side of and away from the point at which the drum and casing meet. The water impinges upon abutments on the drum, turns the drum, and discharges from the engine

about two-thirds of the way around the casing. The abutments on the drum slide into the drum to pass the casing and are held against the casing by springs.

#### LEFFEL HYDRAULIC TURBINE, c. 1883

U.S.N.M. no. 180193; model; gift of James Leffel & Co., not illustrated.

The model represents a mixed-flow turbine, the rotor of which is in two sections. The upper section is so constructed that it is in effect a simple inward-flow turbine from which the water discharges radially to the center. The lower section is a mixed-flow rotor from which the water discharges downward parallel to the axis of the rotor. Both sections are cast together to form one rotor, and both parts receive water from the same guide vanes, which are of the adjustable register type.

#### DOBLE WATER WHEEL, 1899

U.S.N.M. no. 309207; original patent model; transferred from the United States Patent Office; not illustrated.

This model was submitted with the application for the patent issued to William A. Doble, of San Francisco, Calif., February 7, 1899, no. 619149.

The model represents a small sector of the rotor of a water wheel to which are attached three buckets, which illustrate, generally, the characteristics of the modern tangential water-wheel bucket, i. e., the notched lip, the splitter wedge, the curved face and back, and the method of attaching the buckets to the rotor. (See also U.S.N.M. no. 310390.)

The feature of this particular bucket is the form of the curved faces, which are designed to disturb the jets of water as little as possible in any way except in the plane of the wheel's rotation. The curves are developed upon the theory that the water moving at high velocity has a tendency to remain in one plane, called "kinetic stability", so that the resultant angles of reaction caused by the reversing curves of the bucket faces are not a normal result of these curves but are divergent therefrom.

#### PELTON WATER-WHEEL BUCKETS, 1901-1912

##### PLATE 8

U.S.N.M. nos. 310386-310390; originals; gift of the Pelton Water Wheel Co.; photograph no. 4814 (group).

U.S.N.M. no. 310386 is a rectangular bucket divided by a central splitter edge into two hollow semicylindrical compartments. The bucket is designed to receive and divide the jet upon the splitter edge and direct the water to either side, discharging at the sides. No provision is made for the flow of water in a radial direction along the

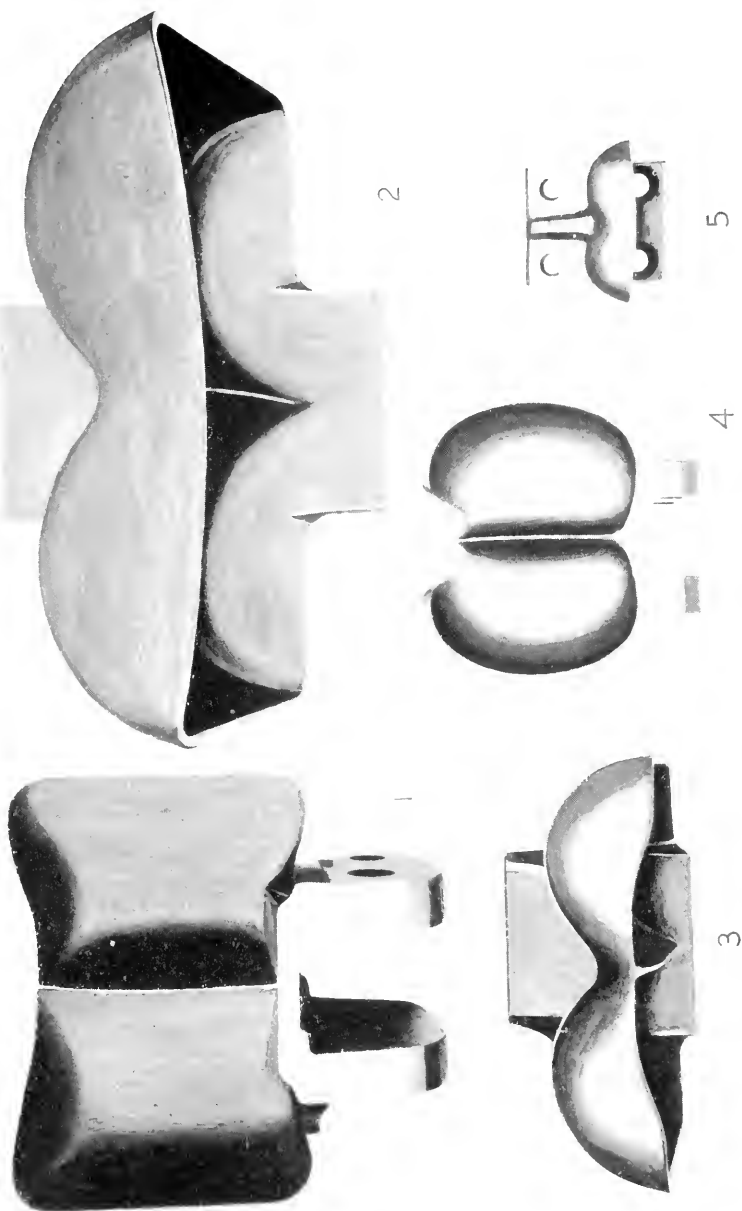

PFLTON WATER-WHEEL BUCKETS, 1901-1912.

U.S.N.M. nos. 310386-310390. See p. 22.

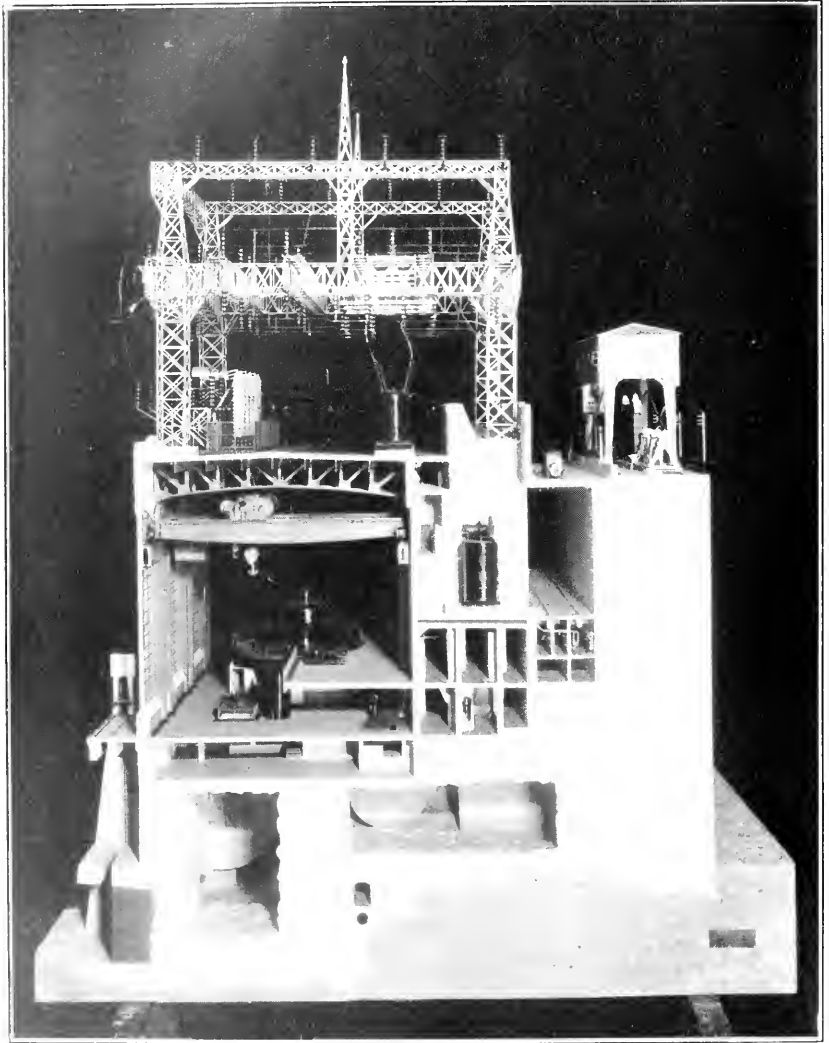

CONOWINGO HYDROELECTRIC GENERATING STATION, 1928.

Model (U.S.N.M. no. 310254). See p. 23.

31017D

bucket, and the outer end of the bucket makes sharp angles with the sides and bottom. The extreme lip of the bucket is very slightly depressed, suggesting the notched lip developed later. The back of the bucket is provided with lugs, which slip over the rim of the wheel center to which it is attached by bolts passing through the lugs and rim parallel to the shaft. The bucket is made of cast iron, measures about  $11\frac{1}{2}$  inches wide, and weighs 30 pounds. This bucket was made about 1901. (Pl. 8, fig. 1.)

U.S.N.M. no. 310387 is a rectangular bucket similar in most respects to the above. The lip is curved out rather than in, and the back is a flat flange through which the bolts that hold the bucket to the wheel pass in the radial direction. The outside end of the bucket, which is flat, slopes down toward the back so that the back or bottom of the bucket is shorter than the face. This is a large bucket, 17 inches wide, and weighs about 50 pounds. It was made about 1903. (Pl. 8, fig. 2.)

U.S.N.M. no. 310388 is practically the same as the first (no. 310386), though it is slightly smaller and very much lighter. It has a flange back, is  $10\frac{1}{2}$  inches wide, and weighs about 16 pounds. This bucket was made about 1905. (Pl. 8, fig. 3.)

U.S.N.M. no. 310389 is a very small rectangular bucket similar to the above. It has a flange back, is about 4 inches wide, and weighs 2 pounds. This bucket was made about 1911. (Pl. 8, fig. 5.)

U.S.N.M. no. 310390 is a bronze bucket of a recent type. It has the notched lip and ellipsoidal faces of the modern buckets. The bucket bowls are ground but not polished. Cast in the metal is "W. A. Doble—Pat. Sept. 19, 1899." The bucket is  $7\frac{1}{2}$  inches wide, weighs about  $9\frac{1}{2}$  pounds, and has the lug type of back. It was made about 1912. (Pl. 8, fig. 4.)

## CONOWINGO HYDROELECTRIC GENERATING STATION, 1928

### PLATE 9

U.S.N.M. no. 310254; model; gift of the Philadelphia Electric Co.; photograph no. 31017D.

This model represents a section of the hydroelectric generating station on the Susquehanna River at Conowingo, Md., a unit of the Philadelphia Electric Co. System. The model is a cross section through the dam and power-house and shows practically every feature of the installation, including the water intakes, butterfly valve, scroll case, water wheel, draft tube and generator of one generating unit, the control room, electrical equipment sections, pipe room, transformers, oil circuit breakers, and the outdoor switching structure on the roof of the power-house.

The turbine shown in the model is one of the seven of the present installation. The wheel of the original is 17 feet 9 inches in diameter, weighs about 240,000 pounds, and develops 54,000 horsepower. It turns 81 revolutions per minute and requires 6,000 cubic feet of water a second at full operation. The model shows the scroll case that conducts the water to the runner and the butterfly valve at the entrance to the scroll. This valve is actually 27 feet in diameter and was the largest ever built. The valve is sealed after closing by admitting water pressure to a rubber tube 3 inches in diameter set in the inside face of the valve housing. The valves are used also as head gates. The draft tube is the Moody type, with a concrete cone extending from the bottom to the hub of the runner. A water-wheel governor of the actuator type of oil-pressure, relay governor, having flyballs mechanically driven from the main shaft of the water wheel, is shown. A curtain wall protects the water entrances from ice, and trash racks are located in each intake opening. Gantry cranes for handling the trash racks and emergency sectional head gates are shown in the model.

The Conowingo station is (1934) the second largest hydroelectric generating plant in the United States, being surpassed only by installations at Niagara Falls. It has a present capacity of 378,000 horsepower, with an ultimate development of 11 54,000-horsepower units, or 594,000 horsepower. The dam provides a head of 89 feet and is seven-eighths of a mile in length. The station was first operated in March 1928.

#### ADDITIONAL WATER MOTORS IN THE COLLECTION, NOT DESCRIBED

Rotary engine (water-wheel), Patent Office model, Patent no. 51389, December 5, 1865, issued to G. A. Lamb. U.S.N.M. no. 309202.

Water motor, Patent Office model, Patent no. 185946, January 2, 1887, issued to Kelsey L. Mills. U.S.N.M. no. 309205.

Water motor, Patent Office model, Patent no. 236554, January 11, 1881, issued to H. M. Colton. U.S.N.M. no. 309206.

#### THE STEAM ENGINE

The early history of the steam engine has been written so often that little more than the briefest outline is necessary here.

In a review of the technical knowledge of his time, Heron of Alexandria (about 150 A. D.) suggested some elementary mechanical devices to use the pressure of steam and described the earliest form of steam engine, a simple reaction turbine, or "aeolipile." No practical use of these devices was ever made, and steam itself remained a mysterious gas until comparatively recent times. The work of Cardan (1501-1576), and Porta (1543-1615), and de Caus (1576-

1630), Italian physicists and mathematicians, established some of the "capabilities" of steam, namely, that steam is evaporated water; that it returns to water when cooled; and that a vacuum is formed by condensing steam in a closed vessel. De Caus built a fountain from which water was forced by the pressure of steam. This knowledge plus that derived from the work of Galileo (1564-1642) and Torricelli (1608-1647) in Italy; Pascal (1623-1662) in France; and von Guericke (1602-1686) in Germany, whereby the true nature of the vacuum was demonstrated, formed the background for the modern development of the steam engine. Edward Somerset (1601-1667), second Marquis of Worcester, is thought to have built at Vauxhill, England, about 1663-1669, the first useful and practical steam engine. This engine consisted of a high-pressure boiler into which water was forced by atmospheric pressure, after the contained steam had condensed, and from which the water was then discharged by steam pressure, raising the water, in all, about 40 feet. This method was extensively applied by Thomas Savery (1650-1715), who patented a similar apparatus in 1698 and built several such steam engines to pump water from mines.

In the meantime Huygens (1629-1695) had, about 1680, attempted an atmospheric (explosive) engine, and Papin (1647-1712) in 1690 demonstrated the suitability of using steam to produce a vacuum in a piston engine. It remained for Thomas Newcomen (1663-1729), however, to perfect about 1712 an atmospheric steam engine in which a vacuum could be formed repeatedly and regularly in a cylinder beneath a reciprocating piston. Newcomen later (1713 or 1718) provided a valve gear to make the engine completely automatic in its operation. This engine supplied, for the first time in history, large units of cheap and reliable power, and is the form from which the growth of the modern steam engine is continuously traced. The importance of the Newcomen engine cannot be overestimated.

James Watt (1736-1819) became interested in the steam engine when he was employed, about 1763, to repair a working model of a Newcomen engine. His great work consisted in devising all the numerous changes in the Newcomen engine that were necessary to convert it, in principle at least, to the steam engine of the present day. Watt invented the separate condenser, the condenser air pump, the steam-jacketed cylinder, mechanisms for converting reciprocating motion to rotary motion, and the double-acting cylinder. He was the first to use "high" pressure steam and steam expansively. The results of Watt's work are best shown by a comparison of the efficiency of a Newcomen engine of 1767 (three years after Watt began his work) with that of a Watt engine of 1800. The Newcomen engine produced 4.3 million foot-pounds of work (water pumped) for every 112

pounds of coal burned, while the Watt engine, with separate condenser and operating expanding, performed 66.0 million foot-pounds of work from the same weight of fuel.

This much of the story of the steam engine is illustrated in the Museum by a series of models, with relevant photographs and drawings, under the caption:

### THE STORY OF THE STEAM ENGINE

150 A. D. TO 1777

#### HERON'S TURBINE, c. 150 A. D.

##### PLATE 10, FIGURE 1

U.S.N.M. no. 308462; model; made in the Museum; photograph no. 17133.

This model is a pictorial adaptation of the aeolipile described (in *Pneumatica*) by Heron of Alexandria who lived in the first century.

The model consists of a light hollow ball supported on its axis between two trunnions, one of which is hollow. The ball carries four bent nozzles in a plane perpendicular to the line of its axis. Steam, generated in a boiler below, is carried to the ball through the hollow trunnion and escapes through the nozzles. The reaction on the nozzles, due to the steam issuing from them, turns the ball.

Heron of Alexandria (Egypt), a Greek philosopher, who lived some time between 50 B. C. and 150 A. D., left a number of treatises (*Pneumatica*, *Automatopoïika*, *Belopoïika*, *Cheiroballistra*, *Metрика*, *Dioptria*, and *Katoptrica*) in which are collected most of the knowledge of his time in the fields of theoretical and applied mechanics.

#### BRANCA TURBINE, c. 1629

U.S.N.M. no. 308464; model; made in the Museum; not illustrated.

Giovanni Branca, a chemist of Loretto, Italy, suggested a steam engine in which a jet of steam issuing from a nozzle was directed against the blades of a paddle wheel. This is the earliest suggestion of an impulse turbine.

The model shows such a wheel connected to the pestles of a chemist's stamp mill. The nozzle is attached directly to a spherical copper boiler.

Reference, *Le Machine*, Rome, 1668.

#### DEMONSTRATION OF THE "WEIGHT OF THE ATMOSPHERE", 1654

U.S.N.M. no. 305645; model; made in the Museum; not illustrated.

This is a simplified pictorial model of Otto von Guericke's spectacular demonstration before the burghers of Magdeburg, in which he showed the great force required to separate two large hollow hemi-



spheres that were held together only by the pressure of the atmosphere upon them when they had been put lightly together and the air pumped from between them. The model shows two teams of eight horses, each straining against the other to pull the hemispherical cups apart.

The model is exhibited in this series to indicate that the development of the atmospheric steam engines following this date depended upon the knowledge that the atmosphere exerts a fluid pressure upon every surface within it.

Reference, Gaspare Schotts: *Experimenta Nova*, 1672.

#### PAPIN PISTON ENGINE, c. 1690

U.S.N.M. no. 308466; model; made in the Museum; not illustrated.

Denis Papin, a French physician, was the first to demonstrate the suitability of using steam to produce a vacuum in a cylinder under a piston in a manner that the pressure of the atmosphere would force down the piston and thus do work that could be applied usefully. The elements of the later successful atmospheric steam engines were present in the Papin engine, but he never solved the problem of regularly repeating the cycle of the engine.

The model shows a machine (rather than an engine) in which a number of weights on a platform are raised by a rope running through overhead pulleys to a piston in a vertical cylinder. A quantity of water heated in the cylinder filled the space below the piston with steam, which, when allowed to condense, formed a vacuum under the piston and permitted the pressure of the atmosphere to force down the piston and raise the platform.

Shown in the model is a "digester", or pressure cooker, equipped with a weighted-lever plug safety valve, an important device invented by Papin.

References, *The New Digester*, London, 1681; *La Maniere D'Amolir les Os, etc.*, 1682.

#### SAVERY STEAM ENGINE, 1698

U.S.N.M. no. 307238; photograph of drawing; gift of the Science Museum, London; not illustrated.

The following is from the *Catalogue of the Mechanical Engineering Collection in the Science Museum*, London, 1919: "In 1698 Thomas Savery patented an apparatus 'for raising of water and occasioning motion to all sort of mill works, by the impellant force of fire.' No drawing of the arrangement was deposited, but the following year a model of the machine was shown at the Royal Society, and is illustrated in the *Philosophical Transactions*.

"The apparatus in its simplest form consisted of a high pressure boiler supplying steam to a receiver, which was provided with suction and delivery pipes and the corresponding valves. By means of

a regulator valve worked by hand, steam from the boiler was admitted into a receiver and allowed to blow through it till the air had been expelled; then the supply of steam was cut off and cold water from a cistern above was turned on to the receiver which acting as a surface condenser, condensed the steam, so forming a partial vacuum into which the water rose from the suction pipe, the delivery orifice being at the same time sealed by its valve; the entering water further assisted in this condensation. Steam was again admitted, and by its pressure forced the water in the receiver out through the delivery valve and pipe, the suction pipe in the meantime being closed by its non-return valve."

References, *The Miner's Friend*, 1702; *Philosophical Transactions*, vol. 21, 1699.

### NEWCOMEN ENGINE, 1712

#### PLATE 11

U.S.N.M. no. 308451; print from an engraving of 1717; gift of the Newcomen Society; photograph no. 17872.

This engraving is made from a drawing of 1717 by Henry Beighton, presumably from his own measurements of the engine erected by Thomas Newcomen near Dudley, England, in 1712. It is the oldest present record of a Newcomen engine, and the original engine is believed to have been the first one actually built by Newcomen.

The engine shown has a vertical cylinder directly over the center of a bricked-over hemispherical boiler. The cylinder is hung between two heavy wooden beams, which, in turn, are supported about midway of the height of two thin, wide, brick columns, one on each side of the boiler. One column is hollow and serves as a chimney for the boiler furnace; the other column supports the bearings upon which the beam or great lever of the engine rocks.

The cylinder is open at the top, and the piston rod extends upward, terminating in a hook. A flexible chain from the hook connects it to the end of the engine beam, which is arched so that the point of contact of the chain is always directly over the center of the piston. The pump cylinder is located under the opposite end of the beam, and the pump rod is similarly connected to the beam by chain. The pump rod is shown extending down into the open mouth of a mine pit, over which is erected a windlass for raising and lowering men and ore. A smaller arched head or sector on either side of the center of the beam between the center and the end of the beam operates an auxiliary pump and the plug rod that actuates the valves.

To one side and above the cylinder is a cistern that holds the water for injection into the cylinder for condensing purposes. (See the Newcomen engine, p. 30, for general explanation of the operation.)

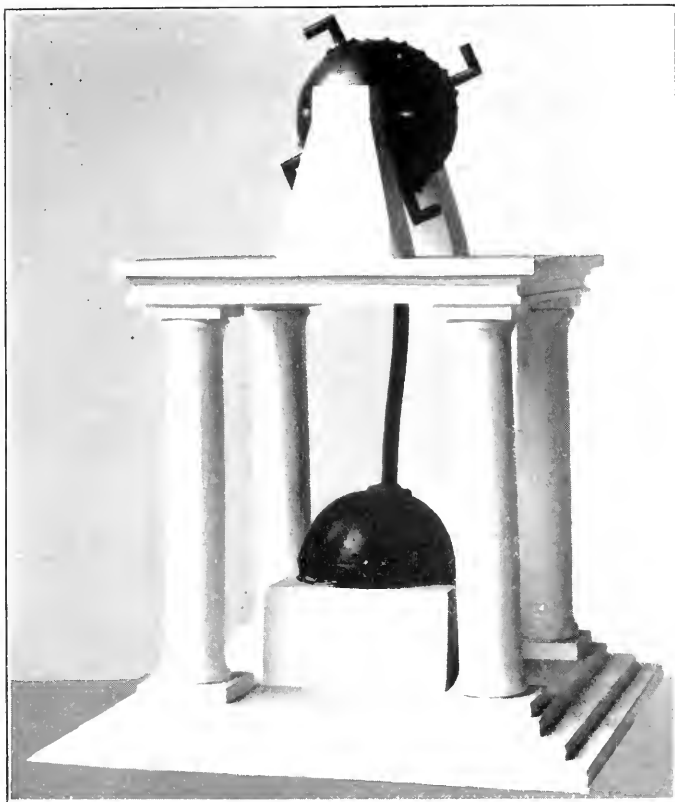

17133

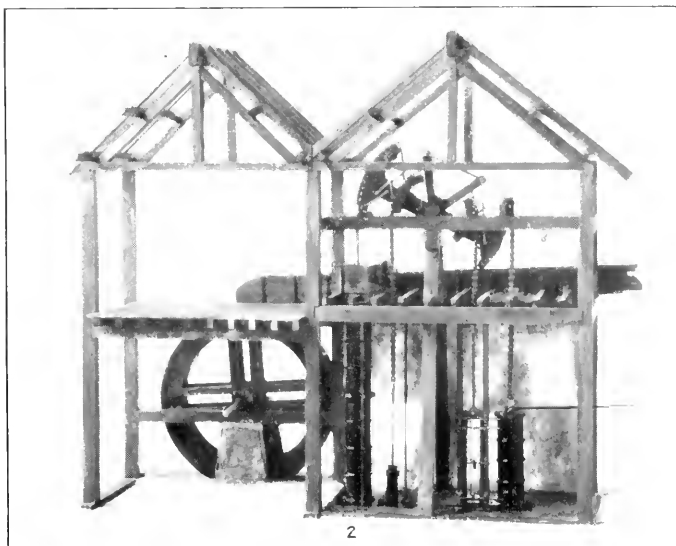

2

17143A

## EARLY STEAM ENGINES.

1. Heron's turbine, c. 150 A. D. (model; U.S.N.M. no. 308462). See p. 26.
2. Watt pumping engine, "Old Bess," 1777 (model; U.S.N.M. no. 308469). See p. 31.

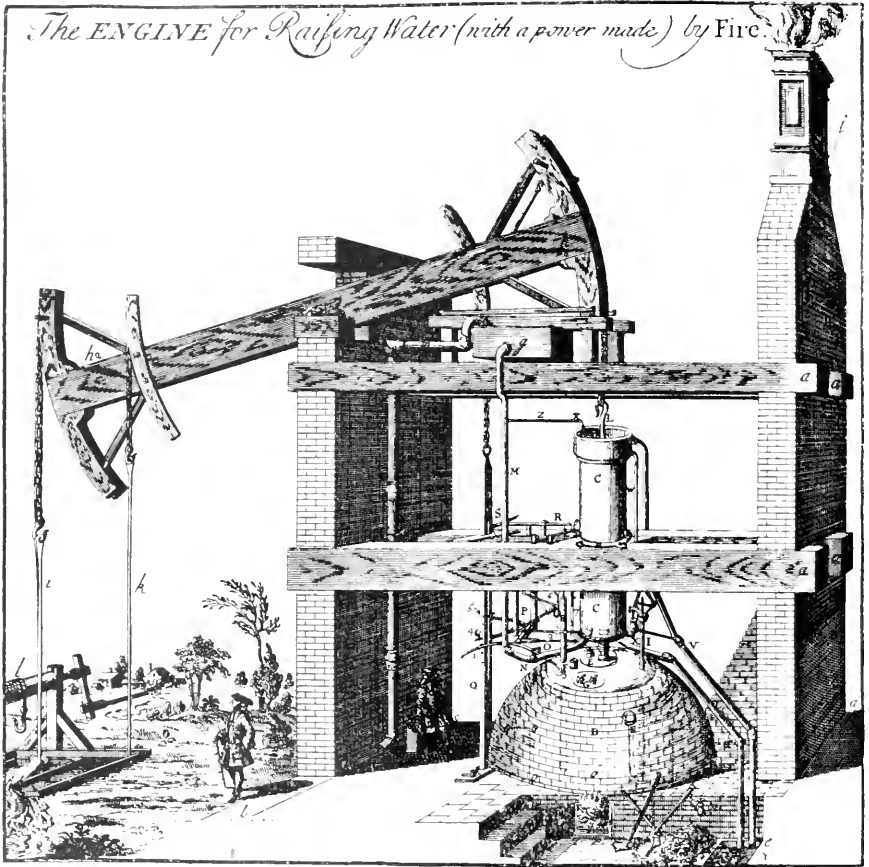

NEWCOMEN PUMPING ENGINE.

Engraving, 1717 (U.S.N.M. no. 308451). See p. 28.

The cylinder is connected to the boiler by a short pipe at the boiler end of which is the sector-plate steam valve called the regulator. The lever of the regulator is attached to a Y-shaped stirrup that leads to levers on a short shaft, which is hung so that two tappets on the same shaft are struck by pins in the plug rod. The plug rod is a beam moving up and down with the beam of the engine. The pins on the plug rod are so placed that the regulator will be jerked open at the end of each down stroke and closed at the end of the upstroke. The injection cock, in the lower bend of the pipe connecting the cistern with the cylinder, has a long sweeping handle, one end of which is weighted so that the valve falls open when the handle is released from its held position. In the closed position the weighted end of the injection cock is held by a catch and released by a rod that projects from a buoy and rises with it. The buoy floats on the surface of water within a pipe connected to the pressure in the boiler. The pressure within the boiler drops sharply with the upstroke of the piston and then increases after the piston comes to rest at the top of the stroke. The water level in the buoy pipe reacts with this change in pressure, and the buoy rod at its highest point releases the injection cock handle. This arrangement necessitates a short pause at the end of each stroke. A pin on the plug rod engages the opposite end of the injection cock handle and replaces the weighted end in the catch.

The engraving was first published in "Savery, Newcomen and the Early History of the Steam Engine," by Rhys Jenkins, *Transactions of the Newcomen Society*, vol. 4, 1923-24. A supplementary note to the article remarks on the similarity between this and the illustration in Desaguliers' *Course of Experimental Philosophy, 1734*, and presents the following legend for this drawing as prepared with the aid of the Desaguliers illustration:

LEGEND OF BEIGHTON'S DRAWING

- A. Fireplace.
- B. Boiler and seating.
- C. Cylinder with piston.
- D. Steam pipe from boiler to cylinder.
- E. Steam cock or regulator.
- F. Puppet clack or safety valve.
- G. Gauge pipes to show when the level of the water in the boiler is too high or too low.
- H. Buoy pipe; the shank of the buoy when the steam becomes strong forces up the lever **R** and interceptor **7** thereby lifting the notch from the lever of the injection cock which is opened by the fall of the weight **3**. The tail **1** of the lever is restored by a pin in the plug rod.
- I. Standpipe for shank **K**, to indicate height of water in boiler.
- K. Float in boiler.
- L. Shank of the piston.
- M. Injecting pipe bringing cold water from cistern **g**.

- N. Injecting cock.
  - O. Lever or spanner of injecting cock.
  - P. Two standards supporting the Y to work the regulator; 4 and 5 are arms to work the Y by pins in the plug rod; 6 is a strap to restrain the Y.
  - Q. Working beam or plug rod.
  - R. Lever, one end of which turns on a pin and the other is attached to the interceptor 7; the lower end of this is attached to the notched lever 2 that releases the injection cock.
  - S. Counterweight to lever R.
  - T. Eduction pipe.
  - V. Overflow pipe from top of cylinder and from shifting valve.
  - W. Pipe supplying boiler with water from top of piston.
  - X. Sniffing valve.
  - Y. Waste well.
  - Z. Pipe supplying water from cistern g to top of piston.
  - aaaa. Four great beams supporting the engine and the floor of the house.
  - bede. Ground floor of the house.
  - f. Chimney.
  - g. Cistern of cold water to supply injection.
  - h. h2. Great lever or beam.
  - i. Rod and chain fixed to the outer end of the beam working pumps from the bottom of the mine.
  - k. Small force pump supplying cistern g.
  - l. Windlass and rope, whereby men and materials are conveyed up and down the pit.
  - m. Pipe by which pump K supplies cistern g.
  - oooo. Outline of boiler.
- [Note: *Interceptor* should read *inceptor*.]

#### NEWCOMEN PUMPING ENGINE, c. 1712

U. S. N. M. no. 30846S; model; made in the Museum; not illustrated.

This model illustrates the general arrangement of a Newcomen atmospheric engine with its boiler and engine house.

The Newcomen engine consisted of an open-top vertical cylinder mounted above and connected through a valve to a steam boiler. A piston within the cylinder was connected by chain to one end of an oscillating overhead beam. To the other end of the beam was connected the pump rods and plungers extending into the mine shaft. The weight of the pump rods, etc., was sufficient to overbalance the weight of the piston and at rest would maintain the piston at the top of the cylinder. In operation, steam was admitted to the cylinder to fill the space below the piston; then with all valves closed, cold water was injected into the cylinder from an overhead cistern, condensing the steam to form a partial vacuum in the cylinder, with the result that atmospheric pressure would force down the piston and raise the pump rod. At the end of the down stroke, steam was admitted, the condensed water and air were ejected, and the piston was returned to the top of the cylinder. The steam and water-injection valves were operated by a mechanism attached to the beam.

Thomas Newcomen, of Dartmouth, England, with John Cawley (or Calley) made the first successful atmospheric engines about 1712. Though these engines incorporated most of the features of a successful reciprocating steam engine and were a great advance over the Savery engine (above), they infringed the broad patent granted to Savery and were therefore made for several years under his patents.

#### WATT PUMPING ENGINE, c. 1776

U. S. N. M. no. 308130; colored drawing made from the engine; gift of A. W. Willet; not illustrated.

The engine shown in the drawing is one of two engines designed and built by Boulton and Watt for the Birmingham (England) Canal Co. about 1776-78. The engines were erected at Smethwick and employed to pump lockage water from the lower levels of the canal to a summit at that point. One engine remained in use until 1892, when it was replaced by a modern pumping plant. The company's engineer, G. R. Gebb, caused the engine to be preserved and had it reerected at the Canal Co.'s Ocker Hill Works, where it still remains in working order. The donor, who succeeded Mr. Gebb, had the drawings made from the engine for the James Watt Centenary Celebration in 1919.

The engine is a typical Watt beam engine with vertical, double-acting cylinder, 32 inches in diameter and 8-foot stroke. The pump cylinder is 29 inches in diameter. The speed was 13 strokes a minute and the steam pressure 10 pounds per square inch. The engine is equipped with a separate jet condenser and a 14-inch condenser air pump operating from the beam. The drawing includes a section through the lower valve chest showing the exhaust, intake, and equilibrium valves. The valves are operated by a rod from the beam.

The drawing is about 27 by 40 inches and is made to the scale of  $\frac{3}{4}$  inch equals 1 foot.

#### WATT PUMPING ENGINE, "OLD BESS", 1777

##### PLATE 10, FIGURE 2

U.S.N.M. no. 308469; model; made in the Museum; photograph no. 17143A.

This model was made from a photograph and description of the working model in the Science Museum, London.

The engine "Old Bess" was built by Watt for the hardware factory of Matthew Boulton at Soho, England. The factory was operated by an overshot water wheel, 24 feet in diameter, 6-foot breast, and the engine was used to pump water from the lower wheel race to the flume above, to turn the wheel during dry seasons when the natural flow of water was not sufficient.

The engine resembled the Newcomen beam engines in appearance, with the piston rod and pump rod connected to the opposite ends of a heavy walking beam. The huge double-acting cylinder was 33 inches in diameter and permitted a 7-foot stroke. The valves were operated by a "plug-frame", which was raised and lowered by the beam. The engine was equipped with a separate condenser and condenser air pump.

#### THE EARLY STEAM ENGINE IN AMERICA

The first steam engine in America was erected at the copper mine of Col. John Schuyler, on Barbadoes Neck, N. J., in 1755. This was an atmospheric engine of the Newcomen type and was built in Cornwall, England, by Joseph Hornblower and his sons, engineers and engine builders. The engine was brought to America by Josiah Hornblower, who erected it and operated it for many years. It was disabled by fire in 1768, and in 1793 was broken up and disposed of. A portion of the cylinder of the engine is exhibited in the National Museum. (References: Nelson, William, *Josiah Hornblower*, 1883; Loree, L. F., "The First Steam Engine in America", in the *Delaware & Hudson Co. Bulletin*, July 15, Aug. 15, 1929.)

The next engine of record is the one constructed at Philadelphia in 1773 by Christopher Colles to pump water for a distillery there. Colles, a well-educated and ingenious Irishman and the pupil and protégé of Dr. Poccoke, the Bishop of Ossory, came to America in 1765 after the bishop's death. In 1772 he delivered a series of lectures at the hall of the American Philosophical Society on pneumatics, hydrostatics, and hydraulics, illustrated by demonstrations of models he had constructed, including models of steam engines. That the pumping engine that Colles built in 1773 was cheaply made and did not perform satisfactorily, though it demonstrated that he understood the construction of engines, was reported by a committee of the Philosophical Society. (Reference: Bishop, J. L., *History of American Manufactures*, vol. 1, pp. 576-577, 1866.)

The next year, 1774, Colles contracted to build a reservoir for the council of the City of New York. This work, the completion of which was prevented by the war, was renewed in 1785 when surveys were made by Colles and others. (Reference: Booth, Mary L., *History of the City of New York*, 1859.)

A newspaper of February 1775, however, announced that a large cylinder for the steam engine of the waterworks was cast at the foundry of Sharp and (Peter T.) Curtenius, the first performance of the kind attempted in America (Bishop, vol. 1, pp. 534, 537). That this engine was completed and operated can be inferred from an entry in the journal of Isaac Bangs (*New Jersey Historical Society Proceedings*, vol. 8, p. 121, May 20, 1858), who visited the Schuyler mine



in 1776 and compared the engine there with the New York engine. He wrote: ". . . it [the Hornblower engine] was constructed upon the same principles and much in the same form as that of New York . . ." (Nelson, *Josiah Hornblower*, p. 22).

Shortly after the war and before 1790 a single-acting atmospheric engine was built by Joseph Brown at the Hope Furnace in Scituate, R. I., to drain the ore pits at Cranston, R. I. David Wilkinson saw Elijah Ormsbee working on (repairing) the engine at Cranston about 1790. "This engine was made with the main cylinder open at the top as the news of the cap on the cylinder by Boulton and Watt had not yet come to this country when the engine was built" (letter from David Wilkinson, *Transactions Rhode Island Society for the Encouragement of Domestic Industry*, 1861, p. 104).

In 1785 Gen. Thomas Johnson and his brother at their Catoctin Iron Furnace in Frederick County, Md., made parts of the engine that James Rumsey used in his steamboat trials on the Potomac River.

It is probable that John Nancarrow had constructed steam engines at Philadelphia before 1786. At that time he was the proprietor of an iron furnace there, and was one of the two men to whom John Fitch, the steamship inventor, was referred for advice. In 1770 Nancarrow was one of the two principal builders of atmospheric steam engines in England (Smeaton) and in 1799 was the author of a memoir on his improvements to the Savery type of engine in *Transactions American Philosophical Society*, vol. 4, 1799 (Bishop, vol. 1, p. 577).

In 1786-87 John Fitch, with Henry Voight, a Dutch watchmaker of Philadelphia, constructed two models of steam engines and a full-size engine of the Boulton and Watt type with a 12-inch cylinder. Later, in 1790, Fitch, William Thornton, and John Hall together constructed an efficient engine that was used to propel a packet boat (Bishop, vol. 1, p. 577).

As early as 1788 Nathan Read, graduate of Harvard College and resident of Salem, Mass., became interested in the propulsion of boats by steam and directed his attention to the design of lighter and more efficient machinery. On August 26, 1791, he received a United States patent for a vertical multitubular boiler, one of the first four United States patents, all of which were issued on the same day. Read's boiler is the earliest multitubular boiler of record (Read, David, *Nathan Read and the Steam Engine*, 1870).

In 1794, Jacob Mark, Philip Schuyler, and Nicholas J. Roosevelt purchased six acres of land from Josiah Hornblower, then a substantial citizen of New Jersey, and put up a foundry, machine shop, and smelter for the use of the New Jersey Copper Mine Association, which they as directors had organized to resume mining at the

Schuylker mine. This establishment was located on Second River near Belleville, N. J., and was called "Soho" after the Boulton and Watt works of the same name. In 1798, under the direction of Roosevelt, who was then probably the sole owner, a steam engine was made for the boat *Polacca*. This engine had a 20-inch diameter cylinder and a 24-inch stroke (Nelson, *Josiah Hornblower*). The boat was the result of the combined efforts of Col. John Stevens, of Hoboken, Robert R. Livingston, of New York, and Roosevelt.

On March 21, 1799, Roosevelt contracted to build the engines for the Center Square and the Schuylkill (at Chestnut Street) stations of the Philadelphia waterworks. These were large engines of the Boulton and Watt type and were put in operation in December 1800 and January 1801. The contract price was \$30,000 for the two, but Roosevelt claimed that they cost him \$77,192 to build. Complete descriptions of these are given in an illustrated paper by Fred. Graff, C. E., quoted in the article "The History of the Steam Engine in America" in the *Journal of the Franklin Institute*, October 1876, and also in *United States Centennial Commission: Reports and Awards, International Exhibition*, vol. 6, p. 197, 1876. The same references show that in July 1800 a small cylinder for a steamboat engine (for Roosevelt, Livingston, and others) was being bored at the "Soho" works.

Col. John Stevens in 1799 became the engineer of the Manhattan Company, which was organized that year to supply water to the City of New York. He convinced the directors that a steam pump should be substituted for the horsepower pumps with which the company started, and in 1800 constructed (probably at his own shop in Hoboken) an engine of the Savery type embodying several of his own improvements. This was not satisfactory, and Stevens then attempted to construct an engine with "Doc" Appollos Kinsley, owner of a small machine shop in Greenwich Street, New York. Kinsley wrote in August 1801 that he had the engine in operation, ready to deliver, but he became ill before its completion and Stevens procured an engine of the Boulton and Watt type, constructed by Robert McQueen, of New York. This engine continued in operation to about 1844 (Turnbull, A. D., *John Stevens, An American Record*, pp. 151-152, 1928).

Oliver Evans, millwright and engineer, speculated on the use of the steam engine to propel land carriages as early as 1773-74. He filed an application for a patent with the United States Patent Office in 1792 containing specifications for horizontal and vertical reciprocating engines and a rotary engine. In 1801 he completed a practical steam engine, which, if it did grind plaster and saw marble, was the first steam engine to be used in a manufacturing process in this country, all earlier engines having been used to pump water or

propel boats. Shortly thereafter Evans established the Mars Iron Works in Philadelphia and began the manufacture of steam engines. Evans built small, high-pressure, beam engines that found a ready sale and were sent to many parts of the country. At Evans' death in 1819 more than 50 of his engines are said to have been in use in a great variety of work. The business was continued by David Muhlenburg and James Rush at Philadelphia and by Stackhouse & Rogers, licensees, at Pittsburgh.

A description of the engine built by Oliver Evans for the steamboat *Aetna* appears in L.-B. Marestier: *Mémoire sur le Bateau à Vapor*, Paris, 1824. *Oliver Evans: A Chronicle of Early American Engineering*, by Greville and Dorothy Bathe, Historical Society of Pennsylvania, Philadelphia, 1935, is an excellent record of Evans' life and work.

Robert Fulton imported a Boulton and Watt steam engine in 1805-6 for his steamboat experiments on the Hudson River. This engine, a double-acting, separate-condenser type, was used in the successful *Clermont*. This was the first Boulton and Watt engine now definitely known to have been brought to this country and was probably the second engine imported from England.

*Early steam-engine manufactures.*—With the success of Evans and Fulton the general interest in steam engines for both manufactory and boat power increased tremendously, and steam engines were built in all parts of the country. Prior to this, steam engines had been built at iron furnaces and in the establishments making mill machinery, stoves and kettles, and plates and rods, all of which had grown out of iron furnaces and foundries. The Soho works of Roosevelt was originally the smelter and shops of the New Jersey Mine Association; John Nancarrow at Philadelphia was the proprietor of an iron furnace (Nancarrow and Matach), which, according to George Washington (1787), was the largest and best equipped in the country; John Hall, steam-engine mechanic, with Fitch and Stevens owned a plating forge and tilt hammer at Philadelphia in 1750; and Robert McQueen (with Sturtevant) and James F. Allaire, at New York, were the proprietors of an iron furnace and foundry, respectively. Evans' Mars Iron Works was probably the first to specialize in steam engines, though James Smallman was listed in the Philadelphia directory of 1802 as maintaining an establishment for making steam engines of all sizes and varieties (Westcott and Scharf, *History of Philadelphia*). Smallman seems to have been the first to export a steam engine from the country, as he built a steam flour mill for Cadiz, Spain, in 1806.

Immediately after the successful trip of the *Clermont*, Fulton began to build engines and steamboat machinery at his shops in what is now Jersey City.

Staudinger, who had worked with Roosevelt at Soho and Stevens at Hoboken, was Fulton's chief engineer. Iron castings were obtained from McQueen and John Youle and brass castings from Allaire, all of New York. Many successful engines were built before Fulton's death in 1815, after which Staudinger and Allaire took over the works and continued there until Staudinger's death the next year. Allaire, then, as sole owner, removed the works to the location of his original brass and bell foundry in Cherry Street, New York City, where he continued the manufacture of large marine and stationary engines until he retired from the business in 1842. The Allaire Works was incorporated in 1850, with T. F. Secor president, and continued to 1868, when it was purchased along with most of the other engine works in New York City by John V. Roach to form John V. Roach & Sons.

#### HALF CYLINDER OF THE FIRST STEAM ENGINE IN AMERICA, 1755

##### PLATE 12, FIGURE 1

U.S.N.M. no. 180143; original; deposited by the New Jersey Historical Society; photograph no. 32578.

The engine of which this relic was a part was constructed in Cornwall, England, by Joseph Hornblower and his sons, engine builders and engineers, for Col. John Schuyler, of New Jersey. It was brought to America in 1753 by Josiah Hornblower and erected by him at Colonel Schuyler's copper mine on Barbadoes Neck, N. J. The engine was started in 1755 and used to pump water from the mine until 1768, when it was disabled by fire. It was used again from 1793 until some time early in the nineteenth century, when it was dismantled and the parts disposed of. This portion of the cylinder is the only part known to have been preserved to the present time.

The engine was an atmospheric steam engine of the Newcomen type, in which the piston was connected by a flexible chain to a walking beam to the other end of which were connected the heavy pump rods and parts. The weight of the pump rods pulled down the pump end of the beam, raising the piston end so that the engine piston was held at the top of the cylinder. Steam was admitted to the cylinder, the valves were closed, cold water injected, and the steam condensed, forming a partial vacuum under the piston, with the result that atmospheric pressure pushed down the piston and raised the pump rod. The cylinder was then opened to the atmosphere and the weight of the pump returned the piston to the top of the cylinder so that the cycle could be repeated. The reciprocating motion of the pump rods pumped the water from the mines.

This description is general, as no detailed account of the engine exists and the only illustration of the engine is that of the engine house in the Hornblower family seal.

## JAMES RUMSEY'S STEAM ENGINE, 1787

"A SHORT TREATISE ON THE APPLICATION OF STEAM . . . APPLIED TO  
PROPEL BOATS OR VESSELS . . . GRIST-MILLS, SAW-MILLS, ETC."

BY JAMES RUMSEY (1787)

U.S.N.M. no. 160398; original; purchased from Thomas Rumsey; not illustrated.

This treatise (26 pp.), written by the author to set forth his claims as the original inventor of the steamboat, is of interest here because it describes one of the earliest steam engines (or steam pumps) built in the United States.

The engine described was a direct-connected atmospheric pumping engine. A vertical steam cylinder  $2\frac{1}{2}$  feet in length (diameter not stated) was mounted upon and directly bolted to a pump cylinder of the same diameter. The pump piston and the steam piston were connected together by a "smooth bolt passing through the bottom of the upper cylinder." Steam from the boiler was admitted to the upper cylinder "under its piston which is then carried to the top of the cylinder by the steam (at the same time, the piston of the lower cylinder is brought up to its top, from its connection with the upper piston, by the aforesaid bolt), they then shut the communication from the boiler, and open another to discharge the steam for condensation; by this means the atmosphere acts upon the piston of the upper cylinder, and its force is conveyed to the piston in the lower cylinder, by the aforesaid connecting bolt, which forces the water, then in the lower cylinder, through the trunk, with considerable velocity; the reaction of which on the other end of the trunk, is the power that propels the boat forward."

It appears from this that the engine employed the pressure of the steam for raising the piston and was equipped with a separate condenser. Affidavits included in the *Treatise* estimate the weight of the machinery as 500 to 800 pounds, occupying a space less than that required for "four flour barrels" or about "four feet by three feet", that the fuel consumption was not more than 4 bushels of coal in 12 hours, and that the boat laden with 2 to 3 tons exclusive of the machinery was driven at a speed of 3 to 4 miles an hour.

A new type of boiler, which "Charles (Morrow) conceives to be the most capital contrivance to make steam that can be invented, for when the machine is not at work, the whistling of the steam may be heard at least half a mile", held only 20 pints of water and made "more steam than a five hundred gallon boiler in the common way." This was probably a boiler of the flash type.

## JOHN STEVENS STEAMBOAT ENGINE, 1804

## PLATE 12, FIGURE 2

U.S.N.M. no. 181179; original; deposited by Edwin A. Stevens; photograph no. 21855.

This is the high-pressure, reversible steam engine built by Col. John Stevens, of Hoboken, N. J., and used in his successful steamboat experiments on the Hudson River in 1804. The engine was preserved by members of the Stevens family. In 1844 it was partially restored when a reproduction of the original boat was made and run on the Hudson River. The engine is believed to be the oldest steam engine built in the United States now in existence, as well as the oldest complete engine of any that were used here.

The engine has a double-acting, vertical cylinder,  $4\frac{1}{2}$  inches in diameter with 9-inch stroke. The piston rod extends upward and terminates in a cross arm (cross head) or yoke, from either end of which a connecting rod extends downward to a crankshaft. Two crankshafts to drive the two propellers of the boat are located one on either side of and slightly below the bottom of the cylinder. Two large cast-iron gears, one on each of the crankshafts, run in mesh and keep the two cranks turning together in the proper relative positions so that the resultant horizontal thrust of the two connecting rods on the cross head will be zero. (This method of dispensing with a cross-head guide was used by Dr. Cartwright of England in several small engines erected near London about 1800.) The valves of the engine are 2-way plug valves, one of which serves each end of the cylinder. The valve stem of each valve carries a small spur gear, the two being oscillated by one rack, which moves vertically up and down. The rack that works the valves is driven by a lever and connecting rod from a crank pin on a crank disk, which is carried loosely on the end of one crankshaft.

A collar, which is something less than a complete ring, projects from the back of the crank disk and partially encircles the shaft. A lug projecting from the shaft in the plane of the collar engages with either end of the collar depending upon the direction in which the engine is started. As the lug on the shaft is directly opposite the crank, and the crank pin is located just midway of the ends of the collar, the crank pin will be in the same position relative to the crank when running in either direction. A handwheel geared to the crank disk permits the crank disk to be turned by hand for approximately half a turn ahead of its driven position for starting the engine in the desired direction.

The engine is exhibited with the original tubular boiler and a reproduction of the boiler feed pump.

MACHINERY OF THE "CLERMONT" AND THE "CHANCELLOR  
LIVINGSTON"

U.S.N.M. no. 180137; drawings; deposited by the Stevens Institute of Technology; not illustrated.

The information given to the Museum with the drawings is as follows:

"These drawings of the machinery of the first steamboats of Robert Fulton, the *Clermont*, and the *Chancellor Livingston* were made by Robert Fulton and used by Mr. Allaire, the engine builder, who subsequently presented them to Charles H. Haswell, Esq.

"The first named was afterward lost at the West Point Foundry and when afterward found was given by the discoverer to Chief Engineer Wm. H. Shock, U. S. Navy, by whom it was, eighteen years later, in 1871, presented to the Stevens Institute of Technology.

"The second drawing remained in the possession of Mr. Haswell until, in 1872, it was presented to the Institute by its owner, who surrendered all proprietary claim to the other sketch."

## THE CLERMONT DRAWINGS

The drawing of the *Clermont* (really the *North River*, the remodeled *Clermont*) machinery is a nicely executed wash drawing, 14 by 22 inches in size, of a longitudinal section in elevation through the "engine room" part of the vessel, including a portion from a point slightly aft of the boiler grates forward to include the entire machinery and its framework. The floor timbers and deck beams are shown. An inscription, evidently added after the drawing was found at the West Point Foundry, reads: "Engine of Steamboat Clermont-North River. The Original Drawing Drawn by Robert Fulton, Esqr. New York 1808. From the archives of the West Point Foundry Association."

The drawing unfortunately is stained and worn to the extent that many details are obliterated. On the other hand, it is believed to be a duplicate of one of several original drawings by Fulton now in the possession of the New Jersey Historical Society, and from a study of both drawings together with a description of the boat deposited in the New York Historical Society by Richard Varick De Witt in 1858 (published in *Robert Fulton and the Clermont*, by A. C. Sutcliff, 1908) the following description of the engine can be given with some degree of accuracy:

The engine was constructed at Birmingham, England, by Boulton and Watt and shipped to New York in 1806. It was double acting, with a cylinder 2 feet in diameter and a 4-foot stroke. The cylinder stood upon a condenser shell of the same diameter and about 2 feet in height. The piston rod extended upward and terminated in a cross head, which traveled in guides on vertical timbers of a gallows

frame erected over the cylinder. A connecting rod extended downward from each side of the cross head to the aft end of a bell-crank lever, one of which was located on each side of the cylinder. The bell cranks were triangular trusses constructed with a long horizontal lower member pivoted at a point about a foot forward and slightly below the bottom of the cylinder. This member extended aft so that the end that was connected to the cross head was approximately opposite the center of the cylinder and under the cross head. The same member extended forward from the pivot about the same distance and the forward end was heavily weighted to counterpoise the weight of the connecting rod. Integral with the lower horizontal member of the lever, perpendicular to it, and rising from it at the pivot point was a short arm, which formed, with the lower member, a right-angle bell crank. From the top of the short member a long connecting rod extended forward to a crankpin in the side of the rim of a large gear wheel, which meshed with and turned a larger gear on the paddle-wheel shaft. From a point forward of the pivot of each lever a connecting rod extended upward to the cross head of an air pump and to the end of a vibrating beam from which motion was taken to operate two other pumps, which were probably bilge and boiler feed pumps. A large flywheel was mounted directly over the keel on the paddle-wheel shaft. The valves and valve gearing of the engine are not detailed, and all that can be said is that there was a valve chest at either end of and on the aft side of the cylinder connected together by a pipe on the starboard side. De Witt states that "the valves of the cylinder were poppet valves operated by the clack gearing, then in use." The valves of the engines in the model of the *Clermont* in the water craft collections of the Museum are indicated as having been operated by hand. Drawing 7 attached to Fulton's U. S. Patent Specification of 1809 from a copy in the Boulton and Watt manuscript in the possession of George Sangyl, Birmingham, England, first published in *Robert Fulton, Engineer and Artist*, by H. W. Dickinson, London, 1914, indicates a practically identical arrangement of machinery. This drawing shows a plug tree, for actuating the valves, connected to the vertical arm of the bell crank by means of a flexible cord or chain turning over a guide pulley. The plug tree was raised by the pull of the cord and returned by its own weight.

The boiler was a return-flue cylindrical shell boiler set in brickwork. The brickwork formed the furnace under the forward end of the shell and a long narrow flue under it to the back of the boiler. The grates were horizontal. The chimney was at the front of the boiler (the forward end) and was supported on a brick column, which also enclosed the front smoke box. An inclined chute through the brick column permitted fuel to be put upon the grates. The shell of the



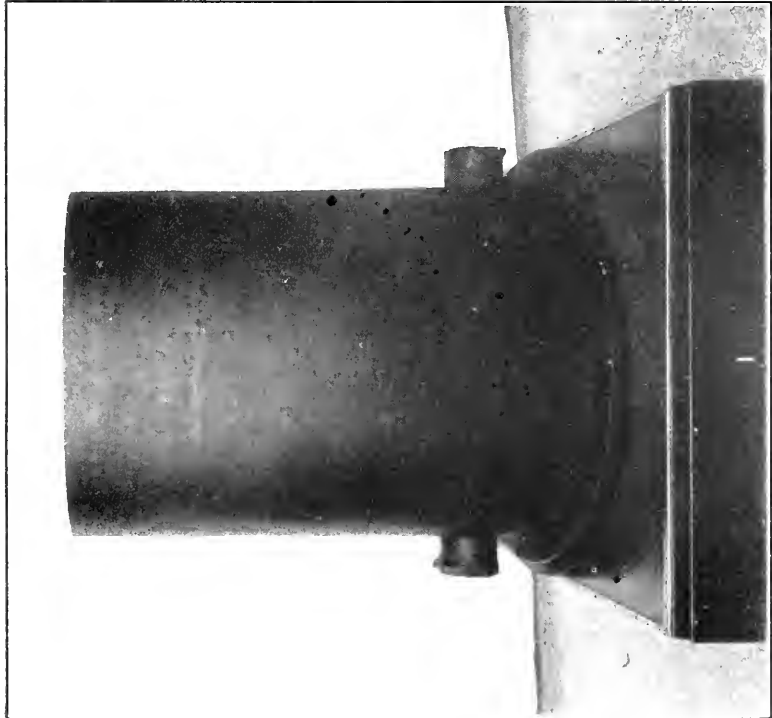
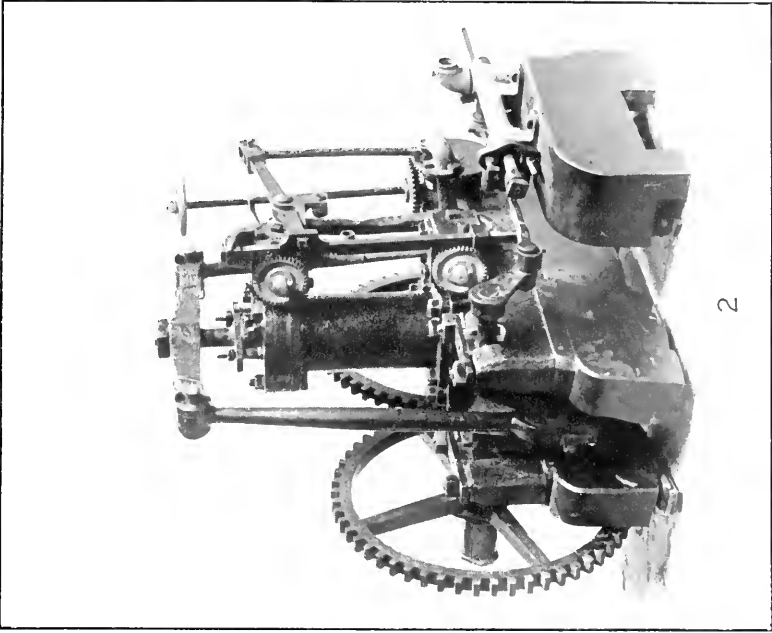

32578

EARLY STEAM ENGINES IN AMERICA.

1. Half cylinder of the first steam engine in America, 1755 (U.S.N.M. no. 180143). See p. 37.
2. John Stevens steamboat engine, 1804 (U.S.N.M. no. 181179). See p. 38.

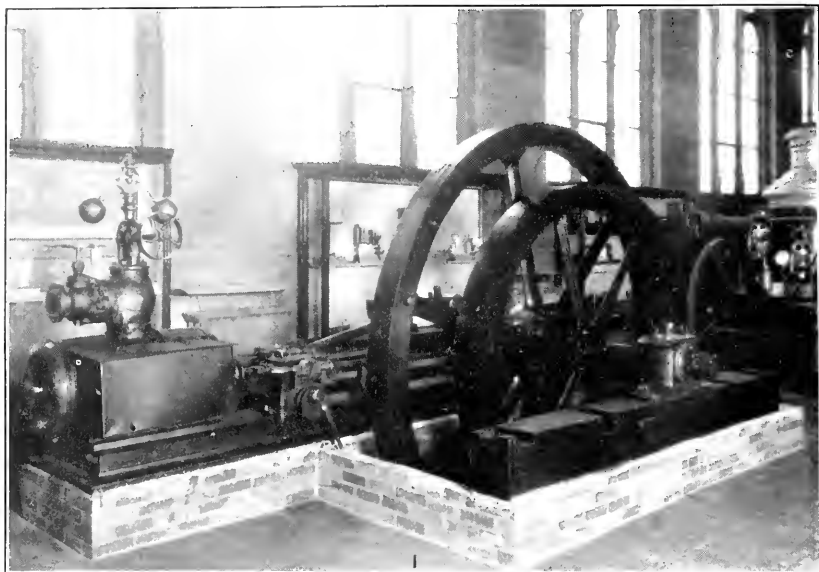

31026

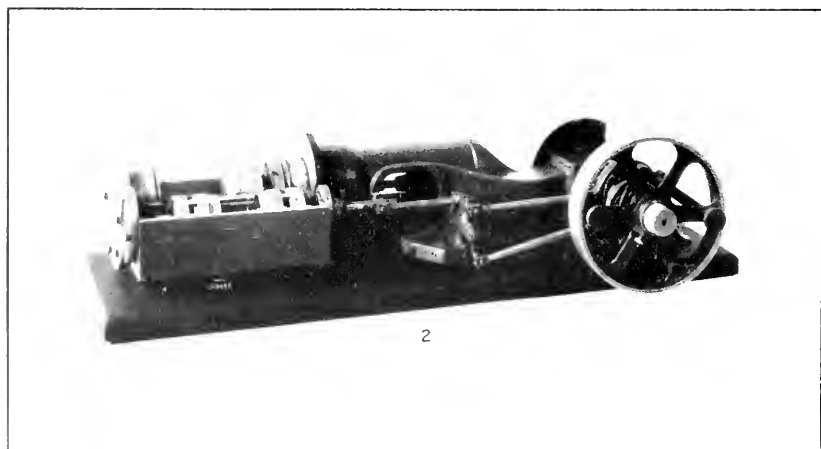

19922

STEAM ENGINES, 1864-1875.

1. Horizontal steam engine, 1864 (U.S.N.M. no. 310241). See p. 48.
2. Thompson and Hunt steam engine, c. 1875 (model; U.S.N.M. no. 309645). See p. 50.

boiler was of copper, weighed 4,399 pounds, and was constructed by Cave & Son, of London, England. The boiler was approximately 40 inches in diameter, the flue about 14 inches.

#### THE CHANCELLOR LIVINGSTON DRAWING

This is a mechanical drawing in pencil on buff drawing paper, 15 by 22 inches, scale  $\frac{3}{4}$  inch=1 foot, somewhat torn and stained. The drawing shows a section through the cylinder, condenser, air pump, and boiler feed pump, with the valves and valve chests completely drawn in section. The lever that drove the air pump and the linkages to the feed pump and valve mechanism are shown, but the valve mechanism itself is barely indicated in free-hand drawing, and the connecting rod from the cross head to the crank at the side of cylinder is omitted. The gear train to the flywheel shaft and the rim of the flywheel are indicated.

The engine consisted of a vertical double-acting cylinder, 40 inches in diameter with a 5-foot stroke, placed upon a cylindrical condenser shell of the same diameter, 3 feet tall. The piston rod extended upward to a cross head the guides for which are not shown, though an A-frame rising about 18 feet above the bottom of the condenser shown in the drawing would have had no other purpose than to carry guides for the cross head. A very long connecting rod extended downward from the cross head to one end of a straight lever, the opposite end of which was similarly connected to the cross head of a vertical air pump, 28 inches in diameter, 30-inch stroke. The lever was pivoted on a pedestal located forward of the cylinder, between the cylinder and the air pump. The base of the condenser, the pedestal, and the air pump were apparently bolted to the same base, which contained a passage connecting the condenser with the air-pump cylinder. The intake valve of the air pump was a very large lift valve apparently closed by its own weight, located in the center of the lower end of the cylinder. The piston of the air pump had an annular port around the piston rod, which was closed by a lift valve that slid on the piston rod. The discharge was at the side of the upper end of the cylinder, through a hinged check valve into a discharge chamber, which was connected to the suction of the boiler feed pump. The boiler feed pump and probably the valves of the engine were operated from a rod worked up and down by a vibrating lever, one end of which was attached to the piston rod, the other end indicated as being fixed at a point above and several feet aft of the cylinder. The valves of the engine were located in a valve chest at each end of the cylinder. Each valve chest was divided into three parts by two poppet valves and valve seats. The central part in each valve chest between the valves was connected to the passage leading

to the end of the cylinder. The space above the upper valve in each chest was connected to the boiler steam pressure, the lower space to the condenser. In each case the stem of the valve extended upward, the stem of the lower valve passing through the upper valve and valve stem. The valve-actuating mechanism was very lightly sketched in the drawing, and the exact method of operation is not discernible. It is fairly clear that a bracket bolted to each valve chest extended upward and carried the pivots for two bell cranks, which were attached to collars on the valve stems. A third bracket slightly aft of the valve chests and just below the upper valve chest carried the pivots of two other bell cranks. These two bell cranks had their afterarms drawn out and curved into hooks, which may have been handles for manual operation of the valves or which may have engaged with some valve-actuating mechanism not shown. Each of these two bell cranks had two other arms connected by links to the bell cranks on the valve chest brackets. The upper one operated the steam valve of the upper end of the cylinder, opening it as it opened the exhaust valve of the lower end. The lower crank opened the exhaust valve of the upper end while it opened the steam valve of the lower end, and vice versa. The crankshaft of the engine was directly under the cross head and slightly below the top of the cylinder. The crank was carried on the side of a 6-foot gear wheel, which meshed with a 3-foot gear on the flywheel shaft. The flywheel sketched was approximately 13 feet 6 inches in diameter.

#### JAMES WATT ENGINE AT SAVANNAH, GA., 1815

U.S.N.M. no. 309800; blueprint of drawing made from the engine; gift of John Rourke, Sr.; not illustrated.

This print is a side and end elevation of a 90 horsepower beam engine, built by James Watt at Lancashire, England, in 1815. The engine was brought to Savannah, Ga., and erected at the rice mills of Messrs. McAlpin and McInnis, where it worked regularly to about 1900. In 1891 it was generally overhauled and repaired by John Rourke & Son, Novelty Iron Works, Savannah, when this drawing was made. When the mill was dismantled about 1900 the engine was stored by Mr. Rourke who recognized its historical value. Unfortunately it was destroyed by fire several years later.

The engine had a 31-inch cylinder, 72-inch stroke, and operated at 18 revolutions a minute on 8 pounds per square inch steam pressure. It was equipped with a common jet condenser and a 24-inch air pump. A boiler feed pump worked from the beam. The crankshaft and connecting rod were cast iron.

## STATIONARY ENGINE, 1829

U.S.N.M. no. 180010; original model; gift of Charles M. Blackford; not illustrated.

This is an operating model of a simple steam engine made by William M. Blackford, a lawyer and editor of the Political Arena at Fredericksburg, Va., in 1829. At that time steam engines were so rare that Mr. Blackford was induced to deliver public lectures on the steam engine, using the model as an illustration. It is believed that the model illustrates the general form of the simple steam engine as it was being built about 1829.

The model has a vertical, double-acting cylinder, with the piston rod connected by a double pin joint to one end of a walking beam. The other end of the beam carries a connecting rod that turns a crank, crankshaft, and flywheel. A slide valve moves across the lower end of the cylinder and is driven by an eccentric on the shaft through a valve rod, bell crank, and eccentric rod. Steam is carried to the upper end of the cylinder through a passage extending along the whole length of the cylinder.

## "LIGHTHALL'S IMPROVED HORIZONTAL AND BEAM ENGINE", 1838

U.S.N.M. no. 308639; original patent model; transferred from the United States Patent Office; not illustrated.

This model was submitted with the application for the patent granted to William A. Lighthall, of Albany, N. Y., April 14, 1838, no. 696.

The engine is designed primarily for boat propulsion and permits the use of a horizontal steam cylinder installed low within the boat in combination with a beam working vertically as in a beam engine.

The model is diagrammatic in form, is made of wood, and is not complete. The engine represented is essentially a beam engine laid upon its side so that the cylinder is horizontal and the beam is supported vertically. The patent drawing shows the cylinder placed directly upon the keelson of a boat with the beam held so that the lower end is at the approximate level of the center of the cylinder. A long connecting rod attached to the upper end of the beam reaches back over the cylinder to a crank on the engine shaft, which is located above the cylinder and back of it.

## MAUDSLAY AND FIELD MARINE ENGINE, 1842

U.S.N.M. no. 251298; original patent model; transferred from the United States Patent Office; not illustrated.

This model was submitted with the application for the patent issued to Joseph Maudslay and Joshua Field, of Lambeth, England, June 11, 1842, no. 2668.

The engine represented is one in which the crankshaft is located close to the top of the vertical cylinder and is driven by a return connecting rod from the cross head, which is above the shaft. It is designed to utilize all the limited height available within a boat below the paddle shaft.

Peculiarities of the engine are the use of two piston rods, one on either side of the crank throw, and the location of the cylinder so that its axis does not pass through the center of the crankshaft. The piston rods terminate in a cross head that works in vertical cylindrical guides from which a connecting rod returns to the crank located just above the cylinder.

The patent also describes the Maudslay and Field "Siamese" engine, a double, return-connecting rod engine; and a method of controlling the expansion valves of the two cylinders simultaneously and without stopping the engine. This last was effected by changing the position of a pair of spiral cams (snail cams), which operated the expansion valves.

U.S.N.M. no. 309353, original patent model, transferred from the United States Patent Office, is a duplicate model of this engine.

#### LOPER STEAM ENGINE, 1845

U.S.N.M. no. 251297; original patent model; transferred from the United States Patent Office; not illustrated.

This operating model was submitted with the application for the patent issued to R. F. Loper, of Philadelphia, Pa., November 26, 1845, Patent no. 4289.

The engine was designed to drive two parallel crankshafts in opposite directions at the same speed, for the purpose of turning screw propellers of the "inventor's and others' design", for the propulsion of ships.

The single horizontal cylinder of the engine is located a short distance from one end of a long rectangular bed frame. At each end of the frame is a crankshaft connected by its connecting rod to the cross head, which moves in guides near the middle of the frame. A third vibrating rod pivoted on the cross-head pin at the side of the cross head extends the entire length of the engine and connects the two crankshafts for the purpose of keeping them in their proper relative and opposed positions.

#### BENSON STEAM ENGINE, 1847

U.S.N.M. no. 309197; original patent model; transferred from the United States Patent Office; not illustrated.

This model was part of the application for the patent issued to Benjamin S. Benson, July 10, 1847, no. 5185.

The machine represented by the model is a very early example of the "wobble disk" type of engine or pump. Many engines and pumps using this principle of operation have been designed from time to time, and experiments are carried on today with internal combustion engines of this form. Combinations of one unit used as a pump and one used as a fluid motor are very successfully used for power transmissions.

The machine consists of four cylinders placed around the axis of a shaft, parallel with and at equal distance from it, with the rods of the pistons that work in the cylinders connected to arms projecting from a shaft not parallel to the axis about which the cylinders are placed. With this arrangement rotary motion of the shaft is accompanied by reciprocating motion of the pistons, and the device may be used as a motor or a pump.

#### LOPER MARINE STEAM ENGINE, 1849

U.S.N.M. no. 309198; original patent model; transferred from the United States Patent Office; not illustrated.

This was submitted with the application for the patent issued to R. F. Loper, of Philadelphia, August 28, 1849, no. 6673.

This is a nicely made working model of a 2-cylinder vertical marine engine directly connected to a 2-throw propeller shaft, upon which is mounted a 4-blade propeller. The model is complete with boiler, feed-water pump, condenser, and condenser air pump. The peculiar feature of the invention is the manner of connecting the air pump to the engine and the method of quickly converting the engine from condensing to noncondensing operation.

The engine represented consists of a heavy bed plate shaped to fit the hull of a vessel, upon which are attached the bearing of the propeller shaft and the frame that supports the cylinders. The cylinders are double-acting and are "reversed from the ordinary position of engines, the piston rod running down through the lower head and connecting by the usual connecting rod with the cranks on the shaft below." "The valves of the engine take their motion from eccentrics on the main shaft coupled with a valve lever by proper eccentric rods. The lever is affixed to its axis by its center and is made double, so that the eccentric rod can be thrown to either end to reverse the motion or may be wholly detached." The cut-off is worked by another eccentric on the shaft. The feed-water pump is worked directly from the cross head. The air pump is driven by a beam and connecting rod, which is driven by a crankpin upon a gear wheel that engages a pinion on the crankshaft. The ratio of the gears is such that the air pump performs only one stroke to two of the engine. The air pump communicates with the condenser into which

the exhaust pipe opens. The escape pipe is also connected with the condenser, which, when open, allows the steam to escape without condensing.

#### LIGHTHALL HALF-BEAM MARINE ENGINE, 1849

U.S.N.M. no. 308641; original patent model; transferred from the United States Patent Office; not illustrated.

This model was submitted with the application for the patent issued to William A. Lighthall, of Albany, N. Y., October 23, 1849, no. 6811.

The model shows a combination of a horizontal cylinder with a vertical beam to which the engine's force is applied between the fulcrum and the connecting rod to the engine crank. It permits locating the propelling machinery of a side-wheel steamboat low within the hull.

The model is a panel representing a horizontal cylinder with piston rod connecting to a short beam pivoted at a point below the level of the cylinder. From a short distance above the point at which the piston force is applied to the beam a long connecting rod connects to the crank on the engine shaft located above the cylinder and at the middle of its length. The location of the condenser below the cylinder and the location of the air pump and the manner of operating it are shown by the model.

#### JOHN ERICSSON STEAM ENGINE, 1849

U.S.N.M. no. 251299; original patent model; transferred from the United States Patent Office; not illustrated.

This model formed part of the application for the patent issued November 6, 1849, no. 6844.

The invention illustrated in this model is an engine in which the resistance applied to the piston rod by the load on the engine decreases in the exact ratio of the decreasing pressure of the steam as it expands in the cylinder of the engine. It is intended to apply the irregular pressure on the piston in such a manner that a continuous power will be transmitted to the crank.

The engine consists of one small and one large diameter vertical cylinder from each of which a piston rod extends upward to the end of a rocking beam. The other end of each beam is connected to a throw of a horizontal crankshaft, the two throws of which are 180° apart. Steam is admitted to the upper end of the small cylinder, when that piston is at the top of its stroke, and acts directly upon the piston for part of the downstroke. The steam is then cut off and expanded to the end of the stroke, when the expanded steam is passed to the upper end of the large cylinder, where it expands further as that piston moves down to the end of the stroke. At the same time



the lower part of the small cylinder is opened to the same steam, so that the pressure on either side of the small piston is balanced during its upward stroke. The lower end of the large cylinder is always connected to the condenser and during the upstroke of the large piston the pressure is balanced by opening the upper end to the condenser also. The proportions of the engine are selected so that "the force transmitted to the crank during the first and second halves of its semirevolution shall be alike although the steam be expanded more than twenty times."

The witnesses to the patent application for the above invention were Peter Hogg and James B. Ward of the old Hogg & Delameter Iron Works.

#### ERICSSON STEAM ENGINE, 1858

U.S.N.M. no. 251295; original patent model; transferred from the United States Patent Office; not illustrated.

This model was submitted with the application for the patent issued to John Ericsson, July 6, 1858, no. 20782.

The purpose of this design was to obtain the maximum of compactness and power in a horizontal engine so that it could be located transversely and very low within a boat for driving the screw propeller of the boat.

The engine represented consists of two short-stroke, large-diameter, horizontal, double-acting cylinders placed with their head ends bolted together and located so that the propeller shaft is in the plane in which the cylinders are joined together. The piston rods of the two cylinders are connected by like combinations of rocker arm and connecting rod to a single crank on the propeller shaft.

#### SHLARBAUM OSCILLATING ENGINE, 1863

U.S.N.M. no. 251293; original patent model; transferred from the United States Patent Office; not illustrated.

This model was submitted with the application for the patent issued to Herrmann Shlarbaum, New York, N. Y., September 1, 1863, Patent no. 39756.

This engine has a reciprocating piston working in a vertical cylinder oscillating on trunnions near the center of the cylinder. The piston rod is directly connected to a crankshaft supported over the cylinder in the same columns that carry the cylinder trunnions. The feature of this engine is the manner of admitting steam to the cylinder and controlling the exhaust by means of sliding surfaces located on the sides of the cylinder at the lower end of the cylinder. Admitting steam in this manner rather than through the trunnions was supposed to reduce the trouble caused by baking the lubricating oil on the trunnions.

## ERICSSON STEAM ENGINE, 1864

U.S.N.M. no. 308672; original patent model; transferred from the United States Patent Office; not illustrated.

This model was filed with the application for Patent no. 41612, issued to John Ericsson, February 16, 1864.

This model shows a horizontal reciprocating steam engine to the piston of which is linked a rolling weight, which has a corresponding reciprocating motion but always moves in a direction opposite to that of the piston. The intention of the inventor was to diminish the concussion and shaking of a marine engine bed caused by the starting and stopping of the mass of the piston, piston rods, and cross head by adding a similar reciprocating mass moving in the opposite direction.

This model was made to demonstrate the principle involved in the invention. It is driven by a spring motor and is mounted on rollers so that it is free to move if there is any tendency to do so. The counterbalancing weight rolls back and forth in the hollow wooden base of the model.

A brass plate on the model is engraved "J. Ericsson, Inventor, 1863."

## HORIZONTAL STEAM ENGINE, 1864

## PLATE 13, FIGURE 1

U.S.N.M. no. 310241; original; gift of the Southern Railway System; photograph no. 31026.

This engine was built in 1864 at the Alexandria, Va., shops of the United States Military Railroad Department under the direction of W. H. McCafferty, master mechanic. It was used to furnish power to the machine shops of the then Alexandria & Orange Railroad and was continued in the same service to 1921. The engine is typical of the best construction of simple stationary steam engines as they were built in 1864 and for many years thereafter.

The engine consists of a 12-inch diameter by 24-inch horizontal cylinder bolted to a rectangular box frame of cast iron mounted upon a low brick foundation. The crankshaft turns in one pillow block on the frame and an outboard bearing block, which is carried on a brick and timber base. The shaft carries a slender flywheel, 10 feet in diameter, and a wide face belt pulley, 6 feet in diameter. The flywheel and pulley turn in a pit between the frame and the outboard bearing. The cross-head guide is of the double-V type and is supported upon turned pillars rising from the frame. The valve is a long slide valve, H-shape in plan, and in effect a simple B-valve. It is driven from an eccentric on the shaft by a hook-and-latch eccen-

tric rod, which can be lifted out of engagement with the valve rod to permit the valve to be worked by a hand lever provided for that purpose. The speed of the engine was governed by a flyball throttling governor, driven from a pulley on the shaft through belts to a jack-shaft and then to the governor pulley.

#### WILLIAM MONT STORM ENGINE, 1865

U.S.N.M. no. 309195; original patent model; transferred from the United States Patent Office; not illustrated.

This model formed part of the application for the patent issued to William Mont Storm on July 11, 1865, no. 48777.

This is a 3-cylinder engine of a radial type, designed to produce rotary motion with compactness and simplicity.

The engine consists of two horizontal, opposed, single-acting cylinders and one vertical double-acting cylinder. The pistons of the horizontal cylinders are extended and joined to form a slotted crosshead in which one crank of the crankshaft moves. The piston in the vertical cylinder has a much shorter stroke and the piston rod from it extends to a second cross head and crank. D-slide valves are operated by a very small crank at the end of the crankshaft, in a valve chest located at the center of the engine. The engine is reversible.

#### WILLIAM SELLERS OSCILLATING ENGINE, 1872

U.S.N.M. no. 251296; original patent model; transferred from the United States Patent Office; not illustrated.

This model formed part of the application for the patent issued to William Sellers, of Philadelphia, Pa., June 11, 1872, Patent no. 127928.

This engine provides an oscillating engine valve gear capable of variable motion and an adjustable guide that relieves the piston-rod stuffing box of the wear and strain developed in rotating the crank.

The engine is operated by a plain D-slide valve that receives a constant motion, for giving a uniform lead, from the eccentric and a variable and reversible motion, for cutting off the steam at different portions of the stroke, and for reversing the movement of the engine, from the oscillation of the cylinder.

This is not the first oscillating engine in which the valve was operated by the combined motion of the eccentric and the movement of the cylinder.

The piston rod guide is a sleeve-like bearing cast in a piece with the cylinder head and surrounding but separate from the stuffing box. It is designed to prevent wear and leakage of the packing and permit oscillating engines to run at high speeds.

## HIRAM MAXIM PUMPING ENGINE, 1874

U.S.N.M. no. 308683; original patent model; transferred from the United States Patent Office; not illustrated.

This model was submitted with the application for the patent issued to Hiram S. Maxim, of New York, N. Y., December 22, 1874, no. 158105.

This model represents a steam engine, pump, and gas-fired boiler, equipped with automatic valves for maintaining the proper level of water in the boiler and for holding a steady pressure in the boiler by starting or stopping the burner. The combination is a steam-pumping unit intended to function automatically without the services of an attendant.

The engine is supported upon the boiler and consists of a rectangular bed, which serves as the pump suction chamber, upon which is the vertical pump cylinder and the pedestal that supports the flywheel and crankshaft journals and the oscillating steam cylinder. Within the base of the pedestal is a feed-water heater through which the exhaust from the engine passes. A float-operated, weighted, pin valve admits water to the boiler from the discharge pipe of the pump when the level in the boiler falls. The boiler is a cylindrical shell type with combustion chamber formed by water legs in the shape of a truncated cone. A ring burner for gas or kerosene is located in a cylindrical firepot within the combustion chamber. The fuel valve to the burner is held open by a spring and is closed by the pressure within the boiler exerted upon a diaphragm and lever. A hole through the valve permits a small pilot flame to burn at all times.

## THOMPSON AND HUNT STEAM ENGINE, c. 1875

## PLATE 13, FIGURE 2

U.S.N.M. no. 309645; model; gift of N. C. Hunt; photograph no. 19922.

This is a model of the widely used and very successful "Buckeye" engine developed by J. W. Thompson and Nathan Hunt about 1875. It was one of the first of the high-speed, variable cut-off ("automatic") engines of the modern type.

The engine is a horizontal, overhung crank engine with cross-head guides cast within a skeleton cylindrical projection of the cylinder. The valve is a hollow-piston slide valve, taking steam at the center and passing it through the hollow center of the valve to ports through the walls of the valve. A sleeve-like cut-off valve operates within the main valve to close the ports. The main valve is operated by a fixed eccentric on the crankshaft and the cut-off valve by a shifting eccentric, the position of which is varied by a centrifugal governor of the Thompson and Hunt type (see below).

## HIGGINSON STEAM ENGINE, 1877

U.S.N.M. no. 309194; original patent model; transferred from the United States Patent Office; not illustrated.

This model was part of the application for the patent issued to Andrew Higginson, of Liverpool, England, October 23, 1877, no. 196451.

The engine represented in the model is a radial reciprocating engine with three single-acting cylinders. The admission of steam and the exhaust are controlled by ports in the cylinder walls and in the piston.

A steam and an exhaust port in each cylinder wall are alternately connected to the space above the piston by being uncovered by a single port in the skirt of the piston. The piston oscillates in the cylinder to uncover either port, the direction of rotation of the crank determining which port is opened first. The engine, therefore, will run in either direction in which it is started. The "cylinders" and pistons are rectangular in section.

## VERTICAL STEAM ENGINE

U.S.N.M. no. 309685; model; gift of Robert E. M. Bain; not illustrated.

This is an operating model of a small, high-speed, vertical steam engine, of a type that has been widely used since about 1880 to furnish small powers for general use. They have had a wide application in driving small shops, electric generators, small mine hoists, and flour mills and in larger sizes for rolling mills. They have now been generally replaced by more modern engines and electric drives.

The model has a double-acting vertical cylinder supported on a tapering columnar frame with openings in the side to allow free access to all working parts within. The cross-head slide and bearings are cast with the column. A slide valve operates in a steam chest on the side of the cylinder and is driven by an eccentric on the shaft. The crankpin is carried in a counterbalanced crank disk. The engine in the model is direct-connected to a hoisting drum.

## BAKER STEAM ENGINE, 1878

U.S.N.M. no. 309246; original patent model; transferred from the United States Patent Office; not illustrated.

This model was submitted with the application for the patent issued to John G. Baker, of Philadelphia, Pa., September 10, 1878, no. 207936.

The model represents a small vertical single-acting engine in which the connecting rod is attached to the piston by a ball-and-socket joint, and the space enclosed within the cylinder and the face of the piston is alternately opened to the exhaust and to the steam pipes by rotating the piston laterally in the cylinder. The piston is rotated by a simple bent rod, one end of which turns and slides in an opening in the con-

necting rod, and the other end slides and turns in a socket in the skirt of the piston. Turning the piston causes two longitudinal grooves in the piston to register periodically with exhaust and steam ports in the cylinder wall.

#### MAYHEW DIAPHRAGM STEAM ENGINE, 1879

U.S.N.M. no. 308705; original patent model; transferred from the United States Patent Office; not illustrated.

This model was submitted with the application for the patent issued to Theophilus Mayhew, of New York, N. Y., July 8, 1879, no. 217392.

The engine consists of a hemispherical cuplike chamber over the concave opening of which is stretched a flexible diaphragm. This chamber connects to a valve chest in which a flat plate valve works over the intake and exhaust ports. A lever extends from the frame of the machine over the diaphragm upon which a projection of the lever rests. Inflation and deflation of the diaphragm by admitting and exhausting steam raise the lever and permit it to fall by its own weight. A system of cranks and springs actuated by the lever operates the valve. The engine was designed as a simple device for operating churns and similar machines.

#### GRAHAM STEAM ENGINE, c. 1880

U.S.N.M. no. 310898; model; presented by C. F. Germeyer; not illustrated.

This model is of a type of small oscillating steam engine designed and built by William Graham, of Carlisle, Pa., about 1880. Built in sizes of 5 to 10 horsepower, these engines were popular in central Pennsylvania for small shop power.

On the oscillating cylinder of the engine is a cylindrical valve chest containing a cylindrical rocking valve in the form of a "rolled-up" D-valve. The valve is rocked by the motion of the cylinder, through the action of an adjustable valve gear, which moves on a pivot fixed to the stationary base of the engine.

#### SCIPLE PORTABLE STEAM ENGINE, 1880

U.S.N.M. no. 308710; original patent model; transferred from the United States Patent Office; not illustrated.

This model was submitted with the application for the patent issued to Harry M. Sciple, Selinsgrove, Pa., February 10, 1880, no. 224481.

The model represents a small vertical steam engine designed to have the pedestal, cylinder, and steam chest cast in one piece for lightness of construction. The cross head and cross-head guides are located above the cylinder so that a connecting rod much longer than

is usual in these engines is employed. The valve is an oscillating valve operated from an eccentric on the shaft. The cross head does not have sliding faces but is guided by rollers attached to the cross head by pins. These rollers turn over one complete turn and back in each cycle of the piston.

#### FISKE OSCILLATING ENGINE, 1880

U.S.N.M. no. 308712; original patent model; transferred from the United States Patent Office; not illustrated.

This model was submitted with the application for the patent issued to William S. Fiske, of Stamford, Conn., August 24, 1880, no. 231551.

The model represents a vertical steam engine with an oscillating cylinder, circular slide valve, and hollow cylinder trunnions for the admission and exhaust of steam. Steam is admitted to the center of the annular valve through the adjacent trunnion. The exhaust is conveyed from the valve seat around the cylinder in a hollow band cast on the cylinder for that purpose and leaves the engine through the opposite trunnion. The valve is driven by an eccentric on the shaft. The valve rod is provided with a cross head moving in a guide on the cylinder and oscillating with it. The eccentric rod carries a pin that slides in a curved slot in the cross head and produces an even motion of the valve thereby.

#### MARINE WALKING BEAM STEAM ENGINE, 1888

U.S.N.M. no. 310311; model; gift of Andrew L. Weis; not illustrated.

The model represents a typical American river paddle-wheel steamboat engine of the late nineteenth century. A piston operating in a vertical steam cylinder works upon one end of a walking beam overhead, while a long connecting rod works from the other end of the beam directly upon the crank in the paddle-wheel shaft. The model was made by Frank N. Weis, an assistant engineer on the Maumee River steamboat *Chief Justice Waite* and is presumed to represent the engine of that boat.

The beam of the engine is supported between bearings at the tops of two tall cast-iron A-frames, which in the steamboat would rest directly upon box-girder keelsons in the hull. The steam cylinder stands between the forward legs of the A-frames. Forward of the cylinder are two columnar pipes bolted to horizontal valve chests above and below, which join the pipes but are not connecting. Each valve chest is divided at the center so that one pipe and its side of both the upper and lower valve chest form the steam-supply passage, while the other pipe and its side of the valve chests form the exhaust passage connected to the condenser located below and aft of the cylinder.

The valves are vertical poppet valves with stems projecting upward from the valve chests. The valve stems are fixed to short arms attached to vertical lifting rods fitted with "long-toe" followers, or cams, which ride upon similar tappet cams operated by eccentric rods from eccentrics on the paddle-wheel shaft. There are two eccentric rods, one on either side of the cylinder, one of which operates the steam valves, the other the exhaust valves. The rods are hook-ended and work through stirrups, which when raised disengage the rods from the valve camshafts. A lever is provided to work the valves by hand in maneuvering.

#### FIRST STANLEY STEAM AUTOMOBILE ENGINE, 1897

##### PLATE 14, FIGURE 1

U.S.N.M. no. 310524; original; gift of the Mason Regulator Co.; photograph no. 9872A.

The Mason Regulator Co. built this engine for the first steam automobile constructed by F. E. and F. O. Stanley in 1897. It is a 2-cylinder engine with cylinders, cross-head guides, and crankshaft bearings bolted to a wide flat bedplate. The valves are piston slide valves with separate steam chests and are operated by individual eccentrics and simple Stephenson valve gears. The bore is  $2\frac{1}{2}$  inches; the stroke is 4 inches.

The engine has the original bronze cylinders that were used on the engine when it was first tested by the maker. These were removed and cast-iron cylinders substituted for actual use in the automobile.

#### WESTINGHOUSE JUNIOR AUTOMATIC ENGINE, c. 1900

##### PLATE 14, FIGURE 2

U.S.N.M. no. 309924; original; from the Mengel Co.; photograph no. 32583B.

The original Westinghouse engine of this type was one of the earliest of the modern small high-speed steam engines designed for small powers and auxiliary drives. This particular engine was used for about 25 years to drive a lighting generator on an Ohio River steamboat.

Some of the characteristics of this engine have been incorporated in the present-day internal combustion engines of the automobile type. It is a 6-by-5-inch, 2-cylinder, vertical, single-acting engine, with cylinders cast in a block and a bolted-on closed crankcase. A piston slide valve operates in a cylindrical steam chest cast across the tops of both cylinders. The valve is driven from an eccentric through a short, ball-jointed connecting rod and bell crank. The eccentric is carried in the weighted lever of a flywheel governor.



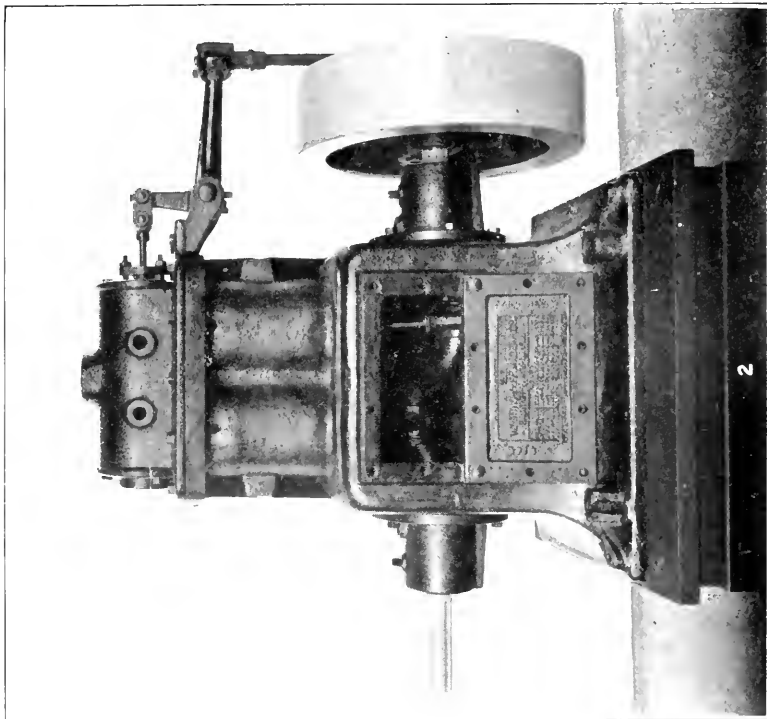

6764R

SMALL MULTICYLINDER STEAM ENGINES

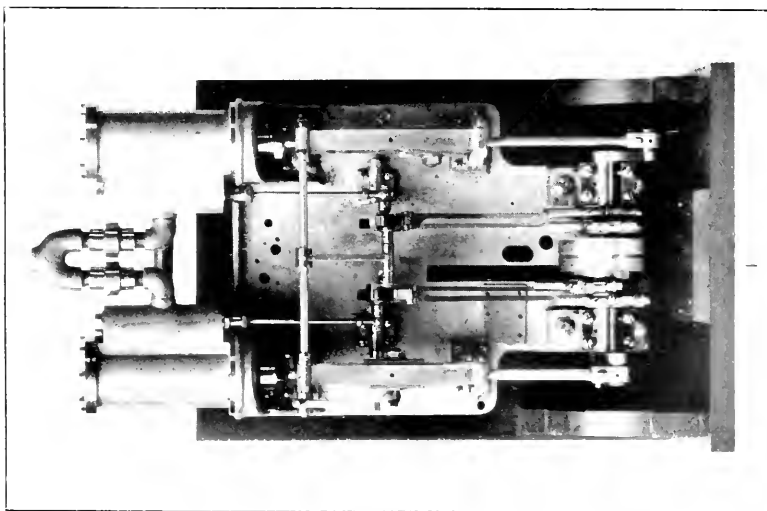

677A

1. First Stanley steam automobile engine, 1897 (U.S.N.M. no. 310524). See p. 51.  
2. Westinghouse Junior automatic engine, c. 1900 (U.S.N.M. no. 309974). See p. 41.

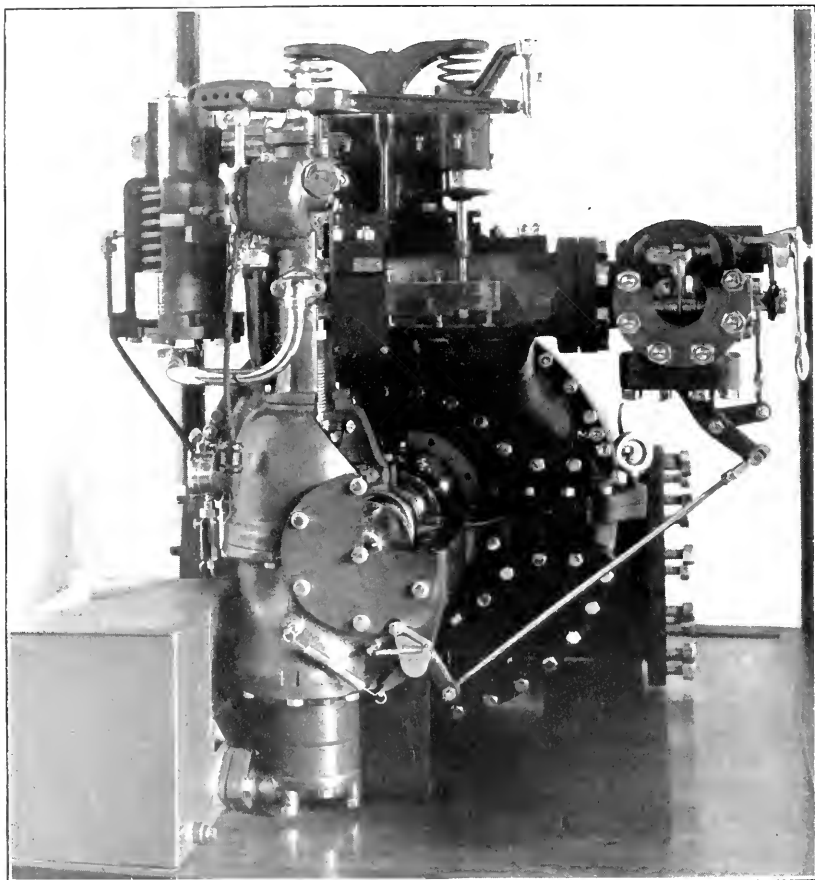

THREE-STAGE STEAM TURBINE, 1926-1930.  
Cutaway (U.S.N.M. no. 309881). See p. 57.

39036A

Lubrication is effected by the splash of the cranks in a layer of oil that floats on water in the crankcase. The throws of the crank are formed by bends in the crankshaft. The engine has the manufacturer's number 2909.

#### AUTOMOBILE STEAM ENGINE, 1901

U.S.N.M. no. 307387; original; gift of Louis S. Clarke; not illustrated.

This is a light 2-cylinder, high-pressure, reversible steam engine of the type used in the early Locomobile automobile.

The engine consists of two vertical double-acting cylinders,  $2\frac{1}{2}$  inches in diameter by 4 inches stroke, cast with a valve chest joining them. An ordinary D-slide valve for each cylinder is operated by a separate Stephenson link motion with two eccentrics for each. A lever and bell crank shifts the two links together. The two cranks are at the extreme ends of the crankshaft and overhang the bearings. The crankshaft and crankpin bearings are provided with roller bearings. The power is taken from the engine by a chain from a 12-tooth sprocket at the center of the engine shaft. A boiler feed pump bolted to the frame is operated by a rocking lever actuated by a pin on one cross head. The engine usually operated on a steam pressure of 150 pounds per square inch, though the boiler safety valves were frequently set as high as 240 pounds per square inch.

#### STANLEY STEAM AUTOMOBILE ENGINE, c. 1923

U.S.N.M. no. 310537, original, gift of Laurence J. Hathaway, not illustrated.

This engine is one of the last type built by the Stanley Automobile Co. It is a 2-cylinder engine of 4-inch bore and 5-inch stroke, nominally rated at 20 horsepower. The engine would actually develop 155 horsepower at 600 pounds per square inch pressure,  $200^{\circ}$  superheat and 80 percent cutoff at 600 revolutions per minute.

### ROTARY STEAM ENGINES

#### BAKER AND BALDWIN ROTARY STEAM ENGINE, 1839

U.S.N.M. no. 308647; original patent model; transferred from the United States Patent Office; not illustrated.

This model was submitted with the application for the patent issued to William H. Baker and Samuel H. Baldwin, of Cohoes, N. Y., August 21, 1839, no. 1295.

This is an early example of a steam engine in which two cams turn together in a closed casing so that steam admitted to the casing will force apart abutments on the cams and cause the cams and the shafts on which they are mounted to turn. This engine may also be used as a pump.

## MILLER ROTARY STEAM ENGINE, 1859

U.S.N.M. no. 251294; original patent model, transferred from the United States Patent Office; not illustrated.

This model was submitted with the application for the patent issued to Charles Miller, of Belleville, Ill., May 3, 1859, no. 23852.

The engine has two oval pistons or cams each running in a separate circular cylinder or casing. Sliding abutments in the casing bearing on the edges of the cams direct the steam in the forward direction around the casing. Admission of steam is controlled by two flat slide valves working in steam chests on top of the casing. The valves are operated by two eccentrics on the engine shaft. The engine is reversible.

## JAMES PLATT ROTARY STEAM ENGINE, 1862

U.S.N.M. no. 251292; original patent model; transferred from the United States Patent Office; not illustrated.

This model was submitted with the application for the patent issued to James Platt, of Utica, N. Y., April 15, 1862, no. 34981.

The engine consists of a rotating cylinder in the form of a hollow ring within which are a stationary abutment face and two pistons. The pistons are caused to move by the force of the steam admitted between the face of the abutment block and each piston in turn as it comes around. The cylinder turns with the pistons, and the power shaft is bolted to the cylinder. A stationary cam causes the pistons to move in and out in a radial direction so that they will clear the abutment as they approach it from the back during each revolution.

## GABRIEL ROTARY STEAM ENGINE, 1867

U.S.N.M. no. 309196; original patent model; transferred from the United States Patent Office; not illustrated.

This model was submitted with the application for the patent issued to Matthias Gabriel, of Newark, N. J., August 6, 1867, no. 67527.

The engine represented in the model is one of a great many similar designs for rotary steam engines, in which a vane or paddle on a rotary drum fits closely in the annular chamber between the drum and an outer casing and is driven around the chamber by the pressure of steam expanding between the paddle and an abutment that temporarily closes the chamber back of the paddle.

This engine has two sliding abutments, which are moved in (to close the chamber) and out (to clear the paddle as it passes) by means of a cam on the shaft of the engine and a system of followers and yokes. A plain D-slide valve is operated by pinions and rack from an eccentric on the shaft. Two expansions per revolution are obtained.

## REILY AND WALDO ROTARY ENGINE, 1875

U.S.N.M. no. 309192; original patent model; transferred from the United States Patent Office; not illustrated.

This model was submitted with the application for the patent, issued to Henry Reily and P. G. Waldo, of Pennsylvania, September 28, 1875, no. 168184.

The engine represented by the model is one of the large class of rotary steam engines in which a rotating drum forms an annular chamber with a larger cylindrical housing, within which a driving-head bolted to the drum is forced around the annular space by the expansion of steam between the movable driving head and a stationary abutment projecting into the annular space. The engine is provided with two stationary abutments so that two expansions may be obtained in one revolution of the driving head. The method of controlling the admission of steam and the device for withdrawing the stationary abutments to permit the passage of the driving head are the peculiar features of this particular engine.

## SCHOFIELD ROTARY ENGINE, 1876

U.S.N.M. no. 309193; original patent model; transferred from the United States Patent Office; not illustrated.

This model was submitted with the application for the patent issued to Frederick F. Schofield, of Oscoda, Mich., September 19, 1876, no. 182291.

This is a rotary engine in which the outer casing rotates and acts as both flywheel and belt pulley. Otherwise it does not differ materially from the many other rotary engines in which an annular space between a casing and a drum is divided by movable abutments in the outer casing, and is traversed by a driving head on the drum. In this case the drum is held stationary and the abutments in the casing are driven around by the pressure between the abutments and the head on the drum.

## THREE-STAGE STEAM TURBINE, 1926-1930

## PLATE 15

U.S.N.M. no. 309881; original; gift of the General Electric Co.; photograph no. 39036A.

This is a modern steam turbine of the General Electric-Curtis type, designed for auxiliary drives and small powers requiring 50 to 100 horsepower, at 500 to 7,600 revolutions per minute, using steam at pressures of 100 to 400 pounds per square inch. The turbine is cut away to show the details of construction and operation.

In this turbine steam expands from boiler pressure to exhaust pressure in three steps or stages, in the nozzles of a nozzle plate, the first diaphragm and a second diaphragm. Following both the nozzle plate and the first diaphragm are three rows of blades or buckets consisting of two movable rows attached to the rotor of the turbine and one row of intermediate buckets attached to the turbine casing. Only one row of movable blades is provided after the second nozzle diaphragm. The steam expands in the nozzles in each stage with a resulting increase in the velocity of the steam. As the steam issues with great velocity from the nozzles it impinges on moving blades, which are curved in the direction of the path of the steam flow. Through the interaction of the forces necessary to change the direction of the path of the steam, energy is imparted to the movable blades causing the rotor to turn as well as reducing the velocity of the steam. This process is repeated in each stage until the pressure of the steam is reduced to the exhaust pressure.

Steam is admitted to the first nozzle through a set of conical lift valves, so arranged that they open in sequence as the load on the turbine increases. This method permits the sensitive control of the steam flow with a much smaller throttling loss than would occur with a single large valve. The valves are operated by oil-driven pistons and are controlled by a centrifugal governor, a small synchronous governor, and a hand speed-control adjustment. The speed regulation of the turbine is very close. The turbine is equipped with emergency steam valve, oil pump, cooler, and filter.

#### VACUUM VAPOR POWER PLANT, 1933

U.S.N.M. no. 310651; original, gift of the Cochrane Corporation; not illustrated.

The miniature vapor turbine power plant, designed by G. H. Gibson, utilizes the difference in temperature generally existing between that indicated by an ordinary (dry bulb) thermometer and that by a thermometer the bulb of which is kept wetted by a wick dipping into water (wet bulb). The "plant" is made of glass and consists of a boiler, which is a spiral of bare glass tubing in which vapor is generated by the heat in the surrounding atmosphere, a nozzle through which the vapor jets upon the buckets of a tiny turbine wheel mounted on jeweled bearings, and a condenser, which is also a spiral of glass tubing covered and cooled by wetted wicking. The condensate returns to the boiler by gravity. In an ordinary atmosphere the turbine will spin indefinitely as long as the wick is kept moist.

The leading dimensions and design data are as follows :

Boiler heating surface.....	1.88 sq. ft.
Condenser surface.....	1.25 sq. ft.
Temperature difference assumed between wet and dry bulbs.....	10° F.
Temperature difference between steam in boiler and steam in condenser.....	3° F.
Difference in steam pressures.....	1 in. water col.
Spouting velocity.....	600 ft. per sec.
Diameter of nozzle.....	0.102 in.
Rate of steam flow.....	0.004 lb. per hr.
Horsepower of jet.....	0.000016.
Rankine cycle efficiency.....	1 percent.

The designer points out that a difference of wet bulb and dry bulb temperature always exists except in "saturated" atmospheres. In homes during winter months and in arid climates the difference may be as much as 20°. This figure is comparable with the temperature range between sea water at great depths and at the surface, which Claude's deep-sea thermal plant seeks to utilize and upon which vast sums of money have been expended.

#### ADDITIONAL STEAM ENGINE MATERIAL IN THE COLLECTIONS, NOT DESCRIBED

Heron's rotary steam engine (aeolipile), model deposited by the U. S. Department of the Interior, 1906. U.S.N.M. no. 244887.

Papin's steam engine, model, deposited by the U. S. Department of the Interior, 1906. U.S.N.M. no. 244888.

Solomon de Caus' steam fountain, 1615; photographic transparency, made in the Museum, 1926. U.S.N.M. no. 308463.

Thomas Savery's steam pumping engine, 1698; photographic transparency; made in the Museum, 1926. U.S.N.M. no. 308467.

Steam engine, patent model, transferred from the U. S. Patent Office, 1926. Patent issued to G. W. Van Deren, August 14, 1860; Patent no. 29642. U.S.N.M. no. 308663.

Steam engine, patent model, transferred from the U. S. Patent Office, 1926, not identified. This is a curious form of engine in which the cylinder revolves on the crank and the piston rod is directly connected to the rim of the flywheel. U.S.N.M. no. 308727.

Marine steam engines; models, made by Frank A. Wardlaw and presented by Frank A. Wardlaw, Jr. Three finely made small models of a 1-cylinder, a compound, and a triple expansion, vertical reciprocating marine engine. U.S.N.M. no. 310587.

Steam engine and boiler, model, presented by Walter N. Willis. The model represents an engine with a pear-shaped cam on the shaft in lieu of a crank. A patent on this mechanism was issued to the donor, November 20, 1883, Patent no. 288684. U.S.N.M. no. 310625.

Static pressure turbine element, model, presented by Oscar N. Davis. This is an experimental demonstrating model of an element of a turbine, which was the subject of Patent no. 1952197, issued to the donor, March 27, 1934. U.S.N.M. no. 310824.

Triple expansion steam engine, model (incomplete), presented by Mrs. R. F. M. Bain. U.S.N.M. no. 310837.

Flat panel model of a beam steam engine, made of lead fitted in a wooden case. Not identified. U.S.N.M. no. 308730.

#### MILLER MERCURY MOTOR, 1877

U.S.N.M. no. 308696; original patent model; transferred from the United States Patent Office; not illustrated.

This model was submitted with the application for the patent issued to Thomas Davidson Miller, of Pittsburgh, Pa., November 6, 1877, no. 196759.

The model represents a boiler, a condenser, and an overshot wheel, connected with suitable piping so that mercury placed in the boiler will be sublimated there and the fumes will rise to the condenser where they will be condensed. From the condenser the liquid mercury runs over the buckets of the wheel where the weight of the mercury is employed in turning the wheel. Suitable sheathing about the wheel collects the mercury and returns it to the boiler, which it enters by reason of its weight.

#### STEAM-ENGINE VALVES AND VALVE GEARS

In 1769 James Watt discovered that a saving in steam could be effected in a steam engine by cutting off the supply of steam early in the stroke and permitting the steam to complete the stroke expanding. This principle was first used practically in 1776 and was patented in 1782. After about 1800 many valves and valve gears were developed to permit the steam to be cut off at any point in the stroke. These took the various forms of separate steam valves that could be closed at any time relative to the position of the piston and the exhaust valves; valve gears to vary the cut-off by varying the valve actuating mechanism relative to the position of the engine crank; and independent cut-off valves that operated to cut off the supply of steam to nonvariable valves of simple forms. All these in their original form were set by hand for the most economical cut-off for the speed and load at which the engine was to operate. In 1834 Zachariah Allen constructed one of the earliest forms of valve gears in which an engine governor was used to determine the point at which an independent cut-off valve would cut off the supply of steam. The next step was the invention of the drop cut-off, or detachable valve gear, in which a poppet steam valve was raised by a catch that could be thrown out at the proper moment by a wedge or some other detaching device with which it came in contact as it rose with the opening valve. The wedge was adjustable so that the valve could be detached and let fall to its seat at any point in the stroke. The invention of this device is generally credited to Frederick E. Sickels, who patented it in 1841 (see below), though Peter Hogg, of New York, N. Y., also claimed the invention. The drop cut-off provided



a quick, sharp cut-off that could be varied without interference with the other valve events. At first it was designed only for hand adjustment of the detaching device. In 1849 George H. Corliss patented the first valve gear in which the drop cut-off was combined with and controlled by the engine governor (see below). This invention with its subsequent refinements was very widely adopted by engine builders throughout the world and has very substantially affected the design of steam engines down to the present time. It has been said of the Corliss valve gear that "no other device has given greater prestige to American engineering."

The Corliss inventions and engines represented in the Museum collection are grouped together at the end of this title.

#### SICKELS DROP CUT-OFF VALVE GEAR, 1841

U.S.N.M. no. 308650; original patent model; transferred from the United States Patent Office; not illustrated.

This model was part of the application for the patent issued to Frederick E. Sickels, of New York, N. Y., May 20, 1842, no. 2631.

The Sickels valve gear is generally considered to be the first successful and practical drop cut-off. It was widely used on the engines of the side-wheel steamboats up to the beginning of the present century and was the forerunner of the many subsequent designs of drop cut-off valve gears. This valve gear provides a means of rapidly cutting off the admission of steam to the cylinder of the engine at any point in the stroke of the piston. It accomplishes this by tripping or disengaging the valve from the valve gear and permitting it to drop to its seat under the impulse of a spring. A plunger operating in a water chamber gradually retards the falling valve and brings it to rest without shock.

The Sickels valve is of the conical or poppet type, working vertically with the valve stem directed upward. Motion is transmitted to the valve through a lift rod working up and down continuously parallel to the valve stem. Spring clips on the lift rod engage with the projections on the valve stem and lift and open the valve, until the clips come into contact with wedge-shaped blocks, which spread the clips and permit the valve to fall back to its closed position. The wedge-shaped disengaging block can be placed so as to cause the valve to disengage and close at any desired instant during the up or down movement of the lift rod. A spring bearing upon the top of the valve stem causes it to close rapidly, while a plunger or piston attached to the under side of the valve and working in a chamber of water retards the valve gradually and permits it to close without shock. The lift rod may be actuated by an eccentric or, as was more usually the case, by cam and follower of the "alligator jaw" or steamboat type of gear.

## SICKELS DROP CUT-OFF VALVE GEAR, 1841

## PLATE 16, FIGURE 1

U.S.N.M. no. 180973; model; deposited by Frederick E. Sickels; photograph no. 32595.

This is a nicely made brass duplicate of the original Patent Office model (see above) of the Sickels valve gear, deposited in the Museum by Frederick E. Sickels, the inventor, in 1891.

The Museum has a certificate (U.S.N.M. no. 180974), dated April 8, 1891, stating "that the annexed (this model) is a duplicate of the model filed in the matter of the Letter Patent granted to Frederick E. Sickels, May 20, 1842 for Improvement in Lifting, Tripping and Regulating the Closing of Steam Valves." This is signed by C. E. Mitchell, Commissioner of Patents, and sealed with the seal of the Patent Office.

## ALLEN ADJUSTABLE CUT-OFF VALVE GEAR, 1841

## PLATE 16, FIGURE 2

U.S.N.M. no. 308649; original patent model; transferred from the United States Patent Office; photograph no. 32595B.

This model was submitted with the application for the patent issued to Horatio Allen, of New York, N. Y., August 21, 1841, no. 2227.

This is a very early example of an adjustable riding cut-off valve in which the riding valve is formed in two parts provided with a suitable mechanism to vary the distance between the two parts and thus vary the cut-off.

The model represents a double-acting, horizontal, direct-connected engine with flat slide valve and riding cut-off valve driven by separate eccentrics on the crankshaft. The model is of a section through the cylinder and valve chest of the engine. The model shows a long D-slide valve with ports through a projection of the valve instead of the usual steam edge. Steam is admitted and cut off through these ports, which are opened and closed by the riding valve. The main valve operates as a simple slide valve, while the riding valve performs the function of cutting off the steam. The riding valve is in two parts carried on a rod threaded through lugs on the valves with one right-hand and one left-hand thread, so that turning the rod moves the parts of the valve away from or toward each other. The farther apart the two parts are, the earlier the cut-off will occur. A bevel gear and spline on the threaded rod permits the adjustment to be made without stopping the engine.

The patent refers to other ways of obtaining an adjustable cut-off and suggests that the second eccentric be dispensed with and motion for the riding valve be taken directly from the engine cross head.

The inventor refers to his invention as an improvement on the Isaac Adams riding cut-off valve patented in May 1838.

## ALLEN CUT-OFF VALVE, 1842

U.S.N.M. no. 308640; original patent model; transferred from the United States Patent Office; not illustrated.

This model was submitted with the application for the patent issued to Horatio Allen, of New York, N. Y., April 30, 1842, no. 2597.

The model represents a valve gear in which separate steam chests are employed for the head-end and crank-end main steam valves. The supply of steam to each of these steam chests is controlled by additional cut-off valves, the movement of which is adjustable. The inventor refers to this invention as an improvement in the valve gear patented by him August 21, 1841 (see U.S.N.M. no. 308649, p. 62).

The model shows a portion of the cylinder of a horizontal engine with only the piston rod and cross head represented. A steam chest in which are located the ports leading to the inner or main steam chests is shown in section, revealing the cut-off valves on their seats. These cut-off valves are plain flat plates connected to opposite ends of a beam, which receives a vibratory motion from the cross head of the engine. The beam and its rock shaft are pivoted in a lever by which the pivot can be moved and the time of cut-off varied. This the inventor calls "cut-off with movable rock shaft." He suggests that a similar result can be obtained by constructing the cut-off ports in a movable plate which he calls "cut-off with single adjustable seat."

## ALLEN CUT-OFF VALVE GEAR, 1848

U.S.N.M. no. 308643; original patent model; transferred from the United States Patent Office; not illustrated.

This model was submitted with the application for the patent issued to Horatio Allen, of New York, N. Y., August 29, 1848, no. 5745.

This is an adjustable drop cut-off valve gear in which a poppet valve is raised by a lift rod but is permitted to return to its seat sooner or more rapidly than the lift rod returns.

The model represents a poppet steam valve raised from its seat by an arm fixed at right angles to a lift rod, which works vertically and parallel to the valve stem. Upon the face of the arm is a movable block a part of the upper surface of which is parallel to the face of the arm and a part of which is a steep curve. All the movement of the valve is transmitted to it through a roller on its stem, which rolls on the surface of this block. The block is so linked with a vibratory rod, which receives its motion from the cross head of the engine, that the block will move along the face of the lift rod arm and bring different points of its surface under the roller of the valve stem. By proper adjustment the roller will rest upon the flat part

of the block and move with the lift rod as it is rising and the valve is opening, then the block moves so that the roller comes to the edge of the inclined portion and rolls down the incline permitting the valve to drop more quickly than the lift rod. The movement of the block on the arm and consequently the point of cut-off are fully adjustable.

#### SICKELS TRIPPING CUT-OFF VALVE, 1852

U.S.N.M. no. 308654, original patent model; transferred from the United States Patent Office; not illustrated.

This model was submitted with the application for the patent issued to Frederick E. Sickels, of New York, N. Y., February 24, 1852, no. 8760.

The model represents a valve chest and drop cut-off valve of the Sickels type (see above) in which an adjustable cam operates the catch during the opening movement of the valve so that the valve may be released as near the beginning of the closing movement as is desired. In the earlier cut-offs the catch was operated by the closing movement alone, and the valve could not be tripped until sufficient closing movement had taken place to operate the whole extent of the catch.

#### UHRY AND LUTTGENS VALVE GEARING, 1855

U.S.N.M. no. 308656; original patent model; transferred from the United States Patent Office; not illustrated.

This model was submitted with the application for the patent issued to H. Uhry and H. A. Luttgens, of Paterson, N. J., March 20, 1855, no. 12564.

The model represents a "link motion" applicable to marine, locomotive, or stationary steam engines. It is a combination of three eccentrics, the ordinary Stephenson link motion, an additional link pivoted to the Stephenson link, a differential rocker, and a main rocker. The main rocker and the Stephenson link operate one valve, which distributes steam to the cylinder, supplies outside lead, and cuts off the steam in proportion to the decrease of travel. The valve operated by the differential rocker exhausts the steam and opens and cuts off the admission of steam near full stroke of the piston.

#### ALLEN TWO-MOTION CONE-VALVE, 1855

U.S.N.M. no. 308655; original patent model; transferred from the United States Patent Office; not illustrated.

This model was submitted with the application for the patent issued to Horatio Allen, of New York, N. Y., June 19, 1855, no. 13075.

The model represents a conical plug valve, connected to a valve gear, which gives it two distinct motions. The first motion is a slight one parallel with the axis of the cone and directed toward its larger end; the other is in a direction tending to rotate the valve. Because the valve and valve seat are conical, the first motion effects a very slight separation of the valve from its seat and permits the rotary motion to be given without friction upon those parts.

#### WIEGAND VARIABLE ECCENTRIC, 1857

U.S.N.M. no. 308659; original patent model; transferred from the United States Patent Office; not illustrated.

This model was submitted with the application for the patent issued to S. Lloyd Wiegand, of Philadelphia, Pa., September 29, 1857, no. 18311.

The model represents an eccentric for operating the valves of a steam engine. It is carried on a section of the engine shaft, which is oblique to the axis of the shaft and free to slide along the shaft. The eccentric is held so as not to move along the shaft, but the oblique slide passes through the eccentric disk. The position of the slide on the shaft determines the amount of "throw" that will be given to the eccentric and, correspondingly, the length of stroke of the valve.

#### ALLEN CUT-OFF VALVE GEAR, 1857

U.S.N.M. no. 308657; original patent model; transferred from the United States Patent Office; not illustrated.

This model was submitted with the application for the patent issued to Horatio Allen, of New York, N. Y., December 15, 1857, no. 18837.

The model represents a valve gear in which the steam valve is raised by means of a loose toe on a rock shaft and returned to its seat by lowering or by tripping the loose toe. This particular invention is an improvement on the valve gears of this type patented February 6, 1849, by Horatio Allen and December 10, 1850, by Samuel H. Gilman. It provides a piston or plunger in a chamber containing oil or water connected to the loose toe to control its fall.

The model shows a vertical valve rod tappet raised and lowered by a loose toe on a rock shaft located below the tappet. The toe is raised by a latch that engages with an arm fixed to the rock shaft so that the motion of the toe is the same as if it were keyed to the shaft. An adjustable disengaging lug is provided that may be set to trip the latch so that the toe will swing freely on the rock shaft and fall, permitting the valve to close. This lug is set by a screw and hand wheel to provide cut-off at any point. Attached to the loose toe is a plunger that operates to force a fluid through an adjustable orifice in a dash pot whereby the fall of the loose toe is controlled.

## WOODBURY VALVE GEAR, 1859

U.S.N.M. no. 308644; original patent model; transferred from the United States Patent Office; not illustrated.

This model was submitted with the application for the patent issued to D. A. Woodbury, of Rochester, N. Y., April 19, 1859, no. 23737.

The model represents two rotary main steam valves permanently connected to and operated with a regular movement by an eccentric on the crankshaft. Between each steam valve and the steam chest is a rotary cut-off valve operated by the same eccentric but fitted with a sliding link by which the position of the cut-off valve relative to the eccentric position may be varied without disengaging the valve gear or stopping the engine. This link and with it the time of cut-off may be changed by hand or by the operation of an engine governor.

## FRANCIS B. STEVENS CUT-OFF, 1861

## PLATE 17, FIGURE 1

U.S.N.M. no. 308644; original patent model; transferred from the United States Patent Office; photograph no. 846A.

This model was submitted with the application for the patent issued to Francis B. Stevens, December 3, 1861, no. 33855.

The valve gear represented is an improvement of the Robert L. and Francis B. Stevens valve motion, which was patented January 25, 1841. It involves the introduction of adjustable hinged pieces on the tops of the "long toe" tappets that operate the valves for the purpose of rapidly opening the exhaust valves and for varying the point at which the steam valves will be closed.

The valve gear consists of a main rock shaft to which are keyed four long, curved tappets each of which engages with a shoe or follower on a valve lift rod, which it raises and lowers as the rock shaft is worked with a vibratory motion by an eccentric on the engine crankshaft. The two tappets that work the lift rods of the exhaust valves are the same length and attached to the shaft at the same angle as those that operate the steam inlet valves, but the exhaust valves are prevented from closing too soon and the steam valves are caused to close whenever desired by the combination of hinged faces on the tappets and a second hollow rock shaft fitted with lugs or small cams, which raise the hinged pieces and change the movement of the followers on the lift rods. The hinged pieces on the tappets are hinged at the toes of the tappets and are lifted from the heels of the tappets by the lugs on the hollow rock shaft, placed over the main rock shaft and worked by another eccentric, which in the earlier Stevens gear works the exhaust valves.

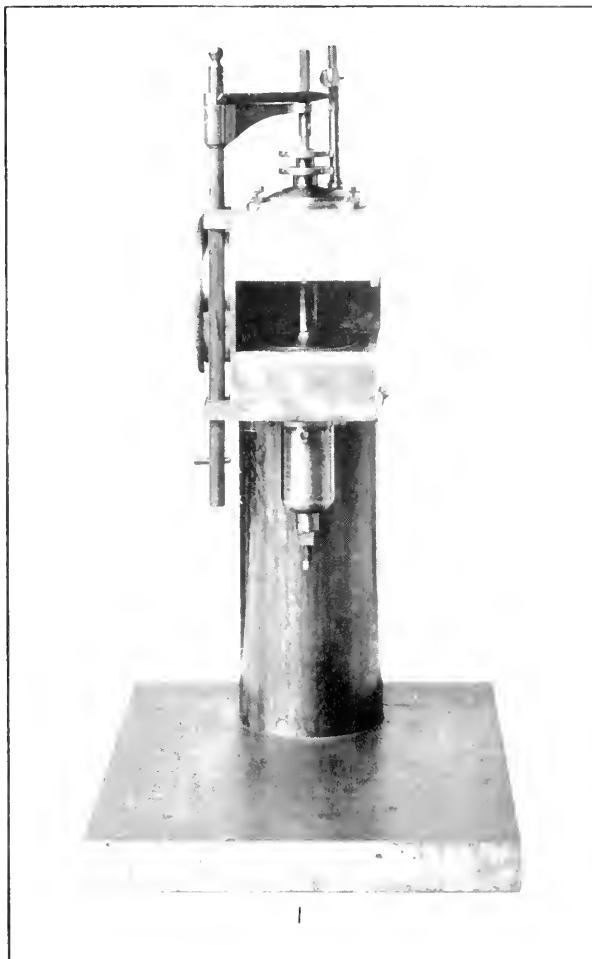

32595

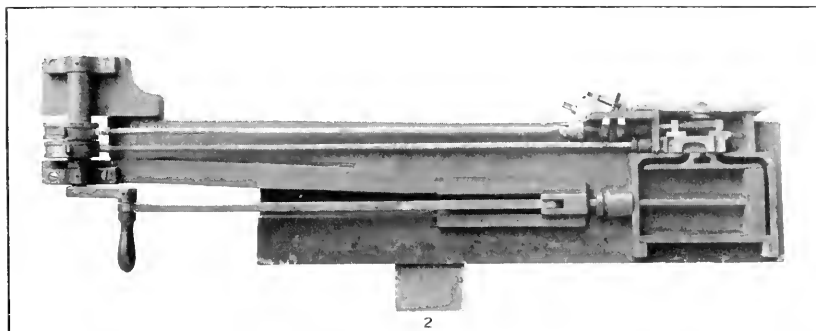

32595B

## ADJUSTABLE CUT-OFF VALVE GEARS.

- 1 Sickels drop cut-off valve gear, 1841 (model; U.S.N.M. no. 180973). See p. 62.
2. Allen cut-off valve gear, 1841 (model; U.S.N.M. no. 308649). See p. 62.

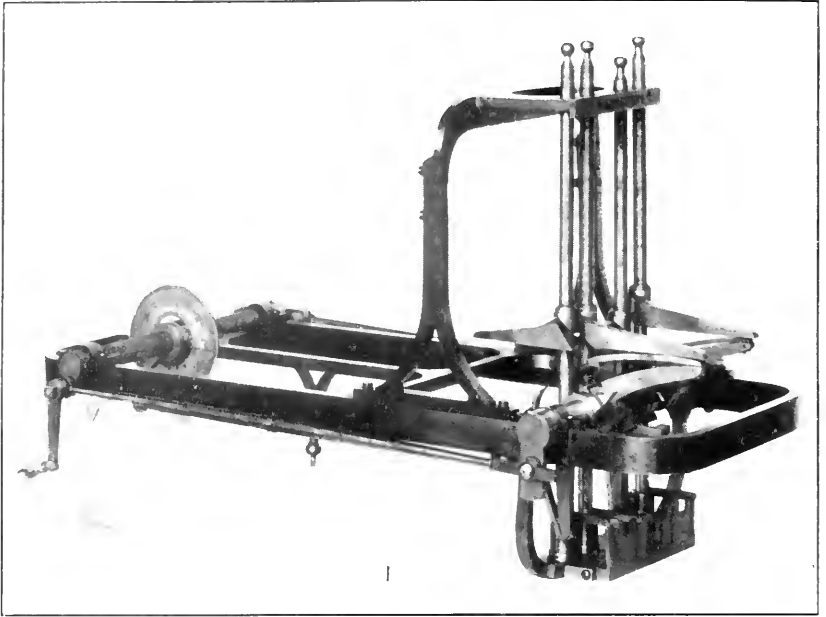

846A



31694

ADJUSTABLE CUT-OFF VALVE GEARS.

1. Francis B. Stevens cut-off, 1861 (model; U.S.N.M. no. 308644). See p. 66.
2. Corliss drop cut-off valve gear, 1849 (model; U.S.N.M. no. 308646). See p. 71.



## CARHART BALANCED VALVE, 1866

U.S.N.M. no. 308671; original patent model; transferred from the United States Patent Office; not illustrated.

This model was submitted with the application for the patent issued to John W. Carhart, of Troy, N. Y., March 27, 1866, no. 53410.

The model represents a conical plug valve with an annular exhaust space between the plug and the valve and a steam passage through the hollow core of the plug. The peculiar feature of the valve is the provision of recessed annular spaces in the valve, which, with the valve seat, form small pistons and cylinders designed to balance the valve longitudinally when connected to the steam passages. Screw adjustments on the valve stem and the small end of the valve are provided for setting the valve in a position giving proper contact with the minimum of friction.

## BABCOCK AND WILCOX VALVE GEAR, 1866

U.S.N.M. no. 308673; original patent model; transfer from the United States Patent Office; not illustrated.

This model was submitted with the application for the patent issued to G. H. Babcock and S. Wilcox, Jr., of Providence, R. I., April 24, 1866, no. 54090.

The valve gear represented by the model is an early governable one of the class of riding cut-off valves in which the riding valve is operated by a small independent auxiliary steam cylinder, equipped with its own steam valve. The valve controlling the admission of steam to the auxiliary steam cylinder is in turn controlled by the action of the engine governor.

The main valve of the engine is a flat lap valve, machined top and bottom with mortises through the valve near each end. The valve functions as a common D-valve admitting steam through the mortises instead of at its ends. Solid cut-off valves working on the back of the main valve, over the mortises, are joined by a rod, which passes through a small auxiliary steam cylinder and at the middle of which within the cylinder is the small actuating piston. The valve of the auxiliary cylinder is operated transversely across the cylinder by an eccentric on the end of a lay shaft. This shaft revolves at the same speed as the crankshaft and the main-valve eccentric, but its position at any time relative to the main-valve eccentric is determined by the governor, as follows:

The lay shaft is divided into two shafts, one driving, the other driven. The connection between the two is maintained by means of a driving bevel gear on the driving shaft, an intermediate idling bevel gear, and a driven bevel gear on the driven shaft. Though

the driving and driven shafts turn in opposite directions, they turn with the same relative positions so long as the intermediate gear remains in one position. However, the axle of the intermediate gear is pivoted about the driving shaft and is held in position only by the governor rod, and the position of the intermediate gear changes with each change of position of the governor rod. A change in position of the intermediate gear advances or sets back the position of the driven shaft relative to the driving shaft and varies the action of the auxiliary steam valve relative to the action of the main-valve eccentric.

#### RICHARDS BALANCED VALVE, 1866

U.S.N.M. no. 308676; original patent model; transferred from the United States Patent Office; not illustrated.

This model was submitted with the application for the patent issued to Thomas Richards, of Lansingburg, N. Y., May 22, 1866, no. 54959.

This model represents a slightly conical plug valve fitted within a conical valve housing, which is provided with eight equally spaced steam ports so arranged that diametrically opposite ports are connected together in pairs. The result is that the pressure on the valve due to the steam or exhaust pressure in each pair of ports is perfectly balanced.

Three adjoining ports in the valve housing are continued through the housing, which is provided at that point with a flat surface that permits the valve to be placed against the ordinary valve seat of a D-slide valve engine, the three ports registering with the steam passages to the ends of the cylinder and with the exhaust passage at the center of the seat. The valve is constructed with four equally spaced longitudinal recesses with four alternate bands. The valve is operated by rocking it a part of a turn in each direction from the center.

The form of this valve and valve seat was patented by the inventor February 23, 1858.

#### BARTLETT POPPET VALVE GEAR, 1867

U.S.N.M. no. 308674; original patent model; transferred from the United States Patent Office; not illustrated.

This model was submitted with the application for the patent issued to Louis D. Bartlett, of Fitchburg, Mass., January 15, 1867, no. 61141.

The patent refers to an engine with separate valve chests at head end and crank end, each enclosing balanced steam and exhaust poppet valves, and describes particularly the construction of the valve boxes. These are designed for simplicity of casting, machining, and accessibility but are difficult to describe without reference to the drawings in the patent specifications. The valve gear used is said

to be similar to one described in a patent granted to Charles H. Brown and Charles Burleigh, January 15, 1856. The valve stems are operated by short levers, which are raised and lowered by cams on a lay shaft paralleling the cylinder. The levers that operate the steam valves have variable fulcrums, which are controlled by a governor so that the steam can be cut off at any point of the stroke.

#### THOMPSON BALANCED AND CUT-OFF VALVE, 1875

U.S.N.M. no. 308688; original patent model; transferred from the United States Patent Office; not illustrated.

This model was submitted with the application for the patents issued to Joseph W. Thompson, of Salem, Ohio, April 27, 1875, nos. 162714 and 162715. These were assigned to the Buckeye Engine Co., of the same place.

The model represents the first form of J. W. Thompson's balanced and cut-off valve gear, which was one of the earliest of the "automatic" valve gears. It was introduced in the very successful and well-known Buckeye engine.

The model represents a horizontal steam engine with one fixed eccentric and one shifting eccentric driving the main slide valve and the riding cut-off valve, respectively. The valve of the engine is in the shape of a hollow rectangular box the top of which works in close proximity to the valve chest cover and has a steam-tight, ring-packed opening through which steam is admitted to the inside chamber of the valve. The bottom of the hollow box forms the main valve taking steam through the chamber and into the valve chest at the ends of the valve. The opening through which steam is admitted is made enough larger than the steam pipe opening to cause the steam pressure within the chamber to exert some force to keep the main valve on its seat; otherwise the valve is perfectly balanced. A riding cut-off valve operates on the inside face of the bottom of the hollow main valve.

The main valve is operated from a rock shaft directly connected to the rod of the fixed eccentric. The riding cut-off valve is operated from a double-arm rock shaft, which is carried in the main valve rock shaft, one arm being connected to the valve rod, the other to a shifting eccentric on the engine shaft. The position of this eccentric will determine the position of the double-arm rock shaft relative to the main valve rock shaft and will in this way control the point of cut-off.

A shaft governor of the Thompson and Hunt design (see below) carries the shifting eccentric and varies its position relative to the crank with changes in speed of the shaft. The governor is mounted in a disk on the shaft and not in the flywheel as has since become the practice.

## OTTO AND BELL BALANCED SLIDE VALVE, 1883

U.S.N.M. no. 308719; original patent model; transferred from the United States Patent Office; not illustrated.

This model was submitted with the application for the patent issued to Henry Otto and Patrick F. Bell, of Bloomington, Ill., December 18, 1883, no. 290650.

The model represents a flat D-slide valve of ordinary shape, with most of the back cut away and formed in the shape of a short hollow cylinder. This cylinder is filled with a closed piston suspended on rollers on a flat bar, which, in turn, is suspended from the top of the valve chest. The bar passes through a tunnel in the piston and is of sufficient length to accommodate the valve travel. The effect of this construction is that the steam pressure ordinarily exerted on the back of a flat valve is in this case exerted on a piston that is not a part of the valve but is suspended independently.

## WHEELOCK VALVE AND VALVE SEAT, 1885

U.S.N.M. no. 310251; model; gift of the Franklin Machine Co.; not illustrated.

This is a nicely made model of the valve and valve seat patented by Jerome Wheelock, of Worcester, Mass., September 22, 1885, no. 326820.

The model represents a wide gridiron slide valve assembled on a skeletonized taper plug, which serves as the valve seat and supports the rock shaft connected to the slide by links or "toggles." The whole assembly is designed to fit into a taper hole bored into the cylinder block and connected by suitable ports to the cylinder. The advantage of this arrangement over ordinary plug valves is that it does not require that a valve seat be formed within the large cylinder casting, and it permits the delicate fitting of the valve to the valve seat to be performed at a work bench or upon a machine away from the engine.

The complete Wheelock valve gear (Patent no. 326819) consists of one steam valve and one exhaust valve at each end of a cylinder with the rock arms of the exhaust valves permanently connected to the eccentric, so that the valve is at rest during part of the travel of the eccentric, while the steam valves are connected through a detachable latch so that they may be detached and closed quickly at any point during the stroke of the piston.

## GREENE-WHEELOCK VALVE AND VALVE SEAT

U.S.N.M. no. 310250; model; gift of the Franklin Machine Co.; not illustrated.

This model represents a skeletonized taper plug in which are formed two gridiron valve seats and a bonnet that carried a rock-arm collar and cams for actuating one steam and one exhaust valve

on the valve seats. The valves are long narrow gridiron valves, which reciprocate in the direction parallel to the axis of the plug. They are actuated by rods and slides and roller cams, which are actuated by curved slots in a collar, which, in turn, is rocked by a rock shaft on the collar. The steam valve slide has a disengaging pawl to provide an adjustable cut-off.

#### ADDITIONAL STEAM-ENGINE VALVE GEARS IN THE COLLECTION, NOT OTHERWISE DESCRIBED

Cut-off, Thomas Rogers, patented in 1845, Patent Office model, transferred from the United States Patent Office. U.S.N.M. no. 308642.

Valve action, patented by Sulzer Brothers, Patent Office model, transferred from the United States Patent Office. U.S.N.M. no. 308729.

Adjustable eccentrics on a common shaft, Patent Office model, Patent no. 46278, issued to J. M. Stone February 7, 1865. Transfer from the United States Patent Office. U.S.N.M. no. 309249.

### INVENTIONS OF GEORGE H. CORLISS

#### CORLISS DROP CUT-OFF VALVE GEAR, 1849

##### PLATE 17, FIGURE 2

U.S.N.M. no. 308646; original patent model; transferred from the United States Patent Office; photograph no. 31694.

This model was submitted with the application for the patent issued to George H. Corliss, of Providence, R. I., March 10, 1849, no. 6162; reissued May 18, 1851, no. 200.

This is considered the first variable cut-off valve gear in which the point of the cut-off is determined by the engine governor. The patent was the first issued to George H. Corliss for steam engine improvements and the model represents the original form of the Corliss steam engine.

The engine represented by the model consists of a heavy horizontal bed at one end of which is a large, vertical, double-acting cylinder, at the other the bearings in which a crankshaft and large flywheel turn. At the center of the bed two columns carry the bearings of a horizontal rocking beam. Both columns and the beam are castings combined with tension rods in a manner covered by the patent. The valves of the engine, the flat slide type, are arranged above and below the top and bottom of the cylinder in steam chests. A separate steam and exhaust valve is provided at each end of the cylinder. All four valves are operated from a wrist plate or disk, which is oscillated by one eccentric on the crankshaft. Four rods connect the wrist plate with rocking levers or bell cranks, which, in turn, are connected to the valve rods. The rods of the exhaust valves are permanently connected to their individual rock levers, which move the valves as the wrist plate is oscillated. The steam valves are connected in a similar

manner except that the rock levers, instead of being connected to the valve stems, are provided with geared sectors that operate sliding racks, and these racks are connected to the valve stems by means of catches that permit the steam valves to be engaged or disengaged from the rest of the valve gear. When the steam valves are closed the racks move sufficiently far to engage the valve rods, and on the return motion open the valve until the catch strikes a cam, which disengages the valve rod and permits it to be closed quickly under the force of a heavy weight provided for that purpose. The cam is a helical projection on the sliding shaft of a centrifugal governor. Its position determines the point in the stroke of the piston at which the disengaging catch releases the steam valve and cuts off the steam. When the engine runs faster than the desired speed, the governor changes the position of the cam to cut off earlier in the stroke. This reduces the steam supplied to the engine and it slows down. If the engine runs slower than the desired speed, the cut off occurs later and the speed of the engine increases.

In addition to the automatic drop cut-off this valve gear gives but little motion to the valves when they are closed and diminishes the power required to operate the valves.

#### CORLISS CUT-OFF GEAR, 1851

U.S.N.M. no. 308653; original patent model; transferred from the United States Patent Office; not illustrated.

This model was submitted with the application for the patent issued to George H. Corliss, July 29, 1851, no. 8253; reissued July 26, 1859, no. 780.

This valve gear is a more compact combination of the elements of the disengaging gear of the first Corliss design (above). It exhibits for the first time some of the characteristic arrangements that have identified Corliss engines to the present time, such as the wrist plate located at the side of the cylinder, separate steam and exhaust valves at opposite sides and at each end of the cylinder, and valve spindles or rock shafts and arms for moving the valves. The combination of these rock shafts with flat slide valves is a transition in the development of the pure rotary valve, which is so well suited to the Corliss gear (see below).

The model represents a vertical cylinder with two steam and two exhaust valves, one of each on opposite sides of each end of the cylinder. A wrist plate (or rock disk), located at the side and center of the cylinder, is connected to an eccentric on a shaft directly above the cylinder. From the wrist plate rods extend to arms on the short rock shafts, which move the exhaust valves so that the connection of the exhaust valves to the wrist plate and thus to the eccentric is permanent and the exhaust valves will be alternately

opened and closed with a regular movement. Similar rods from the wrist plate extend to the arms on the rock shafts of the steam valves, but these rods terminate in hooks that engage with toes on the ends of the valve rock shafts and are not permanently connected thereto. As long as the hooks are engaged the steam valves will be opened and closed with a regular movement just as are the exhaust valves, but when disengaged the valves are free to close under the force of weights permanently attached to the rock arms. The hooks are caused to disengage at any point in the stroke of the engine piston or not, as is desired, by means of adjustable stops that force the hooks away from the toes of the rock arms. These stops are moved by means of inclined blocks, the position of which (in the model) is varied by a worm and rack set by hand, though the patent suggests that these blocks could be attached to the slide of the governor for automatic regulation of the cut-off. The weights that close the steam valves are nicely fitted to recesses in the engine frame so that air may be trapped under them to cushion the fall of the weights and bring them to rest without jar. The valves are flat slide valves operated by the rock shafts through short arms on the shafts, which connect to the backs of the valves with cylinder and cylindrical socket joints.

#### CORLISS STEAM PUMP, 1857

U.S.N.M. no. 308722; original patent model; transferred from the United Patent Office; not illustrated.

This model was submitted with the application for the patent issued to George H. Corliss, of Providence, R. I., June 2, 1857, no. 17423.

The invention offers a means of constructing a direct connected steam pump in which steam can be worked with expansion without employing a flywheel. The pump is an arrangement in one horizontal plane of 15 radial cylinders (10 single-acting water cylinders and 5 steam cylinders) in five groups, with each steam cylinder flanked on either side by a water cylinder. Each connecting rod from the cross heads of 14 of the cylinders works upon a pin in the enlarged disk-shaped end of the fifteenth connecting rod, which works directly upon the crankpin. "In such a combination the varying pressure exerted by any one piston by working the steam expansively to the farthest practical limit does not affect the uniform transmission of force to the pumps and the disc constitutes the common recipient to which the collective force of the different steam pistons is imparted and from which it is transmitted or distributed to the pumps."

The invention of the method of forming the connection between a series of radial cylinders and a single crankpin by means of one disk-ended connecting rod is claimed.

#### CORLISS VALVE GEAR, 1859

U.S.N.M. no. 308648; original patent model; transferred from the United States Patent Office; not illustrated.

This model was submitted with the application for the patent issued to George H. Corliss, July 5, 1859, no. 24618.

The model represents the first valve gear to combine all the elements of the typical Corliss engine. It shows the wrist plate, detachable steam link, variable disengaging wedge, a spring for closing the steam valve, the air dash pot to prevent jar in closing the valves, and rotating valves.

The valve gear represented includes the features of the two previous ones, with the exception that a spring is used to supply the force to close the steam valves instead of weights, and rotating valves are used instead of sliding valves. The peculiar feature of the spring is the mode of attaching it to a curved support, which receives motion with the valve gear so that the bearing point of the spring is shifted and the best tension is obtained for closing the valve at every position of the cut-off.

#### CORLISS CUT-OFF VALVE GEAR

U.S.N.M. no. 309817; model; gift of the Franklin Machine Co.; not illustrated.

This model represents a detachable valve gear in which an inclined block on the slide of a ball governor determines the point of cut-off. The valve is closed by the force of a compressed, coiled spring, and its closing movement is gently arrested by a dash pot.

This model shows one flat slide valve from which two parallel valve rods extend through a guide block and terminate in a cross head running in guides parallel to the rods. The guide block supports a stationary piston or plunger, which extends into a cylinder bored in a saddle carried between the valve rods close to the cross head. These combine to form a dash pot in which the plunger is stationary and the cylinder moves with the valve. A finger projects from the same saddle and engages a coil spring, which is compressed as the valve opens and serves to close the valve when it is disengaged from the gear. From the cross head a connecting rod extends to a block that is reciprocated by the eccentric on the crankshaft of the model. This connecting rod is provided with a hook that engages with a plate edge on the reciprocating block. It is held in engagement by a flat spring pressing it upward. When engaged the valve has a regular movement corresponding to the block reciprocated by the eccentric, but when disengaged the valve is quickly closed by



the action of the coiled spring. A slide on the governor, which is operated from the crankshaft, carries an inclined block that registers with the hooked connecting rod, depresses it against the action of the flat spring, and releases it from the reciprocating block. The time at which the valve is released depends upon the position of the inclined block, which, in turn, depends upon the position of the governor balls and finally upon the speed of the engine.

#### CORLISS PRESSURE REGULATOR, 1869

U.S.N.M. no. 309236; original patent model; transferred from the United States Patent Office; not illustrated.

This model was submitted with the application for the patent issued to George H. Corliss, of Providence, R. I., January 5, 1869, no. 85566.

The model represents a device for the automatic reduction of the pressure of steam when it is to be used for heating or any other purpose requiring steam at less than boiler pressure.

The device consists of a flat-sided circular chamber to which the steam at high pressure is admitted. At the center of one side of the chamber is a connecting space from which the low-pressure steam is taken. The passage between the chamber and the space is closed by a conical valve, the seat of which is formed in the side of the chamber and the valve disk of which is supported on a post fixed to the center of the other side of the chamber. The valve closes inward, so that spreading the two sides of the chamber will tend to close the valve. As the pressure of steam within the chamber tends to spread the sides of the chamber, an increase in the higher steam pressure will diminish the valve opening and thus diminish the flow of steam. By proper adjustment and proportioning of the valve area the regulator should maintain a constant pressure in the low-pressure space.

#### CORLISS COMPOUND BEAM PUMPING ENGINE, 1870

##### PLATE 18, FIGURE 1

U.S.N.M. no. 309820; model; gift of the Franklin Machine Co.; photograph no. 18114.

This is a model ( $\frac{1}{10}$  actual size) of a large, vertical, 2-cylinder, compound beam engine operating four pump cylinders of the city-waterworks type. The model was made at the original Corliss Engine Works at Providence, R. I., during the lifetime of George H. Corliss.

The engine consists of one high-pressure and one low-pressure vertical cylinder, each equipped with the simple Corliss valve gear. Upon each cylinder is a skeleton cylindrical column in which are cast the cross-head guides. From each cross head the connecting rod goes

to one end of its individual walking beam, from the other end of which a connecting rod connects to a crank on a crankshaft carrying a large flywheel common to the two cylinders. From either side of the center of each beam a connecting rod goes to the piston rod of one of the four pump cylinders. A condenser pump is also operated from one of the two walking beams. The valve gears are operated by eccentrics on the shaft, through a series of bell cranks and rods, and ball governors driven by belts from the shaft control the cutting-off of steam to the cylinders through rods extending to the tripping mechanism on the cylinder steam valves. Each cylinder, valve gear, governor, and walking beam is a separate and complete unit. The beam, flywheel, and operating cylinders are located below the level of the steam cylinders in a well formed of heavy masonry, which also forms the foundation of the engine. The model is operated by a hand crank.

#### CORLISS VACUUM DASH POT, 1875

U.S.N.M. no. 308692; original patent model; transferred from the United States Patent Office; not illustrated.

The model was filed October 27, 1875, with the application for the patent issued to George H. Corliss, June 6, 1876, no. 178275.

The model is a brass miniature of a vacuum dash pot designed to combine the functions of supplying the force to close the steam valve and to arrest the motion without shock after the valve is closed. The vacuum dash pot has some advantages over heavy weights and springs for closing valves.

The dash pot consists of a casting in which is bored a cylinder having a lower section of small diameter and an upper section of larger diameter. A plunger, having corresponding sections of large and small diameters, fits the cylinder. When the steam valve to which the plunger is attached is opened the plunger rises in the cylinder forming a vacuum in the part of smaller diameter. At the same time small leather valves in the larger part of the plunger open and allow air to enter the cylinder under this part of the plunger. When the valve is released the vacuum draws down the plunger and closes the valve. The air under the upper part escapes through a port in the cylinder until the plunger covers the port. The air trapped in the cylinder at this point acts as a cushion and brings the valve quickly but gently to rest.

#### CORLISS STEAM PUMP FOR WATER AND AIR, 1876 AND 1877

U.S.N.M. no. 308694; original patent model; transferred from the United States Patent Office; not illustrated.

This model represents two patents issued to George H. Corliss, of Providence, R. I., December 19, 1876, and May 22, 1877, nos. 185390 and 190958.

The two patents relating to this model refer to Patent no. 17423, which is described above under U.S.N.M. no. 308722.

This model represents a radial arrangement of horizontal water cylinders (185390) or air cylinders (190958) the pistons of which act upon a common crank on a short vertical shaft. A horizontal steam engine drives a vertical crankshaft, which is geared at its lower end to the crankshaft of the radial cylinders. A horizontal flywheel is attached to the engine shaft between the crank and the gear. The improvement claimed is that the steam engine may operate rapidly and economically while the pump pistons are worked slowly. For the air pump it is claimed that the arrangement of cylinders will permit the pump to be located near and below the main engine cylinder to take water freely from the condenser without the necessity of extending the engine framing.

#### CORLISS VALVE GEAR

U.S.N.M. no. 309816; model; gift of Franklin Machine Co.; not illustrated.

This is a finely made, crank-operated bronze model of an early type of Corliss detachable rotary valve gear. It is accompanied by a picture of a large engine installed at the New England Rolling Mills in 1860, on which this type of gear was used.

The valve stem terminates in a short lever by which the valve is rotated. This lever is permanently connected to a plunger in a closed cylinder or dash pot located below the valve. A hook or latch is operated up and down in a position so that the hook engages with the lever on its upstroke and rotates the valve to open it. A stiff flat spring holds the hook against the lever, while a bearing pin is so located that it will force the hook out of engagement with the valve stem lever after the hook has raised it a determined amount. When the lever is freed a spring closes the valve. The dash pot prevents the too rapid closing of the valve.

#### CORLISS EXHAUST-VALVE GEAR, 1876

U.S.N.M. no. 308693; original patent model; transferred from the United States Patent Office; not illustrated.

This model was submitted with the application for the two patents issued to George H. Corliss, May 9, 1876, nos. 177059 and 177099.

The model represents the valve gear of a horizontal cylinder with a separate rotary steam and exhaust valve at each end of the cylinder. The valves are driven from one wrist plate, the steam valves through disengaging hooks or catches, which are controlled by the governor, the exhaust valves by a series of permanently connected links designed to effect a quick closing of the exhaust valves. The steam valves are closed by vacuum dash pots instead of by weights or springs as in the earlier Corliss valve gears.

## CORLISS PUMPING ENGINE, 1879

U.S.N.M. no. 251291; original patent model; transferred from the United States Patent Office; not illustrated.

Model submitted with the application for patent issued May 27, 1879, Patent no. 215803.

The model shows a compound pumping engine with a high-pressure and a low-pressure horizontal steam cylinder each in line with a pump cylinder. The steam pistons are directly connected to the pump pistons, and a tail rod from each pump piston is connected by a system of oscillating levers to a crank on a flywheel shaft. The flywheel shaft is carried in bearings that are mounted upon the pump cylinders. As is usually the case in engines using steam expansively, the power developed during the admission of steam is in excess of that absorbed by the pumps, and the excess is stored in the flywheel from which it is drawn to carry the load during the expansion of the steam after the steam supply to the cylinder is cut off. The unique feature of the engine is the manner of connecting the piston rods to the cranks. The diameter of the circle in which the crank travels is made much larger than the stroke of the engine with the purpose of making the bearing pressures on the crank and connecting-rod pins smaller and the connecting rods lighter in order to diminish the friction losses in these parts during the transmission of power to and from the flywheel.

An engine of this design is pictured on page 212 of Thurston's *Manual of the Steam Engine*, under the caption "Corliss's Pawtucket Engine."

## CORLISS STEAM-ENGINE GOVERNOR, 1882

U.S.N.M. no. 308715; original patent model; transferred from the United States Patent Office; not illustrated.

This model was submitted with the application for the patent issued to George H. Corliss, August 8, 1882, no. 262209.

The model represents a flyball governor in which the motion of the slide, owing to a change in the speed of the engine to which the governor is attached, not only changes the position of the cut-off or throttle devices to regulate the speed of the engine but also changes the gear ratio between the engine and the governor to change the speed of the governor relative to the speed of the engine.

When the governor speed is increased by an increase in the speed of the engine, the balls rise and communicate motion to a slide, which, in turn, affects the throttle or cut-off to return the engine to its lower speed. At the same time the motion of the slide shifts a friction roller on its driving disk so that the governor speed is increased relative to the engine causing an additional motion of the

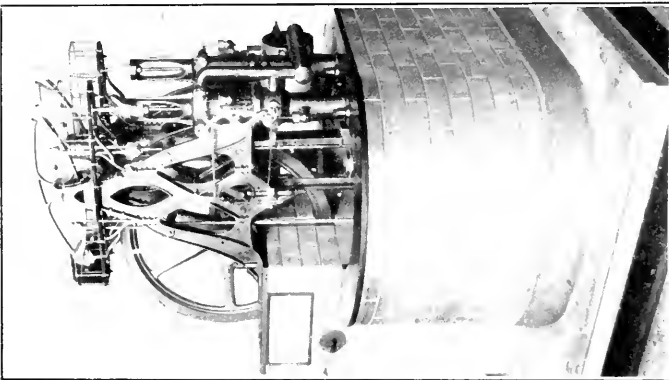

18114

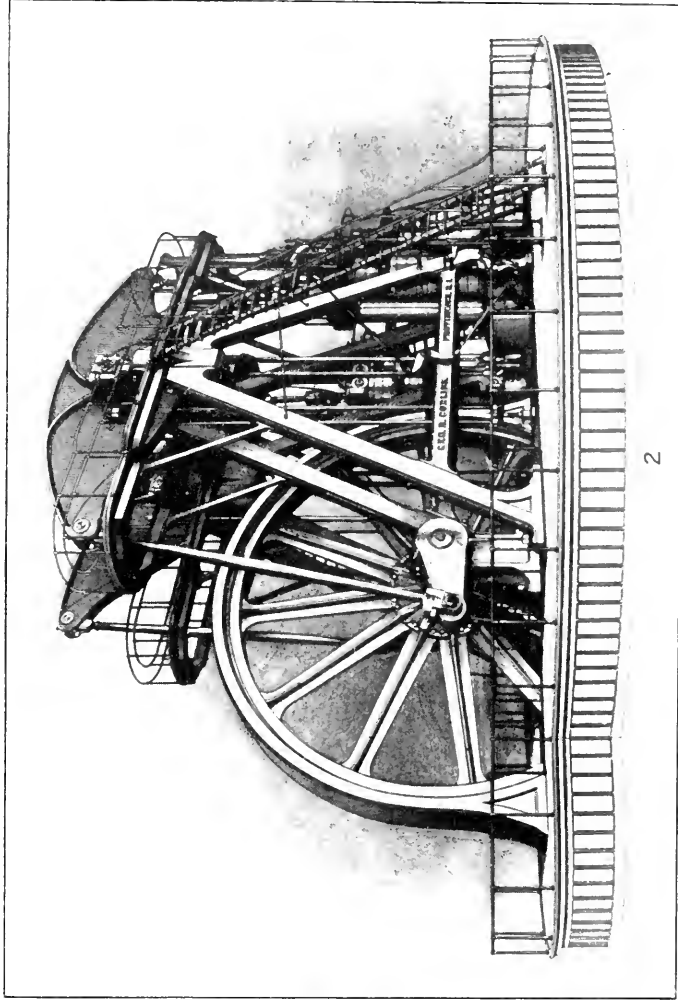

32644F

2

CORLISS BEAM ENGINES.

- 1. Corliss compound beam pumping engine, 1870 (model; U.S.N.M. no. 309820). See p. 75.
- 2. Corliss Centennial steam engine, 1876 (engraving, courtesy of American Historical Society). See p. 80.

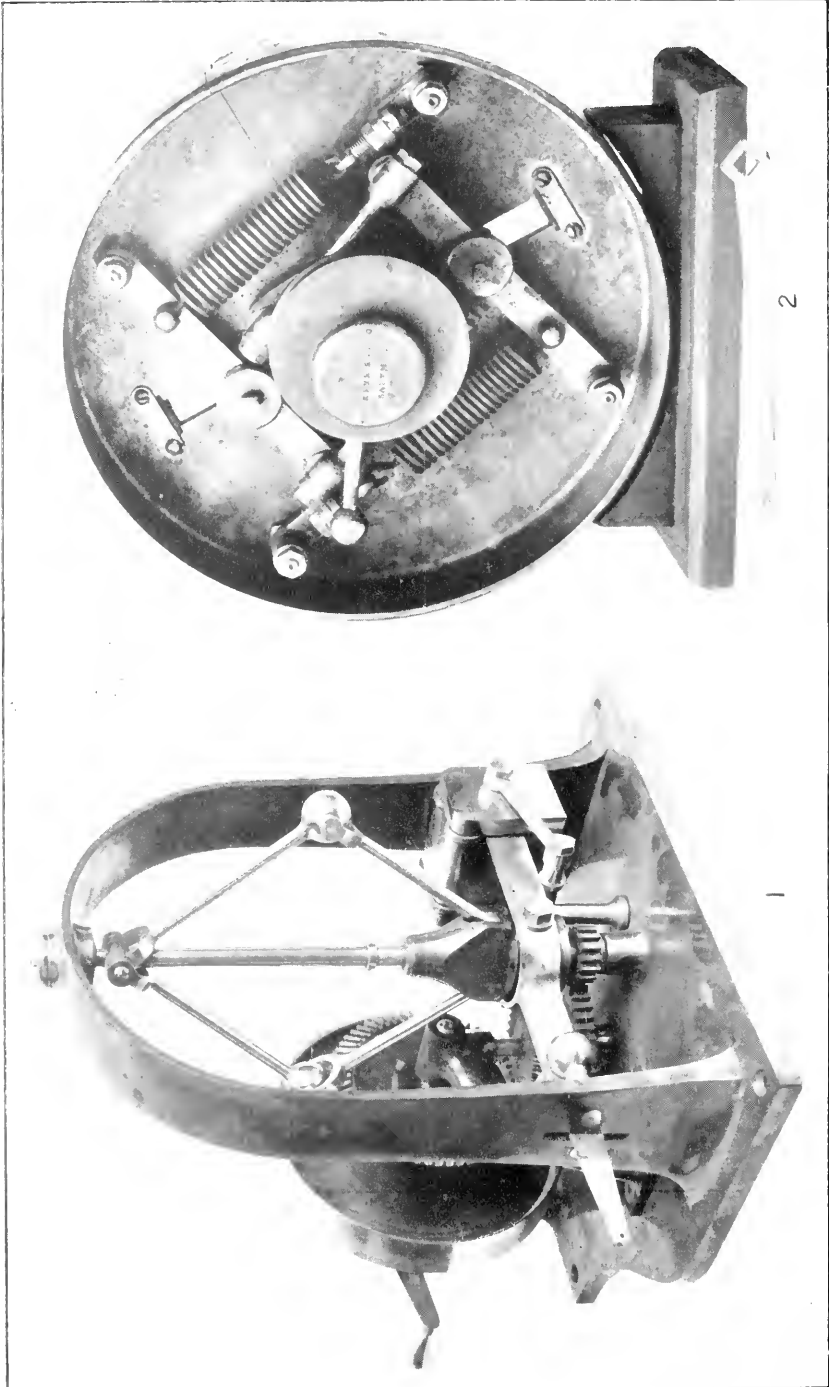

30368

STEAM-ENGINE GOVERNORS.

1. Porter weighted governor, 1858 (model; U.S.N.M. no. 251289). See p. 81.
2. Thompson and Hunt shaft governor, 1878 (model; U.S.N.M. no. 308700). See p. 85.

32789

slide in the same direction. As a result, the governor slide is given a greater motion for a given change in speed than would otherwise result.

#### DROP CUT-OFF VALVE AND MECHANISM

U.S.N.M. no. 309819; model; gift of the Franklin Machine Co.; not illustrated.

This is a wooden model of a very simple variable drop cut-off valve gear in which a poppet valve is lifted by a bell crank operated by a cam. The cam is a cylinder that may be moved parallel to its axis, so as to bring any part of the cam against the follower of the bell crank. The cam is so shaped that the valve will open at the same time for all positions of the cam, but the valve will close progressively earlier or later as the cam is moved along its shaft.

#### GOVERNOR AND THROTTLE VALVE

U.S.N.M. no. 309818; model; gift of the Franklin Machine Co.; not illustrated.

This is a crank-operated, wooden model of a ball governor connected to a throttle valve in a short section of pipe.

The governor consists of balls hung in the usual manner upon arms attached by pin joints at their upper ends to the top of the governor spindle. Radius rods from the centers of the ball arms connect to a collar upon the spindle, so that the collar moves up and down as the balls are swung in or out by changes in the speed of the engine. The sliding collar is connected to a crank on the axis of the disk of a plain butterfly valve.

#### CORLISS MARINE-BOILER IMPROVEMENTS, 1862

U.S.N.M. no. 308666; original patent model; transferred from the United States Patent Office; not illustrated.

This model was submitted with the application for the patents issued to George H. Corliss, Providence, R. I., August 26, 1862, nos. 36279 and 36281.

The model represents a pair of internally fired, fire-tube boilers of the "locomotive" type, each equipped with a steam main connected to the steam space at six different points for the purpose of diffusing the draft of steam from over the whole surface of the water in the boiler and thus prevent priming; and provided with a salt-water evaporator located in the breeching, so as to obtain heat from the hot flue gases, and connected to the surface condenser to lower the pressure on the boiling salt water to facilitate evaporation.

The purpose of the peculiar arrangement of steam pipes is to provide a method of obtaining steam free from water without the necessity of a high steam chamber, which would be a vulnerable part of a naval vessel. The theory is that the filling of any of the many tubes

with water, due to the pitching of the vessel, would cause the other tubes to supply the steam to the engines and the water would not travel far in the immersed tubes.

#### CORLISS WATER-TUBE BOILER, 1879

U.S.N.M. no. 309214; original patent model; transferred from the United States Patent Office; not illustrated.

This model was submitted with the application for the patent issued to George H. Corliss, of Providence, R. I., May 27, 1879, no. 215798.

The model represents a bank of curved water tubes joined in vertical rows by the separate cases or tube ends, which are the subject of the patent. Each end of each tube is threaded into the side of the cylindrical casting, which is provided with machined surfaces that allow the separate castings to go together tightly to form a continuous tube sheet or header for each vertical row of tubes. The castings forming each header are held together by a single long bolt, which threads into a casting that forms a common connector along the lower ends of the vertical headers.

#### "EVOLUTION OF THE GEORGE H. CORLISS STEAM ENGINE"

##### PLATE 18, FIGURE 2

U.S.N.M. no. 310252; 21 blueprints; gift of the Franklin Machine Co.

This is a cloth-bound volume of lithographs of many types of Corliss steam engines, pumps, and engine details. They consist principally of illustrations from sales literature and instruction books published at various times during the existence of the George H. Corliss Engine Works at Providence, R. I.

#### CORLISS CENTENNIAL ENGINE, 1876

##### PLATE 18, FIGURE 2

U.S.N.M. no. 310252; 21 blueprints; gift of the Franklin Machine Co.; photograph no. 32644F.

The drawings consist of 21 30-by-42 inch blueprints of the working drawings from which was constructed the 4,000-horsepower Corliss engine that supplied the power to the mechanical exhibits at the Centennial Exposition at Philadelphia in 1876.

### ENGINE GOVERNORS

#### LUTTGENS ENGINE GOVERNOR, 1851

U.S.N.M. no. 251288; original patent model; transferred from the United States Patent Office; not illustrated.

This model was submitted with the application for the patent issued to H. A. Luttgens, of New York, N. Y., October 21, 1851, no. 8447.



In this design a flyball governor operates to increase the throw of the engine valve eccentric as the engine speed increases. It is one of the earliest of the automatically controlled shifting eccentric types of governor.

A slotted eccentric disk is carried in guides on the face of a pulley fixed to the engine shaft. A gear-driven setscrew causes the eccentric to move in or out relative to the center of the shaft as the screw is turned. A bevel gear at the end of the screw meshes with another gear on the end of a small spindle, which is carried parallel to the crankshaft. On the other end of the spindle a small spur gear meshes with an annular ring gear fastened to a friction disk, which is free to turn on the shaft. This friction disk is held against the face of a pulley that turns on the crankshaft in the same direction but slightly faster than the shaft. The tendency of this combination is to turn the annular gear faster than the shaft, causing the spur gear to turn and move the setscrew in the direction to decrease the throw of the eccentric. However, the annular gear is also fastened to a brake drum, the band on which is tightened by the governor as the engine speed increases. The effect of this is to hold back the annular gear and turn the spur gear in the opposite direction, with the result that the throw of the eccentric would be increased. By adjusting the tension on the brake band so that it would overcome the friction on the disk just sufficiently to permit the annular gear to turn at the same speed as the shaft, at the desired speed of the engine, the action of the governor would maintain this speed.

#### STEARNS AND HODGSON ENGINE GOVERNOR, 1852

U.S.N.M. no. 251287; original patent model; transferred from the United States Patent Office; not illustrated.

This model was submitted with the application for the patent issued to George S. Stearns and William Hodgson, of Cincinnati, Ohio, August 31, 1852, no. 9236.

The feature of this governor is the use of toothed sectors on the weight arms meshed with a cylindrical rack instead of the usual pin and link mechanism to actuate the governed gear. Otherwise it is a simple flyball governor of the old form.

#### PORTER WEIGHTED ENGINE GOVERNOR, 1858

##### PLATE 19, FIGURE 1

U.S.N.M. no. 251289; original patent model; transferred from the United States Patent Office; photograph no. 30368.

The model formed part of the application for the patent issued to Charles T. Porter, of New York, N. Y. July 13, 1858, no. 20894; reissued June 21, 1859, no. 740.

This was one of the earliest of the weighted flyball governors of very light construction, designed to rotate at high speeds. It is more sensitive to small changes in the engine speed and quicker to respond to the changes than was the heavy-ball, unweighted governor. The Porter governor was an important feature of the well-known Porter-Allen engine that was successfully introduced about 1867, and the weighted principle is used in practically all ball governors of the present time.

The governor is a very light one of the common form, with the usual sliding element connected to the engine regulator. Attached to the sliding element is a lever that carries a sliding weight so connected that the effective weight of the counterpoise remains the same as the sliding element moves through its range.

#### KELLY AND LAMB STEAM ENGINE GOVERNOR, 1865

U.S.N.M. no. 308667; original patent model; transferred from the United States Patent Office; not illustrated.

This model was submitted with the application for the patent issued to Oliver A. Kelly and Estus Lamb, of Slatersville, R. I., January 31, 1865, no. 46111.

The model represents a ball governor in which part of the regulating motion is obtained directly from the change in position of the governor balls and partly from the motion of a nut along a screw shaft.

The motion of the nut is determined by the rotation of the screw shaft, which, in turn, is derived from a ratchet wheel and two pawls. The pawls are given a rocking motion by a crank on the governor drive shaft. A cam slot controlled by the movement of the balls permits one or the other pawl to engage the wheel as the balls move away from their normal position and so determine the direction and amount of the rotation of the screw shaft.

#### PEAVEY FLUID ENGINE GOVERNOR, 1870

U.S.N.M. no. 308678; original patent model; transferred from the United States Patent Office; not illustrated.

This model was submitted with the application for the patent issued to Andrew J. Peavey of Boston, Mass., August 16, 1870, no. 106400.

The model represents a stationary cylinder filled with oil within which turns a paddle wheel driven by the engine at a speed dependent upon the velocity of the engine. Also within the stationary cylinder and surrounding the paddle wheel is a hollow cylinder, which is hung loosely upon the shaft of the paddle wheel and is free to revolve independently of it. This cylinder has a series of blades or abutments projecting from the inner side of its rim, so that as the paddle wheel causes the oil to revolve in the cylinder the moving oil

will come into contact with the abutments and tend to turn the loose cylinder. Attached to the loose cylinder is a pinion that meshes with a toothed sector, which, in turn, is connected with the counterweight on a lever arm raised by the turning movement of the loose cylinder and so tends to oppose the turning of that cylinder. As the height to which the counterweight will be raised is a function of the velocity of the engine, this velocity can be governed by properly connecting the counterweight to the cut-off or throttle valve.

#### WOODBURY SHAFT GOVERNOR, 1870

U.S.N.M. no. 251290; original patent model; transferred from the United States Patent Office; not illustrated.

This model was submitted with the application for the patent issued to Daniel A. Woodbury, of Rochester, N. Y., September 27, 1870, no. 107746.

This is a very simple form of shaft governor in which the position of a shifting eccentric is varied by the combined action of centrifugal weights and springs; so that changes in the engine speed change the effective throw of the eccentric and the angle between the eccentric and the crank to change the timing of the valve relative to the piston and thus regulate the speed of the engine.

The eccentric disk is held in a short lever that swings about a pin attached to a spoke of the flywheel so located that the eccentric is approximately in the same position that would be occupied by an ordinary fixed eccentric. In swinging about the pin the throw or center of the eccentric changes its position relative to the center of the shaft and the engine crank. The lever is connected by curved links to two weights, which are held by stiff flat coiled springs, so arranged that an increase in speed causes the centrifugal force due to the weights to move the lever slightly against the resistance of the springs and swing the eccentric so as to advance the eccentric and decrease the throw. The effect of this is that cut-off will occur earlier and the engine speed tend to decrease and return to the former slower speed. The arrangement of the weights is such that they are not swung out suddenly by their inertia when the engine is suddenly started, a difficulty often resulting in cut-off occurring so soon as to stop the engine on dead center.

#### JUDSON AND COGSWELL GOVERNOR, 1875

U.S.N.M. no. 309244; original patent model; transferred from the United States Patent Office; not illustrated.

This model was submitted with the application for the patent issued to Junius Judson and William A. Cogswell, of Rochester, N. Y., November 9, 1875, no. 169815.

The model represents a flyball governor in which the driving pulley is fitted loosely to the driving shaft and connected to it by a spiral

spring, which allows a free turning of the pulley on the shaft to an extent sufficient to counteract the jerks or impulses, which are transmitted to the governor by the uneven operation of the engine.

The inventor states that the ordinary crank motion of a steam engine results in an unequal operation that is not always equalized by the flywheel of the engine. This irregularity, though not always perceptible, is transmitted to the governor, which, when operated unevenly, would exaggerate the variations. This device is designed to prevent the jerks being transmitted to the governor.

#### BODEMER INDIRECT ACTING GOVERNOR, 1876

U.S.N.M. no. 309243; original patent model; transferred from the United States Patent Office; not illustrated.

This model was submitted with the application for the patent issued to Johann Georg Bodemer, of Zschopau, Germany, April 25, 1876, no. 176591.

The model represents a ball governor, connected to a belt shifter and a tight and loose pulley, through the medium of which the regulator valve is opened or closed according to which of two belts is transferred from the loose to the tight pulley.

The belt shifter is actuated by a friction pin and is so arranged that it will put the regulator into immediate action in the required direction as soon as the governor balls deviate from their normal position; it will keep the regulator in action as long as the balls continue to deviate in the same direction; it will put the regulator out of action as soon as the balls start to return toward normal; it keeps the regulator out of action as long as the balls are returning to normal; and causes the regulator to renew its action should the balls again begin to increase their deviation before having arrived at the normal.

#### FOWLE MARINE-ENGINE GOVERNOR, 1877

U.S.N.M. no. 308698; original patent model; transferred from the United States Patent Office; not illustrated.

This model was submitted with the application for the patent issued to Joseph W. Fowle, of Boston, Mass., August 14, 1877, no. 194037.

The model represents a 1-cylinder, vertical marine engine connected to a propeller shaft and propeller in the ordinary manner, with a float or inertia device for closing the throttle valve of the engine each time the vessel in which the engine is installed pitches sufficiently to raise the propeller out of the water.

The gear consists of a heavy weight suspended in suitable guides and stops near the keel of the ship. This weight is not rigidly fixed relative to the ship but tends to float in position as the vessel rises and falls. The change in relative positions actuates a valve lever on an auxiliary steam cylinder and piston, which, in turn, moves the main throttle valve of the engine.

## THOMPSON AND HUNT SHAFT GOVERNOR, 1878

PLATE 19, FIGURE 2

U.S.N.M. no. 308700; original patent model; transferred from the United States Patent Office; photograph no. 32799.

This model was submitted with the application for the patent issued to Joseph W. Thompson and Nathan Hunt, of Salem, Ohio, June 18, 1878, no 204924. One-half of the inventors' right was assigned to the Buckeye Engine Co., of the same place.

The model represents a centrifugal governor in which weights rotate with and upon the driving shaft and operate by variation of annular velocity to vary the position of an eccentric thereon, relative to the crank. The peculiar features of this governor are the use of ball-and-socket joints to connect the weighted arms to the eccentric and the provision of stop pins moving in cushioned slots to prevent shock due to sudden changes in speed while permitting the engine to be run in either direction.

The inventors refer to former shaft governors as having been patented by Jacob D. Custer, no 1179, June 21, 1839, and by Joseph W. Thompson, no. 162715, April 27, 1875. The invention of the shaft governor has heretofore been generally attributed to J. C. Hoadley.

The Buckeye engine, which has been a representative and successful type of high-speed, automatic engine, was developed mainly under the patents of J. W. Thompson and Nathan Hunt. The peculiar type of shaft governor and the balanced flat valve (see above) were the characteristics of the engine.

## REID GYROSCOPIC ENGINE GOVERNOR, 1879

U.S.N.M. no. 309242; original patent model; transferred from the United States Patent Office; not illustrated.

This model was submitted with the application for the patent issued to Joseph Reid, Monroe, La., October 21, 1879, no. 220867.

This model represents a hollow vertical spindle geared to be driven by the engine. Pivoted at the top of the spindle is a gyroscopic wheel, which ordinarily rests at an inclination to the spindle but when rotated is acted upon by gyroscopic and centrifugal forces tending to swing the axis of the wheel to the vertical. The changes in position of the wheel follow changes in velocity of the wheel, so that by suitable connections of the axis of the wheel to a governor valve the device will control the speed of the engine to which it is attached.

## PICKERING BALL GOVERNOR, OLD STYLE

U.S.N.M. no. 310289; original; gift of the Pickering Governor Co.; not illustrated.

In this governor each ball is supported at the center of a vertical, flat, laminated spring, so arranged that as the balls move away from the spindle of the governor, owing to centrifugal force, and cause the

springs to bow, the upper support of the springs is drawn down, closing the throttle valve to which it is attached. This very simple and widely used form of the ball governor was invented by Thomas R. Pickering, of New York, N. Y., in 1862.

The governor employs three balls, each attached to the center of a spring. Each spring is attached at its lower end to a collar that is driven by the engine and turns freely on a vertical hollow shaft. The upper ends of the springs are attached to another collar supported on a rod, which is free to revolve and to move up and down. As the centrifugal force moves the balls out from the spindle, the upper collar and rod are drawn down. The vertical rod is connected to a throttle valve within the casting, which forms the support of the governor.

This specimen is a governor made in the form of the early Pickering governor.

#### PICKERING BALL GOVERNOR, 1931

U.S.N.M. no. 310290; original; gift of the Pickering Governor Co.; not illustrated.

This is the modern form of the Pickering governor, described above, and has the same spring mechanism carrying the governor balls. It is provided with a speed ranger for obtaining different engine speeds up to a 50 percent increase over the minimum speed, and includes also an enclosure over the ball and gear mechanism.

The principle of the Pickering governor has been very widely adopted to governing the speed of practically every type of machine and mechanism. It does not depend upon gravity for its proper operation and can, therefore, be used in any position, while the simplicity of its construction permits it to be made in every size. The principle is employed in the governors of telephone dials, talking machines, internal-combustion engines, air compressors, steam engines, and steam turbines.

### CONDENSERS

#### JAMES WATT SURFACE CONDENSER, 1769

U.S.N.M. no. 180614; two photoengravings; deposited by J. E. Watkins; not illustrated.

These prints include a photograph of the Watt surface condenser in the Science Museum of London, and a line-drawing plan and elevation of the condenser.

The condenser shown is a small, tubular, surface condenser complete with air and condensate pump. The condenser is a vertical cylindrical shell with a circular tube sheet, or diaphragm, within the shell near each end. The small spaces at each end of the condenser are connected by some 140 tubes, which fill a large proportion of the space between the tube sheets. The cold condensing water passes

through these tubes. The steam enters the space between the tube sheets at the top at one side, flows around the tubes, and down and out (as condensate) the opposite side at the lower end into the air pump. The steam and cooling water apparently travel in the same direction, that is, downward.

The air pump consists of two vertical tubes joined at the bottom to form a V-tube. One of the two tubes is bolted to the side of the condenser so that the bottom of the tube is some distance below the bottom of the condenser; the condensate outlet of the condenser is at a point about two-thirds of the height of the tube and opening into it through a hinged valve (the inlet valve of the pump). The outlet valve of the pump is in the top of the tube above the inlet valve. A piston is fitted to the other tube of the pump. The movement of the piston in the one tube caused a water column to rise and fall in the other tube, drawing in air and water from the condenser and discharging it (the air first) from the top of the tube.

The condenser has all the elements of the present-day surface condenser, which is the type in most general use, and the air pump incorporates the principle upon which most present successful vacuum pumps operate. Watt did not, however, overcome the difficulties of maintaining the tubes tight in the tube sheets, and he supplied the jet type of condenser with his engines. (See the Fulton engine drawings above.)

#### STEVENS SURFACE CONDENSER, 1862

U.S.N.M. no. 308665; original patent model; transferred from the United States Patent Office; not illustrated.

This model was submitted with the application for the patent issued to Francis B. Stevens, of New York, N. Y., October 28, 1862, no. 36807.

The model represents a surface condenser formed of coils of pipe to be located outside of the hull of a vessel. The peculiar feature is that cocks and valves are provided so that the condenser can be disconnected from the engine and used to distil sea water for the boilers and also permit steam to be blown through the condenser for cleaning the tubes.

#### STEVENS STEAM-ENGINE CONDENSER, 1863

U.S.N.M. no 309238; original patent model; transferred from the United States Patent Office; not illustrated.

This model was submitted with the application for the patent issued to Francis B. Stevens, November 3, 1863, no. 40510.

The condenser represented in the model consists of a large vertical cylinder and pump plunger with various connected chambers designed

to function as a condenser, a condenser air pump, and feed-water hot well and heater.

The invention "consists in simplifying the apparatus that condenses the steam discharged by the first eduction from the cylinder of a condensing steam-engine by closing the hot well of the engine against the atmosphere and by keeping a portion of the space of the hot well free from water, and by delivering the steam discharged from the cylinder by the first eduction into the hot well, so that it may be condensed or partially condensed by the water delivered by the air-pump into the hot well." The hot well is thus made "to act also as an additional condenser and dispense altogether with an additional air pump to draw the water from the additional condenser."

#### PITTS AND GLUYAS CONDENSER, 1872

U.S.N.M. no. 309239; original patent model; transferred from the United States Patent Office; not illustrated.

This model was submitted with the application for the patent issued to George K. Gluyas and Washington R. Pitts, of San Francisco, Calif., October 1, 1872, no. 131779.

The model represents a simple arrangement of two rectangular chambers joined by rows of tubes and fitted with baffles so that steam admitted at one end would traverse the tubes in three directions before passing out. The inventor designed the condenser to be located in the wheel box of a paddle-wheel steamer where the water and spray from the wheel would cool the tubes and condense the steam.

#### STARBUCK SIPHON CONDENSER, 1878

U.S.N.M. no. 309354; original patent model; transferred from the United States Patent Office; not illustrated.

This model was submitted with the application for the patent issued to George H. Starbuck, of Troy, N. Y., September 10, 1878, no. 207827.

The model represents a form of barometric condenser in which an annular jet of water is brought into contact with an annular jet of the steam to be condensed, and the resulting mixture is conducted from the condenser by a pipe extending 33 feet or more below it. The peculiar feature of this condenser is the bulbous valve, which fits within the water pipe and forms a variable annular water passage by which the quantity of water flowing can be adjusted while the shape of the annular jet of water, which is essential to the best operation of the condenser, is maintained unbroken.



## ENGINE INDICATORS

An engine indicator is an instrument for graphically recording the pressure within an engine cylinder at every instant during the stroke of the piston. The diagram produced by the indicator is used by engineers to check many features of both the design and performance of the engine. From it may be ascertained the amount of work done by the steam or gas upon the piston; the exact part of the stroke at which each valve event occurs; the average pressure in the cylinder during the stroke; and many other facts of interest and value.

The indicator is one of the many inventions attributed to James Watt, who devised it primarily to measure the work done by his steam engines. Watt was paid for his engines on the basis of the work that they did as compared to the number of horses that they displaced, and before the invention of the indicator his customers' low estimates of the efforts of his engines caused him to complain that "the power of a horse is growing to that of an elephant."

The first form of the indicator was a modification of the vacuum gauge, which was connected to the cylinder of the engine and was read by an observer at any required intervals during the ponderous stroke of the then slow-speed engines. The important addition of a pencil attached to the pointer of the instrument, and so arranged that it would register its position on a sheet of paper fastened to a flat board that moved in synchronism with the engine piston, is believed to have been suggested by John Southern, one of Watt's assistants.

At just what date the first indicator was used is not known. Watt found it of so much assistance to him in properly adjusting the valves of his engines that he kept it secret as long as he could. The story is told that an indicator was accidentally packed with an engine sent from the Watt factory to Holland, where it subsequently fell into the hands of an agent of a competitor and through him was revealed to the world.

The reciprocating drum to carry the paper, which is a part of every present-day indicator, was introduced about 1825 to 1830 by John McNaught of Glasgow. McNaught's indicator retained the fixed connection between the piston rod of the indicator and the pencil, which required that the piston move as far as the pencil must travel to produce a diagram large enough to be legible. Prof. C. B. Richards, of Connecticut, in 1862 designed the first indicator in which a comparatively short movement of the indicator piston was multiplied many times by suitable linkage to produce the required movement of the pencil. By thus reducing the movement of the piston its linear speed was also reduced, and the errors and distortion of the diagram occasioned by the inertia of the indicator parts at high speed were partially eliminated. The Richards is considered the first of the modern type

of indicators. Since 1862 the advance in design has been largely in the refinement of various parts, lightening the piston and pencil mechanism, steam jacketing the cylinder, and making the parts more accessible and the whole instrument more rapid to use. The latest indicator in the Museum's collection is equipped with an appliance for taking an uninterrupted record of diagrams of the successive strokes of an engine.

#### WATT STEAM-ENGINE INDICATOR, c. 1796

U.S.N.M. no. 309680; copy; made in the Museum; not illustrated.

This is a copy of an indicator in the Science Museum at London, which belonged to one of the Boulton, Watt & Co. agents at Manchester, England.

The instrument consists of a vertical brass cylinder fitted with a piston, 1 square inch in area, provided with a rod attached to the piston and projecting from the upper end of the cylinder. Between the piston and the cap at the upper end of the cylinder and fastened to both is a helical spring that is lengthened and shortened by variations in pressure below the piston and causes the height of the piston to be a measure of the pressure. The lower end of the cylinder is fitted with a tapered plug cock by which it could be attached to the tapered sockets provided in the cylinders of the early engines. Attached to the upper end of the piston rod is a pencil that traces a curve on paper fastened to a small board, which is moved across the point of the pencil by the motion of the engine. The motion of the engine was transmitted to the paper by a cord from a point on the bridle of the engine, and the return motion of the board was caused by a weight and cord.

The first form described by Watt was an adoption of the vacuum gauge consisting of a spring-loaded piston nicely fitted to a cylinder. A pointer connected to the piston indicated the pressure within the cylinder. With the slow-moving engines with which this was used, readings of the pressure could be made at known points in the engine's stroke, and the data plotted.

#### DIAGRAM TAKEN WITH WATT INDICATOR

U.S.N.M. no. 180629; print; deposited by J. E. Watkins; not illustrated.

This diagram was taken with a Watt indicator on a low-pressure condensing engine by Edward Cooper, August 1840. It represents the full-load diagram of the engine. The maximum pressure above the atmospheric line is 5 pounds per square inch, and the exhaust pressure is 13 pounds per square inch vacuum. The card is practically rectangular and is computed to have indicated 120 horsepower. Additional notes on the card describe the engine as having a 7-foot stroke, a speed of  $17\frac{1}{2}$  revolutions per minute, and a rating of 60 horsepower.

## McNAUGHT INDICATOR. c. 1835-1842

## PLATE 20, FIGURE 1

U.S.N.M. no. 307516; original; gift of the Ball Engine Co.; photograph no. 15260A (group).

This is an original indicator made by the old Novelty Iron Works, of New York City. Marked "Novelty Iron Works, New York, No. 4."

This indicator is one of the first type to employ a cylindrical drum to carry the paper, in place of the flat board of the Watt indicator. This feature was the invention of John McNaught, of Glasgow, Scotland, who introduced an indicator with this improvement about 1825-1830.

The indicator consists of a vertical cylinder and a closely fitted piston with a helical spring between the piston and the cap at the upper end of the cylinder. A piston rod projects beyond the top of the cylinder, as in the Watt indicator, but in this case the pencil is attached to the rod just above the piston. The fitting that carries the pencil slides in a vertical slot provided for it in the wall of the cylinder. A hollow metal drum is supported on a bracket close to and parallel with the cylinder. A spring on the pencil fitting presses the pencil against the surface of the drum (in some of the earlier models the paper was cemented to the drum). The paper drum is revolved by a cord wrapped about the base of the drum and is returned by a light coil spring within the drum. The piston rod extends beyond the top of the cylinder and is fitted with a small knurled nut so that an additional spring can be added for higher pressures. A scale is marked off along the edge of the slot in which the pencil fitting moves so that pressures may be read directly when the indicator is used with a slow-moving engine.

## KRAUSCH ENGINE INDICATOR, 1862

U.S.N.M. no. 308664; original patent model; transferred from the United States Patent Office; not illustrated.

This model was submitted with the application for the patent issued to C. W. T. Krausch, of Chicago, Ill., September 9, 1862, no. 36411.

The model represents an instrument designed to indicate and record speeds, draw-bar loads, boiler water levels, boiler pressures, steam-chest pressures, cylinder pressures, and conditions of the track connected with the operation of a locomotive engine and to plot these on a paper belt driven from a truck axle with a motion corresponding to the progress of the engine.

A series of levers and markers corresponding to the number of the above operations to be recorded works transversely on the paper record as the paper is advanced by the progress of the engine. The

marker indicating speed is actuated by a spring-balanced bellows, the motion of which is determined by the volume of air delivered to it by small air-pump cylinders actuated by any convenient part of the engine. The other markers are actuated mechanically by a series of levers to various indicating instruments on the engine, not described.

RICHARDS INDICATOR, c. 1867

PLATE 20, FIGURE 2

U.S.N.M. no. 307515; original; gift of the Ball Engine Co.; photograph no. 15260A (group).

This is the type of "high speed" steam-engine indicator patented by Prof. C. B. Richards in 1863 (Patent no. 37980) and introduced commercially about 1867.

This is considered the first design of the modern type of indicator. It was the first to employ a multiplying linkage between the piston and the pencil point to reduce the travel of the piston and so avoid the distortion of the diagram due to the inertia of the moving parts. It has a cylinder liner supported so that it is free to expand and contract longitudinally with temperature changes, and it provides a means of moving the pencil into and away from contact with the paper.

The pencil mechanism is a Watt parallel motion that moves the pencil parallel with the piston, coincident with it and in an exact ratio of travel. It multiplies the movement of the piston about four times. The parallel motion is supported by two arms that are a part of a collar that is fitted so that it may be turned about the top of the cylinder to bring the pencil into contact with the paper. The indicator spring is a heavy, single-coil, helical spring fitted with threaded collars by which it is attached to the piston and the cylinder cap. It is easily removable so that lighter or heavier springs may be substituted.

G. H. CROSBY INDICATOR, 1879

PLATE 20, FIGURE 3

U.S.N.M. no. 308701; original patent model; transferred from the United States Patent Office; photograph no. 15260A (group).

This indicator was filed with the application for Patent no. 219149 issued to G. H. Crosby, September 2, 1879.

The improvements claimed for this design are a jacket about the steam cylinder to prevent radiation or loss of heat from the cylinder; a method of supporting the cylinder and jacket so that each might expand freely when heated; the carrying of the rotary drum on a lever so that it could be moved up to and away from the marker;

and a peculiar parallel motion for effecting the straight line motion of the marker in which "the lever is connected with the piston-rod by a joint, and not indirectly by a link, as in the Richards indicator."

#### THOMPSON INDICATOR

U.S.N.M. no. 309644; original; gift of N. C. Hunt; not illustrated.

This indicator was made by the American Steam Gauge Co., of Boston. It is marked "J. W. Thompson Pat. August 31, '75 Pat. June 26, 1883, No. 4302."

In this indicator the piston rod is hollow and serves only as a guide for the piston. The pencil mechanism is connected to the piston by a very light rod that passes through the piston rod and is attached to the piston with a swivel joint. This permits the connecting rod to swing through a slight arc, which in turn permits the use of a very simple and light parallel motion.

The piston is a light cylindrical shell provided with three grooves that collect moisture and steam to lubricate and seal the piston. The inner wall of the cylinder is a liner separate from and secured to the inclosing cylinder only at one end so that it is free to expand and contract with temperature changes, thus avoiding distortion.

#### INDICATOR WITH REDUCING WHEEL, 1930

U.S.N.M. no. 309833; original; gift of the Crosby Steam Gage & Valve Co.; not illustrated.

This indicator, designed to meet the requirements of modern high-speed engines, employs the lightest construction consistent with strength and accuracy. It is equipped with a reducing wheel, which is a self-contained device capable of reducing engine strokes of 14 to 72 inches to the proper stroke of the paper drum.

The cylinder of this indicator is supported so that its lower end is free and its longitudinal expansion or contraction is unimpeded. The annular space between the cylinder and the casing is designed to serve as a steam jacket. The piston is an extremely thin steel shell with shallow channels on its outer surface to provide steam packing and moisture lubrication. The piston rod is hollow and is connected to the pencil mechanism by means of a swivel head that can be screwed in or out of the rod to adjust the position of the diagram on the paper. The pencil mechanism is kinematically a pantograph that theoretically gives the pencil point a movement exactly parallel to the piston and the amount of the movement of the piston is multiplied six times at the pencil point. The design of the piston spring is peculiar to this indicator. It is made of a single piece of spring steel wire wound from the middle into a double coil, the ends of which are screwed into a metal head drilled helically to receive the spring.

The exact strength of spring is obtained by screwing the spring into the head more or less, when they are firmly fixed. The foot of the spring is a small steel bead firmly pinned to the straight portion of wire at the bottom of the spring. This takes the place of the heavier brass foot used in earlier indicators.

#### INDICATOR WITH CONTINUOUS CARD APPLIANCE, 1930

##### PLATE 20, FIGURE 4

U.S.N.M. no. 309834; original; gift of the Crosby Steam Gage & Valve Co.; photograph no. 18547A.

In this indicator the piston spring is located outside of the cylinder casing in a position above the moving parts, where it is not affected by the heat of the steam; and the piston is made in the shape of the central zone of a sphere to reduce the friction caused by possible eccentricity in the action of the spring. The ordinary drum of the indicator has been displaced by an appliance for taking a continuous series of diagrams of the successive strokes of an engine.

The piston is attached by a hollow rod directly to the upper end of the spring and because of its spherical shape moves freely in spite of any eccentric action of the spring. The bearing of the spherical piston on the cylinder wall approaches line contact, so that friction is greatly reduced.

The Lanza continuous diagram appliance is assembled on a bracket that displaces the usual paper drum and supports the indicator proper. It consists of a spindle for receiving the new roll of paper, the drum that feeds the paper forward and upon which the pencil point bears in making the record, and the spool upon which the paper is afterward wound.

The drum is rotated continuously in one direction by the alternate engagement of two clutches controlled by a cord passing over the pulley at the extreme end of the bracket arm and actuated by a cross-head block positively connected to the crosshead of the engine. There is included a device for marking upon the paper at the end of the stroke and an atmospheric marker readily adjustable to any required position.

This appliance is the invention of the late Prof. Gaetano Lanza, of the Massachusetts Institute of Technology. It is used to obtain a continuous series of cards from locomotives, rolling mills, and other engines where the diagrams corresponding to successive revolutions of an engine differ.

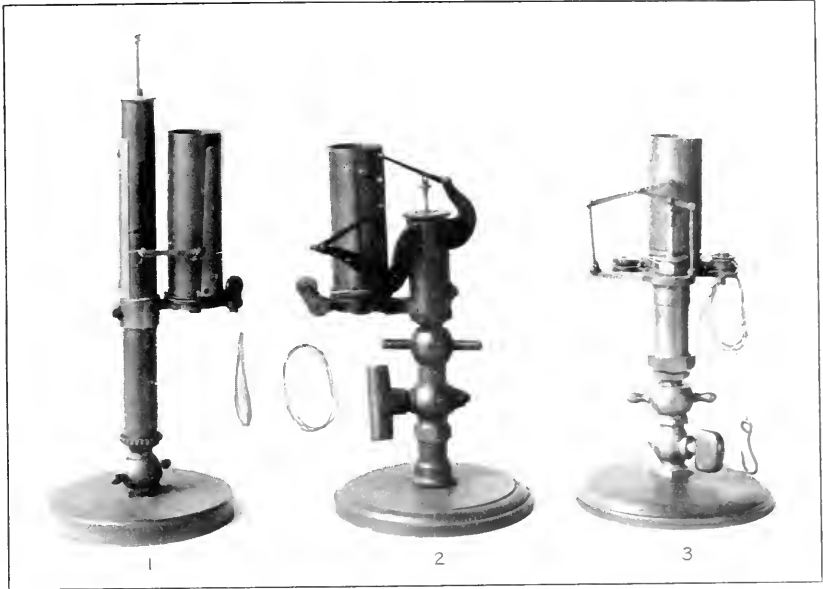

15260A

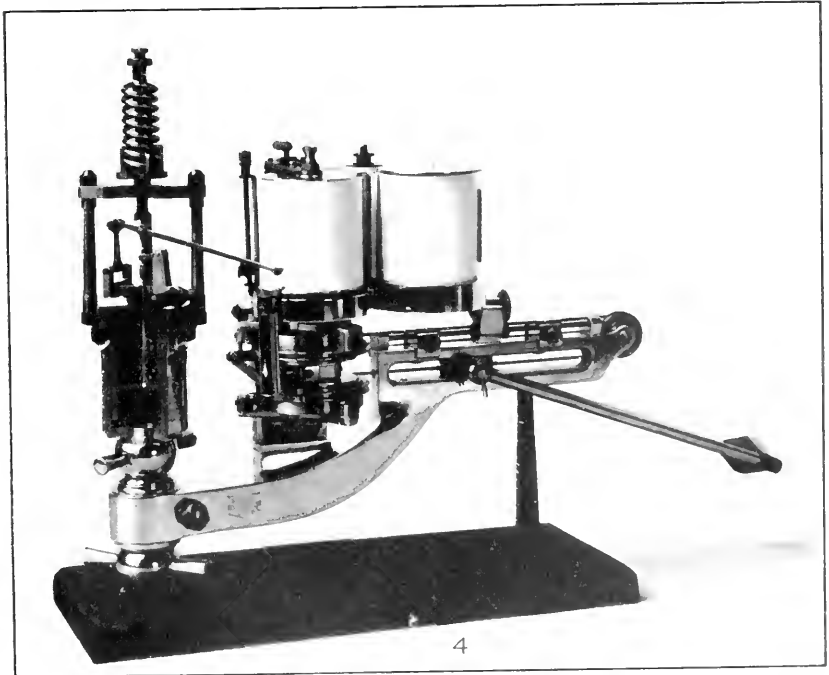

15547A

## ENGINE INDICATORS

1. McNaught, c. 1835-1842 (U.S.N.M. no. 307516). See p. 41.
2. Richards, c. 1867 (U.S.N.M. no. 307515). See p. 92.
3. Crosby, 1879 (model; U.S.N.M. no. 308701). See p. 92.
4. Indicator with continuous card appliance, 1930 (U.S.N.M. no. 309834). See p. 94.

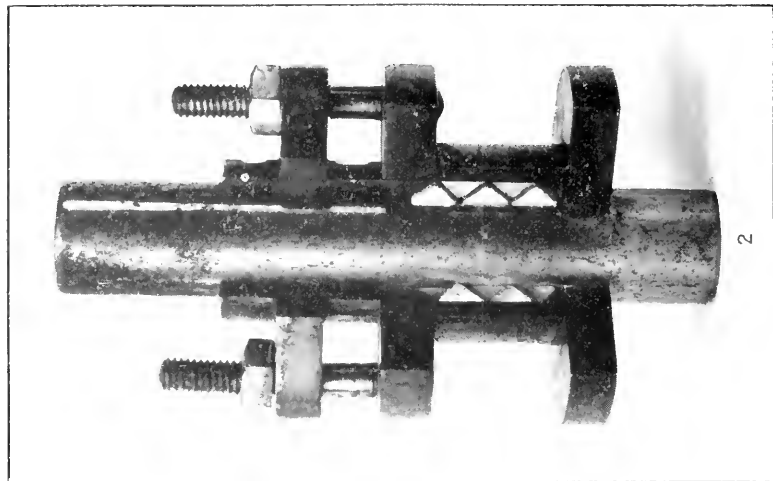

35528A

2

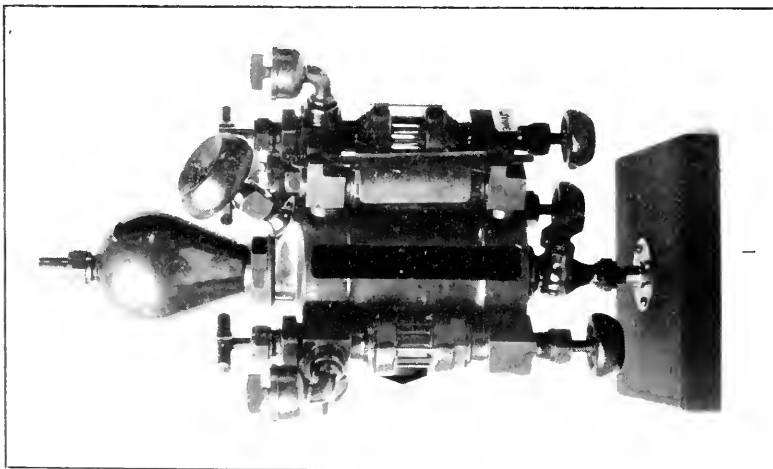

35528B

1

ENGINE ACCESSORIES.

1. Multiple hydrostatic lubricator (model; U.S.N.M. no. 308685). See p. 96.
2. Hewitt piston-rod packing, 1879 (model; U.S.N.M. no. 309247). See p. 98.



## MISCELLANEOUS STEAM-ENGINE ACCESSORIES

## HARRISON LUBRICATOR, 1880

U. S. N. M. no. 308704; original patent model; transferred from the United States Patent Office; not illustrated.

This model was submitted with the application for the patent issued to A. L. Harrison, of Bristol, Conn., March 2, 1880, no. 225124.

The model represents a steam-engine lubricator in which the oil is contained in a reservoir fitted with a balanced diaphragm upon both sides of which the steam pressure in the main acts. The unbalanced pressure required to force the oil into the steam is atmospheric pressure obtained by the use of a vacuum chamber when the engine is operating condensing, or the hydrostatic pressure of a water column when the engine is operating noncondensing.

The lubricator consists of an oval chamber divided by a flexible diaphragm. The space above the diaphragm contains the oil and is connected through a glycerine-filled sight glass to the steam chest or cylinder of the engine. The space below the diaphragm is connected to the steam pipe from the boiler, so that steam pressure acts on both sides of the diaphragm. A rod attached to the center of the diaphragm passes through suitable stuffing boxes to a piston in a cylinder below the diaphragm chamber. The space above the piston is connected to the condenser of the engine so that atmospheric pressure will exert an unbalanced force upon the under side of the piston, and through it upon the diaphragm, sufficient to force the oil out of the lubricator into the engine. When used with a noncondensing engine a water column in the steam pipe connecting to the under side of the diaphragm provides an unbalanced hydrostatic pressure on the diaphragm.

## HAY GRAVITY-FEED OILER, 1888

U.S.N.M. no. 309248; original patent model; transferred from the United States Patent Office; not illustrated.

This oiler was submitted with the application for the patent issued to Peter D. Hay (assignor to the Michigan Lubricator Co.), of Detroit, Mich., June 19, 1888, no. 384762.

The model represents a sight-feed oiler in which the oil is contained in a cylindrical glass reservoir and flows by gravity through a needle valve to the bearing into which the oiler is screwed. The needle of the needle valve when closed is held against its seat by a light spring. It is opened by lifting the needle and giving it a short turn so that a pin on the shaft rises out of a slot and rests on the top edge of a brass thumb nut screwed into the central post of the oiler. This nut may be run up or down on its threads and so determine the amount by which the needle will be raised and held from its seat and

so control the rate at which oil is fed from the reservoir. The nut carries a spring-held pin that rests in shallow recesses in the top of the oiler and holds the nut in the position in which it is set and will not permit the nut to be jarred around by the vibration of the machine to which it is attached.

#### INTERMITTENT GRAVITY OILER

U.S.N.M. no. 311184; model; transferred from the United States Patent Office; not illustrated.

This is a gravity oiler similar to the above in which the lubricating oil is contained in a glass reservoir from which it flows by its own weight through a valve in the bottom of the reservoir. The valve through which the oil flows is a small conical valve held closed by the weight of the oil above it. A stem projects downward from the lubricator, which when pushed upward lifts the valve from its seat and allows the oil to flow. It is probable that this lubricator was designed to release a drop of oil upon the surfaces of some slow-moving machine, such as the guides of a planer when a cam or lug on the moving part engaged the valve stem and raised it.

#### HAND-PUMP PRESSURE LUBRICATOR

U.S.N.M. no. 311185; original; transferred from the United States Patent Office; not illustrated.

This is a pressure lubricator designed to force lubricating oil into the steam being supplied to a steam engine for the lubrication of the piston and valves. It forces the oil into the steam main against the pressure of the steam. It consists of a large glass reservoir into which is built a small simple hand pump. By working the handle of the pump the oil is drawn into the pump cylinder and discharged through the screw fitting at the bottom of the lubricator into the steam main or valve chest to which the lubricator is attached. The efficiency of lubricators of this kind depends entirely upon the judgment of the engineer or oiler. They are generally wasteful of oil.

The lubricator is marked "Buckeye Engine Company."

#### MULTIPLE HYDROSTATIC LUBRICATOR

##### PLATE 21, FIGURE 1

U.S.N.M. no. 308685; original patent model; transferred from the United States Patent Office; photograph no. 3262SB.

This is an automatic lubricator that delivers lubricating oil into the steam being supplied to a steam engine at any desired rate. It employs the pressure due to a column of water plus the pressure of the steam in the main to force the oil into the main against the steam pressure.

The lubricator consists principally of a large cylindrical brass reservoir containing the oil. This reservoir is connected at the top through a length of vertical uninsulated pipe to the steam main. The pipe extends down within the reservoir to a point near the bottom. Steam entering this pipe is condensed to some extent and conveys water into the reservoir, where it displaces the oil to the top. A second pipe entering the reservoir at the bottom extends nearly to the top. The top of this pipe is open, and the oil is forced into it. This pipe conveys the oil to a needle valve at the bottom of a sight glass or water column through which the oil rises in drops to the pipe that conveys it to the steam main. The resistance offered the flow of oil by the pressure in the main is overcome by the pressure exerted on the oil in the reservoir by the steam pressure in the uninsulated pipe plus the pressure due to the height of the column of water standing in the pipe.

The rate of flow of the oil is regulated by the needle valve at the bottom of the sight glass, which is set to deliver oil at the rate required, usually stated in drops per minute. This is a multiple lubricator provided with three delivery valves and sight glasses from which oil may be supplied to three different points at three different rates. A sight level glass on the side of the reservoir is provided to show the quantities of oil and water within the reservoir. Stiff sheet-brass guards surround all the glass parts so that the highly strained gauge glass will not fly far off if the glass should fail under the pressure within the lubricator.

#### BRAMWELL VALVE, 1859

U.S.N.M. no. 309251; original patent model; transferred from the United States Patent Office; not illustrated.

This model was submitted with the application for the patent issued to William Bramwell, of New York, N. Y., June 14, 1859, no. 24639.

The model represents a valve in which a gate swinging upon a horizontal axis is opened or closed by means of a hand wheel, vertical screw, and toggle link.

The gate of the valve is a conical plug that swings on an arm from a pivot above it. When closed the gate fits a conical seat in the valve body; when opened it swings up into the top of the valve body practically clear of the passages. The peculiar feature of the valve is the arrangement of parts, which permits the closing of a swing-gate valve by means of a hand wheel and screw.

## FITTS GOVERNOR VALVE, 1859

U.S.N.M. no. 308662; original patent model; transferred from the United States Patent Office; not illustrated.

This model was submitted with the application for the patent issued to Benaiah Fitts, of Worcester, Mass., August 9, 1859, no. 25005.

The model represents a globular valve in which a conical rotor uncovers a port in a conical seat. It operates without a stuffing box and is designed so that the pressure of steam on the rotor is balanced, reducing friction to a minimum.

## SCHEIDLER AND McNAMAR THROTTLE VALVE, 1875

U.S.N.M. no. 308687; original patent model; transferred from the United States Patent Office; not illustrated.

This model was submitted with the application for the patent issued to Reinhard Scheidler and John H. McNamar, of Newark, Ohio, June 8, 1875, no. 164219.

The model represents a piston shaped regulating valve operated by a lever, sector, and rack on the valve stem. It is designed for use as an auxiliary valve in connection with a throttle valve of ordinary form. The inventors describe the valve as being particularly well fitted for the control of sawmill engines.

## HEWITT PISTON-ROD PACKING, 1879

## PLATE 21, FIGURE 2

U.S.N.M. no. 309247; original patent model; transferred from the United States Patent Office; photograph no. 32628A.

This model was submitted with the application for the patent issued to John Hewitt, of St. Louis, Mo., June 3, 1879, no. 216038.

The model represents a 2-piece, flange-and-gland stuffing box of the usual form, packed with malleable metal rings with beveled edges. The rings are alternately beveled in opposite directions so that adjoining surfaces match. The edges of the flange and gland are beveled so that when the parts are brought together and tightened the effect is of a number of double wedges sliding together and expanding between the stuffing box and the shaft.

## CENTRIFUGAL SEPARATOR, c. 1879

U.S.N.M. no. 180924; original; gift of the Deerfoot Farm Co.; not illustrated.

One of the earliest uses of the centrifugal separator for raising cream from milk was at the Deerfoot Farm, Southborough, Mass. The separator described here was one of the first three employed there in 1879. It is included in this catalog because it is exhibited in the Museum with the centrifugal oil separator, described below.

The separator is a cast-iron cylinder, 2 feet in diameter, with a depth at the circumference of 14 inches. The top of the cylinder is double walled and slightly domed, with an opening at the center  $12\frac{1}{2}$  inches in diameter. It is mounted upon a short vertical shaft that carries a horizontal belt pulley. A heavy cast-iron bedplate supports the bearing of the shaft and carries two stub shafts for idler pulleys to guide the driving belt to the shaft pulley. The scoop pipe and filling faucet are missing.

In use milk was run into the cylinder from a faucet through the opening of the top, and the cylinder was spun at a rate of 1,600 revolutions per minute. In about 20 minutes centrifugal force would have thrown the heavier milk to the wall of the cylinder and the cream would have formed an inner layer inside of the milk. A scoop pipe was inserted through the opening into the revolving layer of cream, which ran out through the pipe to cans. Fresh milk was added to bring the level of cream and then the skim milk up to the scoop pipe. The separator had a capacity of about 516 pounds of milk an hour. It was driven by belting from the line shaft of the dairy, which was powered by a 1-horsepower steam engine.

A discussion of the equipment at the Deerfoot Farm dairy and a brief history of centrifugal milk separators are contained in the article "Deerfoot Farm Centrifugal Dairy", by E. Lewis Sturtevant, in the *Annual Report of the Commissioner of Agriculture for the Year 1880*, Washington, 1881.

#### THOMSON AND HOUSTON CENTRIFUGAL CREAMER, 1881

U.S.N.M. no. 309134; original patent model; transferred from the United States Patent Office; not illustrated.

This model, which is roughly diagrammatic, was submitted with the application (1877) for the patent issued to Elihu Thomson and E. J. Houston, of Philadelphia, April 5, 1881, no. 239659.

The creamer represented by the model is a centrifugal separator with a single source of supply and two distinct discharges designed to give continuous operation without interference of the supplied liquid with the separated products. Stopping the apparatus for the insertion and removal of material, "as in ordinary centrifugal machines", is unnecessary.

The separator has a conical-shaped rotating case on a hollow vertical shaft, which opens into the bottom of it, and a horizontal deflector plate a few inches above the bottom. The liquid is supplied from a pipe above the center of the central top opening of the case. The deflector plate prevents the passage of the supplied liquid directly to the hollow shaft. Under the influence of the rapid rotation of the case the denser ingredients of the liquid accumulate toward the

greatest diameter of the rotor case, which is the lowest part, and pass out through the hollow shaft. The lighter ingredients are displaced toward the axis of rotation and discharge around the opening at the center and top of the rotor case. An outside case, which may be either rotating or stationary, collects the lighter ingredients as discharged.

#### CENTRIFUGAL OIL CLARIFIER, 1931

U.S.N.M. no. 310255; sectioned original; gift of the De Laval Separator Co.; not illustrated.

The clarifier is a steam-driven centrifugal separator prepared for the clarifying of lubricating oil. Similar machines with steam or electric drive modified with the proper bowls and collectors are used to clarify and dehydrate transformer oils, to clarify switch oils and solvents, and to separate liquids of different specific gravities, as cream and milk.

The separator is a heavy metal bowl mounted upon a vertical bowl spindle, which projects upward into the bowl and supports a series of conical disks and covers and a tubular filling shaft. The weight of the bowl is supported by a steel point at the end of the lower spindle resting upon two treadwheels. On the lower spindle is the steam wheel or rotor of a small, single-stage, impulse turbine, which revolves the bowl. The oil to be clarified is led down through a hollow shaft to the bottom of the bowl, where it flows out to the disks where the separation takes place. Under the influence of the forces set up by the rapid rotation of the bowl the heavier liquid passes up along the outside of the disks and out at the lower outlet of the bottom cover. The lighter liquid passes up along the inside of the disks and out through the upper outlet of the bowl to the middle cover. An upper cover is provided to carry off any possible overflow of liquid.

Gustav de Laval, whose name is equally honored in the histories of both centrifugal separators and steam turbines, developed the impulse turbine to produce a motor capable of turning his centrifugal separator at the required high speed. When, in 1883, he applied a steam turbine to a separator he made the first practical use of the modern steam turbine.

#### AIR AND HYDRAULIC ENGINES

##### CHANDLER AND SILVER HYDRAULIC ENGINE, 1878

U.S.N.M. no. 308702; original patent model; transferred from the United States Patent Office; not illustrated.

This model was submitted with the application for the patent issued to Lucius S. Chandler and Samuel N. Silver, of Auburn, Maine, August 27, 1878, no. 207391.

The engine has four single-acting, horizontal cylinders arranged in a block like the chambers of a revolver. Connecting rods from the four pistons connect to pins on crank disks on a common shaft. The head ends of the four cylinders open into a drumlike exhaust chamber. A rotary valve of peculiar construction revolves in the exhaust chamber close to the ends of the cylinders and opens the cylinders to the exhaust chamber or to the pressure inlet pipe, which forms the hollow stem of the valve, in proper sequence. The hollow stem of the valve passes out of the forward side of the exhaust chamber through a gland and bearing. It carries a spur gear that meshes with a pinion on a lay shaft, which parallels the cylinders and is turned by a bevel gear pair at the crankshaft.

#### CARPENTER COMPOUND HYDRAULIC ENGINE, 1878

U.S.N.M. no. 309252; original patent model; transferred from the United States Patent Office; not illustrated.

The model was submitted with the application for the patent issued to Oramill C. Carpenter, of Brooklyn, N. Y., December 17, 1878, no. 210915.

The engine is essentially a hydraulic transmission, which takes motion from eccentric cams on a central shaft turned by a steam or other engine and transmits the motion to shafts on either side of and parallel to the central shaft. The inventor designed the engine to be applied to a streetcar, and the model is mounted in a miniature nickel-plated car truck.

It is a 4-cylinder engine with opposed cylinders in groups of two. Single-acting plungers work in and out of the cylinders as the central shaft is turned. The head of each cylinder leads directly to another cylinder of reduced diameter in each of which a driven piston works through a longer stroke in time with the short stroke of the driving piston. Valves for the relief of an excess pressure of liquid and spring-cushioned piston heads are described for smoother running.

#### COLWELL DISULPHIDE OF CARBON GENERATOR AND ENGINE, 1879

U.S.N.M. no. 308766; original patent model; transferred from the United States Patent Office; not illustrated.

The model was submitted with the application for the patent issued to William S. Colwell, of Pittsburgh, Pa., September 16, 1879, no. 219622.

The model represents a reciprocating engine of more or less conventional steam engine design in which the operating fluid is vaporized carbon disulphide supplied by a boiler or generator and condensed in an air-cooled condenser. The transfer of heat from the fire in the boiler to the carbon disulphide and from the exhaust vapor to the cooling air of the condenser is effected through water. Plumbago,

or black lead, is used to protect the walls of the generator and the engine from the action of the carbon-disulphide vapor. Steam and hot water from the water jacket of the generator are led into passages surrounding the engine cylinder and connecting pipes to prevent the loss of heat from the vapor.

#### KIMMAN COMPRESSED-AIR ENGINE

U.S.N.M. no. 310189; original; gift of Martin T. Kimman; not illustrated.

This small, 3-cylinder, radial, air engine was designed and made by Henry James Kimman (1862-1921), a pioneer inventor of small portable piston air drills. It is believed that the engine was built for a steering engine on a steam roller. The experience gained in the construction of the engine directed his interest to the design of air drills, in which field he made valuable contributions.

The engine is exhibited in the Museum with several forms of the Kimman air drill not described in this publication.

#### MECHANICAL TRANSMISSION OF POWER

The mechanical transmission of power, though a large subject and an important phase of mechanical engineering, is not largely represented in the National Museum collections. A few models of elementary belt drives are included in the group described above under "Models of Mechanical Powers" (p. 3) and the remaining items in the collection are listed here.

#### BELT DRIVING ACCESSORIES (chronologically arranged)

Belt fastener, Patent Office model, Patent no. 25187, issued to Albert Fickett, August 23, 1859. U.S.N.M. no. 309148.

Splicing belts, Patent Office model, Patent no. 66261, issued to N. E. Smith July 2, 1867. U.S.N.M. no. 309154.

Belt lacing, Patent Office model, Patent no. 70775, issued to H. C. Babcock, November 12, 1867. U.S.N.M. no. 309153.

Belt hook, Patent Office model, Patent no. 84968, issued to Charles Sargeant, December 15, 1868. U.S.N.M. no. 309145.

Splicing or joining belts, Patent Office model, Patent no. 86123, issued to John Ashworth, January 26, 1869. U.S.N.M. no. 309155.

Belt joints, Patent Office model, Patent no. 89820, issued to B. P. Walker, May 4, 1869. U.S.N.M. no. 309146.

Method of lacing belts, Patent Office model, Patent no. 153153, issued to George E. Burt, July 21, 1874. U.S.N.M. no. 309150.

Belt fastener, Patent Office model, Patent no. 164855, issued to J. B. McElroy, June 22, 1875. U.S.N.M. no. 309156.

Belt tightener, Patent Office model, Patent no. 196222, issued to Gilbert Greene, October 16, 1877. U.S.N.M. no. 309139.

Belt tightener, Patent Office model, Patent no. 201596, issued to David L. Croft, March 26, 1878. U.S.N.M. no. 309157.

Belt tightener, Patent Office model, Patent no. 226311, issued to V. H. Hallock, April 6, 1880. U.S.N.M. no. 309147.



Method for lacing belt, Patent Office model, Patent no. 228390, issued to O. C. Pomeroy, June 1, 1880. U.S.N.M. no. 309152.

Belt fastener, Patent Office model, Patent no. 229278, issued to A. Schuhknecht, June 2, 1880. U.S.N.M. no. 309149.

Belt coupling, Patent Office model, Patent no. 238164, issued to E. O. Sawyer, February 22, 1881. U.S.N.M. no. 309151.

### ROPE DRIVES

Rope drive, Patent Office model, Patent no. 359597, issued to W. H. Dodge, March 22, 1887. U.S.N.M. no. 308983.

Rope driving apparatus, Patent Office model, Patent no. 478875, issued to Macdonald, Williams, and Hitzeroth, July 12, 1892. U.S.N.M. no. 308849.

### SHAFT BEARINGS

Antifriction journal bearing, Patent Office model, Patent no. 212744, issued to L. Rank, February 25, 1879. U.S.N.M. no. 309143.

Antifrictional bushings, Patent Office model, Patent no. 224453, issued to H. Loud, February 10, 1880. U.S.N.M. no. 309144.

Antifriction alloy, Patent Office model, Patent no. 429249, issued to Samuel Singley, June 3, 1890. U.S.N.M. no. 308842.

### SHAFT COUPLINGS

Shaft coupling, universal joint, Patent Office model, Patent no. 97575, issued to Seih Wheeler, December 7, 1869. U.S.N.M. no. 308848.

Coupling for tumbling shafts, universal joint, Patent Office model, Patent no. 105259, issued to S. C. Scofield, July 12, 1870. U.S.N.M. no. 308847.

Flexible shaft, Patent Office model, Patent no. 130253, issued to Nelson Stow, August 6, 1872. U.S.N.M. no. 311181.

Knuckle joint, universal joint, Patent Office model, Patent no. 215922, issued to C. Q. Hayes, May 7, 1879. U.S.N.M. no. 308824.

### MISCELLANEOUS MECHANICAL TRANSMISSION DEVICES

Connecting rod, Patent Office model, Patent no. 3981, issued to H. Hinkley, April 1, 1845. U.S.N.M. no. 308989.

Reversible mechanism for countershaft, Patent Office model, Patent no. 259572, issued to C. E. L. Moebius, June 13, 1882. U.S.N.M. no. 308840.

Motion transmitting device, roller gear, Patent Office model, Patent no. 705,624, issued to C. F. Stokes and C. E. McGlinchley, July 29, 1902. U.S.N.M. no. 308846.

Clutch pulley, Patent Office model, not identified. U.S.N.M. no. 308984.

Planetary gear, Patent Office model, not identified. U.S.N.M. no. 308851.

### STEAM BOILERS

The steam boiler is as old as the boiling and distilling processes in cooking and manufacturing and naturally antedates the steam engine. The first "power" boilers were described by Heron of Alexandria; they were used to supply steam or vapor to the steam-operated devices, which he discussed. These descriptions are variously translated in name as *vessels*, *cauldrons*, and *spheres*, and the drawings illustrating the several translations show them as hollow

spheres or wide shallow vessels of various and often fantastic shapes covered with flat metal plates. All of them were heated over open fires or simple stone stoves in which the heat of the fire was applied to only a small section of the surface of the vessel. They seem to have been constructed of copper.

The recent and continuous development of the steam boiler begins with the boilers used to supply steam at low pressure to the atmospheric steam engines of Newcomen. It is true that before Newcomen Thomas Savery had constructed boilers for the high pressures that his mine pumps (pulsometers) required, but the difficulty of maintaining them tight and his lack of success with boilers in general were largely responsible for the abandonment of the Savery engine. Before Savery and Newcomen, soapmakers, brewers, and other tradesmen using evaporators and cookers had developed boilers and furnaces with considerable skill and thought. Brick and masonry settings in which flues and passages in the setting were used to conduct the flame and hot gases over the surface of the boiler shell had been evolved. The boilers themselves were simply cylindrical straight-sided and flat-bottomed vessels open at the top and usually made of copper. To adapt them as steam generators they were covered with a sheet of metal, often just a sheet of lead. The boiler illustrated in the engraving of the Newcomen engine of 1712 (see above) was a boiler of this type with a hemispherical, domed top forming a steam chamber above the cylindrical part of the boiler. The top was joined to the lower part in a wide flange, which overhung the sides at the top and formed the top of a flue that surrounded the entire lower part of the boiler. Gradually this type of boiler was rendered more suitable for steam power purposes. Wrought-iron plates and riveted joints were used (about 1725), the sides and bottom were made concave for stiffness, and internal stays were employed. In its improved form the boiler resembled a haystack and was often called the haystack boiler. It was sometimes constructed with a central domelike firebox and an internal helical flue.

To increase the heating surfaces of the boiler James Watt, about 1780-1790, designed the *wagon* type of boiler, which is practically an elongated haystack boiler with flat ends, somewhat resembling a deep rectangular wagon body with an arched top. These boilers had concave sides, which with the adjacent brickwork of the setting formed flues along each side of the boiler. The grates were at the forward end and beneath the boiler, and the hot gases passed under the concave bottom to the back, returned along one side of the boiler, and then passed back again along the opposite side. Later Watt added a square flue through the center of the boiler and caused the

gases to return through the flue, divide at the front, and pass back along each side.

From the wagon type of boiler the horizontal cylindrical shell boiler soon developed, and following it came a great many combinations of cylinders and drums in large and small sizes. The externally fired cylindrical boiler with convex ends and no flues was probably the most widely used boiler from 1800 to about 1850. Woolf's patent steam-engine boiler, 1803 (see below), is an early and typical one of combinations of small cylinders and drums, a modern example of which is the "elephant", or French, boiler still used to some extent in Europe. It is very probable that such combinations of drums and connecting pipes suggested the water-tube boiler.

The internal flue boiler was employed by Smeaton, the English engineer who is often credited with its invention (c. 1740 to 1770), as well as by Watt, as mentioned above. The real development began, however, with the work of Oliver Evans in the United States and Richard Trevithick in England. A model of a locomotive supposed to have been made by Trevithick before 1800 has a horizontal cylindrical shell boiler within which is a large circular flue passing through the shell. Within one end of the flue a grate is provided, and the other end of the flue is joined to a stack. Trevithick's patent of March 24, 1802, and a road locomotive constructed at London in 1803 include a boiler of this type in which the flue was bent in the form of a large U, and the hot gases were required to pass through the entire length of the boiler in each direction. Trevithick constructed several large stationary flue boilers with great success.

Oliver Evans, pioneer builder of high-pressure steam engines, is generally credited with having made the first practical flue boilers in the United States. Evans is believed to have completed his first steam engine in 1802, but it is not clear what type of boiler he used then. *The Abortion of the Young Steam Engineer's Guide*, by Oliver Evans, printed at Philadelphia in 1805, illustrates a steam engine (see above) "on the new principle" (high pressure), including a section of an internally fired flue boiler. The text indicates that he also used externally fired return-flue boilers and mentions his experience with boiling linseed oil in wooden boilers to 120 pounds per square inch pressure and 600°. Evans also used the brick-set multiple-drum boiler of several connected small cylinders all externally fired, in the steamboat *Aetna* of 1818.

Wooden boilers were used by engineers other than Evans, but they seem to be a peculiarly American development. Just as the early cookers of the various trades were used in England as steam generators, in the United States the wooden vats and tanks of the brewers and distillers were to some extent adopted. Staudinger and Livings-

ton who built the engines for the Center Square station of the Philadelphia waterworks in 1801, suggested that wooden boilers be used. These are described below.

High-pressure steam did not come into favor for many years after Trevithick and Evans, and flue boilers were first developed with the object of obtaining the largest heating surface possible with little regard to increasing the strength of the boilers. Many of the early flue boilers were constructed with single flues of large diameter and were not well designed for strength. As pressures were increased it became necessary to give more attention to strength and the realization that large heating surface with greater strength could be obtained with the use of several flues of small diameter was an important step forward in boiler design. The Lancashire boiler with two parallel internally fired flues was introduced by Sir William Fairbairn of England in 1844, and following this a number of variations were introduced. The use of strengthening devices such as cross tubes (first used by Paul Steenstrup in 1828), strengthening rings, and corrugated flues have permitted flue boilers to keep pace with the pressure requirements, and at the present time they are working at the highest pressures employed in ordinary steam-engine practice.

*Fire-tube boilers.*—The fire-tube boiler, with many small tubes within which the flame or hot gases from the fire passed through the water in the boiler, was first suggested by Nathan Read, of Salem, Mass., about 1790. Read, a graduate of Harvard College, began experiments with steam engines about 1788, with a view to adapting them to road vehicles and boats. In 1789, at Danvers, Mass., he operated a boat propelled by paddle wheels turned by hand to satisfy himself that the steam engine might be applied to propulsion in that manner, and in 1790 and 1791 he filed with Congress and the newly appointed Commissioners of Patents applications describing steam-propelled land vehicles, boats, and improvements in the steam engine and boiler. Under date of August 26, 1791, the first United States patents were issued, including one to Read for his boiler. The patented boiler was a vertical *water-tube* boiler with an enclosed firebox, but letters of Read relating to the boiler and sketches found among his papers indicate that he intended the use of the same general design of the boiler with either water or fire tubes. With fire tubes the boiler would resemble the typical vertical hoisting engine boiler of today. It is not probable that Read or James Neville, who patented a similar boiler in England in 1826, used a boiler of this type, and the credit for its first use is usually given to M. Sequin, French engineer, who patented a tubular boiler in February 1828 and applied it to two locomotives early in 1829. The type was brought to practical perfection by George Stephenson, who applied it as the boiler of his locomotive *Rocket* of 1829. It has been the standard loco-

tive boiler type to the present day. The boiler used with the Lawrence, Mass., pumping engine of 1876 (described below) is a typical one of the multitubular locomotive type used for stationary plants. The externally fired horizontal return tubular boiler is the modern stationary boiler of the fire-tube type, and the Scotch marine boiler is an example of a combination of the internally fired flue boiler with fire tubes.

*Water-tube boilers.*—The water-tube boiler, in which the water is contained in tubes or small connected chambers in the path of the flame or hot gases, is one of the oldest forms of the boiler. The Catalogue of the Mechanical Engineering Collections of the Science Museum, London, 1907, mentions copper vessels found in the ruins of ancient Roman cities, which are apparently boiler elements incorporating the principle of water tubes. The recent development is usually traced from the boiler of John Blakey, patented in England in 1766. This consisted of several short tubes inclined at alternately opposite angles and joined with very short bent tubes of small diameter. These tubes were enclosed in a vertical brick furnace, which was merely an enlargement of the base of the chimney. This boiler had no water reservoir or steam chamber. Many of the steam-engine pioneers experimented with the use of water tube and pipe boilers, and very early descriptions of them are not at all uncommon. One of the earliest of the actual uses of the water-tube boiler was by James Rumsey, who employed a pipe boiler in the steamboat he built at Shepherdstown, W. Va., in 1787. This boiler is mentioned in his *Treatise on the Application of Steam, etc.* (see above), and a drawing and description of it (see below) appeared in the *Columbian Magazine* of May 1788. This boiler consisted of a nest of pipes made up of alternate horizontal rows of pipe laid at right angles to each other so that rectangular vertical passages for the hot gases were formed between the tubes. Rumsey described other boilers and patented several water-tube boilers in England and the United States. Col. John Stevens, of Hoboken, N. J., and his son, John Cox Stevens, made successful water-tube boilers for their experimental steamboats and locomotives during the period 1804 to 1825. The porcupine, or dead-ended, water-tube boiler used in the Stevens steamboat of 1804 and the tube and header assembly of the vertical water-tube boiler of the experimental locomotive of 1825 are described below. The second one was patented in the United States in 1803 by John Stevens and in England in 1805 by John Cox Stevens.

In 1821 Julius Griffith built one of the earliest of the sectional water-tube boilers, while Joseph Eve's boiler of 1825 was the first with a well-defined circulation. The short-lived interest in steam road carriages about 1825 was responsible for the introduction of many portable water-tube boilers that contributed little to the de-

velopment. Stephen Wilcox, in 1856, introduced the first boiler with inclined tubes connecting water spaces at the front and rear with steam and water space above. This is a type that has continued to influence the design of boilers to the present day.

### WOODEN STEAM BOILER, 1801-1815

#### PLATE 22, FIGURE 1

U.S.N.M. no. 310849; model; made in the Museum; photograph no. 31630.

The model represents a boiler used at the Center Square pumping station of the Philadelphia waterworks between 1801 and 1815. It is essentially a watertight, planked, wooden steam chest containing a cast-iron firebox and flue. Short cast-iron pipes in the nature of water tubes cross the wide, flat flue.

The model was constructed from the information and drawings contained in the article "History of the Steam Engine in America" in the *Journal of the Franklin Institute*, Philadelphia, vol. 102. The following, which includes a description of the boiler by Benjamin Henry Latrobe in the *Transactions of the American Philosophical Society*, vol. 6 (1804), is quoted from the above article:

Wooden boilers have been applied in America to the purpose of distilling for many years. Mr. Anderson, whose improvements in that art are well known appears to have first introduced them in America. But it was found that the mash had a very injurious effect upon the solidity of the wood: for while the outside retained the appearance of soundness, and the inside that of a burnt, but hard surface, the body of the plank was entirely decayed. It was however still to be tried whether simple water and steam would have the same effect: and upon the hint of Chancellor Livingston, our present Ambassador in France, Messrs. Roosevelt, Smallman and Staudinger contrived the wooden boiler, which has been used for all the engines in New York and Philadelphia; and not without its great, though only temporary advantages. The construction of the wooden boiler, will be best understood, by reference to the plan and section of the new boiler of the engine in Center Square, Philadelphia, which is by far the best of those which have been made. It is in fact only a wooden chest containing the water, in which a furnace is contrived, of which the flues wind several times through the water before they discharge themselves into the chimney.

The boilers were rectangular chests, made of white pine planks five inches thick; they were nine feet square inside at the ends, and fourteen feet long in the clear; braced upon the sides, top, and bottom with oak scantling ten inches square, the whole securely bolted together by one and a quarter inch rods passing through the planks. Inside of this chest was placed an iron fire box twelve feet six inches long, six feet wide, and one foot ten inches deep, with vertical flues, six of fifteen inches diameter and two of twelve inches diameter; through these the water circulated, the fire acting around them and passing up into an oval flue situated just above the fire box, carried from the back of the boiler to near the front, and returned again to the back, where it entered the chimney. This fire box and flues appear to have been at first made entirely of cast-iron; then a wrought-iron fire box was made, the flues still being of cast-iron; this not being satisfactory on account of the unequal contraction and

expansion of the two metals causing leakage, eventually wrought-iron flues were also put in.

Great advantage was at the time supposed to be gained by the nonconducting powers of the wood, and also by the vertical flues in the fire box.

As might be expected, great difficulty was experienced in keeping these boilers steam tight; accordingly, on December 1, 1801, a boiler with cast-iron shell, as well as flues, was put up, and another one, also of cast iron, but of different form, was put in use on March 10, 1803

#### JOHN STEVENS PORCUPINE BOILER, 1804

U.S.N.M. no. 181179; original; deposited by Edwin A. Stevens; not illustrated

This is the boiler of the steamboat used by Col. John Stevens on the Hudson in 1804. It is a multitubular boiler of the type often called "porcupine."

The boiler consists of a rectangular water reservoir from each side of which project 14 closed-end copper tubes about 18 inches long by  $1\frac{1}{2}$  inches in diameter. The water reservoir and tubes are inclosed in a rectangular sheet-metal shell, which supports the grates and forms the furnace of the boiler. The shape of the boiler is such that the flame or hot gases from the grate pass down through the forward cluster of tubes under the reservoir and up through the back tubes to the smokestack. A tall conical-shaped steam dome is bolted to the top of the water reservoir above the shell of the furnace. The boiler is equipped with a plunger feed-water pump and a ball-and-lever safety valve.

#### JOHN STEVENS WATER-TUBE BOILER, 1803-1825

##### PLATE 22, FIGURE 2

U.S.N.M. no. 180029; original; deposited by the Stevens Institute of Technology; photograph no. 25370.

This specimen consists of the headers and tubes of the boiler used by Col. John Stevens on his experimental locomotive at Castle Point, N. J., in 1825. The design was patented by him April 11, 1803.

The relic consists of 20 vertical tubes, each about 40 inches long by  $1\frac{1}{4}$  inches outside diameter, arranged in a 12-inch circle, connecting an annular header at the top with a similar one at the bottom. The headers and tubes are wrought iron. Each header is formed of two flat disks with circular grooves cut in them so that when faced together an annular space 1 square inch in cross section and about  $10\frac{1}{2}$  inches long is formed. The header parts are held together by ten  $\frac{3}{4}$ -inch and five  $\frac{5}{8}$ -inch bolts. Steam was taken from a 1-inch pipe in the top header, and water was put in through a similar pipe in the bottom header.

When used the tubes and header were contained in a sheet-iron shell that supported the grates and formed the ashpit, the furnace, and the stack. The shell is not with the specimen.

The safety valve used with the boiler is exhibited separately in the Museum and is described below under "Steam-boiler Accessories." It bears the same U.S.N.M. number.

#### CRAWFORD BOILER FURNACE, 1850

U.S.N.M. no. 309208; original patent model; transferred from the United States Patent Office; not illustrated.

This model formed part of the application for the patent issued to Benjamin Crawford, of Allegheny, Pa., January 29, 1850, no. 7051; reissued December 2, 1862, no. 135.

The model represents a wide, internally fired, return tubular boiler (western river type) equipped with an air heater using the hot flue gases and exhaust steam from the engine, a forced draft produced by steam jets in the ash-pit, rotary steam jets for increasing turbulence above the fire, and induced draft produced by rotary steam jets in the stacks.

Air for combustion is drawn through tubes in a cylindrical shell into which the exhaust from the engine opens. After passing through this heater the air travels through ducts that are let into the breeching and is further heated by the hot flue gases. Steam jets discharged through the air pipes toward the ashpit induce the flow of air to the ashpit. The steam jets, which produce turbulence over the fire and induce draft in the stacks, issue from nozzles formed of short pipe one end of which is straight and fits over the end of the steam pipe, the other end twisted so that the steam is discharged at an angle to the axis of the pipe, the reaction causing the nozzle to whirl.

#### WIEGAND STEAM BOILER, 1867

U.S.N.M. no. 309209; original patent model; transferred from the United States Patent Office; not illustrated.

This model was submitted with application for the patent issued to S. Lloyd Wiegand, of Philadelphia, Pa., August 6, 1867, no. 67621.

This model is of a boiler having water tubes made up of large tubes closed at the ends with smaller tubes suspended within the large tubes to provide circulation of steam and water upward in the smaller tubes and of the cooler water downward in the annular spaces between the larger and smaller tubes. The inventor suggests the use of tubes of different metals to produce a galvanic action for the purpose of preventing deposits of scale within the tubes.



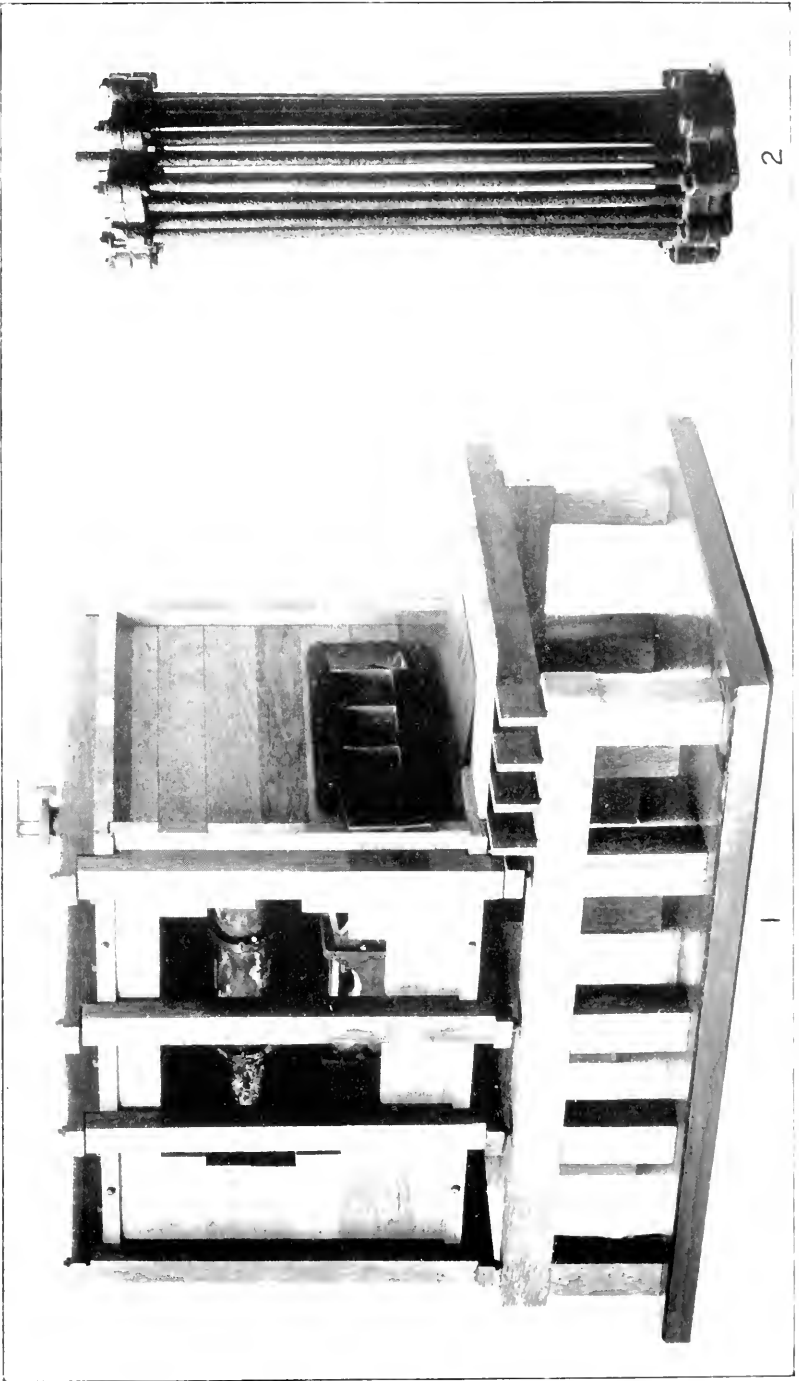

31630

25370

EARLY STEAM BOILERS.

1. Wooden steam boiler, 1801-1815 (model; U.S.N.M. no. 310849). See p. 108.
2. Stevens water-tube boiler, 1803-1825 (U.S.N.M. no. 180029). See p. 109.

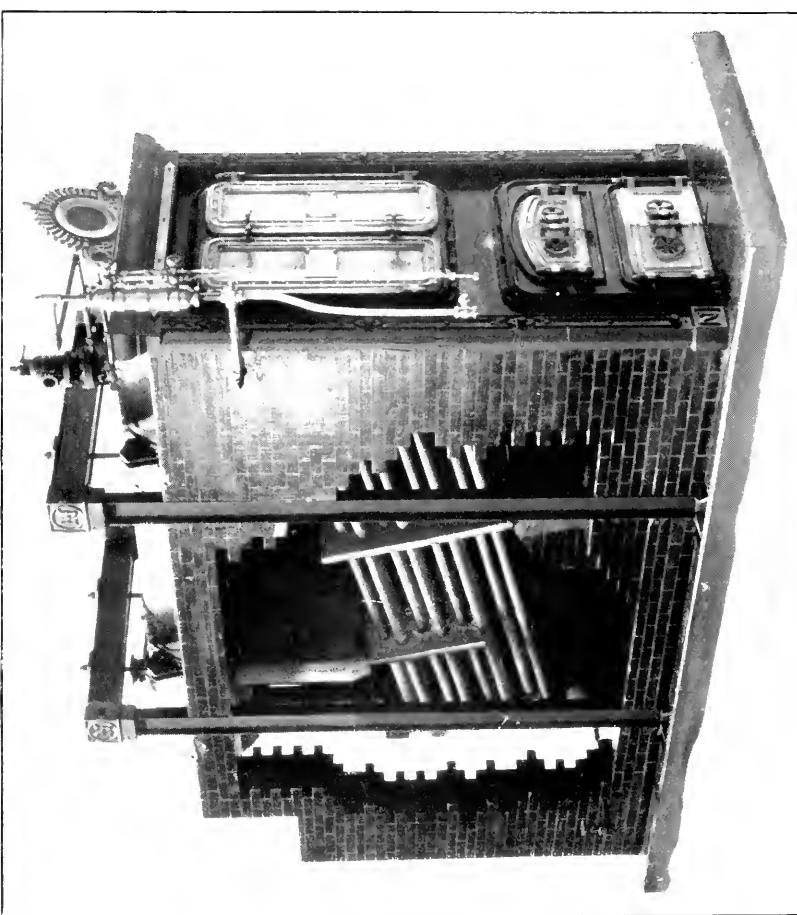

17594

NATIONAL WATER-TUBE BOILER, 1885  
Model (U.S.N.M. no. 309374). See p. 115.

The boiler represented by the model consists of a series of vertical tubes suspended into the furnace from a horizontal header across the top of the boiler setting. The tubes are closed at their lower ends, and within each tube is one of smaller diameter. The smaller tubes are suspended from a plate within the header. The headers connecting each row of tubes across the boiler are, in turn, connected by a longitudinal drum above them.

#### RHODES STEAM GENERATOR, 1869

U.S.N.M. no. 309210; original patent model; transferred from the United States Patent Office; not illustrated.

This model was submitted with the application for the patent issued to William K. Rhodes, of Portland, Maine, June 29, 1869, no. 91869.

The model represents a horizontal inclined water-tube boiler with solid headers and horizontal baffling. Each header is constructed with its outside face vertical and the tube sheet perpendicular to the tubes so that the front header has a larger volume at the top to be used as a steam reservoir, while the back header has a larger volume at the bottom for water.

#### LÜDERS STEAM BOILER, 1869

U.S.N.M. no. 309211; original patent model; transferred from the United States Patent Office; not illustrated.

This model was submitted with the application for the patent issued to Herman W. Lüders, of Philadelphia, Pa., August 31, 1869, no. 94226.

The model represents a boiler having inclined water tubes projecting through forward and back brick walls, which form the furnace and boiler setting. The ends of the tubes projecting from the setting front and back are joined in sets of three by short horizontal cross tubes to large, vertical, upright pillar tubes on either side of the setting, which, in turn, connect to a horizontal drum on each side of the top of the setting. A third longitudinal drum is placed between the other two drums, and all three are joined by one cross drum above them. The short horizontal tubes at the back are cast in longitudinal sections and connected by ball-and-socket joints designed to permit the free expansion and contraction of the tubes.

#### HOWARD AND BOUSFIELD BOILER, 1871

U.S.N.M. no. 309212; original patent model; transferred from the United States Patent Office; not illustrated.

This model was submitted with the application for the patent issued to James Howard and Edward Bousfield, of Bedford, England, April 4, 1871, no. 113298.

The model represents a sectional marine water-tube boiler in which the proportions of the elements and the manner of their connections are designed by the inventor to facilitate the removal of tubes or sections within a relatively small space.

The boiler is constructed of sections, each of which consists of a vertical tube at the back of the boiler from which projects a vertical row of horizontal tubes. Each horizontal tube is closed at the front end with a screw plug through which a short central tube connects to a small vertical tube, common to all the horizontal tubes of a vertical row. These vertical tubes at the front are closed at the bottom end and are joined by a transverse steam pipe at the top. The horizontal tubes are staggered and may be withdrawn horizontally by disconnecting them from the two vertical tubes at front and back. Each horizontal tube has an internal tube designed to improve the circulation. The back vertical tubes are flat-sided and placed together to form the back of the boiler. The horizontal tubes in the outside sections are assembled close together to form the sides of the boiler.

#### RITTY STEAM BOILER, 1875

U.S.N.M. no. 309215; original patent model; transferred from the United States Patent Office; not illustrated.

This model was submitted with the application for the patent issued to Sebastian Ritty, of Dayton, Ohio, July 22, 1873, no. 141172.

The model represents a horizontal cylindrical flue boiler from the center of which is suspended a rectangular water chamber or header. From this header a series of horizontal closed-end water tubes extend forward and back within the furnace below the drum. The outside ends of the tubes are closed and are supported in sheets, which form the front and back walls of the furnace. The forward lower tubes support the grates, and the products of combustion pass through an opening in the central header around the back tubes up and then forward through the flues of the drum.

#### FIRMENICH AND STIKER BOILER, 1875

U.S.N.M. no. 309213; original patent model; transferred from the United States Patent Office; not illustrated.

This model was submitted with the application for the patent issued to Joseph Firmenich and Flavius P. Stiker, of Buffalo, N. Y., November 16, 1875, no. 169977.

The model represents a boiler made up of sections, each of which consists of two longitudinal horizontal drums, one set in the under side of the brick work at the top of the boiler, the other well below it, and the two connected by two rows of vertical tubes. The lower drums in alternate section are below the grates and act as mud drums;

the other lower drums are located just above the grates. The upper drums are connected to one large horizontal cross drum. The drums are flattened for greater convenience in joining the two rows of vertical tubes. Passages are provided in the brickwork through which air for combustion is drawn and preheated.

#### TROWBRIDGE STEAM GENERATOR, 1878

U.S.N.M. no. 308699; original patent model; transferred from the United States Patent Office; not illustrated.

This model was submitted with the application for the patent issued to W. P. Trowbridge, of New Haven, Conn., January 1, 1878, no. 198863; Automatic Boiler & Engine Co., assignee.

The model represents a small vertical coiled water-tube boiler provided with a stack or hopper in the center of the shell, which acts as a fuel reservoir to supply fresh fuel to the fire automatically.

The boiler consists of a cylindrical shell the base of which forms the ashpit above which the grates are supported. The shell above the grates is built with increasing diameter upward to form the firebox, and immediately above this it is contracted for a short distance and then continues in a cylinder of constant diameter. Around the firebox and fitting closely to the shell is a single coil of tubing, which is continued up through the cylindrical portion where alternate coils are staggered slightly. Projecting downward within the coils is a second cylindrical shell closed at the top by a removable cover. This shell is used as a fuel reservoir and feeding device and also forms an annular passage with the outer shell which requires the hot gases of combustion to pass over the coils. The automatic fuel supply device is not shown or described.

#### NATIONAL WATER-TUBE BOILER, 1885

##### PLATE 23

U.S.N.M. no. 309374; model; gift of John A. Manley; photograph no. 2799D.

This is a model of an inclined-tube solid-header boiler of the type constructed by the National Water Tube Boiler Co. about 1885-1890. It incorporates many features patented by W. E. Kelly. .

The model represents an inclined-tube, 3-pass, inclined solid header boiler, with longitudinal drum. The risers both front and back consist of one group of four tubes arranged in a diamond-shaped group. The boiler is complete with ornamental front, gauges, and blow-off safety valve. It is equipped with grates for hand firing. The brickwork setting is cut away to show the boiler parts and the method of suspension.

## ERIE CITY DRUM-TYPE BOILER, 1928

U.S.N.M. no. 309411; gift of the Erie City Iron Works; not illustrated.

This is a model of a modern 500-horsepower boiler of the curved tube or drum type, equipped with a unit coal pulverizer and burner. The boiler has the Seymour water-cooled furnace walls and a vertical, curved-tube, drum-type economizer.

The brickwork of the boiler is represented cut away to show the arrangement of all the heating elements, including the furnace wall cooling tubes and the economizer. The headers of the water walls are connected to the upper forward or steam drum, while water from the economizer is fed to the upper back drum. The combustion chamber extends over the entire height of the boiler with two coal-burner nozzles directed downward from the top.

## "EVOLUTION OF THE STEAM BOILER"

U.S.N.M. no. 309876; 14 drawings; gift of the Babcock & Wilcox Co.; not illustrated.

This is a series of 18-by-24-inch illuminated drawings showing the evolution of stationary and marine water-tube boilers from Heron's aeolipile of the first century, B. C., to the 1400-pounds-per-square-inch boilers of 1928. The drawings are by Edmund Mills.

In the order in which they are displayed, the drawings illustrate and describe the following boilers:

(1) Heron of Alexandria, boiler and engine, c. 50 B. C.: John Blakey water tube boiler, 1766; James Rumsey, 1788; Joseph Eve first sectional water-tube boiler, 1825.

(2) Goldsworthy Gurney, 1826; Stephen Wilcox inclined water-tube boiler, 1856; George Twibill inclined-tube sectional boiler, 1865; Babcock & Wilcox bolted-header inclined-tube boiler at Cape Fear Fibre Co., 1872.

(3) Babcock and Wilcox sinuous-header boiler at Pearl Street Station of Edison Illuminating Co., New York, 1881; model of Pearl Street Station, 1881-1890.

(4) Babcock and Wilcox, 1,400 pounds per square inch pressure, 1,510 rated horsepower boiler, with underfeed stoker, superheater, water economizer, air preheater, and reheater superheater, for Edison Electric Illuminating Co., Boston, 1927.

(5) Manufacture of high-pressure (1,400 pound) forged-steel seamless drums from ingot mold to completed forging, showing pouring, reheating, cropping, hot-punching, expanding the ingot, elongation, furnace annealing, boring, turning, closing the ends, and several completed forgings.

(6) Allan Stirling 3-drum boiler, 1889; typical 5-pass, 4-drum boiler, 1898; Stirling boiler, with superheater and natural draft stoker, 1914; Stirling boiler installation with superheater and forced-blast chain-grate stoker, 1920.

(7) High-pressure drum-type boiler, 2,853 rated horsepower, 1,390 pounds steam working pressure, with plate air preheater, radiant heat superheater, radiant heat reheater superheater, and water-cooled (30,000 cu. ft.) powdered coal furnace, installed at the Lakeside Station of the Milwaukee Electric Railway & Light Co., 1926.

(8) Stirling water-tube boiler, 469 rated horsepower, 450 pounds steam working pressure, with superheater, air preheater, and pulverized coal furnace, for the American Tobacco Co., 1928.

(9) Stirling water-tube boiler with superheater and slag-tapped pulverized coal furnace, 1929.

(10) "Marine Boilers", Blasco de Garay, 1543; Denis Papin, 1707; John Fitch (and Henry Voight) pipe boiler, 1787; James Barlow boiler, 1793; Col. John Stevens "porcupine" boiler, 1804; John Babcock, 1826; Babcock & Wilcox, U. S. S. *Munroe* boiler, 1876.

(11) Babcock and Wilcox marine boiler, tested 1895, installed in S. S. *Beardsley*, 1901; U. S. S. *Alert* type, 1899; Shipping Board type with coiled superheater, 1918.

(12) Inclined ( $18^\circ$ ) tube, cross-drum boiler of the type used on battleships of the U. S. S. *Oklahoma* and U. S. S. *Maryland* classes, 1912; Type of boiler of which 12 were installed in S. S. *California*, 1925 (275 pounds working pressure,  $130^\circ$  superheater); express type, 3-drum, bent, 1-inch-tube boiler for large powers with minimum weight for fast vessels.

(13) Large marine boiler, with interdeck superheater, air heater, and under-fed stoker, 1926.

(14) Early type of Great Lakes boiler, installed on S. S. *Empire City*, with upper deck of 2-inch tubes in groups of four, lower deck of 4-inch tubes, and 4-inch side-wall tubes, 1897; installation in S. S. *City of Saginaw* and S. S. *City of Flint* of typical Great Lakes boiler with chain-grate stoker, 1929.

## BABCOCK AND WILCOX STEAM GENERATOR, 1867

### PLATE 24, FIGURE 1

U.S.N.M. no. 309837; original patent model; transferred from the United States Patent Office; photograph no. 2715SF.

This model was submitted with the application for the patent issued to George H. Babcock and Stephen Wilcox, Jr., of Providence, R. I., May 28, 1867, no. 65042.

This boiler is described as one in which the water being converted into steam is held in a number of small containers rather than in one large mass. The advantages that the inventors mention are a comparatively greater resistance to the expansive force of the steam within the smaller sections, the losing of a smaller destructive force following the rupturing of any section, and a greater economy in construction as the design permits the use of cast iron instead of wrought iron. Disadvantages common to boilers of this class, such as deficient circulating capacity, difficulty of removing incrustations, and a want of economy in applying heat to the heating surfaces, were said to be eliminated in this boiler.

The model represents a nest of horizontal tubes, which serve as a steam and water reservoir above and connected to a second nest of inclined tubes normally filled with water. The tubes in both nests are arranged in vertical rows, the tubes in each row being connected by means of suitable end tubes, which are cast as part of the individual tubes. The end tubes are held together by

long bolts passing through their axes and secured at the ends by nuts. Each vertical row of horizontal and inclined tubes forms a section and the various sections are joined together by a double transverse pipe at the top and back of the boiler. Each inclined tube is fitted with a small circulating pipe extending through the axis of the main pipe "to allow the colder particles of the water in the main pipe to separate from the warmer particles and return through the smaller pipe to the lower end of the main pipe."

#### BABCOCK AND WILCOX BOILER, 1876

U.S.N.M. no. 309868; model; gift of the Babcock & Wilcox Co.; not illustrated.

This is a half-size model of the boiler that won the award for sectional steam generators at the Centennial Exposition in Philadelphia in 1876. It was in service until recent years and is now preserved by the Babcock and Wilcox Co., the makers.

The boiler represented is a hand-fired, inclined-tube boiler, with two parallel longitudinal drums connected by a cross steam drum. The headers are of the earliest type of cast-steel sinuous header and are seven tubes high. The boiler is suspended from two cast-iron arched beams that rest upon the side walls of the brickwork. The highly ornamental cast-iron front is trimmed in gold paint. The boiler is equipped with a ball-and-lever safety valve, three water-level sight gauges, and a pressure gauge.

The Centennial boiler was sold to the De Castro and Donner Sugar Refinery in Brooklyn, N. Y., after the exposition and was continued in service until recently.

#### BABCOCK AND WILCOX STEAM GENERATOR, 1876

U.S.N.M. no. 308690; original patent model; transferred from the United States Patent Office; not illustrated.

This model was submitted with the application for the patent issued to George H. Babcock, of Plainfield, N. J., and Stephen Wilcox, of Brooklyn, N. Y., April 4, 1876, no. 175548.

The model represents the typical elements of an inclined tube, horizontal longitudinal drum boiler upon which are shown the mode of mounting and supporting such boilers and the provisions for making the connections of the parts that are the subject of the patent.

The drum of the boiler is represented as having cast-iron ends, each of which is formed with a stout horn near the top adapted to receive a suspension link from a cross girder resting upon columns at the sides of the boiler. Each end casting is further provided with a series of holes near the bottom properly adapted to receive tubes joined thereto by the process known as expanding. These tubes at front and back are joined to the vertical tubes rising from the water-tube headers by means of hollow castings in which hand holes are



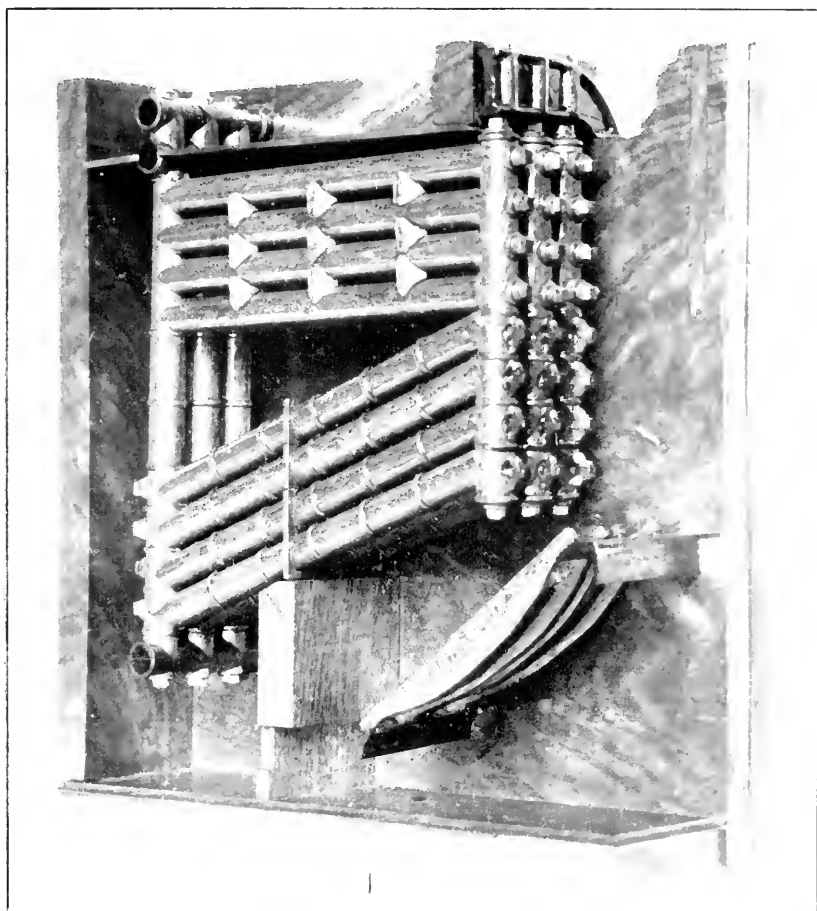

L. 1317

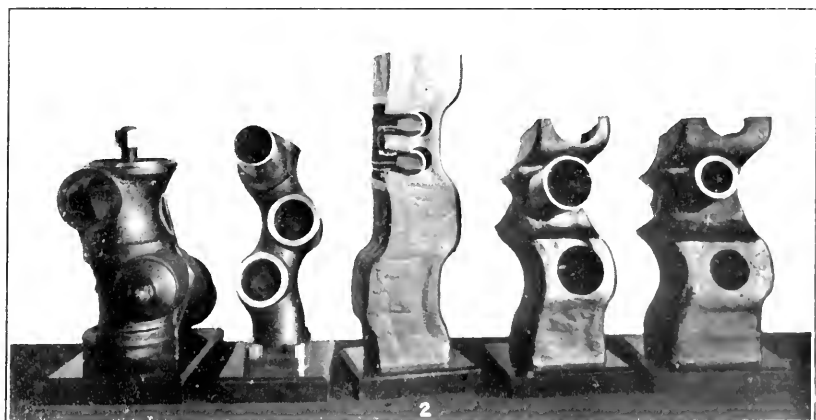

2

## SECTIONAL BOILERS

1. Babcock and Wilcox steam generator, 1867 (model; U.S.N.M. no. 309837). — Sec. 1, 115.  
 2. Simuous boiler headers, 1867-1926 (cut away; U.S.N.M. nos. 309871-309875). — Sec. 1, 115.

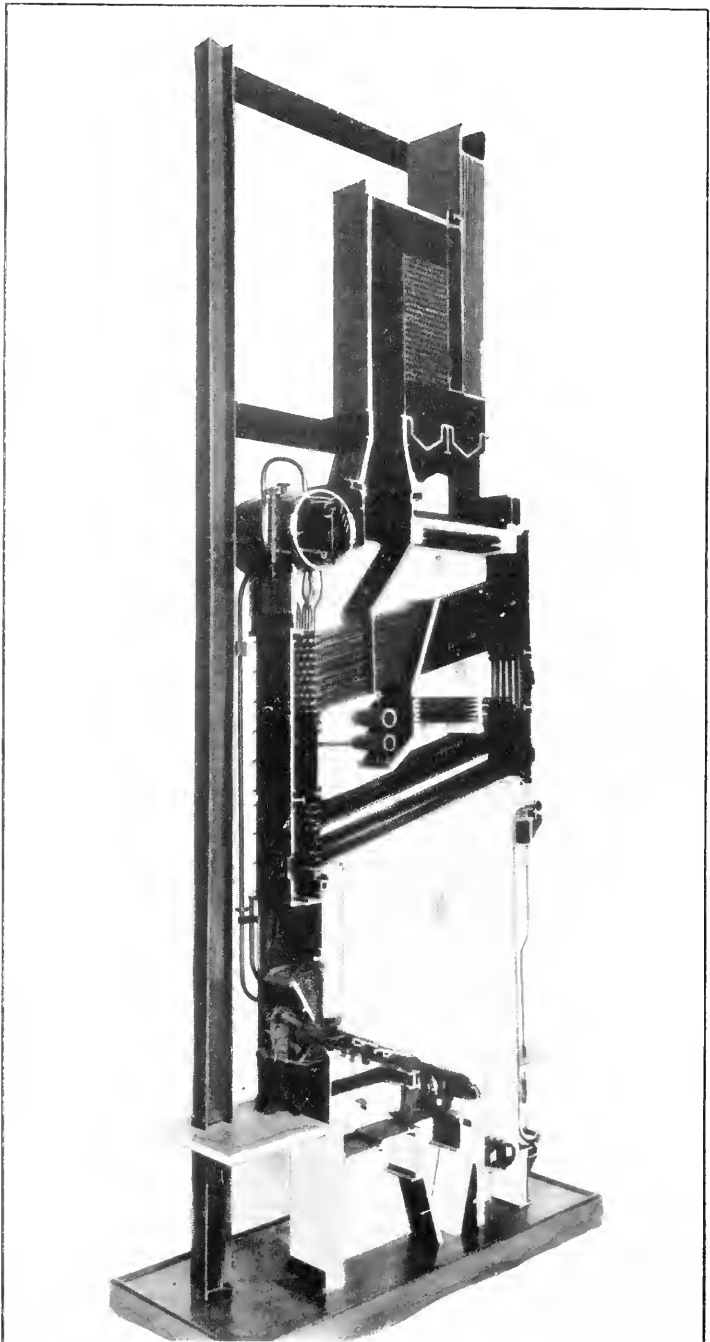

DOUBLE-DECK INCLINED-TUBE BOILER, 1929.

Model (U.S.N.M. no. 309869). See p. 117.

32799A

provided that permit both sets of tubes to be expanded in the openings in the castings.

These improvements are said to be the results of the inventors' experience with the boiler patented by them February 18, 1873, no. 135877.

#### DRUM-TYPE WATER-TUBE BOILER, 1929

U.S.N.M. no. 309870; model; gift of the Babcock & Wilcox Co.; not illustrated.

This is a one-eighth size model of a Stirling 4-drum bent-tube boiler, with superheater, air preheater, and water-cooled pulverized-coal furnace. The boiler is rated at 579 horsepower and is designed for 415 pounds steam working pressure and 250° F. superheat at 300 percent of rating.

The boiler represented is approximately 56 feet high from the ashpit floor and 35 feet from front to back. The boiler heating surface is 5,790 square feet; the superheater 1,606 square feet; and the air heater 7,350 square feet. The boiler is equipped with Bailey walls and Bailey-Tenney burners.

#### DOUBLE-DECK INCLINED-TUBE BOILER, 1929

##### PLATE 25

U.S.N.M. no. 309869; model; gift of the Babcock & Wilcox Co.; photograph no. 32799A.

This is a one-eighth size sectional model of a large inclined-tube boiler, with interdeck superheater, air preheater, economizer, water-cooled furnace walls, and underfeed stoker. The boiler is rated at 1,658 horsepower and is designed for 375 pounds steam working pressure and 677° total steam temperature.

From ashpit floor to top of air preheater the boiler represented is approximately 80 feet high by 35 feet from front to back. The boiler has 16,583 square feet of heating surface; the superheater, 3,150 square feet. The boiler is equipped with a Webster furnace with Bailey furnace walls. It is fired by a Westinghouse underfeed stoker.

#### SINUOUS BOILER HEADERS, 1867-1926

##### PLATE 24, FIGURE 2

U.S.N.M. nos. 309871-309875; originals; gift of the Babcock & Wilcox Co.; photograph no. 32809 (group).

The group of sections of actual boiler headers shows important steps in the development of the header from the cast-iron built-up headers of 1867 to forged-steel headers designed for 1,400 pounds per square inch pressure.

*The built-up tubular header of 1867* is made up of the single tube ends cast on each end of each tube. The faces of the tube ends are

carefully machined and are assembled, staggered, one on top of the other, with a through bolt from top to bottom holding each vertical row of tubes together. Two short lengths of tubes with tube ends and T-head through bolt and plates comprise the exhibit. The tubes and tube ends are of cast iron.

*The cast-steel sinuous header of 1874* is an example of a very early type of continuous header. This is the form that was used on the Centennial boiler of 1876 (see above). The header is in effect a curved tube with expanded portions into which the ends of the boiler tubes are let. The expanded portions have circular holes cut to receive the tube ends and opposite holes through which the tube ends can be rolled in assembling and through which the tubes may be cleaned. These holes are covered with outside fitting, circular plates. The header is designed so that the tubes in one vertical row are staggered in order that the next vertical row will fit snugly against it. The header section exhibited is three tubes high with a short length of tube rolled into the top tube opening.

*The cast-steel marine boiler header, 1901*, is a sinuous header of rectangular section, arranged to take 2-inch tubes in groups of four. Each group of four tubes has a square hand-hole fitting. Boilers with headers of this type were installed on naval vessels of the *Oklahoma* and the *Maryland* type. The header section exhibited is about four tube groups high, with the top group fitted with two short tube ends and sectioned. The other tube openings are not bored.

*The vertical wrought-steel header of 1921* is used to the present day for boiler pressures of 450 pounds per square inch. The header is square in section, sinuous in form, and about five-eighths inch thick. Hand holes are elliptical in shape, machine faced, and milled to a true plane to form a gasket seat. The openings are closed by inside fitting, forged-steel plates, shouldered to center in the opening. The section exhibited is a 4-tube piece with the upper end and a hand-hole cover in section. A short length of tube is rolled into the upper tube opening.

*The forged steel header of 1926* for 1,400 pounds per square inch steam pressure is designed for boilers for central power stations of which there are a number operating at this pressure in the United States. The header is rectangular in section with rounded corners, sinuous in form, and made of forged steel approximately 1 inch thick. The tube openings are provided with grooves into which the tube ends are expanded. The specimen exhibited is about three tubes high, with a  $\frac{3}{8}$ -inch thick tube expanded into the upper opening and sectioned.

## STEAM-BOILER ACCESSORIES AND BURNERS

## STEVENS SAFETY VALVE, 1825

## PLATE 26, FIGURE 1

U.S.N.M. no. 180029; original; deposited by the Stevens Institute of Technology; photograph no. 2720.

This is the safety valve used with the Stevens water-tube boiler of 1803-1825 described above under "Steam Boilers." It is a simple disk valve held closed by a spherical lead weight and stirrup at the end of a lever of the "second-order." The lever or beam of the valve is notched so that the weight can be moved to set the valve to open at different steam pressures. The effective area of the disk is approximately 0.6 square inch; the notches of the lever are  $4\frac{1}{2}$ ,  $5\frac{5}{8}$ ,  $6\frac{3}{4}$ ,  $8\frac{7}{8}$ , 9, and  $10\frac{1}{2}$  inches from the pivot; the center of the valve is  $1\frac{3}{16}$  inches from the pivot; and the ball weighs 3 pounds 14 ounces.

## ROEBLING SAFETY STEAM GAUGE, 1842

U.S.N.M. no. 308651; original patent model; transferred from the United States Patent Office; not illustrated.

This model was submitted with the application for the patent issued to John A. Roebling, of Saxonburg, Pa., July 16, 1842, no. 2728.

The model represents a section of a steam-boiler flue and head to which is attached the safety gauge. The gauge consists of a box fastened to the top of the flue and containing a fusible metal upon which rests a weight connected through a lever to a valve in the boiler head. Should the level of water within the boiler fall below the top of the flue, the fusible metal would melt and allow the weight to fall and open the valve, attracting the attention of the engineer. A rod is provided by which the lever and weight are raised by the engineer before admitting more water, so that the fused metal will solidify below the weight and the gauge be in a position to function again.

WORTHINGTON AND BAKER "PERCUSSION" WATER-LEVEL GAUGE.  
1847

U.S.N.M. no. 308652; original patent model; transferred from the United States Patent Office; not illustrated.

This model was submitted with the application for the patent issued to Henry R. Worthington, of New York, N. Y., and William H. Baker, of Williamsburg, N. Y., February 20, 1847, no. 4972.

The model represents a steam-boiler water-level gauge in which a vertical metal cylinder is connected to the boiler so that water and steam stand in the cylinder at the height of the water and steam in the boilers. Within the cylinder is a piston connected to a handle

and pointer in a quadrant case above the cylinder. To operate the gauge the piston is raised by the handle to the top of the cylinder and then brought sharply down "so as to act with percussive force upon the surface of the water by which it will be suddenly arrested", thus indicating the height of water in the boiler. "This apparatus has been attached to a boiler furnished with the ordinary try cocks, and has proved them to vary in some instances, four inches and a half from the truth, while the indications by percussion have been unvarying."

#### FRICK FEED-WATER APPARATUS, 1858

U.S.N.M. no. 308661; original patent model; transferred from the United States Patent Office; not illustrated.

This model was submitted with the application for the patent issued to Jacob Frick, of Philadelphia, Pa., December 14, 1858, no. 22284. It is an improvement on the patent issued to Frick, March 18, 1856, no. 14449.

The model represents a combination of an air chamber, a safety valve, feed-water and blow-off cocks, a feed-water failure alarm, and a water jet for extinguishing fires, all arranged in one instrument so that all can be secured to the boiler by one attachment only, thereby avoiding the necessity of piercing and "wounding" the boiler in several places.

#### GILL STEAM-PRESSURE GAUGE AND ALARM, 1859

U.S.N.M. no. 308917; original patent model; transferred from the United States Patent Office; not illustrated.

This model was submitted with the application for the patent issued to W. Y. Gill, of Henderson, Ky., March 8, 1859, no. 23166.

The invention represented by the model consists in constructing the piston of a gauge in which a piston acts in opposition to a coiled spring so that the upper portion of the stem of the piston may be marked with indications on several sides, while at the same time the lower part of the cylinder is pierced with a number of openings through which steam will escape and attract attention when the piston is forced beyond the opening by the pressure of steam in the boiler.

The gauge resembles the familiar automobile-tire pressure gauge of similar construction except that the indicating stem is attached to the piston and rises and drops with it. The inventor suggests that if the piston is made a known part of a square inch the gauge can be calibrated or checked very simply by turning it upside down and hanging weights on a ring provided at the end of the stem.

## GARVIN AND PETTIBONE TUBULAR GRATE, 1867

U.S.N.M. no. 309216; original patent model; transferred from the United States Patent Office; not illustrated.

This model was submitted with the application for the patent issued to Benjamin Garvin and R. J. Pettibone, of Oshkosh, Wis., February 12, 1867, no. 62022.

The model represents a furnace grate formed of tubes designed to be connected to the boiler so that water will be circulated through the grates and be partially heated therein. The particular feature of this invention is the manner of supporting and connecting the tubes so that they might expand and contract freely.

## COLLINSON MANHOLE COVER FOR BOILERS, 1875

U.S.N.M. no. 309219; original patent model; transferred from the United States Patent Office; not illustrated.

This model was submitted with the application for the patent issued to Henry Collinson, Boston, Mass., April 13, 1875, no. 161934.

The invention consists of a lid or cover with a true flat face arranged in such a manner that while being forced home against a flat seat it receives a sliding and rotating motion thereon.

The model represents an opening in a plate around which is formed a flat plane face, which forms a seat for the dish-shaped lid or cover. A curved bar of metal spans the opening over the cover and supports a threaded nut through which passes a T-handled screw by which the cover is forced against the seat. At the inner end of the screw is an eccentric head that fits in a recess in the center of the cover, so that turning the screw forces the cover against the seat and moves the center of the cover in a circle, while the friction causes the cover to rotate somewhat about its own center. The result is a combined sliding and rotating of the cover as it is forced against the seat.

## COCKRELL PULVERIZED-FUEL SYSTEM, 1876

U.S.N.M. no. 308753; original patent model; transferred from the United States Patent Office; not illustrated.

This is the model submitted with the application for the patent issued to Allin Cockrell, of Lamar, Mo., August 1, 1876, no. 180550.

The model represents a 2-door return-flue boiler equipped with a pulverizing mill, a screw conveyor for supplying the fuel to feeding spouts, and a paddle-bladed fan or blower. The fan, which has a long, 4-bladed, paddle-wheel rotor, spans the front of the boiler. Its cylindrical housing is extended as two ducts or spouts into the two combustion chambers of the furnace under the boiler. The screw conveyor from the pulverizing mill extends across the boiler over

the two air ducts, discharging the fuel into the air streams halfway between the fan and the furnace. The system was designed to burn tanbark, culm, sawdust, etc. One feature described is the connection between the smoke box at the forward end of the flue and the fan housing, by which hot gases were returned to the furnace in the mixture of air and fuel. Cool air was drawn into the fan through its hollow shaft.

#### SALISBURY HYDROCARBON BURNER, 1879

U.S.N.M. no. 308764; original patent model; transferred from the United States Patent Office; not illustrated.

This model was submitted with the application for the patent issued to Silas C. Salisbury, June 24, 1879, no. 216898.

The model represents a burner in which two concentric annular chambers are framed around a central hollow tube. The chambers are connected to pipes so that the fuel is fed to the outer chamber, steam to the inner one, while air for combustion is supplied through the central tube. The shells forming the annular chambers, and the tube are assembled with long threaded joints, which permit the positions of the parts to be varied for the purpose of controlling the combustion. The inventor described a burner with the forward ends of the shells and tube flared outward as well as one with the ends curved inward, either of which would be used depending upon the shape of the flame desired.

#### DEXTER HYDROCARBON (OIL) BURNER, 1879

U.S.N.M. no. 308765; original patent model; transferred from the United States Patent Office; not illustrated.

This model was submitted with the application for the patent issued to Thomas B. Dexter, of Lynn, Mass. (assignor of one-half his right to the Gilmanton Mills, Belmont, N. H.), August 19, 1879, no. 218619.

The model represents a tubular burner with a slightly reduced tip, provided with a vertical diaphragm that divides the burner into two sections. The space on one side of the diaphragm is connected to the oil line and to an air inlet pipe provided with a damper for adjusting the flow of air. The other space is connected to the steam line. In operation the flow of steam from the tip creates suction enough to draw the oil and air through the burner. The oil and air are heated by contact with the diaphragm, which separates them from the steam, and are intimately mixed when they issue from the burner. The diaphragm is notched just inside the tip so that the mixing of the steam and the air and oil results in the formation of a wide, thin, horizontal sheet. This produced a sheet of flame that spread over a large part of the furnace.



## STEVENS ROCKING GRATE BAR, 1879

U.S.N.M. no. 309217; original patent model; transferred from the United States Patent Office; not illustrated.

This model was submitted with the application for the patent issued to Francis B. Stevens, November 11, 1879, no. 221430.

The model represents a grate surface formed of ordinary fish-bellied grate bars on each of the lower ends of which two journal bearings are formed that fit into and rest in two corresponding rounded socket bearings. The bar is made to rock in each of these bearings alternately to the right and left, so that the upper part of the grate overhangs the right-hand socket when rocked to the right, and the left-hand socket when rocked to the left. That the upper part of the grate bar will overhang the center on which it turns is the improvement claimed by the inventor.

## REXFORD FIRE GRATE, 1883

U.S.N.M. no. 309218; original patent model; transferred from the United States Patent Office; not illustrated.

This model was submitted with the application for the patent issued to Philander Rexford, of Syracuse, N. Y., August 14, 1883, no. 283144.

The model represents a furnace grate made up of long grate bars, which are pivoted midway of their depth and have projecting from the upper part of one side of each bar a series of teeth or ribs. When in their normal positions the bars stand obliquely and the smooth solid back of one bar and the ribbed face of the next form the two sides of a trough across the grate. The solid portion is designed to support very fine coal, while the ribbed portion permits the passage of air for combustion.

## RAY OIL BURNER, 1914

U.S.N.M. no. 311161; original; gift of the Ray Oil Burner Co.; not illustrated.

This is a horizontal, rotary oil burner and is of the first type manufactured under the patents of William R. Ray. Its essential element is a rapidly revolving atomizing cup that breaks the oil into minute particles by centrifugal force and discharges them from the rim of the cup directly into a stream of air from a fan built into the burner. The cup, which is of brass and about an inch inside diameter, is turned at high speed by an electric motor. Oil enters the cup from a small stationary pipe led into the center of the cup through the hollow cup shaft. A fan is mounted on the same shaft and enclosed in a flat circular housing to which the motor and various parts of the burner are attached and which is hinged so that the entire unit swings away from the furnace door for inspection or adjustment.

The air leaves the fan through an annular passage surrounding the atomizing cup so that the swirl of oil from the cup mixes intimately with the swirl of air. This old burner is rated at a capacity of 2 to 8 gallons of oil an hour. It has a  $\frac{1}{3}$ -horsepower motor.

The burner was in use from 1914 to 1936, when it was removed from service for presentation to the Museum.

#### BABCOCK AND WILCOX MECHANICAL OIL BURNER, 1929

##### PLATE 26, FIGURE 2

U.S.N.M. no. 309878; original; presented by Babcock & Wilcox Co.; photograph no. 13477A.

This burner, known as the Lodi design, consists of a mechanical atomizer element and an adjustable air register. The atomizer element consists of a gooseneck connector body, which incloses a strainer, an extension tube, a sprayer plate, and a tip. Oil heated to the proper fluidity enters the element under pressure furnished by the fuel pumps and leaves the sprayer plate and tip in the form of a hollow cone of very finely atomized oil.

The air register consists of a cylindrical air chamber, the rim of which is composed of hinged, adjustable air doors, which automatically close in the event of a furnace explosion or flare-back. The furnace side of the air chamber connects to a cast-iron spiral-bladed air cone converging toward the furnace. Concentric with the air cone is a conical center impeller placed with its blades surrounding the tip of the atomizer. Air control is by means of the adjustable air doors and by adjusting the position of the atomizer and center impeller in the air cone.

The burner is designed for natural or forced draft. Its capacity is 1,500 pounds of oil an hour.

#### METTLER GAS BURNER, 1930

U.S.N.M. no. 310203; original; gift of the Lee B. Mettler Co.; not illustrated.

This is a low gas pressure, atmospheric air pressure, multijet, multiunit type of gas burner. It consists of a number of tubes within which the gas and air are mixed, heated, and ignited. The tubes are holes formed in a thick refractory block that protects the gas manifold from the heat of the flame and provides an incandescent zone at the mouth of each tube, which heats and ignites the mixture. The gas is supplied under pressure to each tube through four jets impinging at a central point within the tube with a resulting agitation and mixing of the gas and air within the tube. The air is drawn into the furnace through the tube by reason of the draft within the furnace. It is claimed that the burner effects complete combus-

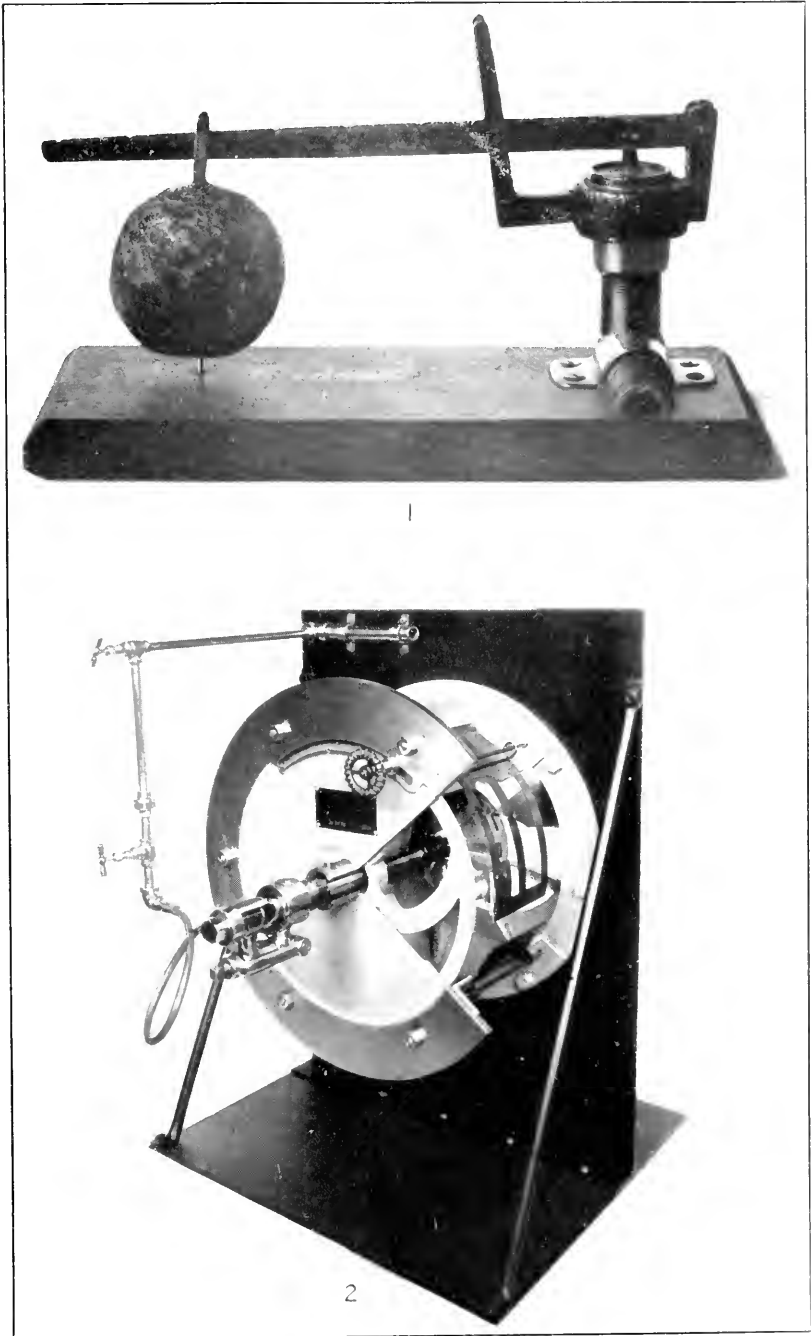

BOILER ACCESSORIES.

2733; 1947A

1. Stevens safety valve, 1825 (U.S.N.M. no. 180029). See p. 119.
2. Babcock and Wilcox mechanical oil burner, 1929 (cutaway; U.S.N.M. no. 309878). See p. 124.

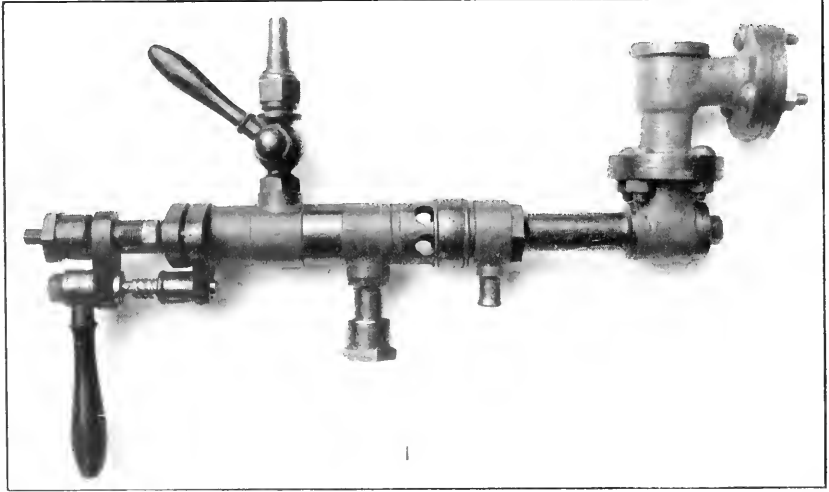

15316C

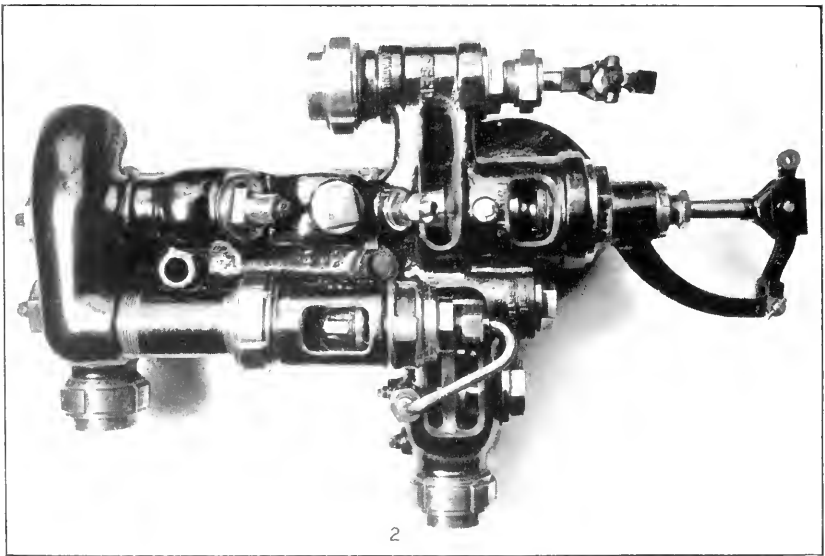

15316B

FEED-WATER INJECTORS.

1. Giffard injector, 1860 (model; U.S.N.M. no. 309368). See p. 127.
2. Sellers exhaust feed-water heater injector (cutaway; U.S.N.M. no. 309561). See p. 132.

tion of the fuel with only 12 to 14 percent of the air in excess of that theoretically required for complete combustion.

This burner has eight burner tubes and consists of three principal parts, the refractory block in which the tubes are formed, the gas manifold, and the air damper. The gas manifold is a rectangular box that fits against the back of the tube block and has cylindrical openings in line with the tubes. In each tube opening in the manifold are cast the four jets through which gas is supplied to the tube. The damper is a hinged door that fits over the back of the gas manifold and controls the flow of air into the air tubes.

This burner, which is 11 inches square, burns 1,500 cubic feet of natural gas an hour at 3-ounce gas pressure, or 2,400 cubic feet at 10-ounce pressure.

### BOILER FEED-WATER PUMPS AND INJECTORS

The problem of putting water into a steam boiler against the pressure of the steam within the boiler was not a serious one when the pressures used were only slightly above atmospheric pressure. The first boiler feed-water pumps were small pump pistons attached to the walking beams of the early engines which pumped water to elevated reservoirs from which the water flowed into the boilers by its own weight. Later these pumps were designed to pump water directly into the boilers as it was needed. So long as the boiler was considered a part of the steam engine it was reasonable and practical to operate the boiler feed pump directly from the engine and this arrangement continued to the middle of the nineteenth century. In the meantime the steamboat and the steam locomotive had been successfully introduced, and it was found that running a steamboat while made fast to a landing and idling a locomotive up and down a terminal track, for no purpose other than to replenish the water in their boilers, were awkward procedures, and separate steam operated pumps soon came into use on boats and locomotives. Finally engines and boilers came to be considered as entirely independent units, and in stationary land plants boilers were located in separate parts of the buildings under the direction of individual boiler operators, and practical arrangement required that boiler feed pumps be designed as boiler accessories independent of any connection with the main plant engines. Boiler feed pumps have taken many forms, including the most popular direct-connected "simplex" and "duplex" reciprocating pumps and the recent steam and electric, multistage, centrifugal pumps. Several forms of reciprocating feed-water pumps are described below under the section "Steam Pumps" (p. 133).

Apart from the development of the feed-water pump was the perfection of the boiler feed-water injector, a device that employs steam from the boiler, acting directly upon the water to force the

water into the boiler against the pressure of the steam therein. This device was the invention of Henri Jacques Giffard, of France, engineer and mathematician. About 1849 Giffard became interested in the development of dirigible balloons and the designing of light-weight steam engines and boilers to power them. In this connection he invented the feed-water injector as a light-weight substitute for the steam pump as a means of supplying water to the dirigible boiler. On May 8, 1858, Giffard received French letters patent for his "injecteur automoteur," a simple combination of nozzles and tubes by which a jet of steam draws water into the injector, imparts to it a high velocity, and discharges the rapidly moving stream of water into a gradually enlarging passage in which the stream slows down and the energy apparently lost in diminishing velocity is converted to an increase in pressure sufficient to overcome the pressure in the boiler.

The original injector was made by M. Flaud & Co., of Paris, and is now preserved there in the Conservatoire des Arts et Metiers. The theoretical analysis that Giffard made of the action of the steam jet and of the laws of velocity, acceleration, and pressure was so sound that the curves of nozzles and tubes laid down by him for the original model are still followed where the elementary form of the injector is manufactured. For his invention Giffard was awarded the Grand Mechanical Prize for 1859 by the Académie des Sciences of France.

The story is told that subsequent improvements in the design and performance of his dirigibles permitted Giffard to use heavier pumps, and he abandoned the development of the injector until he was urged by Sharp, Stewart & Co. to permit them to introduce the injector into England. It is further related that this firm suggested that it be introduced into the United States and recommended William Sellers & Co., of Philadelphia, to accomplish this. On April 24, 1860, Giffard was issued United States Patent no. 27979, and William Sellers commenced the manufacture of the Giffard injector the same year. The model submitted with the application for the patent, actually the first injector in the United States, was made by M. Flaud, the maker of the original one, which it greatly resembles.

The injector was applied to several locomotives during the first year and after several years slowly overcame all opposition, to take its place as a dependable method of replenishing locomotive and stationary boilers.

The development of the injector has been to make it as nearly self-adjusting as possible under fluctuations in steam pressure and water supply, to improve its lifting action, to make it self-starting after interruption of the water supply, and finally to incorporate in it the functions of an exhaust steam feed-water heater. The develop-

ment is illustrated by the injectors in the collections, which are described below.

### GIFFARD INJECTOR, 1860

#### PLATE 27, FIGURE 1

U.S.N.M. no. 309368; original patent model; transferred from the United States Patent Office; photograph no. 15316C.

This model was submitted with the application for the patent issued to Henry Giffard, of Paris, France, April 24, 1860, no. 27979.

This injector is the first seen in the United States and was made for Giffard by M. Flaud & Co., of Paris, who made the original Giffard injector in 1858. It greatly resembles the first injector, its appearance being characterized by its length and the ring of adjustable windows through which the state of the jet could be examined.

Within the tube of the injector is a steam nozzle or jet that is opened or closed by a conical plug operated by a crank projecting from the end of the injector. This nozzle projects into the end of a converging tube so that an annular space is formed around the nozzle tip. This space is connected to the water reservoir, and the effect of the steam rushing into the tube is to entrain the air in the space and form a partial vacuum there, which draws water into the tube. Water entering the tube "has an impulsive force imparted to it by the steam-jet and simultaneously receives a considerable amount of heat therefrom before it enters the boiler." On issuing from the tube the jet of water and condensed steam enters a second tube, which gradually diverges so that the velocity of the water is reduced (and the pressure increased) and the water arrives at the boiler end of the injector with a pressure slightly above boiler pressure and a very low velocity.

### MILLHOLLAND INJECTOR, 1862

U.S.N.M. no. 309369; original patent model; transferred from the United States Patent Office; not illustrated.

This model was submitted with the application for the patent issued to James Millholland, Reading, Pa., June 10, 1862, no 35575.

The inventor of this very simple injector declared that it could be made for one-twentieth of the cost of the "elaborate and costly Giffard's injector." It consists principally of a casting having a chamber connected to a water inlet and, through a nozzle-shaped bore, to the boiler pipe. A separate steam nozzle projects through the chamber into the opening of the bore. The injector has no valves or overflow opening and requires that the steam supply be controlled by a valve in the steam line and that a bypass and suitable cock be provided in the boiler pipe to return the overflow to the water tank when starting.

## GIFFARD-SELLERS INJECTOR, 1863

U.S.N.M. no. 309367; original patent model; transferred from the United States Patent Office; not illustrated.

This model was submitted with the application for the patent issued to William Sellers, of Philadelphia, Pa., July 21, 1863, no. 39313.

William Sellers, who introduced the Giffard injector into the United States in 1860, immediately invented useful improvements in its construction. This model incorporates an improvement in the packing between the steam and water chambers and effects a material reduction in the length of the whole injector.

## GIFFARD-SELLERS INJECTOR, 1865

U.S.N.M. no. 309187; original patent model; transferred from the United States Patent Office; not illustrated.

This model was submitted with the application for the patent issued to William Sellers, of Philadelphia, Pa., August 15, 1865, no. 49445.

Injectors before this required that the supply of water and steam be constantly regulated by hand and the overflow, which was always provided to permit the escape of water until the jet attained the proper velocity, was also used to permit the excess of steam or water caused by fluctuations in boiler pressure to escape without stopping the operation of the jet. This injector is designed to use the pressure created by an overflowing jet to adjust immediately the parts of the injector to check the tendency to overflow and to use the partial vacuum that will result from an excess of steam over water supply, and to adjust the injector to correct this condition without wasting water at the overflow. These objects are accomplished by means of a "floating" combining tube, which is free to move along the axis of the tube under the influence of variations in the absolute pressure within the overflow chamber and automatically preserve the correct ratio between water and steam supply.

## ROBINSON AND GRESHAM INJECTOR, 1866

U.S.N.M. no. 309189; original patent model; transferred from the United States Patent Office; not illustrated.

This model was submitted with the application for the patent issued to John Robinson and James Gresham, of Manchester, England, May 29, 1866, no. 55218.

The feature of this injector is to provide a means of varying the area of the annular space through which the water enters the combining tube for the purpose of properly proportioning the steam and water supplies. The combining tube is made free to slide in



the direction of the axis of the tube and is adjusted by a hand wheel at the side of the injector, the shaft of which projects into the injector and carries a small pinion that meshes with a short rack formed on the tube. Packing around the sliding tube is dispensed with by forming the tube in two parts, a fixed part and a sliding part, and proportioning the two parts so that the ends of the sliding part will be "opposite that part of the passing current where it has attained its highest velocity; and by this arrangement the passing liquid has no tendency to escape but rather to draw in air or fluid."

#### GIFFARD-SELLERS INJECTOR, 1868

U.S.N.M. no. 309372; original patent model; transferred from the United States Patent Office; not illustrated.

This model was submitted with the application for the patent issued to William Sellers, of Philadelphia, Pa., March 3, 1868, no. 75059.

The objects of the improvements incorporated in this design of injector were to enable injectors to throw a smaller quantity of water without affecting their maximum capacity, to permit them to draw water from a lower level, and to make the waste orifice self-closing.

#### FRIEDMAN INJECTOR, 1869

U.S.N.M. no. 308679; original patent model; transferred from the United States Patent Office; not illustrated.

This model was submitted with the application for the patent issued to Alexander Friedman, of Vienna, Austria, April 6, 1869, no. 88620.

The model represents a steam injector designed for elevating or forcing water and reducing the shock produced by the sudden condensation of steam when brought into contact with the water.

The injector is of the usual form with the addition of a small auxiliary steam jet, or ejector, which serves to draw water into the mixing chamber before the main steam valve is opened. A safety cock is also provided, which permits a part of the water to escape as the pressure is being raised to the degree sufficient to overcome the resistance against which the injector is working.

#### SELLERS SELF-ADJUSTING INJECTOR, 1876

U.S.N.M. no. 309558; original; gift of William Sellers & Co., Inc.; not illustrated.

This is the 1876 commercial form of the floating combining tube, self-adjusting injector first patented in 1865 (see above). It is constructed for convenient operating and repairing and is started,

regulated, and stopped by means of a single lever requiring no hand adjustment for variations in pressure of steam, height of lift, or temperature of the feed water.

#### WOTAPEK INJECTOR, 1884

U.S.N.M. no. 309181; original patent model; transferred from the United States Patent Office; not illustrated.

This model was submitted with the application for the patent issued to Joseph Wotapek, of New York, N. Y., May 6, 1884, no. 298329; assigned to the Nathan Manufacturing Co.

The improvement involved in this injector is the use of a nozzle holder by which the scale-incrusted nozzle or tube of the injector may be easily removed to permit cleaning. The holder is threaded into the shell of the injector from which it and the tube are drawn by unscrewing the holder. The holder turns independently of the tube so that the tube itself is not subjected to torsion when being withdrawn from the shell.

#### JENKS AND HART INJECTOR, 1886

U.S.N.M. no. 309182; original patent model; transferred from the United States Patent Office; not illustrated.

This model was submitted with the application for the patent issued to James Jenks and Thomas J. Hart, Detroit, Mich.

The principal feature of this injector is the method provided for varying the area of the water passage that surrounds the steam-forcing jet. A conical nut screwed onto threads on the outside of the steam tube forms one wall of the water space. The position of the nut on the tube and the area of the water space are changed by turning the nut. The nut is turned by a handwheel, worm, and worm wheel.

#### SELLERS SELF-ACTING INJECTOR, 1887-1927

U.S.N.M. no. 309559; original; gift of William Sellers & Co., Inc.; not illustrated.

This is a modern lifting injector that incorporates features developed in 1887. The injector has an auxiliary annular steam nozzle that lifts the water and discharges into a draft tube surrounding the forcing steam nozzle from which the jet receives the impulse that causes it to enter the boiler. Free discharge is provided for the lifting jet with the result that a vacuum is maintained in the lifting pipe, which always raises water to the injector after interruptions of the water supply and restores the continuity of the jet.

## MURDOCK INJECTOR, 1890

U.S.N.M. no. 309186; original patent model; transferred from the United States Patent Office; not illustrated.

This injector was submitted with the application for the patent issued to Horace B. Murdock, of Detroit, Mich., November 11, 1890, no. 440183; assigned to the American Injector Co.

This is a double injector having two force tubes arranged in parallel order and operated with a single actuating shaft. The overflow valves as well as the steam valves of the two sets of tubes are operated by the same shaft so that the steam valve of the first set opens in advance of the steam valve of the second set and the overflow valve of the first set closes in advance of the overflow valve of the second set. The stems of all conical plug valves are extended outside of the injector shell and are provided with slotted ends by which they may be turned with a suitable tool to grind upon the valve seats.

## SCHUTTE INJECTOR, 1892

U.S.N.M. no. 309010; original patent model; transferred from the United States Patent Office; not illustrated.

This injector was submitted with the application for the patent issued to Louis Schutte, of Philadelphia, Pa., February 9, 1892, no. 468698.

This is a double-tube injector in which water is delivered by one set of tubes, or nozzles, generally known as the lifting tubes into another set generally known as forcing tubes through which the water is forced into the boiler. The peculiar feature of this injector is a means of increasing or reducing the area of the opening of the steam nozzle of the lifting tubes, by which the quantity of water discharged by the injector is controlled without in any way interfering with the operating mechanism for starting and stopping the injector.

## SELLERS SELF-ACTING INJECTOR, 1900-1927

U.S.N.M. no. 309560; original; gift of William Sellers & Co., Inc.; not illustrated.

This is a self-adjusting and restarting injector similar to the preceding one, but it does not have the steam jet for lifting water to the injector. It has the floating combining tube of the earlier injectors and the combination of two tubes in the same axial line with apertures between them, as in the preceding injector, which develop a vacuum in the feed pipe and make the injector automatically restarting.

## DESMOND INJECTOR, 1901

U.S.N.M. no. 309190; original patent model; transferred from the United States Patent Office; not illustrated.

This model was submitted with the application for the patent issued to John Desmond, of Cincinnati, Ohio, October 8, 1901, no. 683914; assigned to the Lunkenheimer Co.

Features of this injector are the construction of the starting lever, which with one motion operates both the steam and overflow valves and also permits the overflow valve to close independently of the lever; a removable ring of resistant metal inserted in the combining tube at its smallest diameter to receive the corroding action of the jet at that point; and an arrangement of steam and water passages designed to prevent the raising of the temperature of the feed water to such a temperature as to deposit scale within the tubes of the injector.

## ALLEN AUTOMATIC INJECTOR, 1902

U.S.N.M. no. 309176; original patent model; transferred from the United States Patent Office; not illustrated.

This model was submitted with the application for the patent issued to Charles B. Allen, of Wadsworth, Ohio, April 15, 1902, no. 697770.

This injector is designed to start itself automatically when supplied with steam and connected to the water supply and to restart automatically if for any reason the jet should be temporarily interrupted. The peculiar feature of the injector is the forcing tube, which is provided with two successive overflows formed in it by a series of laterally opening holes which have a definite areal relation to the smallest cross-sectional area of the combining tube and which are in addition to the usual large overflow between the combining tube and the forcing tube.

## SELLERS EXHAUST FEED-WATER HEATER INJECTOR, 1925

## PLATE 27, FIGURE 2

U.S.N.M. no. 309561; original; gift of William Sellers & Co., Inc.; photograph no. 15316B.

This is a nonlifting injector within which water from the locomotive tank is heated by exhaust steam, picked up by one set of exhaust steam injector tubes, and delivered to a live-steam injector, which forces the water into the boiler at a temperature of about 260° to 300°. The object of this design of injector is to save the large quantity of heat usually lost in the exhaust steam and return it to the boiler, thereby improving the economy of operation of the locomotive.

## MISCELLANEOUS STEAM INJECTORS

The following patent models of injectors, transferred from the United States Patent Office, are not otherwise described or illustrated. The list is chronological.

U. S. N. M. No.	Patentee	Patent no.	Date
309188	T. O'Rorke.....	129491	July 16, 1872
309371	James Jenks.....	314553	Mar. 24, 1885
309370	W. B. Mack.....	334124	Jan. 12, 1886
309179	W. L. Messinger.....	350547	Oct. 12, 1886
309177	Louis Schutte.....	377912	Feb. 14, 1888
309175	Thomas J. Sweeney.....	407499	July 23, 1889
309178	Albert Lambert.....	416702	Dec. 3, 1889
309185	H. B. Murdock.....	No number	Apr. 15, 1890
308721	Jacob Huber.....	604233	May 17, 1898
309174	Francis Sticker.....	645274	Mar. 13, 1900
309180	Francis Sticker.....	645273	Mar. 13, 1900
309183	H. T. Nice.....	662459	Nov. 27, 1900
309191	Unidentified.....	-----	-----

Cataloged photographs of injectors in the collection are as follows:

U.S.N.M. nos. 309522A and E. Two photographs and one card of the original Giffard injector. From the Conservatoire des Arts et Metiers.

U.S.N.M. no. 309525. A colored phantom photograph of a modern Sellers injector showing the construction and operation. From Gatchel & Manning, Inc.

## STEAM PUMPS

## WORTHINGTON DIRECT-ACTING STEAM PUMP, 1855

## PLATE 28, FIGURE 1

U.S.N.M. no. 309245; original patent model; transferred from the United States Patent Office; photograph no. 32644D.

This model was submitted with the application for the patent issued to Henry R. Worthington, July 31, 1855, no. 13370.

The model represents a double-acting water cylinder of a direct-connected steam pump so designed that toward the end of each stroke the pressure on each side of the water piston will be momentarily balanced to permit the expansion of steam already in the steam cylinder to quickly move the piston so that the steam valve operated by the piston will be quickly and positively opened for the return stroke.

At the midpoint of the water cylinder is an opening connected to the force pipe through which the water is discharged. The piston is made of such length that this opening is uncovered to the suction side of the piston only near the end of the stroke. The effect of this is momentarily to subject both sides of the piston to the same water pressure and so relieve the steam piston of most of its resistance so that it can move rapidly and actuate the valve sharply and positively.

The inventor refers to this as an improvement on the invention of "a new and improved method of insuring the action of steam valves in direct-acting pumping engines", patented by himself and William H. Baker, April 3, 1849.

#### WORTHINGTON "DUPLEX" STEAM PUMP, 1859

U.S.N.M. no. 251300; original model; transferred from the United States Patent Office; not illustrated.

This model was part of the application for the patent issued to Henry R. Worthington, of Brooklyn, N. Y., July 19, 1859, no. 24838.

This is a 2-cylinder, direct-connected steam pump in which the steam and exhaust valves of each steam cylinder are actuated in part by the motion of the piston in the other cylinder. The "duplex" pump has had a wide application as a boiler feed-water pump.

The engine consists of two horizontal double-acting steam cylinders, each directly connected to a double-acting pump cylinder. In operation steam is admitted to one steam cylinder forcing the piston to move, until at some position in its stroke it engages a series of levers that open the steam valve of the other cylinder. The piston continues on until it engages a second lever, which shuts off the steam to its cylinder and the piston comes to rest. Meanwhile the second piston, moving through its stroke, actuates levers that open the steam valve to the first cylinder and causes the first piston to start on its return stroke. The second piston continues to move until it closes its own steam valve and then remains at rest until its steam valve is opened by the movement of the first piston, and so on.

This arrangement of valves produces a positive motion of the pump, prevents "short-stroking", and provides the action of at least one piston upon the water at all times, thereby reducing shock or pounding in the water discharge.

#### SEWELL AND CAMERON STEAM PUMP, 1864

U.S.N.M. no. 308669; original patent model; transferred from the United States Patent Office; not illustrated.

This model was submitted with the application for the patent issued to William Sewell and Adam S. Cameron, of New York, N. Y., May 10, 1864, no. 42694.

The model represents a direct-connected steam pump in which the water piston rod is keyed in a socket in the end of the steam piston rod, so that the two may be disconnected when it is desired to operate the pump by hand. The socket is sufficiently long to serve as a guide for the water piston rod, and a suitable rock shaft and capstan head is provided for working the pump by hand.

The purpose of the combination is to provide a hand pump for the various purposes for which a pump might be required aboard a

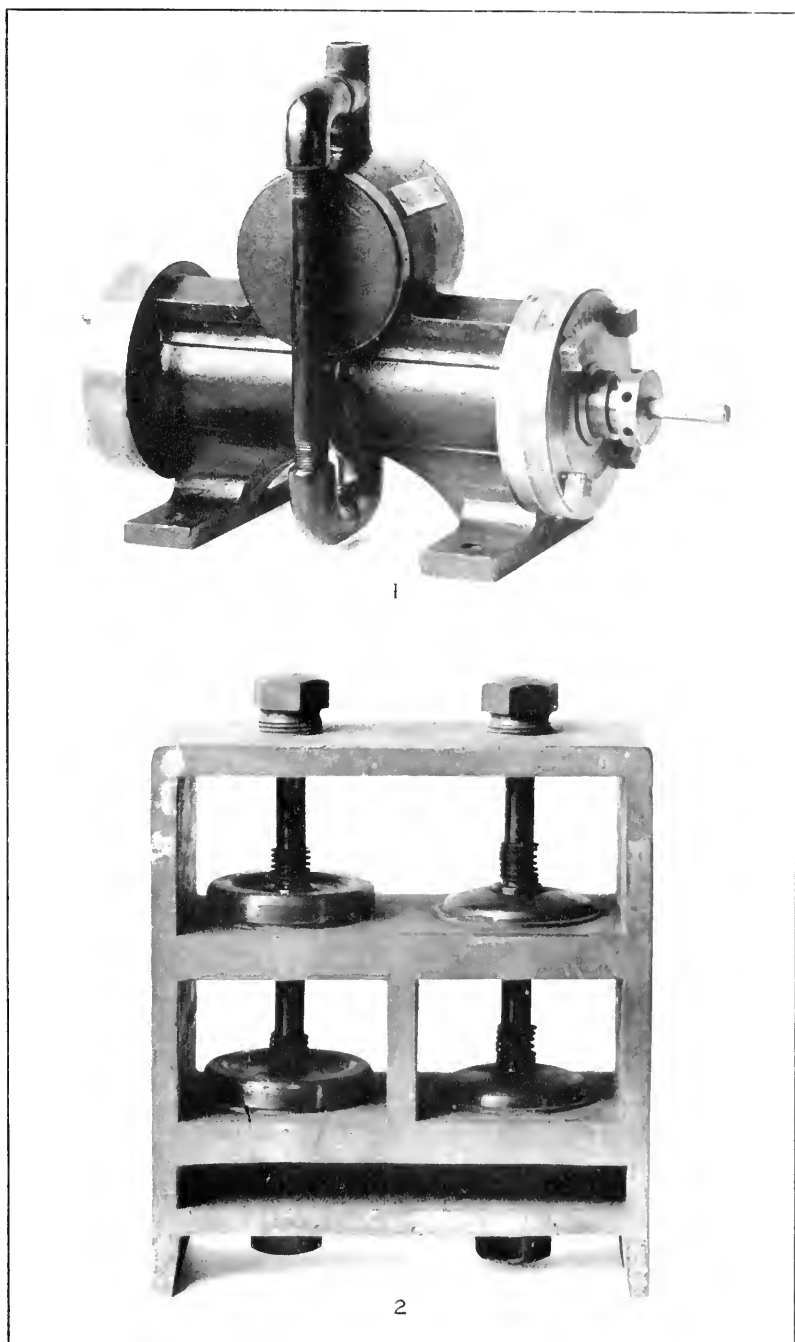

STEAM PUMPS.

35844D. E

1. Worthington direct-acting steam pump, 1855 (model; U.S.N.M. no. 309245). See p. 133.
2. Cameron pump valves, 1874 (model; U.S.N.M. no. 308686). See p. 135.

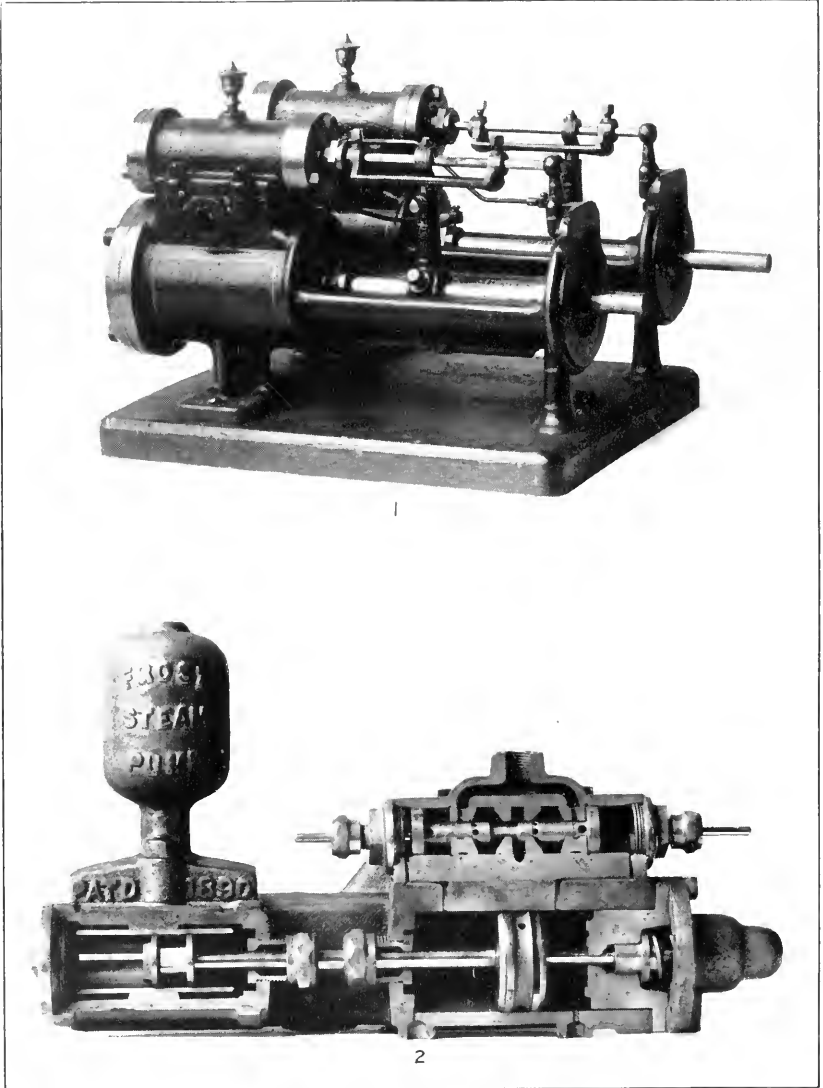

STEAM PUMPS.

32644C, B

1. Knowles steam pump, 1879 (model; U.S.N.M. no. 309250). See p. 136.
2. Frost steam-pump valve, 1890 (model; U.S.N.M. no. 308718). See p. 138.



vessel when steam is down and the steam pump cannot be used, while eliminating some of the piping that would be necessary if separate pumps were provided.

#### KING DIRECT-ACTING PUMP VALVE GEAR, 1870

U.S.N.M. no. 308682; original patent model; transferred from the United States Patent Office; not illustrated.

This model was submitted with the application for the patent issued to John C. King, of New York, N. Y., September 20, 1870, no. 107504.

The model represents a direct-connected steam pump provided with rotary oscillating valves on the steam and water cylinders operated by an arm on the piston rod and a swinging lever. The peculiar feature of the design is the use of a sharp-edged spring-actuated slide, which acts upon a roller on the swinging lever to rapidly change the valve position as the pistons near the end of their strokes. During the first part of the stroke the roller on the swinging lever acts upon one side of the slide and forces it up against a coil spring. Toward the end of the stroke the roller passes under the sharp edge of the slide and the force of the spring causes the slide to push the roller and swinging lever rapidly in the direction in which it is traveling.

#### WORTHINGTON DUPLEX STEAM PUMP, 1871

U.S.N.M. no. 308681; original patent model; transferred from the United States Patent Office; not illustrated.

This model was submitted with the application for the patent issued to Henry R. Worthington, of New York, N. Y., June 20, 1871, no. 116131.

The model is a relief panel showing a section through the two steam cylinders of a duplex pump arranged to use steam at boiler pressure in one steam cylinder of small diameter, expand the exhaust steam in a receiver of much larger volume than the small cylinder, and use the steam at low pressure in a second cylinder of larger diameter. This arrangement was devised to permit the use of steam expansively in a duplex pump without the use of two compound cylinders, as was formerly the method.

#### CAMERON PUMP VALVES, 1874

##### PLATE 28, FIGURE 2

U.S.N.M. no. 308686; original patent model; transferred from the United States Patent Office; photograph no. 32644E.

This model was submitted with the application for the patent issued to Adam S. Cameron, of New York, N. Y., November 10, 1874, no. 156769.

This invention relates to a design of pump valves so controlled by spindles and guides that the necessity of central bearings in the valve seat is avoided, leaving a clear circular opening for the passage of the fluid being pumped.

The model represents a valve chest of a pump cylinder equipped with four valves arranged in pairs, in which one valve is located above the other. In each pair the valve stem of the upper valve projects upward into a hollow plug in the top of the valve chest and downward into a socket in the lower valve. The socket of the lower valve extends downward into a hollow plug or guide in the bottom of the valve chest. Both valves are spring closed and the lower valve is free to move independently of the upper valve.

### KNOWLES STEAM PUMP, 1879

#### PLATE 29, FIGURE 1

U.S.N.M. no. 309250; original patent model; transferred from the United States Patent Office; photograph no. 32644C.

This model was filed with the application for the patent issued to Lucius J. Knowles, of Worcester, Mass., April 1, 1879, no. 213823.

The model represents the steam cylinders of a duplex pump fitted with what the inventor calls auxiliary engines to operate the valves of each cylinder when it is desired to use one cylinder of a duplex pump without the other. Actually the piston of the auxiliary engine is the valve of the main cylinder and the invention is in effect a one cylinder or "simplex" pump with steam-actuated valve. This is one of the earliest uses of the steam-actuated valve for steam pumps.

The auxiliary cylinder forms the steam chest and valve ports of the main cylinder while the auxiliary piston acts as the valve. The auxiliary piston has its own valve system, which consists of ports in the auxiliary cylinder wall connected to the main steam passages and so located that they will register with openings in the auxiliary piston when the auxiliary piston is given a slight twist at the end of the main piston's stroke. These openings connect to passages in the auxiliary piston that direct the steam pressure to the proper end of the auxiliary cylinder to cause the auxiliary piston to move to the other end of the cylinder and so reverse the stroke of the main piston.

Lucius James Knowles (July 2, 1819–February 26, 1884) originated and developed the Knowles Steam Pump Co. and the L. J. Knowles & Brother Loom Works at Warren, Mass., and Worcester, Mass., both of which became leading organizations in their respective fields. The Knowles steam pump was one of the best known of the

direct-acting pumps, and Knowles is recognized as having contributed much to the final development and refinement of the device. He was one of the first to take up and develop the steam-actuated valve and received several patents for his inventions of improvements in valves

#### DOW DIRECT-ACTING STEAM PUMP, 1879

U.S.N.M. no. 308703; original patent model; transferred from the United States Patent Office; not illustrated.

This model was filed with the application for the patent issued to G. E. Dow, of San Francisco, Calif., November 4, 1879, no. 221220.

The model represents a form of valve gear for a direct-connected steam engine in which the main valve is partially operated by a system of cam-shaped levers actuated from the main piston rod and partially by a supplementary steam piston, the movement of which is controlled by valves connected to the same levers.

#### DAVIES STEAM PUMP, 1880

U.S.N.M. no. 308711; original patent model; transferred from the United States Patent Office; not illustrated.

This model was submitted with the application for the patent issued to Joseph D. Davies, of Covington, Ky., March 9, 1880, no. 225351.

The model represents a direct-acting steam pump, provided with two auxiliary oscillating cylinders, which offer a constantly decreasing resistance to the movement of the steam piston during the first half of its stroke and a constantly increasing assistance during the remaining half. The purpose of this is to equalize the effective force of the steam piston throughout its stroke when the steam is used expansively.

The two auxiliary cylinders are mounted in trunnions, one on each side of the frame of the engine. The rods from the auxiliary pistons are attached to a clamp on the main piston rod, so located that the auxiliary cylinders are perpendicular to the main piston rod when the main piston is at midstroke. The auxiliary pistons, in the model, work against a spiral spring, which is compressed during the first half of the stroke and which expands during the last half. In effect the springs act as would a flywheel, storing the energy in excess of the resistance, while steam at high pressure acts upon the engine piston, and delivering the stored energy after the steam has been cut off and is expanding in the cylinder. The inventor described his device using a fluid, as steam or water under pressure within the auxiliary cylinders.

## FROST STEAM-PUMP VALVE, 1890

PLATE 29, FIGURE 2

U.S.N.M. no. 308718; original patent model; transferred from the United States Patent Office; photograph no. 32644B.

This model was submitted with the application for the patent issued to Richard L. Frost, of Battle Creek, Mich., February 11, 1890, no. 421355. The patent was assigned to the Union Manufacturing Co. of the same place.

The model represents a section through the steam cylinder, piston, and steam valve of a direct-connected steam water pump. The valve is a steam-actuated piston valve so designed that an increase in the exhaust pressure cannot act on the valve as to entirely close the live-steam port and stop the engine.

The valve is a piston slide valve that admits live steam at its ends through a hollow section to the cylinder steam ports close to the middle of the valve. The exhaust is to the center. Formed on the ends of the piston valve are enlarged pistons which closely fit cylinders provided for them. Ports in these cylinders are so connected to the main cylinder ports and the main cylinder that pressure on one end serves practically to balance the valve, while pressure on the other end actuates the valve. The main piston is relatively long and has an annular depression between its two ends. The space thus formed between the piston ends and the cylinder in combination with ports in the cylinder acts to supply steam to the valve cylinder to actuate the valve.

## MOORE STEAM PUMP, 1891

U.S.N.M. no. 308717; original patent model; transferred from the United States Patent Office; not illustrated.

The model was submitted with the application for the patent issued to Ila N. Moore, of Battle Creek, Mich., June 23, 1891, no. 454753.

The feature of this pump power is a piston with steam ports in the piston leading to the ends of the cylinder and a valve fitted to slide on the elongated and reduced barrel of the spool-shaped piston controlling the admission of steam through the steam ports. The object is to provide a steam pump requiring no steam chest. Steam is admitted at the center of the cylinder through two short passages connecting directly with the steam pipe. Exhaust is to a chamber on the opposite side of the cylinder. A hollow tail rod, gland, and housing form part of the exhaust passage. The piston valve, which slides on the barrel of the piston, is actuated in part by the pressure of the steam and in part by the motion of the piston. Packing rings on the outside of the valve heads operate across the steam inlet ports in the cylinder wall and the lands between grooves in the bore of the valve operate across the ports in the piston barrel.

## ADDITIONAL STEAM BOILER ITEMS IN THE COLLECTION, NOT OTHERWISE DESCRIBED

A model of a locomotive stack feed-water heater patented by Matthias Baldwin and David Clark of Philadelphia, Pa., February 14, 1854, no. 10514. Transfer from the United States Patent Office. U.S.N.M. no. 308992.

A small vertical copper-tube boiler heated by a spirit lamp, used to demonstrate three working models of steam steering engines (U.S.N.M. nos. 310475 and 310476) invented by Herbert Wadsworth. U.S.N.M. no. 310477.

A model of a brass boiler mounted on a swivel. Not identified. Transfer from the United States Patent Office. U.S.N.M. no. 309011.

A model of a draft blower. Not identified. Transfer from the United States Patent Office. U.S.N.M. no. 308723.

## FIRE ENGINES

## HUNNEMAN HAND-PUMP FIRE ENGINE, 1854

U.S.N.M. no. 310747; original; gift of Charles T. Nehf; not illustrated.

This engine is a fairly large hand-pumper typical of city fire-fighting apparatus just prior to the introduction of steam fire engines. It has a history that is also typical in that it was purchased first by a volunteer company of a city, Terre Haute, Ind., served there until replaced by newer equipment, when it was given to the town of Jasper, Ind., where it was the village fire fighter until motorized, consolidated companies gave outlying communities adequate modern protection at costs they could afford. It was then acquired by the donor as a memorial to the services of the company which first owned it and of which he was a member.

The engine was built in 1854 by Hunneman & Co. at Boston and sold originally at \$720.

It consists of a large tank body mounted on wheels and acting as the support of a 2-cylinder beam-actuated pump. The beam, which runs lengthwise of the vehicle, carries two long handle bars parallel to the beam but so attached as to swing across the ends of the beam to permit 8 to 12 men to pump at each end of the beam. Water entered the pump from a short suction hose when a stream or pool could be reached, otherwise a bucket brigade poured water into the tank body of the engine from which it was delivered by the pump to hoses to play upon the fire. A hand-hammered copper surge chamber, or dome, is a striking feature in the appearance of the engine.

## CLAPP AND JONES PISTON STEAM FIRE ENGINE, 1876-1878

U.S.N.M. no. 310396; original; gift of the United Fire Engine Co. No. 3; not illustrated.

This steam fire engine was one of three exhibited by the makers, Clapp & Jones, of Hudson, N. Y., at the Philadelphia International Exposition in 1876, where it assisted in securing for the makers the award in the class of piston steam fire engines. In 1878 the engine

was purchased by the United Fire Engine Co. No. 3 of Frederick, Md., and was used continuously until 1912. It is a remarkably well preserved example of the best in steam fire engines of the period of 1876. The United Co. has a collection of about 20 trophies that have been awarded to it over a period of many years for achievements of the engine. The engine has for many years been known throughout the vicinity of Frederick as the "Lily of the Swamp." It proudly carries the motto of the United Co., *Veni-Vidi-Vici*.

The engine has a vertical boiler, with both fire tubes and water tubes. The fire tubes extend from the crown sheet of the fire box up through the top of the shell and the water tubes hang from the crown. The outer rows of water tubes extend nearly to the bottom of the fire box and surround rows of shorter tubes, which are about half the length of the outer row. In each water tube long narrow sheet-metal diaphragms form a triangular passage in the center of the tube for the return of water carried up by the steam. The diaphragms are stamped with lipped openings turned upward, which serve to drain into the return passage much of the water lifted with the steam before it reaches the top of the tube.

The pump is 1-cylinder, double-acting, and horizontal. The water enters the pump in the center of the front head and is distributed to all sides of the pump cylinder and the valve chambers through an annular space that surrounds the entire cylinder. This space is so designed that it makes a very free watercourse to the valves and also retains sufficient water in the pump to assure positive starting without priming even against very high suction lifts. No connection to the boiler or other means of priming with grease or water is provided on the engine. The intake valves of the pump are arranged in a ring surrounding each end of the cylinder. This ring is easily removed with the cylinder head. The valves of either end are the same and are interchangeable. The discharge valve is a ring of india rubber attached to the front cylinder head but is enough longer than the head to reach over an annular space at the center of the cylinder and lap over a ring on the cylinder that forms the valve seat. This annular space or band around the middle of the cylinder is connected to the discharge gates and discharge dome. The air chambers provided permit the pump to work at very high speeds. The piston is all metal and is water packed.

The steam engine that drives the pump is small, double-acting, direct-connected, and horizontal. A cross head is provided from which a connecting rod drives a shaft on which are a pair of light flywheels and an eccentric for operating the valves of the engine.

When first made the engine was drawn by hand, but in 1905 it was slightly remodeled by adding a shaft and a driver's seat, so that it could be drawn by horses.

## AMOSKEAG STEAM FIRE ENGINE, c. 1885

U.S.N.M. no. 310467; model; gift of Frank A. Wardlaw, Jr.; not illustrated.

This is a fully operating model of the fire engine no. 444 built by the Amoskeag Manufacturing Co., of Manchester, N. H.; and used by the New Brighton, Staten Island, N. Y., fire department. The model was made by Frank A. Wardlaw, father of the donor, in 1912-13. It was awarded a silver medal at the Exhibition of the Society of Model and Experimental Engineers at London, October 1913.

The fire engine depicted by the model consists of a vertical steam cylinder connected to a vertical pump cylinder placed directly below it. The connecting rods of both cylinders connect to a single crank on a shaft, located midway between them, which swings a light-weight flywheel. The boiler is a vertical water-tube boiler enclosed in the typical brightly plated and polished shell. The engine was horse-drawn.

The model burns coal, operates on a pressure of 55 pounds per square inch, and throws a stream of water a distance of 46 feet.

## AMOSKEAG FIRE-ENGINE PUMP

U.S.N.M. no. 309821; model; gift of the Franklin Machine Co.; not illustrated.

The model, which is cut away, represents one vertical pump cylinder of a fire engine. The cylinder itself is enclosed at the center of a cylindrical casing of much larger diameter, one side of which is the intake or suction passage, the other side being the delivery or pressure passage of the pump. The cylinder heads enclose the ends of the outer casing and form a chamber over each end of the piston cylinder. The annular space between the piston cylinder and the casing is closed at top and bottom with an annular valve seat each containing four circular intake and four circular delivery valves.

## "METROPOLITAN" STEAM FIRE ENGINE, 1906

U.S.N.M. no. 309884; original; gift of the American-La France and Foamite Corporation; not illustrated.

Built by the American Fire Engine Co., of Seneca Falls, N. Y., in 1906, this engine was purchased by the city of Alexandria, Va., where it was used until about 1930. It is typical of the final development in horse-drawn, steam, fire engines before they were replaced by self-propelled and motor-driven fire apparatus.

This is a vertical 2-cylinder steam engine direct-connected to a 2-cylinder double-acting pump. The valves of the engine are operated from a crankshaft driven by connecting rods running from wrist pins on the engine and pump rods. The boiler is of the vertical, water-tube type in which the tubes are lengths of pipe joined by pipe fittings in loops that are laid together in a nearly solid cube of horizontal

and vertical tubes, filling the entire center of the shell. The shell of the boiler is double, with the space between serving as the water reservoir, which is small compared to the tube surfaces. The exhaust, let into the top of the stack, induces the draft through the boiler. The grates are fixed and flat. No ashpit is provided.

### MISCELLANEOUS PUMPS

#### CLOW ROTARY WATER PUMP, 1856

U.S.N.M. no. 308653; original patent model; transferred from the United States Patent Office; not illustrated.

This model was submitted with the application for the patent issued to C. N. Clow, of Port Byron, N. Y., July 1, 1856, no. 15221.

The model represents a cam pump in which two smooth elliptical cams run in contact in a casing, which is roughly a horizontal figure-eight in cross section. The cams are made to revolve together correctly by means of gear wheels on the outside of the casing on the same shafts to which the cams are attached. The pitch line of the gears correspond in shape to the elliptical peripheries of the cams. The pump is operated by a hand crank.

#### EADS SAND PUMP, 1869

U.S.N.M. no. 308143; models; gift of the American Society of Civil Engineers; not illustrated.

Sand pumps or ejectors of the pattern of these models were designed and used under the direction of James B. Eads for removing sand and gravel from the caissons employed in the construction of the bridge over the Mississippi River at St. Louis, 1868-1874.

The pump consists of a cylindrical casing into which water is pumped under pressure and from which it can escape only through a concentric internal pipe leading and discharging upward. The water enters the lower end of the discharge pipe through a passage that gives the water the shape of an annular jet. The jet creates a vacuum below it by which suction is created in a short intake pipe let into the sand. Sand is thus drawn into the jet and carried upward with the stream of water.

As used at St. Louis the pumps with 3-inch discharge pipes each discharged 10 cubic yards of sand and gravel in an hour including stones as large as  $2\frac{1}{2}$  inches in diameter.

One model is sectioned, and both are mounted in an old little exhibition case marked "Designed by James B. Eads, July 1st, 1869; St. Louis, Mo."



## JOHNSTON AIR COMPRESSOR, 1879

U.S.N.M. no. 308706; original patent model; transferred from the United States Patent Office; not illustrated.

This model was submitted with the application for the patent issued to William Johnston, of Washington, D. C., November 4, 1879, no. 221318.

The compressor represented by the model is in effect a bellows. It is constructed as a cylindrical casing mounted upon a stationary horizontal shaft about which it oscillates. Two diaphragms extend in radial planes from the inside and top of the casing to a bearing on the upper side of the shaft. The space between these diaphragms is wedge-shaped. The two spaces thus formed are valve spaces, inlet and outlet, respectively. Flap valves are let into the diaphragm connecting the valve spaces with the lower part of the casing interior. A third diaphragm, called a lug, is fixed to the under side of the shaft and extends downward to the cylinder casing.

In use the casing is filled with water to the level of the center of the shaft. When the case is rocked the water is held approximately stationary by the lug and the air between the surface of the water and the diaphragm on the down side is compressed while a partial vacuum is formed in the space between the surface of the water and the diaphragm on the up side. The compressed air escapes through the outlet valve and air is drawn into the up side through the inlet valve. As the casing is rocked back and forth it is in effect a double-acting bellows.

## INTERNAL-COMBUSTION ENGINES

*Early history.*—Strictly speaking the history of the internal combustion engine begins in the thirteenth century with the first use of the cannon. However, the first explosive engine capable of producing work was that designed by the Abbé Hautefeuille, the son of an Orleans (France) baker. In 1678 he suggested a motor to raise water by burning powder in a vessel communicating with a reservoir of water. As the gases of combustion cooled a partial vacuum was formed in the vessel and atmospheric pressure raised the water from the reservoir. In 1682 he described a machine in which water was raised by the direct expansive action of the gases of combustion. Christian Huygens in 1680 was the first to employ a cylinder and piston in an explosive engine, and Denys Papin in 1690 made an improvement in the valves of the Huygens engine. Huygens died in 1695, and Papin turned his attention to steam, and for a hundred years no new explosive engine was produced. In 1791 John Barber of England made an engine in which wood, coal, or petroleum gas was mixed with air and pumped into a vessel termed the "exploder",

where the mixture was ignited. The resulting flame issued in a steady stream against the blades of a paddle wheel. The next engine (1794), that of Robert Street of England, might be called the first of the modern idea of an internal-combustion engine. Turpentine or petroleum was introduced into the cylinder, which was warmed by an external fire. The fuel, vaporized by the heat, was mixed with a quantity of fresh air drawn into the cylinder by the upstroke of the piston. The mixture was ignited by a flame sucked in from a burner outside the cylinder. The explosion drove up the piston and forced down the piston of a pump for raising water. Philippe Lebon of France in 1801 patented an engine in which the mixture was ignited by an electric spark and had other admirable features. Samuel Brown in 1823-1826 brought out his vacuum gas engines, which were the first explosive engines to run in London. William Barnett, of England, who brought out three engines in 1838, may be said to be the first to compress the explosive mixture in the cylinder before ignition as is now done. Between the years 1838-1860 many engines were designed and patented in England, France, and America, but few were built. Barsanti and Mattenci, of Italy, patented engines in England in 1854 and 1857 that failed through mechanical defects but contained many of the features later found in the free piston engine of Otto and Langen. These engines involved the fundamental principle of utilizing the whole force of the explosion in as complete expansion as possible. The first practical working gas engine is credited to Jean-Joseph-Étienne Lenoir, of Paris, who brought out his first engine in 1860. This engine was double-acting and worked on a 2-stroke cycle without compression before ignition. Air and gas were drawn into the cylinder during the first part of the forward stroke of the piston, the intake valves then closed, and the mixture was exploded at the same time. Expansion took place to the end of the stroke when the exhaust valves opened. The burned gases were exhausted on the back stroke. Ignition was effected by an electric spark. During the first year one of 6 horsepower and another of 20 horsepower were built, and in the first five years more than 300 were made in France and about 100 in England. The first trials of any gas motors were made by Tresca on the Lenoir engine. Insufficient expansion (or late ignition) and the absence of compression resulted in a low economy, which with certain difficulties of lubrication brought forth concerted condemnation of the engine. For silent, smooth, and regular working, however, it has seldom been surpassed, and its success was sufficient to bring out a host of imitators as well as those who set up claims to prior invention. Lenoir applied his motor to the propulsion of a wagon and shares with Siegfried Marcus, of Vienna, and George B. Brayton, of Boston, the recognition for having made the earliest

attempts to propel vehicles with internal-combustion engines. Reithman, of Munich, designed an engine similar in principle to that of Lenoir in 1858, and Hugon, of Paris, who brought out a similar engine in 1862, patented 1865, claimed that his patent of 1858 was the Lenoir engine in principle. Gustave Schmidt in 1861 declared that better economy would result from compression of the explosive mixture, and Million the same year applied the principle of previous compression of the gas and air by means of a separate pump. The next important development was the descriptive patent of Beau de Rochas, of France, in which were set forth the events of the 4-stroke cycle and a discussion of its advantages. Fifteen years elapsed before this cycle, which is the most common in use today, was carried out in an engine. In 1866 Nicolaus Otto and Eugen Langen, of Cologne, brought out their atmospheric, or free-piston, engine (see U. S. N. M. no. 308675) constructed on the lines of the Barsanti and Mattenci engine of 1857. It succeeded where the earlier engine failed because of a more ingenious mechanical design. At the time of its introduction it was the most economical of gas engines. The Bisschop (England) engine was of similar design, embodying improvements to avoid noise and recoil. Brayton's engine of 1873 and Simon's (England) of 1878 involved the principle of ignition at constant pressure (see under "American Developments"). In 1876 Otto and Langen abandoned the noisy, unsteady, and irregular free-piston engine and patented one in which the important innovation was the compression of the charge of air and gas before ignition (see U. S. N. M. nos. 251284 and 309556). In this engine the whole cycle advocated by Beau de Rochas is effected in one cylinder. The engine was single acting, and in it one explosion or impulse was obtained in every four piston strokes. The first stroke compressed the explosive mixture and explosion occurred near the end of this stroke, the force of the explosion drove out the piston on the third stroke, and in the fourth stroke the products of combustion were discharged. The earliest trials of the Otto engine (Braner and Slaby in Germany, 1878) showed a striking economy of 38 to 40 cubic feet of gas per horsepower hour, as compared to 44-50 cubic feet with the Lenoir. The success of this engine was undoubted from the first, and for many years few others were sold. It superseded all others and is the design from which all the 4-stroke gas and gasoline engines of today were developed. In 1880 Dugald Clerk of England introduced an engine in which an explosion was obtained after every second stroke or one explosion in every revolution. This was the 2-stroke cycle engine. Compression of the mixture was obtained in a separate pump cylinder. Atkinson introduced several engines that were of more interest as ingenious mechanisms than as any great advance. His engine of 1884 operated on the 4-stroke cycle effected in four

separate strokes of *different lengths*. Beck in 1888 introduced an engine operating on a new cycle, the 6-stroke cycle in which there was an explosion every six strokes of the piston. The object was to obtain a more complete elimination of the products of combustion by admitting fresh air on the fifth stroke and discharging it to the atmosphere on the sixth stroke. These two strokes were known as "scavenger" strokes.

*American developments.*—Oliver Evans, who built steam engines at Philadelphia before 1800, described a volcanic engine that, in spite of its name, was not an explosive engine. Samuel Morey, of Orford, N. H., designed the first American internal-combustion engine of record. His vapor engine was described in the *Journal of the Franklin Institute* of 1826, and a letter of his indicates that he used the engine to drive a small boat (probably a model) successfully. In the Morey engine a vacuum was produced in the cylinder by firing an explosive mixture of air and vapor from common proof spirits mixed with a small portion of spirits of turpentine. A model of this engine ran smoothly for periods of several hours, but there is no record that a large engine was ever built. A "gentleman" did "go to England for the purpose of obtaining a patent in that country." Morey's engine was an atmospheric engine but Stuart Perry, of Newport, N. Y., patented an engine in 1844 that operated on the expansion of the products of combustion occurring within the cylinder. This was the first of the class of noncompression gas engines, the type successfully introduced by Lenoir, of France, about 15 years later. The Perry engine operated on the explosive vapors obtained from rosin heated by the exhaust gases in a retort that was a part of the engine. He patented an improved engine in 1846 that incorporated water cooling of the cylinder, an incandescent platinum igniter, and a receiver for compressed air to be used in starting the engine. Dr. Alfred Drake, of Philadelphia, patented an engine in 1855 that was similar to one he had exhibited at Philadelphia as early as 1843. A Drake engine with a 16-inch cylinder and a large fly-wheel—"the whole resembling a steam engine of about 25 horsepower"—was used to furnish part of the power for the machine room of the 27th Annual Exhibition of the American Institute at New York in 1855. This was probably the first internal-combustion engine other than a model to be built in the United States. Drake later advertised his engines for sale. The Otto & Langen atmospheric free-piston engine, however, was the first to be used here in any number. It was patented in this country in 1867 and was introduced a short time later. George B. Brayton, of Exeter, N. H., and Boston, Mass., was the first American to design and build an engine that was a commercial success. He built and ran an engine as early as 1870 and patented his design in 1872. His engine operated with combus-

tion at constant pressure. The explosive mixture of gas and air entered the cylinder through a series of wire-gauze diaphragms, was ignited just before admission, and entered the cylinder as a flame. A steady combustion was maintained behind the piston during about one-third of the stroke. Brayton experienced difficulty with the use of gas as a fuel for this engine and designed one in 1874 to employ a light petroleum oil. This engine is considered to be the first safe and practical oil engine ever built. It employed a heated-surface carburetor and was quite efficient in the use of fuel. Many of these were built in various sizes and combinations of cylinders, and a small three cylinder one is shown in the drawing on which George Selden obtained his well-known automobile patent. Its chief drawback was the gas-burning grate, which required frequent renewal. The Otto 4-cycle engine was patented in the United States in 1877 and was introduced shortly after this, the first engines being large, slow-moving, horizontal, and stationary and having flame ignition. Gottlieb Daimler, of Cologne, Germany, patented the first compound- or multiple-expansion engine in the United States in 1879. This was the first engine employing two cylinders operating independently on the 4-stroke cycle but connected to the same crankshaft. It might be considered the forerunner of the present-day multiple-cylinder high-speed automobile engine. The first 2-stroke cycle engine patented in the United States was that of Wittig and Hees, of Hanover, Germany, who patented their engine in 1880. This is quite similar to the engine patented here in 1881 by Dugald Clerk, who is usually considered the inventor of the 2-stroke cycle engine. L. H. Nash in 1888 patented the 2-cycle engine using inlet and exhaust ports controlled by the piston and effecting compression in the crankcase of the engine. In 1895 Selden received the first patent for the application of the internal combustion engine to a road vehicle, and from this date on the development of the internal combustion engine for automotive use has been in engineering refinement rather than in principle.

#### STUART PERRY GAS OR VAPOR ENGINE, 1844

##### PLATE 30, FIGURE 1

U.S.N.M. no. 309253; original patent model; transferred from the United States Patent Office; photograph no. 18493C.

This model was submitted with application for Patent no. 3597, issued May 23, 1844, to Stuart Perry, of Newport, N. Y.

This is the first of the class of noncompression gas engines to be patented in the United States. It preceded the Lenoir (U. S. Patent no. 31722, Mar. 19, 1861), the best known of this type, by about 16 years. It was designed to use the inflammable vapors of liquids or

solids, such as undistilled turpentine or rosin, generated in the retort that was part of the engine.

The model shows an engine with a horizontal double-acting cylinder. The piston transmits its motion to a vertical walking beam from which a connecting rod drives the motor crankshaft. Beneath the cylinder is located a pump beam. Below the engine cylinder also is a rectangular tank or retort for vaporizing the fuel. This retort has tubular openings through which the hot exhaust gases are directed. The pump supplies air to the retort and directly to the engine cylinder in proportions regulated by hand cocks. The combustible mixture from the retort and additional air from the pump are admitted to the engine by a rotary cylindrical valve. The valve is driven by gearing from the crankshaft, and the engine may be reversed by shifting the valve gears. Ignition is effected by flames from lamps at either end of the cylinder. The ignition valves are operated by pins on the piston. A lamp is also provided below the retort for vaporizing the fuel in starting the engine.

In operation a mixture of vapor and air from the retort is admitted with a quantity of pure air as the piston moves away from the cylinder head. Ignition occurs at the same time, and combustion continues for a part of the stroke when admission stops and the piston is carried to the end of the stroke by the expanding gases.

Perry operated the engine with a retort heated solely by the heat of the cylinder, and he also suggested jacketing the cylinder and cooling it with a stream of air from a blower.

#### STUART PERRY GAS ENGINE, 1846

U.S.N.M. no. 251278; original patent model; transferred from the United States Patent Office; not illustrated.

This model was submitted with application for Patent no. 4800, issued October 7, 1846.

This engine is very similar to the Perry engine of 1844. It differs in that the cylinder is water-jacketed and the hot cooling water is used to heat the fuel retort. Ignition is effected by heated platinum exposed to or separated from the explosive mixture by a valve.

The model shows a horizontal double-acting engine completely water-jacketed. Beside the cylinder is the retort for generating the vapors. Air is mixed with the vapor in a valve box above the retort, and valves operated by cams from a lay shaft admit the explosive mixture to passages leading to the cylinder. The gas is ignited by incandescent platinum, and combustion continues during about one-third of the stroke, the expansion of the products of combustion forcing the piston to the end of the stroke.

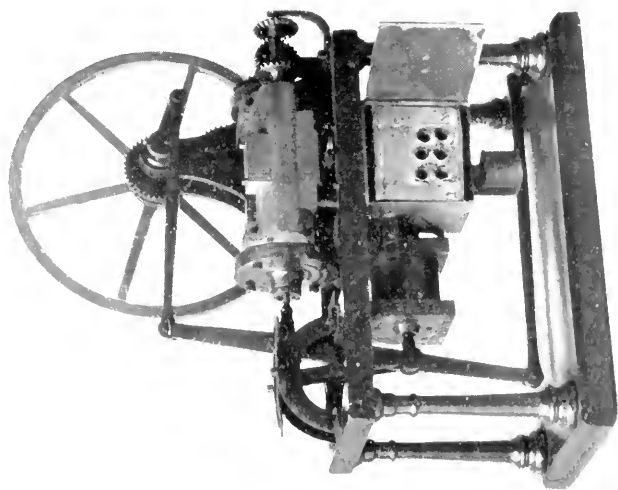

18493C

## INTERNAL-COMBUSTION ENGINES.

1. Stuart Perry gas or vapor engine, 1844 (model; U.S.N.M. no. 309253). See p. 147.
2. Alfred Drake gas engine, 1855 (model; U.S.N.M. no. 308724). See p. 149.

18493D

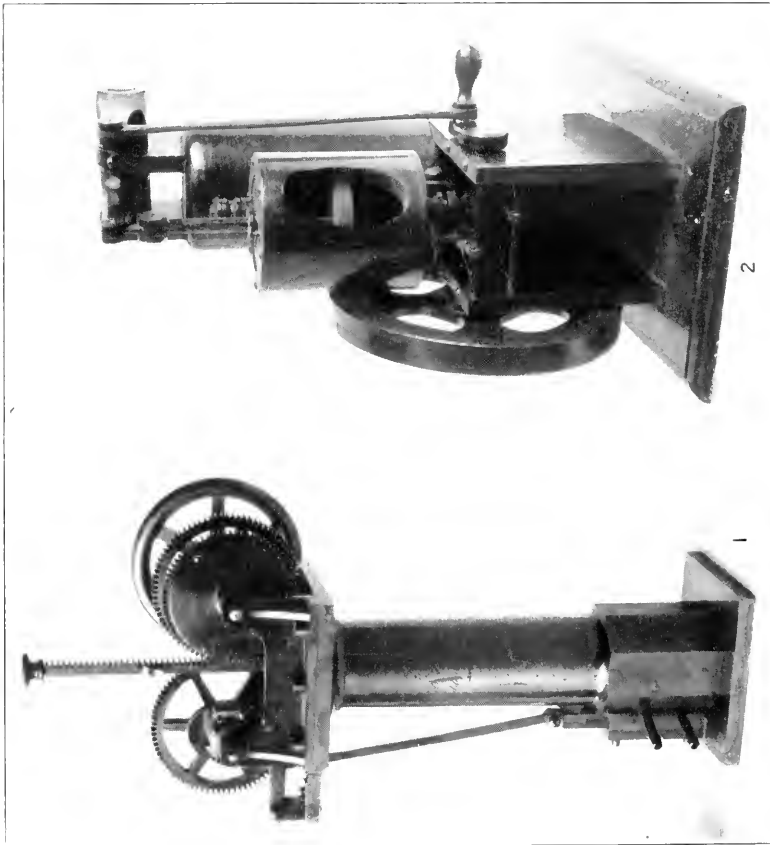

30417

10498

INTERNAL-COMBUSTION ENGINES.

1. Otto and Laugen gas engine, 1867 (model; U.S.N.M. no. 308675). See p. 149.
2. Brayton oil engine, 1874 (model; U.S.N.M. no. 251281). See p. 151.



To start the engine it was necessary to heat the water about the retort to generate the vapor and to heat the igniter. When running the engine developed sufficient heat for both purposes.

Perry designed this engine so that the water served not only to cool the cylinder but also to lubricate the piston and piston rod.

#### ALFRED DRAKE GAS ENGINE, 1855

##### PLATE 30, FIGURE 2

U.S.N.M. no. 308724; original patent model; transferred from the United States Patent Office; photograph no. 18493D.

This model was submitted with the application for Patent no. 12715, issued to Alfred Drake, of Philadelphia, Pa., April 17, 1855.

As early as 1843 Alfred Drake exhibited a gas engine at Philadelphia. This one of 1855, however, is the only one that he patented. The incandescent igniter is the novel feature of the engine.

In this engine and the earlier one gas and air were drawn into the cylinder at atmospheric pressure, and the mixture was fired by a small metal tube kept at white heat by an external flame. The force of the explosion drove out the piston, giving a maximum pressure of about 100 pounds per square inch. The cylinder has a water jacket, and the piston is hollow.

The engine was afterward modified and worked chiefly by petroleum.

#### OTTO AND LANGEN GAS ENGINE, 1867

##### PLATE 31, FIGURE 1

U.S.N.M. no. 308675; original patent model; transferred from the United States Patent Office; photograph no. 10498.

This model was submitted with the application for Patent no. 67659, issued August 13, 1867, to Nicolaus Otto and Eugen Langen, of Cologne, Germany.

This is the Otto and Langen free-piston or atmospheric gas engine introduced at the Paris Exposition of 1866. In this design the inventors improved the expansion of gases in the engine by employing a free piston, which, in theory, gives unlimited expansion.

In the model a long, slender, vertical cylinder, water-jacketed for one-third of its lower end, is fitted with a short piston. The piston rod is a toothed rack that is always engaged with a gear wheel at the top of the cylinder. This gear runs free on the motor shaft during the upstroke of the piston but is connected automatically to the shaft in an ingenious roller clutch during the downstroke. A valve rod driven by an eccentric on an auxiliary shaft operates a slide valve at the base of the cylinder. Air and gas are drawn into the cylinder during the upstroke. The mixture is exploded by a flame when the piston is

partly advanced, and the free piston is driven to the top of its stroke. Cooling of the gases then forms a partial vacuum in the cylinder, and the piston, which is now engaged to the motor shaft, is driven downward by atmospheric pressure. A slight compression of the gases of combustion at the bottom of the cylinder retards the fall of the piston sufficiently to free it from the motor shaft so that it may be picked up again lightly for the next stroke. A heavy flywheel carries the engine through the cycle.

Engines of this type consumed 44 cubic feet of Paris gas per indicated horsepower hour. The maximum pressure in these engines seldom exceeded 50 pounds per square inch. The great defects of the engine were its noisy and unsteady action and the excessive vibration and recoil.

See *Gas, Oil and Air Engines*, by Bryan Donkin (London, 1905), for drawings, indicator diagram, and description.

#### BRAYTON GAS ENGINE, 1872

U.S.N.M. no. 251280; original patent model; transferred from the United States Patent Office; not illustrated.

This *working* model was submitted by George B. Brayton, of Boston, Mass., with his application for U. S. Patent no. 125166, dated April 2, 1872.

The engine was the first to employ the principle of combustion at constant pressure. It also accomplished compression of the explosive mixture before ignition and was one of the first gas engines built commercially. See also Brayton Oil Engine, 1874.

In this engine gas and air were drawn in above the piston, compressed in the upper part of the cylinder, and discharged into a receiver under pressure of about 60 pounds per square inch. The explosive mixture entered the lower part of the cylinder through a series of wire gauze diaphragms, which prevented the flame from flashing back to the explosive mixture in the receiver. The mixture was ignited just before admission and entered the cylinder in a state of flame and drove the piston forward without any rise in pressure, a steady combustion being maintained behind the piston during one-third of the forward stroke.

#### ERRANI AND ANDERS PETROLEUM ENGINE, 1873

U.S.N.M. no. 251283; original patent model; transferred from the United States Patent Office; not illustrated.

This model was submitted with application for Patent no. 140021, issued to Louis Charles Errani and Richard Anders, of Liège, Belgium, June 17, 1873.

This is the first oil engine patented in the United States in which the fuel was vaporized within the cylinder. It is also the first to

inject the oil into the cylinder in the form of a spray. It was provided with electric ignition.

In construction the engine resembles a steam engine, including a horizontal single-acting cylinder in which is a reciprocating piston, a crank deriving its motion from the piston, a flywheel on the main shaft, and valve gear for operating a main valve connected with the engine cylinder. It was actuated by the combustion of a mixture of sprayed petroleum and air during a portion of the stroke. The petroleum was sprayed by means of a jet of air from a rubber bulb, acted upon by a sliding plunger, in combination with a tube and nozzle rising from the oil reservoir in the base of the engine, somewhat in the manner of a common household atomizer. The quantity of petroleum supplied to the cylinder was regulated by a bypass cock in the air line from the rubber bulb.

#### HOCK PETROLEUM ENGINE, 1874

U.S.N.M. no. 251282; original patent model; transferred from the United States Patent Office; not illustrated.

This model accompanied the application for Patent no. 151129, issued to Julius Hock, of Vienna, Austria, May 19, 1874.

This engine, which resembles the slightly earlier Errani and Anders engine in many details, attained nearly the same degree of popularity abroad as did the Brayton oil engine in this country and England. It differs from the Errani and Anders engine in having the oil reservoir separate from the engine, in having flame ignition, and in the method of controlling the supply of oil from the reservoir. It was not so successful as the Brayton because it used a lighter and more dangerous fuel.

Like the Errani and Anders, it resembled a single-acting horizontal steam engine. The oil tank stood back of the cylinder and was equipped with a plunger by which the height of the column of oil supplying the spraying device could be varied to change the quantity of oil being supplied. The oil was atomized by air from a rubber bulb compressed by a plunger on the crankshaft. The engine operated on the 2-stroke noncompression cycle similar to the Lenoir, Brayton, Errani and Anders, and others.

#### BRAYTON OIL ENGINE, 1874

##### PLATE 31, FIGURE 2

U.S.N.M. no. 251281; original patent model; transferred from the United States Patent Office; photograph no. 30417.

This model was submitted with the application for Patent no. 151468, issued to G. B. Brayton, of Boston, Mass., June 2, 1874.

When Brayton experienced difficulty with the flame of the cylinder striking back into the explosive mixture in the receiver of his gas

engine of 1872, he redesigned the engine to use petroleum. The resulting engine, the one described in this patent, is considered to be the first safe and practical oil engine.

The model (wooden) shows an engine that resembles the earlier gas engine in arrangement. It consists of a vertical cylinder closed at both ends, cast integral with a tall, heavy tank. The rod from the piston extends upward to a bell crank at the top of the tank. The other arm of the bell crank drives, through a long connecting rod, a crankshaft running under the cylinder. Cams on the crankshaft operate the intake or carburetor valve and the petroleum pump.

In operation, air is drawn into the upper part of the cylinder, compressed, and stored in the receiver tank. Petroleum is pumped under pressure into the carburetor, which is one of the most interesting features of the engine. It consists of a chamber containing a porous material into which jets of petroleum and air impinge, the air acting to break up or pulverize the petroleum. A lift valve admits air to the carburetor from the receiver, which dilutes the mixture in the carburetor and continues, through a wire-gauze diaphragm, into a chamber in which a flame burns continuously. The mixture is ignited and issues into the cylinder as a flame. The wire gauze prevents the striking back of the flame as in a safety lamp. Combustion continues for about one-third of the stroke when the air valve closes. The air and petroleum valves operate at the proper time, and the cycle is repeated.

#### DAIMLER GAS ENGINE, 1875

U.S.N.M. no. 308689; original patent model; transferred from the United States Patent Office; not illustrated.

This model was submitted with the application for Patent no. 168623, issued to Gottlieb Daimler, of Muelheim-on-the-Rhine, Prussia, October 11, 1875.

Daimler, who was managing director of Otto's Gas Moteren Fabric, 1872-1882, introduced this engine as an improvement over the Langen and Otto engine of 1866. The engine is of the double-acting, free-piston, atmospheric type.

A water-jacketed cylinder open to the atmosphere at both ends contains a working piston and two other pistons, one on each side of the working piston, which are loose or unconnected and operate in conjunction with the working piston in the following manner: With the working piston at the end of its back stroke, a charge of gas and air is drawn into the space between it and the front loose piston and is exploded. The said loose piston is thrown to the front end of the cylinder (without doing work) where it is held by a wedge device, whereupon a partial vacuum being formed in the cylinder by the expansion and cooling of the gaseous products

of combustion, the working piston will by atmospheric pressure be caused to perform its forward stroke, the back loose piston traveling with it. On approaching the front loose piston the back loose piston is arrested in its motion while the working piston completes its stroke, moving close up to the front loose piston and expelling the products of combustion from between them, while at the same time a charge of gas and air is drawn into the space formed between the working piston and the back loose piston. On the charge being exploded, the back loose piston is thrown to the back end of the cylinder and the working piston performs its back stroke, together with the front loose piston, and the operation is repeated as above described.

#### GILLES GAS ENGINE, 1876

U.S.N.M. no. 311362; original patent model; transferred from the United States Patent Office; not illustrated.

This model was submitted with the application for the patent issued to Friedrich W. Gilles, of Kalk, Germany, July 11, 1876, no. 179782.

The engine represented by the model is a 1-cylinder vertical gas engine employing two pistons, a working piston (the lower one) and a loose piston (the upper one). The loose piston was intended to fly to the top of the cylinder where it would be caught and held, producing within the cylinder a reduced pressure, which would cause the work piston to return under the pressure of the atmosphere and thereby perform work on the return stroke as well as the explosion stroke. Provision was made to cushion the free piston at the top of its stroke for the purpose of quiet running. The combustible mixture was drawn in and ignited on the explosion stroke without compression.

#### OTTO GAS ENGINE, 1877

##### PLATE 32. FIGURE 1

U.S.N.M. no. 251284; original patent model; transferred from the United States Patent Office; photograph no. 18623A.

This model was submitted with the application for Patent no. 194047, issued to Nicolaus Otto, of Deutz, Germany, August 14, 1877.

This patent was the first issued for a 4-stroke cycle engine in this country and marks the introduction of this important engine here.

The model shows a horizontal single-acting piston engine, with a lay shaft, driven by bevel gearing from the crankshaft, extending to the head end of the cylinder. The lay shaft terminates in a crank that operates a slide valve across the head of the cylinder. A cam on the lay shaft operates through a crank a drop valve on the opposite side of the cylinder, and a centrifugal governor is driven from a gear on the lay shaft. The cylinder is water-jacketed. The slide valve acts

as a gas intake valve and ignition valve. The drop valve is the exhaust valve, and the governor acts on the gas throttle valve. The cycle is the Otto, or 4-stroke.

#### OTTO AND CROSSLEY GAS ENGINE, 1877

U.S.N.M. no. 308695; original patent model; transferred from the United States Patent Office, not illustrated.

This model was submitted with the application for the patent issued to Nicolaus A. Otto, of Deutz, Germany, and Francis W. and William J. Crossley, of Manchester, England, October 23, 1877, no. 196473.

The gas engine described is designed to effect a gradual combustion of the charge by the use of a weak mixture in the cylinder. In order that the mixture would not ignite too slowly a strong or explosive mixture was introduced into a separate but connecting chamber and ignited in the conventional way. The flame issuing with some force from the chamber into the cylinder effected a sufficiently rapid ignition of the weak charge.

The inventors also describe a means of raising the pressure on the cavity of the slide valve carrying the burning ignition charge in a flame ignition engine, high enough to equal the compression pressure within the cylinder of the engine.

#### MULTIPLE-PISTON GAS ENGINE, 1879

U.S.N.M. no. 308726; original patent model; transferred from the United States Patent Office; not illustrated.

This model was submitted with the application for the patent issued to Wilhelm Wittig and Wilhelm Hees, of Hanover, Prussia, March 25, 1879, no. 213539.

This model shows an engine with a vertical cylinder open at both ends. Within the cylinder are two pistons, so connected to the same crankshaft that they move in unison in and out from the midpoint of the cylinder, alternately traveling apart and then approaching each other at the midpoint. The intake and exhaust valves are the poppet type. Ignition is effected by a flame timed by a slide valve.

The engine works on the 4-stroke cycle. As the pistons travel away from the midpoint of the cylinder the combustible mixture of air and gas is drawn into the space between them. When the pistons come together on the next stroke the charge is compressed and when near the end of the stroke ignited. Combustion drives the pistons to the ends of the cylinders, performing work, and the spent gases are expelled on the next instroke of the piston.

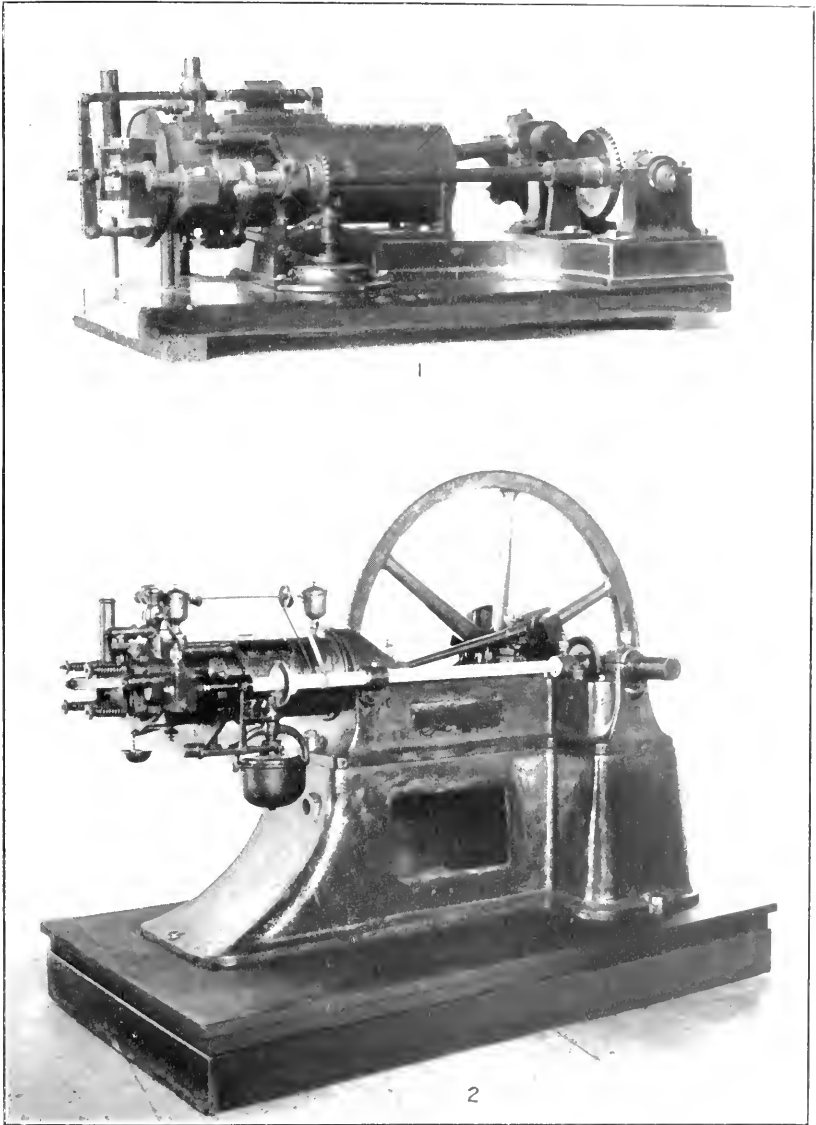

INTERNAL-COMBUSTION ENGINES.

18623A; 10498A

1. Otto 4-stroke cycle engine, 1877 (model; U.S.N.M. no. 251284). See p. 155.
2. Otto gas engine, 1882 (U.S.N.M. no. 503556). See p. 156.

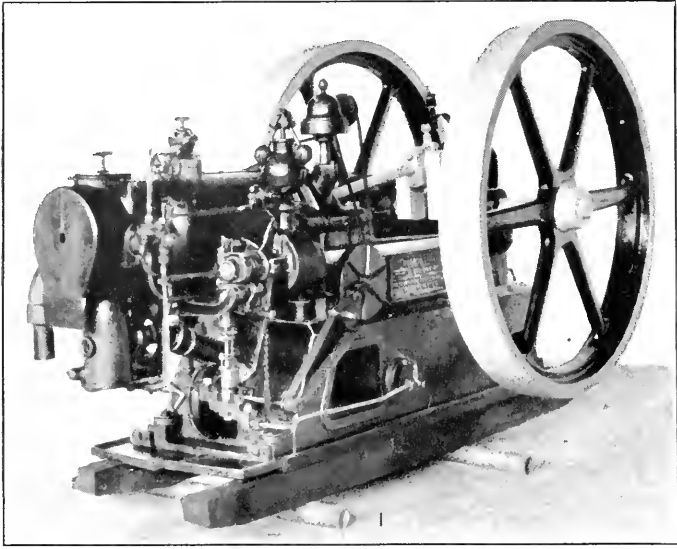

6092

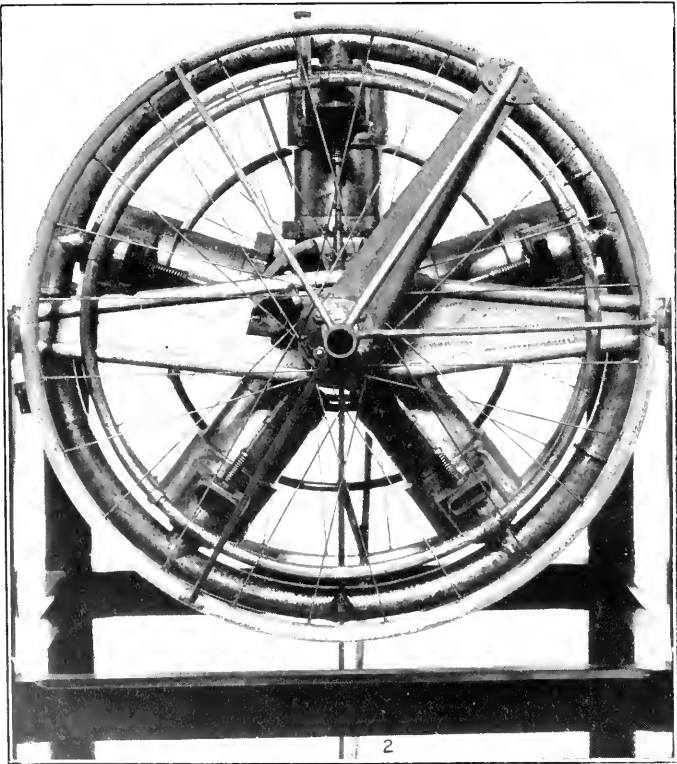

30592A

INTERNAL-COMBUSTION ENGINES.

1. Hornsby-Akroyd oil engine, 1893-1895 (U.S.N.M. no. 309637. See p. 157.
2. Charles Manly radial engine, 1901 (U.S.N.M. no. 248651). See p. 158.



## DAIMLER COMPOUND GAS ENGINE, 1879

U.S.N.M. no. 308697; original patent model; transferred from the United States Patent Office; not illustrated.

This model was submitted with the application for Patent no. 222467, issued to Gottlieb Daimler, of Deutz-on-Rhine, Germany, December 9, 1879.

This is the first compound or multiple-expansion internal combustion engine patented in the United States. It was also the earliest engine employing two cylinders operating independently on the 4-stroke cycle but connected to the same crankshaft and so timed that a power stroke occurred once in every revolution of the shaft.

The model shows two horizontal single-acting cylinders connected to cranks at either end of the same crankshaft. The two cranks are in the same plane. A third cylinder of large capacity is located between these two and connects to a crank  $180^\circ$  ahead of the other two cranks and on the same shaft. The two smaller cylinders each draw in a combustible charge, compress it, fire it, and perform their strokes together, but the working stroke of one cylinder takes place while the other cylinder is taking in its combustible charge. The products of combustion expelled from these cylinders pass to the third or low pressure cylinder and perform further work by expansion therein. The low pressure piston performs its working stroke during each instroke of the high pressure cylinders. The high-pressure cylinders in construction and operation resemble the Otto Engine of 1877 (*q. v.*).

## WITTIG AND HEES TWO-CYCLE GAS ENGINE, 1880

U.S.N.M. no. 308707; original patent model; transferred from the United States Patent Office; not illustrated.

This model was filed in 1879 with the application for U. S. Patent no. 225778, issued to Wilhelm Wittig and Wilhelm Hees, of Hanover, Germany, March 23, 1880.

This is the first 2-cycle engine patented in the United States. It is of that class of engines having two cylinders, between which the operations of the Otto cycle are divided. One cylinder and piston serve to draw in, compress the explosive charge, and deliver it to the working cylinder so that in the working cylinder a power impulse is obtained on every alternate stroke. This type of engine is generally considered the invention of Dugald Clerk, of Glasgow, who received British Patent no. 1089, March 14, 1881, and United States Patent no. 249307, November 8, 1881, for a similar engine.

The model, which is made principally of wood, is purely diagrammatic and illustrates only the features of the engine that are covered by the patent. It indicates two parallel cylinders, with pistons con-

nected to cranks on the same shaft. An automatic intake valve in the right hand or pump cylinder, a lift valve, operated by push rod and cam, between the cylinders, and a similar exhaust valve in the working cylinder are shown. In operation, the combustible mixture is drawn into the pump cylinder by the back stroke of the pump piston. The mixture is compressed during the forward stroke, near the end of which the valve between the two cylinders opens and the compressed mixture enters the work cylinder, where it is immediately ignited and performs work during the outstroke of the piston. The exhaust valve of the work cylinder is open during the return stroke of the work piston, and the spent gases are expelled. Both pistons make their strokes together, *i. e.*, there is no angular distance between the cranks.

#### OTTO GAS ENGINE, 1882

##### PLATE 32, FIGURE 2

U.S.N.M. no. 309556; original; purchased from the Otto Engine Works; photograph no. 10498A.

This engine, serial no. 554, was built by Schleicher, Schum & Co., of Philadelphia, in 1882. It was used at Princeton University in the mechanical laboratories to 1928, when it was procured for the Museum by the Otto Engine Works.

This is a 4-horsepower, flame-ignition, 4-stroke cycle, horizontal gas engine, the same as the first of the type introduced into the United States in 1878. In appearance it resembles a horizontal steam engine, with cross head, connecting rod, crankshaft, and flywheel. It is, however, single acting. A lay shaft driven by bevel gearing from the crankshaft extends the whole length of the engine and performs many duties. A small belt from the lay shaft operates the lubricators, bevel gears drive the ball governor, cams on the lay shaft through a crank and lever operate the exhaust valve on the opposite side of the cylinder, and the shaft ends in a crank that operates the slide valve across the end of the cylinder. The slide valve acts as gas and air intake and ignition valve. The intake picks up a charge of gas, exposes it momentarily to a flame that burns continuously outside the engine, and carries the little quantity of burning gas to a passage in the head of the engine to ignite the compressed explosive mixture in the cylinder.

In the operation of the engine, air and gas are drawn into the cylinder through the slide valve by the backstroke of the piston, the valve closes, and the mixture is compressed on the forward stroke; near the end of the stroke the compressed mixture is ignited, and the combustion drives the piston back; on the next forward stroke the exhaust valve opens, and the gases of combustion are expelled; the exhaust valve closes just before the end of the stroke, and the cycle is repeated.

## ATKINSON "CYCLE" GAS ENGINE, 1889-90

U.S.N.M. no. 310371; original; gift of the heirs of Samuel Powel; not illustrated.

This is a 2-horsepower, 4-stroke cycle, illuminating-gas engine, built in 1889-90 by Henry Warden, of Philadelphia, licensee under patents of James Atkinson, of Hampstead, England, Patent no. 367496, August 2, 1887.

The feature of the engine is the vibrating toggle linkage between the piston rod and crankshaft by which four piston strokes of different lengths are produced in each revolution of the crank. This arrangement gives one explosion stroke per revolution and permits the use of an explosion stroke considerably longer than the suction or compression strokes with a resulting degree of expansion greater than is obtained with the usual four strokes of equal lengths.

The cylinder of the engine is horizontal, the crankshaft is well above the center of the cylinder, and the connecting rod from the crank has a short T-head to one pin of which is attached the piston rod, to the other a vibrating arm pivoted to the engine frame slightly below the center of the cylinder and beyond the center of the crankshaft.

This arm swings through an arc of approximately 90°, and the crank is the only revolving part of the system. Valves for exhaust, air intake, and fuel intake are located in the head of the cylinder and are operated by a short cam shaft, which, in turn, is driven by a bevel gear from a long inclined lay shaft to the crankshaft of the engine. The lay shaft carries a small centrifugal governor, which moves the fuel valve follower away from its actuating cam when the speed of the engine increases. Ignition is by means of a hot tube located on the top of the cylinder and heated by a gas burner and refractory lined chimney. The ignition port is uncovered by the piston. The cylinder diameter is 5 inches, suction stroke 4½ inches, compression stroke 3½ inches, explosion stroke 5 inches, and exhaust stroke 6 inches.

The engine was built for Samuel Powel, of Newport, R. I., who used the engine to power a small experimental machine shop there.

## HORNSBY-AKROYD OIL ENGINE, 1893-1895

## PLATE 33, FIGURE 1

U.S.N.M. no. 309637; original; from Robert McReady; photograph no. 6002.

This engine was the first one built by the De La Vergne Refrigerating Machine Co. after acquiring the American license to the inventions of H. Akroyd Stuart and C. R. Binney in 1893. It was the first 4-stroke, heavy-oil engine including a hot-bulb vaporizer and igniter built in the United States. Built as an experimental engine in 1893, it was run for test purposes at the factory until 1895.

when it was given the serial number 1501 and sold as the first one of thousands of its type.

Stuart and Binney patented the hot-bulb vaporizer and igniter in England in 1890, and in the same year they introduced an engine in which fuel oil was sprayed into the cylinder after the compression of pure air. United States patents were granted in 1890 and 1893. The hot-bulb vaporizer is an uncooled chamber extending from the cylinder and connected to it by a constricted passage. This chamber is maintained at red heat by the combustion in the cylinder.

The engine operates on a 4-stroke cycle, drawing in a charge of air on the back stroke of the piston, compressing the air on the return stroke. Ignition is caused by the increase in temperature due to compression aided by the hot surfaces of the vaporizer. Combustion drives out the piston on the power stroke and the spent gases are exhausted on the return. Oil is injected into the vaporizer just before the end of the compression stroke.

A torch and hand-driven blower are provided to heat the vaporizer for starting the engine. The oil pump supplies a constant quantity of oil at each stroke. Governing is accomplished by diverting part of the oil back to the reservoir, through a bypass valve that is controlled by a flyball governor.

#### CHARLES MANLY RADIAL ENGINE, 1901

##### PLATE 33, FIGURE 2

U.S.N.M. no. 248651; original; deposited by the Smithsonian Institution; photograph no. 30592A.

This is the 5-cylinder, 4-cycle, radial, water-cooled, gasoline engine built by Charles M. Manly in the shops of the Smithsonian Institution at Washington for the full-size Langley Aerodrome. The engine was completed in December 1901 and was tested in January 1902. Under a Prony brake load of 52.4 horsepower at 950 revolutions per minute, it ran continuously during three 10-hour tests. The net weight of the engine proper is 124.2 pounds; with the two flywheels, 140 pounds; and with 20 pounds of cooling water and accessories the total weight of the airplane power plant was 207.5 pounds, or 3.96 pounds per horsepower.

The following account of the building of the Manly engine, its description, and tests is based on *Langley Memoir on Mechanical Flight, pt. 2, 1897-1903*, by Charles M. Manly, Smithsonian Contributions to Knowledge, vol. 27, no. 3, pp. 123-284, 1911.

When Dr. Langley decided to build a full-size flying machine as a result of his success with small models, he required an assistant with engineering ability. Accordingly, Charles M. Manly was employed at the suggestion of Dr. R. H. Thurston, director of Sibley

College at Cornell University, where Manly was a student, and he assumed charge of the experimental work as assistant in charge of experiments in June 1898. It was then the intention of Dr. Langley to have the engine for the aerodrome constructed for him by some established engine builder, while he and Manly constructed the aerodrome proper. A contract was therefore made with a builder who agreed to construct an engine to weigh not more than 100 pounds and to develop not less than 12 horsepower. This arrangement failed to produce an engine, and a new contract was entered into with S. M. Balzer, automotive engine builder of New York City, who agreed to furnish an engine of the above description before March 1, 1899.

The engine was not delivered within the contract time, and in May 1900 Manly went to New York to assist in the completion. When it was found then that the engine developed not quite 3 horsepower, it was decided that Manly should accompany Dr. Langley, who was then preparing to leave for Europe, and they would attempt to have the engine built abroad. No one in France, Germany, or England would attempt the job, and Langley was told rather generally that such an engine was an impossibility. The two returned in August 1900 and found the engine still below specifications, whereupon Balzer was paid the contract price for the engine as it stood, and Manly returned to Washington to continue the construction of the engine himself. Using some of the parts from the Balzer engine and constructing others, Manly within little more than a month had an experimental engine at work that developed  $18\frac{1}{2}$  horsepower on the Prony brake at 715 revolutions per minute and weighed 108 pounds. This was a "patched up" affair that was provisionally cooled by wrapping wet cloths around the cylinders and accordingly could run for only a few minutes at a time. It was so successful, however, that plans were made to construct an engine for the full-size aerodrome immediately. Another delay was met in obtaining materials for the engine, and construction was not started until the summer of 1901. The first part of the year was not wasted, however, as a long series of tests was run on the experimental engine to determine the most satisfactory carburetor and ignition arrangement. The wiping contact sparker proved unsatisfactory and was abandoned, and Manly then devised what is supposed to have been a new and valuable multiple-sparking arrangement whereby only one battery, one coil, and one contact maker were utilized for causing the spark in all five cylinders.

A small commutating arrangement in the high-tension circuit distributed the sparks to the proper cylinders. Most of the spark plugs then available were found unsatisfactory, and so Manly constructed his own. In this connection he effected one minor improvement that

has since been incorporated in all plugs. Difficulty was experienced from a coating of soot that formed on the porcelain and caused a short circuit between the points. This was overcome by extending the metal portion of the plug into the cylinder about three-quarters of an inch beyond the porcelain. The terminal through the insulator was also extended about half an inch and bent to co-act with a piece of platinum on the inside wall of the plug. After this improvement was made, no difficulty from short circuits was experienced. The float-feed type of carburetor proved unsuitable as the tremor of the frame caused the float to act as a pump, periodically flooding the carburetor. Manly next tried a type of mixing valve in which the gasoline was fed through the valve seat of a lightly loaded valve that opened when there was suction in the intake pipe. The amount of gasoline was controlled by a pin valve. He then built and tested several shapes and sizes of tanks filled with absorbent material that was saturated with gasoline and the surplus drawn off before starting. As the result of about one dozen tests he found the best type to consist of a tank filled with small lumps of a porous cellular wood (tupelo wood) initially saturated with gasoline and into which gasoline was fed through a distributing pipe as rapidly as it was taken up by the air. Heated air was drawn from around the cylinders to counteract the cooling effect of the evaporation within the carburetor. A carburetor of this type kept the engine running at full speed even when the aerodrome had turned completely over on its back.

The full-size engine finally built is the 5-cylinder, water-cooled, radial engine shown in the accompanying illustration. Construction was started in the summer of 1901, and it was completed in December of the same year.

The engine cylinders each consist of a main outer shell of steel one-sixteenth of an inch thick, near the bottom end of which was screwed and brazed a suitable flange by which it was bolted to the supporting frame drum or crank chamber. These shells, which were seamless with the heads formed integral, were designed to be of sufficient strength to withstand the force of the explosion in them, and in order to provide a suitable wearing surface for the piston, a cast-iron liner one-sixteenth of an inch thick was carefully shrunk into them. At the side of the cylinder near the top was the combustion chamber, machined out of a solid steel forging also forming the port that entered the cylinder and was fastened to it by brazing. The water jackets, which were formed of sheet steel 0.020 inch thick, were also fastened to the cylinders by brazing.

The pistons are of cast-iron having a slightly convex head reinforced by two deep but thin ribs. The head is approximately one-eighth inch thick, the side walls above the wrist pin journal one-quarter inch, and the skirt below the wrist pin about one-sixteenth

inch thick. The pistons are 5 inches in diameter and 4 inches long. They are slightly tapered from the middle, where they are 0.005 inch smaller than the cylinder bore toward the outer end, where they were 0.0075 inch smaller than the bore. The outer piston ring was 0.0035 inch narrower than its groove, the second one 0.003 inch, the third 0.0025 inch, and the inner one 0.002 inch narrower than its groove. The rings were bored one-sixteenth inch off center with the exterior surface and had one-eighth inch diameter of spring. They were of the lap joint type, with the sides of the laps carefully fitted and only one sixty-fourth inch clearance at the ends of the laps to allow for thermal expansion. As no grinding facilities were available in Washington, the cylinders were carefully bored smooth and free from taper, and the pistons were worn in to a perfect fit by running them in by a belt for 24 hours with a copious oil supply.

The main connecting rod was seven-eighths inch in diameter and solid, while the other four were of the same diameter but with a  $\frac{5}{8}$ -inch hole in them. The gudgeon pins in the pistons were hollow steel tubes, seven-eighths inch in diameter and case hardened, and were oiled entirely by oil thrown off by centrifugal force from the crankpin bearing, the oil running along the connecting rods and through suitable holes in the heads into oil grooves in the bronze bushings in these heads.

The arrangement of connecting rods consists of a main connecting rod formed of a steel forging terminating in a sleeve that encircles the crankpin and is provided with a bronze bushing for giving a proper bearing surface between the connecting rod and the crankpin, both the steel sleeve and the bronze liner being split, at right angles to each other, to permit assembling them on the crankpin. This steel sleeve, the upper half of which is formed integral with the main connecting rod, is rounded off to a true circle on its exterior circumference except at the point where the rod joins it. The other four connecting rods terminating in bronze shoes are then made to bear on the exterior of this sleeve, being held in contact therewith, and permitted to have a sliding motion thereon sufficient to take care of the variation in angularity of the connecting rods, by means of cone nuts, which are screw-threaded to the sleeve and locked thereto by means of jam nuts. The main connecting rod acts in the same way as in the ordinary case where each cylinder has its separate crankpin. The other four connecting rods deliver their effort to the crankpin through the sleeve in which the first connecting rod terminates, and they, therefore, do not receive any of the rubbing effect due to the rotation of the crankpin except that of slipping a very short distance over the circumference of the sleeve during each revolution, the amount of slipping depending on the angularity of the connecting rod.

The lubrication of the main crankshaft bearing and the crankpin was effected by means of a small oil cup fastened to the port bed plate, which fed oil through a hole in the hub of the drum to a circular groove formed in the bronze bushing of the hub. The crankshaft being hollow, a hole was drilled through it in line with the groove in the bushing, and the oil was then led from the interior of the crankshaft through a pipe connected to the plug in the end thereof and through a hole drilled in the crank arm to the hollow crankpin. Small holes through the crankpin permitted oil to pass to the exterior thereof and thus oil the bearing of the main connecting rod. Small holes through the sleeve and bushing of the main connecting rod fed oil under the shoes of the other four connecting rods, the small holes being placed in oil grooves formed in the interior of the bronze bushing. The lubrication of the pistons was effected by means of small crescent-shaped oil cups fastened to the outer walls of the cylinders, which distributed the oil equidistantly around the circumference of the pistons, through small tubes that projected through corresponding holes drilled in the cylinder wall. These oil cups for the cylinders were, while small, of sufficient size to furnish a supply for approximately one hour, and were positioned on each cylinder to have a gravity feed. The crankshaft bearing in the starboard drum was oiled from an oil cup mounted on the outside of the bed plate and connected by a pipe to a hole in the inner wall of the drum which was connected to the oil grooves in the bronze bushing in the hub of the drum.

The sparking apparatus comprised first a primary sparker of the form in which a cam driven by the engine co-acts with a pawl on the end of a spring, but in this case, as the sparker was used for all five cylinders, the cam was driven at a speed of two and one-half times that of the engine speed, thus making and breaking the primary circuit five times in each two revolutions of the engine. Second, a spark coil the primary terminals of which were connected to the primary sparker and to a set of dry batteries. Third, a secondary distributor consisting of a disk carrying a contact brush and driven at a speed one-half that of the engine, this brush being constantly connected through a contact ring to one of the terminals of the high tension side of the spark coil and running over the face of a five section commutator, each of the sections of which was connected to a spark plug, the other high tension terminal of the spark coil being of course grounded on the engine frame. After considerable trouble with the insulation of the high-tension wires it was found impossible to purchase any wire properly insulated, and it was finally necessary to insulate these wires by covering them with several thicknesses of ordinary rubber tubes of different diameters telescoped one over the other.



After the engine was connected to the transmission equipment, it was found necessary to add flywheels. After much experimenting these were made of two automobile wheels with tangent spokes in which special cast aluminum rims of U-section were substituted for the original too flexible steel rims.

When completed the net weight of the engine proper was 124.47 pounds; with the two flywheels, 140 pounds; and with 20 pounds of cooling water and accessories the total weight of the power plant was 207.47 pounds.

In three separate tests of 10 hours each, of continuous running, the engine carried a continuous load of 52.4 horsepower at 950 revolutions per minute.

#### HAYNES AUTOMOBILE ENGINE, 1914

U.S.N.M. no. 283279; original; presented by the Haynes Automobile Co.; not illustrated.

This is a 6-cylinder, L-head, gasoline engine. The cylinders are cast in pairs, the bore is  $4\frac{1}{4}$  inches, the stroke  $5\frac{1}{2}$  inches. The valves are the poppet type operated by a camshaft geared to the crankshaft. The engine developed 65 horsepower and weighs 1,000 pounds. It has splash lubrication with a plunger pump to return the oil to the splash basins. It is equipped with a Leece-Neville electric starting and lighting system and high-tension magneto ignition. The carburetor is a Stromberg, to which gasoline is fed under pressure supplied by a hand pump and a mechanical air pump.

The engine is exhibited with its transmission, which is fitted with a Vulcan electric solenoid gearshift.

#### AUTOCAR GASOLINE TRUCK ENGINE, 1921

U.S.N.M. no. 307254; original; gift of the Autocar Co.; not illustrated.

This is a 4-cylinder, vertical, cast-in-block, 4-cycle, cylinders-in-line, water-cooled, gasoline engine. It has  $4\frac{1}{2}$ -inch bore,  $5\frac{1}{2}$ -inch stroke; and A. L. A. M. rating of 28.9 horsepower. The crankshaft is supported in two annular roller bearings, with no center bearing. Lubrication is by the splash of the connecting rods in cups on the ends of standpipes located under each crank. Oil is circulated from the reservoir in the bottom of the crankcase through a strainer to the splash cups, by a gear pump. Water is circulated by a centrifugal pump. The engine is equipped with Bosch high-tension magneto and a Stromberg carburetor. A centrifugal governor operating from the camshaft limits the top speed of the engine.

## BUDA ENGINE, 1924

U.S.N.M. no. 308340; original; gift of the Buda Co.; not illustrated.

This is an example of the modern 4-cylinder, 4-cycle gasoline engine built for use in motor-coach and truck service. The engine, which is sectioned, is revolved by an electric motor to illustrate the operation of the engine.

This engine has a  $4\frac{1}{4}$ -inch base and  $5\frac{1}{2}$ -inch stroke and develops 53 horsepower at 2,000 revolutions per minute. The four cylinders are cast in block and are jacketed for water cooling. The water is circulated by a centrifugal pump regulated by a Fulton thermostat. Intake and exhaust valves are of the mushroom type and located on the same side of the cylinders. A 3-bearing camshaft operates the valves. The cylinder head is of the type known as L-head. The spark plugs are located at the centers of the cylinder heads. The pistons are packed with three rings above the wrist pin and a wiper or oil ring below. The crankcase is made of aluminum alloy. The crankshaft is counterbalanced and is supported in three bearings. It is drilled for lubrication. An oil pump supplies the lubricant to all bearing surfaces under pressure. The engine is equipped with magneto ignition and a combination electric starter-generator. The carburetor receives air through a centrifugal dust remover.

## WILLYS-KNIGHT AUTOMOBILE ENGINE, 1927-28

U.S.N.M. no. 310292; original; presented by Willys-Overland, Inc.; not illustrated.

This is a 6-cylinder engine of the Knight sleeve-valve type. It has 177.9 cubic inches displacement and is rated at 20.7 horsepower at 300 revolutions per minute and develops 53-horsepower maximum.

The valves are cast-iron sleeves with annular slotted ports near the tops. These sleeves, two to a cylinder, fit one within the other with the inside ones forming the cylinders within which the pistons work. The sleeves are operated by short rods from eccentrics on two eccentric shafts and move up and down a distance of about 1 inch. The valves are adjusted so that the intake opens  $10^\circ$  after top center and closes  $35^\circ$  after bottom center; the exhaust opens  $50^\circ$  before bottom center and closes  $5^\circ$  before bottom center.

## OTHER GASOLINE AND OIL ENGINES

There are many gasoline and oil engines included in the aeronautical and automotive collections of the Division of Engineering, but not described in this publication. A few are mentioned below, though many of equal interest are omitted. None are illustrated.

*Automobile Engines*

Make	Type	U. S. N. M. no.
Duryea, 1892-93	1-cylinder, horizontal	307199
Haynes, 1893-94	1-cylinder, vertical, 2-horsepower	262135
Balzer, 1894	3-cylinder, rotary	181658
Olds, 1896	1-cylinder, horizontal, 6-horsepower	286567
Knox, 1900	1-cylinder, air-cooled	308332
Autocar, 1901	2-cylinder, opposed, horizontal	307257
Winton "Bullet #1," 1901-2	4-cylinder	309602
Cadillac, 1903	1-cylinder, vertical, 10-horsepower	308217
Simplex, 1912	4-cylinder, cast in 2 blocks of 2	309549
Ford, 1913	4-cylinder	311052
Cadillac, 1923	8-cylinder, V-type	308218

*Airplane Engines*

Wright, 1909	4-cylinder, in-line, 30-horsepower	271135
Curtiss, 1909	8-cylinder, V-type, 50-horsepower	309380
James Martin, K III, 1917	Gnat ABC, 2-cylinder, opposed, 45-horsepower.	308351
Spad (French), 1918	Hispano Suiza, 220-horsepower	307722
Fokker D-7, 1918	Mercedes, 6-cylinder; 180-horsepower	307726
DeHavilland-4, 1918	Packard #4, the first 12-cylinder Liberty engine.	307693
Curtiss Racer, 1925	Curtiss V-1400; 610-horsepower	308526
"Spirit of St. Louis", 1928	Wright, Whirlwind, radial	309414
"Polar Star", 1935	Pratt & Whitney "Wasp"	311095
Curtiss-Baldwin, 1908	4-cylinder, vertical	310268
Wright, 1911	6-cylinder, in-line, 60-horsepower	310661
Hendee, 1911	2-cylinder, rotary, 50-horsepower	308221
Hall-Scott, 1911	8-cylinder, V-type, A-type, 80-horsepower.	310269
Gyro, 1913	#50, 5-cylinder, rotary, 30-horsepower	276602
LeRhone, 1917	rotary, 7-cylinder, 80-horsepower	307733
Gnome, 1917	rotary, 9-cylinder, 100-horsepower	308119
Liberty, 1917	first 8-cylinder, V-type, 250-300-horsepower.	308489
King Bugatti Dusenbergl, 1918	16-cylinder, V-type, with two crankshafts, 460-horsepower.	307729
Curtiss O-X-5, 1918	8-cylinder, V-type, 90-horsepower	307730
Maybach, 1918	6-cylinder, in-line, 260-horsepower	310655
Curtiss C-D-12, 1921	12-cylinder, V-type, 400-horsepower	308486
Wright D-1, 1923	dirigible engine, 6-cylinder, in-line, 400-horsepower.	308487
Packard Diesel, 1928	9-cylinder, radial, 225-horsepower	310291

The collections include also an additional model of a gas engine for which a patent was issued to N. A. Otto, but not otherwise identified. U.S.N.M. no. 308728.

## CARBURETORS

At the time when useful internal combustion engines were beginning to appear, manufactured illuminating gas was available in the principal cities of the world, and inventors of combustion engines designed them to use gas as fuel. For this reason the internal-combustion engine reached practical perfection as a *gas* engine.

It was then apparent that the usefulness of the engine would be greatly increased if it did not depend upon a connection to a gas-manufacturing plant for its fuel. Combustible liquids such as turpentine, alcohol, and petroleum were used in the earliest engines by heating the liquid fuel in separate retorts or within the cylinders of the engines and mixing the evaporated vapor with air to form combustible mixtures. Also, several early engines had atomizers and oil "pulverizers", which operated under pressure from fuel pumps to spray finely divided oil into the air before or after it entered the cylinder. However, the internal-combustion engine did not cease to be the *gas* engine until the invention of carbureting devices that formed combustible mixtures from liquid fuels through the action of the suction stroke of the engine alone. Carburetors in this sense have been historically of three classes, surface carburetors, mixing valves, and spray carburetors.

Surface carburetors are essentially mixing chambers in which a quantity of the liquid fuel is so contained that air drawn through the chamber passes over the largest possible surface of the fuel, to become saturated or carbureted with the vapor of the fuel. In the earliest ones the fuel was held in shallow trays or allowed to run over metal screens to obtain the necessary surface area of liquid. They were at first large clumsy tanks, often installed underground, and, though they permitted the gas engine to be used where gas was not available, they did not add much to the portability of the engine. Later surface carburetors were made with such porous materials as wood, wicking, and gauze in place of the trays or screens, with the result that when the absorbent material was wetted with fuel a much larger total surface of liquid was obtained in a smaller space. The Manly carburetor, described below, is an example of the use of wood for this purpose. An English automobile was equipped with a surface carburetor in which cotton wicking was used, as late as 1911. The first small and portable carburetors were the surface carburetors of Daimler and Benz in which the air was drawn across the surface of the fuel through a diffuser floating upon the surface. These carburetors made the internal combustion engine portable and made possible the early development of the gasoline automobile. However, they lacked the flexibility necessary to supply correct mixtures at varying speeds and temperatures and frequently removed the lighter constituents from the fuel leaving behind the heavier liquids, which in time clogged the surfaces. Surface carburetors were generally superseded by *mixing valves*.

The usual form of the mixing valve was a flat conical valve, the tip of which shut off the fuel supply at the same time that the body of the valve closed the air intake passage. The valve was closed by a light spring and was opened by the partial vacuum created by

the suction stroke of the engine. When open, the fuel ran down over the surface of the valve to mingle with the stream of air, which was drawn through the valve to the engine. In many of the mixing valves excess fuel drained into a lower tank from which it was pumped to a fuel tank higher than the mixing valve. Dugald Clerk, the Scotch inventor, is credited with having first used the mixing valve in 1881. C. Sintz and A. Winton patented carburetors of this type in the United States in 1896 and 1898. The Haynes-Apperson mixing valve (below) is a good example of a typical one.

All these earlier forms of carburetors gave way gradually to the spray type of carburetor, in which a spray of fuel is drawn into the air by the flow of the air past a jet connected to the fuel supply. In these, various methods of maintaining the supply of fuel at the jet have been employed. The first was by pumping the fuel in measured quantities through the jet, as shown in the atomizers attached to the Errani and Anders and the Hock petroleum engines (above). Another method was that of allowing the fuel to run by gravity to the jet in quantities metered by an adjustable valve. The carburetor of the R. E. Olds automobile of 1896 (below) is an example of this type. The next step in the development toward the present-day carburetor was that of maintaining under all conditions of operation a constant level of fuel in the reservoir supplying the jet. An early method of accomplishing this was to have the reservoir provided with an overflow outlet and then supply fuel to the reservoir at a rate slightly faster than it would be drawn through the jet, the excess spilling over the overflow and draining to a second fuel tank. This is the method employed in the carburetor used on the Duryea automobile of 1892-93 (below). In the present-day carburetors the level of liquid in the reservoir is maintained constant by a float in the reservoir that closes the fuel intake valve when the level of liquid in the reservoir is correct. The "Inspirator" of Edward Butler, England, 1889 (patented in the United States in 1890), was the first of this class known as float-feed, constant-level, induced-jet carburetors. This and the Maybach, Germany, 1893, are considered the first of the modern type. Charles E. Duryea was probably the first to use the float-feed carburetor on an automobile for sale in the United States. To correct the tendency of the spray carburetor to form mixtures of increasing richness as the engine speed increases, various means have been adopted. Spring-closed valves that open as the suction increases in the mixing chamber to supply supplementary air to dilute the mixture were first used by Charles E. Duryea in 1901 and by A. Krebs, of France, in 1902. In 1906-1908 M. Baverey, of France, introduced a combination of two jets, one of which tended to produce a leaner mixture at higher speeds, the other a richer mixture giving an average mixture of

proper strength at all speeds. A modern carburetor using this principle is the Zenith described below. The Tillotson carburetors (below) show the use of the bypass, accelerating pump, and economizer in modern automobile carburetors.

### DURYEA CARBURETOR

#### PLATE 34, FIGURE 1

U.S.N.M. no. 307199; original, gift of Inglis M. Uppercu; photograph no. 18076.

This carburetor was made by Charles E. Duryea and was used by him on his successful gasoline automobile of 1892-93. It is a positively controlled, constant-level, induced-jet, spray carburetor, in which the quantity of gasoline supplied to the jet is controlled by a needle valve and the volume of air is determined by the setting of a rotary-disk valve.

The carburetor consists of two tubular chambers put together in the form of a T, with the axes of both chambers horizontal. The construction is evident from the illustration. The short chamber through which gasoline is permitted to flow corresponds to the float chamber of the present-day carburetor. Entering it are two pipes, one of which leads to a tank above the carburetor, the other to a tank below it. Gasoline flowed continuously into the chamber from the tank above and overflowed from the chamber to the tank below, maintaining a constant level of gasoline somewhere between the lip of the overflow pipe and its center. The rate of flow was controlled by a valve and could be observed through a sight glass in the feed line. The gasoline that reached the lower tank was returned to the upper one by means of a hand pump. The gasoline entered the small space about the shaft of the needle through the valve seat and stood in this space at the height of the gasoline in the constant level chamber. The jet consists of this space and a horizontal tube of very small bore leading from it slightly above the level of gasoline to the mixing chamber. The mixing chamber is simply a hollow tube obstructed by a diaphragm having a large circular hole through its center and small openings near the wall of the tube. Against the diaphragm is a movable disk similarly pierced and carrying at its center a tube, which is slightly converging in the direction of flow and into the entering end of which is bent the small-bore jet tube. At all times the opening through the center of the flow tube and diaphragm is unobstructed, but the openings in the diaphragm near the wall of the tube may be varied or closed by moving the disk. Air is drawn through the mixing chamber by the suction of the intake stroke of the piston of the engine, and that part of the air passing through the tube draws a spray of gasoline from the jet tube. This gasoline mixes with the air and passes to the engine. Both the needle

valve and the air supply valve are positively controlled, that is, they must be set for the speed and load under which the engine is to operate.

#### OLDS CARBURETOR

U.S.N.M. no. 286567; original; gift of the Olds Motor Works; not illustrated.

This carburetor is a part of the automobile built by Ransom E. Olds in 1896, as it is now exhibited in the Museum.

In this carburetor fuel feeds by gravity to a nozzle in the air intake passage. The rate of flow of the fuel is controlled by a needle valve. The fuel is raised to the level of the carburetor by a pump; that not drawn into the engine returns by gravity to the tank.

The carburetor consists of an upper chamber to which the fuel is pumped from the tank below. A return line from this chamber carried fuel back to the tank when the supply pump exceeded the quantity used. The fuel passes through a strainer into a small-bore copper tube that projects into a mixing chamber below. A needle valve controls the rate at which the fuel enters this tube. The suction stroke of the engine draws air through this chamber and gasoline is drawn from the tube and mixed with the air. The air intake passage is protected by a wire-mesh screen. The fuel that might drip from the nozzle between suction strokes of the engine returns to the fuel tank through a return line from the bottom of the mixing chamber.

#### A. L. DYKE FLOAT-FEED CARBURETOR, 1900

##### PLATE 34, FIGURE 2

U.S.N.M. no. 308479; original; gift of A. L. Dyke; photograph no. 18494C.

This is a single-jet constant-level carburetor with a main air inlet and a throttle of the vertical, barrel, rotary type. The constant level of the gasoline in the carburetor was maintained by a float-operated, needle, feed valve. Designed by A. L. Dyke and G. P. Dorris and manufactured by A. L. Dyke, at St. Louis, Mo., in 1900, carburetors of this type were the first to be manufactured and marketed in the United States. It involves many features of the present-day carburetor.

The carburetor is of cast brass and consists of two main compartments, the float chamber and the mixing chamber. Gasoline enters the top of the float chamber through a fitting that carries a needle-valve seat. Within the chamber is a hollow brass float carrying a needle shaft that rises to close the valve when the gasoline within the chamber reaches the proper level. A spring held "flusher pin" is fitted to the float chamber for the purpose of depressing the float to "flood" the carburetor for starting. The mixing chamber is a hollow cylinder having a large air intake opening at the bottom and

side and a large opening at the center, through which the mixture of air and gasoline passes to the engine. Rising vertically from the center of the bottom of the chamber is a hollow tube or jet connected to the bottom of the float chamber, so that gasoline stands in the tube at the level of the gasoline in the float chamber. Surrounding the jet is a hollow barrel valve controlling the volume of the mixture that can pass to the engine. Air enters the bottom of the chamber and sweeps up and around the jet, drawing a spray of gasoline mixed with the air into the engine. An adjusting screw operates a needle valve at the tip of the jet to control the richness of the mixture.

#### HAYNES-APPERSON MIXING VALVE, c. 1900

U.S.N.M. no. 262135; original; gift of Elwood Haynes; not illustrated.

This carburetor is part of the equipment of the Haynes automobile of 1893, as it is now exhibited in the Museum. This type of carburetor was patented by Elwood Haynes, May 30, 1905, Patent no. 791192.

This is typical of the class of carburetors known as mixing valves. In it gasoline flows by gravity to the seat of a flat conical (mixing) valve, which is caused to open by the suction of the engine piston, allowing the gasoline to spray over the valve and mix with the air, which is drawn past the valve into the engine.

In this carburetor gasoline flows to the mixing valve through a needle valve, which is adjustable to control the rate of flow of the gasoline. Air enters the mixing chamber by way of a gate valve. The same lever controls the needle valve and the air valve, opening or closing both together. This lever was controlled by a pedal on the dash of the machine. As used, gasoline flowed to the carburetor from a small tank above it, which was filled from the main tank by a small pump operating from the engine shaft.

#### "AUTOCAR" CARBURETOR, 1901

U.S.N.M. no. 307257; original; gift of the Autocar Co.; not illustrated.

This is a float-feed, constant-level, induced-jet carburetor of early and very simple construction. It is a part of the Autocar automobile of 1901, as exhibited in the Museum.

This carburetor, which is of cast aluminum, is constructed in two compartments, the float chamber and the mixing chamber. A cork float operates a needle valve in the gasoline feed line to maintain a constant level of gasoline in the float chamber and in the jet in the mixing chamber. Air is drawn through the carburetor by the suction induced by the piston of the engine and by inspirator action draws a spray of gasoline from the jet. The mixture passes out of the carburetor to the engine manifold by way of a rotary-barrel type of



throttle valve. A conical piece of wire gauze directly above the jet acted to assist the "atomization" and subsequent vaporization of the mixture which impinged upon the gauze.

#### CARBURETOR OF THE MANLY ENGINE, 1901

##### PLATE 34. FIGURE 3

U.S.N.M. no. 310194; original; deposited by the Smithsonian Institution; photograph no. 18081.

This is an elementary type of surface carburetor. It consists of a large copper tank (approximately 10 by 18 by 24 inches) filled with small pieces of a porous, cellular wood (tupelo wood) and fitted with a gasoline inlet valve, two gasoline drains, a great many small air-inlet tubes, and a large outlet from which the mixture was drawn by the suction of the engine.

This carburetor was adopted by Charles Manly in 1901 for the engine of the Langley Aerodrome after testing the various mixing valves and float-feed carburetors then available. It performed satisfactorily in the attempted flight and kept the engine running after the aerodrome turned over on its back.

#### ZENITH CARBURETOR, MODEL U5, 1921

U.S.N.M. no. 308362; original; gift of the Zenith-Detroit Corporation; not illustrated.

In this carburetor two fuel nozzles are employed in combination to obtain automatic regulation of the strength of the mixture regardless of the changes in suction, due to variations of the speed and load of the engine. One nozzle flows a constant amount of fuel regardless of suction and alone would produce a mixture growing leaner and leaner as the suction increased. The other nozzle flows more fuel as the suction increases and alone would produce a richer mixture as the suction increased. The two in combination give an average mixture of correct proportions. This principle was developed by M. Baverey, of France, 1906-1908.

The carburetor consists of three compartments: The float chamber, the mixing chamber, and a small gravity chamber. Gasoline feeds to the bottom of the float chamber through a needle valve controlled by a float to maintain a constant level of fuel within the carburetor. Within the mixing chamber are a main gasoline nozzle surrounded by a second annular nozzle and a small orifice just opposite the edge of the disk throttle valve. The small orifice and the annular nozzle are in permanent communication with the small gravity chamber, which is open to the air and which is supplied with gasoline at a slow but constant rate from the float chamber. At starting, the gravity chamber is full of gasoline, and a rich mixture is ob-

tained as the main and annular nozzles and the small orifice all supply gasoline to the entering air. For slow running at light load the throttle is nearly closed and the orifice alone supplies the gasoline to the air. At normal speed and load the gravity chamber becomes depleted and the carburetion of the air is mainly dependent upon the inner main nozzle.

These carburetors are still being made, though they have been to a large extent supplanted by improved Zenith carburetors employing the same compound-nozzle system but embodying automatic, built-in, accelerating, economizing, and starting devices.

#### ZENITH CARBURETOR, MODEL U, 1924

U.S.N.M. no. 308343, original; gift of the Zenith Carburetor Co.; not illustrated.

This carburetor, similar to the one preceding, is sectioned and exhibited with the Buda engine (U.S.N.M. no. 308340) described above.

#### TILLOTSON CARBURETOR, MODEL SP-19C, 1926

U.S.N.M. no. 309613, original; gift of the Tillotson Manufacturing Co.; not illustrated.

This carburetor is of the type known as plain tube, as opposed to air-valve and combination designs. In addition to a bypass or low-speed jet and a main nozzle, the carburetor is equipped with an accelerating pump and an economizer to meet the accelerating and power requirements of 6- and 8-cylinder automobile engines.

The economizer consists of a metering pin, or lift needle, in an auxiliary fuel passage to the main nozzle. In use this pin is raised by the choke control and allows a predetermined quantity of fuel to deliver into the main nozzle to assist in warming a cold engine. The pin is also connected to the fuel throttle so that it is raised at approximately full throttle to supply an additional flow of fuel for maximum power requirements.

The accelerating pump is added for the purpose of temporarily enriching the mixture for a sudden acceleration of the engine. It consists of a piston operating in a fuel-filled well, which is in communication with an accelerating jet. The piston is depressed when the throttle lever is opened and a sudden opening of the throttle forces the fuel in the well into the accelerating jet. Fuel that will not immediately pass the restricted jet opening is driven into a gravity chamber above the jet, from which it flows into the jet prolonging the accelerating effect.

## TILLOTSON CARBURETOR, MODEL V2A, 1927

U.S.N.M. no. 309614; original; gift of the Tillotson Manufacturing Co.; not illustrated.

This carburetor is of the plain-tube type, employing a bypass or low-speed jet, a main fuel nozzle, an economizer, and an accelerating pump. Its operation is in principle the same as that of the preceding Tillotson carburetor model SP-19C.

## BOSCH FUEL INJECTION PUMP FOR OIL-ENGINES, 1935

U.S.N.M. no. 311017; original; gift of the United American Bosch Corporation; not illustrated.

This unit is a cut-away injection system for a solid-injection, 4-cylinder, oil engine. It comprises four individual pump elements, an injection advance device (timer), a manual fuel-supply priming pump, an idling and maximum speed governor, and one nozzle and nozzle holder. It is the Bosch model P E 4 D, adapted for hand-crank operation in the Museum.

In this system fuel is supplied to the injection nozzle of each cylinder of the engine at the proper pressure and in the proper amount by a constant-stroke single plunger per cylinder. Each pump element consists of a ground-steel pump plunger and pump barrel. Each element is a self-contained fuel metering device of the plunger-controlled, bypass type, as well as a pump.

The plunger is girdled with an annular groove with a helical upper edge, which starts just below the head of the plunger and spirals down about half an inch. This groove is connected by a vertical groove with the space above the plunger. The barrel of the pump is pierced with a fuel inlet and a bypass port, which are covered by the plunger as it starts its upward stroke. Fuel is delivered through a third port or delivery valve to the engine cylinder until the helical edge of the groove uncovers the bypass port, when the remaining fuel above the plunger passes down and out through the bypass port. The point in the plunger stroke at which the port is uncovered is adjustable by rotating the barrel about its axis. This places the port at different points about the circumference of the plunger where it will register with differing heights of the helical groove. The position of the barrel is controlled by means of a toothed quadrant on the barrel and a rack that engages quadrants on all the barrels of the unit and is connected to the manual control rod or governor.

## INTERNAL-COMBUSTION ENGINE ACCESSORIES

The following are internal-combustion engine accessories in the collection not otherwise described:

## MAGNETOS, DYNAMOS, AND GENERATORS

Vincent Apple ignition dynamo, 1895. Gift of the Vincent G. Apple Laboratories. U.S.N.M. no. 310748.

Apple Gas Engine Igniter (dynamo), 1899. Gift of the Vincent G. Apple Laboratories. U.S.N.M. no. 310749.

Apple belt pulley clutch governor for regulating ignition dynamo, 1902. Gift of the Vincent G. Apple Laboratories. U.S.N.M. no. 310759.

Automobile generator, 1902. Gift of Edward T. Birdsall. U.S.N.M. no. 309623.

Flywheel magneto, 1902-03. Gift of the Vincent G. Apple Laboratories. U.S.N.M. no. 310750.

Atwater Kent high-tension ignition system. From Ransom Matthews. U.S.N.M. no. 308517.

Motsinger magneto. From Ransom Matthews. U.S.N.M. no. 307369.

Automobile generator (incomplete), 1904. Gift of the Vincent G. Apple Laboratories. U.S.N.M. no. 310752.

Automobile generator and starter combined, 1910-11, Aplco, model A-75. Gift of the Vincent G. Apple Laboratories. U.S.N.M. no. 310735.

Controller for Aplco generator-starter above. Gift of the Vincent G. Apple Laboratories. U.S.N.M. no. 310760.

Apple Electric Co. generator, model S-R.2, 1911. Gift of the Vincent G. Apple Laboratories. U.S.N.M. no. 310754.

Bosch magneto, NU-4. From Ransom Matthews. U.S.N.M. no. 308518.

Eisemann magneto (impulse starter). Gift of the Eisemann Magneto Corporation. U.S.N.M. no. 306998.

German Bosch magneto. From Ransom Matthews. USNM. no. 308519.

Splitdorf magneto (accessory on Buda engine, U.S.N.M. no. 308341), 1924. Gift of the Splitdorf Electrical Co. U.S.N.M. no. 308341.

Acme magneto, type "JS." From Ransom Matthews. U.S.N.M. no. 308116.

Bosch magneto, type 1822H. From Ransom Matthews. U.S.N.M. no. 308117.

## IGNITERS

C. C. Chamberlain "make and break" igniter, 1902. From the United States Patent Office. U.S.N.M. no. 308720.

"Make and break" igniter. From Ransom Matthews. U.S.N.M. no. 307370.

Webster Electric Co. combined rocker magneto and "make and break" igniter. Type A. From Ransom Matthews. U.S.N.M. no. 308520.

## SPARK PLUGS

The collection includes about 270 spark plugs of almost as many designs, intended principally for automotive engine use. The majority of these were received from Ransom Matthews, but they include also gifts from Daniel A. Abbott and the Splitdorf Electrical Co.

## ENGINE STARTERS

Compressed-air automobile-engine starter. Experimental model. Gift of Albert M. McMillan. U.S.N.M. no. 310828.

"Everready Automatic Engine Starter." A spring-actuated, automobile-engine starter. Gift of Van Dusen's Garage. U.S.N.M. no. 310974.

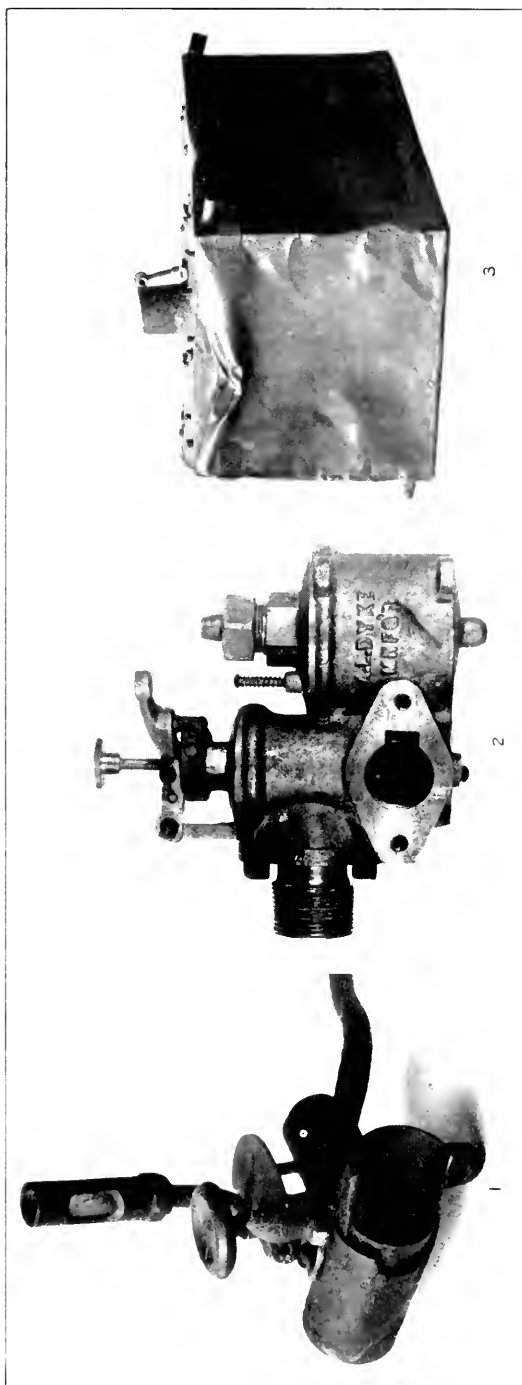

18076

18494C

## CARBURETORS

18751

1. Duryea carburetor, 1895 (U.S.N.M. no. 307199). See p. 168.
2. Dyke float-feed carburetor, 1900 (U.S.N.M. no. 308479). See p. 169.
3. Carburetor of the Manly engine, 1901 (U.S.N.M. no. 310194). See p. 171.

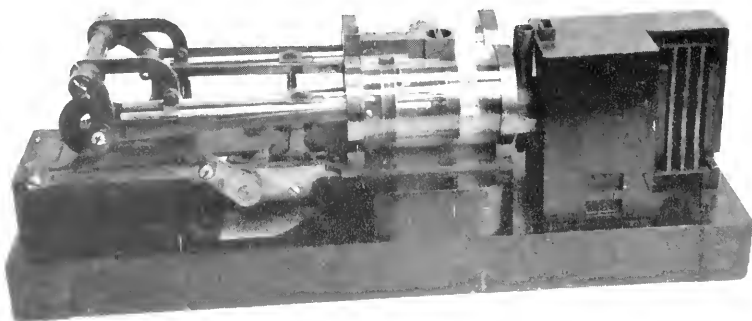

1

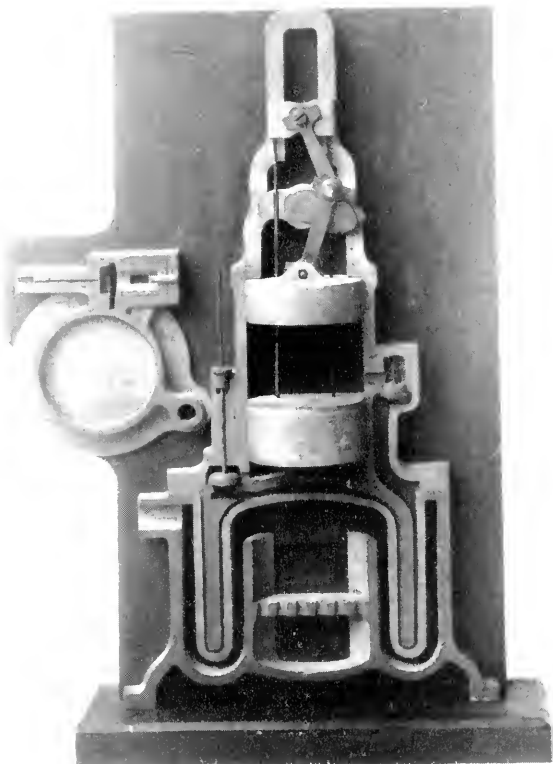

2

## HOT-AIR ENGINES

30369: 33\*134

1. Ericsson hot-air engine, 1855 (model; U.S.N.M. no. 251279). See p. 177.
2. Rider hot-air engine, 1871 (model; U.S.N.M. no. 308714). See p. 180.

## CALORIC, OR HOT-AIR, ENGINES

Turbines driven by hot air or hot gases are very old. Heron (Alexandria, 50 A. D.) described a simple hot-air reaction turbine that mysteriously animated dancing figures when an altar fire was lighted; Leonardo da Vinci (Florence, c. 1490) in his notes and sketches suggested the chimney-jack or chimney-gas turbine to utilize the hot gases from a fire to turn a roasting spit; and Guillaume Amontons (France, 1699) had an atmospheric "fire wheel" in which a heated column of air was made to drive a wheel. Some chimney jacks, toys, and the small exhaust-gas turbines used to drive superchargers for automobile and aircraft engines are probably the only present-day uses of this form of hot-air engine.

The use of heated air expanding in a cylinder against a piston to perform work is just as old. The recent development, however, dates from the British patent of Glazebrook (1797), followed by Cayley (1807) and Stirling (1826), and reached its peak about 1850-1860 following Ericsson's demonstrations of 1845-1855. These engines in their simplest form consist of two chambers filled with air or gas and connected by pipes with the opposite ends of a cylinder in which a piston reciprocates as the bodies of air in the chambers are alternately expanded and contracted by heating and cooling the chambers. This is the form of Stirling's engine. The great number of hot-air engine designs are but variations of this idea. Some compress the air before or after heating, others separate the heaters from the chambers, or discharge the air at the end of the stroke; some use screens and baffles as regenerative heaters; and others use moistened air, mixtures of steam and air, and water pistons to cut down friction and abrasion.

John Ericsson (1803-1858), who applied the screw propeller to ship propulsion and designed the U. S. S. *Monitor*, of Civil War fame, devoted a large part of his life to the development of the hot-air engine. As early as 1826 he made one at Havre, France, which he demonstrated unsuccessfully at London. In 1833 he patented a regenerator to utilize the heat in the exhausted air to preheat the new supply of cold air. He continued his experiments after coming to America in 1839 and built eight hot-air engines between 1840 and 1850. He gradually increased the size of his engines and in 1851 built the ninth (at a cost of \$17,000), which had a 2-foot stroke and two compressing cylinders of 4-foot diameter. He claimed an economy of 1 horsepower-hour from 11 ounces of coal. Two large engines working satisfactorily in factories at New York received favorable notice in the press and enabled Ericsson to obtain the support necessary to construct a ship propelled by a caloric engine with four 168-inch working cylinders and four 137-inch compressing

cylinders, each with 6-foot stroke. This vessel made a successful trip from New York to Washington, D. C., and return, only to founder in a sudden tornadolike squall in New York Bay. Ericsson then returned to the construction of smaller engines, and in the following two years he built over a thousand of them. He employed large hot-air engines to drive air compressors and distributed compressed air to drive small individual air motors on sewing machines in clothing-factory buildings. Later he developed small hot-air engines that operated over gas burners to furnish individual drives to machines and machine tools.

Between 1855 and 1875 there were about 80 different hot-air engines introduced and manufactured. Descriptions of those of Stillman (1860), Roper (1863), Baldwin (1865), Messer (1865), Wilcox (1865), Lauberan (1849), Schwartz (1864), Peters (1862), Bickford (1865), and Kritzer (1862) are given in the article "Air Engines" in the *American Mechanical Dictionary*, by Edward H. Knight, New York, 1874.

Hot-air engines in large sizes have not proved generally practical. The maximum permissible temperature is rather low, owing to lubrication difficulties and the characteristics of the common metals, with the result that the capacities of hot-air engines are extremely low for their size as compared to steam and internal combustion engines. The result has been that few engines of more than 1 horsepower have been built.

The value and popularity of hot-air engines are due to the fact that they are safe and dependable and can be operated by the least skilled of attendants. They are cheap, and their economy compares favorably with other prime movers of the same power. In farm installations, particularly for pumping water, many are still in use. At one time they were regularly installed to pump water in school and office buildings in New York City, where they were also used extensively for driving such machines as sewing machines (in clothing factories) and printing presses. Because of their dependability many were purchased by the Bureau of Lighthouses and installed to generate power in isolated houses. Since 1900 the increasing convenience of electric power has diminished the demand for hot-air engines, though they are still being built and sold.

#### LYMAN AIR ENGINE, 1854

U.S.N.M. no. 311371; original patent model; transferred from the United States Patent Office; not illustrated.

This model was submitted with the application for the patent issued to A. S. Lyman, of New York, N. Y., February 28, 1854, no. 10576.



The model represents a high-pressure hot-air engine employing two vertical transfer (called generating) cylinders and a horizontal work cylinder. The upper walls of the transfer cylinders are heated by hot water from a separate tubular boiler, while the lower walls are cooled by cold water from a separate tubular refrigerator. In operation the transfer cylinders move the air alternately from the hot to the cold walls, causing it to expand and contract. Each transfer cylinder is connected to one end of the work cylinder. They are timed somewhat as the valves of a steam engine so that the work piston moves alternately from end to end of the work cylinder as the air in each transfer cylinder expands and contracts. The work piston is connected to the crankshaft of the engine as in a steam engine. The transfer pistons are raised and lowered by plunger rods, which are racks meshing with tooth segments that are rocked by levers worked by cams on the crankshaft.

The novel features of the engine are claimed to be the use of glass, which is relatively nonconducting, in rods and tubes as the heat-storing or regenerative surfaces (see the Ericsson engine of 1855, next below); the use of large passages between the working and transfer cylinders; and use of water and oil to seal the working surfaces. Comparison with the engines of Stirling and Ericsson and suggestions for the use of liquid carbonic acid instead of air are made in the patent.

#### ERICSSON HOT-AIR ENGINE, 1855

##### PLATE 35, FIGURE 1

U.S.N.M. no. 251279; original patent model; transferred from the United States Patent Office; photograph no. 30369.

This model was filed with the application for Patent no. 13348, issued to John Ericsson, July 31, 1855.

This model shows a 2-cylinder, horizontal engine, in each cylinder of which are two pistons so connected that cold air is drawn into the cylinder, compressed, transferred to the heater, returned to the same cylinder, and then expanded. It includes the regenerator that Ericsson developed in 1833 to utilize the heat in the exhausted air to heat the new supply of air. From this design were developed most of the commercial hot-air engines used in this country.

The operation within each cylinder is the same though the pistons move always in opposite directions. When the pistons in a cylinder are at the end nearest the crank the two are close together, but when they start away from the crank the inner or transfer piston moves faster than the other (the work piston) and draws air into the cylinder between the two. When they approach the other end of the stroke they close up again and the air is compressed between them.

This air then passes through a regenerator on the way to the furnace where it is heated. The heated air returns to the cylinder and expands against the outer piston, producing motive power. After expanding in the cylinder, the hot air is exhausted to the atmosphere through the regenerator. The regenerator is a vessel containing a nest of metal tubes so arranged that the cold air going to the heater after compression passes through the tubes and is warmed by the transfer of heat from the hot exhaust air, which passes through the vessel around the tubes to the atmosphere. The two cylinders produce two power impulses per revolution.

#### ERICSSON HOT-AIR ENGINE, 1858

U.S.N.M. no. 308660; original patent model; transferred from the United States Patent Office; not illustrated.

This model was submitted with the application for Patent no. 22281, issued to John Ericsson, December 14, 1858.

This is one of the earliest hot-air engines in which cold air is drawn into, compressed, heated, and expanded within the same cylinder. This and the Ericsson engine of 1855 were the basis of design for most of the later commercial hot-air engines introduced in this country.

The model is of an engine having a very large horizontal cylinder, one end of which is occupied by the grate and flue of a furnace. In the cylinder beyond the furnace are two pistons, one of which is a transfer or pump piston, the other the working piston. The two pistons complete their outward stroke (away from the furnace) at about the same time, but the transfer piston, which is nearer the furnace, moves inward faster than the work piston and draws in a supply of cold air through a self-acting valve in the working piston. Upon the outward stroke the transfer piston closes up on the work piston and compresses the charge between the two and transfers it through valves to the space around the heater. The pressure produced by the increase of temperature during this transfer propels the working piston through the outward stroke and supplies the motive force. The return stroke is effected by means of a flywheel.

#### ERICSSON HOT-AIR ENGINE, 1860

U. S. N. M. no. 309822; original patent model; transferred from the United States Patent Office; not illustrated.

This model was submitted with the application for the patent issued to John Ericsson, October 9, 1860, no. 30306.

This engine employs two "equilibrium" pistons in connection with two cylinders and a work piston to prevent diminution of the working pressure during the stroke of the work piston.

The engine consists of two "equilibrium" cylinders placed in line end to end and a short distance apart. Within each cylinder is a hollow equilibrium piston, both connected by a long piston of relatively small diameter, called the working piston, which passes through airtight stuffing boxes in the heads of the equilibrium cylinders. The cylinders are connected to a heater and to a water-cooled chamber, through suitable valves and passages, so that both ends of one equilibrium cylinder are simultaneously in communication with the cooler. The pressure being higher in the heater than in the cooler, the effect is to force the working piston out of the cylinder in communication with the heater into the other. The equilibrium pistons move with the work piston and circulate the air in the cylinders to the heater or cooler and back to the respective cylinders, maintaining a constant pressure in each cylinder throughout the stroke. When the piston has completed its stroke the valves are reversed and a continuous motion is produced. This engine includes the regenerator or "heat deposit vessel", which was a feature of most of Ericsson's engines. In this construction it is a vessel filled with disks of wire cloth, which are heated by the hot air passing from the cylinders to the cooler and, in turn, give up this heat to the air passing from the cooler to the heater.

#### CRANE HOT-AIR ENGINE, 1865

U.S.N.M. no. 308670; original patent model; transferred from the United States Patent Office; not illustrated.

This model was submitted with the application for the Patent no. 46084, issued to Moses G. Crane, of Newton, Mass., January 31, 1865.

This engine consists of one vertical work cylinder and two pump or air-transfer cylinders connected to two furnaces. In operation two separate quantities of air are used repeatedly. One quantity of air is circulated between one furnace and the upper end of the work cylinder by one of the air pumps, while the other charge of air is supplied from the other furnace to the lower end of the work cylinder. In each case the air is heated in the furnace, transferred to the work cylinder, allowed to expand doing work against the piston, and is then returned to the furnace by the pump, to be reheated. The pump pistons and valves are actuated by slotted bell cranks on the ends of the engine crankshaft.

## RIDER HOT-AIR ENGINE, 1871

## PLATE 35, FIGURE 2

U.S.N.M. no. 308714, original patent model; transferred from the United States Patent Office; photograph no. 39028.

This model was submitted with the application for Patent no. 111088, issued to Alexander K. Rider, of New York, N. Y., January 17, 1871, reissued August 24, 1880, no 9353.

This engine consists of a power piston and a transfer piston so connected with valves and passages that the cold air is received and compressed in the same cylinder in which the hot air performs its work. Its simple construction is an improvement on the John Ericsson hot-air engines of 1855-1858.

A vertical cylinder contains two independent pistons with suitable valves that permit cold air to be drawn into the cylinder, compressed, circulated between heated furnace walls, expanded under a power piston and then exhausted. The upper piston is equipped with two spring-closed intake valves that open on the upstroke of the piston allowing air to fill the cylinder between the upper and lower pistons. This air is then compressed on the downstroke of the upper piston until the pressure is sufficient to open a valve in a passage leading to a heated space surrounding the furnace. The heated and compressed air then passes into the cylinder below the lower piston where it expands, performing work against the piston.

## OTTO CALORIC ENGINE, 1875

U.S.N.M. no. 308684; original patent model; transferred from the United States Patent Office; not illustrated.

This wooden model (incomplete) was submitted with the application for Patent no. 145123, issued to Nicolaus Otto, of Deutz, Germany, December 2, 1873.

In this engine hot gases were admitted to the cylinder above the piston during one-third of the downstroke. The remainder of the stroke dilated the confined gases and rendered a great portion of the heat of the gases latent. The remaining portion of the heat was absorbed by the water-cooled cylinder surfaces and the piston was returned by the pressure of the atmosphere. The piston is so connected to the crankshaft that the upward stroke was much slower than the downward stroke to permit the heat that was rendered latent on the downstroke and that was liberated during the upstroke to be absorbed by the cooled surfaces of the cylinder.

## ERICSSON HOT-AIR ENGINE, 1880

U.S.N.M. no. 251286; original patent model; transferred from the United States Patent Office; not illustrated.

This model was submitted with the application for Patent no. 226052, issued to John Ericsson, of New York, N. Y., March 30, 1880.

In this engine a charge of air is repeatedly heated and cooled as it is transferred from end to end of a single cylinder, one end of which is surrounded by a furnace, the other end of which is water-jacketed. The air expands and contracts beneath a work piston that travels through a short stroke near the upper end of the cylinder. The air is displaced from end to end of the cylinder at the proper time by a large loosely fitting transfer piston independently connected to the crankshaft.

This model is similar in design to the pumping engine of 1906, described below.

## ERICSSON HOT-AIR ENGINE, c. 1880

U.S.N.M. no. 308142; original demonstrating model; gift of the American Society of Civil Engineers; not illustrated.

This is a small demonstrating engine of the type patented by John Ericsson on March 30, 1880 (see above).

This engine is equipped with a gas-heated furnace and has metal radiating fins at the upper end of the cylinder in place of the usual water jacket.

A brass plate on the engine is inscribed: "To Mrs. E. W. Stoughton from her friend John Ericsson."

## ERICSSON PUMPING ENGINE, 1906

## PLATE 36

U.S.N.M. no. 309533; original; gift of Jonathan Hagan; photograph no. 3902S-A.

This is an 8-inch,  $\frac{1}{2}$ -horsepower (120 revolutions per minute) engine of the type patented by John Ericsson on March 30, 1880 (see above). It was built by the Rider-Ericsson Engine Co. in 1906 and was used to operate a deep-well pump on the farm of the donor until 1927. Wood was used for fuel. The engine is about 66 inches high and has a 30-inch flywheel.

The engine has a long slim vertical cylinder closed at the lower end, with a short closely fitting work piston near its upper end and a large loosely fitting transfer piston below the work piston. The lower end of the cylinder is surrounded by a furnace; the upper end is cooled by a water jacket. The work piston and transfer piston move

independently of each other. The quantity of air contained within the cylinder is used repeatedly.

At the beginning of the cycle of operation the work piston is at the bottom of its stroke, and the transfer piston is near the top of its stroke, having displaced the air to the bottom of the cylinder. The air absorbs heat from the furnace walls and expands, performing work as it forces the work piston to the top of its stroke. The transfer piston in the meantime travels to the bottom of the cylinder and displaces the air to the top where it gives up heat to the water-jacketed surface and contracts. Atmospheric pressure then forces the work piston down to the bottom of its stroke as the transfer piston rises and displaces the air to the heated lower part of the cylinder, completing the cycle.

### AIR-AND-STEAM ("AERATOR") ENGINES

A class of engines known as aerosteam engines, using the expansive power of a mixture of heated air and steam and supposed to attain the better features of both air and steam engines, engaged the attention of many inventors during the nineteenth century. Oliver Evans (c. 1790) suggested a "volcanic engine" in which the gases from the furnace were mixed with the steam going to the engine. The hot-air engine of Glazebrook, mentioned above, used moistened air to reduce abrasion of the sliding surfaces. Bennet (1838), William Storm (1851-5), Washburn (1865), and Tarr (1867) made aerosteam engines of various types.

#### WHITING AEROSTEAM ENGINE, 1879

U.S.N.M. no. 251285; original patent model; transferred from the United States Patent Office; not illustrated.

This model was submitted with its application for Patent no. 217758, issued to James M. Whiting, of Providence, R. I., July 22, 1879.

This is an example of combined air and steam engines, many designs of which have been proposed and built. In this engine the use of steam is intended to reduce the bulk of the heated air required to operate an engine of a given capacity and consequently reduce the size of the engine.

The model shows a vertical fire-tube steam boiler of ordinary construction above the tubes of which is placed a hollow drum that is heated by the hot gases from the boiler. There is also a small steam pump and a vertical high-speed steam engine of the slide-valve type. Steam from the boiler is mixed with the heated air in the upper drum, and the mixture of heated air and steam is led directly to the engine and expanded. The air pump supplies air to the heated drum.

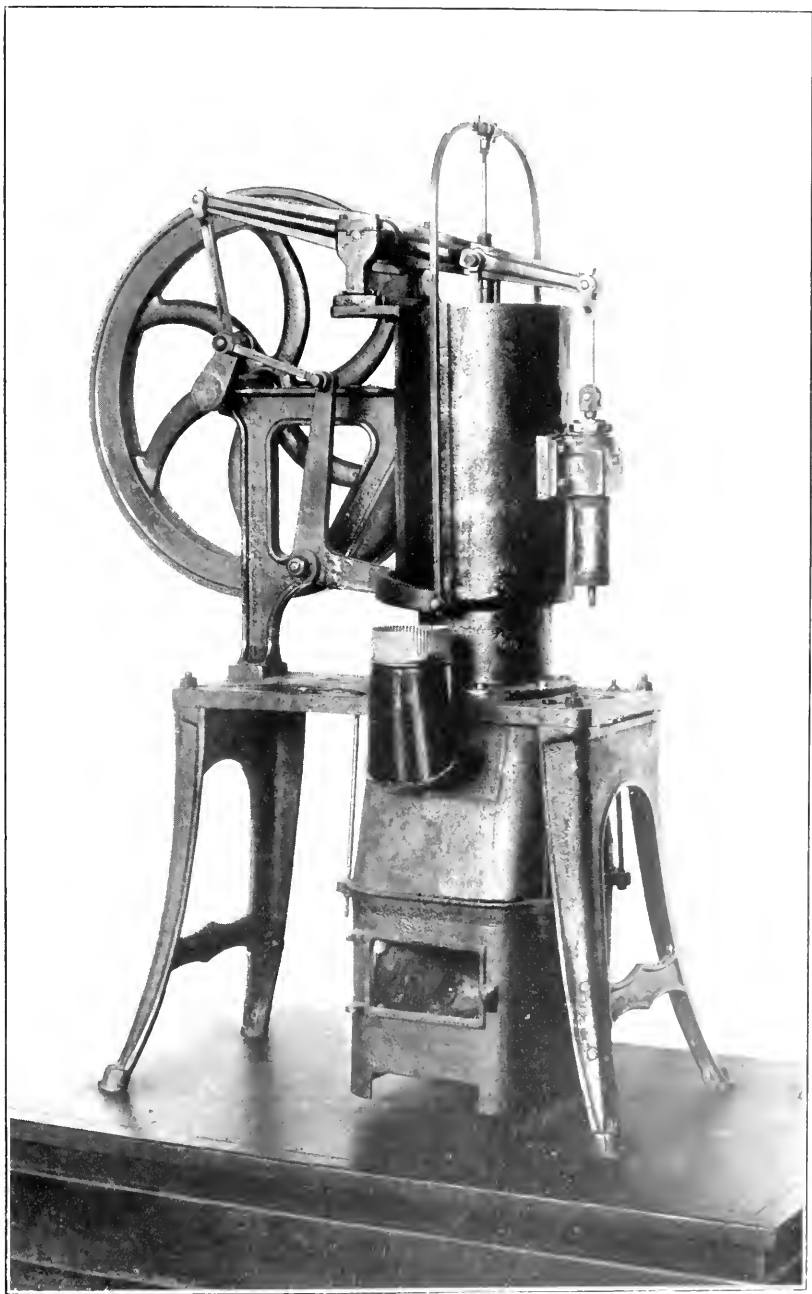

ERICSSON HOT-AIR PUMPING ENGINE. 1905

U.S.N.M. no. 309533. See p. 181.

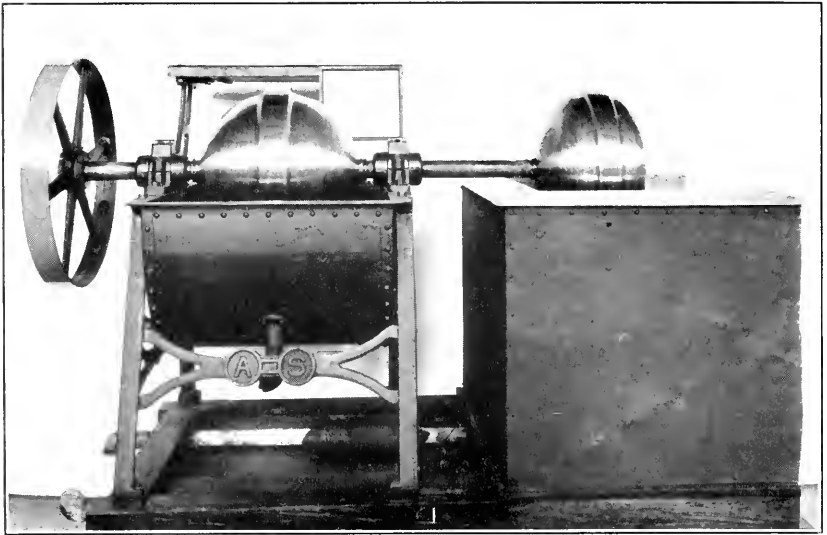

32583A

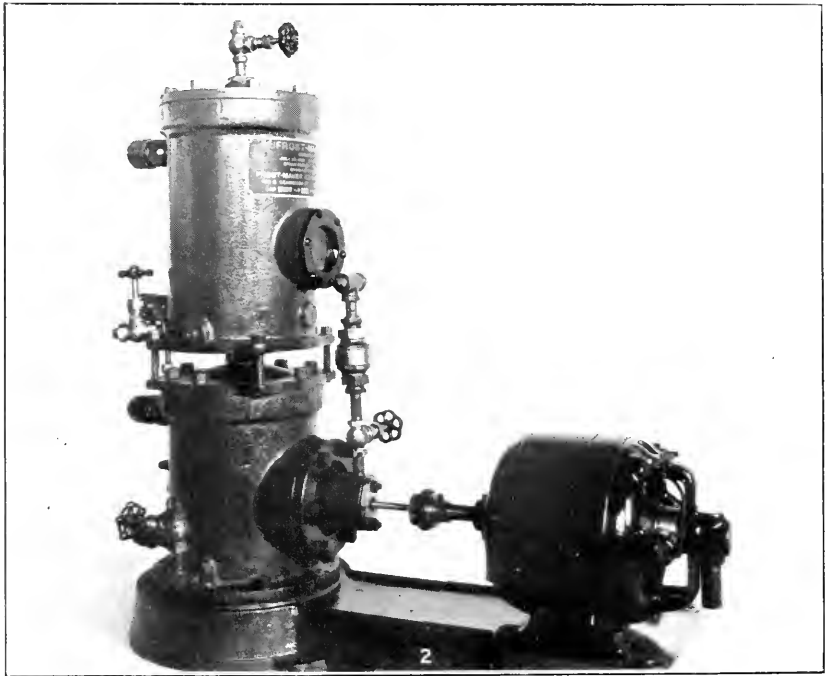

33065A

REFRIGERATING MACHINES.

1. Audiffren refrigerating machine, 1913 (U.S.N.M. no. 311060). See p. 183.
2. Frost-Maker domestic refrigerating unit, c. 1914 (U.S.N.M. no. 311358). See p. 184.



## REFRIGERATING MACHINES

## GORRIE ICE MACHINE, 1851

U.S.N.M. no. 285397; original patent model; transferred from the United States Patent Office; not illustrated.

This model was submitted with the application for the patent issued to John Gorrie, of New Orleans, La., May 6, 1851, no. 8080.

The model represents the first patent for a mechanical refrigerating or ice-making machine issued by the United States Patent Office. It is of additional interest in that the inventor successfully employed ice and cooled air in the treatment of tropical diseases, and for his work in this connection and the invention of the ice machine he is honored by a statue placed in Statuary Hall in the United States Capitol by the State of Florida.

The machine was designed "to convert water into ice artificially by absorbing its heat of liquefaction with expanding air." The model, made largely of wood, is diagrammatic only. It consists of a double-acting compressor cylinder and a double-acting work or expanding cylinder, the pistons of which are connected to a crankshaft designed to be turned by a steam engine or other prime mover not shown. The air compressed in the compressor cylinder was cooled by the immersion of the cylinder in cold water, the injection of cold water into the cylinder and by passing the air through a worm immersed in a tub of water. The compressed air was led to a receiver and thence to the expanding cylinder, which was surrounded by a cistern of "uncongealable" liquid. The expansion of air absorbed heat from the liquid, which was circulated to a worm in a freezing tub where the liquid absorbed heat from water in the tub causing it to freeze.

## AUDIFFREN REFRIGERATING MACHINE, 1913

## PLATE 37, FIGURE 1

U.S.N.M. no. 311060; transferred from the United States Department of Agriculture; photograph no. 32583A.

The refrigerating machine invented by the Frenchman Abbé Audiffren about 1904 is interesting as the first entirely self-contained and sealed machine. It was introduced for manufacture in the United States about 1911, and this one was purchased by the United States Bureau of Plant Industry in 1913.

The unit resembles a large dumbbell in appearance, with two large balls on a hollow shaft with which they are turned by a belt-pulley on the end of the shaft. One ball contains the compressor, which hangs, cylinder down, on a crankshaft, which turns with the unit. This ball turns in a tank of circulating cooling water. The compressor is connected through the hollow shaft to the other ball, which is the

expansion or cooling chamber. This ball in the original installation turned in a tank of brine, which was chilled thereby and circulated where needed.

These machines were charged with the necessary refrigerant ( $\text{SO}_2$ ) and lubricating oil at the factory and usually required little attention during years of service. This machine operated for 22 years with the same oil and refrigerant and only one adjustment in that period.

#### FROST-MAKER REFRIGERATING UNIT, c. 1914

##### PLATE 37, FIGURE 2

U.S.N.M. no. 311358; original; gift of W. W. Stuart, photograph no. 33065A.

This is a small, direct-drive, water-cooled, gear-pump type of domestic refrigerating unit. It used  $\text{SO}_2$  as a refrigerant and had a rated capacity equivalent to the heat absorbed by the melting of 300 pounds of ice per day (I. M. E.). It is of the type of machine variously marketed as the Frost-maker, Isko, and Jack Frost during the early period of domestic refrigerating machines.

In the machine a condenser chamber enclosing the condenser coil and a reservoir for liquid sulphur dioxide is supported upon a cylinder containing the compressor and oil-cooling coil. These are bolted to a base with an electric motor directly connected to the compressor shaft. The compressor is a herringbone gear pump. The compressed gas entered the top of the condenser chamber and passed over the nest of coils through which the cooling water circulated. The cooled liquid sulphur dioxide collected at the bottom of the chamber from which it discharged to the refrigerator.

The name plate reads: "Frost-Maker, Patented July 22, 1913, Feb. 10, 1914. Frost-maker Ice Machine Co., 140 S. Dearborn St. Chicago, Ill. Capacity 300#, hp.  $\frac{1}{2}$ , serial no. 156."

#### DOMESTIC ELECTRIC REFRIGERATING UNIT, c. 1918

U.S.N.M. no. 310729; original; gift of Winslow-Baker-Meyering Corporation; not illustrated.

The essential elements of the automatic electric reciprocating compressor type of refrigerating unit for cooling household refrigerators are combined in this old machine. It consists of a small, motor-driven, 1-cylinder, air-cooled compressor, mounted inside of the coils of a so-called "cage" condenser, which is a continuous, rectangular coil of copper tubing. Compressor cylinder and condenser are cooled by a stream of air from the fanlike spokes of the compressor fly-wheel-pulley. The cooling coils are contained in a zinc brine chamber provided with openings to take ice freezing trays of muffin-pan design. The operation of the motor is controlled by a thermostat switch

designed to hold the temperature of the brine at an approximately even temperature.

In operation a refrigerant gas,  $\text{SO}_2$ , is compressed in the cylinder of the compressor and delivered to the condenser, where it is cooled to approximately the temperature of the air that is blown over the condenser. The compressed and cooled  $\text{SO}_2$  then passes through a reducing valve, which permits it to expand to a low pressure in the cooling coils in the brine tank. As it is a physical property of a gas that in expanding it absorbs heat, the expanding  $\text{SO}_2$  takes heat from the surrounding brine and thus lowers the temperature of the chamber. The  $\text{SO}_2$  then returns to the compressor where it is again compressed and the process continues. When the brine is cold enough the thermostat switch turns off the motor until the temperature rises a few degrees when it starts the motor again.

The unit is said to be the one that Edmund J. Copeland, then chief engineer of the Kelvinator Corporation, believed to be the first one of his designs to approach successful, automatic, dependable operation. It contains parts taken from earlier machines and now includes parts of later dates.

## SELECTED BIBLIOGRAPHY

The bibliography of the fields included in the mechanical collection of the Museum is large. A few of the more useful publications are listed here in groups corresponding to subdivisions of the catalog. In each list the leading items are placed first because they are recent or current works, are generally available, present broader views of subjects treated, and in most instances contain bibliographies. The use of these will give the student the best start in developing the details and exhausting the sources of the various divisions. It is suggested that reference to the standard encyclopedias, particularly the older editions in which bibliographies or sources were included in the articles, will in many cases give the beginner his most efficient approach. The lists given here are not exhaustive, and many fine works will not be found.

### GENERAL HISTORIES AND BIBLIOGRAPHIES OF INVENTION, TECHNOLOGY, AND ENGINEERING

1. USHER, ABBOTT PAYSON: A history of mechanical inventions. McGraw-Hill Book Co., New York, 1929. Bibliography, pp. 373-382.
2. NEUBERGER, ALBERT: Technical arts and sciences of the ancients (translated by Henry L. Brose). Macmillan Co., New York, 1930.
3. BISHOP, CARL WHITING, in collaboration with CHARLES GREELY ABBOT and ALEŠ HEDLIČKA: Man from the farthest past. Smithsonian Scientific Series, vol. 7. Smithsonian Scientific Series, Inc., New York, 1930.
4. KAEMPFERT, WALDEMAR: A popular history of American invention, 2 vols. Charles Scribner's Sons, New York, 1924.
5. NEWCOMEN SOCIETY for the Study of the History of Engineering and Technology: Transactions, vols. 1-15 (annual). London, 1921-1935. Annual analytical bibliography of the history of engineering and technology.
6. SHAW, RALPH R.: Engineering books available in America prior to 1830. Bull. New York Public Library, Jan.-May 1933.
7. HODGINS, E., and F. ALEXANDER MAGOUN: Behemoth: The story of power. Doubleday, Doran & Co., Garden City, N. Y., 1932.
8. VOWLES, HUGH P. and MARGARET W.: The quest for power from prehistoric times to the present day. Chapman & Hall, London, 1931.
9. BYRN, EDWARD W.: The progress of invention in the nineteenth century. Munn & Co., New York, 1900. A review of developments based on United States patents granted.
10. MASON, OTIS TUFTON: The origins of invention. Charles Scribner's Sons, New York, 1905.
11. BECKMANN, JOHN: A history of inventions and discoveries (translated by William Johnston), ed. 3, 4 vols. London, 1817.
12. KNIGHT, EDWARD H.: American mechanical dictionary, 3 vols. J. B. Ford & Co., New York, 1874.

13. AMERICAN SOCIETY OF MECHANICAL ENGINEERS: The engineering index. An index of current engineering periodicals from 1884 to date. Many articles on engineering history have appeared in the periodicals indexed, and the notices may be quickly located under subject headings. Now an annual. Vol. 1 (1884-1891) was published by the Association of Engineering Societies; vols. 2-4 (1892-1905) by the Engineering Magazine Co.
14. REES, ABRAHAM: The cyclopedia, or universal dictionary of arts, sciences, and literature, 30 vols. London, 1819.
15. EWBank, THOMAS: Descriptive and historical account of hydraulic and other machines for raising water, ancient and modern, with observations on the mechanic arts, and the development of the steam engine, ed. 16. New York, 1870.
16. SOTHERAN, HENRY, LTD.: Bibliotheca chemico-mathematica. Catalogue of works . . . on exact and applied science, with subject index, 2 vols. London, 1921; 1st suppl., 1932.

## ANIMAL POWER

*Refer to Items 1, 7, 8, and 9 above.*

17. BENNETT, R., and J. ELTON: History of corn milling, 4 vols. London, 1898-1904. Hand, animal, wind, and water mills.
18. JENKINS, RHYS: The collected papers of Rhys Jenkins. Newcomen Society, Cambridge, 1936. Note on "Elizabethan Human-power Engine," pp. 1-8.
19. MARKS, LIONEL SIMEON, editor: Mechanical engineers' handbook, ed. 1. McGraw-Hill Book Co., New York, 1916. Article, "Muscular Energy of Men and Animals," pp. 863-864. Many of the engineering handbooks have historical notes dispersed through their texts; others are old enough to indicate changes in practice over long periods through their various editions. Trautwine, Clark, and Kent are editors of handbooks known by their names that might prove helpful.
20. BECKMANN, JOHN: A history of inventions and discoveries (translated by William Johnston), ed. 3, 4 vols. London, 1817. Article, "Corn-mills," vol. 1, pp. 227-272.

## WINDMILLS

*Refer to Items 1, 17, and 20 above.*

21. WAILES, REX: Windmills of eastern Long Island. Trans. Newcomen Soc., vol. 15, pp. 117-151, 1934-35. Short bibliography.
22. WOLFF, ALFRED R: The windmill as a prime mover. John Wiley & Sons, New York, 1885.
23. TAYLOR, A. HOYT: Development, storage and utilization of wind power. University of South Dakota, 1912.
24. PERRY, THOMAS O.: Experiments with windmills. U. S. Geol. Surv. Irrigation Paper no. 20, 1899. Other Geological Survey Irrigation Papers containing interesting notes on windmills are nos. 29, 41, and 42.
25. CARLILL, JAMES: Wind power. Smithsonian Inst. Ann. Rept. for 1918, pp. 147-156. Washington, 1920. Reprinted from the Edinburgh Review, Oct. 1918.
26. SMEATON, JOHN: An experimental inquiry concerning the natural powers of water and wind. London, 1760.

## WATER WHEELS AND TURBINES

*Refer to Items 1, 17, and 20 above.*

27. MEAD, DANIEL WEBSTER: Water power engineering, ed. 2. McGraw-Hill Book Co., New York, 1920. Historical introduction, pp. 1-23, illus.; bibliography of water-wheel and water-power development.
28. AMERICAN SOCIETY OF MECHANICAL ENGINEERS: Mechanical Engineering, vol. 52, no. 4, pp. 386-400, Apr. 1930. Articles, "The Pelton Wheel," by E. M. Breed; "American Hydraulic Turbines," by W. M. White; "Early Hydraulic Turbine History," by E. D. Adams; "Hydroelectric Engineering," by L. F. Harza.
29. FRIZELL, J. P.: The old-time water wheels of America. Trans. Amer. Soc. Civil Eng., vol. 28, pp. 237-249, illus., 1893.
30. FRANKLIN INSTITUTE: Journal. Papers on early turbine development appear in vol. 20, 1850; vol. 22, 1851 (Geyelin); vol. 4, 1842 (Morris); vol. 6, 1843 (Morris); vol. 8, 1844 (Whitelaw).
31. GLYNN, JOSEPH: Power of water, ed. 6. London, 1879. (Ed. 1, 1852; ed. 2, 1866.) Historical introduction, pp. 1-10, illus.
32. FRANCIS, JAMES B.: Lowell hydraulic experiments. Little, Brown & Co., Boston, 1855.
33. TYLER, W. W.: The evolution of the American type of water wheel. Trans. Western Soc. Eng., vol. 3, pp. 879-901, 1898.
34. RICE, A. C.: Notes on the history of turbine development in America. Engineering News, vol. 48, pp. 208-209, 1902.
35. ADAMS, EDWARD DEAN: Niagara power, history of the Niagara Falls Power Company, 1886-1918, 2 vols. Niagara Falls, N. Y., 1927.

## THE STEAM ENGINE

*Refer to items 1, 7, and 8 above.*

36. DICKINSON, H. W., and RHYS JENKINS: James Watt and the steam engine. Watt Centenary Memorial Volume, 1927.
37. JENKINS, RHYS: Savery, Newcomen, and the early history of the steam engine. Trans. Newcomen Soc., vol. 3, pp. 96-118, 1922-23; vol. 4, pp. 113-133, 1923-24.
38. STUART, ROBERT: Historical and descriptive anecdotes of steam engines and of their inventors and improvers, 2 vols. London, 1829.
39. THURSTON, ROBERT H.: A history of the growth of the steam engine. D. Appleton & Co., New York, 1891. This extends the earlier histories through the "period of refinement" of the steam engine.
40. THURSTON, ROBERT H.: A manual of the steam-engine, 2 vols. John Wiley & Sons, New York, 1891.
41. RANKINE, WILLIAM J. M.: Manual of the steam engine and other prime movers, ed. 14. London, 1897.
42. STANWOOD, JAMES B.: Recent American steam engine practice. Cassier's Mag., vol. 18, no. 6, pp. 488-502, Oct. 1900.
43. SMITH, EDGAR C.: A short history of naval and marine engineering. Cambridge University Press, London, 1938.

## THE STEAM TURBINE

44. STODOLA, A.: Steam turbines (translated by Louis C. Lowenstein). Historical Rev., art. 66, pp. 302-307, 1905.

45. **SOSNOWSKI, K.**: Roues et turbines à vapeur. Series of articles in Bull. Soc. d'Encouragement l'Industrie Nat., ser. 5, vol. 1: Aug. 1896, pp. 1153-1168; Sept. 1896, pp. 1227-1261; Oct. 1896, pp. 1319-1357; Nov. 1896, pp. 1491-1525. Paris. A profusely illustrated review of the turbine history from Heron to 1896, taken largely from patent records. The last article includes a detailed account of De Laval turbines and De Laval turbine pump, separator, and generator units.
46. **KELLER, EMIL, and FRANCIS HODGKINSON**: The steam turbine in the United States, Part I—Developments by Westinghouse Machine Company. Mechanical Engineering, vol. 58, no. 11, pp. 683-696, Nov. 1936.
47. **CHRISTIE, ALEXANDER GRAHAM**: The steam turbine in the United States, Part II—Early Allis-Chalmers steam turbines. Mechanical Engineering, vol. 59, no. 2, pp. 71-82, Feb. 1937.
48. **ROBINSON, ERNEST L.**: The steam turbine in the United States, Part III—Developments by the General Electric Company. Mechanical Engineering, vol. 59, no. 4, pp. 239-256, Apr. 1937.

## STEAM-ENGINE VALVES AND GEARS

*Refer to Items 38 and 39 above.*

49. **MONE, F.**: Treatise on the steam engine. New York, 1852. Describes early cut-off valves and valve gears.
50. **PEABODY, CECIL H.**: Valve-gears for steam engines. John Wiley & Sons, New York, 1892-1900.
51. **ROSE, JOSHUA**: Modern steam engines. Henry Carey Baird & Co., Philadelphia, 1887.
52. **ZEUNER, GUSTAV ANTON**: Treatise on valve-gears, ed. 3, 1869.

## INVENTIONS OF G. H. CORLISS

*Refer to Item 39 above.*

53. **AMERICAN HISTORICAL SOCIETY**: The life and work of George H. Corliss. New York, 1930.
54. **SHILLITTO, FRANK W., Jr.**: Handbook of Corliss steam engines, ed. 3. Bridgeport, 1902.

## STEAM-ENGINE INDICATORS

55. **PRAY, THOMAS, JR.**: Twenty years with the indicator. New York, 1896.
56. **MILLER, EDWARD F.**: Steam engine indicator. Crosby Steam Gage & Valve Co., Boston, 1917-1921.

## STEAM BOILERS

*Refer to Items 1 and 38 above.*

57. **BABCOCK & WILCOX Co.**: Steam, ed. 36. New York, 1931.
58. **ARMSTRONG, R.**: An essay on the boilers of steam engines. London, 1839.
59. **PEABODY, C. H., and E. F. MILLER**: Steam boilers. John Wiley & Sons, New York, 1897-1902.
60. **BABCOCK & WILCOX Co.**: Fifty years of steam. New York, 1931.
61. **THURSTON, ROBERT H.**: A manual of steam boilers, their designs, construction and operation, ed. 7. John Wiley & Sons, New York, 1901.
62. **JENKINS, RHYS**: The collected papers of Rhys Jenkins. Newcomen Society, Cambridge, 1936. Note on early "boiler-making," pp. 126-130.
63. **PERKINS, JACOB**: On the explosion of steam boilers: On the economy of using highly elastic steam. London, c. 1840.

## INTERNAL COMBUSTION ENGINES AND ACCESSORIES

64. DONKIN, BRYAN: Gas, oil and air engines, ed. 2. London, 1896. Contains detailed history, with tables of trials, results, indicator diagrams, and other details of performance.
65. CLERK, DUGALD: The gas, petrol, and oil engine. London, 1909-10.
66. MORRISON, LACEY H.: Diesel engines. McGraw-Hill Book Co., New York, 1923.
67. STREETER, R. L., and L. C. LICHTY: Internal-combustion engines: Theory, analysis and design, ed. 4. McGraw-Hill Book Co., New York, 1933.
68. BUTLER, EDWARD: Carburetors, vaporizers and distributing valves. London, 1909.
69. ALLEN, JAMES TITUS: Digest of United States patents: Air, caloric, gas and oil engines, 1789-1906, 5 vols. Washington, 1907.
70. ALLEN, JAMES TITUS: Digest of United States patents for automobile construction, 3 vols. and supplements. Washington, 1900-1911.
71. HISCOX, G. D.: Gas, gasoline and oil vapor engines. N. W. Henley & Co., New York, 1897. Contains list of United States patents, 1875-1896, inclusive, by years.
72. MORRISON, L. H.: Thirty years of the Diesel engine. Power, vol. 69, no. 12, pp. 468-469, Mar. 19, 1929.
73. ROSBLOOM, JULIUS: Diesel handbook. Diesel Engineering Institute, Jersey City, 1937.
74. DIESEL PUBLICATIONS, INC.: Diesel Power and Diesel Transp., vol. 16, no. 5, May 1938. Anniversary number, 40 years of the American Diesel.



## INDEX

---

- Abbott, D. A., donor, 174.  
 Acme magneto, 174.  
 Adams, I., riding cut-off valve, 62.  
 Aeolipile, 25, 26, 59, 114.  
 Aerator engines, 182.  
 Aerometer, windmill, 11.  
 Aerosteam engines: Bennet, 1838;  
   Storm, 1851-55; Tarr, 1867, Wash-  
   burn, 1865; Whiting, 1879, 182.  
 Aetna, steamboat, 1818, 35; boilers of,  
 105.  
 Agriculture, U. S. Department of, donor,  
 183.  
 Air-and-steam engines, 182.  
 Air compressor, Johnston, 1879, 143.  
 Air engines, Kimman, 102. (*See also*  
   Hot-air engines.)  
 Air pumps. (*See* Condenser air pumps.)  
 Alexandria & Orange Railroad, shop en-  
   gine, 1864, 48.  
 Allaire, J. F., 35-37, 39.  
 Allaire Works, 36.  
 Allen, C. B., injector, 1902, 132.  
 Allen, Horatio, valve gears, 1841, 62;  
   1842, 63; 1848, 63; 1855, 64; 1857, 65.  
 Allen, T. S., 4.  
 Allen, Z., valve gear, 60.  
 American Fire Engine Company's  
   "Metropolitan," 1906, 141.  
 American Injector Co., assignee, 131.  
 American Institute, N. Y., exhibition,  
 146.  
 American-La France and Foamite Cor-  
   poration, donor, 141.  
 American Ship Windlass Co., 4.  
 American Society of Civil Engineers,  
 donor, 142, 181.  
 American Steam Gauge Co., 93.  
 American Tobacco Co., boiler, 1928, 115.  
 Amontons, G., fire wheel, 175.  
 Amoskeag fire engine, c. 1885, 141; fire-  
   engine pump, 141.  
 Anders, R., and L. C. Errani, oil engine,  
 1873, 150, 167.  
 Anderson woden boilers, 108.  
 Animal power, 4-7; bibliography, 187.  
 Antifriction bearings and alloys, 103.  
 Apple, V. G., dynamo pulley governor,  
   flywheel magneto, generators, gener-  
   ator-starter and controller for, igniter  
   (dynamo), ignition dynamo, 174.  
 Appleton Co., turbine for, 17.  
 Archimedes, 2.  
 Archytas, 2.  
 Aristotle, 2.  
 Arnold, Gov. Benedict, 10.  
 Ashworth, J., belt splicing, 102.  
 Atkins, J., hydraulic turbine, 18, 19.  
 Atkinson, J., engine, 1884, 145; 1889-90,  
   157.  
 Atmosphere, weight of, model, 1654, 26.  
 Atmospheric engines. (*See under* In-  
   ternal combustion engines, Free pis-  
   ton, and Steam engines, atmospheric.)  
 Atwater Kent ignition system, 174.  
 Audiffren, A., refrigerating machine,  
 1913, 183.  
 Autocar, carburetor, 1901, 170; engine,  
 163, 165.  
 Autocar Co., donor, 163, 170.  
 Automatic Boiler & Engine Co., as-  
   signee, 113.  
 Automobile engines, 147, 163, 165;  
   steam, 54, 55; igniters, q. v., starters,  
   q. v.  
 Automotive vehicles, first, 144.  
 Babcock, G. H., and S. Wilcox, Jr.,  
   steam boilers, 1867, 115; 1876, 115;  
   steam generator, 1876, 116; valve gear  
   (steam engine), 1866, 67. (*See also*  
   Babcock & Wilcox Co.)  
 Babcock, H. C., belt lacing, 102.  
 Babcock, J., marine boiler, 115.  
 Babcock & Wilcox Co., boiler headers,  
   1867-1929, 117-118; Centennial boiler  
   (model), 1876, 116-118; donor, 114-  
   118, 124; double-deck, inclined-tube  
   boiler (model), 1929, 117; drum type  
   boiler (model), 929, 117; "Evolution  
   of the Steam Boiler" (drawings),  
   114; oil burner, 1929, 124.  
 Bailey furnace walls, 117.  
 Bailey-Tenney burners, 117.  
 Bain, R. E. M., donor, 51.  
 Bain, Mrs. R. E. M., donor, 59.  
 Baker, J. G., steam engine, 1878, 51.  
 Baker, W. H., and H. R. Worthington,  
   water-level gauge, 1847, 119; and S. H.  
   Baldwin, rotary engine, 1839, 55.  
 Baldwin hot-air engine, 176.  
 Baldwin, M., and D. Clark, feed-water  
   heater, 139.  
 Baldwin, S. H., and W. H. Baker, rotary  
   steam engine, 1839, 55.  
 Ball Engine Co., donor, 91, 92.  
 Balzer, S. M., aerodrome engine, 159;  
   automobile engine, 165.  
 Bangs, Isaac, 32.  
 Barber, J., gas engine, 1791, 143.

- Barker, Dr., turbine, 15.  
 Barlow, J., marine boiler, 115.  
 Barnett, W., gas engine, 1838, 144.  
 Barsanti and Mattenci gas engine, 144.  
 Bartlett, L. D., valve gear, 1867, 68.  
 Baverey, M., carburetors, 1906-1908, 167, 171.  
 Bearings. (*See* Shaft bearings.)  
 Beau de Rochas, engine cycle, 145.  
 Beck gas engine, 146.  
 Beighton, H., engraver, Newcomen engine, 28.  
 Bell, P. F., and H. Otto, slide valve, 1883, 70.  
 Belt driving accessories, 102-103.  
 Bennet, aerosteam engine, 182.  
 Benson, B. S., steam engine, 1847, 44.  
 Benson, J., windmill, 14.  
 Benz carburetor, 166.  
 Bevil, H. H., windmill, 13.  
 Bickford hot-air engine, 176.  
 Binney, C. R., and H. A. Stuart (Hornsby-Akroyd engine), 157.  
 Birdsall, E. T., donor, 174.  
 Birmingham (England) Canal Co., 31.  
 Bisschop gas engine, 145.  
 Blackford, C. M., donor, 43.  
 Blackford, W. M., 1829, 43.  
 Blakey, J., boiler, 107, 114.  
 Bodemer, J. G., governor, 1876, 84.  
 Boiler accessories, steam, 119-139; injectors, 125-133; pumps, 133-138.  
 Boiler headers, 1867-1929, 117-118.  
 Boiler pumps. (*See* Injectors, Steam pumps.)  
 Boilers, marine steam: U. S. S. *Alert*, 1899, 115; Babcock, 1826, 115; Babcock & Wilcox, 1867, 1876, 115; Barlow, 1793, 115; Blasco de Garay, 1543, 115; S. S. *Beardsley*, 1901, 115; U. S. S. *California*, 1925, 115; S. S. *City of Flint*, 115; S. S. *City of Saginaw*, 1929, 115; Corliss, 1862, 79; S. S. *Empire City*, 1897, 115; Fitch and Voight, 1787, 115; Great Lakes, 1897-1929, 115; U. S. S. *Maryland*, 1912, 115, 118; U. S. S. *Munroe*, 1876, 115; U. S. S. *Oklahoma*, 1912, 115, 118; Papin, D., 1707, 115; Shipping Board type 115; Stevens, 1804, 109, 115.  
 Boilers, steam: American Tobacco Co., 1928, 115; Automatic Boiler & Engine Co., assignee, 113; Babcock and Wilcox, 1867, 115; Babcock & Wilcox Co., q. v.; 1872, 114; 1876, 115, 116; 1881, 114; bibliography, 188-189; Blakey, 1766, 107, 114; Bousfield and Howard, 1871, 111; Cape Fear Fibre Co., 1872, 114; Corliss, 1879, 80; Crawford furnace, 1850, 110; drums for manufacture of, 114; Erie City Iron Works, 1928, 114; Edison Electric Illuminating Co., 1927, 114; Edison Illuminating Co., 1881, 114; Erie City, 1928, 114; Evans, 105-106; Eve, 1825, 107, 114; "Evolution of" (drawings), 114-115; Fairbairn, 1844, 106; fire-tube, 106-107; Firmenich and Stiker, 1875, 112; Griffith, 1821, 107; Gurney, 1826, 114; headers, 1867-1929, 117-118; 1879, 80; Heron, 103, 114; Howard and Bousfield, 1871, 111; Kelly, 113; Lakeside Station, Milwaukee, 1926, 114; Lancashire, 106; Lawrence, Mass., pumping station boiler, 107; Lüders, 1869, 111; Milwaukee Electric Railway & Light Co., 1926, 114; National, 1885, 113; Neville, J., 106; Newcomen, 104; patents for first U. S., 106; Read, 1790, 106; Rhodes, 1869, 111; Ritty, 1875, 112; Roman, 107; Roosevelt, Smallman, and Staudinger, 108; Rumsey, 37, 107, 114; safety valves, 109, 110; Savery, 104; Sequin, 106; Seymour furnace walls, 114; Smeaton, 105; Staudinger and Livingston, 105; Steenstrup, 1828, 106; Stephenson, 106; Stevens, J., locomotive, 1803-25, 107, 109; steam-boat, 1804, 107, 109; Stevens, J. C., 107; Stiker, 1875, 112; Stirling, 1889-1920, 114; Trevithick, 105-106, Trowbridge, 1878, 113; Twibill, 1865, 114; wagon type, 104; water-tube, 107; Watt, 104; Wiegand, 1867, 110; Wilcox, 1856, 108, 114; Wilcox and Babcock, 1867, 115; wooden, 1801-15, 108; Woolf, 105.  
 Booth Cotton Mills, turbine, 18.  
 Bosch fuel pump, 1935, 173.  
 Bosch magneto, 163, 174.  
 Bosch magneto, German, 174.  
 Boulton, M., 31.  
 Boulton & Watt, 31, 33; engine, 35; engine for Fulton, 39; Mss., 40.  
 Bousfield, E., and J. Howard, boiler, 1871, 111.  
 Box, A., chain hoist, 4.  
 Boyden, U., hydraulic turbine, 17.  
 Bozerian, E. E. G., foot-power treadle, 7.  
 Bramwell, W., gate valve, 97.  
 Branca, G., turbine, 1629, 26.  
 Braner and Slaby, gas engine tests, 145.  
 Brayton, G. B., automotive vehicle, 144; gas engine, 1872, 150; oil engines, 145-147, 151.  
 Brooks, E. B., water wheel, 1880, 21.  
 Brown, C. H., and C. Burleigh, valve gear, 69.  
 Brown, J., atmospheric steam engine, c. 1790, 33.  
 Brown, R. T., hydraulic turbine buckets, 19.  
 Brown, S., vacuum gas engine, 144.  
 Buckeye Engine Co., assignees, 69, 85; lubricator, 96.  
 Buckeye steam engine, 69; c. 1875, 50, 85.  
 Buda Co., donor, 164.  
 Buda engine, 1924, 164; carburetor of, 172, magneto of, 174.

- Burleigh, C., and C. H. Brown, valve gear, 69.
- Burners. (*See* Gas burners, Oil burners, etc.)
- Burnham, J. P., windmills, 10.
- Burt, G. E., belt lacing, 102.
- Butler, E., carburetor, 167.
- Cadillac automobile engines, 165.
- Cameron, A. S., pump valves, 1874, 135; and W. Sewell, steam pump, 1864, 134.
- Cape Fear Fibre Co., boiler, 114.
- Carbon disulphide engine, Colwell, 1879, 101.
- Carburetors, 165-173; atomizers, 150, 166; Autocar, 1901, 170; Baverey, 1906-1908, 167, 171; Benz, 166; Bosch fuel pump, 1935, 173; Butler, 1889, 167; Clerk, 1881, 167; Daimler, 166; Dorris and Dyke, 1900, 169; Duryea, 1892-93, 167-168; 1901, 167; Dyke and Dorris, 1900, 169; Errani and Anders, 167; float feed, early, 167, 169-173; Haynes-Apperson, c. 1900, 167, 170; Haynes, 170; "Inspirator," 1889, 167; jet, *see* Spray; Krebs, 1902, 167; Manly, 166, 171; Maybach, 1893, 167; mixing valves, 166, 167, 169, 170; Olds, 1896, 167, 169; Sintz, 1896, 167; spray, 166-169, 171-173; Stromberg, 1914 and 1921, 163; surface, 166, 171; Tillotson, 168; 1926, 172; 1927, 173; Winton, 1898, 167; Zenith, 168, 1921, 171; 1924, 172.
- Cardan, 24.
- Carhart, J. W., balanced valve, 1866, 67.
- Carpenter, O. C., hydraulic engine, 1878, 101.
- Cartwright, Dr., 38.
- Cato the Elder, 5.
- Catoctin Iron Furnace, 33.
- Cattle mills, 5.
- Cave & Son, boiler for Fulton, 41.
- Cawley, J., atmospheric steam engines, 31.
- Cayley, hot-air engine, 175.
- Centrifugal separators, 98-100; Deerfoot Farm, 1879, 98; DeLaval, 1931, 100; Thomson and Houston, 1881, 99.
- Chain hoists, 3, 4.
- Chamberlain, C. C., igniter, 174.
- Chancellor Livingston, steamboat, machinery of (drawing), 39, 41.
- Chandler, L. S., and S. N. Silver, hydraulic engine, 1878, 100.
- Chief Justice Waite, steamboat, engine, 53.
- Chimney jacks, 175.
- Chinese windlass, 3.
- Clapp & Jones, fire engine, 1876, 139.
- Clark, D., and M. Baldwin, feed-water heater, 139.
- Clarke, L. S., donor, 55.
- Clerk, D., carburetor, 167; gas engine, 145, 147, 155.
- Clermont, steamboat, 35; machinery of, 39; model, 40.
- Clow, C. N., rotary pump, 1856, 142.
- Clutch pulley, 103.
- Coal, powdered. (*See* Pulverized fuel.)
- Cochrane Corporation, donor, 58.
- Cockrell, A., pulverized fuel system, 1876, 121.
- Cogswell, W. A., and J. Judson, governor, 1875, 83.
- Colles, C. steam-engine builder, 32.
- Collinson, H., manhole cover, 1875, 121.
- Colton, H. M., water motor, 24.
- Colwell, W. S., carbon-disulphide engine, 1879, 101.
- Compressed-air engine, Kimman, 102.
- Condenser air pumps, Corliss, 1876-77, 76; Watt, 1769, 25, 86.
- Condensers, steam-engine, 86-88; Pitts and Gluyas, 1872, 88; Starbuck, 1878, 88; Stevens, 1862, 1863, 87; Watt, 1769, 25, 86.
- Connecting rod, Hinkley, 103.
- Connecting rods for Manly radial engine, 161.
- Conowingo hydroelectric generating station, 1928, 18, 23.
- Conservatoire des Arts et Metiers, 126, 133.
- Cook, J., windmill, 14.
- Cooper, E., 90.
- Copeland, E. J., 185.
- Corliss, G. H., bibliography, 189; boilers, marine, 1862, 79; water-tube, 1879, 80; Centennial engine, 1876, 80; governor valve, 79; pressure regulator, 1869, 75; pumping engine, 1870, 75; 1879, 78; steam engine, "Evolution of," 80; steam engine governor, 1882, 78; steam pump, 1857, 73; 1876, 1877, 76; vacuum dash pot, 1875, 76; valve gears, 1849, 61, 71; 1851, 72; 1859, 74; 1860, 77; 1875, 76; 1876, 77, 79.
- Cornell University, 159.
- Cottle, J., and F. M., windmill, 1879, 13.
- Crane, M. G., hot-air engine, 1865, 179.
- Crawford, B., boiler furnace, 1850, 110.
- Cream separators. (*See* Centrifugal separators.)
- Croft, D. L., belt tightener, 102.
- Crosby, G. H., indicator, 1879, 92.
- Crosby Steam Gage & Valve Co., indicators, 1930, 93-94.
- Crossley, W. J., and N. A. Otto, gas engine, 1877, 154.
- Curtenius, Sharp and, foundry, 32.
- Curtiss engines, 165.
- Custer, J. D., engine governor, 85.
- Cylinders of steel tubing and cast-iron liners, Manly, 160.
- Daimler, G., carburetor, 166; compound gas engine, 147, 155; free piston engine, 1875, 152.
- Dardan, 8.
- Davies, J. D., steam pump, 1880, 137.

- da Vinci, Leonardo, 8, 175.  
 Davis, O. N., donor, 59.  
 De Castro and Donner Sugar Refinery, 116.  
 de Caus, S., 24, 25, 59.  
 Deerfoot Farm Co., centrifugal separator, 1879, 98.  
 de Garay, Blasco, boiler, 1543, 115.  
 De Laval, G., turbine, 100, 189.  
 De Laval Separator Co., centrifugal oil clarifier, 1931, 100.  
 De La Vergne Refrigerating Machine Co., 157.  
 Desmond, J., injector, 1901, 132.  
 Detmold, C. E., horsepower locomotive, 1830, 6.  
 De Witt, R. V., description of *Clermont's* engine, 39, 40.  
 Dexter, T. B., oil burner, 1879, 122.  
 Doble, A., 19.  
 Doble, W. A., water wheel, 1889, and water-wheel buckets, 22, 23.  
 Dodd, water-wheel buckets, 19.  
 Dodge, W. H., rope drive, 103.  
 Dog power, 4, 5, 7.  
 Dorris, G. P., and A. L. Dyke, carburetor, 1900, 169.  
 Dow, G. E., steam pump, 1879, 137.  
 Draft blower, unidentified model, 139.  
 Drake, A., gas engine, 1843, 146; 1855, 149.  
 Drop cut-off. (*See* Valve gears; Corliss, G. H.; Sickels, F. E.)  
 Duryea, C. E., automobile engine, 165; carburetor of, 167-168.  
 Dyke, A. L. and G. P. Dorris, carburetor, 1900, 169.  
 Dynamos for engine ignition, 174.  
 Eads, J. B., sand pump, 1869, 142.  
 Eclipse windmill, 10.  
 Edison Electric Illuminating Co., Boston, boiler, 1927, 114.  
 Edison Illuminating Co., New York, boiler, 114.  
 Eisemann magneto, 174.  
 Engines, gas and oil, internal combustion, etc. (*See* Internal-combustion engines.)  
 Engines, steam, air, etc. (*See* under name of, as Steam engines.)  
 Ericsson, John, hot-air engines, 1845-55, 175; 1855, 177; 1858, 178; 1860, 178; 1880, 1906, 181; steam engines, 1849, 46; 1858, 47; 1864, 48.  
 Errani, L. C., and R. Anders, carburetors, 167; oil engine, 1873, 150, 151.  
 Erie City Iron Works, boiler, 114.  
 Estes, C. H., donor, 20.  
 Evans, O., 34, 35; boilers, 105-106; volcanic engine, 146, 182.  
 Eve, J., boiler, 107, 114.  
 "Everready Automatic Engine Starter," spring actuated, 174.  
 Eyster, W. F., water motor, 21.  
 Fairbairn, Sir William, boiler, 106.  
 Farmer, M. G., wind-electric generator, 1880, 11, 13.  
 Feed-water apparatus, Frick, 1858, 120.  
 Feed-water heater (injector), 132, 139.  
 Feed-water pumps and injectors, 125; steam pumps, 125, 133. (*See* Injectors.)  
 Fickett, A., belt fastener, 102.  
 Field, J., and J. Maudslay, steam engine, 43.  
 Fire engines, American Fire Engine Co., 1906, 141; Amoskeag, model, c. 1885, 141; Amoskeag, pump, 141; Clapp & Jones, 1876-78, 139; hand pumper, 1854, 139; Hunneman & Co., 1854, 139; "Lily of the Swamp," 140; "Metropolitan," 1906, 141.  
 Fire wheel, smoke jack, 175.  
 Firmenich, J., and F. P. Stiker, boiler, 1875, 112.  
 Fiske, W. S., steam engine, 1880, 53.  
 Fitch, J., 33, 35, 115.  
 Fitts, B., governor valve, 1859, 98.  
 Flaud & Co., M., Giffard injector, 126, 127.  
 Flexible shaft, Stow, 1872, 103.  
 "Flying Dutchman," horsepower locomotive, 1830, 6.  
 Foot-power motor, 7.  
 Ford automobile engine, 165.  
 Fourneyron, B., hydraulic turbine, 16, 17.  
 Fowle, J. W., governor, 1877, 84.  
 Francis, J. B., hydraulic turbine, 1849, 17, 18.  
 Franklin Machine Co., donor, 70, 74, 75, 77, 79, 80, 141.  
 Frick, J., feed-water apparatus, 1858, 120.  
 Friedman, A., injector, 1869, 129.  
 Frost, R. L., steam pump valve, 1890, 138.  
 Frost-maker, refrigerating unit, c. 1914, 184.  
 Fuel, pulverized. (*See* Pulverized fuel.)  
 Fulton, R., 6, 35, 36, 38-40.  
 Fulton thermostat, 164.  
 Furnace walls, Bailey, 117; Seymour, 114.  
 Furnaces, boiler, Crawford, 1850, 110; Webster, 1929, 117.  
 Gabriel, M., rotary steam engine, 1867, 56.  
 Galileo, 25.  
 Gantry cranes, 24.  
 Garvin, B., and R. J. Pettibone, grate, 1867, 121.  
 Gas burner, Mettler, 1930, 124.  
 Gas Moteren Fabric, 152.  
 Gatchell & Manning, Inc., 133.  
 Gauge, steam, and alarm, Gill, 1859, 120; Safety steam gauge, Roebing, 1842, 119.

- Gauge, water-level, Worthington and Baker, 1847, 119.
- Gear, planetary, 103.
- Gear, roller, Stokes and McGlinchley, 103.
- Gears, wooden, c. 1870, 20.
- Gearshift, Vulcan electric, 163.
- Gebb, G. R., engineer, 31.
- General Electric Co., steam turbine, 1926-30, 57.
- Generators, engine ignition, 174.
- German Bosch, magneto, 174.
- Germeyer, C. F., donor, 52.
- Gibson, G. H., vacuum vapor power plant, 58.
- Giffard, H. J., injector, 1860, 126, 127.
- Giffard-Sellers injector, 1863, 1865, 128; 1868, 129.
- Gill, W. Y., steam gauge and alarm, 1859, 120.
- Gilles, F. W., gas engine, 1876, 153.
- Gilman, S. H., valve gear, 65.
- Gilmanton Mills, assignee, 122.
- Girard, hydraulic turbine, 19.
- Glazebrook, hot-air engine, 175, 182.
- Gluyas, G. K., and W. R. Pitts, condenser, 1872, 88.
- Gnat ABC engine, 165.
- Gnome engine, 165.
- Gorrie, J., ice machine, 1851, 183.
- Governor valves, Corliss, 79; Fitts, 1859, 98.
- Governors, engine: Bodemer, 1876, 84; Cogswell & Judson, 1875, 83; Corliss, 1882, 78, valve for, 79; Custer, 1839, 85; Fowle, 1877, 84; Hodgson and Stearns, 1852, 81; Hunt and Thompson, 1878, 69, 85; Judson and Cogswell, 1875, 83; Kelly & Lamb, 1865, 82; Luttgens, 1851, 80; Pickering, old style, 85; 1931, 86; Peavey, 1870, 82; Porter, 1858, 81; Reid, 1879, 85; Stearns and Hodgson, 1852, 81; Thompson and Hunt, 1878, 69, 85; Woodbury, 1870, 83.
- Graham, W., steam engine, c. 1880, 52.
- Grates, furnace, Garvin and Pettibone, 1867, 121; Rexford, 1883, 123; rocking bar, Stevens, 1879, 123.
- Greek mills, 14, 15.
- Greene, G., belt tightener, 102.
- Greene-Wheelock, valve, 70.
- Gresham, J., and J. Robinson, injector, 1866, 128.
- Griffith, J., boiler, 107.
- Gurney, G., boiler, 114.
- Gyro engine, 165.
- Hagan, J., donor, 181.
- Hall, J., steam engine builder, 33, 35.
- Halladay Co., 10.
- Halladay, D., windmill, 10.
- Hallock, V. H., belt tightener, 102.
- Hall-Scott engine, 165.
- Hand-and-foot motor, Mott, 7.
- Harrison, A. L., lubricator, 1880, 95.
- Hart, T. J., and J. Jenks, injector, 1886, 130.
- Haswell, C. H., 39.
- Hathaway, L. J., donor, 55.
- Hautefeuille, Abbé, explosive engine, 143.
- Haworth, J., water motor, 20.
- Hay, P. D., oiler, 1888, 95.
- Hayes, C. Q., universal joint, 1879, 103.
- Haynes-Apperson carburetor, c. 1900, 167, 170.
- Haynes Automobile Co., donor, 163.
- Haynes automobile engine, 163, 165.
- Haynes, Elwood, mixing valve, 170.
- Headers, boiler, 1867-1929, 117-118.
- Hees, W., and W. Wittig, gas engine, 1879, 154, 155; 1880, 147.
- Hendee engine, 165.
- Heron of Alexandria, 8, 24, boilers, 103, 114; hot-air turbine, 175; steam turbine (aeolipile), 24, 26, 59, 114; wind wheels, 8.
- Herot, 2.
- Hesse, Prof., hydraulic turbine buckets, 19.
- Hewitt, J., piston-rod packing, 1879, 98.
- Higginson, A., steam engine, 1877, 51.
- Hinkley, H., connecting rod, 103.
- Hispano Suiza engine, 165.
- Hitzeroth, Macdonald, and Williams, rope drive, 1892, 103.
- Hoadley, J. C., governor, 85.
- Hock, J., carburetor, 167; oil engine, 1874, 151.
- Hodgson, W., and G. S. Stearns, governor, 1852, 81.
- Hogg & Delameter Iron Works, 47.
- Hogg, P., 47; valve gear, 60.
- Hoists, 3, 4.
- Hope Furnace, 33.
- Hornblower engine, 33.
- Hornblower, Joseph, 32, 36.
- Hornblower, Josiah, 32, 33, 36.
- Hornsby-Akroyd oil engine, 1893-95, 157.
- Horse mills, 5, 6.
- Horse-powered ferry boat, 6; locomotive, 6.
- Horsepower unit, 5, 6.
- Hot-air engines, 175-182; Baldwin, 1865, 176; Bickford, 1865, 176; Cayley, 1807, 175; Crane, 1865, 179; Ericsson, 1845-1855, 177; 1858, 178; 1860, 178; 1880, 181; c. 1880, 181; 1906, 181; Glazebrook, 1797, 175, 182; Kritzer, 1862, 176; Lauberon, 1849, 176; Lyman, 1854, 176; Messer, 1865, 176; Otto, 1875, 180; Peters, 1862, 176; Rider, 1871, 180; Rider-Ericsson Engine Co., 1906, 181; Roper, 1863, 176; Schwartz, 1864, 176; Stillman, 1860, 176; Stirling, 1826, 175; summary, 175-176; Wilcox, 1865, 176.
- Hot-air and steam engines, 182.

- Hot-bulb and hot-tube igniter, 157, 158. (*See also* Igniters and Ignition devices.)
- Houston, E. J., and E. Thomson, centrifugal creamer, 1881, 99.
- Howard, J., and E. Bousfield, boiler, 1871, 111.
- Howd, S. B., hydraulic turbine, 17.
- Huber, J., injector, 133.
- Hug, water-wheel buckets, 19.
- Hugon, gas engine, 145.
- Human treadmill, 5, 6.
- Hunneman & Co., fire engine, 1854, 139.
- Hunt, N., and J. W. Thompson, governor, 1878, 69, 85; steam engine, 1875, 50.
- Hunt, N. C., donor, 50, 93.
- Hurdy-gurdy tangential water wheel, 19.
- Huygens, C., 25; explosive engine, 143.
- Hydraucone draft tube, 18.
- Hydraulic engines, Chandler and Silver, 1878, 100; Carpenter, 1878, 101.
- Hydraulic turbines. (*See* Turbines, hydraulic; Water motors; and Water wheels.)
- Hydrocarbon burners. (*See* Oil burners.)
- Hydrostatic engine lubricator, 96.
- Igniters and ignition devices, 174 (*see also* Spark plugs); electric spark, 1801, 1860, 144; 1873, 150; flame, 1844, 148; 1867, 149; 1872, 150; 1874, 151; 1874, 152; 1877, 154; 1879, 154; 1882, 156; hot-bulb, 1889-90, 157; 1893-95, 157; incandescent metal, 1846, 146; 1855, 149; Manly engine, 159, 162.
- Impulse starter, Eisemann magneto, 174.
- Inclined plane, mechanical element, 2, 3.
- Indicators, engine, 89-94, bibliography, 189; continuous card, 1930, 94; Crosby, 1879, 92; Crosby Steam Gage & Valve Co., 1930, 93-94; Krausch, locomotive, 1862, 91; Lanza, 94; McNaught, 89; c. 1835-42, 91; Novelty Iron Works, N. Y., 90; reducing wheel, 93; Richards, 1862, 89; c. 1867, 92, 93; Southern, 89; summary, 89-90; Thompson, c. 1883, 93; Watt, 89, c. 1796, 90.
- Injectors, boiler feed-water: Allen, 1902, 132; American Injector Co., assignee, 130; Conservatoire des Arts et Metiers, photographs, 133; Desmond, 1901, 132; feed-water heater, 1925, 132; Friedman, 1869, 129; Gatchel & Manning, Inc., photographs, 133; Giffard, 1858: (photographs) 133; 1860, 126, 127; Giffard-Sellers, 1863, 1865, 128; 1868, 129; Gresham and Robinson, 1866, 128; Hart and Jenks, 1886, 130; Huber, 1898, 133; Jenks and Hart, 1886, 130; Jenks, 1885, 133; Lambert, 1889, 133; Lukenheimer Co., assignee, 1901, 132; Mack, 1886, 133; Messenger,
- 1886, 133; Millholland, 1862, 127; Murdoch, 1889, 133; 1890, 131; Nathan Manufacturing Co., assignee, 130; Nice, 1900, 133; O'Rourke, 1872, 133; Robinson and Gresham, 1866, 128; Schutte, 1892, 131; 1888, 133; self-acting, 130, 131; Sellers, 1863, 1865, 128; 1868, 129; Sellers, William, & Co., 1876, 129; 1887-1927, 130; 1900-1927, 131; 1925, 132; photographs, 133; Sticker, 1900, 133; summary, 125-127; Sweeney, 1889, 133; unidentified, 133; Wotapek, 1884, 130.
- "Inspirator," carburetor, 167.
- Internal-combustion engines: American developments, 146; Anders and Errani, oil engine, 1873, 150, 151; Atkinson, unequal stroke, 1884, 145; 1889-90, 157; Autocar, 1901, 165; 1921, 163; Balzer, 159; rotary, 1894, 165; Barber, gas engine, 1791, 143; Barnett, 1838, 144; Barsanti and Matenci, 1854, 1857, 144; Beau de Rochas, 4-stroke cycle, 145; Beck, 6-stroke, 1888, 146; bibliography, 190; Binney and Stuart, 157; Bisschop, 145; Braner and Slaby, tests, 1878, 145; Brayton, oil engine, 145; 1874, 147, 151; gas engine, 1872, 150; Brown, vacuum gas engine, 1823-26, 144; Buda, gasoline, 1924, 164, 172; Cadillac, 1903, 1923, 165; Clerk, 2-stroke, 1880, 145, 147; 1881, 155; Crossley & Otto, 1877, 154; Curtiss, q. v.; Curtiss-Baldwin, 1908, 165; Daimler, q. v.; Drake, 1843, 1855, 146; 1855, 149; Duryea, 1892-93, 165; Errani and Anders, oil engine, 1873, 150, 151, 167; Ford, 1913, 165; free piston engines, 144-146, 152, 153; Gilles, loose piston, 1876, 153; Gnat ABC, 1917, 165; Gnome, 1917, 165; Gyro, 1913, 165; Hall-Scott, 1911, 165; Hautefeuille, explosive engine, 1678, 143; Haynes, q. v.; Hende, 1911, 165; Hispano Suiza, 1918, 165; Hock, oil engine, 1874, 151, 167; Hornsby-Akroy, oil engine, 1893-95, 157; Hugon, 1858, 1862, 1865, 145; Huygens, explosive engine, 1680, 143; King Bugatti Dusenbergh, 1918, 165; Knight, sleeve valve, 1927-28, 164; Knox, 1900, 165; Langen and Otto, free piston, 144, 145; Lebon, 144; Lenoir, gas, 1860, 144, automobile, 144-146; LeRhone, 1917, 165; Liberty, 1917, 165; Manly, radial, 1901, 158-163; Marcus, automobile, 144; Matenci and Barsanti, 1854, 1857, 144; Maybach, 1918, 165; Mercedes, 1918, 165; Million, 1861, 145; Morey, first American, vacuum, 1826, 146; Nash, 2-stroke, 1888, 147; Olds, 1896, 165; Otto, q. v.; Packard, Liberty, 1918, 165; Diesel, 1928, 165; Papin, 1690, 143; Perry, q. v.; Pratt & Whitney "Wasp," 1935, 165; radial, 1901, 158; 1928, 65; Reithman, 1858, 145; rotary,

- 1894, 1911, 1913, 165; Schmidt, compression, 1861, 145; Selden, automobile, 1895, 147; Simon, 1878, 145; Simplex, 1912, 165; Slaby and Braner, tests, 1878, 145; Street, 1794, 144; Stuart and Binney, 157; summary, 143-147; tests of, 144, 145; Tresea, tests, 144; Willys-Knight, 1927-28, 164; Winton, 1901-1902, 165; Wittig and Hees, 2-stroke, 1880, 147, 155; multiple piston, 1879, 154; Wright, q. v.
- Internal-combustion engine accessories, 173-174. (*See also* Carburetors, Igniters, and Ignition devices.)
- Invention, bibliography of, 186-187.
- I. P. Morris turbine, 18.
- Jenks, James, injector, 133.
- Jenks, James, and T. J. Hart, injector, 1886, 130.
- Jenks, Joseph, water mill patent, 16.
- Jet carburetors. (*See* Carburetors, spray.)
- Johnson, T., pawl and ratchet, 4.
- Johnson, Gen. T., iron furnace, 33.
- Johnston, W., air compressor, 1879, 143.
- Jonal, N., hydraulic turbine 16, 17.
- Judson, J., and W. A. Cogswell, governor, 1875, 83.
- Kelly, O. A., and E. Lamb, governor, 1865, 82.
- Kelly, W. E., 113.
- Kelvinator Corporation, 185.
- Kilburn, G., hydraulic turbine, 17.
- Kimman, H. J., compressed-air engine, 102.
- Kimman, M. T., donor, 102.
- King Bugatti Dusenbergl engine, 165.
- King, J. C., pump-valve gear, 1870, 135.
- Kingsbury bearing, 18.
- Kinsley, A., 34.
- Knight, sleeve-valve engine, 1927-28, 164.
- Knight, water wheel, 19.
- Knowles, L., simplex pump, 1879, 136.
- Knox automobile engine, 165.
- Knox, W. C., animal treadmill, 1882, 7.
- Krausch, C. W. T., indicator, 1862, 91.
- Krebs, A., carburetor, 1902, 167.
- Kritzer, hot-air engine, 176.
- Kumme windmill, 11.
- Lakeside Station, Milwaukee, boiler, 114.
- Lamb, E., and O. A. Kelly, governor, 1865, 82.
- Lamb, G. A., water wheel, 24.
- Lambert, A., injector, 133.
- Lancashire boiler, 106.
- Langen, E., and N. Otto, free-piston gas engine, 1866, 144-146, 152; 1867, 149.
- Langley aerodrome, engine for, 158; carburetor, 171.
- Langley, S. P., 158, 159.
- Lanza, G., indicator, 94.
- Lauberan, hot-air engine, 176.
- Lawrence, Mass., pumping station boiler, 107.
- Lebon, P., gas engine, 144.
- Leece-Neville, automobile starting and lighting, 163.
- Leffel, J., hydraulic turbine, c. 1883, 18, 22.
- Leffel, James, & Co., turbine, 22.
- Lenoir, J.-J.-E., gas engine, 1860, 144-147, 151.
- LeRhone, aircraft engine, 165.
- Leuchsenring, R., water engine, 1880, 21.
- Levers, mechanical elements, 2, 3.
- Liberty aircraft engine, 165; Packard, 1918, 165.
- Lighthall, W. A., steam engine, 1838, 43; 1849, 46.
- Lighthouses, Bureau of, hot-air engines, 176.
- "Lily of the Swamp," steam fire engine, 140.
- Livingston, Chancellor R. R., 6, 34, 105-108.
- Locomobile engine, 55.
- Lodi oil burner, 124.
- Loper, R. F., steam engine, 1845, 44; 1849, 45.
- Los Angeles hydroelectric plant, 18.
- Loud, H., antifriction bushings, 103.
- Lubricators, engine, gravity oiler, 96; hand-pump (Buckeye Engine Co.), 96; Harrison, 1880, 95; Hay, 1888, 95; hydrostatic, 96.
- Luders, H. W., boiler, 1869, 111.
- Lunkenheimer Co., assignee, 132.
- Luttgens, H. A., engine governor, 1851, 80.
- Luttgens, H. A., and H. Uhry, valve gear, 64.
- Lyman, A. S., hot-air engine, 1854, 176.
- Macdonald, Williams, and Hitzeroth, rope drive, 103.
- Maek, W. B., 133.
- Magnetos, dynamos, and generators for engine ignition, 174.
- Magnus effect, windmills, 11.
- Make-and-break igniters, 174.
- Manhattan Co., 34.
- Manhole cover, boiler, Collinson, 1875, 121.
- Manley, J. A., donor, 113.
- Manly, C. M., carburetor, 1901, 166, 171; radial aerodrome engine, 1901, 158-163.
- Manual or muscular power, 1-3, 5, 6.
- Marcus, S., early automotive vehicle, 144-145.
- Mark, J., part in foundry, 33.
- Mars Iron Works, 35.
- Mason Regulator Co., donor, 54.
- Matach and Nancarrow, 35.
- Mattenel and Barsanti, gas engine, 144.
- Matthews, R., donor, 174.

- Maudslay, J., and J. Field, steam engines, 1842, 43-44.
- Maxim, H. S., steam pumping unit, 1874, 50.
- Maybach carburetor, 167; engine, 165.
- Mayhew, T., diaphragm steam engine, 1879, 52.
- McAlpin and McInnis, rice mills, 42.
- McCafferty, W. H., 48.
- McElroy, J. B., belt fastener, 1875, 102.
- McGlinchley, C. E., and C. F. Stokes, roller gear, 103.
- McMillan, A. M., engine starter, 174.
- McNamar, J. H., and R. Scheidler, throttle valve, 1875, 98.
- McNaught, J., indicator, 89; c. 1835-42, 91.
- McQueen, R., steam engine builder, 34-36.
- McReady, R., 157.
- Mechanical elements and powers, 2-4.
- Mengel Co., 54.
- Mercedes engine, 165.
- Mercury motor, Miller, 1877, 60.
- Merrimac Co., 17.
- Messer, hot-air engine, 176.
- Messinger, W. L., injector, 133.
- "Metropolitan" steam fire engine, 1906, 141.
- Mettler, Lee B. Co., donor, 124; gas burner, 1930, 124.
- Michigan Lubricator Co., 95.
- Miller, C., rotary steam engine, 1859, 56.
- Miller, T. D., mercury motor, 1877, 60.
- Millholland, J., injector, 1862, 127.
- Million, gas engine, 1861, 145.
- Mills, E., draftsman, 114.
- Mills, K. L., water motor, 24.
- Milwaukee Electric Railway & Light Co., 1926, 114.
- Mithridates, 14.
- Mixing valves. (*See under* Carburetors.)
- Moebius, C. E. L., reversing mechanism, 103.
- Monitor, U. S. S., 175.
- Monitor windmill, 1881, 10, 11.
- Moody, L. F., draft tube, 18, 24.
- Moore, I. N., steam pump, 1891, 138.
- Moore, J., water wheel, 19.
- Moore, T., chain hoist, 4.
- Morey, S., first gas (vacuum) engine in America, 146.
- Morin, animal power capacity, 6.
- Morris, Ellwood, hydraulic turbine tests, 17.
- Morris, I. P., hydraulic turbine, 18.
- Morrow, Charles, 37.
- Motsinger magnet, 174.
- Mott, D. W., hand and foot motor, 7.
- Muhlenburg, D., 35.
- Murdock, H. B., injector, 1889, 133; 1890, 131.
- Nancarrow, J., steam-engine builder, 33, 35.
- Nash, L. H., 2-stroke gas engine, 147.
- Nathan Manufacturing Co., assignee, 130.
- National Water Tube Boiler Co., boiler, 1885, 113.
- Nehf, C. T., donor, 139.
- Neville, J., boiler, 106.
- Newcomen, Thomas, 25; boiler, 104; steam engine, 1712, 28-32, 36.
- Newcomen Society, donors, 28.
- New England Rolling Mills, 77.
- New Jersey Copper Mine Association, 33, 35.
- New Jersey Historical Society, donor, 36; original Fulton drawings at, 39.
- New York Historical Society, description Fulton drawings, 39.
- Nice, H. T., injector, 133.
- "Noria," 14.
- Norse mills, 14, 15.
- North River, steamboat, 39.
- Novelty Iron Works, N. Y., 91.
- Novelty Iron Works, Savannah, 42.
- Oak Grove hydroelectric plant, 18.
- Oil burners, Babcock & Wilcox, 1929, 124; Dexter, 1879, 122; Lodi, 1929, 124; Ray, 1914, 123; Salisbury, 1879, 122.
- Oil engines. (*See* Internal-combustion engines.)
- Oilers. (*See* Lubricators, engine.)
- "Old Bess," Watt steam engine, 31.
- Olds Motor Works, donor, 169.
- Olds, R. E., automobile engine, 165; carburetor, 167, 169.
- Ornsbee, E., repairing steam engine, 33.
- O'Rourke, T., injector, 133.
- Otto, H., and P. F. Bell, slide valve, 1883, 70.
- Otto, N. A., 4-stroke gas engine, 1876, 145; 1882, 156; hot air engine, 1875, 180; models of, 153, 165; tests of, 145, 146.
- Otto, N. A., and E. Langen, free piston gas engine, 1866, 144-146, 152; 1867, 149.
- Otto, N. A., and W. J. Crossley, gas engine, 1877, 154.
- Otto Engine Works, 156.
- Packard aircraft engines, 165.
- Papin, D., steam engines, c. 1690, 25, 27, 59; 1707, 115; internal-combustion engine valve, 143.
- Pascal, 25.
- Patents, first U. S. steam boiler, 106.
- Pearl Street Station, 114.
- Peavy, A. J., governor, 1870, 82.
- Pelton, L. A., water wheels, 19.
- Pelton Water Wheel Co., 19; buckets, 1901-1912, 22, 23.
- Perry, S., gas engine, 146-148.
- Perry, T. O., windmills, 10, 11.
- Peters hot-air engine, 176.
- Pettibone, R. J., and B. Garvin, grate, 1867, 121.



- Philadelphia Electric Co., 18, 23.  
 Philadelphia waterworks, 34, 106, 108.  
 Philo of Byzantium, water wheel, 14.  
 Pickering, J., chain hoist, 1870, 4.  
 Pickering, T. R., governor, 85.  
 Pickering Governor Co., donor, 85; governor, 1931, 86.  
 Pitts, W. R., and G. K. Gluyas, condenser, 1872, 88.  
 Planetary gear, 103.  
 Platt, J., rotary steam engine, 1862, 56.  
 Poccocke, Dr., 32.  
*Polacca*, steamboat, 1798, 34.  
 Pomeroy, O. C., belt lacing, 103.  
 Poncelet, G., 11; water wheel, 15; hydraulic turbine, 16, 18.  
 Porta, 24.  
 Porter, C. T., governor, 1858, 81.  
 Portland Railway Light & Power Co., 18.  
 Powdered fuel. (*See Pulverized fuel.*)  
 Powel, heirs of Samuel, donors, 157.  
 Prairie windmill, 12.  
 Pratt & Whitney "Wasp" engine, 165.  
 Prayer wheel, 7.  
 Pressure cooker, Papin, 27.  
 Princeton University, 156.  
 Pulley, mechanical element, 2, 3.  
 Pulverized fuel system, Cockerell, 1876, 121.  
 Pump, rotary water, Clow, 1856, 142.  
 Pump, sand, Eads, 1869, 142.  
 Pump, ship's combination, 1864, 134-135.  
 Pumping engine, steam, Corliss, 1870, 75; 1879, 78.  
 Pumping unit, automatic steam, Maxim, 1874, 50.  
 Pumps, steam. (*See Steam pumps.*)
- Rank, L., antifriction journal bearing, 103.  
 Rankine, animal power tests, 6.  
 Ray Oil Burner Co., donor, 123.  
 Ray, W. R., oil burner, 1914, 123.  
 Read, N., boiler, 106; steam engine, 33.  
 Refrigerating machines: Audiffren, 1913, 183; domestic electric unit, c. 1918, 184; Frost-maker, c. 1914, 184; Gorrie, 1851, 183.  
 Reid, J., governor, 1879, 85.  
 Reily, H., and P. Waldo, rotary steam engine, 1875, 57.  
 Reithman, internal-combustion engine, 145.  
 Reversing mechanism, Moebius, 103.  
 Rexford, P., fire grate, 1883, 123.  
 Rhodes, W. K., boiler, 1869, 111.  
 Richards, C. B., indicators, 89; c. 1867, 92, 93.  
 Richards, T., balanced valve, 1866, 68.  
 Rider, A. K., hot-air engine, 1871, 180.  
 Rider-Ericsson Engine Co., 181.  
 Ritty, S., boiler, 1875, 112.  
 Roach, John V., engine builder, 33.  
 Robeson & Sons, hydraulic turbine at 17.  
 Robinson, J., and J. Gresham, injector, 1866, 128.  
*Rocket*, locomotive, boiler of, 106.  
 Roebbling, J. A., safety steam gauge, 1842, 119.  
 Rogers, T., cut-off, 71.  
 Roller gear, Stokes and McGlinchley, 103.  
 Roosevelt, Nicholas, 33-36.  
 Roosevelt, Smallman, and Staudinger, boiler, 108.  
 Rope drives, 103.  
 Roper, hot-air engine, 176.  
 Rotary water engine, 21.  
 Rotary water pump, Clow, 1856, 142.  
 Rourke, J., Sr., donor, 42.  
 Rumsey, J., 33; boiler, 37, 107, 114.  
 Rumsey, T., 37.  
 Rush, J., steam engine builder, 35.
- Safety gauges. (*See Gauge, steam, and Safety valves.*)  
 Safety valves, boiler, Frick, 1858, 120; Papin, c. 1690, 27; Roebbling, 1842, 119; Stevens, 1804, 109; 1803-25, 110; 1825, 119.  
 Salisbury, S. C., hydrocarbon burner, 1879, 122.  
 San Francisquito No. 2 hydroelectric generating station, 18.  
 Sand pump, Eads, 1869, 142.  
 Sangyl, George, 40.  
 Sargeant, C., belt hook, 102.  
 Savery, T., 25; boilers, 104; engine, 1698, 27, 59.  
 Sawyer, E. O., belt coupling, 103.  
 Scheidler, R., and J. H. McNamar, throttle valve, 1875, 98.  
 Schleicher, Schum & Co., 156.  
 Schmidt, G., gas engine, 145.  
 Schofield, F. F., rotary steam engine, 1876, 57.  
 Schuhknecht, A., belt fastener, 103.  
 Schutte, L., injector, 131.  
 Schuyler, Col. J., 32, 36.  
 Schuyler, P., 33.  
 Schwartz hot-air engine, 176.  
 Science Museum, London, 86, 90, 107.  
 Sciple, H. M., steam engine, 1880, 52.  
 Scofield, S. C., universal joint, 1870, 103.  
 Screw, mechanical element, 2.  
 Secor, T. F., 36.  
 Selden, G., automobile patent, 147.  
 Sellers, William, Giffard-Sellers injectors, 1863, 1865, 128; 1868, 129; steam engine, 1872, 49.  
 Sellers, William, & Co., Inc., donors, 129-131; injectors, 1876, 129; 1887-1927, 130; 1900-1927, 131; 1925, 132; introduced Giffard injector, 126.  
 Separators, centrifugal. (*See Centrifugal separators.*)  
 Sequin, boiler, 106.  
 Sewell, W., and A. S. Cameron, steam pump, 1864, 134.

- Seymour furnace walls, 114.  
 Shafts, bearings, 103; couplings, 103; flexible, Stow, 1872, 103.  
 Sharp and Curtenius, 32.  
 Sharp, Stewart & Co., 126.  
 Shlarbaum, H., oscillating engine, 47.  
 Shock, W. H., 39.  
 Siamese steam engine, 44.  
 Sickels, F. E., drop cut-off, 1841, 61, 62; 1852, 64; valve gear, 60.  
 Silver, S. N., and L. S. Chandler, hydraulic engine, 1878, 100.  
 Simon, engine, 145.  
 Simplex automobile engine, 165.  
 Singley, S., antifriction alloy, 103.  
 Sintz, C., carburetor, 167.  
 Slaby & Braner, gas engine tests, 145.  
 Smallman, J., 35.  
 Smallman, Staudinger, and Roosevelt, boiler, 108.  
 Smeaton, boiler, 105.  
 Smith, E. H., windmill, 14.  
 Smith, N. E., belt splicing, 102.  
 Smithsonian Institution, 158, 171.  
 Smoke jacks, 175.  
 Soho (N. J.) engine works, 34, 35.  
 Solenoid electric gear shift, 163.  
 Somerset, E., Marquis of Worcester, steam engine, 25.  
 South Carolina Railroad Co., 6.  
 Southern, J., indicator improvement, 89.  
 Southern Railway System, donor of steam engine, 48.  
 Spark plugs, 174. (*See also* Igniters and ignition devices.)  
 Sparks, L. H., windmill, 11.  
 Splittorf Electrical Co., magneto, 174.  
 Spring motor, Warren, 1880, 7.  
 Stackhouse & Rogers, steam-engine manufacturers, 35.  
 Stanley Automobile Co., 55.  
 Stanley, F. E., and F. O., automobile engine, 1897, 54, 55.  
 Starbuck, G. H., condenser, 1878, 88.  
 Starters, engine, 174; generator, Apple, 1911, 174.  
 Staudinger, 36; Staudinger, Roosevelt, and Smallman, boiler, 108; Staudinger and Livingston, boiler, 105.  
 Steam-boiler accessories, steam boilers, etc. (*See* Boilers, steam, etc.)  
 Steam-engine accessories, 95-100. (*See also* Belt drives, Governors, Indicators, Valve gears): Bibliography, 189; gate valve, Bramwell, 1859, 97; governor valve, Fitts, 1859, 98; lubricators, gravity oilers, 96; Harrison, 1880, 95; Hay, 1888, 95; hydrostatic, 96; oil clarifier (centrifugal), De Laval, 1931, 100; piston-rod packing, Hewitt, 1879, 98.  
 Steam engines, atmospheric, 25, 27-33, 36; "Automatic," Thompson and Hunt, 1875, 50; Westinghouse, Junior, c. 1900, 54; automobile, Locomobile, 1901, 55; Stanley, first, 1897, 54; c. 1923, 55; bibliography, 188; diaphragm type, Mayhew, 1879, 52.  
 Steam engines, general: Aeolipile, c. 150, 24, 26, 59; Allaire, 36; Baker, 1878, 51; beam (model), 60; Benson, 1847, 44; Blackford, 1829, 43; Boulton and Watt, c. 1776, 31; c. 1801, 34; 1805-6, 35; Branca, c. 1629, 26; Brown, c. 1790, 33; Buckeye, q. v., 1875, 50; builders, early, 35-36; Cardan, 24; *Chancellor Livingston*, 41; *Clermont*, 39, 40; Colles, 1773-74, 32; compound, models by Wardlaw, 59; Corliss, G. H., q. v.; de Caus, 24, 25, 59; Ericsson, J., 1849, 46; 1858, 47; 1864, 48; Evans, O., 1773-1819, 34, 35; exported, 1806, 35; first in America, 1755, 32, 36; Fitch, 1786-87, 33; Fitch, Thornton, and Hall, 1790, 33; Fulton, 1805-1806, 35, 39-42; Heron, q. v.; Higginson, 1877, 51; history (early) 24; history (in America), 32; horizontal (full size) 1864, 48; Hornblower, 1755, 32, 36; indicator and diagram, 1840, 90; Kinsley, 1801, 34; Lighthall, 1838, 43; 1849, 46; Loper, 1845, 44; 1849, 45; Manufacturers, early, 35-36; Maudslay and Field, 1842, 43; Maxim, 1874, 50; Mayhew, 1879, 52; McQueen, c. 1801, 34, 36; mercury vapor, Miller, 1877, 60; Nancarrow, c. 1876, 33; Newcomen, q. v.; New York waterworks, 1774-75, 1785, 32; 1799 and 1801, 34; "Old Bess," 1777; oscillating cylinders, q. v.; Papin, c. 1690, 24, 27, 59; Porta, 24; portable, Sciple, 1880, 52; radial, William Mont Storm, 1865, 49; Read, 1788, 33; John V. Roach & Sons, 36; Roosevelt, Schuyler, and Mark, 1798-1800, 33, 34; Rumsey, 33, 37; at Savannah, 1815, 42; Savery, 1698, 25, 27, 59; Sciple, portable, 1880, 52; Smallman, 1802-1806, 35; Soho, N. J., 1798, 34; Somerset, Marquis of Worcester, c. 1663, 25; steamboat, *see* Steam engines, marine; Stevens, 1804, 38; Stevens, Livingston, and Roosevelt, 1798, 34; Storm, radial, 1865, 49; Thompson and Hunt, 50; triple expansion, models by Wardlaw, 59; Van Deren, 1860, 59; vapor, carbon disulphide, Colwell, 1879, 101; vertical hoisting, 51; vertical, models by Wardlaw, 59; Watt, q. v.; Willis, W. N., 59; wobble disk type, 45.  
 Steam engines, marine: Balanced, 1864, 48; *Chancellor Livingston*, 39, 41-42; *Chief Justice Waite*, 1888, 53; early experimenters, *see also* by name, 33-41; Ericsson, 1858, 47; 1864, 48; half-beam, 1849, 46; horizontal, 1845, 44; horizontal with vertical beam, 1838, 43; 1849, 46; Lighthall, 1838, 43; 1849, 46; Loper, 1845, 44; 1849, 45;

- Maudslay and Field, 1842, 43-44;  
Rumsey, 1787, 37; Stevens, 1804, 38;  
walking beam, 1888, 53.
- Steam engines, oscillating cylinders,  
Fiske, 1880, 53; Graham, c. 1880, 52;  
piston, Baker, 1878, 51; Sellers, 1872,  
49; Shlarbaum, 1863, 47.
- Steam engines, rotary (*see also Tur-*  
*bines, steam*): Baker and Baldwin,  
1839, 53; Gabriel, 1867, 56; Miller,  
1859, 56; Platt, 1862, 56; Reily and  
Waldo, 1875, 57; Schofield, 1876, 57;  
unidentified, 59.
- Steam-engine valve gears. (*See Valve*  
*gears, steam engine.*)
- Steam gauges. (*See Gauges, steam.*)
- Steam pumps, 125, 133-138: Cameron  
and Sewell, 1864, 134; Corliss, q. v.;  
Davies, 1880, 137; direct-acting, 133,  
135, 137; Dow, 1879, 137; duplex, 134,  
135; Knowles, 1879, 136; Moore, 1891,  
138; Sewell and Cameron, 1864, 134;  
simplex, Knowles, 1879, 136; Worth-  
ington, 1855, 133; 1859, 134; 1871, 135.
- Steam pump valves: Cameron, 1874,  
135; Frost, 1890, 138; King, valve  
gear, 135; Union Manufacturing Co.,  
assignee, 138.
- Stearns and Hodgson, governor, 1852, 81.
- Steenstrup, Paul, 106.
- Stephenson, G., locomotive boilers, 106.
- Stephenson valve gears, 54, 55, 64.
- Stevens, E. A., 38; donor, 109.
- Stevens, F. B., condensers and still,  
1862, 1863, 87; grate bar, 1879, 123;  
valve gear, 1861, 66.
- Stevens, F. B., and R. L., valve gear, 66.
- Stevens, J. G., 34-36; boiler, 107; 1804,  
109, 115; 1803-25, 109; safety valve,  
1825, 119; steamboat engine, 38.
- Stevens, J. C., boiler, 107.
- Stevens, R. L. and F. B., valve gear,  
1841, 66.
- Stevens Institute of Technology, 39,  
119; donor, 109.
- Sticker, F., injectors, 133.
- Stiker, F. P. and J. Firmenich, boiler,  
1875, 112.
- Still, sea water. Stevens, 1863, 87.
- Stillman, hot-air engine, 176.
- Stirling, A., boilers, 114, 115.
- Stirling hot-air engine, 175, 177.
- Stoker, Westinghouse, 117.
- Stokes, C. F. and C. E. McGlinchley,  
roller gear, 103.
- Stone, J. M., adjustable eccentrics, 1865,  
71.
- Storm, W. M., aerosteam engine, 182;  
steam engine, 1865, 49.
- Stoughton, Mrs. E. W., 181.
- Stow, N., flexible shaft, 103.
- Strabo, 14.
- Street, R., gas engine, 144.
- Stromberg carburetor, 163.
- Stuart, H. A., and C. R. Binney  
(Hornsby-Akroyd engine), 157.
- Stuart, W. W., donor, 184.
- Sturtevant and McQueen, 35.
- Sulzer Brothers, valve gear, 71.
- Swain, A. M., hydraulic turbine, 18.
- Sweeney, T. J., injector, 133.
- Tabor, Amos, windmill, 10.
- Tarr, aerosteam engine, 182.
- Thermostat, Fulton, on gasoline engine,  
164.
- Thompson, J. W., indicator, 93; valve  
gear, 1875, 69, 85.
- Thompson, J. W., and N. Hunt, governor,  
69; 1878, 85; steam engine, c. 1875,  
50.
- Thomson, E., and E. J. Houston, cen-  
trifugal creamer, 1881, 99.
- Thornton, W., steamboat engine, 33.
- Thurston, R. H., 158.
- Tillotson carburetor, 168; 1926, 172;  
1927, 173.
- Tillotson Manufacturing Co., donor, 172,  
173.
- Torricelli, 25.
- Transmission of power, mechanical,  
102-103.
- Traxler, F. K., dog power, 1878, 7.
- Treadles, Bozerian, 7; Mott, 7.
- Treadmills, 5-7.
- Tresca tests, 144.
- Trevithick, R., boiler, 105.
- Trowbridge, W. P., boiler, 1865, 114.
- Turbines, hydraulic (*see also Water*  
*motors, Water wheels*): Bibliog-  
raphy, 188; first in United States,  
17; impulse or tangential, 18-23:  
Atkins, 1853, 18, 19; bucket, develop-  
ment, 19; Doble, 22, 23; Girard, 19;  
hurdy-gurdy, 18, 19; jets, control of,  
19, 20; Pelton, 22, 23. Reaction, 15-  
18, 24; axial flow, first, 14, 15; Bar-  
ker, 1743, 15; Boyden, 1844, 17;  
Brooks, 1880, 21; at Conowingo, 24;  
double runner, Leffel, 18, 22; draft  
tube, 18; efficiency of early, 17;  
Fournexron, 16, 17; Francis, 17, 18;  
Greek mills, 14, 15; guide vanes, 18;  
high head, 18; Howd, 17; Hydracone,  
18; I. P. Morris, 18; Jonval, 16, 17;  
Kilburn, 17; mixed flow, 18; Morris,  
17; Norse mills, 14, 15; Poncelet, 16,  
18; radial flow, 16, 17; Scotch mills,  
16; seal rings, 18.
- Turbines, steam (*see also Steam en-*  
*gines, rotary*): Bibliography, 188;  
Branca, 26; Davis, static pressure,  
59; De Laval, 1883, 100, 189; Gen-  
eral Electric, 1926-1930, 57; Heron,  
24, 26, 59.
- Tuthill, N., windmill, 10.
- Twibill, G., boiler, 114.

- Uhry, H., and H. A. Luttgens, valve gearing, 1855, 64.
- Union Manufacturing Co., assignees, 138.
- United American Bosch Corporation, donor, 173.
- United Fire Engine Co., No. 3, donor, 140.
- United States Military Railroad Department, engine, 1864, 48.
- Universal joints, 103.
- Uppercu, I. M., donor, 168.
- Vacuum vapor "power plant," 1933, 58.
- Valve gears, steam engine, 60-79: Adams, 1838, 62; Allen, 1841, 62; 1842, 63; 1848, 63; 1855, 64; 1857, 65; Babcock & Wilcox, 1866, 67; Bartlett, 1867, 68; Brown and Burleigh, 1856, 69; Buckeye Engine Co., 69; Carhart, 1866, 67; Corliss, 1849, 71; 1851, 72; 1859, 74; 1860, 77; 1875, 76; 1876, 77; 1882, 78, 79; cut-offs: drop, 60-65, 71-74, 76-79; first, Watt, 1776, 1782, 60; riding, 62, 67; rotary, 66; separate valves, 63; variable, 60; Gilman, 1850, 65; Greene-Wheelock, 70; link motion, 54, 55, 64; Otto and Bell, 1883, 70; poppet, 61-65, 68; Richards, 1866, 68; Rogers, 1845, 71; Sickels, 1841, 60-62; 1852, 64; steam-boat, Stevens, 1861, 66; Steenstrup, boiler, 1828, 106; Stephenson, 54, 55, 64; Stevens, F. B., 1861, 66; Stevens, F. B. and R. L., 1841, 66; Stone, 1865, 71; Sulzer Brothers, 71; Thompson, 1875, 69, 85; Uhry and Luttgens, 1885, 64; Wiegand, 1857, 65; Wheelock, 1885, 70; Woodbury, 1859, 66.
- Valves, steam-engine: Balanced, 67, 68; cone valve, 64; governor, 79, 98; grid-iron plug valves, 70; slide valve, 70; throttle, 79, 98.
- Van Deren, G. W., steam engine, 59.
- Van Dusen's Garage, donor, 174.
- Vapor engines, carbon disulphide, 1879, 101; mercury, 1877, 60; vacuum vapor power plant, 1933, 58.
- Vertical windmill, 1879, 12.
- "Viking Tower," 9.
- Vincent G. Apple Laboratories, donor, 174.
- Vinci, Leonardo da, 8; chimney jack, 175.
- Vitruvius, water mill, 14.
- Voight, H., 33, 115.
- Volcanic engine, Evans, 146, 182.
- von Guericke, 25, 26.
- Vulcan electric gearshift, 163.
- Wadsworth, H., boiler models, 139.
- Waldo, P. G. and H. Reily, rotary steam engine, 1875, 57.
- Walker, B. P., belt joint, 102.
- Ward, J. B., 47.
- Warden, H., licensee, 157.
- Wardlaw, F. A., model of fire engine, 141; steam engines, 59.
- Wardlaw, F. A., and F. A. Jr., donors, 59, 141.
- Warren, J., spring motor, 1880, 7.
- Washburn, aerosteam engine, 182.
- Washington, George, 5, 35.
- Water engine, Leuchsenring rotary, 1880, 21.
- Water-level alarm, Frick, 1858, 120.
- Water mill, first, 14; gearing, c. 1870, 20.
- Water motors, Colton, 1881, 24; Lamb, 1865, 24; mills, 1887, 24; domestic Eyster, 1879, 21; Haworth, 1878, 20.
- Water wheels (*see also* Pelton, Turbines, hydraulic, and Water motors): Bibliography, 188; breast wheel, 15; Brooks, 1880, 21; current wheel, 14, 18; Doble, 1899, 22; efficiencies of, 15, 17; firsts, the *Noria*, chain of buckets, water mill, 14; over-shot, 15; Poncelet, 15, 18; Roman mill, 14; tangential, 18; undershot, 15, 16.
- Watkins, J. E., donor, 86.
- Watt, James, 5, 25; boilers, 104-105; condenser, 1769, 25, 96; engines, 31; engine at Savannah, 1815, 42; engine cut-off, 60; engine indicators, 89, c. 1796, 90; indicator diagram, 90. (*See also* Boulton & Watt.)
- Webster Electric Co., magneto and igniter, 174.
- Webster furnace, 117.
- Weis, A. L., donor, 53.
- Weis, F. N., model river steamboat engine, 53.
- Westinghouse, stoker, 117; junior steam engine, c. 1900, 54.
- Weston, T. A., chain hoist, 4.
- West Point Foundry, 39.
- Wheel-and-axle, mechanical element, 2.
- Wheeler, L. H., windmill, 10.
- Wheeler, S., universal joint, 1869, 103.
- Wheeler, W. A., windmill, 1879, 12.
- Wheelock, J., valve, 1885, 70; Greene-Wheelock valve, 70.
- "Whirlwind," Wright engine, 165.
- White, W. M., hydracone, 18.
- Whiting, J. M., aerosteam engine, 1879, 182.
- Wiegand, S. L., valve gear, 1857, 65; boiler furnace, 110.
- Wilcox, S., Jr., boiler, 108, 114; hot-air engine, 176.
- Wilcox, S., Jr., and G. H. Babcock, boilers, 1867 and 1876, 115; steam generator, 1876, 116; valve gear, 1866, 67. (*See also* Babcock & Wilcox Co.)
- Wilkinson, D., 33.
- Willet, A. W., 31.
- Williams, Hitzeroth, and Macdonald, rope drive, 103.
- Willis, W. N., steam engine, 59.
- Willys-Knight, engine, 1927-28, 164.
- Willys-Overland, Inc., donors, 164.
- Wind-electric generators, 11; Farmer, 1880, 13.

- Windmills, 7-14: Airplane-propeller, 11; American type, 9, 11, 13; Benson, 1878, 14; Bevil, 1880, 13; bibliography, 187; brakes, 8, 13; Burnham and Halladay, 10; construction, early, 8; Cook, 1878, 14; Cottle, 1879, 13; Crusaders brought to Europe, 8; directing into wind, 8-11, 13; Dutch type, a Flemish invention, 9; Dutch type in America, 9, 10; electric generators, 11; Farmer, 11, 13; firsts, authentic record, 1191, 8; wind wheels, 7, 8; governors, 9, 10; Halladay and Burnham, 1854, 10; Halladay Co., 10; Heron, c. 150 A. D., 8; horizontal, 11; Kumme system, 11; "Magnus effect," 11; Monitor, 1881, 11; at Newport, 1677, 9; paddle wheel, horizontal and vertical, 12; Perry, T., experiments, 10, 11; improved efficiency, 11; post mills, 8, 9; prairie, 12; pulley winder, 9; Smith, E. H., 1878, 14; smock, 8; Sparks, Monitor, 1881, 11; tower mills, 9; vertical, 12; Wheeler, 1879, 12; Wood, 1879, 14.
- Wind power, 7-14.
- Wind wheels, 7, 11.
- Winslow-Baker-Meyering Corporation, donor, 184.
- Winton, A., automobile engine, 165; carburetor, 167.
- Wittig, W., and W. Hees, gas engines, 1879, 154, 155; 1880, 147.
- Wood, H. M., windmill, 14.
- Woodbury, D. A., shaft governor, 1870, 83; valve gear, 1859, 66.
- Woolf's boiler, 105.
- Worcester, Marquis of, steam engine, 25.
- Worthington, H. R., direct-acting pump, 1855, 133; "duplex" pumps, 1859, 134; 1871, 135.
- Worthington, H. R., and W. H. Baker, direct-acting pump, 1849, 134; water-level gauge, 1847, 119.
- Wotapek, J., injector, 1884, 130.
- Wright aircraft engines, 165.
- Yale and Towne Manufacturing Co., donor, 3.
- Youle, J., iron castings, 36.
- Zenith carburetor, 168, 171, 172.
- Zenith-Detroit Corporation, donor, 171, 172.













SMITHSONIAN INSTITUTION LIBRARIES



3 9088 01421 2567