

THE BUSINESS HEN

(THE LATEST HATCH)



THE RURAL NEW-YORKER, NEW YORK



Class S F 487
Book - C 7
Copyright N^o _____

COPYRIGHT DEPOSIT.



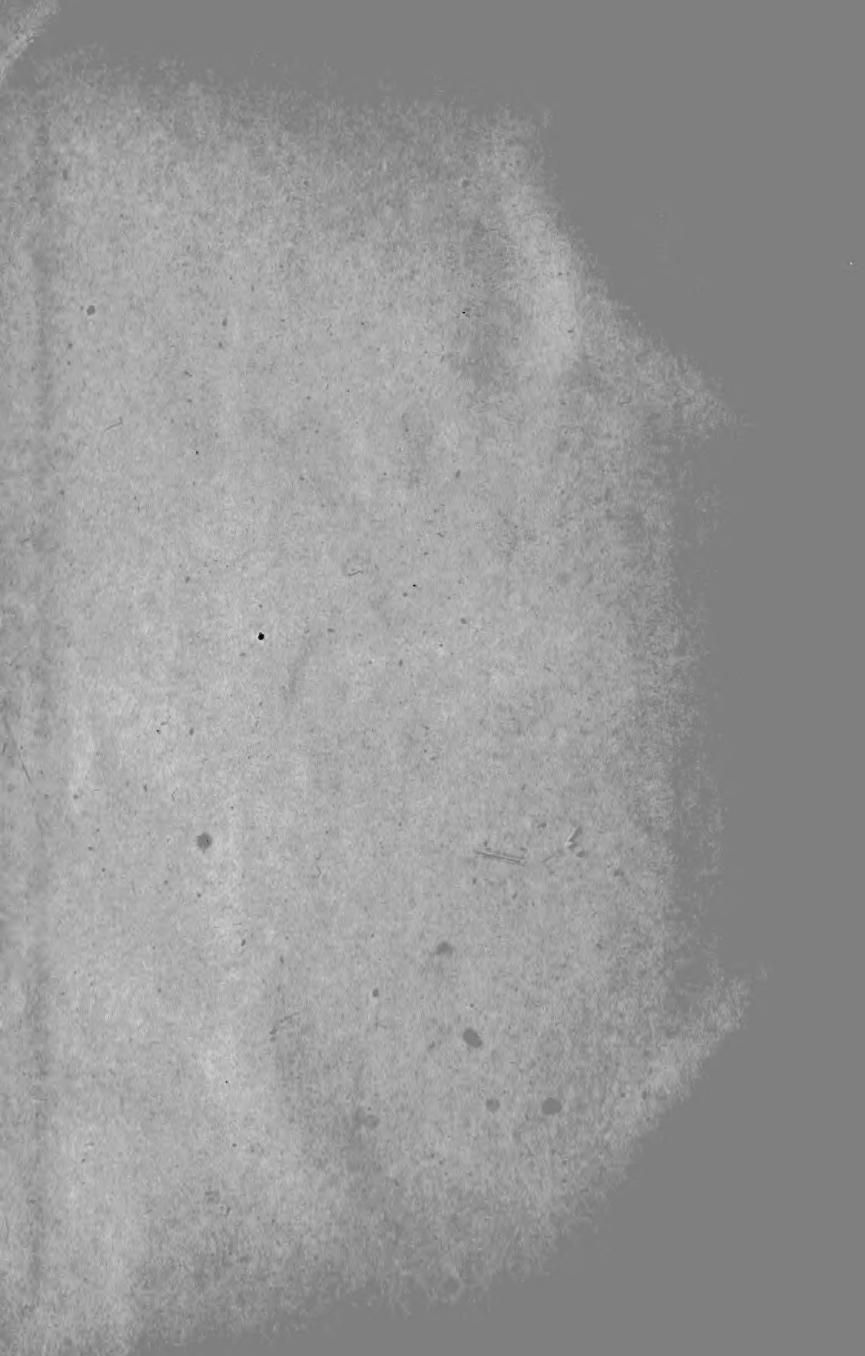





11

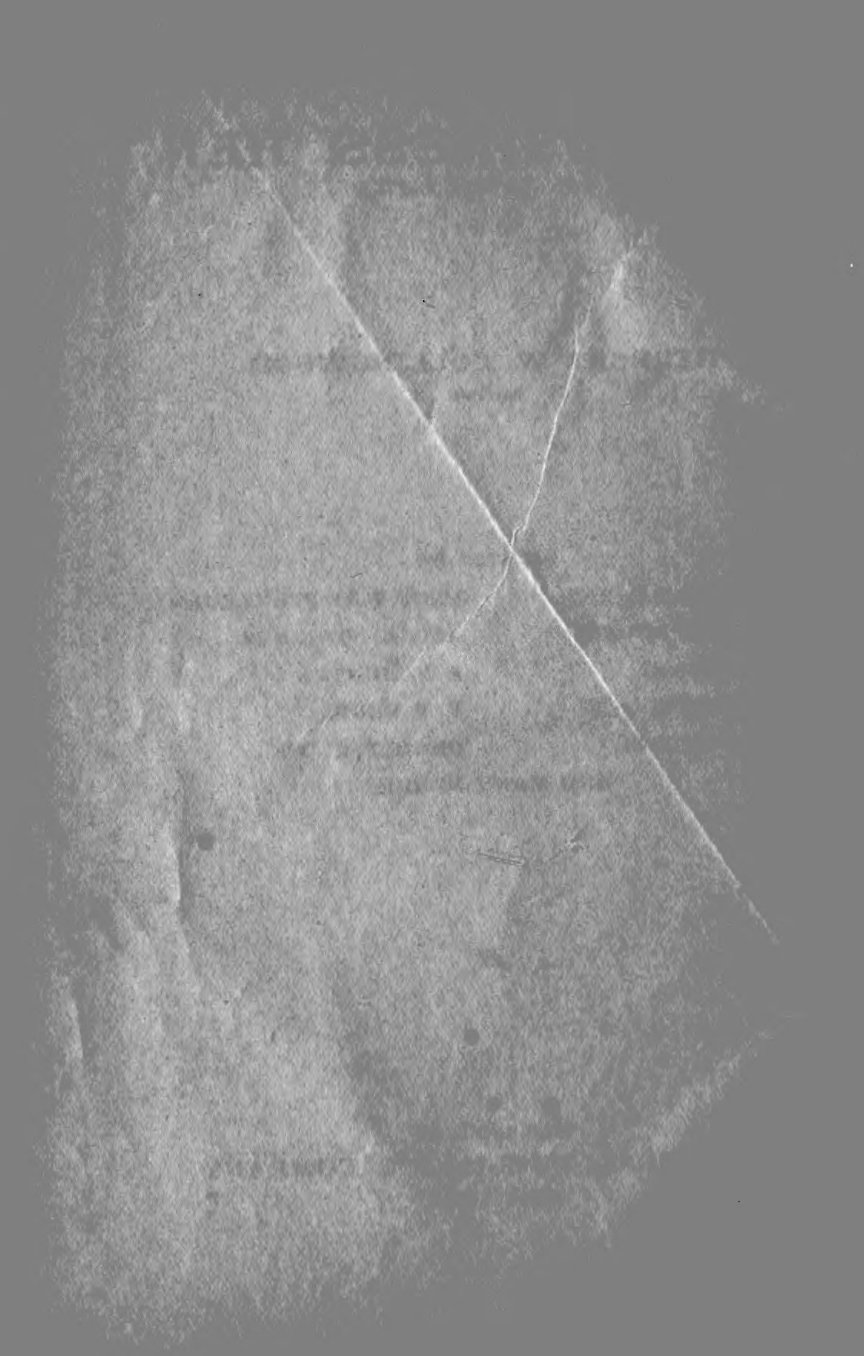

THE BUSINESS HEN

(THE LATEST HATCH)

HERBERT W. COLLINGWOOD

EDITOR

720

686

ASSISTED BY

PROF. JAMES E. RICE

PROF. F. H. STONEBURN

PROF. C. A. ROGERS

GEO. A. COSGROVE

C. S. GREENE

A. F. HUNTER

F. Q. WHITE

F. T. FINCH

W. W. HIGGINS

JESSIE F. CLOSE

AND MANY OTHERS



PUBLISHED BY

THE RURAL PUBLISHING COMPANY

NEW YORK

SF487

C7.

COPYRIGHT, 1910,
BY THE RURAL PUBLISHING CO.
All rights reserved.

out. Dec. 22, 1910.

FOREWORD

There's lots of folks that love a horse
About as well as they know how.
We ain't all built alike—of course
There's them that do just love a cow
Above their wives. Some folks will sleep
When hogs or horses have the talk,
But start a word edgeways on sheep
And see the way their tongues will walk.
And some folks sit up half the night
To paint the virtues of a hog,
And I know folks uncommon bright,
Who rub their love thick on a dog.
I have, 's now I do rejoice
No quarrel with my fellow men,
But of all animals my choice
Forever is—the Business Hen.
She may not average quite so strong
As sheep or hog or horse or cow,
But then she rolls her eggs along
And pays her bills—that suits me now.
I'm not the one to fight or knock
When others claim big things—but then
My mind is made up like a rock;
You can't fool *me*—I love the hen.

INTRODUCTION

It is now nearly twenty years since the first edition of "The Business Hen" was published. That book was prepared in order to answer thousands of questions which were asked by readers of THE RURAL NEW-YORKER. The original volume was crude and imperfect, yet it met with a large sale, chiefly because it was practical and gave the everyday experiences of working hen men. The questions continued to come, and we found as the years went by that poultry culture was developing rapidly. Many new ideas were being developed, and continued years of experience gave a vast amount of new and useful information. Six years ago we issued a new edition of the book which was called "A New Brood." With the help of expert poultry teachers and successful hen men the book was greatly improved in every way and many thousands were sold. The edition was soon exhausted, yet though many new poultry books have been published, there were still calls for "The Business Hen." We found that the poultry business was still developing. Study and experience were constantly changing some of the old ideas, and the questions still continue to come. We have therefore prepared this new volume which we call "The Latest Hatch." We started its preparation with the ambition to get together the most useful poultry book in the language. The reader must decide for himself how far this ambition has been gratified. We have read all the poultry books we could find. Most of them seemed to us to be published for certain definite objects—to tell some "great story," to exploit some personal views or to advertise either the book itself, some breeder's stock or some manufactured article. "The Business Hen" does none of these things. We have purposely avoided all reference to big stories in the book, for those things do far more harm than good to the beginner in poultry, and there is no such thing as a concealed advertisement to be found in this volume. We have simply tried to tell in simple language which all can understand how to breed, hatch, raise and handle the hen that is capable of feeding the family or rolling a mortgage away upon her eggs. That is what we conceive the "Business Hen" to be, and we have tried to hold

INTRODUCTION.

fast to the subject. As we have stated, the original book grew out of an effort to answer thousands of poultry questions which were asked by our readers. These questions have become more numerous than ever, and in "The Latest Hatch" they have been grouped and classified for answer. Our plan has been to go to some expert with each group of questions and let him cover them in a concise and practical chapter. Thus the chapter on "Incubation," by Mr. Finch, is, we believe, the most useful discussion of the subject ever given in condensed form. In like manner the chapter on "Brooding," by F. Q. White, is the boiled-down experience of a life spent in the chicken yard. The entire book has been prepared in this way. The chapter on "The Business Hen House," by Professor Rogers and the chapters by Professor Rice and Professor Stoneburn, in fact the entire book, form a solid foundation for the study of poultry culture. Our effort has been to give facts and state principles clearly. No man can give another "instinct" or that peculiar quality which makes the successful hen man. We realize that no one can obtain this quality from the printed page. The reader must understand that he must develop that for himself, and if he will do it he will find no better friend on the farm than our little servant in feathers, "The Business Hen."

CONTENTS

	PAGE
Chapter I. The Business Breeds.....	9
Chapter II. What Is an Egg?.....	14
Chapter III. Hatching the Egg.....	24
Chapter IV. Brooding	40
Chapter V. The First Summer.....	50
Chapter VI. The Business Henhouse.....	56
Chapter VII. Diseases of Poultry.....	68
Chapter VIII. Feeding the Business Hen.....	82
Chapter IX. Breeding the Business Hen.....	92
Chapter X. A Connecticut Man's Experience.....	108
Chapter XI. Marketing Eggs.....	116
Chapter XII. Killing and Marketing Poultry.....	121
Chapter XIII. A Woman's Hens.....	126
Chapter XIV. The Poultry "Systems" Discussed.....	131
Chapter XV. Side Lines in Poultry.....	136
Chapter XVI. Homemade Poultry Devices.....	143
Chapter XVII. Poultry in Large Flocks.....	154
Chapter XVIII. Companions of the Hen.....	163
Chapter XIX. A Big Family of Roasters.....	169
Chapter XX. All Sorts of Hen Methods.....	173
Chapter XXI. Odds and Ends.....	180

CHAPTER I.

THE BUSINESS BREEDS.

No man can succeed with poultry unless he is "half hen with feathers growing on his back." This means that such a man must love the business and also love and understand a hen, otherwise he can not gain that "instinct" which is the foundation of all success in handling animals. We recognize this at the beginning, and therefore do not attempt to lay down any cast-iron rules for poultry keeping. A man who gains this hen instinct can make a success with any breed of poultry. To such a man, any breed, no matter what, is the best business breed, but as a rule any man will do his best with a breed which possesses temperament and action not unlike his own. There is much human nature in a hen, and a man may well look for this quality in his feathered friend, just the same as in his human companions. That is why we would not pretend to select a breed of poultry for a stranger, nor would we lay down any definite advice regarding this point. All that we can fairly do is to give the simple characteristics of the various business breeds or types, leaving the reader to study the hen himself and make his own choice. The wisdom of this will be recognized by anyone who remembers that there will be as great difference in profit between two flocks of the same breed as there will be between two flocks of different breeds. There may be mutual exchange of character between a man and his flock of hens, and possibly that is one reason why some men grow better when they become hen keepers, while some flocks grow poorer through association with men.

The average man will not care so much where the breed comes from or for its fancy points of feather and shape, as for its general characteristics, and whether it is adapted to his temperament and condition. This book is not for the fancier or for the men who pay most attention to feathers, comb and feet, but rather for plain people who do not want to keep hens so much as to have hens keep them. For such purpose we may roughly class the business breeds for profit and quality under four heads—the Mediterranean or nervous, non-sitting breeds; the American breeds, those originated or made up in this country to suit local or special conditions; the Asiatics, which represent a large, heavy type of birds, useful mainly

as meat producers or for crossing upon other breeds, and the Europeans or breeds native of Europe and Great Britain, which combine to some extent the good quality of the three other classes.

The Leghorn is the best example of the non-sitting class. This is a small nervous high-strung hen with a very large comb. The Leghorn without question is the best breed for those who want an abundance of large white eggs, and are willing to hatch the chickens very largely in incubators. In our own experience the Black Minorca, which resembles the Leghorn in many respects, lays a larger white egg, but we find this breed is not as hardy as the Leghorn. In fact, it is quite tender in a damp climate and requires on the whole considerable more food. The Black Minorca with us stands confinement better than the Leghorn, but does not mature as early. There were originally two distinct types of the Leghorn, the Brown and White. We have found the Browns rather smaller than the Whites. The young greatly resembling young partridges. The Brown lays a smaller egg, except in a few families which have been selected or bred with a view to increasing the size of the egg. The Brown is probably hardier than the White, does not appear to be so nervous, will stand confinement better, and the average specimen will probably lay a few more eggs than the Whites. The Browns, however, are very difficult to breed true to color, and they do not make as good a carcass when dressed. The White Leghorn may be said to represent in the poultry world about what the Jersey cow does in the dairy—nervous, active, small in size, but great in production. Some of the most successful poultry plants in the country use the White Leghorn exclusively. The objections to Leghorns are the small size in some families, the large comb which makes them tender in Winter and in some places the fact that the hens rarely sit, so that an incubator must be used. This, however, is not much of an objection in modern poultry keeping where the incubator is considered a necessity anyway. The White Leghorn hen is not only a most excellent layer, but her brother, the cockerel, makes a good broiler, growing rapidly, and when properly fed and handled giving a good proportion of breast meat. One argument in favor of the Leghorn is their small size, which will enable one in a town lot or in a back yard to keep a good number of them in one house. From our experience, however, we should prefer the Wyandottes or Light Brahmas in such situations, since they are tamer and will stand confinement better. As a rule, the eggs from the Leghorn are very fertile, and the hens mature rapidly when given good care. There are several other breeds which are put in this class, but the Leghorn is typical of the lot.

Of the American breeds the three most prominent are Plymouth Rock, Wyandotte, and Rhode Island Red. These are all "made" breeds, originated by crossing two or more breeds and carefully selecting through several generations until a definite type has been fixed. The history of the Rhode Island Red gives us a good instance of this. For a good many years certain farmers in Rhode Island selected red fowl out of their flocks. The reasons they gave for doing this was that they believed these red birds were particularly hardy. At that time there was much foreign shipping from the ports of Rhode Island, and the sea captains brought home fowls from other countries. These birds came from Europe and Asia, and the result of bringing them over and mixing them with Rhode Island flocks was the production of what was practically a new breed. Through the selection of these red birds, naturally when picking by color many different types of birds were brought out, but finally it was decided to select not only by color, but for definite form, shape and other characteristics. The result was an ideal hen, and by holding to this ideal in the selection of birds the Rhode Island Red breed, as we have it now, was brought out. This breed is very popular in many places. It is probably the best Winter layer of any of the American breeds. The hens are good sitters, mature early, and are quiet and good-natured under confinement. They make a good carcass, and are greatly prized for their color. This color, however, is not as well fixed as in the case of the Plymouth Rock and the Wyandotte, and those who breed Rhode Island Reds are still obliged to reject a fair number of their birds each year for this reason. The Plymouth Rock is an older breed than the Rhode Island Red, supposed to have resulted from crossing the old Dominique and the Java with the Brahmas. It is also claimed that Game blood was used. The breed now, however, is thoroughly fixed. Originally the Plymouth Rocks were barred or speckled, but of late years half a dozen colors have appeared such as White and Buff. It is not claimed that the colors particularly improve the quality or value of the bird, although without question new blood of other breeds was used with the original Plymouth Rock to produce the new colors. The Wyandotte is also a "made" breed, produced by crossing two or more other breeds. As between the Plymouth Rock and the Wyandotte there is much argument as to which is the better bird. It would be easy to find a single flock of one breed which is better than another flock of the other breed, but this would be due more to the care in selection of the owner than to the natural qualities of the breeds. Generally speaking, the Plymouth Rock is a larger bird than the Wyandotte, and also lays a larger egg of a more dis-

tinct color. While some flocks of Plymouth Rock will lay more eggs than the Wyandotte, the two breeds are probably about equal in this respect. The Plymouth Rock as a rule will average larger than the Wyandotte, although it is claimed for the better class of Wyandottes they are of somewhat better shape and that when dressed for market they have fewer dark pin feathers and also show clear, yellow skin. The Wyandottes also, as a rule, being smaller birds, will mature quicker than the Rocks. Good arguments can be made for all three of the leading American breeds, so that it is largely a question of the man behind them rather than the birds themselves. A new breed known as Buckeye has now appeared. These Buckeyes are said to have been made by crossing a Pea Comb Rhode Island Red with an Indian Game. They are very much like the Rhode Island Red fowl, except in the under color, but for practical purposes the Buckeyes are much like the Reds, and very useful as general purpose fowls. One feature of this American breed is the fact that, with the exception of the Reds, they are bred in various colors and also various forms of comb, both single and rose comb being found.

The Asiatic breeds are very much larger and less active than either the Mediterranean or the Americans. The most prominent example of this class in this country is the Light Brahma, a very old breed which has been kept true to type. With us the Light Brahma is a very useful breed. They are very slow, very quiet in disposition, and well adapted to a cold country or to limited space. They stand confinement well and are exceedingly good birds to have upon a lawn, as they present a beautiful appearance, and will not do much damage in a garden. We have seen them lying down in the shade under the lawn trees very much like a flock of sheep. The comb is small, the legs are well feathered and the hens seem to be well dressed in fur for Winter. We find it harder to keep Brahmas free from vermin than the lighter and thin-feathered breeds, and they cannot be fed safely on food that would be suitable for a Leghorn. When given too much corn, they fatten and stop laying. With us Brahmas rank as good layers, some families being quite equal to the smaller American birds. They grow rapidly when young and fatten easily. At broiler size they are rather skinny and bony, but for roasters they greatly excel. We think there is likely to be a revival of interest in Brahmas in coming years. They have been crowded out by the smaller breeds, but they are likely to come back in popular demand. The Light Brahma has been used in developing many of the newer breeds. The Columbian Wyandotte has the white color and black neck marking of the Brahma without the

feathered legs. The Cochins, like the Brahmas, have yellow legs and skin and are slow, good-natured birds. The Cochins are not as good layers as the Brahmas. They are very clumsy, and with us are heavier eaters and not as profitable. The Langshan is a large black bird not so heavily feathered on the leg as the Brahma, and more active than that breed, quite desirable where a black, heavy breed is wanted.

The great majority of what we call business hens will belong to one of the above named breeds. Still there are other breeds which demand attention. In recent years the Orpingtons have gained many friends. Originally an English breed, they have been well tested in America and greatly liked by some breeders. Like the American breeds, the Orpingtons were "made" by mixing the blood of several breeds. In most cases when a new breed is developed some of the Asiatics were used, and probably the Langshans are partly responsible for the Orpingtons. They are classed as fine layers and with a good carcass, but they lack the yellow skin so prominent in the American breeds. The Dorking is a very old English breed, large and well shaped. They are fair layers, excellent mothers, and probably the finest of all as table fowls, but not as hardy as others. Games have a reputation as fighters and are not much used as business birds, as we use the term. The hens lay fairly well and the flesh of the Game is excellent. In some districts where the hens run on a wide range purebred Games are crossed with Leghorns or other breeds. Such half-bred Games are good layers, very active and with enough of the fighting spirit to protect themselves against vermin. A hen with Game blood has been known to face a hawk and give it a good battle in defense of her brood of chicks. As we have stated, every breed can be used to produce the true business hen, if the man back of her knows his business. These various breeds, or most of them, appear in various colors. For example, the Plymouth Rocks and Wyandottes, originally speckled, are now to be found in white and buff. The new colors are usually produced by breeding in some outside blood and then selecting carefully for a type. There is little in the color of the plumage to indicate any superiority. The color is barely skin deep, but each variety has its admirers, and all are capable of becoming the "Business Hen."

CHAPTER II.

WHAT IS AN EGG?

The egg is the first stage in the production of birds. Its function primarily is to produce offspring, secondarily to furnish food for man. The hen, therefore, fulfills dual purposes which, in a measure, are antagonistic in their requirements. The demand of nature is that the hen shall produce eggs that possess all the qualities of life and nutrition necessary to produce strong chickens; the demand of man is that she shall furnish eggs good to hatch and to eat and lots of them. In order to satisfy the commercial requirements of man the hen often is compelled to sacrifice the higher demands of nature. It becomes a vital question, therefore, for every poultryman to decide to what extent he can force heavy laying without sacrificing the fertility of the eggs or the vitality of the chickens. It is well, then, that we inquire what an egg is and how it is formed.

HOW THE EGG IS MADE.—The first stage in the development of the egg is the formation of the "yolk." The "ovary" or "egg cluster," which forms a part of the muscular tissue on the left side of the spine, contains many yolks in various stages of development, depending upon the condition of the hen, from the full-sized ripe yolk ready to be detached, to the microscopic cells so small that they cannot be discerned by the naked eye. Within this ovarian tissue is the power to develop countless other yolks not yet apparent. The number of these yolks or "ova," which may be developed, is not a fixed quantity, certainly not exactly 600, as is frequently stated. The number of eggs which a hen will lay depends upon the inherited tendency of each hen to reproduce, and upon her vigor and vitality to withstand the heavy drain upon her system. The ovary of certain hens is absolutely sterile. Others have the power to produce a few eggs in short litters, while some have an ovary so strong and reproductive that they lay almost without cessation, and continue to do so for years. The egg-laying power is a matter of inheritance. It is a question of selection and breeding and of stimulating the ovaries to activity by proper feeding.

The cut (from Duval's "Embryology") shows the ovary and oviduct of a hen; (1) is the ovary; (2) is the yolk held within the ovisac or follicle (5). When the yolk is fully ripe, it bursts from the follicle and drops into the neck of the oviduct (3). Here

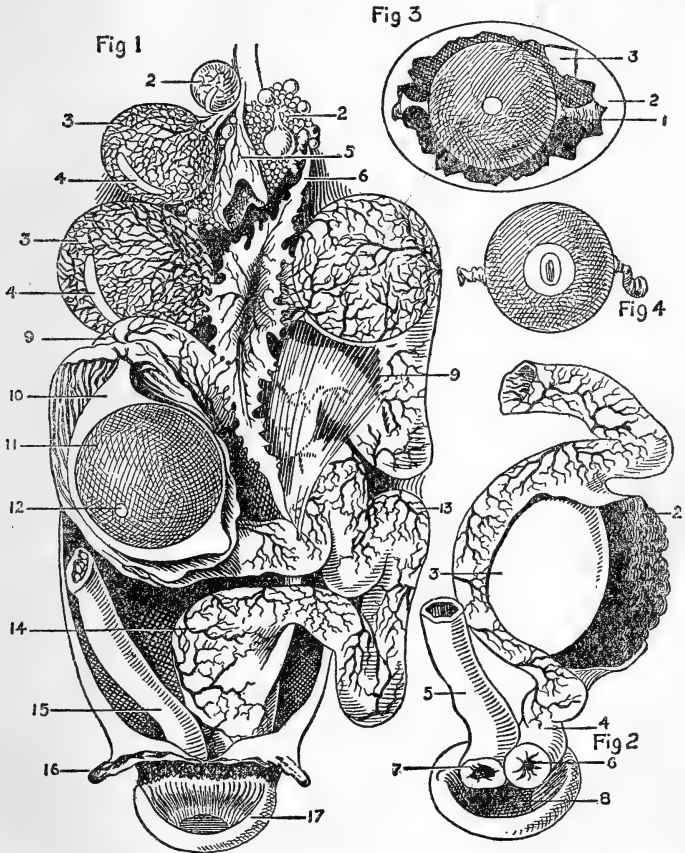

EGG ORGANS OF A HEN. FIG. 1.

we see a wise provision of nature. In order to prevent rupture of blood vessels where the follicle opens, there is a suture mark around the entire surface, where the blood vessels meet, but do not cross (4). If, for any reason, the follicle is ruptured before

it is matured, through rough handling of the fowl or because of weakness due to debility, a slight clot of blood may escape. This remains on the surface of the yolk or mingles with the white, which leads the consumer to suspect an egg which is perfectly fresh to have been slightly incubated. Occasionally, when hens are in perfect laying condition, two yolks will ripen and burst their follicles at the same time, and be encased within the same shell, producing a double yolked egg. It is perfectly apparent, then, that if the yolk is the first part of the egg to be formed, all the conditions for its development must be met, or the hen cannot make a perfect egg. The activity of development of the ovary depends first upon good health. The hen in the best laying condition is in the best health. Reproduction is a question of nerve strength, which is dependent upon physical vigor. The over-fat hen does not lay well, because over-fatness is an indication of physical weakness, which ends in debility. A poor hen cannot lay because there is no surplus fat with which to make the egg. Analysis of the dry matter of an egg shows it to be more than one-half fat. Unless the fowl can supply the available fat, the yolk cannot develop. Therefore, it will be found that the hens in their best laying condition will have a little surplus fat in their bodies.

When the yolk has entered the oviduct it is quickly passed along where the albumen or "white" is deposited (10). During the passage it is pushed forward by the contraction of the muscles of the oviduct, which, being twisted and convoluted, gives the yolk a turning motion as it advances, so that the albumen is deposited in several layers. These layers may be seen by examining carefully a hard-boiled egg. The twisting motion of the yolk in its passage causes a special deposit of albumen to form twisted, string-like fibres on two sides of the yolk. These are called the "chalazæ" Fig. 3-1. They cause the yolk to swing in the watery albumen like a hammock. This tends to prevent injury to the yolk by any jarring or jolting which the egg may receive. Whatever way the egg is turned, the yolk quickly assumes its natural position. The yolk, containing a large amount of fat, is lighter than the albumen, therefore has a tendency to float upward toward the surface, which, during incubation, allows the young germ of life, which is on the surface of the lightest portion of the yolk, to float in the warmest portion of the egg, which is in contact with the body of the incubating hen.

The yolk is covered by the "vitelline" membrane (11). The yellow liquid within the membrane is called the "vitellus," which

is used, for the most part, to nourish the young chicken just before and for several days after it hatches. The color of the yolk depends upon the kind of food fed. Yellow corn and green food produce a deep colored yolk, while oats, wheat and buckwheat produce a light yellow, due to the absence of coloring pigments in the grain. One of the first signs of weakened vitality in hens is a tenderness of the vitelline membrane, which often ruptures when eggs are roughly handled. This allows the vitellus to escape and mingle with the white. The yolks, therefore, of perfectly fresh eggs, from such hens, are likely to rupture even when the egg is carefully broken. Keeping eggs weakens the vitelline membrane.

Just under the vitelline membrane, and at the surface of the yolk, is the "germinal vesicle" (12), the vital life principle of the egg. Without fecundation by the male no life would be developed in the germinal vesicle, and the egg would be infertile. If fecundation should take place and the hen should not be in vigorous condition, life would not necessarily be developed. Infertility is due quite as much to lack of vital force of the hen, because of close confinement, excessive laying or improper feeding, as to any fault of the male. Fecundation probably cannot take place until the yolk has burst from the tough skin of the follicle (6) and has entered the oviduct (9). Here it comes in contact with the "spermatozoa" of the male, which there swarm and live for several weeks, growing less numerous and less active with age. The spermatozoa penetrates the vitelline membrane, unite with the germinal vesicle and life is begun. If the eggs should be retained for any considerable time, which often happens, the body heat will start the process of incubation, which will continue until the egg is placed in a temperature too cold for development. Eggs which are not fertile will, therefore, continue, without danger of incubation, in a temperature that would allow life to develop within a fertile egg.

After the albumen has been secreted in the part of the oviduct indicated (9), it is pushed along to a point where the shell membrane is formed. This is supposed to be somewhere at or between 13-14, after which another membrane is added. Then the egg passes to position marked (15), where the glands secrete a liquid which contains carbonate of lime and other mineral matters. The hardening process is completed frequently while the hen is on the nest. A color pigment is sometimes secreted with the shell-making liquid, which gives to eggs their characteristic colors. The color of the shell is largely an individual characteristic, and remains practically constant with the individual, except that the egg shell gradually fades in color toward the end of the laying period. This is

particularly noticeable in comparing the first and the last eggs laid by turkeys. The shell-making fluid appears to be secreted by tiny ducts, which leave their impression by numerous fine depressions or pores in the egg shell, which can be easily seen upon close inspection. The importance of providing mineral matter in the form of cracked oyster shell, mortar and bone, is seen in the fact that if the hen lacks these materials or through debility cannot assimilate them, her eggs will be soft-shelled. Naturally, when the egg production has drained her system of this material, her appetite craves it, and if it is not otherwise supplied, she will instinctively eat the egg shells. This is the most common cause of egg eating.

When the egg rests in the "cloaca," (5), before being laid, it is covered with a secretion that assists in the depositing of the egg, which, when dry, gives the shell its natural fresh appearance, and which, undoubtedly, has much to do with controlling the evaporation of the contents of the egg. Therefore eggs for hatching should not be washed unless it be to remove dirt which would materially stop the pores in the shell. This oily coating is particularly apparent on duck eggs.

It is to be doubted whether a hen can voluntarily stop the formation of an egg up to the point of its completion. But she can retain the egg at will for considerable time thereafter. It is perfectly certain, however, that improper feeding, neglect, fright, or any condition that interferes with digestion or peace of mind will stop the process of egg making in any of its stages. Frequently the white is deposited without yolk or shell. It is very common to find eggs devoid of shell, and occasionally a yolk will be laid without shell or albumen. It is not uncommon to find an egg with white and shell complete without the yolk. In rare instances a perfect egg has been found within an egg. This is brought about by the completed egg being forced back by injury through the portion of the oviduct where additional albumen is secreted and then returned to the place where a new shell is deposited. When the egg evaporates, the outer membrane continues to adhere to the shell, while the inner membrane follows the contents of the egg as it shrinks in size, thus forming the air space, which is usually at the large end of the egg, occasionally on the side and rarely on the small end.

SHAPE, SIZE AND COLOR OF EGGS.—The shape of the egg is determined by the form of the mold in which it is cast, which differs with breeds, varieties and even with individuals of the same strain. The form of egg peculiar to an individual remains

practically constant, so much so that one can pick out an egg from certain hens from a large flock with quite a degree of certainty, purely by the shape of the egg. The groups of eggs shown on next page, Fig. 2, show this point very accurately. The eggs marked (a) were laid by hen No. 56; those at (b) by hen No. 148, both White Wyandottes; those at (c) by hen No. 70; those at (d) by hen No. 75, both Single Comb White Leghorns; those at (e) were laid by a White Plymouth Rock; those at (f) by a Barred Plymouth Rock. It will be seen that each hen has a type of egg which is peculiarly her own, differing only slightly from day to day, except in a case of abnormality due to some unusual condition. The eggs marked a, b, c and d were picked out of a large tray full of eggs which were laid by different hens. The selection was made strictly upon their shape and color, without looking at the number of the hen, which is marked on the large end of the egg when it is gathered. The peculiar characteristics distinguishing the egg were so marked that scarcely any error was made guessing the identity of the hen that laid them. The eggs marked (a) were distinguishable by their large size, extreme length, and rich, uniform light brown color; eggs marked (b) by their perfect egg shape, large size and dark brown color; eggs marked (c) by their long, thin form with a tendency to a slight ridge in the center; eggs marked (d) by their almost abnormal roundness; eggs marked (e) by the peculiar wart-like excrescence on the small end of each egg.

ABNORMAL EGGS.—Abnormal eggs are due either to injury to the fowl while the egg is being formed or to faulty nutrition. Various types of abnormal eggs are shown in the cut (c) and (l) are too long; (m), (e) and (o) too round; (k) is wedge shaped; (o) has a decided ridge at the center; (f) and (q) are flattened on one side; those marked (j) are elliptical; (i) are almost cylindrical; (a) is drawn out at the point; (p) are eggs with rough, weak shells; (g) is as round as a marble and about the size of a hickory nut; (h) is about the same size, but elongated; those marked (r) represent the two extremes in size, a double yolked egg and a diminutive but perfect shaped egg. These small eggs are nearly always devoid of yolks. It does not follow that a hen that lays a diminutive egg has laid similar eggs previously or that she will do so again. Eggs marked (g), in the cut, were all laid by the Single Comb White Leghorn hen No. 85; those eggs marked (h), were laid by the Single Comb White Leghorn hen No. 82, the two normal eggs in each case being laid a few days after the abnormal. The abnormality, however, may continue. One hen laid seven diminutive eggs continuously and then stopped laying. Of the five eggs marked

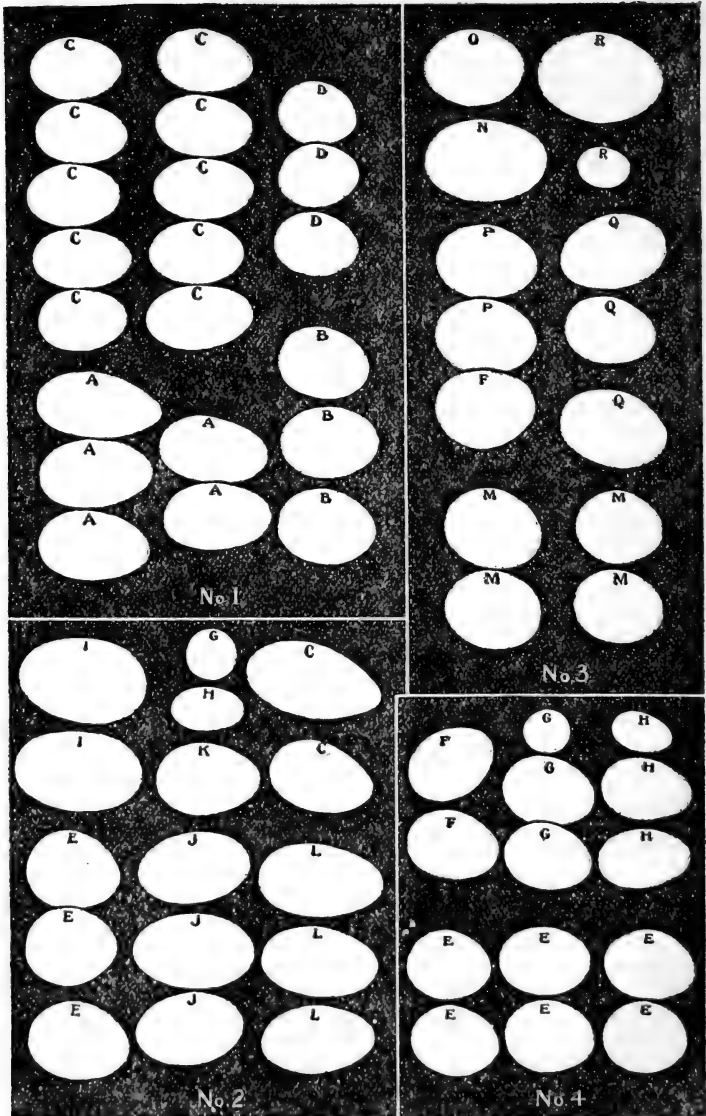

TYPES OF EGGS. FIG. 2.

(a), Fig. 2, the first two eggs which are perfect and normal were followed by the abnormal long-drawn-out egg which was so weak at the point that it scarcely retained the egg contents. Within two or three days following the other two eggs were laid which were perfectly normal and sound.

TIME REQUIRED TO MAKE AN EGG.—Just how long it takes for each part of the egg to be secreted is not known. The whole process is supposed to take about eighteen hours. Considerable time is taken for the shell to be deposited and to harden. Two eggs can be under way in the oviduct at the same time. When the hen is not laying the oviduct is shrunken and not more than one-fifth its natural size. Like all secretory organs, the oviduct enlarges when it is active. In this one respect it may be compared to the udder of a cow "fresh in milk" and one "gone dry." The oviduct when stretched out and congested is normally a little over twenty inches long.

EGG MAKING AN EXHAUSTIVE PROCESS.—The development of an egg is more elaborate and more exhaustive than a simple secretion like that of milk-making. It is both a reproductive and a secretory process. The perfect egg contains the materials and the life to form a new animal, a shell to protect it during subsequent development, and the food to nourish it for several days after it is born. A good hen is expected to lay, that is, in reality, to give birth to about 150 offspring in a year, which is equivalent to about five times her own weight. This is a heavy drain upon her system. Something of its immediate effect will be seen by the fact ascertained by one of our students (Henry Jennings) that a hen's temperature immediately after laying is from two to three degrees higher than normal, the normal being about 106.

COMPOSITION OF THE EGG.—The composition of the egg remains practically constant. This is true even under different systems of feeding. Careful observations of two Plymouth Rock hens was made and the eggs analyzed after they had been fed about three months on radically different rations. Pen No. 1 was fed largely on protein-rich foods; pen No. 2 was fed largely on foods deficient in protein, the former being a ration for making muscle and the latter for making fat. Nevertheless the eggs from the two pens remained practically identical in composition. This illustrates one of the highest laws of nature; namely, that the animal will sacrifice its own bodily strength in an effort to make a perfect offspring, which is a necessary provision to insure the perpetuation of the species. There is little difference in the composition

of eggs from different breeds, or between light-shelled and dark-shelled eggs.

There is a difference between hens that are well fed and those that are improperly fed, as shown in their fertility, the strength of the germs and the vitality of the chickens. The chemist may not be able to find the difference in the composition of the eggs, but the difference is there, nevertheless. Hens that are closely confined to limited quarters where they do not get exercise nor have access to sunshine and fresh air, even though well fed, are almost certain to produce eggs low in fertility and weak in vitality. Over-fat hens and very poor hens, if they lay at all, are certain to produce eggs which are almost devoid of the life-giving principles.

While forced feeding of highly stimulating foods during Fall and Winter might result in a condition of nerve exhaustion during the hatching season and would naturally result in less fertile eggs, it does not follow that just because hens do not lay during the Fall and Winter they will give more fertile eggs during the Spring. Most frequently the hens that do not lay during the Winter have not been properly cared for, they being either too fat from over-feeding or improper feeding, or too poor because under-fed. The fowl that lays the most fertile eggs is the one that is in the best health. She may be the hen that has laid regularly for a long period of time. To get fertile eggs, open-air exercise and plenty of meat and green food are necessary.

FERTILITY.—The proportion of males to females in the breeding flock depends upon the breed, also upon the individual. One vigorous, active, prepotent male will give greater fertility than three or four sluggish males. I have known almost perfect fertility with 36 White Leghorn females to one male and have seen almost absolute sterility where one male ran with eight females. Other conditions being equal, the Mediterranean class (Leghorns, Minorcas, etc.) can usually be mated, 20 to 25 hens to one male; the American class (Plymouth Rocks, Wyandottes, Javas, etc.), 15 to 20 females to one male; Asiatic (Cochins, Brahmas, etc.), 8 to 12 females to one male. Where fowls are kept in flocks which require two males (for instance, 40 or 50 Leghorn females), it is better to allow only one of the males at a time with the flock. The other one should be kept in a coop with plenty of water, grit and food containing an abundance of meat. Two males running together in the same flock dissipate too much of their energy in fighting. This is particularly true if they are in limited quarters. Very good results, however, are obtained by allowing one male to 25 females where fowls run together in flocks of several hundred on unlimited range.

EGG TYPE A BREED CHARACTERISTIC.—The shape, size and color of the egg being comparatively constant with individuals, it is evident that like other characteristics, they can be transmitted from one generation to another, and therefore by selecting only eggs of a certain size, shape and color for hatching, their characteristics become fixed so that a strain of hens will be developed which will lay eggs of the desired type with great regularity. This has been demonstrated where, for years, only eggs have been used that weighed two ounces or more, of perfect shape and pure white color, for hatching. Each year the percentage of hatchable eggs astonishingly increased, and the number of eggs which would have to be thrown out because of not fulfilling the requirements, materially decreased. The result is that the average size and beauty of the egg has materially increased year by year. This principle also has been strikingly illustrated on a farm where the person who took charge of the hens believed that round eggs would hatch pullets and long eggs slightly wrinkled at the small end, would hatch cockerels. For years she would select the roundest eggs for hatching, with the result that year by year the eggs became rounder and rounder, until they were abnormally so and it became almost a trade mark of the eggs from this farm. Of course the per cent of pullets continued as usual. Mother Nature could not be thwarted thus. The sex of an egg cannot be determined by shape or other external conditions.

It is well to select only perfectly shaped eggs, uniform in color, of good texture and firm shell, neither over large nor very small, because they will be more likely to produce chickens that lay similar eggs, which look better and therefore sell for a higher price and which also hatch more satisfactorily.

KEEPING EGGS FOR HATCHING.—Keeping eggs weakens their vitality. If they are held at too low a temperature the chilling injures them. If they are kept in too warm a temperature, development begins. Just what temperature is best for holding eggs for hatching is not known. It appears to be between 45 and 55 degrees Fahrenheit. Eggs evaporate moisture very rapidly if kept in a very dry room. Therefore they should be kept from a direct draft of air. They should be turned daily in order to prevent the yolks rising to the surface and adhering to the shell, in which case the vitelline membrane may become ruptured when the egg is turned. Eggs should prove fertile within three or four days after the male has been introduced to the flock. They should be fertile with the second egg after copulation takes place and may be fertile with the first egg.

CHAPTER III.

HATCHING THE EGG.

Inasmuch as strong, vigorous chicks are not always the result obtained from properly incubated eggs, it will readily be seen that successful chicken hatching does not depend entirely on the methods of incubation. The production of perfect baby chicks necessitates care and consideration further back than the development of the embryo. The selection of strong, fully matured breeding stock, well mated, properly fed and housed, has as much, if not more, to do with the production of strong offspring as proper incubation. Eggs from hens that have been laying heavily all Winter, or that have not had a sufficient amount of green food, can hardly be expected to hatch well. Eggs from hens fed a forcing ration will not produce as strong chicks as those from hens allowed to take a more natural course. The egg provides the nourishment on which the embryo grows, and it must contain the proper material to produce desirable chicks by any system of hatching. It is just as essential that we feed our breeders for strong germ production as it is to feed our layers for heavy egg production.

SELECTING EGGS.—A great deal of improvement can be made in the flock, as well as bettering the hatches, by carefully selecting the eggs for incubation. Take out all the ill-shaped eggs as well as those with thin, porous, or coarse shells. On close examination, the shells of some eggs will be found very thin and wrinkly at the little end. Such eggs are often broken during incubation. It is well to sound each egg as they are selected, by tapping two together. In this way one will soon be able to tell those with weak or cracked shells. Eggs with defective shells are sometimes selected by testing, but this method takes some time and is not considered worth while. If possible, set the eggs from each breed separate, for the eggs from some classes of fowls hatch earlier than others. The Leghorn eggs, if fresh, will hatch earlier than those from heavier breeds, and consequently some of the younger chicks will be trampled on or even prevented from breaking out of the shell. For a good, even hatch set eggs as near of an age as possible, the fresher the better.

KEEPING EGGS.—Eggs should be set as soon as possible after they are laid. It has been found that eggs set the same day they are laid

will hatch from 18 to 20 hours earlier than those kept two weeks. I believe that eggs kept over one week before setting lose hatching power, but experiments have been tried at the Department of Poultry Husbandry, Cornell University, which show that eggs can be kept two weeks under proper conditions, and still hatch well. If they are to be kept more than two or three days, it is best to turn them once a day. The eggs can be turned satisfactorily by packing them in a common egg crate and turning it each day as a new lot of eggs is packed. As soon as the eggs are gathered they should be placed in a cool place, preferably 50° F., or as near that as possible. The air of the room in which they are kept should be just moist enough to prevent evaporation of the egg contents. In cold weather, the eggs intended for incubation purposes should be gathered several times a day to prevent chilling. However, eggs containing strong germs will hatch after being subject to a very low temperature. I recently set 30 eggs which had been in cold storage two weeks, and hatched 16 apparently strong and healthy chicks. The eggs you wish to incubate should be clean, but not washed unless just before setting, and if washed, the water should never be allowed to soak in.

SHIPPING EGGS.—Nature has so perfectly constructed the egg that it will stand considerable rough handling without injury, if properly packed. Good hatches can be obtained from eggs shipped a long distance, if the shipper understands packing them. A light, well-constructed box or basket should be used. First, place a layer of excelsior in the bottom and around the sides of the basket. Then roll each egg, first in soft paper and then in excelsior. See that they are well covered and do not touch each other in the basket. After a layer has been packed, place a layer of excelsior over them. Put as many layers of eggs on top of these as you wish, but be careful to pack them with a layer of excelsior between the layers. After all the eggs are in the basket, place a good layer of excelsior over them, and sew a stout cloth cover over the top. A large, conspicuous label marked "Eggs For Hatching. Handle With Care" should be fastened on the basket. The shipper's and consignee's name and address should be plainly written on a shipping tag and securely fastened to the handle. Never ship other than strictly fresh eggs. Sometimes eggs going only a short distance are delayed several days on the road. After receiving eggs for hatching, they should be allowed to stand three or four hours before starting to incubate.

DEVELOPMENT OF THE EMBRYO.—Just beneath the vitelline membrane in the upper surface of the yolk of all eggs is found the life germ. The yolk floats in a dense mass of albumen, called the chalaza, which is in the form of cords or a hammock. The chalaza keeps

the life germ near the surface of heat, and also protects the growing embryo from injury. Although the life germ exists in all eggs, it will not develop without the introduction of the male element. The germ is fertilized while in the oviduct, and a certain stage of development is reached before the egg is laid. After the egg leaves the body development is retarded unless kept at the proper temperature. Occasionally a freshly laid egg is found to contain a partly developed embryo. In such a case the egg has doubtless been delayed for some time in its passage through the oviduct, and development continues until the egg is laid. As soon as the egg becomes heated to the proper temperature, either by contact with the hen's body or by other means, the germ again resumes its course of development, and if kept under the proper conditions of moisture and ventilation, it will continue to grow. It was formerly supposed that the germ cell contained a very small chick and that the process of development was simply enlargement. It has later been found that the germ cell contains no organs, and that its only function is to reproduce other cells like itself, these in turn having the same power of reproduction. This reproduction takes place through division; each cell becomes divided into two, each enlarging to the size of the original cell, and with the same functions. The fertile egg germ can be determined before incubation only by breaking the egg in a saucer. The fertile germ has a clear outer rim or circle with little white dots in the center, while an infertile germ is whitish in appearance and lacks the clear outer rim. After about 24 hours of incubation, blood vessels may be seen and the heart commences to beat about the twenty-seventh hour, and it commences to pulsate about the fortieth hour. The network of blood vessels continue to grow until they form a complete membrane lining the shell membrane. This is called the allantois, and its function is to take up the oxygen which penetrates the shell through the pores, thereby performing the duties which are to be performed by the lungs about the nineteenth day. The embryo appears about the second day of incubation. The eye, head, neck, heart and wings are about the first to be distinguishable. The heart may be located the third day, and the embryo which has been lying mouth downward, is turned on its left side. On the fourth day the legs appear; and the lungs begin to be formed on the fifth, but are inactive until the nineteenth day. Up to the sixth day, the embryo has been lying very still, but soon shows signs of voluntary motion. From that time on the different parts of the body, including the bill, legs, and wings, take their form, but are soft until the ninth day, when bone begins to form. During the remaining days the yolk becomes thinner, the rapidly growing embryo drawing very

heavily upon it for nourishment. By the nineteenth day the chick is fully formed and the yolk should be nearly all taken into the body. Very soon the chick should break through the air cell and use its lungs both to breathe and utter sounds, and by holding the egg to a tester the chick may be seen pushing through. After the air cell has entirely disappeared the shell will soon yield to the interior force and the chicken will begin life in a new world.

DISTINGUISHING THE SEX.—There is no means by which we can distinguish the sex before incubation. Neither is there any method of mating that will govern the sex, notwithstanding the fact that many claim that sex is indicated by the shape of the egg, such as round eggs for pullets, or that the air cell, which has a base parallel to the width of the egg, will produce a cockerel, while those which vary from this position will produce pullets.

POSITION OF EGG.—The position of the egg during incubation has some influence on the development of the embryo. If the small end is up, the head of the chick will develop in this end and the chick will be unable to free itself. In natural incubation an egg with the small end up is very rarely found. As the air space increases in size, the center of gravity lowers. In this way the large end is kept uppermost at different angles.

NATURAL VS. ARTIFICIAL INCUBATION.—Both methods of incubation have their points of merit and demerit. The methods that should be used can only be satisfactorily decided by weighing the advantages and disadvantages of each system as they would be realized if employed by you. "A good hen is, all things considered, a better incubator than man has yet invented." The old hen will very often hatch all the fertile eggs given her with very little trouble to the owner, but we must consider that all hens are not good sitters. Also, it is hard to find enough hens to cover the eggs, if a large number are to be set at a time. Often the owner has to search the country for broody hens. It is often difficult to make them sit in their new quarters. There is also great danger of breaking eggs in the nest and smearing the remaining eggs. The filthy condition draws lice and the hen is very often driven from the nest, leaving the eggs to spoil before the trouble is noticed. It is very difficult to get sitters early in the season, especially if the Winter is severe, for the laying season will be delayed somewhat, and a late broody season will be the consequence. Yet in spite of all these difficulties we cannot get around the fact that hen-hatched chickens have every reason to be perfect, as far as incubation is concerned. To be certain that the process of incubation is not at fault is enough to make us decide in favor of the hen when only a few chickens are to be raised

each season. The proof of the real value of artificial incubation in hatching large numbers of chickens lies not only in its growing popularity, but in the great advantages and remarkable results obtained, if properly handled. To be able to incubate eggs at any time, and in large numbers, is one of the great advantages which does not apply equally to hens. One incubator holding 300 eggs will do more work with less trouble than 20 hens. It is possible with machines, to hatch enough chickens in two hatches to replenish the stock and have chickens to sell. By starting the hatch early, it is possible to get out chickens before the other fellow's hens are ready to sit, and in this way have the surplus cockerels on the market when they bring the best price. Artificial incubation also makes it possible to develop practically non-sitting strains. By breaking up the sitters we are gradually doing away with the broody instinct. It is said that in Egypt, where hatching in ovens has been practiced for centuries, the hens have entirely lost their desire to incubate. Next to these valuable factors we must consider the cleanliness of incubators. With proper precautions, artificially hatched chickens are absolutely free from lice, while it is almost impossible to find a broody hen that isn't lousy, the insects are sure to get on the small chickens just when they need vitality most, causing great mortality and unthriftiness. Along with the advantages of artificial incubation comes the disappointments due to carelessness and improper management, such as overheating the eggs, lack of moisture or improper handling. There are also unjust insurance restrictions. Insurance companies refuse to admit that a building is safer with a modern incubator in it than with the common portable house lamps.

ARTIFICIAL INCUBATION.—Before installing incubators, one must consider that the operator is not relieved to any great extent. The work becomes more exacting than with hens; the results depending very much upon the operator's good sense, and a great amount of careful, regular attention, even with the best of incubators. Do not invest any money in a cheaply constructed machine. There are a great many good machines on the market; in fact most of the low-grade machines have been forced off the market or improved. When it comes to capacity, consider a long time before purchasing a small machine. Nearly all incubator firms manufacture small machines, not because they possess any special merit, but because some people demand a small one or none. There are no great advantages in buying a 60 or 65-egg incubator for the following reasons: First, a lamp that will heat a machine of smaller size will also heat one of a much larger capacity. Second, the small machines lack air capacity and are more easily affected by outside temperature.

Third, by the time the second test has been made there are not enough eggs left to pay for the oil consumed and time spent in caring for them, and the chickens hatched would get lost in a fair-sized brooder. Incubators holding from 100 to 250 eggs are most commonly used, but a 400-egg capacity incubator will produce just as good results, with not a great deal more oil, and only a little more labor. Some machines will work well and hatch a good per cent of chickens under certain good conditions. The machine to buy, however, is the one that will bring out all the healthy chicks possible, almost anywhere and at any time with the least possible care. The value of a machine should not be measured by flashy advertisements but by the results.

WHAT TO EXPECT OF AN INCUBATOR.—The novice very often expects too much of his machine, and is ready to condemn it when a few unhatched eggs are found on the trays after the hatch is completed. The fault-finder must stop to consider that when hens hatch all the eggs they are usually set on one hen's eggs, very often stealing their nests and sitting on their own eggs. These same results may be obtained in an incubator if one will go to the trouble of using trap nests and setting the eggs from each individual hen, separate from the others in pedigree trays. In this way it will be found that many hens lay strictly hatchable eggs, while the eggs from other individuals will be nearly all infertile or nearly all fertile, but too weak to hatch. Then remember that the eggs usually set in an incubator are a collection from the whole flock, and on a much larger scale than those set under a hen, and consequently the number of unhatched eggs would increase accordingly. We think very little of finding two, three, or four unhatched eggs under a hen, but the same per cent of unhatched eggs in an incubator seems destructive.

INCUBATOR CELLARS.—Owing to fire insurance restrictions, it is best to operate incubators in a building set aside from the others. They may be run above ground with some success, but generally best results are obtained under the conditions existing in a well-ventilated, partly-submerged room. It is much easier to keep an even temperature in such a room than above ground, and in warm weather is much cooler. An ideal incubator cellar should have a very high ceiling, from nine to 10 feet being a good height. The distance from the floor to the top of the ground should be about six feet, making the room about four feet above ground. The windows should be about seven feet from the floor. To afford air and water drainage, erect the building on sloping ground, having the lower end of the room above ground and the end in the slope almost entirely submerged. Plenty of windows are essential, and if

made to drop down from the top they will afford good ventilation as well as light. The windows may be shaded on bright days if the sunlight affects the temperature.

DISINFECTING.—Each time before putting in the eggs, the machine should be thoroughly cleaned, disinfected and aired. The lamp should be started and the machine kept closed for a day or so, then the incubator doors should be opened until it is well dried out and odorless. To disinfect properly, remove all diaphragms and trays, give them a good washing or spraying with some good disinfectant and put them out in the sun to dry. Then spray the inside of the machine in the same way. Leave the trays and diaphragms out until the machine is thoroughly dry. Caution: Never use kerosene oil in an incubator. If the operator is not careful, about as much harm can be done by disinfecting as without it. An oily machine, or the odor from a strong disinfectant, is fatal to embryo chicks. Nevertheless, it is essential to use some disinfectant. There are several good liquids, but a weak solution of creolin, or five per cent solution of carbolic acid which is one part carbolic acid to 19 parts water, will kill all bad odors and is also a germicide. The necessity of using only thoroughly disinfected machines is shown by experiments tried by Dr. Jones, of the New York State Veterinary College, Cornell University, in which it was found that the germs of white diarrhoea reached the incubator from the egg shell. There is also some danger of lice reaching the machine in the same way.

REGULATING.—The operator must remember that he is to do the thinking. Most machines are self-regulating to some extent, but a severe change in the weather will be likely to change the temperature in the machine unless the operator looks after the lamp flame. The thumb screw attached to the regulator should be screwed down until the temperature is kept at the proper degree, with the disk raised a third of an inch above the heater. After the machine is regulated it will be necessary to change the regulator only slightly, except in rare instances. The less you change the thumb screw after once it is regulated to run with slight variations at the proper degree, the better hatch you will get. Remember that raising the disk over the heater lowers the temperature and lowering it raises the temperature. Never put the eggs into the machine until it is correctly regulated.

FILLING THE TRAYS.—After the machine is heated and regulated to the proper temperature and thoroughly dried, remove the egg trays and fill them with the selected eggs. The trays may be filled full if necessary, but it is not wise to place the eggs on top of each

other. Before putting the eggs in the machine see that the ventilators are arranged according to directions sent out with the machine. After the trays are placed keep the machine closed until the next day, when turning should commence.

CLEANING AND OPERATING LAMP.—The lamp should be filled once a day, each morning preferred. When filled in the morning the operator has time to get the flame regulated before leaving for the night. Otherwise the flame may run up and smoke the heater after being newly trimmed, especially if a new wick is used. The lamp should never be filled quite full. The charred portion of the wick is easily removed by drawing a burnt match or a knife across the wick tube. Never cut away the unburnt portions of the wick. This method of trimming makes it harder to get an even flame and uses up the wick very soon. After the wick has been trimmed turn it down and clean the wick tube and other parts of the burner. This can be done with a knife or piece of sandpaper and then wiped off with a cloth. The burner should always be kept bright and the screen around the wick tube should be kept free from dirt. Always wipe the lamp thoroughly before replacing. It is best to keep a comparatively low flame at first until the operator becomes accustomed to the work. The flame will always increase instead of diminish after the wick is trimmed. After the operator becomes familiar with the lamp, the flame should be run high enough to keep disk slightly raised over the heater during the day. Then if the night is cold you have an extra supply of heat ready to be used. Otherwise the temperature in the machine will lower. The flame should never flicker. If it does there is something wrong, and the operator may look for a broken isinglass in the heater or a disarranged screen in the burner, or perhaps a draught. Use only high-grade oil in incubator lamps.

THERMOMETER.—Always use the make of thermometer sent out with the machine you are using. It is well to test the thermometer each season. This can be done by placing a doctor's thermometer in a basin of warm water with the one you intend to use. The water should register at least 100° F. and the thermometer should be held upright with the bulb submerged. If the incubator thermometer registers incorrectly, the difference may be marked on the metal part of the thermometer or on a tag fastened to it. Be sure your thermometer rests in the proper position in the machine according to directions sent out by the incubator manufacturers. In case the mercury becomes separated, take hold at the top of the thermometer and swing the bulb end downward with a jerk until the mercury comes together.

TEMPERATURE.—With machines where the thermometer hangs above the eggs it is advisable to keep the temperature as near $102\frac{1}{2}^{\circ}$ the first week as possible, 103° the second week, with a gradual increase to 104° after the nineteenth day. In machines using a contact thermometer, 102° is sufficient for the first week, 103° the second, with a gradual increase to 104° at the latter end of the third week. The temperature should be allowed to increase gradually to the proper degree, and should be kept as near there as possible. However, a slight variation may be expected, and without injuring the eggs. Good hatches have been obtained when the mercury has run up to 110° F. for a short time. There is more danger of injury from a high temperature at the beginning of incubation than toward the last, owing to the very delicate blood vessels which are being formed the first few days, and are very easily injured by excessive heat. For best results, the temperature should never exceed 106° F., and this only at hatching time. In case the mercury rises to 106° at any other time than at hatching, it would be better to take out the lamp or open the door for a while than to chance the regulator. The temperature will always drop on opening the machine door to remove the trays, and will remain low for some time after the eggs are replaced, but do not change the regulator, as the mercury will reach the proper degree in due time. At hatching time the operator should watch the thermometer carefully. The heat from the chicks will usually raise the temperature to 104° if there are enough eggs containing live chicks. If not, the lamp flame should be turned up a little. When the chicks start to break through the shell, the temperature will very often rise to extreme height. If the chicks seem to be suffering from the excessive heat, the lamp flame should be turned down until the temperature lowers somewhat. If the heat still remains too high, the lamp may be removed for a time. Very often the heat will remain high with the lamp out for several hours. If the chickens pant when the temperature is only 105° there is no need to worry, as this will not injure them. As soon as the hatch has passed its best and the number of chicks hatched per minute is gradually decreasing, the temperature will drop, sometimes very rapidly. This is a critical period, and the operator should be on hand to turn up the flame. Sometimes it is necessary to turn the thumb screw until the disk drops down on the heater. Otherwise the mercury will drop down to 100° F. or a little lower, and the chickens that are a little late in pipping, will be unable to hatch.

MOISTURE AND VENTILATION.—Correct moisture, evaporation, circulation, and ventilation are the very important factors of incubation and all are too closely linked together to be considered

apart from each other. Proper ventilation is as necessary as moisture, but we cannot have excessive circulation without too much evaporation. Too great a change of air absorbs the moisture in the egg too rapidly for successful development of the embryo. The result of incubation under such conditions would be a few small, weak chickens and a large per cent of unhatched eggs. Yet a deficient supply of air would be disastrous. Evaporation of the egg contents should be greatest toward the latter part of incubation, with a small amount of evaporation at first. To obtain these conditions we must have very little ventilation the first few days. This makes it plain that moisture is as necessary at the beginning as at the close of the incubation period. Eggs will stand a great amount of moisture and hatch well. The best of hatches will be accompanied by more or less moisture on the glass and door of the incubator. Very often the glass will be so wet that it will be impossible to read the thermometer for some time. Evaporation of the hen's egg will be about 16 per cent of its weight before incubation, but the amount of evaporation varies so much that it is hardly possible to determine just how much evaporation should take place. However, the amount of moisture, ventilation, and cooling necessary for correct evaporation can be determined to some extent by noting the size of the air cells and testing the eggs. Most incubator companies send complete directions for supplying moisture and operating the ventilators. Follow these directions closely. Only operators with thorough understanding of incubation and its laws should depart from the rules laid down by the manufacturers. However, there is no set of rules that will fit the needs of incubation in every locality without some alterations; but the general principles should always be followed. A general plan is to keep the ventilation restricted for the first few days of incubation, and gradually increase it from day to day thereafter. There are good machines in which ventilation is controlled by the machine itself. With these, there is no need for worry on the part of the operator as long as he does not tamper with the ventilators. It is generally considered advisable where the ventilation is controlled by slides, to close the ventilators at pipping time and leave them so until the hatch is completed. As moisture helps to control evaporation, it is just as essential when the eggs are first put into the machine, and we are trying to prevent more than a gradual amount of evaporation taking place, as it is at a later stage of development. When using a sand tray machine keep the sand wet at all times from start until finish. If hatching in cold weather, use warm water to replenish the supply. If you are using a non-moisture machine you must consider the weather

conditions and the humidity of the air in the room your incubator is in, before supplying moisture. If it is a very dry place it is best to keep the floor of the room wet. Or if in a living room, place pans of water under the machine. Use water in the machine only as a last resort.

TURNING THE EGGS.—The objects in turning eggs during incubation, are, first, to keep the germ from drying fast to the shell, also to equalize the heat units by changing the position on the tray, it being impossible to supply the same amount of heat to each egg on the tray at the same time. Operators vary in opinion as to the proper time to commence turning, but the writer's rule is to turn the second day of incubation, and continue turning, twice daily up to the nineteenth day, and as near 12 hours apart as possible. As the most important factor in turning eggs is to keep the germ from drying to the shell we only do them justice by giving them a good thorough rolling around. Do not be particular about turning them just half way over, as old operators believed. If there is a tendency to dry in the shell a careful half way turn would be of little value. Shuffle them around on the tray with the palms of the hand as though you were mixing up dominoes, avoiding sudden jerks. If there is only one tray in the machine write "Morning" one end of the tray and "Night" on the other. Then see that the end marked "Morning" is out at morning turning and the reverse at night. If there are two trays change them from one side of the machine to the other in the morning and change ends at night. In this way you are aiding in distribution of equal heat units to all the eggs in the machine.

THE NECESSITY OF COOLING.—There is some disagreement among authorities as to the proper value of cooling eggs during incubation, although it may be possible to secure fair hatches in some incubators without paying much attention to airing. In most cases it is a great deal better to use a good common sense system of cooling. In natural incubation eggs receive more or less cooling. The hen, if allowed her liberty, in most instances remains on the nest for the first few days and then leaves her nest for a very short time each day, early in the incubation period, increasing the length of time off the nest as the hatch advances. The number of times the hen leaves the nest varies with individual hens and the weather conditions. We are led to believe that the hen leaves the nest not only in search of food and recreation, but to aid in the development of the chick within the shell. The result of the proper amount of airing would be the giving off of bad odors which would naturally collect and the taking in of a new supply

of fresh air which would assist in evaporating the egg contents. As the ventilation the eggs receive in artificial incubation is crude compared to natural methods, it is all the more necessary that a system of airing be followed out as near to the natural process as possible.

COOLING DIRECTIONS.—As the eggs receive sufficient cooling the first week during the process of turning, it is not advisable to give it further attention until the seventh day, especially in cold weather. It would be impossible to form a set of rules for cooling which could be satisfactorily used with all machines, and under the various weather conditions. The length of time to cool must rest very much with the operator's good judgment. Never use your watch, as this system is too mechanical to meet the changing conditions. The most satisfactory way is to go entirely by feeling of the eggs and the number of days they have been incubating. When properly cooled they will feel quite cool, but not void of warmth when brought in contact with the face or eye. The first few days after extra cooling is commenced, it will take only a few minutes, perhaps three or five or even 10 to cool them properly. The length of time will increase as the development of the embryo progresses. By the end of the second week of incubation the live embryo will supply such an amount of animal heat that it will take some minutes to cool them sufficiently, and toward the eighteenth day if it is warm weather the operator will be almost afraid to leave them out so long. Very often in warm weather it will take from 30 to 60 minutes to cool them properly. If the weather is cold, the hatch would be ruined by such treatment. Always consider the temperature of the room and never expose eggs long in a very cold room while they are undergoing the process of incubation. There can be some dependence placed on the size of the air cells at different periods of incubation. Although the size of the air cell in two certain eggs may differ greatly at the same period of incubation and under the same condition, a degree of uniformity will be found if a number are examined. By testing the eggs at frequent intervals that are being incubated by a hen, it is possible to get a good idea about the size of the air cell; compare these with those in the incubator if set at the same time. If, after cooling for a week or more, the eggs in the machine show air cells much larger than those under the hen, and you have been following the incubator directions in regard to moisture and ventilation, you may feel quite certain that you have cooled them too much and the egg contents have dried down too rapidly; if much smaller, you should air them longer. The eggs can be successfully cooled on top of the

machine or by dropping the doors down and leaving the eggs in unless you are using an incubator containing a sand tray. With such a machine it is best to put the egg tray on top and close the doors unless it is very warm weather. A number of trays of eggs can be cooled at the same time by taking them out or dropping the doors down before commencing to turn the eggs, if you are sure you can finish turning them before they are too cool. To be sure no mistake is made, you should try only two or three machines at a time, at first, and increase the number as the eggs take more cooling. In this way a great amount of time can be saved, especially if you are handling several hundred eggs. If only two or three machines are set at a time, cool only these at a time unless you are very familiar with your work and can handle several batches of eggs without an error.

TESTING EGGS.—To learn the per cent of fertility and strength of the germs is not the only object in testing eggs. By removing the infertile and dead germs there is more room for the strong germs and the machine is more easily kept free from bad odors. The infertile eggs may be used for cooking purposes. Unless a dark room is handy, it is best to do the testing in the evening. Never allow draughts in the room while the testing is being done. If it is cold, the eggs should be kept covered, and the work done as rapidly as possible. Eggs may be satisfactorily tested in sunlight by hanging a dark cloth over the window with a round hole cut in it a little smaller than an ordinary egg. If a large number of eggs are to be tested care should be exercised in locating the tester. If not at the proper height it will become tiresome to hold the arm extended toward the tester. It may be found convenient to have the tray of eggs at the left of the tester, and in front of the operator. There should be an empty tray at the right on which to put the eggs which prove satisfactory. There should also be two small baskets handy, one for infertile, and one for dead germs. The person doing the testing should stand a little to one side of the tester so that the right hand is directly in front of it. In this way it is much easier for the eyes if looking directly into the light. Take three eggs at a time with the left hand and pass them to the right one at a time. Hold them before the tester in the right hand, large end up. As the eggs are tested, hold the good ones in the hand and place those containing dead germs or that are infertile in their proper place. As each handful is tested place the good ones on the empty tray and take three more with the left hand. In this way a great many eggs can be successfully tested in a short time without breaking them. The first test should be made the seventh day.

White eggs may be tested the fourth or fifth day, but there are generally weak germs which do not die until the sixth or seventh day, and if testing is done earlier, these remain until the second test. At first test an infertile egg is distinguished by a small dark spot with spider-like veins branching from it in different directions. This is the embryo. If the embryo is living, it will be movable. A small stationary dark spot, without the blood vessels, is a dead germ, stuck to the shell. Other indications of the dead germ are blood rings. These indicate a hemorrhage. A dead embryo sometimes floats about in the white of the egg. If the egg contents appear cloudy, with no indications of life, the germ has started and died. Perfectly clear eggs are infertile. With proper conditions of moisture and ventilation, the air cell in the large end of the egg will not be much larger than in an unincubated egg, if the testing is done on the seventh day or before. The usual time for the second test is on or about the fourteenth day of incubation.

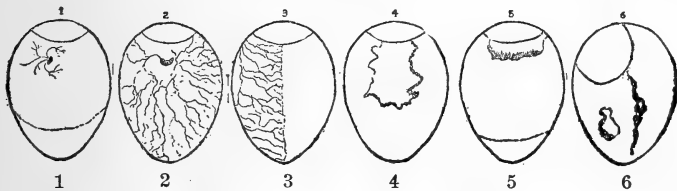

By this time the embryo should be so far developed that the space between the air cell and the embryo should be very firm and distinct, the air cell being much larger than at first test. The embryo will very often move about when held to the light. If only partial development has taken place and the division between the air cell and the chick is very dim, the egg is usually worthless. The above drawings were made from eggs which had just completed the first seven days of incubation. Nos. 1, 2 and 3 represent live germs. Nos. 4, 5 and 6 represent dead germs. No. 1 shows a weak germ, with a few blood vessels branching from it; the rest of the egg being very clear and the lowest end of the yolk is easily seen in the small end of the egg. No. 2 shows a strong germ with a net work of blood vessels surrounding it. No. 3 is the same egg turned half way around. The germ is not visible. No. 4 shows a dead germ stuck to the shell with a blood ring around it, the blood settled in this way from the burst vessels. No. 5 represents an egg which once had life. A blood clot is visible near the air cell. No. 6 shows a floating dead germ and blood

clot, also a misplaced air cell. Eggs with air cells in such a position often hatch.

THE HATCH.—Before the chick commences to pip the shell, the operator should arrange the ventilators according to directions, also arrange the trays so the chicks will drop into the nursery as they come toward the light. If pedigree trays are to be used, they should be placed the eighteenth day, after which the machine should be kept closed until the hatch is finished. If the warm air is allowed to escape, the cold air rushes in chilling the chicks. As soon as the hatch is completed, the egg trays should be removed and the ventilators opened full width. After the chickens have dried off thoroughly, the door can be fastened open about a half inch at the top unless the weather is too cold. The chickens should remain in the nursery until the afternoon of the twenty-second day, then they can be removed to the brooder. The trays, nursery drawers, if any, and the felt or burlap diaphragm should be removed and given a thorough scraping and then scrubbed with a stiff brush, using warm water or hot soap and water. The disinfectant may be mixed in this or supplied later with a spray pump. After disinfecting, the removable parts should be placed in the sun to dry. If more hatching is to be done the lamp may be left in and the eggs may be put on the trays as soon as the machine is thoroughly dried and aired. If no more eggs are to be incubated, close the machine and empty the oil out of the lamp. This will prevent the evaporation of oil into the heater, causing the lamp to smoke badly when relighted.

NATURAL INCUBATION.—Not all hens make good sitters. Nervous or ugly hens will make poor work of hatching and will doubtless trample on some of the chicks before they are strong enough to get out of the way. The best sitters are generally of the general-purpose breeds. The hen, if allowed to choose her nesting place, will often find some secluded spot in a heavy growth of grass or weeds. Under such conditions perfect hatches are often obtained, and it is customary to make the conditions as near as possible like those. A piece of sod placed in the nest can easily be shaped to conform with the hen's body. This should be covered with leaves, hay or short straw. The nest should not be placed where the hen will have to fly to and from it, and should not be so deep that she will have to jump down on the eggs when returning; but deep enough to prevent the young chicks from leaving the nest. Sitters should be placed where the other hens cannot lay to them. If many are to be set at a time, it is best

to use a separate building or pen if one is available. If not, several small coops can be constructed with run-ways attached. These coops should contain a large, roomy nest, also a place for the hen to dust in during stormy weather; and they should be high, affording plenty of air space. A common board roof is better than tin or tar paper, for such a coop, as it does not draw heat so easily. Before setting the hen, give her a good thorough dusting with lice powder, then sift some powder into the nest. The hen should be allowed to sit on china eggs for a few days before putting good eggs under her, especially if she is moved from her usual resting place. Do not use rotten eggs to start the hen with; they are easily broken and are more or less filthy, at best. The eggs may be tested the seventh day, and all clear eggs and dead germs removed. In this way one hen will often cover two hen's eggs, and the other may be broken up or given a fresh lot of eggs.

CHAPTER IV.

BROODING.

“Dwelling on, with anxiety.”—Webster.

The rock that wrecks more poultrymen than all else, is raising the necessary young stock. In other words, more people get discouraged, give it up and go out of the business because they cannot raise enough chicks to keep their flock up as it should. The trouble is not in hatching the eggs, but in rearing the chick after it is hatched. There are a good many incubators made that will, if given good fertile eggs, hatch a large per cent of strong chicks. We never worry over the hatching part. The machines are in a cellar where there is a fairly even temperature, and they are bunched so it is easy to care for them. But after the hatching come entirely different circumstances. The chicks are taken to small brooders that are

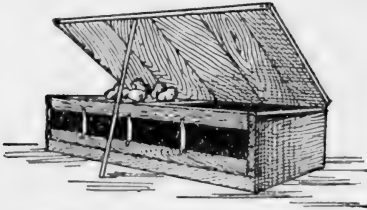

SMALL OUTDOOR BROODER.

FIG. 4.



COLONY BROODER-HOUSE.

FIG. 5.

scattered around an acre of land, or else taken to the long pipe brooder-house, and now their troubles commence.

In the small outdoor brooder we have instead of the even temperature of the incubator cellar, a variation, 50° to 75° between noon and midnight, and we have to guard against getting them too hot and weakening the chicks or having them get chilled, which is still worse for them.

The small outdoor brooder is an ideal way to raise healthy chicks, if anyone has time to attend to them properly. The great trouble is, it takes so many brooders and so much running around to care for many chicks that way, and in stormy weather it is almost out of the question to give the chicks the proper care. Anyone down on his knees behind one of these little brooders in a driving rain-

storm trying to fix the lamp, knows what trouble means. Now the other extreme is the long pipe brooder-house, which is the easiest way to care for little chicks, for you can work inside, storms cease to worry, and the temperature is more even; the chicks are not likely to get chilled, and they are together where you can care for them handily. But because the chicks are together there is much greater danger of disease spreading among them.

The runs soon get foul, and unless the surface soil is changed in the runs some way they become a menace, and in a few years a brooder house is "to let"; some one has gone out of the business, or else there is a fire and an expensive plant goes up in smoke. These are the extremes, and I would advise neither of them for the best results. We come naturally to the colony house brooder, as something large enough to accommodate 150 to 200 chicks, where the caretaker can get inside and so care for them during severe storms,



LARGE BROODER-HOUSE. FIG. 6.

yet not so large that they cannot be readily moved to new ground each year. The colony-house brooder system has been very carefully worked out at Cornell University, which has given us the Cornell A type brooder.

When Prof. James E. Rice took charge of the poultry department at Cornell he carried with him the idea of the gasoline-heated colony-house brooder which they had been building and using on their plant at Yorktown. Mr. White is still using one of the houses built when Prof. Rice was on the farm, and has the best of success rearing chicks in them. There are certain necessities which must be provided the chick in the brooder which we never worry about when the hen is caring for them. First is heat from some source, either steam, hot water, hot air, or from their own bodies, as in the tiny fireless brooders. The proper temperature for the baby chick is from 90 to 100 degrees, and the brooder that will always give 100° at its

warmest place is right in this particular. Along with the right temperature must be fresh air, which should be supplied freely, but never must cold air or a draft be allowed to strike the chicken. Plenty of exercise must be provided, which can be done by feeding in the fine litter on the floor of the brooder so the little fellows must scratch for their living. Chicks running with the hen get too much

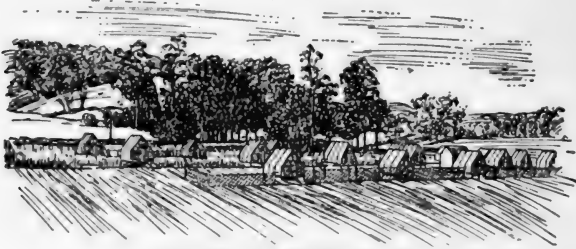

A COLONY OF HOUSES. FIG. 7.

exercise unless the hen is confined part of each day. But the average brooder caretaker seems to think that as long as the chick eats well and does not "holler" he is all right; then when the chick goes off his feet, he will lay it to the brooder, forgetting that no brooder can know more than the one caring for it.

Some advantages of this Cornell gasoline-heated colony brooder house are that it gives plenty of pure air, without drafts; provides

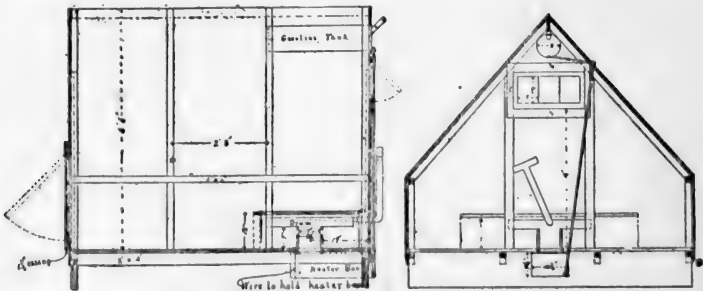

SIDE VIEW BROODER-HOUSE. FIG. 8. SECTIONAL VIEW. FIG. 9.

proper temperature, plenty of sunlight, a place for the chicks to exercise, and is roomy for the attendant. The building is eight feet square inside, side walls two feet, and is six feet from floor to top of ridge board. When intended to be movable, it should be set on sills 2x12-inch, beveled at the ends to be used as runners. The four floor joists are 2x4's, halved into the runners, making a strong

frame that will hold its shape when hauled. A double floor is best, the first being of rough material laid diagonally as a brace. On this is put building paper, and the top floor of matched dressed lumber is laid on this. Studding, 2x2 inch, is toe-nailed to floor flush with edge and plates are nailed to top of the studding.

Figs. 8 and 9 (from Cornell Bulletin, 277) show sectional and side views of this brooder-house, and Figs. 10 and 12 give vertical and ground plans of the gasoline heater, the same letters applying to both cuts. A is the burner box; B a standard Dangler lamp burner No. 154; C, pipe connecting burner and outside supply

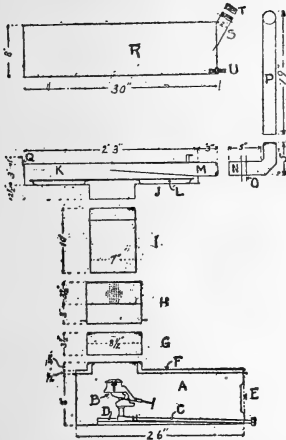
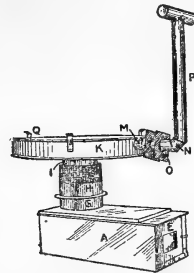
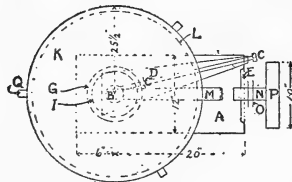

FIG. 10.—Section plan of the parts of the gasoline heater

SECTION OF HEATER. FIG. 10.



VIEW OF HEATER. FIG. 11.



GROUND PLAN. FIG. 12.

pipe; D, drip pan to carry outside any escaping gasoline, or when fire goes out unexpectedly; E is door in front of burner box, covered with wire cloth to admit air, draft being prevented by tin shield inside. Air also enters through holes in bottom of rear end of burner. F is chamber above heater box, where air entering by four one-fourth-inch holes at inside end is warmed by contact and sent through perforated tin of chick guard. G is floor collar fitting over collar of chamber F. H is chick guard, fitting over collar, G, protecting chicks from hot steam, I, and giving entrance for fresh air under hover. I is stem connecting with radiator, K. L is tin diaphragm with thick layer of asbestos on top, supported three-fourths inch

above bottom of radiator, and extending within three-fourths inch of its outer rim. M is outlet to radiator. N connection between outlet and vent pipe, P. O is sheet of tin nailed to rear wall of house, through which vent pipe passes. Q is guard to prevent hover from resting on radiator. R is gasoline tank; S, filler plug; T, filler cap, and U outlet connecting with supply pipe, C.

The method of feeding the chick in the brooder makes less difference than the care with which that feeding is done, also the kind of feed fed is not of as much importance as the condition of the feed. You cannot exercise too much care in feeding. Never feed any sour, mouldy or musty feed. Nearly all the trouble among brooder chicks comes from this cause. Either the feed dealer has ground up some feed that has started to spoil, or the feed has heated after it was ground, and, although not bad enough to be readily detected, it will cause indigestion and finally death to the chick.

To start the baby chick there is nothing finer than bread dried in the oven, ground fine and, mixed with hard-boiled eggs, run shells and all through a meat chopper; a few onions, also chopped fine, is very good to add to this. In a few days we begin mixing chick feed with this, gradually adding more until we are only feeding the chick feed for the grain ration entirely, then at three weeks old begin to add more wheat and cracked corn to the chick feed, and so in a short time you have switched them on wheat and cracked corn in equal parts without making any abrupt change in their feed. This is one of the secrets of success in feeding, to give the greatest possible variety of feed all the time and never make an abrupt change in the feed. In feeding the soft feed or mash, follow much the same plan, starting with clear, flaky bran in cake tins and switching gradually over to the regular ration of mixed dry mash, and also changing from the cake tins to deeper basins until you can use the big outdoor hoppers that only have to be filled once a week, and where the chicks run whenever they want to and help themselves. Grit is best furnished by having the floor of the brooder covered with nice sharp sand, which should be renewed every time the brooder is cleaned. Later, when the chicks are fed on the range, the grit should be scattered over the range; this is a much better way than small hoppers in the brooder. For green feed there is nothing better than fine chopped onions and lettuce for early; later on a clover sod placed in the brooder is greatly relished. But we should get the little chicks out on the grass just as soon as it is possible. The weather and temperature will change this rule, but we like to get them out on the ground when one week old; at least for an hour at the middle of the day, and just as soon as they can

be trusted to go inside if they feel cold at all, they can be let out in the morning and not shut up until night. Another necessity for little chicks is plenty of fresh water always before them. The water basins should never be allowed to become dirty or dry. If the chicks become thirsty because their basins are dry, you are in for trouble, for when water is given they will pile up around the basins, and a lot of drenched little chicks will result, which may cause chills and heavy loss.

Some partisans of the long pipe brooder-house system claim that you can raise the chicks there until three weeks old and then place them out in fireless brooders on the range where they can develop. This is all right in theory, and although all poultrymen admit a chick has very little brains, yet they have a wonderful home instinct and, if possible to get around it, should not be moved from one brooder to another. It is much better to move the brooder, chicks and all, than to try to move the chicks to new quarters while they are small. Great loss has frequently occurred after moving chicks to new quarters by their huddling on account of fright at the strangeness of their new quarters.

The many diseases of chicks should not come under the head of brooding, although they are all part of the anxiety of the poultryman, and many of them occur only during the early or "brooder stage" of the chick's life, and are nearly all caused by some neglect or blunder of the one running the brooder. Neither should vermin come in this chapter, although they are the torment of the poultryman's life, especially during the brooding season, and must always be taken account of when figuring on the season's work. The old saying, "Not every egg becomes a chicken," is true, and with the best of care "not every chicken becomes a hen or even a rooster." The awful loss among brooder chicks is responsible for a new business called the "baby chick" trade. There are lots of poultrymen who have ample capacity in their incubators for all their needs if they could only raise a fair proportion of the chicks hatched. But as the season advances and they figure up their mortality, in desperation they send to some hatchery and buy baby chicks by the thousand in order to come somewhere near the number of birds they need to fill their houses. Of course there is a demand for these baby chicks from people who have no incubators, but that this is small can be reasoned, because anyone going into the poultry business extensively will have his own incubators, as the hatching is the easiest part of the business.

Some years ago it took a whole lot of nerve to pack a lot of freshly hatched chickens in a box and ship them away by express.

and if the one who first tried it was very familiar with the express companies' methods how surprised he must have been to find the chicks had arrived safely at their destination! From some such small experiment has grown the new business, that of selling and shipping baby chicks or "day olds" as they are sometimes called. This business is done by large hatcheries, in mammoth incubators and on an immense scale. There are men with their incubator capacity of many thousands of eggs who make a business of hatching and shipping baby chicks all over the country. Many smaller breeders are advertising eggs for hatching and baby chicks at the same time, counting on hatching the eggs they can't sell for others to hatch. This is no business for the amateur to start, as only an expert with the incubators can be sure of "good hatches," and there is no money in anything but the best of hatches from vigorous stock, for one has to get a reputation for strong vitality in the chicks if he would sell twice in the same neighborhood. It takes lots of nerve for a lover of chickens to take a hundred of the little downy balls and pack them in a flat box, nail down the cover and leave them to the tender mercies of the express company. Yet there are thousands shipped every day throughout the hatching season. Baby chicks must be shipped direct from the incubators before they have been fed. We commonly use a box with sides about five inches high and large enough to hold 100 or more chicks, first spreading some muslin or burlap over the bottom of the box, on which we spread a good layer of cotton and then fold back the cloth on which we then place the baby chicks just enough so they will not pile up on each other, then back over the chicks goes the cloth, to be again covered with cotton and after folding back again over the cotton the box is ready for the cover to be nailed on. Some shippers use feathers instead of cotton, and it is wonderful how they will stand transportation if rightly packed.

A CONNECTICUT MAN'S OUTFIT.

If the average poultryman would spend as much for a chick raising outfit adapted to natural methods, as he does for equipment based on artificial methods, he would get considerably better results, and at the same time reduce the cost for labor and feed materially. When I first began raising chickens I was not able to find that anybody had put much thought into the problem of raising chicks with a minimum of attention. The outfit illustrated at Figs. 13-14 is the product evolved through experience, and after several seasons' use I cannot suggest any material modification. In round numbers I have in one year raised to broiler size or beyond,

700 chicks out of 1,000 hatched. So far as I could see practically all that loss was due to lack of inherited vigor.

Given a good chick to start with, the problem is to protect from vermin and storms, and at the same time maintain favorable environment. The latter requirement means frequent change to fresh ground and my "chickery" is designed to provide this with a minimum of labor. Everything is so that it is only necessary to lift slightly on the end away from the coop and drag as far as may be desired. On rainy days an old sack is thrown over the open part of the top, so the storm danger is practically eliminated.

By running the eggs under the hen for nineteen days and then shifting to the incubator to hatch, the little fellows have a couple of days to get on their pins, safe from lice or being trodden under-foot. Then I take them out, grease their heads, put about a dozen under a hen, and keep them in the "chickery" for three weeks. When they are about a week old I grease their heads again, and

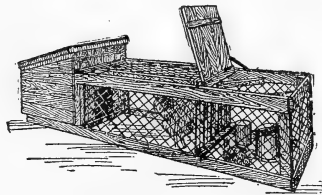
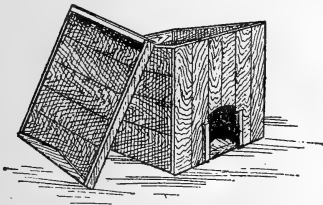

SMALL CHICK HOUSE. FIG. 13. WITH YARD ATTACHED. FIG. 14.

then make a final application when they are given free range. For three weeks they seem perfectly contented in their confinement, but after that they grow restless, and do better running free.

These outfits are 7 feet long over all, 2 feet wide and 20 inches high. The chicks are fed commercial chick feed by means of an automatic device made of wire screens. By pecking at this they work out just what they need but no more. The slatted partition lets the chicks into the feeding compartment, but keeps the hen out. The saving in feed at $2\frac{1}{2}$ cents a pound is no small item of advantage. The water can hangs from above, the same as the feeder. The hen can reach it to drink all she pleases, but she cannot tip it over, or scratch it full of dirt. Beef scrap is supplied after the first week, in a little hopper tacked to the corner post, opposite the feeder. The old hen is fed principally on whole corn.

With these outfits it is not necessary to go near the little chicks oftener than once a day in good weather. Any attention may be given after dark as well as at any other time. I have

frequently gone out in the evening, moved the chicks to fresh ground, filled up the water tanks and feeders, thrown in some whole corn for the old hen's breakfast, and then returned thirty-six hours later to find everything all right. But best of all, the feed is right there waiting the moment the chicks wake up in the morning, and that is several hours earlier than a good many people realize. System and the right equipment make it possible to raise first-class chickens without much interference with the regular daily routine.

HOMEMADE BROODER.—"The material required is an empty one-pound coffee can, a two-pound coffee can, a piece of galvanized sheet iron 24x36 inches, with a hole in center that will just fit the one-pound can, 85 feet of seven-eighths-inch matched pine and six feet of one-half-inch pine. Make the four sides of the box nine inches high; that will just take in the sheet iron; put strips $\frac{7}{8}$ x1 inch inside the box two inches below top edge, for the sheet iron to

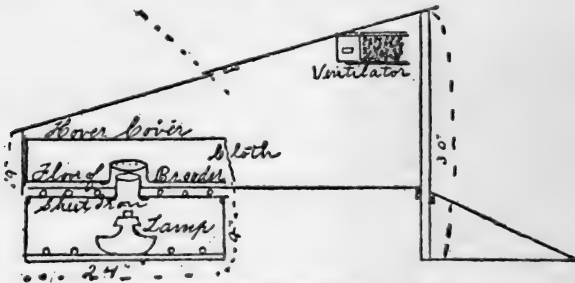

HOMEMADE BROODER. FIG. 15.

rest on. Take the one-pound can and cut slits a half inch apart all around the top edge; cut just down to where the bulge in the tin is (about one-half inch), put the slit part through the sheet iron and bend the slit pieces down flat on the iron. The bulge prevents the can from going through the iron, and if the slit pieces are hammered down tight it makes nearly an air-tight job, but to make sure that no fumes from the lamp get above the sheet iron it is better to solder it tight. Place the iron in the box and nail strips on top of iron, pressing it down tight on the under strips. Nail a floor of $\frac{7}{8}$ -inch stuff on top of box, cutting a hole in center the size of the two-pound coffee can; slit the can like the other, bend the pieces out and nail on top of floor, but first punch the top of can full of $\frac{1}{4}$ -inch holes to let the hot air out. Then bore five or six half-inch holes on the two ends through sides of box between sheet iron and floor of brooder to let in air; also four holes in each end of box

one inch in diameter near bottom edge to let in air for lamp. The rest is plain carpenter work. Take a piece nine inches wide, length of box, and nail or screw on back end, letting it come down only an inch or so below the edge of box. Then nail on sides, using two 2x2-inch posts 30 inches long to hold up front end. I line the hover part with $\frac{1}{2}$ -inch pine $6\frac{1}{2}$ inches wide, nailing on strips at top and bottom edge one-half inch square, so that it makes a half-inch air space on ends and back.

"The hover cover of $\frac{7}{8}$ -inch stuff rests on this lining and is not fastened, can be lifted out to clean out brooder, and as chicks get old enough is removed entirely. To the front of hover cover are tacked strips of cloth two inches wide, reaching the floor. Some of these cloth strips can be turned up on top of cover to let out hot air on warm days. On front part of sides bore holes as shown in figure, and make a sliding cover so as to close or open these holes. The amount of air entering the half-inch holes above sheet iron and passing over chicks is governed by these ventilators. The front half of roof is screwed to sides and front and middle bar. The back half is loose and projects three inches under front part; can be lifted up as shown by dotted lines, then by lifting hover cover the floor can be easily cleaned."

CHAPTER V.

THE FIRST SUMMER.

The business hen should make her start early in the year. Hatch as early as possible and get the chick well on its way before hot weather comes on. You want the pullets to begin laying early, while the old hens are moulting. This means 200 days or more of growth, and this growth must be rapid and steady if you expect the pullet to attend to business early. If the early part of the season is warm the chicks will be weaned at eight to 10 weeks old. Then the old hen deserts them, or they leave the brooder and must shift for themselves. The growth they make during this "first Summer" determines most of their usefulness. We should give the pullets free range, within reasonable limits. We find an apple orchard with reasonably low trees a good place for the pullets to make their growth. They will occupy the brooder or colony house for a time, but finally, as they gain size and strength, will fly up and roost in the trees. They do no harm, but benefit themselves in this way, and we permit them to stay in the trees until late Summer or early Fall, when they are put into the Winter houses. It is something of a job to catch these tree roosters, but the free life through the Summer does them good. If the pullets are kept free from lice and given what they want of pure water and clean food they will pretty much take care of themselves, and be the better for doing it. The great point is to keep them contented and growing steadily, with plenty of exercise. The old plan of feeding is now giving way to the modern method of keeping a hopper of "dry mash" constantly before them, so that they can help themselves at will. A feeding outfit used in Minnesota is shown at Fig. 18. A "dry mash" is a mixture of grains or dried meat—much like the old wet mash with the water left out. There is some controversy as to the value of dry mash in unlimited quantities for laying stock, but it seems to be demonstrated that for young birds the dry food is superior. It is a more economical way of feeding—saving much labor and time. One method of dry mash feeding is described by A. F. Hunter.

He uses a commercial dry mash mixture already mixed, but if a man is raising chickens on a large scale he may mix his own dry

mash. A good mixture is recommended by the Maine Experiment Station. This consists of 200 pounds of wheat bran, 100 pounds cornmeal, 100 pounds middlings, 100 pounds gluten meal or brewers' grains, 100 pounds linseed meal and 100 pounds of beef scrap. These materials are spread on the floor in layers, one above the other, and thoroughly mixed with a shovel or hoe. Smaller amounts in the same proportion can be mixed in the same way. Mr. Hunter thinks this dry mash is too forcing for some breeds, at least, and he would recommend leaving out the linseed meal from the mixture. The commercial feeds often contain small quantities of buckwheat, some sunflower seed and Kaffir corn, all of which add to the variety, and that pleases the birds. This dry mash is fed to the young birds in a hopper, such as is described in the picture, Fig. 16. One picture shows the hopper complete, and the other with the top taken off, so that it may be filled. The roof is made of a good quality of roofing paper, and as shown in the pic-

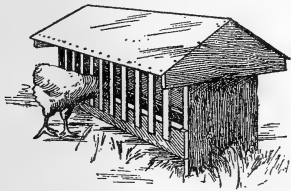

DRY MASH HOPPER. FIG. 16.

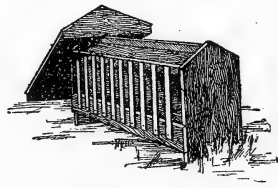

WITH COVER REMOVED. FIG. 17.

ture, projects four inches beyond the edges of the trough, and this protects the grain from a driving rain. This hopper can be made of any desired size. The one shown in the picture holds about half a bushel of grain on each side. The slats, through which the hens put their heads to feed, are made of lath, and there is a slanting lip made of a planed lath along the front of the trough, which prevents the grain being thrown out when the birds are feeding. Such a hopper will provide a dry mash for about 50 birds, and require filling once a week, so there is little labor required in caring for the birds. In some systems of colony feeding the water supply is provided by filling a barrel with water with a faucet draining into a small pan. The faucet is arranged so that it drops slowly, drop by drop. This provides water enough for the chicks and can be regulated properly, and the barrel, if covered, will hold pure water enough for a week's supply. In this system little labor is required, and the chicks grow rapidly and well. Under Mr. Hunter's system the cockerels are left with the pullets until the former weigh about

3½ pounds; that is, for Plymouth Rocks or Wyandottes. At this weight the cockerels are taken out and shut up for fattening. We would rather remove the cockerels earlier and fatten them from the time they can be separated from the pullets.

It is understood that the pullets alone are to be fed in this way. It would not pay to handle the young cockerels in like manner. They should be sold as soon as a profitable buyer can be found, or eaten at home. As soon as they can be detected, separate them from the pullets and put them in a small covered pen by themselves. With the pullets, the object is to force them to make bone and muscle without too much fat, while the cockerels are not to be kept any longer than is necessary. Running at large, they will worry and fight and eat their heads off without growing fat enough to sell. Cooped up and stuffed with a fattening ration they can be sold as squab broilers or as larger birds. There is a good demand for squab broilers, weighing from 12 to 14 ounces each.



MINNESOTA HOPPER. FIG. 18.

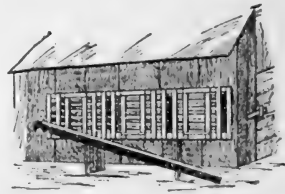

FATTENING COOP. FIG. 19.

It requires considerable skill to pick a squab broiler nicely. The skin is tender and the appearance of the bird adds much to its value. A broiler with the skin torn in pieces would be rejected by many buyers. Skillful pickers of larger birds frequently give up in disgust after trying to pick the broilers. Only those with yellow skin and legs are desired, and, of course, they must be plump and well shaped. These little birds are deprived of food for at least 12 hours before killing, so as to have the crop empty; hang the chickens by both feet and bleed them by opening the mouth and with a sharp knife cutting the main artery at the base of the tongue. Draw all the blood quickly, pull out the large wing and tail feathers first, then the smaller feathers and finally the pin feathers.

The greatest care must be taken in picking the wings and breast, for there the skin tears easily. As soon as the feathers are off throw the little bird in ice water, as this cools it quickly and prevents discoloring. When ready for shipment take them from the ice water and pack in pounded ice. Squab broilers are a luxury,

high priced at that, and like the production of fancy strawberries or apples, certified milk or any other form of luxurious food, require special knack and "instinct" to do the work properly. Unless a man can master some of these qualities he would better let the birds grow larger and sell as large broilers or roasters.

Cockerels fed well until they weigh about two pounds often make very profitable brothers to the business hen—far more so than when they are permitted to run at large. One cause of loss on some poultry farms is the failure to handle the cockerels properly. Where they are wanted for breeders, of course, they should not be handled in this way, but given free range and fed like the pullets, but the great majority of them should be put by themselves as soon as they are recognized and fed a fattening ration. A good mixture is four parts by weight of cornmeal, two parts wheat middlings and one part beef scraps. This is wetted with skim-milk into a soft mush or porridge, wet enough to run from the spoon. When cockerels are fed all they will eat of this, with plenty of water and kept quietly in the shade, they will grow fast and give soft, sweet meat, far superior to that of the skinny bird, which runs at large. Anyone who has ever tasted the flesh of "milk fed" poultry will appreciate such meat, and this plan of separating the cockerels early and feeding them this porridge may well be practiced even by those who have but a small flock.

Some poultrymen who follow the colony plan—that is, hens in small houses scattered over a large field—winter the pullets in the houses, which serve as brooders early in the season. A cheap and sensible house of this character is shown in the illustrations, Figs. 20-21-22-23, and thus described by C. M. Gallup, with whom it originated. Early in the season the little chicks can be brooded in such a house and later a flock of matured pullets wintered in it.

"In addition to the advantages common to all colony houses, this design has several all its own. The space beneath the floor provides shade from the hot sun, shelter from storms and protection against hawks. The absence of a foundation or underpinning leaves nothing to harbor rats. Then the weight of the structure makes moving to fresh ground a very simple matter. One horse will drag it any distance, and for a matter of a few hundred feet it can be kedged along with a chain and a crowbar. Ample ventilation at night is provided by the cloth screen, which slides in grooves. If birds are to be confined during the day, a wire screen is desirable. The depth of the house makes cleaning with a hoe easy, so that the lack of headroom is no objection. I use this house for an outdoor brooder shed early in the season, a roosting coop

later on, and then do the culling and leave the pullets right where they feel at home. Then there is no break in the continuity of their lives just as they are ready to lay.

"The house is seven feet long by five feet deep, three feet high at the rear, with a pitch of three inches per foot to the roof. The frame is of ordinary hardwood boards, $3 \times \frac{7}{8}$ inches, assembled as

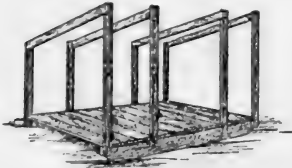

FRAME OF HOUSE. FIG. 20.



REAR VIEW. FIG. 21.

shown by the picture. The sills are 2×6 inches, and the flooring is $\frac{7}{8}$ -inch stuff, laid parallel to the ends of the house. The sheathing is 7-16-inch Southern pine, tongued and grooved. This is nailed vertically on the ends, and horizontally over front, top and back. This makes the whole thing remarkably rigid for its weight, and there is no tendency for the house to rack when it is moved or propped up. The patent roofing, which covers the top, ends and rear, makes it wind-tight and dry. Battened down with lath, this covering lasts for a good many years. The materials used in building this house cost almost exactly six dollars three years ago. Experience developed the interesting fact that the hens were just as ready and willing to lay in a nest outside the house, as one

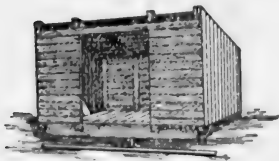

AS LAYING HOUSE. FIG. 22.

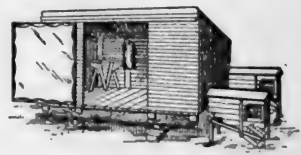

AS BROODER HOUSE. FIG. 23.

within, so that makes a further saving of floor space possible. The perches are simply light horses, which are taken outside for spraying, and to make cleaning out easy. The size of this house makes it just right for a breeding pen. Of unmated females, it will house 25 without much crowding. In growing capons, I have wintered 35 or 40 in it and had them do well."

The lighter and more active breeds of cockerels may be fattened in a pen, but the heavier breeds will make quicker growth in a fattening crate. The Minnesota Experiment Station recommends a crate such as is shown at Fig. 19, and described as follows:

"The fattening crate is quite easily constructed and will last for years if properly made. It is usually six feet long, 16 inches wide, 18 inches high, and is divided into three equal-sized compartments, each holding from four to six birds, as the case may be. The slats or laths, which are usually $1\frac{1}{4}$ inches wide, are placed $1\frac{1}{2}$ inches apart at the ends, sides and top of the crate, but those in front are placed vertically and are two inches apart, giving the birds plenty of room to put their heads through to eat from the trough. The floor of the crate is made of slats, which run lengthwise and are placed one inch apart, leaving a one-inch space on either side between the first lath and the sides of the crate. The crate should stand on short legs or trestles to allow for convenience in cleaning out the droppings which fall to the floor. The trough is made the full length of the crate, and should be about three or four inches deep."

At this station the pens for fattening cockerels are made movable. The roosting coop for such a pen is three feet wide, six feet long, two feet high at back and three feet in front. The yard is made of two hurdles of wire netting 12 feet long and 18 inches high and one six feet wide. A large hurdle covers the top. This outfit will hold 25 to 50 cockerels and is moved around from day to day.

CHAPTER VI.

THE BUSINESS HENHOUSE.

The writer of this chapter wishes to describe the construction of a poultry building which is comfortable, inexpensive, and simple in design, and to include in this discussion the principles to be considered when designing poultry houses. It is, of course, impossible to meet all conditions or suit all tastes in one type of house. Familiarity with the principles of poultry-house construction, however, makes it possible for one to mould this type of house, or any other, into a type more suitable to his tastes and convenience, and to climatic conditions.

It is of prime importance that the house be located in a convenient, accessible place, one protected from the cold Winter winds, and at the same time exposed to warmth of the morning and mid-day sun. A southern or southeastern slope, because of the more direct exposure to the sun's rays, is consequently more desirable. Such a slope, furthermore, is drier, often making it possible for the fowls to get on to dry ground several weeks earlier in the Spring and later in the Fall. Sunshine, dryness, warmth and accessibility are the influential factors in locating the site of the house.

In the construction of the "Business Henhouse" illustrated in Fig. 24, a rectangular enclosure is staked out 16 feet wide and 32 feet long, with the long side running as near east and west as the slope of the land and the nearness of other buildings will allow. A trench about 12 inches wide is next dug around the edge of this enclosure, the outer edge of the trench being about three inches outside of the 16x32 foot enclosure. In ordinary soils this trench should be about 30 inches deep, but in sandy or gravelly soils it need not exceed one foot in depth. The trench should then be filled with cobblestones or coarse gravel to within four inches of the ground level. In this manner a well-drained bottom is prepared for the foundation wall of the house, and prevents its heaving and cracking by frost. A cement wall six inches thick makes an excellent foundation for the building. This wall should be at least six inches above the ground so as to turn surface wash aside and to make a raised floor possible. If the ground is uneven the wall will need to be higher in places to bring the top edge level. The outer edge of this

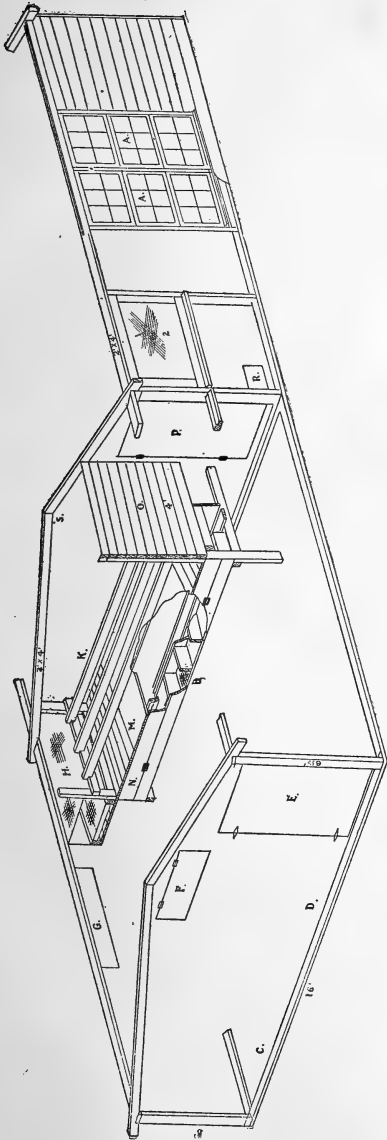

THE BUSINESS HENHOUSE. FIG. 24.

Above is shown general plan of the "Business Henhouse." The frame is 2x4 joist 16x32 feet, 6½ feet high in front and 5 in rear. Rafters are 32 inches apart, covered with tight matched boards and building paper in addition to roofing. Novelty siding is used. A A are windows of 8x10 glass, hinged to swing in like a door; B, nest boxes, details of which are shown in sectional cut next page; C, feed hopper; D, water pan; E, door, 3 feet wide; F, G, doors for Summer ventilation; H, broody coop, enclosed with poultry wire; K, perches of 2x3-inch joist; M, droppings board; N, drop door to nests; O, shield to perches, 4 feet wide; P, door swinging both ways; R, exit for hens, 10x12 inches, 6 inches above sill; Z, muslin curtain.

top should coincide with the original outline of the proposed building. All is now ready for the floor.

In Fig. 25 details of the roost and nest arrangements are given. K is the roost; M, droppings board; B, nests, and N, drop door to nests. At the rear is a wire-screened jail for broody hens, and in front is the shield O, protecting the roosts from drafts. Fig. 26 from the center front shows arrangement of cloth curtain

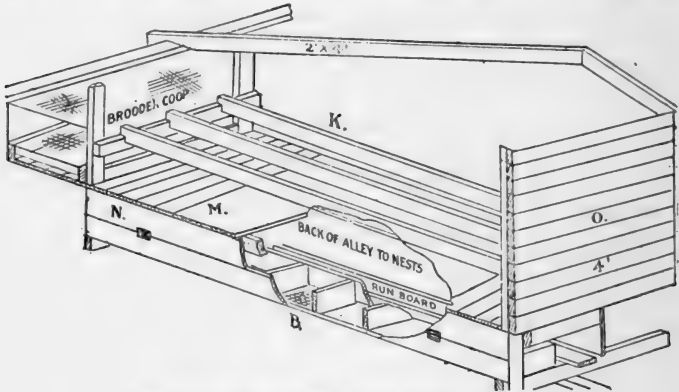

DETAILS OF ROOST AND NEST. FIG. 25.

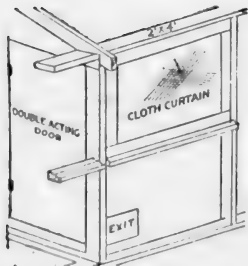

CENTER FRONT. FIG. 26.

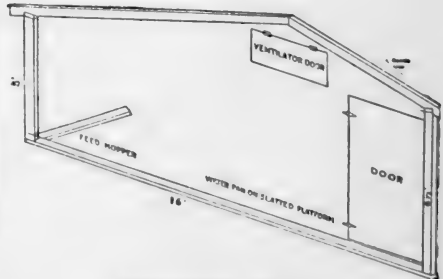

END VIEW. FIG. 27.

and small exit for hens, and one end of the house, with place for feed hopper, water pan and outer door is shown at Fig. 27.

The warmth and dryness of the house greatly depends upon the construction of the floor. The average soil is sufficiently heavy to retain enough moisture to make the house damp and exceedingly dangerous to the fowls' health during certain seasons of the year. This condition can be forestalled by filling in with cobblestones, gravel or cinders. The level of the floor should be raised above that

of the ground outside, even if the dirt floor is to be used. The cement floor, however, is preferable to either the wooden or earth floor, since it is so much more easily cleaned and freed from rats, mice and vermin. Moreover, it is dry when properly constructed. To make it so, fill in the space between the foundation walls to within two inches of the top level with stones and gravel. The last two inches can then be filled with concrete similar to that used in the wall. If the mixture is made rather watery, the top can be troweled off smooth and level, making it unnecessary to add a finishing or wearing surface of richer and finer material. A good thickness of tarred paper laid beneath the layer of concrete helps to keep moisture from coming up into the floor. A well-drained floor, however, will be dry without this precaution.

The framework of this house can be constructed from two by four-inch timbers, as illustrated in Fig. 24. If the roof is very flat the rafters should be of heavier material.

One thickness of tight matched boards is sufficient covering for any part of the building. In localities where the temperature goes below zero for weeks at a time, the extra protection of a roofing paper, on the side exposed to the cold winds, is desirable. The house can be made still warmer by covering the inside studding with unmatched boards, or fine mesh wire, and filling the air space with straw. The inside boards should be far enough apart to allow circulation of air in the space between the walls, or it would be even colder than the single matching. Unfortunately, such a wall furnishes an excellent hiding and breeding place for mice and vermin, and is, consequently, advised in extremely cold climates only.

The sides should be built low in order to lessen the amount of air which the fowls will have to warm. For this reason also the house is often ceiled with either matched boards or straw, supported loosely by boards or poultry wire. When used, the ceiling extends from the front plate to the rafters opposite, thence down to the rear plate. Although a ceiling adds to the expense of the house, it does make the house warmer in the Winter and cooler in the Summer by virtue of the fact that the air space above holds the cold coming through the roof in the Winter, and the heat in the Summer. When using either kind of ceiling openings should be made in each end of the peak in order to allow a slight circulation of air in both Winter and Summer, otherwise the extreme outside heat, or cold, will eventually penetrate this air space and make the ceiling as hot or cold as the roof. The amount of ventilation given this chamber should, of course, be greater in the Summer than in the Winter.

A ceiling is more appropriate in a gable or combination-roof house than in a shed-roof house. The shed-type house is rarely ceiled unless very wide and very high in front. The shed-type roof, however, has the advantage of being easy to construct. It turns all the water to the back and gives a high front exposure to the sun's heat. It does not make as attractive a building as the combination or gable. The combination style utilizes a lower rear wall and a higher front exposure than the gable. In this way it economizes on both lumber and cubic feet air space. Both these types require that the rafters be securely tied to prevent the weight of the roof from spreading the plates. The tie beams should be near the peak unless the roof is ceiled.

Undoubtedly, the most economical covering for the roof is a good grade of roofing paper or tin on a tight board surface. Such roofing material makes it possible to use a flat pitched roof. If the roof is shingled instead, the pitch or slope must be at least one-third, or 30 degrees, thus increasing the air space of the house, and unless the roofing boards are tight, making a looser and colder roof. Such construction makes the inside ceiling more necessary.

Probably most important of all is the front of the house where the glass windows and other openings are placed. All the openings are placed on the one side, so that by keeping the other three sides tightly closed a draft is prevented from passing through the open front and out through the opening on the other side, or vice versa. The glass windows should be large, and placed vertically extending from a few inches above the floor to a point six or seven feet higher. This position of the windows allows the sun's rays to reach every part of the floor from front to back, thereby keeping the house brighter, drier and healthier. The windows can be opened by sliding to one side, or by swinging outward from hinges placed at the top or bottom of the sash, but when arranged as in Fig. 24 the separate sash are fastened together and hinged at the side to open like a door. Enough blank wall space should be left at the side of the window to allow it to open fully against the wall where it will not be broken. The window opening should be covered with poultry mesh wire, so as to prevent the fowls escaping when the windows are open. This wire can best be put on the window studding and be cased in by the siding. The size of the windows to be used should provide about one square foot of glass for every 10 to 16 square feet of floor space. The "business henhouse" has one square foot to every 12.8 square feet floor space. Each window has three sash of six 8x10-inch lights fastened together and hinged to swing back against the wall.

An additional window covered with cloth is used for ventilating this house. The size of this window should be varied according to climatic conditions, and should be placed where it will allow the least amount of draft to reach the fowls, especially while roosting. The window in the "business henhouse" is 3x4 feet in size, and placed near one end of each pen. There is also a shield between this window and the perches. The curtain frame is covered with light muslin and hinged at the top to swing up and fasten to the ceiling. The opening is covered with mosquito mesh wire which serves to turn the storm and wind better than poultry mesh wire, and makes it unnecessary to drop the cloth curtain except on very cold nights or during prolonged storms. This ventilating window should be placed at least three feet above the floor in order that the incoming air may be broken up and distributed before reaching the fowls on the floor.

For Summer, additional ventilation is necessary. It is well to have a small trap door in the back of the pen which can be opened as soon as the hot weather comes and closed tightly in the Fall to remain so all Winter. If perches are placed in the rear of the pen a shield should be placed in front of this opening to prevent the air blowing on to the roosting fowls.

INTERIOR ARRANGEMENT.

When considering the comfort of the fowls and the convenience of the caretaker, the interior arrangement of the pen is nearly as important as the construction of the building. The warmest part of the building should be selected for the perches. It is even advisable in very cold climates to give them the additional protection of double walls and a cloth curtain in front. The arrangement of the roosts in the "business henhouse" is such that the fowls of the adjoining pens are next to the same partition where each flock can be of mutual assistance in providing warmth. The perches are placed high enough to make their removal unnecessary when cleaning the droppings platform. All the perches must be of the same height, or the fowls will fight for the higher warmer ones. Each fowl should be allowed from six to eight inches linear perch room. The droppings platform, on the other hand, may have a slight forward pitch. This will keep the fowls from squatting on it at night, as well as facilitating cleaning. Usually at one end of this platform a small space is partitioned off by a wire screen and fitted with a hardware cloth, or slat-bottom frame to be used for breaking up sitters. The slatted bottom can be removed when cleaning or when the coop is used for an extra cock bird or injured fowl.

When droppings platforms are used, which is advisable, they make an excellent cover for the nests. However, the nests are frequently built on the side wall and a separate slanting cover put over them. If placed under the droppings board as shown in Fig. 25, the nests are made in the form of a frame with a bottom of wood or quarter-inch mesh hardware cloth. Each nest should be about 14 inches square and six to eight inches deep. A hinged door covering the front darkens the nests and makes them seem secluded to the fowls. They are entered from the enclosed runway behind which has an opening at either end. These openings can be closed with small sliding doors and the broody hens and pullets kept from roosting in the nests at night.

Each pen should be further equipped with a dry mash, self-feeding hopper, a water pan, and with a grain supply can in case the pen is distant from the feed barn. The feed hopper and water pan may be placed on a raised platform from 15 to 18 inches above the floor both to give greater floor space and to prevent the litter from being kicked into the feed and water when the fowls work in the litter. These devices should be arranged in the most convenient places left vacant after the doors and perches and nests are located. The entire back wall or side wall can be used for these purposes in the "business henhouse." No obstruction should be placed along the front wall because the passageway to adjoining pens is so close to it. Many would wish to put a box or form in front of the windows to be filled with dust-bath material. This would not be advantageous in the "business henhouse." The box should be put at the rear or on one side.

The partitions between pens in open front houses should be solid from the floor to the ceiling. Wire partitions endanger the fowls to drafts. Half board partitions finished with cloth to the ceiling are sometimes used, but the partition near the roosting chamber should always be of tight boards. The door between pens is located in the most convenient place with reference to the roosts and nests and feed hoppers. It is placed in about the center of the partition when the roosts are along the rear side, but in houses arranged like the "business henhouse" with the perches along the partition wall, the door can best be placed near the front. With the door in this position there is little chance of a draft between pens. All partition doors and exits should have a six-inch threshold to hold the litter in the pens. This description of the "business henhouse," and the principles upon which it is based apply to many other styles of buildings and make it possible for one to alter the size or style of this house to their own desire or requirements.

The "business henhouse" is designed for flocks of about one hundred fowls. The two pens make it possible to separate the old from the young, or the better from the poorer ones. For smaller flocks the same design can be used with shorter measurements. This style also enables the construction of a long house with a number of pens.

REMODELING HOUSES OF FAULTY CONSTRUCTION.

It is quite as possible also to use these principles in remodeling an old house or fitting up an unused barn or outbuilding into a comfortable poultry house. Occasionally after building a house of approved design it is found to be too cold or dark, or poorly ventilated and damp. At such times a slight alteration or addition will often remedy this condition and make the house desirable instead of dangerous.

A frequent mistake is to build a house with high walls back and front and without ceiling, making it very spacious and cold. It is a simple matter to spike 2x4-inch supports to the side walls and with cross beams to construct a ceiling about 6½ feet above the floor. This ceiling can be covered with tight-fitting boards, or with straw 18 inches thick, supported by poultry mesh wire or by loosely joined boards. In either case, there should be a small ventilating door to this air space above in each end of the house.

A less serious error is to use an alley-way. It is an expensive luxury, occupying valuable space which cannot be used by the fowls for exercise, but has to be warmed up by them. Such an alley-way can easily be torn out and the pens arranged as suggested in the "business henhouse." Practically, the only advantage of an alley-way house is its cleaner appearance and separate entrance for exhibiting stock to visitors. As such pens are generally arranged they do not expedite work even in long houses. It is also a fallacy to believe that the fowls are frightened more when fed directly in the pen than from the alley-way. They soon become accustomed to the feeder, and can be watched more closely to discover any sick or poor ones which would be hidden from the alley.

Probably, the most faulty construction in the old types of houses is the lack of proper ventilation. In those styles ventilation was possible only when the door was opened and closed by the feeder, or through small exit doors. Such houses cannot accommodate their full capacity of fowls, and the moisture given off in the fowls' breath is retained in the pen, making it damp, and in the Winter frosty. This moisture-laden air should have a chance to escape and drier, pure air take its place. Such a condition can be provided by substituting a porous cloth curtain in place of a glass window, or

if there is too little glass area already, by cutting an opening in the front of the house and fitting in a cloth curtain similar to the one in the "business henhouse." This opening should provide about one square foot of cloth to about 16 to 20 square feet of floor space. Under normal conditions this ventilation will keep the house dry and the air pure. Other methods of ventilation have been found less satisfactory, and in some instances, the more expensive systems do not work at all, due to the slight difference in temperature of the air inside and outside. When fresh air is abundant, a larger number of fowls can be kept in the same pen with safety. The working rule is four square feet of floor space per fowl.

During extremely cold weather even the cloth window does not always prevent the frost from collecting on the walls. The frost will usually be found in houses where the fowls are roosting at the back or coldest side, where the moisture in their breath striking against the cold wall is condensed and frozen before it is removed. To relieve this condition tightly enclose the roosting chamber on the back and top by ceiling from the droppings platform up the rear studding and under the rafters, leaving a space so that the air can circulate between the rafters and entirely about this chamber as represented in Fig. 25. The circulation of air within this space caused by the warmth of the fowls roosting nearby carries off and distributes the cold before it penetrates to the inner boards. In this way the air within the roosting chamber, moist with breath, is allowed to pass off before being condensed and frozen. It is occasionally necessary, however, to enclose this chamber on the front with a cloth curtain hanging several inches in front of the perches to allow sufficient air to enter and give the fowls opportunity to get down to the floor early in the morning. Such a curtain must be used judiciously, since there is much danger of overheating and weakening the fowls if it is dropped on warm nights.

Dampness in a house also comes through the floor. Ground floors which are not raised on the inside or filled in with sand, or concrete floors constructed without under drainage, allow the moisture to rise through them and into the house. The dirt floor can be remedied by filling in with sand or by building a concrete floor if found to be necessary. The dampness in an improperly drained concrete floor can be temporarily lessened by covering it with an inch or two of sand. When concrete floors are laid in early Winter, their drying can be hastened by covering them with sand. This will also help protect them from freezing. In these and similar ways a cold, damp and disagreeable house can be made warm, dry and comfortable.

COLONY HOUSES VS. LONG HOUSES.

The design of the "business henhouse" is adaptable to either the single pen colony house or a long house with several pens. Usually the farmers' small flock requires but a small house with two pens. Larger houses or more of them, however, are necessary for the occasional farmer or poultryman who keeps several hundred mature fowls. It is the custom among such poultrymen either to scatter their flocks in colony houses or to keep them in one or two long houses. Each system has advantages and some disadvantages.

The colony house system allows the fowls greater freedom. They can go in all directions from their house, whereas in the long house they are usually restricted to one side, and frequently to a narrow patch leading away from their pens. A hen always wishes to get on the other side of the fence, and for this reason, if no other, do away with fences as much as possible and instead run the fowls together in large outdoor flocks, or in colonies far enough apart so that they do not mix easily. Fences are very expensive and a nuisance in every way.

There is less chance of disease spreading from colony to colony than from pen to pen in a long house. And because of the greater freedom and the lesser contamination of the ground around a colony house fowls get diseased less frequently. It is generally accepted that fowls kept in small flocks give greater returns both in the number and the hatching power of the eggs produced. For these reasons the colony system should be used for the breeding stock. The long house system on the other hand, minimises the time and labor needed in feeding and caring for the fowls, thereby enabling one to personally manage a much larger plant. All of the work is done indoor and under shelter, and because of the compactness of the plant many labor-saving devices, such as the overhead feed car, can be used advantageously. The long house also can be built much more economically than the colony houses of the same capacity, for in bringing two colony houses together one end of each house is saved. For this reason, too, the long house is less exposed and is consequently warmer.

Perhaps the greatest objection to the long house is the probable contamination of the ground in front of the pens, unless the land be very sandy. This condition can be prevented by using the double yard system, with one yard in front and one in back. These yards can be used alternately, and one yard be cultivated and cropped while the other is used by the fowls. In this way contamination is prevented, and in addition the valuable fertilizer from these fowls, otherwise lost, is turned into excellent crops. A consideration of

the advantages of each system leads to a natural combination of the two methods, a combination which at present is practiced too seldom. This combination would make use of the colony houses for the breeding stock only, and of the long houses for the bulk of the stock kept primarily for egg production. This practice would provide the breeding stock in colony houses with conditions conducive to the production of strong eggs capable of hatching out vigorous

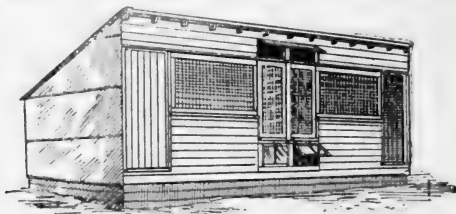

CORNELL LAYING HOUSE. FIG. 28.

chicks, and on the other hand it would enable the poultryman to care for large numbers of laying hens in the long house with the least amount of labor and expense.

The "New York State Model Laying House," in use at Cornell University, is shown at Fig. 28. This is a good illustration of the shed-type, fresh-air house. The back and ends, as well as the roof, are covered with paper to make the house tighter. There is a Summer ventilator above the glass windows and a

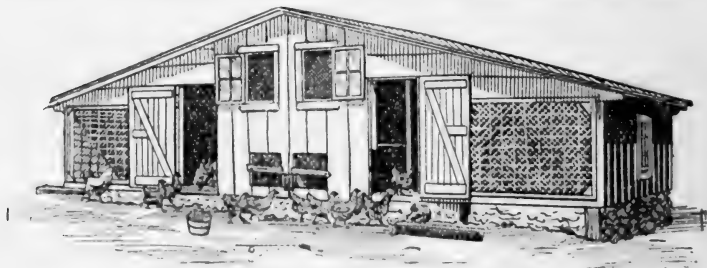

A TWO-FAMILY HOUSE. FIG. 29.

covered dust wallow just inside the lower sash. This house can be used singly or in series.

Fig. 29 illustrates a two-pen colony breeding house, built by D. J. Lambert, Apponaug, R. I. The shape of this house makes it economical. The fowls roost next to the partition between pens. The opening in front is covered by a frame of cloth, which swings open against the side.

A MAKESHIFT HOUSE.—Some good hen records are made in cheap houses not built on scientific lines. Such a house is described below. In such cases it is not so much the house as the man who knows by instinct how to make the hens comfortable.

“What results would you expect from 75 hens wintered in a coop of this cost? I had 75 May-hatched pullets to winter. I built a coop 12x18 feet, inside measurement. The material was sod for the sides; the roof was straw, covered with corn fodder; the floor, Nature’s deodorizer, natural earth. I first selected a well-sheltered location, then proceeded by setting three crotches, each crotch set three feet deep. This for the peak of my roof. Next I set ordinary six-foot fence posts on side four feet apart, two feet deep, leaving sides of coop four feet high, plenty high enough for sides of any coop. Then I spiked poles on to those fence posts on top, and nailed on small poles on sides of posts; laid poles in those center crotches, then laid poles from post plates to crotch poles for rafters,

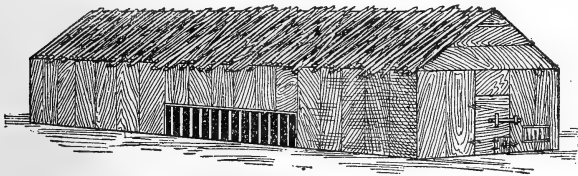

SOD AND POLE HOUSE. FIG. 30

and my frame was complete. I put in a window frame of plank on south side 2x8 feet, covered same with muslin curtain (no glass); but door in east end. I cut sod and sodded up sides; put a little brush crosswise of rafter poles, covered with straw and shingled with corn fodder. The foundation of my coop is raised slightly so water runs away from it, which is very important. So my labor and all would amount to about \$12. I put pullets in coop in December and they soon began laying. In January, February, March and April I averaged close to five dozen eggs per day. My income was a little better than \$1 per day clear of feed; and they have continued laying well all Summer till molting this Fall. Now they are mostly through the molt and are going right into the egg producing business again.”

CHAPTER VII.

DISEASES OF POULTRY.

It is unquestionably true that a large number of the failures in poultry enterprises are due directly to disease and that these diseases are, as a rule, not of a communicable nature, but rather the result of mismanagement, unskilled feeding, and too little attention to general sanitation. Any system of feeding and care which does not keep the fowls active, bright-eyed, of keen appetite, slick in appearance, and of hard flesh, is fundamentally wrong. It is by careful housing, feeding and management that the diseases described in the following paragraphs may be prevented. One must recognize that disease is a sign that proper care and sanitation have not been practiced and must take immediate steps to rectify these conditions. The individual treatment of fowls is expensive and unsatisfactory, for after the fowl is cured it usually takes a little longer time to get her back into laying condition. The preventive method of treatment is the safest and most economical.

For this reason importance should be attached to sanitation. The pens should be thoroughly sprayed with a disinfecting solution or whitewashed at least twice a year. It is advisable to spray the perches and nest boxes frequently during warm weather. As soon as the litter becomes damp or filthy, replace it. Use the droppings board underneath the perches and remove the droppings at least once a week, always sprinkling coal ashes or land plaster on the clean boards and again over the droppings once or twice between cleanings. This practice not only keeps the pen cleaner and sweeter, but makes it easier to clean the droppings board and greatly increases the value of the manure because it absorbs the liquid and retains the nitrogen. Provide a dust wallow in which the fowls can remove the scurf from their bodies and fight their body lice. For disinfecting with whitewash, the addition of one pint of crude carbolic acid to every two gallons of the mixture makes it much more effective in destroying both animal parasites and bacteria. For spraying, a solution of three parts kerosene and one part crude carbolic acid, gives excellent results.

BLACK HEAD is a disease common and fatal to young turkeys and quite serious among chickens. It is usually recognized in the

turkey by the stunted growth and emaciated condition of the body. Internal examination usually discloses large, discolored diseased areas on the liver and greatly enlarged cæca (blind intestines). If recognized in time and careful, sanitary conditions of feeding and brooding are provided, many of the afflicted chicks can be saved. Sour skim-milk has been found quite effective in checking the disease. After one experience with the disease, it will be readily conceded that the preventive method is most satisfactory. In hatching, use incubators or strong, disease-free hens, and wash the eggs in 95 per cent alcohol before setting. Furthermore, since the disease commonly spreads through ground infection, the newly hatched brood should be taken to ground not commonly used by either turkeys or hens. Here they should be brooded in carefully disinfected quarters and their coops frequently moved to fresh places. If hens are used to brood the chicks, strong, healthy individuals, showing no evidence of having had the disease, should be chosen. Should the hen have the disease, it may be transmitted to the young. The older chickens should not be encouraged to join with the later hatches while feeding, but should be fed elsewhere and their place of feeding changed from time to time, to prevent contamination.

BLEEDING FROM THE COMB.—In cold weather it is not uncommon, especially among large comb breeds, for a laying pullet to bleed to death from an injury or a crack on the comb. The blood being started from either of these causes continues to flow, both on account of frequent shaking of the head and because of the slow coagulation of blood on a very cold day. If this flow is not speedily stopped, the loss of blood and consequent exhaustion, together with the cold, overcome the fowl. As soon as this condition is noticed, remove the fowl and wash the comb in warm water. This is usually sufficient to stop the flow of blood, but if not, touch a styptic pencil or a hot iron to the wound. Before returning the fowl to the pen, grease the comb with vaseline.

BLINDNESS.—There are at least three causes for blindness in fowls: 1, accident; 2, the effects of another disease; and 3, a parasite. When accidental, the fowl is usually blind in one eye only. There is no economic treatment. The inflamed part should be bathed in a weak solution of boracic acid and greased with vaseline in order to effect a speedy healing of the sore. The most common form of blindness closely follows or accompanies another disease. When due to roup a swelling among the tissues of the eye, caused by the hardening of the mucus secretions of the head and eyes, destroys the sight. When roup has progressed to this stage, there is little profit in treating it. There is also an eye worm or parasite which infects

poultry, causing inflammation of the eye and occasional blindness. This parasite can be removed by surgical means only. The wound should be bathed with a weak solution of boracic acid and kept greased with vaseline until healed.

BUMBLEFOOT.—Bumblefoot is a term commonly applied to the condition when an injury has resulted in the formation of pus in the fleshy part of the foot. The injury may be received in various ways, such as dropping or falling from a high perch on to a bare, cement floor, or scratching on a floor of cinders. The formation of pus causes a swelling and wears down the tissues until it breaks forth either at the upper or lower surface. A scab forms over this opening, but the continued formation of pus repeatedly forces open the wound.

For treatment, remove the scab or lance the swollen area and thoroughly clean and disinfect the cavity with a dilute solution of carbolic acid or hydrogen peroxide. Keep the sore well greased with carbolated vaseline until healed.

CHICKEN POX.—Although in cold climates chicken pox is almost unknown, it is all too common in the Southern States. It is easily recognized by yellowish, wartlike sores which appear on the face and head and inside the mouth. Often, if only local, these sores spontaneously dry up and disappear, but if they extend to other portions of the body, the fowl becomes emaciated and dies from exhaustion. Dr. D. E. Salmon in "Diseases of Poultry," advises feeding sulphur and applying a sulphur ointment to the nodules twice a day. Others have successfully checked the disease, greasing the sores with carbolated vaseline or with glycerine, containing two per cent. of carbolic acid. The disease is communicable and necessitates thorough disinfection. See communicable diseases.

CHOLERA.—It is a common error for the layman to think that every disease among his fowls, which manifests itself by a looseness of the bowels, a yellowish discharge, and a pale or yellow color about the face and head, is cholera. As a matter of fact, this disease is common only in the warm climates and is rare elsewhere. It is communicable and very destructive. Fowls often die within a few days after being exposed to the disease, even before they are suspected of being stricken. In other cases it takes on a chronic form. It requires a bacteriological examination definitely to recognize the disease. Scientists have failed to find a cure for it. Thorough disinfection of the entire plant and a rigid separation of the exposed from the non-exposed flocks should be practiced. See communicable diseases.

COLDS.—The first indication of a cold is a snuffing or a rattling in the throat. Usually the secretions which cause this sound have but little, if any, perceptible odor. A cold is due to exposure to conditions under which the body has difficulty in keeping its normal temperature. Common among such conditions are crowding at night by young stock, which have outgrown their quarters, contact with damp floors and filthy houses, and especially, exposure to draughts which blow on the fowls while they are working or roosting. The obvious treatment is to correct those conditions which have induced the cold, to disinfect the drinking water and, in severe cases, to spray the perches as suggested in the treatment of roup.

CROP COMPACTION.—Crop compaction is usually a clogging of the outlet of the crop by twisted grass or rough grain. Occasionally the ration contains too much middlings, or other sticky foods, fed either dry or moist, which, under certain conditions, bake together and clog the passageway. In a vain effort to satisfy the increased appetite, the fowl distends its crop with food. In a few days, unless the obstruction is removed, the fowl shows signs of weakness and eventually dies of starvation. A common way of removing the contents of the crop is to give several teaspoonfuls of castor oil, at the same time massaging the crop till the contents soften. Then hold the fowl by the feet and gradually work the contents of the crop out through the mouth. Sometimes crop compaction cannot be relieved in this way. It is then necessary to cut into the crop. After the contents are thoroughly removed, the crop should be carefully washed with a weak solution of boracic acid and the edges of the wound drawn together and sewed once or twice with silk thread. If an operation is necessary, it should be made before the fowl has become badly weakened from the lack of food.

COMMUNICABLE DISEASES.—There are a number of communicable diseases, such as cholera and diphtheretic roup, which are very difficult to treat successfully. In fact, it is almost useless to attempt a cure of the stricken fowl. The most that can be done is to keep the mortality as low as possible by the rigid culling and burning up of diseased individuals, and the thorough disinfection of their pens, and especially of the eating and drinking utensils. It is frequently to the owner's advantage, unless the stock be highly prized, to kill and burn every individual showing symptoms of the disease and to dispose of the healthy ones of the flock on the public market. This practice is especially advisable when there are several flocks in houses well scattered. This radical practice, together with

thorough disinfection of the pens where the disease has not yet appeared, will prevent the spread of the disease throughout the plant. One of the best reasons for such wholesale disposal of the stock is that many communicable diseases are carried in a dormant state in the partially cured individual until conditions are right for another outbreak. When all stock is sold and the houses carefully disinfected, new stock can be put into these quarters without fear of a recurrence of the disease unless it be brought in through a bird purchased elsewhere, or through fowls exposed to the disease at a poultry show. The houses occupied by diseased fowls should not be used again until carefully disinfected. All other fowls should be kept off the ground on which the diseased fowls ranged until the following Spring, at which time the ground should be cultivated. Chickens hatched from these fowls, before or at the time of their sickness, can be brooded on separate land with safety and be used to refill those houses emptied by the disease.

DIARRHŒA.—Diarrhœa in some form accompanies and is a symptom of many common communicable diseases. Because of this fact, the layman interprets diarrhœa as the indication of a dangerous disease. As a matter of fact, diarrhœa is more often the result of indigestion. It is caused by over-consumption of rich, highly stimulating foods, by tainted meat, musty grain, green or milky grain in the stalk, irregular feeding of green foods in the Winter, excessive amounts of green cut bone, or a stale or irregular supply of water. It may also follow the sudden, radical changes in diet. The extent of the trouble is limited only by the amount of unwholesome food eaten. The best treatment of such diarrhœa is to remove the irritant or to shut in the fowls from it, giving them a regulating ration. They will soon readjust themselves. Diarrhœa frequently follows a change to hot weather, which quickly taints meat and other foods which the fowls pick up, and, in addition, makes the process of digestion more sluggish. At such times the fowls have great difficulty in readjusting themselves, even when their rations are better balanced. It then becomes necessary to provide food in a form which will be quickly and easily digested and assimilated. This ration should be composed of fresh and finely ground grains, moistened with buttermilk or sour skim-milk. One such feeding should be given daily, in addition to their regular ration. Clabbered or sour skim-milk is also valuable for drinking. They should have fresh water all the time. General cleanliness and occasional disinfection is advised at such times. Diarrhœa brought about by the presence of a communicable disease cannot be treated in this way. See communicable diseases.

BLOODY EGGS.—Objection is always raised to eggs containing blood spots. They are not due to deterioration of the eggs or to disease, as many people conjecture. However, since there is this aversion to using such eggs, it is well to check their production. The presence of the blood is due to a hemorrhage of the blood vessels in the glands of the oviduct. The hemorrhage is the result of fright, injury, or forced feeding, which overworks the blood vessels carrying supplies to the organs of secretion. Blood spots are usually found in the albumen, since the glands secreting this material are delicately responsive to forced feeding. If the fowls are producing bloody eggs in numbers, the rich meat materials should be decreased and green food increased. Exercise should be encouraged and disturbing conditions eliminated. Occasionally an individual hen, through weakness or disease, will produce bloody eggs regularly. Such a fowl should be removed from the pen and fed carefully until her body regains its normal condition.

EGG-BOUND.—Pullets, producing their first eggs, and over-fat, weak or injured hens, often become egg-bound. The most common symptoms of this trouble are frequent trips to the nest and much squatting and straining. In extreme cases the fowl will crawl along with her body upright and her tail dragging. Fowls in this condition usually die from exhaustion unless relief is speedily given. It is advisable to remove the afflicted bird to a quiet place and inject sweet oil into the cloaca and oviduct. This will relieve the fever in these organs, encourage proper secretions and assist the fowl in laying her egg normally. Unwise forcing of pullets to early egg production and breeding for large-sized eggs are the common causes among pullets. When this trouble is prevalent among mature fowls, it should be taken as an indication of low physical vigor and attention given to feeding well balanced rations in a way which will encourage exercise and regulation of diet.

EGG EATING HABIT.—An accident is very often accountable for starting the vice of eating eggs. The accident occurs when a heavy fowl drops on to an egg in a deep nest, or in flying out of the nest, especially when frightened, kicks an egg against the side of the box. The first hen to observe the broken egg eats the contents and begins scratching in the nesting material for more. Another egg is broken, as a result, and the habit started. Such accidents occur more commonly when the egg shells are weak and easily broken. At this time, also, the fowl is most eager for the egg and its shell, since her body is deficient in shell-forming materials. The habit is seldom acquired when the body health is good. This absence of shell-forming secretions is not necessarily due to the

absence of lime and other minerals in the ration, although without lime in the form of oyster shells or lime grits, this cessation of the shell-forming secretions would result. But this condition is frequently the result also of over-feeding and consequent lack of exercise, which disorganizes the organs of secretion and produces general weakness and debility. The obvious treatment is to correct the method of feeding and to provide sufficient mineral and animal food to supply the body needs. The use of china eggs or eggs filled with red pepper and mustard is not highly recommended, although occasionally they are effective. In extreme cases a special nest box can be used. Such a nest is made by padding the center and edges of a box about a foot square and eight inches deep, and loosely fastening over the top a burlap sack with a hole in the center. The egg rolls into the box beneath as soon as laid. When using this box, place it in the position occupied by the regular nest.

AN EGG WITHIN AN EGG.—Several instances have been reported of finding within an apparently normal egg a second fully formed egg. The production of such abnormal eggs is due to injury, to fright or to paralysis of the muscles of the oviduct, which sends back up the oviduct an egg, ready to be laid. In due course the egg again starts down the oviduct and stimulates a secretion of albumen and later of calcareous materials, which enclose the original egg in another layer of albumen and put a shell around the whole. Such an egg rarely has a yolk in the second formation, unless, by chance, a yolk sac emptied its contents into the oviduct at the time the first egg was forced back.

EGG WITH TWO YOLKS.—There are two possible explanations for the formation of double yolked eggs. The usual one is that during a period of heavy production two yolk sacs deposit their yolks in the oviduct at so nearly the same time that both are encased in the same albumen and shell. The more feasible explanation is that the two yolks are originally contained in the same yolk sac and consequently are deposited in the oviduct at the same time. This theory is supported by embryologists, who have found the two yolks enclosed in one sac in microscopical sections of the ovary. If incubated, double yolked eggs, as a rule, do not hatch.

FATTY DEGENERATION.—When over-fed fowls become fat, sluggish and inactive, a general breaking down of their body tissues gradually takes place. This is called fatty degeneration. With the heavier varieties this condition is commonly indicated by the accumulation of fat in a large bunch under the abdomen, causing their fluff to hang low. In so debilitated a condition, the fowl is unable to produce the greatest possible number of eggs and those

eggs, which are produced lack, when incubated, the strength to develop normal, healthy, livable chicks. Soft shelled eggs and egg eating habits may well be feared in such a state of health. Fowls which have broken down under forced feeding or over-feeding cannot entirely recover their normal condition, but judicious feeding on wholesome grains, with plenty of green food and exercise will in a great measure restore their health.

FEATHER PULLING.—One of the most distressing and unmanageable vices of fowls is feather pulling. It starts through fighting or accidents and continues for lack of sufficient mineral and animal food. The vice spreads rapidly among the fowls in a flock. It is seldom acquired in properly managed flocks. This vice is the result of erroneous methods of feeding and management, similar to the conditions which encourage egg eating. Give the fowls as much liberty and freedom as possible. Increase the amount of animal food in the ration. If the pens are small, it sometimes becomes necessary to change the fowls to a different house, or to harness their bills with feather pulling bits, which prevent them from getting a grip on the feather.

FROSTED COMBS AND WATTLES.—On extremely cold nights, unless warm roosting places are provided, the fowls' combs and wattles will get frosted. The resulting pain stops the hens from laying, and, in severe cases, even kills them. When frosted, these appendages swell up and turn to a purple color. The frosted parts should be thawed out with ice or snow and greased with vaseline. It is often well to cut away the frosted parts entirely, using a hot iron to heal the wound.

GAPES.—The frequent gasping for breath by chickens suffering with parasitic worms in the windpipe is called gapes and the worm, the gape worm. The difficulty of eating, combined with the weakening effect of the parasites, stunts the growth of the chickens. Its feathers become soiled, torn and ruffled for lack of proper nourishment. The worms and their eggs are coughed up by the chickens on to their food or into the drinking water, where other chickens consume them. In this way the parasite is transmitted. A common treatment of the individual is to thrust a twisted horsehair or stiff thread, saturated in turpentine, down its windpipe. The turpentine loosens and kills the worms. Those which are not withdrawn with the horsehair are coughed out. A second method of treatment, somewhat more dangerous, but easier and quicker, is to place about 25 chickens in a box covered with burlap and to surcharge the air with the fumes of burning tobacco stems. The fumes can be supplied through an opening in the bottom of the box, this opening

being fitted over a firebox containing the burning stems. The chickens should be removed as soon as they show signs of exhaustion. The fumes overcome or even kill the worms. Their hold on the windpipe is relaxed and they are coughed up. Ground on which chickens suffering with gapes have ranged becomes infected and should not be used in succeeding years. The trouble can be minimized by practicing rigid disinfection and cleanliness in the coops, yards and eating places. Feeding strong onions or garlic, chopped and mixed with other food and fed before the worms gain a foothold, is beneficial in keeping down the growth and development of the parasite. Early hatching also is advised. Keeping the chicks on a board floor—away from all soil, will prevent the trouble.

GOING LIGHT.—This is a term commonly applied to a bacterial disease which interferes with the assimilation of the food and allows the body to starve to death. The symptom is a gradual loss of flesh, which results eventually, in weakness, debility and starvation. The disease, although communicable, spreads slowly. Fowls thus afflicted should be destroyed and their pens disinfected. Strict cleanliness will aid in warding off further outbreaks.

LEG WEAKNESS.—There are two different kinds of leg weakness. One is rheumatism, caused by dampness and insufficient ventilation in the pen. This form is remedied by correcting the method of housing and ventilating. The other form is due to over-feeding and lack of exercise. This combination of mismanagement makes the fowls over-fat and heavy and their muscles, at the same time, become soft and flabby. Their physical condition is such that a marked increase in humidity or any extra demand made on their body debilitates and partially paralyzes their legs. Cleanliness, more careful methods of feeding and increased range will overcome this weakness.

LICE.—There are many kinds of lice which are common among domestic fowls. They have the same general characteristics, however, and all are combated in the same way. Lice may remain on the body of the fowl both day and night. They are also commonly found on the perches and nest boxes. This necessitates treating both the fowls and the perches. A very effective spray for the perches is a solution of one part crude carbolic acid and three parts kerosene. It can be applied with a brush or, preferably, with a pump and spray, which will force the mixture into the cracks and crevices, where the lice accumulate. The fowls can be treated by dusting a fine powder into their feathers. The dust fills up the breathing pores on the body of the louse and suffocates it. Such a powder is more effective if it contains a drying and burning ingred-

ient, or one giving off fumes. R. C. Lawry, while an assistant in the Department of Poultry Husbandry at the New York State College of Agriculture at Cornell University, formulated an exceedingly effective homemade lice powder. It is prepared as follows: One-fourth pint of crude carbolic acid, mixed with three-fourths pint gasoline is thoroughly stirred into $2\frac{1}{2}$ pounds plaster of paris. The whole is forced through a sieve to break up the lumps. It is then allowed to dry in the air and when dry is tightly bottled. The stock mixture remains effective indefinitely. To apply this powder, make nail holes in the top of a tin can and use the can as a shaker. The fowl should be held by the legs with its head down. In this position the feathers fall away from the body and readily receive the powder, making it easy to work it down to the skin, by ruffling the feathers with the hand. This treatment is especially recommended for setting hens. Ten days later the dusting should be repeated in order to destroy the lice which are hatched out after the first application. It is not often necessary to dust every individual of an entire pen of fowls. The economical way to keep a pen free from lice is to spray the perches when necessary and to provide a dust wallow of coal ashes, land plaster or road dust, in which the fowls can wallow and kill body lice. This dust wallow should be in a warm, dry part of the pen, so as to attract the fowls to it. A small amount of this material can be scattered on and under the perches, and this part of the pen kept freer from lice.

LIMBER NECK.—The general paralysis of the muscles of a fowl, especially those in the neck, produces a condition known as limber neck. The fowl is unable to lift its head from the ground and, in fact, has very little power of locomotion. The cause is usually directly attributable to ptomaine poisoning, resulting from eating decomposed meat or flesh. The disease is consequently confined, usually, to the warmer months of the year and is most prevalent in the Southern States. The disease is not necessarily fatal nor is it communicable. Relief quickly follows any treatment which speedily flushes the digestive system. The usual doses are Epsom salts or one grain of calomel. Recovery has followed the use of a simple tonic known as the Douglas Mixture, which can be used to advantage in all digestive troubles. A stock solution of the Douglass Mixture is made by dissolving one-half pound sulphate of iron in a gallon of water and adding one-half ounce sulphuric acid. The clear liquid is used in the proportion of one pint to a pail of water.

During the warm months all dead or dying fowls or animals should be removed from the yards or pens at once and no tainted or fly-blown meat given to them.

MITES.—The mite is another external parasite of the fowl, which sucks the blood at night and returns to the perch before morning, remaining there during the day. It is only when mites have accumulated in large numbers and are unable to get enough blood during the night that they remain on the fowl during the day. The most common variety is red, and when these gather in numbers, they make a reddish black spot. The mite is killed by the direct application of a burning solution. They withstand ordinary sprays better than lice can. However, the solution of one-fourth pint crude carbolic acid and three-fourths pint kerosene has been found very destructive.

ROUP.—The term roup is used to cover several distinct diseases of the throat and head, some of which are very dangerous and difficult to cure, while others are comparatively simple. The most common form of roup is an exaggerated cold, which causes a fevered condition and stimulates the nasal secretions. These secretions have a strong, pungent odor. They stop up the nasal passages, producing a rattling sound when the fowl breathes. Many times this sound is heard when the secretions are not noticeable in either the nasal or throat passages. In such instances, look for a soiled place under the bow of the wing, where the fowl often puts its head. The odor alone, however, is sufficient indication of the disease. The cause of this kind of roup is exposure for a prolonged period to those conditions and surroundings which produce colds. It is thought that this disease is not communicable from one fowl to another, but spreads because conditions are favorable to the development of the disease in many individuals. If the disease is allowed to run its course, the fevered condition hardens the nasal secretions into a cheesy substance which accumulates in the tissues of the head, causing the eyes or other parts of the face, to bulge out. When this stage is reached, the irritation and fever becomes so great that the fowl soon dies from weakness and exhaustion. It is quite useless to attempt to cure at an advanced stage. Treatment should be given during the earlier stages. It is obvious that the first step is to rectify those conditions which encourage the disease. In addition to making the pens clean and dry, the following simple remedies can be used: One ounce permanganate of potash in three pints of water; use one pint of this stock solution in every three or four pints of drinking water. This will serve to disinfect the mouth and throat. It can also be administered, in its undiluted form, as a head dip. To do this, grasp the legs and wings of the fowl in one hand and the back of its head in the other. Thrust the bill into the solution nearly to the eyes and hold it there long enough so that the fowl

will draw in some of the solution while striving to breathe. Fifteen to twenty seconds is usually long enough. This cuts and loosens the accumulated mucus so that the fowl can shake it out. Another simple but very effective and wholesale treatment of roup is to paint or spray the perches with any coal tar product which gives off penetrating fumes. These fumes are breathed by the fowls all night and during this long period are effective in loosening up the nasal secretions and in checking the disease. Such treatment will serve also to check cankerous and diphtheretic roup, which are communicable forms of this disease, but, in most instances, it fails to effect a cure of either. The disease germs of these forms of roup develop more rapidly and are not so dependent upon damp and unsanitary conditions. The germ is usually introduced through newly purchased fowls or through exposure to the disease at public exhibitions or competitions. Cankerous roup is accompanied by and takes its name from the sores in the mouth and on the head. For treatment, see communicable diseases.

SCALY LEGS.—The term scaly leg is applied to a condition of the fowl's shanks, in which the scales have become roughened, swollen and filthy. A small parasite, working underneath the scales on the shank, causes this roughness. The parasite spreads by crawling along the perch until it reaches another fowl. A simple treatment is to soften the shanks in warm water and carefully remove the filth from underneath the scales. This should be followed by a thorough washing with five per cent carbolic acid, which kills the parasite. The shank should then be well greased with carbolated vaseline to keep the wound soft and clean until it heals.

VENT GLEET.—A communicable disease which affects the cloaca or vent is called vent gleet. This disease greatly irritates and inflames the vent, producing a sense of fullness and causing the fowl to attempt frequent voidings. A diarrhoea and a mucous discharge from the vent accompany this condition. The fluff becomes soiled and looks filthy. This discharge has a strong, offensive odor. If not treated at once, ulcers develop on the skin near the vent and the inflammation extends into the oviduct. At this stage the disease becomes critical. For treatment, the male should be removed from the pen until the trouble ceases, since he is mainly responsible for spreading the disease. The afflicted fowl should also be taken to quiet surroundings, where it can receive medical treatment. The principle on which a cure is effected is to cleanse the vent and fluff daily with warm water, to which a few drops of carbolic acid are added, following with an injection of sweet oil or a greasing with vaseline. This also should contain a few drops of carbolic acid.

The afflicted bird should be kept in a warm, protected place and fed on soft, nourishing foods, until it is strong enough to return to the pen.

VERTIGO.—Congestion of the brain is readily recognized by the giddy actions of the fowl and a habit of bending the head as far backward as possible. The bird assumes this attitude when frightened in order to relieve the sudden blood pressure on the brain. The disease is usually found among over-fat, plethoric fowls. It is one of the evils resulting from over-feeding. Irritation from worms in the intestines will also produce it. A few such cases should warn the feeder to exercise greater care in his method of feeding and the kinds of food provided. For individual treatment, Dr. D. E. Salmon suggests cooling the head of the fowl with ice until it is thoroughly chilled and giving one dose of either thirty grains of Epsom salts or one and one-half grains of calomel. In case the congestion is caused by intestinal parasites, treat to remove the cause.

WHITE DIARRHOEA IN CHICKENS.—The term white diarrhœa is used indiscriminately to apply to a large number of chicken diseases and troubles, including indigestion, pneumonia, coccidiosis, bacillary white diarrhœa, aspergilosis, and others, all of which produce very similar external symptoms, prominent among which is some form of diarrhœa. These diseases result from various causes. Some of them are produced directly by specific organisms, whereas others are the result of erroneous feeding and brooding, or are due partially to the careless selection and management of the breeding stock. The method of incubation also may be responsible for some weakness. Very little can be done to cure chickens suffering with this disease. The sick ones should be removed and burned, the brooders and feeding places kept sanitary, and the chickens given wholesome, nourishing food, free from much rich material. Clabbered milk is destructive to certain bacteria and should be fed liberally. A few crystals of potassium permanganate dropped into the drinking water free it from germs and make it an internal disinfectant. The preventive treatment is the best safeguard against these diseases and troubles. Exercise the greatest care in selecting the breeding stock, choosing strong, vigorous, healthy yearling or two-year-old fowls. Use a method of feeding which will force them to exercise while obtaining their food. This practice, in connection with feeding a variety ration of hard grains and succulent food, will do more than anything else toward keeping their bodies in a normal, healthy condition. Eggs from such fowls will produce strong, able chickens, capable of living and growing under ordinary

conditions. It is comparatively easy to raise a large percentage of chickens from strong, healthy stock, but even a good feeder has great difficulty in rearing weak chicks. Practice thorough sanitation while the chicks are young more than at any other time. Feed liberally, but do not allow food to accumulate in the brooder. Make the chicks clean it up between each feeding. In this way the ordinary chick troubles, commonly called white diarrhœa, will be avoided. Such a practice, however, does not entirely prevent the ravages of all. This is especially true of bacillary white diarrhœa, which is, apparently, born with the chick and is usually fatal within the first two or three weeks. The only practical treatment of such a disease is to replace the breeding stock with disease-free individuals. Unfortunately, it requires a bacteriological examination to determine the presence of this and similar diseases, making it impossible for the layman to diagnose the trouble. In such instances he should seek the aid of his State college of veterinary science.

WORMS.—There are a large number of species of parasitic worms found in the digestive organs of the fowl. The most common of these are the round worm, the tape worm, and a small worm, which bores into the walls of the gizzard. Fowls infected with worms become stupid and indifferent, and subject to sudden fits of wakefulness. Their appetite often becomes poor and their bodies show emaciation. Such symptoms are sometimes accompanied by a slight diarrhœa. For positive evidence, post mortem a dead fowl and examine the digestive tract. A dose of two teaspoonfuls of essence of turpentine is generally sufficient to dispose of the parasites. Powdered areca nut, in doses of 30 to 40 grains, is advocated by Zurn. Dr. Salmon advises mixing a teaspoonful of powdered pomegranate root bark in the food for 50 fowls, following with a purgative dose of two teaspoonfuls of castor oil.

CHAPTER VIII.

FEEDING THE BUSINESS HEN.

The poultryman has frequently been referred to as a manufacturer, with laying hens and growing stock for machines, the various poultry feeds the raw material, and eggs and meat the finished product. Obviously his profits will depend largely on two things:—the use of raw material of the right kind and in the right condition, and of efficient machines especially adapted to a definite purpose. It is difficult to say which of these factors is the more important. Certain it is that no machine can do its best work with unsuitable raw material, nor can a poor machine use to advantage the best of material. There is ample reason, therefore, for the poultryman to study carefully how to feed his birds to get the best results, and how to breed stock that will satisfactorily respond to proper feeding by economically producing eggs or meat. Birds lacking in vigor and vitality are never profitable, and therefore, should be discarded by the commercial poultryman. Every effort should be exerted to secure stock possessing great vigor of constitution and the ability to consume, assimilate and convert a large amount of food into the special product. Attention to this point is as much a characteristic of a successful feeder as is a knowledge of feeds and the compounding of rations.

For some years the columns of our poultry publications have teemed with the expressions "balanced rations," "nutritive ratio," "scientific feeding;" and as a result much confusion exists in the minds of those who have had no opportunity to study the matter carefully. Some poultrymen seem to think that a knowledge of the principles of feeding will enable one to determine absolutely the amount and character of the ration which will exactly meet the requirements of a flock of birds of a given number and weight. As a matter of fact, but few scientific experiments in poultry feeding have been conducted, and our knowledge of the subject is based largely upon the work of successful poultry feeders, and upon certain conclusions drawn from experiments conducted with other domestic animals. Under existing conditions, therefore, we must content ourselves with a knowledge of the chemical composition of various feeding stuffs suitable for poultry, and so be able to make

up rations from the available materials which will approximate those used by successful feeders who are operating under conditions similar to our own. Such information will not only enable us to use to best advantage the feeding stuffs produced locally, but it will help us to determine what materials should be purchased to make the ration complete. In the limits of a single chapter it is impossible to discuss at any length the principles of nutrition and feeding. But for a better understanding of our subject it is necessary that a few of the important points be briefly stated.

COMPOSITION OF FEEDS.—The chemist can readily analyze our various feeding stuffs and accurately determine their chemical composition. He finds a large number of substances, but for convenience these are placed in five groups, viz., water, ash, protein, carbohydrates, and ether extract. Every feed contains a certain amount of necessary moisture varying from eight to 90 per cent of the total weight. It is the most abundant constituent of the animal body and must be supplied abundantly, but because it can be easily and cheaply furnished in other ways it need not be considered in the feed. The roots of plants derive from the soil certain mineral matter, which, though comparatively small in amount, is absolutely essential to the ration. This ash, so called because it is the residue after the complete burning of the food, is largely used in the skeleton of the animal, and is present in every portion of the body. Without a sufficient supply of this material no animal can long retain health. In the protein group are placed any ingredients of plant or animal in which nitrogen is present. Common examples are white of egg and lean meat. Protein has been aptly described as a “flesh-former, a machine maker, the repairer of wear and tear.” It is evident from the above that no other group is more important. The carbohydrates are almost exclusively vegetable products. They contain sugar, starch, gums, and other substances. Included is the crude fibre or skeleton of plants, and the nitrogen-free extract. The materials extracted from feeding stuffs by ether, such as fat, resin and wax are placed in the ether extract or fat group. The functions of fat and carbohydrates in animal nutrition are the production of muscular energy and heat, and the formation of body fat.

It is evident that the value of food is determined by the amount *digested*, not by the amount *eaten*. While the scientists can tell us the chemical composition of food they cannot, without resorting to digestion experiments, inform us just how much of the material can be actually used by the animal. To conduct such experiments complicated apparatus is required, but briefly stated the food given and the wastes thrown off by the animal are weighed and analyzed,

the difference being the amount digested or the digestible nutrients. Unfortunately there have been but few digestion experiments conducted with fowls, so for the present we must depend upon the results secured from other domestic animals. For convenience, the table on next page gives both the chemical composition and the percentage of digestible nutrients of the various feeding stuffs used in poultry feeding.

When a ration is compounded in such a manner as to supply the animal with a sufficient amount of each group of digestible nutrients it may be called a balanced ration. The aim of every feeder should be to use a ration that furnishes enough of each group of nutrients fully to meet the requirements of the animal, but without an excess which might be wasted.

Investigators have endeavored to ascertain the amount of digestible nutrients and the proportion of the different groups required in rations intended for specific purposes, and as a result of this work we have a series of feeding standards for most domestic animals. Though far from being perfect as yet these standards are extremely valuable as they furnish a definite starting point. A ration compounded theoretically by the use of these tables may not work out well in practice, but using it as a basis the feeder can make such changes as experience and observation warrant or economy dictates.

The relative proportion of the various nutrients in a ration is termed the nutritive ratio. This is easily ascertained by the use of the accompanying table, and is expressed by the proportion of protein to all the non-nitrogenous digestible materials reckoned in terms of carbohydrates. For instance, in 100 pounds of wheat are found the following digestible nutrients: Protein, 10.2 pounds; carbohydrates, 69.2 pounds; ether extract, 1.7 pounds. As each pound of ether extract has $2\frac{1}{4}$ times the heating value of the carbohydrates, the first step in ascertaining the nutritive ratio is to multiply the amount of ether extract by $2\frac{1}{4}$, and thus reduce it to its carbohydrate equivalent. This product added to the amount of carbohydrates present gives the carbohydrate value of all the digestible nutrients in the ration aside from the protein. The sum thus secured is divided by the amount of protein present, and the result expresses the relative proportion of these two classes of nutrients present in the ration, or the nutritive ratio. Taking the figures quoted above and following this rule we get the following:

$$\begin{aligned} 1.7 \times 2.25 &= 3.8 \\ 3.8 + 69.2 &= 73.0 \\ 73.0 \div 10.2 &= 7.1 \end{aligned}$$

FEEDS.

AVERAGE COMPOSITION AND DIGESTIBILITY.

Compiled from various authorities.

FEEDING MATERIALS.	PERCENTAGE COMPOSITION.						Percentage Dry Matter.	PERCENTAGE DIGESTIBLE NUTRIENTS.		
	Water.	Ash.	Protein.	Crude Fiber.	Nitrogen-Free Extract.	Ether Extract.		Protein.	Carbo-hydrates.	Ether Extract.
GRAINS AND SEEDS—										
Corn—Dent	10.6	1.5	10.3	2.2	70.4	5.0	89.4	7.8	66.7	4.3
" Flint	11.3	1.4	10.5	1.7	70.1	5.0	88.7	8.0	68.2	4.3
" Sweet	8.8	1.9	11.6	2.8	66.8	8.1	91.2	8.8	63.7	7.0
Wheat	10.5	1.8	11.9	1.8	71.9	2.1	89.5	10.2	69.2	1.7
Oats	11.0	3.0	11.8	9.5	59.7	5.0	89.0	9.2	47.3	4.2
Barley	10.9	2.4	12.4	2.7	69.8	1.8	89.1	8.7	65.6	1.6
Buckwheat	12.6	2.0	10.0	8.7	64.5	2.2	87.4	7.7	49.2	1.8
Rye	11.6	1.9	10.6	1.7	72.5	1.7	88.4	9.9	67.6	1.1
Kafir Corn	9.3	1.5	9.9	1.4	74.9	3.0	84.8	7.8	57.1	2.7
Sunflower Seed	8.6	2.6	16.3	29.9	21.4	21.2	92.5	12.1	20.8
Millet Seed	14.0	3.3	11.8	9.5	57.4	4.0	86.0	8.9	45.0	3.2
Hemp Seed	92.0	10.0	45.0	21.0
Wheat Screenings	11.6	2.9	12.5	4.9	65.1	3.0	88.4	9.8	51.0	2.2
MEALS, Etc.—										
Cornmeal	15.0	1.4	9.2	1.9	68.7	3.8	85.0	6.3	65.3	3.5
Wheat Bran	11.9	5.8	15.4	9.0	53.9	4.0	88.1	12.2	39.2	2.7
Wheat Middlings	12.1	3.3	15.6	4.6	60.4	4.0	87.9	12.8	55.0	3.4
Red Dog Flour	9.0	3.8	22.2	1.9	57.4	5.7	91.0	17.8	46.5	4.9
Oatmeal	7.9	2.0	14.7	0.9	67.4	7.1	92.1	11.5	52.1	5.9
Brewers' Grains—Wet	75.7	1.0	5.4	3.8	12.5	1.6	24.3	3.9	9.3	1.4
" " Dry	8.2	3.6	19.9	11.0	51.7	5.6	91.8	15.7	36.3	5.1
Malt Sprouts	10.2	5.7	23.2	10.7	48.5	1.7	89.8	18.6	37.1	1.7
Buckwheat Middlings	13.2	4.8	28.9	4.1	41.9	7.1	87.3	22.0	33.4	5.4
Linseed Meal—Old pr.	9.2	5.7	32.9	8.9	35.4	7.9	90.8	29.3	32.7	7.0
" " New pr.	10.1	5.8	33.2	9.5	38.4	3.0	89.9	28.2	40.1	2.8
Cottonseed Meal	8.2	7.2	42.3	5.6	23.6	13.1	91.8	37.2	16.9	12.2
Peanut Meal	10.7	4.9	47.6	5.1	23.7	8.0	89.3	42.9	22.8	6.9
Pea Meal	10.5	2.6	20.2	14.4	51.1	1.2	89.5	16.8	48.0	0.7
Gluten Meal	8.2	0.9	29.3	3.3	46.5	11.8	91.8	25.8	43.3	11.0
ROOTS, Etc.—										
Garden Beets	88.5	1.0	1.5	0.9	8.0	6.1	11.5	1.2	8.8	0.1
Sugar Beets	86.5	0.9	1.8	0.9	9.8	0.1	13.5	1.1	10.2	0.1
Mangolds	90.9	1.1	1.4	0.9	5.5	0.2	9.1	1.1	5.4	0.1
Turnips	90.5	0.8	1.1	1.2	6.2	0.2	9.5	1.0	7.2	0.2
Carrots	88.6	1.0	1.1	1.3	7.6	0.4	11.4	0.8	7.8	0.2
Pumpkin	90.9	0.5	1.3	1.7	5.2	0.4	9.1	1.0	5.8	0.3
Potatoes	78.9	1.0	2.1	0.6	17.3	0.1	21.1	0.9	16.3	0.1
Cabbages	90.5	1.4	2.4	1.5	3.9	0.4	15.3	1.8	8.2	0.4
Lettuce	4.1	1.0	1.6	0.2
Rape	84.5	2.0	2.3	2.6	8.4	0.5	14.0	1.5	8.1	0.2
Apples	80.8	0.4	0.7	1.2	16.6	0.4	19.2	0.2	14.3	0.3
Red Clover—Fresh	70.3	2.1	4.4	8.1	13.5	1.1	29.2	2.9	14.8	0.7
" " Dry	15.3	6.2	12.3	24.8	38.1	3.3	84.7	6.8	35.8	1.7
Alfalfa—Fresh	71.8	2.7	4.8	7.4	12.3	1.0	28.2	3.9	12.7	0.5
" " Dry	8.4	7.4	14.3	25.0	42.7	2.2	91.6	11.0	39.6	1.2
ANIMAL FEEDS—										
Milk	87.2	0.7	3.6	4.9	3.7	12.8	3.6	4.9	3.7
Skim-milk	90.6	0.7	3.1	5.3	0.3	9.4	2.9	5.2	0.3
Buttermilk	90.1	0.7	4.0	4.0	1.1	9.9	3.9	4.0	1.1
Dried Fish	10.8	29.2	48.4	11.6	89.2	44.1	0.0	10.3
Dried Blood	8.5	4.7	84.4	2.5	91.5	52.3	0.0	2.5
Beef Scrap*	1.3	15.3	88.7	48.5	15.2

* There is a wide variation in the composition of commercial beef scrap. In thirty samples of "meat meals and beef scraps" recently analyzed at the New Jersey Agricultural Experiment Station, the percentage of protein ranged from 27.44 to 66.50, with an average of 49.38.

Therefore there is one part of protein to 7.1 parts of carbohydrates, and the nutritive ratio of wheat is 1 to 7.1. For convenience this is usually written 1:7.1.

The nutritive ratio of a mixed ration is found by adding the amounts of nutrients of the various classes in the various feeds used, and proceeding as above. Rations having a nutritive ratio of 1:5.5 or under are called narrow; between this and 1:8 are called medium, and over the latter are termed wide. Some years ago the New York Experiment Station determined certain feeding standards for poultry, indicating the average quantities of dry matter and the various digestible nutrients required by some classes of fowls under certain conditions. Portions of these standards follow:

Rations for Chicks.—Digestible nutrients per day for each 100 pounds live weight.

	Total Dry Matter lbs.	Ash lbs.	Pro- tein lbs.	Carbohy- drates lbs.	Fat lbs.	Nutri- tive ratio
For the first 2 weeks.....	10.1	.5	2.0	7.2	.4	1:4.1
From 2 to 4 weeks of age..	9.6	.7	2.2	6.2	.5	1:3.4
From 4 to 6 weeks of age..	8.6	.6	2.0	5.6	.4	1:3.3
From 6 to 8 weeks of age..	7.4	.5	1.6	4.9	.4	1:3.7
From 8 to 10 weeks of age..	6.4	.5	1.2	4.4	.3	1:4.3
From 10 to 12 weeks of age..	5.4	.4	1.0	3.7	.3	1:4.4

Rations for Laying Hens.—Digestible nutrients per day for each 100 pounds live weight.

	Total Dry Matter lbs.	Ash lbs.	Pro- tein lbs.	Carbohy- drates lbs.	Fat lbs.	Nutri- tive ratio.
Hens of 5 to 8 lbs. weight.	3.30	.20	.65	2.25	.20	1:4.2
Hens of 3 to 5 lbs. weight.	5.50	.30	1.00	3.75	.35	1:4.6

Attention is again drawn to the fact that these standards are an aid to intelligent feeding, but must not be considered absolute rules. Aside from the chemical composition of the ration there are many factors to be considered, such as the mechanical condition of the various feeding stuffs used, their palatability, comparative cost, etc.

In discussing the essentials of the ideal poultry ration, Doctor Brigham says that it should contain the four groups of supplies that the birds naturally secure when at liberty on ample range, viz., grains, grubs, greens, grits. When poultry keepers learn to include all of these in the bill of fare of their fowls we will have fewer complaints of unsatisfactory results. An examination of the feeding methods of successful poultrymen will demonstrate that in every case representative feeding stuffs from each of the above groups are included in the ration.

In the first group, the grains, are included the various seeds and grains and their by-products. Fed in various ways, whole, cracked and ground, they form the major portion of the feed required by all classes of poultry. The grains most commonly used by poultrymen in the eastern part of the United States are corn, wheat, barley and oats. Buckwheat, Kaffir corn and sunflower seeds, usually in comparatively small quantities, are frequently added for variety. Corn is the cheapest of the grains and as a result it is frequently fed too freely. Carefully used it is an economical feed. Wheat is commonly considered the best grain for poultry, and it may be fed liberally when the price warrants. Shrunken and broken wheat are as valuable as plump wheat for poultry feeding, but so-called wheat screenings which consist largely of weed seeds, light oats and other wastes, are not desirable. Barley is an excellent feed and makes a fair substitute for wheat. Oats are especially valuable, and in some form should appear in the rations of both growing and laying stock. Some object to the use of oats on account of the hulls, but experienced poultrymen feed them liberally with excellent results. Buckwheat is useful as a feed for layers, and can be used to special advantage at the time the pullets are being matured. Sunflower seeds contain a very high percentage of crude fiber, but may be fed sparingly at all times, and more liberally during the molting season.

Of the innumerable by-products the best are wheat bran, wheat middlings, linseed meal and gluten meal. Pea meal and peanut meal are worthy of careful trial, though both are hard to secure in some localities and the cost is frequently prohibitive. Green food is very important, not because of its nutritive value alone, which is comparatively slight, but on account of its tonic influence on the digestive system. A regular and liberal supply of succulent feed seems to be an essential part of the ration for all ages.

During the growing season the green food may be easily supplied by allowing the birds access to growing grass or young grain. If this is not convenient, rape, Swiss chard or other similar crops may be grown. The various roots and vegetables may be used during the Winter season, but everything considered, mangolds are probably the most satisfactory. Of late many poultrymen have adopted the use of sprouted oats, and the results seem to be excellent. Oats are spread on trays to the depth of one to two inches and kept damp and warm. The result is a very rapid growth of tender, succulent sprouts. When the latter reach the height of four to six inches the matted mass is fed to the birds, a block 6x10 inches in size daily being sufficient for 100 hens. It is advisable to use new, heavy oats for this purpose, as they germinate better than old grain.

For feeding young chicks wheat may be sprouted in the same manner and the danger from oat hulls is thus eliminated. Dry lawn clippings, clover and Alfalfa hay are excellent Winter feeds. They may be used dry, or if preferred, soaked or steamed. When on range poultry pick up much animal food in the form of insects of various kinds, but under ordinary conditions the amount is too small to give the best results. The deficiency may be met by supplying animal food of some other kind. Such foods are highly nitrogenous and are an essential part of the ration. It has been clearly demonstrated that protein from animal sources is much more valuable in poultry feeding than that of vegetable origin. In fact it is doubtful whether the latter can successfully be substituted for the former.

The animal foods most in use are beef scrap, meat meal, milk in various forms and desiccated and fresh fish. Both beef scrap and animal meal vary widely in composition, and for protection the poultryman should use brands sold under a guaranteed analysis. Milk in any form may be fed freely, either separately or mixed with the mash. It seems to have a practical feeding value much greater than indicated by its chemical analysis. The same is true of fish, though many hesitate to use fish because it has been charged with giving an undesirable flavor to the eggs. Fresh fish should be boiled before feeding, and in no case should any be used that is not absolutely sweet.

Under the head of grits may be grouped the gravel and other substances used by the birds as grinding materials; the oyster shells commonly used to supply carbonate of lime for the egg shells and the bone, which helps build the skeleton. This group, especially the bone, is frequently overlooked. As has been previously stated, the ash constituents of the food are very important, and since the bulk of the feeding stuffs have a low ash content, green bone, cracked bone or bone meal should be used to add the necessary phosphate of lime, especially in the ration for growing stock. It is a good practice to keep grit, shell, bone and charcoal in hoppers where the birds can have access to them at all times. Fowls should also be given a limited amount of salt, from one-quarter to one-half pound being added to each 100 pounds of mash.

When planning a system of poultry feeding consideration must be given to two important points: First, the cost of the ration, and second, the amount of labor involved in feeding it. At this point the individual poultryman must decide for himself and adopt the ration and feeding system that best meets his needs under the peculiar conditions surrounding his plant. It is conceivable that a ration might be adopted which would give an unusually heavy egg produc-

tion but costing so much that the resulting profit would be small. On the other hand a complicated system of feeding might require so much labor that comparatively few birds could be cared for by one man. Under these conditions the profit *per hen* might be large, but the *aggregate* income altogether too small. As a commercial proposition the net profit *per bird* is not as important as the net profit *per man*.

Occasionally a poultryman will feed whole grain exclusively, but the general rule is to supply a portion of the grain food in the form of mash, a mixture of various ground grains and by-products. This is fed either wet or dry. A great difference of opinion exists among poultrymen as to the relative merits of these two methods, but it is generally held that wet mash, properly fed, will produce a better egg yield, while dry mash feeding is easier and safer. The latter system is in more general use on commercial poultry farms at present. The beginner will appreciate the fact that definite directions as to the *amount* to feed a given lot of birds can be stated when dry mash feeding is followed.

The Maine Agricultural Experiment Station method of feeding laying hens has received great publicity and been widely adopted. At this Station the stock consists of Barred Plymouth Rocks housed in curtain-front buildings. The feeding is as follows:—

Dry mash is kept in open hoppers before the birds at all times. Also grit, oyster shell, cracked bone and charcoal. Green food, either mangolds or sprouted oats, is supplied, and five pounds of cut clover hay is fed dry daily to each 100 birds. Early in the morning for each 100 hens, four quarts of whole corn is scattered in the litter, and at 10 o'clock they are fed two quarts of oats and two quarts of wheat.

The dry mash was formerly made up as follows: 200 pounds wheat bran, 100 pounds cornmeal, 100 pounds wheat middlings, 100 pounds gluten or brewers' grain, 100 pounds linseed meal, 100 pounds beef scrap.

Thousands of poultrymen used this formula, many with satisfactory results, while others found it too concentrated and made changes as dictated by their judgment. The Station has recently made some changes in the mixture. Pullets are brought into the laying house in September, and during that month the mash is made up of: 300 pounds bran, 100 pounds cornmeal, 100 pounds middlings, 100 pounds beef scrap. For October the mash contains: 200 pounds bran, 100 pounds cornmeal, 100 pounds middlings, 100 pounds gluten meal, 100 pounds beef scrap. For November 50 pounds of linseed meal is added to the above. For December the

October mixture is used again. Thereafter this amount of linseed is added on alternate months.

The Station claims for this revised system of feeding that it maintains the vitality of the stock and induces an even egg production during the Winter months.

On a New England farm, where 1,000 Buff Plymouth Rocks are kept, a system has been evolved that has given good satisfaction and enabled the owner to show a handsome profit annually. The stock is kept under the double yard system, having access to growing green food at all times. Dry mash, beef scraps, grit, shell and charcoal are constantly kept in hoppers before the birds. At 3 P. M. daily 10 quarts of grain are fed to each 100 birds. This mixture consists of equal parts by weight of corn, wheat and oats. Twice weekly the birds are fed boiled vegetables in troughs, all they will eat in a half hour.

The basis of the mash is the above grain mixture ground. To each 100 pounds of this mixture is added five pounds linseed meal, 10 pounds blood meal and 20 pounds Alfalfa meal.

On another successful egg farm using Rhode Island Reds, dry mash, shell, grit and bone are constantly supplied in hoppers, and green food is furnished in liberal amounts. To each 100 hens three quarts of a grain mixture is fed in the morning and three quarts of coarse cracked corn at night. The grain mixture is made up of seven parts, by measure, of wheat, seven parts of oats, four parts of fine cracked corn.

The mash mixture contains 200 pounds bran, 100 pounds middlings, 100 pounds gluten, 100 pounds ground oats, 100 pounds meat meal. A good mash mixture that has given satisfactory results for years consists of 200 pounds bran, 200 pounds cornmeal, 200 pounds ground oats, 100 pounds middlings. Beef scrap may be added to this, or fed separately in hoppers.

Any of the above mixtures would make a good wet mash. In feeding wet mash great care should be exercised to make the mixture the proper consistency, moist and crumbly, but never sloppy.

For best results, wet mash should be fed just before the birds go to roost. The whole grain may be fed in the morning—or thrown into the litter after the birds have gone to roost; a green food given at noon and at night all the mash they will clean up quickly. This system of feeding keeps the birds active all day and sends them to roost with full crops.

A study of the above rations serves to emphasize the fact that there is no one best ration for laying hens. Within reasonable limits the exact proportions of the different foods does not seem

to make a great difference, but in every case we find included in satisfactory rations the four groups of feed stuffs already discussed—grains, grubs, greens, grits.

There is no gain from supplying a mere maintenance ration. Profit can be secured only from that part of the ration which the fowl can assimilate in addition to her own bodily needs. Rapid growth and heavy egg production can be secured only by heavy feeding. The fattening of market poultry should be given more attention. A large proportion of our market stock is sold in poor condition, to the detriment of producer and consumer alike. A comparatively short period of confinement in a comfortable pen with liberal feeding of corn in some form, and beef scraps, will greatly improve the condition of fowls and chickens intended for market. Of course the best way to finish market stock is crate fattening. The birds are placed in small compartments in crates, kept quiet and comfortable, and for about three weeks are fed twice daily, either in troughs or by the use of the cramming machine.

At the Ontario Agricultural College the following ration proved an economical producer of yellow flesh: five pounds cornmeal, four pounds middlings, one pound oat meal, one pound animal meal. A professional fattener in New York uses equal parts by weight of cornmeal, ground oats and ground barley. For best results these materials must be ground exceedingly fine. Milk, either sour or buttermilk, is used to reduce the mixture to a creamy consistency. In the absence of milk, water may be used, in which case a small amount of animal meal should be added to increase the amount of protein.

CHAPTER IX.

BREEDING THE BUSINESS HEN.

WHAT BREEDING CAN AND CANNOT DO.—All improvement of the domestic fowl is the result of careful selection and mating, combined with improved methods of feeding and care. When once secured superior quality of egg production, growth of flesh or high exhibition points are difficult to maintain. The natural tendency is downward rather than upward. High standards of excellence are sustained and improved only by the guiding hand of man. Left to shift by themselves it is safe to predict that most of our so-called breeds or varieties of poultry would gradually revert back to a few primitive races. Careful breeding alone, important though it is, will not insure permanent improvement. No amount of good breeding for size or prolificacy will take the place of good feeding and care, or can ever overcome the evil influences of improper methods of rearing. Good feeding and good breeding are twin sisters in the improvement of the domestic fowl. One is as important as the other, and one is indispensable to the other. Many flocks of good purebred poultry have been blamed for poor egg yield which was due to improper methods of feeding, housing and care, and the breeder paid the penalty. If we would produce good layers of large high-quality eggs, we must rear large healthy stock. Our business hen machine must be well built. She must be grown under fresh air, free range conditions and judicious liberal feeding. The business hen must be bred for business. She must fulfill the following qualifications: She must be of good size, hardy, attractive, an economical producer of eggs and flesh, and must be especially adapted to the specific purpose for which she is kept.

CONSTITUTIONAL VIGOR.—Whatever may be the object in breeding, whether for exhibition, for egg production or flesh, the first consideration is strong vigorous stock. This is especially true in breeding for egg production. In view of the great importance of breeding poultry for increased egg production, and the consequent demands upon the fowl for greater physical strength to withstand the heavy strain upon the system, it is of prime importance to know to what extent constitutional vigor influences the egg-laying qualities of fowls, the fertility and hatching power of their eggs and the

development of their offspring. The modern heavy-laying fowl probably performs the greatest feat of digestion, assimilation and reproduction of any of our domesticated animals. She is our greatest transformer of food into a finished product. She is our best condenser of raw materials. This point is clearly emphasized by Dr. W. H. Jordan, of the New York State Experiment Station at Geneva, who compared a Leghorn fowl, weighing $3\frac{1}{2}$ pounds and laying 200 eggs per year, weighing 25 pounds, with a Jersey cow, weighing one thousand pounds and giving in a year 7,000 pounds of milk containing 14 per cent solids. He stated that "If you take the dry matter of the hen and compare it with the dry matter in the eggs she lays in a year, there will be $5\frac{1}{2}$ times as much dry matter in the eggs as in her whole body. The weight of the dry matter in the cow's body to the weight of the dry matter in the milk will be as one to two and nine-tenths. In other words, based upon dry matter, the hen does twice as well as the cow. I suspect the hen is the most efficient transformer of raw material into the finished product that there is on the farm. Her physiological activity is something remarkable. So in that particular the hen stands in a class by herself."

A good fowl is expected to average 135 to 150 eggs per year. Three of the Cornell Poultry Department flocks this year averaged 152, 156 and 175 eggs per hen respectively, an average of 161 eggs per hen. Several hens have laid more than 200 eggs each, and one laid 240 eggs. These hens averaged $3\frac{1}{2}$ pounds each in weight, and laid five times their weight in eggs. This is, in fact, quite similar, though not entirely comparable, to the giving birth of an offspring every other day during the year. To do this requires not only an inherited tendency to large production, but also an inherited constitutional vigor to withstand the great physical strain. Reproduction, presumably, is the most exhausting physical function. In view of the enormous work of digestion, growth and production which a hen is expected to perform during her short life of two or three years, it must be apparent that the most important factor in breeding poultry is not the breed or variety, or the high scoring qualities of the individual as an exhibition fowl, or the number of eggs its ancestors have laid that determines its value, important though they are, but rather the good health, natural stamina and the constitutional vigor of the fowls to be mated, and their ability to eat, digest and assimilate large quantities of food.

CONSTITUTION AND VITALITY.—A factor quite as important as determining whether or not constitutional vigor influences the function of reproduction, is to learn whether there are

physical differences which distinguish the constitutionally strong from the constitutionally weak fowls, and if so, whether they can be easily distinguished by physical characteristics which can be used as a basis on which to select strong fowls for breeding purposes. In order to determine whether or not physical strength or weakness influences production, fertility and hatching power of eggs, and growth of chickens, and if so, whether there are physical characteristics by which these weaknesses may be recognized in the selection of breeders, a large number of experiments have been conducted by the Poultry Department of the New York State College of Agriculture at Cornell University, the results of which show that there are great differences in the number of eggs laid, their fertility and hatching power, and the vigor of chickens from fowls that have strong constitutions as compared with those of low vitality. These differences amounted to a dozen and more eggs a year per hen in favor of the hens of strong constitution. Seven-months-old pullets from hens of high vitality weighed from one-half to one pound more than pullets of the same age and variety and method of hatching and rearing that were hatched from eggs laid by stock of low vitality. The method by which the flocks were selected was based on the theory that strong fowls differ from weak fowls in type, action and various other physical characters. Among the points to be observed in selecting fowls with reference to their constitutional vigor are the following: A fowl's actions are a splendid indication of its health. This is especially true as regards the appetite. Fowls that are strong, vigorous and active usually are good feeders. Generally among fowls of the same variety the heaviest eaters are the heaviest layers. Fowls that are in the best physical condition generally are off the perches first in the morning and go to roost last at night. Hens of low vitality are much upon the roosts during the day and are inclined to stand around listlessly. Crowing is an excellent character to indicate vigor and vitality, and should always be used in selecting males for breeding purposes. It indicates physical strength and masculinity. Gallantry on the part of the male in calling the hens to eat choice morsels of food is also a character of considerable importance. Courage as contrasted with fear is also a good indication of constitutional vigor. Fear and physical weakness usually go together.

Type is next in importance to the action of the fowl as an indication of constitutional vigor. The body of the vigorous fowl is broad, deep and blocky, as contrasted with the long, thin, slender type. The difference is primarily in the length of the joints and the size of the bone and muscles. There is a correlation between

the parts of a fowl, so that these are associated together as indications of high or low vitality. For example, a fowl of pronounced low vitality is likely to have a long, flat, narrow head, long, thin, flat beak, long, thin neck, long, slender body, long, thin thighs and shanks, and long toes. Pale, thin, cold shanks are an almost infallible indication of lack of vitality. The fowl of pronounced strong vitality is more likely to have a short, thick, curved beak, round full head, large comb, short, stocky neck, short, thick, deep body, short, heavy thighs and shanks. The eye is a mirror of the health, reflecting vitality and life. It should be round and full. Sunken eyes and drooping eyelids indicate low vitality. The plumage of the fowl also indicates its vitality. In fowls of low vitality the plumage is likely to be ruffled, dry, lusterless and broken and not fully developed. Chickens of low vitality are slow to feather. The way a fowl carries the tail and wings is a good indication of its vigor. Sick fowls nearly always carry the tail drooping. This is particularly true in the case of young chickens. The luster of the plumage is dependent to a large extent upon proper nourishment and the oiling of the plumage from the oil glands, which, in the fowl of low vitality, do not contain sufficient oil for the purpose. The breast and keel of the fowl of strong vitality are usually full and meaty and the fluff plump and full. This is one of the first places to examine in selecting fowls for low vitality. Depth and width of the body indicate a large capacity to digest and assimilate food. Both characters are applicable in selecting fowls of any age. Selection for breeding purposes should be continuous: from the egg, the chick and chicken, the cockerel and pullet, and mature stock. We should eliminate weakness wherever we see it.

BREEDING FOR EGG PRODUCTION.—The business hen must be bred to lay more eggs of better quality and to lay them at the time when they will bring the highest price at the lowest possible cost for food and care. Improvement must, therefore, be made in quantity, quality and cost. Trap nests supply the only certain way of breeding from the highest producers. Trap nests, however, are not to be recommended except for persons who can give special attention to the breeding of pedigree stock. It costs in the neighborhood of 50 cents per year per hen for labor in trap-nesting and keeping the records. There are a few things the poultryman or farmer can do without trap-nesting that will be likely to enable him to improve the egg producing qualities of his flock.

(1) Pick out the pullets of the same age that lay first. Chickens, like all animal kind, show early in life the characteristics that dominate later. A careful study of the individual records of hens

indicates that the earliest producing pullets are likely to be the most prolific.

(2) Breed from the hens that lay best in the Fall and early Winter. It has been found that only the best layers are likely to lay in the Fall and early Winter when conditions are most favorable for egg production. This season, then, is the time of the year in which to select and mark the fowls for breeding. The most unfavorable season to make the selection is in the Spring, when both the high and low-producing fowls are laying, and when it is difficult to distinguish one from the other. By selecting for breeding the fowls that lay in the Fall and Winter, we not only are more likely to get the highest producers, but also those that have a tendency to lay the largest proportion of their eggs when they are the highest in price.

(3) Breed only from hens of good size. A small hen cannot lay as many large eggs as a large hen can without undue physical exertion. The size of the hen must be kept in proportion to the size and number of eggs she lays. We cannot afford to overload our hens any more than we should overload an engine. This does not imply that the largest hens are necessarily the most prolific, but it is intended to emphasize the necessity of having large, vigorous stock, capable of digesting and assimilating a large amount of food in order to produce a large number of large-sized eggs.

(4) Breed from the hens that moult late in the Fall and also show evidence of physical strength. Late moulting, when coupled with constitutional vigor, indicates that the fowl had continued to lay late into the Fall of the year. Experiments at Cornell have shown that the highest producers are likely to moult late. The fact that fowls are in good health and moult late is not only a good indication of high production, but indicates that the fowl is not likely to lay many, if any, eggs during the remainder of the Winter and, therefore, is likely to be in the best possible physical condition to lay large perfect hatchable eggs during the hatching season.

(5) Select egg-type fowls for breeding. While it is a disputed point as to whether or not there is such a type, poultrymen who are close observers are pretty well agreed on the type of certain individuals which they have come to recognize as their best producers. These characters may not be precisely the same with all varieties. Each breeder must become thoroughly familiar with his variety. There are many methods, more or less reliable, for telling a hen that is laying from a hen that is not laying at a given time. However, in these days when complete and careful records are being kept for the year, the so-called systems are of limited value in determining the largest producers. The shape of the hen's body, size

and color of her comb change from time to time during the year, which interferes with any method of selecting fowls of the "egg type." The egg type is not yet scientifically proven, even though good poultrymen learn to select with considerable accuracy the individuals that are most likely to give the best results. The differences in productive capacity undoubtedly accompany and are the result of a difference in body type. Good type, however, does not mean body type alone. High productive power apparently is dependent not only upon the inheritance of the function of egg production, but also of the body best suited to large production, and also upon a highly-developed nervous organization and strong powers of digestion, any one of which, or all four of which factors presumably may be inherited by the individual. The body type can in a measure be determined by physical examination. The nervous force is indicated by the action, intelligence and bright eye. Strong digestion and assimilation are shown in the appetite and ability to handle food. Constitutional vigor by type, action, color and size of comb, shanks, etc. When all these qualities are combined in an individual we get the highest producing fowl.

(6) Constitution vigor. Only individuals showing characters of strong constitutional vigor should be retained for breeders.

(7) Use hens instead of pullets for breeding, thus increasing the size of the chick and improving its vigor, and at the same time developing the tendency to breed for longevity of the race.

BREEDING FOR LONGEVITY.—We must breed a long-lived hen, a long distance hen, one that can keep up the process of good egg production for a period of two or three years and remain strong and hardy. There are long-lived families of hens just as there are long-lived families of humans. The tendency of long life appears to be a hereditary character. The tendency of modern poultry breeding on many of the large poultry farms has been to shorten the normal life of the race of the domestic fowl. This has been brought about in a variety of ways, chief of which is the breeding from cockerels and pullets instead of cocks and hens. This is because pullets lay the largest number of eggs during the first six months of their laying year, which is the last six months of their first year from the shell. While they are doing this they are also expected to increase in size. They are then not in a proper physical condition to produce eggs for breeding as compared with hens that are kept under similar environmental conditions. Close confinement, forced feeding and early maturity have also contributed to shorten the normal life and lower the vitality of the fowl.

AGE AS A FACTOR IN BREEDING.—A good male should be used until a stronger and superior individual can be found. The

age of usefulness of a male will depend more upon his inherited vitality and physical characters than on any particular breed or stated age. Males of the large breeds frequently become heavy and clumsy. A White Leghorn male, now nine years old, is known to be a valuable breeder still. Two or three years, however, usually is the limit of profitable usefulness. Under-sized cockerels should never be used. Maturity and full development are essential. Strong, large, early-hatched cockerels are as a rule as desirable as old males, except that they have not been tried and their power of reproducing desirable characters has not been proven. A male's value is two-fold: his ability to produce fertility and his power to reproduce his own desirable qualities. Males that excel in one quality do not always in both. It is generally a good practice to keep a male if he remains active until you can get a better one. Breed from mature stock. Fowls two or three years old which have robust constitutions are more desirable for breeders than younger stock, either male or female. Professor Atwood, of the West Virginia Experiment Station, proved in six experiments where he compared eggs for hatching from hens and pullets, that the former not only laid larger eggs that produced larger chickens, but also gave the best results in fertility and hatching power, and that these differences were apparent for many weeks after hatching, in size and health of chickens. Hens have the advantage of having had an opportunity to prove themselves. The breeder has had an opportunity to observe and eliminate during the two or three years of observation the weaker and less attractive, poorer developed, less productive and improperly marked fowls. Two-year-old hens lay less eggs during the Winter season than do those that are one year old (pullet year), and therefore, other conditions being equal, should have greater vitality and hence should transmit more vigor to the chicks. Hens that have not laid freely during the early Winter, other conditions being equal, are more likely to produce a larger supply of hatchable eggs at the right time for hatching. It does not follow that just because hens do not lay during the Winter that their eggs will be more hatchable. They may fail to lay because improperly fed or housed and in that event the eggs would be likely to be less hatchable. Hens having reached maturity are more likely to throw their energy into eggs of larger size. The size of the eggs, other things being equal, determines the size of the chicks. By increasing the natural length of life of productiveness of the domestic fowl we decrease the liability to mortality in rearing, chickens having been bred to inherit a tendency to live. By breeding fowls to lay a reasonable number of eggs for two or three years in succession we vastly decrease the number of chickens to be reared each year to

renew the flock. It is better to do this than to breed an excessively high-producing, short-lived fowl.

BREED TO IMPROVE THE QUALITY OF THE EGGS.—The business hen must be bred to lay eggs that will bring the highest price. These should be of large size, weighing two to $2\frac{1}{4}$ ounces each, uniform egg shape, uniform light or dark brown or white in color. Such eggs bring from five to 10 cents per dozen more than eggs irregular in shape and size and differing in color. This would make a net difference of 50 to 75 cents per year in the selling value of the eggs per hen. The greatest improvement in breeding poultry lies in the direction of improving the quality rather than in increasing the quantity of eggs. Improving the quality of eggs as to color and shape may be brought about entirely by selecting eggs of the right type for hatching. It costs no more to produce eggs of the right color and shape than it does to produce eggs of irregular shape and color, so far as cost of food and care are concerned. Improvement in the quality of eggs may be brought about by observing the law that every hen is born to lay an egg of given size, shape and color, and to continue to lay eggs of similar type during her natural life, with the exception that there is a tendency for the eggs to grow slightly larger as the hen grows older. The next step is to apply the law of inheritance, i. e.: that "similar tends to produce similar," which means that, generally speaking, the color, shape and size of the egg is likely to be transmitted from parent to offspring. By using only eggs for hatching that are perfect in size, shape and color for a few years, the quality can be radically changed in these respects. In many instances this will mean an increase in the selling quality of the eggs as much as 15 to 20 per cent. This is the easiest way to increase the income from poultry.

BREEDING FOR MEAT PRODUCTION.—This is easier than breeding for egg production and fancy points. The first essentials for meat production are a strong constitution, a good appetite, a meat producing stock. The selection of these qualities calls for a tendency to increased longevity. Developing the true meat type will have a tendency to build up instead of break down the natural physical qualities of the animal. Experience and experiments indicate that in developing superior meat qualities in the general purpose or meat type fowl there is a tendency to reduce egg production. This results in reducing the number of offspring to be secured from the highest type of meat fowl, and constitutes a serious difficulty in the profitable breeding of fowls for meat production. In breeding for meat type, it is comparatively easy to select from among a large number of individuals those that grow most rapidly and reach in

the shortest length of time the desired weight for any given purpose. By selecting individuals that best meet the requirements as to type and quick growth, great improvement can be made in the meat qualities of our fowls. By a close study of type and careful selection of individuals for breeding, great gain can be made in developing a type that will give the least possible loss in dressing.

KEEP PUREBRED POULTRY.—The chief advantage of keeping purebred poultry as compared to common or graded stock is to be found in the many advantages resulting from the uniformity in the stock and its products. These advantages will be treated separately. Pure breeds can be bred more successfully because more satisfactory results can be secured in feeding purebred poultry for egg production because they are similar in their tastes, habits, prolificacy, and character of growth. This uniformity in type is most likely to be found in pure breeds. Where only one distinct type of fowls is fed in a flock, better results can be secured from it, because each fowl will be more likely to be fed according to its particular needs. The heavier and slower and more phlegmatic types are, such as Brahmas and Cochins, etc., the more likely they are to be overfed when fed on similar food and given similar care as the more active, sprightly, prolific types of fowls. Better results can be secured in feeding purebred fowls for meat production. Where there are several types in one flock growthy fowls will be disturbed by the active, noisy fowls. This is extremely marked where the four extremes of type are allowed to run together; the slow, clumsy, good-natured Asiatics (Brahmas, Cochins, etc.), the strong, active Americans (Plymouth Rocks, Wyandottes, etc.), the strong, assertive precocious Mediterraneans (Leghorns, Minorcas, etc.), and the active, quarrelsome Games.

No ration can be fed or any system of care practiced which will exactly suit the four extreme types in one flock. Uniformity in habit and type of the fowl in the pure breeds will enable rations to be fed which will more likely produce similar results and more satisfactory growth. There is a great difference in the way various individuals make use of food. Some have a tendency to produce growth, others fat, and still others to produce eggs. Purebreds are more uniform in appearance when bred for market. Uniformity in appearance of dressed poultry has much to do with the selling price. A consignment of dressed poultry, some large, others small, some with feathered shanks, others clean, some with yellow skin, others white, some with black shins, others with yellow or pink, some with long thin bodies, others with rounded, plump bodies, makes a motley bunch which no one wants at a fair price. Purebred fowls lay eggs

more uniform in color, shape and size. Uniformity in the appearance of eggs as well as their eating quality determines their selling value. A crate containing large and small eggs, light and dark brown, pink, cream-colored and white eggs, roundish, long and elliptical shaped eggs, have the appearance of being ordinary, picked-up store eggs, and therefore will bring the lowest possible price. A crate of all brown, or all white, or all cream-colored eggs, uniform also in size and shape, have the earmarks of quality and bring the highest possible price. Eggs from the pure breed, other things being equal, are likely to give better results in hatching. Better results in hatching can be secured where there is uniformity in type and characteristics of the body of the fowls. Big and little eggs do not get the same degree of heat in the incubator, because the larger eggs, being higher up, are in the warmer stratum of air. A person can learn how to handle a certain machine to hatch eggs from a certain breed, but he cannot run the machine to meet all sizes, shapes and conditions of eggs at one time. When fowls of different types and characters are crossed, it seems reasonable to believe that misfits would be produced. For instance, a chick which should have a thin shell, may be born in a thick shell. A chick inheriting the large body of the father may be inclosed in the small shell produced by the small mother. The shells evaporate very rapidly. The more differences there are in the types of the breeding flock, the greater will be the variation.

Purebred fowls have greater power of transmitting their qualities to their offspring. Purebred fowls should have the advantage of the developing influence of generations of intelligent feeding, mating and care, and therefore ordinarily will have greater prolificacy, and more profitable growth because they are further removed from the wild type, which is limited to a few distinct varieties for the most part of small size and not suited to the demands of the market. Pure breeding carries with it the decided advantage of breeding more true to a given standard and for a special purpose type, so that there will be greater certainty of producing value in the offspring, when such value is possessed by the parents. A pure breed, because more valuable and attractive, will be given more and better care, because the owner places greater value on it and takes pride in it. The market value of fowls for breeding is far greater than the value to eat or for eggs.

THE NUMBER OF VARIETIES TO KEEP.—One variety is all that should be kept at first for commercial egg or meat production. Any one variety, produced in its perfection, will furnish business enough for men of the best executive ability and business

capacity. The more fowls of a single breed that are kept, the more the poultryman becomes an authority and popular headquarters for that particular breed. Where one breed is kept, the danger of fowls becoming mixed and valuable breed qualities lost, is eliminated. After a poultryman has the business thoroughly established with one breed, he may, perhaps, with profit, keep a second breed if it is to supply a different kind of product for market. Two breeds, one a distinctive egg producing fowl and the other a pronounced meat type fowl, frequently can be kept to advantage on the same farm, where both breeds are kept separate and pure and are bred in large enough quantities to supply large markets. Where the poultryman is to make a business of exhibiting poultry, and advertising extensively eggs and stock for sale for breeding purposes, it may be desirable to keep several varieties, but this would never apply where a stock is kept for commercial purposes.

CROSSING.—The crossing of two pure breeds in most instances is a mistake. It frequently has been done in the belief that something was to be gained in vigor, size and egg yield. Careful records of the results of crosses indicate that while the size of chickens may be increased by crossing with a male larger than the hens, or that egg production may be increased by crossing the poorer layers with a male from the egg-laying breed, the gain in weight or egg yield generally is not equal to the weight or the egg yield of the pure breed, which was used to increase the size or egg production. In other words, better results generally will be obtained, if the pure breed which best meets our needs for any given purpose is bred pure and only the best individuals are used for breeding. In an experiment at the New York State College of Agriculture, where Single Comb White Leghorns and Barred Plymouth Rocks were compared with their crosses, it was found that the Leghorns were far superior as egg producers to the Rocks or either of their crosses and that the Rocks were superior to the Leghorns or either of their crosses for quick growth and size as meat fowls, and that nothing was gained in health or vigor in either cross as compared to the pure breeds, as shown by the following table:

	White Leghorn.	Rock on Leghorn.	Rock.	Leghorn on Rock.
Fertile eggs to total.....	94.7	83.2	84.2	90.
Weight of chicks at 7 months.....	3.42	4.35	5.05	3.75
Eggs produced	175	146	124	144

Even if anything could be gained in egg yield or weight by crossing, it would be questionable if it would not be better in the long run to keep a pure breed because of the necessity in crossing of purchasing or breeding two pure breeds each year in order to make

the crosses, and the necessity which this practice would require of providing separate pens and yards for all three or four classes of fowls, i. e., for the crosses and each of the pure breeds. Moreover, all the arguments advanced for keeping pure breeds apply as reasons why we should not cross our fowls. In one year by crossing two pure breeds, we destroy the constructive work of generations of careful breeding in developing them to their present state of perfection of type and performance, and it would require a decade of the same careful selection and mating to breed up to the former perfection the two pure breeds from the crosses. Why this destructive waste of energy? A person who appreciates uniformity of type of body and of egg, who has any conception of the intrinsic value of the quality of transmitting these qualities to the offspring finds little inducement in cross breeding. If new life and vigor is to be considered, it is far better to get this by introducing new blood of the same variety. The appearance alone of a flock of cross-bred fowls when compared with the pure breeds from which they came should be sufficient argument to cause a breeder to hesitate to resort to crossing. This is particularly true in the second or third generation. One could not take pride in looking at, much less in showing a cross-bred flock of various sizes, shapes and colors. If we could see more dollars in the crosses than in the pure breeds, we might be able to overlook appearances, but in this instance both profit and beauty are to be gained by breeding the pure breeds.

GRADING UP THE FLOCK.—Grading up the flock may be desirable unless a pure breed is to be kept. It is not usually to be recommended because it is so easy to secure pure-bred stock and eggs. A superior male of the breed desired, when crossed by common stock or a mixed breed, is likely to quickly and very materially improve the quality of the offspring. The continued use of the pure-bred males of the same variety would result in three or four generations in the production of a flock which to all appearances would be equal to the pure breed, except in breeding qualities. Generally, however, time and money will be saved by commencing with a pure breed. There is always more or less uncertainty as to the result to be obtained in grading up a flock. When this method of improving a flock is tried, males of the same breed and similar line of breeding should be used, if possible, each year. When purebred males can be secured in most neighborhoods at approximately market prices for killing, there is no excuse for anyone having mongrel poultry. Grading offers the easiest and cheapest way to get uniformity and superior quality of meat or eggs where one has common mongrel stock, and with proper selection of females most closely resembling

the purebred male used each year, surprising improvement in quality and a proportionate increase in profits may be expected.

MONGRELS AND BARNYARD FOWLS.—They are the last resort in the poultry business. They are better than none, but they are to modern poultry husbandry what cider apples are to the choicest modern varieties. Why begin 50 years behind the times in getting a start? Why not begin where the other fellow leaves off, up-to-date, by securing a small start by the purchase of a few eggs or chickens of a good modern farm run on pure breed principles, and thus get the full value of the food and care which you give to your poultry, or at least by grading up with a purebred male? All pure breeds are not superior necessarily just because they are pure breeds. There are many blue-blooded aristocrats in the poultry world who travel on their shape and dote on their pedigree and who, like some humans, so far as any honest work is concerned, take it for granted that the world owes them a living. The old adage should be applied in the breeding of the "business hen," "to prove all things and hold fast to that which is good."

NUMBER OF FEMALES TO ONE MALE.—The number of females which can safely be allowed to one male depends more upon the natural reproductive power of the male and female than upon the breed. In general more males are required with the heavy breeds. The safe rule, other conditions being equal as to health, size and season, is one male to eight or 10 females for Brahmas, Cochins, etc., one male to 15 or 20 females for Plymouth Rocks, White Wyandottes, etc., and one male to 20 or 25 females for Leg-horns, Hamburgs, etc.

LENGTH OF FECUNDATION.—Eggs are likely to be fertile after a male has been in the flock from seven to 10 days, depending upon the condition of the male and females, and the number in the pen, etc. If mating should take place soon after an egg has been laid, the next egg to be laid probably will prove fertile. Eggs may remain fertile for three or four weeks after the male has been removed from the flock, but it is generally not safe to use the eggs for hatching after the male has been removed one week. When exchanging males in the flock, it is better not to use the eggs for hatching until two or three weeks. The male last with the flock will be more likely to dominate in fertilizing the egg.

EXCHANGING THE MALES IN THE BREEDING PENS.—The practice of keeping two males for each flock, only one of which is permitted to run with the flock, has several decided advantages. Twice as many hens can be kept in one flock. The males have an opportunity to recuperate as compared with letting two or

more males run together with the flock; it prevents fighting which may result in permanent injury and impaired action. It also eliminates fear on the part of either or both, which would interfere with their digestion and, therefore, with their good health and efficiency. Where a large number of breeders are kept and small pens of special matings are not necessary, the most satisfactory method is to allow all the breeders to run together on a large common range. The flocks have a tendency to separate into natural groups, one male with each. By this means serious injury from fighting does not occur, because of the opportunity for the more timid males to get away. This system insures the largest influence of the strongest and best individuals and provides an opportunity for natural selection.

INFLUENCE OF MALES ON EGG PRODUCTION.—Experiments tried at Cornell and the New York Experiment Station at Geneva indicate that the male does not influence the productivity of the flock with which he runs. Therefore, except in the cases of breeding flocks, the males would be a disadvantage instead of an advantage, especially if more than one were in a breeding pen. This is due to the injuries caused by fighting. The space required by males in flocks for commercial egg production could be better utilized by hens. Males in the flock during warm weather would be a detriment on account of producing fertile eggs, which are known to have poorer keeping qualities.

INFLUENCE OF PREVIOUS IMPREGNATION.—Whatever may be true of the influence of previous impregnation on the future offspring, it may be put down as not true of poultry beyond the short life of the spermatozoons, which would not extend beyond a few weeks with fowls and a season with turkeys. Therefore, it would be perfectly safe to breed, after a few weeks absence from a male, from hens of any variety that have been previously mated to a different variety with a certainty of knowing that no effects of the previous mating will appear in the offspring. There being no complete connection between the fertilized egg and the hen and because the life of the male germs is known to be short, it is impossible that his influence should continue indefinitely.

CARE OF THE MALES DURING THE NON-BREEDING SEASON.—There are three ways of handling males during the non-breeding season. The first is to keep them confined in small separate coops by themselves. This is expensive as to labor and equipment and does not permit of sufficient exercise. The second is to allow the males to run with the flock all year. Except for the disadvantage of producing fertile eggs during the hot weather, this is the most economical and best method, so far as the welfare and well-

being of the hens and males are concerned. The third practice is to remove all males from the flocks during the Summer and keep them in a flock by themselves, far removed from the hens to prevent fighting. If a large range with numerous feeding and watering places is provided and if the males are watched at first to prevent serious injury from fighting, the plan works well. It is of utmost importance that whatever system may be practiced, the males must not be allowed to become frightened, because this and the lack of proper feeding and wholesome surroundings will certainly lower the vitality.

CONTROLLING SEX.—No one, so far as the writer knows, has yet solved the mystery of controlling the sex in breeding poultry. Many theories have been advanced, the chief of which is the one that the shape of the egg may be used as an indication of the sex. For instance, long eggs will be more likely to produce cockerels, and round ones pullets. The claim that mating young males and old hens will result in producing more pullets and that old males mated to pullets will produce more cockerels has been tried repeatedly without establishing the claim. It has been claimed that the season of hatching influences or determines the sex, the general belief being that the early hatches appear to contain a larger proportion of pullets than do the late hatches. All these and other theories of sex control have abundant verification in specific instances where they have proved true, but in as many other instances the reverse has been true.

HOW TO INTRODUCE NEW BLOOD.—If one has a choice strain of fowls and desires to bring in new blood, it is better to take two years to do it. This is done in order to test the results on a few individuals before trying it on all the breeding flock. Serious results from the introduction of impure blood may thus be avoided. It is better to purchase a few superior hens and mate them with your best males or to secure superior males and mate with a few of your best females and study the offspring for a year, and then, if they are satisfactory, to use them by mating with the balance of the flock.

IN-BREEDING.—There is little danger from in-breeding where a large number of fowls of the same variety are kept if reasonable care is exercised each year in selecting only vigorous breeders. If it becomes desirable to introduce new blood, the rule should be not to do so just because it is new blood, but because it is superior and not simply equal to your own in vigor and other qualities. The common notion that it is necessary each year to exchange males tends to keep the flock only equal to the average of those who are concerned, and prevents improvement that might be secured by developing a superior strain by judicious line breeding.

LINE BREEDING.—This term applies to the practice of keeping separate strains or matings on the same farm, always going systematically to one line for the males and to the other line for the females, these two lines having been started by mating the best male which forms the male line to the best female which forms the female line, and thereafter to continue mating the male offspring of the male line to the female offspring of the female line, or the original male to his daughter or the female to the son, and each generation to continue to systematically mate from these male and female lines, which will tend to produce in each generation a line having a larger and larger proportion of the blood of the original female on the one side and a line having a larger and larger proportion of the original male on the other, and an intermediate line may be kept, if so desired, that will contain one-half of each line. Line breeding is a type of systematic in-breeding and is practiced in order to intensify and fix certain qualities and to avoid as far as possible the evil results of close indiscriminate in-breeding.

GETTING A START WITH PUREBRED POULTRY.—When one already has poultry and desires to change the variety, the cheapest way to get a new flock is by the purchase of breeding stock in the Fall of the year, when breeders must sell hens to make room for pullets. This method has the advantage of providing hens instead of pullets for breeders the following Spring, and to purchase the stock when it is at its worst, at the close of the laying and moulting season, hence to note lack of vigor and faulty feathering, etc. Each hen should be counted on with good care to produce during the 2½ to three months laying season at least 45 to 50 eggs, 30 of which probably could be used for hatching. These, at the regular prices of eggs for hatching, should pay for the hen and male and there should be left the stock and a good margin of profit on the investment. If a start is made in the Spring, the high prices charged for breeding stock generally makes it desirable to purchase eggs or day-old chicks, the last in particular if a large number are to be reared. More chances are taken in purchasing the eggs as to their infertility, weak vitality and the uncertainty of incubating and brooding. However, when the business has already been established and the element of time in making the change is less important, the purchase of eggs or day-old chicks from a well-known reliable breeder enables one to get a start with the least possible outlay.

CHAPTER X.

A CONNECTICUT MAN'S EXPERIENCE.

Mr. Geo. A. Cosgrove, of Connecticut, gives the following statement of personal experience with hens:

Some years ago a prominent magazine published an article in which was expressed the thought that there comes a time in the life of very many men, especially in the cities, when there is an ever-deepening cloud overshadowing their lives, which colors all their thoughts, and which cannot be shaken off. It persistently intrudes itself into all their pleasures, and is not absent from their daily tasks. And the shadow deepens as the years roll on. That shadow is caused by the question "What shall I do when increasing age causes me to lose my situation; how shall I support my family when I lose my job?" And the question will not be put down, but constantly recurs and demands to be answered. As the weeks and months roll by the man never loses consciousness of the fact that any day the time may come when it *must* be answered. Honest, sober, industrious men, city born and bred, who know nothing whatever about country life, or how to perform the labor necessary on a farm, still read with mingled hope and fear the advertisements of cheap farms for sale, and wonder if they could make a living for themselves and their families on a farm, and it is for the encouragement of such men that this chapter is written. Success or failure will depend largely upon the attitude towards the undertaking which his wife and family assume. If they realize fully the situation, and know that it is almost their only chance to make a living; if they are willing for a time to deny themselves city comforts and luxuries; if the wife will loyally support the efforts and labors of the husband, and not add to his burdens by fault-finding and worse than useless regrets; if they will put themselves in sympathy with nature and enjoy the varying seasons, and "bird and bee and flower;" if they will appreciate at its true worth the independence and safety of the farm, then indeed may they hope to succeed in their farm life, for there is nothing in the farm labor that cannot be quickly learned by any man who has brains enough to be a good mechanic. The writer speaks from the standpoint of personal experience, for he moved out of New York when 57 years of age, broken in health, with no boys

to help, and absolutely without farm experience, and bought a run-down farm in northeast Connecticut. Now, after 15 years have elapsed, the only regret is that we did not leave the city 10 years sooner. In these 15 years health has been regained, the value of the farm trebled, and a few dollars laid away for "old age." Of course we have made many mistakes; if we could begin again and have the benefit of present experience to commence with, far greater success from the money standpoint could be achieved. But there are other successes than financial ones; the building up and beautifying of a home, acquiring the respect and esteem of one's neighbors and townsmen, as evidenced by being called to public service in the State; the strengthening of one's own character, which the independence of farm life greatly promotes, all these are successes of more value to a true man than a few added dollars.

A city man buying a farm has usually a very indefinite idea of what he is going to do with it. Somehow he expects the farm is going to provide a living for himself and family, but just exactly how he really does not know. Of course he expects to have a garden, raise his own potatoes and with cow and chickens contrive to get a living. So he drifts along for a few years without "getting anywhere." It is far better to have a definite plan, to decide on what you would like to do, what you feel best fitted to undertake. Then before concluding the purchase, go over the farm very carefully and see if it is fitted for the carrying out of the plan you have in mind. What are the facilities for getting the product to market after you have raised it, and is the soil suitable? I have seen land on the very top of a round hill that was so wet as to be unfit to cultivate. Note particularly the distance to the nearest grain store, also to the express office. It makes a big difference whether you must spend five or six hours on the road once or twice a week, or one or two hours. The water supply, both for home and in pasture, should also be carefully looked after, and whether it fails or not in a dry time. The wood lot, from which to obtain fuel, should consist of not less than 20 acres. No one thing on a farm contributes more to the comfort and happiness of the farmer's wife than plenty of properly prepared and dry fuel. Many an otherwise good farmer fails entirely to consider what an unnecessary annoyance it is to his wife to have the wood split in such large pieces that it will not kindle readily. Keep always a stock of old rails or dead wood from the forest, split into pieces not larger in diameter than your finger, for kindling wood. Wood should always be cut a year before using, so that it will have time to get the sap dried out, but if it is not possible to do this, the seasoning may be hastened by cutting down the trees before the

leaves fall and letting the trees lie for a few weeks before they are cut into lengths. The leaves will draw nearly all the sap out of the wood.

Two of the things most frequently thought of by the city man as a means of getting a living on a farm, are fruit raising and poultry keeping. The two can be very easily joined together. To the high-growing berries like blackberries and raspberries, tied to stakes driven into the ground, poultry do very little damage, as nearly all the fruit is set high enough to be out of their reach. The strawberry patch must be fenced so that poultry cannot get at it. One or two acres of good land devoted to raspberries and blackberries will produce enough to support, *in the country*, an ordinary family. Of course, it is supposed that the farmer raises his own potatoes, his milk, butter, eggs, poultry, etc., so that he has very much less to buy than when living in the city. The berry patch is an ideal place to raise the growing chicks; they help to keep down the weeds, while the cultivating of the ground furnishes them with worms and bugs, and the plants furnish shade and shelter from hawks and crows. Suppose a man has decided to go into poultry, eggs, and berries as a means of getting a living on a farm. He finds that he can ship in the evening the berries picked that day, and that they will arrive at his city market next morning early, and that the cost of express service is not so high as to reduce his profit unduly. Now he is ready to look into the poultry part of his undertaking. Does his market pay a premium for white eggs, or are brown eggs preferred? White eggs sell for most in New York; in Boston brown eggs bring the highest price. All the small breeds, the Leghorns, Andalusians, Anconas, also the larger Minorcas, lay white eggs. The American breeds, Plymouth Rocks, Wyandottes, R. I. Reds, lay mainly brown eggs. But the color, especially of Wyandottes and R. I. Red eggs, varies a good deal, shading all the way from a dark brown to nearly white. For a year there has been an effort under way at Storrs College to produce a strain of White Wyandottes that would lay white eggs, the object being to produce a fowl that would overcome the objections to the Leghorns, viz., their small size, high flying, and the fact that they do not lay well in Winter when eggs are highest. Any of the American breeds will average twice the size of ordinary Leghorns, and are better Winter layers. The Leghorns are non-sitters, and an incubator becomes a necessity unless birds of some other breed are bought to do the sitting. In fact if hundreds of early chicks are to be hatched, one or more incubators are a necessity, no matter what breed is kept. Many prefer nowadays to buy the chicks already hatched, which can be done in any quan-

tity at a cost usually of from 10 to 15 cents apiece. This does away with the cost of incubators, eliminates the problem of what incubator to buy, and where to put it, and on the whole the cost of the chicks is not very much greater than it would cost to produce them at home. Of course the above applies only to the producer of market eggs and poultry; the poultry fancier, who is trying to produce high-class breeding stock must hatch his own eggs.

Having settled the question as to which breed he is going to keep, and whether it is the production of fancy stock, or simply market eggs and poultry, the next question that arises is the location of the poultry houses. Nearness to the water supply, whether it is a well or brook, is an important consideration when one has to carry water 365 days in the year. By all means avoid a damp or low situation; the top of a high and breezy hill is better than a low place where the cold and damp air settles at night. A gravelly or sandy soil is much better than a rich dark loam; the latter absorbs the droppings and becomes in time an ill-smelling, disease-breeding place. Don't forget that the fowl's nose is only a foot from the ground. If the fowls are to be kept in yards and on level land, arrange the houses so as to have two yards to each house, that one may be plowed and a crop of some kind grown to take the foulness out of the soil, while the other yard is being used. Rye is the quickest to grow, and hardest for the hens to kill out, when they are turned into that yard, which they should be as soon as the rye is three inches high.

Housing is one of the biggest problems to settle, but the chapter devoted to that subject in this book is very complete, and the novice should be able to select from the many plans something that would suit both his taste and his pocketbook. The writer built houses 10 feet square on the ground, setting the houses 10 feet apart. Then by roofing over the space between the houses and boarding up the back, and making a wire netting front, a scratching shed was made for each house. There is a wire netting door in the front of each shed, and the coop door opens into the scratching shed. These houses and sheds may be added to from year to year as the increasing number of fowls require. These houses will accommodate 25 to 30 fowls each, and the cost for material, including windows and roofing, is about \$18. Material for scratching sheds would add about \$6. The only foundations of these houses are wide chestnut boards sunk into the earth, and projecting above the ground about eight inches. The sills of the houses rest on the edge of these boards, and the siding comes down about two inches below the sills, overlapping the joint where the sills

rest on the chestnut boards. Pine boards sunk in the earth would rot in a year, but chestnut will last indefinitely. In my case they have been in use a dozen years and are still serviceable. The earth is banked up against the boards outside so that water runs away from the coops. These chestnut foundation boards keep the frost and moisture out of the coops, and the earth floor inside is perfectly dry at all times, and never freezes in the coldest Winter, although the door is always kept wide open except during driving snowstorms, or on coldest nights. A dry earth floor in the poultry houses is much better than a board floor; it makes a dust bath in which all the fowls can wallow at the same time if they desire, and by scraping off the top earth and scattering it an inch deep on the droppings boards under the roost, it makes a good absorbent for the manure, and the surface of the floor is cleaned at the same time. It is the practice of the writer to put one or two wagon loads of sifted earth in each house in the Fall, using the driest earth to be obtained.

It is impossible to imagine all the mistakes a novice may make, and caution against each one. A letter recently received from a lady asking instruction, says: "I let the hen set six weeks and she didn't hatch out a chick." Now with an egg tester she could have told in seven days whether the eggs had any chance to hatch or not, and in any case it was useless to let the hen sit more than three weeks. The chick will begin to pick at things the first day it is hatched, but that must not be taken as an indication that it is hungry; the yolk of the egg which the chick's body surrounded before it kicked itself out of the shell, furnishes all the nutrition the chick needs for three or four days, so that very little food should be given for the first few days, and only what will be eaten up in five minutes, but it should be given five or six times a day for the first week. It does not make a great deal of difference what is fed; any of the advertised chick feeds if fresh and sweet, hard-boiled egg mixed with bread crumbs, or rolled oats, and all chopped fine; and I have raised every chick feeding nothing but coarse cracked corn taken out of the horse's feed bin. But in this case the hen and chicks were down at my barn, and the hen balanced the ration by scratching in the manure pile.

Brooding the chicks is a most important matter; it is very easy to spoil a lot of chicks, either in the hatching or brooding. Brooders without artificial heat are coming into use more and more. These are made to conserve the natural heat of the chicks by blankets or covers over the chicks, additional covers being used on extra cold nights. A sufficient number of chicks, 25 to 50, must

be kept together to generate enough heat. Where two or three chicks would freeze in such a brooder, 25 or 30 would be quite comfortable. These brooders must be used in a house, or well covered shed, where they will be protected from storms and winds. I took a common soap box, cut a hole, 3x4 inches, in one side near the bottom, made a light frame that would just drop in the box, and nailed a small cleat an inch from the top edge of box on each end for the frame to rest on; tacked a piece of muslin to each end of the frame, the muslin being longer than the frame, so that it would sag down in the middle; filled the box with hay, and put 23 chicks a day old on the hay. The muslin "sheet" rested on the chicks, and two or three thicknesses of old carpet was laid on the sheet for "blankets." Three half-inch holes were bored in each end for ventilation. The chicks using this box as their brooder, lived and thrived better than those kept in heated brooders. They were put in about the middle of April when water would freeze at night. The box was kept in a 6x8-foot house and the chicks had the run of the floor. For the first week or two it is necessary to push the chicks back into the box after feeding until they learn to go in themselves. When the chicks are large enough to run outdoors it is a good practice to scatter oats thickly on the ground where they run, and spade them under. As soon as the green shoots show above ground, dig a little hole so as to expose the white rootlets of the oats, and the chicks will work and scratch among them all day, eating the whole thing, oats, roots and sprouts, and it is a most excellent feed for them.

As the chicks get to broiler size the cockerels may be culled out and sent to market, and the earlier this is done the better the price obtained will be. Two things are to be carefully guarded against; one is lice, the other is colds, which may run into roup, the dread of all poultrymen. "Blue ointment," mercurial ointment, which can be cheaply obtained at any drug store, is a specific against lice. If chicks are running with hens, take a piece twice the size of a pea and rub under the hen's wings, and along on her body where she has stripped the feathers off to line her nest, and to bring her bare skin in contact with the eggs while sitting; also in the hollow spot just above the vent, and in the feathers below the vent. Do this just at night and the chicks and hen will be free from lice for weeks. Observe if there are little bunches of "nits" at the base of the feathers below the vent; if so lard or grease of any kind will kill them. Look out for colds, especially when the Fall rains come. When you notice that the chicks have wet nostrils, put in their drinking water permanganate of potash,

enough to give the water a strong wine color; say a teaspoonful of the crystals to eight or 10 quarts of water. Keep doing it until there are no more wet nostrils. The above two recipes are worth a hundred dollars to anyone going into the poultry business.

I do not think it wise for a man who is new to the poultry business to attempt to raise a large number of birds the first year; better go slow and learn the business by handling only 100 or 200 the first Winter. To get 200 good pullets, at least 500 chicks must be hatched, and it will only be with good luck that one who hatches 500 chicks will find himself in the Fall in possession of 200 good pullets. The poor pullets should be culled out as well as the surplus cockerels, and the most profitable time to dispose of the latter is as soon as they weigh one and a half to two pounds each, and earlier than that if the market will accept them. As to how many fowls one should keep when the business has been learned, that will depend on the man. Almy with the help of a boy cares for 2,000 R. I. Reds, Tillinghast with one man cares for 3,000 White Leghorns; both of these men using the colony system; that is, detached houses holding about 50 birds each scattered over many acres of ground. Mr. Tillinghast uses large hoppers holding a week's supply of wheat screenings to which the fowls have access at all times, and each day when the eggs are gathered sufficient beef scraps for a day are put where the fowls can get them. It is not a pleasant job on a rainy afternoon to drive over 100 acres back and forth among the houses gathering eggs, etc., but this colony system with free range for the fowls on grassland is undoubtedly the healthiest for the fowls, and the system most likely to endure. Some men can keep 2,000 hens successfully in one house, but I would not advise any novice to attempt it until he had served an apprenticeship to some one who was successfully doing it. But it must be remembered that caring for 2,000 hens is not the really difficult part; where the expert part of the business comes in, is in raising the young stock to renew this flock from year to year. The agricultural colleges in many of the States give a short course of five or six weeks in poultry keeping both in Winter and Summer, which it is very advisable for one who wishes to learn the business to attend.

How much can a man reasonably expect to make per year, keeping poultry? is a question frequently asked. Selling eggs and poultry at market prices only, a man can figure safely on \$1 a year from each hen. Mine have netted me from \$1.50 to \$2 per hen for years, but part of that has come from sale of eggs for hatching and cockerels for breeders.

The man who has other farm work to do, who raises corn, potatoes, oats or rye or barley or buckwheat for his fowls, who has cows to milk, and other "chores" to do, will find 500 head of poultry about as many as he will have time to care for, in addition to the 500 young chicks being raised to replace the old stock. I have three yards, each containing about an acre, devoted entirely to poultry. They are located on the south slope of a hill. In the north yard are nine houses; here are kept the two-year-old hens; in the middle yard are kept the yearlings; in the south yard the young chicks and growing stock. The largest part of this south lot is planted with corn for shade and shelter for the chicks. A strip about 30 feet wide by 300 feet long is left bare, and on this strip oats are thickly scattered, then turned under by the cultivator. This is done so that the young sprouts will make green feed for the chicks. This season I have planted on this strip at different times, oats, barley, rye and buckwheat, and the chicks have not allowed anything to get two inches high. It has been replanted six times and the chicks, about 200 in number, have not only eaten that strip bare, but have eaten all the lower corn blades off for quite a distance into the corn. Of course the young chicks are not allowed in the corn lot until the corn is six inches high; then if they are supplied with grass or other green food for awhile they will not damage the corn enough to amount to anything, and in a couple of weeks the corn is too large to be hurt. From present indications there will be 200 bushels of ears on this part of one acre, and it is the fourth year of corn on the same ground. In the Fall when most of the hens are molting and the egg output is low, the two-year-old hens are shipped alive to the New York market, their houses cleaned out and the year-old hens put in the north yard, and the middle yard houses made ready to receive the laying pullets. Shipping the old fowls alive to the New York market is much the best way to dispose of them, as the price obtained is usually just as much per pound for the live birds as for dressed ones, and sometimes it is more; the reason being the large Jewish trade, which buys all their fowls alive. Six substantial shipping coops holding from 12 to 20 fowls each, can be bought for \$5, and as the express companies return the empties for 10 or 15 cents, they may be used many times. The first Summer on a farm is likely to be for the city man the busiest season he ever knew, and it is not wise to undertake to do too much, or too many things with the result that none of them is well done, and he must expect to work harder and more hours than he ever did before, but there is a joy, a satisfaction, a happiness in it.

CHAPTER XI.

MARKETING EGGS.

The easiest money to be made in the poultry business is in marketing the products. A successful poultryman must be a good salesman. The extra money that may be secured by selling eggs to a special trade at an advanced price is almost clear gain. It should be 25 to 50 per cent additional above the profit in selling at the highest wholesale price. The margin will vary from one cent per dozen in small towns to five to 10 cents per dozen in large cities. It is not an easy matter to secure this high-class trade. Like everything else worth while, it requires years of effort and painstaking care. A poultryman must grow into his trade. High price is simply the premium paid for confidence in the goods. It is a just reward for a good reputation. Any neat and careful poultryman, however, should find no difficulty in raising his price two cents per dozen above the highest market in his neighborhood. As his customers become educated up to good eggs the price can be increased. The first essential in working up a special market is the ability to produce and deliver the goods. To do this three things are absolutely necessary; good eggs, an attractive package and regular delivery every week in the year. One is just as important as the other.

GOOD EGGS.—There is a great difference in eggs. They must, first of all, be new laid, that is to say, not over one week old. If they are gathered regularly each day and placed in a cool, dry, clean room, they should suit the requirements of the most delicate taste. Daily or twice a week shipments are necessary with a private family trade, and would greatly increase the labor of handling and keeping of accounts as well as multiplying express charges. On the whole "eggs is eggs" when they go to or leave the average country store. A good farmer's good egg sells for no more than the poor farmer's poor egg when they once get into the class of ordinary "store-gathered" eggs, because they are in bad company. It is a positive injustice to the hens that laid the eggs, to the man who grew the grain to produce them, and to the one who gathers them thus to sell good eggs for the lowest possible price. The element of uncertainty as to just what is covered by

the egg shell exaggerates the real difference in quality and magnifies the premium paid for guaranteed fresh eggs. In other words, people are willing to pay an extra price rather than take any chances. While the general quality of market eggs has considerably increased in some respects of late years, due to the more systematic method in handling of eggs by large dealers, the feature of age, which has much to do with quality, remains the same.

The eggs should be of large size. The customer who pays a good price is entitled to eggs that weigh not less than two ounces each. Eggs under two ounces should be sold to a special customer at a somewhat reduced rate. Small or medium eggs always suffer by contrast with large ones, but when placed in a crate by themselves they will show off to better advantage, and as they have the same quality of freshness and neatness as the other eggs, they should command a premium above the general market. The best and finest grade of eggs should weigh two and one-quarter ounces each. Good eggs should also be uniform in color, and the color should suit the fancy of the customer. The New York City market requires a pure white egg. Boston has a decided preference for a dark brown egg. Other things being equal, a difference of at least two cents per dozen will be paid just on account of color in these and other markets. It is a common practice now to assort and ship eggs according to the color requirements of the respective markets. Uniformity of grade counts for as much in the selling of eggs as it does in marketing fruit. One would not expect to ship red, green and russet apples of large, medium and small size in the same barrel. Yet it is a rule, not an exception, to find all kinds of eggs, big ones and little ones, long ones and round ones, eggs with brown, white, speckled or cream-colored shells in the same crate when they leave the farm. The very fact that they are mixed in colors and in sizes brands them as "common eggs" in the eyes of the purchaser. They give the impression of not having come from any particular place or any special breed, but from anywhere and everywhere; just "picked up" eggs. This is a serious handicap. In order to produce the highest priced eggs, one must keep purebred fowls, not because their eggs are any better to eat, but because they are better to look at. Here is where appearances count.

Cleanliness is a necessity in selling eggs. A dirty egg is a disgrace. It may be fresh, but no one will believe it. There are many degrees of cleanliness; spotlessly clean, clean, "tolerably clean" and dirty. Eggs as they come from the nest are usually "tolerably clean." They are never spotlessly clean until each egg

has been carefully inspected and the faintest trace of stain or dirt removed. Much can be done to keep eggs from becoming soiled, which will save a large amount of labor. Dirty hen houses and yards cause dirty feet, which make dirty eggs. Clean nests will help to keep the eggs clean. Bright oat straw is one of the most desirable nest materials. Sawdust or clover hay and some other materials are likely to stain the shells. When cleaning eggs, both dry and damp cloths should be at hand. Sapolio or baking soda are good to scour off a stain. A little sal soda in water will remove dirt more quickly. Vinegar and water will do the same thing. One should use as little water as possible. Washed eggs lose their natural finish and will not keep as well. Very dirty eggs, however, should be put in water for a few minutes to soften the material but not long enough to permit the water to be absorbed by the shell. Otherwise the color and flavor of the eggs will be impaired. All eggs should be perfectly dry when placed in the crates, and covered so that dust cannot settle on them. This cleaning operation is not expensive when done systematically. One cent per dozen for grading, cleaning and packing eggs, both for market and for hatching, is a liberal allowance. At this price, the person who does the work should make good wages.

The quality of fancy eggs must be good as to flavor, firmness of white and color of yolk. Care therefore must be taken in the feeding of fowls to have plenty of green food and a certain amount of corn, both of which give to the dull yolks a deep yellow color. Very pale yolks, which are certain to follow prolonged feeding without the foods mentioned, are likely to be looked upon with suspicion by particular customers. It is true that excessive feeding of laying hens upon foods which have a very pungent odor, such as onions, will affect the flavor of the eggs. Both turnips and cabbage, however, can be fed with perfect safety in limited quantities, especially if fowls are well supplied with other foods.

THE PACKAGE.—A good article is worthy of a neat package. Appearances count for much in catching the eye or pleasing the palate. If eggs go to market in a neatly made, well varnished, carefully stenciled crate, the customer has reason to expect that the same care used in packing the eggs has been exercised in producing and gathering them, and in this he usually is not mistaken. Good serviceable egg crates can be made with very slight expense. Most farmers should be able to make them. It is the most profitable kind of rainy day work. The crates which are used to ship eggs by express from the Cornell University poultry plant have a capacity of multiples of three dozen; that is, three dozen, six

dozen, nine dozen, 12 dozen, 15 dozen or 30 dozen. Regular commercial egg crates are purchased for five to 10 cents each with fillers. The best ends are used to form the ends of the new crates of various sizes. Three-eighths-inch Georgia pine ceiling is used for sides and top, which is nailed with two-inch finishing nails. The bottoms are made from the best of the material taken from the sides of the egg crates. Narrow cleats are placed on the sides for handles, and upon the top of the cover to make it solid. Two three-inch strap hinges and a hasp are placed on the cover. The whole box is then sandpapered if necessary, covered with hard oil finish, which makes a much neater looking package, easier to keep clean than one which is painted. The name of the farm or of the proprietor, with the home address and the products shipped, should then be stenciled on the top of the package, also upon the sides where room will permit. The Cornell stencil is in two parts. With the first part a large white egg, ten inches long, is painted upon the box. When this is dry another stencil is used to print the words, "Cornell University, College of Agriculture, Poultry Products, Ithaca, N. Y. Quality Guaranteed." A neat stencil on any package is a splendid advertisement, and makes the chances of loss of crates in transit very much less. As a finishing touch we purchase little brass padlocks; with duplicate keys. They cost 12½ cents each and they are money makers, not so much because they prevent stealing eggs, but because the wealthy customer is willing to pay at least a cent a dozen just for the sake of having his neighbor see that he gets eggs direct from the farm by express each week with a padlock on the box. Actual experience in working up a large private family trade in and about New York City proves that the "best advertiser is a pleased customer." To illustrate, one family that has purchased eggs for many years, referred a friend who became a regular customer, who, in turn, wanted the assertion sent to another friend. Another string of customers was started by a wealthy man visiting the farm and finding a person packing eggs for the private family trade. He asked why he could not have eggs sent to him also. He became one of the best customers and through his friendship four others were secured. Farmers who take Summer boarders, or those who sell produce to Summer hotels, have excellent opportunities for finding city customers for eggs. The private family trade, however, is not without its disadvantages. One of these is that there are a multitude of details in looking after a large number of comparatively small shipments ranging from six to 15 dozen. This makes a good deal of bookkeeping. Families are likely to leave

the city at certain times during the year which necessarily interrupts the general output of eggs. However, some customers continue to have eggs shipped to their Summer resort, where, if necessary, they are willing to pay double express charge. The most serious difficulties have been the breakage by express companies. Usually they make good the loss after much correspondence and delay.

REGULARITY OF SHIPMENT.—The people who pay high prices must have their eggs on time, rain or shine. They usually want the same number per week the year round. One's capacity, therefore, to cater to this trade is somewhat measured by the number of eggs which he can produce during the months of greatest scarcity; namely October, November and December. It will be found, however, that customers are very obliging and stay over these periods with a somewhat diminished supply. In order to discourage excessive egg eating during the period of scarcity the prices should be made according to the law of supply and demand. While these prices are not as high, perhaps, as some are getting, one should be well pleased with the results, but should be always looking for higher prices. A good scale of prices is 30 cents per dozen for April, May, June and July; 40 cents for August and September; 45 cents for October and November; 50 cents for December and January; 40 cents for February and March. The customer, in every case, should pay the express charges and return the empty box. There is less trouble from breakage where the customer who is on the spot is personally responsible for settling with the express company for damage. These prices, however, net about seven to eight cents per dozen by the year more than the highest wholesale market quotation for nearby fancy white eggs. During the Spring months, when most eggs are laid, a large trade in eggs for hatching takes care of most of the surplus. At the end of a hatching season the Summer hotel trade will handle any surplus which one may have at about 25 cents per dozen. Whatever the system of marketing, the problem of regularity of supply throughout the year is the hardest to meet, and in a measure it remains unsolved. With the best of care one cannot expect to get more than 10 to 15 eggs per day per 100 hens in large numbers during the months of October, November and December, and not over 20 to 30 per cent from early-hatched pullets. It is true that individual flocks should do much better than this for a time, but if there are many flocks, some of the others will not be laying as well.

CHAPTER XII.

KILLING AND MARKETING POULTRY.

STICKING AND BLEEDING IN THE MOUTH.—This method may be used for either dry picking or scalding. Hang fowl from ceiling by cord, loop or wire attached to the shanks, or hold in the hands while sitting. Seize the head in the left hand, back of the head in the palm of the hand, palm upward, the thumb and first finger of left hand pressing firmly back of the eye, but not on neck, which would retard bleeding. With the right hand run the blade of the sticking knife into the throat until the large artery on the left side of the throat is severed. *Always bleed before sticking.* It gives better drainage of blood and less delay before plucking feathers. Then quickly insert the blade into the slit of the roof of the mouth and plunge it backward into the brain directly back of the eye. When the brain is hit there will be a violent muscular convulsion or quiver, which is usually accompanied by a characteristic squawk. Give the knife a quick, sharp twist and withdraw it. The feathers will then loosen. Pluck a few from the breast, careful to note whether the sticking is perfect, then begin picking rapidly. If the bleeding has not been complete the blood will follow the feathers and cause the skin to be spotted and red. The success of dry picking lies in getting the "right bleed" and the "right stick." If the knife plunges too low, it enters the bones of the neck; if too high, it enters the hollow space in the head. The lobes of the brain, which are located directly in the rear of the eye, must be hit in order to produce paralysis of the nervous system, when death quickly follows from the profuse bleeding while the fowl is still (supposedly) unconscious.

DRY PICKING.—This method usually requires more time and skill and leaves the skin in a more natural and attractive condition than scalding. Therefore, fowls should bring, and usually do bring, a higher price. The feathers are left in a better condition for drying. Rapid work is only acquired through long practice. Begin picking immediately after the sticking has produced the muscular contraction of the skin, which loosens the feathers. Pick with both hands. "Rough" pick breast and body feathers first, then wing and tail feathers. The quill feathers of wing and tail should be pulled

before close "ruffing" is completed and kept separate from the body feathers. As far as possible, the white and colored feathers should be kept separate. Avoid pulling too many feathers at one time to prevent tearing the skin. Give a rolling motion to pull a full handful of feathers, as you would remove a porous plaster from yourself. Tearing is most likely to occur on either side of the breast and on the neck. Rough pick the entire fowl before pin-feathering. Dampen the fingers occasionally. It helps to make the feathers stick to the hand. Use a stub knife before pin-feathering; avoid hard rubbing, it is liable to loosen and scarf skin; avoid rough handling; tender fowls are easily injured; keep tools, clothes, tables and everything that comes in contact with the fowl scrupulously clean to prevent infection and thus improve the keeping quality. Throw fowl, when finished, into water about 60 degrees temperature for about one hour to remove animal heat; then place in ice water or cracked ice to chill; cold, dry air is vastly to be preferred for cooling and chilling. Poultry dressed by any method looks better and keeps longer if it does not touch water. When animal heat is removed, sponge the carcass clean, fold wings on back, tie feet together and hang in a cool room to dry. Discoloration is likely to occur, especially about the vent, if carcass is allowed to remain long without removing animal heat. Quick picking means quick thinking. It is the mind that pushes the fingers. "Say nothing and keep picking" is a good motto for the picking room. Ease of picking depends upon season, age and breed. It costs three, four or five cents for killing and dry picking fowls. One hundred to 200 fowls are picked a day by an expert picker.

SCALDING.—This is the most rapid way of removing the feathers where the methods are right and the picking room conveniently arranged. There is slightly less loss in dressed weight by the scalding process than by dry picking, due to the absorption of a small amount of water by the body in the plumping process. The skin shows the fat more prominently because the hot plunge brings the fat to the surface, and the chilling process which follows, sets it at the surface, thus making the fowl look in better condition of fatness. The danger in the scalding method lies in not getting the water the correct temperature or leaving the body submerged too long. If too hot, the skin is cooked and the thin scarf skin peels off, which causes the flesh to look bruised. If not enough heat is applied, the feathers stick and, as a result, the skin is liable to become torn. The temperature of the water should be about 180 to 190 degrees. Immerse the entire body except the head, its appendages and the shanks. These parts change color and the skin peels if

scalded. Move the body forward from head to tail through the water and withdraw frequently to prevent the water penetrating through the feathers to the skin. The feathers rather than the skin should be scalded. When the skin contracts see that the feathers stand out from the body. Remove from the water and pick rapidly, but carefully, and avoid rubbing. Remove animal heat in water at 60 degrees. Then submerge in ice water or cracked ice. To plump fowls, plunge an instant in water 160 to 170 degrees. This shrinks the skin, which gives a plumper appearance and brings fat to surface. If possible, place in cold, dry air to chill. Sew up all tears. Singe with alcohol flame to remove hairs.

SHAPING.—This is done to keep the body in compact and attractive form. All such special preparations produce a good impression on a prospective purchaser who believes, and justly, that a poultryman who would take so much pains to prepare poultry attractively would be equally particular to produce good quality by proper feeding and breeding.

FASTING.—All poultry intended for a slaughter should be fasted for 24 hours before killing. This is required by law in some States. Water should always be supplied during the fasting period. By this treatment the crop and intestines are emptied, which helps to prevent decomposition of food materials within the body and therefore adds to the keeping quality and also avoids danger of tainted flesh, which might result if poultry were not drawn at time of killing.

GRADING.—It is important to select and pack poultry in such manner that it will be most attractive to the purchaser, and best meet the demands of a special trade. It pays to carefully grade all stock and sell it graded by itself. Poor quality stock suffers by contrast with medium or good quality. Each grade should be uniform in size, shape, color of skin and shanks, age and quality of fatness.

THE PACKAGE.—We should aim so to prepare fowls in packages for shipment that they will be most attractive to the purchaser, and arrive in the best possible condition. The package frequently sells the product. Indicate clearly the contents of the package as to kind of poultry, number, weight and quality. It should also bear the brand of the shipper as a guarantee of good faith. Boxes should be made to ship different sizes of fowls as follows: Each box or barrel should be lined with paper before packing. This helps to prevent evaporation or injury to the product from rough handling. Special parchment paper should be purchased for the purpose. Clean rye or wheat straw may be used to advantage

in large boxes or barrels. For packing boxes for cold storage or Winter shipment, the fowls should be laid in one or two tiers. For the latter, back down, head toward the center and folded under the body, legs pressed down and tied to the body. This helps to protect the breast from injury. In warm weather, make a layer of cracked ice, and place second layer of chickens, reversing the order so that the backs of the fowls shall be uppermost, rumps to the center.

PACKING IN BARRELS.—Make hole for drainage, place layer of ice, lay fowls backs up, feet toward middle, cover with ice, fill in center with cracked ice, and cover barrel with burlap. This protects the breast and keeps the package coldest on outside. The vents of the fowls will thus be covered with ice and the iced water will drain toward outside of barrel.

A FEW SELLING NOTES.

The first requisite in shipping poultry to a large market is to have something worth selling, and the next is to know a commission man who is worthy of selling it. Such a man is found through experience, either one's own or that of a neighbor, and, when found, he is worth sticking to. He will appreciate this, and in 10 years more money will have been made than by scattering the shipments about.

In New York City and other sections having a considerable Hebrew population, there is a steady demand for live poultry, which must be slaughtered under the supervision of their official butchers. This trade is heaviest just before the Jewish holidays, chief of which are Hebrew New Year, Feast of Tabernacles, Feast of Laws and the Passover, the last named occurring in Spring. These feasts are movable, and the exact date for any year can be learned from dealers in live poultry. Special care should be taken not to crowd coops of live poultry, as otherwise the loss from trampling and suffocation may be heavy.

The farmer is usually most interested in the Fall and Winter poultry markets. He has something to sell at Thanksgiving time, and disposes of the remainder for later holiday trade. At Thanksgiving the weather is usually cool enough to make dry packing safe. If more than a very small quantity is sent, it is better to sort the poultry, putting hen and tom turkeys in separate packages, and culls in another. Barrels or boxes of moderate size may be used. Very heavy packages are more likely to be smashed in handling.

In small towns, where the receiver sells direct to the consumer, receipts as late as the day before a holiday may be handled to advantage, but poultry for New York Thanksgiving trade should be on

hand not later than Monday of that week, as the retailers begin stocking up then if the weather is favorable. Unless there is a scarcity, late shipments are likely to meet a slack trade.

Most cities have laws regarding the handling of poultry, whether it should be drawn or not, etc., and the shipper should learn from his receiver what the law and custom of his market demands. Most poultry sent to New York is undrawn, with head and feet on. The crop must be removed unless empty, but all poultry should be kept without food for several hours before killing.

Cold storage is the balance wheel of the egg and poultry trade, keeping it going at a comparatively even gait the year around, preventing the scarcity which causes prohibitive prices to all but the wealthy, and the glutted market, with figures below cost of production. The range of prices for a year will still show very high figures, such as 60 cents a dozen for new-laid eggs and 35 cents for fresh-killed poultry, yet there is no time when both eggs and poultry from storage, not fresh, but palatable and reasonably wholesome, may not be had at prices within reach of almost anyone. The scope of refrigeration has been much enlarged by dry air processes, which have made it possible to handle products that get musty under the dampness of ordinary ice storage. There are still many losses from improper handling, but good eggs properly stored may be kept for a full year.

As abuses have sprung up in the cold storage business, it is evident that strict legislation regarding it is needed. No tainted or otherwise unwholesome product, no matter how little damaged, should be stored. Cold may arrest the decay, but investigation has shown that chemical changes dangerous to health frequently take place. Another abuse is the secret storage of large quantities of foodstuffs, with the resulting monopoly and restraint of trade. The law should compel a detailed report of the quantity of such products held in storage. This would put the market on the basis of supply and demand, instead of the present speculative basis, where large quantities of foods are put away and held secretly until, by the constantly repeated talk of scarcity, prices are materially advanced and the goods doled out just fast enough to maintain these high prices.

CHAPTER XIII.

A WOMAN'S HENS.

It is said that a small army of women having an itching to engage in the poultry business are seeking for light on the subject. Some gleanings from the experience of a woman may help these women to recognize their fitness or unfitness for the work.

The Arabs have a saying, "All sunshine makes the desert." If there were no clouds in the poultry keeper's sky the bottom would fall out of the poultry business. It is because profitable poultry keeping is difficult that the comparatively few who have the ability to overcome these difficulties are successful. A few chickens on a farm will get much of their living from what would otherwise go to waste. Increase in numbers requires skill in management, if there is to be any profit. It is idle to suppose that this skill will come without effort or that everyone making the effort will succeed in acquiring it.

Skill is "ability to perceive and perform." It all depends on the woman. She must perceive the business side, the hen side, her own side. Particularly must she see herself as she is. Has she health, perseverance, grit, gumption? No woman not in fair health should undertake the entire charge of poultry. The frequent change from indoor to outdoor dress is tiring and takes time. There is temptation to go out just as she is. There is no surer foe to health than draggled skirts and wet feet and ankles. Rubber boots, leggings and bloomers are necessities. Fortunate is she, who, in stress of weather, can say beseechingly to some trousered creature, "Go," and he goeth.

Has she perseverance? Poultry keeping means work every day. Hens are like sheep, much attached to the person tending them and distrustful of strangers. For this reason and because no one not constantly tending them can possibly know just what to do during the breeding season, for best results one must be constantly on the job.

Has she grit? It takes grit to do the dirty work. Cleaning droppings board, coops and brooders may be disagreeable, but it is not the dirtiest work; the dust boxes are responsible for that. An energetic hen, she is the kind to have, can kick up a deal of dust.

Multiply her by one or two hundred. If she is to have the dust, it must be got in and after she has scattered it to the remotest corner of the premises it must be got out. A vacuum cleaner, adapted to this work, will be a boon. Whitewashing sounds clean. Then there is that interesting job applying some sort of dope for the extermination of vermin; that is, you hope it is extermination, but it isn't, and you do it again and again.

Has she gumption? Great is gumption! It is both chart and compass on an unsailed sea.

THE BUSINESS SIDE.—Too little attention is paid to the business side of rural life. It is not a condition peculiar to poultry keeping. One is told *ad infinitum*, that the poultry house must not be damp; that the hens must have grit, but it is like hunting for a pearl among oysters to find a practical business suggestion. Let the beginner decide whether to cater to local trade, sell to the shipper or do a possible shipping business. Having decided this point, study the conditions to be met. What does the market call for that is most profitable to produce? For example, the New York market quotes fancy white eggs at a premium, but it does not follow that white eggs are most profitable to produce. The white egg layer is fastidious. Unless she has things quite to her liking she will not fill the egg basket when prices are soaring. Then, again, the season of highest prices may not be the season of greatest profit. If plump, yellow-skinned, yellow-fleshed broilers and roasters are wanted, it is folly to produce thin, white-fleshed, dingy skinned birds. It is a mistake to sell raw-boned fowls. It costs more to produce frame than it does to produce flesh. Why let the middleman add the cheap flesh to your expensive frame and reap more profit from two to four weeks' feeding than you do from two to four months or longer, or why sell inferior stuff at an inferior price. It is an advantage to keep enough laying stock to fill a 30-dozen egg crate and have the eggs reasonably fresh. The city market quotes hennery eggs at a premium over gathered eggs. Why not gather that premium in for yourself. Once you have found a reliable dealer, stick to him and give him every reason to stick to you.

While on the subject of selling, just a word about eggs for hatching and breeding stock. There are many persons who want to get purebred stock for what the butcher would pay for them, and eggs from purebred stock for the market price of eggs by the crate. To many, visions of getting rich quick from the sale of eggs and stock will prove a mirage. Business has a buying, as well as a selling side. Buy in large quantities whenever practicable. Buy in time. Do not get out of supplies. Especially is this to be guarded against

in care of little chickens; some are dainty in their tastes, and will eat only certain kinds of food. If this is withheld they will starve with plenty of other food before them. Another example of buying right: Learn when eggs are likely to be cheapest and have your water glass ready. Do not wait until it is time to use it, then find your dealer hasn't it in stock. Find out whether he is charging you two prices; that is, twice the profit he should have; two to one, he is. Look around and save that profit for yourself. To do so, perhaps you will have to send away for it. Then when the howl is raised, "Home trade is what our town needs," be ready with your answer, "Exactly, what the town needs, not what the country needs." The town has fattened on the country long enough.

THE HEN SIDE; HER BREEDING.—Shall she be purebred? Better a good mongrel, or shall we say, grade, than a purebred with all the stamina and get-up-and-dust bred out of her. A hen's a hen, however bred. Buy performance, not pedigree, and breed the same way. What to feed, how much to feed, where and how and why? These are questions to turn the hair white, at least, the hair will be white before all are answered satisfactorily. There are many combinations of various foodstuffs that give good results. Just which particular combination will suit each peculiar circumstance is something no mortal can tell. It seems certain the growing chick, the laying hen, the fleshening fowl, need differing treatment. The growing chick needs to roam, the laying hen to exercise, the fleshening fowl to be confined. Frame and flesh and eggs are built up by a differently balanced ration, but to enter into this subject comprehensively is beyond the limits of this chapter.

HEN HOUSING.—The ideal house has yet to be built. Let the novice be prepared to be dissatisfied. When that ideal house is built the hens will roost high in it, and the nest boxes will not be little stuffy ones, built in a row and stuck in under the droppings boards, or in some other low-down place. Most beginners will have to make-shift with what they have in the house line, and here is where the average woman will beat the average man. This is how the small boy puts it:

"At home it seems to be the rule
Pa never has the proper tool,
Or knack to fix things. For the stunt
That stumps ma, though, you'll have to hunt.
So when my things get out of fix,
Do I ask pa to mend 'em? Nix!
But ma just grabs what's near at hand
And togs things up to beat the band."

In like manner the hen house can be tugged up; cloth windows out of sugar sacks, cracks pasted up with strong paper; curtains to

enclose the roosts, of gunny sacks, covered with newspapers or paper flour sacks sewed on with darning needle and twine. Any woman who can handle a saw and drive a nail can make food hoppers. It isn't necessary to have expensive drinking fountains; a flat gallon butter jar, costing eight cents, answers admirably. When there are little chicks about, likely to drown, a stone in the middle provides a means of escape. For wee chicks a granite pie dish with a stone to weight it and keep the water from being soiled, answers every purpose. No more 50-cent drinking fountains, thank you! If one cannot have a separate breeding pen, and it is possible to buy eggs for hatching from properly mated birds, it is well to do so and dispense with chanticleer in your own flock. Do this by all means, as soon as the hatching season is over; then if the hens are too cunning for you, they will not be coming off a stolen nest with a batch of late hatched chicks, and the infertile eggs will keep better during the hot weather. The hen is the best mother, whether she or the incubator does the hatching. A hen and a brooder makes a combination that suits the writer. As far as known, no one has invented an automatic scratching attachment to the brooder, and a chick to thrive its best needs to be scratched for.

The writer does some scratching on her own account; that is, she digs in the garden and invites the chickens to a bug, worm and weed-seed festival. The invitation is accepted with alacrity, and the guests do ample justice to the viands. It is an open question as to which receives the greater benefit, chickens or garden. Certain it is, the gardener hen woman receives two benefits, aye, three, for digging in a garden comes near to being a panacea for the ills of the flesh, and of the spirit. This garden includes mangles and cabbage for the hens. A large patch of sweet corn is planted, and the chickens allowed to harvest what is not used for the table. No weeds worth mentioning grow in that corn; the chickens wallow in the mellow earth in the shade they need so much during the hot weather. The corn grows amazingly and so do the chickens. It is such a happy combination that more corn and more chickens are planned for next year. The brooders are set in the midst of this garden. "Horrors!" did some one say? and in cleaning them the droopings are put on the corn. Poultry netting is put around such things, as the chickens might damage, the strawberries in fruiting season and tomatoes and melons later. Part of this garden, which is large, is put to rye in the Fall and to clover in the Spring, and the chickens are in clover sure enough. The rye gives them shade before the corn is large enough. The rye is cut for hay in time to give the clover a good chance to grow.

A good-sized cart is a great convenience. The one the writer uses has two wheels, 28 inches in diameter. The box is 37 inches long, 20 wide and 8 inches depth. In this the droppings in boxes are wheeled out and dust brought in. It can be loaded up with feed, shells, charcoal, grit, etc. Alas! it will not carry water, but perhaps it will if a discarded milkcan can be found. Much fun is made of this little red wagon, but the owner laughingly declares she would rather have it than an automobile. Its usefulness is not confined to the poultry department; it carries the clothes basket, is indispensable in gardening; in short its uses are legion, and make it possible for one woman to accomplish many things. A mill to grind feed to suit the varying needs of the flock and the household is another helpful implement, sometimes on a hot day it takes something of faith and hope as well as a strong right arm to make the wheels go 'round. Some day the mill will be changed from hand to motor power. This hoping for better things is what gives zest to the business, and enables one to resist the hard knocks that are reasonably sure to come.

CHAPTER XIV.

THE POULTRY "SYSTEMS" DISCUSSED.

Since the last edition of "The Business Hen" was published there have appeared on the market numerous "systems" and secret methods for conducting the poultry business. These systems, methods and secrets are practically all unpatented and unpatentable. The fact that there have been sold hundreds of thousands of these pamphlets and books shows that there is a great demand for poultry information, but if each person who buys a book of secrets, systems or methods could produce the results claimed by the different authors to be "easily obtained" the market for poultry and eggs would be flooded, not only in the United States but also in foreign countries; and the price of eggs and market poultry would surely drop at least 50 per cent. The truth is, however, that the price of eggs and market poultry has not been reduced but, on the contrary, it is gradually going higher, and there are no evident forces in the field at the present time that can or will produce any great change in the market prospects for the future. These facts prove without any question that the numerous claims of the different authors that they will or have revolutionized the poultry business, and that by following their particular methods and instructions, each hen can be made to produce from 150 to 280 eggs per year, and return a net profit to her owner of from \$6.41 to \$120 are extravagant claims which should not be taken seriously. Experienced poultrymen occasionally find hints or suggestions in these works which may be profitably applied to any system of poultry keeping; but amateurs should be careful not to expect too much from following the advice given.

There is one great principle taught by all of these different "systems," and that is it pays to be systematic in our work with poultry, and remember the truth of the old saying that "a thing worth doing at all is worth doing well." Successful poultrymen understand this rule, and amateurs must learn it before any great degree of success can be attained. Fowls acquire a habit and cling to it. Any attempt to change these habits always disturbs the flock and reduces production for a time, so there should be a time for all work, and everything done at its proper time each day.

Poultry keeping is a science, and must be learned at least partly by experience before sure results can be expected by the average man or woman, so it is plainly evident that the numerous claims by poultry writers and authors that big money can be easily made from a flock of fowls by any inexperienced person in any location is misleading, to say the least. It has been said that there is only one way to do anything and that is the right way; but the fact that several different methods are being used in conducting the poultry business, and that they are equally successful proves that a person may adopt any good system and that the chances for success depend, not so much upon which system is adopted, as how much skill, energy and perseverance are used in its application.

In selecting a system, the novice or amateur poultryman or woman should take into consideration these facts: That each one was written primarily for the purpose of making money—not for the person who bought the system, but for the person or persons who wrote the works and put them on the market. Then, too, the authors of some systems are also the manufacturers of a line of poultry supplies without which it would appear their systems could not be successfully applied, so the system becomes practically an advertisement paid for by the purchaser instead of the seller.

One of the first, most valuable and most closely guarded secrets is how to tell the laying hen without trap-nests. This secret is sold by the different authors at from \$1 to \$10 each. It has also been sold in a book of poultry secrets for 25 cents. It has been known by some old poultrymen for over 30 years, so it can truthfully be called a secret no longer. It consists simply of taking the hen in the left hand with the head at the left or under the left arm. Then with the fingers of the right hand imbedded in the fluff the ends of the pelvic bones between which the egg passes can be plainly felt. The condition of these bones and their distance apart determines the value of the bird. The ends of three fingers can easily be placed between the bones of a good layer in laying condition, while, if there is only room for two fingers, the bird is just an average layer. If there is room for but one finger, the bird is not laying, and if she does not get into laying condition in at least four to six weeks should be sold for market. Cocks and cockerels are tested in the same way, and those showing the greatest space between the ends of the pelvic bones should be kept for breeding layers, provided they are good birds otherwise. This method saves the labor involved in trap-nesting layers, as it takes but a few minutes to test 100 hens. Then, too, as it is impossible to trap-nest

the males, much time and labor is lost each year by breeding from inferior birds, unless this system is applied. While it is true that accurate records can only be made with trap-nests, these records are valuable to the average poultryman only for comparison, so when the best layers can be selected for breeding without the use of trap-nests as good results can be attained in building up a strain of layers with one system as with the other; therefore the difference in the two systems is largely a question of time and expense in their application.

The different systems which have found such a ready sale pretend to teach a person how to produce fertile eggs, how to hatch more chickens from them, how to raise the chickens without much loss and how to produce eggs and broilers at the lowest cost when prices are high. One writer tells us that he feeds his Leghorn hens seven-eighths of an ounce of green cut bones each per day and that the eggs are fertile and hatch well during the season. Another writer, equally as notorious, states that this cannot be done. In other words, excessive feeding of green cut bones during the Winter and Spring weakens the vitality of the breeding stock to such an extent that it is practically impossible to secure high average hatches, although the fertility of the eggs may run as high as 90 per cent. at the first test after being incubated about six days. After this many germs die in the shell, and many of the young chickens hatched will die before they are four weeks old. This is the experience of many poultrymen, and substantial evidence must be produced before a change of opinion can be expected.

The similarity of many systems is very marked, their difference lying chiefly in the size and style of houses used or some difference in the feeds used or manner of feeding; but there are several principles which practically all agree cannot be overlooked on a successful poultry plant. The first principle is cleanliness. Neither chickens nor fowls will do their best unless their houses and yards are kept clean. Clean litter must also be provided for the birds to scratch in, as damp, dirty litter offers but little attraction to a well-bred hen. Exercise is just as important for both fowls and chickens as their food. The old method of feeding a warm morning mash has been abolished, and the new systems advocate feeding the mash at from noon to three P. M. The first feed in the morning and last feed at night is whole or cracked grains, usually a mixture of corn, oats, wheat and buckwheat scattered in deep litter on the floor. The fowls get plenty of exercise working for this grain on the floor, and are ready for some green feed at noon, such as cabbage, cut clover or Alfalfa, sprouted oats or mangels. Then early

in the afternoon they will eat a good feed of mash. When forcing hens to their greatest production of eggs, the mash contains from one-fourth to one-half green cut bones or lean meat, while the rest is made up of bran, ground oats, wheat middlings, cornmeal and gluten feed. These ingredients are mixed into a crumbly mash which is fed very dry. No oil meal should be used except during the moulting season. This mash is made palatable enough so the hens will eat heartily without eating too much, and go to roost with full crops, the principle of this method of feeding being never to feed a hen all she will eat except at the last feed in the day, given about an hour before sunset.

Poultrymen all agree that beef scrap, lean meat or green cut bones must be fed liberally if a large egg yield is expected. This animal food may either be fed with the mash or kept by the hens all the time in hoppers. The green cut bones and lean meat should be fed with the mash, while ground beef scrap may be accessible to the fowls at all times in open hoppers.

Another principle is to give the fowls plenty of fresh air without drafts or undue exposure during inclement weather. This is accomplished by means of muslin curtains, except in a few cases where the windows are left open, allowing the fresh air to come in unrestricted. It is possible to use the latter method successfully by watching it closely and opening a part or all of the windows as the weather may permit. Fresh air and sunshine are as indispensable as the feed is for fowls or chickens, and worth more than all the medicine in a drug store for keeping the flock in a healthy condition.

The systems of hatching and raising chickens are many and varied. To the experienced poultryman or woman it seems entirely unnecessary to be told to run an incubator at 102 degrees the first week, 103 degrees the second week and 103½ degrees the third week, yet this is about the extent of the system's teachings. A close study of all the principal systems on the market at the present time has failed to reveal any valuable new features in regard to hatching or rearing young chickens. Simple directions are usually given which prove successful under favorable conditions.

Here is one of the best methods of feeding chickens in common use. Begin feeding when about 36 hours old. The first feed is oat flakes and bread crumbs, equal parts mixed with a little hard-boiled egg chopped fine, shell and all. The bread should be dried and ground fine before mixing. This should be moistened slightly with a little sweet milk and fed twice daily until the chicks are three weeks old, gradually changing to a cheaper mash, such as is recom-

mended for older birds. A very little fine sifted beef scrap is fed after the first week, and green feed is fed every day after the chicks are three days old. Commercial chick feed is scattered in clean litter on the floor two or three times a day, just enough to keep the chicks busy, but not enough to overfeed them. Great care must be exercised not to feed chicks too much before they are four weeks old, as they are more apt to overeat during this time than they are later. Fresh water, grit and charcoal should always be accessible after the little fellows have learned to eat. If grit is given before any feed, sometimes chicks will eat too much and death will result.

The question of brooding chickens has been, perhaps, the most difficult to solve, and there is yet much to learn before perfection is reached. Chickens have been successfully raised in unheated brooders, but many failures have been reported, especially during cold weather. It would therefore be advisable to use unheated brooders only during moderately warm weather. In using brooders heated with a lamp, every precaution should be taken to maintain an even temperature, as the fluctuations of the brooder temperature cause a large share of the mortality with incubator chickens. Unless a brooder can be regulated within five degrees, it cannot be expected to produce the best results.

Chickens on free range can be fed all they will eat after they are a month old without much danger of overfeeding, while old hens, after passing their first laying year, become over-fat very easily, and they must be fed in such a manner that it will not be possible for them to get in this condition.

Upon the number of hens kept in each flock depends, to a great extent, the style of houses to build. The systems recommend keeping all the way from six to 1,500 hens in one flock. From 50 to 100 hens should be kept in each flock when a large number are to be cared for during Winter weather, while in Summer 10 or 15 of these flocks may have free range together. While six hens may be kept safely in a small house, and made to produce eggs in paying quantities, it is not reasonable to expect them to produce fertile eggs with strong germs while kept in close confinement. It requires much more labor to care for the same number of hens in small flocks than it does with large flocks, but it is a recognized fact that young chickens should be kept in flocks of 50 or less for best results.

CHAPTER XV.

SIDE LINES IN POULTRY.

FARM CROPS WITH POULTRY.—Chicken men who go to the country and locate on a farm often ask what crops they should grow to best advantage in connection with the birds. In theory one would think that it would pay a hen man to try to raise all his grain, but as a rule this will not be found wise. If a man is going into the chicken business he should plan to give most of his time to it, make that his sole motive and make other crops side issues. Probably corn, of all the grains, is best suited to the chicken man. Chicken manure is well adapted to the growth of this crop, and practically all poultry rations have corn for their basis. The corn crop can be grown as easily as any other grain, and will produce a larger amount of food to the acre than most others. The chicken man should try to follow intensive farming, that is, not try to cover too much ground, but to produce as much as he possibly can from each acre. A crop of mangels or sugar beets should also be grown on a hen farm. Some enormous crops of roots can be produced with a little care, and they are of immense value in feeding hens. On some chicken farms a good crop of cabbage is found very useful, as chicken manure is particularly valuable for all crops which make large growth above ground. The solid heads of cabbage can be sold, while the soft heads can be kept for Winter feeding, and hung up by the roots where the hens may jump and pick the cabbage to pieces. A hen man should also have a fair crop of clover or Alfalfa, for by cutting and feeding a well-cured crop of either he can save a large proportion of his grain feed. Some poultrymen prefer to have a truck or fruit crop in connection with their hens, and if they have plenty of help, so that they can give time to it, this will pay. As a rule, however, such crops require the greatest care just when the young chickens need attention, and unless there is careful labor at hand one crop or the other will suffer. That is why late maturing crops like cabbage or clover are better suited to the hen man's care. He should of course have a good garden and keep his hens out of it. If possible he should have a double system of yards, so that the hens may be turned from one to the other at will.

Our own plan has been to have yards on both sides of the house. Early in Spring oats are sown on the south side of the house. When it is up fairly well so as to make a feed for the hens the birds are let in, while the other yard is closed. Then in this other yard we can sow Dwarf Essex rape. By the time the birds have eaten the oats down the rape has made a good growth; then the hens may be turned back into the rape, and the first yard is worked up again and seeded to Crimson clover and cow peas. When these are large enough the hens may be turned in and the other yard sown to buckwheat and Crimson clover. That in turn gives place to rye. In this way a constant supply of green feed may be grown for the hens, and the yards kept seeded and clean. If the yards are small and the hens are inclined to scratch up and destroy the growing crop this can be prevented by putting bricks or planks along the sides of the yard and stretching wire netting across the green crop. This will grow up through the wire netting and enable the hens to reach it while they cannot tear up the roots with their feet.

HANDLING CHICKEN MANURE.—If a man wishes to keep the business hen in a business-like way he must plan to make every edge cut and save what he can. There is often considerable loss in the way poultry manure is handled, largely through a failure to understand certain things about this fertilizer. This manure is quite rich in nitrogen, with less of potash and phosphoric acid as compared with ordinary stable manure. It is worth four or five times as much, pound for pound, and when properly handled is a very valuable manure for all kinds of crops. The proper way to handle it is to save as much of the ammonia as possible. This ammonia will not be lost so long as the manure is kept perfectly dry. For that reason the best plan is to use dry absorbents under the roosts, and to clean off the droppings board frequently. Various substances are used to dry the manure. Road dust collected in the dry Summer and stored in barrels answers the purpose. Of late years many poultrymen are using "floats," which is the raw phosphate rock ground to a fine powder and not treated with sulphuric acid. This makes a very good dust, and as it contains phosphoric acid it adds to the value of the manure. Some years ago land plaster or gypsum was the favorite material used for this purpose and it is very useful. Some form of dust, however, should be scattered each day under the perches, and before the droppings accumulate heavily they should be scraped off and put in bins or barrels in a dry shed. More of the dust is scattered over them as they are stored. The result is that Spring will find them in dry hard

chunks with little of the ammonia lost. Early in the Spring, before the manure is needed, these chunks should be crushed and ground as finely as possible. This can be done fairly well by putting the chunks on a cement floor and smashing them with a heavy shovel or a maul. As the chicken manure is richer in nitrogen than any other fertilizing elements it can be used to advantage to make a good mixture. The following mixture will prove very useful for most crops; 400 pounds sifted hen manure, 200 pounds dissolved bone black, 100 pounds muriate of potash, and 150 pounds of plaster and 100 pounds nitrate of soda. Such a mixture is excellent for garden or small fruit crops. The crushed manure must be sifted in, order to make a perfect mixture. If this is properly done it will give as good results as the great majority of expensive brands. In many cases farmers do not care to go to the trouble of mixing the chemicals with the manure. In that case, the chunks are crushed and the manure applied direct by hand, usually in the hill or drill. Chicken manure is excellent for corn, and will perhaps give better results on that crop than any other. Some chicken men do not bother with saving and drying, but clean out the houses at intervals and carry the manure direct to the field, broadcasting it over the grass or grain. During the Winter this gives good results where the soil has some living crop like grass or corn growing on it. It would not be recommended for bare fields which might be washed by floods. The one thing *not* to do with hen manure is to mix lime or wood ashes with it. This would be the worst thing you could do, since the lime will liberate the ammonia. Some poultrymen use "kainit," a German potash salt with the manure. This preserves it well, but leaves it moist and sticky. After several years of use the runs or chicken yards become very rich from the droppings and the constant working of the hens. When a chicken man has time for it it will pay during late Fall or early Spring to take off the upper three or four inches of these yards and spread them as he would any manure or fertilizer in fields where crops are to be grown. A good way to do this work is to take a small plow or horse cultivator and run over the surface of the yard; then with a scraper scrape the earth into piles and shovel it into a wagon or a stone-boat. When these yards are cleaned in this way dirt should be brought in to take its place, and this can be left two years and then taken out. An easier way to clean the yards is to change them, that is, move the hens to another point, tear down the fences, plow up the old yards and use them one year or more as a garden. This soil will produce enormous crops of all garden

vegetables, and after growing such crops it will be fitted again for a chicken yard. It has been well said that the business hen will give a profit in the present and leave a blessing behind her. A Connecticut Yankee will buy a bushel of Western corn, feed it to his hens at a profit, and then by adding chemicals to the resulting manure raise another bushel of corn.

HENS, TREES AND INSECTS.—Tree fruits, and especially apples, make good partners for the business hen. Chicken manure is excellent for apple trees, especially if wood ashes can also be used—not, however, mixed with the manure. In many apple growing sections hens are being selected as the best live stock to keep in the orchards. In such cases the hens are usually kept in colony houses—that is, small buildings scattered about the orchard. The hens have a free range under this system. That means plenty of exercise, a good pasturage and an abundance of insects. A hen on the range will provide a large part of her food by picking clover, grass and seeds, and hunting insects. During the laying period such hens should be fed some grain, but eggs are produced at much less cost in this way than when the hens are kept housed or yarded with little chance at grass or insects. A man starting in the hen business can sometimes buy a farm with a few level acres, and the rest rough and hilly. Such farms are usually sold at a low figure, because the rough part is not considered suitable for crop production. These are locations for the business hen to make good. The flocks can be started near the farm buildings and apple or peach trees planted on the hills. It is possible to make fair and steady growth without high culture. A few furrows may be plowed on either side of the tree rows, and this plowed space worked several times during the season with a cultivator. Then the trees are “mulched”; that is, manure, grass, weeds, fine brush or anything that will rot, is piled around them. Chicken manure or the litter used on the floor of the house makes a fine mulch for these young trees. Efforts should be made to collect forest leaves, straw, crushed corn cobs or any material of the sort to be used on the henhouse floors and afterwards used for mulching these trees. If the hen manure can be crushed or handled, as described elsewhere in this book, it will make a better fertilizer for the trees. In this way a good apple orchard may be developed as the flock is growing, and in time, as the flock is enlarged, the orchard will provide a good run for the hens.

Fruit trees are often planted in chicken yards. Apple and plum do better in such situations than peach. The soil of such yards is well manured, and the hens dig and dust around the trees. This

means the highest manuring and cultivation. The hens also roost in the trees, and the manure thus accumulated makes the soil very rich. Apple and plum can stand this heavy manuring better than peach. The tender growth of the latter is likely to winter-kill.

Aside from their work in orchards, hens are of great service in destroying insects. One of the best "remedies" for onion maggot or asparagus beetle is a collection of hens with their little chicks. The hens are put in coops which are scattered over the onion field—the chicks being left free to run about. The little chicks will clean out the maggots without scratching enough to hurt the onions. They will also get many of the beetles on asparagus. After some observation, we feel sure that both hens and turkeys pick out the green worms in cabbage. There are several reports from reliable people who have kept half grown chickens enclosed in potato fields. These claim that the chicks cleaned up the potato beetles so that there was no need of spraying. In our own experience, we have not noticed that hens or ducks will eat potato beetles, but they are useful in potato fields—that is, when too young to do a full job of scratching. No full-grown hen should be left at large in a garden, but a hen with chicks may be cooped in it, for the little fellows will run out and get many insects.

LAW OF THE HEN.—Some bitter neighborhood feuds have been started by straying hens. When a man living in a small place starts a good vegetable and flower garden, it becomes an object of pride. It is impossible for a hen to scratch in a more sensitive place than in this same pride, and when she comes back day after day and tears up seeds or young plants, there is a fall for somebody. The question of what can be done in such cases comes up again and again. It is sometimes claimed that a hen destroying a neighbor's garden becomes a wild bird and can be shot. That is not so. You shoot such straying hens at your own risk, but about all the owner can do at law is to bring suit for the value of the hens. All you could sue him for would be the value of crops destroyed. So that lawing is about the most unsatisfactory part of a hen quarrel. A reasonable man will keep his hens shut up if you go at him right. If he will not do so, the treatment varies as to whether you are aggressive or diplomatic. The fighting man generally shoots a few hens and carries them to the neighbor's property. This makes bad feeling, but the hens are kept at home. The diplomatist makes the hens welcome—puts up a little house and yard with nests, and entices the hens into it. They will lay there and usually go home when night comes. You

get their eggs and the owner usually gets wise and shuts them up. If you cannot get the owner to keep them at home, you will have to protect your plants with wire netting. A lively young dog can be trained to drive the hens away. As a last result the suggestion which follows might be taken:

A maiden lady owned a piece of ground,
 And morn and eve in Summer she was found
 Within her garden. But her neighbor kept,
 A flock of hens, and while she worked or slept,
 With busy feet they dug her finest seed.
 In vain she chased them at her utmost speed,
 And "shooed" and stoned them, quite undignified,
 The while her neighbor laughed until he cried.
 But women who can foil the wiles of men,
 Will not be daunted by a Leghorn hen.
 The hand that rocks the cradle, still can block
 Man's ridicule, and give his nerves a shock.
 Our lady cried a bit—as was her right—
 Then took some cards and on each one did write:
 "Please keep your hens at home!" A seed of corn
 She strung to each. With early break of dawn
 Back came the hens; they gobbled grain and string,
 Then back for home they started on the wing.
 "Please keep," he scratched his head—his heart was hard,
 From every mouth they dragged the lady's card.
 But shame cut through it like a knife, and hence
 His hens no more flew o'er the lady's fence.

FITTING EXHIBITION BIRDS.—Preparing birds for exhibition is an art in which a person must be thoroughly interested and willing to work weeks, months and even years to accomplish a certain object. The object in this case is to win the blue ribbon at some of our large poultry shows. Competition is so keen and close at the present time that the preparation for exhibition must begin with a bird's ancestors. Good breeding, which usually means line breeding, is necessary to produce the best specimens. The question is often asked if incubator chickens are as good for exhibition as those hatched by the natural method. In my experience, I can see no difference when the birds are kept in houses of the same size and in the same sized flocks. Fifty chickens in a brooder are not as apt to develop into exhibition specimens as quickly or surely as 10 chickens hatched and raised by a hen, provided both have proper feed and care. As a rule, the small flocks of 10 to 20 birds

in a good-sized house with free range, develop into finer specimens than those raised in larger flocks or in confinement. It is also advisable to grow the birds near an orchard or cornfield, where there is plenty of shade, as some varieties will not hold their proper color when exposed too much to the sun. The birds should be grown and developed just as fast as possible, with good feed and care, without forcing. The feed does not vary much from that recommended for the general flock, except that more hominy, cornmeal and cracked corn are usually required to get young stock in the proper condition. Old stock should be in full feather and standard weight, without being over fat. Care should be taken not to feed too much beef scrap during the conditioning period, as it is likely to make the pullets lay too quickly. A pullet is usually in the best condition for exhibition just when she reaches laying maturity, and cockerels should be in full feather and up to standard weight. Birds intended for exhibition should be handled and trained for several weeks before the show, so they will learn to pose in natural and attractive positions, instead of acting afraid and sulky when approached by the judge.

Cocks and cockerels, and hens and pullets should be conditioned in separate pens, to avoid injury to the feathers by each other. *The American Standard of Perfection* is the guide used in judging at all poultry shows. It describes all recognized breeds and varieties, so that each exhibitor can become familiar with the standard requirements of the breed or breeds he is handling.

About 10 days before the show, all white birds should be washed, and again two or three days before showing. Colored birds do not, as a rule, require washing. To wash a bird properly requires a great deal of care and some experience. The process is as follows: Provide two warm rooms, adjoining each other, one heated to about 75 degrees for washing and the other heated to 90 or 95 degrees for drying. The drying room should be fitted with plenty of cloth-covered coops with open front, and set well up off the floor. The washroom should be supplied with four tubs, the first containing quite warm water for washing, the next two contain slightly cooler water for rinsing, and the fourth contains cooler water, blued just right for fine linen. Wash each bird clean in the first tub with good white soap, being careful not to muss or break any feathers. Then rinse thoroughly in the second and third tubs, and dip in the blue water before placing in the drying coops. Keep an even temperature in the drying room until all the birds are dry, and then cool it off gradually.

CHAPTER XVI.

HOMEMADE POULTRY DEVICES.

Here is a cut of a hen coop that I have found very convenient in raising chicks with hens, to keep them from the hawks when small. The cage in front of the common A coop is made of half-inch lumber and covered with 1½-inch poultry netting. It is attached to each side of the coop with one nail so it will easily fit any unevenness of the ground. Being light it can be moved a little every day or two to give a clean spot and fresh grass. The hen is confined in the coop, and, after the chicks are old enough, the front of cage can be raised up on a brick so they can run out. I let them stay in the coop nights after taking

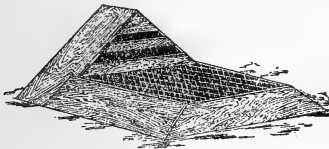

HAWK-PROOF COOP. FIG. 31.

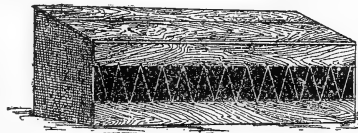

HANDY FEED HOPPER. FIG. 32.

the hen away till I want to put them in the Winter quarters. They are easily shut in by pulling the brick out. G. W. S.

Vermont.

We devised and are using the hopper shown at Fig. 32 for feeding fattening fowls of all ages. The front consists of two strips two inches wide, with a space of three inches between. The ends are made of thick boards six inches wide, seven inches high at front and 10 inches at back. The lid consists of two boards two inches and four inches wide respectively, the wider attached to the narrow by means of hinges. A board two inches wide is sufficient for the back, which is placed against one side of the room in which the fowls are confined. On each side of front space small nails are driven about two inches apart and in nearly to the head. To prevent crowding and smaller fowls from creeping in, wire clipped from baled straw is stretched across from one nail to another in front space. The bottom is a separate piece sawed to fit inside and on which the feed is placed. It may be

made any length desired. One eight feet long is sufficient for 20 fowls, broiler size.

J. C. C.

Pennsylvania.

I make lice-proof roosts as follows. Get one-half-inch round iron, stick through the floor into the ground far enough to be firm, and on these the 2x4 stick for roost. Then make a cup of



LICE-PROOF ROOST. FIG. 33.

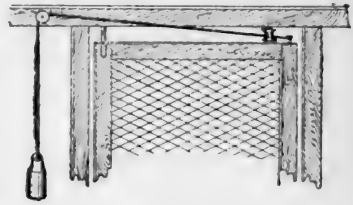

GATE DEVICE. FIG. 34.

tin and core to fit on the round iron, and fill cup with kerosene. Fig. 33 shows how it is done.

H. G.

Washington.

Fig. 34 shows a device I am using on partition doors in my hen houses. As far as I know it is original. The door swings on pins for hinges so it opens either way without the attendant stopping to fasten or unfasten. The string passes between two spools over the front end of the door. A brick makes about the right weight.

Connecticut.

G. T. J.

The Figs. 35-36 show a homemade gate that I find of considerable service around my poultry yards. I arranged this gate at first

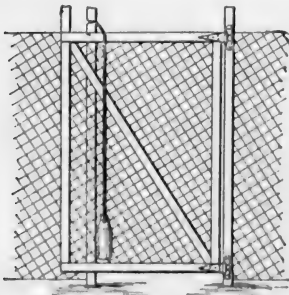

GATE CLOSED. FIG. 35.

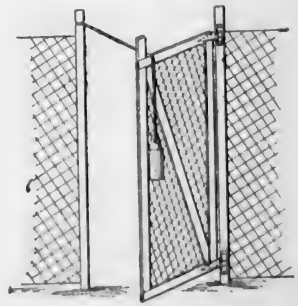

GATE OPEN. FIG. 36.

to allow my dog to have free access to the poultry runs, so that if there was any disturbance night or day he could get there right

away and see about it. I also found that I could use it to my own advantage in passing through the gates with feed or water pails in each hand. I take a rope about the size of a clothesline, or what is better, three small ropes and braid them, the braided rope will not chafe out so quickly as the single rope, then fasten to the top of gate post. To the other end of rope I attach a block of 2x3 joist 12 or 15 inches long, and throw over the gate as shown. This will close the gate, and dog or man can push it open, and pass under the rope. In making the gate allow the upright near the rope to extend up a few inches to keep the rope on, and bevel the top part of gate where the rope passes over. It did not take over five minutes to teach the dog to open the gate from either side.

Massachusetts.

H. W. R.

Here is a picture, Fig. 37, of a drinking fountain that has proved valuable to me. It is made from any jug. The jug should

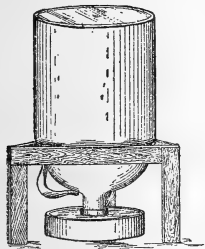

JUG-DRINKING FOUNTAIN.

FIG. 37.

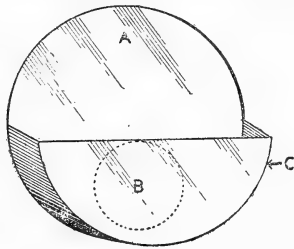

USING A FRUIT CAN.

FIG. 38.

have a rim around the top as this is what it rests on when inverted on the frame or support. The support is triangular in shape and is made to fit under the rim of the jug. I usually make the support out of some strips three inches wide and one inch thick. There is a leg at each corner made of the same stuff. The legs should be long enough to place the mouth of the jar about three inches from the ground. In that case they will be six inches long or perhaps a little longer. This is regulated by the depth of the pan under the jug, the mouth of the jug should be about a half inch below the top of the pan, and the jug will keep that much water in the pan until the jug is empty. I use gallon jugs, carry them to the well two at a time and fill with a hose. They are carried to the frame under which the pan is kept and inverted. The jugs being white they will keep the water cooler than any other thing I know of.

W. D. S.

Virginia.

A good water fount for chicks can be made out of a Mason fruit jar by taking the cover and putting a hole a half inch from the edge. Solder a lip on. Then notch two pieces of board and nail slats to sides to lay jar in. This is easily kept clean. A, Fig. 38, is top of jar cover, B, hole in cover, C, lip to be soldered on.

A good way for town poultry keepers to keep green feed before the chickens at all times, without much labor, is to make a frame of three-inch boards, the boards standing on edge and cover with one-half-inch square mesh wire cloth or netting. This can be made any size to suit, the one I have reference to is 6x4 feet. Take a piece of ground the size of frame and after spading in a lot of manure rake it level, sow oats on it rather heavy, and cover with good soil. Then put the frame over and let it grow. The chickens will see that it does not grow above the wire.

Pennsylvania.

G. G. L.

We live out on this Western prairie, away from any good source of supplies. I wanted something to feed and water my

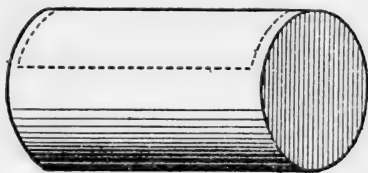

CAN MADE USEFUL.

FIG. 39.

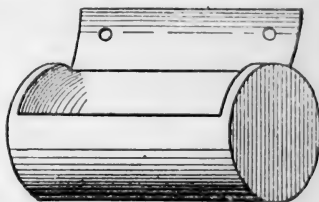

HOW IT HANGS UP.

FIG. 40.

chickens out of, that they couldn't soil, and made it for them from tomato and salmon cans. I opened the cans, when I wished to use the contents, down the side and a few inches on either end, then turned the opened piece of tin back and made a couple of holes in it to hang up by. The birds cannot get into them and they are very easily cleaned. Figs. 39-40 show how this is done.

North Dakota.

V. E.

When the chicks are too small to feed in a trough, and you want to put feed for them on a flat board, the old hen gets on and scratches it to waste. Fasten a section of wire netting on to the board, flat, and put on the feed as before, no matter whether it is dry or wet. Next time the hen tries to scratch her body will move instead of her feet.

To provide green food for chicks early in the season, get a block 6x8 inches square, or 6x10 would be better; saw a notch in

the upper side, three inches deep and three wide at one side, and six at the other. Get a piece of light sleigh-shoe steel, about two feet long, and get the smith to draw out one end to put a handle on, punch a hole in the other, and grind, hammer or file to a sharp edge a section of the steel wide enough to reach across the notch in block and about six inches from end, with hole in it. Bolt the knife to block a little lower than bottom of notch. Bevel to knife should be all on one side and away from block. When grass gets long enough to cut with knife or grass hook, take some of it, put in notch in block and feed it along with left hand, and with the right hand on knife you can cut it as fine as you please. When the bottom of notch gets worn away, insert a section of stout hoop iron for knife to play down beside, so as to make clean cut. Figs. 41-42 show how this is done.

When chicks get older and you want to give them weeds or any kind of large leaves, tack some wire netting on a frame and

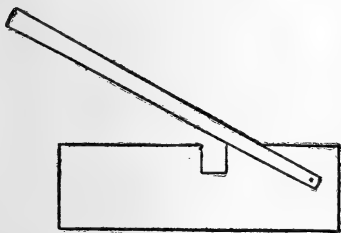

GRASS CUTTER. FIG. 41.

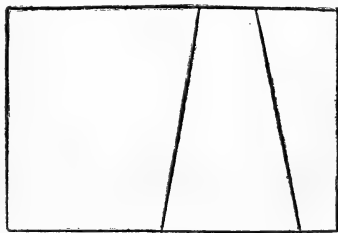

TOP OF BLOCK. FIG. 42.

place it on the weeds to hold them down. The fowls can tear off what they want as well as if plants were growing. They are very fond of plantain leaves and clippings from too vigorous Dahlias.

When you have surplus sweet corn to give the chickens, drive wire nails, five or six inches long, through a stout board, turn it over and set the ears on these nails, and chicks will clean corn all off without rolling it about in the dirt.

O. H. L.

New Hampshire.

Flour barrels make excellent coops, roomy and cheap. A little frame is made for the front, consisting of four pieces of board, the uprights 6x24 inches, and two crosspieces, top and bottom, 2x20 inches. Fasten frame to front of barrel by wire, leaving opening for door. Fix so that a slide door, eight inches wide, can be easily dropped in from the top. This door is made of one-half-inch mesh cellar window wire, nailed or stapled to strips of wood. This gives good ventilation and is absolutely vermin-proof. Cover

barrel with old tin roofing or spouting, so as to make rain-proof and prevent the sun from warping it. Of course, a coat of paint will add to its attractiveness, but is not necessary for practical purposes. Runs of any size made of wire netting can be attached to barrel, and with the netting over the top of runs the chicks are safe from crows or the annoyance of grown chickens. Barrels and runs can be readily moved on to fresh ground. The runs are made substantial by the addition of a few stakes driven into the ground to support the wire netting. Front and side views are shown in Figs. 43-44. For feeding dry mash, we use a box two inches deep at sides and three and one-half inches deep at ends, seven inches wide, 42 inches long, inside measure. For feet, have four pieces, one inch square and 12 inches long. Nail these to ends

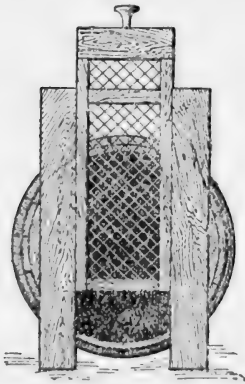

BARREL COOP. FIG. 43.

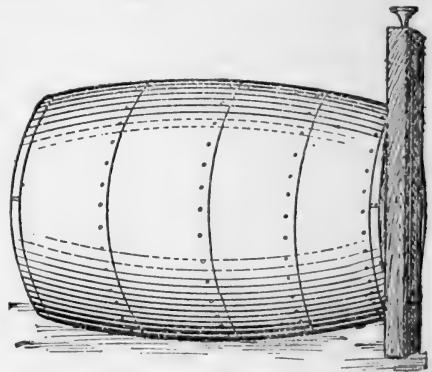

SIDE VIEW. FIG. 44.

of box, having top of three and one-half-inch ends, eight and one-half inches high. For top have board five inches wide, nailed on to cleat at each end of top, to prevent its slipping out of place. This trough keeps the feed clean and chickens do not scratch it out.

A. E. F.

Pennsylvania.

In Fig. 45 is shown a scraper for cleaning the droppings boards. The blade, indicated by arrow *a*, is made of three-sixteenths or one-fourth inch sheet steel. The bottom edge is twenty-four inches long and the top twenty-two inches. The width of the blade is four inches. The handle is made of three-quarter inch pipe and threaded on one end. A hole is bored near the top in the centre of the blade. This is threaded with an ordinary tap

and the handle is then securely screwed in place. A scraper made in this manner will last a lifetime, and prove to be a very practical tool.

In running an egg farm there often is a good deal more young stock in the Summer than there is house room for. Unless these young pullets are trained to roost soon after they leave the brooders, there will be trouble teaching them this accomplishment. A standardized roost for temporary quarters has been found a great convenience. Take some rough-backed young saplings, cutting a lot of supports about two and one-half inches in diameter and 54 inches long, drive in a four-inch spike 15 inches from each end and one in the middle, leaving two inches of the spike to protrude for a support. Then set these poles at an angle of 45 degrees, against the walls of any building to be used for temporary roosting place, and put any convenient length poles on the spike in the supports for

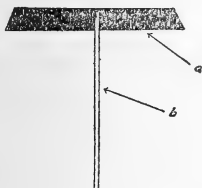

DROPPINGS BOARD SCRAPER.

FIG. 45.

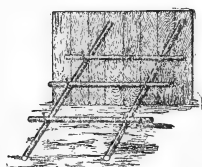

TEMPORARY ROOST.

FIG. 46.

roosts. They can be used year after year if kept in a dry place when not in use. The cut, Fig. 46, shows this.

P. B.

Michigan.

One of the most provoking problems in poultry keeping is the determination of the hens to lay in one nest. No matter whether half a dozen other nests exactly alike in every respect are right near that one, they will crowd and fight around one or two nests, often smashing a couple of eggs, soiling the nest and causing trouble all around. Last year I found a way to prevent this. I made a frame out of $1\frac{1}{2}$ -inch strips of pine boards, size of frame 16x36 inches. Next I took a piece of galvanized poultry netting $\frac{1}{2}$ -inch mesh, size 24x48 inches, stapling this to the frame, turning the corners in. This forms a continuous nest, about 3 feet long. After one hen has squatted down to lay the next one will sit down close alongside of her, and I have had as many as ten of them sitting in a row, as peaceful as it is possible for that number of biddies to be. As soon as one hen is done and leaves, the nearest one of the hens next to her will carefully roll that egg

under herself, and most of the time the last hen or two will have all the eggs under them. Two or three such nests will be sufficient for fifty to sixty hens. One improvement I have lately added, by making the frame out of old pieces of $\frac{1}{2}$ -inch pipe, using elbows for the corners. This way I can take the nest outside and set fire to it. I believe anyone who has tried to keep the old wooden nest boxes clean during hot weather, will appreciate the improvement.

C. H.

Illinois.

INSIDE HOUSE ARRANGEMENT.—“I enclose sketch of sectional view of our henhouse, Fig. 47. A indicates an aisle three feet wide running full length of building, which is 40 feet; B, scratching and roosting section; I, partition with studding eight inches apart

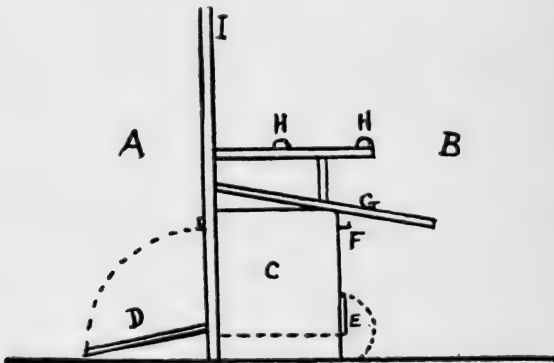

INSIDE HOUSE ARRANGEMENT. FIG. 47.

and covered with poultry netting; C, row of nests, each 15 inches square, raised four inches off the floor. On these rests the droppings board G, and above on brackets the two lines of roosts H. Board E is hinged every four feet at the bottom, that it may be dropped to facilitate cleaning and disinfecting the nest boxes. The hens, being in the scratching pen, enter the nests from that side. The doors, D, being separate for each nest, made of 1x3-inch pieces into a square frame and covered with fine netting, are hinged at the bottom and kept closed by a wooden button, except when gathering the eggs from the alley. When a hen becomes broody she is given her complement of eggs in the nest she has selected, and trespassers are kept from troubling her by hanging on the hook F a lattice door made of pieces of lath. The door D is then left open and the sitters

exercise in the alley where food and water are at hand. We hatched over three hundred chicks here last Spring and the plan worked beautifully.”

W. H. FISHER.

Ohio.

THE TRAP NEST.

It is generally conceded that trap-nesting is too expensive a plan of selection for the average poultryman to use. On page 95

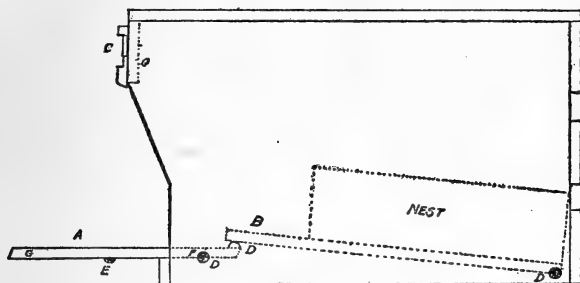

TRAP NEST OPEN. FIG. 48.

Prof. Rice states that it costs about 50 cents to trap-nest a hen for a year and keep the necessary records. For the convenience of those who wish to try the experiment the accompanying illustrations and notes by a practical poultryman are given:

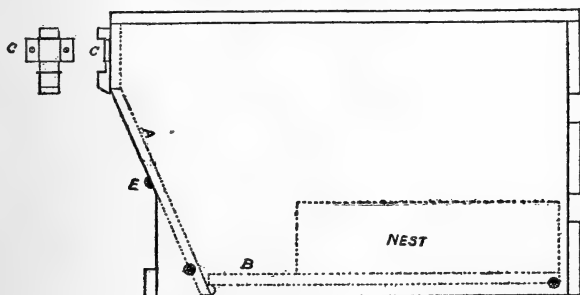

TRAP NEST SHUT. FIG. 49.

“The accompanying designs show a trap nest of my invention, closed and open. Both cuts show a side view of the device. The nest proper is in an outer box. This outer box may slide like a drawer at under side of droppings board. The outer box may be without bottom, thus saving lumber. Fig. 48 shows trap A open. As the hen steps in at B her weight closes the trap A. C is a

catch or button that automatically operates when trap closes and locks trap. D. D. D. are half-round hardwood mouldings, fastened across trap and rear end of nest which revolve in half-inch holes in outer box at F. F. E is a moulding across trap and projecting enough to strike against sides of outer box, preventing trap from closing too far in. The shoulders of this moulding E, as also shoulders of catch C, may be provided with a piece of felt or rubber, to lessen the noise of closing trap. Dimensions may vary with size of fowls. Inside of nest may be about 11x11 inches and four inches high. The device is very easily operated. A weight of 2½ pounds at B, easily closes trap. After the hen has laid, she will put her head through a hole that is cut at each G. G. After egg is deposited, the hen has sufficient room in front of nest to keep nest from fouling. Excepting nails, there is no hardware about this device, as strap in which catch C plays, may be wood."

MOVABLE POULTRY YARDS.

The essential features in poultry keeping are clean quarters, grass and exercise; coops that are easy to clean, easy to feed and not expensive to make. After many years of study and experiment with all the different kinds of poultry houses I find the following plan is the simplest and by far the best, except in the snowy period of Winter, when the birds and yards can be placed in an open shed facing south. The yards are built in sections four feet wide, two feet high and 16 feet long. Fig. 50 shows the plan.

One or 20 sections can be placed end to end and the length of the yard is only limited by your boundary or whatever else there is to restrict you. A grass and clover field is the best, but when I started my yards they were on corn stubble and a fine grassy yard has grown without seeding in two years. The materials are kept in all lumber yards. Six arbor laths 1x2x16 white pine finished and free from knots and other weak spots, cost about 25 cents each, will make the frame. The sides, ends and top can be made up of plaster laths nailed one inch apart for small chickens and 1½ to two inches for adult fowls. Porch lattice strips are neater, better and a little more expensive, but if painted would make a neater appearance and be more lasting. The end section should be closed at the ends with a sliding door to shut all birds in when moving yards; intermediate sections are braced on the ends and left open otherwise.

The top of each section should have four feet closed with light lumber or a sheet of galvanized iron which will furnish shade for the fowls on warm days. For brooder yards these sections should have the whole top covered with galvanized iron or light lumber and

it will save much loss from sudden showers, but make them light enough to move easily. The roosting room should be four feet square and two feet high with two roosts and open at the top like a box. These coops are easy to move by just dragging them along. They will hold 12 or 14 Leghorns and have roosting coops enough to accommodate your flock. Laying houses are the same size with four nests on each side opened at the top. These houses should be closed at the evening feeding time to stop birds from roosting in the house or nests. Dry mash hoppers are kept in another house of the same pattern and each house should have one or more sections between them.

These yards make ideal Leghorn yards (they are always in their own place and not scratching at your neighbor's garden), which is their greatest recommendation. I am a trucker and my neighbor's chickens do me more harm than all the bugs. Each morning a

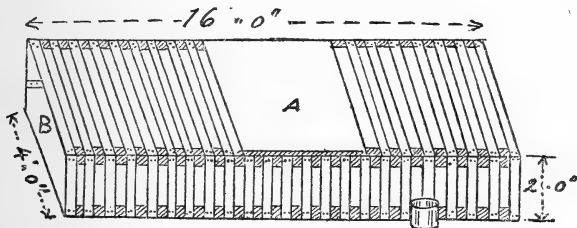

MOVABLE POULTRY YARD. FIG. 50.

little grain is thrown in the end section, and when all the birds are in close the slide and then move each section over sideways till all are on the clean grass, then move the end section, birds and all, taking care not to pinch their toes, but they are usually too eager for the new grass to get their toes pinched.

Roosting houses should have no bottom. Laying houses have only wire netting on bottom of the nests to keep in the straw when moving the house. The dry mash feeding house should have a wood floor. Water, grit, shells and charcoal can be kept in tomato cans or lard pails on the outside of the yards where the birds can reach them easily by putting their heads through the slatted sides of the yards, and the feeder can see at a glance if each pail is full. The water, grit, etc., will always be free from droppings, which is never the case when these utensils are kept inside a poultry house. The ground will have grown up to grass in about two weeks' time when you can move the yards back to their original place and move over daily, a task that will but take about two minutes per section.

CHAPTER XVII.

POULTRY IN LARGE FLOCKS.

The "colony plan" of poultry keeping, that is small houses scattered over a wide area, has its advantages and its drawbacks. So has the opposite plan of crowding large flocks of birds into one building. As is stated in the following chapter by Dr. Buchanan Burr, the plan of feeding a "dry mash" has given renewed opportunity for large flock feeding. The statement which follows tells how it is done.

As the object of most persons who engage in poultry raising is to have a flock large enough to support the owner, and as most failures in the business arise from ignorance as to how to enlarge the successful small plant, this chapter will endeavor to take the poultryman or poultrywoman who has arrived at this point safely over this bridge. Assuming as the basis of this chapter that 1,000 laying hens are needed to support the owner, it will be at once apparent that to raise the 3,000 chicks yearly to keep up this number of healthy well-developed egg machines, fireless brooders, lamp brooders, colony brooders are out of the question, and we are forced by every reason of economy and sanitation to build a proper brooder house with heater and pipe system.

BROODING IN LARGE FLOCKS.—The pipe system brooder house fell into disrepute some years ago for two reasons; first because the pipes were put too low over the chicks, and second, the heat was not run high enough. With four 1½-inch pipes from 12 inches to 14 inches from floor, run at a temperature on your heater thermometer of 120° to 140°, the chicks will not only never feel chilled but will be forced apart and found lying comfortably along the edge of the flannel curtain which comes to within two inches of the floor. The roof is the most expensive part of the building. My own preference is for a two-story brooder house 21 feet wide by any length needed to supply the necessities of the plant. This makes a double house facing east and west, with pens three feet wide upstairs and four feet wide downstairs. The baby chicks are taken to the upstairs pens, not more than 50 in a pen, for 10 days. Then they are sorted by size, and all defective ones killed, and the others taken to the larger downstairs pens, where they have outdoor runs. The

water pans for all pens are, upstairs, $6\frac{1}{2} \times 1\frac{1}{2}$ -inch galvanized iron or agate pans, setting one-third in passage and two-thirds in pen, the pen portion being covered by having nailed to the board partitions one inch above the hole through which pan is pushed into pen, a semi-circle of wood two inches smaller than pan, on the edge of which finish nails are driven one inch apart, Fig. 51. By this arrangement the chicks cannot get in the water to soil it and a glance at each pan in going through the house tells where water is needed. The pans can all be washed daily without going into the pens. For the downstairs brooders a $10 \times 2\frac{1}{2}$ -inch pan can be used. I find it a great advantage to cut the hole high enough to place a board under the pan, coming out in the pen about three inches beyond the pan. This keeps the pan above the sand and litter in the pen and keeps the water cleaner. I said take the chicks from incubator as soon as dry to these pens, but they are not to be fed for 48 hours, so in front of the flannel curtains in each hover I drop a board six

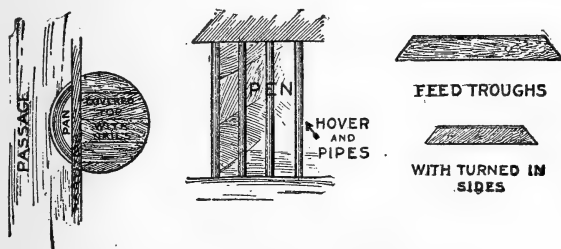

SECTION OF HOUSE INTERIOR. FIG. 51.

inches wide in slots, converting the hover into a dark, warm pen with clean, fresh, sharp sand on the floor, and there they stay warm and quiet until the yolk is absorbed. Then the front board is removed, a little chick feed scattered on the floor, and they get their first feed and drink. After another 24 hours the back board is removed. For feeding chicks I use the "Burr" chick trough, keeping mixed grain and dry mash in separate troughs before them all the time. For small chicks a trough two feet long and 12 inches wide with sides three inches high is ample. Take a 12-inch board two feet long and bevel sides and ends to 45° . To these four beveled sides nail half-inch strips three inches wide and you will have a trough as shown in Fig. 54. By laying this trough on the floor and piling the sand up against the sides and ends chicks 48 hours old can run in and out of them easily. The object of the turned-in sides is to prevent the chicks scratching feed all over the pens. By sifting out with a flour sieve once a week, all the sand will be removed, and

with a coarser sieve all the manure, and the feed remains always clean. Once in two weeks the mash troughs may be dumped out and the contents scattered in the henyard, where it is eagerly scratched over and eaten, so that no waste occurs. For the lower section where chicks are 10 days old the same troughs are used, only they are made three feet long, 16 inches wide and the sides are five inches high, Fig. 55. Chicks of this age will scratch feed out of the smaller troughs. These larger troughs are also used in the colony houses up to three months of age, when they are replaced with the "Burr" hen trough. By this system of feeding chicks are only fed once a day, which is a great saving of labor, and there is always feed for strong and weak with no danger of over-eating or under-feeding. Once a day they should receive green feed, in Winter beets run through a meat chopper or sprouted oats, with a quart of swamp muck if it is obtainable to each pen twice a week. After they are a week old a hopper of beef scrap should be kept filled in each pen and grit, chick shell and ground bone kept before them all the time. The dry mash used for chicks is the same as used for the laying hens and the formula will be given later.

The great objection raised against the brooder house and in favor of the colony system of brooders has been that the yards will get foul, but with removable fences, fastened to the houses and to the end posts 50 feet away; with simple L posts in between, all these fences can be taken down in a few hours, the yards limed, plowed and seeded to rape and fences replaced. After chicks are all out of brooder house these yards may be plowed again and seeded to White clover and lawn grass for the following Spring. With this objection removed, there is no comparison either in economy or the health of chicks raised between the two systems up to six weeks of age, when your April-hatched layers are ready to be put in colony houses, without heat, where they will remain until housed in laying houses for the Winter.

STARTING A FLOCK.—As the line between profit and loss in a large poultry plant lies between 100 and 145 eggs per hen per year, it is very necessary that the individuals composing this flock should each be healthy and to all appearance able to hold up their share of the load, but more than that, the owner should know that the ancestors as far back as he can trace them have been Winter layers of large eggs. The buying of day-old chicks, or of eggs for hatching, except from known breeders without a guarantee that they are from aged hens only and not from pullets' eggs, is a very serious source of loss and disappointment. The safest and surest way is to raise or buy enough yearling or two-year-old hens. These hens should be

mated to healthy cockerels, say in February. Hold them back from laying by a grain diet and plenty of exercise until this time. Keep them in colony houses and their eggs will hatch chicks that want to live and that when they mature will lay, and lay when eggs are high. After your first year the close culling of your flock of yearlings will give better and better breeders each year, and bred to cockerels each year there is no danger of inbreeding. Any unusually good cock bird can be kept for another year or two and bred to a special pen of the best hens to tone up the grade of the whole flock.

HOUSING AND FEEDING.—It may be roughly stated that the advent of dry mash before the hens all the time made possible the keeping of large flocks together. Before that time with feeding three times a day the active, hustling hen got more than her share to the detriment of the less active members of the flock. Under present conditions of feeding there is no limit to the size of a flock that can be kept profitably except the element of labor. As 2,000 hens can be easily cared for by one man and kept in perfect condition all the time, so in a complete one-man plant 1,000 hens may be considered as a unit, leaving time enough for incubator and brooder house work. It is of course an advantage where the farm is large enough to pay to keep a man for this other work and to help with the rough and heavy work on the poultry plant.

My own preference is for the two-story type of house with two short roosts on each side of a central passage running at right angles to the passage, 22 inches apart and 22 inches from the floor, simple 2x2-inch with upper corners rounded, five feet long and supported on three-eighths-inch iron rods driven into floor and into hole in roost. This in a house 20 feet wide and 100 feet long gives 16 roosts between four-foot windows on each side of house, with a passage along each side in front of nest boxes on the wall. These windows being 4x5 feet, with upper half muslin and lower half glass, give perfect ventilation Winter and Summer. The downstairs part being for feeding and watering and exercise, with 1,000 hens in such a house each hen has four square feet, but in reality has the freedom of 4,000 square feet, except that occupied by the other 999 hens.

A much less expensive house of the regular type can be built 18 feet wide and 100 feet long, 4½ feet high in the rear and 6½ feet in front, shed roof with rear wall sheathed to plate, and roof sheathed up six feet. Droppings boards are 2½ feet from floor, four roosts 12 inches from droppings boards. The front of this house could be boarded up for two feet from the bottom and a foot from the top, leaving three feet that could be closed in with 3x6-foot screens

covered with unbleached muslin, with a 3x2-foot sash in between each muslin screen. The muslin is closed on stormy days only and at night in cold weather. Such a house would house 500 hens comfortably, where a two-story house of the same size would hold 1,000. Either house should be faced a little to the south of southeast, as this gives the most sun in Winter and the least in Summer. Any laying house should be built on posts with a grade at top of sill of 18 inches above the average natural grade. Fill this 18 inches in with dry dirt to top of sill. This makes the best floor. By keeping this dirt loose it makes all the dust baths necessary. The top can be raked off weekly and spread on the droppings boards. It will be necessary to fill in about six inches of clear dry dirt in May and September; thus the house floor is renewed and never becomes foul. If it can be placed in a field with say 150 feet front and back for yards and a fence running from each end to make a front and back yard, by plowing and sowing oats, millet, rape and Crimson clover in rotation in each yard, you have continuous green feed from March until December, which is both healthy and economical. Avoid planting fruit trees in either poultry or brooder yards, as the continuous plowing necessary for health will ruin the trees before they are large enough to be productive, and artificial shade is much better, the cheapest way to make the latter being to tack two-inch mesh wire on a frame 3x6 feet and nail on legs one foot long on one side and 18 inches on the other. Cover with burlap or building paper. The legs can be knocked off in the Fall and the screens stored away. A crop of potatoes or corn can be taken alternately from the front or back yards, following potatoes with rye and Crimson clover, and planting in rape and rye with the last cultivation of the corn.

FEEDING FOR WINTER EGGS.—If you have culled out 500 or 1,000 of the best of those pullets we left in the colony houses last May, when some of the combs begin to redden the last of September, put them in your laying house, leave them shut in for a few days, until they feel at home, and the feeding and watering problem now presents itself. For watering a large flock there is nothing as convenient as one or more 10-foot lengths of five-inch double-lipped galvanized iron eaves trough or gutter. Have the plumber solder in two sloping ends, and near one end a piece of $\frac{3}{4}$ -inch brass pipe. I say brass pipe because it is even enough to have a cork fit tight, whereas the galvanized iron pipe will leak. Take two pieces of board three inches wide and the length of your trough, and nail to two square end pieces, so that each board will fit under one lip of trough to support it. Set this trough on a

platform high enough above the floor to get a pail under the pipe to empty it into, and build a running board on each side of it for the hens to stand on when drinking, and you are fixed. In Winter the trough can be emptied at night, and filled through the day at intervals with hot water to keep ice melted. Put the pail under the pipe, remove cork and brush out trough with a sink brush and it is clean.

The object to be attained by feeding these hens is to keep them healthy, make them eat egg-making food and drink clean water, so as to produce the most clean eggs with high-colored yolks, and no bad smell or flavor. If left to herself she would much rather spend her time scratching in a manure pile or old wood pile for a bug or two, eat turnips or onions, and not lay any more than she had to until Spring. While the man does not live who can make a hen lay, you can so feed her in the Fall that there is a super-supply of protein, fat and mineral matter that will, against her inclination,

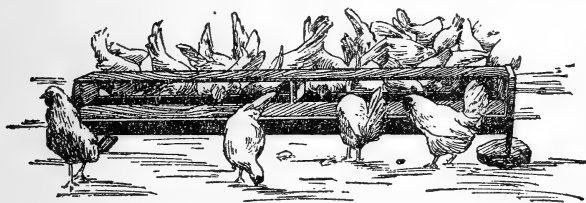

THE BURR HEN TROUGH. FIG. 52.

go to the development of the embryonic ovules, and as they grow they cause a drain on her system which she locates as hunger, and supplies, hence Winter eggs. This can only be done by confining her in large yards and not letting her out of the house in the morning until she has eaten her breakfast, giving food she is fond of to encourage her to eat more than she otherwise would, and keeping such a mixture before her as will develop the ovaries and the albumen secreting glands. If these pullets are all April and early May hatched, and are housed by October, go through your flock on December first and cull out any immature, undeveloped pullet, in fact every one that does not show a developed comb, and sell them for roasters. I say developed, and not red comb, for some of the April pullets that laid through October and November will be resting now, and the combs will not be so red. What I want to impress on you is that any pullet in the flock that does not look like laying on this date will be carried through the Winter at a loss, and would better be disposed of now.

After trying all the hoppers made and making many more, I finally hit upon what is known as the "Burr" trough as the simplest and most economical appliance for feeding.

To explain Fig. 53, if you take two pieces of half-inch board six inches wide and eight feet long, and nail them together, you will get a V trough six inches wide on one side and $6\frac{1}{2}$ inches on the other. Take another piece of board six inches wide and rip it in two, one piece being $2\frac{3}{4}$ inches wide and the other $3\frac{1}{4}$ inches. Nail the first piece on the inner lip of the wide side, and the latter on the top edge of the narrow side, and you have your trough; nail on the ends and put on the top. The hens cannot waste any feed out of this trough, cannot soil it, and yet it is always there before them. Ten

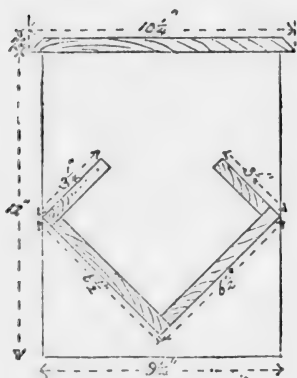

SECTION OF
BURR TROUGH.

FIG. 53.

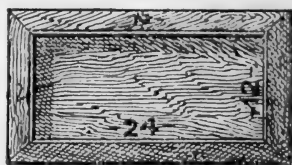

HOPPER FOR LITTLE CHICKS

FIG. 54.

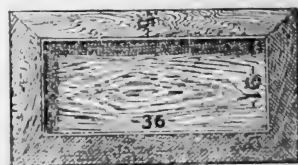

FOR LARGER CHICKS.

FIG. 55.

such troughs, half for grain and half for dry mash, are enough for 1,000 hens, and need be filled only once a day. Of course the grain ration before them all the time applies only to Leghorns, who cannot over-eat. With the heavier breeds the mash may be kept before them all the time, and the grain fed in litter night and morning. Even with the heavier breeds, grain troughs that can be closed except at supper time are an advantage, as where all grain is fed in litter many hens go to bed without enough supper, which means less eggs.

For the grain ration almost any mixture of wheat, cracked corn, with some buckwheat during Winter, will do. Watch the troughs and mix your grain to suit the hens' appetite, using more of one or the other grain as they eat them more eagerly. For the

mash I use as a standard: 200 pounds bran, 100 pounds ground oats or barley, 200 pounds coarse cornmeal, 100 pounds shredded wheat (waste), 100 pounds middlings, 100 pounds best beef scrap (with some bone in it), if not add 25 pounds granulated bone, 100 pounds clean sifted charcoal (granulated), no dust, 25 pounds salt. Vary this by adding in Summer 50 pounds oil meal. This mash is kept before them all the time. Sprouted oats are fed once a day, all they will eat up readily, or alternately with mangels or sugar beets run through a meat cutter. These they eat greedily, and where green bone cannot be obtained I mix 25 pounds of beef scrap with 100 pounds of ground beets and feed it. The sprouted oats and beets should be fed in flat troughs six feet long, 12 inches wide, with three-inch sides; these when not in use can be hung .p. Of course there is no egg-making food that can compare with green bone as a maker of Winter eggs, and if it can be obtained even at three cents per pound cut it is worth it. Feed every other day up to one pound for every 30 hens, and reduce the percentage of beef scrap in the mixture by one half. As the markets require in Winter eggs a high-colored yolk it is necessary to feed three times a week cut dry clover or Alfalfa. While sprouted oats will help it is very much cheaper to produce this color with clover or Alfalfa; which they eat greedily. Too much clover or Alfalfa will cut down your egg yield, as they will eat too much of it in place of more nutritious food. With dry airy houses, cleaned daily, with plenty of dry dirt on the floors for absorbent and dust baths, with roosts and nest boxes gone over carefully twice a year with crude petroleum and any coal-tar insecticide, with this system of feeding only sweet clean grain, there can be no question of your success, *if you like hens*, and if you do not you would better leave them alone, for they have very pronounced ideas of their own, and while if they trust you you can coax them, you can never drive them, and a scared hen in a large flock tells her story in the egg basket for several days.

The best cure for all poultry diseases is the ax, and burn the remains. Much trouble is caused by curing(?) mild cases of roup or canker and using these birds for breeders. It will take years to eradicate a taint thus bred in. There is much, however, that can be done in the way of prevention. By breeding only from healthy mature stock, by proper hatching and good brooding the chick gets a living start. White diarrhoea can be absolutely prevented by this means, by thorough sterilizing of the incubators after each hatch, and in cases where there is any suspicion of tuberculosis in the flock, by dipping the eggs for hatching in a solution of corrosive sublimate one part to 5,000 of water. All breeding hens should be carefully

examined before putting them in the mating pens, as I have found some of the best hens to look at infected with canker of the vent which would infect every egg. Some apparently healthy hens have at all times a strong ropy smell at the nostrils and should be killed at once as, while immune themselves, they scatter ropy germs which are taken up and develop in the other hens who are not immune. In every normal hatch there will be a few chicks that do not properly absorb the yolk. They drag along, usually showing some signs of indigestion; an examination of the abdomen shows a hard lump in addition to the gizzard. Kill them at once as they drag along and cost more to make broilers of even than they are worth. If the brooder conditions are not correct and chicks get chilled and huddle, the flock will show in a few days all the appearance of white diarrhœa; they mope, drop their wings and huddle together. The only thing to do is to separate the healthy ones and kill off all moping chicks. When chicks learn that they can get warm by crowding, the whole flock is doomed; therefore keep up high temperatures in your brooder pipes so that as they snuggle together at bedtime, as they always will, the heat will be uncomfortable, and before the crowding can do any harm the flock separates for the night. Watch every flock at bedtime and prevent any settling in corners, as they will always go back to the spot they first settled in. This is also another reason why flocks should never be more than 50 when young, as the animal heat of a larger number will overheat some, and an overheated chick is doomed. With chicks normally hatched and brooded there is but one other serious trouble that can occur. For want of a better term I call it secondary bacterial infection. Unless the yards are disinfected, spaded up and seeded, after the first lot have been removed to the colony houses, the next lot getting out on the foul yards will, especially during a hot day following a cold rainy spell, eat everything they can scratch up and become infected with bacteria, and die like flies. The intestines will be filled with blood from infection, and unless you recognize the condition you will think some one has poisoned the flock. There is no cure; prevention is all; recognize the danger ahead and prevent it. In feeding lawn clippings, and they are excellent feed for hens and chicks, be sure that the fruit trees are not being sprayed with some arsenical preparation or trouble will ensue. Good healthy stock, with clean water, fresh air, clean feed, using the same horse sense in caring for them that you would in any other business, and there is no mystery or secret about the raising of poultry in large numbers.

CHAPTER XVIII.

COMPANIONS OF THE HEN.

DUCKS.—We do not offer advice to the extensive duck raiser who keeps birds by the thousand, but to the farmer who keeps a flock of reasonable size. If a man intend to make duck raising a specialty, he should go to some large duck ranch and study the business. The principal breeds are Pekin, Rouen, Cayuga, Muscovy, Aylesbury and Indian Runner. The Pekin is the most popular breed, and is usually kept by farmers. The Indian Runner is the best laying duck, ranking with the Leghorn among hens as an egg producer. Ducks are usually hatched in incubators or under hens. For the first few days they are fed much like young turkeys, on bread crumbs and boiled eggs or rolled oats. After five days sand or gravel is added to the food, and gradually meal and bran are substituted for egg and bread—with later beef scraps, salt and abundance of chopped green food. Ducks need shade—an orchard makes a good place for them. Breeders should have a place to swim, but fattening ducks should be kept from the water. Mr. G. A. McPettridge tells how ducks are handled on a large duck ranch. With proper modification this plan will answer on a farm.

“Anyone who wishes to succeed at raising much have his ducks in market at the age of 10 weeks. At that age they should, if properly cared for, average at least five pounds apiece. It is a good plan to pick out your stock ducks, at the same time (10 weeks) selecting the finest shaped and active ones. Arrange to have the males at least one month older than the females, and keep them separate. Give them a stronger feed, with about five per cent scrap; they will require it. With the females it is different, for they do not need a strong feed, but a light bulky feed. If they are picked out in May at the age of 10 weeks and fed on strong feed they will start to lay in September, which is too early; the middle of November is about right. A good feed for them is something like this: By measure, four parts of bran, four of middling or red dog, one of corn chop, one-half part sand, and one-third of the whole amount of some kind of filler. Use what is at hand, almost any green vegetable, second crop clover and Alfalfa. This mixture makes a good light feed, and if fed properly will give good results at this time when muscle-forming is the main object.

"By all means get them on a clover plot, keep visitors out and keep them quiet. In case a clover plot is not obtainable, then manage to get some kind of greens for them to pick at; it will aid digestion. Supposing they are selected by the 20th of May, then they are fed the above feed judiciously up to September 20, then use the same kind of mixture, but give them all they can get away with, being careful not to overdo them, and you will find by October 20 they will be shed pretty well. The drakes, of course, are in a separate yard, and can be fed more corn chop and about 10 per cent beef scrap after September 20.

"Suppose they have shed all their feathers, wings and tails, as they will by October 20, and their Winter quarters are all in shape, then comes the mating. To every five ducks put one drake; you can put 20 ducks and four drakes together safely, although I have seen good results when mated up to 150 in each yard. I find it to be a good plan to keep some extra drakes at the start and distribute them among the rest; then by keeping track of your yards you may find one or more yards that fail in fertility; a change of drakes will be all that is required. After mating them, a more substantial food can be fed, as follows: By measure, two parts bran, four parts middlings, two parts corn chop, four parts whole corn, four parts cut second crop clover, one part sand, one-half part oyster shell, 10 per cent of beef scrap (not counting clover). You will notice that they will not eat near so much of that feed as they do when fed the former, but it is a great egg output by increasing or diminishing the whole corn and beef scrap."

TURKEYS.—Many hen men and women have an ambition to keep a few turkeys. In northern New York or in some other localities turkey raising on a large scale is carried on with much success. The turkeys have a wide range, and on the clean, wind-swept hills are healthy and strong. In such places the business is often profitable, though blackhead and other diseases sometimes sweep off entire flocks. Rhode Island was once a famous turkey country, but blackhead has nearly ruined the business in that State. These large turkey raisers are often women, who seem specially adapted to handling these birds. They often give advice to beginners, and seem puzzled to find that there is any great trouble about making the little turks live. The fact is that until one gets the "instinct" turkey raising is the most hazardous kind of poultry culture, for the little things will persist in dying in spite of all your care. Our own experience as beginners may help others to start. The two most popular breeds of turkeys are Mammoth Bronze and White Holland. The Bourbon Red is popular in some parts of the West, and is highly

praised as a hardy, handsome bird of medium size. The Bronze turkeys are larger than the Whites, but we chose the latter because they are more domestic and do not roam away as the Bronze do. We have frequently had flocks of Bronze travel from distant points to visit our Whites, while the latter have never failed to remain at home. This is a good feature in a settled country where the farms are small, for in such situations the Bronze birds become a nuisance to the neighbors.

We bought a trio of birds—the gobbler not related to the hens. Our observation is that this a surer than to buy eggs, although it may seem a slow way to start with but two hens. The children were afraid the turkeys would freeze when they insisted on flying into the trees during the Winter, but it is their nature to prefer the outside of a house. We drove them inside during cold storms, though they went unwillingly. They were fed much the same as the hens, but they were cleaner about their food and drink. One reason why many fail with turkeys is because they will not keep the birds dry and clean.

Late in April we noticed the hens looking about in an uneasy way, and wandering further from the house. We had been told to let them find their own nests, but to tempt them if possible by leaving barrels and boxes with clean straw near the henhouse. This failed to tempt them, and we should not have found where they layed but for the gobbler who waited for and thus betrayed them. One hen climbed to the loft of the wood shed and began laying on a board. The eggs would have rolled off, but we put a box with straw on the board and put the eggs in it. The foolish bird came back, accepted the nest and kept on laying. We left the eggs there as they accumulated. The other hen went along the fence by the side of a tree and made her nest there in the open. We kept these eggs in the house until the hen began sitting and then they were all put under her. A box was fitted over the nest so as to give shelter. Between them these hens laid 24 eggs and hatched out 19 turks. One died at once. The other 18 were given to one of the turkeys. The other, after grieving a day or so, mated again and proceeded to lay another clutch of about a dozen eggs. The season was so wet and unpromising that we did not set these later eggs.

It is said that a young turk will die if it run against a wet blade of grass. They are remarkably tender, and wet weather usually melts them down. We were also told that they would die if kept in a coop. A neighbor had a good hatch, but the young birds died rapidly. They seemed to become tired with chasing the hen. In the morning they were dragged by the dew and fell behind, where they

were captured by cats or chilled. As the rain continued we put hen and turks in a large coop, and kept them there except at intervals when the sun came out. Then they had the run of a small yard. For feed they were given chopped boiled egg and dry bread crumbs with chopped onion. They had all they would eat clean of this four times a day, and plenty of fresh water frequently changed. A cake or biscuit made of horse feed (which on our farm is a ground mixture of cornmeal, oats and wheat bran) crumbled up fine was relished by the turks. The old hen was fed a quantity of cracked corn, and in a few weeks the little birds began to eat that also. Rain continued, and we were obliged to keep the turks confined in the coops until the latter part of June. We did not expect to save any of them, judging from the advice we received and the experience of neighbors who let the young birds run with the old hen through the wet grass, but out of the 18 put in the coop 15 were alive in July. When the weather turned dry we let them follow the old hen about the farm. Cats and vermin captured several, and others died from various causes, and we ended the season with five turkeys. This may seem like a poor record if we judged from the stories of parties who claim to raise every turkey, but actual experience as reported to us shows that the great number of persons who tried to raise turkeys on a small scale had a worse record even than we did. Some of them lost every bird, while others raised only one or two from a flock of three or four hens. Turkey raising evidently requires greater care than chicken culture, and it appears as if printed or spoken advice is of little help in learning how to raise the birds. Personal experience alone can show how to do it. We can do it much better another and drier season. In a general way it must be remembered that the young turkey is more tender than the average chicken. It is cleaner in its habits and requires clean food and pure water. The old hens do not show good judgment in caring for the turkeys, but will lead them through wet grass or upon long journeys where the little things are quickly tired. We should be careful to keep them in coops until the sun has thoroughly dried the grass and watch the hens carefully so that they will not wander too far away.

PIGEONS AND SQUABS.—We would not advise an amateur to expect to make any fortune or even a living at producing squabs. Probably as much money has been lost in the poultry business trying to make good on squab breeding as in any other department. The stories told of the great success of a few people are very plausible and have led many unfortunate men and women on to loss and disappointment. Our advice would be to start with a few

pairs of pigeons and not attempt to go into the business on a large scale unless experiments with a few pigeons indicate success. It is often a desirable thing to have a few pairs of pigeons on the farm, as squabs make delicate food for invalids and there is nothing better in some cases of sickness. In a town yard these squabs can be grown to advantage, but let no one expect to plunge into the business at once and make a fortune out of it. Almost any room that is fairly warm can be fixed up for pigeons. You must have a good roof, no cracks or holes in the sides and a building that is strictly rat proof. Rats will clean out the squabs if they ever get a taste of them and can get near them. Allow about 250 square feet of floor space for each 50 pairs of pigeons.

THE GUINEA FOWL.—There are two distinct varieties of Guineas, Pearl and White. There is no difference in their characteristics save in their color. The Pearl variety should be bluish-gray in color, each feather covered with white spots resembling pearls, hence its name. It should be free from any white feathers in any part of the plumage. The neck is covered with black hairs near the head, and between that and the feathers is a soft down, of a light brown color, that glistens in the sun. On the top of the head is a horny spike that turns backward. The bill and legs are brown. The White variety should be a pure white in plumage, with a yellow orange or yellowish-white bill and legs, this being the only difference between them and the Pearl variety. Some birds of the Pearl variety have white feathers in the breast and wings, but are mongrels, being a cross between the two varieties. They are great foragers, and will pick up enough bugs and injurious insects more than to pay for themselves. They do not stand confinement well, and will not lay more than one-half as many eggs as if allowed to run at large. If fed regularly morning and night they will always be on hand for their share. They desire to roost in trees near the barn at night, and are most excellent guards either night or day; anything out of the usual stir, they will set up a great cry. They roost so high that they are out of the way of thieves or wild animals. In their wild state they will fight and drive other fowls, but if used kindly as other poultry, they will stay and feed with other fowls without showing much of this pugnacious habit. The Guinea hen is a Spring and Summer layer, and lays from 90 to 120 eggs yearly. They like a secluded place to lay in. When their nests are found, leave two or three eggs, or they will leave the nest for another place. Better set their eggs under hens to hatch, as the Guinea does not sit until too late in this latitude to have the young get grown before Winter. Besides, if raised by common hens, they can be taken care

of better, for they must be fed often, as the young eat but little at a time. Fifteen to 17 eggs can be set under a good-sized hen, and with good care all can be raised. Their eggs are small, but make up in quality what is lost in size. Their meat is excellent, and has a gamy flavor. The cocks can be distinguished by their screeching noise, also by the spike on their heads being larger, and by holding their heads higher. Their ear tubes are larger, and generally curl in a sort of semi-circle toward the beak. The hens make a noise that sounds like "too quick," and seldom screech.

BANTAM BREEDING.—"Bantams need but little room, and little feed. They are very attractive and useful, not merely pets, as they are good layers of good-sized and rich eggs. I have used an incubator for hatching, but prefer hens. If I have Bantams that I can spare I use them, but usually common hens. If large hens are used their nests should be in a low box six inches deep, the nest made but little dishing, as the eggs will move more readily as the hen steps among them. For this reason the fewer eggs under a hen the better. The eggs are quite as likely to be fertile and hatch as any larger breeds. A box should be placed over the hen after she has been fed and watered each day. This not only secures her from being disturbed, but prevents her from coming off many times a day, as some will, each time endangering the eggs. I do not find the chicks quite as hardy or as easy to raise as larger breeds until feathered. They feather so young and fast that they need good feed and care at this time. For a few days when first hatched, hard-boiled eggs and bread crumbs chopped fine are best for them; later cracked wheat, millet and ground beef scraps, and some whole grain. For head and throat lice and around the little cluster of feathers in front of the vent use a little grease. Fresh butter is good; sweet cream is still better, and will not injure if used liberally on turkeys or chickens. This will do little good, however, if the hen has lice. This season I have taken a feather, and with a liquid lice killer touched the hen under and above in many places. If this is done in the morning when the chicks are a few days old, and the hen in an open coop, so the chicks can get plenty of air, it will not hurt them, but will rid both hen and chicks of lice for a long time."

CHAPTER XIX.

A BIG FAMILY OF ROASTERS.

One of the most successful poultry men in the country is Henry D. Smith, of Massachusetts. Mr. Smith makes a specialty of raising roasters, which are young birds large enough to stuff and roast. He started in a very modest way and slowly increased his business until he turned off from 5,000 to 7,000 roasters each year. This required 400 hens, and Mr. Smith made the statement publicly that one man could do all the work provided he had everything fixed properly. When we asked him how this was possible he made the following statement. The incubators have a capacity of about 3,000 eggs and the brooder houses will accommodate from 2,500 to 3,000 little chicks. Of these about 1,800 will live to a size large enough to enable them to go out to colony houses, which are 6x8 feet and which will hold 50 chicks. Each house has a feed hopper, a box for scraps, another for grit and shells and a water vessel. Here is Mr. Smith's programme:

"Allowing that we have saved a few cases of July eggs we will now lay out the work for a year, beginning August 1. Get up in the morning at six o'clock, feed the horse and the hens and turn the eggs in the incubators before breakfast is ready. Feeding the hens is done by taking sufficient grain in a bag on your shoulder and going through one house of six pens and back through another of the same size, and scattering said grain in the litter; then take another bag with a dry mash and go through again, and put the necessary amount in boxes provided for the purpose; time for both trips 25 minutes; then turn the eggs, which will take from two to three minutes to each machine. Eight machines will be sufficient at the most, and they will not all be running all of the time. The eggs will have to be tested twice to each hatch, time one hour, and another hour will carry out a hatch of chickens and reset the machine, which takes two hours to each machine, setting every three weeks. Clean out the horse stall and curry the horse, when breakfast should be ready. The water barrel should be placed in the farm wagon and a hose led to it from the water system and allowed to fill while some of the above chores were being done, so that after breakfast, say from 7.45 to eight o'clock, you harness

into the farm wagon, and after putting on what grain, scraps, grit and shells you will need, start for the colony houses, which have got your 400 pullets and several cockerels for the coming season. The barrel being fitted with a two-inch molasses faucet it does not take long to rinse out the water bucket (using a little broom-corn brush), fill it and replace; then put in some grain, scraps, grit and shells, where necessary. Speak to the horse and pass to the next house and repeat, finishing each house on the one trip, and this job will be all done by nine o'clock. This leaves three hours before dinner and the only chore at noon is to feed the horse. At 4.30 to five o'clock you will go through the hen houses again with one bag of grain only, and pick up the eggs, feed the horse, turn the eggs and fill and trim the incubator lamps. I can turn the eggs and take care of the lamps to the eight machines in less than 30 minutes, so that you will be ready for supper before six o'clock, and this makes not over 10 hours of actual labor per day. The above arrangement leaves six hours per day for the next three weeks, in which time you can clean out the brooder houses if you have not already done so, spread on the grass land and fill up again with fresh sand. This will take four days, and allowing for a few stormy days there will be ample time to clean out and fill all of the empty colony houses before the brooder will have to be started, also to clean off the droppings boards once a week and spray the roosts, and give the hens some green stuff at least twice a week.

"Now we will start one of the brooder houses and bring what chicks you have hatched, and until you have more than one house will hold, there will only be one fire to attend to, and the pens, as fast as you are able to fill them with chicks. We will have the grain room between the two brooders and to feed will take a bucket of mixed grains and a small scoop; walk right along throwing the proper amount according to age, number, etc., all over the pen, and coming back pick up the dead ones, then take another bucket of dry mash and scraps. Keep moving right along, throwing this on to the feed board placed on the floor just beyond the pipes, so the feed can be put on it easily. Then take a bag of cut clover and go up through the pens, this time putting a little in each pen, and opening the slides for the chicks to go out of doors on the same trip. If your partitions are too high to walk over you will have to have self-closing gates. You will remember that these are all watered automatically, so that this takes care of the brooder in the morning excepting shaking down the fire and putting on some coal, and 20 minutes will take care as above of both brooder

houses, 2,500 to 3,000 chicks, with no worry about the heat. After all of the morning chores are done, say about 9.30, come back to brooder and give the little chicks less than two weeks old a little grain to scratch for, and sift your ashes, putting the screenings back into the heater; time 15 minutes. You now have two hours before it is time to feed the two kinds of grain again and fix the fire at noon, and there are three hours in the afternoon before beginning the night chores, with the exception of about five minutes at 2.30 to feed those smallest chicks, and about twice a week give them a little grit and charcoal in boxes for the purpose within reach of the walk. Clean out under the pipes about three times while the chicks are in the brooder, time two hours each time, and then have a thorough cleaning between each lot; time refilling and all 20 hours.

“PREPARING FOR WINTER—The above figures are based on both brooder houses being full, the work in the incubator cellar begins to decrease and finally stops by October 15, so that there will be nearly five hours daily on the average in which to clean out and fill up the balance of the colony houses, clean and refill the henhouses, whitewash (with a spray pump) and make the necessary repairs for Winter, and haul into the barn cellar or some suitable place 30 to 40 loads of sand to be used here and there during the Winter. During the past month or so you have been selling off the old hens as fast as they stop laying, and crowding together the remaining ones, so as to empty the pens as fast as possible, and as soon as ready pick your most forward pullets and put into these pens. As soon as the incubators are set that are required to fill the brooders, sell off all of the old hens and put in the remainder of the pullets as soon as you can. Then as soon as the chicks in the brooder are feathered out enough, say eight to nine weeks old, they go out to the colony houses and as soon as you see that one of the brooders will be empty, cleaned out and refilled, in three weeks you start up the incubators again, this time on the pullets' eggs, throwing out the small ones.

“We will now begin November with practically all of the odd jobs cleaned up. The incubators are getting started again as fast as the pullets furnish the eggs, and the youngest chickens in the brooder are about to pass the delicate age, so that three times daily is all the care the brooder needs, which can be done in 20 minutes each time. The work in the brooder now decreases about as fast as it increases in the incubator house, and the care of the horse and hens remains about the same the year round, but the work in the colony houses is gradually increasing all the time, for

by the last of November you will have nearly all of the first lot of chickens (say 1,800 to 2,500) out in the colony houses, which means about $1\frac{1}{2}$ hour as soon as you can get to it. The morning chores will now take until about 10 o'clock, and 20 minutes at noon, with $1\frac{1}{2}$ hour at night, will leave about four hours per day to do the regular chores, and this gives for the whole month about 100 hours, in which time is done the testing, carrying the chicks to brooder, setting machine, cleaning off droppings boards, cleaning out brooders, refilling with sand from the cellar, etc. The work for December is practically the same as November, with the exception of the caponizing. By the first of January the brooder house will be nearly full again, if not quite, with the incubators about stopped, so that in January while there is a little more work in the brooder there is less in the incubator house. The regular amount of work remains about the same until more chickens go out to the colony houses, and during February and the first of March the remainder of the colony houses will be full, and as they fill the brooder grows empty, and will take another hour per day for the regular work, leaving only three hours per day for the odd jobs. In the meantime the incubators have started again for the last time. By the first of March the oldest pullets will begin to lay and must be sold, and the second lot must be caponized. The brooder is being filled for the last time, so that by April 1 the incubators are all done. The brooder house is full, as well as the colony houses, but we will now gladly devote two or three hours per week to selling off the oldest birds as fast as they get "ripe." As soon as any of the colony houses are empty they are cleaned out thoroughly and refilled again with chicks from the brooder house.

"VACATION TIME.—By the middle of May the brooder house is empty and the regular chores begin to decrease, and some time in June the caponizing will be done, leaving just the hens and colony houses to see to, and the money to take in. The brooder houses may now be thoroughly cleaned and refilled ready for the next season, and there will be many an hour between now and August 1 to lie in the shade and make short pleasure trips, or get a neighbor to do the few chores and stay away awhile. The number of chickens raised for the 13 years that we have been here is about as follows: 700, 1,000, 1,200, 1,500, 2,000, 2,500, 3,000, 4,200, 3,200, 4,200, 5,000, 5,100 and 5,200, and I have 3,400 on hand now (January 25). I hope and expect to get a good 2,000 more before this season is gone."

CHAPTER XX.

ALL SORTS OF HEN METHODS.

We have said that a true hen man can take any breed and evolve the business hen. That is correct, and he will do it by studying the hen and adapting her whims and needs to his conditions. There are hundreds of ways of keeping hens. The methods may differ, but the foundation principles are the same, viz., selecting a good hen and keeping her clean, healthy, contented and well fed. That is the entire story. The majority of hen failures are due to a violation of one of these principles. Sometimes it is the hen. People will persist in breeding from birds which they know do not lay well and which have been lazy scrubs for generations. The flock is inbred year after year with no effort to select the best. The result is what you might expect from selecting small seed potatoes from the pile year after year. It is now known that most of the small potatoes are all grown by certain definite hills. If you keep planting these small potatoes you will grow more small ones, because that is the habit and destiny of such tubers. When you pick the seed out of the pile where all have been thrown together you never know what you are getting, but the chances favor the poorest selection you could make. When you select the best hills in the field, and use that seed, you know what you have, and are breeding for improvement. It is just the same with hens. A man who wants to improve his birds should get an ideal hen in his mind and hunt through his flock for it. Pick out the hens which come up to this ideal, and use them for breeders with the best male bird you can afford. There is not a farm in this country where such practice could not be followed out, or where it would not pay better than any ordinary farm operation. Mr. Geo. A. Cosgrove gives sound advice to a would-be farmer, but he does not tell us how he worked out this theory with such success. Mr. Cosgrove took Wyandottes and followed the plan outlined above, selecting the hens which came nearest his standard of what a business Wyandotte ought to be. As a result he finally produced a bird which attracted attention—first at home, then through the State, and finally throughout the country. The same thing can be done with any breed, or one can start with a flock of common barnyard scrubs and by selection and good breeding turn out a uniform flock of hens that will pay twice the profit the old ones did.

But unless this superior hen is healthy and contented she will not pay. Contentment in a hen is not based on any intellectual experience but on comfort, cleanliness and good food. Some people have a curious idea of what a "clean" henhouse is. Lice are responsible for more failures with hens than those who make the failures will admit. The man who can stay by a lousy henhouse until it is actually clean deserves to succeed and usually will. The insects are small and the cracks are large, and every hair's breadth must be covered. On a fruit farm where lime-sulphur is used for killing the scale a hen man can hardly do better than soak the inside of the henhouses with this odorous mess. The profit on some hen farms is largely eaten up by the young roosters when they are permitted to run at large with the flock. These birds become a great nuisance. They should be separated as soon as possible, shut up and fattened rapidly and sold. Let them all go except the few needed for breeders. As for feeding, probably the greatest mistake is made in the Fall just after cold weather starts in. At this time the hens seldom lay, and are profitless. They are also deprived of most of the insects and green food which make a good share of their food as they range about. With both pullets and old hens there will be a "drought" of eggs for at least 60 or 75 days. No profit can be expected at this time, yet these hens should be full fed in the most careful manner—just as an athlete should be fed on strong food through the weeks of his training. These hens will never pay if they are scrimped in their food during the Fall and early Winter, yet the temptation is great to neglect them then; in fact, this is one of the hardest things for the beginner to learn. It will help to have a good flock of old hens and fat young roosters to sell at this time. With money coming in at this season it is not quite so hard to pay money out for feeding the idle hens. During the Summer the idle hens may be left on a ration that will merely keep them going, but when the Fall comes and they go into their houses stuff them with good food. These principles are understood by all successful hen men, and it is interesting to see how they are applied under different condition.

A hen man in New Jersey has a small place on which he grows vegetables and fruit. There is not enough land to follow the colony plan of having small houses scattered over a large field, so he follows a sort of hen soiling system. The hens are kept in small flocks of a dozen or more—each flock in a small house with a light yard of wire fence panels attached. No food is put inside the house or yard, but in dishes outside—the hens putting their heads through the fence to eat and drink. Every day or two the house and coop are pulled on to fresh ground—usually sod. In this way the hens are always on

clean ground and always have good pasture. Many coops can be kept on an acre, and the manure is deposited evenly over the field. Of course the labor of changing the coops must be considered, but this plan is well suited to a small farm where the land is needed for fruit or vegetables. You can easily see how such a system would fit the land for a crop. The hens will tear up weeds, burrow in the soil and leave the manure behind them. They are clean and contented.

So they are in a California fruit orchard where much the same plan is followed. In this case the houses and yards are on runners, and are just about long enough to stretch from tree to tree in the rows. After standing for a few days in one place they are hauled one row ahead or back as desired by hitching a horse to the house. Thus they travel back and forth through the orchard, working the soil and leaving the manure near the trees. The orchard mentioned is well filled with these movable houses, and the hens give a good income and take good care of the trees. If such an orchard can be seeded to rape and Crimson clover the hens will get one-third of their living from such a green crop.

In great contrast with this is the way a farmer in North Dakota winters his hens. In this cold country the hen cannot be contented unless she be kept warm, and lumber may be too expensive to make the business henhouse profitable. So this farmer puts up a framework of poles and throws straw around and over it. Straw has no commercial value out there, and it can be piled on four feet thick if necessary. A door and windows are put in, and the hens are literally stacked up against Winter in comfortable quarters. Such hens when well fed and watered do well inside their straw houses, and imagine that Summer has come in February. These stack houses are also often made for cattle. The cows have the advantage of the hens in the fact that they can and do turn in and eat up their own house of straw. The hens cannot do this, and if they leave the house well filled with vermin it is an easy matter in that country to burn down the old house and build another like it the next season.

Something of the same plan is followed by a farmer in Virginia, near the opening to Chesapeake Bay. In this mild climate the hens may run out all Winter. Crimson clover is seeded in late Summer to serve as pasture for them. Little houses like army tents are made by driving in poles and heaping hay or straw over them. The hens live in these little houses and range on the clover, obtaining a good share of their living from it, and giving a good supply of Winter eggs at low cost. The reverse of this plan was followed for some years by Mr. Hayward, of New Hampshire. He also had little

tent-like houses, but his were well made of lumber, with solid back, but a wire screen front. Pullets were put into these little houses in the late Fall and kept there without removal or range for about a year, when they were taken out and sold as hens to make room for a new supply of pullets. Mr. Hayward did not hatch any stock himself, but bought young birds in northern Vermont and brought them to his farm. He kept 5,000 or more of these hens, and made a good profit—buying all the grain and putting the hen manure on an apple orchard. The contrast between this plan of close confinement and the Virginia plan of free range on green clover is great, and shows how the business hen can be adapted to almost any conditions.

This plan of close confinement is the principle employed in the so-called Philo system. The idea is to hatch the chicks in the ordinary way and raise them in a "heatless brooder;" that is, a box so padded and protected that little if any heat will escape. Gentle ventilation is provided, so that the animal heat of the chicks is retained, and this is sufficient to keep them warm. Under Philo's "system" the birds are kept closely confined after they graduate from this heatless brooder. They are supposed to pass their entire life in a cabinet somewhat smaller than a piano box. Those we have seen in their narrow quarters were of good size, but seemed listless and dull. The plan might work with a few hens in a back yard, but we do not consider it adapted for really business hen keeping. The so-called "Corning" system is largely adapted from the excellent methods worked out at the Maine Experiment Station. The hens are crowded close together in the houses, but are kept clean and given good food and care. As one visitor remarked, "The hens are packed so close that they seem to be piled up in heaps." It is a special method of forcing hens to high production, but it remains to be seen whether this heavy forcing will give chicks strong enough to keep up the vigor of the stock. The egg yield is said to be heavy, and high prices are obtained, in some cases 60 cents or more per dozen for table eggs. It is claimed that with these high prices the hens give a profit of over \$6 each. While such "systems" are interesting as showing the possibilities of poultry keeping, it is a mistake to present them as if anyone could follow out the plan and obtain similar results. That is impossible—as much so as it would be for an average man to take the place of a great lawyer before a jury, or for an untrained clerk to step right into a blacksmith's shop and shoe a horse. Let it be clearly understood that these various "systems" all have some merit, but that the chief reason why they are talked about is not to benefit mankind, but to sell the "secret" con-

nected with the system, and usually this secret has been talked for years. A very good statement of many principles of the Corning system is given in Dr. Burr's story of large henhouse in Chapter 17.

Some of the English farmers have a modification of the colony system. They mount small poultry houses on wheels and haul them from place to place in the grain fields. The hens pick up the scattered grain and come back to the wagon houses to lay and to drink. In this way the fields are well gleaned and a good supply of eggs obtained. We have heard of a man who sailed down the Mississippi River on a flatboat with an outfit of bees and ducks. The bees hunted honey all the way along, while the ducks made their home on the boat and got nearly their entire living as they went along. In other cases vessels on the ocean have carried hens in coops somewhat like those built for the Philo "system," and had a supply of fresh eggs for the entire voyage. Another strange experience was that of a man who carried an outfit of baby chicks to Florida in the early Fall. His theory was that these little chicks could be forced so as to provide good-sized broilers for the great hotels, which do an enormous business during the Winter. The scheme did not work properly, for during the short Winter days the baby chicks did not grow as was expected. It would seem as if Florida would furnish a wonderful opportunity for the business hen. The State is thronged every Winter with thousands of visitors literally shaking money and calling for good things to eat. And yet most of the chickens and eggs served to them come out of cold storage houses at the North. In Florida a remarkable remedy for hawks is advocated. Chickens are fed strychnine in their food, or the poison is pasted on their heads. The theory is that this poison will not kill the chickens, while it *will* destroy the hawks. The belief in this remedy is quite general throughout the State. The explanation is a theory that both the animals and plant are natives of India, and probably the animals become wonted to it before they were domesticated. No doubt the younger animals would be more immune than older ones.

The "colony plan" has been worked out with variations in all the corners of the country. In New England are several large farms where the hens practically wait on themselves. The feed is kept in hoppers—either in the form of dry mash or with the different grains in separate bins. There is usually a brook or pond where the hens range, and in Winter they often depend on snow for their water supply. Some experiments have been tried in keeping hens in small tents during the Winter—with grain fed in hoppers and snow to "drink." This would not suit the large-combed breeds like the Leghorns, but the warmer clad breeds with small combs like R. I.

Reds or Brahmas actually keep good natured under such treatment and lay eggs. In fact we think the great supply of market eggs in the future will come from these large "hen ranches." These will not produce the expensive Winter eggs, but *will* send out great quantities of Summer eggs which can be held in cold storage or preserved in water glass. Considering the low cost of production when things are fixed so one man can care for over 1,000 hens, there is profit in producing Summer eggs on the colony plan. The latest scheme is to raise the chicks in scattered brooder houses, separate out the roosters early, and then by changing the inside fixtures to use the house for wintering the pullets.

The increased use of the colony plan or range system has increased the peculiar disease known as "limberneck," which is described under the chapter on diseases. At one time the greater number of our questions referred to colds or bowel troubles—now they deal with blindness or the nervous trouble called "limberneck." The chief cause is eating putrid meat, and this the hens pick up on the range. It may be some dead fowl or the carcass of some vermin which they eat, but there is evidently serious trouble from it. All such carcasses should be buried at once. Do not let them stay near the yards and houses. We put them in deep holes by the side of fruit trees or vines. It is a mistake to throw them on the manure pile where the hens and other animals can get at them.

There are still many places where large flocks of hens are kept in one house. In some cases such are very successful, but the general tendency is to break up the flocks and separate them into smaller houses. The liability to diseases is greater when the hens are crowded in close quarters, and the sick hen must be attended to at once. She will show her condition in various ways, but when a hen drops her feathers, puts her head down and mopes about it is time to attend to her. Get her away from the rest at once. We have a small room known as the hen hospital, where such sick hens are taken. A barrel with clean straw at the bottom is a good hospital bed for a hen. She must be kept warm and dry, and in many cases a few days of "rest" with food and some tonic like "Douglas Mixture" in the water will revive her. Read the chapter on "Diseases" and treat the hen as directed, but it seldom pays to try to dose an ordinary hen. She is hardly worth it, and nine times out of 10 if well fed and free from lice and permitted to keep dry she will not "mope" or drop her feathers.

It cannot be repeated too often that in all these different methods one of the hardest battles is that against vermin. We are often asked *how* to destroy lice on the living hen. Mr. Cosgrove mentions

one method, but it is often necessary to sift the hen's feathers full of powder. A good powder for this purpose is described under "Diseases." We hold the hen up by one leg and sift the powder among her feathers by dusting it out of a pepper box or from a tin can with holes punched through the top with a small nail. In some cases the hens are put into a box hung like a revolving churn. A handful of the powder is put in with them and the box turned over and over. The hens flutter and are well dusted. Head lice are harder to kill, and they often torture the chicks. A mixture of sulphur and lard will get them.

Another question often asked about all these systems is how to prevent loss from chicken thieves. This is a serious problem in many localities near a large town or close to a well-travelled road. In some cases electric alarms are connected with all doors and windows, but these do not always work, and a bright thief can cut the wires. A good dog is the best protection. He should be trained to sleep by day and watch by night, and given full swing of the premises. The doors of the yards should be built to swing on a weight so the dog can make his way anywhere. The right kind of a dog will prove a genuine uncle to the business hen. He should not be permitted to make friends with everyone. A dog with a dash of bull or bloodhound blood will be better than some good-natured breed. A poultry keeper in New York had such a dog with a cross of Cuban bloodhound. This terrible animal was respected by every chicken thief within 20 miles. Another man kept a large, good-natured dog as chicken guard. Thieves stole the dog, carried him away and "got acquainted with him." When he came home his master thought he would guard as before; but when the thieves came back he welcomed them as friends.

CHAPTER XXI.

ODDS AND ENDS.

In thickly settled regions there is often great loss from cats. Many so-called pet cats are little better than wild animals and unless they are carefully watched they will do great damage to the young chickens. A good shotgun and a marksman will do much to get rid of these marauders, but it will usually make great trouble with the neighbors if cats are killed in this way, because most people will not admit that their pets would ever kill a chicken. We have found it an excellent plan to cover the runs where the chickens are confined with twine netting such as is used by fishermen. This is cheaper than wire netting, lighter and easier to handle and can be taken down with ease when the chickens are large enough and packed away for the next season's use. These nets are also a good protection from hawks and a large pen can be protected in this way at reasonable cost.

The poultryman must understand that dampness will be death to his flock. He must try above all things to give the hen a dry place in which she can scratch and dust, for a damp cold house will be sure to bring on cases of rheumatism or colds. Special pains should be taken to have the floor of the house well drained. In case a dirt floor is used ditches should be dug around the house and filled with stones. We know of one case where even this precaution did not prevent damp floors as there was a heavy drip from the eaves all along the house. This was overcome by running a trough along the eaves so as to carry the water away to the end of the house. This made all the difference between dampness and dry floor.

It is now generally agreed by poultrymen that where fowls are feeding heavily on a mixture of food an ample supply of charcoal is necessary. We have tried the experiment again and again of taking the charcoal away from the hens and we are thoroughly satisfied that it is a necessity if we would have best results, especially in

Winter. When the hens are housed, we would keep the charcoal constantly before them where they may help themselves to it from a hopper and they will show that it is a necessity by the way they clean it up.

The trouble from egg eating often becomes a nuisance, especially where hens are kept in close confinement. The poultryman sometimes finds the habit firmly fixed before he is aware of it. We have found that some birds are confirmed egg-eaters. They are smarter than the rest and know how to break the shell and get at the contents. We have seen them wait until the egg was laid and then deliberately break the egg and set the example of eating it. We should never attempt to tarry with these hens, but kill and eat them at once. They are a nuisance in the flock and cannot well be cured. Various plans are suggested for handling them, such as cutting off the end of the beak so that they cannot strike the egg without hurting themselves or of blowing out the contents of the egg and filling it with a mixture of red pepper or some bitter substance. The theory of this is that the hen will break such an egg, get one taste of it and certainly conclude that she never did like eggs any way. This is a pretty theory but will not work in practice. We advise killing the confirmed egg-eaters, feeding an increased supply of meat and grain food, making the hens work for their grain and arranging the nest so that the eggs must be laid in the dark.

Hens sometimes become cannibals. Little chickens sometimes turn upon one member of the flock, chase it about, peck it to death, and then deliberately consume the body. We have known this to happen in a number of cases. Full grown birds will in the same way sometimes turn upon one of their members and peck it to death. This trouble is generally started by some bruise or injury on the victim. The blood starts and the other fowls peck at it curiously and get a taste. If they have not been properly fed with meat food this taste of blood appears to craze them and they will chase the afflicted fowl about pecking at it, opening the wound and weakening it until it dies. The best remedy is to feed meat and take the wounded bird out of the flock as soon as found.

We are frequently asked what substance is best for use in the dust boxes. The hen must have a chance to dust herself through the Winter, for this is her method of taking a bath and she will not get along well without it. A dry dirt floor raised above the

surrounding ground so that dampness will not rise to the surface will give the hen her choice, but it often happens that on concrete or board floors dust boxes must be provided properly. Sifted coal ashes will do as well as anything. The cinders should be sifted out and the dry fine powder used. Do not use wood ashes. They contain lime and will take the gloss off the plumage. A mixture of coal ashes and floats or ground phosphate rock will make a very good dust for the birds. Road dust taken up from the road during a drought will work well. Coal ashes are also excellent for use under the droppings board; they do not contain lime and will not drive the ammonia away.

It frequently happens that all through the Summer as the chicks grow up a number of them lose all their feathers and go about naked except for a few wing feathers. We are frequently asked the cause for this trouble. Most poultrymen have observed it. It appears to be characteristic of some of the heavier breeds like the American breeds or the Asiatics and various reasons have been given for it. It is probably due more than anything else to a lack of bodily vigor or ability to assimilate the food properly. Now and then these naked chickens grow and clothe themselves properly before the Winter, but as a rule they suffer when cold weather comes and are not likely to thrive. As a matter of business it will hardly pay to keep them.

The hen keeper must not only use his eyes but be trained to use his ears as well, for he must be quick to distinguish the characteristic rattle or sound of roup. During the season when roup is dangerous it will pay a hen man to go slowly at night after the hens are on the roost and listen carefully for this roup cry or sound. Practice will enable him to distinguish it and whenever it is detected his best plan is to take the afflicted bird out at once for treatment. It is folly to let her remain in the house, also with the little chicks. The hen man soon comes to know from the sound which the chickens make whether they are happy or ailing. In fact the chicken is like a baby in making its wants known. We know of a case where a man who was succeeding well as a hen man found that he was losing his hearing and he quickly realized what a loss this would be to him because he had come to depend upon his ears in detecting disease or lack of food. His wife and children came to the rescue and went with him at night listening to the hens and chickens and acting as ears for him. In this way he was able to detect disease in spite of his defective hearing. This

picking out ailing hens or chickens before disease has a hard grip on them is one of the tricks of the trade.

Every poultryman should keep a medicine chest. While we do not approve of drugs or of dosing hens continually, there are a few remedies which a good poultryman will always keep on hand. The chapter on diseases gives simple methods of handling disease, but in the medicine chest we would recommend the following. First of all a sharp little ax and the inclination to use it even upon your best hens when they become afflicted with an incurable disease. After all the ax is the best agent for the help of the flock. Then keep a good quantity of vaseline. It is excellent for frozen combs, wounds, and many other things noted in the disease chapter. The Douglas mixture as is noted in that chapter is made by dissolving one-half pound sulphate of iron in a gallon of water and adding one ounce sulphuric acid. The clear liquid is used in the proportion of one pint to a pail of water, and is one of the best tonics to be used. Also keep a package of ginger and a package of red pepper. In many cases small quantities of this in the mash will act as a stimulant and help the hens. Charcoal would hardly be called a medicine. We regard it more as a food and you will need more than you can get in the medicine chest. Fair quantities of chlorate of potash and permanganate of potash are useful and are mentioned elsewhere. A bottle of peroxide of hydrogen is very useful to apply to wounds and stop the flow of blood. There should also be a quantity of tincture of iron. Kerosene will of course be on hand for the brooders and incubators and a quantity of carbolic acid and gasoline with plaster of paris to be used in making lice powder, which is described elsewhere.

The meat supply for the poultry flock often presents something of a problem. Beef scraps are excellent, but they are high priced and they will not keep properly for a long time. Many farmers can obtain through the Winter various carcasses of horses, cows or similar animals and they are able to grind or chop them up with great benefit to the hen. During Winter when the weather is cold the disposition of these carcasses is not difficult. We have known cases where large chunks of the meat were hung up attached to a string in the henhouse so that the hens were obliged to jump up and peck at the meat, after the plan in which cabbage is usually fed. This gave the hen exercise and it was surprising to see how they polished off the bones. In many cases the carcasses are chopped up and packed away in ice or snow, using barrels or boxes for the

package. In this frozen condition they will keep until late Spring and are fed as above described, run through a bone cutter or cooked in kettles. We have heard of cases where such meat kept reasonably well even in warm weather by packing it as soon as the carcasses were cut up in layers of ground limestone. We do not mean the burned lime, but the limestone crushed without the burning. With the meat entirely surrounded with this limestone it remains sweet for a long time. Charcoal will keep the meat for a reasonable time, but it makes it dirty and dries it out considerably. Where there is a cooker on the place, the meat can be thoroughly boiled and jammed down into airtight packages of stone or wood packed in solidly. It is done in much the same way that sausages are kept in the country. Such meat can be kept for several weeks at least. Where one is keeping a large flock the plan of utilizing such carcasses in Winter is a good one whenever the animals are not diseased but are killed, as many are, when they are too old for work or when they meet with some accident. Some years ago we gave an old mare to a poultryman who was to kill her humanely and feed the meat to his hens. A month later we found that the horse was still alive. She had been put in one end of a house and acted as a stove, her bodily heat keeping up the temperature. As the hen man put it, "A hen would get cold feet, fly on to old Katie's back, warm her feet and then go and lay another egg."

One of the most annoying things in poultry keeping is to have a supply of rats with access to the feed house. It is often much cheaper to buy a large supply of grain in the Fall, keep it and feed it out through the Winter, but whenever this is done great care must be taken to keep the feed dry and away from the rats. It is often possible to save from 10 to 20 cents per hundred in buying at the right time. If, however, the feed house is not rat proof you will more than lose the money saved on the feed. All feed houses of this kind should be raised above the ground from 18 inches to two feet at least and are better when perched upon cement posts. Let the timber be put directly upon these posts, and, in order to make doubly sure that the rats shall not enter, an inverted tin pan may be placed at the top of the posts. Then proceed to build in the ordinary way, making the steps of the door movable, and never leave them against the building, except when some one is in the house. Never under any circumstances permit piles of rubbish to be placed anywhere near the building. Otherwise the rats will run to the top of these piles and jump from

them into the house. They can only enter by crawling up the sides of the posts, getting in through the steps or jumping from a pile of rubbish. As we have stated they cannot climb the cement posts, and if they are of wood the inverted pans will turn them back. If you forget and leave the movable steps in place over night the chances are that your house will be over-run by rats and that you will lose a fair share of your grain.

A sheep kept in a henhouse has been found useful in keeping down the supply of vermin. It is stated that the hens and roosts were freer from lice when the sheep was on hand. The wool of the sheep is oily and oil is death to lice. There seems to be no better explanation of it.

Every poultry keeper should know how to make the lime-sulphur wash. It is the great medicine for trees and will kill all the lice it can reach. Take 40 pounds of stone lime, 20 pounds of sulphur and five pounds caustic soda for 60 gallons of water, or smaller proportions for less water. Slake the lime by pouring water over it. Make a thin paste of the sulphur and pour it in while the lime is slaking. Keep stirring. Dissolve the caustic soda in water, pour into the lime water and keep stirring. It will make a reddish brown liquid which may burn the fingers and eyes—but it will kill the lice.

People who live in town often keep a small flock of hens and some of them make great records. We find the larger breeds better for this back-yard work and from choice would take Light Brahmas. Good strains of this breed will lay well if properly handled, and they stand confinement well. The hens are good sitters and the chicks grow rapidly into a large carcass. R. I. Reds, Wyandottes and Plymouth Rocks are all good for the back yard. We would rather give such active breeds as Leghorns a chance for more range and a larger yard. Some people keep a dozen hens in a piano box with great success, but it is not safe to figure that because a dozen hens pay a large profit each 2,000 will do equally well. Mr. S. D. Hainley, of Pennsylvania, wrote us that he made his hens pay a profit of \$4.68 each. When asked for the figures he gives them. They are correct, but you must remember that Mr. Hainley is one of the men who are "half hen." His estimate of the value of good hen manure is right, if you have a good garden of vegetables or fruit.

"You ask me how I made \$4.68 a year per hen and what kind they were? About the best way I can explain that is to give you

the account for that year, which was 1905, when I had 12 hens. In January they laid 194 eggs which sold for \$5.66. February they only laid 126, for it was a very cold, stormy month all through. Cold, stormy weather affects all live stock (human included). It seems more severe on fowls for they do not have the body to hold the animal heat to keep them warm. If we do not protect them they will fall off in the egg production, and as I have not the time nor inclination to do this, my chickens go without it. But these 126 eggs sold for \$3.67. In March they laid 267, sold for \$6.70; April, 188, sold for \$3.92; May, 150, sold for \$2.75; June, 98, sold for \$1.64; July, 126, sold for \$2.10; August, 54, sold for 90 cents; September, 30, sold for 62 cents; October, 31, sold for 64 cents; November, 42, sold for \$1.05; December, 72, sold for \$1.80. About the first of July I sold five hens so that left me seven to lay the rest of the year. I set 76 eggs and hatched out 55. You may think that was poor hatching, and it certainly was, for I had six hens sitting on these eggs and there was one old thing that went from one nest to another and would fight the other hens off and break the eggs. From these 55 chicks I raised 48. A rat took the other seven when they were three weeks old. The way I feed is to have a deep litter in which I scatter all the grain they get, which is corn, oats, buckwheat, and at the present time I have wheat screenings. This is fed at night, and as soon as they get off the roost they go to work. Whatever they get they have to work for, for I have to work for everything I get and I am going to apply that rule to everything on the place, for I believe that work is the best cure for most ailments. I have not had a sick chicken on the place for five years, for they have to hustle for a living and that gives them a good hardy constitution. The chicks when hatched are rugged and they start in to scratch for a living, for they get no soft feed, no mashes for me. The chicks have a grist mill of their own and nature does not supply feed of this kind. I know it will make those fowls grow 'faster that are bred to it, but I believe it weakens the digestion and they grow soft and weak so that they cannot put up a successful struggle against the many diseases that attack them. I like to give them all the green food I can, such as small potatoes (raw), beets, cabbage and anything bulky and green that they will eat. I also have a green bone cutter and they get bone three times a week in Summer or when I can get it fresh, and in the Winter it is before them about all the time. These 48 chicks with what stock I sold in Fall brought me \$31.43; eggs, \$33.45; total, \$64.93. Eggs set were worth \$1.58; feed, \$10.76. Dr. Burr says that the droppings are worth 30 cents a head per year, \$3.60; that would give me a grand total of \$68.53; less

eggs and feed, \$56.19, leaves an average of \$4.68 $\frac{1}{4}$ a year. This is an average of 138 eggs per year. A dozen of these eggs weighed 29 ounces. These chickens are Barred and White P. Rocks. All stock and eggs are sold at market price. I never received over 35 cents for a dozen of eggs and not over 15 cents a pound for stock. You may think that was an off year, but in 1907 a larger flock paid me a net profit of \$4.77 $\frac{1}{4}$ each. This year I cannot count them before they are hatched, but I am going to try to make them pay me \$5 apiece. But when I look at the price of feed, corn \$1.10, oats 70 cents, wheat screenings \$1.15 per bushel, it makes me smile but it will show what is in me."

To show how hens may sometimes be left to take care of themselves, we give the following little statement from Massachusetts. We have had many statements from clerks and mechanics who worked long hours and in Winter could only look after the hens at night and morning. Yet by arranging their work systematically they made the hens lay and developed a fine flock. In several such cases these men were finally able to give up their town work and make a good living from the flock which they developed from a few hens.

"I began 1907 with three mongrel old hens and 16 purebred R. I. Red pullets. I could give the fowls no attention except at the two ends of the day and on Sundays and holidays, for I worked all day in the city, nine miles away; so they got no care by daylight during the short Winter days. Before leaving for work each morning in Winter there was the following hen work to see to: Open up the henhouse, raise the window curtain and adjust the ventilator, fork over the scratching litter, adding to it a little hay or dry leaves, together with such grain as would tempt the hens to scratch, replenish the feed hopper, give the hens some green food such as a turnip, beet or cabbage to peck at, fill the drinking pail with warm water, and leave hot mash in the feed pan. This mash consisted of table scraps and meal, shorts, middlings and ground oats, with beef scraps or animal meal added, and the whole seasoned with a little salt. Occasionally charcoal was added. Many of the hens learned to come down from the roost and eat by lantern light; the others got their mash cold. On the south side of the henhouse was a glass-covered run where the hens sunned themselves. The run was really an A-shaped coop made of old windows with the broken panes replaced by tarred paper or shingles. During the Summer the hens had the run of an inclosure which included a gravel bank and some brushy hillside, and sometimes they were let out to forage in the dooryard.

"I set the first hen on 10 R. I. Red eggs, January 22, in the cold loft of the barn, but the nest-box was packed all around with excelsior. Each evening I took the hen off the nest and waited with the lantern while she took food and water. On February 13 all 10 eggs had hatched, but the temperature that day was five below zero and one of the chicks got chilled and died. The remaining nine survived and proved to be seven pullets and two cockerels. Though the loft floor was strewn with gravel and hay, a place where water froze in a few minutes was not suitable for young chicks or for the old hen either, so I moved them outdoors into sheltered coop packed inside with fine ashes and hay and banked up outside with coal ashes and snow. The top of the coop was flat and was made of an old window hinged to swing upward. Here the chicks got all the sun to be had, and when they had outgrown this coop they were put into another and larger one, made of old windows partly covered with bagging to give shade. They were fed commercial chick feeds, with other ingredients added, such as beef scraps, millet, rape seed, hemp seed, or chopped cabbage or onion. They seemed to grow visibly between morning and night. The first cockerel crowed at 10 weeks of age. The first pullet laid May 31 at three months 19 days; the second laid June 5 at three months 24 days, and on June 8 three pullets laid. In June this flock of seven February-hatched pullets laid 42 eggs, and in July 69 eggs. At the close of the year my 19 hens had paid a profit of \$1.35 per hen."

O. J. F.

During the Summer we receive many questions about preserving eggs. The hen does not distribute her favors evenly throughout the year. She lays well from April to August and then takes a vacation. Many a farm flock will not give an egg for four months. The theory of preserving is to take a one-cent egg and hold it so that it may be used when eggs are worth four cents or more. Formerly eggs were packed in salt or in thick lime water or wash. This kept them after a fashion but the salt eggs were likely to taste, while the limed eggs had a brittle shell, which prevented their use for some purposes. Commercial eggs are now kept in cold storage, such handling having become a great business. It is out of the question for a farmer to put up cold storage but by using water glass he can hold the cheap eggs of May and June until needed in Winter.

Water glass, or silicate of soda, can be bought at most drug stores or from large manufacturers. It is a thick creamy liquid which dissolves in water. The operation of preserving is simple. Nine parts of water are put in a wood or stone vessel and one part

of the water glass poured in. It is better to boil the water thoroughly before using, letting it cool of course before mixing. Stir up the solution thoroughly and cover with a lid which prevents evaporation and keeps out the dust. Put the package in a cold cellar until it is wanted for use. Perfectly fresh eggs kept in this solution will be good at the end of a year, but they must be sound and fresh when put into the solution. You cannot expect it to restore stale or spoiled specimens. One pound of water glass properly diluted with nine pounds of water will cover about 14 dozen eggs. Put the eggs into the liquid gently so they will not crack and then put on a wooden cover so as to keep them in the solution. Dirty eggs should be wiped clean before putting in. We have used the same solution two years in succession, but it would be better to start each year with a fresh supply, as the cost is not great. The only change that you will note in such eggs is that the white or albumen will appear more watery than it is in perfectly fresh eggs, otherwise they resemble new-laid eggs in appearance after being thoroughly rinsed and dried off. They can be used for all household purposes except it may be boiling in the shell. When boiled they crack and they are likely to split if heated too suddenly and again when boiled the interior does not look as inviting when opened. For most cooking purposes, however, they are quite equal to the fresh eggs and we have found that in cold weather these eggs will keep well for two weeks after coming out of the solution. We must understand, however, just what the limitations of this process are. These eggs are not fresh and should never be offered for sale as such. Some people have endeavored to do this by putting up barrels of them when eggs were cheap and tried to sell them through the Winter as fresh eggs. In every case they came to grief and practically ruined their trade in actual fresh eggs, as their customers had no confidence in them afterward. If commercial eggs are to be kept they would much better be put in cold storage. The water glass method is an excellent one for household purposes and where but a comparatively few dozen will be needed. With a stock of fresh eggs preserved in April and May there will be a supply for family use all through the Fall and Winter, but it must be repeated over and over that there is no use putting a stale egg into water glass. If you attempt this method make special preparations to have the eggs fresh. Some people do not gather the eggs for several days and in such cases the egg may remain on the nest under a sitting hen for two days or more. In that case such an egg is about 15 per cent chicken and will prove a nuisance when put into water glass. When eggs come to the city for sale they are

promptly candled, that is, passed before a powerful light so that the candler can quickly tell their condition. This is a business by itself and it would be impossible to deceive an expert, but some farmers do not realize just what a stale egg is. We know of one case where a man sent a quantity of eggs from the country guaranteeing that they had all been candled and were fresh. The candler in the city found a large proportion of them stale and so notified the shipper. He still insisted that they had been candled, but when asked how he candled them he said he stood inside of a barn and held the eggs up to a knot hole and looked through them. That might suit him but not the buyer. The best eggs for preserving are those from pens where no male birds are kept.

The "rot" of the egg is due to bacteria, of which there are several kinds. This has been proved by cultivating these bacteria and putting them into perfectly fresh eggs. The rot developed rapidly just as cream will ripen when a "starter" is put into it. Some of these bacteria are in the hen and enter the egg before it leaves her. Many eggs are infected while in the nest before they are taken up. In Connecticut nine different kinds of bacteria were taken from one nest. This ought to show anyone the folly of letting the nests become as filthy as some of them are. It has been found that eggs contain most of these rot bacteria in late Summer. They are most free from them in April and May and that is the best season for taking eggs for preserving.

You will notice that the American and Asiatic breeds lay brown eggs varying from light to very dark. These breeds are well feathered and are bred with very small combs so they will stand the cold. The hens which lay white eggs are of a different type, nervous, with thin feathering and large combs, and this large comb is the special target for Jack Frost. The white egg is desirable in most market but many poultrymen want a more rough and ready breed than the Leghorn. They are after the "hen in fur," that is, one which can stand frost and still lay a white egg. Mr. Cosgrove says in his chapter that the Connecticut Experiment Station is trying to breed a Wyandotte strain of white egg layers. The hen they are working on is not a pure Wyandotte but a mixture of breeds. You will see that a Wyandotte, a "Rock" or a "Red" can squat down on the nest and in this way keep her feet warm. Her comb is small and she can put her head under her wing. Thus she is fully protected by her warm feathers. A Leghorn under the same conditions could not put her big comb in her "pocket" and on a cold night in a colony house it would be frosted.

Thus what is wanted is the Leghorn's ability to lay white eggs with the "fur" of the warmer breeds. It seems strange that in all the attempts at breed making this idea has not been worked out before. It is practical and the combination has already been made in Connecticut. Of course, in "making" such a bird, blood of the Leghorn will be used to obtain the large white egg. Naturally the breeders who are now breeding Leghorns with success will say that this new breed is not needed. In their warm and comfortable houses there is little danger from frosted combs. They must remember, however, that new conditions have made new methods necessary. It has been frequently pointed out that the use of a dry mash in feeding has more than doubled the size of the flock which one man can control, while thick feathering and small comb will without doubt cheapen the cost of housing hens in a cold country. The "hen in fur" therefore has her place and it is worth while to try to develop her, though, as a rule, cross-breeding is to be avoided. In fact we may end this book, as we began it, by saying that there are few, if any, cast iron rules in poultry keeping. The hen man must follow certain general principles, yet he must win success if at all by learning from the hen how to adapt his particular circumstances and conditions to her needs or requirements.

INDEX

	PAGE		PAGE
Bantams	168	Egg-Eating	18
Breeds, Crossing	102	How Mechanic Kept	187
Breeding, Limitations of	92	In Back Yard	185
Brooder House, Colony	40	Kept by Woman	126
House, Gasoline-Heated	42	Selecting	173
House, Large	41	With Bumble Foot	69
Small	40	Henhouse, Business	56
Chick Brooder, Homemade	48	Damp	180
Brooding	44, 113	Interior	61
Embryo, Developing	25	Straw	175
Outfit, Convenient	47	Incubator Cellars	29
Chicks, Baby, Selling	46	Disinfecting	30
Feeding	112	Lamp, Regulating	31
In Brooder, Trouble with	45	Regulating	30
Chicken Thieves	179	Thermometer	31
Chickens, Naked	182	Temperature for	32
Cockerels, Fattening	52	Ventilating	33
Combs, Frosted	75	Kafir Corn for Poultry	87
Cosgrove, Geo. A., Experience of	108	Lice	76, 112
Diarrhœa	72	Limbber Neck	77
White	80	Lime Sulphur for Vermin	185
Diseases, Communicable	71	Longevity, Breeding for	97
Ducks, Keeping	163	Mash, Dry, How Made and Fed	89
Dust Boxes, Material for	181	Meat, Breeding for	99
Egg Constituents of	16	Foods for Hens	88, 183
Distinguishing Sex in	27	Milk for Poultry	88
Eating Habit	73, 181	Mites	78
Fertility	22	Nest, Trap	151
How Made	14	Oats, Sprouted	87
Life Germ in	17	Pigeons and Squabs	163
Quality, Improving	98	Poultry, Breeds of	9
Shell, When Made	18	Devices, Homemade	143
Time Required to Make	21	Diseases	68
Type Fixed	23	Dry Picking	122
With Two Yolks	74	Fattening Coop	52
Within an Egg	74	Fitting for Exhibition	141
Eggs, Abnormal	19	Grading up	103, 123
Bloody	73	House, Burr	155
Breeding for	95	House, Colony	65
For Fancy Trade	120	House, Gallup	54
For Hatching, Cooling	35	House, Large	66
For Hatching, Keeping	23	House, Sod	67
For Hatching, Shipping	25	Houses, Dampness in	64
Marketing	116	Houses, Remodeling	63
Natural Incubation of	38	In-Breeding	106
Package for	118	In Large Flocks	154
Preserving	188	Killing	121
Rot in	189	Line Breeding	107
Selecting for Hatching	24	Medicine Chest	183
Shape, Size and Color of	18	Packing	123
Testing	36	Purebred	100
Turning	34	Scalding	122
Feather Pulling	75	Selling Notes	124
Feed Hopper, Hunter	51	Systems	132
Hopper, Minnesota	52	With Chicken Pox	70
Trough, Burr	160	With Colds	71
Feeds, Analysis of	85	With Crop Compaction	71
Gapes, Treatment for	75	With Farm Crops	136
Gasoline Heater, Details of	45	Yard, Movable	152
Grits, Need of	88	Rats, Damage from	184
Guinea Fowls	167	Roasters, Raising	169
Hen, Egg Organs of	15	Roasters, Care of	105
Feeding	82	Getting Rid of	174
In Fur	190	Number Required	104
Law of	140	Roup, Treatment for	78, 182
Manure, Handling	138	Sheep in Henhouse	185
Young, Caring for	50	Turkeys, Blackhead in	68
Hens and Fruit	174	Keeping	163
Bleeding from Comb	69	Vent Gleet	79
Blind	69	Vertigo, Cause of	80
Cannibal	181	Worms in Poultry	81

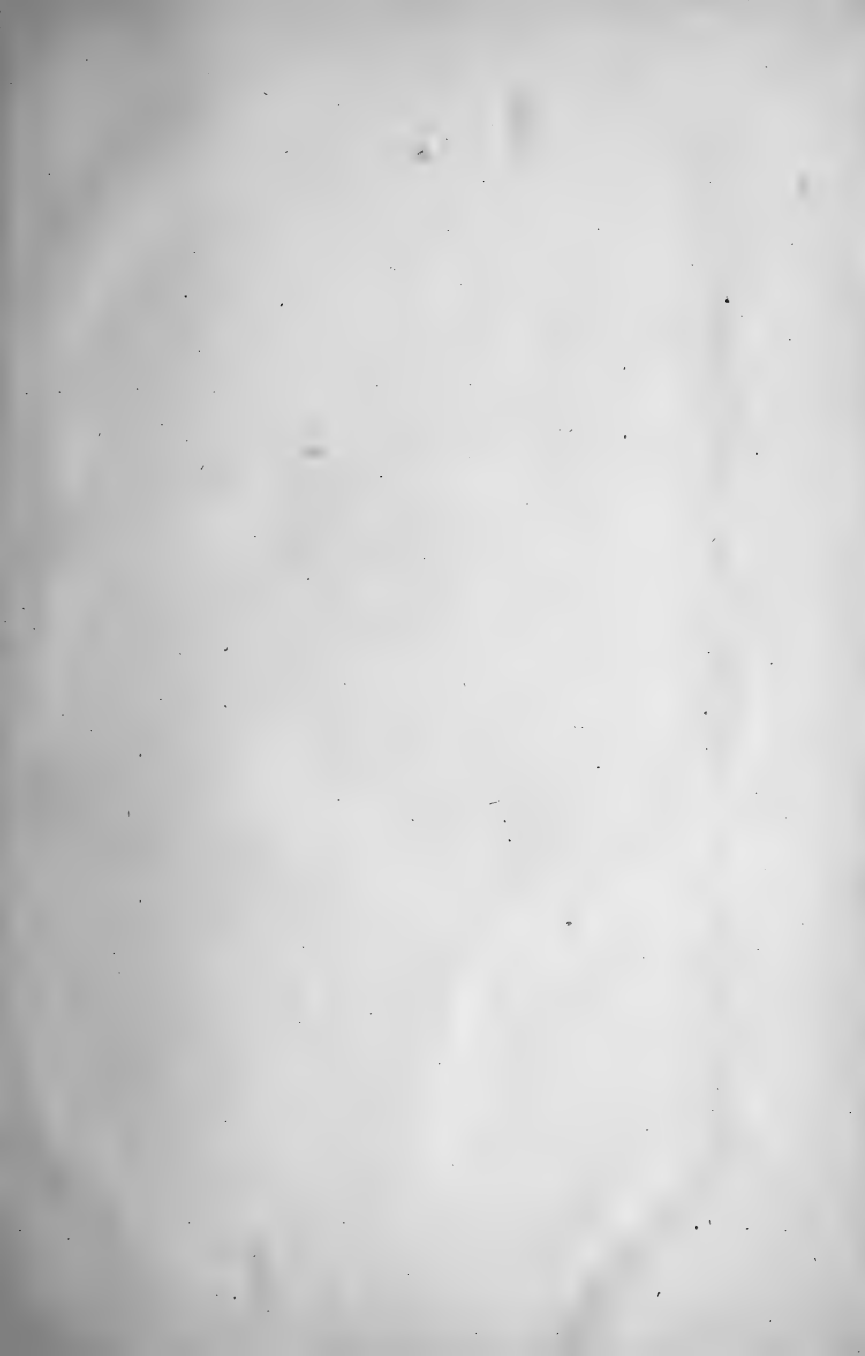

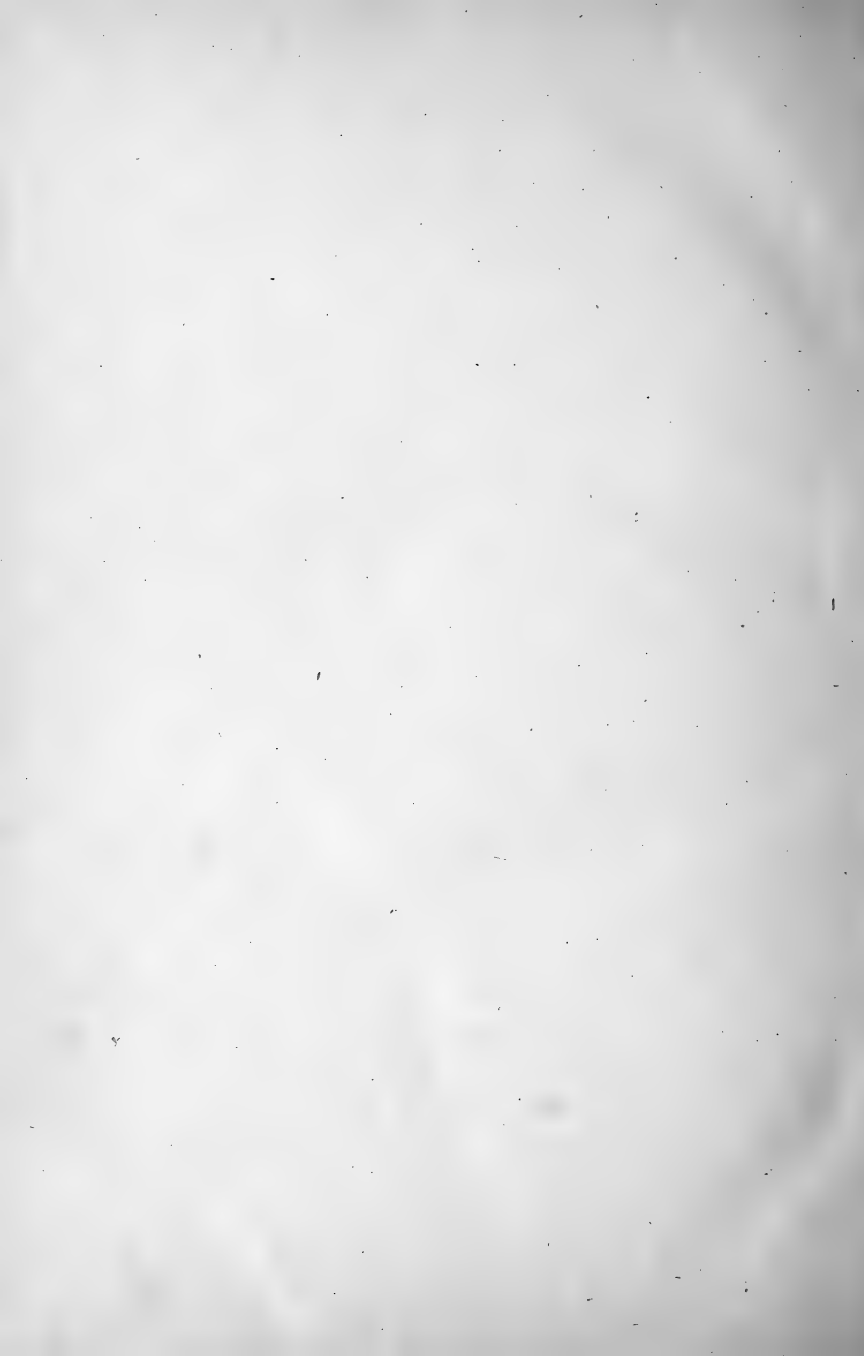

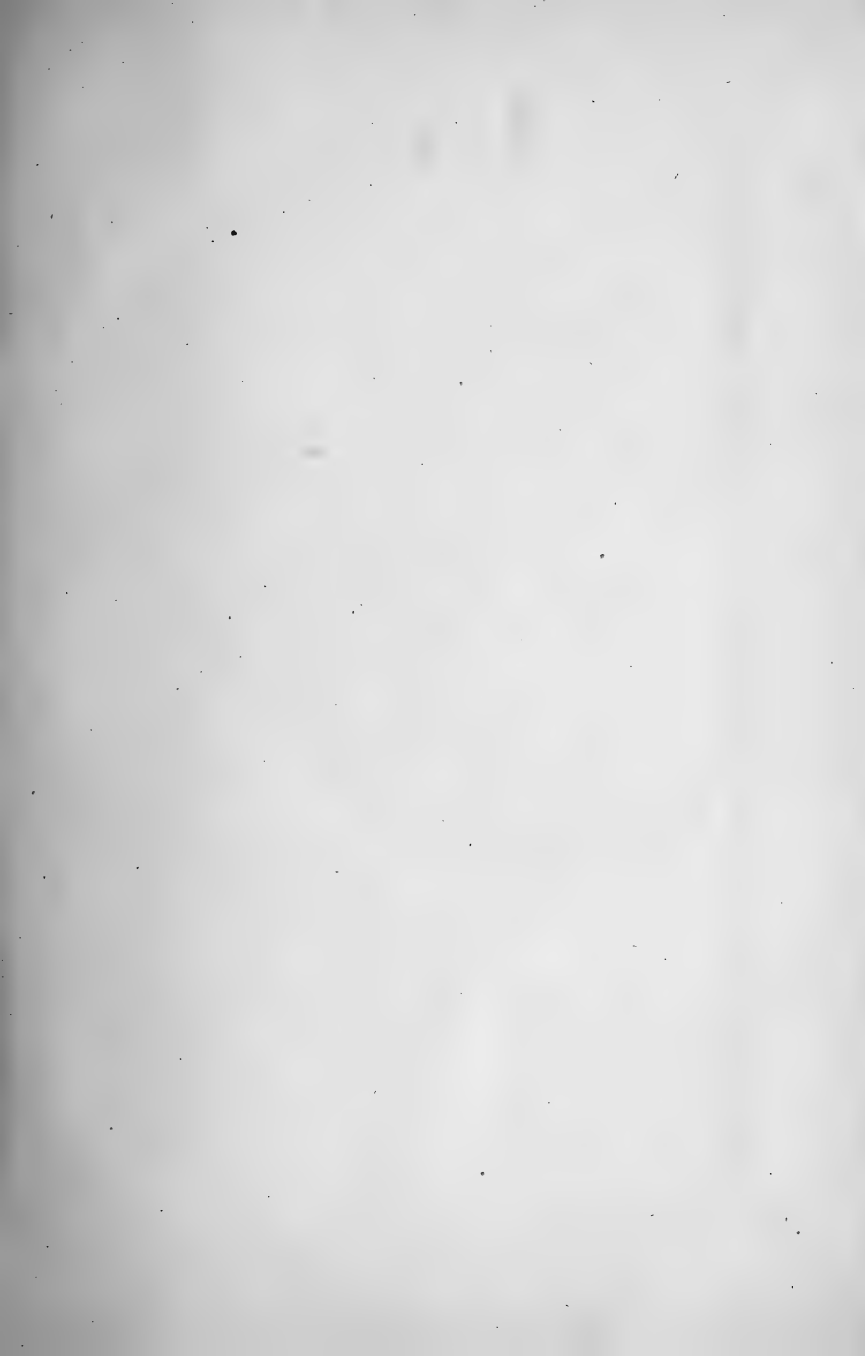





LIBRARY OF CONGRESS



0 002 840 041 A