

Digitized by the Internet Archive
in 2009

<http://www.archive.org/details/caesarsgallicwar00caes>



CAIUS JULIUS CAESAR.
(Bust in the Museum of the Louvre.)

CÆSAR'S GALLIC WAR

(ALLEN AND GREENOUGH'S EDITION)

REEDITED BY

JAMES B. GREENOUGH

BENJAMIN L. D'OUGE AND M. GRANT DANIELL



GINN AND COMPANY

BOSTON · NEW YORK · CHICAGO · LONDON
ATLANTA · DALLAS · COLUMBUS · SAN FRANCISCO

COPYRIGHT, 1898, BY
GINN AND COMPANY
—
ALL RIGHTS RESERVED

425.9

The Athenæum Press
GINN AND COMPANY • PRO-
PRIETORS • BOSTON • U.S.A.

P R E F A C E.



THE editors have undertaken the task of reëditing entirely the well-known Allen & Greenough's *Cæsar*, to satisfy the ever-increasing demands of modern secondary education. In view of the improvements lately made in the text of *Cæsar* by Meusel and others, they have changed the readings in many places, following chiefly Meusel's as almost a new *textus receptus*. Most of the changes will at once commend themselves. The editors have in general been conservative in regard to spelling, especially the new spelling of old Gallic names, feeling that much that is proposed of that kind as yet lacks certainty. But they have adopted the spelling *-īs* for the accusative plural of *i*-stems in accordance with the prevailing usage. They have allowed themselves full liberty in enriching the notes as to grammar, exegesis, and subject-matter. They have added very full suggestions for parallel reading, and have spared no pains to enrich the study of this famous piece of literature. The treatises on military affairs and other introductory matters have been rewritten and brought out of the notes under one head, so that a pupil may have a chance to gain some general information before he begins to read. Special attention has been given to indirect discourse, the bugbear of Latin education, and throughout the earlier books the direct form has been printed in full in the notes, that any teacher who desires may

begin either the first or second book and avoid at the start the enormous difficulties of the indirect form. They have endeavored to put in every kind of illustration that might tend to make the story more real to the pupil's imagination.

In order to encourage pupils to associate words together for acquiring a vocabulary they have made a large number of groups of words containing the same elements without introducing the vague notion of roots. It is hoped that these may be found convenient to learn by heart, at least in some measure. Attention is also called to the foot-notes which have been added to the text. In the first four books these refer backward to some previous use of the same word. In the last three books reference is made to words of similar or opposite meaning, whereby it is thought that sight-reading may be facilitated. The editors have not thought it desirable to give any pronouncing vocabulary of proper names, as generally these may be pronounced in the Latin manner, except those few that are familiar enough to have become English words, like *Caesar* and *Cicero*, which of course must be pronounced like English. The vocabulary has been enriched by a fuller insertion of idioms, and the etymological matter has been made clearer without sacrificing its peculiar character.

APRIL, 1898.

J. B. G.
B. L. D.
M. G. D.

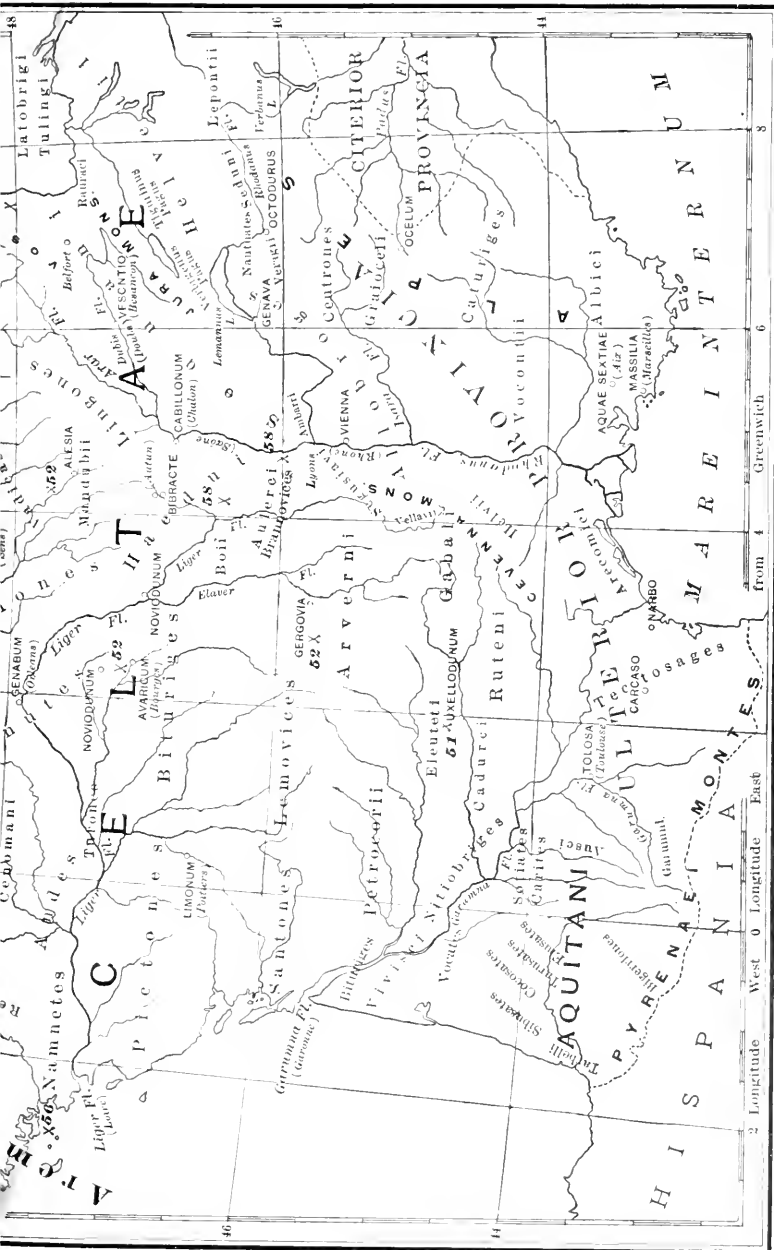

from 1 Greenwich

West 0 Longitude East

CONTENTS.



	PAGE
LIST OF MAPS AND ILLUSTRATIONS	vii
INTRODUCTION.	
I. LIFE OF CÆSAR	xiii
II. ROMAN MILITARY AFFAIRS	xxix
III. GAUL AND THE GAULS	xlv
IV. THE BRITONS	lii
V. THE GERMANS	liii
VI. THE CAMPAIGNS IN GAUL	liv
VII. READING COURSES	lv
VIII. DIRECTIONS FOR READING	lvii
BOOK I	I
BOOK II	49
BOOK III	74
BOOK IV	94
BOOK V	117
BOOK VI	157
BOOK VII	186
NOTES	247
GROUPS OF RELATED WORDS	443
VOCABULARY.	

LIST OF MAPS AND ILLUSTRATIONS.

ABBREVIATIONS.

- Babelon.*—Description historique et chronologique des Monnaies de la République romaine. 1885.
- Baumeister.*—Denkmäler des klassischen Altertums. 1885-88.
- Bertrand and Perrot.*—Revue archeologique, 3^e Série, Tome X.
- Cohen.*—Description générale des Monnaies de la République romaine, etc. 1857.
- Fleury.*—Antiquités et Monuments du département de l'Aisne, etc. 1877-78.
- Froehner.*—La Colonne trajane d'après le surmoulage exécuté à Rome en 1861-62, reproduite en phototypographie par Gustave Arosa. 1872.
- von Göler.*—Caesar's Gallischer Krieg, etc. 1880.
- Grasset.*—Costumes de Guerre de l'âge du bronze et de l'ère gauloise. 1886.
- Guhl and Kohner.*—The Life of the Greeks and Romans, described from Antique Monuments. 1875.
- Head.*—A Guide to the Principal Gold and Silver Coins of the Ancients. (Br. Mus.) 1881.
- Jeuffrain.*—Essai d'Interprétation de Types de quelques Médailles muettes, émises par les Celtes-Gaulois. 1846.
- von Kampen.*—XV ad Caesaris de Bell. Gall. Commentarios Tabulae. 1879.
- Lindenschmidt.*—Tracht und Bewaffnung des Römischen Heeres während der Kaiserzeit, etc. 1882.
- Oehler.*—Bilder-Atlas zu Caesars Büchern de Bell. Gall. 1890.
- Rheinhard.*—C. Iulii Caesaris Commentarii de Bell. Gall. 1896.
- Schreiber.*—Atlas of Classical Antiquities.
- Stoffel.*—Guerre de César et d'Arioviste. 1890.
- Visconti.*—Iconographie romaine. 1817-24.

FIG.

PAGE

- | | | |
|----|---|----------------------|
| 1. | Cæsar. Bust in the Museum of the Louvre . . . | <i>Frontispiece.</i> |
| 2. | Map of Gaul. | |
| 3. | Campaign map of B.C. 58 | 1 |
| 4. | Two coins of Cæsar. (1) Obverse: head of Venus. Reverse: Æneas with Anchises and the palladium. CAESAR. (2) Obverse: head of Venus. Reverse: trophy and captives. CAESAR. <i>Head</i> | 1 |
| 5. | Pas de l'Ecluse (looking down stream). <i>Photograph</i> . . . | 5 |
| 6. | Map of Helvetia. <i>Oehler</i> | 5 |

FIG.	PAGE
7. Junction of the Rhône and Saône (looking south). <i>Photograph</i>	9
8. Coin of Piso. Obverse: head of a youth with winged diadem; behind, a star and crown; before, a <i>simpulum</i> . Reverse: M. PISO. M[arci] F[ilius] FRUGI; a <i>patera</i> and a <i>secespita</i> , inclosed within a laurel wreath. <i>Cohen</i>	10
9. Coin of Cassius. Obverse: head of Apollo with sceptre behind. Reverse: Q. CASSIUS. Eagle resting on a thunderbolt, between a <i>lituus</i> and a <i>praefericulum</i> . <i>Cohen</i>	10
10. Loading boats with supplies. <i>Froehner</i>	14
11. Gallic remains. <i>Grasset</i>	16
12. Cavalryman charging. Gravestone in Mainz. <i>Oehler</i>	19
13. Cavalryman with <i>vexillum</i> . Col. of M. Aurelius. <i>Oehler</i>	19
14. Soldiers marching with packs (<i>sarcinae</i>). <i>Froehner</i>	21
15. Roman javelins (<i>pila</i>). <i>Oehler</i>	22
16. Plan of battle with the Helvetii. <i>von Kampen</i>	23
17. Roman swords. <i>Oehler</i>	25
18. View of Besançon (Vesontio). From a drawing	33
19. C. Marius. Impression of a coin. <i>Visconti</i>	35
20. View of the fortress of Belfort. <i>Photograph</i>	38
21. Coin of the Fabian family. Obverse: ROMA Q. MAX. Laurelled head of Apollo, lyre in front. Reverse: horn of plenty filled with fruits; thunderbolts; the whole in a wreath of grain ears and poppy. <i>Cohen</i>	41
22. Map of the campaign with Ariovistus. <i>Stoffel</i>	43
23. Soldiers attacked while encamping. <i>Froehner</i>	44
24. Ostheim, looking towards Zellenberg. <i>Photograph</i>	47
25. Plan of battle with Ariovistus. <i>Stoffel</i>	47
26. Campaign map of B.C. 57	48
27. Writing materials: <i>atramentarium</i> (for black and red ink); papyrus letter sealed and addressed (M LVCRETIO FLAM[ini] MARTIS DECVRIONI POMPEI[s]); <i>dip-tycha</i> (folding tablet), <i>stilus</i> , and erasing knife. Wall painting. <i>Overbeck's Pompeii</i>	49
28. Gaul with trumpet. Restoration from carvings on the <i>Arc de Triomphe</i> at Orange. <i>Grasset</i>	50
29. Coin of Diviciacus, king of the Suessiones. <i>Fleury</i>	51
30. Slinger (<i>funditor</i>). <i>Dict. des Antiquités</i>	53
31. Berry au Bac. <i>Photograph</i>	54
32. Battle on the Aisne. <i>Oehler</i>	55

FIG.		PAGE
33.	Vinea or Testudo. <i>Oehler</i>	58
34.	Hautmont. <i>Photograph</i>	61
35.	Defeat of the Nervii. <i>Oehler</i>	61
36.	Lituus	63
37.	Tuba	63
38.	Cornu	63
39.	Aquilifer. <i>Lindenschmidt</i>	66
40.	Centurio. <i>Lindenschmidt</i>	66
41.	Citadel of Namur. <i>Photograph</i>	69
42.	Siege of the stronghold of the Aduatuci. From first ed. .	69
43.	Siege works. <i>von Göler</i>	70
44.	Gallic coins. (1) Obverse: a Gaul running, with torch in one hand and <i>torque</i> (?) in the other. Reverse: bear (?). (2) Obverse: ox-head. Reverse: bear of the Helvetii. <i>Fleury</i>	73
	(3) (4) Of uncertain interpretation. Some modification of the human head is seen, also the form of a horse or boar, with ornaments. <i>Jeuffrain</i>	73
45.	Shipbuilder. Grave relief (Ravenna). <i>Schreiber</i>	74
46.	Map of Octodurus. <i>von Kampen</i>	75
47.	Cæsar. Bust in the British Museum	76
48.	Galley. From the Præneste relief. <i>Baumeister</i>	79
49.	Map of the Veneti neighborhood. Altered from modern map	81
50.	View at mouth of the Loire. <i>Photograph</i>	82
51.	Roman battle ship. Wall painting at Pompeii. <i>Oehler</i> . .	83
52.	Trading vessel. Ancient relief. <i>Baumeister</i>	85
53.	Gallic sword-blade. Museum at Namur. <i>Photograph</i> . .	87
54.	Soldiers making camp. <i>Froehner</i>	91
55.	Pack-wagons and carts. Col. of M. Aurelius. <i>Oehler</i> . .	94
56.	Campaign map of B.C. 55-53	94
57.	Coins of Cæsar. (1) Obverse: head of Venus. Reverse: trophy of Gallic arms. CAESAR. (2) Obverse: veiled head of <i>Pietas</i> . CAESAR CO[n]S[ul]TER. Reverse: <i>lituus</i> , <i>præfericulum</i> , and axe. A[ulus] HIRTIUS PR[æfectus]. <i>Head</i>	96
58.	Scenery on the Meuse. <i>Photograph</i>	99
59.	Bridge. From first ed.	103
60.	Cliffs of Dover. "Shakespeare's Cliff." <i>Photograph</i> . .	107
61.	Catapulta. Modern restoration	109

FIG.		PAGE
62.	Anchor and tackle. <i>Arc de Triomphe</i> at Orange. <i>Schreiber</i>	111
63.	Soldiers foraging. <i>Froehner</i>	113
64.	Gallic coin. <i>Jeuffrain</i>	116
65.	Map of campaigns in Britain	116
66.	British coins. (1) Obverse: ear of grain, CAMV[lodunum]. Reverse: prancing horse, CVNO[belinus] (the Cymbeline of Shakespeare). (2) Obverse: unexplained devices. Reverse: horse, TASCOVIANUS. <i>Head</i>	117
67.	Boulogne. <i>Photograph</i>	118
68.	Testudo. <i>Froehner</i>	123
69.	Soldiers building camp, with guards. <i>Froehner</i>	125
70.	Signa Militaria. <i>Guhl and Koner</i>	129
71.	Roman Transports. <i>Froehner</i>	132
72.	Coin of L. Plancus. Obverse: bust of Victory. CAES[ar]. DIC[tator]TER. Reverse: a <i>praefericulum</i> . L. PLANC[us]. PRAEF(ectus). <i>Head</i>	134
73.	Hollow square. Col. of M. Aurelius. <i>Oehler</i>	139
74.	Roman camp assaulted. <i>Froehner</i>	143
75.	Ballista. Modern restoration	146
76.	Gallic coin. Obverse: human figure seated. Reverse: bear, serpent, and stars. <i>Jeuffrain</i>	152
77.	Gallic <i>torques</i> . Museum at Namur. <i>Photograph</i>	156
78.	Cæsar. Bust in the Naples Museum	157
79.	Gallic chief. Museum at Avignon. <i>Photograph</i>	160
80.	Bridge. Model in the Museum of St. Germain. <i>Oehler</i>	162
81.	Gallic coin. <i>Jeuffrain</i>	166
82.	Gallic coins. LVCOTI (Paris?); human eye in profile, sup- posed to symbolize the sun. <i>Fleury</i>	168
83.	Statue of Ambiorix at Tongres. <i>Photograph</i>	174
84.	Sacrifice in camp. Military band (<i>Cornicines</i>). <i>Froehner</i>	178
85.	Soldiers marching in presence of the Imperator. <i>Froehner</i>	182
86.	Chain mail. Fragment found at Mainz. <i>Oehler</i>	185
87.	Helmets. <i>Schreiber</i>	186
88.	Campaign map of B.C. 52	186
89.	Coin of Brutus and Albinus. Obverse: head of Mars. Reverse: ALBINVS BRVTI F[ilius]. Two Gallic trumpets crossed, oval and round shields. <i>Head</i>	191
90.	Siege of Avaricum. <i>von Kampen</i>	194
91.	Bourges. <i>Photograph</i>	196
92.	View of siege works. <i>von Kampen</i>	198

FIG.		PAGE
93.	Plan of siege works. <i>von Kampen</i>	199
94.	Gallic wall. Model in the Museum of St. Germain, slightly restored from existing remains at Murcens. <i>Oehler</i>	202
95.	Scorpio. Modern restoration	204
96.	Coin of the Bituriges. Obverse: beardless male head. Reverse: galloping horse, flying eagle above; below three circles. ABVDOS (name of chief?). <i>Head</i>	207
97.	Siege of Gergovia. <i>Oehler</i>	209
98.	Care of the wounded. <i>Froehner</i>	216
99.	Expeditio Labieni. <i>von Kampen</i>	225
100.	Defeat of Vercingetorix at the Vingeanne. <i>von Kampen</i>	231
101.	Alise Ste. Reine (Alesia). <i>Photograph</i>	232
102.	Siege of Alesia. <i>Oehler</i>	234
103.	View of Cæsar's line of works before Alesia. Model in the Museum of St. Germain. <i>Oehler</i>	236
104.	Light-armed soldier. <i>Lindenschmidt</i>	241
105.	Archer. <i>Lindenschmidt</i>	241
106.	Statue of Vercingetorix. Erected at Alesia by order of Napoleon III. Designed by Bartholdi. <i>Photograph</i>	244
107.	The legionary. Slightly altered from Bartholdi's Model in the Museum of St. Germain.	248
108.	Coin of Cæsar. Obverse: head of Augustus. IMP[erator] CAESAR·DIVI·F[ilius]III(trium)·VIR·ITER[um] R[ei] P[ublicae] C[onstituendae]. Reverse: Julius Cæsar standing in a temple. DIVO IVL[io]. Star and altar. CO[n]S[ul] ITER[um]·ET·TER·DESIG[natus]. <i>Cohen</i>	249
109.	Gallic coin. <i>Fleury</i>	252
110.	Gallic coin. Obverse: horse. VIRO (perhaps name of a chief), or VIRO[mandui]. Reverse: various devices. <i>Fleury</i>	255
111.	Gallic coin. Rude representation of a human head. <i>Fleury</i>	258
112.	Gallic coin. Horse, stars, circles. <i>Fleury</i>	261
113.	Gallic coin. Cock. <i>Fleury</i>	263
114.	Signifer. <i>Lindenschmidt</i>	267
115.	Soldiers. From first ed.	273
116.	Scutum. <i>Rheinhard</i>	283
117.	Scutum. <i>Rheinhard</i>	283
118.	Wall and ditch. <i>Oehler</i>	307
119.	Castra Romana. <i>Rheinhard</i>	310
120.	General view of siege operations. <i>Rheinhard</i>	332

FIG.		PAGE
121.	Vexillum	335
122.	Aquila	374
123.	Gallic coin. Reverse: L. Hostilius Sasern[a]. Warrior fighting, armed with spear and shield, in a Gallic chariot (<i>essedum</i>) driven by a charioteer holding a whip. <i>Babelon</i> .	376
124.	Gallic coin. Reverse: Warrior armed with spear and shield, and holding a Gallic trumpet (<i>carnyx</i>), standing in a two-wheeled chariot, drawn by two galloping horses. L[ucius] LIC[inius] CN[aeus] DOM[itius]. <i>Bertrand & Perrot</i> .	377
125.	Caliga. <i>Oehler</i>	379
126.	Oppugnatio. From first ed.	390
127.	Signum	393
128.	Tabernaculum. <i>Rheinhard</i>	415
129.	Pluteus. Modern restoration	427
130.	Pluteus. Modern restoration	427
131.	Litium. <i>Oehler</i>	442
132.	Stimulus. <i>Oehler</i>	442

INTRODUCTION.



I.

THE LIFE OF CAIUS JULIUS CÆSAR.

“Julius Cæsar, whose remembrance yet
Lives in men’s eyes, and will to ears and tongues
Be theme and hearing ever.” — *Shakespeare*.

“The greatest name in history.” — *Merivale*.

I. THE POLITICAL CONDITION OF ITALY IN THE FIRST CENTURY B.C.

THE Roman state was in form and name a commonwealth or republic. While Rome was a small agricultural community and her citizens a body of patriotic, sturdy, and independent freeholders, the task of government was easy and the constitution well adapted to its purpose. The wars that followed for the establishment and extension of her power at first fostered unity and soundness of national life. But in course of time Rome became an imperial state and took upon herself the guardianship of every country in the world. Wealth flowed into her coffers from every quarter of the earth, her citizens became corrupt, and the rule of the people became the rule of a rich landed aristocracy, whose principal ambition was to perpetuate its mischievous power. The organ of this aristocracy was the senate, a body of six or seven hundred men, who became members of it nominally by virtue of holding certain high offices, and who remained senators for life. In theory, therefore, the senate was elective, and rested on the popular will; but the members really became such on account of noble blood, wealth, or political, social, or other influence. Moreover, the great offices of the state came to be bought and sold openly and without shame, and opposing factions contended not with ballots alone, but with iron and

steel, so that the election place was frequently stained with the blood of the slain. It became increasingly difficult for one not possessing and willing to use such means to be elected to any office.

Opposed to the landed aristocracy was a class of wealthy capitalists known as *equites*, the "Equestrian Order." Many of these were as rich as the senators, but their wealth — most of it gained by usury, state contracts, slave-dealing, and tax-gathering — consisted of money instead of land. They took no active interest in politics excepting so far as they could influence legislation to their advantage by lobbying and bribing.

There was no industrious middle class among the free citizens of Rome. Manufacture on a large scale, as a means of wealth, was absolutely unknown; while all mechanical industries were carried on by slaves. The poorer class of citizens, the *plebs*, were wholly influenced in their votes by their wealthy patrons or by scheming demagogues. The freedmen were the only class who could become rich by industry.

The rural portions of Italy were for the most part held in large plantations (*latifundia*), owned by nobles and cultivated by slaves, or, more frequently, occupied by great droves of cattle. This plantation system had crowded out the free peasant proprietors in almost all parts of the peninsula. After throwing up their farms, which foreign competition had made unprofitable, they flocked to Rome to swell the idle mob that lived on what their votes would bring. There still remained, especially in Northern Italy, a considerable body of small land owners; and the municipal towns (*municipia*), about four hundred in number, whose territories comprised, politically speaking, the whole area of Italy, were still the home of a fairly prosperous middle class. These had all received Roman citizenship after the social war (B.C. 90) and might, by their substantial character and intelligence, have served as a strong opposition to the corrupt aristocracy at Rome; but they lacked organization and leadership, and when they went to Rome to vote, they were wholly powerless against the turbulent political clubs of the metropolis, whose violence was a regular feature of all public proceedings. Yet in this class alone was the old Roman virtue to be found, and in it lay whatever hope there was to redeem the state.

Another menace to the government was in the constitution of the armies. After a man had been consul, he was given charge of a province and was put in command of several legions. While abroad he was not amenable to the government at home, and when he returned he used his old soldiers to further his political schemes, and rewarded them at the expense of the opposing faction, often by wholesale spoliation and murder.

Partisans of the nobility were known as *Optimates*; those opposed to them as *Populares*. Before Cæsar, the most conspicuous leader of the former had been Sulla, of the latter, Marius, Cæsar's uncle by marriage. These two men by their thirst for power and mutual hatred filled all Italy with bloodshed and terror for years. Under the established *régime* there was no continuity in government, but a perpetual see-saw between rivals. Rome was kept in a constant electioneering excitement accompanied by the worst forms of demoralization. All the vast interests of the Roman world were sacrificed to the luxury and ambition of a governing class wholly incompetent for its task; and the only resource against anarchy appears to have been that some one man, by craft or by force, should get all the reins of power into his single hand. That man was destined to be Julius Cæsar.

II. CÆSAR'S EARLIER CAREER.

“Better be first, he said, in a little Iberian village,
Than be second in Rome.”—*Longfellow*.

Caius Julius Cæsar (*Gaius Iulius Caesar*) was born July 12th, B.C. 100, or, according to some authorities, two years earlier. Assuming the later date, he was six years younger than Pompey, his great rival, and Cicero, the distinguished orator. His ancestry was of the noblest, and was supposed to reach back on his mother's side to Ancus Marcius, the Roman king, and on the father's to Æneas, the founder of the Roman nation and reputed to be the son of a goddess.

The time of his birth was during the great ascendancy of the *Populares* under Marius, his uncle; and his childhood was passed amid the horrors of the proscriptions that marked Marius's dictatorship. Though Cæsar was connected by blood with the oldest and

proudest houses of Rome, he early showed his predilection for the party of the people ; and the sturdy Marius, with all his defects, doubtless exercised a marked influence over the life and destinies of his young nephew. Cæsar lost his father early in life, so that most of the responsibility for his education and bringing up rested upon his mother, Aurelia. She was a typical matron of the old school, managing her house with simplicity and frugality, and holding to the traditions and virtues of the ancient Romans. Tacitus, the Roman historian, couples her name with that of Cornelia, the famous mother of the Gracchi. Cæsar owed much of his future greatness to her influence, and his love and reverence for her are highly honorable to both.

In the year 86, when Cæsar was still a boy, he was appointed a priest of Jupiter. This office was a perfunctory one and had little real religious significance. In 83 he married Cornelia, the daughter of Cinna, an act which identified him thus early with the *Populares*; for Cinna was a very prominent leader of that party. It was soon after this that Sulla, the leader of the *Optimates*, returned from Asia Minor with a victorious army, prepared to take a terrible revenge for the proscription of Marius. Cæsar soon fell under his displeasure because of his relationship to Marius. He was ordered to divorce his young wife because she was Cinna's daughter. In this crisis Cæsar showed a prominent trait of his character, a trait which led him during all his life to brave every danger rather than allow himself to be controlled. Though but a youth, he refused to obey Sulla's command. A price was set on his head and he was obliged to flee for his life. Often he was in great peril, and once he was taken, and escaped only by bribing his captor. His friends interceded for him, pleading his youth, and finally obtained his pardon, Sulla saying, "Take him, since you will have it so ; but I would have you know that the youth for whom you are so earnest, will one day overthrow the aristocracy. I see in him many Mariuses."

Cæsar thinking it safer to leave Italy for a time went to Asia Minor, where he gained some military experience and distinguished himself for valor by saving a comrade's life. Sulla died in 78 and Cæsar returned to his family and resumed his studies. He was a diligent and thorough student and doubtless followed the usual course

of Greek, rhetoric, grammar, philosophy, and oratory. To be a good speaker was essential to political success, and Cæsar was especially anxious to excel in that direction. He gave some public exhibitions of his skill and won much applause; but anxious to perfect himself still farther he went to Rhodes in 76, to study under Apollonius Molon, the most famous teacher of oratory and rhetoric of the day. On this journey, when near Miletus, he was captured by pirates and held for a heavy ransom. He spent some time among them while waiting for the money, and joined in their sports and games with the greatest freedom, at the same time assuring them that he would hang them all as soon as he was free. They seem to have regarded him with mingled awe and admiration. The ransom was paid. Cæsar was released, went at once to Miletus, where he hastily collected a few ships and made a descent on the pirates before they dreamt of danger. He recovered the ransom money and punished the pirates as he had threatened.

On his return to Rome, he began his political career (B.C. 68) by serving as quæstor, an office connected with the public treasury and the first step toward the consulship. This was followed in 65 by the ædileship. The taking of this office, which was one of the chief magistracies, though it involved only the care of the public buildings and the oversight of the great festivals and games, was considered a direct bid for a future consulship, and a man's claims upon that higher office were determined in large measure by the lavishness and splendor of his ædileship. Cæsar was poor, but with characteristic boldness he played for the highest political stakes and did not hesitate to incur enormous debts, in fact so enormous that those who had not the most perfect confidence in his capacity and his powers believed him irretrievably ruined. His ædileship surpassed all before it in magnificence; but he left it—as he remarked with grim humor—worth more than a million dollars less than nothing.

After his ædileship he identified himself more and more with the popular faction, and even dared to restore some of the statues and trophies of Marius, which had been banished from sight seventeen years before by the order of Sulla. The people began to hope for a successful revival of the Marian party and to look to Cæsar as its leader.

In B.C. 63 he was elected *pontifex maximus* against the strong opposition of the *Optimates*. This office was one of great political power and dignity, though not formally a civil office. Cæsar held it for the rest of his life. In 62 he was elected prætor, an office of a judicial character, and this was followed by a year of command in Spain as proprætor. Before leaving for Spain, his creditors became insistent and threatened to detain him unless he paid them. Cæsar then obtained a large loan from the richest man in Rome, Crassus, who was ambitious for office and doubtless hoped to make good use in turn of Cæsar's brilliant abilities to further his own ends.

In Spain Cæsar gained valuable military experience and made his administration so profitable to himself, as was usual with provincial governors, that, though he left Rome owing millions of sesterces, he returned in the year 60 with enough money to pay all his debts. His design was to run for the consulship, the highest office in the gift of the people. To secure his election he effected a union of interests between himself and Crassus and Pompey. These were the two most powerful men in Rome, — Crassus because of his wealth, Pompey because of his fame as a general and his popularity with the army. The latter was, in fact, really the first man in the state. He had but recently returned from Asia Minor laden with the spoils of the Mithridatic war, and might easily have seized the dictatorship had he so chosen; but he disbanded his army and preferred to appear as a private citizen, but with almost autocratic power. He had quarreled with Crassus, but Cæsar reconciled them, and the three formed a sort of offensive and defensive alliance known as the first triumvirate, — what we should call a political deal. This was for Cæsar, who was at that time quite their inferior in fame and influence, a master stroke of craft and diplomacy.

In 59 Cæsar was elected consul almost without opposition. He well understood the critical condition of affairs and saw clearly the dangers that threatened the state, and instituted valuable reforms looking to its regeneration and salvation. The army and the moneyed classes represented by Pompey and Crassus were with him, and he could do almost as he pleased. His first act was the passage of an agrarian law, by which thousands of acres were to be distributed to the poor. This was not a mere act of bribery, but an attempt to

restore the peasant freeholders, who had been dispossessed by the rich. Then he passed the excellent body of laws known as the *Leges Juliae*, which mark an epoch in Roman jurisprudence, and which were devised in the interests of individual rights, purity of justice, morality, and good government. All that one man could do in a single year to save his country from anarchy, Cæsar did.

Cæsar was now forty-three years of age. With the exception of the time spent in Spain, his life had been employed in petty miserable contests with Roman factions. He longed for a new and larger field where he might have freedom to perform deeds worthy of his surpassing abilities and unbounded ambition. This opportunity came to him when, as proconsul, he was entrusted with the protection of the northern frontier against the Gauls, and was assigned the provinces of Cisalpine and Transalpine Gaul and Illyricum. It was a most hazardous post and doubtless many of the *Optimates* thought that they were well rid of him.

III. CÆSAR IN GAUL.

“What security men derive from a resolute spirit.” — *Cæsar.*

By the ‘deal’ of the triumvirate, Cæsar was to have the government of Gaul for five years, while Crassus and Pompey were to remain in the city to look after the interests of the coalition. The bond was farther strengthened by the marriage of Pompey with Julia, Cæsar’s young and beautiful daughter.

Cæsar, as we have seen, was over forty when he went to Gaul. He was more of a civilian than a soldier and was far more at home in the Forum than in the camp. Alexander, Hannibal, and Napoleon had been trained in war from childhood. The qualities that are most potent in war — hope, confidence, audacity, and pugnacity — are qualities that belong to youth. So Cæsar is an anomaly in military history. In spite of his years and his comparative inexperience, he leaped at once to the highest place, and is counted to-day among the three or four greatest generals in history, if not the greatest of them all. He never lost a set battle and he showed infinite versatility in adapting means to ends, always doing the right thing at the

right time. He never admits the possibility of defeat and overcomes the most stupendous difficulties with such ease that he rarely speaks of them. His promptness of decision and rapidity of execution were such that the enemy were constantly overwhelmed with awe and were led to regard him as a supernatural being. 'Forced marches,' 'continuous marching day and night,' 'as quickly as possible' are phrases that recur again and again in his narrative. Only a natural ruler of men could get things done with such swiftness. He carried out his plans with the greatest audacity and, at the same time, without recklessness. No one could be more minute and thorough in preparations than he. No one left less chance for luck, good or bad, to enter into the result. In all that was done, his was the masterful and presiding genius, and the legions rarely accomplished much in his absence. His relations with his soldiers were most cordial. They idolized him and he respected and admired them and constantly labored for their safety and comfort. He allows them to share in the glory of his victories and in his story lingers with delight over their heroic exploits. He shared all their dangers and privations, he excelled personally in deeds of arms, and he allowed himself no luxury but a favorite horse. It is not strange that when trouble came upon their master, his soldiers were true to him, and even volunteered to serve without pay. Only three of his officers, two of them Gauls, went over to the enemy, while thousands came to him from the other side.

After two successful campaigns in Gaul, in the spring of B.C. 56, Cæsar met his two confederates at Luca, in Etruria, to arrange their future schemes. The conference was held with great display, almost like a royal court. More than two hundred senators were present, and one hundred and twenty lictors were in attendance, attached to the several magistrates. At this conference it was agreed that Pompey and Crassus should hold the consulship the following year, and, after their term of office, should receive by popular vote a similar command to that held by Cæsar,—namely, that Pompey should command in Spain and Crassus in Syria for five years each; also that when Cæsar's five years were up, he should receive in the same way a second term of five years. His ten years' administration would then close at the end of B.C. 49; after which time

-- an interval of ten years having elapsed -- he would be eligible again as consul.

The programme was duly carried out. Crassus departed (B.C. 54) to his province, where he was defeated the next year by the Parthians in the battle of Carrhæ, and shortly after entrapped and killed. Pompey put his province into the hands of one of his subordinates, and remained in the neighborhood of Rome, unwilling to remove from the seat of his personal influence.

Cæsar served eight campaigns in Gaul, an account of which is contained in the eight books of his Commentaries. Seven of these he wrote himself. The eighth was written by his friend and staff-officer, Hirtius. During these years he stormed more than 800 towns and subdued 300 tribes, engaged with more than 3,000,000 men, swept over a million human beings from the earth, and took a million more prisoners to be sold into slavery. "He was the first to lead an army into interior Gaul, the first to cross the Rhine into Germany, the first to bring a navy into the Western Ocean or to sail into the Atlantic with an army to make war." He left a magnificent country for the Romans to appropriate and retain until their increasing corruption left it in turn an easy prey to the Germans. He inspired such terror of the Roman arms that the tide of barbarian invasion was stayed for centuries.

IV. CÆSAR'S LATER CAREER.

"The foremost man of all this world." — *Shakespeare.*

"Cæsar could bear no superior, Pompey no equal." — *Lucan.*

Meanwhile events had been moving on at Rome. With Crassus dead, Cæsar and Pompey were left in the enjoyment of almost absolute authority. They had been friends from youth, but none the less rivals, and the death of Julia (B.C. 54) sundered the last ties that bound them together. In 52 Pompey had been made sole consul and found himself at the head of a party which, under cover of the constitution, was determined to destroy Cæsar that it might retain the power which his reforms threatened to place in worthier hands.

Cæsar's proconsulship of Gaul would expire at the end of B.C. 49. He wished to run for a second consulship in B.C. 48. The senate

resolved to prevent this, and commanded him to resign his office and disband his army several months before the expiration of his term. If they could once get him to Rome as a private citizen without an army, they knew they could crush him. Cæsar knew this too, and refused to obey the decree unless Pompey should also disband his troops. Pompey would have been willing to agree to this fair proposition, but his friends would not permit him, and were bent on destroying Cæsar. Naturally the charge of false play was made on both sides, and the strife continued until Cæsar was finally declared a public enemy. He therefore crossed the Rubicon, a small stream which formed the boundary of his province and the limit of his authority, and began to march towards Rome. He took but a single legion with him and continued his efforts to come to an understanding with the *Optimates*, having hopes of a compromise. He made a speech to his soldiers, explaining the situation, and was assured of their enthusiastic support. Labienus alone deserted him, corrupted, it is said, by Roman gold.

Cæsar's march through Italy was like a triumphal procession ; the cities opened their gates to him and he was everywhere hailed with enthusiasm. Among the *Optimates* there was nothing but consternation and fear. They had pinned their faith to Pompey, who had boasted that he had but to stamp his foot on the ground and legions would spring from the earth ready to obey him. He had vastly overrated himself (as was his wont), and had no conception of Cæsar's power and genius. Cicero well sums up the situation in a letter to his friend Atticus : "The consuls are helpless. There has been no levy. With Cæsar pressing forward and our general doing nothing, the men will not come to be enrolled. Pompey is prostrate, without courage, without purpose, without force, without energy." Pompey had been looked upon by his partisans as almost divine. He had been peculiarly fortunate throughout his career and had made a great military reputation by assuming the laurels that others had won. Mommsen says of him : "He was radically a commonplace man, formed by nature to make a good corporal, but forced by circumstances to be a general." Now that he was confronted by a really serious difficulty and by a really able man, he was paralyzed.

Pompey with his forces and accompanied by the senators fled in

a panic to Brundisium and sailed across the Adriatic to Epirus. Cæsar meanwhile continued his victorious advance, and in sixty days was master of Italy. Then he went to Spain, and before autumn closed had met and defeated all opposition there. Returning to Rome he made preparations to follow Pompey. Many prominent *Optimates* had fallen into his hands, but he let them all go free, to their own great amazement and to Cæsar's eternal praise. In a letter he says: "I will conquer after a new fashion and fortify myself in the possession of the power I acquire by generosity and mercy."

Cæsar followed Pompey across the sea from Brundisium, transporting his army in two divisions. He encountered considerable difficulty on account of storms and the lack of ships. After much skirmishing, anxiety, and suffering (on Cæsar's part), owing to scarcity of food and supplies, he fought a battle at Pharsalia in Thessaly on Aug. 9, B.C. 48. Before the battle Pompey's officers felt so sure of victory that a rich banquet was spread awaiting their return from the field. In numbers and equipment Pompey was much superior, and with him was all the wealth and respectability of Rome. He had 45,000 infantry and 5000 cavalry against Cæsar's 22,000 and 1000, respectively; but he was overwhelmingly defeated and the battle ended in a terrible panic and great slaughter, in which 15,000 men lost their lives. As Cæsar viewed the slain he said sadly: "They would have it so. After all that I had done for my country, I, Gaius Cæsar, should have been condemned as a criminal if I had not appealed to my army."

Pompey fled for his life and took ship to Egypt and was there murdered by the king, who hoped thus to win Cæsar's favor. When Cæsar arrived there, however, a few days later, and Pompey's head was presented to him, he is said to have turned away from the sight with horror and grief. He now overcame all remaining opposition in several short and brilliant campaigns. The first of these was in Asia Minor, where he conquered so easily that he reported it to the senate in the words that have since become famous: "*Veni, vidi, vici.*" By the battle of Thapsus in Africa (B.C. 46) and that of Munda in Spain (B.C. 45), the Pompeian party was finally crushed.

Cæsar now returned to Rome, where he was made *imperator*—possessing the entire *imperium*, or military dominion of Rome, not

of a single colony or province merely — and perpetual dictator (*dictator perpetuo*), which offices clothed him with all the political authority of the state. By the powers thus conferred he laid the foundations of the Imperial constitution, which was afterwards (B.C. 30) set in operation by his grand-nephew and adopted son, Octavianus, later known as Augustus. This scheme of government eventually became (as was possibly foreseen from the start) an hereditary monarchy, under the name and form of a republic. During the short period of Cæsar's rule he continued the good work of his first consulship and carried a series of measures of wise and practical statesmanship, such as the reform of the calendar, the regulation of the administrative system, and the policy of checks upon the abuses of the money power. He also planned extensive military expeditions against Parthia, Scythia, and Germany, and large public works and improvements, such as draining the Pomptine marshes and cutting through the isthmus of Corinth. With characteristic energy he accomplished much in a very short time.

But the possession of this exalted authority involved the utter overthrow of the constitution and necessarily excited alarm and jealousy among patriots and demagogues alike. Rumors were abroad that Cæsar was seeking to be king, a name detested at Rome since the foundation of the republic. His rivals were jealous, and not a few friends were disappointed at not having received as large favors as they thought they deserved. Many of his former enemies were bitter against him, because he had been magnanimous enough to forgive them. These feelings culminated in a conspiracy against his life. The leaders were Cassius, a violent and fearless man driven mad by jealousy and baffled ambition; and Marcus Brutus, who had no better friend than Cæsar, but who fancied that he must emulate his ancestor, Brutus the first consul, who expelled the Tarquins. Cæsar received many warnings of what was going on, but disregarded them all with his usual indifference to danger. The deed was consummated in the senate-house on the Ides of March, B.C. 44. The great dictator was struck down by false friends and fell, pierced with wounds, at the foot of Pompey's statue. This dastardly act received the condemnation it deserved, and few have dared to defend it on the ground of patriotism. Those concerned in it all

died violent deaths soon after. Both Brutus and Cassius committed suicide, the latter stabbing himself with the very dagger which he had used against Cæsar.¹

V. PERSON AND CHARACTER OF CÆSAR.

“Death makes no conquest of this conqueror
For now he lives in fame, though not in life.”—*Shakespeare.*

“Great Julius, whom all the world admires.”—*Milton.*

Suetonius describes Cæsar when a youth as tall, slight, and handsome, with dark piercing eyes, a sallow complexion, large nose, lips full, features refined and intellectual, neck sinewy and thick. He adds further that he was neat to effeminacy about his dress and appearance. Fond of athletics, he excelled in all manly sports, especially in riding. In danger he knew no fear and often performed acts of great personal daring. His health was vigorous until his later years, and he could endure an apparently unlimited amount of labor and hardship. Added years gave him a majestic and commanding presence without detracting from the grace and courtesy of his bearing. We judge him to have been a man of singular charm and of unusual personal magnetism.

Thanks to the peculiar skill possessed by the ancients in the art of portraiture, we have good reason to believe that we may see the great dictator as he was, from existing statues and busts. Two of the most noted of these are the busts in the British Museum (Fig. 47) and that in the Louvre (Fig. 1). The one in the Naples Museum (Fig. 78) is judged by competent critics to be conventional and not modelled after the living man. Those first mentioned are thought to be true to life. The one in the British Museum shows us Cæsar the statesman, the man of peace; the one in the Louvre, Cæsar the man of action, the martial hero.²

¹ For a vivid imaginative account of the conspiracy, see Shakespeare's "Julius Cæsar."

² On the portraits of Cæsar, see an illustrated article by Mr. John S. Ropes in *Scribner's Magazine* for February, 1887, and S. Baring-Gould's "Tragedy of the Cæsars," Vol. I.

What Alexander was to the Greeks, and Hannibal to the Carthaginians, that and much more was Cæsar to the Romans. The two former excelled all men of their times in war only ; but Cæsar had such extraordinary abilities in widely different directions that many regard him as the most remarkable man that history records. In whatever he did, he always did the best possible. He had the greatest diversity of gifts : as a student of language, he composed a treatise on grammar while crossing the Alps ; as an orator, Quintilian says he would have rivalled Cicero had he devoted his time to this art ; as a general, he has had no superior and hardly a peer ; and, above all, he was the greatest politician and statesman of his time. To his statecraft all his other acts are subordinate, and by this they should be interpreted.

Cæsar was too great a man to be without enemies. He has been accused of being a traitor to his country, who by a deep-laid scheme overthrew its constitution. He was undoubtedly ambitious for power, and he used it in making such changes in the constitution as were sorely needed to keep it from going to pieces ; but how far the acts by which he accomplished this desirable end were the result of a plan to further his personal ambition, and how far they were compelled by the stress of circumstances, we cannot judge. We do know, however, that he professed an earnest desire for peace, until he was driven into war by the hatred and perversity of his opponents.

He has also been accused of immorality, cruelty, and irreligion. It would be vain to maintain that Cæsar was a model of virtue in an age that was notoriously and openly wicked and profligate. We know that Cæsar was a man of perfect self-control, and that he was remarkable for extreme abstemiousness in eating and drinking. As for the rest, he was probably no worse than the average.

Doubtless he was cruel, judged by modern standards. He butchered without mercy thousands of defenceless men, women, and children. But we must remember that Cæsar was a Roman, of a people naturally cruel and careless of bloodshed, and, again, that he was dealing with Gauls and Germans, whom the Romans despised, and for whom he had not, nor could have, any feelings of sympathy or kindness. The doctrine of human brotherhood is something he never heard of. But, on the other hand, contrast with this his constant care

and anxiety for the welfare of his soldiers, his patience and forbearance with their mistakes, such as no modern commander has exhibited in his memoirs, and, above all, recall his mercy to his opponents in the Civil War, whom he freely pardoned and restored to honor and favor. Contrast Cæsar's dictatorship with the horrors of Marius and Sulla, and we cannot wonder that his clemency became famous.

That Cæsar was a skeptic is no doubt true. The age was skeptical and the learned classes no longer believed in the gods of their forefathers. What Cæsar's real beliefs were, or if he had any, we do not know. He often speaks of fortune as ruling in the affairs of men, and probably had some vague and dimly defined belief in a supreme power.

VI. CÆSAR'S LITERARY WORK.

As a man of letters Cæsar is hardly less eminent. His vast and massive intellect could hold in its grasp a great variety of subjects. He wrote on many different themes, such as philosophy, language, astronomy, and divination. Of all his books only his Commentaries on the Gallic and Civil Wars have come down to us in complete form. They stand as the best military history that was ever written. Their ulterior purpose was to justify him in the eyes of the world for the course he took in opposing the senate and the government. He does this rarely by argument, but by such a tactful and masterful collocation of facts that the unthinking reader feels himself persuaded that Cæsar could hardly have done otherwise.

The style of these memoirs is remarkable for directness, terseness, and simplicity. Cicero, one of the greatest masters of style, says of them, "I pronounce them indeed to be very commendable, for they are simple, straight-forward, agreeable, with all rhetorical ornament stripped from them as one strips off a garment." While the language is lucid, it is packed full of meaning, and even a good Latinist needs to read slowly and with deliberation that the full thought of each sentence may be gathered. Sometimes a whole sentence is crammed into an adjective or a participle. To translate into good English requires, therefore, frequent amplification.

Like all great men, Cæsar rarely speaks of himself. In his works he refers to himself in the third person and with such modesty and

impartiality that you would never suspect him to be the writer. He betrays his identity by three slips of the pen where he uses the first person. He never struts or poses for effect, not even when he is narrating sublime deeds of heroism.

Cæsar wrote his Commentaries in the midst of intense activity. They were jotted down as he journeyed and fought; mere notes, as it were, for future amplification. Hirtius says, "While others know how faultlessly they are written, I know with what ease and rapidity he dashed them off."

For us the Gallic War has a peculiar interest because it treats of the peoples with whom we are most familiar and from whom most of us derive our ancestry. It marks, in a sense, the beginning of modern history. Active, keen-sighted, and truthful, Cæsar gives us such insight into these nations as serves to explain many of their present political and social peculiarities.

VII. IMPORTANT EVENTS IN CÆSAR'S LIFE.

B.C. 100	Born, July 12th.
" 83	Marries Cornelia, the Daughter of Cinna.
" 80-78	Serves with the Army in Asia.
" 76-75	Studies Oratory at Rhodes.
" 68	Quæstor.
" 65	Ædile.
" 63	Pontifex Maximus.
" 62	Prætor.
" 61	Proprætor in Spain.
" 60	Forms the First Triumvirate.
" 59	Consul.
" 58-49	Proconsul in Gaul.
" 56	Meeting of the Triumvirate at Luca.
" 50	The Trouble with Pompey begins.
" 49	Crosses the Rubicon. Civil War begun.
" 48	The Battle of Pharsalia.
" 46	The Battle of Thapsus. Declared Dictator for ten years.
" 45	The Battle of Munda. Appointed Imperator for life.
" 44	The Conspiracy. Assassinated in the Senate House on the Ides of March.

II.

ROMAN MILITARY AFFAIRS.

I. THE ARMY AND ITS DIVISIONS.

- | | |
|----------------------------------|--------------------------------|
| 1. The Legions. | 4. The Engineers and Artisans. |
| 2. The Cavalry. | 5. The Artillery. |
| 3. The Auxiliaries. | 6. The Baggage Train. |
| 7. The Officers and their Staff. | |

II. THE STANDARDS.

III. THE MUSIC.

IV. THE LEGIONARY.

- | | | |
|-----------------------|--------------------|-----------------------|
| <i>a.</i> Enlistment. | <i>d.</i> Weapons. | <i>g.</i> Work. |
| <i>b.</i> Clothing. | <i>e.</i> Baggage. | <i>h.</i> Pay. |
| <i>c.</i> Armor. | <i>f.</i> Food. | <i>i.</i> Discipline. |

V. THE CAMP.

VI. THE MARCH.

VII. THE BATTLE.

VIII. THE SIEGE.

IX. THE FLEET.

I. THE ARMY AND ITS DIVISIONS.

I. The Legions.

The Roman legion corresponded to a modern Division, but was more an organic whole, since it was the smallest unit that had separate line officers. What its normal strength was in Cæsar's time we have no means of knowing; but a probable estimate puts it at 5000 men. The actual effective strength in the field, however, was usually much less, falling to 3000 men, as at the battle of Pharsalia (on Cæsar's own authority). This variation in number was due to the many absences from duty which always occur in a military organization, and to the losses incurred by the individual legions in previous campaigns. Losses in old legions were not usually made good by new recruits, but the latter were formed into new legions; hence the older the legion, the smaller usually its enrollment. The average effective strength of the legion in the Gallic War was probably near 3600 men.

The subdivisions of the legions were as follows :

1 legion = 10 cohorts of about 360 men each.

1 cohort = 3 maniples of 120 men each.

1 maniple = 2 centuries of 60 men each.

There were, therefore, 10 cohorts, 30 maniples, and 60 centuries in each legion. These divisions did not, however, like our companies, have special "commissioned officers," but were commanded by centurions who came from the ranks. The legions constituted the main body of the army and did most of the fighting, but there were other arms employed for various purposes (see below). The legions were designated by numbers, given in the order of their enlistment.

2. The Cavalry.

The cavalry (*equitatus*), originally of Roman citizens, was in Cæsar's time composed almost exclusively of recruits from subject or allied states. In Cæsar's army it was composed of Gauls, Spaniards, and Germans. There was no fixed ratio between the number of legionaries and cavalry. In the campaign against the Helvetians, Cæsar had 4000 *equites*, in the battle of Pharsalia, 1000; but the number of legions was the same in both.

The cavalry was divided into regiments (*alae*) of about 330 horsemen each; these were subdivided into 10 squadrons (*turmae*) of 33 horsemen each; and these again into 3 squads (*decuriae*) of 11 each. See Figs. 12, 13.

3. The Auxiliaries.

The auxiliaries (*auxilia peditum*) were infantry forces from allied and subject states. Cæsar nowhere gives the number of his *auxilia*, and it was doubtless as various as that of his cavalry. They were the light-armed soldiers (*milites levis armaturae*), the archers (*sagittarii*), and the slingers (*funditores*). See Figs. 30, 104, 105, 115. The best slingers came from the Balearic Islands, the best archers from Crete and Numidia. The light-armed soldiers wore no heavy armor and carried a light round shield (*parma*). The archers had neither corselet, helmet, nor shield. The latter they could not carry on account of their bows.

Cæsar placed little reliance on his *auxilia* for actual fighting, but used them for the most part to make a show of force and frighten the enemy (Bk. i. 51), and to assist in building fortifications. In engagements the bowmen and slingers were usually stationed on the wings (*alae*), and from this were called *alarii*.

4. The Engineers and Artisans.

The engineers and artisans (*fabri*) sometimes formed a separate corps under the command of a chief engineer (*praefectus fabrum*), and sometimes they were called from the ranks of the legions when their services were needed. Cæsar had a chief engineer, but no special body of men (cf. Bk. v. 11). They were employed in building bridges, ships, winter quarters, and in repairing weapons and equipments.

5. The Artillery.

Engines of war were not often used on the battlefield, where modern artillery forms such an important branch of the service, but mainly in the defence and assault of fortified cities or camps. They had a limited use also in the fleet (Bk. iv. 25).

We have no exact account of the construction of these engines. Cæsar almost always calls them *tormenta* (cf. *torquere*, to twist), a name which clearly points to the elasticity of twisted rope, sinew, or hair, for the source of their energy. They were of three kinds: *catapultae*, *ballistae*, and *scorpiones* (see Figs. 61, 75, 95). The *catapultae* shot great arrows in a horizontal direction, like a cannon; the *ballistae* hurled great stones or heavy blocks of wood through the air in a high curve, as a mortar throws shells. The range of these weapons was from 1500 to 2000 ft. A *scorpio* was a small catapult having a range of about 350 ft. It was an accurate and deadly weapon. Cæsar tells of one at the siege of Avaricum that marked and killed man after man in the same spot (Bk. vii. 25). The *tormenta* were usually served and kept in repair by the *fabri*, but as Cæsar had no such corps, they were probably in his army served by legionaries.

6. The Baggage Train.

The baggage of the army, except the packs corresponding to knapsacks which the soldiers themselves carried (*sarcinae*), was borne by horses and mules (*iumenta*), and in wagons. The latter, however, were used mainly by the traders (*mercatores*) and sutlers (*lixae*) that followed the legion. The baggage of each legion was by no means inconsiderable. It consisted of tents, blankets, tools, the *tormenta*, provisions, etc., and required no less than 500 pack-animals to a legion. The inconvenience and delay occasioned by the care of so much baggage caused the Romans to call it *impedimenta* (incumbrances), and a legion marching with its baggage was called *legio impedita*; when without, *legio expedita*. Along with the baggage train went a multitude of drivers, grooms, officers' servants, and other menials, all of whom are included in the general term *calones*. Most or all of these were slaves. See Figs. 14, 55.

7. The Officers and their Staff.

The superior officers were: (1) the commander-in-chief (*imperator* or *dux belli*). He possessed the *imperium* or supreme military authority by virtue of his office, but by etiquette first received the name *imperator* from his soldiers after his first victory. In Cæsar's case it was bestowed after his victory over the Helvetii.

(2) The *legati*. These were men of senatorial rank (i.e. who had once held a curule magistracy). They were appointed by the senate or the people on the nomination of the proconsul. The senate also determined the number that a general should have; Cæsar had ten. They often acted as ambassadors and made treaties, but their chief duties were military. Their powers were in no way independent, but derived from the general, who might put them in command of one or more legions or confer upon them the *imperium* in his absence (*legatus pro praetore*). In his battle with Ariovistus Cæsar placed a *legatus* at the head of each of his legions (Bk. i. 53), thus giving them an independent command, a practice which he afterwards continued to the great advantage of the service.

(3) The *quaestores* were officers elected by the people annually to administer the financial affairs of the provinces, one for each *imperator*.

They had charge of the military chest, and saw to the pay, clothing, shelter, and general equipment of the legions serving in their respective provinces. On occasion they exercised the military authority of a *legatus* (Bk. i. 53); they were the ancient equivalent of a modern quartermaster. Besides these general officers, there were attached to each legion six *tribuni militum*, who were probably originally in command of the legion. They were divided into three pairs, each pair taking command in its turn. In Cæsar's time they were no longer trained soldiers, but chiefly young men of equestrian rank, who went into the army for a year or two to get some military experience and thus begin their public career (cf. Bk. i. 39), so that ordinarily the legion had no proper commanding officers. Cæsar was not slow to see that these political and social favorites were not the men to lead his legions into battle, and he therefore introduced the lasting reform of transferring this duty to the *legati*, as mentioned above (cf. Bk. ii. 20; v. 1, 25, 47). Thereafter the duties of the tribunes became mainly administrative and judicial; they cared for the levying, the discharge, and the equipment of the troops, and for the army supplies, under the orders of the *quaestor*; and they presided at courts-martial and took part in the councils of war. Sometimes they led the legions on the march and received subordinate military commands (cf. Bk. vii. 47, 52).

Surrounding the superior officers there was always a large number of young men, forming a kind of staff, who acted as orderlies and body-guards. The only officers "of the line" were the tribunes, and, as appears above, their command was limited.

The real leaders of the men were the inferior ("non-commissioned") officers, the centurions. Corresponding to sergeants and corporals, these were always plebeians, often of the lowest birth, who were promoted from the ranks entirely on account of their fighting qualities, and could never rise higher. There were two centurions in each maniple, making six for each cohort and sixty for the legion. The six centurions of the first cohort outranked the others and were called *centuriones primorum ordinum*, and were the only ones that ordinarily sat with the superior officers in the council of war. The first cohort always contained the flower of the legion, and the men in the first century of this cohort excelled all the others. Their leader,

the first centurion of the whole cohort (*primus* or *primipilus*) and so of the whole legion, must needs be a man of great personal prowess and skill, an actual fighter, one to whom all could look as to a model soldier. Such was, for example, Publius Sextius Baculus, who repeatedly deserved the praise of his general (cf. Bk. ii. 25 ; iii. 5 ; vi. 38), and Titus Balventius (*vir fortis et magnae virtutis*, Bk. v. 35). As a badge of his office the centurion carried a short staff (*vitis*), but he was armed much like the other soldiers (see Fig. 40).

The chief distinction in dress between the officers and men was the red *tunica militaris* worn by the legates and tribunes, and the purple cloak (*paludamentum*) worn by the general (Bk. vii. 88). The officers wore also coats-of-mail of gilded bronze (see Fig. 86).

Between the centurions and common soldiers in rank were the *speculatores*, *evocati*, *beneficiarii*, *aquiliferi* or *signiferi*, and *bucinatores*, *tubicines*, or *cornicines*. The *speculatores* or scouts obtained news of the enemy and carried despatches. The *evocati* were veterans who had completed their term of service, but remained in the army at the request of their commander. The *beneficiarii* were soldiers that had received some gift or privilege for meritorious service. The *signiferi* or *aquiliferi* were the standard bearers: soldiers selected for their courage and fidelity. The *bucinatores* and *tubicines* were the musicians. All of these had rights and exemptions not enjoyed by the common soldiers. See Figs. 39, 84, 114.

II. THE STANDARDS.

The term *signa* is applied in a general sense to all the standards of the army. That of the legion was an eagle (*aquila*), usually of silver or bronze, about the size of a dove, on a wooden staff. It was sometimes carried by the chief centurion (*primipilus*) of the legion. Sometimes it had below it a little red or white banner (*vexillum*), inscribed with the number or name of the legion. See Figs. 13, 121, 123.

In a narrower sense, *signum* was used for the standard of the cohort or the maniple. Each cohort had its own *signum* (Bk. ii. 21), and in earlier times each maniple, but probably not in Cæsar's day.

The cavalry and light-armed troops and all separate detachments carried only the *vexillum* (Bk. vi. 36). The general's flag at headquarters was also called *vexillum*. It was a large white banner with an inscription in red, giving the name of the general and that of his army. A large red *vexillum* displayed at headquarters was the signal for battle (Bk. ii. 20). See Fig. 70.

III. THE MUSIC.

The difficulty of carrying the voice through the din of battle early led the Romans to use the penetrating tones of brass instruments for giving orders. The four instruments used by them were the bugle (*bucina*), the trumpet (*tuba*), the cavalry trumpet (*lituus*), and the horn (*cornu*). See Figs. 36, 37, 38, 84.

The *bucina*, whose shape and appearance are uncertain, sounded the changes of the night-watch and the reveille in the morning. The *tuba*, a straight trumpet of brass more than three feet long, with a bell-shaped mouth, gave the signal for attack or retreat, the signal being taken up and repeated by the *cornu*. The latter was a circular-shaped instrument which the performer often placed about his neck. The *tuba* had a deep tone; the *cornu* a sharper one. The general's call to an assembly (*contio*) was the *classicum*, sounded by all the instruments at once.

IV. THE LEGIONARY.

a. Enlistment. — The legion was composed of Romans only. Citizens were liable to conscription between the ages of seventeen and forty-six. The recruit must be of sound health and of suitable height. The Romans, as a rule, were rather undersized. Cæsar expressly mentions the small stature of his troops as compared with that of the Germans (Bk. i. 39; ii. 30); but the Romans had learned the lesson of civilization, — that victories are gained not by huge bones and big bodies, but by trained skill and scientific tactics. Man for man, the Germans were doubtless more than a match for the Romans; but against the organized and disciplined legion — the most effective machine for battle that the world had yet seen — they were almost

powerless. The term of service was twenty years, and after this the veteran was discharged with enough to provide for his old age. Often he reënlisted for farther service (*evocatus*).

b. Clothing. — All the legionaries were clothed alike. Next the skin was a nearly or quite sleeveless woollen shirt (*tunica*), reaching nearly to the knees; over this a leathern coat strengthened by bands of metal across the breast, back, and shoulders (*lorica*). In cold or wet weather the soldier wore about him a wide woollen mantle (*sagum*), which was fastened by a clasp (*fibula*) on the right shoulder, leaving the right arm free. At night the *sagum* served as a blanket. About his waist was a leather belt (*cingulum militiae*), bound with metal and with strips of metal hanging from the front as a protection to the lower part of the body. His feet were covered with strong half-boots (*caligae*). This might be called his undress uniform. See Figs. 107, 115, 126, etc.

c. Armor. — The defensive armor consisted of a coat-of-mail (*lorica*, described above), a helmet, and a shield. The helmet (*galea* or *cassis*), of iron or of leather strengthened with brass, was open in front and adorned with a white crest, which was one of the *insignia* put on at the beginning of a battle (Bk. ii. 21). See Fig. 87, etc. The shield (*scutum*) was rectangular, about four feet long and two feet wide; it was made of wood slightly curved, and covered with linen and heavy leather. About the rim it was bound with metal, and also in the centre. There was a single handle on the inside and opposite it on the outside a boss or knob (*umbo*) of metal, to divert missiles and to strengthen the whole. A common device on the outside was a winged thunderbolt. See Figs. 116, 117, etc.

d. Weapons. — The weapons of offence were the sword and spear. The sword (*gladius Hispanus*) was about two feet long, straight and two-edged. It was used more for thrusting than for striking, and was not usually hung from the body-belt, but from a belt passing over the left shoulder to the right hip (*balteus*). See Figs. 17, 115, etc.

The spear (*pilum*) of Cæsar's soldiers was between six and seven feet long. The shaft was of wood and about four feet long. Into this was fitted the slender iron shank that ended in a barbed head. From monuments and from remains that have been found in various places, the weight is estimated at about three pounds and the

hurling distance about 100 feet. Each legionary had one of these weapons. See Figs. 15, 107.

e. Baggage (Packs). — Besides his arms and armor, the legionary carried tools for digging, cooking utensils (*vasa*), food for at least two weeks (*cibaria*), his cloak or blanket (*sagum*), and usually one or two stakes (*valli*) for the rampart of the camp. The weight of the whole was about sixty pounds. For convenience in carrying, the *vasa*, *cibaria*, and other small articles were tied in a compact bundle to the end of a forked stick and carried over the shoulder. During a halt this rested on the ground and the soldier could lean on it for support. Upon a sudden call to battle he could quickly lay it down and be ready (*expeditus*) for the fray. The forked sticks were named Marius's mules (*muli Mariani*), after the great Marius who introduced their use. The collective personal baggage of the legionary was called his *sarcina* (see Figs. 14, 115).

f. Food. — The food provided for the legionary was coarse flour or unground wheat or barley. This he must grind for himself. The ration of food for one day was about two pounds. Every fifteen days he received two *modii*, — about two pecks. This monotonous diet was varied occasionally by meat and such food as he could find by foraging; and there was always the chance of bartering his rations for the greater variety carried by the traders (*mercatores*), who followed the army in large numbers and did a thriving business with the soldiers.

g. Work. — It has been truthfully said that Cæsar conquered Gaul as much with the spade and shovel as with the sword and spear. The legionary was above all a skilful digger, and besides the actual fighting, no small part of his labor was the almost daily task of fortifying the camp (*castra munire*). At least three hours were needed for this work. After this there were the watches to keep, the arms to burnish, and all the other busy routine of camp life.

h. Pay. — Cæsar paid his legionaries 12½ cents a day or about \$45 a year. This was nearly the same amount that a day laborer could earn at Rome. The soldier was better off than the laborer merely by his shelter and by the certainty of employment. A deduction from the pay was made for food and equipments furnished by the state. Food, however, was very cheap, and a soldier in active

service could always expect a considerable increase in his income from booty and from the gifts of his general.

i. Discipline.— The martial spirit of the soldiers and their attention to duty were maintained and increased by appropriate rewards and punishments. Among the latter the most usual were withholding of wages, degradation in rank, corporal punishment, dismissal from the service, and, in cases of flagrant offences, death. A minor offence committed by a company of soldiers was punished by putting them on barley rations and giving them extra work on the fortifications. Among rewards may be mentioned public praise in the presence of the army, promotion in rank, increase in wages, or the presentation of a crown of leaves or grasses, which corresponded to the bestowal of a modern military decoration.

V. THE CAMP.

The success of Roman arms in hostile and barbarous countries was largely due to the custom of guarding against surprise by making fortified camps. The summer camp (*castra aestiva*) and the winter camp (*castra hiberna*) seem to have been alike in all essential features. In the latter, however, more provision was made for the comfort and convenience of the men. Instead of tents, huts of timber and earth, thatched with straw or covered with hides, were provided for them. The camp was regularly in the form of a square, often with rounded corners, but the lay of the land necessitated many variations from the regular plan (see Fig. 119). Of all the camps of Cæsar that have been discovered, but one, that on the Aisne (Bk. ii. 5), approaches a square form. The site was chosen with great care, and was always on high ground and near wood and water. An ideal spot was the slope of a hill with some kind of natural defence on the sides and rear, and with sufficient ground in front for the array of the legions. Such a position would give the Romans an opportunity for their favorite onslaught *e superiore loco* (cf. Bk. ii. 8; Bk. v. 50).

A small force of soldiers under centurions was sent ahead to select the site for the camp and stake it out. Two bisecting lines were drawn at right angles to each other to mark the four gates (see Fig. 119): the *porta prætoria*, facing the enemy; the *porta decumana*,

in the rear; the *porta principalis dextra*, on the right side; the *porta principalis sinistra*, on the left. Between the gates on the right and left ran a broad street, the *via principalis*. The forward half of the camp was allotted to the soldiers, the rear half to the officers and their attendants. All about the inside of the fortifications ran a broad space, at least one hundred feet wide, left vacant for baggage, evolutions of troops, and to protect the tents within from missiles that the enemy might hurl over the walls. Near the middle of the camp was an open square (*praetorium*), in which stood the general's tent (*tabernaculum ducis*). Before this was the altar on which he sacrificed, and on the left was a sodded mound of earth (*tribunal* or *suggestus*; cf. Bk. vi. 3), from which he pronounced judgment and addressed the assembled soldiers. The full details of the interior arrangement of Cæsar's camp are not known; but every officer, every cohort, every maniple, every man had his appointed place.

No night passed that the army was not housed in such a camp, fortified by wall and ditch. As soon as the soldiers arrive at the spot marked out for them, laying aside helmet, shield, and spear, they begin to dig the ditch (*fossa*), the earth from which is used in constructing the wall (*vallum*). If time permits, the sides of the embankment are covered with sods to hold the earth, or with bundles of brush (*fascines*). The ditch was usually nine feet wide and seven feet deep, the wall six to ten feet high, and wide enough on the top to afford good standing room for a soldier in action. An ordinary camp for a night's sojourn could be fortified in about three hours. If the camp was intended for more than one night (*castra stativa*), the fortifications were made stronger. The earth was made firmer by imbedding in it several lines of fascines parallel to the length, and on its top was set a breastwork of stakes (*valli* or *sudes*; cf. Bk. v. 40; Bk. vii. 72). This breastwork was about four feet high (see Fig. 118). Often wooden towers were erected on the walls (cf. Bk. v. 40; Bk. vii. 72), connected by galleries (*pontes*). The wall was made easy of access on the inner side by steps of brush. Sometimes small redoubts (*castella*) were built at a distance from the main camp. These were made on the same general plan.

After the camp had been fortified and the leathern tents (*tentoria*, *pelles*) put up in their assigned places, guards were set at the gates, and the regular routine of camp life began.

VI. THE MARCH.

When the trumpet gave the signal (*signum profectionis*) to break up camp (*castra movere*), the soldiers struck their tents and packed their baggage (*vasa conligere*); at the second signal the baggage (*impedimenta*) was put on the pack-animals and in the wagons; at the third signal the army (*agmen*) began its march. The start was made usually at sunrise, but it might be made earlier on special occasion. The ordinary day's march lasted about seven hours, and covered about 15 miles; a forced march (*magnum iter*) about 25. Cæsar made many such, his men travelling immense distances with incredible swiftness.

When marching in the enemy's country, the main body of troops (*agmen*) protected itself by a vanguard (*agmen primum*) of cavalry, light-armed infantry, and scouts (*exploratores*), and by a rear guard (*agmen novissimum*). Sometimes individual spies (*speculatores*) were sent far in advance to reconnoitre the country and the movements of the enemy's forces.

The order of march of the main body depended on the nearness of the enemy. When no enemy was near, each legion marched in a single column and was followed by its baggage train (see Bk. ii. 17). In the neighborhood of the enemy, a single column of troops in fighting trim (*expediti*), i.e. without packs (*sarcinae*), followed directly after the vanguard; then came the baggage of the whole army, while the remaining forces acted as a rear guard (cf. Bk. ii. 19). Sometimes, for additional security against flank attacks, columns of infantry marched on each side of the baggage train, forming a hollow square (*agmen quadratum*; see Fig. 73). If, when marching in this order, the army was compelled to halt and defend itself, the soldiers, by facing about, presented to the foe a complete circle (*orbis*) of armed men. When the foe was near and the ground level and open, the march was sometimes made in three parallel columns, which, by a simple evolution, could be quickly changed to the triple battle line (*acies triplex*), the regular formation for an engagement.

Streams were crossed either by fords or bridges. Romans could cross deeper fords than we, for they had no powder to keep dry

(cf. Bk. v. 18). Sometimes a line of cavalry was sent across the stream to break the force of the current (cf. Bk. vii. 56). Bridges were usually very simple affairs of logs covered with earth and brush, or of boats, but Cæsar's masterpiece of military engineering was his roadway forty feet wide with which he twice spanned the Rhine (Bk. iv. 17 ; Bk. vi. 9 ; see Figs. 59, 80).

VII. THE BATTLE.

As has been said (V), the camp was so chosen that the ground in front of it would be suitable for battle. The usual order of battle was *triplex acies*. The first line of the legion was formed of four cohorts and each of the others of three. In each cohort the three maniples stood side by side, and in each maniple the two centuries stood one behind the other, varying in formation according to the depth of the line. As to the distance between the lines we have no definite information ; nor even as to whether spaces were left between the cohorts. There were probably spaces between the different legions and doubtless between the centre (*media acies*), where the legionaries stood, and the wings (*cornua*), composed of auxiliaries and cavalry. Cæsar's lines were probably eight men deep. That would give each legion, estimated at 3600 men, a front of 180 legionaries, 45 for each cohort. When standing in open order for fighting, giving to each man the space necessary for the free use of his weapons, the front of each legion covered probably about 1000 feet, supposing the cohorts to stand close together ; all this, however, is very uncertain.

When an attacking enemy had reached the right distance, the bugle sounded the charge, and the legions rushed forward, sword in sheath, and the front ranks with spears uplifted ready to hurl. When within range, the spears were thrown in a shower, the swords drawn, and a fierce charge made upon the mass of the foe, more or less disordered by the volley of spears. Along the front of the cohort rages a series of combats. The rear ranks press forward, throw their spears over the heads of their comrades, and take their places as the latter are wounded or weary. When the first line of cohorts has done its best, it makes room for the second line, re-forms, and gets breath for a new onset. Thus the battle goes on with the two

lines in almost constant motion. The enemy are given no rest and are worn out by the repeated charges of the cohorts. The third line, however, is held in reserve, and is brought into action only in case the other two prove insufficient.

The cavalry in the rear, or on the wings, stand ready when the enemy break and flee to ride down the fugitives and cut them to pieces.

There were times when troops had to be arranged in special formations. The most important of these were the *cuneus*, or wedge, the *testudo*, or tortoise, and the *orbis*, or circle. The first was an attack in column instead of in line, and was of use in cutting through and dividing an opposing battle line. The second, in which the shields overlapped above like shingles on a roof, was used especially in approaching and storming walls, or whenever the enemy were to be driven from a higher position (cf. Bk. ii. 6; see Fig. 68). The last formation was like a modern hollow square with officers in the centre—except that from the character of ancient fighting it was rather circular than rectangular. It was necessary when the attack came from all sides at once (see Bk. iv. 37).

VIII. THE SIEGE.

The Romans excelled in the art of taking walled cities, and this skill gave them an immense advantage in their warfare with semi-barbarous and ignorant peoples. There were three methods of doing this: first, by an immediate attack (*oppugnatio repentina*); second, by an active siege, brought to a close by an assault (*expugnatio*); third, by investment and blockade (*obsidio*).

If there seemed to be a chance of success, a city was stormed at once with no formal preparation (*ex itinere*). Its defenders were driven from the walls by a shower of missiles (Bk. iii. 25); the moat was filled with brush and earth; the assaulters with shields locked in a *testudo* attempted to break open the gates or scale the walls with ladders.

If this method proved unsuccessful or impossible, a regular siege was begun. The work of a regular siege centred about the mound or *agger*, and to its construction everything else was subordinated.

It was begun at a distance from the wall, very nearly out of reach of the missiles of the enemy. It was then gradually extended in the direction of the point to be attacked, and was at the same time gradually increased in height until on a level with the top of the wall, or even higher. At Avaricum the mound was 80 feet high (Bk. vii. 23-28). Its width was possibly 40 or 50 feet. It was made of earth and timber, and had connected galleries running through its various stories, through which the soldiers could move under cover (see Fig. 120). The men engaged in constructing the *agger* had to be protected from the enemy. Those who were building worked behind lines of *plutei* (see Figs. 130, 131), large standing shields, which were moved forward from time to time as the *agger* progressed. Those bringing material for the builders walked under rows of sheds called *vineae* (see Figs. 33, 120), extending the length of the *agger*. The workmen were protected also by archers and slingers and by engines of war (*tormenta*) standing behind lines of *plutei* or upon movable towers (*turres*). The latter stood on the *agger* or on either side of it, and advanced with it, and as they advanced increased in height story by story. As the workmen get nearer the wall the *plutei* will no longer protect them. Then they find refuge under strong sheds of wood called *testudines* or *musculi*, placed at the ends of lines of *vineae*.

When the mound has reached the wall, a breach is made through it for the final assault (*expugnatio*). Sometimes this was accomplished by undermining the wall, or it was pulled down from the top with huge iron hooks (*falces murales*). But the most common and most effective means was the battering ram (*aries*), a huge swinging beam from 60 to 100 feet long with a heavy mass of metal at one end, often shaped like a ram's head. This under a *testudo*, or in the lowest story of a tower, was brought with tremendous force against the opposing masonry. When the final assault was made, soldiers rushed in from every quarter, over the mound, through the breach, and from the movable towers, from whose highest stories draw-bridges stretched to the walls.

Against these forms of assault the inhabitants used such means of resistance as they could. The most effective were masses of stone, thrown from the wall upon the works, and fire. To guard against

the latter, the besiegers had to cover all exposed woodwork with green hides. Battering rams and mural hooks were caught in slings and held fast, or drawn into the city, and mines were met by countermines. See Figs. 92, 93, 127.

When the location of the place was such that it could not be taken by such a siege as that described above, it was invested on every side (*obsidio*) and the inhabitants starved into submission. Among sieges of this kind were those of Gergovia (Bk. vii. 44-53) and Alesia (Bk. vii. 72-80), of which the last was one of the most remarkable of ancient times; see Figs. 97, 102.

IX. THE FLEET.

Cæsar mentions two principal classes of ships: *naves longae*, or war galleys, and *naves onerariae*, or freight and transport vessels. As compared with the former, the latter were shorter, broader, and deeper; hence could carry greater burdens and were more seaworthy. They depended mainly on their sails, but often had rowers in addition. The *naves actuariæ* of Bk. v. 1 were a special class of transport vessel, with both sails and oars. Cæsar used them to carry troops, horses, and munitions of war to Britain. See Figs. 48, 51, 52.

The war galley was long, low, and narrow; armed at the prow with a sharp beam (*rostrum*) shod with bronze, for ramming the enemy's ships; and propelled by one or two sails and a large force of rowers. The seamen (*nautæ*) attended to the steering and the managing of the sails, and were freemen. The rowers (*remiges*) were usually slaves. Galleys in Cæsar's time mostly had three banks of oars. The steering apparatus was two broad-bladed oars near the stern, one on each side. The speed of these vessels was remarkable, almost equalling that of a modern steamship.

The fighting men were the legionaries embarked for the purpose. In fact, there was no distinct naval service, as with us. A fleet was simply an army afloat, and was commanded by military officers. Before going into action *tormenta* were placed on the deck, and also a *turris*; the mast was taken down and the sails and tackle housed. See Fig. 62.

III.

GAUL AND THE GAULS.

I. THE GALLIC PROVINCE.

THE district upon whose government Cæsar entered in the spring of B.C. 58 consisted primarily of the two Gallic provinces, Cisalpine and Transalpine. Cisalpine Gaul was the northern portion of Italy, which several centuries earlier had been occupied by invaders from Gaul proper, and was not yet reckoned politically as a part of Italy; it was a wealthy, populous, and orderly country, the proconsul's main dependence for troops and supplies, and his regular winter residence. Transalpine or Narbonnese Gaul received its name from its capital, the Roman colony Narbo. It contained some thriving cities and peaceful districts; but as a whole it had been but recently brought under the authority of Rome, and was still essentially a foreign country. It comprised the whole coast of the Mediterranean from the Pyrenees to the Alps, having for its northern boundary an irregular and uncertain line, which separated the territory of the conquered nations of Gaul from the states which were still free. To these two provinces was added also Illyricum, which was a source of strength, but did not receive much of his attention.

The authority of the governor over his province was that of a military commander, whose power was not limited by the laws which protected the citizens of Rome. A few privileged cities or nations, such as the old Greek city Massilia, were wholly exempted from his authority; but all other parts of the province, including Roman colonies like Narbo, were liable to tribute and under the jurisdiction of the governor, though the rights of Roman citizens were secured to them. A consular army consisted regularly of two legions; to these were added auxiliaries, both foot and horse, but the governor had power to levy new legions as he required them. Thus we find that Cæsar had six legions in his campaign against the Nervii.

The free territories adjoining a Roman province were in no respect under the authority of the governor; but they were regarded as a legitimate field for his ambition, if there was any excuse for war, and

of such excuses there was usually no lack. The Roman policy was to enter into friendly relations with one of the parties or tribes in the free territory, load this with favors and privileges, and make use of it to overcome its rivals; in Gaul the Haedui, attached to Rome through some local rivalries, very well served this purpose.

Cæsar's province, at its western extremity, reached to Spain, a country which had belonged to the empire for more than a hundred and fifty years. To the north lay four great nationalities, with all of which he was ultimately brought in contact. These were the Gauls proper, the Belgians, the Germans, and the Britons.

Free Gaul (*Libera Gallia*) at that time consisted of all the unsubdued territory between the Pyrenees and the ocean on the one side, and the Rhine and the Alps on the other, thus comprising, in general, modern France and Belgium, with parts of Holland, Germany, and Switzerland. The central portion of this territory, fully a half of it in extent and population, was occupied by the Gauls proper, or, as they called themselves, Celts, no doubt originally the same word. Southwest of these were the Aquitani, a separate people of Iberian race, cognate to the Spanish; of these, the Basques of the present day are the representatives. To the northeast lived the Belgians, whose ethnic affinities are much disputed; all that can be considered certain is that they were largely mixed with Germans. The Belgians occupied more territory than is now known as Belgium, including a considerable part of Holland on the one hand, and the northern belt of France on the other.

2. THE GALLIC PEOPLE.

a. Origin and Early History. — The Gauls were a branch of the great nations of the Indo-European family that in prehistoric times occupied parts of Asia and the greater part of Europe. They were known to the ancients as Celts or Gauls, and this name was applied without discrimination to all the barbarous peoples of the unknown west of Europe. The term was rather geographical than racial. The Romans, though they had been brought into contact with the barbarians of the north by war and commerce for many centuries, made no distinction, before Cæsar's time, between German and Gaul.

The Phœnicians, those pioneer traders and intrepid sailors of antiquity, had had commercial dealings with the Gauls at a very remote period. Several centuries later, but still at an early date (about B.C. 600), the Greeks had made a settlement near the mouth of the Rhone, which afterwards grew into the prosperous city of Massilia (Marseilles), and opened up some trade routes into the interior. Both Phœnicians and Greeks found the most powerful part of the Celts already well established in western Europe, and showing evidence of previous possession for a period going back of any assignable date.

The Celts had been for centuries a migratory and always a warlike people. These characteristics led them into many countries where they made settlements of more or less importance. Besides those who occupied Gaul proper, there were Iberian Celts (Celtiberi) in Spain, British Celts, Belgic Celts, Italian Celts in northern Italy, Celts in the Alps (notably the Helvetii), Illyrian Celts, and Asiatic Celts, who had settled in Asia Minor and were known as Galatians. It was to them, after they were Christianized, that Paul wrote his well-known epistle.

What knowledge the Greeks and Romans had of this powerful nation of barbarians was extremely vague. They had long hung like a dark storm-cloud on the northern frontier of both countries, and at intervals poured forth in overwhelming and destructive numbers. Once they spread desolation and dismay through Greece, and all but succeeded in plundering the rich temple of Delphi. In B.C. 390 Rome was destroyed by these same barbarians, and in B.C. 102 it was only the military genius of C. Marius that spared Italy a similar visitation.

Long before the time of Cæsar, the Romans had succeeded in subduing the Gauls south of the Alps, making the prosperous and orderly province of Cisalpine Gaul, as related above. Transalpine Gaul and Illyricum were more recent additions to the empire, and were less thoroughly subdued and civilized. They had been finally conquered by Q. Fabius Allobrogicus. All to the north had as yet been unexplored and uninvaded by Roman arms. The Gauls, according to circumstances and location, showed at this time various degrees of civilization. Those to the south and west, being nearer to the refinement of the province, had made rapid strides, had built many

flourishing cities, enjoyed prosperous and on the whole peaceful community life, and practised the arts and commerce. But those farther removed in the east and north, and the Britons, were still in a semi-savage condition. Cæsar's expeditions among these are somewhat like similar military expeditions that nations are sending in our day to explore and subdue unknown Africa; and the trading posts established among them by the enterprising Greek merchants of Massilia, like the business ventures formerly sent among the Indians.

b. Character and Customs.—The Gauls are described as tall and of great physical strength, with a fair skin and blonde hair, which they often reddened by artificial means. Men of rank and of authority wore the hair and beard long. The more barbarous tribes gave themselves a terrible aspect by painting hideous devices on their half-naked bodies. Their voices were rough and harsh, their words few, and their language obscure and figurative. Disparaging others, boastful of themselves, arrogant, fond of idleness, they were very quarrelsome and always ready to fight, to relieve the monotony of their existence, if for no other reason. They were, however, high-spirited and brave to utter recklessness and contempt for death.

The Gallic women are described by an ancient writer as the most beautiful of all barbarian women and as thrifty housewives. He adds that, aided by his wife, who is much more formidable than he, the Gaul will hold his own in any conflict. The Roman invaders were often witnesses of the heroism of these veritable Amazons.

The Gauls lacked stability of character, and are often criticized by Cæsar for their fickleness; they were also very avaricious and given to superstitions. On the other hand, they were not vicious, but naturally of a simple and teachable disposition. They were very quick to learn and adopt whatever useful arts their neighbors brought to them. Their love of freedom was passionate; but their long years of wandering had not developed in them that feeling of national unity and that love of the soil that we include under the term patriotism.

The life of the less civilized tribes was rude in the extreme. Their houses were little more than huts of clay and wood, thatched with straw and branches. The dwelling was open to daylight by the door

alone, and had little or no furniture. Their beds were heaps of straw or furs. War was their principal occupation. They gave some attention to agriculture, raising the coarser grains, the better sort of fruits and vegetables being unknown to them. They also had large flocks and herds. They ate but little bread, but large quantities of meat, which they are described as cutting with their swords and eating in a ravenous manner.

The Gauls knew something of the arts and sciences. They did some weaving, and those on the coast had skill in shipbuilding and in navigation, and the Aquitanians were skilful miners. Their attempts at art were mainly imitations of what other lands brought to them. For example, they made more or less successful attempts to imitate the artistic coins of the Greeks and Romans. Several illustrations of Gallic coins may be found in the text (see Figs. 29, 64, 66, 81, etc., etc.). Cæsar was the first to bring to the world authentic information about most of these matters, and the student is referred for farther interesting details to his narrative (see especially Bk. vi).

c. Dress. — The details of Gallic dress are not fully known. Like most semi-civilized or savage people, they were very fond of bright colors and finery. They wore much jewelry — both men and women — of gold, if they could afford it, otherwise of bronze. Especially characteristic was the heavy collar of twisted gold (*torquis*, see Fig. 77), worn about the neck. The principal garments were a short, bright-colored tunic, either with or without sleeves, confined by a girdle of silver or gold, and trousers (*bracæ*). Over the shoulders was worn a short cloak (*sagum*) often of fine material and of gorgeous color. The character of the costume depended upon the rank and wealth of the wearer. The feet were protected by shoes or by soles of wood strapped on with leathern thongs. See Fig. 28.

d. Arms and Military Tactics. — As has been said, a Gaul's chief business was war. He was always a soldier and, whether in youth or in old age, hastened to war with the same ardor. His principal weapon was a long two-edged sword, hanging from an iron or steel chain at the right side. It was adapted for striking and cutting, but not so much for thrusting, and was but poorly tempered. This in itself gave the Romans a great advantage through the superiority of their arms. The Gallic bronze sword came into use later,

and was a much better weapon. In Cæsar's time the iron sword probably still predominated. They had also various kinds of pikes, lances, and javelins, some made with peculiar waving and twisted blades to cause an uglier wound. Many weapons are mentioned with special names, but they are not capable of identification. Bows and slings, too, were used by them.

Ordinarily the Gaul wore no defensive armor. In fact, the common soldier went into battle with body almost bare. But the principal warriors wore chain mail (see Fig. 86), which is said to be a Gallic invention. At first this was made of iron. Later, better and lighter suits were made of bronze, and were sometimes adorned with silver and gold. The usual means for defence were the helmet and the shield. Shields were of various shapes and sizes and were adorned with figures of animals, etc., to suit the caprice or wealth of the owner, but the designs were of ancient origin. The helmets were surmounted with great horns, forms of birds or beasts, etc., designed to terrify the enemy (see Fig. 11). These also were, no doubt, survivals of earlier barbarism.

In battle they placed much reliance on their cavalry and in Northern Gaul and Britain on their war chariots. The infantry was arranged in great masses of men in close order, like the old Greek phalanx, with a line of shields before and on the sides, and sometimes with a roof of shields overhead, something like the *testudo* formation of the Romans. When they had drawn near, champions were accustomed to leave the ranks, and, brandishing their arms, challenge the foe to single combat. The first onset of the Gallic phalanx was terrific and often swept everything before it; but if that could be withstood, the advantage lay with the open and pliable order of the legion. In the latter every soldier was called into action, but in the former the great bulk of the Gallic warriors was practically imprisoned in the mass, and only those on the outside could use their arms.

e. Government. — The Gauls were not a single nation, but a group of nations or tribes, about sixty in number, united by a very slight bond of consanguinity and common religion. These tribes, which may be loosely compared to those of the North American Indians, though most of them were at a very much higher degree of civilization, varied greatly in extent and power, the smaller ones often main-

taining only a nominal independence under the protection of some larger one. They were for the most part ruled by a turbulent and oppressive aristocracy, sometimes with an elected chief magistrate. But sometimes an ambitious leader, like Orgetorix, succeeded in establishing for a time a kingly power. Thus the several states were torn by hostile parties, and were at the same time grouped into national factions, under the lead of the more powerful states. At the time of Cæsar, royalty had been almost abolished, and yearly magistrates (*vergobrets*) were elected instead. Every year representatives from the different states met in assembly, and questions of national policy were discussed. Owing to the violent and excitable natures of the Gauls, these assemblies often ended in tumultuous scenes of disorder.

At the commencement of war, a call to arms was sounded, to which old and young responded. The last man to appear was put to death with tortures in the presence of the assembled people.

f. Religion.—*The Druids.*—Cæsar says that the Gauls were devoted to religious matters. They were under the control of a class of priests known as Druids, who acted not only as priests, but also as arbiters and judges. By them was treasured the religious and philosophic lore of the Gauls, and to them the Gallic youth went for instruction, some of them remaining in training as long as twenty years. One of their most important doctrines was that of the transmigration of souls. Belief in immortality gave the Gauls a contempt for death which enabled them to face the greatest dangers without finching.

The Druids gave their instructions and performed their bloody sacrifices in the depths of the forest. The oak and the mistletoe were sacred in their eyes. The mysterious rites of their worship are not well known, but many cruel and horrible practices are attributed to them by ancient writers, among them human sacrifices. Cæsar mentions these, but did not know of their actual occurrence from personal observation.

The principal religious observances of the Gauls were gradually abolished under Roman rule, but many of them were 'baptized' into Christianity and survive to-day in various modified forms as a part of the popular religion.

The strange monuments of stone found in many lands, called 'cromlechs' and 'menhirs,' popularly supposed to be Druidic monuments, are far older than the Druids and have nothing to do with their religion.

Cæsar gives the first authentic information about the Druids in his narrative (Bk. vi. 13-16).

3. SUBSEQUENT HISTORY OF GAUL.

Cæsar left Gaul subdued and open to Roman occupation and greed. The country was rapidly colonized and civilized. Augustus divided it into four provinces and established the Roman authority on a firm basis. Only one great patriotic uprising occurred after Cæsar's time, though the Gauls took part in the contests later for the imperial throne. In course of time the very language of Gaul became Latin, and this became the parent of modern French. In the fifth century tribes of Germans began to make inroads on the Roman domain, and the Franks, under Clovis as king, firmly established themselves in the north. Their power spread; they subjugated the inhabitants, and gave their name to the country, which it bears to this day, — France, the lands of the Franks. There were many social and political changes after this time, but the same life flowed on from Roman Gaul to modern France. The French still display many of the characteristics of the ancient Gauls; they live in substantially the same limits; many of their mountains, cities, and streams still bear the old names.

IV.

THE BRITONS.

WITH Cæsar begins the history of England. He found there a Celtic people, differing but little from those on the continent, save that they were more barbarous. What the condition or history of the British Isles was before Cæsar's invasion is wrapped in obscurity. A few Greek writers refer vaguely to them, and there was an equally vague knowledge of the smaller islands lying near. Even Cæsar

gained but little detailed and accurate knowledge of the country, and after him the Romans did not go there for nearly one hundred years. Subsequently it was subdued and brought under Roman dominion. England still shows many traces of the Roman occupation. Many of her cities were founded by the Romans and bear Roman names. After the Romans came the northern invaders, who drove out or destroyed most of the original Celtic population. Those that survived are represented to-day by the Irish, the Welsh, and the Highland Scotch, among whom a branch of the Celtic language is still spoken to a considerable extent.

V.

THE GERMANS.

THE Germans first appear in history in the campaigns of the Cimbri and Teutones (B.C. 113-101), the latter of whom were undoubtedly of Germanic origin. The Romans obtained their first considerable knowledge of the country from Cæsar. The ancient limits assigned to it were less on the west and south, but indefinitely greater on the east and north, than the modern. In those directions it was *terra incognita* to the Romans, and always remained so. They never did more than subdue the border tribes along the Rhine and Danube. Cæsar had relatively little to do with the Germans, but made such investigations as he could, the results of which are succinctly given in his narrative (Bk. iv. 1-3; Bk. vi. 21-28). The next account, in greater detail, was given by Tacitus in his "Germania," who corroborates Cæsar in all important particulars.

The Germans were much less civilized than most of the Gauls. They were just at the end of the nomadic stage, and were settling down and beginning community life. Their last onward nomadic movement was that under Ariovistus, which it was Cæsar's fortune to arrest (Bk. i. 31-54). They were a more manly and vigorous race than the Gauls, warlike, independent, and virtuous. The country is described as a dismal land, covered for the most part with forests and swamps, producing little food, and subject to almost constant winter.

VI.

THE CAMPAIGNS IN GAUL.

THE campaigns of Cæsar in Gaul lasted through eight seasons (B.C. 58–51), and are told in eight books,—the last written by Hirtius, an officer of Cæsar, — each book containing the operations of a single year. The following is a brief outline :

Book I. B.C. 58. Cæsar checks the attempt of the Helvetians to settle in Western Gaul, and, after a bloody defeat, forces the remnant to return to their own territory. He then engages with a powerful tribe of Germans, who had made a military settlement in Eastern Gaul, and drives them, with their chief, Ariovistus, back across the Rhine.

Book II. B.C. 57. A formidable confederacy of the northern populations of Gaul is suppressed, with the almost complete extermination of the bravest Belgian tribe, the *Nervii*, in a battle which seems to have been one of the most desperate of all that Cæsar ever fought. In this campaign the coast towns of the west and northwest (Brittany) also are reduced to submission.

Book III. B.C. 56. After a brief conflict with the mountaineers of the Alps, who attacked the Roman armies on their march, the chief operations are the conquest of the coast tribes of Brittany (*Veneti*, etc.), in a warfare of curious naval engineering in the shallow tide-water inlets and among the rocky shores. During the season, the tribes of the southwest (*Aquitani*), a mining population, allied to the Iberians or Basques, are reduced by one of Cæsar's officers.

Book IV. B.C. 55. An inroad of the Germans into Northern Gaul is repulsed, and Cæsar follows them by a bridge of timber hastily built across the Rhine. Returning, he crosses to Britain in the early autumn for a visit of exploration.

Book V. B.C. 54. The partial conquest of Britain (second invasion) is followed by various movements in Northern Gaul, in which the desperate condition of the Roman garrisons is relieved after serious losses by the prudent and brave conduct of Labienus and Quintus Cicero.

Book VI. B.C. 53. Cæsar makes a second brief expedition across the Rhine against the Germans. Some general disturbances are quelled, and Northern Gaul is reduced to peace.

Book VII. B.C. 52. Vercingetorix, a brave and high-spirited chief of Southern Gaul, effects a confederacy of the whole country, which is at length subdued. Vercingetorix surrenders himself to secure the quiet of the country, and is taken in chains to Rome, where he was afterwards put to death at Cæsar's triumph.

Book VIII. B.C. 51. Slight insurrections breaking out here and there are easily subdued; and by the capture of the last native stronghold, Uxellodunum, the subjugation of Gaul is made complete.

VII.

READING COURSES.

IN order to make a wider acquaintance with the Gallic War easy and practicable, and, further, to bring greater variety and interest to the narrative for teachers and students alike, the following reading courses are suggested, any one of which covers an amount equivalent to the first four books.

COURSE I.

General Description of Gaul, Bk. i. ch. 1.

The War against the Belgian Confederacy, Bk. ii.

The Campaign against the Usipetes and Tencteri, and the First Invasion of Germany, Bk. iv. chs. 1-19.

The Second Invasion of Germany, and the Customs of the Gauls and Germans, Bk. vi. chs. 9-29.

The General Uprising of Gaul under Vercingetorix, Bk. vii.

COURSE II.

General Description of Gaul, Bk. i. ch. 1.

The Campaign against the Helvetii, Bk. i. chs. 2-29.

The First Invasion of Britain, Bk. iv. chs. 20-36.

The Second Invasion of Britain, Bk. v. chs. 1-23.

The General Uprising of Gaul under Vercingetorix, Bk. vii.

COURSE III.

- General Description of Gaul, Bk. i. ch. 1.
 The Campaign against the Helvetii, Bk. i. chs. 2-29.
 The Campaign against Ariovistus, Bk. i. chs. 30-54.
 The Campaign against the Veneti, Bk. iii. chs. 7-16.
 Crassus in Aquitania, Bk. iii. chs. 23-27.
 The Expedition against the Morini and Menapii, Bk. iii. chs. 28, 29.
 The First Invasion of Britain, Bk. iv. chs. 20-36.
 The Second Invasion of Britain, Bk. v. chs. 1-23.
 The Revolt of Ambiorix, Bk. v. chs. 24-53.
 Pursuit of Ambiorix and the Punishment of the Eburones, Bk. vi.
 chs. 29-44.

COURSE IV.

- General Description of Gaul, Bk. i. ch. 1.
 The Campaign against the Helvetii, Bk. i. chs. 2-29.
 The Campaign against Ariovistus, Bk. i. chs. 30-54.
 The Customs of the Gauls and Germans, Bk. vi. chs. 11-29.
 The Campaign against the Veneti, Bk. iii. chs. 7-16.
 The Revolt of Ambiorix, Bk. v. chs. 24-53.
 The Pursuit of Ambiorix, and the Punishment of the Eburones,
 Bk. vi. chs. 29-44.
 The Uprising of Gaul under Vercingetorix, Bk. vii. chs. 1-11.
 The Siege of Alesia, Bk. vii. chs. 68-90.

COURSE V.

- General Description of Gaul, Bk. i. ch. 1.
 The War against the Belgian Confederacy, Bk. ii.
 The Campaign against the Usipetes and Tencteri, and the First
 Invasion of Germany, Bk. iv. chs. 1-19.
 The Second Invasion of Germany, and the Customs of the Gauls
 and Germans, Bk. vi. chs. 9-29.
 The First Invasion of Britain, Bk. iv. chs. 20-36.
 The Second Invasion of Britain, Bk. v. chs. 1-23.

The General Rising of Gaul under Vercingetorix, Bk. vii. chs. 1-15.

The Siege and Sack of Avaricum, Bk. vii. chs. 16-30.

Operations against Gergovia, and Plots among the Hædui, Bk. vii. chs. 31-56.

VIII.

DIRECTIONS FOR READING.

As "Cæsar," though in many respects a book for advanced students, is often the first Latin classic put into the learner's hands, it may be well to give a few hints as to the method of study.

1. Before beginning to read, the learner should be familiar with the forms of Inflection, the simpler rules of Agreement and Construction of Cases and Moods, the use of Tenses, and the Definitions of common grammatical terms such as Sentence, Subject, Predicate, Object, Transitive and Intransitive, Phrase, Clause, and the like.

2. Notice at once the inflectional terminations, so that the number, case, tense, person, etc., — which show the corresponding relations of the words and ideas to each other, — may be present to your mind. If the form of the word gives several possibilities, hold them all in your mind, so far as may be, till something occurs in the progress of the sentence to settle the doubt.

3. Always try to take in the ideas in that order in which the Latin presents them. Read every word as if it were the last on a page and you had to turn over without being able to turn back. The mind soon becomes accustomed to the order of any language, as we see by the constant and almost unnoticed inversions of common speech and poetry. If, however, you are obliged to turn back, begin again at the beginning of the sentence and proceed as before. The greatest difficulty to a beginner is his inability to remember the first parts of a complex idea. This difficulty can often be lessened by jotting down, in a loose kind of English, the words as they come in the Latin. In this way it is often easy to see what a string of words *must* mean, though we should never say anything like it in English.

4. Don't try to *translate formally* until you have got a complete *idea* of some *integral part* of the sentence. It makes nonsense

to render words mechanically, without thinking the corresponding ideas.

5. From the outset, notice that the emphatic position of words plays a most important part in Latin writing, and try to feel the emphasis of position as you read. (See § 595-601 (343-346), and compare B. 348-351; G. 671-687; H. 663-685 (559-573); H-B. 620-630.)

As an illustration of § 5 we append a translation of the first chapter of Book II with especial reference to the emphasis indicated by the order. As the translation is made expressly to bring out explicitly the force of order, it should not be taken as a model of desirable translation. Such a translation as is here given forces the emphasis on the attention more than is perhaps natural in English. The force is all present in the Latin, but in English it may often be left to be brought out by the context or by some kindred emphasis which the English substitutes. A short, easy passage from Book V is also given without comment for study and practice.

And BEING¹ thus in *Hither*² Gaul, as I have shown above, CÆSAR³ had FREQUENT⁴ rumors brought to him,⁵ and DESPATCHES⁶ also from LABIENUS⁷ continued to inform him that ALL⁸ the BELGÆ,⁹ who constituted a *third part*¹⁰ of [the whole of] Gaul, as I had [previously] stated, were conspiring [for an attack] against the *Roman gov-*

Cum esset Caesar in ceteriōre Galliā, ita utī suprā dēmōnstrāvimus, crēbrī ad eum rūmōrēs adferēbantur, litterīsque item Labiēni certior fiēbat omnīs Belgās, quam tertiam esse Galliae partem dixerāmus, contrā populum Rōmānum coniūrāre obsi-

¹ The emphasis on *being* binds this part of the narrative with the situation left at the end of the last book, as if it were "Caesar went to Hither Gaul, — and while he was engaged there."

² Opposed to *Farther* Gaul, where the troops were.

³ The main subject of discourse.

⁴ The repetition of the stories is the significant fact, "he kept hearing," but at the same time the rumors are opposed to Labienus's despatches.

⁵ An emphasis continued in Latin from *Cæsar*, the main person, but lost in English. See § 598. *l* (344. *l*); H-B. 627. 2.

^{6, 7} Opposed to the rumors.

^{8, 9} Both words together the subject of discourse, but the adjective most prominent, "the entire body of the Belgæ."

¹⁰ Opposed to the whole, as one might say, "a full third of the whole."

ernment¹¹ and exchanging hostages. That for THIS CONSPIRACY¹² the reasons were *these*,¹³ namely: in the first place, because THEY WERE AFRAID¹⁴ (i.e. in their own minds) that when Gaul was ALL¹⁵ *subdued*,¹⁶ our army would be brought against *them*¹⁷; and in the second place, because *some*¹⁸ of the *Gauls*¹⁸ (i.e. from outside) were tampering¹⁸ with them. These Gauls were PARTLY those who were disturbed that the ROMAN¹⁹ army should pass the *winter*²⁰ and *get a*²⁰ *footing* in Gaul, *just as*²¹ they had been unwilling that the GERMANS²² should *stay any longer*²³ there, and PARTLY those who from [mere] *fickleness*²⁴

dēsque inter sē dare. Coniūrāndī hās esse causās: primum quod verērentur nē omnī pācātā Galliā ad eōs exercitus noster addūcerētur; deinde quod ab nōn nullīs Gallīs sollicitārentur, — partim quī, ut Germānōs diūtius in Galliā versārī nōluerant, ita populī Rōmānī exercitum hiemāre atque inveterāscere in Galliā molestē ferēbant; partim quī mōbilitāte et levitāte

¹¹ Here not the conspiracy itself, but the aim of it is the most important part of the idea.

¹² The main subject of discourse, "now *this* conspiracy, the reports said," etc.

¹³ The difference between "the reasons why were *these*" and "these were *the reasons* why" is obvious. Cæsar might say either.

¹⁴ A peculiar emphasis not directly carried out. Cicero would very likely have been more rhetorical and have opposed "*fear*" to "*being tampered with*." But Cæsar changes his point of view in the course of the sentence; and, as if he had said *ipsi* in the first member, opposes to the motives of the Belgæ *themselves*, the Gauls by whom *outside* influence was brought to bear.

¹⁵, ¹⁶ The *completion* of the business now in hand is first emphasized, then the business itself.

¹⁷ Cæsar brings out the whole force of the idea by opposing "*them*" to "Gaul," which has not before been emphatic, but which is now made so by being contrasted with the Belgians; cf. Chiasmus, § 598. *f* (344. *f*); B. 350. 11, *c*; G. 682 and R.; H. 666. 2 (562); H-B. 628.

¹⁸ See note 14.

¹⁹ Opposed to the "Germans."

²⁰ Opposed to "stay any longer."

²¹ The English emphasis here represents the position of the two clauses, relative and antecedent.

²² Opposed to the "Romans."

²³ See note 20.

²⁴ Notice that the view of the first party is a rational idea seriously thought out, to which implied state of mind the *inconstancy* of the second party is opposed.

and *unsteadiness*²⁴ were [always] eager for *new*²⁵ forms of government; [they were stimulated] by SOME also besides, who, inasmuch as in *Gaul*²⁶ regal power was regularly usurped by the *more powerful*²⁷ and by those who had means to *employ soldiers*,²⁸ could not SO EASILY²⁹ succeed in *such usurpations*³⁰ under our *imperial control*.³¹

²⁵ A natural consequence of their character. For no good reason they got tired of the established order and wanted a *change*.

²⁶ Opposed to other countries in which the government was more stable.

²⁷, ²⁸ The two means of attaining regal power.

²⁹ And consequently wanted to rebel.

³⁰ The Latin often compresses into an indefinite, and to us unemphatic, word (as **rem** here) a whole important idea. In such cases the true emphasis appears in English only when a suitable descriptive word is substituted for the vague one according to our way of saying things.

³¹ This control, of course, tended towards establishing order.

V. 23. AFTER TAKING HOSTAGES he led his *army* back to the sea [where he] found the *ships* repaired. HAVING LAUNCHED THEM, inasmuch as he had a great number of *captives*, and *some* of the ships had been lost in the *storm*, he proceeded to transport his army in *two voyages*. And [fortunately] it so HAPPENED that out of so *many* ships in so *many* voyages not a *single* one was lost that carried soldiers either *that year* or the year *before*, while of THE SHIPS which were sent back to him *empty* from the continent after discharging the soldiers of the first voyage, as well as of the seventy others that Labienus had built *later*, very few reached their destination. Almost all the *rest* were driven back.

animī novīs imperiīs studēbant, — ab nōn nullīs etiam, quod in Galliā ā potentiōribus atque eīs quī ad condūcendōs hominēs facultātis habēbant volgō rēgna occupābantur, quī minus facile eam rem imperiō nostrō cōsequī poterant.

Obsidibus acceptis exercitum redūcit ad mare, nāvīs invenit reffectās. Hīs dēductis, quod et captivōrum māgnum numerum habēbat, et nōn nullae tempestāte dēperierant nāvēs, duōbus commeātibus exercitum reportāre instituit. Āc sic accidit uti ex tantō nāvium numerō, tot nāvīgātiōnibus, neque hōc neque superiōre annō ūlla omnīnō nāvis quae militēs portāret dēsiderārētur; at ex eīs quae inānēs ex continentī ad eum remitterentur, [et] priōris commeātūs expositis militibus, et quās postea Labiēnus faciendās cūrāverat numerō LX, perpaucae locum caperent; reliquae ferē omnēs rēicerentur.

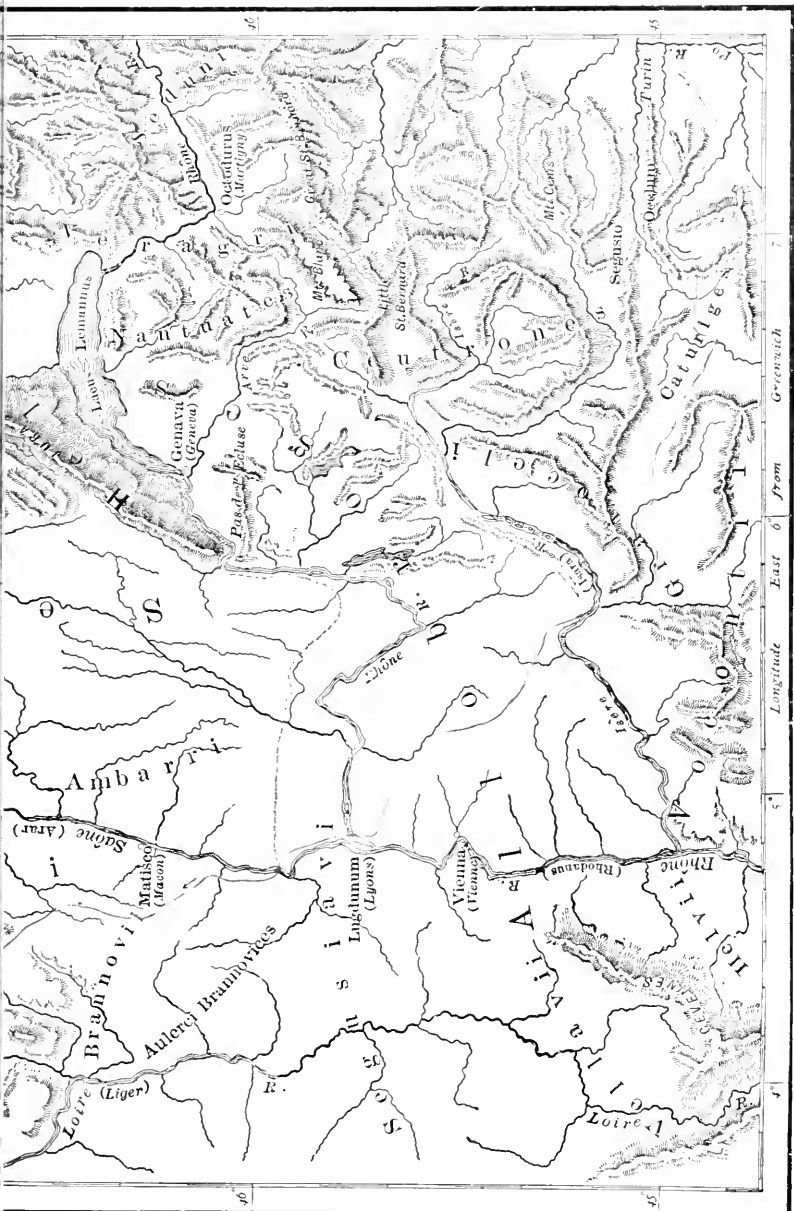

46

45

Greenwich

East 6

from

Longitude

5

4

46

45



FIG. 4.—COINS OF CÆSAR.

THE GALLIC WAR.

BOOK I.

CAMPAIGNS AGAINST THE HELVETII AND ARIOVISTUS. B.C. 58.

The Nations of Gaul.

GALLIA est omnis divisa in partis trēs ; quārum ūnam incolunt Belgae, aliam Aquitāni, tertiam quī ipsōrum linguā Celtae, nostrā Galli appellantur. Hī omnēs linguā, institūtis, lēgibus inter sē differunt. Gallōs ab Aquitānis Garumna flūmen, ā Belgis Mātrona et Sēquana dividit.¹ 5

Their Characters Compared.

Hōrum omnium fortissimī sunt Belgae, proptereā quod ā cultū atque hūmānitāte prōvinciae longissimē absunt, minimēque ad eōs mercātōrēs saepe commeant atque ea quae ad effēminandōs animōs pertinent important ; proximēque sunt Germānis quī trāns Rhēnum incolunt,² quibuscum continenter bellum gerunt. Quā dē causā Helvētii quoque 10 reliquōs Gallōs virtūte praecēdunt, quod ferē cotidiānis proeliis cum Germānis contendunt, cum aut suis finibus eōs prohibent aut ipsī in eōrum finibus bellum gerunt.

Cf. ¹ *dīvisa*, l. 1. — ² *incolunt*, l. 2.

The Territories of Each.

Eōrum ūna pars,¹ quam Gallōs obtinēre dictum est, initium capit ā flūmine Rhodanō; continētur Garumnā flūmine, Ōceanō, finibus Belgārum; attingit etiam ab Sēquanis et Helvētiis flūmen Rhēnum; vergit ad septentriōnēs. Belgae ab extrēmis Galliae finibus oriuntur, pertinent ad inferiōrem partem flūminis Rhēni, spectant in septentriōnem et orientem sōlem. Aquitānia ā Garumnā flūmine ad Pŷrēnaeōs montis et eam partem Ōceanī quae est ad Hispaniam pertinet; ² spectat inter occāsum sōlis et septentriōnēs.

Orgetorix with his Fellow Nobles Forms a Plan to Invade Gaul.

2. Apud Helvētiōs longē³ nōbilissimus fuit et ditissimus Orgetorix. Is, M. Messālā et M. Pīsōne cōsulibus, rēgni cupiditāte inductus coniūrātiōnem nōbilitātis fēcit, et civitātī persuāsit ut dē finibus suis cum omnibus cōpiis exirent: ¹⁵ perfacile esse, cum virtūte omnibus praestārent, tōtius Galliae imperiō potiri.

He Persuades his People, the Helvetii.

Id hōc facilius eis persuāsit, quod undique loci nātūrā Helvētiī continentur:⁴ ūnā ex parte flūmine Rhēnō lātissimō atque altissimō, quī agrum Helvētium ā Germānis dividit; ²⁰ alterā ex parte monte Iūrā altissimō, quī est inter Sēquanōs et Helvētiōs; tertiā lacū Lemannō et flūmine Rhodanō, quī prōvinciam nostram ab Helvētiis dividit.

They Assent, being Warlike and feeling Cramped by their Narrow Limits.

His rēbus fiēbat ut et minus lātē vagārentur et minus facile finitimis bellum inferre possent; quā ex parte homi-

Cf. ¹ *partis*, p. 1, l. 1. — ² *pertinent*, l. 5. — ³ *longissimē*, 1, 7. — ⁴ *continētur*, l. 2.

nēs bellandī cupidī māgnō dolōre adficiēbantur. Prō multitudīne autem hominū et prō glōriā belli atque fortitudinis, angustōs sē finis¹ habēre arbitrābantur, quī in longitūdinem milia passuum CCXL, in lātitudinem CLXXX patēbant.

5

They Employ Two Years in Preparations.

3. His rēbus adductī et auctōritāte Orgetorigis permōti cōstituērunt ea quae ad proficiscendum pertinērent² comparāre, iūmentōrum et carrōrum quam maximum numerum coēmere, sēmentis quam maximās facere, ut in itinere cōpia frūmentī suppeteret, cum proximīs³ civitatibus pācem et
10 amicitiam cōfirmāre. Ad eās rēs cōficiendās biennium sibi satis esse dūxērunt; in tertium annum profectiōnem lēge cōfirmant.

Orgetorix Conspires with Other Gallic Chiefs.

Ad eās rēs cōficiendās Orgetorix dēligitur. Is sibi lēgatiōnem ad civitatē suscepit. In eō itinere persuādet⁴ Casti-
15 ticō, Catamantaloedis filiō, Sēquanō, cuius pater rēgnum in Sēquanis multōs annōs obtinuerat⁵ et ā senātū populi Rōmāni amicus appellātus erat, ut rēgnum in civitatē suā occupāret, quod pater ante habuerat; itemque Dumnorigi
Haeduō, frātrī Diviciaci, qui eō tempore principātum in civi-
20 tātē obtinēbat ac maximē plēbi acceptus erat, ut idem cōnāretur persuādet, eiūque filiam suam in mātrimonium dat.

His Arguments.

Perfacile factū esse illis probat cōnāta perficere, propterea quod ipse suae civitatē imperium obtentūrus esset: nōn esse dubium quin tōtius Galliae plūrimū Helvētīi possent;
25 sē suis cōpiis suoque exercitū illis rēgna conciliātūrum cōn-

Cf. ¹ finibus, p. 2, l. 3. — ² pertinent, 2, 5. — ³ proximī, 1, 9. — ⁴ persuāsīt, 2, 14. — ⁵ obtinēre, 2, 1.

firmat. Hāc ōrātiōne adducti inter sē fidem et iūsiurandum dant, et rēgnō occupātō¹ per trēs potentissimōs ac firmissimōs populōs tōtius Galliae sēsē potiri² posse spērānt.

Orgetorix is Brought to Trial.

4. Ea rēs est Helvētiis per indicium ēnūntiāta. Mōribus 5 suis Orgetorigem ex vinculis causam dicere coēgērunt. Damnātum poenam sequi oportēbat ut igni cremārētur.

He Escapes.

Diē cōstitūtā³ causae dictiōnis Orgetorix ad iūdicium omnem suam familiam, ad hominum mīlia decem, undique coēgit, et omnis clientis obaerātōsque suōs, quōrum māgnum 10 numerum habēbat, eōdem condūxit; per eōs nē causam diceret sē ēripuit.

His Death.

Cum civitās ob eam rem incitāta armis iūs suum exsequi cōnārētur, multitudinemque hominum ex agris magistrātūs cōgerent,⁴ Orgetorix mortuus est; neque abest suspiciō, ut 15 Helvētīi arbitrantur, quī ipse sibi mortem cōsciverit.

Still the Helvetii Persist in the Attempt.

5. Post ēius mortem nihilō minus Helvētīi id quod cōstituerant facere cōnantur,⁵ ut ē finibus suis exeant.⁶ Ubi iam sē ad eam rem parātōs esse arbitrāti sunt, oppida sua omnia, numerō ad duodecim, vicōs ad quadringentōs, reliqua 20 privāta aedificia incendunt; frūmentum⁷ omne, praeter quod sēcum portātūrī erant, combūrunt, ut — domum reditiōnis spē sublātā — parātiōrēs ad omnia pericula subeunda essent; trium mēnsium molita cibāria sibi quemque domō efferre iubent.

Cf. ¹ occupāret, p. 3, l. 19. — ² potiri, 2, 16. — ³ cōstituerunt, 3, 7. — ⁴ coēgit, l. 9. — ⁵ cōnarētur, l. 13. — ⁶ exirent, 2, 14. — ⁷ frūmentī, 3, 10.

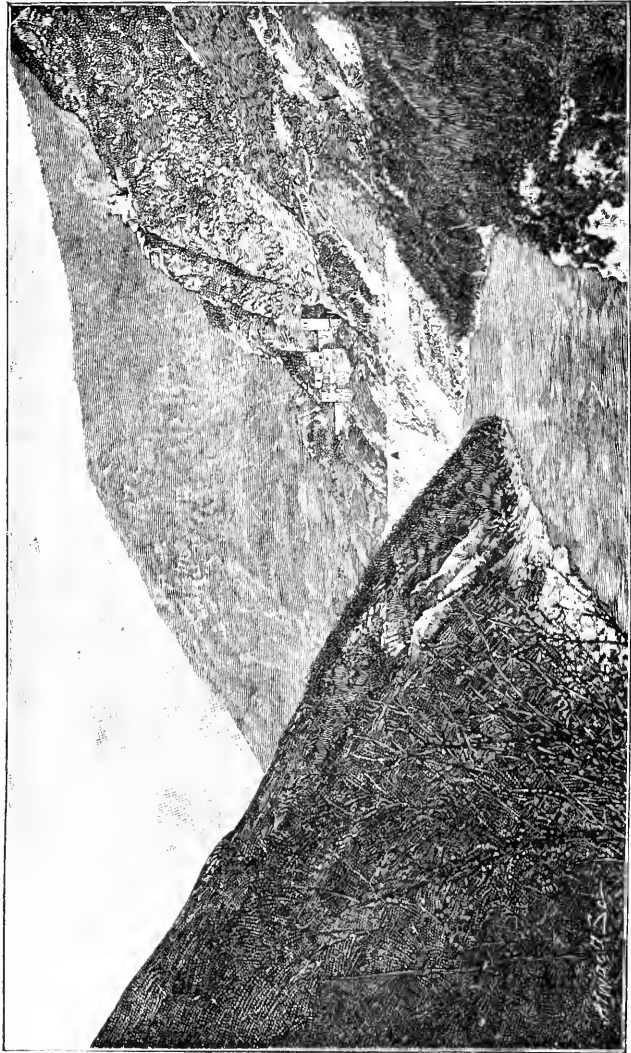

FIG. 5 — PAS DE L'ECLUSE

Other Tribes are Persuaded to Join them.

Persuādent Rauracis et Tulingis et Latobrigis finitimis utī eōdem ūsī cōnsiliō, oppidis suis vicisque exūstis, ūnā cum eis proficiscantur¹; Bōiōsque, quī trāns Rhēnum incoluerant et in agrum Nōricum trānsierant Nōrēiamque oppugnārant, receptōs ad sē sociōs sibi adsciscunt.

5

Two Routes for Invasion Described.

6. Erant omnīnō itinera duo quibus itineribus domō exire possent : ūnum per Sēquanōs, angustum et difficile,

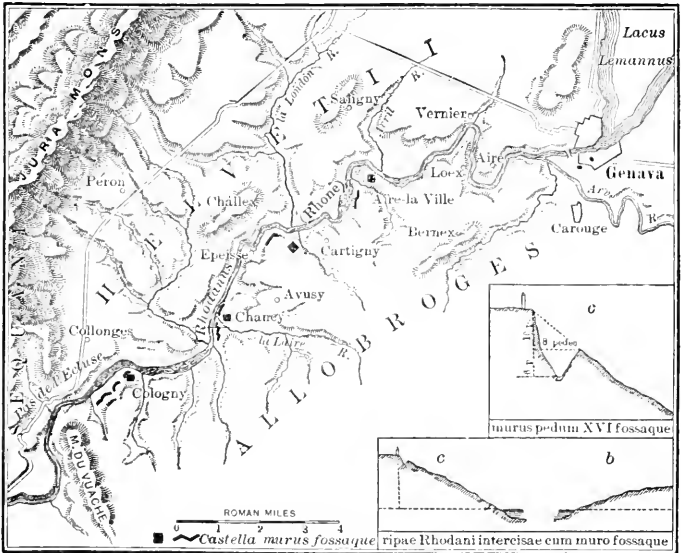

FIG. 6. — MAP OF HELVETIA.

inter montem Iūram et flūmen Rhodanum, vix quā singuli carri² dūcerentur; mōns autem altissimus impendēbat, ut

Cf. ¹ proficiscendum, p. 3, l. 7. — ² carrōrum, 3, 8.

facile perpauci prohibēre¹ possent: alterum per prōvinciam nostram, multō facilius atque expeditius, proptereā quod inter finis Helvētiōrum et Allobrogum, qui nūper pācātī erant, Rhodanus fluit, isque nōn nūllis locis vadō trānsitur.²
 5 Extrēmum oppidum Allobrogum est proximumque³ Helvētiōrum finibus Genāva.

They Decide to March through the Province.

Ex eō oppidō pōns ad Helvētiōs pertinet. Allobrogibus sēsē vel persuāsūrōs (quod nōndum bonō animō in populum Rōmānum vidērentur) existimābant, vel vī coāctūrōs⁴ ut
 10 per suōs finis eōs ire paterentur. Omnibus rēbus ad perfectiōnem comparātis diem dīcunt quā diē ad ripam Rhodanī omnēs conveniant. Is diēs erat a. d. v. Kal. Apr., L. Pisōne A. Gabiniō cōsulibus.

Cæsar Resolves to Stop them, and Destroys the Bridge near Geneva.

7. Caesari cum id nūntiātum esset eōs per prōvinciam
 15 nostram iter facere cōnārī,⁵ mātūrat ab urbe proficiscī,⁶ et quam maximis potest itineribus in Galliam ulteriōrem contendit et ad Genāvam pervenit. Prōvinciae tōtī quam maximum potest militum numerum imperat (erat omnīnō in Galliā ulteriōre legiō ūna), pontem qui erat ad Genāvam
 20 iubet rescindī.

They Ask Cæsar's Permission.

Ubi dē ēius adventū Helvētiī certiōrēs factī sunt, lēgātōs ad eum mittunt nōbilissimōs civitātis, cūius lēgatiōnis⁷ Nammēius et Verudoctius prīncipem locum obtinēbant, qui dicerent 'sibi esse in animō sine ūllō maleficiō iter per prō-
 25 vinciam facere, proptereā quod aliud iter⁸ habērent nūllum; rogāre ut ēius voluntāte id sibi facere liceat.'

Cf. ¹ prohibent, p. 1, l. 14. — ² trānsierant, 5, 4. — ³ proximīs, 3, 10. — ⁴ coēgit, 4, 9. — ⁵ cōnantur, 4, 17. — ⁶ proficiscantur, 5, 3. — ⁷ lēgatiōnem, 3, 14. — ⁸ itinera, 5, 6.

Cæsar Unwilling, but Puts them off to Gain Time.

Caesar, quod memoriā tenēbat L. Cassium cōsulem occisum exercitumque ēius ab Helvētiis pulsum et sub iugum missum, concēdendum nōn putābat; neque hominēs inimicō animō, datā facultāte per prōvinciam itineris faci- undi,¹ temperātūrōs ab iniuriā et maleficiō existimābat.² 5 Tamen, ut spatium intercēdere posset dum militēs quōs imperāverat convenirent,³ lēgātis respondit diem sē ad dēliberandum sūmptūrum; si quid vellent, ad Id. Apr. reverterentur.

Cæsar Constructs Fortifications to Stop the Helvetii.

8. Intereā eā legiōne quam sēcum habēbat militibusque 10 quī ex prōvinciā convēnerant, ā lacū Lemannō, quī in flūmen Rhodanum influit, ad montem Iūram, quī finis Sēquanōrum ab Helvētiis dividit, milia passuum decem novem mūrū in altitudinem pedum sēdecim fossamque perdūcit. Eō opere perfectō⁴ praesidia dispōnit, castella commūnit, quō 15 facilius, si sē invitō trānsire cōnārentur, prohibēre posset.

The Helvetii Attempt to Pass, but are Repulsed.

Ubi ea diēs quam cōstituerat cum lēgātis vēnit, et lēgāti ad eum revertērunt,⁵ negat sē mōre et exemplō populī Rōmānī posse iter ūlli per prōvinciam dare; et, si vim facere cōnentur, prohibitūrum ostendit. Helvētiī, eā spē dēiectī, 20 nāvibus iūctis ratibusque complūribus factis, aliī vadīs⁶ Rhodanī, quā⁷ minima altitudō flūminis erat, nōn numquam interdiū, saepius⁸ noctū, si perrumpere possent cōnātī, operis mūnitiōne et militum concursū et tēlis repulsi, hōc cōnātū dēstitērunt. 25

Cf. ¹ facere, p. 6, l. 25. — ² existimābant, 6, 9. — ³ convenient, 6, 12. — ⁴ perficere, 3, 23. — ⁵ reverterentur, l. 9. — ⁶ vadō, 6, 4. — ⁷ quā, 5, 8. — ⁸ saepe, 1, 8.

Through the Influence of Dumnorix, a Hæduan, they are Allowed to Pass through the Sequanian Territory.

9. Relinquēbātur ūna per Sēquanōs via, quā Sēquanīs invītīs¹ propter angustias² ire nōn poterant. Hīs cum suā sponte persuādēre nōn possent, lēgātōs ad Dumnorīgem Haeduum mittunt, ut eō dēprecātōre ā Sēquanīs impetrārent. Dumnorix grātiā et largitiōne apud Sēquanōs plūrimū³ poterat et Helvētiīs erat amicus, quod ex eā civitate Orgetorigis filiam in mātirimōnium dūxerat; et cupiditate rēgnī adductus novīs rēbus studēbat et quam plūrimās civitātis suō beneficiō habēre obstrictās volēbat. Itaque rem
10 suscipit et ā Sēquanīs impetrat ut per finis suōs Helvētiōs ire patiantur,⁴ obsidēsque utī inter sēsē dent perficit: Sēquanī, nē itinere Helvētiōs prohibeant; Helvētiī, ut sine maleficiō et iniūriā trāseant.

Cæsar Opposes this Movement also.

10. Caesari renūtiātur Helvētiīs esse in animō⁵ per agrum Sēquanōrum et Haedūorum iter in Santonum finis
15 facere, quī nōn longē⁶ ā Tolōsātium finibus absunt, quae civitās est in Prōvinciā. Id si fieret,⁷ intellegēbat māgnō cum periculō⁸ prōvinciae futūrum ut hominēs bellicōsōs, populī Rōmānī inimicōs, locis patentibus⁹ maximēque frū-
20 mentāriīs finitimōs habēret.

He Takes Active Measures.

Ob eās causās eī mūnitiōnī¹⁰ quam fēcerat T. Labiēnum lēgātum praeficit; ipse in Ītaliā māgnīs itineribus contendit duāsque ibi legiōnēs cōnscrībit, et trēs quae circum

Cf. ¹ invītō, p. 7, l. 16. — ² angustum, 5, 7. — ³ plūrimum, 3, 25. — ⁴ paterentur, 6, 10. — ⁵ esse in animō, 6, 24. — ⁶ longissimē, 1, 7. — ⁷ fiēbat, 2, 23. — ⁸ pericula, 4, 22. — ⁹ patēbant, 3, 5. — ¹⁰ mūnitiōne, 7, 24.

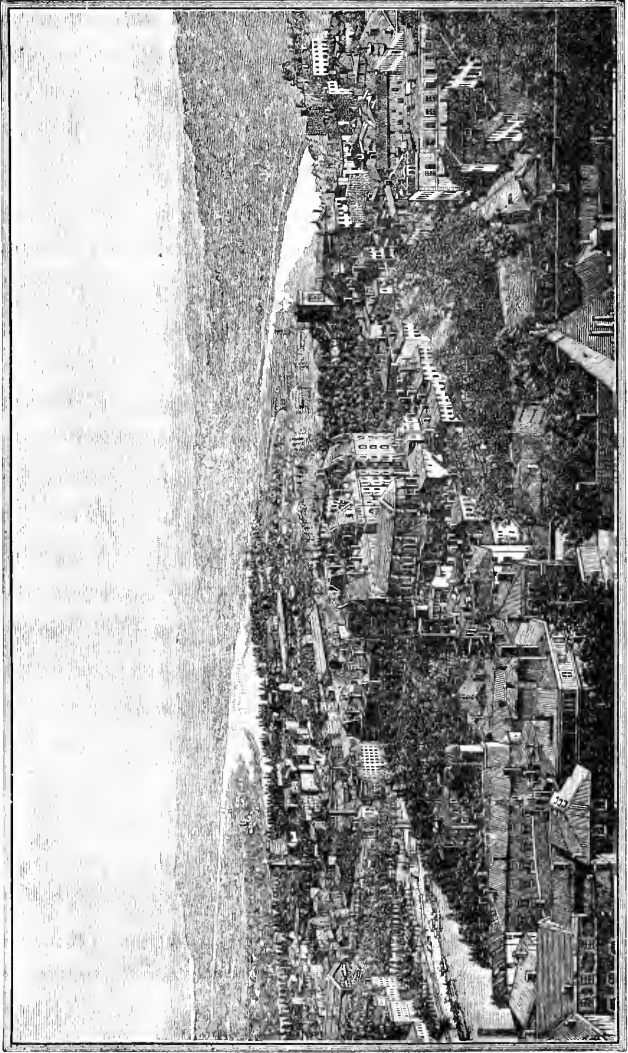

FIG. 7.—JUNCTION OF THE RHONE AND SAONE.

Aquilēiam hiemābant ex hibernis ēdūcit, et, quā proximum iter in ulteriōrem¹ Galliam per Alpīs erat, cum his quinque legiōnibus ire contendit.

Some Tribes Resist his March, but he Crosses the Rhone with his Army.

Ibi Ceutrones et Grāiocelī et Caturīges locis superiōribus occupātis itinere exercitum prohibēre cōnantur. Complūri- 5
bus his proeliis pulsīs,² ab Ocelō, quod est citeriōris prōvin-
ciae extrēmum, in finis Vocontiōrum ulteriōris prōvinciae
diē septimō pervenit;³ inde in Allobrogum finis, ab Allo-
brogibus in Segusiāvōs exercitum dūcit. Hī sunt extrā
prōvinciam trāns Rhodanum primī. 10

The Helvetii Commit Depredations on their March, and Several Tribes Ask for Cæsar's Help against them.

11. Helvētīi iam per angustiās et finis Sēquanōrum suās cōpiās trādūxerant, et in Haeduōrum finis pervēnerant eōrumque agrōs populābantur. Haeduī, cum sē suaque ab eis dēfendere nōn possent, lēgātōs ad Caesarem mittunt rogātum⁴ auxilium: 'Ita sē omnī tempore dē populō Rō- 15
mānō meritōs esse ut paene in cōspectū exercitūs nostrī agrī vastārī, liberī [eōrum] in servitūtem abdūcī, oppida expūgnārī nōn dēbuerint.' Eōdem tempore Haeduī Ambarri, necessārii et cōsanguīneī Haeduōrum, Caesarem certiōrem⁵ faciunt sēsē dēpopulātis agrīs nōn facile ab oppidis vim 20
hostium prohibēre. Item Allobroges, quī trāns Rhodanum vicōs⁶ possessiōnēsque habēbant, fugā sē ad Caesarem recipiunt et dēmōnstrant sibi praeter agrī solum nihil esse reliquī.⁷ Quibus rēbus adductus Caesar nōn exspectandum sibi statuit dum, omnibus fortūnis sociōrum⁸ cōsūmptis, in 25
Santonōs Helvētīi pervenirent.

Cf. ¹ *ulteriōrem*, p. 6, l. 16. — ² *pulsum*, 7, 2. — ³ *pervenit*, 6, 17. — ⁴ *rogāre*, 6, 26. — ⁵ *certiōrēs*, 6, 21. — ⁶ *vicōs*, 4, 19. — ⁷ *reliqua*, 4, 19. — ⁸ *sociōs*, 5, 5.

The Helvetii Attempt to Cross the Saône.

12. Flūmen est Arar, quod per finis Haeduōrum et Sēquanōrum in Rhodanum influit, incrēdibili lēnitāte ita ut oculis in utram partem fluat iūdicārī nōn possit. Id Helvētīi ratibus ac lintribus iūctis trānsibant. Ubi per
5 explōrātōrēs Caesar certior factus est trēs iam partis cōpi-
ārū Helvētīōs id flūmen trādūxisse,¹ quartam ferē partem
citrā flūmen Ararim reliquam esse, dē tertiā vigiliā cum
legiōnibus tribus ē castris profectus,² ad eam partem per-
vēnit quae nōndum flūmen trānsierat.

Cæsar Cuts to Pieces a Part (the Tigurini), Who had not yet Crossed.

10 Eōs impeditōs et inopinantis adgressus māgnam partem
eōrum concidit; reliquī sēsē fugae mandārunt atque in
proximās³ silvās abdidērunt. Is pāgus appellābātur Tiguri-
nus; nam omnis civitās Helvētia in quattuor pāgōs divisa
est. Hic pāgus ūnus, cum domō exisset,⁴ patrum nostrōrum
15 memoriā L. Cassium cōsulem interfēcerat et eius exercitum
sub iugum miserat.

Thus he Wipes out a Long-standing Disgrace.

Ita sive cāsū sive cōsiliō deōrum immortalīum, quae pars



FIG. 8. — COIN OF PISO.

FIG. 9. — COIN OF CASSIUS.

civitātis Helvētiaē insīgnem calamitātem populō Rōmānō
intulerat,⁵ ea pīnceps poenās persolvit. Quā in rē Caesar

Cf. ¹ trādūxerant, p. 9, l. 12. — ² proficīscī, 6, 15. — ³ proximum, 9, 1.
⁴ exīre, 5, 7. — ⁵ īferre, 2, 24.

nōn solum publicās sed etiam privātās iniūriās ultus est ; quod eius socerī L. Pisōnis avum, L. Pisōnem lēgātum, Tigurinī eōdem proeliō quō Cassium interfēcerant.

Cæsar Crosses the Saône.

13. Hōc proeliō factō, reliquās cōpiās Helvētiōrum ut cōsequi posset, pontem in Ararī faciendum cūrat atque 5
ita exercitum trādūcit.

The Helvetii Send an Embassy.

Helvētīi repentinō eius adventū¹ commōti, cum id quod ipsi diēbus xx aegerrimē cōfēcerant,² ut flūmen trānsirent, illum unō diē fēcisse intellexerent,³ lēgātōs ad eum mittunt ; cūius lēgātiōnis Divicō princeps fuit, qui bellō Cassiānō dux 10
Helvētiōrum fuerat.

Divico's Speech.

Is ita cum Caesare ēgit : ' Si pācem populus Rōmānus cum Helvētiis faceret, in eam partem itūrōs atque ibi futūrōs Helvētiōs ubi eōs Caesar cōstituisset⁴ atque esse voluisset ; sīn bellō persequi perseverāret, reminiscerētur et 15
veteris incommodi populi Rōmāni et pristinae virtūtis Helvētiōrum. Quod imprōvisō unum pāgum adortus esset, cum eī qui flūmen trānsissent suis auxilium⁵ ferre nōn possent, nē ob eam rem aut suae māgnopere virtūti tribueret aut ipsōs dēspiceret ; sē ita ā patribus māiōribusque 20
suis didicisse ut magis virtūte contenderent quam dolō aut insidiis niterentur. Quā rē nē committeret ut is locus ubi cōstitissent ex calamitāte populi Rōmāni et interneciōne exercitūs nōmen caperet aut memoriam prōderet.'

Cf. ¹ adventū, p. 6, l. 21. — ² cōficiendās, 3, 11. — ³ intellegēbat, 8, 17. — ⁴ cōstitutā, 4, 7. — ⁵ auxilium, 9, 15.

Cæsar's Reply.

14. His Caesar ita respondit : 'Eō sibi minus dubitātiōnis dari quod eās rēs quās lēgātī Helvētīi commemorāssent memoriā tenēret,¹ atque eō gravius ferre, quō minus meritō populī Rōmānī accidissent ; quī sī alicūius iniūriæ sibi cōn-
 5 sciis fuisset, nōn fuisse difficile cavēre ; sed eō dēceptum, quod neque commissum ā sē intellexeret² quā rē timēret, neque sine causā timendum putāret.³ Quod sī veteris⁴ contumēliæ oblivisci vellet, num etiam recentium iniūriarum, quod eō invitō⁵ iter per prōvinciam per vim temptāssent,
 10 quod Haeduōs, quod Ambarrōs, quod Allobrogas vexāssent, memoriā dēpōnere posse ? Quod suā victōriā tam insolenter glōriārentur, quodque tam diū sē impūne iniūriās tulisse⁶ admirārentur, eōdem pertinēre.⁷ Cōnsuēsse enim deōs immortalīs, quō gravius hominēs ex commūtātiōne
 15 rērum doleant, quōs prō scelere eōrum ulcisci⁸ velint, his secundiōrēs interdum rēs et diūturniōrem impūnitātem concēdere.⁹

He Proposes Terms, Which are not Accepted.

Cum ea ita sint, tamen sī obsidēs ab eis sibi dentur, uti ea quae polliceantur factūrōs intellegat, et sī Haeduis dē
 20 iniūriis quās ipsis sociisque eōrum intulerint, item sī Allobrogibus satisfaciant, sēsē cum eis pācem esse factūrum.' Divicō respondit : 'Ita Helvētiōs ā māiōribus¹⁰ suis institūtōs esse uti obsidēs accipere, nōn dare, cōnsuērint ;¹¹ eius rei populum Rōmānum esse testem.' Hōc respōnsō datō
 25 discessit.

Cf. ¹ tenēbat, p. 7, l. 1. — ² intellegēbat, 8, 17. — ³ putābat, 7, 3. — ⁴ veteris, 11, 16. — ⁵ invitō, 7, 16. — ⁶ ferre, l. 3. — ⁷ pertinent, 1, 9. — ⁸ ultus, 11, 1. — ⁹ concēdendum, 7, 3. — ¹⁰ māiōribus, 11, 20. — ¹¹ cōnsuēsse, l. 13.

Slight Reverse of Cæsar's Cavalry.

15. Posterō diē castra ex eō locō movent. Idem facit Caesar, equitātumque omnem, ad numerum quattuor milium, quem ex omnī prōvinciā et Haeduis atque eōrum sociis coāctum¹ habēbat, praemittit quī videant quās in partis hostēs iter faciant. Quī cupidius² novissimum agmen inse- 5
cūtī aliēnō locō cum equitātū Helvētiōrum proelium com-
mittunt; et paucī dē nostris cadunt.

The Helvetii Move on; Cæsar Follows.

Quō proeliō sublātī Helvētīi, quod quīngentis equitibus tantam multitudinem equitum prōpulerant, audācius subsistere nōn numquam³ et novissimō agmine proeliō nostrōs 10
laccessere coepērunt. Caesar suōs ā proeliō continēbat, ac satis habēbat in praesentiā hostem rapīnis [pābulātiōnibus] populātiōnibusque prohibēre. Ita diēs circiter quīndecim iter fēcērunt utī inter novissimum hostium agmen et nostrum primum nōn amplius quīnis aut sēnis milibus passuum 15
interesset.

The Hædui Neglect to Furnish Grain.

16. Interim cotidiē Caesar Haeduōs frūmentum quod essent pūblicē polliciti flāgitāre. Nam propter frīgora, quod Gallia sub septentriōnibus⁴ (ut ante dictum est) posita est, nōn modo frūmenta in agris mātūra nōn erant, sed nē 20
pābuli quidem satis māgna cōpia suppetēbat;⁵ eō autem frūmentō quod flūmine Ararī nāvibus subvēxerat proptereā minus ūtī poterat, quod iter ab Ararī Helvētīi āverterant, ā quibus discēdere⁶ nōlēbat. Diem ex diē dūcere Haedui; cōferri, comportāri, adesse dīcere. 25

Cf. ¹ coēgit, p. 4, l. 9. — ² cupidī, 3, 1. — ³ nōn numquam, 7, 22. — ⁴ septentriōnēs, 2, 4. — ⁵ suppeteret, 3, 10. — ⁶ discessit, 12, 25.

Cæsar Summons their Chiefs and Upbraids them.

Ubi sē diūtius dūci intellēxit¹ et diem instāre quō diē frūmentum militibus mētiri oportēret, convocātis eōrum principibus, quōrum māgnam cōpiam in castris habēbat, — in



FIG. 10. — LOADING BOATS WITH SUPPLIES.

his Diviciācō et Liscō, qui summō magistrātui praeerat quem
 5 vergobretum appellant Haedui, qui creātur annuus et vitae
 necisque in suōs habet potestātem, — graviter² eōs accūsāt,
 quod, cum neque emī neque ex agris sūmī³ posset, tam
 necessariō tempore, tam propinquis hostibus, ab eis nōn

Cf. ¹ intellēbat, p. 8, l. 17. — ² gravius, 12, 14. — ³ sūmptūrum, 7, 8.

sublevētur; praesertim cum māgnā ex parte eōrum precibus adductus bellum suscēperit,¹ multō etiam gravius quod sit dēstitūtus queritur.

Liscus Explains the Situation: a Party Opposed to the Romans Prevents the Supply.

17. Tum dēmum Liscus orātiōne Caesaris adductus quod anteā tacuerat prōpōnit: ‘Esse nōn nullōs² quōrum auctōritās apud plēbem³ plūrimum valeat, quī privātīm plūs possint quam ipsī magistrātūs. Hōs sēditiōsā atque improbā orātiōne multitudinem dētterrēre nē frūmentum cōferant⁴ quod dēbeant: praestāre, sī iam principātum⁵ Galliae obtinēre nōn possint, Gallōrum quam Rōmānōrum imperia perferre; neque dubitāre quīn, sī Helvētiōs superāverint Rōmānī, unā cum reliquā Galliā Haeduis libertātem sint ēreptūrī.⁷ Ab eīsdem nostra cōnsilia quaeque in castris gerantur hostibus ēnūntiārī;⁸ hōs ā sē coercērī nōn posse. Quīn etiam, quod necessārīō rem coactus Caesarī ēnūntiārīt, intellegere sēsē quantō id cum periculō fēcerit, et ob eam causam quam diū potuerit tacuisse.’

Liscus Privately Discloses the Ambition and Treachery of Dumnorix, who Favors the Helvetii.

18. Caesar hāc orātiōne Lisci Dumnorigem, Diviciāci frātrem, dēsīgnārī sentiēbat; sed, quod plūribus praesentibus eās rēs iactārī nōlēbat,⁹ celeriter concilium dimittit, Liscum retinet. Quaerit ex sōlō ea quae in conventū dixerat. Dicit liberius atque audācius.¹⁰ Eadem sēcrētō ab aliīs quaerit; reperit esse vēra: ‘Ipsum esse Dumnorigem, summā audāciā, māgnā apud plēbem propter liberālitātem grātiā,¹¹ cupidum rērum novārum. Complūrīs annōs portōria

Cf. ¹ *suscipit*, p. 8, l. 10. — ² *nōn nullīs*, 6, 4. — ³ *plēbī*, 3, 21. — ⁴ *cōnferri*, 13, 25. — ⁵ *principātum*, 3, 20. — ⁶ *obtinēbant*, 6, 23. — ⁷ *ēripuit*, 4, 11. — ⁸ *ēnūntiātā*, 4, 4. — ⁹ *nōlēbat*, 13, 24. — ¹⁰ *audācius*, 13, 9. ¹¹ *grātiā*, 8, 5.

reliquaque omnia Haeduōrum vectigālia parvō pretiō redēpta habēre, proptereā quod illō licente contrā licēri audeat nēmō. His rēbus et suam rem familiārem auxisse et facultātis ad largiendum māgnās comparāsse; māgnū numerum equitātūs suō sūmptū semper alere et circum sē habēre, neque solum domī sed etiam apud finitimās¹ civitātis largiter posse; atque hūius potentiae causā mātrem in Biturigibus hominī illic nōbilissimō ac potentissimō conlocāsse, ipsum ex Helvētiis uxōrem habēre, sorōrem ex mātre et propinquās suās nūptum in aliās civitātis conlocāsse. Favēre et cupere Helvētiis propter eam adfinitātem, odisse etiam suō nōmine Caesarem et Rōmānōs, quod eōrum adventū potentia ēius dēminūta et Diviciācus frāter in antīquum locum grātiaē atque honōris sit restitūtus. Sī quid accidat Rōmānis, summam in spem per Helvētiōs rēgnī obtinēdi² venire; imperiō populī Rōmānī nōn modo dē rēgnō, sed etiam dē eā quam habeat grātiā, dēspērāre.’ Reperiēbat³ etiam in quaerendō⁴ Caesar, quod proelium equestre adversum paucīs⁵ ante diēbus esset factum, initium⁶ [ēius] fugae factum ā Dumnorige atque ēius equitibus, — nam equitātū, quem auxiliō Caesari Haeduī miserant, Dumnorix praeerat;⁷ eōrum fugā reliquum esse equitātum perterritum.

Cæsar Thinks that Dumnorix should be Punished.

19. Quibus rēbus cōgnitis, cum ad hās suspiciōnēs certissimae rēs accēderent, — quod per finis Sēquanōrum Helvētiōs trādūxisset, quod obsidēs inter eōs dandōs cūrasset,⁸ quod ea omnia nōn modo iniūssū suō et civitātis sed etiam inscientibus ipsīs fēcisset, quod ā magistrātū Haeduōrum accūsārētur, — satis esse causae arbitrābātur⁹ quā rē in

Cf. ¹ finitimōs, p. 8, l. 20. — ² obtinēre, 15, 9. — ³ reperit, 15, 23. — ⁴ quaerit, 15, 23. — ⁵ paucī, 13, 7. — ⁶ initium, 2, 1. — ⁷ praeerat, 14, 4. — ⁸ cūrāt, 11, 5. — ⁹ arbitrantur, 4, 15.

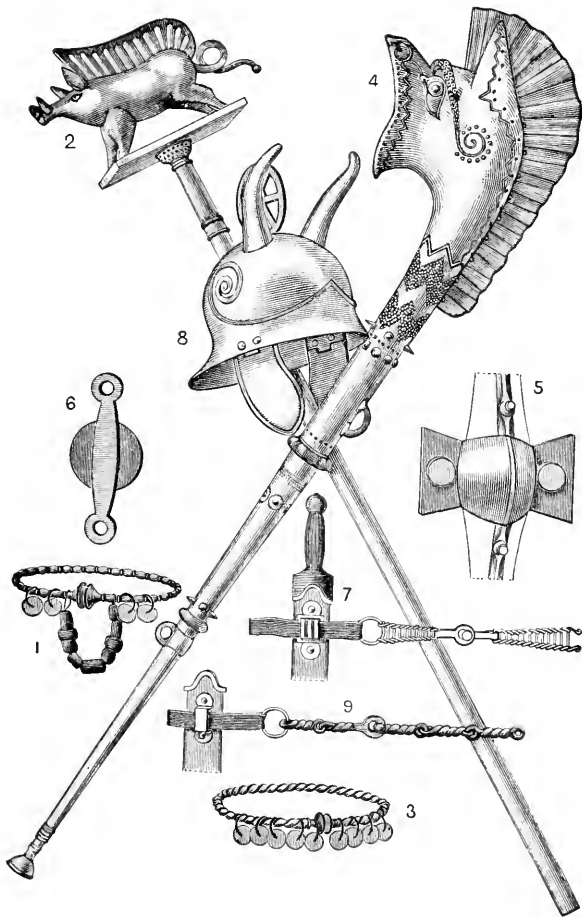

FIG. 11. — GALIC REMAINS.

1 and 3. Necklaces with amber and coral pendants. 2. Military standard. 4. Bronze trumpet (carnyx). 5. Iron boss of shield. 6. Iron holder. 7. Sword-hilt and girdle. 8. Iron helmet. 9. Iron belt-chain.

eum aut ipse animadverteret aut civitatem animadvertere iubēret.

But Summons Diviciacus, Whom he does not Wish to Offend.

His omnibus rēbus ūnum repūgnābat, quod Diviciāci frātris summum in populum Rōmānum studium, summam in sē voluntātem,¹ ēgregiam fidem, iūstitiam, temperantiam cōgnō- 5
verat : nam nē ēius supplicio Diviciāci animum offenderet verēbātur. Itaque prius quam quicquam cōnārētur,² Diviciācum ad sē vocārī iubet, et cotidiānis³ interpretibus remōtis per C. Valerium Procillum, principem⁴ Galliae prōvinciae, familiārem suum, cui summam omnium rērum 10
fidem habēbat, cum eō conloquitur ; simul commonefacit quae ipsō praesente in concilio [Gallōrum] dē Dumnorige sint dicta ; et ostendit⁵ quae sēparātim quisque dē eō apud sē dixerit ; petit atque hortātur ut sine ēius offēnsiōne animi vel ipse de eō, causā cōgnitā, statuat⁶ vel civitatem 15
statuere iubeat.

Diviciacus Pleads for his Brother's Pardon.

20. Diviciācus, multis cum lacrimis Caesarem complexus, obsecrāre coepit nē quid gravius in frātrem statueret : ‘ Scire sē illa esse vēra, nec quemquam ex eō plūs quam sē dolōris⁷ capere, proptereā quod, cum ipse grātiā plūrimum domi 20
atque in reliquā Galliā, ille minimum propter adulēscentiam posset, per sē crēvisset ; quibus opibus ac nervis nōn solum ad minuendam grātiā sed paene ad perniciem suam ūterētur ;⁸ sēsē tamen et amōre frāternō et existimātiōne volgi commovēri. Quod sī quid eī ā Caesare gravius accidisset,⁹ 25
cum ipse eum locum amicitiae apud eum tenēret, nēmīnem¹⁰

Cf. ¹ voluntāte, p. 6, l. 26. — ² cōnārī, 6, 15. — ³ cotidiānis, 1, 12. — ⁴ principibus, 14, 2. — ⁵ ostendit, 7, 20. — ⁶ statuit, 9, 25. — ⁷ dolōre, 3, 1. — ⁸ ūtī, 13, 23. — ⁹ accidat, 16, 14. — ¹⁰ nēmō, 16, 3.

existimātūrum¹ nōn suā voluntāte factum; quā ex rē futurum uti tōtius Galliae animi ā sē āverterentur.²

And for his Sake Dumnorix is Spared.

Haec cum plūribus verbis flēns ā Caesare peteret, Caesar eius dextram prendit; cōsōlātus rogat finem ōrandi faciat; 5 tantī eius apud sē grātiā esse ostendit uti et rei pūblicae iniūriam et suum dolōrem eius voluntāti ac precibus³ condōnet. Dumnorigem ad sē vocat, frātre adhibet; quae in eō reprehendat ostendit; quae ipse intellegat, quae civitās querātur,⁴ prōpōnit;⁵ monet ut in reliquum tempus omnis 10 suspiciōnēs vitet; praeterita sē Diviciācō frātri condōnāre dicit. Dumnorigī custōdēs pōnit, ut quae agat, quibuscum loquātur, scire possit.

Cæsar Prepares for a Battle.

21. Eōdem diē ab explorātōribus⁶ certior factus hostis sub monte cōsēdisse milia passuum ab ipsius castris octō, 15 quālis esset nātūra montis et quālis in circuitū ascēsus, quī cōgnōscerent misit. Renūtiātum⁷ est facilem esse. Dē tertiā vigiliā⁸ T. Labiēnum, lēgātum prō praetōre, cum duābus legiōnibus et eis ducibus quī iter cōgnōverant, summum iugum montis ascendere iubet; quid suī cōsili⁹ sit 20 ostendit. Ipse dē quartā vigiliā eōdem itinere quō hostēs ierant ad eōs contendit, equitātumque omnem ante sē mittit. P. Cōnsidius, quī rei militāris perītissimus habēbātur et in exercitū L. Sullae et postea in M. Crassī fuerat, cum explorātōribus praemittitur.¹⁰

Cf. ¹ existimābat, p. 7, l. 5. — ² āverterant, 13, 23. — ³ precibus, 15, 1. — ⁴ queritur, 15, 3. — ⁵ prōpōnit, 15, 5. — ⁶ explorātōrēs, 10, 5. — ⁷ renūtiātur, 8, 14. — ⁸ vigiliā, 10, 7. — ⁹ cōsilia, 15, 13. — ¹⁰ praemittit, 13, 4.

Considius, being Panic-stricken, Delays the Plan.

22. Primā lūce, cum summus mōns ā Labiēnō tenērētur, ipse ab hostium castris nōn longius¹ mille et quīngentis passibus abesset,² neque, ut postea ex captivis comperit, aut

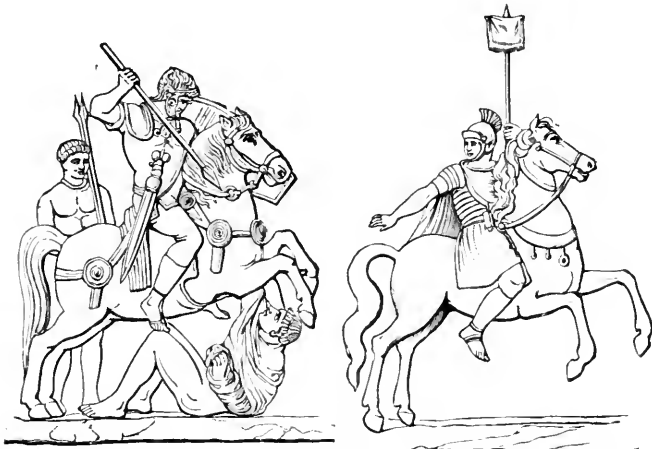

FIG. 12.—CAVALRYMAN CHARGING. FIG. 13.—CAVALRYMAN WITH *Vexillum*.

ipsius adventus aut Labiēnī cōgnitus³ esset, Cōnsidius equō
 admissō ad eum accurrit; dicit montem quem ā Labiēnō
 occupārī⁴ voluerit⁵ ab hostibus tenēri; id sē ā Gallicis armis
 atque insignibus cōgnōvisse. Caesar suās cōpiās in proxi-
 mum⁶ collem subdūcit, aciem instruit. Labiēnus, ut erat eī
 praeceptum ā Caesare nē proelium committeret, nisi ipsius
 cōpiae prope hostium castra visae essent, ut undique ūnō
 tempore in hostis impetus fieret, monte occupātō nostrōs
 expectābat proeliōque abstinēbat. Multō dēnique diē per
 explorātōrēs Caesar cōgnōvit et montem ā suis tenēri et

Cf. ¹ longē, p. 8, l. 16. — ² absunt, 1, 7. — ³ cōgnōverat, 17, 5. — ⁴ occupātis, 9, 5. — ⁵ velint, 12, 15. — ⁶ proximās, 10, 12.

Helvētiōs castra mōvisse¹ et Cōnsidium timōre perterritum quod nōn vidisset prō visō sibi renūntiāsse. Eō diē, quō cōnsuērat intervāllō, hostis sequitur et milia passuum tria ab eōrum castris castra pōnit.

Cæsar Turns towards Bibracte to Get Supplies. The Helvetii, Emboldened, Follow him.

5 23. Postridiē ēius diēi, quod omninō² biduum supererat cum exercituī frūmentum metiri³ oportēret,⁴ et quod ā Bibracte, oppidō Haeduōrum longē maximō et cōpiōsissimō, nōn amplius⁵ milibus passuum XVIII aberat, rei frūmentāriæ prōspiciendum existimāvit; *itaque* iter ab Helvētiis āvertit
10 ac Bibracte ire contendit.⁶ Ea rēs per fugitivōs L. Aemili, decuriōnis equitum Gallōrum, hostibus nūntiātur. Helvētiū, seu quod timōre perterritōs Rōmānōs discēdere ā sē existimārent, eō magis quod pridīē superiōribus locis occupātis proelium nōn commisissent,⁷ sive eō quod rē frūmentāriā⁸
15 interclūdī posse cōfiderent, commūtātō cōnsiliō atque itinere conversō nostrōs ā novissimō⁹ agmine insequi¹⁰ ac lacessere¹¹ coepērunt.

Both Sides Prepare for Battle.

24. Postquam id animum advertit, cōpiās suās Caesar in proximum collem subducit equitātumque quī sustinēret
20 hostium impetum¹² mīsit. Ipse interim in colle mediō triplicem aciem instrūxit¹³ legiōnum quattuor veterānārum; sed in summō iugō duās legiōnēs quās in Galliā citeriōre¹⁴ proximē cōscripserat et omnia auxilia conlocārī, [ac tōtum montem hominibus complērī, et intereā] sarcinās in ūnum locum

Cf. ¹ movent, p. 13, l. 1. — ² omninō, 6, 18. — ³ metiri, 14, 2. — ⁴ oportēret, 14, 2. — ⁵ amplius, 13, 15. — ⁶ contendit, 18, 21. — ⁷ committeret, 19, 9. — ⁸ frūmentāriis, 8, 19. — ⁹ novissimum, 13, 5. — ¹⁰ insecuti, 13, 5. — ¹¹ lacessere, 13, 11. — ¹² impetus, 19, 11. — ¹³ instruit, 19, 8. — ¹⁴ citeriōris, 9, 6.

cōferri, et eum ab his quī in superiōre aciē cōstiterant¹ mūniri iussit. Helvētii cum omnibus suis carris secūti,



FIG. 14.—SOLDIERS MARCHING WITH PACKS (*sarcinae*).

impedimenta in ūnum locum contulērunt; ipsi cōfertissimā aciē, rēiectō nostrō equitātū, phalange factā, sub primam nostram aciem successērunt.

5

Cf. ¹ cōstitissent, p. 11, l. 23.

The Battle.

25. Caesar primum suō deinde omnium ex cōspectū¹ remōtis equīs, ut aequātō omnium periculō spem fugae tolleret, cohortātus suōs proelium commisit. Militēs ē locō superiōre pilis missis facile hostium phalangem perfrēgērunt. Eā disiectā, gladiīs dēstrictis in eōs impetum fēcērunt. Gallis māgnō ad pūgnam erat impedimentō quod, plūribus eōrum scūtis ūnō ictū pilōrum trānsfixis et conligātis, cum ferrum sē inflexisset, neque ēvellere neque sinistrā

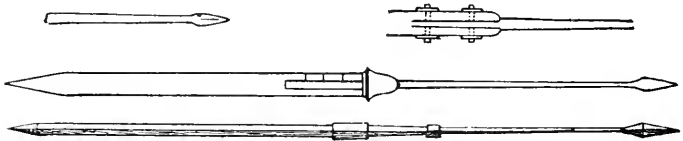
FIG. 15.—ROMAN JAVELINS (*pila*).

impeditā² satis commodē pūgnāre poterant, multī ut diū iactātō bracchiō praeoptārent scūtum manū ēmittere et nūdō corpore pūgnāre. Tandem vulneribus dēfessi et pedem referre et, quod mōns aberat circiter mille passuum, eō sē recipere coepērunt. Captō monte et succēdentibus³ nostris, Bōiī et Tulingī, quī hominum milibus circiter xv agmen hostium claudēbant et novissimis praesidiō erant, ex itinere nostrōs ab latere apertō adgressi⁴ circumvenire; et id cōspicātī Helvētīi, quī in montem sēsē recēperant, rūsus instāre et proelium redintegrāre coepērunt. Rōmāni conversa signa bipartitō intulērunt: prima et secunda aciēs, ut victis ac submōtis resisteret; tertia, ut venientis sustinēret.

Cf. ¹ cōspectū, p. 9, l. 16. — ² impeditōs, 10, 10. — ³ successērunt, 21, 5. — ⁴ adgressus, 10, 10.

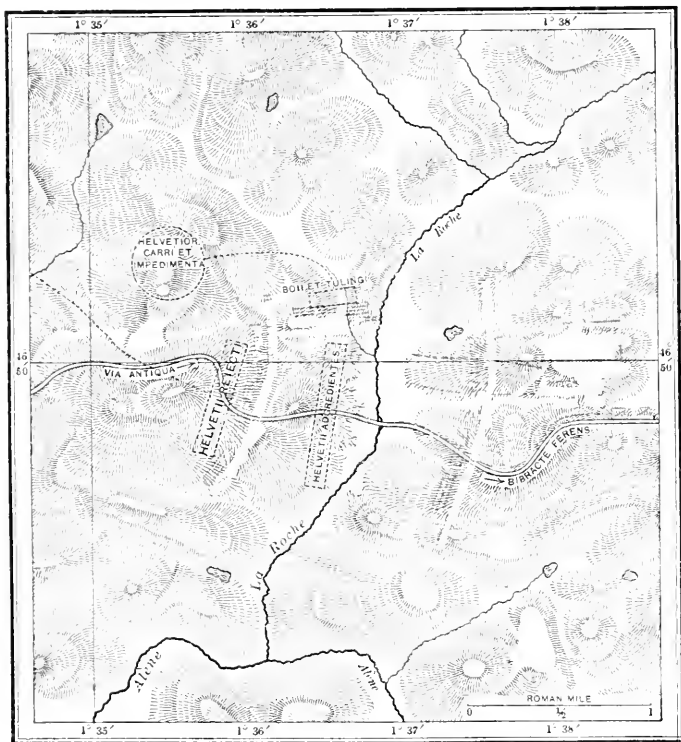

FIG. 16.—DEFEAT OF THE HELVETII.

The Helvetii are Defeated with Great Loss. They Retreat.

26. Ita ancipiti proeliō diū atque ācriter pūgnātum est. Diūtius cum sustinēre¹ nostrōrum impetūs nōn possent, alteri sē, ut coeperant, in montem recēpērunt, alteri ad impedimenta² et carrōs suōs sē contulērunt. Nam hōc tōtō proeliō, cum ab hōrā septimā ad vesperum pūgnātum 5

Cf. ¹ sustinēret, p. 20, l. 19.—² impedimenta, 21, 3.

sit, āversum hostem vidēre nēmō potuit. Ad multam noctem etiam ad impedimenta pūgnātum est, proptereā quod prō vāllō carrōs obiēcērant et ē locō superiōre in nostrōs venientis tēla coniciēbant, et nōn nūlli¹ inter carrōs rēdāsque
 5 matarās ac trāgulās subiciēbant nostrōsque volnerābant. Diū cum esset pūgnātum, impedimentis castrisque nostrī potitī² sunt. Ibi Orgetorigis filia atque ūnus ē filiis captus est. Ex eō proeliō circiter hominum milia cxxx superfuērunt, eāque tōtā nocte continenter³ iērunt: [nūllam partem
 10 noctis itinere intermissō] in finis Lingonum diē quartō pervēnērunt,⁴ cum et propter volnera militum et propter sepultūram occisōrum⁵ nostrī [triduum morātī] eōs sequi nōn potuissent. Caesar ad Lingonas litterās nūntiōsque misit nē eōs frūmentō nēve aliā rē iuvārent; qui sī iūvissent, sē
 15 eōdem locō quō Helvētiōs habitūrum. Ipse triduō intermissō cum omnibus cōpiis⁶ eōs sequi coepit.

Negotiations for Surrender.

27. Helvētīi omnium rērum inopiā adductī lēgātōs dē dēditionē ad eum misērunt. Quī cum eum in itinere convēnissent sēque ad pedēs prōiēcissent suppliciterque locūti
 20 flentēs⁷ pācem petissent,⁸ atque eōs in eō locō quō tum essent suum adventum⁹ expectāre iussisset, pāruērunt. Eō postquam Caesar pervēnit, obsidēs,¹⁰ arma, servōs qui ad eōs perfūgissent poposcit.

Six Thousand Helvetii Flee, but Later are Captured.

Dum ea conquiruntur et cōferuntur,¹¹ [nocte intermissā]
 25 circiter hominum milia vi eius pāgī¹² qui Verbigenus appellātur, sive timōre perterriti,¹³ nē armis trāditis supplicio¹⁴

Cf. ¹ nōn nūllōs, p. 15, l. 5. — ² potirī, 2, 16. — ³ continenter, 1, 10. — ⁴ pervēnit, 10, 8. — ⁵ occisum, 7, 2. — ⁶ cōpiās, 19, 7. — ⁷ flens, 18, 3. — ⁸ peteret, 18, 3. — ⁹ adventū, 16, 12. — ¹⁰ obsidēs, 12, 18. — ¹¹ cōferri, 21, 1. — ¹² pāgus, 10, 12. — ¹³ perterritōs, 20, 12. — ¹⁴ supplicio, 17, 6.

adficerentur, sive spē salutis inducti, quod in tantā multitudi-
dine dēditiciōrum suam fugam aut occultāri aut omninō

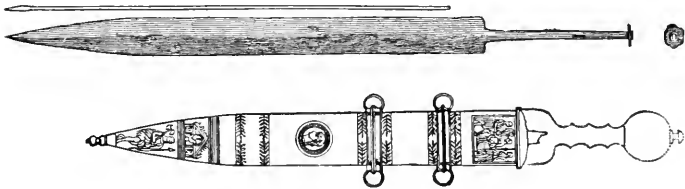

FIG. 17. — ROMAN SWORDS (*gladii*).

ignōrāri posse existimārent,¹ primā nocte ē castris Helvētiōrum
ēgressi ad Rhēnum finisque Germānōrum contendērunt.

28. Quod ubi Caesar resciiit, quōrum per finis ierant, his
utī conquīrerent² et redūcerent, si sibi pūrgāti esse vellent,
imperāvit; reductōs in hostium numerō habuit;³ reliquōs
omnis, obsidibus, armīs, perfugis trādītis in dēditionem⁴
accēpit.

The Helvetii Forced to Return.

Helvētiōs, Tulingōs, Latobrigōs in finis suōs, unde erant
profecti, reverti iussit; et quod omnibus frūgibus āmissis
domi nihil erat quō famem tolerārent, Allobrogibus impe-
rāvit ut eis frūmentī cōpiam⁵ facerent; ipsōs oppida vicōs-
que, quōs incenderant,⁶ restituere⁷ iussit. Id eā maximē
ratiōne fēcit, quod nōluit eum locum unde Helvētiū disces-
serant⁸ vacāre, nē propter bonitātem agrōrum Germāni, qui
trāns Rhēnum incolunt, ē suis finibus in Helvētiōrum finis
trānsirent, et finitimī⁹ Galliae prōvinciae Allobrogibusque
essent. Bōiōs petentibus Haeduis, quod ēgregiā¹⁰ virtūte
erant cōgniti, ut in finibus suis conlocārent, concessit;¹¹

Cf. ¹ existimātūrum, p. 18, l. 1. — ² conquīruntur, 24, 24. — ³ habitū-
rum, 24, 15. — ⁴ dēditione, 24, 18. — ⁵ cōpiam, 12, 3. — ⁶ incendunt,
4, 20. — ⁷ restitūtus, 16, 14. — ⁸ discēdere, 20, 12. — ⁹ finitimās, 16, 6.
— ¹⁰ ēgregiam, 17, 5. — ¹¹ concēdere, 12, 17.

quibus illi agrōs dedērunt, quōsque posteā in parem iūris libertātisque condiōnem atque ipsi erant recēpērunt.

Census of the Tribes Before and After their March.

29. In castris Helvētiōrum tabulae repertae¹ sunt litteris Graecis cōfectae et ad Caesarem relātae, quibus in tabulis
5 nōminātīm ratiō cōfecta erat, quī numerus domō exisset eōrum
quī arma ferre possent, et item sēparātīm *quot* pueri, senēs
mulierēsque. Quārum omnium rērum summa erat capitum
Helvētiōrum milium CCLXIII, Tulingōrum milium XXXVI, Lato-
brīgōrum XIII, Rauracōrum XXIII, Bōiōrum XXXII; ex his
10 quī arma ferre possent, ad milia XCII. Summa omnium fuē-
runt ad milia CCCLXVIII. Eōrum quī domum rediērunt cēnsū
habitō, ut Caesar imperāverat, repertus est numerus milium
C et X.

Gallic Chiefs Congratulate Cæsar.

30. Bellō Helvētiōrum cōfectō tōtius ferē Galliae lēgāti,
15 principēs civitātum, ad Caesarem grātulātum convēnērunt:
'Intellegere sēsē, tametsi prō veteribus² Helvētiōrum iniūriis
populi Rōmāni ab his poenās bellō repetisset, tamen eam
rem nōn minus ex ūsū terrae Galliae quam populi Rōmāni
accidisse; ³ proptereā quod eō cōnsiliō flōrentissimis rēbus
20 domōs suās Helvētiī reliquissent,⁴ utī tōtī Galliae bellum
inferrent imperiōque potirentur⁵ locumque domiciliō ex
māgnā cōpiā dēligerent,⁶ quem ex omni Galliā opportūnissi-
mum ac frūctuōsissimum iūdicāssent, reliquāsque civitātis
stīpendiāriās habērent.'

They Request a Council.

25 Petiērunt utī sibi concilium tōtius Galliae in diem certam
indicere idque Caesaris voluntāte facere licēret:⁷ sēsē habēre

Cf. ¹ *reperiēbat*, p. 16, l. 17. — ² *veteris*, 12, 7. — ³ *accidisset*, 17, 25.
— ⁴ *relinquēbātur*, 8, 1. — ⁵ *potitū*, 24, 7. — ⁶ *dēligitur*, 3, 14. — ⁷ *liceat*,
6, 26.

quāsdam rēs quās ex commūnī cōsēnsū ab eō petere vel-
lent. Eā rē permissā diem conciliō cōstituērunt et iūre
iūrandō nē quis ēnūntiāret,¹ nisi quibus commūnī cōsiliō
mandātum esset, inter sē sānxērunt.

Private Interview with Cæsar.

31. Eō conciliō dimissō idem principēs civitātum quī 5
ante fuerant ad Caesarem revertērunt² petiēruntque uti
sibi sēcrētō [in occultō] dē suā omniumque salūte³ cum eō
agere⁴ licēret. Eā rē impetrātā⁵ sēsē omnēs flentēs Caesari
ad pedēs prōiēcērunt :⁶ ‘Nōn minus sē id contendere et
labōrāre, nē ea quae dixissent ēnūntiārentur, quam uti ea 10
quae vellent impetrārent ; propterea quod, si ēnūntiātum
esset, summum in cruciātum sē ventūrōs vidērent.’

Speech of Diviciacus the Hæduan. He Complains of the Encroachments
of the Germans.

Locūtus⁷ est prō his Diviciācus Haeduus : ‘Galliae tōtius
factiōnēs esse duās ; hārum alterius principātum tenēre 15
Haeduōs, alterius Arvernōs. Hī cum tantopere dē poten-
tātū inter sē multōs annōs contenderent, factum esse uti
ab Arvernīs Sēquanisque Germāni mercēde arcesserentur.
Hōrum primō circiter milia xv Rhēnum trānsisse ; postea-
quam agrōs et cultum et cōpiās Gallōrum hominēs ferī ac
barbarī adamāssent, trāductōs plūris ; nunc esse in Galliā 20
ad centum et xx milium numerum. Cum his Haeduōs
eōrumque clientis semel atque iterum armīs contendisse ;
māgnam calamitātem pulsōs⁸ accēpisse, omnem nōbilitātem,
omnem senātum, omnem equitātum āmississe.⁹ Quibus proe-
liis calamitātibusque frāctōs, quī et suā virtūte et populī 25
Rōmāni hospitiō atque amicitia plūrimum ante in Galliā

Cf. ¹ ēnūntiārī, p. 15, l. 14. — ² revertī, 25, 11. — ³ salūtis, 25, 1. —
— ⁴ ēgit, 11, 12. — ⁵ impetrat, 8, 10. — ⁶ prōiēcissent, 24, 19. — ⁷ locūtī,
24, 19. — ⁸ pulsīs, 9, 6. — ⁹ āmissīs, 25, 11.

potuissent, coactōs¹ esse Sēquanīs obsidēs dare nōbilissimōs civitātis, et iūre iūrāndō civitātem obstringere² sēsē neque obsidēs repetitūrōs³ neque auxilium ā populō Rōmānō implōrātūrōs neque recūsātūrōs quō minus perpetuō sub illōrum
 5 dīcīōne atque imperiō essent. Ūnum sē esse ex omnī civitāte Haeduōrum quī addūcī nōn potuerit ut iūrāret aut liberōs suōs obsidēs daret. Ob eam rem sē ex civitāte profūgisse et Rōmam ad senātum vēnisse auxilium postulātum, quod sōlus neque iūre iūrāndō neque obsidibus
 10 tenērētur.⁴

The Hard Lot of the Sequani.

Sed pēius victōribus Sēquanīs quam Haeduīs victis accidisse, proptereā quod Ariovistus, rēx Germānōrum, in eōrum finibus cōnsēdisset⁵ tertiamque partem agrī Sēquanī, quī esset optimus tōtīus Galliae, occupāvisset, et nunc dē alterā
 15 parte tertiā Sēquanōs dēcēdere iubēret, proptereā quod paucīs mēnsibus⁶ ante Harūdum milia hominum xxiiii ad eum vēnissent, quibus locus ac sēdēs parārentur. Futūrum esse paucīs annīs utī omnēs ex Galliae finibus pellerentur atque
 20 omnēs Germānī Rhēnum trānsīrent; neque enim cōferendum esse Gallicum cum Germānōrum agrō, neque hanc cōnsuētūdinem victūs cum illā comparandam.

Tyranny of Ariovistus.

Ariovistum autem, ut semel Gallōrum cōpiās proeliō vice-rit, quod proelium factum sit ad Magetobrigam, superbē et crūdēliter imperāre, obsidēs nōbilissimī cūiusque⁷ liberōs
 25 poscere,⁸ et in eōs omnia exempla cruciātūsque⁹ ēdere, sī qua rēs nōn ad nūtum aut ad voluntātem ēius facta sit. Hominem esse barbarum, irācundum, temerārium; nōn posse ēius imperia diūtius¹⁰ sustinēri.

Cf. ¹ coactus, p. 15, l. 15.—² obstrictās, 8, 9.—³ repetisset, 26, 17.—⁴ tenēri, 19, 6.—⁵ cōnsēdisse, 18, 14.—⁶ mēnsium, 4, 23.—⁷ quisque, 17, 13.—⁸ poposcit, 24, 23.—⁹ cruciātum, 27, 12.—¹⁰ diū, 23, 1.

The Gauls have no Hope but in Cæsar.

Nisi quid in Caesare populōque Rōmānō sit auxili, omnibus Gallis idem esse faciendum quod Helvētiī fēcerint, ut domō ēmigrent, aliud domicilium aliās sēdis remōtās ā Germānis petant fortūnamque, quaecumque accidat, experiantur. Haec sī ēnūntiāta Ariovistō sint, nōn dubitāre quī 5 dē omnibus obsidibus quī apud eum sint gravissimum supplicium sūmat. Caesarem vel auctōritāte suā atque exercitūs vel recentī victōriā vel nōmine populi Rōmāni dēterrere posse nē māior multitudō Germānōrum Rhēnum trādūcātur,¹ Galliamque omnem ab Ariovisti iniūriā posse dēfendere.' 10

The Sequani Remain Silent. Diviciacus Shows their Desperate Condition.

32. Hāc ōrātiōne ab Diviciācō habitā omnēs quī aderant māgnō flētū auxiliū ā Caesare petere coepērunt.² Animadvertit Caesar ūnōs³ ex omnibus Sēquanōs nihil eārum rērum facere quās cēteri facerent, sed tristis capite dēmissō terram intuēri. Eius rei quae causa esset mirātus ex ipsis quae- 15 siit.⁴ Nihil Sēquanī respondēre, sed in eādē tristitiā taciti permanēre. Cum ab his saepius quaereret neque ūllam omninō vōcem exprimere posset, idem Diviciācus Haedus respondit : 'Hōc esse miseriōrem et graviōrem fortūnam Sēquanōrum quam reliquōrum,⁵ quod sōlī nē in occultō 20 quidem queri⁶ neque auxiliū implōrāre audērent; absentisque Ariovisti crūdēlitātem, velut sī cōram adesset, horrērent, propterea quod reliquīs tamen fugae facultās⁷ darētur, Sēquanīs vērō, quī intrā finis suōs Ariovistum recēpissent, quōrum oppida omnia in potestāte eius essent, omnēs cruci- 25 ātūs essent perferendi.'

Cf. ¹ trāductōs, p. 27, l. 20. — ² coepit, 24, 16. — ³ ūnum, 28, 5. — ⁴ quaerendō, 16, 18. — ⁵ reliquās, 26, 23. — ⁶ querātur, 18, 9. — ⁷ facultāte, 7, 4.

Cæsar's Reasons for Checking Ariovistus.

33. His rēbus cōgnitīs¹ Caesar Gallōrum animōs verbīs cōfirmāvit, pollicitusque² est sibi eam rem cūrae futūram; māgnam sē habēre spem et beneficiō suō et auctōritāte adductum Ariovistum finem iniūriīs factūrum. Hāc ōrāti-
 5 ōne habitā concilium dīmisit. Et secundum ea multae rēs eum hortābantur³ quā rē sibi eam rem cōgitandam et suscipiendam putāret: imprimīs, quod Haeduōs, frātrēs cōsanguineōsque⁴ saepenumerō ā senātū appellātōs, in servitūte atque in diciōne⁵ vidēbat Germānōrum tenēri, eōrumque
 10 obsidēs esse apud Ariovistum ac Sēquanōs intellegēbat; quod in tantō imperiō populi Rōmāni turpissimum sibi et reī pūblicae esse arbitrābātur.⁶ Paulātīm autem Germānōs cōnsuēscere⁷ Rhēnum trānsire et in Galliam māgnam eōrum multitudinem venire, populō Rōmānō periculōsum vidēbat;
 15 neque sibi hominēs ferōs ac barbarōs temperātūrōs⁸ existimābat quīn, cum omnem Galliam occupāvissent, ut ante Cimbrī Teutonīque fēcissent, in prōvinciam exirent atque inde in Ītaliā contenderent; [praesertim cum Sēquanōs ā prōvinciā nostrā Rhodanus divideret]; quibus rēbus quam mātūrrimē
 20 occurrendum putābat. Ipse autem Ariovistus tantōs sibi spīritūs, tantam adrogantiam sūmpserat, ut ferendus nōn viderētur.

He Requests an Interview with Ariovistus, Who Declines.

34. Quam ob rem placuit eī ut ad Ariovistum lēgātōs mitteret, quī ab eō postulārent utī aliquem locum medium
 25 utriusque conloquiō dēligeret: velle sēsē dē rē pūblicā et summīs utriusque rēbus cum eō agere.⁹ Eī lēgātiōnī Ariovistus respondit: 'Sī quid ipsī ā Caesare opus esset, sēsē

Cf. ¹ cōgnitūs, p. 19, l. 4. — ² pollicitī, 13, 18. — ³ hortātūr, 17, 14. — ⁴ cōsanguineī, 9, 19. — ⁵ diciōne, 28, 5. — ⁶ arbitrābātur, 16, 28. — ⁷ cōnsuērat, 20, 3. — ⁸ temperātūrōs, 7, 5. — ⁹ agere, 27, 8.

ad eum ventūrum fuisse ; sī quid ille sē velit, illum ad sē venīre oportēre.¹ Praetereā sē neque sine exercitū in eās partīs Galliae venīre audēre² quās Caesar possidēret, neque exercitum sine māgnō commeātū atque mōlimentō in ūnum locum contrahere posse. Sibi autem mirum vidērī³ quid in 5 suā Galliā, quam bellō vīcisset, aut Caesari aut omnīnō populō Rōmānō negōtī esset.’

Cæsar Sends a Second Message Stating his Demands.

35. His respōnsis ad Caesarem relātis, iterum ad eum Caesar lēgātōs cum hīs mandātis mittit : ‘ Quoniam tantō suō populūque Rōmānī beneficiō adfectus, cum in cōsulātū 10 suō rēx atque amicus ā senātū appellātus esset, hanc sibi populōque Rōmānō grātiā referret, ut in conloquium venīre invitātus gravārētur neque dē commūnī⁴ rē dicendum sibi et cōgnōscendum putāret, haec esse quae ab eō postulāret : primum, nē quam multitudinē hominum amplius⁵ trāns 15 Rhēnum in Galliam trādūceret ; deinde obsidēs quōs haberet ab Haeduis redderet, Sēquanisque permetteret ut quōs illi habērent voluntāte eius reddere illis liceret ; nēve Haeduōs iniūriā lacesseret,⁶ nēve hīs sociisque eōrum bellum inferret. Sī id ita fēcisset, sibi populōque Rōmānō perpetuam grātiā atque amicitiam cum eō futūram ; sī nōn impetrāret,⁷ sēsē, --- quoniam M. Messālā M. Pisōne cōsulibus senātus cēnsuisset utī quicumque Galliam prōvinciam obtinēret, quod commodō rei pūblicae facere posset, Haeduōs cēterōsque amicōs populī Rōmānī dēfenderet, — sē Haeduō- 25 rum iniūriās nōn neglētūrum.’

Ariovistus's Haughty Reply.

36. Ad haec Ariovistus respondit : ‘ Iūs⁸ esse bellī ut

Cf. ¹ oportēbat, p. 4, l. 6. — ² audērent, 29, 21. — ³ vidērentur, 6, 9. — ⁴ commūnī, 27, 1. — ⁵ amplius, 20, 8. — ⁶ lacessere, 13, 11. — ⁷ impetrātā, 27, 8. — ⁸ iūris, 26, 1.

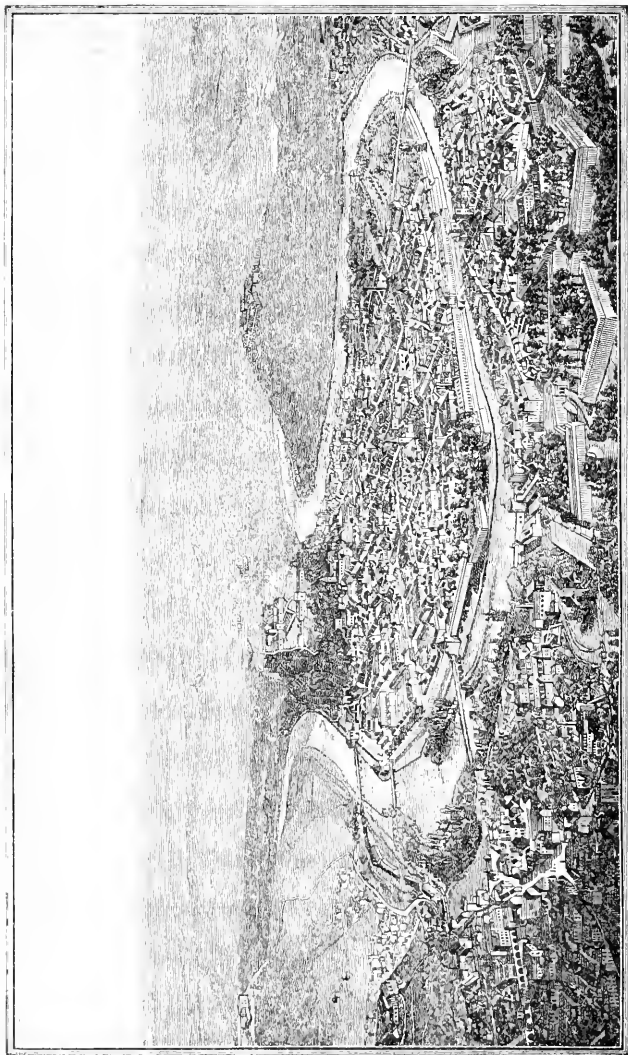

FIG. 18. — BESANÇON (*Vesontio*).

celerrimē¹ potuit comparātā, māgnīs itineribus ad Ariovistum contendit.

Both Strive to Reach Vesontio.

38. Cum trīdui² viam prōcessisset, nūntiātum est eī Ariovistum cum suis omnibus cōpiīs ad occupandum Vesontionem, quod est oppidum māximum Sēquanōrum, contendere, 5
[trīduique viam ā suis finibus prōcessisse]. Id nē accideret³ māgnopere sibi praecavendum Caesar existimābat. Namque omnium rērum quae ad bellum ūsui erant summa erat in eō oppidō facultās ; idemque nātūrā loci sic mūniēbatur ut māgnam ad dūcendum bellum daret facultātem,⁴ propterea 10
quod flūmen Dubis, ut circinō circumductum, paene tōtum oppidum cingit ; reliquum spatium, quod est nōn amplius pedum sexcentōrum, quā flūmen intermittit, mōns continet māgnā altitūdine, ita ut rādicēs montis ex utrāque parte rīpae flūminis contingant. Hunc mūrus circumdatus arcem 15
efficit et cum oppidō coniungit. Hūc Caesar māgnīs nocturnīs diurnisque itineribus contendit,⁵ occupātōque oppidō ibi praesidium conlocat.

The Roman Soldiers are Panic-stricken.

39. Dum paucōs diēs ad Vesontionem rei frūmentāriae commeātūsque⁶ causā morātur,⁷ ex percontātiōne nostrōrum 20
vōcibusque Gallōrum ac mercātōrum, quī ingenti māgnitūdine corporum Germānōs, incredibili virtūte atque exercitātiōne in armīs esse praedicābant, — saepenumerō⁸ sēsē cum his congressōs⁹ nē voltum quidem atque aciem oculōrum dicēbant ferre potuisse, — tantus subitō timor omnem exer- 25
citurum occupāvit ut nōn mediocriter omnium mentis animōsque perturbāret. Hic primum ortus¹⁰ est ā tribūnis militum,

Cf. ¹ celeriter, p. 15, l. 20. — ² trīduum, 24, 12. — ³ accidat, 29, 4. —
⁴ facultās, 29, 23. — ⁵ contenderent, 30, 18. — ⁶ commeātū, 31, 4. —
⁷ morātī, 24, 12. — ⁸ saepenumerō, 30, 8. — ⁹ congredērētur, 32, 16. —
¹⁰ oriuntur, 2, 5.

praefectis reliquisque, quī ex urbe amicitiae causā Caesarem secūtī nōn māgnū in rē militārī ūsum habēbant; quōrum aīus aliā causā inlātā quam sibi ad proficiscendum necessāriam esse diceret, petēbat ut ēius voluntāte¹ discēdere
 5 liceret; nōnnūllī pudōre adductī, ut timōris suspiciōnem vitārent,² remanēbant. Hī neque voltum fingere neque interdum lacrimās tenēre poterant; abditī³ in tabernāculis aut suum fātum querēbantur aut cum familiāribus⁴ suis commūne periculum miserābantur. Volgō tōtis castris tes-
 10 tāmenta obsignābantur. Hōrum vōcibus ac timōre paulātim etiam eī quī māgnū in castris ūsum habēbant, militēs centuriōnēsque quīque equitātui praecerant, perturbābantur. Quī sē ex hīs minus timidōs existimārī volēbant, nōn sē hostem verērī, sed angustias itineris et māgnitudinem silvārum quae
 15 intercēderent inter ipsōs atque Ariovistum, aut rem frūmentāriam, ut satis commodē⁵ supportārī posset, timēre dīcēbant. Nōn nūllī etiam Caesari nūntiābant, cum castra movērī ac signa ferrī iussisset, nōn fore dictō audientis militēs neque propter timōrem signa lātūrōs.

Cæsar Makes Light of their Fears, and Proposes to Advance at Once.

20 40. Haec cum animadvertisset,⁶ convocātō cōnsiliō omniumque ōrdinum ad id cōnsilium adhibitīs⁷ centuriōnibus, vehementer eōs incūsāvit: primum quod aut quam in partem aut quō cōnsiliō dūcerentur sibi quaerendum aut cōgitandum⁸ putārent. ‘Ariovistum sē cōnsule cupidissimē populī
 25 Rōmānī amicitiam adpetisse; cūr hunc tam temerē quisquam⁹ ab officiō discessūrum iudicāret?¹⁰ Sibi quidem persuādērī, cōgnitis suis postulātis atque aequitate conditionum perspectā, eum neque suam neque populī Rōmānī

Cf. ¹ voluntāte, p. 31, l. 18. — ² vitet, 18, 10. — ³ abdidērunt, 10, 12. — ⁴ familiārem, 17, 10. — ⁵ commodē, 22, 9. — ⁶ animadvertit, 29, 12. — ⁷ adhibet, 18, 7. — ⁸ cōgitandam, 30, 6. — ⁹ quemquam, 17, 19. — ¹⁰ iudicāssent, 26, 23.

grātam repudiātūrum. Quod si furōre atque āmentīā impulsus bellum intulisset, quid tandem verērentur? aut cūr dē suā virtūte aut dē ipsius diligentiā dēspērārent? ¹ Factum ēius hostis periculum patrum nostrōrum memoriā, cum Cimbris et Teutonīs ā Gaiō Mariō pulsīs nōn minōrem laudem 5 exercitus quam ipse imperātor meritis ² vidēbātur; factum etiam nūper in Italiā servilī tumultū, quōs tamen aliquid



FIG. 19. — MARIUS.

ūsus ³ ac disciplīna quam ā nobīs accēpissent sublevārent. ⁴ Ex quō iūdicārī posse quantum habēret in sē bonī cōstantia, proptereā quod, quōs aliquamdiū inermis sine causā 10 timuissent, hōs postea armātōs ac victōrēs superārent. ⁵

Dēnique ⁶ hōs esse eōsdem Germānōs quibuscum saepenumero Helvētiī congressī, nōn solum in suis sed etiam in illōrum finibus, plērumque superārint: quī tamen parēs ⁷ esse nostrō exercitūi nōn potuerint. Si quōs adversum proelium et 15 fuga Gallōrum commovēret, hōs, si quaerent, reperire posse diūturnitate belli dēfatigātīs Gallīs Ariovistum, cum multōs mēnsis castris sē ac palūdibus tenuisset neque suī potestā-

Cf. ¹ dēspērāre, p. 16, l. 17. — ² meritōs, 9, 16. — ³ ūsum, 34, 2. — ⁴ sublevētur, 15, 1. — ⁵ superāverint, 15, 11. — ⁶ dēnique, 19, 12. — ⁷ parem, 26, 1.

tem fēcisset, dēspērantis iam dē pūgnā et dispersōs subitō adortum,¹ magis ratiōne et cōsiliō quam virtūte vicisse. Cui ratiōnī contrā hominēs barbarōs atque imperitōs locus fuisset, hāc nē ipsum quidem spērāre nostrōs exercitūs capi
5 posse.

Quī suum timōrem in reī frūmentāriæ simulātiōnem angustiasque itineris cōferrent, facere adroganter, cum aut dē officiō² imperātōris dēspērāre aut praescribere³ vidērentur. Haec sibi esse cūrae; frūmentum Sēquanōs, Leucōs,
10 Lingonēs subministrāre, iamque esse in agrīs frūmenta mātūra;⁴ dē itinere ipsōs brevī tempore iūdicātūrōs.

Quod nōn fore dictō audientēs neque signa lātūrī⁵ dicantur, nihil sē eā rē commovērī; scīre enim, quibuscumque⁶ exercitus dictō audiēns nōn fuerit, aut male rē gestā fortunam
15 dēfuisse, aut aliquō⁷ facinore compertō avāritiam esse convictam; suam innocentiam perpetuā vitā, fēlicitātem Helvētiōrum bellō esse perspectam.⁸

Itaque sē quod in longiōrem diem conlātūrus fuisset praesentātūrum, et proximā nocte dē quartā vigiliā castra
20 mōtūrum, ut quam primum intellegere posset utrum apud eōs pudor⁹ atque officium an timor plūs valeret.¹⁰ Quod sī praetereā nēmō sequātur,¹¹ tamen sē cum sōlā decimā legiōne itūrum, dē quā nōn dubitāret, sibique eam praetōriam cohortem futūram. Huic legiōnī Caesar et indulserat praecipuē
25 et propter virtūtem cōfidēbat maximē.

Effect of Cæsar's Speech. He Advances.

41. Hāc orātiōne habitā mirum in modum conversae sunt omnium mentēs, summaque alacritās et cupiditās¹² belli gerendī innāta est; prīncepsque¹³ decima legiō per tribūnōs

Cf. ¹ adortus, p. 11, l. 17. — ² officiō, 34, 26. — ³ praescriberet, 32, 4. — ⁴ mātūra, 13, 20. — ⁵ lātūrōs, 34, 19. — ⁶ quaecumque, 29, 4. — ⁷ aliquem, 30, 24. — ⁸ perspectā, 34, 28. — ⁹ pudōre, 34, 5. — ¹⁰ valeat, 15, 5. — ¹¹ secūtī, 34, 2. — ¹² cupiditāte, 8, 7. — ¹³ prīnceps, 10, 19.

militum eī grātiās¹ ēgit, quod dē sē optimum iūdiciū fēcisset, sēque esse ad bellum gerendum parātissimam cōfirmāvit. Deinde reliquae legiōnēs cum tribūnis militum et primōrum ōrdinum centuriōnibus ēgērunt utī Caesarī satisfacerent :² ‘Sē neque umquam dubitāsse neque timuisse 5 neque dē summā belli suum iūdiciū, sed imperātōris esse existimāvisse.’ Eōrum satisfactiōne acceptā et itinere exquisitō per Diviciācum, quod ex aliis eī maximam fidem³ habēbat, ut milium amplius quīnquāgintā circuitū locis apertis exercitum dūceret, dē quartā vigiliā, ut dixerat, profectus 10 est. Septimō diē, cum iter nōn intermitteret, ab explorātōribus certior factus est Ariovisti cōpiās ā nostrīs milia passuum quattuor et vīginti abesse.

Ariovistus Requests an Interview. Cæsar's Precautions.

42. Cōgnitō Caesaris adventū Ariovistus lēgātōs ad eum mittit : ‘Quod antē dē conloquiō⁴ postulāsset, id per sē 15 fieri licēre, quoniam propius accessisset, sēque id sine periculō facere posse existimāret.’ Nōn respuit condiōnem Caesar, iamque eum ad sānitātem reverti arbitrābatur, cum id quod antē petenti⁵ dēnegāsset ultrō pollicērētur; māgnamque in spem veniēbat, prō suis tantis populīque Rōmānī 20 in eum beneficiis, cōgnitis suis postulātis,⁶ fore utī pertināciā dēsisteret.

Diēs conloquiō dictus est ex eō diē quīntus. Interim saepe cum lēgātī ultrō citrōque inter eōs mitterentur, Ariovistus postulāvit nē quem peditem ad conloquium Caesar 25 addūceret: ‘Verērī sē nē per insidiās ab eō circumvenirētur; uterque cum equitātū veniret; aliā ratiōne sēsē nōn esse ventūrum.’ Caesar, quod neque conloquium interpositā causā tolli⁷ volēbat neque salūtem suam Gallōrum equi-

Cf. ¹ grātiā, p. 31, l. 12. — ² satisfaciant, 12, 21. — ³ fidem, 17, 11. — ⁴ conloquiō, 30, 25. — ⁵ petēbat, 34, 4. — ⁶ postulārent, 30, 24. — ⁷ tolleret, 22, 2.

tātuī committere audēbat, commodissimum esse statuit, omnibus equis Gallis equitibus detractis, eō legiōnāriōs militēs legiōnis decimae, cui quam maximē cōfidēbat,¹ impōnere, ut praesidium² quam amicissimum, sī quid opus³ 5 factō esset, habēret. Quod cum fieret, nōn inridiculē quīdam ex militibus decimae legiōnis dixit plūs quam pollicitus esset Caesarem facere; pollicitum sē in cohortis praetōriae locō decimam legiōnem habitūrum; ⁴ ad equum rescribere.

Cæsar Pleads with Ariovistus, but Renews his Demands.

43. Plānitiēs erat māgna et in eā tumulus terrēnus satis 10 grandis. Hīc locus aequō ferē⁵ spatiō ab castris Ariovisti et Caesaris aberat. Eō, ut erat dictum, ad conloquium vēnērunt. Legiōnem Caesar quam equis dēvēxerat passibus ducentis ab eō tumulō cōstituit. Item equitēs Ariovisti pari intervāllō cōstitērunt.⁶ Ariovistus ex equis ut conlo- 15 querentur et praeter sē dēnōs ad conloquium addūcerent postulāvit. Ubi eō ventum est, Caesar initiō ōrātiōnis sua senātūsque in eum beneficia commemorāvit,⁷ quod rēx appellātus esset ā senātū, quod amicus, quod mūnera amplissimē missa; quam rem et paucis contigisse et prō 20 māgnis hominum officiis cōsuēsse tribuī docēbat; illum, cum neque aditum neque causam postulandī iūstam habēret, beneficiō ac liberālitāte suā ac senātūs ea praemia cōsecutum. Docēbat etiam quam veterēs quamque iūstae causae necessitudinis ipsis cum Haeduīs intercēderent, quae senātūs 25 cōnsulta, quotiēns quamque honōrifca in eōs facta essent, ut omnī tempore tōtius Galliae prīncipātum Haeduī tenuissent, prius etiam quam nostram amicitiam adpetissent. ‘Populī Rōmānī hanc esse cōsuētūdinem⁸ ut sociōs atque amicōs nōn modo suī nihil dēperdere, sed grātiā, dignitāte,

Cf. ¹ cōfidēbat, p. 36, l. 25. — ² praesidiō, 22, 15. — ³ opus, 30, 27. — ⁴ habuit, 25, 7. — ⁵ ferē, 26, 14. — ⁶ cōstitērant, 21, 1. — ⁷ commemorāssent, 12, 2. — ⁸ cōsuētūdinem, 28, 21.

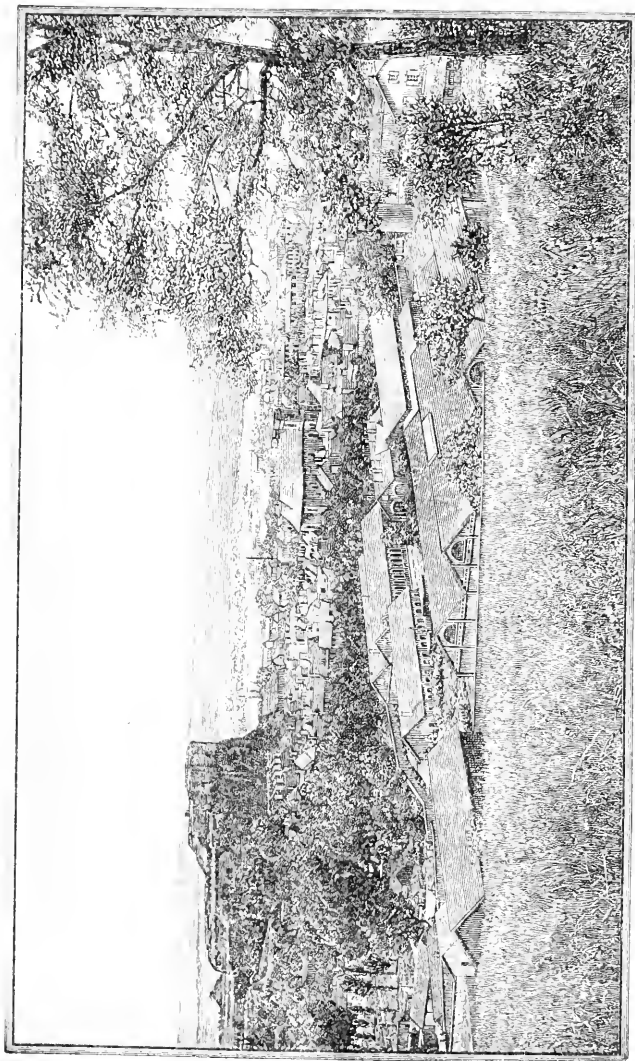

FIG. 20. — BELFORT.

honōre auctiōrēs vellet esse ; quod vērō ad amīcitiā populī Rōmānī adtulissent, id eis ēripī¹ quis patī posset? Postulāvit deinde eadem quae lēgātīs in mandātīs dederat : nē aut Haeduis aut eōrum sociis bellum inferret ; obsidēs redderet ;² sī nūllam partem Germānōrum domum remittere 5 posset, at nē quōs amplius Rhēnum trānsire paterētur.

Ariovistus Arrogantly Repeats his Claims.

44. Ariovistus ad postulāta Caesaris pauca respondit ; dē suis virtūtibus multa praedicāvit :³ ‘Trānsisse Rhēnum sēsē nōn suā sponte, sed rogātum et arcessitum ā Gallis ; nōn sine māgnā spē māgnisque praemiis domum propinquōsque⁴ 10 reliquisse ; sēdis habēre in Galliā ab ipsis concessās, obsidēs ipsōrum voluntāte datōs ; stīpendium capere iūre⁵ bellī quod victōrēs victis impōnere cōsuērunt. Nōn sēsē Gallis, sed Gallōs sibi bellum intulisse ; omnīs Galliae civitātis ad sē oppūgnandum vēnisse ac contrā sē castra habuisse ; eās 15 omnīs cōpiās ā sē unō proeliō pulsās ac superātās esse. Sī iterum⁶ experiri velint, sē iterum parātum esse dēcertāre ; sī pāce ūti velint, iniquum esse dē stīpendiō recūsāre quod suā voluntāte ad id tempus pependerit.’⁷

Amīcitiā populī Rōmānī sibi ōrnāmentō et praesidiō,⁸ 20 nōn dētrīmentō esse oportēre, idque sē hāc spē petisse. Sī per populum Rōmānum stīpendium remittātur et dēditiciī⁹ subtrahantur, nōn minus libenter sēsē recūsātūrum populī Rōmānī amīcitiā quam adpetierit.¹⁰

Quod multitūdinem Germānōrum in Galliam trādūcat, id 25 sē sui mūniendī, nōn Galliae impūgnandae causā facere : eius rei testimōnium esse quod nisi rogātus nōn vēnerit, et quod bellum nōn intulerit, sed dēfenderit. Sē prius in

Cf. ¹ ēreptūrī, p. 15, l. 12. — ² redditūrum, 32, 10. — ³ praedicābant, 33, 23. — ⁴ propinquās, 16, 10. — ⁵ iūs, 31, 27. — ⁶ iterum, 31, 8. — ⁷ penderent, 32, 12. — ⁸ praesidium, 38, 4. — ⁹ dēditiciōrum, 25, 2. — ¹⁰ adpetissent, 38, 27.

Galliam vēnisse quam populum Rōmānum. Numquam ante hōc tempus exercitum populī Rōmānī Galliae prōvinciae finibus ēgressum.¹ Quid sibi vellet? Cūr in suās possessionēs venīret? Prōvinciam suam hanc esse Galliam, sicut
5 illam nostram. Ut ipsī concēdi² nōn oportēret, sī in nostrōs finis impetum faceret, sic item nōs esse iniquōs quod in suō iūre sē interpellārēmus.

Quod frātrēs ā senātū Haeduōs appellātōs dīceret, nōn sē tam barbarum neque tam imperitū³ esse rērum ut nōn
10 scīret neque bellō Allobrogum proximō Haeduōs Rōmānīs auxilium tulisse, neque ipsōs, in his contentiōnibus quās Haeduī sēcum et cum Sēquanīs habuissent, auxiliō populī Rōmānī ūsōs esse.

Dēbere⁴ sē suspicārī simulātā Caesarem amicitīā quem
15 exercitum in Galliā habeat suī opprimendī causā habēre. Qui nisi dēcēdat⁵ atque exercitum dēducāt ex his regiōnibus, sēsē illum nōn prō amicō, sed prō hoste habitūrum. Quod sī eum interfēcerit,⁶ multis sēsē nōnobilibus prīncipibusque populī Rōmānī grātum esse factūrum; id sē ab ipsis per
20 eōrum nūntiōs compertum⁷ habēre quōrum omnium grātiā atque amicitiam ēius morte redimere⁸ posset. Quod sī discessisset et liberam possessionē Galliae sibi trādidisset,⁹ māgnō sē illum praemiō remūnerātūrum, et quaecumque bella gerī vellet sine ūllō ēius labōre et periculō cōfectūrum.¹⁰

Cæsar Does not Yield.

25 45. Multa ab Caesare in eam sententiam dicta sunt quā rē negotiō¹¹ dēsistere nōn posset: ‘Neque suam neque populī Rōmānī cōsuētūdinem patī¹² utī optimē meritōs sociōs dēsereret, neque sē iūdicāre Galliam potius esse

Cf. ¹ ēgressī, p. 25, l. 4. — ² concessit, 25, 20. — ³ imperitōs, 36, 3. — ⁴ dēbeant, 15, 9. — ⁵ dēcēdere, 28, 15. — ⁶ interfēcerat, 10, 15. — ⁷ compertō, 36, 15. — ⁸ redimere, 32, 23. — ⁹ trāditīs, 25, 8. — ¹⁰ cōnfectō, 26, 14. — ¹¹ negotī, 31, 7. — ¹² patī, 39, 2.

Ariovisti quam populi Rōmānī. Bellō superātōs esse Arvernōs et Rutēnōs ab Q. Fabiō Maximō, quibus populus Rōmānus ignōvisset neque in prōvinciam redēgisset neque stipendium imposuisset. Quod si antiquissimum quodque
 5 tempus spectārī oportēret, populi Rōmānī iūstissimum esse

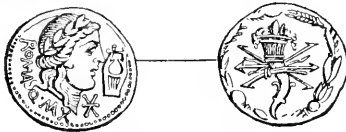

FIG. 21. — COIN OF THE FABIAN FAMILY.

in Galliā imperium;¹ si iūdicium senātūs observārī oportēret, liberam dēbere esse Galliam, quam bellō victam suis lēgibus ūtī voluisset.⁷

The Germans Make a Treacherous Attack, and Cæsar Withdraws.

46. Dum haec in conloquiō geruntur,² Caesari nūntiātum est equitēs Ariovisti propius³ tumulum accēdere,⁴ et ad nos- 10 trōs adequitāre, lapidēs tēlaque in nostrōs conicere.⁵ Caesar loquendi finem fēcit, sēque ad suōs recēpit suisque imperāvī nē quod omninō tēlum in hostis rēicerent. Nam etsi sine ūllō periculō legiōnis dēlēctae cum equitātū proelium fore vidēbat, tamen committendum nōn putābat, ut pulsīs 15 hostibus dīcī posset eōs ab sē per fidem in conloquiō circumventōs.⁶ Posteaquam in volgus militum ēlātum est quā adrogantiā in conloquiō Ariovistus ūsus omnī Galliā Rōmānis interdixisset, impetumque⁷ in nostrōs eius equitēs fēcissent, eaque rēs conloquium ut dirēmisset, multō māior 20 alacritās studiumque pūgnandī māius exercitū iniectum est.

Cf. ¹ imperiō, p. 28, l. 5. — ² gerantur, 15, 13. — ³ propius, 37, 16. — ⁴ accessisset, 37, 16. — ⁵ coniciēbant, 24, 4. — ⁶ circumvenīrētur, 37, 26. — ⁷ impetum, 40, 6.

Seizure of Two of Cæsar's Envoys by Ariovistus.

47. Bīduō post Ariovistus ad Caesarem lēgātōs mittit :
 'Velle sē dē hīs rēbus quae inter eōs agī coeptae neque
 perfectae essent agere cum eō ; utī aut iterum conloquiō
 diem cōstitueret,¹ aut, sī id minus vellet, ē suis lēgātīs
 5 aliquem ad sē mitteret.' Conloquendī Caesari causa vīsa,
 nōn est ; et eō magis quod prīdiē² ēius diēi Germāni reti-
 nēri nōn poterant quā tēla in nostrōs conicerent. Lēgātum
 [ē suis] sēsē māgnō cum periculō ad eum missūrum et homi-
 nibus feris obiectūrum existimābat. Commodissimum³
 10 vīsum est Gāium Valerium Procillum, C. Valeri Caburī
 filium, summā virtūte et hūmānitāte adulēscentem, — cūius
 pater ā Gāiō Valeriō Flaccō civitāte dōnātus erat, et propter
 fidem et propter linguae Gallicae scientiam, quā multā iam
 Ariovistus longinquā cōsuētūdine ūtēbātur, et quod in eō
 15 peccandī Germānis causa nōn esset, — ad eum mittere, et
 M. Mētium, quī hospitio⁴ Ariovisti ūtēbātur. His man-
 dāvit ut quae dīceret Ariovistus cōgnōscerent et ad sē
 referrent.⁵ Quōs cum apud sē in castrīs Ariovistus cōn-
 spēxisset, exercitū suō praesente conclāmāvit : 'Quid ad sē
 20 venirent ? an speculandī causā ?' Cōnantis dicere prohibuit
 et in catēnās coniēcit.

Manœuvering and Skirmishing.

48. Eōdem diē castra prōmōvit et milibus passuum sex ā
 Caesaris castrīs sub monte cōnsēdit. Postridiē⁶ ēius diēi
 praeter castra Caesaris suās cōpiās trādūxit et milibus pas-
 25 suum duōbus ultrā eum castra fēcit, eō cōnsilio utī frūmentō
 commeātūque quī ex Sēquanīs et Haeduis supportārētur
 Caesarem interclūderet.⁷ Ex eō diē diēs continuōs quīnque
 Caesar prō castrīs suās cōpiās prōdūxit et aciem instrūctam⁸

Cf. ¹ cōstituērunt, p. 27, l. 2. — ² prīdiē, 20, 13. — ³ commodissi-
 mum, 38, 1. — ⁴ hospitio, 27, 26. — ⁵ referēbantur, 32, 19. — ⁶ postridiē,
 20, 5. — ⁷ interclūdī, 20, 15. — ⁸ instrūxit, 20, 21.

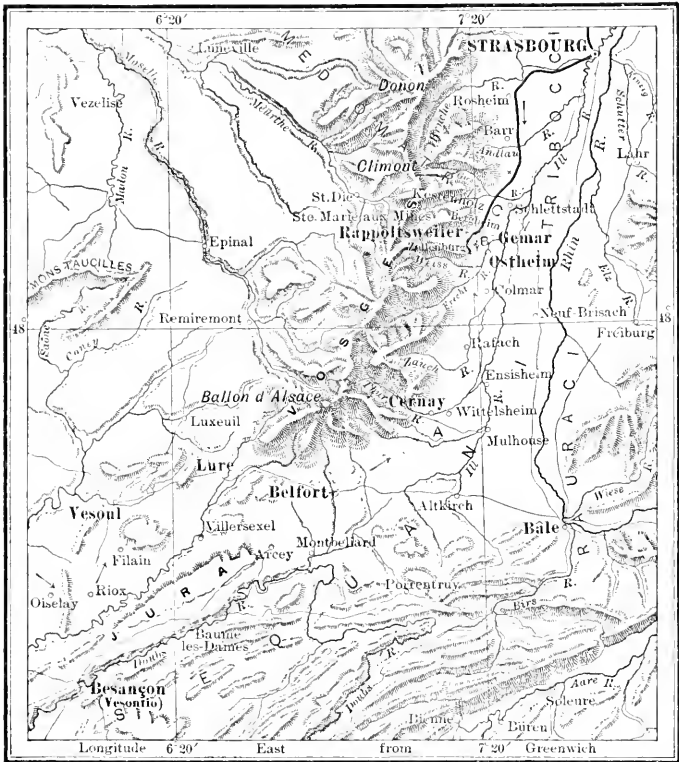

FIG. 22. — MAP OF THE CAMPAIGN WITH ARIOVISTUS.

habuit, ut, si vellet Ariovistus proeliō contendere, ei potestās¹ nōn deesset.² Ariovistus his omnibus diēbus exercitum castris continuit, equestri proeliō cotidiē³ contendit.

German Method of Fighting.

Genus hōc erat pūgnæ quō sē Germāni exercuerant. Equitum milia erant sex, totidem numerō peditēs vëlōcissimi 5

Cf. ¹ potestātem, p. 35, l. 18. — ² deesset, 36, 15. — ³ cotidiē, 13, 17.

ac fortissimī, quōs ex omnī cōpiā singulī singulōs suae salutis causā dēlēgerant ; cum hīs in proeliis versābantur. Ad eōs sē equitēs recipiēbant ;¹ hī, si quid erat dūrius, concurrēbant ; si quī graviōre² vulnere acceptō equō dēciderat, 5 circumstībant ; si quō erat longius prōdeundum aut celerius³ recipiendum, tanta erat hōrum exercitātiōne celeritās ut iubis sublevātī equōrum cursum adaequārent.

Cæsar Fortifies another Camp.

49. Ubi eum castris sē tenēre Caesar intellēxit, nē diūtius commēatū prohibērētur, ultrā eum locum quō in locō Ger-



FIG. 23. — SOLDIERS ATTACKED WHILE ENCAMPING.

10 mānī cōsēderant, circiter passūs sexcentōs ab hīs, castris idōneum locum dēlēgit, aciēque triplici instrūctā ad eum locum vēnit. Primam et secundam aciem in armis esse, tertiam castra munire⁴ iussit. Hic locus ab hoste circiter

Cf. ¹ recēpit, p. 41, l. 12. — ² graviōrem, 29, 19. — ³ celerrimē, 33, 1. — ⁴ muniēbātur, 33, 9.

passūs sexcentōs, uti dictum est, aberat. Eō circiter hominum numerō sēdecim milia expedita cum omnī equitātū Ariovistus misit, quae cōpiae nostrōs terrērent¹ et mūnitōne prohibērent. Nihilō sēcūs Caesar, ut ante cōstituerat, duās aciēs hostem prōpulsāre, tertiam opus perficere 5 iussit. Mūnitīs castrīs duās ibi legiōnēs reliquit et partem auxiliōrum,² quattuor reliquās in castra māiōra redūxit.

More Skirmishing, but No General Engagement.

50. Proximō diē institūtō suō Caesar ē castrīs utrisque³ cōpiās suās ēdūxit, paulumque ā māiōribus castrīs prōgressus aciem instrūxit, hostibus pūgnandī potestātem fēcit. 10 Ubi nē tum quidem eōs prōdire⁴ intellēxit, circiter meridiē exercitum in castra redūxit. Tum dēmum Ariovistus partem suārum cōpiārum quae castra minōra⁵ oppūgnāret misit. Ācriter utrimque ūsque ad vesperum pūgnātum est. Sōlis occāsū⁶ suās cōpiās Ariovistus multis et inlātis⁷ et acceptis 15 volneribus in castra redūxit.

Reason for the Germans' Delay.

Cum ex captivīs quaereret Caesar quam ob rem Ariovistus proeliō nōn dēcertāret,⁸ hanc reperiēbat causam, quod apud Germānōs ea cōsuētūdō esset ut matrēs familiae eōrum sortibus et vāticinātiōnibus dēclārārent utrum proelium 20 committī ex ūsū⁹ esset necne; eās ita dicere: 'Nōn esse fās Germānōs superāre, sī ante novam lūnam proeliō contendissent.'

Cæsar Forces a Battle.

51. Postridiē eius diēi Caesar praesidiō utrisque castrīs quod satis esse vīsum est reliquit, ālāriōs omnīs in cōspectū 25 hostium prō castrīs minōribus cōstituit,¹⁰ quod minus multi-

Cf. ¹ perterritī, p. 24, l. 26. — ² auxilia, 20, 23. — ³ uterque, 37, 27. — ⁴ prōdeundum, 44, 5. — ⁵ minōrem, 35, 5. — ⁶ occāsū, 2, 9. — ⁷ intulerat, 10, 19. — ⁸ dēcertāre, 39, 17. — ⁹ ūsū, 26, 18. — ¹⁰ cōstituit, 38, 13.

tūdine militum legiōnariōrum prō hostium numerō valēbat,¹ ut ad speciem ālāriis ūterētur; ipse triplicī instrūctā aciē ūsque ad castra hostium accessit.² Tum dēmum necessariō Germāni suās cōpiās castris ēdūxērunt generātimque cōnstituērunt paribus intervāllis, Harūdēs, Marcomannōs, Tribocēs, Vangionēs, Nemetēs, Sedusiōs, Suēvōs, omnemque aciem suam rēdis et carris circumdedērunt, nē qua spēs in fugā relinquerētur. Eō mulierēs³ imposuērunt, quae ad proelium proficiscentīs, passis manibus flentēs, implōrābant
10 nē sē in servitūtem Rōmānis trāderent.

Description of the Battle.

52. Caesar singulis⁴ legiōnibus singulōs lēgātōs et quaestōrem praefēcit,⁵ utī eōs testis⁶ suae quisquē virtūtis haberet; ipse ā dextrō cornū, quod eam partem minimē firmam hostium esse animadverterat, proelium commisit. Ita nostri
15 ācritē in hostis signō datō impetum fēcērunt, itaque hostēs repente celeriterque prōcurrērunt ut spatium⁷ pila in hostis coniciendī nōn darētur. Rēiectis pilis cōminus gladiis pūgnātum est. At Germāni celeriter ex cōsuetūdine suā phalange factā impetūs gladiōrum excēpērunt. Repertī
20 sunt complūrēs nostrī quī in phalanga⁸ insilirent et scūta manibus revellerent et dēsUPER volnerārent. Cum hostium aciēs ā sinistrō⁹ cornū pulsa atque in fugam coniecta esset, ā dextrō cornū vehementer multitūdine suōrum nostram aciem premēbant. Id cum animadvertisset P. Crassus
25 adulēscēns,¹⁰ quī equitātui praerat, quod expeditior¹¹ erat quam eī quī inter aciem versābantur, tertiam aciem labōrantibus nostrīs subsidiō misit.

Cf. ¹ valēret, p. 36, l. 21. — ² accēdere, 41, 10. — ³ mulierēs, 26, 7. — ⁴ singulī, 44, 1. — ⁵ praeficit, 8, 22. — ⁶ testem, 12, 24. — ⁷ spatium, 7, 6. — ⁸ phalange, 21, 4. — ⁹ sinistrā, 22, 8. — ¹⁰ adulēscēntem, 42, 11. — ¹¹ expedita, 45, 2.

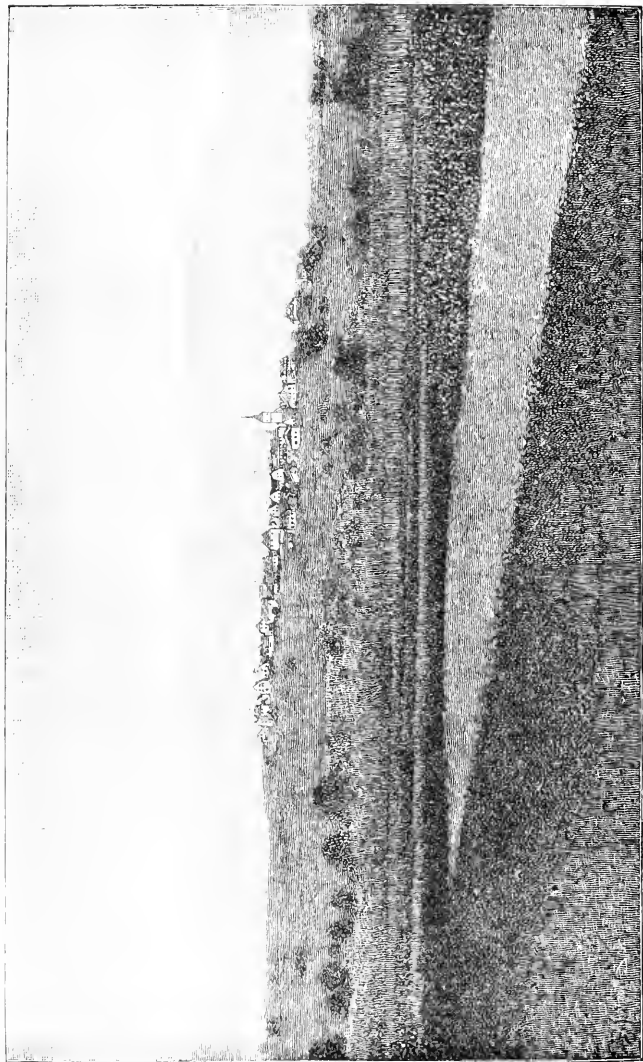

FIG. 24. — VIEW FROM OSTHEIM, LOOKING TOWARDS ZELLENBERG.

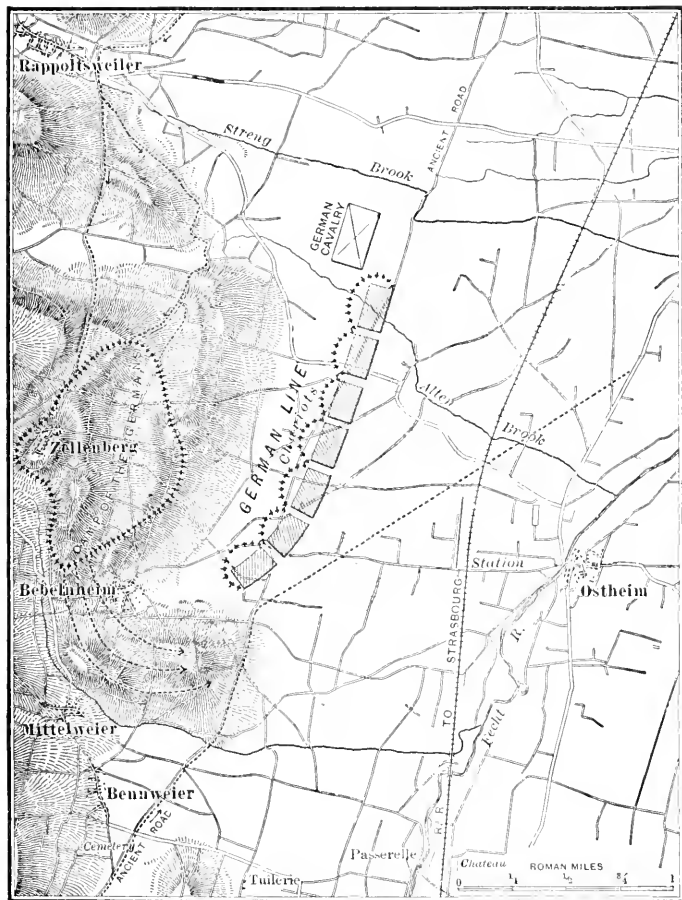

FIG. 25. — PLAN OF BATTLE WITH ARIOVISTUS.

Complete Defeat of the Germans. Recovery of the Two Envoys.

53. Ita proelium restitutum est atque omnēs hostēs terga vertērunt, neque prius fugere dēstitērunt¹ quam ad flūmen

Cf. ¹ dēsistere, p. 40, l. 26.

Rhēnum, mīlia passuum ex eō locō circiter quīnque, pervēnērunt. Ibi perpaucī aut vīribus cōfisī¹ trānāre contendērunt aut lintribus² inventīs sibi salūtem repperērunt. In hīs fuit Ariovistus, quī nāviculam dēligātā ad
 5 rīpam nactus eā profūgit; reliquōs omnis cōsecūtī equitēs nostrī interfēcērunt. Duæ fuērunt Ariovistī uxōrēs, ūna Suēva nātiōne, quam domō sēcum dūxerat, altera Nōrica, rēgis Vocciōnis soror, quam in Galliā dūxerat ā frātre missā; utraque in eā fugā periit. Duæ filiae hārum
 10 altera occīsa, altera capta est. Gāius Valerius Procillus, cum ā custōdibus³ in fugā trinīs catēnīs⁴ vinctus traherētur, in ipsum Caesarem hostis equitātū insequentem incidit. Quæ quidem rēs Caesari nōn minōrem quam ipsa victōria voluptātem adtulit, quod hominem honestissimum
 15 prōvinciae Galliae, suum familiārem et hospitem, ēreptum ē manibus hostium, sibi restitūtum vidēbat; neque eius calamitāte dē tantā voluptāte et grātulātiōne quicquam fortūna dēminuerat.⁵ Is sē praesente dē sē ter sortibus⁶ cōnsultum dicēbat utrum igni statim necārētur an in aliud tempus
 20 reservārētur; sortium beneficiō sē esse incolumem. Item M. Mētius repertus et ad eum reductus est.

The Army Goes into Winter Quarters. Cæsar Goes to Hither Gaul.

54. Hōc proeliō trāns Rhēnum nūntiātō Suēvī, quī ad rīpās Rhēnī vēnerant, domum revertī⁷ coepērunt; quōs Ubii, quī proximī Rhēnum incolunt, perterritōs insecūtī
 25 māgnūm ex eis numerum occidērunt. Caesar ūnā aestāte duōbus maximīs bellīs cōfectis, mātūrius⁸ paulō quam tempus annī postulābat, in hiberna in Sēquanōs exercitum dēdūxit; hibernīs Labiēnum praeposuit; ipse in citeriōrem Galliam ad conventūs agendōs profectus est.

Cf. ¹ cōfidēbat, p. 36, l. 25. — ² lintribus, 10, 4. — ³ custōdēs, 18, 11. — ⁴ catēnās, 42, 21. — ⁵ dēminūta, 16, 13. — ⁶ sortibus, 45, 20. — ⁷ revertī, 37, 18. — ⁸ mātūrrimē, 30, 19.

Longitude East from Greenwich

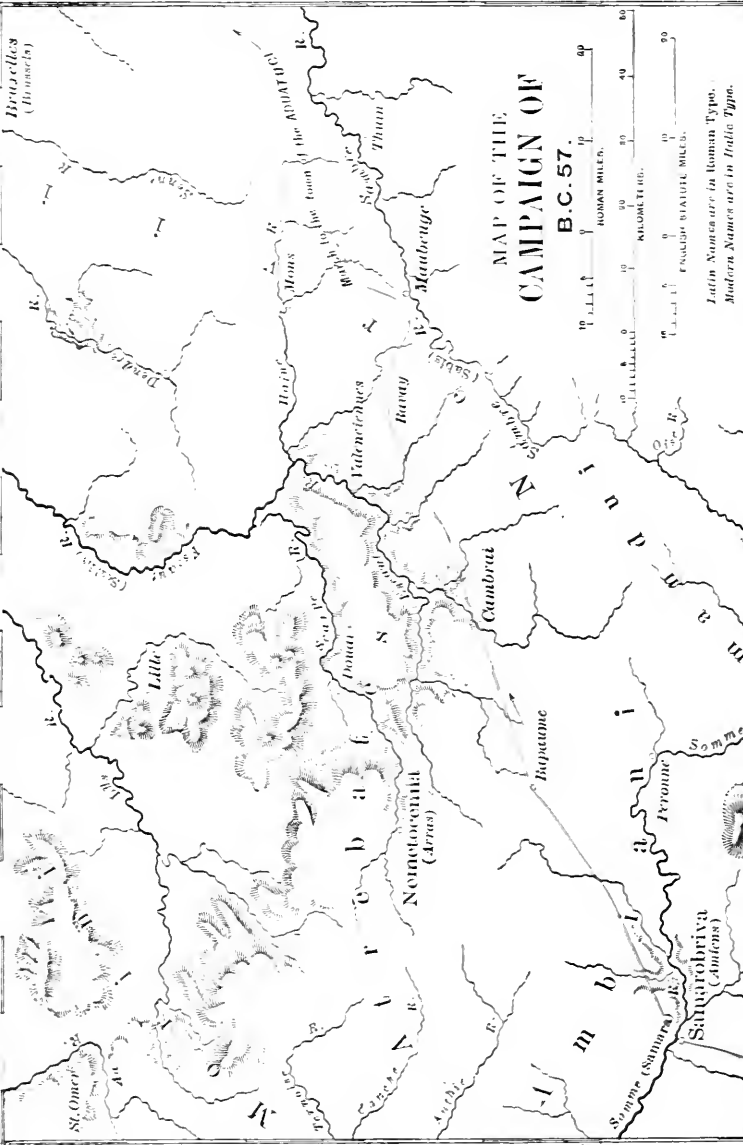

MAP OF THE
CAMPAIGN OF
B.C. 57.

ROMAN MILES. 0 10 20 30 40 50

ENGLISH STATUTE MILES. 0 10 20 30 40 50

Latin Names are in Roman Type.
Modern Names are in Italic Type.

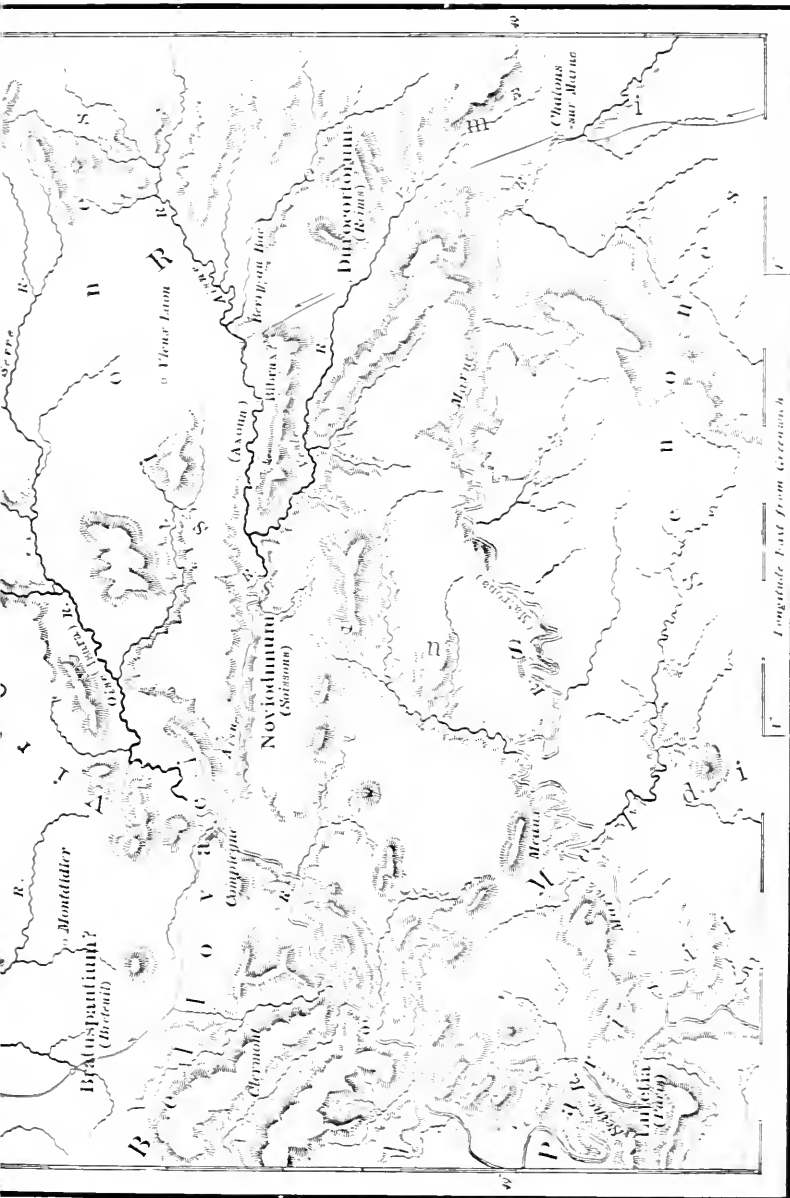

Braspantium?
(Barden)

Montdidier

Compiègne

Noviodunum
(Soissons)

Durocoronum
(Reims)

Soissons

Langres
(Langres)

Meaux

Paris

Paris

Paris

Paris

Paris

Paris

Paris

Paris

Paris

Paris

Paris

Paris

Paris

Paris

Paris

Paris

Paris

Paris

Longitude East from Greenwich

1

2

3

4

5

6

7

8

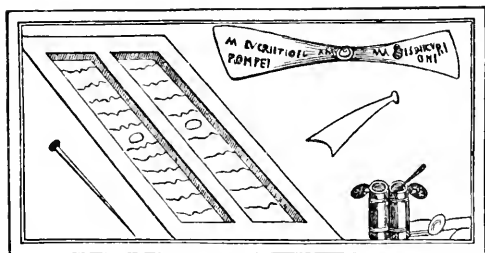

FIG. 27. — WRITING MATERIALS.

BOOK II.

THE BELGIAN CONFEDERACY. B.C. 57.

II the Belgian Tribes Conspire against the Romans. Reasons for this.

CUM esset Caesar in citeriōre Galliā ita uti suprā dē-
 mōnstrāvimus, crēbri ad eum rūmōrēs adferēbantur,¹
 tterisque item Labiēni certior² fiēbat omnis Belgās, quam
 certiam esse Galliae partem dixerāmus, contrā populum
 Rōmānum coniūrāre obsidēsque inter sē dare. Coniūrandi
 5
 cās esse causās : primum quod verērentur³ nē omni pācātā
 Galliā ad eōs exercitus noster addūcerētur ; deinde quod ab
 nōn nullis Gallis sollicitārentur, — partim quī, ut Germānōs
 iūtius in Galliā versārī⁴ nōluerant, ita populī Rōmāni exer-
 itum hiemāre atque inveterāscere in Galliā molestē ferē-
 10
 ant ; partim quī mōbilitāte et levitāte animī novis imperiis
 tudēbant, — ab nōn nullis etiam, quod in Galliā ā potentiōri-
 bus atque eis quī ad condūcendōs hominēs facultātis habē-
 ant volgō rēgna occupābantur, quī minus facile eam rem
 imperiō nostrō cōsequi⁵ poterant.

15

Cf. ¹ adtulit, p. 48, l. 14. — ² certior, 37, 12. — ³ verērī, 34, 14. —
 versābantur, 44, 2. — ⁵ cōsecūtum, 38, 22.

Cæsar promptly Moves against them.

2. His nūntiis litterisque commōtus Caesar duās legiōnēs in citeriōre Galliā novās cōscripsit, et initā aestāte¹ in interiōrem Galliam quī dēdūceret Q. Pedium lēgātum misit. Ipse, cum primum pābuli cōpia esse inciperet, ad exercitum
5 vēnit. Dat negotium Senonibus reliquisque Gallis quī finitimī Belgis erant, utī ea quae apud eōs gerantur cōgnōscant sēque dē his rēbus certiōrem faciant. Hī cōstanter omnēs nūntiāvērunt manūs² cōgī, exercitum in ūnum locum cōdūcī. Tum vērō dubitandum nōn existimāvit quin ad eōs
10 proficiscerētur. Rē frūmentāriā comparātā castra movet diēbusque circiter quīndecim ad finis Belgārum pervenit.

The Remi Submit and Promise Aid.

3. Eō cum dē imprōvisō celeriusque³ omnium opīniōne vēnisset, Rēmī, quī proximī Galliae ex Belgis sunt, ad eum lēgātōs Iccium et Andocombogium, primōs civitātis, misē-
15 runt, quī dicerent: 'Sē suaque omnia in fidem atque in potestātem populī Rōmānī permittere; neque sē cum reliquis Belgis cōsensisse neque contrā populum Rōmānum coniūrāsse,⁴ parātōsque esse et obsidēs dare et imperāta facere et oppidīs recipere et frūmentō cēterisque⁵ rēbus iuvāre;⁶
20 reliquōs omnīs Belgās in armis esse, Germānōsque, quī cis Rhēnum incolant,⁷ sēsē cum his coniūnxisse, tantumque esse eōrum omnium furōrem ut nē Suessiōnēs quidem, frātrēs cōsanguineōsque⁸ suōs, quī eōdem iūre et isdem lēgibus ūtantur, ūnum imperium ūnumque magistrātum cum ipsis
25 habeant, dēterrere⁹ potuerint quin cum his cōsentirent.'

Origin and Strength of the Belgæ as Told by the Remi.

4. Cum ab his quaereret¹⁰ quae civitatēs quantaeque in armis essent et quid in bellō possent, sic reperiebāt: plē-

Cf. ¹ aestāte, p. 48, l. 25. — ² manūs, 32, 27. — ³ celerius, 44, 5. — ⁴ coniūrāre, 49, 5. — ⁵ cēterī, 29, 14. — ⁶ iuvārent, 24, 14. — ⁷ incolunt, 48, 24. — ⁸ cōsanguineōs, 30, 7. — ⁹ dēterrere, 29, 8. — ¹⁰ quaereret, 45, 17.



FIG. 28. — GAUL WITH TRUMPET (*carnyx*).

rōsque Belgās esse ortōs¹ ab Germānis, Rhēnumque anti-
 quitus trāductōs propter loci fertilitātem ibi cōnsēdisse
 Gallōsque qui ea loca incolerent expulisse, sōlōsque² esse
 qui patrum nostrōrum memoriā, omni Galliā vexātā,³ Teu-
 tonōs Cimbrōsque intrā suōs finis ingredi prohibuerint; quā 5
 ex rē fieri uti eārum rērum memoriā māgnam sibi auctōri-
 tātem māgnōsque spīritūs⁴ in rē militāri sūmerent.⁵ Dē
 numerō eōrum omnia sē habēre explorāta Rēmī dicēbant,
 proptereā quod propinquitātibus adfinitātibusque coniūcti,
 quantam quisque multitudinem in commūni Belgārum con- 10



FIG. 29. — COIN OF DIVICIACUS, KING OF THE SUESSIONES.

ciliō ad id bellum pollicitus sit cōgnōverint. Plūrimum inter
 eōs Bellovacōs et virtūte et auctōritāte et hominum numerō
 valēre; hōs posse cōficere armāta milia centum, pollicitōs⁶
 ex eō numerō ēlēcta milia sexāgintā, tōtiusque belli imperium
 sibi postulāre.⁷ Suessiōnēs suōs esse finitimōs;⁸ finis lātissi- 15
 mōs ferācissimōsque agrōs possidēre. Apud eōs fuisse rēgem
 nostrā etiam memoriā Diviciācum, tōtius Galliae potentissi-
 mum,⁹ qui cum māgnae partis hārum regiōnum tum etiam
 Britanniae imperium obtinuerit; nunc esse rēgem Galbam;
 ad hunc propter iūstitiam prūdentiamque summam¹⁰ tōtius 20
 belli omnium voluntāte dēferri; oppida habēre numerō XII,
 pollicērī milia armāta quinquāgintā; totidem Nervīōs, qui

Cf. ¹ ortus, p. 33, l. 27. — ² sōlā, 36, 22. — ³ vexāssent, 12, 10. — ⁴ spī-
 ritūs, 30, 21. — ⁵ sūmpserat, 30, 21. — ⁶ pollicitum, 38, 7. — ⁷ postulandī,
 38, 21. — ⁸ finitimī, 50, 5. — ⁹ potentiōribus, 49, 12. — ¹⁰ summā, 37, 6.

maximē ferī inter ipsōs habeantur longissimēque absint;¹ quindecim milia Atrebātēs, Ambiānōs decem milia, Morinōs xxv milia, Menapiōs vii milia, Calētōs x milia, Veliocassēs et Viromanduōs totidem, Aduatucōs decem et novem milia; 5 Condrūsōs, Eburōnēs, Caerōsōs, Paemānōs, qui ūnō nōmine Germāni appellantur,² arbitrārī ad xl milia.

Cæsar Marches to the Aisne, and Encamps beyond it.

5. Caesar Rēmōs cohortātus liberāliterque ōrātiōne prōsecūtus, omnem senātum ad sē convenīre princīpumque liberōs obsidēs ad sē addūcī iussit. Quae omnia ab his diligenter 10 ad diem facta sunt. Ipse Diviciācum Haeduum māgnopere³ cohortātus docet quantō opere rei pūblicae commūnisque salutis⁴ intersit manūs⁵ hostium distīnērī, nē cum tantā multitudīne ūnō tempore cōnflīgendum sit. Id fieri posse, si suās cōpiās Haedui in finis Bellovacōrum intrōdūxerint 15 et eōrum agrōs populārī⁶ coeperint. His *datīs* mandātis eum ā sē dimittit. Postquam omnis Belgārum cōpiās in ūnum locum coāctās⁷ ad sē venīre [vidit] neque iam longē abesse ab eis quōs miserat explōrātōribus et ab Rēmīs cōgnōvit, flūmen Axonam, quod est in extrēmīs Rēmōrum finibus, 20 exercitum trādūcere mātūrāvit⁸ atque ibi castra posuit. Quae rēs et latus ūnum castrōrum ripis flūminis mūniēbat et post eum quae erant tūta ab hostibus reddēbat, et comēātūs⁹ ab Rēmīs reliquisque civitātibus ut sine periculō ad eum portārī possent efficiēbat. In eō flūmine pōns erat. 25 Ibi praesidium pōnit et in alterā parte flūminis Q. Titūrium Sabinum lēgātum cum sex cohortibus relinquit; castra in altitudinē pedum xii vāllō fossāque duodēvīgintī pedum mūnīrī iubet.

Cf. ¹ aberat, p. 45, l. 1. — ² appellātōs, 40, 8. — ³ māgnopere, 33, 7. — ⁴ salutem, 48, 3. — ⁵ manūs, 50, 8. — ⁶ populārentur, 32, 22. — ⁷ cōgī, 50, 8. — ⁸ mātūrandum, 32, 27. — ⁹ commeātū, 42, 26.

The Belgæ Attack Bibrax, a Town of the Remi, Eight Miles Away.

6. Ab his castris oppidum Rēmōrum nōmine Bibrax aberat
mīlia passuum octō. Id ex itinere māgnō impetū Belgæ
oppūgnāre coepērunt. Aegrē¹ eō diē sustentātum est. Gal-
lōrum eadem atque Belgārum oppūgnātiō est haec. Ubi
circumiectā multitudīne hominū tōtis moenibus undique in
mūrum lapidēs iaci coepti sunt² mūrusque dēfēnsōribus
nūdātus est, testūdine factā [portās] succēdunt mūrumque



FIG. 30. — SLINGER (*funditor*).

subruunt. Quod tum facile fiēbat. Nam cum tanta multi-
tūdō lapidēs ac tēla conicerent, in mūrō cōsistendī potestās
erat nulli. Cum finem oppūgnandī nox fēcisset, Iccius 10
Rēmus summā nōbilitāte et grātiā inter suōs, quī tum oppidō
præerat, ūnus ex eis quī lēgātī dē pāce ad Caesarem vēne-
rant, nūntium ad eum mittit: nisi subsidium sibi submit-
tātur, sēsē diūtius³ sustinēre nōn posse.

Cf. ¹ aegerrimē, p. 11, l. 8. — ² coeptae, 42, 2. — ³ diūtius, 49, 9.

Cæsar Sends Relief and the Belgæ Advance on his Camp.

7. Eō dē mediā nocte Caesar isdem ducibus ūsus quī nūntiī ab Iccīō vēnerant, Numidās et Crētas sagittāriōs et funditōrēs Baleārēs subsidiō¹ oppidānis mittit; quōrum adventū et Rēmīs cum spē dēfēnsiōnis studium² prōpūgnandī accessit, et hostibus eādem dē causā spēs potiundī oppidī discessit. Itaque paulisper apud oppidum morātī agrōsque Rēmōrum dēpopulātī, omnibus vicīs³ aedificiisque quō adire potuerant incēnsīs, ad castra Caesaris omnibus cōpiīs contendērunt et ā milibus passuum minus duōbus castra posuērunt; quae
10 castra, ut fūmō atque ignibus significābātur, amplius milibus passuum octō in lātitudinem patēbant.

Cæsar Strengthens his Position.

8. Caesar primō et propter multitudinem hostiū et propter eximiam opīniōnem virtūtis proeliō supersedēre statuit:⁴ cotidiē tamen equestribus proeliis quid hostis virtūte posset
15 et quid nostrī audērent⁵ periclitābātur. Ubi nostrōs nōn esse inferiōrēs intellēxit, locō prō castris ad aciem instruendam nātūrā opportūnō⁶ atque idōneō,—quod is collis ubi castra posita erant paululum ex plānitiē⁷ ēditus, tantum adversus in lātitudinem patēbat quantum loci aciēs instrūcta
20 occupāre poterat, atque ex utrāque parte lateris⁸ dēiectūs habēbat et in fronte lēniter fastigātus paulātīm⁹ ad plānitiem redībat,—ab utrōque latere eius collis trānsversam fossam obdūxit circiter passuum quadringentōrum et ad extrēmās fossās castella cōstituit ibique tormenta conlocāvit, nē, cum
25 aciem instrūxisset, hostēs, quod tantum multitudine poterant, ab lateribus pūgnantis suōs circumvenire possent. Hōc factō duābus legiōnibus quās proximē cōscripserat¹⁰ in castris

Cf. ¹ subsidiō, p. 46, l. 27. — ² studium, 41, 21. — ³ vicōs, 25, 13. — ⁴ statuit, 38, 1. — ⁵ audēbat, 38, 1. — ⁶ opportūnissimum, 26, 22. — ⁷ plānitiēs, 38, 9. — ⁸ latus, 52, 21. — ⁹ paulātīm, 34, 10. — ¹⁰ cōscripsit, 50, 2.

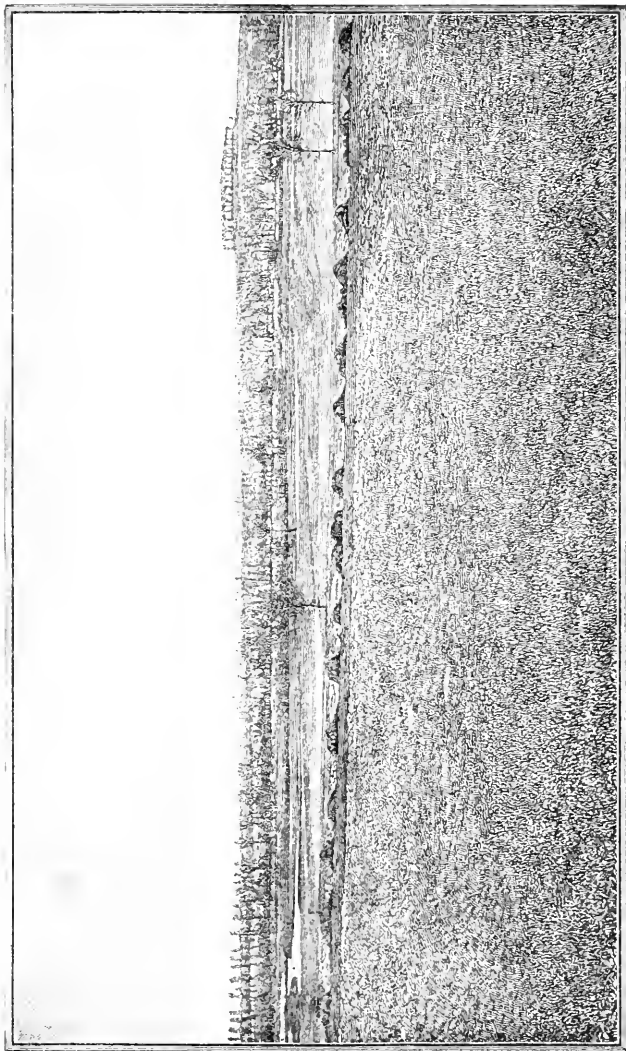

FIG. 31. — BERRY AU LAC.

relictis, ut, si quō opus esset, subsidiō dūcī possent, reliquās sex legiōnēs prō castris in aciē cōstituit. Hostēs item suās cōpiās ex castris ēductās instrūxērunt.

The Belgæ Try to Cross the Aisne to Attack him in the Rear.

9. Palūs erat nōn māgna inter nostrum atque hostium exercitum. Hanc si nostrī trānsirent hostēs expectābant; nostrī autem, si ab illis initium trānseundi fieret, ut impeditōs adgrederentur¹ parātī in armis erant. Interim proeliō equestri inter duās aciēs contendēbātur. Ubi neutri trāns-

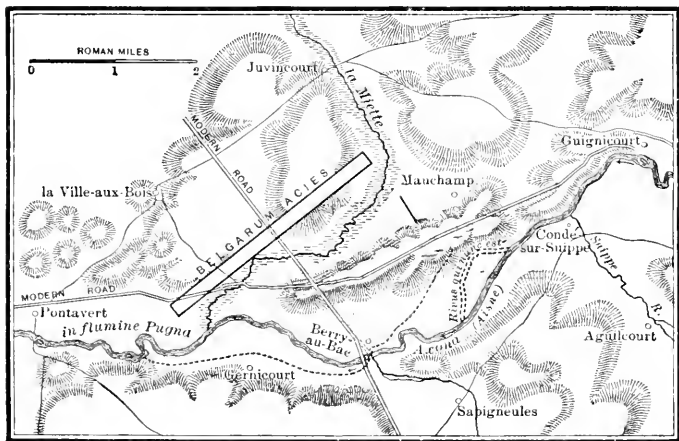

FIG. 32 — BATTLE ON THE AISNE (Axona).

eundi initium faciunt, secundiōre² equitum proeliō nostris Caesar suōs in castra redūxit. Hostēs prōtinus ex eō locō ad flūmen Axonam contendērunt, quod esse post nostra castra dēmōnstrātum³ est. Ibi vadis repertis⁴ partem suā-

Cf. ¹ adgressī, p. 22, l. 16. — ² secundiōrēs, 12, 16. — ³ dēmōnstrāvimus, 49, 1. — ⁴ repertiēbat, 50, 27.

rum cōpiārum trādūcere cōnāti sunt, eō cōnsiliō ut, si possent, castellum cui praeerat¹ Q. Titūrius lēgātus expūgnārent pontemque interscinderent; si minus² potuissent, agrōs Rēmōrum populārentur,³ quī māgnō nōbis ūsuī ad
5 bellum gerendum erant, commeātūque⁴ nostrōs prohibērent.

Cæsar Crosses, and Defeats them. They Decide to Disband.

10. *Caesar* certior factus ab Titūriō omnem equitātum et levis armātūrae Numidās, funditōrēs⁵ sagittariōsque pontem trādūcit atque ad eōs contendit. Ācritēr in eō locō pūgnātum est. Hostīs impeditōs nostrī in flūmine adgressī
10 māgnū eōrum numerum occidērunt; per eōrum corpora reliquōs audācissimē trānsire cōnantis multitudīne tēlorum reppulērunt, primōsque, quī trānsierant, equitātū circumventōs interfēcērunt. Hostēs ubi et dē expūgnandō oppidō et dē flūmine trānseundō spem sē fefellisse intellēxērunt, neque
15 nostrōs in locum iniquiōrem prōgredi pūgnandī causā vidērunt, atque ipsōs rēs frūmentāria⁶ dēficere coepit, conciliō convocātō cōstituērunt optimum esse domum suam quemque⁷ reverti, et, quōrum in finis primum Rōmānī exercitum intrōdūxissent, ad eōs dēfendendōs undique⁸ convenirent,
20 ut potius in suis quam in aliēnis finibus dēcertārent et domesticis cōpiis rei frūmentāriae ūterentur. Ad eam sententiam cum reliquīs causis haec quoque ratiō eōs dēdūxit, quod Diviciācum atque Haeduōs finibus Beilovacōrum adpropinquāre cōgnōverant. His persuādēri ut diūtius
25 morārentur⁹ neque suis auxilium ferrent nōn poterat.

On their Retreat, they are Pursued with Great Slaughter.

11. Eā rē cōstitutā secundā vigiliā māgnō cum strepitū ac tumultū castris ēgressī nullō certō ordine neque imperiō,

Cf. ¹ praeerat, p. 53, l. 12. — ² minus, 42, 4. — ³ populārī, 52, 15 — ⁴ commeātus, 52, 22. — ⁵ funditōrēs, 54, 2. — ⁶ frūmentāriae, 36, 6. — ⁷ quisque, 51, 10. — ⁸ undique, 53: 5 — ⁹ morātī, 54, 6.

cum sibi quisque primum itineris locum peteret et domum pervenire properaret, fecerunt ut consimilis fugae profectio¹ videretur. Hac re statim² Caesar per speculatores cognita,³ insidias veritus, quod qua de causa discederent⁴ nondum perspexerat, exercitum equitatumque castris continuit. Prima 5 luce confirmata re ab exploratoribus, omnem equitatum qui novissimum agmen moraretur praemisit. His Q. Pedium et L. Aurunculium Cottam legatos praefecit; T. Labienum legatum cum legionibus tribus subsequi iussit. Hi novissimos adorti⁵ et multa milia passuum prosecuti⁶ magnam 10 multitudinem eorum fugientium conciderunt; cum ab extremo agmine, ad quos ventum erat, consisterent fortiterque impetum nostrorum militum sustinerent, priores, quod abesse a periculo viderentur neque ulla necessitate neque imperio continerentur,⁷ exaudito clamore perturbatis ordinibus omnes 15 in fuga sibi praesidium ponerent. Ita sine ulla periculo tantam eorum multitudinem nostri interfecerunt quantum fuit diei spatium; sub occasum solis sequi destiterunt seque in castra, ut erat imperatum, reciperunt.

The Suessiones, Alarmed by Cæsar's Advance, Surrender.

12. Postridie eius diei Caesar, priusquam se hostes ex 20 terrore ac fuga reciperent, in finis Suessionum, qui proximi⁸ Remis erant, exercitum duxit et magno itinere ad oppidum Noviodunum contendit. Id ex itinere oppugnare⁹ conatus,¹⁰ quod vacuum ab defensoribus esse audiebat, propter latitudinem fossae murique altitudinem paucis defendentibus 25 expugnare non potuit. Castris munitis vineas agere quaeque ad oppugnandum usui erant comparare coepit. Interim omnis ex fuga Suessionum multitudino in oppidum proxima

Cf. ¹ profectiōnem, p. 6, l. 10. — ² statim, 48, 19. — ³ cognoscant, 50, 6. — ⁴ discessisset, 40, 21. — ⁵ adortum, 36, 2. — ⁶ prosecutus, 52, 7. — ⁷ continēbat, 13, 11. — ⁸ proximī, 50, 13. — ⁹ oppugnare, 53, 3. — ¹⁰ cōnantis, 56, 11.

nocte convēnit. Celeriter vineis ad oppidum āctis, aggere iactō turribusque cōstitutis,¹ māgnitudine operum, quae

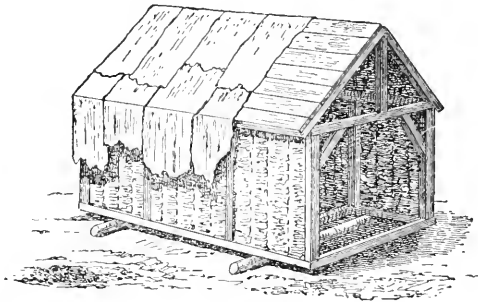

FIG. 33. — VINEA OR TESTUDO.

neque viderant ante Gallī neque audierant, et celeritāte Rōmānōrum permōtī, lēgātōs ad Caesarem dē dēditione² mittunt et petentibus Rēmīs ut cōservārentur impetrant.³

In Like Manner the Bellovacī Surrender.

13. Caesar obsidibus acceptis primis civitatis atque ipsius Galbae rēgis duōbus filiis, armisque omnibus ex oppidō traditis in dēditionem Suessiōnēs accipit exercitumque in Bellovacōs dūcit. Quī cum sē suaque omnia in oppidum 10 Bratuspantium contulissent, atque ab eō oppidō Caesar cum exercitū circiter milia passuum quīnque abesset, omnēs māiōrēs nātū ex oppidō ēgressi manūs ad Caesarem tendere et vōce significāre coepērunt sēsē in eius fidem⁴ ac potestātem venīre neque contrā populum Rōmānum armīs contēdere. 15 Item, cum ad oppidum accessisset castraque ibi pōneret, puerī mulierēsque ex mūrō passis⁵ manibus suō mōre pācem ab Rōmānis petiērunt.

Cf. ¹ cōstituit, p. 54, l. 24. — ² dēditionem, 25, 8. — ³ impetrāret, 31, 22. — ⁴ fidem, 50, 15. — ⁵ passis, 46, 9.

Diviciacus, Leader of the Hædui, Pleads for the Bellovaci.

14. Prō his Diviciācus — nam post discessum Belgārum dīmissis¹ Haeduōrum cōpiis ad eum reverterat — facit verba : ‘Bellovacōs omni tempore in fidē atque amicitia civitātis Haeduae fuisse ; impulsōs² ab suis principibus, quī dicerent Haeduōs ā Caesare in servitūtem redāctōs³ omnis 5 indignitātis contumēliāsque perferre, et ab Haeduīs dēfēcisse et populō Rōmānō bellum intulisse. Quī eius cōnsili principēs fuissent, quod intellegerent quantam calamitatem civitāti intulissent, in Britanniam profūgisse. Petere nōn solum Bellovacōs sed etiam prō his Haeduōs ut suā clēmen- 10 tiā ac mānsuētūdine in eōs utātur. Quod si fēcero, Haeduōrum auctōritatem⁴ apud omnis Belgās amplificātūrum, quōrum auxiliis atque opibus,⁵ si qua bella inciderint, sustentāre⁶ cōsuērint.’

The Ambiani Surrender. Reports of the Nervii, Who are Waiting to Give Battle beyond the Sambre.

15. Caesar honōris Diviciāci atque Haeduōrum causā sēsē 15 eōs in fidem receptūrum et cōservātūrum dixit, et quod erat civitās māgnā inter Belgās auctōritate atque hominum multitudine praestābat, sexcentōs obsidēs poposcit. His trāditis omnibusque armis ex oppidō conlātis, ab eō locō in finis Ambiānōrum pervēnit, quī sē suaque omnia sine morā dēdi- 20 dērunt. Eōrum finis Nervii attingēbant ; quōrum dē nātūrā mōribusque Caesar cum quaereret, sic reperiēbat : Nullum aditum esse ad eōs mercātōribus ; nihil pati vinī reliquārumque⁷ rērum ad lūxuriam pertinentium inferri, quod his rēbus relanguēscere animōs et remitti virtūtem existimārent ; esse 25 hominēs ferōs māgnaeque virtūtis ; increpitāre atque incūsāre⁸ reliquōs Belgās, qui sē populō Rōmānō dēdidissent

Cf. ¹ dīmissō, p. 27, l. 5. — ² impulsus, 35, 1. — ³ redēgisset, 41, 3. ⁴ auctōritatem, 51, 6. — ⁵ opibus, 17, 22. — ⁶ sustentātum, 53, 3. — ⁷ reliquīs, 50, 5. — ⁸ incūsāvit, 34, 22.

patriamque virtūtem prōiēcissent; cōfirmāre¹ sēsē neque lēgātōs missūrōs neque ūllam condiōnem pācis acceptūrōs.

16. Cum per eōrum finis triduum iter fēcisset, inveniēbat ex captivīs Sabim flūmen ā castrīs suis non amplius milia
5 passuum x abesse; trāns id flūnen omnis Nervīōs cōnsēdisse² adventumque ibi Rōmānōrum exspectāre ūnā cum Atrebātibus et Viromanduis, finitimīs suis (nam his utrīsque³ persuāserant utī eandem belli fortūnam experirentur⁴); exspectārī etiam ab eīs Aduatucōrum cōpiās atque esse in
10 itinere; mulierēs quīque per aetātem ad pūgnam inūtilēs vidērentur in eum locum coniecisse, quō propter palūdēs⁵ exercitū aditus nōn esset.

The Nervii, on Information Given by Deserters, Decide to Attack Cæsar while Pitching Camp.

17. His rēbus cōgnitis explōrātōrēs centuriōnēsque prae mittit quī locum castris idōneum⁶ dēligant.⁷ Cum ex
15 dēditiciīs Belgīs reliquīsque Gallis complūrēs Caesarem secūtī ūnā iter facerent, quīdam ex his, ut postea ex captivīs cōgnitum est, eōrum diērum cōnsuētūdine itineris nostrī exercitūs perspectā,⁸ nocte ad Nervīōs pervēnērunt; atque his dēmōnstrārunt inter singulās legiōnēs impedimentōrum
20 māgnum numerum intercēdere, neque esse quicquam negōtī, cum prīma legiō in castra vēnisset reliquaeque legiōnēs māgnum spatium abessent,⁹ hanc sub sarcinīs adorirī; quā pulsā impedimentisque direptis futūrum ut reliquae contrā cōsistere nōn audērent. Adiuvābat etiam eōrum cōnsilium
25 quī rem dēferēbant, quod Nervīi antiquitus,¹⁰ cum equitātū nihil possent (neque enim ad hōc tempus eī rei student,¹¹ sed quicquid possunt pedestribus valent¹² cōpiīs), quō facilius

Cf. ¹ cōfirmāvit, p. 37, l. 2. — ² cōnsēdisse, 51, 2. — ³ utrāque, 54, 20. — ⁴ experiantur, 29, 4. — ⁵ palūs, 55, 4. — ⁶ idōneum, 44, 11. — ⁷ dēlēgerant, 44, 2. — ⁸ perspectam, 36, 17. — ⁹ absint, 52, 1. — ¹⁰ anti-
quitus, 51, 1. — ¹¹ studēbant, 49, 12. — ¹² valēre, 51, 13.

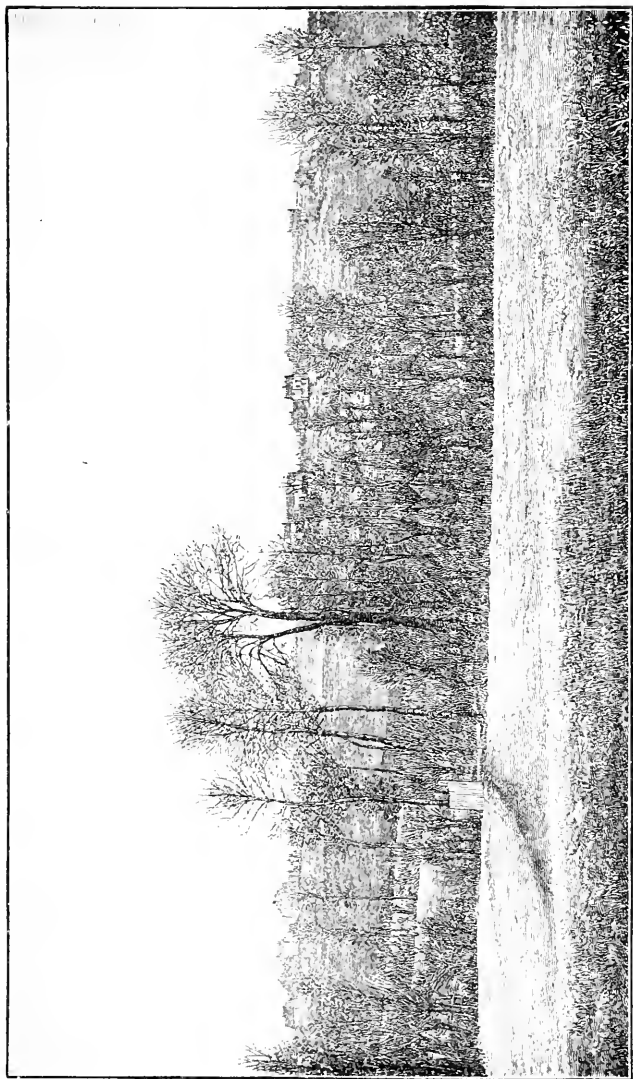

FIG. 34. — HAUTMONT.

finitimōrum equitātum, sī praedandī causā ad eōs vēnissent, impedirent, tenerīs arboribus incīsīs atque inflexīs, crēbrisque in lātitudinem rāmīs enātīs, et rubīs sentibusque interiectīs, effēcerant¹ ut instar mūrī hae saepēs mūnimenta 5
 praebērent, quō nōn modo nōn intrārī sed nē perspicī quidem
 posset. His rēbus cum iter agminis nostrī impedirētur, nōn
 omittendum sibi cōnsilium Nervii existimāvērunt.

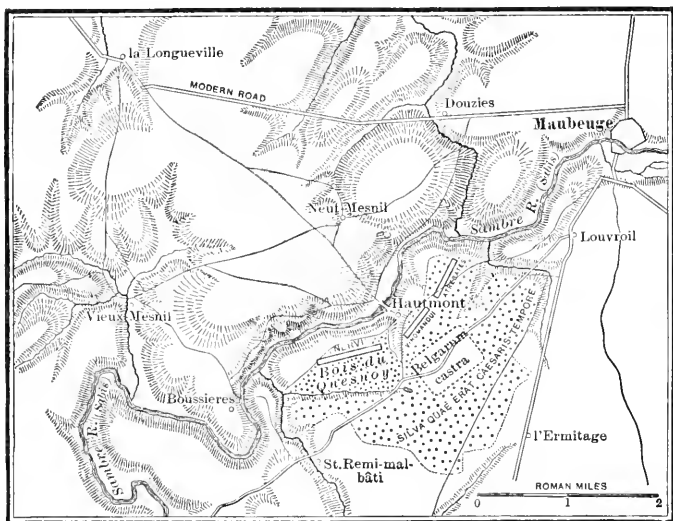

FIG. 35.—DEFEAT OF THE NERVII.

Nature of the Ground.

18. Locī nātūra erat haec quem locum nostrī castris dēlēgerant. Collis ab summō aequālīter dēclivis ad flūmen Sabim, quod suprā nōmināvīmus, vergēbat. Ab eō flūmine 10
 parī² acclivitate collis nāscēbātur adversus³ huic et contrārius, passūs circiter ducentōs infimus apertus,⁴ ab superiōre

Cf. ¹ efficiēbat, p. 52, l. 24.—² paribus, 46, 5.—³ adversus, 54, 18.—⁴ apertis, 37, 9.

parte silvestris, ut nōn facile intrōrsus perspicī posset. Intrā eās silvās hostēs in occultō sēsē continēbant; in apertō locō secundum flūmen paucae statiōnēs equitum vidēbantur. Flūminis erat altitudō pedum circiter trium.

The Nervii Make a Furious Assault and Throw the Romans into Confusion.

5 19. Caesar equitātū praemissō subsequēbātur¹ omnibus cōpiis; sed ratiō ordōque agminis aliter sē habēbat ac Belgae ad Nervios dētulerant. Nam quod hostibus adpropinquābat, cōnsuetūdine suā Caesar sex legiōnēs expeditās² dūcēbat; post eās totius exercitūs impedimenta conlocārat; 10 inde duae legiōnēs quae proximē³ cōscriptae erant tōtum agmen claudēbant praesidiōque⁴ impedimentis erant. Equitēs nostrī cum funditōribus sagittariisque flūmen trānsgressi cum hostium equitātū proelium commīsērunt. Cum sē illi identidem in silvās ad suos reciperent ac rūsus⁵ ex silvā in 15 nostrōs impetum facerent, neque nostrī longius quam quem ad finem porrēcta loca aperta pertinēbant cēdentis insequi audērent,⁶ interim legiōnēs sex quae primae vēnerant opere dimēnsō castra mūnire coepērunt. Ubi prima impedimenta nostrī exercitūs ab eis quī in silvis abditī⁷ latēbant vīsa sunt, 20 quod tempus inter eōs committendī proeli convēnerat,⁸ ut intrā silvās aciem ordinēsque cōstituerant⁹ atque ipsi sēsē cōfirmāverant, subitō omnibus cōpiis prōvolāvērunt impetumque in nostrōs equitēs fēcērunt. His facile pulsīs ac prōturbātis, incredibili celeritāte ad flūmen dēcucurrērunt, ut 25 paene ūnō tempore et ad silvās et in flūmine [et iam in manibus nostrīs] hostēs vidērentur. Eādem autem celeritāte adversō colle ad nostra castra atque eōs quī in opere occupātī erant contendērunt.

Cf. ¹ subsequi, D. 57, l. 9. — ² expedita, 45, 2. — ³ proximī, 50, 13. — ⁴ praesidium, 52, 25. — ⁵ rūsus, 22, 17. — ⁶ audērent, 54, 15. — ⁷ abditī, 34, 7. — ⁸ convēnisset, 32, 11. — ⁹ cōstituit, 54, 24.

The Critical Situation. The Discipline of the Roman Army.

20. Caesarī omnia ūnō tempore erant agenda: vēxillum prōpōnendum (quod erat insigne cum ad arma concurrī oportēret), signum tubā dandum, ab opere revocandī militēs, quī paulō longius aggeris petendī causā prōcesserant arcescendī, aciēs instruenda,¹ militēs cohortandī,² signum dandum. Quārum rērum māgnam partem temporis brevītās et successus hostium impediēbat.² His difficultātibus duae rēs erant



FIG. 36. — LITUUS.



FIG. 37. — TUBA.



FIG. 38. — CORNU.

subsidiō,⁴ — scientiā⁵ atque ūsus militum, quod superiōribus proeliis exercitātī quid fierī oportēret nōn minus commodē ipsī sibi praescribere quam ab aliis docērī⁶ poterant; et quod ab opere singulisque legiōnibus singulōs lēgātōs Caesar discēdere nisi mūnītis castrīs vetuerat. Hi propter propinquitātem et celeritātem hostium nihil iam Caesaris imperium exspectābant, sed per sē quae vidēbantur administrābant.

Caesar Addresses the Tenth; the Rest are Already Engaged.

21. Caesar necessariis rēbus imperātis ad cohortandōs militēs quam in partem fors obtulit dēcucurrit, et ad

Cf. ¹ *instruendam*, p. 54, l. 16. — ² *cohortātus*, 52, 7. — ³ *impediērent*, 61, 2. — ⁴ *subsidiū*, 53, 13. — ⁵ *scientiam*, 42, 13. — ⁶ *docet*, 52, 11.

legiōnem decimam dēvēnit. Militēs nōn longiōre ōrātiōne cohortātus quam utī suae pristinae virtūtis memoriam retinērent neu perturbārentur¹ animō hostiumque impetum fortiter sustinērent, quod nōn longius hostēs aberant quam
 5 quō tēlum adici posset, proeli committendi sīgnum dedit. Atque in alteram partem item cohortandi causā profectus, pūgnantibus occurrit. Temporis tanta fuit exiguitās hostiumque tam parātus² ad dimicandum animus ut nōn modo ad insīgnia accommodanda sed etiam ad galeās induendās
 10 scūtisque tegimenta dētrahenda tempus dēfuerit. Quam quisque ab opere in partem cāsū dēvēnit, quaeque prima signa cōspēxit ad haec cōstitit,³ nē in quaerendis suis pūgnandi tempus dimitteret.

The Varying Fortunes of the Battle.

22. Īnstrūctō exercitū magis ut locī nātūra dēiectusque⁴
 15 collis et necessitās temporis quam ut rei militāris ratiō atque ōrdō postulābat, cum diversae legiōnēs aliae aliā in parte hostibus resisterent, saepibusque⁵ dēnsissimis (ut ante dēmōstrāvimus) interiectis⁶ prōspectus impedirētur, neque certa subsidia conlocārī neque quid in quāque parte
 20 opus⁷ esset prōvidērī neque ab ūnō omnia imperia administrārī poterant. Itaque in tantā rērum iniquitāte fortunāe quoque ēventūs variī sequēbantur.

Two Legions Force the Atrebates into the River ; Two Pursue the Viro-
 mandui, but the Nervii Gain the Camp.

23. Legiōnis nōnae et decimae militēs, ut in sinistrā parte aciē cōstitērant, pīlis ēmissis cursū ac lassitudīne ex
 25 animātōs volneribusque cōfectōs Atrebātēs — nam his ea pars obvenerat — celeriter ex locō superiori in flūmen compulērunt, et trānsire cōnantis⁸ insecūtī gladiis māgnam

Cf. ¹ perturbātis, p. 57, l. 15. — ² parātissimam, 37, 2. — ³ cōnsistendī, 53, 9. — ⁴ dēiectūs, 54, 20. — ⁵ saepēs, 61, 4. — ⁶ interiectis, 61, 4. — ⁷ opus, 55, 1. — ⁸ cōnātus, 57, 23.

partem eorum impeditam interfecerunt. Ipsi transire flumen non dubitaverunt, et in locum iniquum¹ progressi rursus resistentis hostis redintegrato proelio in fugam coniecerunt. Item alia in parte diversae duae legionēs, undecima et octava, profligatis Viromanduis, quibuscum erant 5 congressi, ex loco superiore in ipsis fluminis ripis proeliabantur. At totis ferē castris a fronte et ab sinistra parte nudatis,² cum in dextro cornu³ legio duodecima et non magno ab ea intervallō septima constitisset, omnes Nervii confertissimo agmine duce Boduognato, qui summam⁴ im- 10 peri tenebat, ad eum locum contendērunt; quorum pars apertō latere legionēs circumvenire, pars summum castrorum locum petere coepit.

The Enemy have the Advantage. The Treveri, Panic-stricken, Withdraw to their Homes.

24. Eodem tempore equites nostri levisque armaturae⁵ peditēs, qui cum eis una fuerant, quos primo hostium 15 impetu pulsos dixeram, cum se in castra reciperent, adversis hostibus occurrēbant ac rursus aliam in partem fugam petēbant; et calones, qui ab decumana porta ac summo iugo collis nostrōs victōrēs flumen transisse conspexerant, praedandi⁶ causā egressi, cum respexissent et hostis in nostris 20 castris versari viderent, praecipitēs fugae sese mandabant.⁷ Simul eorum qui cum impedimentis veniebant clamor fremitusque oriebatur, alique aliam in partem perterriti ferēbantur. Quibus omnibus rebus permoti equites Treveri, quorum inter Gallōs virtutis opinio⁸ est singularis, qui 25 auxilii causā a civitate missi ad Caesarem venerant, cum multitudine hostium castra compleri, legionēs premi⁹ et paene circumventas teneri, calones, equites, funditores,

Cf. ¹ iniquiorem, p. 56, l. 15. — ² nudatus, 53, 7. — ³ cornu, 46, 22. — ⁴ summam, 51, 20. — ⁵ armaturae, 56, 7. — ⁶ praedandi, 61, 1. — ⁷ mandarunt, 10, 11. — ⁸ opinionem, 54, 13. — ⁹ premebant, 46, 24.

Numidās dispersōs dissipātōsque in omnis partis fugere vidissent, dēspērātis¹ nostris rēbus domum contendērunt; Rōmānōs pulsōs superātōsque, castris impedimentisque eōrum hostis potitōs, civitātī renūntiāvērunt.

Caesar Enters the Fight in Person and Inspires his Soldiers.

5 25. Caesar ab decimae legiōnis cohortātiōne ad dextrum cornū profectus, ubi suōs urgēri signisque in ūnum locum conlātis duodecimae legiōnis cōnfertōs² milites sibi ipsōs



FIG. 39. — AQUILIFER.



FIG. 40. — CENTURIO.

ad pūgnam esse impedimentō³ vidit, — quartae cohortis omnibus centuriōnibus occisīs,⁴ signiferō interfectō, signō⁵ 10 āmissō, reliquārum cohortium omnibus ferē centuriōnibus

Cf. ¹ dēspērātis, p. 36, l. 1. — ² cōnfertissimo, 65, 10. — ³ impedimentō, 22, 6. — ⁴ occidērunt, 56, 10. — ⁵ signum, 63, 5.

aut volnerātis aut occisis, in hīs primipilō P. Sextiō Baculō, fortissimō virō, multīs gravibusque volneribus cōfectō, ut iam sē sustinēre nōn posset; reliquōs esse tardiōrēs et nōn nullōs¹ ab novissimis dēsertō proeliō excēdere ac tēla vitāre, hostis neque ā fronte ex inferiōre locō subeuntis 5
intermittere et ab utrōque latere instāre, et rem esse in angustō vidit neque ūllum esse subsidium quod submitti² posset,—scūtō ab novissimis [ūnī] militi dētrāctō, quod ipse eō sine scūtō³ vēnerat, in primam aciem prōcessit; centuriōnibusque nōminātim appellātis reliquōs cohortātus 10
militēs signa inferre et manipulōs laxāre iussit, quō facilius gladiis ūti possent. Cūius adventū spē inlātā militibus ac redintegrātō⁴ animō, cum prō sē quisque in cōspectū imperātōris etiam in extrēmīs suis rēbus operam nāvāre cuperet, paulum⁵ hostium impetus tardātus est. 15

Meanwhile Labienus, having Taken the Enemy's Camp, Sends a Reinforcement to Cæsar.

26. Caesar cum septimam legiōnem, quae iūxtā cōstitērat, item urgērī ab hoste vidisset, tribūnōs militum monuit ut paulātīm sēsē legiōnēs coniungerent et conversa signa in hostis inferrent.⁶ Quō factō, cum alius aliī subsidium ferret neque timērent nē āversī ab hoste circumvenīrentur, audā- 20
cius resistere ac fortius pūgnāre coepērunt. Interim militēs legiōnum duārum quae in novissimō agmine praesidiō impedimentis fuerant, proeliō nūntiātō, cursū⁷ incitātō in summō colle ab hostibus cōspiciēbantur; et T. Labiēnus castris hostium potitus⁸ et ex locō superiōre quae rēs in 25
nostris castris gererentur⁹ cōspicātus, decimam legiōnem subsidiō nostris misit. Quī, cum ex equitum et cālōnum fugā quō in locō rēs esset quantōque in periculō et castra et

Cf. ¹ nōn nullis, p. 49, l. 8. — ² submittātur, 53, 13. — ³ scūtis, 64, 10. — ⁴ redintegrātō, 65, 3. — ⁵ paulum, 45, 9. — ⁶ intulērunt, 22, 19. — ⁷ cursū, 64, 24. — ⁸ potiundī, 54, 5. — ⁹ gerantur, 50, 6.

legiōnēs et imperātor versārētur cōgnōvissent, nihil ad cele-
ritātem sibi reliquī fēcērunt.

The Tide of Battle Turns.

27. Hōrum adventū tanta rērum commūtātiō est facta ut
nostrī, etiam quī volneribus cōfecti¹ prōcubuissent, scūtis
5 innixī proelium redintegrārent, cālōnēs perterritōs hostis
cōspicātī etiam inermēs armātis occurrerent ;² equitēs vērō,
ut turpitūdinem fugae virtūte dēlērent, omnibus in locis pūg-
nant, quō sē legiōnāriīs militibus praeferrent. At hostēs
etiam in extrēmā spē salutis tantam virtūtem praestitērunt
10 ut, cum primī eōrum cecidissent, proximī iacentibus insiste-
rent atque ex eōrum corporibus pūgnārent ; his dēiectis et
coacervātis cadāveribus, quī superessent ut ex tumulō tēla
in nostrōs conicerent³ et pila intercepta remitterent ; ut nōn
nēquiquam tantae virtūtis hominēs iūdicārī dēbēret ausōs
15 esse trānsire lātissimum⁴ flūmen, ascendere altissimās rīpās,
subīre inīquissimum⁵ locum ; quae facilia ex difficillimis
animī māgnitūdō redēgerat.

The Nervii Utterly Routed, and Most of them Slain.

28. Hōc proeliō factō et prope ad interneciōnem gente ac
nōmine Nerviorum redactō, māiōrēs nātū, quōs ūnā cum
20 puerīs mulieribusque in aestuāria ac palūdēs⁶ coniectōs
dixerāmus, hāc pūgnā nūntiātā, cum victōribus nihil impedi-
tum, victis nihil tūtum⁷ arbitrārentur, omnium quī supererant
cōnsēnsū lēgātōs ad Caesarem misērunt sēque ei dēdidērunt ;⁸
et, in commemorandā⁹ civitātis calamitāte, ex sexcentis ad
25 trēs senātōrēs, ex hominum milibus LX vix ad quīngentōs
quī arma ferre possent sēsē redactōs esse dixērunt. Quōs
Caesar, ut in miserōs ac supplicēs ūsus misericordiā vidērē-

Cf. ¹ cōfectōs, p. 64, l. 25. — ² occurrēbant, 65, 17. — ³ cōnicerent, 53, 9. — ⁴ lātissimōs, 51, 15. — ⁵ inīquum, 65, 2. — ⁶ palūs, 55, 4. — ⁷ tūta, 52, 22. — ⁸ dēdidērunt, 59, 20. — ⁹ commemorāvit, 38, 17.

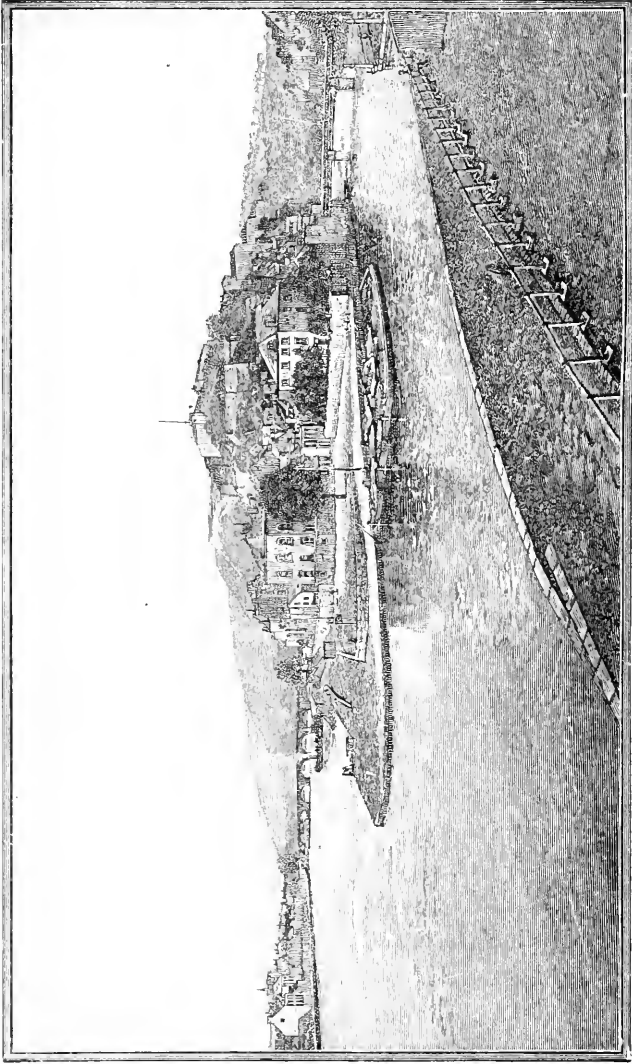

FIG. 41.—CITADEL OF NAMUR.

tur, diligentissimē cōservāvit suisque finibus atque oppidis
ūtī iussit, et finitimis imperāvit ut ab iniuriā et maleficiō sē
suosque prohibērent.¹

The Aduatuci Withdraw to a Strongly Fortified Position.
Account of their Origin.

29. Aduatuci, dē quibus suprā diximus, cum omnibus
cōpiis auxiliō Nervii venirent, hāc pūgnā nūntiātā ex itinere 5
domum revertērunt; cūctis oppidis castellisque² dēsertis

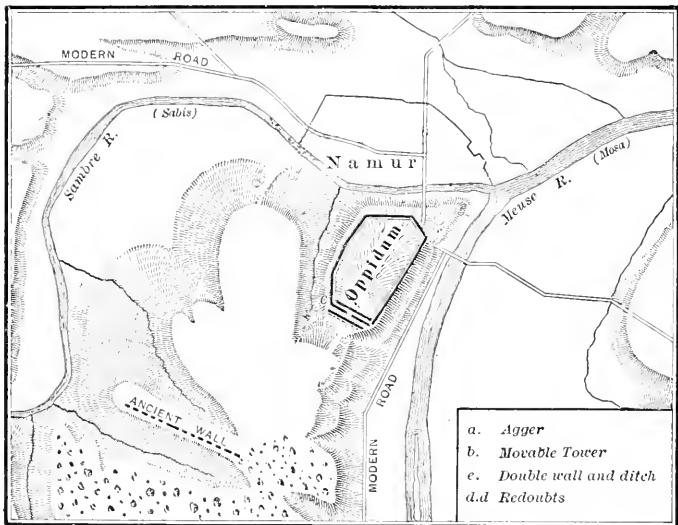

FIG. 42. — SIEGE OF THE STRONGHOLD OF THE ADUATUCI.

sua omnia in ūnum oppidum ēgregiē nātūrā mūnitum contu-
lērunt.³ Quod cum ex omnibus in circuitū partibus altissi-
mās rupis dēspectusque habēret, ūnā ex parte lēniter⁴

Cf. ¹ prohibuerint, p. 51, l. 5. — ² castellum, 56, 2. — ³ contulissent, 58, 10. — ⁴ lēniter, 54, 21.

acclivis aditus in lātitudinem nōn amplius pedum cc relin-
quēbātur ; quem locum duplici altissimō mūrō mūnierant ;
tum māgnī ponderis saxa et praeacūtās trabis in mūrō con-
locābant. Ipsī erant ex Cimbris Teutonisque prōgnātī, qui,
5 cum iter in prōvinciam nostram atque Ītaliā facerent, eis
impedimentis quae sēcum agere ac portāre nōn poterant
citrā flūmen Rhēnum dēpositis, custōdiam ex suis ac praesi-
dium sex milia hominum ūnā reliquerant. Hī post eōrum
10 obitum multōs annōs ā finitimis exagitātī, cum aliās bellum
inferrent aliās inlātum dēfenderent, cōnsēnsū eōrum omnium
pāce factā hunc sibi domiciliō locum dēlēgerant.

They Scoff at the Roman Siege Works.

30. Ac primō adventū¹ exercitūs nostrī crēbrās² ex oppidō
excursiōnēs faciēbant parvulisque proeliis cum nostris con-
tendēbant ; postea vāllō pedum XII, in circuitū xv milium,
15 crēbrisque castellis circummūniti oppidō sēsē continēbant.

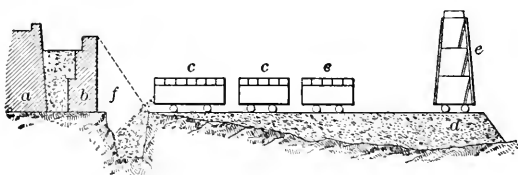

FIG. 43.—SIEGE WORKS.

a, b, Double wall. *e*, Movable tower.
c, c, c, Vineæ. *f*, Ditch.
d, Agger.

Ubi vineis³ āctis aggere⁴ exstrūctō turrim procul cōstitui
vidērunt, primū inridēre ex mūrō atque increpitāre vōcibus
quod tanta māchinātiō ab tantō spatiō instituerētur : ‘Qui-
busnam manibus aut quibus vīribus⁵ praesertim hominēs
20 tantulae statūrae’ — nam plērumque hominibus Gallis prae

Cf. ¹ *adventum*, p. 60, l. 6. — ² *crēbrī*, 49, 2. — ³ *vīneās*, 57, 26. —
⁴ *aggere*, 58, 1. — ⁵ *vīribus*, 48, 2.

māgnitūdine corporum suōrum brevitās nostra contemptū est — ‘tantī oneris turrim in mūrō sēsē conlocāre cōnfiderent?’

They Become Alarmed, and Offer to Surrender Conditionally.

31. Ubi vērō movēri et adpropinquāre¹ moenibus² vidē-
runt, novā atque inūsitatā speciē commōti³ lēgātōs ad
Caesarem dē pāce mīsērunt, quī ad hunc modum locūtī : 5
‘Nōn existimāre Rōmānōs sine ope divinā bellum gerere,
quī tantae altitudinis māchinātiōnēs tantā celeritāte⁴ prō-
movēre possent; sē suaque omnia eōrum potestātī permit-
tere’⁵ dixērunt. ‘Ūnum petere ac dēprecārī: sī forte prō
suā clēmētiā ac mānsuētūdine,⁶ quam ipsī ab aliis audī- 10
rent, statuisset Aduatucōs esse cōservandōs, nē sē armīs
dēspoliāret. Sibi omnis ferē finitimōs esse inimicōs ac suae
virtūti invidēre; ā quibus sē dēfendere trādītis armīs nōn
possent. Sibi praestāre, sī in eum cāsum dēdūcerentur,
quamvis fortūnam ā populō Rōmānō patī quam ab his per 15
cruciātum⁷ interficī inter quōs dominārī cōsuēssent.’

They Accept Cæsar's Terms, but Treacherously Retain Part of their Arms.

32. Ad haec Caesar respondit: ‘Sē magis cōsuētūdine
suā quam meritō eōrum civitātem cōservātūrum, sī, prius
quam⁸ mūrū ariēs attigisset, sē dēdidissent; sed dēditiōnis
nūllam esse condiōnem nisi armīs trādītis. Sē id quod 20
in⁹ Nerviiis fēcisset factūrum, finitimisque imperātūrum nē
quam dēditiciis populī Rōmānī iniūriam inferrent.’ Rē
nūntiātā ad suōs, quae imperārentur facere dixērunt. Armō-
rum māgnā multitudīne dē mūrō in fossam quae erat ante
oppidum iactā, sic ut prope summam mūri aggerisque alti- 25
tūdinem acervi armōrum adaequārent,¹⁰ et tamen circiter

Cf. ¹ adpropinquāre, p. 56, l. 24. — ² moenibus, 53, 5. — ³ commōtus, 50, 1. — ⁴ celeritās, 44, 6. — ⁵ permittere, 50, 16. — ⁶ mānsuētūdine, 59, 11. — ⁷ cruciātūs, 28, 25. — ⁸ priusquam, 57, 20. — ⁹ in, 42, 14. — ¹⁰ adaequārent, 44, 7.

parte tertiā, ut posteā perspectum est, cēlātā atque in oppidō retentā, portis patēfactis eō diē pāce sunt ūsī.

They Make a Sally from the Town, but are Repulsed. More than 50,000 Sold as Slaves.

33. Sub vesperum Caesar portās claudī militēsque ex oppidō exīre iussit, nē quam noctū oppidānī¹ ā militibus 5 iniūriam acciperent. Illi ante initō (ut intellēctum est) cōnsiliō, quod dēditōne factā nostrōs praesidia dēductūrōs aut dēnique indiligentius servātūrōs crēdiderant, — partim cum eis quae retinuerant et cēlāverant armīs, partim scūtīs ex cortice factīs aut viminibus intextīs, quae subitō, ut temporis 10 exiguitās² postulābat, pellibus indūxerant, — tertiā vigiliā, quā minimē arduus ad nostrās mūnitiōnēs ascēsus vidēbatur, omnibus cōpiīs repente ex oppidō ēruptiōnem fēcērunt. Celeriter, ut ante Caesar imperārat, ignibus sīgnificātiōne factā, ex proximīs castellis eō concursum³ est, pūgnātumque 15 ab hostibus ita ācritur est ut ā virīs fortibus in extrēmā spē salutis, iniquō locō, contrā eōs quī ex vāllō⁴ turribusque tēla iacerent, pūgnārī dēbuit,⁵ cum in ūnā virtūte omnis spēs cōnsisteret. Occisīs ad hominum milibus quattuor reliquī in oppidum rēiectī sunt. Postridiē eius diēi refrāctis portis, 20 cum iam dēfenderet nēmō, atque intrōmissis militibus nostrīs, sectiōnem eius oppidi ūniversam Caesar vēndidit. Ab eis quī ēmerant capitem numerus ad eum relātus est milium quinquāgintā trium.

Crassus Subdues many Coast Towns.

34. Eōdem tempore ā P. Crassō, quem cum legiōne 25 ūnā miserat ad Venetōs, Venellōs, Osismōs, Coriosolitas, Esviōs, Aulercōs, Redonēs, quae sunt maritimae civitatēs Oceanumque attingunt, certior factus est omnis eās civi-

Cf. ¹ oppidānīs, p. 54, l. 3. — ² exiguitās, 64, 7. — ³ concurrī, 63, 2. — ⁴ vāllō, 52, 27. — ⁵ dēbēret, 68, 14.

tātēs in diciōnem potestātemque populī Rōmānī esse redāctās.¹

The Army Goes into Winter Quarters. A Thanksgiving for Cæsar's Victories is Decreed at Rome.

35. Hīs rēbus gestis, omnī Galliā pācātā,² tanta hūius belli ad barbarōs opīniō perlāta est utī ab eis nātiōnibus quae trāns Rhēnum incolerent lēgātī ad Caesarem mitterentur quī sē obsidēs datūrās, imperāta³ factūrās pollicērentur.⁴ Quās lēgātiōnēs Caesar, quod in Ītaliā Īllyricumque properābat, inītā proximā aestāte ad sē revertī iussit. Ipse in Carnutēs, Andēs, Turonōs, quaeque civitātēs propinquae eis locis erant ubi bellum gesserat, legiōnibus in hiberna dēductis in Ītaliā profectus est. Ob eāsque rēs ex litteris Caesaris diēs quīndecim supplicātiō dēcrēta est, quod ante id tempus accidit nūlli.

Cf. ¹ redāctō, p. 68, l. 19. — ² pācātā, 49, 6. — ³ imperāta, 50, 18. — ⁴ pollicitōs, 51, 13.

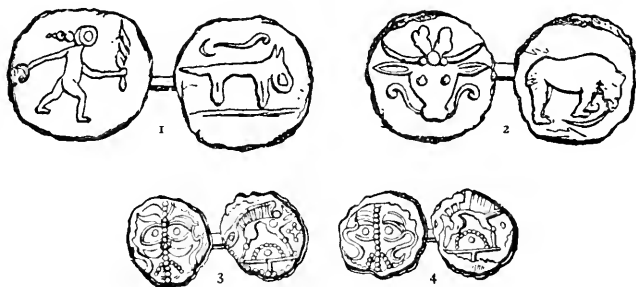

FIG. 44. — GALLIC COINS.

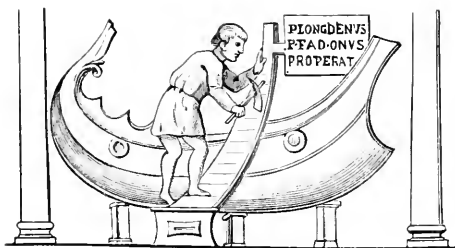

FIG. 45. — SHIPBUILDER.

BOOK III.

CÆSAR'S THIRD CAMPAIGN. B.C. 56.

Galba is Sent to Guard the Passes of the Alps about the Upper Rhone.

CUM in Ætaliam proficisceretur Caesar, Ser. Galbam cum legiōne XII et parte equitātis in Nantuātis, Veragrōs Sedūnōsque mīsit, quī ā finibus Allobrogum et lacū Lemannō et flūmine Rhodanō ad summās Alpīs pertinent. Causa
 5 mittendī fuit quod iter per Alpīs, quō māgnō cum periculō māgnisque cum portōriis¹ mercātōrēs ire cōsuērāt, patē fieri volēbat. Huic permīsit, si opus esse arbitrārētur, uti in his locīs legiōnem hiemandi causā conlocāret. Galba, secundis aliquot proeliis factis castellisque complūribus
 10 eōrum expūgnātis, missis ad eum undique lēgātis obsidibusque datis et pāce factā, cōstituit cohortis duās in Nantuātibus conlocāre et ipse cum reliquīs eius legiōnis cohortibus in vicō Veragrōrum, quī appellātur Octodūrus, hiemāre; quī vicus positus in valle, nōn māgnā adiectā plānitie, altissimis
 15 montibus undique continetur. Cum hīc in duās partis flūmine dīvideretur, alteram partem eius vicī Gallis [ad hiemandum] concessit, alteram vacuam² ab his relictam cohortibus attribuit. Eum locum vāllō fossāque mūnīvit.

Cf. ¹ portōria, p. 15, l. 25. — ² vacuum, 57, 24.

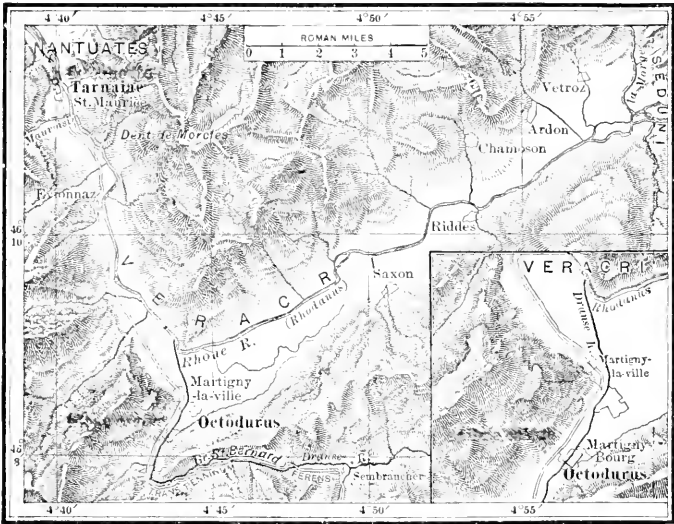

FIG. 46. — MAP OF OCTODURUS.

Having Gone into Winter Quarters, He is Threatened by Large Numbers of the Native Tribes, Who Occupy the Neighboring Heights.

2. Cum diēs hibernōrum complūrēs trānsissent frūmentumque eō comportārī iussisset, subitō per explorātōrēs certior factus est ex eā parte vicī quam Gallis concesserat omnis noctū discessisse, montisque quī impendērent ā maximā multitudīne Sedūnōrum et Veragrōrum tenērī. Id aliquot dē causis acciderat ut subitō Galli belli renovandī legiōnisque opprimendae cōsiliū caperent: primum, quod legiōnem — neque eam plēnissimam, detrāctis cohortibus duābus et complūribus singillātīm, quī commeātūs petendī causā missi erant — propter paucitātem dēspiciēbant; ¹ tum etiam quod propter iniquitātem locī, cum ipsi ex montibus in vallem dēcurrerent et tēla conicerent, nē primum quidem posse impetum suum sustinērī existimābant. Accēdēbat

Cf. ¹ dēspiceret, p. 11, l. 20.

quod suōs ab sē liberōs abstrāctōs obsidum nōmine dolēbant,¹ et Rōmānōs nōn sōlum itinerum causā sed etiam perpetuae possessiōnis culmina Alpium occupāre cōnārī et ea loca finitimae prōvinciae adiungere sibi persuāsum habēbant.

Galba Calls a Council. He will Defend the Camp, if Possible.

3. His nūntiis acceptis Galba, cum neque opus hibernōrum mūnitiōnēsque plēnē essent perfectae neque dē frūmentō reliquōque commeātū satis esset prōvisum, quod dēditōne factā obsidibusque acceptis nihil dē bellō timendum exīstīmāverat, cōnsiliō celeriter convocātō sententiās exquirere coepit. Quō in cōnsiliō, cum tantum repentīnī² periculi praeter opiniōnem accidisset, ac iam omnia ferē superiōra loca multitudine armātōrum complēta cōspicerentur, neque subsidiō venīrī neque commeātūs supportārī interclūsīs
15 itineribus possent, prope iam dēspērātā salūte nōn nullae ēius modi sententiae³ dicēbantur ut, impedimentis relictis ēruptiōne factā, isdem itineribus quibus eō pervēnissent ad salutem contenderent. Māiōrī tamen partī placuit hōc reservātō ad extrēmum cōnsiliō interim rei ēventum experīrī
20 et castra dēfendere.

The Gauls Attack Vigorously.

4. Brevi spatiō interiectō, vix ut eīs rēbus quās cōstituissent conlocandis atque administrandis tempus darētur, hostēs ex omnibus partibus signō datō dēcurrere, lapidēs gaesaeque in vāllum conicere. Nostrī primō integris viribus
25 fortiter prōpūgnāre neque ūllum frūstrā tēlum ex locō superiōre mittere, et quaecumque pars castrōrum nūdāta dēfēnsōribus premī⁴ vidēbātur, eō occurrere et auxilium ferre; sed hōc superārī quod diūturnitate pūgnae hostēs dēfessi⁵ proeliō excēdēbant, aliī integris viribus succēdēbant: quārum

Cf. ¹ doleant, p. 12, l. 15. — ² repentīnō, 11, 7. — ³ sententiam, 56, 21. — ⁴ premī, 65, 27. — ⁵ dēfessi, 22, 11.



FIG. 47. — GAIUS IULIUS CAESAR.

rērum ā nostris propter paucitatem fieri nihil poterat, ac nōn modo dēfessō ex pūgnā excēdendī, sed nē sauciō quidem eius loci ubi cōstiterat relinquendī ac suī recipiendī facultās dabātur.

The Battle Rages for Six Hours. The Only Hope is in Making a Sortie.

5. Cum iam amplius hōris sex continenter pūgnārētur ac nōn solum virēs sed etiam tēla nostrōs dēficerent,¹ atque hostēs ācrius instārent languidiōribusque nostris vāllum scindere et fossās complēre cōepissent, rēsque esset iam ad extrēmum perducta cāsum, P. Sextius Baculus, primī pili centuriō, quem Nervicō proeliō complūribus cōnfectum volneribus diximus, et item Gāius Volusēnus, tribūnus militum, vir et cōsili māgnī et virtūtis, ad Galbam accurrunt atque ūnam esse spem salūtis docent, sī ēruptiōne factā extrēmum auxilium experirentur. Itaque convocātis centuriōnibus celeriter militēs certiōrēs facit paulisper² intermitterent proelium, ac tantummodo tēla missa exciperent sēque ex labōre reficerent; post datō signō ex castris ērumperent atque omnem spem salūtis in virtūte pōnerent. 15

The Gauls are Defeated with Great Loss; but Galba Withdraws to the Province.

6. Quod iūssi sunt faciunt ac subitō omnibus portis ēruptiōne factā neque cōgnōscendī quid fieret neque suī conligendī hostibus facultatem relinquunt. Ita commūtātā³ fortunā eōs quī in spem potiundōrum castrōrum vēnerant undique circumventōs interficiunt; et ex hominum milibus amplius xxx, quem numerum barbarōrum ad castra vēnisse cōstābat, plūs tertiā parte interfectā reliquōs perterritōs in fugam coniciunt ac nē in locis quidem superiōribus cōsistere patiuntur. Sic omnibus hostium cōpiis fūsis armisque exūtis sē intrā mūnitiōnēs suās recipiunt. Quō proeliō factō, quod saepius fortunam temptāre Galba nōlēbat, atque aliō

Cf. ¹ dēficere, p. 56, l. 16. — ² paulisper, 54, 6. — ³ commūtātō, 20, 15.

se in hiberna cōsiliō vēnisse meminerat, aliis occurrisse rēbus viderat, maximē frūmentī commeātūque inopiā¹ permōtus, posterō diē omnibus ēius vicī aedificiīs incēnsīs in prōvinciam revertī contendit, ac nullō hoste prohibente aut
5 iter dēmorante incolumem² legiōnem in Nantuātis, inde in Allobrogēs perdūxit ibique hiemāvit.

Operations in Northwestern Gaul on the Seacoast. Crassus Sends Messengers to Collect Supplies.

7. His rēbus gestis cum omnibus dē causis Caesar pācātam Galliam existimāret [superātis Belgis, expulsis Germānīs, victis in Alpihus Sedūnis], atque ita initā hieme in
10 Illyricum profectus esset, quod eās quoque nātiōnēs adire et regiōnēs cōgnōscere volēbat, subitum bellum in Galliā coörtum est. Eius belli haec fuit causa. P. Crassus adulēscēns cum legiōne VII proximus mare Oceanum in Andibus hiemābat. Is, quod in his locis inopia frūmentī erat, praefectōs
15 tribūnōsque militum complūrīs in finitimās civitātis frūmentī causā dīmīsit; quō in numerō erat T. Terrasidius missus in Esuviōs, M. Trebius Gallus in Coriosolitas, Q. Velānius cum T. Siliō in Venetōs.

The Messengers are Seized by the Veneti, under whose Lead the Maritime Tribes Demand a Return of their Hostages.

8. Hūius est civitātis longē amplissima auctōritās omnis
20 ōrae maritimae regiōnum eārum, quod et nāvis habent Venetī plūrimās, quibus in Britanniam nāvigāre cōsuērunt, et scientiā atque ūsū rērum nauticārum cēterōs antecēdunt, et in māgnō impetū maris *vāsti* atque apertī paucis portibus interiectis, quōs tenent ipsī, omnis ferē quī eō marī ūtī cōn-
25 suērunt habent vectigālis. Ab his fit initium retinendī Sili atque Velāni, quod per eōs suōs sē obsidēs quōs Crassō dedissent recuperātūrōs existimābant. Hōrum auctōritāte finitimi adducti (ut sunt Gallōrum subita et repentina cōn-

Cf. ¹ inopiā, p. 24, l. 17. — ² incolumem, 48, 20.

silia), eādem dē causā Trebium Terrasidiumque retinent; et celeriter missis lēgātis per suōs principēs inter sē coniūrant nihil nisi commūnī cōnsiliō āctūrōs eundemque omnis fortūnae exitum esse lātūrōs; reliquāsque civitātēs sollicitant¹ ut in eā libertāte quam ā māiōribus accēperint permanēre 5 quam Rōmānōrum servitūtem perferre mālint. Omnī ōrā maritimā celeriter ad suam sententiam perductā commūnem lēgatiōnem ad P. Crassum mittunt: 'Si velit suōs recipere, obsidēs sibi remittat.'²



FIG. 48 — GALLEY.

Cæsar Orders a Fleet to be Built on the Loire. The Veneti Prepare for War and Summon Allies.

9. Quibus dē rēbus Caesar ab Crassō certior factus, quod 10 ipse aberat longius, nāvīs interim longās aedificārī in flūmine Ligerī, quod influit in Ōceanum, rēmigēs ex prōvinciā institui, nautās gubernātōrēsque comparārī iubet. His rēbus

Cf. ¹ sollicitārentur, p. 49, l. 8. — ² remittere, 39, 5.

celeriter administrātis ipse, cum primum per anni tempus potuit, ad exercitum contendit. Venetī reliquaeque item civitatēs cōgnitō Caesaris adventū [certiōrēs facti], simul quod quantum in sē facinus¹ admisissent intellegēbant, lēgā-

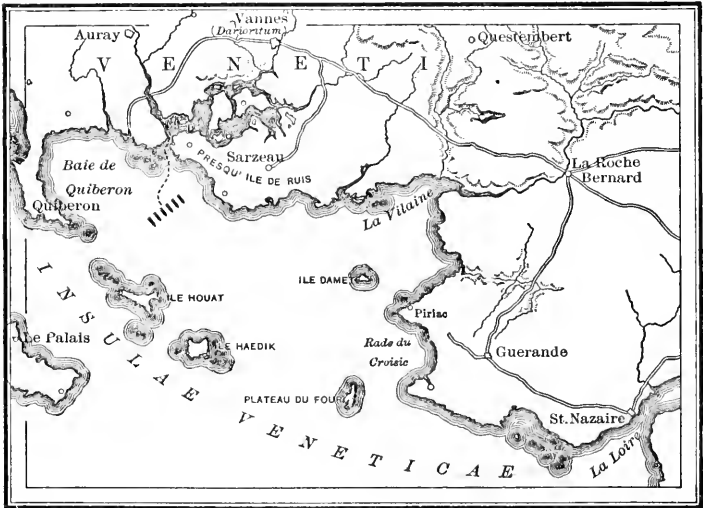

FIG. 49. — MAP OF THE VENETI NEIGHBORHOOD.

5 tōs — quod nōmen ad omnis nātiōnēs sānctum inviolātum-
que semper fuisset — retentōs ab sē et in vincula coniectōs,
prō māgnitūdine periculi bellum parāre et maximē ea quae
ad ūsum nāvium pertinent prōvidēre instituunt, hōc māiore
spē quod multum nātūrā loci cōfidēbant. Pedestria esse
10 itinera concīsa aestuāriis, nāvigātiōnem impeditam propter
īncientiam locōrum paucitātemque portuum sciēbant, neque
nostrōs exercitūs propter frūmenti inopiam diūtius apud sē
morārī posse cōfidēbant ; ac iam ut omnia contrā opiniōnem

Cf. ¹ facinore, p. 36, l. 15.

acciderent, tamen sē plūrimum nāvibus posse, Rōmānōs neque ūllam facultātem habēre nāvium, neque eōrum locōrum ubi bellum gestūrī essent vada, portūs, insulās nōvisse; ac longē aliam esse nāvīgātiōnem in conclusō mari atque in vāstissimō atque apertissimō Ōceanō perspiciēbant. His 5
 inītis cōsiliis oppida mūniunt, frūmenta ex agris in oppida comportant, nāvis in Venetiam, ubi Caesarem primum bellum gesturum cōnstābat,¹ quam plūrimās possunt cōgunt. Sociōs sibi ad id bellum Osismōs, Lexoviōs, Namnetēs, Ambiliātōs, Morinōs, Diablintēs, Menapiōs adsciscunt; auxilia 10
 ex Britannīā, quae contrā eās regiōnēs posita est, arcessunt.²

Cæsar's Reasons for Prosecuting the War. His Strategy "Divide and Conquer."

10. Erant hae difficultātēs bellī gerendī quās suprā ostendimus, sed tamen multa Caesarem ad id bellum incitābant: iniūria retentōrum equitum Rōmānōrum, rebelliō facta post dēditiōnem, dēfectiō datis obsidibus, tot civitātum 15
 coniūrātiō, imprimis nē hāc parte neglēctā reliquae nātiōnēs sibi idem licēre arbitrarentur. Itaque cum intellexeret omnīs ferē Gallōs novīs rēbus studēre et ad bellum mōbilitē celeriterque excitārī, omnīs autem hominēs nātūrā libertātī studēre et condiōnem servitūtis ōdisse,³ priusquam plūrēs 20
 civitātēs cōspīrarent, partiendum sibi ac lātius distribuendum exercitum putāvit.

Labiens Sent to the East, Crassus to the South, Sabinus to the North. Brutus has Charge of the Fleet.

11. Itaque T. Labiēnum lēgātum in Trēverōs, quī proximī flūminī Rhēnō sunt, cum equitātū mittit. Huic mandat Rēmōs reliquōsque Belgās adeat atque in officiō 25
 contineat; Germānōsque, quī auxiliō ā Gallīs arcessitī dicē-

Cf. ¹ cōnstābat, p. 77, l. 25. — ² arcessendī, 63, 4. — ³ ōdisse, 16, 11.

bantur, si per vim nāvibus flūmen trānsire cōnentur, prohibeat. P. Crassum cum cohortibus legiōnāriis XII et māgnō numerō equitātūs in Aquitāniam proficisci iubet, nē ex hīs nātiōnibus auxilia in Galliam mittantur ac tantae
 5 nātiōnēs coniungantur. Q. Titūrium Sabīnum lēgātum cum legiōnibus tribus in Venellōs, Coriosolitas Lexoviōsque mittit, quī eam manum distinendam¹ cūret. D. Brūtum adulēscentem classī Gallicisque nāvibus, quās ex Pictonibus et Santonīs reliquisque pācātis regiōnibus convenire iusserat,
 10 praeficit, et cum primum possit in Venetōs proficisci iubet. Ipse eō pedestribus cōpiis contendit.

Situation of the Strongholds of the Veneti.

12. Erant ēius modi ferē sitūs oppidōrum ut posita in extrēmīs lingulis prōmuntūriisque neque pedibus aditum habērent, cum ex altō sē aestus incitāvisset (quod [bis]
 15 accidit semper hōrārū XII spatiō), neque nāvibus, quod rūsus minuente² aestū nāvēs in vadīs adflictārentur. Ita utrāque rē oppidōrum oppūgnātiō impediēbātur; ac si quandō — māgnitūdine operis forte superāti, extrūsō marī aggere ac mōlibus atque hīs oppidi moenibus adaequātis —
 20 dēspērāre fortūnis suis coeperant, māgnō numerō nāvium adpulsō, cūius rei summam facultātem habēbant, sua dēportābant omnia sēque in proxima oppida recipiēbant; ibi sē rūsus isdem opportunitātibus loci dēfendēbant. Haec eō facilius māgnam partem aestātis faciēbant, quod nostrae
 25 nāvēs tempestātibus dētīnēbantur summaque erat vāstō atque apertō marī, māgnīs aestibus, rārīs ac prope nullis portibus, difficultās nāvīgandī.

Description of their Ships. Comparison with those of the Romans.

13. Namque ipsōrum nāvēs ad hunc modum factae armataeque erant: carinae aliquantō plāniōrēs quam nostrārum

Cf. ¹ *distinēri*, p. 52, l. 12. — ² *minuendam*, 17, 23.

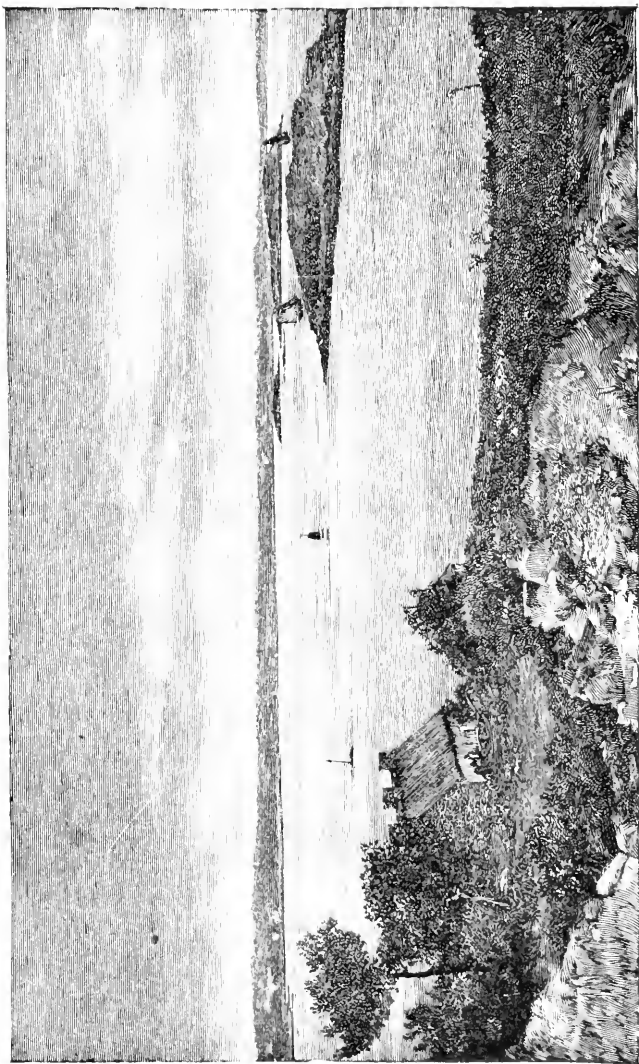

FIG. 50. — MOUTH OF THE LOIRE.

nāvium, quō facilius vada ac dēcessum aestūs excipere possent; prōrae admodum ērēctae atque item puppēs ad māgnitudinem fluctuum tempestātumque accommodātae; nāvēs tōtae factae ex rōbore ad quamvis vim et contumēliam perferendam; trānstra ex pedālibus in altitudinem trabibus cōn- 5
fixa clāvis ferreīs digiti pollicis crassitūdine; ancorae prō fūnibus ferreīs catēnis¹ revinctae; pellēs² prō vēlis alūtaeque tenuiter cōfectae, sive propter inopiam linī atque ēius ūsūs

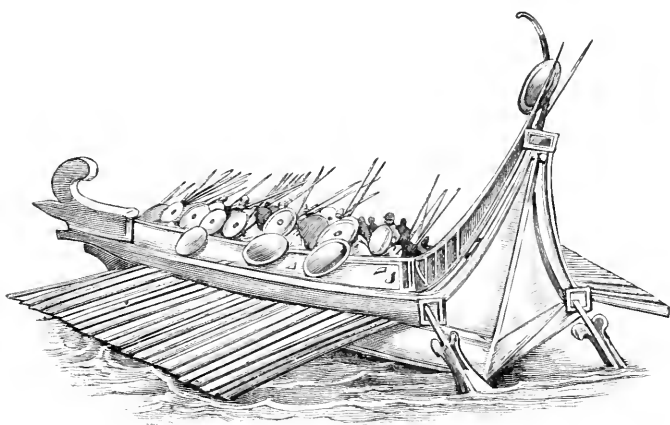

FIG. 51. — ROMAN BATTLE SHIP

inscientiam sive eō (quod est magis vērissimile) quod tantās tempestātis Oceanī tantōsque impetūs ventōrum sustinērī ac 10
tanta onera nāvium regī vēlis nōn satis commodē posse arbitrābantur. Cum hīs nāvibus nostrae clāssi ēius modī congressus erat ut ūnā celeritāte et pulsū rēmōrum prae-
stāret; reliqua prō locī nātūrā, prō vī tempestātum, illis
essent aptiōra et accommodātiōra. Neque enim eis nostrae 15
rōstrō nocēre poterant — tanta in eis erat firmitūdō — neque

Cf. ¹ catēnīs, p. 48, l. 11. — ² pellibus, 72, 10.

propter altitudinem facile tēlum adigēbātur et eādem dē causā minus commodē cōpulis continēbantur. Accēdēbat ut, cum saevire ventus coepisset et sē ventō dedissent, et tempestātem ferrent facilius et in vadis cōsisterent tūtius
 5 et ab aestū relictæ nihil saxa et cōtis timērent; quārum rērum omnium nostris nāvibus cāsus erat extimēscendus.

The Battle. How the Romans Overcame their Disadvantages.

14. Complūribus expūgnātis oppidis Caesar, ubi intellēxit frūstrā tantum labōrem sūmī, neque hostium fugam captis oppidis reprimi neque eis nocēri posse, statuit exspectan-
 10 dam classem.¹ Quæ ubi convēnit ac primum ab hostibus vīsa est, circiter CCXX nāvēs eōrum parātissimæ atque omnī genere armōrum ōrnatissimæ profectæ ex portū nostris adversæ cōstitērunt; neque satis Brūtō, quī classi praeerat, vel tribūnis militum centuriōnibusque, quibus sin-
 15 gularæ nāvēs erant attribūtæ, cōstābat quid agerent aut quam ratiōnem pūgnæ insisterent. Rōstrō enim nocēri nōn posse cōgnōverant; turribus autem excitātis tamen hās altitudō puppiū ex barbaris nāvibus superābat ut neque ex inferiōre locō satis commodē tēla adigī possent et missa
 20 ā Gallis gravius acciderent. Ūna erat māgnō ūsuī rēs prae-parāta ā nostris, — falcēs praeacūtæ² insertæ adfixæque longuriis nōn absimili formā mūrālium falcium. His cum fūnēs quī antemnās ad mālōs dēstinābant comprehēnsi adductique erant, nāvigiō rēmīs incitātō prærumpēbantur.
 25 Quibus abscisis antennæ necessāriō concidēbant; ut, cum omnis Gallicis nāvibus spēs in vēlis armāmentisque cōsisteret, his ēreptis³ omnis ūsus nāvium ūnō tempore ēriperētur. Reliquum erat certāmen positum in virtūte, quā nostri militēs facile superābant atque eō magis, quod in cōspectū
 30 Caesaris atque omnis exercitūs rēs gerēbātur, ut nullum

Cf. ¹ classī, p. 82, l. 8. — ² praeacūtās, 70, 3. — ³ ēripī, 39, 2.

paulō fortius factum latēre¹ posset ; omnēs enim collēs ac loca superiōra, unde erat propinquus dēspectus in mare, ab exercitū tenēbantur.

They Defeat the Enemy and Capture their Ships.

15. Disiectis (ut diximus) antemnis, cum singulās binae ac ternae nāvēs circumsteterant, militēs summā vī trāscendere in hostium nāvis contendēbant. Quod postquam barbarī fieri animadvertērunt, expūgnātis complūribus nāvibus, cum eī rei nūllum reperirētur auxilium, fugā salūtem petere



FIG. 52. — TRADING VESSEL.

contendērunt. Ac iam conversis in eam partem nāvibus quō ventus ferēbat, tanta subitō malacia ac tranquillitās exstitit 10 ut sē ex locō movēre nōn possent. Quae quidem rēs ad negōtium cōficiendum maximē fuit opportūna ; nam singulās nostrī cōsectātī expūgnāvērunt, ut perpaucae ex omnī numerō noctis interventū ad terram pervēnerint, cum ab hōrā ferē IIII ūsque ad sōlis occāsum pūgnārētur. 15

Cf. ¹ latēbant, p. 62, l. 19.

The Veneti Surrender. Their Leaders are Put to Death, the Rest Sold as Slaves.

16. Quō proeliō bellum Venetōrum tōtiusque ōrae maritimae cōfectum est. Nam cum omnis iuventūs, omnēs etiam graviōris aetātis, in quibus aliquid cōsili aut dignitātis fuit, eō convēnerant, tum nāvium quod ubique fuerat in
 5 ūnum locum coēgerant; quibus āmissis reliquī neque quō sē reciperent neque quem ad modum oppida dēfenderent habēbant. Itaque sē suaque omnia Caesari dēdidērunt. In quōs eō gravius Caesar vindicandum statuit, quō diligentius in reliquum tempus ā barbaris iūs lēgātōrum cōnser-
 10 vārētur. Itaque omni senātū necātō reliquōs sub corōnā vēndidit.

Meanwhile Sabinus Goes among the Venelli, and is Challenged by them. He Avoids an Engagement.

17. Dum haec in Venetis geruntur, Q. Titūrius Sabinus cum eīs cōpiis quās ā Caesare accēperat in finis Venellōrum pervēnit. His praeerat Viridovix ac summam imperi tenē-
 15 bat eārum omnium civitātum quae dēfēcērant,¹ ex quibus exercitum māgnāsque cōpiās coēgerat; atque his paucis diēbus Aulerci, Eburovicēs, Lexoviique senātū suō interfectō, quod auctōrēs belli esse nōlēbant, portās clausērunt sēque cum Viridovice coniūnxērunt; māgnaque praetereā
 20 multitudō undique ex Galliā perditōrum hominum latrōnumque convēnerat, et quōs spēs praedandī studiumque bellandī ab agricultūrā et cotidiānō² labōre revocābat. Sabinus idōneō omnibus rēbus locō castris sēsē tenēbat, cum Viridovix contrā eum duōrum milium spatiō cōnsēdisset
 25 cotidiēque prōductis cōpiis pūgnandī potestātem faceret, ut iam nōn solum hostibus in contemptiōnem Sabinus veniret sed etiam nostrōrum militum vōcibus nōn nihil carperētur; tantamque opīniōnem timōris praebuit ut iam ad vāllum castrōrum hostēs accēdere audērent. Id eā dē causā faciēbat

Cf. ¹ dēfēcisse, p. 59, l. 6. — ² cotidiānis, 17, 8.

quod cum tantā multitudīne hostium, praesertim eō absente quī summam imperī tenēret, nisi aequō locō aut opportunitate aliquā datā, lēgātō dīmīcandum nōn existimābat.

By a Stratagem he Induces Viridovix to Attack him.

18. Hāc cōfirmatā opīniōne timōris idōneum quendam hominem et callidum dēlēgit, Gallum, ex eīs quōs auxili 5 causā sēcum habēbat. Huic māgnīs praemiīs pollicitātiōnibusque persuādet utī ad hostis trānseat et quid fierī velit ēdocet. Quī ubi prō perfugā¹ ad eōs vēnit, timōrem Rōmānōrum prōpōnit; quibus angustiis ipse Caesar ā Venetis premātur docet; neque longius abesse quā proximā nocte 10



FIG. 53. — GALLIC SWORD-BLADE.

Sabinus clam ex castris exercitum ēdūcat et ad Caesarem auxili ferendī causā proficiscātur. Quod ubi auditum est, conclāmant omnēs occasiōnem negōtī bene gerendī āmittendam nōn esse, ad castra irī oportēre. Multae rēs ad hōc cōnsilium Gallōs hortābantur: superiōrum diērum Sabini 15 cunctātiō, perfugae cōfirmātiō, inopia cibāriōrum, cui rei parum diligenter ab eīs erat prōvisum, spēs Venetici belli, et quod ferē libenter² hominēs id quod volunt crēdunt. Hīs rēbus adductī nōn prius Viridovicem reliquōsque ducēs ex conciliō dīmīttunt quam ab eīs sit concessum arma utī 20 capiant et ad castra contendant. Quā rē concessā laeti ut explorātā victōriā, sarmentis virgultisque conlētis quibus fossās Rōmānōrum compleant,³ ad castra pergunt.

Complete Victory of Sabinus.

19. Locus erat castrōrum ēditus⁴ et paulātim ab imō acclivis circiter passūs mille. Hūc māgnō cursū contendērunt, 25

Cf. ¹ perfugīs, p. 25, l. 8. — ² libenter, 39, 23. — ³ complēta, 76, 13. — ⁴ ēditus, 54, 18.

ut quam minimum spatī ad sē conligendōs armandōsque Rōmānīs darētur, exanimātique pervēnerunt. Sabīnus suōs hortātus cupientibus signum dat. Impeditīs hostibus propter ea quae ferēbant onera, subitō duābus portīs ēruptiōnem
 5 fieri iubet. Factum est opportunitāte locī, hostium īncientiā ac dēfatigātiōne, virtūte militum et superiōrum pūgnarum exercitātiōne, ut nē primum quidem nostrōrum impetum ferrent ac statim terga verterent. Quōs integrīs¹ vīribus militēs nostrī cōsecūtī māgnum numerum eōrum occidē-
 10 runt; reliquōs equitēs cōsectātī paucōs quī ex fugā ēvāserant reliquērunt. Sic ūnō tempore et dē nāvālī pūgnā Sabīnus et dē Sabīnī victoriā Caesar est certior factus; civitātēsque omnēs sē statim Titūriō dēdidērunt. Nam ut ad bella suscipienda Gallōrum alacer ac prōmptus est
 15 animus, sic mollis ac minimē resistēns ad calamitātis perferendās mēns eōrum est.

In Aquitania Crassus is Attacked by the Sotiates.

20. Eōdem ferē tempore P. Crassus cum in Aquitāniam pervēnisset, — quae, ut ante dictum est, [et regiōnum lātitūdine et multitūdine hominum] est tertia pars Galliae [est
 20 aestimanda], — cum intellexeret in eīs locīs sibi bellum gerendum ubi paucīs ante annīs L. Valerius Praecōninus lēgātus exercitū pulsō interfectus esset, atque unde L. Manlius prōcōnsul impedimentis āmissis profūgisset, nōn mediocrem sibi diligentiam adhibendam intellegēbat. Itaque rē
 25 frūmentāriā prōvisā, auxiliis equitātūque comparātō, multis praetereā virīs fortibus Tolōsā et Narbōne (quae sunt civitātēs Galliae prōvinciae finitimae [ex] his regiōnibus) nōminātīm ēvocātis, in Sōtiātium finis exercitum intrōdūxit. Cūius adventū cōgnitō Sōtiātēs māgnis cōpiīs
 30 coāctis equitātūque, quō plūrimum valēbant, in itinere agmen nostrum adorti primum equestre proelium commisē-

Cf. ¹ integrīs, p. 76, l. 29.

runt ; deinde equitatū suō pulsō atque insequentibus nostris, subitō pedestris cōpiās, quās in convalle in insidiis coniocāverant, ostendērunt. Hī nostrōs disiectōs adortī proelium renovārunt.¹

He Defeats them in Battle and Besieges their Stronghold. They Surrender.

21. Pūgnātum est diū atque ācriter, cum Sōtiātes superiōribus victōriis frētī in suā virtūte tōtius Aquitāniae salutem positam putārent ; nostrī autem quid sine imperātōre et sine reliquis legiōnibus adulēscentulō duce efficere possent perspicī² cuperent ; tandem cōfectī volneribus hostēs terga vertērunt. Quōrum māgnō numerō interfectō Crassus ex itinere oppidum Sōtiātium oppūgnāre coepit. Quibus fortiter resistentibus vineās turrisque ēgit. Illi, aliās ēruptiōne temptātā, aliās cuniculis ad aggerem vineāsque āctis (cūius rei sunt longē perītissimi³ Aquitāni, proptereā quod multis locis apud eōs aerāriae sectūraeque sunt), ubi dilīgentiā nostrōrum niħil his rēbus prōfici posse intellēxērunt, lēgātōs ad Crassum mittunt, sēque in dēditionem ut recipiat petunt. Quā rē impetrātā, arma trādere iūssi, faciunt.

The Soldurii, or Brothers in Arms.

22. Atque in eam rem omnium nostrōrum intentis animis, aliā ex parte oppidī Adiatunnus, quī summam imperī tenēbat, cum de dēvōtis, quōs illi solduriōs appellant, — quōrum haec est condiciō uti omnibus in vitā commodis⁴ unā cum eis fruantur quōrum sē amicitiae dēdiderint ; si quid his per vim accidat, aut eundem cāsum unā ferant aut sibi mortem cōnsciscant ;⁵ neque adhūc hominum memoriā repertus est quisquam quī, eō interfectō cūius sē amicitiae dēvōvisset, mortem recūsāret, — cum his Adiatunnus ēruptiōnem facere cōnātus, clāmōre ab eā parte mūnitiōnis sublātō, cum ad

Cf. ¹ renovandī, p. 75, l. 6. — ² perspiciebant, 81, 5. — ³ perītissimus, 18, 22. — ⁴ commodō, 31, 24. — ⁵ cōnsciverit, 4, 15.

arma militēs concurrissent vehementerque ibi pūgnātum esset, repulsus in oppidum tamen utī eādem dēditiōnis condiōne ūterētur ā Crassō impetrāvit.

Crassus Proceeds against Other Aquitanian Tribes Who are Conspiring, and Decides to Give Battle.

23. Armīs obsidibusque acceptīs Crassus in finis Vocā-
 5 tium et Tarusātium profectus est. Tum vērō barbarī com-
 mōtī, quod oppidum et nātūrā locī et manū mūnitum paucīs
 diēbus quibus eō ventum erat expūgnātum cōgnōverant,
 lēgātōs quōqueversus dimittere, coniūrāre, obsidēs inter sē
 dare, cōpiās parāre coepērunt. Mittuntur etiam ad eās
 10 civitātis lēgātī quae sunt citeriōris Hispāniae finitimae
 Aquitāniae; inde auxilia ducēsque arcessuntur; quōrum
 adventū māgnā cum auctōritāte et māgnā hominum multitu-
 dine bellum gerere cōnantur. Ducēs vērō ei dēliguntur qui
 ūnā cum Q. Sertōriō omnīs annōs fuerant summamque sci-
 15 entiam rei militāris habēre existimābantur. Hī cōsuētū-
 dine populi Rōmānī loca capere, castra mūnīre, commeātibus
 nostrōs interclūdere instituunt.¹ Quod ubi Crassus animad-
 vertit,—suās cōpiās propter exiguitātem nōn facile didūci,
 hostem et vagārī et viās obsidēre et castris satis praesidi
 20 relinquere, ob eam causam minus commodē frūmentum
 commeātumque sibi supportārī, in diēs hostium numerum
 augērī,—nōn cunctandum existimāvit quin pūgnā dēcer-
 tāret. Hāc rē ad cōnsilium dēlātā, ubi omnēs idem sentīre
 intellēxit, posterum diem pūgnae cōstituit.

The Enemy Keep to their Camp, Which Crassus Attacks.

25 24. Primā lūce prōductīs omnibus cōpiīs, duplici aciē
 institūtā, auxiliis in mediam aciem coniectīs, quid hostēs
 cōnsili caperent exspectābat. Illi, etsi propter multitudi-
 nem et veterem bellī glōriam paucitātemque nostrōrum sē
 tūtō dīmicitūrōs existimābant, tamen tūtius² esse arbitrā-

Cf. ¹ instituunt, p. 80, l. 8. — ² tūtius, 84, 4.

bantur obsessis viis, commeātū interclūsō, sine volnere victōriā potiri; et, si propter inopiam rei frūmentāriæ Rōmāni sēsē recipere coepissent, impeditōs in agmine et sub sarcinīs infirmiorēs animō adoriri cōgitābant. Hōc cōsiliō probātō, ab ducibus prōductis Rōmānōrum cōpiis, sēsē castris 5



FIG. 54. — SOLDIERS MAKING CAMP.

tenēbant. Hāc rē perspectā Crassus, cum suā cunctātiōne atque opiniōne timōris hostēs nostrōs militēs alacriōrēs ad pūgnandum effēcissent, atque omnium vōcēs audirentur expectāri diūtius nōn oportere quā ad castra irētur, cohortātus suōs omnibus cupientibus ad hostium castra contendit. 10

They Hold their Own for a Time.

25. Ibi cum aliī fossās complērent, aliī multis tēlis coniectis dēfensōrēs vāllō mūnitiōnibusque dēpellerent, auxiliārēsque (quibus ad pūgnam nōn multum Crassus cōfidēbat) lapidibus tēlisque subministrandis et ad aggerem caespitibus comportandis speciem atque opiniōnem pūgnantium prae- 15

bērent; cum item ab hostibus cōstanter ac nōn timidē pūgnārētur tēlaque ex locō superiōre missa nōn frūstrā acciderent, equitēs circumitis hostium castris Crassō renūntiāvērunt nōn eādem esse diligentīā ab decumānā portā castra
5 mūnita facilemque aditum habēre.

But are Forced to Abandon their Camp and Flee.

26. Crassus equitum praefectōs cohortātus ut māgnis praemiis pollicitātiōnibusque¹ suōs excitārent, quid fieri velit ostendit. Illi, ut erat imperātum, dēvectis eīs cohortibus quae praesidiō castris relictæ intritæ ab labōre erant
10 et longiōre itinere circumductis, nē ex hostium castris cōspicī possent, omnium oculis mentibusque ad pūgnam intentis, celeriter ad eās quās dīximus mūnitiōnēs pervēnērunt, atque hīs prōrutis prius in hostium castris cōstitērunt quam plānē ab hīs vidēri, aut quid rei gererētur cōgnōscī
15 posset. Tum vērō clāmōre ab eā parte auditō nostri redintegrātis² viribus, quod plērumque³ in spē victōriæ accidere cōsuēvit, ācrius impūgnāre coepērunt. Hostēs undique circumventi, dēspērātis omnibus rēbus, sē per mūnitiōnēs dēicere et fugā salūtem petere contendērunt.
20 Quōs equitātus apertissimis campis cōsectātus, ex milium L numerō, quae ex Aquitāniā Cantabrisque convēnisse cōstābat, vix quartā parte relictā, multā nocte sē in castra recēpit.

Most of the Aquitanian Tribes Surrender to Crassus.

27. Hāc auditā pūgnā māxima pars Aquitāniæ sēsē
25 Crassō dēdidit obsidēsque ultrō misit; quō in numerō fuērunt Tarbelli, Bigerriōnes, Ptiāniī, Vocātēs, Tarusātēs, Elusātēs, Gatēs, Auscī, Garumni, Sibusātes, Cocosātes; paucae ultimæ nātiōnēs annī temporē cōnfisae, quod hiems suberat, id facere neglēxērunt.

Cf. ¹ pollicitātiōnibus, p. 87, l. 6. — ² redintegrātō, 67, 13. — ³ plērumque, 70, 20.

In the North Cæsar Advances against the Morini and Menapii, Who Take Refuge in Forests and Marshes.

28. Eōdem ferē tempore Cæsar, etsi prope exācta iam aestās erat, tamen quod omnī Galliā pācātā Morinī Menapiique supererant quī in armis essent neque ad eum umquam lēgātōs dē pāce misissent, arbitrātus id bellum celeriter cōficī posse, eō exercitum dūxit; quī longē aliā ratiōne ac reliquī Gallī bellum gerere coepērunt. Nam quod intellegēbant maximās nātiōnēs quae proeliō contendissent pulsās superātāsque esse, continentisque silvās ac palūdēs habēbant, eō sē suaque omnia contulērunt. Ad quārum initium silvārum cum Cæsar pervēnisset castraque mūnīre instituisset neque hostis interim vīsus esset, dispersis in opere nostris subitō ex omnibus partibus silvae ēvolāvērunt et in nostrōs impetum fēcērunt. Nostrī celeriter arma cēpērunt eōsque in silvās repulērunt, et complūribus interfectis longius impeditiōribus locis secūti paucōs ex suis dēperdidērunt.

He Ravages their Territory, and then Goes into Winter Quarters.

29. Reliquis deinceps diēbus Cæsar silvās caedere instituit et, nē quis inermibus¹ imprudentibusque militibus ab latere impetus fieri posset, omnem eam māteriam quae erat caesa conversam ad hostem conlocābat et prō vāllō ad utrumque latus exstruēbat.² Incrēdibili celeritāte māgnō spatiō paucis diēbus cōfectō, cum iam pecus atque extrēma impedimenta ā nostris tenērentur, ipsi dēnsiōrēs silvās peterent, ēius modī sunt tempestātēs cōsecūtae uti opus necessariō intermitterētur et continuātiōne imbrium diūtius sub pellibus militēs continēri nōn possent. Itaque vāstātis omnibus eōrum agrīs, vicis aedificiisque incēnsis, Cæsar exercitum redūxit et in Aulercis Lexoviisque, reliquis item civitatibus quae proximē bellum fēcērunt, in hibernis conlocāvit.

Cf. ¹ inermēs, p. 68, l. 6. — ² exstrūctō, 70, 16.

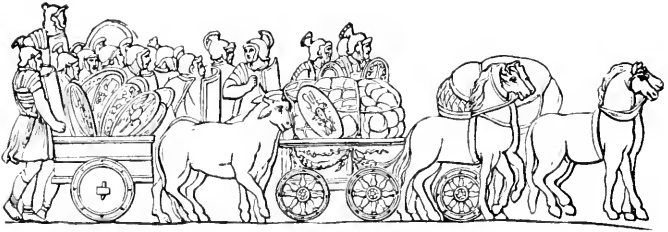

FIG. 55. — PACK-WAGONS AND CARTS.

BOOK IV.

CAMPAIGN AGAINST THE GERMANS. — FIRST INVASION OF BRITAIN. B.C. 55.

German Tribes, Pressed by the Suevi, Cross the Rhine.

EĀ quae secūta est hieme, quī fuit annus Cn. Pompēiō,
M. Crassō cōsulibus, Usipetes Germānī et item Tencerī
māgnā [cum] multitudīne hominū flūmen Rhēnum
trānsiērunt, nōn longē ā marī quō Rhēnus influit. Causa
5 trāseundī fuit quod ab Suēvis complūris annōs exagitātī
bellō premēbantur et agrī culturā prohibēbantur.

Customs of the Suevi.

Suēvōrum gēns est longē maxima et bellicōsissima Ger-
mānōrum omnium. Hī centum pāgōs habēre dicuntur, ex
quibus quotannis singula milia armātōrum bellandī causā
10 ex finibus ēdūcunt. Reliquī, quī domī mānsērunt, sē atque
illōs alunt.¹ Hī rūsus in vicem annō post in armīs sunt,
illī domī remanent. Sic neque agrī culturā nec ratiō atque
ūsus belli intermittitur. Sed privātī ac sēparātī agrī apud
eōs nihil est, neque longius annō remanēre unō in locō co-
15 lendī causā licet. Neque multum frūmentō, sed maximam
partem lacte atque pecore vivunt, multumque sunt in vēnā-
tīōnibus ; quae rēs et cibi genere et cotidiānā exercitātiōne

Cf. ¹ alere, p. 16, l. 5.

et libertate vitæ, quod a pueris nullo officio¹ aut disciplina aduſefacti nihil omnino contra voluntatem faciunt, et viris alit et immāni corporum magnitudine hominēs efficit. Atque in eam se cōſuetudinem adduxerunt ut locis frigidissimis neque vestitus praeter pellis haberent quicquam, quarum 5 propter exiguitatem magna est corporis pars aperta, et lavarentur in fluminibus.

Their Intercourse with Other Tribes.

2. Mercatoribus est aditus magis eo ut quae bello ceperint quibus vendant² habeant, quam quo ullam rem ad se importari desiderent. Quin etiam iumentis, quibus maximē Galli 10 delectantur quaeque impensō parant pretio, [Germani] importatis non utuntur; sed quae sunt apud eos nata, parua atque deformia, haec cotidiana exercitatioe summi ut sint laboris efficiunt.

Their Cavalry Tactics.

Equestribus proeliis saepe ex equis desiliunt ac pedibus 15 proeliantur, equosque eodem remanere vestigio aduſefecerunt, ad quos se celeriter, cum usus est, recipiunt; neque eorum moribus turpius³ quicquam aut inertius habetur quam ephippiis uti. Itaque ad quemvis numerum ephippiatorum equitum quamvis pauci adire audent. Vinum omnino ad se 20 importari non sinunt, quod ea re ad laborem ferendum remollēscere hominēs atque effeminari arbitrantur.

The Ubii, Tributaries of the Suevi.

3. Publice maximam putant esse laudem quam latissime a suis finibus vacare agros: hac re significari magnum numerum civitatum suam vim sustinere non posse. Itaque 25 una ex parte a Suevis circiter milia passuum sexcenta agri vacare dicuntur. Ad alteram partem succedunt Ubii, quorum fuit civitas ampla atque florens, ut est captus Germano-

Cf. ¹ officio, p. 81, l. 25.—² vendidit, 86, 11.—³ turpissimum, 30, 11.

rum ; eī paulō, quamquam sunt ēiusdem generis, sunt cēteris hūmāniōrēs, proptereā quod Rhēnum attingunt, multumque ad eōs mercātōrēs ventitant, et ipsī propter propinquitātem [quod] Gallicis sunt mōribus adsuēfactī. Hōs cum Suēvi
 5 multis saepe bellis expertī propter amplitūdinem gravitātemque civitātis finibus expellere nōn potuissent, tamen vectigālīs sibi fēcērunt ac multō humiliōrēs infirmiōrēsque¹ redēgērunt.

The Usipetes and Tencteri, Expelled from Germany, Overcome the Menapii.

4. In eādē causā fuērunt Usipetes et Tencteri, quōs
 10 suprā diximus, quī complūris annōs Suēvōrum vim sustinuerunt ; ad extrēmum tamen agris expulsī et multis locis Germāniae triennium vagātī² ad Rhēnum pervēnērunt ; quās regiōnēs Menapii incolēbant. Hi ad utramque ripam flūmi-



FIG. 57. — COINS OF CÆSAR.

nis agrōs aedificia vicōsque habēbant ; sed tantae multītū-
 15 dinis aditū perterriti ex eīs aedificiis quae trāns flūmen habuerant dēmigrāverant, et cis Rhēnum dispositis praesidiis Germānōs trānsire prohibēbant. Illi omnia experti, cum neque vī contendere propter inopiam nāvium neque clam trānsire propter custōdiās Menapiōrum possent, reverti
 20 sē in suās sēdis regiōnēsque simulāvērunt³ et trīduī viam prōgressi rūsus revertērunt, atque omnī hōc itinere unā nocte equitatū cōfectō insciōs inopinantisque⁴ Menapiōs oppressērunt ; qui dē Germānōrum discessū per explōrātōrēs

Cf. ¹ infirmiōrēs, p. 91, l. 4. — ² vagārī, 90, 19. — ³ simulātā, 40, 14. — ⁴ inopinantis, 10, 10.

certiōrēs factī sine metū trāns Rhēnum in suōs vicōs remigrāverant. His interfectis nāvibusque eōrum occupātis, priusquam ea pars Menapiōrum quae citrā Rhēnum erat certior fieret, flūmen trānsiērunt atque omnibus eōrum aedificiis occupātis reliquam partem hiemis sē eōrum cōpiis aluērunt. 5

Caesar Distrusts the Gauls on Account of their Fickle Character. He Fears their Alliance with Germans.

5. His dē rēbus Caesar certior factus et infirmitātem Gallōrum veritus, quod sunt in cōsiliis capiendis mōbilēs et novis plērumque rēbus student, nihil his committendum existimāvit. Est enim hōc Gallicae cōsuētūdinis utī et viātōrēs etiam invitōs¹ cōsistere cōgant, et quid quisque 10 eōrum dē quāque rē audierit aut cōgnōverit quaerant; et mercātōrēs in oppidis volgus circumsistat, quibusque ex regiōnibus veniant quāsque ibi rēs cōgnōverint prōnūntiāre cōgat. His rēbus atque auditiōnibus permōtī dē summis saepe rēbus cōsilia ineunt, quōrum eōs in vestigiō paenitēre 15 necesse est, cum incertis rēmōribus serviant et plērique ad voluntātem eōrum ficta respondeant.

He Resolves to Make War on the Germans.

6. Quā cōsuētūdine cōgnitā Caesar, nē graviōri bellō occurreret, mātūrius quam cōsuērat ad exercitum proficiscitur. Eō cum vēnisset, ea quae fore suspicātus erat facta 20 cōgnōvit: missās lēgatiōnēs ab nōn nullis civitatibus ad Germānōs invitātōsque eōs utī ab Rhēnō discēderent, omnia quae [que] postulāssent ab sē fore parāta. Quā spē adductī Germānī lātius iam vagābantur et in finis Eburōnum et Condrūsōrum, quī sunt Trēverōrum clientēs, pervēnerant. 25 Principibus Galliae ēvocātis² Caesar ea quae cōgnōverat dissimulanda sibi existimāvit, eōrumque animis permulsis et cōfirmātis equitātūque imperātō bellum cum Germānis gerere cōstituit.

Cf. ¹ invitō, p. 12, l. 9. — ² ēvocātis, 88, 28.

They Send him a Defiant Message.

7. Rē frūmentāriā comparātā equitibusque dēlectīs, iter in ea loca facere coepit quibus in locis esse Germānōs audiēbat. Ā quibus cum paucōrum diērum iter abesset, lēgātī ab eis vērunt, quōrum haec fuit ōrātiō : ‘ Germānōs neque
5 priōrēs populō Rōmānō bellum inferre neque tamen recūsāre, sī lacessantur,¹ quā armis contendant, quod Germānōrum cōnsuētūdō [haec] sit ā māiōribus trādita, quicumque bellum inferant, resistere neque dēprecārī. Haec tamen dicere, vērunt invitōs, ēiectōs domō ; sī suam grātiā Rōmānī ve-
10 lint, posse eis ūtilis esse amīcōs ; vel sibi agrōs attribuant vel patiantur eōs tenēre quōs armis possēderint : sēsē ūnis Suēvis concēdere, quibus nē diī quidem immortālēs parēs esse possint ; reliquum quidem in terris esse nēmīnem quem nōn superāre possint.’

He Orders them to Withdraw from Gaul.

15 8. Ad haec Caesar quae vīsum² est respondit ; sed exitus fuit ōrātiōnis : ‘ Sibi nūllam cum hīs amīcitiā esse posse, sī in Galliā remanērent ; neque vērū esse quī suōs finis tuērī nōn potuerint aliēnōs occupāre ; neque ūllōs in Galliā vacāre agrōs quī darī tantae praesertim multitudinī sine
20 iniūriā possint ; sed licēre, sī velint, in Ubiōrum finibus cōnsidere, quōrum sint lēgātī apud sē et dē Suēvōrum iniūriis querantur et ā sē auxilium petant ; hōc sē Ubiis imperātūrum.’

They Delay.

9. Lēgātī haec sē ad suōs relātūrōs dixērunt et rē dēlibe-
25 rātā post diem tertium ad Caesarem reversūrōs ; intēreā nē propius sē castra movēret petiērunt. Nē id quidem Caesar ab sē impetrārī posse dixit. Cōgnōverat enim māgnam partem equitātūs ab eis aliquot diēbus ante praedandī frūmen-

Cf. ¹ lacesseret, p. 31, l. 19. — ² vidēbantur, 63, 14.

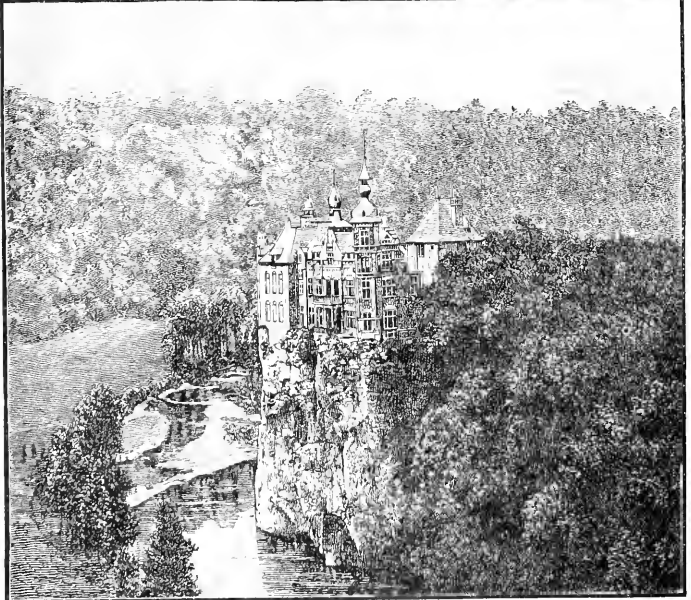
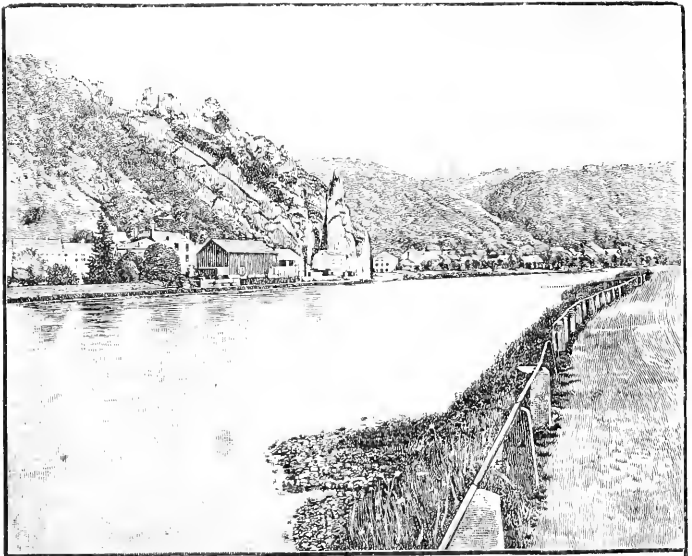

FIG. 58. — SCENERY ON THE MEUSE.

tandique causā ad Ambivaritōs trāns Mosam missam ; hōs exspectārī equitēs atque ēius rei causā moram interpōnī arbitrābātur.

The Meuse and the Rhine Described.

10. Mosa prōfluit ex monte Vosegō, quī est in finibus Lingonum, et parte quādam ex Rhēnō receptā quae appel- 5
lātur Vacalus, insulam efficit Batavōrum [in Ōceanum in-
fluit] neque longius inde milibus passuum LXXX in Ōceanum
influit. Rhēnus autem oritur ex Lepontiīs, quī Alpīs inco-
lunt, et longō spatiō per finis Nantuātium, Helvētiōrum,
Sēquanōrum, Mediomatricum, Tribocōrum, Trēverōrum citā- 10
tus fertur ; et ubi Ōceanō adpropinquāvit, in plūris dēfluit
partis multis ingentibusque¹ insulis effectis, quārum pars
māgna ā feris barbarisque nātiōnibus incolitur, — ex quibus
sunt quī piscibus atque ōvis avium vivere existimantur, —
multisque capitibus in Ōceanum influit. 15

Cæsar Advances. More Parleying to Gain Time.

11. Caesar cum ab hoste nōn amplius passuum XII mili-
bus abesset, ut erat cōstitutum, ad eum lēgātī revertuntur ;
quī in itinere congressī māgnopere nē longius prōgrederētur
ōrābant. Cum id nōn impetrāssent, petēbant utī ad eōs
equitēs quī agmen antecessissent² praemitteret, eōsque pūgnā 20
prohibēret, sibi que ut potestātem faceret in Ubiōs lēgātōs
mittendī ; quōrum sī principēs ac senātus sibi iūre iūrandō
fidem fēcisset, eā condiōne quae ā Caesare ferrētur sē ūsū-
rōs ostendēbant ; ad hās rēs cōficiendās sibi tridui spatium
daret. Haec omnia Caesar eōdem illō pertinēre arbitrābā- 25
tur, ut tridui morā interpositā equitēs eōrum quī abessent
reverterentur ; tamen sēsē nōn longius milibus passuum IIII
aquātiōnis causā prōcessūrum eō diē dixit ; hūc posterō diē
quam frequentissimī convenirent, ut dē eōrum postulātis
cōgnōsceret. Interim ad praefectōs³ quī cum omnī equitātū 30

Cf. ¹ *ingentī*, p. 33, l. 21. — ² *antecedunt*, 78, 22. — ³ *praefectōs*, 92, 6.

antecesserant mittit quī nūntiārent nē hostis proeliō lacesse-
rent; et, si ipsi lacesserentur, sustinērent quoad ipse cum
exercitū propius accessisset.

The German Cavalry Treacherously Attack and Rout the Roman.

12. At hostēs, ubi primum nostrōs equitēs cōspexē-
5 runt, quōrum erat v milium numerus, cum ipsi nōn amplius
dccc equitēs habērent, quod ei quī frūmentandī causā
ierant trāns Mosam nōndum redierant, nihil timentibus
nostris, quod lēgātī eōrum paulō ante ā Caesare discesse-
rant atque is diēs indūtiis erat ab his petitus, impetū factō
10 celeriter nostrōs perturbāvērunt; rūsus his resistentibus,
cōnsuētūdine suā ad pedēs dēsiluērunt,¹ subfossisque equis
complūribusque nostris dēiectis, reliquōs in fugam con-
iēcērunt atque ita perterritōs ēgērunt ut nōn prius fugā
dēsisterent quam in cōspectum agminis nostrī vēnissent.

Gallant Conduct and Death of the Brothers Piso.

15 In eō proeliō ex equitibus nostris interficiuntur IIII et
LXX; in his vir fortissimus, Pisō Aquitānus, amplissimō
genere nātus, cuius avus in civitate suā rēgnum obtinuerat
amicus ab senātū nostrō appellātus. Hic cum frātrī inter-
clūsō ab hostibus auxilium ferret, illum ex periculō ēripuit,
20 ipse equō volnerātō dēiectus quoad potuit fortissimē restitit;
cum circumventus multis volneribus acceptis cecidisset,
atque id frāter, quī iam proeliō excesserat, procul animad-
vertisset, incitātō equō sē hostibus obtulit atque interfectus
est.

**Envoys Come to Cæsar, Whom he Detains. Vigorous Action
Demanded.**

25 13. Hōc factō proeliō Caesar neque iam sibi lēgātōs
audiendōs neque condiciōnēs accipiendās arbitrābātur ab
eis quī per dolum atque insidiās petitā pāce ultrō bellum

Cf. ¹ dēsiliunt, p. 95, l. 15.

intulissent : exspectāre vērō, dum hostium cōpiae augērentur¹ equitātusque reverterētur, summae dēmentiae esse iūdicābat ; et cōgnitā Gallōrum infirmitāte quantum iam apud eōs hostēs unō proeliō auctōritātis essent cōsecūti sentiēbat ; quibus ad cōnsilia capiēda nihil spatī dandum exīstimābat. His cōstitutīs rēbus et cōnsiliō cum lēgātis et quaestōre commūnicātō, nē quem diem pūgnae praetermitteret, opportunissima rēs accidit, quod postridiē eius diēi māne eādem et perfidiā et simulatiōne usi Germāni frequentēs, omnibus prīncipibus māiōribusque nātū adhibitis, ad eum in castra vērunt : simul, ut dicēbātur, pūrgandi² sui causā, quod (contrā atque esset dictum et ipsi petissent) proelium prīdiē commisissent ; simul ut, si quid possent, dē indūtiis fallendō³ impetrārent. Quōs sibi Caesar oblātōs gāvisus illōs retinēri iussit ; ipse omnis cōpiās castris edūxit equitātumque, quod recentī proeliō perterritum esse exīstimābat, agmen subsequi iussit.

Caesar Surprises the German Camp.

14. Aciē triplici institūtā et celeriter viii milium itinere cōfectō, prius ad hostium castra pervēnit quam quid agerētur Germāni sentire possent. Quī omnibus rēbus subitō perterriti et celeritate adventūs nostrī et discessū suōrum, neque cōnsili habēdi neque arma capiēdi spatiō datō perturbantur, cōpiāsne adversus hostem dūcere an castra dēfendere an fugā salūtem petere praestāret.⁴ Quōrum timor cum fremitū et concursū significārētur, militēs nostrī pristini diēi perfidiā incitāti in castra inrūperunt. Quō locō quī celeriter arma capere potuerunt paulisper nostris restitērunt atque inter carrōs impedimentaue proelium commiserunt ; at reliqua multitudō puerōrum mulierumque — nam cum omnibus suis domō excesserant 30

Cf. ¹ augēri, p. 90, l. 22. — ² pūrgāti, 25, 6. — ³ fefellisse, 56, 14. — ⁴ praestāre, 71, 14.

Rhēnumque trānsierant — passim fugere coepit; ad quōs cōnsectandōs Caesar equitātum mīsit.

The Germans are Defeated and Flee; Many are Slain or Perish in the River.

15 Germānī post tergum¹ clāmōre auditō cum suōs interfici vidērent, armīs abiectis signisque militāribus relictis sē
 5 ex castris eīcērunt, et cum ad cōnfluentem Mosae et Rhēnī pervēnissent, reliquā fugā dēspērātā, māgnō numerō interfectō, reliquī sē in flūmen praecipitāvērunt; atque ibi timōre, lassitūdine,² vī flūminis oppressī periērunt. Nostrī ad ūnum omnēs incolumēs perpaucis volnerātis ex tantī
 10 bellī timōre, cum hostium numerus capitum ccccxxx mīlium fuisset, sē in castra recēpērunt. Caesar eis quōs in castris retinuerat discēdendī potestātem fēcit. Illī supplicia cruciātūsque Gallōrum veritī, quōrum agrōs vexāverant, remanēre sē apud eum velle dixērunt. Hīs Caesar libertātem
 15 concessit.

Cæsar's Reasons for Crossing the Rhine and for Building a Bridge.

16 Germānicō bellō cōnfectō multīs dē causīs Caesar statuit sibi Rhēnum esse trānseundum: quārum illa fuit iūstissima, quod, cum vidēret Germānōs tam facile impelli³ ut in Galliam venirent, suis quoque rēbus eōs timēre voluit,
 20 cum intellexerent et posse et audēre populī Rōmānī exercitum Rhēnum trānsire. Accessit etiam quod illa pars equitātūs Usipetum et Tencterōrum, quam suprā commemorāvī praedandī frūmentandīque causā Mosam trānsisse, neque proeliō interfuisse, post fugam suōrum sē trāns Rhēnum in
 25 finīs Sugambrōrum recēperat sēque cum eis coniūnnerat. Ad quōs cum Caesar nūntiōs mīsisset quī postulārent eōs quī sibi Galliaequē bellum intulissent sibi dēderent, responderunt: 'Populī Rōmānī imperium Rhēnum finire; si sē

Cf. ¹ terga, p. 89, l. 10. — ² lassitūdine, 64, 24. — ³ impulsōs, 59, 4.

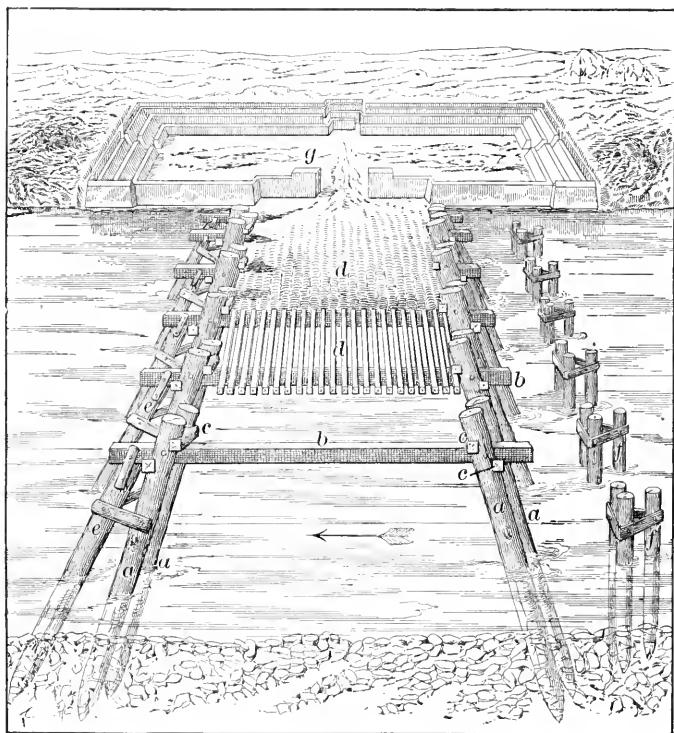

FIG. 59. — PONS A CAESARE IN RHENO FACTUS.

aa, tigna bina sesquipedalia; *bb*, traves bipedales; *cc*, fibulae;
dd, directa materia longuriis cratibusque constrata;
ee, sublicae ad inferiorem partem fluminis pro ariete oblique actae;
ff, sublicae supra pontem immissae;
g, castellum ad caput pontis positum.

invitō Germānōs in Galliam trānsire nōn aequum existimāret, cūr suī quicquam esse imperī aut potestātis trāns Rhēnum postulāret?’ Ubiī autem, qui ūnī ex Trānsrhēnānis ad Caesarem lēgātōs miserant, amicitiam fēcerant, obsidēs dederant, māgnopere ōrābant ut sibi auxilium 5 ferret, quod graviter ab Suēvis premerentur; vel, si id facere occupātiōnibus rei pūblicae prohibērētur, exercitum modo Rhēnum trānsportāret; id sibi *ad* auxilium spemque reliquī temporis satis futūrum. Tantum esse nōmen atque opiniōnem eius exercitūs Ariovistō pulsō et hōc novissimō 10 proeliō factō etiā ad ultimās ¹ Germānōrum nātiōnēs, uti opiniōne et amicitia populi Rōmāni tūtī esse possent. Nāvium māgnam cōpiam ad trānsportandum exercitum pollicēbantur.

Description of the Bridge.

17. Caesar his dē causis quās commemorāvi Rhēnum 15 trānsire dēcreverat; sed nāvibus trānsire neque satis tūtum esse arbitrābātur, neque suae neque populi Rōmāni dignitātis esse statuēbat. Itaque, etsi summa difficultās faciendī pontis prōpōnēbātur propter lātitudinem, rapiditatem, altitudinemque flūminis, tamen id sibi contendendum aut 20 aliter nōn trādūcendum exercitum existimābat. Ratiōnem pontis hanc instituit. Tigna bina sēsquipedālia paulum ab imō praeacūta, dimēnsa ² ad altitudinem flūminis, intervāllō pedum duōrum inter sē iungēbat. Haec cum māchinātiōnibus immissa in flūmen dēfixerat fistūcisque adēgerat, 25 — nōn sublicae modō dērēctē ad perpendicularum, sed prōnē ac fastigātē, ut secundum nātūram flūminis prōcumberent, — eis item contrāria duo ad eundem modum iūncta intervāllō pedum quadrāgēnum ab inferiōre parte contrā vim atque impetum flūminis conversa statuēbat. Haec utraque 30 insuper bipedālibus trabibus ³ immissis, quantum eōrum

Cf. ¹ *ultima*, p. 92, l. 28. — ² *dimēnsō*, 62, 18. — ³ *trabibus*, 83, 5.

tignōrum iūctūra distābat, binīs utrimque fibulis ab extrēmā parte distinēbantur;¹ quibus disclūsīs atque in contrāriam partem revinctīs, tanta erat operis firmitūdō atque ea rērum nātūra ut, quō māior vīs aquae sē incitāvisset, hōc artius inligāta tenērentur. Haec dērēctā māteriā² iniectā contexēbantur ac longuriis crātibusque cōsternēbantur; ac nihilō sēcūs publica et ad inferiōrem partem flūminis obliquē agēbantur, quae prō ariete subiectae et cum omnī opere coniūctae vim flūminis exciperent; et aliae item suprā pontem mediocrī³ spatiō, ut, sī arborum truncī sive nāvēs dēficiendī operis essent ā barbarīs immissae, hīs dēfēnsōribus eārum rērum vīs minuerētur, neu ponti nocērent.⁴

Cæsar Enters Germany.

18. Diēbus x quibus māteria coepta erat comportāri omnī opere effectō exercitus trādūcitur. Caesar ad utramque partem pontis firmō praesidiō relictō in finīs Sugambōrum contendit. Interim ā complūribus civitātibus ad eum lēgātī veniunt; quibus pācem atque amicitiam petentibus liberāliter respondet obsidēsque ad sē addūcī iubet. At Sugambri ex eō tempore quō pōns institui coeptus est fugā comparātā, hortantibus eis quōs ex Tencterīs atque Usipetibus apud sē habēbant, finibus suis excesserant suaque omnia exportāverant sēque in solitūdinem ac silvās abdiderant.

He Learns that the Suevi are Preparing to Resist him, and after Eighteen Days Returns to Gaul.

19. Caesar paucōs diēs in eōrum finibus morātus, omnibus vicīs aedificiisque incēnsis frūmentisque succīsīs, sē in finīs Ubiōrum recēpit; atque hīs auxilium suum pollicitus, sī ab Suēvis premerentur, haec ab eis cōgnōvit: ‘Suēvōs,

Cf. ¹ *distinendam*, p. 82, l. 7. — ² *māteriam*, 93, 19. — ³ *mediocrem*, 88, 23. — ⁴ *nocēre*, 83, 16.

posteaquam per exploratōrēs pontem fieri comperissent, mōre suō conciliō habitō nūntiōs in omnis partis dīmisisse,¹ utī dē oppidīs dēmigrārent, liberōs, uxōrēs, suaque omnia in silvis dēpōnerent, atque omnēs quī arma ferre possent unum in locum convenirent; hunc esse dēlectum medium ferē regiōnum eārum quās Suēvī obtinērent; hīc Rōmānōrum adventum expectāre, atque ibi dēcertāre cōstituisse.⁵

Quod ubi Caesar comperit, omnibus eīs rēbus cōfectis quārum rērum causā trādūcere exercitum cōstituerat, ut Germānis metum iniceret,² ut Sugambrōs ulciscerētur, ut Ubiōs obsidiōne liberāret, diēbus omninō XVIII trāns Rhēnum cōsūmptis, satis et ad laudem et ad ūtilitātem prōfectum arbitrātus, sē in Galliam recēpit pontemque rescidit.³

Cæsar Determines to Invade Britain.

20. Exiguā parte aestātis reliquā Caesar, etsī in hīs locīs (quod omnis Gallia ad septentrionēs vergit) mātūrae sunt hiemēs, tamen in Britanniam proficisci contendit: quod omnibus ferē Gallicis bellis hostibus nostris inde subministrāta⁴ auxilia intellegēbat; et, si tempus [anni] ad bellum gerendum dēficeret, tamen māgnō sibi ūsuī fore arbitrābātur, si modo insulam adisset, genus hominum perspexisset, loca, portūs, aditūs cōgnōvisset; quae omnia ferē Gallis erant incōgnita. Neque enim temerē praeter mercatōrēs illō adit quisquam, neque eīs ipsis quicquam praeter ōram maritimam atque eās regiōnēs quae sunt contrā Galliās nōtum est. Itaque vocātis ad sē undique mercatōribus, neque quanta esset insulae māgnitūdō, neque quae aut quantae nātiōnēs incolerent, neque quem ūsum bellī haberent aut quibus institūtis ūterentur, neque quī essent ad māiōrem nāvium multitudinē idōnei portūs reperire poterat.³⁰

Cf. ¹ dīmittere, p. 90, l. 8. — ² iniectum, 41, 21. — ³ rescindī, 6, 20. — ⁴ subministrandīs, 91, 14.

He Sends Volusenus on a Reconnoissance, then Commius.

21. Ad haec cōgnōscenda, priusquam periculum faceret, idōneum esse arbitrātus, C. Volusēnum cum nāvī longā praemittit. Huic mandat ut explorātis omnibus rēbus ad sē quam primum revertātur. Ipse cum omnibus cōpiis in
 5 Morinōs proficiscitur, quod inde erat brevissimus in Britanniam trāiectus. Hūc nāvis undique ex finitimis regiōnibus, et quam superiōre aestāte ad Veneticum bellum fēcerat classem, iubet convenire. Interim cōsiliō eius cōgnitō et per mercātōrēs perlātō¹ ad Britannōs, ā complūribus in-
 10 sulae civitātibus ad eum lēgātī veniunt quī polliceantur obsidēs dare atque imperiō populī Rōmāni obtemperāre. Quibus auditis liberāliter pollicitus hortātusque ut in eā sententiā permanērent, eōs domum remittit; et cum eis unā Commium, quem ipse Atrebātibus superātis rēgem ibi cōn-
 15 stituerat, cūius et virtūtem et cōsiliū probābat et quem sibi fidēlem esse arbitrābātur cūiusque auctōritās in hīs regiōnibus māgnī habēbātur, mittit. Huic imperat quās possit adeat civitātis, hortēturque ut populī Rōmāni fidem sequantur sēque celeriter eō ventūrum nūntiet. Volu-
 20 sēnus perspectis regiōnibus quantum ei facultātis dari potuit, quī nāvī ēgredi ac sē barbaris committere nōn auderet, quīntō diē ad Caesarem revertitur quaeque ibi perspēxisset renūntiat.

The Morini Submit. A Fleet is Prepared.

22. Dum in hīs locis Caesar nāvium parandārum causā
 25 morātur, ex māgnā parte Morinōrum ad eum lēgātī vēnērunt quī sē dē superiōris temporis cōsiliō excūsarent, quod hominēs barbari et nostrae cōsuētūdinis imperitī² bellum populō Rōmānō fēcissent, sēque ea quae imperāisset factūrōs pollicērentur. Hōc sibi Caesar satis opportūnē acci-

Cf. ¹ perlāta, p. 73, l. 4. — ² imperitum, 40, 9.

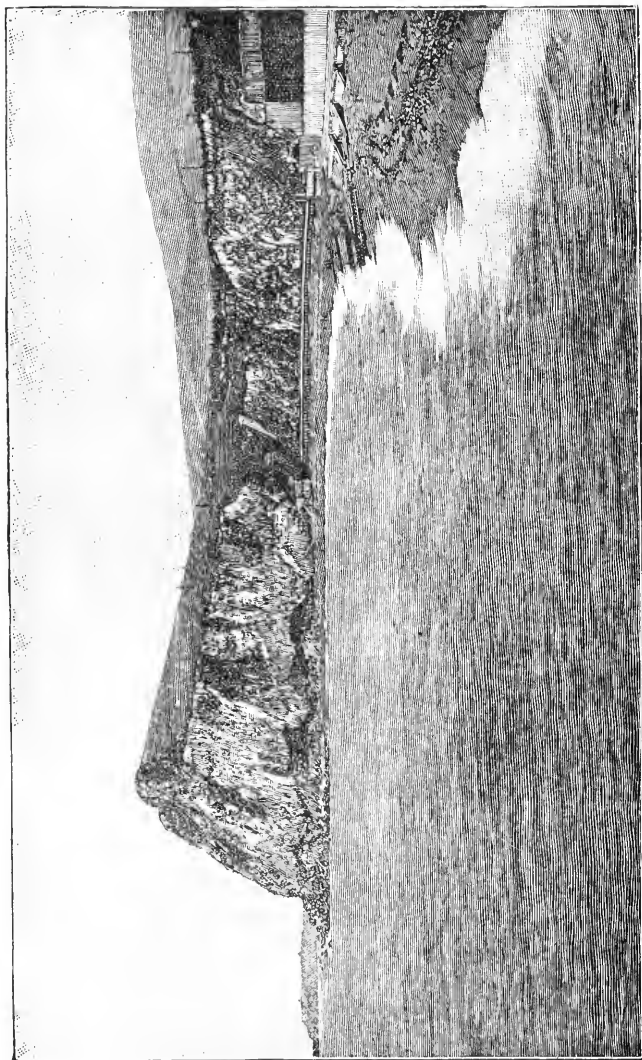

FIG. 60. — CLIFFS OF DOVER.

disse arbitrātus, quod neque post tergum hostem relinquere volēbat neque bellī gerendī propter annī tempus facultātem habēbat neque hās tantulārum rērum occupātiōnēs¹ Britanniae antepōnendās iūdicābat, māgnūm eīs numerum obsidum imperat. Quibus adductis eōs in fidem recipit. 5 Nāvibus circiter LXXX onerāriis coāctis [contrāctisque], quot satis esse ad duās trānsportandās legiōnēs existimābat, quod praetereā nāvium longārum habēbat quaestōrī, lēgātis praefectisque distribuit. Hūc accēdēbant XVIII onerāriae nāvēs, quae ex eō locō ā milibus passuum VIII ventō tenē- 10 bantur quō minus in eundem portum venire possent; hās equitibus distribuit. Reliquum exercitum Titūriō Sabīnō et Aurunculēiō Cottae lēgātis in Menapiōs atque in eōs pāgōs Morinōrum ā quibus ad eum lēgātī nōn vēnerant dūcendum dedit; Sulpiciūm Rūfum lēgātum cum eō prae- 15 sidiō quod satis esse arbitrābātur portum tenēre iussit.

The Fleet Crosses the Channel, Finds Difficulty in Landing, and Comes to Anchor.

23. His cōstitūtis rēbus nactus² idōneam ad nāvigan- dum tempestātem tertiā ferē vigiliā solvit, equitēsque in ulteriōrem portum prōgredi et nāvis cōscendere et sē sequi iussit. Ā quibus cum paulō tardius esset admini- 20 strātum, ipse hōrā diēi circiter quartā cum primis nāvibus Britanniam attigit atque ibi in omnibus collibus expositās hostium cōpiās armātās cōspexit. Cūius loci haec erat nātūra atque ita montibus angustē mare continēbātur uti ex locis superioriōribus in litus tēlum adigi³ posset. Hunc ad 25 ēgrediendum nēquāquam idōneum locum arbitrātus, dum reliquae nāvēs eō convenirent ad hōram nōnam in ancoris exspectāvit. Interim lēgātis tribūnisque militum convocātis et quae ex Volusēnō cōgnōvisset et quae fieri vellet

Cf. ¹ occupātiōnibus, p. 103, l. 7. — ² nactus, 48, 5. — ³ adigēbātur, 84, 1.

ostendit, monuitque, ut rei militaris ratiō, maximē ut maritimae rēs postulārent (ut quae celerem atque instābilem mōtum habērent), ad nūtum¹ et ad tempus omnēs rēs ab eis administrārentur. His dimissis et ventum et aestum
 5 ūnō tempore nactus secundum, datō signō et sublātis ancoris, circiter milia passuum VII ab eō locō prōgressus, apertō ac plānō litore nāvis cōstituit.

The Britons Resist the Landing of the Romans.

24. At barbari cōsiliō Rōmānōrum cōgnitō, praemissō equitātū et essedāriis, quō plērumque genere in proeliis ūti
 10 cōnsuērunt, reliquis cōpiis subsecūtī nostrōs nāvibus ēgredi prohibēbant. Erat ob hās causās summa difficultās quod nāvēs propter māgnitudinem nisi in altō cōstitui nōn poterant; militibus autem, ignōtis locis, impeditis manibus,
 15 māgnō et gravī onere armōrum oppressis, simul et dē nāvibus dēsiliendum et in fluctibus cōsistendum et cum hostibus erat pūgnandum; cum illi aut ex aridō aut paulum in aquam prōgressi omnibus membrīs expeditis, nōtissimis locis, audācter tēla conicerent et equōs insuēfactōs incitarent. Quibus rēbus nostrī perterriti atque hūius omninō
 20 generis pūgnae imperiti nōn eādē alacritāte ac studiō quō in pedestribus ūti proeliis cōnsuērant nitēbantur.

Cæsar Manœuvres for an Advantage. Valor of a Roman Centurion.

25. Quod ubi Caesar animadvertit, nāvis longās, quārum et speciēs² erat barbaris inūsitiōr et mōtus ad ūsum expeditior, paulum removēri ab onerāriis nāvibus et rēmīs³
 25 incitāri et ad latus apertum hostium cōstitui, atque inde fundis, sagittis, tormentis hostis prōpellī ac submovēri iussit; quae rēs māgnō ūsuī nostris fuit. Nam et nāvium figurā et rēmōrum mōtū et inūsitiōne genere tormentōrum permōti barbari cōstitērunt ac paulum etiam pedem ret-

Cf. ¹ ad nūtum, p. 28, l. 26. — ² speciē, 71, 4. — ³ rēmōrum, 83, 13.

tulērunt. Atque nostris militibus cunctantibus,¹ maximē propter altitudinem maris, quī x legiōnis aquilam ferēbat obtestātus deōs ut ea rēs legiōnī fēliciter ēveniret, “Dēsilitē,” inquit, “commilitōnēs, nisi voltis aquilam hostibus prōdere;

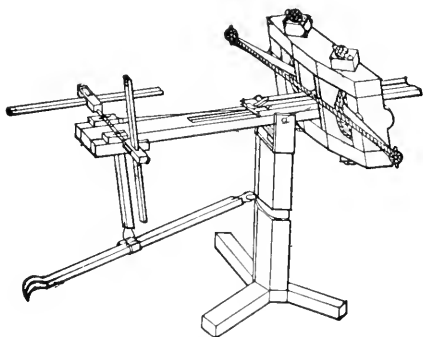

FIG. 61. — CATAPULTA.

ego certē meum rei pūblicae atque imperātōri officium prae- 5
stiterō.” Hōc cum vōce māgnā dixisset, sē ex nāvī prōiēcit
atque in hostis aquilam ferre coepit. Tum nostrī cohortāti
inter sē nē tantum dēdecus admitterētur, ūniversī ex nāvī
dēsiluērunt. Hōs item ex proximīs [primīs] nāvibus cum
cōspexissent, subsecūti hostibus adpropinquāvērunt. 10

The Romans Effect a Landing, but, Having no Cavalry, Cannot Pursue
the Fleeing Britons.

26. Pūgnātum est ab utrisque ācrīter. Nostrī tamen,
quod neque ōrdinēs servāre neque firmiter insistere neque
signa subsequī poterant, atque alius aliā ex nāvī quibuscum-
que signis occurrerat sē adgregābat, māgnopere perturbā-
bantur; hostēs vērō nōtis omnibus vadīs, ubi ex litore 15
aliquōs singulārīs ex nāvī ēgredientis cōspexerant, inci-
tātīs equīs impeditōs adoriēbantur, plūrēs paucōs circum-

Cf. ¹ cunctandum, p. 90, l. 22.

sistēbant, alii ab latere apertō in ūniversōs tēla coniciēbant. Quod cum animadvertisset Caesar, scaphās longārū nāvium item speculātōria nāvigia militibus complēri iussit, et quōs labōrantis¹ cōspexerat hīs subsidia submittēbat. Nostrī
 5 simul in āridō cōstitērunt, suis omnibus cōsecūtis in hostis impetum fēcērunt atque eōs in fugam dedērunt; neque longius prōsequi potuērunt, quod equitēs cursum tenēre atque insulam capere nōn potuerant. Hōc ūnum ad pristinam fortūnam Caesari dēfuit.

Conference with British Envoys, Who Sue for Peace.

10 27. Hostēs proeliō superātī, simul atque sē ex fugā recēpērunt, statim ad Caesarem lēgātōs dē pāce misērunt; obsidēs datūrōs quaeque imperāset factūrōs esse polliciti sunt. Ūnā cum hīs lēgātis Commius Atrebās vēnit, quem suprà dēmōnstrāveram ā Caesare in Britanniam praemisum.
 15 Hunc illi ē nāvī ēgressum, cum ad eōs orātōris modō Caesaris mandāta dēferret, comprehenderant atque in vincula coniēcērant: tum proeliō factō remisērunt; et in petendā pāce ēius rei culpam in multitudinem contulērunt, et propter imprudentiam ut ignōscerētur² petivērunt. Caesar questus³ quod, cum ultrō in continentem lēgātis missis pācem
 20 ab sē petissent, bellum sine causā intulissent, ignōscere imprudentiae dixit obsidēsque imperāvit; quōrum illi partem statim dedērunt, partem ex longinquiōribus locis arcesitam paucis diēbus sēsē datūrōs dixērunt. Intereā suōs re-
 25 migrāre in agrōs iussērunt, principēsque undique convenire et sē civitātisque suās Caesari commendāre coepērunt.

The Cavalry Transports Driven Back by a Storm.

28. Hīs rēbus pāce cōfirmātā, post diem quartum quam est in Britanniam ventum, nāvēs xviii dē quibus suprà

Cf. ¹ labōrantibus, p. 46, l. 26. — ² ignōvisset, 41, 3. — ³ questum, 32, 20.

dēmōnstrātum est, quae equitēs sustulerant, ex superiōre portū lēnī ventō solvērunt.¹ Quae cum adpropinquārent Britanniae et ex castris vidērentur, tanta tempestās subitō cōorta est ut nūlla eārum cursum tenēre posset ; sed aliae

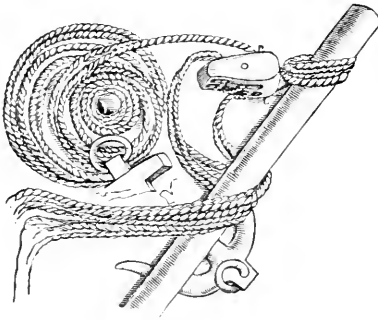

FIG. 62. — ANCHOR AND TACKLE.

eōdem unde erant profectae referrentur, aliae ad inferiōrem 5
partem insulae, quae est propius sōlis occāsū, māgnō suō
cum periculō dēicerentur ; quae tamen ancoris iactis cum
fluctibus complērentur, necessariō adversā nocte in altum
prōvectae continentem petiērunt.

The Fleet almost Wrecked by Storms and High Tides.

29. Eādem nocte accidit ut esset lūna plēna, qui diēs 10
maritimōs aestūs maximōs in Oceanō efficere cōsuēvit,
nostrisque id erat incōgnitum. Ita unō tempore et longās
nāvis. [quibus Caesar exercitum trānsportandum cūrāverat]
quās Caesar in āridum subdūxerat, aestus complēverat ; et
onerāriās, quae ad ancorās erant dēligātae, tempestās adflīc- 15
tābat,² neque ūlla nostris facultās aut administrandī aut
auxiliandī dabātur. Complūribus nāvibus frāctis³ reliquae

Cf. ¹ solvit, p. 107, l. 18. — ² adflīctārentur, 82, 16. — ³ frāctōs, 27, 25.

cum essent — fūnibus, ancoris reliquisque armāmentis āmissis — ad nāvigandum inūtilēs, māgna (id quod nēcesse erat accidere) tōtius exercitūs perturbātiō facta est. Neque enim nāvēs erant aliae quibus reportārī possent; et omnia
 5 deērānt quae ad reficiendās nāvis erant ūsuī; et, quod omnibus cōnstābat hiemārī in Galliā oportēre, frūmentum in his locis in hiemem prōvisum nōn erat.

The Britons Seize the Opportunity and Plan to Renew Hostilities.

30. Quibus rēbus cōgnītis principēs Britanniae, qui post proelium ad Caesarem convēnerant, inter sē conlocūtī, cum
 10 et equitēs et nāvis et frūmentum Rōmānis deesse intellegent, et paucitātem militum ex castrōrum exiguitāte¹ cōgnōscerent, — quae hōc erant etiam angustiora quod sine impedimentis Caesar legiōnēs trānsportāverat, — optimum factū esse dūxērunt, rebellione factā, frūmentō commeātūque
 15 nostrōs prohibēre et rem in hiemem prōducere; quod his superātis aut reditū interclūsis nēminem postea belli inferendī causā in Britanniam trānsitūrum cōfidēbant. Itaque rūsus coniūrātiōne factā paulātim ex castris discēdere et suōs clam ex agris dēducere coepērunt.

Cæsar Suspects their Design.

20 31. At Caesar, etsi nōndum eōrum cōnsilia cōgnōverat, tamen et ex ēventū nāvium suārum et ex eō quod obsidēs dare intermiserant, fore id quod accidit suspicābātur.² Itaque ad omnis cāsūs subsidia comparābat. Nam et frūmentum ex agris cotidiē in castra cōferēbat et quae gra-
 25 vissimē adflīctae erant nāvēs, eārum māteriā atque aere ad reliquās reficiendās ūtēbātur, et quae ad eās rēs erant ūsuī ex continentī comportārī iubēbat. Itaque cum summō studiō ā militibus administrārētur, XII nāvibus āmissis, reliquis ut nāvīgārī *satis* commodē posset effēcit.

Cf. ¹ *exiguitātem*, p. 90, l. 18. — ² *suspicātus*, 97, 20.

He Takes Measures to Thwart them. They Attack a Foraging Party.

32. Dum ea geruntur, legiōne ex cōsuētūdine ūnā frūmentātum missā, quae appellābātur VII, neque ūllā ad id tempus bellī suspiciōne interpositā, — cum pars hominum in agrīs remanēret, pars etiam in castra ventitāret, — eī qui prō portis castrōrum in statiōne erant Caesarī nūntiāvē- 5 runt pulverem māiōrem quam cōsuētūdō ferret in eā parte vidēri quam in partem legiō iter fēcisset. Caesar id quod



FIG. 63. — SOLDIERS FORAGING.

erat suspicātus, aliquid novī ā barbarīs initum cōsili, cohortis quae in statiōnibus erant sēcum in eam partem proficiscī, ex reliquīs duās in statiōnem succēdere, reliquās 10 armārī et cōnfestim sēsē subsequī iussit. Cum paulō longius ā castrīs prōcessisset, suōs ab hostibus premī atque aegrē sustinēre et cōnfertā¹ legiōne ex omnibus partibus tēla conicī animadvertit. Nam quod omni ex reliquīs partibus dēmesso frūmentō pars ūna erat reliqua, suspicātī 15

Cf. ¹ cōnfertōs, p. 66, l. 7.

hostēs hūc nostrōs esse ventūrōs noctū in silvās dēlituerant; tum dispersōs dēpositis armīs in metendō occupātōs subitō adortī, paucīs interfectīs reliquōs incertīs ōrdinibus perturbāverant, simul equitātū atque essedis circumdederant.

Mode of Fighting with War Chariots.

5 **33.** Genus hōc est ex essedis pūgnae. Primō per omnis partīs perequitant et tēla coniciunt atque ipsō terrōre equōrum et strepitū¹ rotārum ōrdinēs plērumque perturbant; et cum sē inter equitum turmās insinuāvērunt, ex essedis dēsiliunt et pedibus proeliantur. Aurīgae interim paulātīm
 10 ex proeliō excēdunt atque ita currūs conlocant utī, sī illi ā multitūdine hostium premantur, expeditum ad suōs receptum habeant. Ita mōbilitātem equitum, stabilitātem peditem in proeliis praestant; ac tantum ūsū cotīdiānō et exercitātiōne efficiunt utī in dēclivī² ac praecipitī locō
 15 incitātōs equōs sustinēre et brevī moderārī ac flectere, et per tēmōnem percurrere et in iugō insistere et sē inde in currūs citissimē recipere cōsuērint.

The Foragers Rescued. Large Numbers of Britons Assemble.

34. Quibus rēbus perturbātis nostrīs nōvitāte pūgnae tempore opportūnissimō Caesar auxilium tulit; namque ēius
 20 adventū hostēs cōstitērunt, nostrī sē ex timōre recēpērunt. Quō factō ad lacessendum hostem et committendum proelium aliēnum³ esse tempus arbitrātus, suō sē locō continuit et brevī tempore intermissō in castra legiōnēs redūxit. Dum haec geruntur, nostrīs omnibus occupātis, quī erant in agrīs
 25 reliquī discessērunt. Secūtae sunt continuōs⁴ complūrīs diēs tempestātēs, quae et nostrōs in castris continērent et hostem ā pūgnā prohibērent. Interim barbarī nūntiōs in omnis partīs dimisērunt paucitātemque nostrōrum militum

Cf. ¹ strepitū, p. 56, l. 26. — ² dēclivis, 61, 9. — ³ aliēnō, 13, 6. — ⁴ continuōs, 42, 27.

suis praedicāvērunt, et quanta praedae faciendae atque in perpetuum sui liberandi facultās darētur, si Rōmānōs castris expulissent, dēmōstrāvērunt. His rēbus celeriter māgnā multitudīne peditātūs equitātūsque coactā ad castra vērērunt.

5

They Give Battle and are Defeated.

35. Caesar, etsi idem quod superiōribus diēbus acciderat fore vidēbat, — ut, si essent hostēs pulsī, celeritāte periculum effugerent, — tamen nactus equitēs circiter xxx, quōs Commius Atrebās (dē quō ante dictum est) sēcum trānsportāverat, legiōnēs in aciē prō castris cōstituit. 10 Commissō proeliō diūtius nostrōrum militum impetum hostēs ferre nōn potuērunt ac terga vertērunt. Quōs tantō spatiō secūti quantum cursū et viribus efficere potuērunt, complūris ex eis occidērunt; deinde omnibus longē lātēque aedificiis incēnsis sē in castra recēpērunt.

15

Cæsar Returns to Gaul.

36. Eōdem diē lēgātī ab hostibus missī ad Caesarem dē pāce vērērunt. His Caesar numerum obsidum quem antēā imperāverat duplicāvit, eōsque in continentem addūci iussit; quod, propinquā diē aequinocti, infirmis nāvibus hiemī nāvigātiōnem subiciendam nōn existimābat. Ipse idōneam 20 tempestātem nactus paulō post mediam noctem nāvis solvit; quae omnēs incolumēs ad continentem pervērērunt; sed ex eis onerāriae duae eōsdem portūs quōs reliquae capere nōn potuērunt et paulō infrā dēlātae sunt.

Attack of the Morini on Cæsar's Troops.

37. Quibus ex nāvibus cum essent expositi militēs circiter 25 ccc atque in castra contenderent, Morinī, quōs Caesar in Britanniam proficiscēns pācātōs reliquerat, spē praedae adducti primō nōn ita māgnō suōrum numerō circumstetērunt ac, si sēsē interfici nōllent, arma pōnere iussērunt.

Cum illi orbe factō sēsē dēfenderent, celeriter ad clāmōrem hominum circiter milia vi convēnerunt. Quā rē nūntiātā Caesar omnem ex castris equitātum suīs auxiliō misit. Interim nostrī militēs impetum hostium sustinuērunt atque
 5 amplius hōris iiii fortissimē pūgnāvērunt, et paucis volneribus acceptis complūrēs ex his occidērunt. Postea vērō quam equitātus noster in cōspectum vēnit, hostēs abiectis armīs terga vertērunt māgnusque eōrum numerus est occisus.

The Rebellious Morini Subdued. Thanksgiving at Rome.

10 **38.** Caesar posterō diē T. Labiēnum lēgātum cum eis legiōnibus quās ex Britannīā redūxerat in Morinōs, quī rebellīōnem fēcerant, misit. Quī cum propter siccitātis palūdum quō sē reciperent nōn habērent (quō per fugiō superiōre annō erant ūsī), omnēs ferē in potestātem Labiēni pervēnerunt.
 15 At Q. Titūrius et L. Cotta lēgātī, quī in Menapiōrum finis legiōnēs dūxerant, omnibus eōrum agris vāstātis, frūmentis succisis, aedificiis incēnsis, quod Menapii sē omnēs in dēnsissimās silvās abdiderant, sē ad Caesarem recēperunt. Caesar in Belgīs omnium legiōnum hiberna cōstituit.
 20 Eō duae omninō civitātēs ex Britannīā obsidēs misērunt, reliquae neglēxērunt. His rēbus gestis ex litteris Caesaris diērum xx supplicātiō ā senātū dēcrēta est.

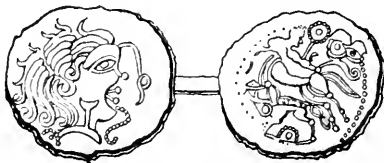

FIG. 64. — GALLIC COIN.





FIG. 66. — BRITISH COINS.

BOOK V.

SECOND INVASION OF BRITAIN. — FRESH RISINGS OF THE GAULS. B.C. 54.

Cæsar, Contemplating a Second Invasion of Britain, Orders a Suitable Fleet Built. Settles Disturbances in Illyricum.

L DOMITIŌ Ap. Claudiŏ cōsulibus, discēdēns ab hibernis Caesar in Ītaliā, ut quotannis facere cōsuērat, lēgātis imperat quōs legiōnibus præfēcerat uti quam plūrimās possint hieme nāvis aedificandās veterēsque reficiendās cūrent. Eārum modum formamque¹ dēmōnstrat. 5
Ad celeritātem onerandi subductiōnisque paulō facit humiliōrēs quam quibus in nostrō mari ūtī cōsuēvimus; atque id eō magis, quod propter crēbrās commūtātiōnēs aestuum minus māgnōs ibi fluctūs fierī cōgnōverat; ad onera ac multitudinem iūmentōrum trānsportandam, paulō lātiōrēs 10
quam quibus in reliquīs ūtimur maribus. Hās omnis āctuariās imperat fierī, quam ad rem multum humilitās adiuvat. Ea quae sunt ūsuī ad armandās² nāvis ex Hispāniā adportārī iubet. Ipse conventibus Galliae citeriōris perāctis in Īllyricum proficiscitur, quod ā Pirūstis finitimam³ partem 15
prōvinciae incursiōnibus vāstārī audiēbat. Eō cum vēnisset, civitātibus militēs imperat certumque in locum convenire iubet. Quā rē nūntiātā Pirūstae lēgātōs ad eum mittunt quī doceant⁴ nihil eārum rērum publicō factum cōsiliō,

Cf. ¹ figūram. — ² ōrmandās. — ³ opp. ultimam. — ⁴ ostendant.

sēsēque parātōs esse dēmōnstrant omnibus ratiōnibus dē iniūriīs satisfacere. Perceptā¹ ōrātiōne eōrum Caesar obsidēs imperat eōsque ad certam diem addūcī iubet: nisi ita fēcerint, sēsē bellō civitātem persecūtūrum dēmōnstrat.
 5 Eīs ad diem adductis ut imperāverat, arbitrōs inter civitātis dat quī litem aestiment poenamque cōnstituant.

Returns to Gaul. Orders the New Fleet to Assemble at the Port Itius. Finds Trouble Brewing among the Treveri.

2. His cōfectis rēbus conventibusque perāctis, in citiōrem Galliam revertitur² atque inde ad exercitum proficiscitur. Eō cum vēnisset, circumitīs omnibus hibernis, singulārī militum studiō in summā omnium rērum inopiā circiter
 10 DC ēius generis, cūius suprā dēmōnstrāvimus, nāvis et longās XXVIII invēnit instrūctās,³ neque multum abesse ab eō quī paucis diēbus dēdūcī possint. Conlaudātis militibus atque
 15 eīs quī negōtiō praefuerant, quid fieri velit ostendit⁴ atque omnīs ad portum Itium convenire iubet, quō ex portū commodissimum⁵ in Britanniam trāiectum esse cōgnōverat circiter milium passuum xxx [trānsmisum] ā continentī. Huic rei quod satis esse vīsum est militum reliquit; ipse cum legiōnibus expeditis IIII et equitibus DCCC in finīs Trē-
 20 verōrum proficiscitur; quod hī neque ad concilia veniēbant neque imperiō pārēbant, Germānōsque Trānshēnānōs sollicitāre dīcēbantur.

Indutiomarus and Cingetorix, Rival Chiefs of the Treveri, Appeal to Cæsar.

3. Haec civitās longē plūrimum tōtius Galliae equitātū valet⁶ māgnāsque habet cōpiās peditum, Rhēnumque, ut
 25 suprā dēmōnstrāvimus, tangit.⁷ In eā civitāte duo dē principātū inter sē contendēbant,⁸ Indūtiomārus et Cingetorix: ex quibus alter, simul atque dē Caesaris legiōnumque ad

Cf. ¹ audītā, intellēctā. — ² redit. — ³ aedificātās. — ⁴ docet. — ⁵ oportūnissimum. — ⁶ potest. — ⁷ attingit. — ⁸ dēcertābant.

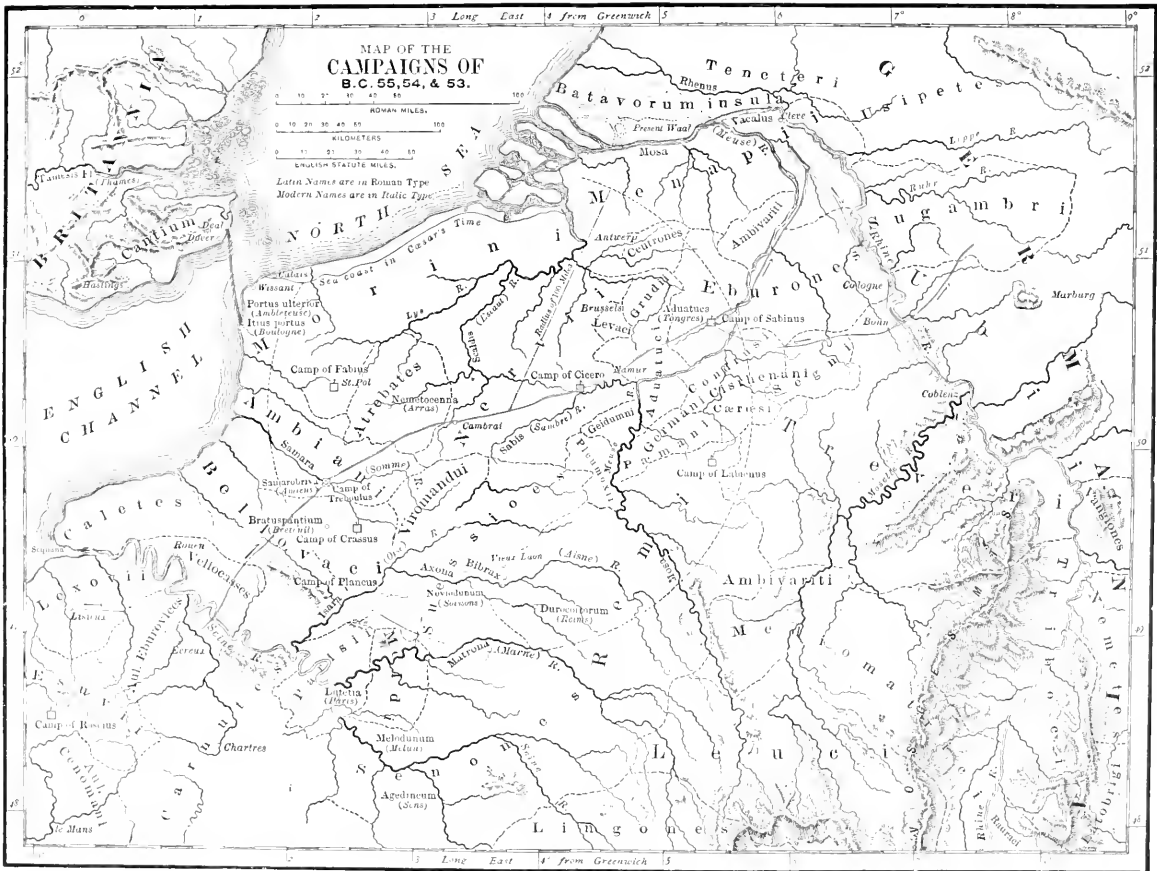

ENGLISH CHANNEL

NORTH SEA

MAP OF THE CAMPAIGNS OF B.C. 55, 54, & 53.

ROMAN MILES.
KILOMETERS.
ENGLISH STATUTE MILES.

Latin Names are in Roman Type
Modern Names are in Italic Type

Sea coast in Caesar's Time

Long East 4' from Greenwich 5

Long East 4' from Greenwich 5

Batavorum insula
Teneveri
Usipete

Mosa
Mela
Mela

Antrop
Castrum
Ambrosium

Brassica
Levac
Adutice
Camp of Sabinus

Camp of Fabius
Camp of Cicerio
Camp of Labianus

Bratuspantium
Camp of Crassus
Camp of Plancus

Noviodunum
Durocoronum
Mebodunum

Agedincum
Lingones

Noviodunum
Durocoronum
Mebodunum

Agedincum
Lingones

Agedincum
Lingones

Agedincum
Lingones

Caletes
Belgic
Ambriani

Caletes
Belgic
Ambriani

Caletes
Belgic
Ambriani

Caletes
Belgic
Ambriani

Caletes
Belgic
Ambriani

Caletes
Belgic
Ambriani

Caletes
Belgic
Ambriani

Caletes
Belgic
Ambriani

Caletes
Belgic
Ambriani

Caletes
Belgic
Ambriani

Caletes
Belgic
Ambriani

Caletes
Belgic
Ambriani

Caletes
Belgic
Ambriani

Caletes
Belgic
Ambriani

Caletes
Belgic
Ambriani

Caletes
Belgic
Ambriani

Caletes
Belgic
Ambriani

Caletes
Belgic
Ambriani

Caletes
Belgic
Ambriani

Caletes
Belgic
Ambriani

Caletes
Belgic
Ambriani

Caletes
Belgic
Ambriani

Caletes
Belgic
Ambriani

Caletes
Belgic
Ambriani

Caletes
Belgic
Ambriani

Caletes
Belgic
Ambriani

Caletes
Belgic
Ambriani

Caletes
Belgic
Ambriani

Caletes
Belgic
Ambriani

Caletes
Belgic
Ambriani

Caletes
Belgic
Ambriani

Caletes
Belgic
Ambriani

Caletes
Belgic
Ambriani

Caletes
Belgic
Ambriani

Caletes
Belgic
Ambriani

Caletes
Belgic
Ambriani

Caletes
Belgic
Ambriani

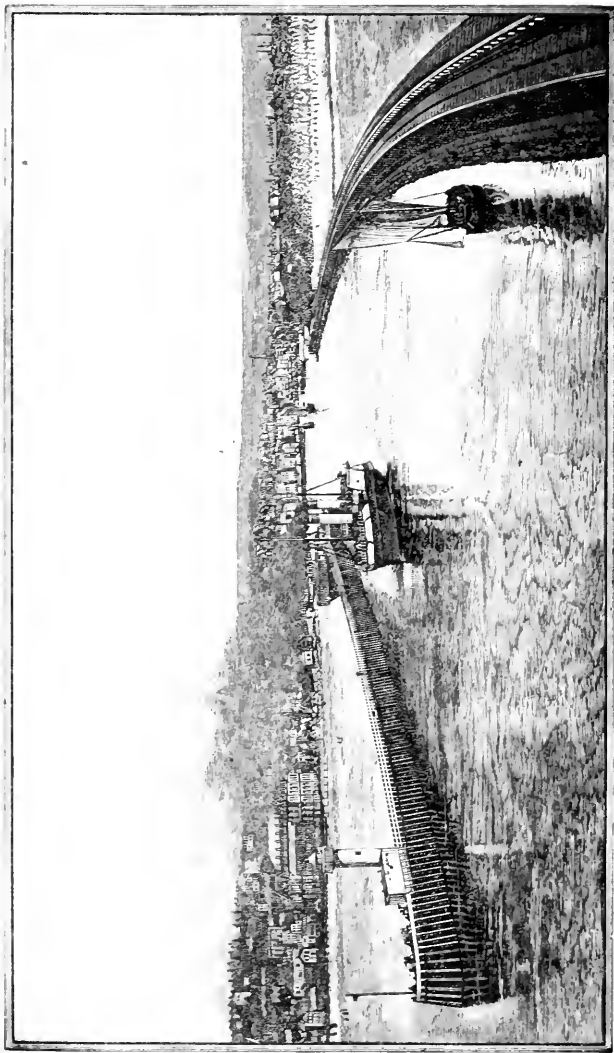

FIG. 67. — BOULOGNE.

ventū cōgnitum est, ad eum vēnit; sē suōsque omnīs in officio futurōs neque ab amicitia populī Rōmānī dēfectūrōs cōfirmāvit; quaeque in Trēverīs gererentur¹ ostendit. At Indūtiomārus equitātum peditātumque cōgere, eisque qui per aetatem² in armīs esse nōn poterant in silvam Arduenam abditis, quae ingentī māgnitudine per mediōs finis Trēverōrum ā flūmine Rhēnō ad initium Rēmōrum pertinet, bellum parāre instituit. Sed posteaquam nōn nulli principēs ex eā civitate et auctoritate Cingetorigis adducti et adventū nostrī exercitūs perterriti ad Caesarem vēnerunt et dē suis privātis rēbus ab eō petere coepērunt, quoniam civitati cōsulere nōn possent; veritus nē ab omnibus dēsererētur Indūtiomārus lēgātōs ad Caesarem mittit: ‘Sēsē idcirco ab suis discēdere atque ad eum venire nōluisse, quō facilius civitatem in officio contineret, nē omnis nōbilitātis discessū plēbs propter imprudentiam lāberētur; itaque civitatem in suā potestate esse sēque, si Caesar permetteret, ad eum in castra ventūrum et suās civitātisque fortunās eius fidei permissūrum.’

He Settles the Dispute in Favor of Cingetorix.

4. Caesar etsi intellegēbat⁴ quā dē causā ea dicerentur quaeque eum rēs ab institūtō⁵ cōsiliō dēterreret, tamen, nē aestatem in Trēverīs cōnsūmere cōgerētur omnibus rēbus ad Britannicum bellum comparātis, Indūtiomārum ad sē cum cc obsidibus venire iussit. His adductis, in eis filio propinquisque eius omnibus, quōs nōminatim ēvocāverat, cōnsolātus Indūtiomārum hortātusque est uti in officio maneret; nihilō tamen sēcius⁶ principibus Trēverōrum ad sē convocātis hōs singillatim⁷ Cingetorigi conciliāvit; quod cum meritō eius ā sē fieri intellegēbat, tum māgnī interesse arbitrābatur eius auctoritatem inter suōs quam plūrimum

Cf. ¹ agerentur. — ² arma ferre. — ³ dēficeret. — ⁴ percipiēbat. — ⁵ inceptō. — ⁶ minus. — ⁷ singulōs.

valēre, cūius tam ēgregiam¹ in sē voluntātem perspexisset. Id factum graviter tulit Indūtiomārus [suam grātiam inter suōs minūi]; et quī iam ante inimicō in nōs animō fuisset multō gravius hōc dolōre exārsit.²

Assembling of Troops at the Port Itius.

5 5. His rēbus cōstitūtis Caesar ad portum Itium cum legiōnibus pervenit. Ibi cōgnōscit LX nāvis, quae in Meldis factae erant, tempestāte rēiectās³ cursum tenēre nōn potuisse atque eōdem unde erant profectae revertisse; reliquās parātās ad nāvigandum atque omnibus rēbus instrūctās
10 invenit.⁴ Eōdem equitātus tōtius Galliae convenit, numerō milia IIII, prīncipēsque ex omnibus civitātibus; ex quibus perpaucōs, quōrum in sē fidem perspexerat, relinquere in Galliā, reliquōs obsidum locō sēcum dūcere dēcrēverat,⁵ quod, cum ipse abesset, mōtum⁶ Galliae verēbātur.

Dumnorix, the Hæduan, Again Appears.

15 6. Erat ūnā cum cēteris Dumnorix Haeduus, dē quō ante ab nōbis dictum est. Hunc sēcum habēre in primis cōstituerat,⁷ quod eum cupidum rērum novārum, cupidum imperī, māgnī animī, māgnae inter Gallōs auctōritātis cōgnōverat. Accēdēbat hūc quod in conciliō Haeduōrum
20 Dumnorix dixerat sibi ā Caesare rēgnum civitātis dēferri;⁸ quod dictum Haeduī graviter⁹ ferēbant neque recūsandī aut dēprecandī causā lēgātōs ad Caesarem mittere audēbant. Id factum ex suis hospitibus Caesar cōgnōverat. Ille omnibus prīmō precibus petere contendit ut in Galliā relinquerētur;
25 partim quod insuētus nāvigandī mare timēret, partim quod religiōnibus impediri¹⁰ sēsē diceret. Posteaquam id obstinātē sibi negārī vidit, omnī spē impetrandī adēemptā,

Cf. ¹ eximiam. — ² cōnflagrāvit. — ³ repulsās. — ⁴ reperit. — ⁵ cōstituerat. — ⁶ tumultum, sēditiōnem. — ⁷ dēcrēverat. — ⁸ trādī. — ⁹ molestē. — ¹⁰ dētinerī.

principēs Galliae sollicitāre, sēvocāre singulōs, hortārique coepit utī in continentī remanērent; metū territāre nōn sine causā fieri ut Gallia omnī nōbilitāte spoliārētur;¹ id esse cōnsilium Caesaris ut, quōs in cōnspectū Galliae interficere verērētur, hōs omnīs in Britanniam trāductōs necāret; fidem reliquīs interpōnere, iūs iūrandum poscere ut, quod esse² ex ūsū Galliae intellēxissent, commūnī cōnsiliō administrārent. Haec ā complūribus ad Caesarem dēferēbantur.

Flight, Capture, and Death of Dumnorix.

7. Quā rē cōgnitā Caesar, quod tantum civitātī Haeduae dignitātis³ tribuēbat, coercendum⁴ atque dēterrendum quibuscumque rēbus posset Dumnorigem statuēbat; quod longius ēius āmentiam prōgredi⁵ vidēbat, prōspiciendum⁶ nē quid sibi ac rei pūblicae nocēre⁷ posset. Itaque diēs circiter xxv in eō locō commorātus, quod Cōrus ventus nāvigatiōnem impediēbat, quī māgnam partem omnis temporis in his locis flāre cōsuēvit,⁸ ⁹dabat operam ut in officiō Dumnorigem continēret; nihilō tamen sēcius omnia ēius cōnsilia cōgnōsceret. Tandem idōneam nactus tempestātem militēs equitēsque cōnscendere nāvis iubet. At omnium impeditis animīs Dumnorix cum equitibus Haeduōrum ā castris insciente Caesare domum discēdere coepit. Quā rē nūntiātā Caesar, intermissā profectiōne¹⁰ atque omnibus rēbus postpositis, māgnam partem equitātūs ad eum insequendum mittit retrahique imperat; sī¹¹ vim faciat neque pāreat,¹² interfici iubet; nihil hunc sē absente prō sānō factūrum arbitrātus quī praesentis imperium¹³ neglēxisset. Ille autem revocātus resistere ac sē manū dēfendere suōrumque fidem implōrāre coepit, saepe clāmitāns liberum sē liberaeque esse

Cf. ¹ prīvārētur. — ² ūsuī. — ³ auctōritātis. — ⁴ reprimendum. — ⁵ prōcēdere. — ⁶ prōvidendum. — ⁷ iniūriās infēre. — ⁸ solitus est. — ⁹ nītēbātur. — ¹⁰ discessiōne. — ¹¹ resistat. — ¹² dictō audiēns sit. — ¹³ auctōritātem, iūssum.

civitātis. Illi, ut erat imperātum, circumsistunt hominem atque interficiunt; at equitēs Haeduī ad Caesarem omnēs revertuntur.

Cæsar Sets Sail for Britain. The Natives in Alarm Withdraw from the Coast.

8. His rēbus gestis,¹ Labiēnō in continente cum III
 5 legiōnibus et equitum milibus duōbus relictō, ut portūs
 tuērētur et rei frūmentāriæ prōvidēret, quæque in Galliā
 gererentur cōgnōsceret cōsiliūque prō tempore et prō rē
 caperet, ipse cum V legiōnibus et parī numerō equitum,
 quem in continentī reliquerat, ad ²sōlis occāsum nāvīs
 10 solvit; et lēni Āfricō prōvectus mediā circiter nocte ventō
 intermissō, cursum nōn tenuit; et longius dēlātus aestū
³ortā lūce sub sinistrā Britanniam relictam cōspexit. Tum
 rūsus aestūs commūtātiōnem secūtus rēmis contendit ut
 eam partem insulæ caperet quā optimum esse ēgressum
 15 superiōre aestate cōgnōverat. Quā in rē admodum fuit
 militum virtūs laudanda, quī vectōriis gravibusque nāvigiis
 nōn intermissō rēmigandī labōre longārum nāvium cursum
 adaequāunt. Accessum est ad Britanniam omnibus
 nāvibus meridiānō⁴ ferē tempore;⁴ neque in eō locō hostis
 20 est vīsus, sed, ut postea Caesar ex captivīs cōgnōvit,⁵ cum
 māgnæ manūs⁶ eō convēnissent, multitudīne nāvium per-
 territæ,⁷ quæ cum annōtinis privātisque, quās suī quisque
 commodī fēcerat, amplius DCCC ūnō erant vīsæ tempore, ā
 litore discesserant⁸ ac sē in superiōra loca abdiderant.

The Army Lands and Advances. The Natives Resist, but are Defeated.

25 9. Caesar expositō exercitū et locō castris idōneō captō,
 ubi ex captivīs cōgnōvit quō in locō hostium cōpiæ cōnsē-
 dissent, cohortibus X ad mare relictis et equitibus CCC qui
 praesidiō⁹ nāvibus essent, dē tertiā vigiliā ad hostis contendit,

Cf. ¹ cōfectis. — ² occidentem sōlem. — ³ primā lūce. — ⁴ meridiē.
 — ⁵ repperit. — ⁶ cōpiæ. — ⁷ permōtæ. — ⁸ excesserant. — ⁹ subsidiō.

-- eō minus veritus nāvibus, quod in litore molli¹ atque apertō dēligatās ad ancorās relinquēbat. Eī praesidiō nāvibusque Q. Ātrium praefēcit. Ipse noctū prōgressus² milia passuum circiter XII hostium cōpiās cōspicātus est. Illi equitātū atque essedīs ad flūmen prōgressi ex locō superiōre 5 nostrōs prohibēre³ et proelium committere coepērunt.

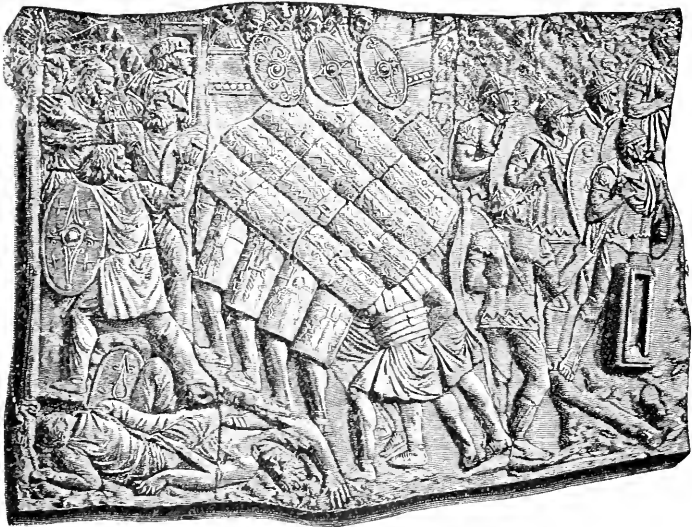

FIG. 68. — TESTUDO.

Repulsi ab equitātū sē in silvās abdidērunt, locum nacti ēgregiē et nātūrā et opere mūnitum, quem domestici belli (ut vidēbantur) causā iam ante praeparāverant; nam crēbris⁴ arboribus succisis omnēs introitus⁵ erant praeclūsī. 10 Ipsī ex silvis rārī prōpūgnābant nostrōsque intrā mūnitiōnēs ingredi⁶ prohibēbant. At milites legiōnis VII, testūdine factā et aggere ad mūnitiōnēs adiectō,⁷ locum cēpērunt

Cf. ¹ lēniter acclīvī. — ² profectus. — ³ impedire. — ⁴ multīs. — ⁵ aditus, opp. exitus. — ⁶ introire. — ⁷ exstrūctō.

eōsque ex silvis expulērunt paucis vulneribus acceptis. Sed eōs fugientis longius Caesar prōsequi vetuit, et quod loci nātūram ignōrābat, et quod māgnā parte diēi cōnsūptā mūnitiōni castrōrum tempus¹ relinqui volēbat.

The Fleet Suffers from a Storm, is Hastily Repaired and Drawn up on Shore.

5 10. ²Postridiē eius diēi māne tripartitō militēs equitēsque in expeditiōnem misit, ut eōs qui fūgerant persequerentur. His aliquantum itineris prōgressis, cum iam extrēmī essent in prōspectū, equitēs ā Q. Ātriō ad Caesarem vēnērunt qui nūntiārent, superiōre nocte maximā coörtā tempestāte, prope
10 omnēs nāvis adflictās atque in litus ēiectās esse; quod neque anchorae fūnēsque sustinērent neque nautae gubernātōrēsque vim tempestātis pati³ possent. Itaque ex eō concursū nāvium māgnū esse incommodum⁴ acceptum.

15 11. His rēbus cōgnitis Caesar legiōnēs equitātumque revocārī atque in itinere resistere iubet, ipse ad nāvis revertitur; eadem ferē quae ex nūntiis [litteris] cōgnōverat cōram perspicit, sic ut āmissis⁵ circiter XL nāvibus reliquae tamen reficī posse māgnō negōtiō⁶ vidērentur. Itaque ex legiōnibus fabrōs dēligit et ex continentī aliōs arcessī iubet;
20 Labiēnō scribit⁷ ut quam plūrimās possit eis legiōnibus quae sunt apud eum nāvis īnstituāt.⁸ Ipse, etsi rēs erat multae operae ac labōris, tamen commodissimum⁹ esse statuit omnis nāvis subdūcī¹⁰ et cum castris unā mūnitiōne coniungī. In his rēbus circiter diēs x cōnsūmit nē nocturnis quidem
25 tempōribus ad labōrem militum intermissis. Subductis nāvibus castrisque ēgregiē mūnitis eāsdem cōpiās quās ante praesidiō nāvibus relinquit; ipse eōdem unde redierat proficiscitur.¹¹ Eō cum vēnisset, māiōrēs iam undique in eum

Cf. ¹ spatium. — ² posterō diē. — ³ perferre. — ⁴ dētrīmentum. — ⁵ perditis. — ⁶ labōre. — ⁷ litterās mittit ad. — ⁸ comparat. — ⁹ utilis-simum. — ¹⁰ opp. dēdūcī. — ¹¹ prōcēdit.

locum cōpiae Britannōrum convēnerant, summā imperi bellique administrandī commūnī cōnsiliō permissā¹ Cassivellaunō; cūius finēs ā maritimis civitātibus flūmen dividit, quod appellātur Tamesis, ā marī circiter milia passuum



FIG. 69. — SOLDIERS BUILDING CAMP, WITH GUARDS.

LXXX. Huic superiōre tempore cum reliquīs civitātibus continentia² bella intercesserant; sed nostrō adventū permōti Britannī hunc tōtī bellō imperiōque praefēcerant.³

The Inhabitants of Britain and its Resources.

12. Britanniae pars interior ab eis incolitur quōs nātōs in insulā ipsī memoriā prōditum dicunt; maritima pars ab eis quī praedae ac bellī inferendī⁴ causā ex Belgiō trānsiērunt 10 (quī omnēs ferē eis nōminibus civitātum appellantur quibus

Cf. ¹ mandātā. — ² perpetua. — ³ praeposuerant. — ⁴ gerendī.

orti ex civitatibus eō pervēnērunt) et bellō inlātō ibi remānsērunt atque agrōs colere coepērunt. Hominum est infinita multitudō crēberrimaque¹ aedificia ferē Gallicis cōsimilia,² pecoris māgnus numerus. Ūtuntur aut aere [aut
 5 nummō aereō] aut tāleis ferreis ad certum pondus exāminātis prō nummō. Nāscitur ibi plumbum album in mediterrāneis regiōnibus, in maritimis ferrum, sed ēius exigua³ est cōpia; aere ūtuntur importātō. Māteria cūiusque generis ut in Galliā est praeter fāgum atque abietem. Leporem et
 10 gallinam et ānserem gustāre fās nōn putant;⁴ haec tamen alunt animī voluptātisque causā. Loca sunt temperātiōra quam in Galliā remissiōribus frigoribus.

Shape and Size of the Island.

13. Īnsula nātūrā⁵ triquetra, cūius ūnum latus est contrā Galliam. Hūius lateris alter angulus, quī est ad Cantium,
 15 quō ferē omnēs ex Galliā nāvēs adpelluntur, ad orientem sōlem, inferior ad meridiem spectat.⁶ Hōc latus pertinet circiter milia passuum D. Alterum vergit ad Hispāniam atque occidentem sōlem; quā ex parte est Hibernia, insula dimidiō minor (ut existimātur) quam Britannia, sed parī
 20 spatiō trānsmisus⁷ atque ex Galliā est in Britanniam. In hōc mediō cursū est insula quae appellātur⁸ Mona; complūrēs praetereā minōrēs subiectae⁹ insulae existimantur; dē quibus insulis¹⁰ nōn nulli scripsērunt diēs continuōs xxx sub brūmam esse noctem. Nōs nihil dē eō percontātiōni-
 25 bus¹¹ reperiēbāmus, nisi certis ex aquā mēnsūris breviorēs esse quam in continētī noctis vidēbāmus. Hūius est longitūdō lateris, ut fert¹² illōrum opīniō,¹³ dcc milium. Tertium est contrā septentriōnēs, cui parti nūlla est obiecta¹⁴ terra; sed ēius angulus lateris maximē ad Germā-

Cf. ¹ frequentissima. — ² paria. — ³ parva. — ⁴ arbitrantur. — ⁵ fōrmā. — ⁶ vergit. — ⁷ trāiectūs. — ⁸ nōminātur. — ⁹ propinquae. — ¹⁰ quidam. — ¹¹ quaestiōne. — ¹² est. — ¹³ sententia. — ¹⁴ opposita.

niam spectat. Hōc mīlium passuum DCCC in longitūdinem esse existimātur. Ita omnis īnsula est in circuitū viciēs centum mīlium passuum.

Customs of the Britons.

14. Ex his omnibus longē sunt hūmānissimī quī Cantium incolunt (quae regiō est maritima omnis), neque multum 5
ā Gallicā differunt cōnsuetūdine. Interiōrēs plērīque frū-
menta nōn serunt, sed lacte et carne vivunt pellibusque
sunt vestitī. Omnēs vērō sē Britannī vitrō inficiunt, quod
caeruleum efficit colōrem, atque hōc horridiōrēs sunt in
pūgnā adspectū; capillōque sunt prōmissō¹ atque omni 10
parte corporis rāsā praeter caput et labrum superius.
Uxōrēs habent dēni duodēnique inter sē commūnis, et
maximē frātrēs cum frātribus parentēsque cum liberis; sed
quī sunt ex his nātī eōrum habentur² liberī quō primum
virgō quaeque dēducta est. 15

Battle with the Britons, Who are Driven Back.

15. Equitēs hostium essedāriique ācrit̄er proeliō cum
equitātū nostrō in itinere cōnflīxērunt,³ ita tamen ut nostrī
omnibus partibus superiōrēs fuerint atque eōs in silvās
collisque compulerint; sed complūribus interfectis cupidius
insecūtī nōn nullōs ex suis āmisērunt. At illi intermissō 20
spatiō,⁴ imprudentibus nostris atque occupātis in mūni-
tiōne castrōrum, subitō⁵ sē ex silvis ēiēcērunt, impetūque
in eōs factō quī erant in statiōne prō castris conlocātī,
ācrit̄er pūgnāvērunt; duābusque missis subsidiō cohortibus
ā Caesare, atque his primis legiōnum duārum, cum eae 25
perexiguō⁶ intermissō loci spatiō inter sē cōstitissent, novō
genere⁷ pūgnae perterritis nostris, per mediōs audācissimē
perrūpērunt sēque inde incolumis⁸ recēpērunt. Eō diē Q.

Cf. ¹ longō. — ² existimantur. — ³ contendērunt. — ⁴ tempore. — ⁵ repente. — ⁶ minimō. — ⁷ modō. — ⁸ tūtōs.

Laberius Dūrus tribūnus mīlitum interficitur. Illi plūribus submissis cohortibus repelluntur.

Their Methods of Fighting.

16. Tōtō hōc in genere pūgnæ, cum sub oculis omnium ac prō castris dīmīcārētur, intellēctum est nostrōs propter
5 gravitātem armōrum, quod neque insequī cēdentis¹ possent
neque ab signīs discēdere audērent, minus aptōs² esse ad
hūius generis hostem; equitēs autem māgnō cum periculō
proeliō dīmīcāre, proptereā quod illi etiam cōsultō plē-
rumque cēderent, et cum paulum ab legiōnibus nostrōs
10 remōvissent, ex essedis dēsilirent et pedibus disparī proeliō
contenderent. [Equestris autem proeli ratiō et cēdentibus
et insequentibus pār atque idem periculum inferēbat.] Ac-
cēdēbat hūc ut numquam cōnfertī³ sed rārī māgnisque
intervāllis proeliārentur⁴ statiōnēsque⁵ dispositās habērent,
15 atque aliōs alii deinceps exciperent, integrīque et recentēs
dēfatigātis succēderent.

They are Again Defeated.

17. ⁶Posterō diē procul ā castris hostēs in collibus cōn-
stitērunt, rārīque sē ostendere et lēnius quam prīdiē nostrōs
equitēs proeliō lacessere⁷ coepērunt. Sed meridiē,⁸ cum
20 Caesar pābulandī causā III legiōnēs atque omnem equitā-
tum cum C. Trebōniō lēgātō mīsisset, repente ex omnibus
partibus ad pābulātōrēs advolāvērunt, sic utī ab signīs legi-
ōnibusque nōn absisterent.⁹ Nostrī ācritē in eōs impetū
factō reppulērunt, neque finem sequendī fēcērunt quoad
25 subsidiō cōnfisī equitēs, cum post sē legiōnēs vidērent,
praecipitēs hostēs ēgērunt; māgnōque eōrum numerō inter-
fectō neque suī conligendī neque cōsistendī aut ex essedis

Cf. ¹ sē recipientis, terga vertentis. — ² idōneōs. — ³ dēnsī. — ⁴ dīmīcārēt. — ⁵ subsidia. — ⁶ postrīdiē eius diēi. — ⁷ vexāre. — ⁸ meridiānō tempore. — ⁹ discēderent.

dēsiliendi facultātem¹ dedērunt. Ex hāc fugā prōtinus quae undique² convēnerant auxilia discessērunt; neque³ post id tempus umquam summis nōbiscum cōpiis hostēs contendērunt.

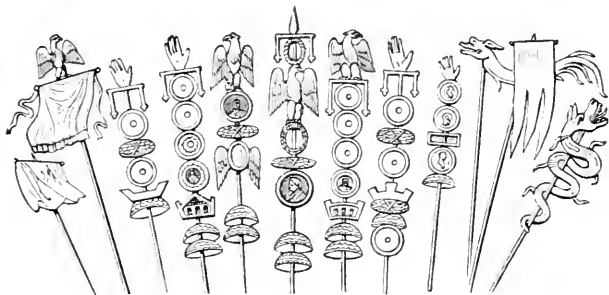

FIG. 70.—SIGNA MILITARIA.

Cæsar Crosses the Thames.

18. Caesar cōgnitō cōnsiliō eōrum ad flūmen Tamesim in finis Cassivellaunī exercitum dūxit; quod flūmen ūnō om- 5
nīnō locō pedibus,⁴ atque hōc aegrē, trānsiri potest. Eō cum vēnisset, animadvertit⁵ ad alteram flūminis rīpam māgnās esse cōpiās hostium instrūctās; rīpa autem erat acūtis sudibus praeifixisque mūnita, eiūsdemque generis sub aquā dēfixae sudēs flūmine tegēbantur. His rēbus cōgnitīs 10
ā captivīs perfugīsque Caesar praemissō equitātū cōnfestim⁶ legiōnēs subsequi iussit. Sed eā celeritāte atque eō impetū militēs iērun, cum capite sōlō ex aquā exstārent, ut hostēs impetum legiōnum atque equitum sustinēre nōn possent rīpāsque dimitterent⁷ ac sē fugae mandārent. 15

Cf. ¹ potestātem. — ² ex omnibus partibus. — ³ postea. — ⁴ vadō. — ⁵ vīdit. — ⁶ continuō. — ⁷ relinquerent.

Cassivellaunus Avoids a General Engagement, but Annoys Cæsar by
Guerilla Tactics.

19. Cassivellaunus, ut suprā dēmōnstrāvimus, omnī dēpositā¹ spē contentiōnis, dimissis ampliōribus² cōpiis, milibus circiter IIII essedāriōrum relictis itinera nostra servābat; paulumque ex viā excēdēbat locisque impeditis ac silvestribus sēsē occultābat atque eis regiōnibus quibus nōs iter factūrōs cōgnōverat pecora atque hominēs ex agris in silvās compellēbat;³ et cum equitātus noster liberius praedandi⁴ vāstandique causā sē in agrōs ēiēcerat, omnibus viis sēmitisque essedāriōs ex silvis ēmittēbat; et māgnō cum periculō nostrōrum equitum cum eis cōnfligēbat⁵ atque hōc metū lātius vagārī prohibēbat. Relinquēbātur ut neque longius ab agmine legiōnum discēdi Caesar paterētur,⁶ et tantum in agris vāstandis incendiisque faciendis hostibus nocērētur quantum *in* labōre atque itinere legiōnārii militēs
15 efficere poterant.

The Trinobantes Yield to Cæsar.

20. Interim⁷ Trinobantes, prope firmissima eārum regiōnum civitās, ex quā Mandubracius adulēscēns Caesaris fidem secūtus ad eum in continentem [Galliam] vēnerat, — cūius pater in eā civitāte rēgnum obtinuerat interfectusque
20 erat ā Cassivellaunō, ipse fugā mortem vitāverat,⁸ — lēgātōs ad Caesarem mittunt pollicenturque sēsē ei dēditūrōs atque imperāta factūrōs: petunt⁹ ut Mandubracium ab iniūriā Cassivellaunī dēfendat, atque in civitātem mittat quī praesit imperiumque¹⁰ obtineat. His Caesar imperat obsidēs XL
25 frūmentumque exercituī, Mandubraciumque ad eōs mittit. Illi imperāta celeriter¹¹ fēcērunt, obsidēs ad numerum frūmentumque misērunt.

Cf. ¹ sublātā. — ² māiōribus. — ³ agēbat. — ⁴ dēpopulandī. — ⁵ pūgnāvit. — ⁶ permitteret. — ⁷ intereā. — ⁸ effūgerat. — ⁹ rogant. — ¹⁰ rēgnum. — ¹¹ cum celeritāte.

Other Tribes also Yield. A British "Oppidum."

21. Trinobantibus dēfēnsis atque ab omnī militum iniuriā prohibitīs, Cēnimāgnī, Segontiācī, Ancalites, Bibrocī, Cassi lēgātiōnibus missis sēsē Caesarī dedunt. Ab his cōgnōscit nōn longē ex eō locō oppidum Cassivellaunī abesse silvis palūdibusque mūnitum, quō satis māgnus 5 hominum pecorisque numerus convēnerit. Oppidum autem Britannī vocant cum silvās impeditās¹ vāllō atque fossā mūniērunt, quō incursiōnis² hostium vitandae causā convenire cōsuērunt. Eō proficiscitur cum legiōnibus; locum reperit³ ēgregiē nātūrā atque opere mūnitum; tamen hunc 10 duābus ex partibus oppūgnāre⁴ contendit. Hostēs paulisper morāti militum nostrōrum impetum nōn tulērunt sēsēque aliā ex parte oppidi ēiēcērunt. Māgnus ibi numerus pecoris repertus, multique in fugā sunt comprehēnsi⁵ atque interfecti. 15

Cassivellaunus at Last Submits.

22. Dum haec in his locis geruntur, Cassivellaunus ad Cantium, quod esse ad mare suprā dēmōnstrāvimus, quibus regiōnibus IIII rēgēs praeerant, Cingetorix, Carvilius, Taximagulus, Segonax, nūntiōs mittit atque his imperat uti coāctis omnibus cōpiis castra nāvālia dē imprōvisō adori- 20 antur atque oppūgnent. Hī cum ad castra vēnissent, nostri ēruptiōne⁶ factā multis eōrum interfectis, captō etiam nōbili duce Lugotorige, suōs incolumis redūxērunt. Cassivellaunus hōc proeliō nūntiātō, tot dētrimentis⁷ acceptis, vāstātis finibus, maximē etiam permōtus dēfectiōne⁸ civitātum, lēgātōs 25 per Atrebātem Commium dē dēditiōne ad Caesarem mittit. Caesar cum cōstituisset hiemāre in continentī propter repentinōs⁹ Galliae mōtūs, neque multum aestātis superesset, atque id facile extrahī¹⁰ posse intellegeret, obsidēs

Cf. ¹ dēnsās. — ² inruptiōnis. — ³ invenit. — ⁴ adoriri. — ⁵ capti. — ⁶ exkursiōne. — ⁷ incommodis. — ⁸ rebelliōne. — ⁹ subitōs. — ¹⁰ prōdūci.

imperat, et quid in annōs singulōs vectigālīs populō Rōmānō Britannia penderet cōstituit. Interdicit atque imperat Cassivellaunō nē Mandubraciō neu Trinobantibus noceat.

Cæsar Returns to Gaul.

23. Obsidibus acceptis exercitum redūcit ad mare, nāvis 5 invenit reffectās. Hīs dēductis,¹ quod et captivōrum māgnū numerum habēbat et ²nōn nullae tempestāte dēperierant

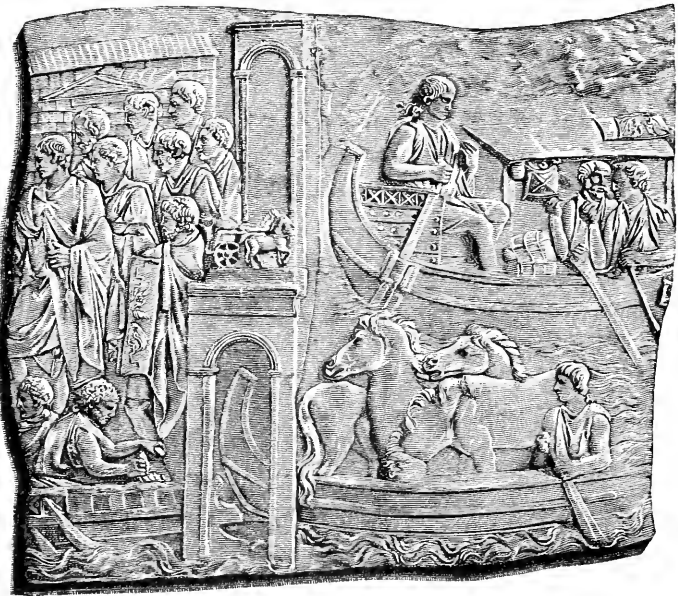

FIG. 71. — ROMAN TRANSPORTS.

nāvēs, duōbus commeātibus exercitum reportāre instituit. Ac sic accidit utī ex tantō nāvium numerō,³ tot nāvigātiōnibus, neque hōc neque superiōre annō ūlla omnīnō nāvis 10 quae militēs portāret dēsiderārētur; ⁴at ex eis quae inānēs

Cf. ¹ opp. subductis. — ² aliquot. — ³ multitudīne. — ⁴ dēperiret.

ex continentī ad eum remitterentur, [et] priōris commeātus expositis militibus, et quās posteā Labiēnus faciendās cūrāverat numerō LX, perpaucae locum caperent; ¹ reliquae ferē omnēs rēicerentur. Quās cum aliquamdiū Caesar frūstrā expectāsset, nē annī tempore ā nāvigātiōne excluderētur, quod aequinoctium suberat, ² necessāriō angustius milites conlocāvit, ac summā tranquillitāte ³ cōsecūtā, secundā initā cum solvisset vigiliā, primā lūce terram attigit ⁴ omnisque incolumis nāvis perdūxit.

On Account of the Scarcity of Supplies, the Army is Widely Distributed for Winter Quarters.

24. Subductis nāvibus conciliōque Gallōrum Samaro- 10
brivae peractō, quod eō annō frūmentum in Galliā propter siccitātis angustius prōvēnerat, coactus est aliter ac ⁵ superioribus annis exercitum in hibernis conlocāre legiōnesque in plūris civitātis distribuere; ⁶ ex quibus ūnam in Morinōs dūcendam C. Fabiō lēgātō dedit, alteram in Nervios Q. 15
Cicerōnī, tertiam in Esviōs L. Rōsciō; quartam in Rēmis cum T. Labiēnō in confiniō ⁷ Trēverōrum hiemāre iussit; trēs in Bellovacis conlocāvit; his M. Crassum et L. Munātium Plancum et C. Trebōnium lēgātōs praefecit. Ūnam legiōnem, quam proximē ⁸ trāns Padum cōscripserat, 20
et cohortis v in Eburōnēs, quōrum pars maxima est inter Mosam ac Rhēnum, qui sub imperiō Ambiorigis et Catuvolci erant, misit. His militibus Q. Titūrium Sabīnum et L. Aurunculēium Cottam lēgātōs praeesse iussit. Ad hunc modum distribūtis legiōnibus facillimē inopiae frūmen- 25
tariae sēsē medēri posse existimāvit. ⁹ Atque hārum tamen omnium legiōnum hiberna, praeter eam quam L. Rōsciō in pācātissimam et quiētissimam partem dūcendam dederat, milibus passuum c continēbantur. Ipse intereā, quoad ¹⁰

Cf. ¹ pervenirent ad. — ² aderat. — ³ malaciā. — ⁴ capit. — ⁵ quam. — ⁶ dividere. — ⁷ finibus. — ⁸ nuper. — ⁹ putavit. — ¹⁰ dum.

legiōnēs conlocātās mūnitaque hiberna cōgnōvisset,¹ in Galliā morārī cōstituit.

Tasgetius, a Friendly Chief, Slain by the Carnutes.

25. Erat in Carnutibus summō locō² nātus Tasgetius, cūius māiōrēs in suā civitāte rēgnum obtinuerant. Huic
5 Caesar prō ēius virtūte atque in sē benevolentīā,³ quod in omnibus bellis singulārī ēius operā fuerat ūsus, māiōrum locum restituerat. Tertium iam hunc annum rēgnantem inimicī palam multis ex civitāte auctōribus interfēcērunt. Dēfertur⁴ ea rēs ad Caesarem. Ille veritus,⁵ quod ad



FIG. 72. — COIN OF L. PLANCUS.

10 plūris pertinēbat, nē civitās⁶ eōrum impulsū dēficeret, L. Plancum cum legiōne ex Belgiō celeriter in Carnutēs proficisci⁷ iubet ibique hiemāre; quōrumque operā cōgnōverit Tasgetium interfectum, hōs comprehēnsōs ad sē mittere. Interim ab omnibus [lēgātis quaestōribusque] quibus
15 legiōnēs trādiderat,⁸ certior factus est in hiberna perventum locumque hibernis esse mūnitum.

Revolt of Ambiorix and Catuvolcus. Sabinus's Camp Attacked.

26. Diēbus circiter xv quibus in hiberna ventum est, initium repentinī tumultūs ac dēfectiōnis⁹ ortum est ab Ambiorige et Catuvolcō; quī, cum ad finis rēgnī suī Sabinō
20 Cottaeque¹⁰ praestō fuissent frūmentumque in hiberna com-

Cf. ¹ intellēxisset. — ² dignitāte. — ³ voluntāte. — ⁴ nūntiātur. — ⁵ metuēns. — ⁶ ab eīs permōta. — ⁷ iter facere. — ⁸ dederat. — ⁹ sēditiōnis. — ¹⁰ adfuissent.

portāvissent,¹ Indūtiomārī Trēverī nūntiis impulsī suōs concitāvērunt subitōque oppressis lignātōribus māgnā manū² ad castra oppūgnanda vērunt. Cum celeriter nostrī arma cēpissent vāllumque adscendissent, atque ūnā ex parte Hispānis equitibus ēmissis equestri proeliō³superiōrēs⁵ fuissent, ⁴dēspērātā rē hostēs suōs ab oppūgnātiōne redūxērunt. Tum suō mōre conclāmāvērunt utī aliquī ex nostrīs ad conloquium prōdīret:⁵ habēre sēsē quae dē rē commūnī dicere vellent, quibus rēbus contrōversiās⁶ minuī posse spērārent.

10

Ambiorix Treacherously Advises Sabinus to Abandon his Camp and Join Cicero or Labienus.

27. Mittitur ad eōs conloquendī causā C. Arpīnēius, eques Rōmānūs, familiāris Q. Titūrī, et Q. Iūnius ex Hispāniā quīdam, quī iam ante missū Caesaris ad Ambiorigem ventitāre cōnsuērat;⁷ apud quōs Ambiorix ad hunc modum locūtus est: ‘Sēsē prō Caesaris in sē beneficiis plūrimum eī¹⁵ cōfitērī dēbēre, quod ēius operā stipendiō liberātus esset quod Aduatucis, finitimis suis, pendere cōsuēsset, quodque eī et filius et frātris filius ab Caesare remissi essent quōs Aduatuci obsidum numerō missōs apud sē in servitūte et catēnis tenuissent; neque id quod fēcerit dē oppūgnātiōne²⁰ castrōrum aut iūdicīō aut voluntāte suā fēcisse, sed⁸ coāctū civitātis; suaque esse ēiusmodī imperia ut nōn minus habēret iūris in sē multitudō quam ipse in multitudinem.

‘Civitātī porrō⁹ hanc fuisse belli causam, quod repentināe Gallōrum coniūrātiōnī resistere nōn potuerit; id sē facile ex²⁵ humilitāte suā probāre posse, quod nōn adeō sit imperītus¹⁰ rērum ut suis cōpiis populum Rōmānum superārī posse cōfidat. Sed esse Galliae commūne cōsiliū; omnibus hibernis Caesaris oppūgnandis hunc esse dictum diem, nē

Cf. ¹ contulissent. — ² cōpiis. — ³ superāssent. — ⁴ spē dēpositā. — ⁵ progredērētur. — ⁶ contentiōnis. — ⁷ solitus erat. — ⁸ ā civitāte coāctus. — ⁹ deinde. — ¹⁰ insciēns.

qua legiō alteri legiōni subsidiō¹ venire posset ; nōn facile Gallōs Gallis negāre potuisse, praesertim cum dē recuperandā² commūni libertāte cōnsilium initum vidērētur.

‘Quibus quoniam prō pietāte satisfēcerit, habēre nunc
5 sē ratiōnem officī prō beneficiis Caesaris ; monēre, orāre³
Titūrium prō hospitiō ut suae ac militum salūtī cōsulat.
Māgnam manum Germānōrum conductam Rhēnum trāns-
isse ; hanc adfore biduō. Ipsōrum esse cōnsilium, velintne
prius quam finitimī sentiant,⁴ ēductōs ex hibernis militēs aut
10 ad Cicerōnem aut ad Labiēnum dēducere, quōrum alter
milia passuum circiter L, alter paulō amplius ab eis absit.
Illud sē pollicēri et iūre iūrando cōfirmāre tūtum sē iter
per suōs finis datūrum ; quod cum faciat, et civitāti sēsē
cōsulere, quod hibernis levētur, et Caesarī prō eius meritis⁵
15 grātiā referre.’ Hāc orātiōne habitā discēdit Ambiorix.

Some of his Officers are Opposed to Such a Movement.

28. Arpinēius et Iūnius quae audierant⁶ ad lēgātōs
dēferunt. Illi repentinā rē perturbātī,⁷ etsī ab hoste ea dicē-
bantur, tamen nōn negligenda⁸ existimābant ; maximēque
hāc rē permovēbantur, quod civitātem ignōbilem atque
20 humilem Eburōnum suā sponte populō Rōmānō bellum
facere ausam vix erat crēdendum. Itaque ad cōnsilium
rem dēferunt māgnaque inter eōs existit contrōversia.⁹
L. Aurunculēius complūrēsque¹⁰ tribūnī militum et primōrum
ōrdinum centuriōnēs nihil temerē agendum, neque ex
25 hibernis iniūssū Caesaris discēdendum existimābant ; quan-
tāsvis [māgnās] cōpiās etiam Germānōrum sustinēri¹¹ posse
mūnitis hibernis docēbant ; rem esse testimōniō, quod
primum hostium impetum multis ultrō¹² vulneribus inlātis
fortissimē sustinuerint ; rē frūmentāriā nōn premi ;¹³ interea

Cf. ¹ auxiliō. — ² recipienda. — ³ obsecrāre. — ⁴ intellegant. — ⁵ beneficiis. — ⁶ cōgnōverant. — ⁷ permōtī. — ⁸ praetermittenda. — ⁹ disputātiō. — ¹⁰ plēriquet. — ¹¹ resistī, w. dat. — ¹² praeterea. — ¹³ urgēri.

et ex proximis hibernis et a Caesare conventura subsidia ;
postrēmō, quid esse levius aut turpius quam auctore hoste
de summis rebus capere¹ cōsiliū?

But Sabinus Argues in Favor.

29. Contrā ea Titūrius ‘Sērō factūrōs’ clāmitābat, ‘cum
māiōrēs manūs hostium adiūctis Germānis convēnissent, aut 5
cum aliquid calamitātis² in proximis hibernis esset accep-
tum ; brevem cōsulendī esse occāsionem.³ Caesarem sē
arbitrārī profectum in Ītaliā ; neque aliter Carnutēs inter-
ficiendī Tasgetī cōsiliū fuisse captūrōs, neque Eburōnēs,
sī ille adesset, tantā contemptiōne nostrī ad castra ventū- 10
rōs esse. Sēsē nōn hostem auctorem sed rem spectāre ;
subesse⁴ Rhēnum ; māgnō esse Germānis dolōri Ariovisti
mortem et superiōrēs nostrās victōriās ; ārdēre⁵ Galliam tot
contumēliis⁶ acceptis sub populī Rōmāni imperium redāc-
tam, superiōre glōriā rei militāris exstinctā. Postrēmō, 15
quis hōc sibi persuādēret sine certā spē Ambiorigem ad
ēiusmodi cōsiliū dēscendisse? Suam sententiam in
utramque partem esse tūtā : sī nihil esset dūrius,⁷ nūllō
cum periculō ad proximam legiōnem perventūrōs ; sī Gallia
omnis cum Germānis cōsentiret,⁸ ūnam esse in celeritāte 20
positam salūtem. Cottae quidem atque eōrum quī dissentī-
rent cōsiliū quem habēre exitum? in quō sī nōn prae-
sēns periculū, at certē longinquā obsidiōne famēs esset
timenda.’

Cotta Throws the Responsibility upon Sabinus.

30. Hāc in utramque partem disputātiōne⁹ habitā, cum 25
ā Cottā primisque ōrdinibus ācritē resisterētur, “Vincite,”
inquit, “sī ita vultis,” Sabīnus, et id clāriōre¹⁰ vōce, ut

Cf. ¹ inire. — ² incommodi. — ³ spatium. — ⁴ prope esse. — ⁵ cōn-
flagrāre. — ⁶ indignitātibus. — ⁷ gravius. — ⁸ cōspirāret. — ⁹ contrō-
versiā. — ¹⁰ māiōre.

māgna pars militum exaudiret; “neque is sum,” inquit, “quī gravissimē¹ ex vōbīs mortis periculō terrear: hī sapient; sī gravius quid acciderit, abs tē ratiōnem repescant; quī, si per tē liceat, ²perendinō diē cum proximis
5 hibernis coniūctī commūnem cum reliquīs belli cāsum sustineant, nōn rēiectī et relēgātī longē ab cēteris aut ferrō aut fame intereant.”

Sabinus Prevails, and the Army Marches Out of Camp.

31. Cōnsurgitur ex cōnsiliō; comprehendunt utrumque et ōrant ‘Nē suā dissēnsiōne³ et pertināciā rem in summum
10 periculum dēdūcant; facilem esse rem, seu maneant⁴ seu proficiscantur,⁵ sī modo ūnum omnēs sentiant ac probent; contrā in dissēnsiōne nūllam sē salutem perspicere.’ Rēs disputātiōne ad mediam noctem perdūcitur. Tandem dat Cotta permōtus manūs; superat sententia Sabīnī. Prōnūn-
15 tiātur primā lūce itūrōs. Cōnsūmitur vigiliīs reliqua pars noctis, cum sua quisque miles circumspiceret, quid sēcum portāre posset, quid ex instrūmentō hibernōrum relinquere cōgerētur. [Omnia excōgitantur quā rē nec sine periculō maneātur et languōre⁶ militum et vigiliīs periculum auge-
20 ātur.] Primā lūce sic ex castris proficiscuntur ut quibus esset persuāsum nōn ab hoste sed ab homine amīcissimō [Ambiorige] cōnsilium datum, longissimō agmine maximisque impedimentis.

They are Suddenly Attacked in a Narrow Defile.

32. At hostēs, posteā quam ex nocturnō fremitū⁷ vigili-
25 isque dē profectiōne eōrum sēnsērunt, conlocātis insidiis bipartitō in silvis opportunō⁸ atque occultō locō ā milibus passuum circiter duōbus Rōmānōrum adventum expectābant; et cum sē māior pars agminis in māgnam convallem

Cf. ¹vehementissimē. — ²bīduō. — ³contrōversiā. — ⁴morentur. — ⁵discēdant. — ⁶lassitūdine. — ⁷clāmōre. — ⁸idōneō.

dēmīssisset,¹ ex utrāque parte ēius vallis subitō² sē ostendē-
runt novissimōsque premere et primōs prohibēre adscēnsū
atque iniquissimō³ nostris locō proelium committere coe-
pērunt.

Sabinus Loses his Self-possession. Cotta Does Nobly, but Makes a Fatal Mistake.

33. Tum dēmum Titūrius, quī nihil ante prōvidisset, tre- 5
pidāre et concursāre cohortisque dispōnere,⁴ haec tamen
ipsa timidē atque ut eum omnia dēficere vidērentur; quod
plērumque eīs accidere⁵ cōsuēvit quī in ipsō negotiō⁶



FIG. 73. — HOLLOW SQUARE (*agmen quadratum*).

cōnsilium capere cōguntur. At Cotta, quī cōgitāset haec
posse in itinere accidere atque ob eam causam profectiōnis 10
auctor nōn fuisset, nullā in rē commūnī salutī deerat, et in
appellandis cohortandisque militibus imperātōris et in pūgnā
militis officia⁷ praestābat. Cum propter longitūdinem ag-
minis nōn facile per sē omnia obire et quid quōque locō
faciendum⁸ esset prōvidēre possent, iussērunt prōnūtiārī 15
ut impedimenta relinquerent atque in orbem cōsisterent.

Cf. ¹ dēscendissent. — ² exstitērunt. — ³ aliēnissimō. — ⁴ distribu-
ere. — ⁵ ēvenīre. — ⁶ discrīmine. — ⁷ mūnera. — ⁸ agendum.

Quod cōnsilium, etsi in ēiusmodi cāsū¹ reprehendendum nōn est, tamen incommodē² cecidit; nam et nostris militibus spem minuit³ et hostis ad pūgnam alacriōrēs effēcit, quod nōn sine summō timōre⁴ et dēspērātiōne id factum
5 vidēbātur. Praetereā accidit,⁵ quod fieri necesse erat, ut volgō militēs ab signis discēderent, quaeque quisque eōrum cārissima habēret ab impedimentis petere atque abripere properāret; ⁶ clāmōre et flētū omnia complērentur.

Policy of Ambiorix.

34. At barbaris cōnsilium nōn dēfuit.⁷ Nam ducēs eō-
10 rum tōtā aciē prōnūntiārī iussērunt nē quis ab locō discēderet; illōrum esse praedam atque illis reservārī quaecumque Rōmānī reliquissent; proinde omnia in victōriā posita existimārent. [Erant et virtūte et numerō pūgnandō parēs.] Nostrī tametsi ab duce et ā fortūnā dēserēbantur, tamen
15 omnem spem salūtis in virtūte pōnēbant; et quotiēns quaeque cohors prōcurrerat, ab eā parte māgnus numerus hostium cadēbat.⁸ Quā rē animadversā Ambiorix prōnūntiārī iubet ut procul tēla coniciant neu propius accēdant, et quam in partem Rōmānī impetum fēcerint cēdant [levitāte armō-
20 rum et cotidiānā exercitātiōne nihil his nocērī posse], rūsus sē ad signa recipientis insequantur.

The Fight Continues, the Romans Continually Worsted.

35. Quō praeceptō ab eis diligentissimē observātō, cum quaequam cohors ex orbe excesserat atque impetum fēcerat, hostēs vëlōcissimē⁹ refugiēbant. Interim eam partem
25 nūdārī necesse erat et ab latere apertō tēla recipere. Rūsus, cum in eum locum unde ¹⁰erant prōgressi reverti coeperant, et ab eis quī cesserant¹¹ et ab eis quī proximi

Cf. ¹ discrimine. — ² male. — ³ detrāxit, opp. auxit. — ⁴ metū. — ⁵ fiēbat. — ⁶ contenderet. — ⁷ dēfēcit. — ⁸ occidēbat. — ⁹ celerrimē. — ¹⁰ exierant. — ¹¹ terga verterant, fugam petierant.

steterant circumveniēbantur; sin autem locum tenēre vel-
 lent, nec virtūti locus¹ relinquerētur neque ab tantā multi-
 tudine coniecta tēla cōfertī vitāre poterant. Tamen tot
 incommodis cōfliktātī,² multis volneribus acceptis resistē-
 bant;³ et māgnā parte diēi cōsūptā, cum ā primā lūce 5
 ad hōram octāvam pūgnārētur, nihil quod ipsis esset indig-
 num committēbant.⁴ Tum T. Balventiō, qui superiōre annō
 primum pilum dūxerat, virō fortī et māgnae auctōritātis,
 utrumque femur trāgulā trāicitur;⁵ Q. Lūcānius, eiusdem
 ordinis, fortissimē pūgnāns, dum circumventō filiō subvenit,⁶ 10
 interficitur; L. Cotta lēgātus omnis cohortis ordinēsque
 adhortāns in adversum ōs fundā volnerātur.

Sabinus Seeks an Interview with Ambiorix.

36. His rēbus permōtus Q. Titūrius, cum procul Ambio-
 rigem suōs cohortantem cōspexisset, interpretem suum Cn.
 Pompēium ad eum mittit rogātum⁷ ut sibi militibusque par- 15
 cat.⁸ Ille appellātus⁹ respondet: ‘Sī velit sēcum conloquī,
 licēre; spērāre ā multitudīne impetrārī posse quod ad mili-
 tum salūtem pertineat; ipsi vērō nihil nocitum irī, inque
 eam rem sē suam fidem interpōnere.’ Ille cum Cottā sau-
 ciō commūnicat, sī videātur, pūgnā ut excēdant et cum 20
 Ambiorige ūnā conloquantur: spērāre sē ab eō dē suā ac
 militum salūte impetrārī posse. Cotta sē ad armātum ho-
 stem itūrum negat atque in eō persevērat.¹⁰

He is Treacherously Slain. The Army Utterly Defeated. Few Escape.

37. Sabinus quōs¹¹ in praesentiā tribūnōs militum circum
 sē habēbat et primōrum ordinum centuriōnēs sē sequī iubet; 25
 et, cum propius Ambiorigem accessisset, iūssus arma ab-
 icere,¹² ¹³imperātum facit suisque ut idem faciant imperat.

Cf. ¹ occāsio. — ² exagitātī. — ³ repūgnābant. — ⁴ admittēbant. —
⁵ trānsfigitur. — ⁶ auxilium fert. — ⁷ petītum. — ⁸ clēmētiā ūtātur in.
 — ⁹ invītātus. — ¹⁰ perstat. — ¹¹ illō tempore. — ¹² dēpōnere. — ¹³ pāret.

Interim, dum dē condiōnibus inter sē agunt longiorque cōsultō ab Ambiorīge instituitur sermō, paulātim circumventus interficitur. Tum vērō suō mōre victōriam conclāmant atque ululātum tollunt, impetūque in nostrōs factō
 5 ōrdinēs perturbant. Ibi L. Cotta pūgnāns interficitur cum maximā parte militum. Reliquī sē in castra recipiunt unde erant ēgressī; ex quibus L. Petrosidius aquilifer, cum māgnā multitudīne hostium premerētur,¹ aquilam intrā vāllum prōicit, ipse prō castris fortissimē pūgnāns occīditur. Illi
 10 aegrē² ad noctem oppūgnātiōnem sustinent; nocte ad ūnum omnēs dēspērātā salūte sē ipsī interficiunt. Paucī ex proeliō ēlāpsi incertis itineribus per silvās ad T. Labiēnum lēgātum in hiberna perveniunt atque eum dē rēbus gestis certiorē faciunt.

Ambiorix Persuades the Aduatuci and Nervii to Join the Revolt.

15 **38.** Hāc victōriā sublātus³ Ambiorix statim cum equitātū in Aduatucōs, quī erant ēius rēgnō finitimī,⁴ proficiscitur; neque noctem neque diem intermittit⁵ peditātumque sē subsequī iubet. Rē dēmōstrātā Aduatucisque concitātis, posterō diē in Nervios pervenit, hortāturque nē suī in
 20 perpetuum liberandī atque ulciscendī Rōmānōs prō eis quās accēperint iniūriis occāsiōnem dīmittant;⁶ interfectōs esse lēgātōs duōs māgnamque partem exercitūs interisse⁷ dēmōstrat; nihil esse negōtī subitō oppressam legiōnem quae cum Cicerōne hiemet interfici; sē ad eam rem profitētur
 25 adiūtōrem. Facile hāc ōrātiōne Nervii persuādet.

A Large Force Attacks the Camp of Q. Cicero.

39. Itaque cōfestim⁸ dīmissis nūntiis ad Ceutronēs, Grudiōs, Levacōs, Pleumoxiōs, Geidumnōs, quī omnēs sub eōrum imperiō sunt, quam maximās possunt manūs cōgunt,

Cf. ¹ urgērētur. — ² vix. — ³ ēlātus. — ⁴ proximī. — ⁵ morātur. — ⁶ āmittant. — ⁷ periisse. — ⁸ statim.

et de improvisō ad Cicerōnis hiberna advolant,¹ nōndum ad eum famā de Titūrī morte perlātā. Huic quoque accidit, quod fuit necesse, ut nōn nulli militēs, qui² lignatiōnis mūnitiōnisque causā in silvās discessissent, repentinō equitum adventū interciperentur. His circumventis, māgnā 5



FIG. 74. — ROMAN CAMP ASSAULTED.

manū Eburōnēs, Nervii, Aduatuci atque hōrum omnium socii et clientēs legiōnem oppugnāre incipiunt. Nostri celeriter ad arma concurrunt, vāllum cōscendunt. Aegrē is diēs sustentātur, quod omnem spem hostēs in celeritāte pōnēbant atque hanc adepti victōriam³ in perpetuum sē fore victōrēs cōfidēbant.

Cicero Makes Vigorous Preparations for Resistance.

40. Mittuntur ad Caesarem cōnfestim ab Cicerōne litterae, māgnis prōpositis⁴ praemiis si pertulissent; obsessis

Cf. ¹ properant. — ² māteriandī. — ³ semper. — ⁴ cōstitutis.

omnibus viis missi intercipiuntur.¹ Noctū ex materiā quam mūnitiōnis causā comportāverant turrēs admodum cxx excitantur² incredibili celeritate; quae deesse operi vidēbantur perficiuntur. Hostēs posterō diē multō māiōribus coactis
 5 cōpiis castra oppūgnant, fossam complent. Ā nostris eādem ratiōne³ quā prīdiē resistitur: hōc idem reliquīs deinceps fit diēbus. Nulla pars nocturni temporis ad labōrem intermittitur; nōn aegris, nōn volnerātis facultās quiētis datur. Quaecumque ad proximī diēi oppūgnatiōnem opus sunt
 10 noctū comparantur; multae praeūstae sudēs, māgnus mūrālium pilōrum numerus instituitur;⁴ turrēs contabulantur;⁵ pinnae lōricaeque ex crātibus attexuntur. Ipse Cicerō, cum tenuissimā⁶ valētūdine esset, nē nocturnum quidem sibi tempus ad quiētem relinquēbat, ut ultrō militum concursū ac
 15 vōcibus sibi parcere cōgerētur.

The Nervian Chiefs Try to Persuade Cicero to Retire. He Refuses.

41. Tunc ducēs principēsque Nerviorum, qui aliquem sermōnis aditum causamque amicitiae cum Cicerōne habēbant, conloquī sēsē velle dicunt. Factā potestāte,⁷ eadem quae Ambiorix cum Tituriō ēgerat commemorant: ‘Omnem
 20 esse in armis Galliam, Germānōs Rhēnum trānsisse, Caesaris reliquōrumque⁸ hiberna oppūgnārī.’ Addunt etiam dē Sabini morte; Ambiorigem ostentant fidei faciendae causā. Errāre eōs dicunt, si quicquam ab eīs praesidi spērent qui suis rēbus diffidant; sēsē tamen hōc esse in Cicerōnem
 25 populūque Rōmānum animō ut nihil nisi hiberna recūsant, atque hanc inveterāscere⁹ cōnsuetūdinem nōlint; licēre illis per sē incolumibus¹⁰ ex hibernis discēdere¹¹ et quāscumque in partis velint sine metū proficisci. Cicerō ad haec ūnum modo respondet: ‘Nōn esse cōnsuetūdinem¹² populī Rō-

Cf. ¹ dēprehenduntur. — ² cōstituuntur. — ³ modō. — ⁴ comparātur. — ⁵ excitantur. — ⁶ aegerrimā. — ⁷ facultāte. — ⁸ ceterōrum. — ⁹ cōnfirmārī. — ¹⁰ tūtīs. — ¹¹ ēgredi. — ¹² mōrem.

mānī accipere ab hoste armātō condiōnem; sī ab ¹armis discēdere velint, sē adiūtōre ūtantur lēgātōsque ad Caesarem mittant; spērāre sē prō eīus iūstitiā quae petierint impetrātūrōs.⁷

They Lay Siege to the Camp.

42. Ab hāc spē repulsi Nervii vāllō pedum x et fossā 5
pedum quīdecim hiberna cingunt. Haec et superiōrum
annōrum cōnsuētūdine ā nōbis cōgnōverant² et quōsdam
dē exercitū nacti captivōs ab his docēbantur; sed nullā
ferrāmentōrum cōpiā quae essent ad hunc ūsum idōnea,³
gladiis caespitēs circumcidere, manibus sagulisque terram 10
exhaurire ⁴cōgēbantur. Quā quidem ex rē hominum mul-
titudō cōgnōsci potuit; nam minus hōris tribus milium pas-
suum xv in circuitū mūnitiōnem⁵ perfēcērunt. ⁶Reliquisque
diēbus turris ad altitudinē vālli, falcis testudinēsque, quas
iidem captivi docuerant, parāre ac facere coepērunt. 15

They Make a Furious Assault, Which is Gallantly Resisted.

43. Septimō oppūgnātiōnis diē maximō coörtō ventō fer-
ventis fūsilēs ex argillā glandis fundis et fervefacta iacula⁷
in casās, quae mōre Gallicō strāmentis erant tēctae, iacere
coepērunt. Hae celeriter ignem comprehendērunt et venti
māgnitūdine in omnem locum⁸ castrōrum distulērunt. Hos- 20
tēs maximō clāmōre, sic uti partā iam atque explōrātā vic-
tōriā, turris testudinēsque agere et scālis vāllum adscendere
coepērunt. At tanta militum virtūs⁹ atque ea praesentia
animī fuit ut, cum undique flammā torrērentur maximāque
tēlōrum multitudīne premerentur suaque omnia impedi- 25
menta atque omnis fortūnās cōnflagrāre¹⁰ intellegerent,¹¹ nōn
modo [dēmigrandi causā] dē vāllō dēcēderet nēmō, sed

Cf. ¹bellum relinquere. — ²didicerant. — ³apta. — ⁴effodere et exportāre. — ⁵mūnimentum. — ⁶postea. — ⁷tela. — ⁸partem. — ⁹fortitūdō. — ¹⁰ardere. — ¹¹sentirent.

paene¹ nē respiceret quidem quisquam; ac tum omnēs ācerrimē fortissimēque pūgnārent. Hic diēs nostris longē gravissimus fuit; sed tamen hunc habuit ēventum ut eō diē maximus numerus hostium volnerārētur atque interficerētur, 5 ut sē sub ipsō vāllō cōnstipāverant² recessumque primīs ultimī nōn dabant. Paulum quidem intermissā flammā et quōdam locō turrī adāctā et contingente vāllum, tertiæ

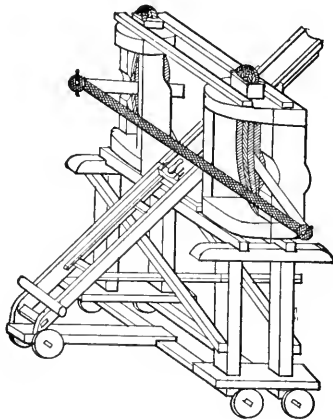

FIG. 75. — BALLISTA.

cohortis centuriōnēs ex eō quō stābant locō recessērunt³ suōsque omnīs remōvērunt; nūtū vōcibusque hostēs si introire vellent vocāre coepērunt, quōrum prōgredi ausus est nēmō. Tum ex omnī parte lapidibus coniectis dēturbātī⁴ turrisque succēnsa est.

Rivalry of Two Centurions.

44. Erant in eā legiōne fortissimī viri, centuriōnēs, qui iam primīs ōrdinibus adpropinquārent, T. Pullō et L. Vorē-

Cf. ¹ ferē. — ² cōnfererant. — ³ sē recēpērunt. — ⁴ dēpulsī.

nus. Hī perpetuās inter sē contrōversiās¹ habēbant uter
 alterī anteferrētur, omnibusque annis dē locō summīs simul-
 tātibus contendēbant. Ex hīs Pullō, cum ācerrimē ad
 mūnitiōnēs pūgnārētur, “Quid dubitās,” inquit, “Vorēne?
 aut quem locum² tuae probandae virtūtis exspectās? Hic 5
 diēs dē nostris contrōversiis iūdicābit.” Haec cum dixisset,
 prōcēdit³ extrā mūnitiōnēs, quāque pars hostium cōnfertis-
 sima est vīsa inrumpit. Nē Vorēnus quidem sēsē tum vāllō
 continet, sed omnium veritus exīstimātiōnem⁴ subsequitur.
 Mediocrī spatiō relictō Pullō pīlum in hostis immittit⁵ atque 10
 ūnum ex multitudīne prōcurrentem trāicit; ⁶ quō percussō
 et exanimātō hunc scūtis prōtegunt⁷ hostēs, in illum ūniversī
 tēla coniciunt neque dant prōgrediendī facultātem. Trāns-
 figitur scūtum Pullōnī et verūtum in balteō dēfigitur. Āver-
 tit hīc cāsus vāginam et gladium ēdūcere cōnantī dextram 15
 morātur⁸ manum, impeditumque hostēs circumstant. Suc-
 currit inimīcus illi Vorēnus et labōranti⁹ subvenit. Ad hunc
 sē cōnfestim ā Pullōne omnis multitudō convertit; [illum
 verūtō trānsfixum arbitrantur]. Gladiō cominus¹⁰ rem
 gerit Vorēnus atque ūnō interfectō reliquōs paulum prō- 20
 pellit; dum cupidius instat, in locum dēiectus inferiōrem con-
 cidit. Huic rūsus circumventō subsidium fert Pullō, atque
 ambō incolumēs complūribus interfectīs summā cum laude
 sēsē intrā mūnitiōnēs recipiunt. Sic fortūna in contentiōne
 et certāmine utrumque versāvit ut alter alterī inimicus auxi- 25
 liō salūtique esset, neque diūdicārī posset uter utrī virtūte
 anteferendus vidērētur.

Efforts to Inform Cæsar of the Danger.

45. Quantō erat in diēs gravior atque asperior oppūgnā-
 tiō, et maximē quod māgnā parte militum cōnfectā¹¹ vol-

Cf. ¹ dissēnsiōnēs. — ² occāsiōnem. — ³ prōgreditur. — ⁴ opiniōnem.
 — ⁵ conicit. — ⁶ trānsfigit. — ⁷ dēfendunt. — ⁸ impedit. — ⁹ pressō. —
¹⁰ pūgnat. — ¹¹ dēfessā, ĩnfirmā; opp. validā.

neribus rēs ad paucitātem dēfēnsōrum¹ pervēnerat, tantō crēbriōrēs litterae nūntiique ad Caesarem mittēbantur; quōrum pars dēprehēnsa in cōspectū nostrōrum militum cum cruciātū necābātur. Erat ūnus intus Nervius nōmine
 5 Verticō, locō nātus² honestō, quī ā primā obsidiōne ad Cicerōnem perfūgerat³ suamque eī fidem⁴ praestiterat. Hīc servō spē libertātis māgnisque persuādet praemiis ut litterās ad Caesarem dēferat. Hās ille in iaculō inligātās effert, et Gallus inter Gallōs sine ūllā suspīciōne versātus ad
 10 Caesarem pervenit. Ab eō dē periculis Cicerōnis legiōnisque cōgnōscitur.⁵

Cæsar Immediately Sends Messages to his Lieutenants.

46. Caesar acceptis litteris hōrā circiter xi diēi statim nūntium in Bellovacōs ad M. Crassum mittit, cūius hiberna aberant ab eō milia passuum xxv; iubet mediā nocte
 15 legiōnem proficisci celeriterque ad sē venire. Exit⁶ cum nūntiō Crassus. Alterum ad C. Fabium lēgātum mittit, ut in Atrebātium finis legiōnem addūcat, quā sibi iter faciendum sciēbat. Scribit Labiēnō, sī rei pūblicae commodō facere possit, cum legiōne ad finis Nerviorum veniat; reli-
 20 quam partem exercitūs, quod paulō aberat longius, nōn putat exspectandam; equitēs circiter cccc ex proximīs hibernis conligit.⁷

Crassus Meets him; Labienus Thinks it Best to Stay Where he is.

47. Hōrā circiter tertiā ab antecursōribus⁸ dē Crassī adventū certior factus, eō diē milia passuum xx prōgreditur. Crassum Samarobrivae praeficit⁹ legiōnemque eī
 25 attribuit,¹⁰ quod ibi impedimenta exercitūs, obsidēs civitātum, litterās pūblicās, frumentumque omne quod eō tolerandae hiemis causā dēvexerat¹¹ relinquebat. Fabius, ut imperā-

Cf. ¹ prōpūgnātōrum. — ² ortus. — ³ cōnfūgerat. — ⁴ officium. — ⁵ reperit. — ⁶ abit. — ⁷ cōgit. — ⁸ explorātōribus. — ⁹ praepōnit. — ¹⁰ tradidit. — ¹¹ dēportāverat.

tum erat, nōn ita multum morātus¹ in itinere cum legiōne occurrit. Labiēnus interitū² Sabīni et caede³ cohortium cōgnitā, cum omnēs ad eum Trēverōrum cōpiae vēnissent, veritus nē, sī ex hibernis fugae similem profectiōnem fēcisset, hostium impetum sustinēre nōn posset, praesertim quōs 5 recentī victōriā efferri sciret, litterās Caesari remittit quantō cum periculō legiōnem ex hibernis ēductūrus esset; rem gestam in Eburōnibus perscribit; docet omnis equitātūs peditātūsque cōpiās Trēverōrum III milia passuum longē ab suis castris cōnsēdisse.⁴ 10

How a Letter is Conveyed to Cicero.

48. Caesar cōnsiliō ēius probātō, etsi opiniōne trium legiōnum dēiectus⁵ ad duās reciderat, tamen ūnum commūni salūtī auxilium in celeritatē pōnēbat. Vēnit māgnis itineribus in Nerviōrum finis. Ibi ex captivīs cōgnōscit⁶ quae apud Cicerōnem gerantur quantōque in periculō rēs sit. 15 Tum cuidam ex equitibus Gallis māgnis praemiis persuādet utī ad Cicerōnem epistulam⁷ dēferat. Hanc Graecis cōscriptam litteris mittit, nē interceptā epistolā nostra ab hostibus cōnsilia cōgnōscantur. Sī adire nōn possit, monet ut trāgulam cum epistolā ad āmentum dēligātā⁸ intrā 20 mūnitiōnēs castrōrum abiciat. In litteris scribit sē cum legiōnibus profectum celeriter adfore; hortātur ut pristinam virtūtem retineat.⁹ Gallus periculum veritus, ut erat praeceptum,¹⁰ trāgulam mittit. Haec cāsū ad turrim adhaesit, neque ab nostris bīduō animadversa,¹¹ tertiō diē ā quōdam 25 milite cōspicitur; dēmp̄ta ad Cicerōnem dēfertur. Ille perlēctam in conventū militum recitat maximāque omnis laetitīā adfcit. Tum fūmī incendiōrum¹² procul¹³ vidēbantur, quae rēs omnem dubitātiōnem adventūs legiōnum expulit.¹⁴

Cf. ¹ cunctātus. — ² morte. — ³ interneciōne. — ⁴ castra posuisse. — ⁵ lāpsus. — ⁶ comperit. — ⁷ litterās. — ⁸ inligātā. — ⁹ servet. — ¹⁰ imperātum. — ¹¹ vīsa. — ¹² ignium. — ¹³ opp. prope. — ¹⁴ sustulit.

The Gauls Abandon the Siege and March against Cæsar, Who Avoids a Conflict.

49. Galli rē cōgnitā per explōrātōrēs obsidiōnem relinquunt;¹ ad Caesarem omnibus cōpiis contendunt; haec erant armāta circiter milia LX. Cicerō datā facultāte Gallum ab eōdem Verticōne quem suprā dēmōnstrāvimus repetit qui
 5 litterās ad Caesarem dēferat;² hunc admonet iter cautē diligenterque faciat; perscribit in litteris hostis ab sē discessisse omnemque ad eum multitudinem convertisse. Quibus litteris circiter mediā nocte Caesar adlātis suōs facit certiorēs eōsque ad dimicandum animō cōfirmat.³ Posterō
 10 diē lūce primā movet castra, et circiter milia passuum IIII prōgressus trāns vallem et rīvum multitudinem hostium cōspicātur. Erat māgnī periculī rēs tantulis⁴ cōpiis iniquō⁵ locō dimicāre; tum, quoniam obsidiōne liberātum Cicerōnem sciēbat, aequō animō remittendum dē celeritāte existimābat.
 15 Cōnsidit et quam aequissimō potest locō castra commūnit. Atque haec, etsi erant exigua⁶ per sē, vix hominum milium VII, praesertim nullis cum impedimentis, tamen angustiis viārum quam maximē potest contrahit, eō cōnsiliō ut in summam contemptiōnem hostibus veniat. Interim
 20 speculātōribus⁷ in omnis partis dimissis explōrat⁸ quō commodissimē itinere vallem trānsire possit.

Cæsar, Feigning Fear, Draws the Enemy on to his Own Ground.

50. Eō diē parvulis equestribus proeliis ad aquam factis utrique sēsē suō locō continent: Galli, quod ampliōrēs⁹ cōpiās quae nōndum convēnerant exspectābant; Caesar, si
 25 forte timōris simulātiōne hostis in suum locum ēlicere posset, ut citrā vallem prō castris proeliō contenderet; si id efficere nōn posset, ut explōrātis itineribus minōre cum

Cf. ¹ dēsistunt, w. abl. — ² referat. — ³ excitat. — ⁴ tam exiguis. — ⁵ aliēnō. — ⁶ parva. — ⁷ explōrātōribus. — ⁸ cōgnōscit. — ⁹ māiōrēs.

periculō vallem rīvumque trānsīret.¹ Primā lūce hostium equitātus ad castra accēdit² proeliumque cum nostris equitibus committit. Caesar cōsultō equitēs cēdere³ sēque in castra recipere iubet; simul ex omnibus partibus castra altiōre vāllō mūniri portāsque obstruī atque in hīs 5 administrandīs⁴ rēbus quam maximē concursārī et cum simulātiōne agī timōris iubet.

In the Attack which Follows the Enemy are Routed.

51. Quibus omnibus rēbus hostēs invitātī⁵ cōpiās trādūcunt aciemque inīquō locō cōstituunt; nostris vērō etiam dē vāllō dēductis propius accēdunt et tēla intrā mūnitiōnem 10 ex omnibus partibus coniciunt praecōnibusque circummissis prōnūntiārī iubent, seu quis Gallus seu Rōmānus velit ante hōram tertiam ad sē trānsire, sine periculō licēre; post id tempus nōn fore potestātem. Ac sic nostrōs contempserunt ut obstrūctis in speciem portis singulis ōrdinibus caespitum, 15 quod eā nōn posse intrōrumpere vidēbantur, aliī vāllum manū scindere, aliī fossās complēre inciperent. Tum Caesar omnibus portis ēruptiōne factā equitātūque ēmissō celeriter hostis in fugam dat, sic utī omninō pūgnandī causā resisteret nēmō; māgnūque ex eis numerum occidit atque omnīs 20 armīs exiit.

Cæsar Reaches the Camp of Cicero and Congratulates him and his Men on their Gallant Defense.

52. Longius prōsequī veritus, quod silvae palūdēsque intercēdēbant [neque etiam parvulō dētrimentō illōrum locum relinqui vidēbat], omnibus suis incolumibus eōdem diē ad Cicerōnem pervēnit. Īnstitūtās⁶ turrīs, testūdīnēs 25 mūnitiōnēsque hostium admirātur; prōductā legiōne cōgnōscit nōn decimum quemque esse reliquum militem sine

Cf. ¹ trānsgrederētur. — ² adgreditur. — ³ pedem referre. — ⁴ gendīs. — ⁵ adlectī. — ⁶ exstrūctās.

volnere. Ex his omnibus iūdicat¹ rēbus quantō cum periculō et quantā virtūte rēs sint administrātae.² Cicerōnem prō ēius meritō legiōnemque conlaudat; centuriōnēs singillātīm tribūnōsque militum appellat, quōrum ēgregiam³ fuisse virtūtem testimōniō Cicerōnis cōgnōverat. Dē cāsū Sabīnī et Cottae certius ex captivīs cōgnōscit.⁴ Posterō diē contiōne habitā rem gestam prōpōnit, militēs cōnsolātur et cōfirmat; quod dētrimentum⁵ culpā et temeritāte lēgātī sit acceptum, hōc aequiōre animō ferendum docet, quod, 10 beneficiō deōrum immortalīum et virtūte eōrum expiātō⁶ incommodō, neque hostibus diūtina⁷ laetitia neque ipsis longior dolor relinquitur.

Indutiomarus Defers his Intended Attack on Labienus. All Signs Point to a General Uprising of the Gauls, so that Cæsar Decides to Spend the Winter with his Army.

53. Interim ad Labiēnum per Rēmōs incrdibili celeritāte dē victōriā Caesaris fāma perfertur, ut, cum ab hibernīs 15 Cicerōnis milia passuum abesset circiter sexāgintā, eōque post hōram nōnam diēi Caesar pervēnisset, ante mediam

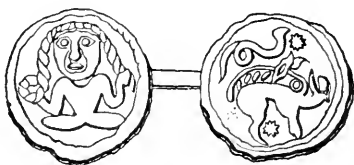

FIG. 76. — GALLIC COIN.

noctem ad portās castrōrum clāmor orirētur, quō clāmōre signīfīcātiō victōriæ grātulātiōque ab Rēmīs Labiēnō fieret. Hāc fāmā ad Trēverōs perlātā Indūtiomārus, qui posterō 20 diē castra Labiēni oppūgnāre dēcrēverat,⁸ noctū profugit cōpiāsque omnis in Trēverōs redūcit. Caesar Fabium cum

Cf. ¹ existimat. — ² gestae. — ³ insignem. — ⁴ reperit. — ⁵ damnum. — ⁶ sanātō. — ⁷ diūturna. — ⁸ instituerat.

suā legiōne remittit in hiberna, ipse cum III legiōnibus circum Samarobrivam trīnis hibernis hiemāre cōstituit;¹ et, quod tantī mōtūs² Galliae exstiterant, tōtam hiemem ipse ad exercitum manēre dēcrēvit. Nam illō incommodō³ dē Sabīnī morte perlātō omnēs ferē Galliae civitātēs dē bellō 5 cōsultābant;⁴ nūntiōs lēgātīōnēsque in omnīs partis dīmittēbant; et quid reliquī cōsiliī caperent atque unde initium belli fieret explōrābant, nocturna⁵ in locis dēsertis⁶ concilia habēbant. Neque ūllum ferē tōtius hiemis tempus sine sollicitūdine⁷ Caesaris intercessit quā aliquem 10 dē cōsiliis ac mōtū Gallōrum nūntium acciperet. In his ab L. Rōsciō, quem legiōnī XIII praefēcerat, certior factus est māgnās [Gallōrum] cōpiās eārum civitātum quae Aremoricae appellantur oppūgnandī suī causā convēnisse neque longius milibus passuum VIII ab hibernis suis āfuisse, 15 sed nūntiō adlātō dē victōriā Caesaris, discessisse adeō ut fugae similis discessus⁸ vidērētur.

The Senones and Other Tribes are Ready to Revolt.

54. At Caesar, principibus cuiusque civitatis ad se ēvocātis, aliās territandō, cum se scire quae fierent⁹ dēnūntiāret,¹⁰ aliās cohortandō,¹¹ māgnam partem Galliae in officiō 20 tenuit. Tamen Senones, quae est civitās¹² in primis firma et māgnae inter Gallōs auctōritātis, Cavarinum, quem Caesar apud eōs rēgem cōstituerat (cūius frāter Moritasgus adventū in Galliam Caesaris, cūiusque māiōrēs rēgnum obtinuerant), interficere pūblicō cōsiliō cōnātī, cum ille prae- 25 sēnsisset ac profūgisset, ūsque ad finis insecūti rēgnō domōque expulērunt;¹³ et missis ad Caesarem satisfaciendī causā lēgātis, cum is omnem ad se senātum venire iussisset,¹⁴ dictō audientēs nōn fuērunt. *Ac* tantum apud hominēs barbarōs

Cf. ¹ dēcrēvit. — ² tumultūs. — ³ dētrīmentō. — ⁴ dēlībērābant. — ⁵ noctū. — ⁶ sēcrētis. — ⁷ cūrā. — ⁸ profectiō. — ⁹ gererentur. — ¹⁰ monēret. — ¹¹ cōnfirmandō. — ¹² maximē. — ¹³ ēiēcērunt. — ¹⁴ nōn pārūrunt.

valuit esse aliquōs repertōs principēs bellī inferendī, tantamque omnibus voluntātum commūtātiōnem attulit¹ ut — praeter Haeduōs et Rēmōs, quōs praecipuō semper honōre Caesar habuit, alterōs prō vetere ac perpetuā ergā populum
 5 Rōmānum fidē, alterōs prō recentibus Gallicī bellī officiīs² — nūlla ferē civitās fuerit nōn suspecta nōbis. Idque adeō haud sciō mirandumne sit, cum complūribus aliīs dē causīs, tum maximē quod quī virtūte bellī omnibus gentibus praeferēbantur,³ tantum sē eius opīniōnis⁴ dēperdidisse⁵ ut
 10 populī Rōmānī imperia perferrent, gravissimē dolēbant.

Activity of Indutiomarus.

55. Trēverī vērō atque Indūtiomārus tōtīus hiemis nūllum tempus intermisērunt quīn trāns Rhēnum lēgātōs mitterent, civitātis sollicitārent, pecūniās pollicērentur, māgnā parte exercitūs nostrī interfectā multō minōrem superesse
 15 dicerent partem. Neque tamen ūlli civitāti Germānōrum persuādēri potuit ut Rhēnum trānsiret, cum sē bis expertōs dicerent, Ariovisti bellō et Tencterōrum trānsitū; nōn esse amplius fortunam temptātūrōs. Hāc spē lāpsus⁶ Indūtiomārus nihilō minus cōpiās cōgere,⁷ exercēre, ā finitimīs
 20 equōs parāre,⁸ exsulēs damnātōsque tōtā Galliā māgnīs praemiīs ad sē adlicere coepit. Ac tantam sibi iam hīs rēbus in Galliā auctōritātem comparāverat⁹ ut undique ad eum lēgātīōnēs concurrerent, grātiam atque amicitiam publicē prīvātimque peterent.

Many Tribes Join him, and he Decides to Attack Labienus.

25 56. Ubi intellēxit ultrō ad sē venīri, alterā ex parte Senonēs Carnutēsque cōnscentiā facinoris¹⁰ instīgārī,¹¹ alterā Nervīōs Aduatucōsque bellum Rōmānīs parāre, neque sibi voluntāriōrum cōpiās dēfore sī ex finibus suis prōgredi coe-

Cf. ¹ effēcit. — ² operā. — ³ prōpōnēbantur. — ⁴ fāmae. — ⁵ āmisisse. — ⁶ dēiectus. — ⁷ cōnferre. — ⁸ comparāre. — ⁹ conlēgerat. — ¹⁰ sceleris. — ¹¹ impellī.

pisset, armātum concilium indicit. Hōc mōre Gallōrum est initium belli, quō lēge commūni omnēs pūberēs¹ armāti convenire cōguntur; quī ex eis novissimus² venit in cōspectū multitudinis omnibus cruciātibus adfectus necātur. In eō conciliō Cingetorīgem, alterius principem factiōnis, generum 5 suum,³ quem suprā dēmōstrāvimus Caesaris secūtum fidem ab eō nōn discessisse, hostem iūdicat bonaque eius pūblicat. His rēbus cōfectis in conciliō prōnūntiat arcessitum⁴ sē ā Senonibus et Carnutibus aliisque complūribus Galliae civitātibus; hūc itūrum per finis Rēmōrum eōrumque agrōs 10 populātūrum;⁵ ac prius quam id faciat, castra Labiēni oppūgnātūrum: quae fieri velit praecipit.⁶

Labiēnus Acts Cautiously.

57. Labiēnus, cum et loci nātūrā et manū mūnitissimis castris sēsē tenēret, dē suō ac legiōnis periculō nihil timēbat; nē quam occāsionem rei bene gerendae dīmitteret⁷ 15 cōgitābat. Itaque ā Cingetorige atque eius propinquis⁸ orātiōne Indūtiomārī cōgnitā quam in conciliō habuerat, nūntiōs mittit ad finitimās⁹ civitātis equitēsque undique ēvocat;¹⁰ his certam diem conveniendī dicit. Interim prope cotidiē cum omnī equitātū Indūtiomārus sub castris eius 20 vagābātur, aliās ut situm¹¹ castrōrum cōgnōsceret,¹² aliās conloquendī aut territandī causā: equitēs plērumque¹³ omnēs tēla intrā vāllum coniciēbant. Labiēnus suōs intrā mūnitiōnem¹⁴ continēbat timōrisque opiniōnem quibuscumque poterat rēbus augēbat. 25

Indutiomarus is Defeated by a Sudden Sally, and Slain.

58. Cum māiōre in diēs contemptiōne Indūtiomārus ad castra accēderet,¹⁵ nocte ūnā intrōmissis equitibus omnium

Cf. ¹ iuvenēs. — ² postrēmus. — ³ eius. — ⁴ vocātum. — ⁵ vāstātūrum. — ⁶ imperat. — ⁷ praetermitteret. — ⁸ necessāriis. — ⁹ proximās. — ¹⁰ arcessit. — ¹¹ locum. — ¹² explōrāret. — ¹³ ferē. — ¹⁴ castra. — ¹⁵ adgrederētur.

finitimārum civitātum quōs arcessendōs¹ cūrāverat, tantā diligentīā omnīs suōs custōdiīs intrā castra continuit ut nullā ratiōne² ea rēs ēnūntiārī aut ad Trēverōs perferri posset. Interim ex cōnsuētūdine cotidiānā Indūtiomārus
 5 ad castra accēdit³ atque ibi māgnam partem diēi cōnsūmit; equitēs tēla coniciunt et māgnā cum contumēliā⁴ verbōrum nostrōs ad pūgnam ēvocant. Nullō ab nostrīs datō respōnsō, ubi vīsum est sub vesperum dispersi ac dissipāti discēdunt. Subitō Labiēnus duābus portis omnem equitātum⁵ ēmittit;
 10 praecipit atque interdicat,⁶ prōterritis hostibus atque in fugam coniectis⁷ (quod fore, sicut accidit, vidēbat), ūnum omnēs petant⁸ Indūtiomārum; neu quis quem prius volneret quam illum interfectum viderit, quod morā reliquōrum⁹ spatium nactum illum effugere nōlēbat; māgna prōpōnit eis
 15 quī occiderint praemia; submittit cohortis equitibus subsidiō. Comprobat hominis cōnsilium fortūna; et cum ūnum omnēs peterent, in ipsō flūminis vadō dēprehēsus Indūtiomārus interficitur caputque eius refertur in castra; redeuntis equitēs quōs possunt cōnsectantur atque occidunt.
 20 Hāc rē cōgnitā omnēs Eburōnum et Nerviōrum quae convēnerant cōpiae discēdunt; paulōque habuit post id factum Caesar quiētiōrem Galliam.

Cf. ¹ ēvocandōs. — ² modō. — ³ opp. discēdit. — ⁴ convīciō. — ⁵ equitēs. — ⁶ prohibet. — ⁷ datīs. — ⁸ adgrediantur. — ⁹ cēterōrum.

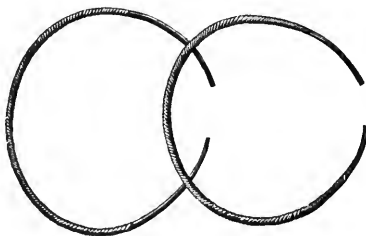

FIG. 77 — GALLIC Torques.

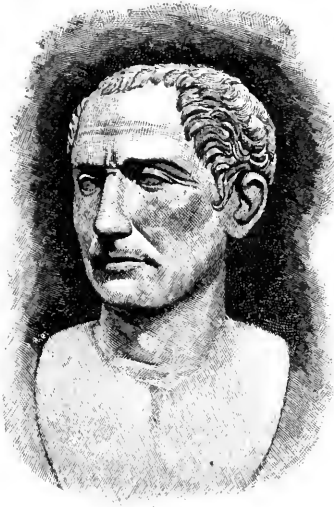

FIG. 78. — GAIUS IULIUS CAESAR.

BOOK VI.

SECOND EXPEDITION INTO GERMANY. B.C. 53.

Cæsar Increases his Forces in Order to Cope with the Rebellious Gauls.

MULTĪS dē causis Caesar māiōrem Galliae mōtum¹ expectāns, per M. Silānum, C. Antistium Rēginum, T. Sextium lēgātōs dēlēctum habēre instituit;² simul ab Cn. Pompēiō prōcōsule petit, quoniam ipse ad urbem cum imperiō rei pūblicae causā remanēret, quōs ex Cisalpīnā Galliā cōsul sacrāmētō³ rogāvisset ad signa convenire et ad sē proficīscī iubēret; māgnī interesse etiam in reliquum tempus ad opīniōnem Galliae existimāns tantās vidēri Ītaliæ facul-

Cf. ¹ tumultum. — ² dēcrēvit. — ³ iūre iūrandō.

tātis¹ ut, si quid esset in bellō dētrimentī² acceptum, nōn modo id brevī tempore sarciri,³ sed etiam māiōribus augēri⁴ cōpiis posset. Quod cum Pompēius et rei pūblicae et amicitiae tribuisset, celeriter cōfectō per suōs dēlēctū, tribus
5 ante exāctam hiemem et cōstitutis et adductis legiōnibus, duplicatōque eārum cohortium numerō quās cum Q. Titūriō āmiserat, et celeritatē et cōpiis docuit⁵ quid populi Rōmānī disciplīna atque opēs possent.

2. Interfectō Indūtiomārō, ut docuimus, ad ēius propin-
10 quōs ā Trēveris imperium⁶ dēfertur. Illi finitimōs Germānōs sollicitāre et pecūniam pollicēri nōn dēsistunt. Cum ā proximis impetrāre nōn possent, ulteriōrēs temptant.⁷ Inventis⁸ nōn nullis civitātibus iūre iūrāndō inter sē cōfirmant obsidibusque dē pecūniā cavent; Ambiorigem sibi societāte
15 et foedere adiungunt. Quibus rēbus cōgnitis Caesar, cum undique bellum parārī vidēret, Nervios, Aduātucōs, Menapiōs, adiūctis Cisrhēnānis omnibus Germānis, esse in armīs, Senonēs ad imperātum nōn venire et cum Carnutibus finitimisque civitātibus cōnsilia commūnicāre, ā Trēveris Ger-
20 mānōs crēbris lēgatiōnibus sollicitārī, mātūrius sibi dē bellō cōgitandum putāvīt.

He Again Ravages the Nervian Territory and Marches against the Senones.

3. Itaque nōndum hieme cōfectā,⁹ proximis IIII coāctis legiōnibus¹⁰ dē imprōvisō in finis Nerviorum contendit,¹¹ et prius quam illi aut convenire aut profugere possent, māgnō
25 pecoris atque hominum numerō captō atque eā praedā militibus concessā¹² vāstātisque agrīs, in dēditiōnem venire atque obsidēs sibi dare coēgit. Eō celeriter cōfectō negōtiō rūsus¹³ in hiberna legiōnēs redūxit. Conciliō Galliae primō vēre, ut instituerat, indictō, cum reliquī praeter Senonēs,

Cf. ¹ opēs. — ² calamitātis. — ³ explērī. — ⁴ amplificārī. — ⁵ dēmōstrāvīt. — ⁶ prīncipātus. — ⁷ sollicitant. — ⁸ aliquot. — ⁹ exāctā. — ¹⁰ repente. — ¹¹ properāvīt. — ¹² datā. — ¹³ iterum.

Carnutēs, Trēverōsque vēnissent,¹ initium belli ac dēfēc-tiōnis² hōc esse arbitrātus, ut omnia postpōnere vidērētur, concilium Lutetiam Parisiōrum trānsfert. Cōnfinēs³ erant hī Senonibus civitātemque patrum memoriā coniūnxerant; sed ab hōc cōnsiliō āfuisse existimābantur. Hāc rē prō 5 suggestū prōnūntiātā eōdem diē cum legiōnibus in Senonēs proficiscitur māgnisque itineribus eō pervenit.

The Senones and Carnutes Submit.

4. Cōgnitō ēius adventū Accō, qui princeps ēius cōnsili fuerat, iubet in oppida multitudinem convenire; cōnantibus, prius quam id effici posset, adesse Rōmānōs nūntiātur. 10 Necessariō sententiā⁴ dēsistunt lēgātōsque dēprecandī causā ad Caesarem mittunt; adeunt per Haeduōs, quōrum antiquitus erat in fidē civitās. Libenter Caesar petentibus Haeduīs dat veniam excūsatiōnemque⁵ accipit, quod⁶ aesti-vum tempus instantis belli, nōn quaestiōnis esse arbitrābātur; 15 obsidibus imperātis c, hōs Haeduīs custōdiendōs trādit. Eōdem Carnutes lēgātōs obsidēsque mittunt, ūsī dēprecā-tōribus Rēmīs, quōrum erant in clientelā; eadem ferunt respōnsa. Peragit concilium Caesar equitēsque imperat civitātibus. 20

Next he Goes against the Menapii; he Forbids them to Harbor Ambiorix.

5. Hāc parte Galliae pācātā tōtus et mente et animō in bellum Trēverōrum et Ambiorīgis insistit.⁷ Cavarinum cum equitātū Senonum sēcum proficisci iubet, nē quis aut ex hūius irācundiā,⁸ aut ex eō quod meruerat odiō, civitātis mōtus existat. His rēbus cōstitūtis, quod prō explorātō⁹ 25 habēbat Ambiorigem proeliō nōn esse contentūrum,¹⁰ reliqua ēius cōnsilia animō circumspiciēbat. Erant Menapii propin-

Cf. ¹ convēnissent. — ² mōtus. — ³ proximī. — ⁴ cōnsiliō. — ⁵ satisfaciōnem. — ⁶ aestātem. — ⁷ incubuit. — ⁸ acerbitāte. — ⁹ certō. — ¹⁰ concertātūrum.

quī¹ Eburōnum finibus, perpetuis² palūdibus silvisque mūniti, quī ūni ex Galliā de pāce ad Caesarem lēgātōs numquam miserant. Cum his esse hospitium Ambiorigī sciēbat; item per Trēverōs vēnisse Germānis in amicitiam cōgnō-
 5 verat. Haec prius illi dētrahenda³ auxilia existimābat quam ipsum bellō lacesseret, nē dēspērātā salūte aut sē in Menapiōs abderet aut cum Trānsrhēnānis congregari cōgerētur. Hōc initō cōnsiliō tōtius exercitūs impedimenta ad Labiēnum in Trēverōs mittit duāsque ad eum legiōnēs proficisci iubet;
 10 ipse cum legiōnibus expeditis quinque in Menapiōs proficiscitur. Illi nullā coāctā manū,⁴ loci praesidiō frētī,⁵ in silvās palūdēsque cōfugiunt suaque eōdem cōferunt.

6. Caesar, partitīs⁶ cōpiis cum C. Fabiō lēgātō et M. Crassō quaestōre celeriterque effectis⁷ pontibus, adit tripartitō,
 15 aedificia vicōsque incendit, māgnō pecoris atque hominum numerō potitur. Quibus rēbus coāctī⁸ Menapii lēgātōs ad eum pācis petendae causā mittunt. Ille obsidibus acceptis hostium sē habitūrum numerō cōfirmat, si aut Ambiorigem aut eius lēgātōs finibus suis recēpissent. His
 20 cōfirmātis⁹ rēbus Commium Atrebātem cum equitātū custōdis locō in Menapiis relinquit; ipse in Trēverōs proficiscitur.

Labiēnus among the Treveri.

7. Dum haec ā Caesare geruntur, Trēverī māgnis coāctis peditātūs¹⁰ equitātūsque¹¹ cōpiis Labiēnum cum ūnā legiōne
 25 quae in eōrum finibus hiemābat adoriri¹² parābant; iamque ab eō nōn longius bīdui viā¹³ aberant, cum duās vēnisse legiōnēs¹⁴ missū Caesaris cōgnōscunt. Positis castris ā milibus passuum xv auxilia Germānōrum exspectāre cōstituunt. Labiēnus, hostium cōgnitō cōnsiliō, spērāns
 30 temeritate eōrum fore aliquam dīmicandi facultātem, prae-

Cf. ¹ cōnfīnēs. — ² continuīs. — ³ adimenda. — ⁴ vī. — ⁵ cōnfīsī. — ⁶ dīvisīs. — ⁷ institūtīs. — ⁸ permōtī. — ⁹ cōstitutītīs. — ¹⁰ peditum. — ¹¹ equitum. — ¹² adgrēdī. — ¹³ itinere. — ¹⁴ ā Caesare missās.



FIG. 79. — ANCIENT STATUE OF GALLIC CHIEF.

sidiō v cohortium impedimentis relictō, cum xxv cohortibus māgnōque equitatū contrā hostem proficiscitur, et mille passuum intermissō spatiō castra commūnit. Erat inter Labiēnum atque hostem difficili trānsitū flūmen ripisque praeruptis.¹ Hōc neque ipse trānsire habēbat in animō 5 neque hostis trānsitūrōs existimābat. Augēbātur auxiliōrum cotidiē spēs.² Loquitur in conciliō palam: ‘Quoniam Germānī adpropinquāre dicantur, sēsē suās exercitūsque fortūnās³ in dubium nōn dēvocātūrum, et posterō diē primā lūce castra mōtūrum.’ Celeriter haec ad hostis dēferuntur, 10 ut ex māgnō Gallōrum equitum numerō nōn nullōs Gallicis rēbus favēre nātūra cōgēbat. Labiēnus nocte, tribūnis militum primisque ōrdinibus convocātis, quid suī sit cōnsilī prōpōnit,⁴ et quō facilius hostibus timōris det suspiciōnem, māiōre strepitū et tumultū quam populi Rōmānī fert cōsuetūdō castra movērī⁵ iubet. His rēbus fugae similem profectiōnem efficit. Haec quoque per explorātōrēs ante lūcem in tantā propinquitāte castrōrum ad hostis dēferuntur.

After Much Manœuvring he Brings on an Engagement and Utterly Defeats them.

8. Vix agmen novissimum extrā mūnitiōnēs prōcesserat, cum Gallī — cohortātī inter sē nē spērātā praedam ex 20 manibus dēmitterent;⁶ longum esse perterritis Rōmānis Germānōrum auxilium exspectāre; neque suam patī⁷ dignitātem ut tantis cōpiis tam exiguam⁸ manum praesertim fugientem atque impeditam adoriri nōn audeant — flūmen trānsire et iniquō⁹ locō committere proelium nōn dubitant. 25 Quae fore suspicātus Labiēnus, ut omnis citrā flūmen ēliceret, eādē ūsus simulatiōne itineris placidē prōgrediēbātur.¹⁰ Tum praemissis paulum impedimentis atque in tumulō¹¹

Cf. ¹ opp. lēniter acclīvibus. — ² opp. dēspērātiō. — ³ in periculum nōn dēductūrum. — ⁴ docet. — ⁵ opp. pōnī. — ⁶ āmitterent. — ⁷ permittere. — ⁸ opp. māgnam. — ⁹ aliēnō. — ¹⁰ prōcēdēbat. — ¹¹ colle.

quōdam conlocātis, “Habētis,” inquit, “militēs, quam petistis facultātem; hostem impeditō atque inīquō¹ locō tenētis; praestāte² eandem nōbis ducibus virtūtem quam saepenumerō imperātōrī praestitistis; atque illum adesse et
 5 haec cōram cernere exīstimāte.” Simul sīgna ad hostem converti aciemque dērigi³ iubet; et paucis turmīs praesidiō ad impedimenta dīmissis reliquōs equitēs ad latera dispōnit. Celeriter nostrī clāmōre sublātō pīla in hostīs immittunt.⁴ Illi, ubi praeter spem quōs fugere crēdēbant infestis sīgnis
 10 ad sē ire vidērunt, impetum nostrōrum ferre⁵ nōn potuērunt, ac primō concursū in fugam coniecti proximās silvās petiērunt. Quōs Labiēnus equitātū cōnsectātus,⁶ māgnō numerō interfectō, complūribus captis, paucis post diēbus civitātem recēpit. Nam Germānī quī auxiliō veniēbant perceptā Trē-
 15 verōrum fugā sēsē domum contulērunt.⁷ Cum hīs propin- quī Indūtiomārī, quī dēfectiōnis auctōrēs fuerant,⁸ comitāti eōs ex civitāte excessērunt. Cingetorigī, quem ab initiō permānsisse in officiō dēmōstrāvimus, principātus atque imperium est trādītum.

Cæsar Again Crosses the Rhine.

20 9. Caesar postquam ex Menapiis in Trēverōs vēnit, duā- bus dē causis Rhēnum trānsire cōstituit: quārum ūna erat quod *Germānī* auxilia contrā sē Trēverīs miserant; altera, nē ad eōs Ambiorix receptum⁹ habēret. His cōstitutis rēbus paulō suprā eum locum quō ante exercitum trādūxe-
 25 rat facere pontem instituit. Nōtā atque institūtā ratiōne, māgnō militum studiō, paucis diēbus opus efficitur. Firmō in Trēverīs ad pontem praesidiō relictō, nē quis ab hīs subitō mōtus¹⁰ orirētur,¹¹ reliquās cōpiās equitātumque trādūcit. Ubiī, quī ante obsidēs dederant atque in dēditionem vēne-

Cf. ¹ opp. idōneō. — ² praebēte. — ³ instruī. — ⁴ coniciunt. — ⁵ sustinēre. — ⁶ insecūtus. — ⁷ retulērunt. — ⁸ cum eīs. — ⁹ recessum. — ¹⁰ sēditiō. — ¹¹ coōrerētur.

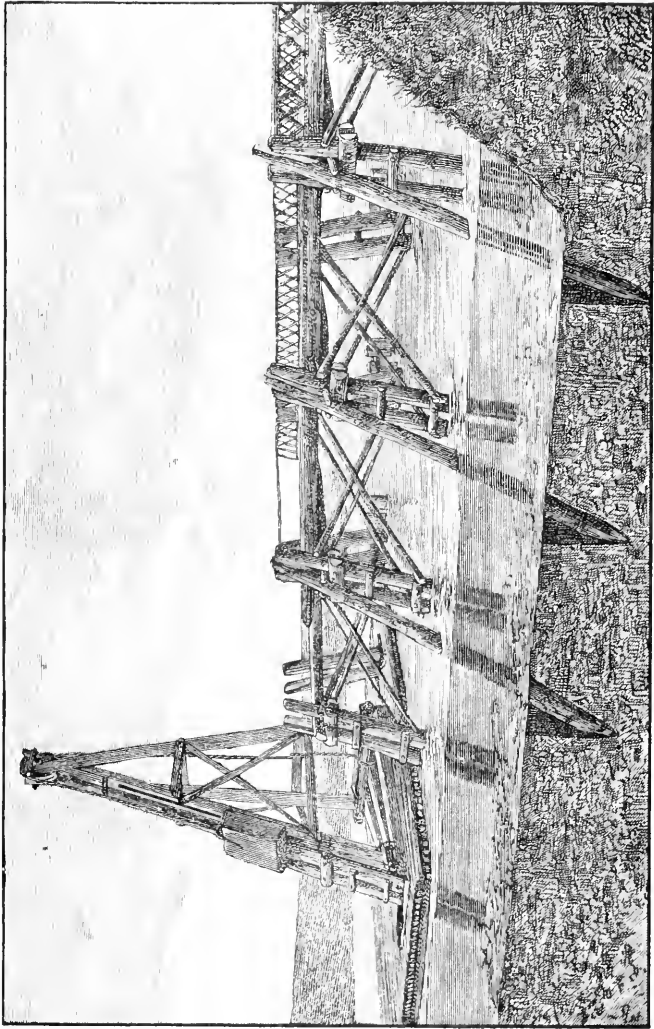

FIG. 80. — PONS A CAESARE IN RHENO FACTUS.



rant, pūgandi¹ suī causā ad eum lēgātōs mittunt qui doceant neque auxilia ex suā civitāte in Trēverōs missa neque ab sē fidem laesam :² petunt atque ōrant ut sibi parcat, nē commūnī odiō Germānōrum innocentēs prō nocentibus poenās pendant ;³ sī amplius obsidum velit dari, pollicentur. Cōgnitā Caesar causā reperit ab Suēvīs auxilia missa esse ; Ubiōrum satisfactiōnem⁴ accipit ; aditūs viāsque in Suēvōs perquirīt.⁵

He Learns from the Ubi that the Suevi have Retreated to the Forest Bacenis.

10. Interim paucīs post diēbus fit ab Ubiīs certior Suēvōs omnīs in ūnum locum cōpiās cōgere, atque eis nātiōnibus quae sub eōrum sint imperiō dēnūtiāre ut auxilia peditātūs equitātūsque mittant. His cōgnitis rēbus rem frūmentāriam prōvidet, castrīs idōneum⁶ locum dēligit, Ubiīs imperat ut pecora dēdūcant suaque omnia ex agrīs in oppida cōferant, — spērāns barbarōs atque imperitōs hominēs inopiā cibariōrum⁷ adductōs ad inīquam pūgnandi condiōnem posse dēdūcī ; mandat ut crēbrōs⁸ explōrātōrēs in Suēvōs mittant quaeque apud eōs gerantur cōgnōscant.⁹ Illi imperāta faciunt et paucīs diēbus intermissis referunt :¹⁰ ‘ Suēvōs omnīs, posteāquam certiōrēs nūntiī dē exercitū Rōmānōrum vēnerint, cum omnibus suis sociōrumque cōpiīs quās coēgissent, penitus ad extrēmōs¹¹ finis sē recēpisse ;¹² silvam esse ibi infīnitā māgnitūdine, quae appellātur Bācenis ; hanc longē intrōrsus¹³ pertinēre, et prō nātivō mūrō obiectam Chēruscōs ab Suēvōrum Suēvōsque ab Chēruscōrum iniūriīs incursiōnibusque prohibēre ; ad ēius silvae initium Suēvōs adventum¹⁴ Rōmānōrum exspectāre cōstituisse.’

Cf. ¹ excūsandī. — ² violātam. — ³ persolvant. — ⁴ excūsātiōnem. — ⁵ explōrat. — ⁶ opp. inīquum. — ⁷ rērum frūmentāriārum. — ⁸ frequētēs. — ⁹ perquirant. — ¹⁰ dēferunt. — ¹¹ ultimōs. — ¹² contulisse. — ¹³ penitus. — ¹⁴ opp. profectiōnem.

Customs of the Gauls. The Two Parties among them.

11. Quoniam ad hunc locum perventum est, nōn aliēnum esse vidētur dē Galliae Germāniaeque mōribus et quō differant hae nātiōnēs inter sēsē prōpōnere.

In Galliā nōn solum in omnibus civitatibus atque in
5 omnibus pāgis partibusque, sed paene etiam in singulis
domibus factiōnēs sunt; eārumque factiōnum prīncipēs sunt
quī summam auctōritātem¹ eōrum iūdiciō² habere existi-
mantur, quōrum ad arbitrium iūdiciūque summa omnium
rērum cōnsiliōrumque redeat.³ Idque ēius rei causā anti-
10 quitus institūtum vidētur, nē quis ex plēbe contrā potentiō-
rem auxili egēret; ⁴ suōs enim quisque opprimī et circumveniri
nōn patitur, neque, aliter sī faciat, ūllam inter suōs habeat
auctōritātem. Haec eadem ratiō est in summā tōtius
Galliae; namque omnēs civitatēs divisae sunt in duās partis.⁵

Influence of the Romans upon the Relations of the Parties in Gaul.
They Favor the Haedui.

15 12. Cum Caesar in Galliam vēnit, alterius factiōnis prīncipēs erant Haedui, alterius Sēquanī. Hī, cum per sē minus⁶ valērent (quod summa auctōritās antiquitus erat in Haeduis māgnaeque eōrum erant clientēlae), Germānōs atque Ariovistum sibi adiūxerant⁷ eōsque ad sē māgnis
20 iactūrīs⁸ pollicitātiōnibusque perdūxerant. Proeliis vērō complūribus factis secundis atque omnī nōbilitāte Haedū-
rum interfectā, tantum potentiā⁹ antecesserant¹⁰ ut māgnam partem clientium ab Haeduis ad sē trādūcerent obsidēsque ab hīs prīncipum filiōs acciperent, et publicē iūrāre cōgerent
25 nihil sē contrā Sēquanōs cōnsiliī inītūrōs, et partem finitimī agrī per vim occupātam possidērent, Galliaeque tōtius prīncipātum obtinērent. Quā necessitāte adductus Diviciācus

Cf. ¹ imperium. — ² sententiā. — ³ revertātur. — ⁴ carēret, w. abl. —
⁵ factiōnēs. — ⁶ nōn. — ⁷ adsciverant. — ⁸ praemiis. — ⁹ potestāte. —
¹⁰ praestiterant.

auxili petendī causā Rōmam ad senātum profectus infectā
 rē redierat. Adventū Caesaris factā commūtatiōne rērum,
 obsidibus Haeduīs redditīs, veteribus¹ clientēlis restitūtis,
 novīs per Caesarem comparātis, quod eī quī sē ad eōrum
 amicitiam adgregāverant² meliōre condiōne atque aequiōre 5
 imperiō sē ūti vidēbant, reliquīs rēbus eōrum grātiā dignitā-
 teque amplificātā,³ Sēquanī principātum dimiserant. In
 eōrum locum Rēmī successerant; quōs quod adaequāre
 apud Caesarem grātiā intellegēbatur, eī quī propter veterēs
 inimicitias⁴ nūllō modō cum Haeduīs coniungī poterant sē 10
 Rēmīs in clientēlam dicābant. Hōs illi diligenter tuēban-
 tur;⁵ ita et novam et repente conlētā auctōritātem tenē-
 bant. Eō tamen statū⁶ rēs erat ut longē principēs habērentur
 Haeduī, secundum locum dignitātis Rēmī obtinērent.

Two Classes of Gallic Nobility, Druids and Knights. The Druids and
 their Power.

13. In omnī Galliā eōrum hominum quī aliquō sunt nu- 15
 merō⁷ atque honōre genera sunt duo. Nam plēbēs paene
 servōrum habētur locō, quae nihil audet per sē, nūllī adhibē-
 tur⁸ cōnsiliō. Plērique, cum aut aere aliēnō aut māgnitū-
 dine tribūtōrum⁹ aut iniūriā potentiōrum premuntur, sēsē in
 servitūtem dicant¹⁰ nōbilibus; *quibus* in hōs eadem omnia 20
 sunt iūra quae dominīs in servōs. Sed dē his duōbus generi-
 bus alterum est druidum, alterum equitum. Illi rēbus
 divinis intersunt, sacrificia pūblica ac privāta prōcūrant,
 religiōnēs interpretantur. Ad eōs māgnus adulēsentium
 numerus disciplīnae causā concurrat,¹¹ māgnōque hī sunt 25
 apud eōs honōre. Nam ferē dē omnibus contrōversiis pū-
 blicis privātisque cōstituunt;¹² et, sī quod est admissum¹³
 facinus, sī caedēs facta, sī dē hērēditāte, dē finibus contrō-

Cf. ¹ antīquīs. — ² concurrerant. — ³ auctā. — ⁴ opp. amicitias. —
⁵ dēfendēbant. — ⁶ condiōne. — ⁷ dignitāte. — ⁸ invitātur. — ⁹ stī-
 pendiorum. — ¹⁰ dēdunt. — ¹¹ sē adgregat. — ¹² dēcernunt. — ¹³ com-
 missum.

versia est, idem dēcernunt; præmia poenāsque cōstituunt; sī quī aut prīvātus aut populus eōrum dēcrētō nōn stetit,¹ sacrificiis interdīcunt.² Haec poena apud eōs est gravissima. Quibus ita est interdīctum, hī numerō impiōrum ac
 5 scelerātōrum habentur, hīs omnēs dēcēdunt, aditum eōrum sermōnemque dēfugiunt,³ nē quid ex contāgiōne incommodi accipiant, neque eis petentibus iūs redditur neque honōs

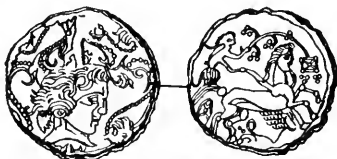

FIG. 81. — GALLIC COIN.

ūllus commūnicātur.⁴ His autem omnibus druidibus praeest
 ūnus, quī summam inter eōs habet auctōritātem. Hōc
 10 mortuō, aut sī quī ex reliquīs excellit⁵ dignitāte, succēdit,
 aut, sī sunt plūrēs parēs, suffrāgiō druidum,⁶ nōn numquam
 etiam armīs dē principātū contendunt. Hī certō annī tem-
 pore in finibus Carnutum, quae regiō tōtius Galliae media
 habētur, cōnsidunt in locō cōsecrātō; hūc omnēs undique
 15 quī contrōversiās habent conveniunt eōrumque dēcrētis
 iūdiiciisque pārent. Disciplina in Britannā reperta atque
 inde in Galliam trāslāta⁷ existimātur; et nunc quī diligen-
 tius eam rem cōgnōscere volunt plērumque illō discendi
 causā proficiscuntur.

Their Privileges and Immunities. Their Education and Beliefs.

20 **14.** Druides ā bellō abesse⁸ cōsuērunt neque tribūta ūnā
 cum reliquīs pendunt; [militiae vacātiōnem omniumque
 rērum habent immūnitātem]. Tantīs excitāti⁹ praemiis et

Cf. ¹ pāruit. — ² prohibent. — ³ vītant. — ⁴ tribuitur. — ⁵ praestat.
 — ⁶ interdum. — ⁷ trāducta. — ⁸ opp. adesse. — ⁹ incitātī.

suā sponte multī in disciplinam conveniunt et ā parentibus propinquisque mittuntur. Māgnū ibi numerum versuum ēdiscere dicuntur. Itaque annōs nōn nullī vicēnōs in disciplinā permanent. Neque fās esse existimant ea litteris mandāre,¹ cum in reliquīs² ferē rēbus, pūblicis privātisque ratiōnibus, Graecis litteris ūtantur. Id mihi duābus dē causis instituisse videntur; quod neque in volgus disciplinam efferrī³ velint neque eōs quī discunt litteris cōnfisōs minus memoriae studēre, — quod ferē plērisque accidit⁴ ut praesidiō litterārum diligentiam in perdiscendō ac memoriam remittant. In primīs hōc volunt persuādēre, nōn interire⁵ animās, sed ab aliīs post mortem trānsire ad aliōs; atque hōc maximē ad virtūtem excitārī putant metū mortis neglētō.⁶ Multa praetereā dē sideribus atque eōrum mōtū, dē mundi ac terrārum māgnitudīne, dē rērum nātūrā, dē deōrum immortalium vī ac potestāte disputant et iuventūti trādunt.

The Knights are the Fighting Men.

15. Alterum genus est equitum. Hī, cum est ūsus atque aliquod bellum incidit (quod ferē ante Caesaris adventum⁷ quotannis accidere solēbat, utī aut ipsī iniūriās⁸ inferrent aut inlātās prōpulsārent⁹), omnēs in bellō versantur; atque eōrum ut quisque est genere cōpiisque amplissimus,¹⁰ ita plūrimōs circum sē ambactōs clientisque habet. Hanc ūnam grātiā potentiamque nōvērunt.

Human Sacrifices.

16. Nātiō est omnis Gallōrum admodum dēdita religiōnibus; atque ob eam causam quī sunt adfectī graviōribus morbis, quīque in proeliis periculisque versantur,¹¹ aut prō victimis hominēs immolant aut sē immolātūrōs vovent,

Cf. ¹ cōnfidere. — ² cēteris. — ³ dīvolgārī. — ⁴ fit. — ⁵ perire. — ⁶ omissō. — ⁷ opp. profectiōnem. — ⁸ bellum. — ⁹ dēfenderent. — ¹⁰ potentissimus. — ¹¹ sunt.

administris que ad ea sacrificia druidibus ūtuntur, — quod, prō vitā hominis nisi hominis vitā reddātur, nōn posse deōrum immortalium nūmen plācārī arbitrantur; pūblicēque eiusdem generis habent institūta sacrificia. Alii immānī¹



FIG. 82. — GALLIC COINS.

5 māgnitūdine simulācra habent, quōrum contexta vīminibus membra vivīs hominibus complent; quibus succēnsīs² circumventī flammā exanimantur hominēs. Supplicia eōrum quī in fūrtō aut lātrōciniō aut aliā noxiā³ sint comprehēnsī grātiōra dīs immortalibus esse arbitrantur; sed, cum eius
10 generis cōpia dēficit,⁴ etiam ad innocentium supplicia dēscendunt.

Gallic Deities. Consecration of the Spoils of War to Mars.

17. Deōrum maximē Mercurium colunt. Hūius sunt plūrima simulācra; hunc omnium inventōrem artium ferunt, hunc viārum atque itinerum ducem, hunc ad quaestūs pecū
15 niae mercātūrāsque⁵ habēre vim māximam arbitrantur. Post hunc Apollinem et Mārtem et Iovem et Minervam. Dē his eandem ferē quam reliquae gentēs habent opiniōnem:⁶ Apollinem morbōs dēpellere, Minervam operum atque artificiōrum initia trādere, Iovem imperium caelestium tenēre,
20 Mārtem bella regere. Huic, cum⁷ proeliō dimicāre cōstituērunt, ea quae bellō cēperint plērumque dēvovent; cum superāvērunt, animālia capta immolant, reliquās rēs in ūnum locum cōferunt. Multis in civitātibus hārum rērum extrūc-

Cf. ¹ ingentī. — ² incēnsīs. — ³ scelere. — ⁴ opp. suppetit. — ⁵ plūrimum valēre. — ⁶ sententiam. — ⁷ proelium committere.

tōs cumulōs¹ locīs cōsecrātīs cōspicārī licet. Neque saepe accidit ut neglēctā quispiam religiōne aut capta apud sē occultāre² aut posita tollere³ auderet; gravissimumque eī rei⁴ supplicium cum cruciātū cōstitutum est.

They Claim Descent from Pluto. Peculiar Treatment of Boys.

18. Gallī sē omnis ab Dīte patre prōgnātōs⁵ praedicant 5
idque ab druidibus prōditum⁶ dīcunt. Ob eam causam spatia omnis temporis nōn numerō diērum sed noctium finiunt; diēs nātālīs et mēnsium et annōrum initia sic observant ut noctem diēs subsequātur. In reliquīs vitāe institūtīs⁷ hōc ferē ab reliquīs differunt, quod suōs liberōs, nisi cum 10
adolēverunt ut mūnus militiae sustinēre possint, palam ad sē adīre nōn patiuntur; filiumque puerilī aetāte in pūblicō in cōspectū patris adsistere turpe⁸ dūcunt.

Dowries. Power of Husbands over Wives. Funeral Rites.

19. Virī, quantās pecūniās ab uxōribus dōtis nōmine accēpērunt, tantās ex suis bonīs aestimātiōne factā cum dōti- 15
bus commūnicant. Hūius omnis pecūniae coniūctim ratiō habētur⁹ frūctūsque servantur; uter eōrum vitā superāvit, ad eum pars utriusque cum frūctibus superiōrum¹⁰ temporum pervenit. Virī in uxōrēs sicut in liberōs vitāe necisque habent potestātem; et cum paterfamiliae inlustriōre locō 20
nātus dēcessit,¹¹ eīus propinquī conveniunt et dē morte, si rēs in suspiciōnem vēnit, dē uxōribus in servilem¹² modum quaestiōnem habent, et si compertum est, ignī atque omnibus tormentīs¹⁸ excruciatās interficiunt. Fūnera sunt prō cultū Gallōrum māgnifica et sūmptuōsa; omniaque quae 25
vīvis cordi¹⁴ fuisse arbitrantur in ignem inferunt,¹⁵ etiam animālia; ac paulō suprā hanc memoriā servī et clientēs,

Cf. ¹ tumulōs. — ² cēlāre. — ³ efferre. — ⁴ factō. — ⁵ ortōs. — ⁶ trādītum. — ⁷ mōribus. — ⁸ opp. honestum. — ⁹ cōnficitur. — ¹⁰ priōrum. — ¹¹ mortuus est. — ¹² servōrum. — ¹³ cruciātīs. — ¹⁴ cāra. — ¹⁵ prōiciunt.

quōs ab eis dilēctōs¹ esse cōnstābat, iūstis fūnebris cōnfectis ūnā cremābantur.

All Rumors from Outside to be Reported to the Magistrates.

20. Quae civitatēs commodius² suam rem publicam administrāre³ existimantur habent lēgibus sānctum, sī quis
5 quid dē rē publicā ā finitimis rūmōre aut fāmā accēperit,⁴ uti ad magistrātum dēferat nēve cum quō aliō commūnicet; quod saepe hominēs temerariōs atque imperitōs falsis rūmōribus terrēri et ad facinus impelli et dē summis rēbus cōnsilium capere cōgnitum est. Magistrātūs quae vīsa sunt
10 occultant, quae esse⁵ ex ūsū iūdicāvērunt multitudinī prōdunt.⁶ Dē rē publicā nisi per concilium loqui nōn concēditur.

Customs of the Germans.

21. Germānī multum ab hāc cōnsuētūdine differunt. Nam neque druidēs habent quī rēbus divinis praesint neque
15 sacrificiis student. Deōrum numerō eōs solōs dūcunt⁷ quōs cernunt et quōrum apertē opibus iuvantur, Sōlem et Volcānum et Lūnam; reliquōs nē fāmā quidem accēpērunt. Vīta omnis in vēnātiōnibus atque in studiis rei militāris cōnsistit; ā parvis labōri ac dūritiae student. Quī diūtissimē⁸ impu-
20 berēs permānsērunt maximam inter suōs ferunt laudem; hōc alī statūrā, alī viris nervōsque cōfirmārī putant. Intrā annum vērō vicēsimum fēminae nōtitiā habuisse in turpissimis habent⁹ rēbus: cūius rei nūlla est occultatiō, quod et prōmiscuē in flūminibus perluuntur,¹⁰ et pellibus aut parvis
25 rēnōnum tegimentis ūtuntur, māgnā corporis parte nūdā.

No Agriculture or Private Ownership of Land.

22. Agrī cultūrae nōn student, māiorque pars eōrum victūs in lacte, cāseō, carne cōnsistit. Neque quisquam agrī mo-

Cf. ¹ amātōs. — ² melius. — ³ gerere. — ⁴ reppererit. — ⁵ ūtilia. — ⁶ efferunt — ⁷ putant. — ⁸ opp. brevissimē. — ⁹ dūcunt. — ¹⁰ lavantur.

dum certum aut finis habet proprios;¹ sed magistrātūs ac principēs² in annōs singulōs gentibus cōgnātiōibusque hominum, quīque unā coiērunť, quantum et quō locō visum est agrī attribuunt, atque annō post aliō trānsire³ cōgunt. Eius rei multās adferunt causās: nē adsiduā⁴ cōnsuētūdine capti studium belli gerendī agrī culturā commūtent; nē lātōs finis parāre⁵ studeant potentiōrēs atque humiliōrēs possessionibus expellant; nē accūrātius⁶ ad frīgora atque aestūs vitandōs aedificent; nē qua oriātur pecūniae cupiditās, quā ex rē factiōnēs dissēnsiōnēsque nāscuntur; ut⁷ animī aequitāte plēbem contineant, cum suās quisque opēs cum potentissimīs aequārī videat.

Their Isolation. How Chiefs are Appointed; their Power. Freebooting no Disgrace. Rites of Hospitality Observed.

23. Cīvitātibus maxima laus est quam lātissimē circum sē vāstātis finibus sōlitudinēs⁸ habēre. Hōc proprium virtūtis existimant, expulsōs agrīs finitimōs cēdere, neque quemquam prope sē audēre cōsistere:⁹ simul hōc sē fore tūtiōrēs arbitrantur, repentināe incursiōnis timōre sublātō. Cum bellum cīvitās aut inlātum dēfendit aut infert, magistrātūs quī eī bellō praesint, et vitae necisque habeant potestātem, dēliguntur. In pāce nūllus est commūnis magistrātus, sed principēs regiōnum atque pāgōrum inter suōs iūs dicunt contrōversiāsque minuunt.¹⁰ Lātrōcinia nūllam habent infāmiā¹¹ quae extrā finis cūiusque cīvitātis fiunt, atque ea iuventūtis exercendae ac dēsidiāe minuendae causā fieri praedicant. Atque ubi quis ex prīncipibus in conciliō dixit ‘sē ducem fore, quī sequī velint profiteantur,’ — cōnsurgunt eī quī et causam et hominem probant suumque auxilium pollicentur, atque ā multitudine conlaudantur; quī ex his

Cf. ¹ prīvātōs. — ² quotannis. — ³ dēmigrāre. — ⁴ perpetuā. — ⁵ adquirere. — ⁶ diligētius. — ⁷ aequō animō. — ⁸ loca dēserta. — ⁹ cōnsidere. — ¹⁰ compōnunt. — ¹¹ ignōmiā.

secūti nōn sunt in dēsertōrum¹ ac prōditōrum numerō dūcuntur² omniumque hīs rērum postēā fidēs dērogātur.⁵ Hospitem violāre fās nōn putant; quī quācumque dē causā ad eōs vērunt ab iniuriā prohibent sāctōsque habent. 5 hīsque omnium domūs patent victusque commūnicātur.

Migration of Certain Gallic Tribes to Germany.

24. Ac fuit antēā tempus cum Germānōs Gallī virtūte superārent, ultrō bella inferrent, propter hominum multitudinem agrīque inopiam trāns Rhēnum colōniās mitterent. Itaque ea quae fertilissima Germāniae sunt loca, circum 10 Hercyniam silvam (quam Eratosthenī et quibusdam Graecīs fāmā nōtam esse vidēō, quam illi Orcyniam appellant), Volcae Tectosagēs occupāvērunt atque ibi cōsēdērunt. Quae gēns⁴ ad hōc tempus hīs sēdibus sēsē continet summamque habet iūstitiae et bellicae laudis opīniōnem.⁵ Nunc quidem 15 in eādē inopiā, egestāte, patientiāque Germānī permanent, eōdem victū et cultū corporis ūtuntur; Gallīs autem prōvinciārū propinquitās et trānsmarinārū rērum nōtia⁶ multa ad cōpiam atque ūsum largītur.⁷ Paulātīm adsuēfactī superārī multisque victī proeliis, nē sē quidem ipsī cum illis vir- 20 tūte comparant.

The Hercynian Forest and its Fauna. The Reindeer (?).

25. Hūius Hercyniae silvae, quae suprā dēmōstrāta est, lātitudō VIII diērum iter expeditō⁸ patet; nōn enim aliter finiri potest, neque mēnsūrās⁹ itinerum nōvērunt. Oritur¹⁰ ab Helvētiorū et Nemetum et Rauracōrum finibus, rēctā- 25 que flūminis Dānuvī regiōne pertinet ad finis Dācōrum et Anartium; hinc sē flectit¹¹ sinistrōrsus diversis ab flūmine regiōnibus multārūque gentium finis propter māgnitudi-

Cf. ¹ perfugārum. — ² habentur. — ³ dētrahitur. — ⁴ adhūc. — ⁵ fāmam. — ⁶ scientia. — ⁷ dōnat. — ⁸ opp. impeditō. — ⁹ longitūdinem. — ¹⁰ initium capit. — ¹¹ convertit.

nem attingit. Neque quisquam est hūius Germāniae qui sē [aut audisse] aut adisse¹ ad initium² eius silvae dicat, cum diērum iter LX prōcesserit, aut quō ex locō oriātur accēperit. Multaque in eā genera ferārum³ nāscī cōstat quae reliquīs in locīs vīsa nōn sint; ex quibus quae maximē 5 differant ab cēteris et memoriae prōdenda⁴ videantur haec sunt.

26. Est bōs cervi figurā,⁵ cuius ā mediā fronte inter auris ūnum cornū existit excelsius⁶ magisque dērēctum hīs quae nōbīs nōta sunt cornibus. Ab eius summō⁷ sicut palmae 10 rāmīque lātē diffunduntur. Eadem est fēminae marisque nātūra, eadem forma māgnitūdōque cornuum.

The Elk and its Habits.

27. Sunt item quae appellantur alcēs. Hārum est cōnsimilis capris figurā et varietās pellium; sed māgnitūdine paulō antecēdunt⁸ mutilaeque sunt cornibus et crūra sine 15 nōdīs articulisque habent; neque quiētis⁹ causā prōcumbunt neque, sī quō adflīctae¹⁰ cāsū concidērunt, ¹¹ ērigere sēsē āc sublevāre possunt. Hīs sunt arborēs prō cubilibus; ad eās sē adplicānt¹² atque ita paulum modo reclinātae quiētem capiunt. Quārum ex vestigiīs cum est animadversum¹³ 20 ā vēnātōribus quō sē recipere cōsuērint, omnēs eō locō aut ab rādicibus subruunt¹⁴ aut accidunt arborēs, tantum ut summa speciēs eārum stantium relinquātur. Hūc cum sē cōnsuētūdine reclināvērunt, infirmās arborēs pondere adflīgunt atque ūnā ipsae concidunt. 25

The Wild Ox.

28. Tertium est genus eōrum quī ūri appellantur. Hī sunt māgnitūdine paulō infrā¹⁵ elephantōs; speciē et colōre

Cf. ¹ adpropinquāsse. — ² opp. finem. — ³ animālium. — ⁴ trādenda. — ⁵ formā. — ⁶ altius. — ⁷ opp. imō. — ⁸ carent. — ⁹ somnī. — ¹⁰ prōstrātae. — ¹¹ opp. prōcumbere. — ¹² adiungunt. — ¹³ compertum. — ¹⁴ suffodiunt. — ¹⁵ opp. suprā.

et figurā taurī. Māgna vīs eōrum est et ināgna vĕlōcitās; neque hominī neque feræ quam cōnspĕxērunt parcut. Hōs studiōsē¹ foveīs captōs interficiunt. Hōc sē labōre dūrant adulēscētēs atque hōc genere vĕnātiōnis exercent, et quī plūrimōs ex hīs interfēcērunt, relātis in pūblicum cornibus quae sint testimōniō, māgnam ferunt² laudem. Sed adsuēscere ad hominēs et mānsuēfierī nē parvulī quidem exceptī possunt. Amplitūdō cornuum et figurā et speciēs multum ā nostrōrum boum cornibus differt. Haec studiōsē³ conquisita ab labris argentō circumclūdunt atque in amplissimīs⁴ epulis prō pōculis ūtuntur.

Cæsar Returns to Gaul and Proceeds against Ambiorix.

29. Caesar, postquam per Ubiōs explōrātōrēs comperit⁵ Suēvōs sēsē in silvās recēpisse, inopiam⁶ frūmenti veritus (quod, ut suprā dēmōnstrāvimus, minimē⁷ omnēs Germānī agrī cultūrae student), cōstituit nōn prōgredi longius; sed, nē omnīnō metum reditūs suī barbaris tolleret, atque ut eōrum auxilia tardāret,⁸ reductō exercitū partem ultimam⁹ pontis, quae ripās Ubiōrum contingēbat, in longitūdinem pedum cc rescindit, atque in extrēmō ponte turrim tabulā-
 20 tōrum IIII cōstituit¹⁰ praesidiumque cohortium XII pontis tuendī causā pōnit māgnisque eum locum mūnitiōnibus firmat. Eī locō praesidiōque C. Volcātium Tullum adulēscētem praeficit; ipse, cum mātūrēscere frūmenta inciperent, ad bellum Ambiorīgis profectus, per Arduennam silvam —
 25 quae est tōtius Galliae maxima atque ab ripīs Rhēnī finibusque Trēverōrum ad Nervīōs pertinet, milibusque amplius D in longitūdinem patet — L. Minucium Basilum cum omnī equitātū praemittit, sī quid celeritāte itineris atque opportūnitāte¹¹ temporis prōficere possit; monet ut ignis in castris

Cf. ¹ diligenter. — ² pariunt. — ³ cupidē. — ⁴ māgnificentissimīs. — ⁵ cōgnōvit. — ⁶ opp. cōpiam. — ⁷ opp. maximē. — ⁸ morārētur. — ⁹ opp. primam. — ¹⁰ contabulāvit. — ¹¹ occāsiōne.



FIG. 83.—STATUE OF AMBIORIX.

fieri prohibeat, nē qua ēius adventūs¹ procul significātiō fiat; sēsē cōfestim² subsequi dicit.

Ambiorix Has the Good Luck to Escape.

30. Basilus ut imperātum est facit. Celeriter contrāque omnium opiniōnem cōfectō itinere multōs in agris inopinantis³ dēprehendit; eōrum indiciō ad ipsum Ambiorigem 5 contendit, quō in locō cum paucis equitibus esse dicēbātur. Multum cum in omnibus rēbus tum in rē militārī potest⁴ fortūna. Nam *ut* māgnō accidit cāsū ut in ipsum incautum etiam atque imparātum incideret, priusque ēius adventus ab omnibus vidērētur quam fāma ac nūntius adferrētur, sic 10 māgnae fuit fortūnae, omnī militārī instrūmentō⁵ quod circum sē habēbat ēreptō, rēdis equisque comprēhēnsis, ipsum effugere mortem. Sed hōc factum est, quod, aedificiō circumdatō silvā, ut sunt ferē domicilia Gallōrum, quī vitandī aestūs⁶ causā plērumque silvārum ac flūminum 15 petunt propinquitātis, comitēs familiārēsque⁷ ēius angustō in locō paulisper equitum nostrōrum vim⁸ sustinuērunt. His pūgnantibus illum in equum quīdam ex suis intulit;⁹ fugientem silvae tēxērunt. Sic et ad subeundum periculum et ad vitandum multum fortūna valuit.¹⁰ 20

His Forces Disband and Withdraw to the Forest and Marshes. Catuvalcus Commits Suicide.

31. Ambiorix cōpiās suās iūdicione¹¹ nōn condūxerit, quod proeliō dīmīcandum nōn existimāret, an tempore excludus et repentinō equitum adventū prohibitus, cum reliquum exercitum subsequi crēderet, dubium est. Sed certē dīmīssis per agrōs nūntiis sibi quemque cōsulere iussit. Quōrum 25 pars in Arduennam silvam, pars in continentis¹² palūdēs

Cf. ¹ opp. discessiō. — ² statim. — ³ insciōs. — ⁴ valet. — ⁵ armamentis. — ⁶ opp. frīgoris. — ⁷ amīcī. — ⁸ impetum. — ⁹ imposuit. — ¹⁰ potuit. — ¹¹ cōsultō. — ¹² perpetuās.

profūgit; quī proximī Ōceanō fuērunt hī insulis sēsē occul-
tāvērunt¹ quās aestūs efficere cōsuērunt; multī ex suis
finibus ēgressī sē suaque omnia aliēnissimīs crēdidērunt.²
Catuvolcus, rēx dimidiae partis Eburōnum, quī ūnā cum
5 Ambiorige cōsiliū inierat,³ aetāte iam cōfectus, cum
labōrem bellī aut fugae ferre nōn posset, omnibus precibus
dētestātus Ambiorigem, quī ēius cōsiliī auctor fuisset, taxō
(cūius māgna in Galliā Germāniāque cōpia est)⁴ sē exani-
māvit.

Cæsar Proceeds to Aduatua and Puts Q. Cicero in Command there.

10 32. Sēgnī Condrūsique, ex gente et numerō Germānōrum,
quī sunt inter Eburōnēs Trēverōsque, lēgātōs ad Caesarem
mīsērunt orātum⁵ ‘nē sē in hostium numerō dūceret nēve
omnium Germānōrum quī essent citrā Rhēnum ūnam⁶ esse
causam iūdicāret; nihil sē dē bellō cōgitāvisse, nūlla Ambi-
15 orīgī auxilia mīsisse.’ Caesar explorātā⁷ rē quaestiōne cap-
tivōrum, sī quī ad eōs Eburōnēs ex fugā convēnissent, ad sē
ut redūcerentur imperāvit; sī ita fēcissent, finīs eōrum sē
violātūrum⁸ negāvit. Tum cōpiīs in trēs partis distribūtis
impedimenta omnium legiōnum Aduatucam contulit. Id
20 castellī nōmen est. Hōc ferē⁹ est in mediīs Eburōnum
finibus, ubi Titūrius atque Aurunculēius hiemandī causā
cōnsēderant. Hunc cum reliquīs rēbus locum probābat,
tum quod superiōris annī mūnitiōnēs integrae manēbant, ut
militum labōrem sublevāret.¹⁰ Praesidiō impedimentis legi-
25 ōnem XIII reliquit, ūnam ex hīs tribus quās proximē cōn-
scriptās ex Italiā trādūxerat. Eī legiōnī castrisque Q. Tul-
lium Cicerōnem praefēcit ducentōsque equitēs attribuit.

Cf. ¹ abdidērunt. — ² commīsērunt. — ³ cēperat. — ⁴ sibi mortem
cōnscīvit. — ⁵ petītum. — ⁶ eandem. — ⁷ perquisītā. — ⁸ vāstātūrum.
— ⁹ prope. — ¹⁰ minueret.

Divides his Forces and Proceeds in Search of Ambiorix.

33. Partitō¹ exercitū T. Labiēnum cum legiōnibus tribus ad Ōceanum versus in eās partis quae Menapiōs attingunt proficisci iubet; C. Trebōnium cum pari² legiōnum numerō ad eam regiōnem quae Aduatucis adiacet dēpopulandam³ mittit; ipse cum reliquis III ad flūmen Scaldim, quod influit in Mosam, extrēmāsque⁴ Arduennae partis ire cōstituit, quō cum paucis equitibus profectum Ambiorigem audiēbat. Discēdens post diem VII sēsē reversūrum⁵ cōfirmat; quam ad diem ei legiōni quae in praesidiō relinquēbātur frūmentum dēbēri sciēbat. Labiēnum Trebōniumque hortātur, si rei pūblīcae commodō facere possint, ad eum diem revertantur; ut, rūsus commūnicātō cōnsiliō explōrātisque hostium ratiōnibus,⁶ aliud initium bellī capere possint.

The Difficulties of the Situation Explained. Cæsar Seeks Alliance with Gallic Tribes against the Eburones.

34. Erat, ut suprā dēmōstrāvimus, manus certa nūlla, nōn oppidum, nōn praesidium quod sē armīs dēfenderet, sed in omnīs partis dispersa⁷ multitudō. Ubi cuique aut vallēs abdita⁸ aut locus silvestris aut palūs impedita spem praesidi aut salūtis aliquam offerēbat, cōnsēderat. Haec loca vicinitātibus⁹ erant nōta, māgnamque rēs diligentiam¹⁰ requirēbat, nōn in summā exercitūs tuendā (nūllum enim poterat ūniversis ā perterritis ac dispersis periculum accidere), sed in singulis militibus cōservandis; quae tamen ex parte rēs ad salūtem exercitūs pertinēbat. Nam et praedae cupiditās multōs longius sēvocābat, et silvae incertis occultisque itineribus cōfertōs adire prohibēbant. Si negotium¹² cōnfici stirpemque¹³ hominum scelerātōrum interfici vellet, dimittendae plūrēs manūs didūcendique¹⁴ erant

Cf. ¹ dīvisō. — ² eōdem. — ³ vāstandam. — ⁴ ultimās. — ⁵ reditūrum. — ⁶ cōnsiliis. — ⁷ dissipāta. — ⁸ remōta. — ⁹ propinquitātibus. — ¹⁰ cūram. — ¹¹ partim. — ¹² operam. — ¹³ genus. — ¹⁴ opp. cogendī.

militēs; si continēre ad signa manipulōs vellet, ut institūta
 ratiō et cōsuētūdō exercitūs Rōmāni postulābat,¹ locus ipse
 erat praesidiō barbaris, neque ex occultō insidiandī et di-
 spersōs circumveniendī singulis deerat audācia. Ut in eius
 5 modi difficultātibus, quantum diligentīā prōvidērī poterat
 prōvidēbātur; ut potius in nocendō aliquid praetermitterē-



FIG. 84. — SACRIFICE IN CAMP. MILITARY BAND

tur, etsi omnium animi ad ulciscendum ardebant, quam cum
 aliquo militum detrimento noceretur. Dimittit ad finitimās
 civitatis nuntios Caesar; omnis evocat spem praedae ad
 10 diripiendos² Eburones, ut potius in silvis Gallorum vita
 quam legionarius miles periclitetur; simul ut magnam multi-
 tudine circumfusam pro tali facinore stirps ac nomen civitatis
 tollatur.³ Magnus undique numerus celeriter convenit.

Cf. ¹ requirēbat. — ² depopulandos. — ³ deleatur.

An Invasion from Germany. The Sugambri Come for a Share in the Plunder of the Eburones. They Advance towards Cæsar's Camp.

35. Haec in omnibus Eburōnum partibus gerēbantur, diēsque adpetēbat¹ VII, quem ad diem Caesar ad impedimenta legiōnemque reverti cōstituerat. Hic quantum in bellō fortuna possit et quantōs adferat cāsūs cōgnōscī potuit. Dissipātis² ac perterritis hostibus, ut dēmōnstrāvimus, manus erat nūlla quae parvam modo causam timōris adferret. Trāns Rhēnum ad Germānōs pervenit³ fāma diripī Eburōnēs atque ultrō omnis ad praedam ēvocārī.⁴ Cōgunt equitum duo mīlia Sugambri, quī sunt proximī Rhēnō, ā quibus receptōs ex fugā Tencterōs atque Usipetēs suprā docuimus. Trānseunt Rhēnum nāvibus ratibusque xxx mīlibus passuum infrā eum locum ubi pōns erat perfectus⁵ praesidiumque ab Caesare relictum. Primōs Eburōnum finis adeunt; multōs ex fugā dispersōs excipiunt,⁶ māgnō pecoris numerō, cūius sunt cupidissimī barbarī, potiuntur. Invitāti⁷ praedā longius prōcēdunt. Nōn hōs palūdēs bellō latrōciniisque nātōs, nōn silvae morantur.⁸ Quibus in locis sit Caesar ex captivīs quaerunt; profectum longius reperiunt omnemque exercitum discessisse cōgnōscunt. Atque ūnus ex captivīs: “Quid vōs,” inquit, “hanc miseram ac tenuem sectāminī praedam, quibus licet iam esse fortunātissimōs? Tribus hōris Aduatucam venīre potestis; hūc omnis suās fortunās exercitus Rōmānōrum contulit. Praesidī tantum est ut nē mūrus quidem cingī possit, neque quisquam ēgredi extrā mūnitiōnēs audeat.” Hāc oblātā spē Germānī quam nacti erant praedam in occultō relinquunt; ipsī Aduatucam contendunt ūsī eōdem duce cūius haec indicio cōgnōverant.

Cf. ¹ accēdēbat. — ² disiectis. — ³ perfertur. — ⁴ arcessī. — ⁵ factus. — ⁶ dēprehendunt. — ⁷ inductī. — ⁸ tardant. — ⁹ rēs familiārīs. — ¹⁰ dēfendī. — ¹¹ invēnerant.

Cicero Unwisely Sends Large Numbers out to Forage.

36. Cicerō (quī omnis superiōrēs diēs praeceptis¹ Caesaris summā diligentīā milītēs in castrīs continuisset, ac nē cālōnem quidem quemquam extrā mūnitiōnem ēgredi passus² esset) VII diē, diffidēns³ dē numerō diērum Caesarem
 5 fidem servātūrum, quod longius prōgressum audiēbat neque ūlla dē reditū ēius fāma⁴ adferēbātur; simul eōrum permōtus vōcibus⁵ quī illius patientiam paene obsessiōnem⁶ appellābant, sī quidem ex castrīs ēgredi nōn licēret; nūllum ēius modi cāsū exspectāns quō, VIII oppositis legiōnibus
 10 maximōque equitātū, dispersis ac paene dēlētis hostibus, in milibus passuum tribus offendī posset, — v cohortis frumentātum in proximās segetēs⁷ mittit, quās inter et castra ūnus omninō collis intererat. Complūrēs erant in castrīs ex legiōnibus aegrī relictī; ex quibus quī⁸ hōc spatiō diērum con-
 15 valuerant, circiter CCC, sub vēxillō ūnā mittuntur; māgna praetereā multitūdō cālōnum, māgna vis⁹ iūmentōrum, quae in castrīs subsēderat, factā potestāte sequitur.

The Germans Assault the Camp. Panic Within.

37. Hōc ipsō tempore¹⁰ [et] cāsū Germānī equitēs interueniunt, prōtinusque eōdem illō quō vēnerant cursū ab de-
 20 cumānā portā in castra inrumpere cōnantur; nec prius sunt visī, obiectis ab eā parte silvis, quam castrīs adpropinquārent, ūsque eō ut quī sub vāllō tenderent¹¹ mercātōrēs recipiendī suī facultātem nōn habērent. Inopināntēs nostrī rē novā perturbantur, ac vix primum impetum cohors in stati-
 25 ōne sustinet. Circumfunduntur hostēs ex reliquis partibus, sī quem aditum¹² reperire possint. Aegrē¹³ portās nostrī tumentur,¹⁴ reliquōs aditūs locus ipse per sē mūnitiōque dēfendit. Tōtis trepidātur castrīs atque alius ex aliō causam

Cf. ¹ mandātis. — ² permīssisset. — ³ opp. cōnfidēns. — ⁴ rumor. — ⁵ verbis. — ⁶ obsidiōnem. — ⁷ agrōs. — ⁸ hīs diēbus. — ⁹ numerus. — ¹⁰ discrimine. — ¹¹ cōnsiderent. — ¹² introitum. — ¹³ vix. — ¹⁴ dēfendunt.

tumultūs quaerit; neque quō signa ferantur neque quam in partem quisque conveniat¹ prōvident. Alius castra iam capta prōnūntiat; alius dēlētō exercitū atque imperātōre victōrēs barbarōs vēnisse contendit; plērique novās sibi ex locō religiōnēs fingunt, Cottaēque et Titūri calamitātem,² quī 5 in eōdem occiderint castellō, ante oculōs pōnunt. Tālī timōre omnibus perterritis³ cōfirmātur opiniō barbaris, ut ex captivō audierant, nūllum esse intus praesidium. Per-rumpere⁴ nītuntur⁵ sēque ipsi adhortantur nē tantam fortū-nam ex manibus dīmittant. 10

P. Sextius Baculus again Distinguishes Himself.

38. Erat aeger in praesidiō relictus P. Sextius Baculus, quī primum pilum apud Caesarem dūxerat, cūius mentiōnem superiōribus proeliis fēcimus, ac diem iam quintum cibō caruerat. Hīc diffīsus suae atque omnium salūti inermis⁶ ex tabernāculō prōdit; videt imminēre hostis atque in 15 summō rem esse discrimine; capit arma ā proximis atque in portā cōsistit: cōsequuntur hunc centuriōnēs eīus cohortis quae in statiōne erat; paulisper unā proelium sustinent. Relinquit animus Sextium gravibus acceptis volneribus; aegrē per manūs trādītus⁷ servātur. Hōc spatiō⁸ 20 interpositō reliquī sēsē cōfirmant⁹ tantum ut in mūnitiōnibus cōsistere audeant speciemque dēfēnsōrum¹⁰ praebeant.

The Foragers Return and Reach the Camp with Some Difficulty and Loss.

39. Interim cōfectā frūmentātiōne militēs nostrī clāmōrem exaudiunt; praecurrunt equitēs; quantō rēs sit in periculō cōgnōscunt. Hīc vērō nūlla mūnitiō est quae perterritōs 25 recipiat; modo¹¹ cōscripti atque ūsūs militāris imperīti ad tribūnum militum centuriōnēsque ōra convertunt; quid ab his praeciipiātur exspectant: nēmō est tam fortis quin rei

Cf. ¹ sē cōferat. — ² caedem. — ³ commōtis. — ⁴ perfringere. — ⁵ cōnantur. — ⁶ sine armīs. — ⁷ ductus. — ⁸ tempore. — ⁹ adhortantur. — ¹⁰ dēfēnsiōnis. — ¹¹ nūper.

novitāte perturbētur. Barbarī signa procul cōspicātī oppugnatiōne dēsistunt:¹ redisse primō legiōnēs crēdunt quās longius discessisse ex captivīs cōgnōverant; postea dēspectā² paucitāte ex omnibus partibus impetum faciunt.

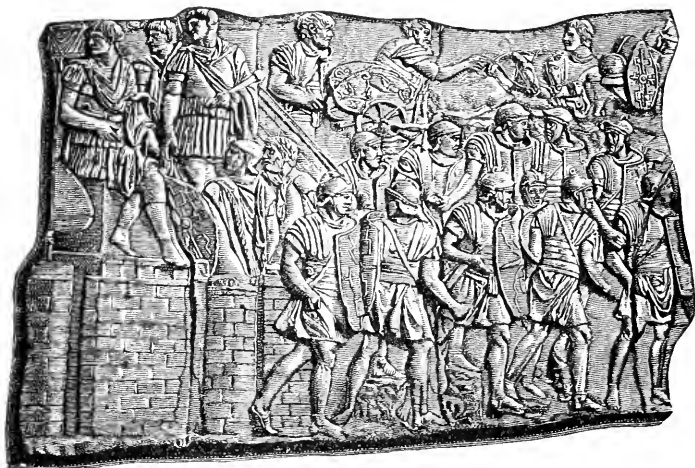

FIG. 85. — SOLDIERS MARCHING IN PRESENCE OF THE IMPERATOR.

5 40. Cālōnēs in proximum tumulum prōcurrunt.³ Hinc celeriter dēiectī⁴ sē in signa manipulōsque coniciunt; eō magis timidōs perterrent milicēs. Alii cuneō factō ut celeriter perrumpant cēsent, quoniam tam propinqua⁵ sint castra; etsi pars aliqua circumventa⁶ ceciderit, at reliquōs servārī
10 posse [confidunt]; aliī ut in iugō cōsistant atque eundem omnēs ferant cāsum. Hōc veterēs⁷ nōn probant milicēs, quōs sub vēxillō ūnā profectōs docuimus. Itaque inter sē cohortātī, duce C. Trebōniō, equite Rōmānō, qui eis erat praepositus, per mediōs hostis perrumpunt incolumēsque ad

Cf. ¹ relinquunt, w. acc. — ² contemptā. — ³ profugiunt. — ⁴ dēpulsī. — ⁵ prope. — ⁶ circumclūsa. — ⁷ veterānī.

ūnum omnēs in castra perveniunt. Hōs subsecūtī cālōnēs equitēsque eōdem impetū militum virtūte servantur. At eī quī in iugō cōstiterant, nullō etiam nunc ūsū reī militāris perceptō, neque in eō quod probāverant cōsiliō permanēre, ut sē locō superiōre dēfenderent, neque eam quam prōfuisse¹ aliīs vim celeritātemque viderant, imitārī potuerunt; sed sē in castra recipere² cōnātī inīquum in locum dēmiserunt.³ Centuriōnēs, quōrum nōn nullī ex inferiōribus ōrdinibus reliquārum legiōnum virtūtis causā in superiōrēs erant ōrdinēs hūius legiōnis trādūctī, nē ante partam reī militāris laudem āmitterent,⁴ fortissimē pūgnantēs concidērunt. Militum pars, hōrum virtūte submōtis hostibus, praeter spem incolumis in castra pervēnit; pars ā barbaris circumventa periit.⁵

The Germans Withdraw. Arrival of Cæsar. Flight of Ambiorix.

41. Germānī dēspērātā expūgnātiōne castrōrum, quod nostrōs iam cōstitisse in mūnitiōnibus vidēbant, cum eā praedā quam in silvis dēposuerant⁶ trāns Rhēnum sēsē recēpērunt. Ac tantus fuit etiam post discessum⁷ hostium terror ut eā nocte, cum C. Volusēnus missus cum equitātū in castra vēnisset, fidem nōn faceret adesse cum incolumi Caesarem exercitū. Sic omnium animōs timor⁸ praeoccupāverat ut paene⁹ aliēnātā mente, dēlētis omnibus cōpiis, equitātum sē ex fugā recēpisse dīcerent, neque incolumi exercitū Germānōs castra oppūgnātūrōs fuisse contenderent. Quem timōrem Caesaris adventus sustulit.

42. Reversus ille, — ēventūs¹⁰ bellī¹¹ nōn ignōrāns, ūnum¹² quod cohortēs ex statiōne et praesidiō essent ēmissae questus, nē minimum quidem cāsui locum relinqui dēbuisse, — multum fortūnam in repentinō¹³ hostium adventū potuisse iūdicāvit; multō etiam amplius, quod paene ab ipsō vāllō

Cf. ¹ iūvisse, w. acc. — ² referre. — ³ dēscendērunt. — ⁴ dēmitterent. — ⁵ interiit. — ⁶ cēlāverant. — ⁷ profectiōnem. — ⁸ metus. — ⁹ āmentīā impulsī. — ¹⁰ cāsūs. — ¹¹ sciēns. — ¹² tantum. — ¹³ subitō.

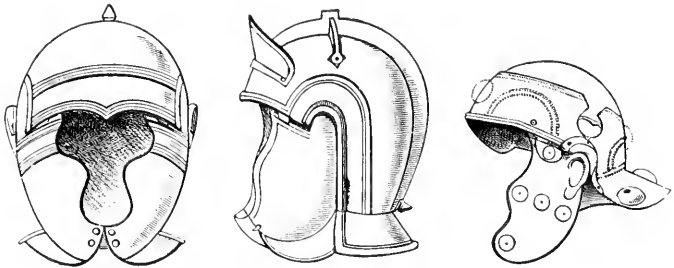

FIG. 87. — HELMETS (*galeae*).

BOOK VII.

UPRISING OF GAUL UNDER VERCINGETORIX. B.C. 52.

General Movement among the Gauls for Independence.

QUIĒTĀ¹ Galliā Caesar, ut cōstituerat, in Ītaliā ad
 conventūs agendōs proficiscitur. Ibi cōgnōscit dē
 P. Clōdī caede; *dē* senātūsque cōsultō certior factus ut
 omnēs iūniōrēs Ītaliāe coniūrārent, dēlectum tōtā prōvinciā
 5 habēre instituit. Eae rēs in Galliam Trānsalpīnam celeriter
 perferuntur. Addunt ipsī et adfingunt rūmōribus Galli
 (quod rēs poscere² vidēbātur) retinēri urbānō mōtū³ Caesa-
 rem neque in tantis dissēsiōnibus ad exercitum venire
 posse. Hāc impulsī⁴ occāsiōne quī iam ante sē populi
 10 Rōmāni imperiō subiectōs dolērent⁵ liberius atque audācius
 dē bellō cōsilia inire⁶ incipiunt. Indictis⁷ inter sē princi-
 pēs Galliae conciliis silvestribus ac remōtis⁸ locis queruntur
 dē Accōnis morte; posse hunc cāsum ad ipsōs recidere
 dēmōnstrant;⁹ miserantur commūnem Galliae fortūnam;
 15 omnibus pollicitātiōnibus ac praemiis dēposcunt quī belli

Cf. ¹ pācātā. — ² postulāre. — ³ tumultū. — ⁴ incitātī. — ⁵ molestē
 ferrent. — ⁶ capere. — ⁷ opp. interdictis. — ⁸ dēsertis. — ⁹ ostendunt.

initium faciant et sui capitis¹ periculō Galliam in libertātem vindicent. In primis ratiōnem² esse habendam dicunt, priusquam eōrum clandestina cōsilia efferantur, ut Caesar ab exercitū interclūdātur. Id esse facile, quod neque legiōnēs audeant absente imperātōre ex hibernis ēgredi, neque imperātor sine praesidiō ad legiōnēs pervenire possit; postrēmō,³ in aciē praestāre⁴ interfici quam nōn veterem bellī glōriam libertātemque quam ā māiōribus accēperint recuperāre.

The Carnutes Begin the Revolt. Rapid Spread of the News.

2. His rēbus agitātis⁵ profitentur Carnutes sē nūllum periculū commūnis salutis causā recūsāre, principēsque⁶ 10 ex omnibus bellum factūrōs pollicentur; et, quoniam in praesentiā obsidibus cavēre inter sē nōn possint, nē rēs efferātur, ut iūre iūrādō ac fidē sanciatūr⁷ petunt, conlātis militāribus signis (quō mōre eōrum gravissima caerimōnia continētur), nē factō initiō belli ab reliquis dēserantur. Tum 15 conlaudātis Carnutibus, datō iūre iūrādō ab omnibus qui aderant, tempore eius rei cōstitutō, ā conciliō discēditur.

3. Ubi ea diēs vēnit, Carnutes Cotuātō et Conconnetodumnō ducibus, dēspērātis hominibus, Cēnabum signō datō concurrunt,⁸ civisque Rōmānōs qui negōtiandi causā ibi 20 cōstiterant, in his C. Fūfium Citam, honestum equitem Rōmānum, qui rei frūmentāriae iūssū Caesaris praeerat, interficiunt bonaque eōrum diripiunt. Celeriter ad omnīs Galliae civitātis fāma perfertur. Nam ubi quae māior atque inlustrior incidit⁹ rēs, clāmōre per agrōs regiōnēsque signi- 25 ficant; hunc alii deinceps excipiunt et proximis trādunt, ut tum accidit. Nam quae Cēnabī oriente¹⁰ sōle gesta essent ante primam cōfectam vigiliam in finibus Arvernōrum audita sunt, quod spatium est milium passuum circiter CLX.

Cf. ¹ vitae. — ² cūram. — ³ dēnique. — ⁴ melius esse. — ⁵ dēliberātis. — ⁶ primōs. — ⁷ cōfirmētur. — ⁸ conveniunt. — ⁹ contingit. — ¹⁰ opp. occidente.

Vercingetorix, Chief of the Arverni, Takes the Lead, and Induces Many Tribes to Join him. Severity of his Rule.

4. Simili ratiōne ibi Vercingetorix, Celtilli filius, Arvernus, summae potentiae¹ adulēscēns, — cuius pater principātum tōtius Galliae obtinuerat, et ob eam causam quod rēgnum adpetēbat² ā civitāte erat interfectus, — convocātis suis
 5 clientibus facile incendit.³ Cōgnitō ēius cōsiliō ad arma concurritur. Prohibētur ā Gobannitiōne, patruō suō, reliquīsque principibus, quī hanc temptandam fortunam nōn existimābant; expellitur⁴ ex oppidō Gergoviā; nōn dēstitit tamen atque in agris habet dēlectum egentium ac perditōrum. Hāc
 10 coāctā manū quōscumque adit ex civitāte ad suam sententiam perdūcit; hortātur ut commūnis libertātis causā arma capiant; māgnisque coāctis cōpiīs adversāriōs⁵ suōs, ā quibus paulō ante erat ēiectus, expellit ex civitāte. Rēx ab suis appellātur. Dimittit quōque versus lēgatiōnēs; obtes-
 15 tātur⁶ ut in fidē maneant. Celeriter sibi Senonēs, Parisiōs, Pictonēs, Cadūrcōs, Turonōs, Aulercōs, Lemovicēs, Andōs, reliquōsque omnīs quī Oceanum attingunt adiungit⁷; omnium cōsēnsū ad eum dēfertur imperium. Quā oblātā⁸ potestāte omnibus his civitātibus obsidēs imperat; certum numerum
 20 militum ad sē celeriter addūci iubet; armōrum quantum quaeque civitās domī, quodque ante tempus efficiat,⁹ cōstituit; in primīs equitātui studet. Summae diligentiae summam imperi sevērītatem addit; māgnitūdine supplicī dubitantis cōgit¹⁰: nam māiōre commissō dēlictō¹¹ igni
 25 atque omnibus tormentis necat; leviōre dē causā auribus dēsectis aut singulis effossis oculis domum remittit, ut sint reliquīs documentō¹² et māgnitūdine poenae perterreant aliōs.

Cf. ¹ potestātis. — ² cupiēbat. — ³ incitāvit. — ⁴ ēicitur. — ⁵ inimīcōs. — ⁶ obsecrātur. — ⁷ adsciscit. — ⁸ trāditā. — ⁹ parat. — ¹⁰ perdūcit. — ¹¹ facinore. — ¹² exemplō.

**He Goes among the Bituriges, Who Appeal to the Hædui for Help.
Being Refused, They Join him.**

5. His supplicis celeriter coactō exercitū Lucterium Cadūrcum, summae hominem audāciae, cum parte cōpiārum in Rutēnōs mittit; ipse in Biturigēs proficiscitur. Eius adventū Bituriges ad Haeduōs (quōrum erant in fidē) lēgātōs mittunt subsidium rogātum, quō facilius hostium cōpiās sustinēre¹ 5 possint. Haeduī dē cōsiliō lēgātōrum, quōs Caesar ad exercitum reliquerat, cōpiās equitātūs peditātūsque subsidiō Biturigibus mittunt. Quī cum ad flūmen Ligerim vēnissent, quod Biturigēs ab Haeduīs dividit, paucōs diēs ibi morātī neque flūmen trānsire ausī, domum revertuntur,² lēgātisque 10 nostris renūntiant³ sē Biturigum perfidiam veritōs revertisse, quibus id cōsiliū fuisse cōgnōverint ut, si flūmen trānsissent, ūnā ex parte ipsī, alterā Arvernī sē circumsisterent.⁴ Id eāne dē causā quam lēgātis prōnūntiārunt an perfidiā adductī fēcerint, quod nihil nōbīs cōstat, nōn vidētur prō certō esse 15 pōnendum. Bituriges eōrum discessū statim sē cum Arvernīs iungunt.

**Cæsar's Difficulty in Reaching his Army. He Proceeds to Narbo to
Counteract the Plans of Lucterius.**

6. His rēbus in Ītaliā Cæsari nūntiātis,⁵ cum iam ille urbānās rēs virtūte Cn. Pompēi commodiōrem⁶ in statum pervēnisse intellexeret, in Trānsalpinā Galliam profectus 20 est. Eō cum vēnisset, māgnā difficultāte adficiēbatur,⁷ quā ratiōne ad exercitum pervenire posset. Nam si legiōnēs in prōvinciam arcesseret, sē absente in itinere proeliō dimicātūrās⁸ intellegēbat; si ipse ad exercitum contenderet, nē eis quidem eō tempore quī quieti vidērentur suam salutem rēctē 25 committi vidēbat.

Cf. ¹ resistere, w. dat. — ² sē recipiunt. — ³ referunt. — ⁴ circumvenirent. — ⁵ perlātis. — ⁶ meliōrem. — ⁷ permovēbatur. — ⁸ pūgnātūrās.

7. Interim Lucterius Cadūrcus in Rutēnōs missus eam civitatem Arvernīs conciliat. Prōgressus in Nitiobrigēs et Gabalōs ab utrisque obsidēs accipit, et māgnā coactā manū in prōvinciam Narbōnem versus¹ inruptiōnem² facere contendit. Quā rē nūntiātā Caesar omnibus cōsiliis antever-
 5 tendum³ existimāvit, ut Narbōnem proficiscerētur. Eō cum vēnisset, timentis cōfirmat, praesidia in Rutēnis prōvincia- libus, Volcīs Arecomicis, Tolōsātibus circumque Narbōnem, quae loca hostibus erant finitima,⁴ cōstituit; partem cōpiā-
 10 rum ex prōvincia, supplēmentumque quod ex Italiā addūxerat in Helviōs, quī finis Arvernōrum contingunt,⁵ convenire iubet.

Cæsar Crosses the Cevennes Mountains through the Snow. Vercingetorix Goes to Protect the Arverni.

8. His rēbus comparātis,⁶ repressō iam Lucteriō et remōtō,⁷ quod intrāre intrā praesidia periculōsum putābat, in
 15 Helviōs proficiscitur. Etsi mōns Cevenna, quī Arvernōs ab Helviis discludit,⁸ dūrissimō tempore annī altissimā nive iter impediēbat; tamen, discussā nive in altitudinem pedum vi atque ita viis patefactis,⁹ summō militum labōre ad finis Arvernōrum pervēnit. Quibus oppressis inopinantibus,
 20 quod sē Cevennā ut mūrō munitōs existimābant, ac nē singulārī¹⁰ quidem umquam hominī eō tempore annī sēmitae¹¹ patuerant, equitibus imperat ut quam lātissimē possint vagentur et quam maximum hostibus terrōrem inferant.

Celeriter haec fāma ac nūntiī ad Vercingetorigem perfe-
 25 runt; quem perterriti omnēs Arverni circumsistunt atque obsecrant¹² ut suis fortūnis cōsulat, neu sē ab hostibus diripi patiātur; praesertim cum videat¹³ omne ad sē bellum trāslātum. Quōrum ille precibus permōtus castra ex Biturigibus movet in Arvernōs versus.

Cf. ¹ adversus. — ² incursiōnem. — ³ antepōnendum. — ⁴ proxima. — ⁵ attingunt. — ⁶ gestis. — ⁷ repulsō. — ⁸ dividit. — ⁹ apertis. — ¹⁰ ūnī. — ¹¹ viae. — ¹² implōrant. — ¹³ perspiciat.

Cæsar Leaves Brutus in Command and Seeks Reënforcements. Vercingetorix Moves towards Gorgobina, a Town of the Boii.

9. At Caesar bīdum in hīs locīs morātus, quod haec dē Vercingetorige ūsū ventūra opīniōne praecēperat, per causam supplēmenti¹ equitātusque cōgendi ab exercitū discēdit; Brūtum adulēscēntem hīs cōpiis praeficit; hunc monet ut in omnīs partīs equitēs quam lātissimē pervagentur²; datūrum 5 sē operam nē longius trīduō ā castrīs absit. Hīs cōstitutīs rēbus, suis inopināntibus, quam maximīs potest itineribus Viennam pervenit. Ibi nactus³ recentem equitātum, quem



FIG. 89. — COIN OF BRUTUS AND ALBINUS.

multis ante diēbus eō praemiserat, neque diurnō neque nocturnō itinere intermissō, per finis Haeduōrum in Lingo- 10 nēs contendit, ubi duae legiōnēs hiemābant; ut, sī quid etiam dē suā salūte ab Haeduis inirētur⁴ cōnsili, celeritāte praecurreret. Eō cum pervēnisset, ad reliquās legiōnēs mittit, priusque omnīs in ūnum locum cōgit quam dē eius adventū Arvernīs nūtiārī posset. Hāc rē cōgnitā⁵ Vercin- 15 getorix rūsus in Biturigēs exercitum redūcit, atque inde profectus Gorgobinam, Bōiōrum oppidum, quōs ibi Helveticō proeliō victōs⁶ Caesar conlocāverat Haeduisque attribuerat,⁷ oppūgnāre instituit.

Cæsar, though Much Perplexed, Determines to Relieve the Boii.

10. Māgnam haec rēs Caesari difficultātem ad cōnsilium 20 capiendum adferēbat: sī reliquam partem hiemis ūnō locō

Cf. ¹ auxiliōrum. — ² vagentur. — ³ adeptus, inveniēns. — ⁴ caperētur. — ⁵ audītā. — ⁶ superātōs. — ⁷ adiūnzerat.

legiōnēs continēret,¹ nē stipendiāriis Haeduōrum expūgnātis cūncta² Gallia dēficeret, quod nūllum amīcis in eō praesidium positum vidēret; sī mātūrius ex hibernis ēdūceret, nē ab rē frūmentāriā dūris subvectiōnibus labōrāret. Praestāre³ 5 vīsum est tamen omnis difficultātis perpeti⁴ quam, tantā contumēliā acceptā, omnium suōrum voluntātis⁵ aliēnāre. Itaque cohortātus Haeduōs dē supportandō commeātū, praemittit ad Bōiōs quī dē suō adventū doceant, hortenturque ut in fidē maneant atque hostium impetum māgnō 10 animō⁶ sustineant. Duābus Agēdincī legiōnibus atque impedimentis tōtius exercitūs relictis ad Bōiōs proficiscitur.

Cæsar Takes Two Towns near the Loire.

11. Alterō diē cum ad oppidum Senonum, Vellaunodūnum, vēnisset, nē quem post sē hostem relinqueret, *et* quō expedi-
tiōre rē frūmentāriā ūterētur, oppūgnāre instituit, eōque 15 biduō circumvallāvit; tertiō diē missis ex oppidō lēgātis dē dēditiōne, arma cōferri,⁷ iūmenta prōdūcī, sexcentōs obsidēs dari iubet. Ea quī cōficeret⁸ C. Trebōnium lēgātum relinquit; ipse ut quam primum iter cōficeret, Cēnabum Carnutum proficiscitur; quī tum primum adlātō nūntiō dē 20 oppūgnātiōne Vellaunodūni, cum longius eam rem ductum iri exīstimārent, praesidium Cēnabī tuendi⁹ causā, quod eō mitterent, comparābant.

Hūc biduō pervenit. Castris ante oppidum positis, diēi tempore exclūsus¹⁰ in posterum oppūgnātiōnem differt, quae-
25 que ad eam rem ūsuī¹¹ sint militibus imperat; et, quod oppidum Cēnabum pōns flūminis Ligeris contingēbat, veritus nē noctū ex oppidō profugerent, duās legiōnēs in armis excubāre iubet. Cēnabēnsēs, paulō ante mediam noctem silentiō ex oppidō ēgressi flūmen trānsire coepērunt. Quā rē per explō-

Cf. ¹ retinēret. — ² tōta. — ³ optimum esse. — ⁴ perferre. — ⁵ animōs. — ⁶ virtūte. — ⁷ comportārī. — ⁸ perficeret. — ⁹ dēfendendī. — ¹⁰ prohibitus. — ¹¹ ex ūsū.

rātōrēs nūntiātā Caesar legiōnēs, quās expeditās esse iusserat, portis incēnsis,¹ intrōmittit atque oppidō potitur, perpaucis ex hostium numerō dēsiderātis quīn cūncti caperentur, quod pontis atque itinerum angustiae multitudinī fugam interclūserant.² Oppidum diripit atque incendit, praedam militibus dōnat; 5 exercitum Ligerim trādūcit atque in Biturīgum finis pervenit.

Noviodunum Surrenders, but the Inhabitants, Seeing Vercingetorix Approaching, Prepare for Defense.

12. Vercingetorix ubi dē Caesaris adventū cōgnōvit, oppūgnātiōne dēsistit atque obviam Caesarī proficiscitur. Ille oppidum Biturīgum positum in viā Noviodūnum oppūgnāre instituerat. Quō ex oppidō cum lēgātī ad eum vēnissent 10 orātum³ ut sibi ignōsceret suaeque vitae cōsuleret,⁴ ut celeritāte reliquās rēs cōnficeret quā plēraque erat cōsecūtus,⁵ arma cōferri, equōs prōdūcī, obsidēs darī iubet. Parte iam obsidum trādītā, cum reliqua administrārentur, centuriōnibus et paucis militibus intrōmissis quī arma iūmenta 15 cōnquīrerent,⁶ equitātus hostium procul visus est, quī agmen Vercingetorigis antecesserat. Quem⁷ simul atque oppidānī cōspexērunt atque in spem auxiliī vēnērunt, clāmōre sublātō arma capere, portās claudere, mūrum complēre coepērunt. Centuriōnēs in oppidō, cum ex significātiōne Gallōrum novi 20 aliquid ab his inīrī cōnsilī intellēxissent, gladiis dēstrictis portās occupāvērunt suōsque omnīs incolumīs⁸ recēpērunt.

Caesar Takes Noviodunum and Marches towards Avaricum.

13. Caesar ex castris equitātum ēdūcī iubet, proeliumque equestre committit; labōrantibus iam suīs Germānōs equitēs circiter cccc submittit,⁹ quōs¹⁰ ab initiō sēcum habēre instituerat. Eōrum impetum Gallī sustinēre nōn potuērunt,

Cf. ¹ exūstīs. — ² impediērant. — ³ obsecrātum. — ⁴ parceret. — ⁵ cōnfēcerat. — ⁶ quaerent. — ⁷ ut semel. — ⁸ tūtōs. — ⁹ auxiliō mittit. — ¹⁰ primō.

atque in fugam coniecti¹ multis āmissis sē ad agmen recēpērunt; quibus prōfligātis² rursus³ oppidāni perterriti comprehēnsōs eōs quōrum operā plēbem concitātam existimābant ad Caesarem perdūxērunt sēsēque eī dēdidērunt. Quibus

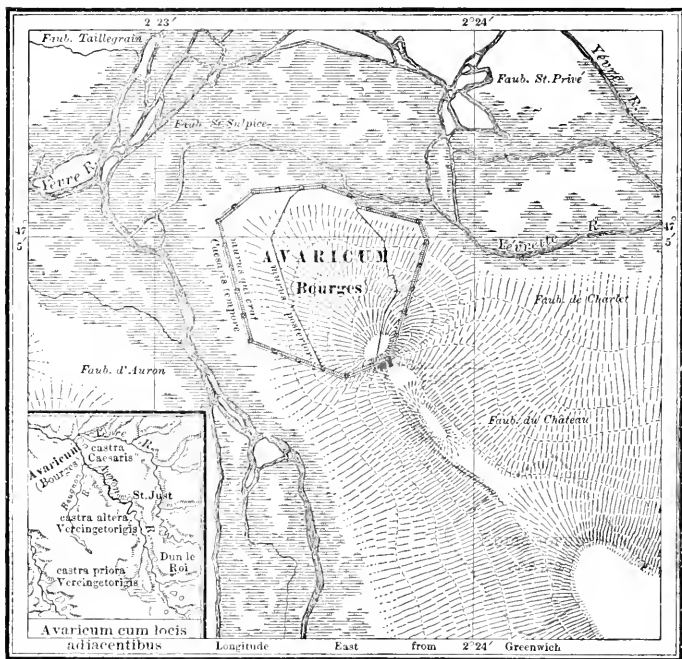

FIG. 90. — SIEGE OF AVARICUM.

5 rēbus cōfectis Caesar ad oppidum Avaricum, quod erat māximum mūnitissimumque in finibus Biturīgum atque agri fertilissimā regiōne, profectus est; quod eō oppidō receptō⁴ cīvitatē Biturīgum sē in potestātem redactūrum cōfidēbat.

Cf ¹ conversi. — ² dēpulsis. — ³ iterum. — ⁴ opp. āmissō.

Vercingetorix Advises the Gauls to Lay Waste their Country, and thus Keep the Romans from Supplies.

14. Vercingetorix tot continuīs incommodis¹ Vellaunodūnī, Cēnabī, Noviodūnī acceptis suōs ad concilium convocat. Docet 'longē aliā ratiōne esse bellum gerendum atque anteā gestum sit; omnibus modis huic rei studendum ut pābulātiōne et commeātū Rōmānī prohibeantur: id esse 5 facile, quod equitātū ipsi abundant² et quod annī tempore subleventur; pābulum secārī nōn posse; necessariō³ dispersōs hostis ex aedificiis petere; hōs omnis cotidiē ab equitibus dēlērī posse. Praetereā, salūtis causā rei familiāris commoda neglegenda; vicōs atque aedificia incendi oportēre 10 hōc spatiō [ā Bōiā] ⁴quōque versus, quō pābulandī causā adire posse videantur. Hārum ipsīs rērum cōpiam suppetere, quod quōrum in finibus bellum gerātur eōrum opibus subleventur⁵: Rōmānōs aut inopiam⁶ nōn lātūrōs aut māgnō cum periculō longius ā castris prōcessūrōs; neque 15 interesse ipsōsne interficiant *an* impedimentis exuant,⁷ quibus āmissis bellum gerī nōn possit. Praetereā, oppida incendi oportēre quae nōn mūnitiōne et loci nātūrā ab omni sint periculō tūta; nē suis sint ad dētrectandam⁸ militiam receptācula, neu Rōmānis prōposita ad cōpiam commeātūs 20 praedamque tollendam. Haec sī gravia aut acerba videantur, multō illa gravius aestimārī dēbēre, liberōs, coniugēs in servitūtem abstrahī, ipsōs interficī; quae sit necesse accidere victis.'

They Burn Many Cities, but Spare Avaricum.

15. Omnium cōsēnsū hāc sententiā probātā ūnō diē 25 amplius xx urbēs Biturīgum incenduntur.⁹ Hōc idem fit¹⁰ in reliquis cīvitatibus. In omnibus partibus incendia cōn-

Cf. ¹ cladibus. — ² plūrimum possint. — ³ necessitāte adductōs. — ⁴ undique. — ⁵ iuventur. — ⁶ opp. cōpiam. — ⁷ dēspolient. — ⁸ vītandam. — ⁹ combūruntur. — ¹⁰ accidit.

spiciuntur, quae etsi māgnō cum dolōre omnēs ferēbant, tamen hōc sibi sōlāci prōpōnēbant, quod sē prope explorātā¹ victōriā celeriter āmissa recuperātūrōs cōfidēbant. Dēliberātūr² dē Avaricō in commūni conciliō, incendi placeat an
 5 dēfendī. Prōcumbunt omnibus Gallis ad pedēs Bituriges, nē pulcherrimam prope tōtius Galliae urbem, quae et praesidiō et ōrnāmentō sit civitātī, suis manibus succendere cōgantur; facile sē loci nātūrā dēfēnsūrōs dicunt, quod,
 10 ūnum habeat et perangustum³ aditum. Datur petentibus venia, dissuādente primō Vercingetorige, post concēdente, et precibus ipsōrum et misericordiā volgī. Dēfēnsōrēs oppidō idōnei dēliguntur.

16. Vercingetorix minōribus Caesarem itineribus subse-
 15 quitur, et locum castris dēligit palūdibus silvisque mūnītum, ab Avaricō longē milia passuum xvi. Ibi per certōs explorātōrēs in singula diēi tempora quae ad Avaricum gererentur cōgnōscēbat, et quid fieri vellet imperābat. Omnis nostrās pābulātiōnēs frūmentātiōnēsque observābat,⁴ dispersōsque,
 20 cum longius necessāriō prōcēderent, adoriēbātur māgnōque incommodō adficiēbat; etsi, quantum ratiōne prōvidēri poterat, ab nostris occurrēbātur,⁵ ut incertis temporibus diversisque⁶ itineribus irētur.

Although Suffering from Lack of Supplies, the Roman Soldiers
 Maintain a Resolute Spirit.

17. Castris ad eam partem oppidī positīs Caesar quae
 25 intermissa [ā] flūmine et palūde aditum, ut suprā diximus, angustum habēbat, aggerem adparāre,⁷ vineās agere, turrīs duās cōstituere⁸ coepit; nam circumvallāre loci nātūra prohibēbat. Dē rē frūmentāriā Bōiōs atque Haeduōs adhortārī nōn dēstitit: quōrum alterī, quod nullō studiō⁹ agēbant,

Cf. ¹ cōfirmātā. — ² cōsultātūr. — ³ angustissimum. — ⁴ speculābātūr. — ⁵ obsistēbātūr. — ⁶ variīs. — ⁷ iacere. — ⁸ excitāre. — ⁹ opp. indiligentiā.

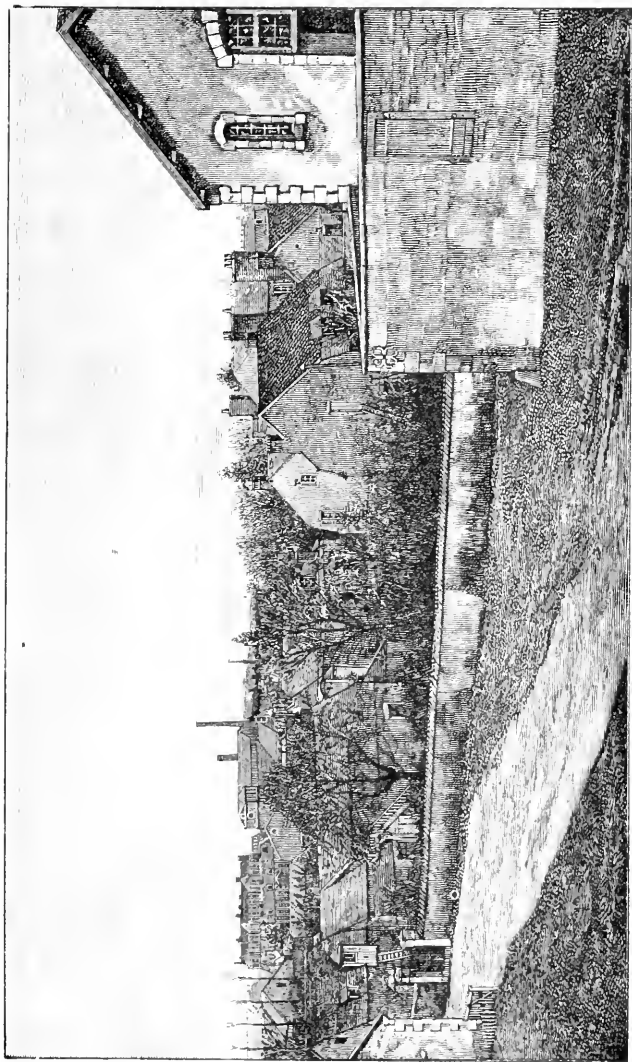

FIG. 94. — BOURGES.



nōn multum adiuuābant; alteri nōn māgnis facultātibus,¹ quod cīuitās erat exigua² et infirma, celeriter quod habuērunt cōsūmpsērunt. Summā difficultāte rei frūmentāriae adfectō exercitū, tenuitāte³ Bōiōrum, indiligentiā Haeduōrum, incendiis aedificiōrum, — ūsque eō ut complūris diēs 5 frūmentō militēs caruerint,⁴ et pecore ē longinquiōribus⁵ vicis adāctō extrēmam famem sustentārint, — nūlla tamen vōx est ab eīs audita populī Rōmānī māiestāte⁶ et superiōribus victōriis indigna. Quin etiam Caesar cum in opere singulās legiōnēs appellāret,⁷ et, si acerbius inopiam ferrent, 10 sē dīmissūrum⁸ oppūgnātiōnem dīceret, ūniversī ab eō nē id faceret petēbant: ‘Sic sē complūris annōs illō imperante meruisse ut nūllam īgnōminiam acciperent, numquam īfectā⁹ rē discēderent; hōc sē īgnōminiae lātūrōs locō, si inceptam oppūgnātiōnem reliquissent¹⁰: praestāre omnīs perferre acer- 15 bitātis¹¹ quam nōn cīuibus Rōmānīs quī Cēnabī perfidiā Gallōrum interīssent¹² parentārent.’ Haec eadem centuriōnibus tribūnisque militum mandābant,¹³ ut per eōs ad Caesarem dēferrentur.

Cæsar Marches towards Vercingetorix.

18. Cum iam mūrō turrēs adpropinquāssent, ex captīvis 20 Caesar cōgnōvit¹⁴ Vercingetorigem cōsūmptō pābulō castra mōvisse propius Avaricum, atque ipsum cum equitātū expeditisque quī inter equitēs proeliārī cōsuēssent, insidiandī causā eō profectum quō nostrōs posterō diē pābulātum ventūrōs arbitrārētur. Quibus rēbus cōgnitis mediā nocte 25 silentiō profectus ad hostium castra māne pervēnit. Illi, celeriter per explōrātōrēs adventū Caesaris cōgnitō, carrōs impedimenta que sua in artiōrēs¹⁵ silvās abdidērunt, cōpiās

Cf. ¹ opibus. — ² parva. — ³ exiguitāte. — ⁴ eguerint. — ⁵ opp. propiōribus. — ⁶ dignitāte. — ⁷ cohortārētur. — ⁸ relictūrum. — ⁹ opp. cōnfectā. — ¹⁰ dīmīssissent. — ¹¹ dūritiās. — ¹² periissent. — ¹³ trādēbant. — ¹⁴ comperit. — ¹⁵ dēnsiōrēs.

omnis in locō ēditō¹ atque apertō instrūxērunt. Quā
rē nūntiātā Caesar celeriter sarcinās cōferri, arma ex-
pediri iussit.

He Finds him too Strongly Intrenched to Warrant an Attack.

19. Collis erat lēniter ab infimō acclivis. Hunc ex
5 omnibus ferē partibus palūs difficilis atque impedita cingē-
bat, nōn lātiōr pedibus L. Hōc sē colle interruptis² ponti-

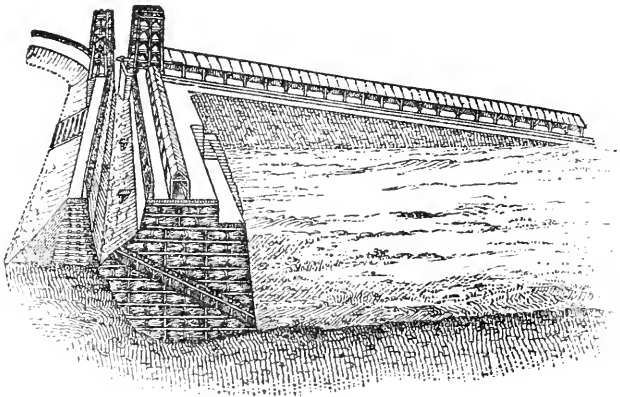

FIG. 92. — VIEW OF SIEGE WORKS.

bus Galli fidūciā locī continēbant, generātimque distribūti
[in civitātis] omnia vada [ac saltūs] eius palūdis obtinēbant,
sic animō parātī ut, sī eam palūdem Rōmānī perrumpere
10 cōnārentur, haesitantis³ premerent ex locō superiōre; ut,
quī propinquitātem locī vidēret, parātōs prope aequō Mārte
ad dīmicandum existimāret; quī inīquitātem⁴ condiciōnis
perspiceret, inānī simulātiōne sēsē ostentāre cōgnōsceret.
Indignantis militēs Caesar, quod cōspectum suum hostēs
15 ferre possent tantulō spatiō interiectō, et sīgnum proeli

Cf. ¹ excelsō. — ² rescissis. — ³ impedītōs. — ⁴ opp. aequitātem.

exposcentis,¹ ēdocet quantō dētrimentō² et quot virōrum fortium morte necesse sit cōnstāre victōriam; quōs cum sic animō parātōs videat ut nūllum prō suā laude³ perīculum recūsent, summae sē inīquitātis condemnārī dēbere, nisi eōrum vītam laude suā habeat⁴ cārīōrem. Sic milites cō- 5
sōlātus eōdem diē redūcit in castra; reliquaque quae ad oppugnātiōnem oppidī pertinēbant administrāre⁵ instituit.

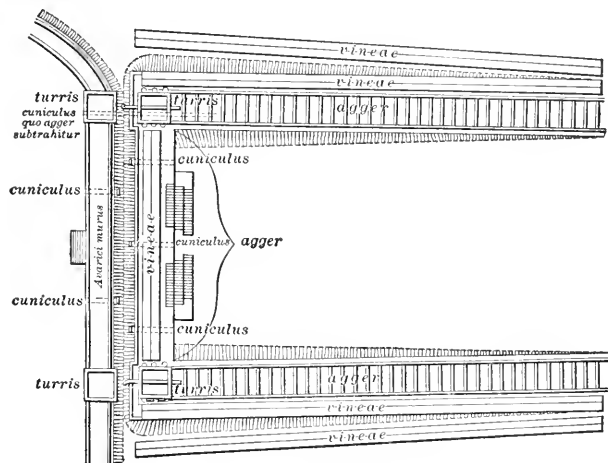

FIG. 93. — PLAN OF SIEGE WORKS.

Suspicious against Vercingetorix, Who Makes a Successful Defense and Appeal to his Countrymen.

20. Vercingetorix cum ad suos redisset, prōditiōnis insimulātus,⁶ — quod castra propius Rōmānōs mōvisset, quod cum omnī equitātū discessisset, quod sine imperiō⁷ tantās 10
cōpiās reliquisset, quod eius discessū Rōmānī tantā opportunitate⁸ et celeritate vēnissent; nōn haec omnia fortuitō⁹ aut

Cf. ¹ petentis. — ² damnō. — ³ glōriā. — ⁴ existimet. — ⁵ comparāre. — ⁶ accusātus. — ⁷ imperātōre. — ⁸ occāsione. — ⁹ forte, cāsū.

sine cōnsiliō accidere potuisse; rēgnum illum Galliae malle
 Caesaris concessū¹ quam ipsōrum habēre beneficiō, — tāli
 modō accūsātus ad haec respondit: ‘Quod castra mōvisset,
 factum inopiā pābuli, etiam ipsis hortantibus²; quod propius
 5 Rōmānōs accessisset, persuāsum loci opportūnitāte, quī sē
 ipse sine mūnitiōne dēfenderet; equitum vērō operam³
 neque in locō palūstri dēsiderārī dēbuisse, et illic fuisse
 ūtilem quō sint profecti. Summam imperi sē cōsultō nulli
 discēdentem trādidiisse, nē is multitudinis studiō ad dimican-
 10 dum impellerētur; cui rei propter animi mollitiem⁴ studēre
 omnīs vidēret, quod diūtius labōrem ferre nōn possent.
 Rōmāni sī cāsū⁵ intervēnerint, fortunae; sī alicūius indicio
 vocātī, huic habendam grātiā, quod et paucitātem eōrum
 ex locō superiōre cōgnōscere et virtūtem dēspicere⁶ potue-
 15 rint, quī dimicāre nōn ausi turpiter sē in castra recēperint.
 Imperium sē ā Caesare per prōditiōnem nullum dēsiderāre,⁷
 quod habēre victōriā posset, quae iam esset sibi atque omni-
 bus Gallis explorāta: quā etiam ipsis remittere, sī sibi
 magis honōrem tribuere quam ab sē salūtem accipere vide-
 20 antur.’ “Haec ut intellegātis,” inquit, “ā mē sincērē prō-
 nūntiārī, audite Rōmānōs militēs.” Prōducit servōs, quōs
 in pābulātiōne paucis ante diēbus excēperat,⁸ et famē vincu-
 lisque ex cruciāverat. Hi, iam ante ēdocti quae interrogātī
 prōnūntiārent, militēs sē esse legiōnāriōs dicunt; famē et
 25 inopiā adductōs clam⁹ ex castris exisse, sī quid frūmentī aut
 pecoris in agris reperire¹⁰ possent; similit omnem exercitum
 inopiā premī, nec iam viris sufficere¹¹ cuiusquam nec ferre
 operis labōrem posse: itaque statuisse imperātōrem, sī nihil in
 oppugnātiōne oppidi profēcissent, trīduō exercitum dēducere.
 30 “Haec,” inquit, “ā mē,” [Vercingetorix] “beneficia habētis,
 quem prōditiōnis insimulātis; cuius operā sine vestrō san-

Cf. ¹ grātiā. — ² monentibus. — ³ officium. — ⁴ infirmitātem. —
⁵ fortuitō. — ⁶ contemnere. — ⁷ cupere. — ⁸ dēprehenderat. — ⁹ opp.
 palam. — ¹⁰ invenire. — ¹¹ satis esse.

guine tantum exercitum victōrem famē cōsūmptum vidētis ; quem turpiter sē ex hāc fugā recipientem nē qua civitās suis finibus recipiat, ā mē prōvīsum¹ est.”

21. Conclāmat omnis multitudō et suō mōre armīs concrepat, — quod facere in eō cōsuērunt cūius orātiōnem adprobant : ‘Summum esse Vercingetorigem ducem, nec dē eiūs fidē dubitandum, nec māiōre ratiōne² bellum administrārī³ posse.’ Statuunt ut x milia hominum dēlēcta ex omnibus cōpiīs in oppidum submittantur, nec sōlis Biturigibus commūnem salūtem committendam⁴ cēsent ; quod paene in eō, sī id oppidum retinuissent, summam victōriæ cōnstāre intellegēbant.

The Gauls Make a Most Skilful Defense against the Roman Works.

22. Singulārī⁵ militum nostrōrum virtūtī cōnsilia cūiusque modī Gallōrum occurrēbant,⁶ ut est summae genus sollertiae, atque ad omnia imitanda et efficienda quae ā quōque trāduntur aptissimum. Nam et laqueīs falcis āvertēbant, quās, cum dēstināverant,⁷ tormentīs intrōrsus redūcēbant ; et aggerem cuniculīs subtrahēbant,⁸ eō scientius quod apud eōs māgnae sunt ferrāriæ, atque omne genus cuniculōrum nōtum atque ūsitātum est. Tōtum autem mūrum ex omnī parte turribus contabulāverant atque hās coriīs intēxerant. Tum crēbris diurnīs nocturnīsque ēruptiōnibus aut aggerī ignem inferēbant⁹ aut militēs occupātōs in opere adoriēbantur¹⁰ ; et nostrārum turrium altitudinem, quantum hās cotidiānus agger expresserat,¹¹ commissīs suārum turrium mālīs adaequābant ; et apertōs cuniculōs praeūstā et praeacūtā materiā et pice fervefactā et maximī ponderis saxīs morābantur moenibusque¹² adpropinquāre prohibēbant.

Cf. ¹ cautum. — ² arte. — ³ gerī. — ⁴ mandandam. — ⁵ eximiae. — ⁶ obsistēbant. — ⁷ adfixerant. — ⁸ subruēbant. — ⁹ iniciēbant. — ¹⁰ adgrediēbantur. — ¹¹ ērexerat. — ¹² mūrīs.

Description of a Gallic Wall.

23. Mūrī autem omnēs Gallicī hāc ferē formā sunt. Trabēs directae, perpetuae¹ in longitudinem paribus intervāllis, distantēs inter sē binōs pedēs, in solō conlocantur. Hae revinciuntur intrōsus et multō aggere vestiuntur²; ea autem
 5 quae diximus intervālla grandibus in fronte saxis effarciuntur.³ His conlocātis et coagmentātis⁴ alius insuper ōrdō

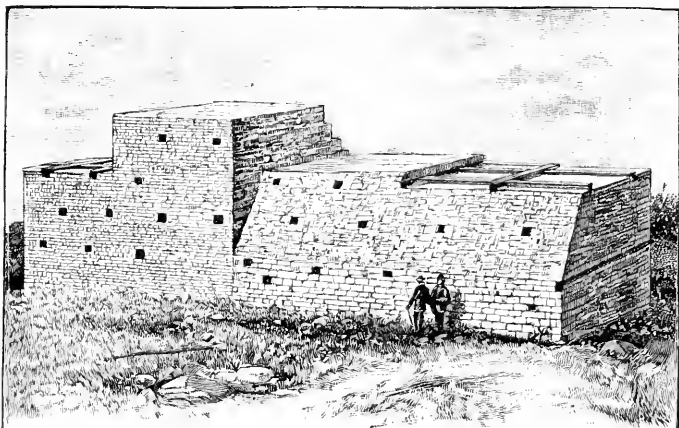

FIG. 94. — GALLIC WALL.

additur, ut idem illud intervāllum servētur neque inter sē
 contingant trabēs, sed, paribus intermissis spatiīs, singulae
 singulis saxīs interiectis artē contineantur. Sic deinceps
 10 omne opus contexitur dum iūsta mūrī altitudō expleātur.
 Hōc cum in speciem varietātemque opus dēforme nōn est,
 alternīs trabibus ac saxīs, quae rēctis lineīs suōs ōrdinēs
 servant, tum ad ūtilitātem et dēfēsiōnem urbium summam
 habet opportunitātem; quod et ab incendiō lapis et ab ariete
 15 māteria dēfendit, quae perpetuis trabibus pedum quadrā-

Cf. ¹ opp. intermissae. — ² integuntur. — ³ complentur. — ⁴ cōnfixīs.

gēnum plērumque¹ intrōrsus revincta neque perrumpi²
neque distrahi potest.

The Gauls Set Fire to the Roman Works and Make a Sortie.

24. His tot rēbus impeditā oppugnātiōne militēs, cum
tōtō tempore frigore et adsiduis³ imbribus tardārentur,
tamen continentī labōre omnia haec superāvērunt, et diēbus 5
xxv aggerem lātum pedēs cccxxx, altum pedēs Lxxx
exstrūxērunt. Cum is mūrū hostium paene contingeret,
et Caesar ad opus cōsuētūdine excubāret militēsque hor-
tārētur nē quod omnīnō tempus ab opere intermitterētur,
— paulō ante tertiam vigiliam est animadversum fūmāre ag- 10
gerem, quem cuniculō hostēs succenderant⁴; eōdemque tem-
pore, tōtō mūrō clāmōre sublātō, duābus portis ab utrōque
latere turrium ēruptiō fiēbat. Alii faciēs atque āridam
māteriam dē mūrō in aggerem ēminus⁵ iaciēbant; picem
reliquāsque⁶ rēs quibus ignis excitārī⁷ potest fundēbant; 15
ut, quō primum occurrerētur aut cui rei ferrētur auxilium,
vix ratiō iniri posset. Tamen, quod institūtō⁸ Caesaris
duae semper legiōnēs prō castris excubābant, plūrēsque
partītis temporibus erant in opere, celeriter factum est ut
alii ēruptiōnibus resisterent, alii turrīs redūcerent⁹ aggerem- 20
que interscinderent, omnis vērō ex castris multītūdō ad
restringendum concurreret.

Heroism of the Gauls.

25. Cum in omnibus locis, cōsūptā iam reliquā parte
noctis, pūgnārētur semperque hostibus spēs victōriae redin-
tegrārētur,¹⁰— eō magis quod deūstōs pluteōs turrium 25
vidēbant, nec facile adire apertōs ad auxiliandum¹¹ animad-
vertēbant, — semperque ipsi recentēs¹² dēfessis succēderent,

Cf. ¹ ferē. — ² perfringī. — ³ perpetuīs. — ⁴ incenderant. — ⁵ opp.
comminus. — ⁶ cēterās. — ⁷ opp. restringūi. — ⁸ cōnsiliō, iūssū. — ⁹ re-
movērent. — ¹⁰ renovārētur. — ¹¹ auxiliū ferendum. — ¹² integrī.

omnemque Galliae salutem in illō vestigiō temporis positam arbitrarentur; accidit inspectantibus nōbis quod dīgnum memoriā visum praetereundum¹ nōn existimāvimus. Quīdam ante portam oppidī Gallus per manūs sēbi ac picis trāditās
5 glēbās in ignem² ē regiōne turris prōiciēbat; scorpiōne ab

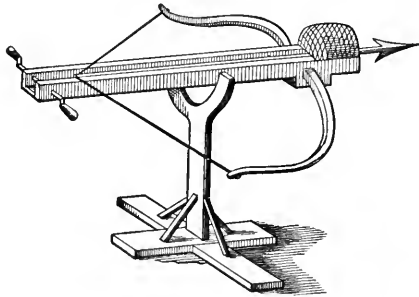

FIG. 95. — SCORPIO.

latere dextrō trāiectus³ exanimātusque concidit. Hunc ex proximis ūnus iacentem trāsgressus eōdem illō mūnere⁴ fungēbatur; eādē ratiōne ictū scorpiōnis exanimātō alterō successit tertius et tertiō quartus; nec prius ille est ā prō-
10 pūgnātōribus vacuus relictus locus quam, restinctō aggere atque omnī parte submōtis hostibus, finis est pūgnandī factus.

The Gauls Prepare to Abandon the Town, but are Dissuaded by the Women.

26. Omnia expertī Galli, quod⁵ rēs nūlla successerat, posterō diē cōnsilium cēpērunt ex oppidō profugere hortante
15 et iubente Vercingetorige. Id silentiō noctis cōnāti nōn māgnā iactūrā⁶ suōrum sēsē effectūrōs spērābant; proptereā quod neque longē ab oppidō castra Vercingetorigis aberant, et palūs perpetua, quae intercēdēbat, Rōmānōs ad Insequen-

Cf. ¹ omittendum. — ² ex adversō. — ³ trānsfossus. — ⁴ officio. — ⁵ nihil profecerant. — ⁶ dētrimentō.

dum tardābat.¹ Iamque hōc facere noctū adparābant, cum mātṛēs familiae repente in pūblicum prōcurrērunt flentēsque, prōiectae ad pedēs suōrum, omnibus precibus petiērunt² nē sē et commūnis liberōs hostibus ad supplicium dēderent, quōs ad capiendam fugam nātūrae et virium infirmitās impe- 5
dīret. Ubi eōs in sententiā³ perstāre⁴ vidērunt, quod plē-
rumque in summō periculō timor⁵ misericordiam nōn recipit,
conclāmāre et significāre dē fugā Rōmānis coepērunt. Quō
timōre perterriti Gallī, nē ab equitatū Rōmānōrum viae prae-
occupārentur, cōnsiliō dēstitērunt. 10

Storming of the Walls.

27. Posterō diē Caesar prōmōtā⁶ turri directisque operi-
bus quae facere instituerat, māgnō coōrtō imbrī, nōn inūtilem
hanc ad capiendum⁷ cōnsilium tempestātem arbitrātus, quod
paulō incautius custōdiās in mūrō dispositās vidēbat, suōs
quoque languidius in opere versārī iussit, et quid fieri vellet 15
ostendit. Legiōnibusque [intrā vineās] in occultō expeditis,
cohortātus ut aliquandō prō tantīs labōribus frūctum⁸ victō-
riae perciperent, eis quī primī mūrū adscendissent praemia
prōposuit militibusque signum dedit. Illi subitō ex omni-
bus partibus ēvolāvērunt mūrūque celeriter complēvērunt. 20

The Town is Taken, and Most of the Inhabitants are Butchered.

28. Hostēs rē novā perterriti, mūrō turribusque dēiecti,
in forō ac locis patentioribus⁹ cuneātīm cōstitērunt, hōc
animō¹⁰ ut, si quā ex parte obviam [contrā] venirētur, aciē
instrūctā dēpūgnārent. Ubi nēminem in aequum locum¹¹ sēsē
dēmittere, sed tōtō undique mūrō circumfundi vidērunt, 25
veritī nē omnīnō spēs fugae tollerētur, abiectis armīs ulti-
mās¹² oppidī partis continentī impetū petivērunt; parsque

Cf. ¹ morābātur. — ² obsecravērunt. — ³ cōnsiliō. — ⁴ permanere. —
⁵ opp. fortitūdō. — ⁶ opp. reductā. — ⁷ opp. omittendum. — ⁸ prae-
mium. — ⁹ apertiōribus. — ¹⁰ cōnsiliō. — ¹¹ dēscendere. — ¹² opp. proxi-
mās.

ibi, cum angustō¹ exitū portārum sē ipsī premerent, ā militibus, pars iam ēgressa portis ab equitibus est interfecta; nec fuit quisquam quī praedae studeret. Sic et Cēnabēnsī caede et labōre operis incitātī nōn aetāte cōfectis, nōn
 5 mulieribus,² nōn infantibus pepercērunt.³ Dēnique ex omni numerō, quī fuit circiter milium XL, vix DCCC, quī primō clāmōre auditō sē ex oppidō ēiēcerant, incolumēs ad Vercingetorigem pervēnērunt. Quōs ille multā iam nocte silentiō ex fugā excēpit, et veritus nē qua in castris ex eōrum
 10 concursū et misericordiā volgī sēditiō orerētur, [ut,] procul in viā dispositis familiāribus⁴ suis principibusque civitātum, disparandōs⁵ dēdūcendōsque ad suōs cūrāvit, quae cuique civitātī pars castrōrum ab initiō⁶ obvēnerat.

Vercingetorix Appeals to the Gauls to Continue the War.

29. Posterō diē conciliō⁷ convocātō cōsōlātus cohortātusque est: ‘Nē sē admodum animō dēmitterent, nēve perturbārentur incommodō; nōn virtūte neque in aciē vicisse Rōmānōs, sed artificiō quōdam et scientiā oppūgnātiōnis, cuius rei fuerint ipsi imperitī; errāre, sī quī in bellō omnis secundōs⁸ rērum prōventūs⁹ exspectent; sibi numquam
 20 placuisse Avaricum dēfēdī, cuius rei testis ipsōs habēret, sed factum imprudentiā Biturigum et nimiā obsequentiā reliquōrum utī hōc incommodum acciperētur; id tamen sē celeriter māiōribus commodis sātātūrum. Nam, quae ab reliquis Gallis civitātēs dissentirent,¹⁰ hās suā diligentiā
 25 adiūctūrum atque ūnum cōsiliū tōtius Galliae effectūrum, cuius cōsēnsuī nē orbis quidem terrārum possit obsistere; idque sē prope iam effectum habēre. Intereā aequum esse ab eis commūnis salūtis causā impetrārī¹¹ ut castra mūnīre instituerent, quō facilius repentīnōs¹² hostium impe-
 30 tūs sustinēre possent.’

Cf. ¹ opp. lātō. — ² fēminīs. — ³ opp. occidērunt. — ⁴ amicīs. — ⁵ distribuendōs. — ⁶ opp. fine. — ⁷ contiōne. — ⁸ opp. adversōs. — ⁹ ēventūs. — ¹⁰ discēderent — ¹¹ obtinērī. — ¹² imprōvisōs

They are Inspired by his Appeal to Renewed Efforts.

30. Fuit haec oratio non ingrata Gallis, et maximè quod ipse animo non defecerat¹ tantò acceptò incommodò, neque se in occultum² abdiderat et conspectum multitudinis fugerat³; plùsque animo providere et praesentire existimabatur, quod re integrà primò incendendum Avaricum, post deserendum censuerat. Itaque, ut reliquorum imperatorum res adversae⁴ auctoritatem minuunt, sic⁵ huius ex contrariò



FIG. 96. — COIN OF THE BITURIGES.

dignitas incommodò acceptò in diès augèbatur. Simul in spem veniebant eius adfirmatione de reliquis adiungendis civitatibus; primumque eò tempore Galli castra munire instituèrunt, et sic erant animo confirmati, hominès insueti labòris, ut omnia quae imperarentur sibi patienda⁶ existimarent.

He Levies New Troops.

31. Nec minus quam est pollicitus Vercingetorix animo laborabat ut reliquas civitatis adiungeret, atque earum principès donis pollicitationibusque adlicièbat.⁷ Huic rei idoneos⁸ hominès deligebat, quorum quisque aut oratione subdola⁹ aut amicitia facillimè capere posset. Qui Avaricò expugnato refugerant, armandos vestiendosque curat. Simul, ut deminutae¹⁰ copiae redintegrarentur, imperat certum numerum militum civitatibus, quem, et quam ante diem, in

Cf. ¹ defuerat. — ² opp. apertum. — ³ vitaverat. — ⁴ opp. secundae. — ⁵ ita. — ⁶ perferenda. — ⁷ conciliabat. — ⁸ aptos. — ⁹ callida. — ¹⁰ opp. auctae.

castra addūci velit¹; sagittariōsque omnis, quōrum erat permāgnus in Galliā numerus, conquiri² et ad sē mitti iubet. His rēbus celeriter id quod Avarici dēperierat³ explētur. Interim Teutomatus, Ollovicōnis filius, rēx Nitiobrigum,
 5 cūius pater ab senātū nostrō amicus erat appellātus, cum māgnō numerō equitum suōrum et quōs ex Aquitāniā condūxerat ad eum pervēnit.⁴

The Hædui Appeal to Cæsar to Settle a Dispute.

32. Caesar Avarici complūris diēs commorātus summamque ibi cōpiam frūmenti et reliquī⁵ commeātūs nactus, exer-
 10 citum ex labōre⁶ atque inopiā reficit. Iam prope hieme cōfectā, — cum ipsō anni tempore ad gerendum bellum vocārētur et ad hostem proficisci cōstituisset, sive eum ex palūdibus silvisque ēlicere sive obsidiōne⁷ premere posset, — lēgātī ad eum principēs Haeduōrum veniunt ōrātum ut
 15 maximē necessāriō tempore civitāti subveniat⁸: ‘Summō esse in periculō rem; quod, cum singulī magistrātūs antiquitus creārī atque rēgiam potestātem annum obtinēre cōsuēssent, duo magistrātum gerant, et sē uterque eōrum lēgibus creātum dicat. Hōrum esse alterum Convictolitavem, flōrentem⁹ et inlustrem adulēscēntem; alterum Cotum, anti-
 20 quissimā¹⁰ familiā nātum, atque ipsum hominem summae potentiae¹¹ et māgnae cōgnātiōnis, cūius frāter Valetiacus proximō annō eundem magistrātum gesserit. Civitātem esse omnem in armīs, dīvisum senātum, dīvisum populum, suās
 25 cūiusque eōrum clientēlās.¹² Quod sī diūtius alātur¹³ contrōversia, fore utī pars cum parte civitātis cōnfligat; id nē accidat positum in ēius diligentiā atque auctōritāte.’

Cf. ¹ opp. nōlit. — ² cōgī. — ³ interierat. — ⁴ opp. discessit. — ⁵ aliūs. — ⁶ opp. quiēte. — ⁷ obsessiōne. — ⁸ succurrat. — ⁹ amplum. — ¹⁰ opp. novissimā. — ¹¹ auctōritātis. — ¹² clientēs. — ¹³ augeātur.

Fig. 97

SIEGE OF GERGOVIA

ROMAN MILE

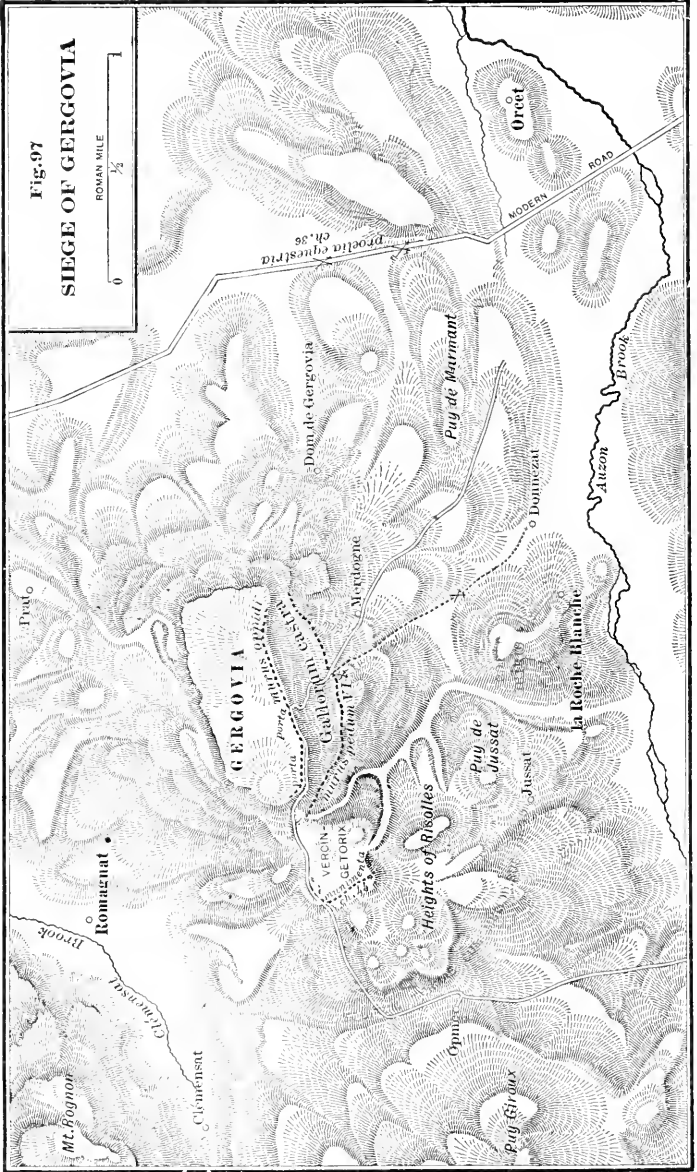

He Goes to them in Person and Decides the Case.

33. Caesar etsi ā bellō atque hoste discēdere dētrimentōsum esse existimābat, tamen nōn ignōrāns quanta ex dissēnsiōnibus incommoda orīri¹ cōsuēssent, nē tanta et tam coniūcta populō Rōmānō civitās, quam ipse semper aluisset omnibusque rēbus ōrnāssent, ad vim atque arma dēscenderet, 5 atque ea pars quae minus² sibi cōfideret auxilia ā Vercingetorige arcesseret,³ huic rei praevertendum⁴ existimāvit; et quod lēgibus Haeduōrum eis quī summum magistrātum obtinērent⁵ excēdere ex finibus nōn liceret, nē quid dē iūre aut dē lēgibus eōrum dēminuisse⁶ vidērētur, ipse in Haeduōs 10 proficisci statuit, senātumque omnem et quōs inter contrōversia esset ad sē Decetiam ēvocāvit. Cum prope omnis civitās eō convēnisset, docērēturque, paucis clam⁷ convocātis, aliō locō, aliō tempore atque⁸ oportuerit, frātre ā frātre renūntiātum, cum lēgēs duo ex ūnā familiā vivō⁹ utrōque 15 nōn solum magistrātūs creārī vetārent,¹⁰ sed etiam in senātū esse prohibērent, — Cotum imperium dēpōnere coēgit; Convictolitavem, quī per sacerdotēs mōre civitātis intermissis magistrātibus esset creātus, potestātem obtinēre iussit.

Caesar Sends Labienus Northward and himself Proceeds towards Gergovia.

34. Hōc dēcrētō interpositō, — cohortātus Haeduōs ut 20 contrōversiārum ac dissēnsiōnis obliviscerentur atque omnibus omissis¹¹ [his] rēbus huic bellō servirent, eaque quae meruissent praemia ab sē dēvictā¹² Galliā exspectārent, equitātumque omnem et peditum milia decem sibi celeriter mitterent, quae in praesidiis rei frūmentāriae causā dispō- 25 neret,¹³ — exercitum in duās partīs divisit: quattuor legiōnēs in Senonēs Parisiōsque Labiēnō dūcendās dedit; sex ipse

Cf. ¹ *existere*. — ² *opp. plūs*. — ³ *vocāret*. — ⁴ *praeciendum*. — ⁵ *gererent*. — ⁶ *opp. auxisse*. — ⁷ *opp. palam*. — ⁸ *quam*. — ⁹ *opp. mortuō*. — ¹⁰ *opp. iubērent*. — ¹¹ *dēpositis*. — ¹² *pācātā*. — ¹³ *distribueret*.

in Arvernōs ad oppidum Gergoviam secundum flūmen Elaver dūxit; equitātūs partem illi attribuit, partem sibi reliquit. Quā rē cōgnitā Vercingetorix, omnibus interruptis¹ eius flūminis pontibus, ab alterā flūminis parte iter facere coepit.

He Succeeds in Crossing the Allier River.

5 35. Cum uterque utrimque exisset exercitus, in cōspectū ferēque² ē regiōne castris castra pōnēbant. Dispositis explorātōribus, nēcubi effectō ponte Rōmāni cōpiās trādūcerent, erat in māgnis Caesari difficultātibus rēs nē māiōrem aestātis partem flūmine impedirētur; quod nōn ferē ante
10 autumnum Elaver vadō trānsiri solet. Itaque, nē id accideret, silvestri locō castris positīs,³ ē regiōne ūnius eōrum pontium quōs Vercingetorix rescindendōs cūrāverat, posterō diē cum duābus legiōnibus in occultō restitit⁴; reliquās cōpiās cum omnibus impedimentis, ut cōnsuērat, mīsit, dis-
15 trāctis quibusdam cohortibus, ut numerus legiōnum cōstāre⁵ vidērētur. His quam longissimē possent prōgredi iūssīs, cum iam ex diēi tempore coniectūram caperet in castra perventum, isdem sublicis, quārum pars inferior⁶ integra remanēbat, pontem reficere coepit.⁷ Celeriter effectō
20 opere legiōnibusque trāductis et locō castris idōneō⁸ dēlēctō, reliquās cōpiās revocāvit. Vercingetorix rē cōgnitā, nē contrā suam voluntātem dimicāre cōgerētur, māgnis itineribus antecessit.

At Gergovia he Gains an Advantage of Position over Vercingetorix.

36. Caesar ex eō locō⁹ quintis castris Gergoviam per-
25 vēnit, equestrique eō diē proeliō levī factō, perspectō urbis sitū, quae posita in altissimō monte omnīs aditūs difficilis¹⁰ habēbat, dē oppugnātiōne dēspērāvit¹¹; dē obsessiōne nōn

Cf. ¹ interscissis. — ² adversus, w. acc. — ³ opp. mōtis. — ⁴ remānsit. — ⁵ explēri. — ⁶ opp. superior. — ⁷ incēpit. — ⁸ opp. iniquō. — ⁹ diē sextō. — ¹⁰ opp. lēniter adclivis. — ¹¹ spem dēposuit.

prius agendum cōstituit quam rem frūmentāriam expedisset.¹ At Vercingetorix castris prope oppidum in monte positis, mediocribus circum sē intervāllis sēparatim singulārum civitātum cōpiās conlocāverat; atque omnibus ēius iugī collibus occupātis quā dēspici poterat, horribilem speciem 5 praebēbat²; principēsque eārum civitātum, quōs sibi ad cōsiliū capiendum dēlēgerat, primā lūce cotidiē ad sē convenire iubēbat, seu quid commūnicandum seu quid administrandum³ vidērētur; neque ūllum ferē diem intermittēbat quīn equestri proeliō, interiectis sagittāriis, quid in 10 quōque esset animī ac virtūtis suōrum periclitārētur. Erat ē regiōne oppidi collis sub ipsīs rādīcibus montis ēgregiē mūnitus atque ex omnī parte circumcīsus,⁴ quem si tenērent nostrī, et aquae māgnā parte et pābulātiōne liberā prohibētūrī hostis vidēbantur; sed is locus praesidiō ab his nōn 15 infirmō⁵ tenēbātur; tamen silentiō noctis Caesar ex castris ēgressus, priusquam subsidiō ex oppidō veniri posset, dēiectō praesidiō potitus locō, duās ibi legiōnēs conlocāvit⁶ fossamque duplicem duodēnum pedum ā māiōribus castris ad minōra perdūxit, ut tūtō ab repentinō hostium incursū⁷ etiam 20 singulī commeāre possent.

Some of the Hædui Organize a Revolt.

37. Dum haec ad Gergoviam geruntur, Convictolitavis Haeduus, cui magistrātum adiudicātum ā Caesare dēmōnstrāvimus, sollicitātus ab Arvernīs pecūniā cum quibusdam adulēscentibus conloquitur, quōrum erat pīnceps Litavicus 25 atque ēius frātrēs, amplissimā familiā nātī⁸ adulēscentēs. Cum his praemium commūnicat⁹ hortāturque ut sē liberōs et imperiō nātōs meminerint: ‘Ūnam¹⁰ esse Haeduōrum civitātem quae certissimam¹¹ Galliae victōriam distineat; ēius

Cf. ¹ prōvidisset. — ² praestābat. — ³ gerendum. — ⁴ praeruptus. — ⁵ opp. validō. — ⁶ posuit. — ⁷ impetū. — ⁸ ortī. — ⁹ partitū. — ¹⁰ sōlam. — ¹¹ explōrātam.

auctōritāte reliquās continēri; quā trāductā locum cōnsistendi Rōmānis in Galliā nōn fore. Esse nōn nullō sē Caesaris beneficiō¹ adfectum, sic tamen ut iustissimam apud eum causam obtinuerit; sed plūs commūni libertāti² tribuere.

5 Cūr enim potius Haedui dē suō iūre et dē lēgibus ad Caesarem disceptātōrem,³ quam Rōmāni ad Haeduōs veniant?’ Celeriter adulēscentibus et orātiōne magistrātūs et praemiō dēductis, cum sē vel principēs eius cōnsili fore profitērentur,⁴ ratiō⁵ perficiendi quaerēbātur, quod civitatem temerē

10 ad suscipiendum bellum addūci posse nōn cōfidēbant. Placuit⁶ ut Litavicus decem illis milibus quae Caesari ad bellum mitterentur praeficerētur, atque ea dūcenda cūrāret frātrēsque eius ad Caesarem praecurrerent. Reliqua quā ratiōne agi placeat cōstituunt.

Litavicus at the Head of the Hæduan Contingent Stops at Some Distance from Gergovia, and Incites his Troops to Abandon the Roman Cause.

15 38. Litavicus acceptō exercitū, cum milia passuum circiter xxx ā Gergoviā abesset, convocātis subitō militibus lacrimāns,⁷ “Quō proficiscimur,” inquit, “militēs? Omnis noster equitātus, omnis nōbilitās interiit; principēs civitātis, Eporēdorix et Viridomārus, insimulāti⁸ prōditiōnis, ab Rōmānis indictā⁹ causā interfecti sunt. Haec ab his cōgnōscite

20 qui ex ipsā caede effūgērunt; nam ego, frātribus atque omnibus meis propinquis interfectis, dolore prohibeor quae gesta sunt prōnūntiāre.” Prōdūcuntur ei quōs ille ēdocuerat quae dici vellet,¹⁰ atque eadem quae Litavicus prōnūntiāverat

25 multītūdini expōnunt: ‘Omnēs equitēs Haeduōrum interfectōs, quod conlocūti cum Arvernīs dicerentur; ipsōs sē inter multītūdinem militum occultāsse¹¹ atque ex mediā caede effūgisse.’ Conclāmant Haedui et Litavicum obsecrant ut

Cf. ¹ opp. maleficiō. — ² opp. servitūtī. — ³ arbitrum. — ⁴ pollicērentur. — ⁵ cōnsilium. — ⁶ cōstitutum est. — ⁷ flēns. — ⁸ accūsātī. — ⁹ opp. dicta. — ¹⁰ opp. nōllet. — ¹¹ abdidisse.

sibi cōsulat. “Quasi vērō,” inquit ille, “cōsili sit rēs, ac nōn necesse sit nōbis Gergoviam contendere¹ et cum Arvernīs nōsmet coniungere! An dubitāmus quin nefariō facinore admissō Rōmānī iam ad nōs interficiendōs concurrant? Proinde, si quid in nōbis animī² est, persequāmur³ eōrum 5 mortem quī indignissimē interiērunt, atque hōs latrōnēs interficiāmus!” Ostendit civīs Rōmānōs quī ēius praesidī fiduciā⁴ ūnā erant; continuō māgnū numerum frūmentī commeātūque diripit; ipsōs crudēliter excruciatōs interficit. Nūntiōs tōtā civitāte Haeduōrum dimittit; eōdem mendaciō⁵ 10 dē caede equitum et principum permovet; hortātur ut simili ratiōne atque ipse fēcerit suās iniūriās persequantur.

Eporēdorix Conveys the News to Cæsar.

39. Eporēdorix Haeduus, summō⁶ locō nātus adulēscēns et summae domī potentiae, et ūnā Viridomārus, pari aetāte et grātiā⁷ sed genere dispari, quem Cæsar ab Diviciācō sibi 15 trāditum ex humili locō ad summam dignitātem perdūxerat, in equitum numerō convēnerant nōminatim ab eō ēvocāti. His erat inter sē dē principātū contentiō; et in illā magistrātuum contrōversiā alter prō Convictolitave alter prō Cotō, summīs opibus⁸ pūgnāverant. Ex eis Eporēdorix cōgnitō 20 Litavicī cōsiliō mediā ferē nocte rem ad Cæsarem dēfert; orat nē patiātur civitātem prāvis⁹ adulēscēntium cōsiliis ab amicitia populī Rōmānī dēficere; quod futūrum prōvideat, si sē tot hominum mīlia cum hostibus coniūxerint, quōrum salutem neque propinquī neglegere neque civitās levi¹⁰ 25 mōmentō aestimāre possit.

Cæsar Immediately Goes to the Hædui and Suppresses the Revolt.

40. Māgnā adfectus sollicitūdine¹¹ hōc nūntiō Cæsar, quod semper Haeduōrum civitāti praecipuē indulserat,¹²

Cf. ¹ concurrere. — ² virtūtis, opp. timōris. — ³ ulciscāmur. — ⁴ opp. perfidiā. — ⁵ simulatiōne. — ⁶ opp. humili. — ⁷ auctōritāte. — ⁸ facultātibus. — ⁹ opp. bonīs. — ¹⁰ opp. gravī. — ¹¹ cūrā. — ¹² fāverat.

¹ nūllā interpositā dubitātiōne legiōnēs expeditās quattuor equitātumque omnem ex castris ēdūcit; nec fuit spatium tāli tempore ad contrahenda castra, quod rēs posita in celeritāte vidēbātur. C. Fabium lēgātum cum legiōnibus duābus
 5 castris praesidiō relinquit. Frātrēs Litavicī cum comprehendī² iussisset, paulō ante reperit ad hostis profūgissee. Adhortātus militēs nē necessariō tempore itineris labōre permoveantur,³ cupidissimis omnibus prōgressus milia passuum xxv, agmen Haeduōrum cōspicātur, immissō equi-
 10 tātū iter eōrum morātur atque impedit; interdicitque⁴ omnibus nē quemquam interficiant. Eporēdorigem et Viridomarum, quōs illi interfectōs existimābant, inter equitēs versārī suōsque appellāre iubet. His cōgnitis et Litavicī fraude⁵ perspectā, Haeduī manūs tendere,⁶ et dēditiōnem
 15 significāre, et prōiectis armīs mortem dēprecārī⁷ incipiunt. Litavicus cum suis clientibus, quibus mōre Gallōrum nefās est etiam in extrēmā fortūnā dēserere⁸ patrōnōs, Gergoviām profugit.

Hastens Back to Gergovia to Relieve Fabius.

41. Caesar nūntiīs ad civitātem Haeduōrum missis quī
 20 suō beneficiō cōservātōs docērent, quōs iūre belli interficere potuisset, tribusque hōris [noctis] exercituī ad quiētem datis castra ad Gergoviam movet.⁹ Mediō ferē itinere equitēs ā Fabiō missi quantō rēs in periculō fuerit expōnunt; ¹⁰ summīs cōpiīs castra oppūgnāta dēmōnstrant, cum crēbrō¹¹
 25 integrī dēfessis succēderent nostrōsque adsiduō¹² labōre dēfatigārent, quibus propter māgnitūdinem castrōrum perpetuō esset isdem in vāllō permanendum; multitūdine sagittārum atque omnī genere tēlōrum multōs volnerātōs; ad haec sustinenda māgnō ūsui fuisse tormenta; Fabium discessū

Cf. ¹ sine morā. — ² opp. liberārī. — ³ sē animō dēmittant. — ⁴ vetat, w. acc. and inf. — ⁵ mendāciō. — ⁶ pandere. — ⁷ opp. petere. — ⁸ relinquere. — ⁹ opp. pōnit. — ¹⁰ nūntiant. — ¹¹ opp. rārō. — ¹² continuō.

eōrum, duābus relictis portis, obstruere cēterās pluteōsque vāllō addere et sē in posterum diem similemque cāsum¹ adparāre. Hīs rēbus cōgnitis Caesar summō studiō militum ante ortum sōlis in castra pervēnit.

Further Plots among the Gauls.

42. Dum haec ad Gergoviam geruntur, Haedui primis 5
nūntiis ab Litavicō acceptis nullum sibi ad cōgnōscendum
spatium relinquunt. Impellit² aliōs avāritia, aliōs irācundia
et temeritās,³ quae maximē illi hominum generi est innāta,
ut levem auditiōnem⁴ habeant prō rē compertā. Bona
cīvium Rōmānōrum diripiunt, caedis faciunt, in servitūtem 10
abstrahunt.⁵ Adiuvat rem prōclinātam Convictolitavis plē-
bemque ad furōrem⁶ impellit, ut facinore admissō ad sānitā-
tem reverti pudeat. M. Aristium, tribūnum militum, iter ad
legiōnēs facientem, fidē datā ex oppidō Cabillōnō ēdūcunt⁷ ;
idem facere cōgunt eōs quī negōtiandī causā ibi cōstiterant.⁸ 15
Hōs continuō *in* itinere adorti omnibus impedimentis exuunt ;
repūgnantis diem noctemque obsident ; multis utrimque
interfectis māiōrem multitudinem ad arma concitant.

The Hædui Seek Reconciliation with Cæsar, but do not Cease Plotting.

43. Interim nūntiō adlātō omnīs eōrum militēs in potestāte
Caesaris tenēri, concurrunt ad Aristium ; nihil pūblicō⁹ fac- 20
tum cōnsiliō dēmōnstrant ; quaestiōnem dē bonis direptis
dēcernunt ; Litavicī frātrumque bona pūblicant ; lēgātōs ad
Caesarem pūrgandi¹⁰ suī grātiā mittunt. Haec faciunt recu-
perandōrum¹¹ suōrum causā ; sed contāmināti facinore et
capti compendiō¹² ex direptis bonis, quod ea rēs ad multōs 25
pertinēbat, et timōre poenae exterriti cōnsilia clam dē bellō
inire incipiunt civitātisque reliquās lēgatiōnibus sollicitant.¹³

Cf ¹ fortūnam. — ² indūcit. — ³ opp. prūdētia. — ⁴ rūmōrem. —
⁵ abdūcunt. — ⁶ āmentiam. — ⁷ adliciunt. — ⁸ cōnsēderant. — ⁹ opp.
prīvatō. — ¹⁰ excūsandī. — ¹¹ opp. āmittendōrum. — ¹² quaestū. —
¹³ concitant.

Quae tametsi Caesar intellegēbat, tamen quam mītissimē¹ potest lēgātōs appellat: ‘Nihil sē propter inscientiam levitātemque volgī gravius dē civitate iūdicāre, neque dē suā in Haeduōs benevolentia dēminuere.’ Ipse māiōrem Galliae



FIG. 98. — CARE OF THE WOUNDED.

5 mōtum exspectāns, nē ab omnibus civitatibus circumsisterētur, cōnsilia inibat² quem ad modum ā Gergoviā discēderet ac rūsus omnem exercitum contraheret, nē profectiō nāta ab timōre dēfectiōnis similisque fugae vidērētur.

Cf. ¹ lēnissimē. — ² quā ratiōne.

Cæsar now Devotes himself to the Capture of Gergovia.

44. Haec cōgitantī accidere vīsa est facultās bene geren-
 dae rei. Nam cum in minōra castra operis perspiciendī
 causā vēnisset, animadvertit collem quī ab hostibus tenēbā-
 tur nūdātum¹ hominibus, quī superiōribus diēbus vix prae
 multitudine cernī poterat. Admirātus quaerit ex perfugīs 5
 causam, quōrum māgnus ad eum cotidiē numerus cōfluēbat.²
 Cōnstābat inter omnis, quod iam ipse Caesar per explorā-
 tōrēs cōgnōverat,³ dorsum⁴ esse ēius iugī⁴ prope aequum,
 sed silvestre et angustum,⁵ quā esset aditus ad alteram par-
 tem oppidi; vehementer huic illōs locō timēre, nec iam aliter 10
 sentire, unō colle ab Rōmānis occupātō, sī alterum āmis-
 sent, quīn paene circumvāllātī⁶ atque omnī exitū et pābulā-
 tiōne interclūsī vidērentur; ad hunc mūniendum omnis ā
 Vercingetorige ēvocātōs.

He Skillfully Arranges his Troops.

45. Hāc rē cōgnitā Caesar mittit complūris equitum tur- 15
 mās eō dē mediā nocte; imperat ut paulō tumultuōsius
 omnibus locis pervagentur. Primā lūce māgnum numerum
 impedimentōrum ex castris mūlōrumque prōdūcī dēque his
 strāmenta dētrahī⁷ mūliōnēsque cum cassidibus, equitum
 speciē ac simulātiōne, collibus circumvehī iubet. His pau- 20
 cōs addit equitēs quī lātius ostentātiōnis⁸ causā vagentur.
 Longō circuitū eādem omnis iubet petere regiōnēs. Haec
 procul ex oppidō vidēbantur,⁹ ut erat ā Gergoviā dēspectus
 in castra; neque tantō spatiō,¹⁰ certī quid esset, explorārī
 poterat. Legiōnem x eōdem lūce mittit et paulum prōgres- 25
 sam inferiōre cōstituit¹¹ locō silvisque occultat.¹² Augētur
 Gallis suspiciō atque omnēs illō ad munitiōnem cōpiae trādū-

Cf. ¹ vacuum. — ² concurrēbat. — ³ reppererat. — ⁴ summum iugum.
 — ⁵ opp. lātum. — ⁶ circumdatī. — ⁷ opp. induī. — ⁸ speciēi. — ⁹ conspi-
 ciēbantur. — ¹⁰ intervāllō. — ¹¹ conlocāvit. — ¹² cēlat.

cuntur. Vacua castra hostium Caesar cōspicātus, tectis
 insignibus suōrum occultātisque signis militāribus, rārōs¹
 militēs (nē ex oppidō animadverterentur) ex māiōribus
 castris in minōra trādūcit, lēgātisque quōs singulis legiōni-
 5 bus praefēcerat quid fieri velit ostendit: in primis monet ut
 contineant militēs nē studiō pūgnandī aut spē praedae
 longius prōgrediantur; quid iniquitās loci habeat incommodi
 prōpōnit; hōc unā celeritāte posse vitārī²; occasiōnis esse
 rem, nōn proeli. His rēbus expositis signum dat et ab
 10 dextrā³ parte aliō ascēnsū eōdem tempore Haeduōs mittit.

He Makes a Sudden Attack and Captures the Enemy's Camp.

46. Mūrus oppidī ā plānitīē atque initiō ascēnsūs rēctā
 regiōne, sī nūllus ānfractus intercēderet, MCC passūs aberat;
 quicquid hūc circuitūs ad molliendum clivum accesserat, id
 spatium itineris augēbat.⁴ Ā mediō ferē colle in longitūdi-
 15 nem, ut nātūra montis ferēbat, ex grandibus⁵ saxīs vi pedum
 mūrum quī nostrōrum impetum tardāret praedūxerant Galli
 atque, inferiōre omnī spatiō vacuō relictō, superiōrem partem
 collis ūsque ad mūrum oppidī dēnsissimis⁶ castris complēve-
 rant. Militēs datō signō celeriter ad mūnitiōnem perveni-
 20 unt eamque trānsgressī trīnis castris potiuntur. Ac tanta
 fuit in castris capiendis⁷ celeritās ut Teutomatus, rēx Nitio-
 brigum, subitō in tabernāculō oppressus,⁸ ut meridiē con-
 quiēverat, superiōre parte corporis nūdā, volnerātō equō vix
 sē⁹ ex manibus praedantium militum ēriperet.⁹

The Troops are Eager to Assault the Town.

25 47. Cōsecūtus id quod animō prōposuerat Caesar recep-
 tū canī iussit, legiōnisque x, quācum erat, contiōnātus,
 signa cōstituit. At reliquārum legiōnum militēs nōn auditō

Cf. ¹ opp. dēnsōs, cōnfertōs. — ² sārārī. — ³ opp. sinistrā. — ⁴ opp. minuēbat. — ⁵ ingentibus. — ⁶ opp. rārissimis. — ⁷ occupandis. — ⁸ dēprehēnsus. — ⁹ effugeret.

sonō tubae, quod satis māgna vallēs intercēdēbat, tamen ā tribūnis militum lēgātisque, ut erat ā Caesare praeceptum,¹ retinēbantur. Sed ēlātī spē celeris victōriae et hostium fugā et superiōrum temporum secundis² proeliis, nihil adeō arduum³ sibi exīstimābant quod nōn virtūte cōsequi⁴ possent; neque finem prius sequendi fēcērunt quam mūrō oppidi portisque adpropinquārunt.⁵ Tum vērō ex omnibus urbis partibus ortō clāmōre, quī longius aberant repentinō tumultū perterriti, cum hostem intrā⁶ portās esse exīstimārent, sē ex oppidō eīēcērunt. Mātrēs familiae dē mūrō vestem argentumque iactābant; et pectore nūdō⁷ prōminentēs, passis manibus obtestābantur Rōmānōs ut sibi parcerent; neu, sicut Avaricī fēcissent, nē ā mulieribus quidem atque infantibus abstinērent. Nōn nūllae dē mūrō per manūs dēmissae sēsē militibus trādēbant.⁸ L. Fabius, centuriō legiōnis VIII, quem inter suōs eō diē dixisse cōstābat excitārī sē Avaricēnsibus praemiis, neque commissūrum ut prius quisquam mūrū ascenderet, trēs suōs nactus manipulārīs atque ab eis sublevātus⁹ mūrū ascendit. Hōs ipse rūsus singulōs exceptāns in mūrū extulit.

The Gauls are Reēnforced.

48. Interim eī quī ad alteram partem oppidi, ut suprā¹⁰ dēmōstrāvimus, mūnitiōnis causā convēnerant, primō exaudītō clāmōre, inde etiam crēbrīs nūntiis incitātī oppidum ab Rōmānis tenērī, praemissis equitibus¹¹ māgnō cursū eō contendērunt. Eōrum ut quisque primus vēnerat, sub mūrō consistēbat suōrumque pūgnantium numerum augēbat. Quōrum cum māgna multitudō¹² convēnisset, mātrēs familiae, quae paulō ante Rōmānis dē mūrō manūs tendēbant,¹³ suōs obtestārī et mōre Gallicō passum capillum ostentāre liberōs-

Cf. ¹ mandātum. — ² opp. adversis. — ³ difficile. — ⁴ adipiscī. — ⁵ subiērunt, w. acc. — ⁶ opp. extrā. — ⁷ apertō. — ⁸ dēdēbant. — ⁹ sublātus. — ¹⁰ opp. infrā. — ¹¹ summā celeritāte. — ¹² numerus. — ¹³ pandēbant.

que in cōspectum prōferre coepērunt. Erat Rōmānis nec locō nec numerō aequa¹ contentiō; simul et cursū et spatiō² pūgnae dēfatigātī nōn facile recentis atque integrōs sustinēbant.

Close and Doubtful Struggle. Gallant Exploit of Petronius.

5 49. Caesar cum iniquō³ locō pūgnārī hostiumque cōpiās augērī vidēret, praemetuēns suis ad T. Sextium lēgātum, quem minōribus castris praesidiō reliquerat, misit ut cohortis ex castris celeriter⁴ ēdūceret et sub infimō⁵ colle ab dextrō latere hostium cōstitueret; ut, sī nostrōs locō dēpulsōs⁶
10 vidisset, quō minus liberē hostēs insequerentur terrēret. Ipse, paulum ex eō locō cum legiōne prōgressus ubi cōstitērat, ēventum pūgnae exspectābat.

50. Cum ācerrimē comminus⁷ pūgnārētur, hostēs locō et numerō, nostrī virtūte cōfiderent, subitō sunt Haedui vīsī
15 ab latere nostris apertō,⁸ quōs Caesar ab dextrā parte aliō ascēnsū manūs distinendae causā miserat. Hī similitūdine armōrum vehementer nostrōs perterruērunt; ac, tametsi dextris umeris exsertis⁹ animadvertēbantur, quod insigne pāctum esse cōsuērat, tamen id ipsum suī fallendī causā
20 militēs ab hostibus factum existimābant. Eōdem tempore L. Fabius centuriō quique ūnā mūrū ascenderant circumventī atque interfectī dē mūrō praecipitābantur.¹⁰ M. Petrōnius, eiusdem legiōnis centuriō, cum portās excidere¹¹ cōnātus esset, ā multitudīne oppressus ac sibi dēspērāns, multis iam
25 volneribus acceptis, manipulāribus suis quī illum secūtī erant, “Quoniam,” inquit, “mē ūnā vōbiscum servāre nōn possum, vestrae quidem certē vitae prōspiciam, quōs cupiditātē¹² glōriae adductus in periculum dēdūxī. Vōs datā facultāte¹³ vōbis cōsulite.” Simul in mediōs hostis inrūpit

Cf. ¹ pār, opp. dispār. — ² diūturnitāte. — ³ aliēnō. — ⁴ opp. tardē. — ⁵ opp. summō. — ⁶ ēiectōs. — ⁷ opp. ēminus. — ⁸ nūdō. — ⁹ nūdīs. — ¹⁰ dēiciēbantur. — ¹¹ rescindere. — ¹² studiō. — ¹³ occāsiōne.

duōbusque inierfectis reliquōs ā portā paulum submōvit. Cōnantibus auxiliārī¹ suis, “Frūstrā,” inquit, “meae vitae subvenire² cōnāminī, quem iam sanguis virēsque dēficiunt. Proinde abite dum est facultās³ vōsque ad legiōnem recipite.”⁴ Ita pūgnāns post paulum concidit ac suis salūtī 5 fuit.

The Romans are Driven Back.

51. Nostrī cum undique premerentur,⁵ XLVI centuriōnibus āmissis dēiectī⁶ sunt locō; sed intolerantius Gallōs insequantis legiō x tardāvit, quae prō subsidiō paulō aequiōre locō cōnstiterat. Hanc rūrsus XIII legiōnis cohortēs excēpē- 10 runt, quae ex castris minōribus ēductae cum T. Sextiō lēgātō cēperant locum superiōrem. Legiōnēs ubi primum plānitium attigērunt, infēstis contrā hostem signis cōstitērunt. Vercingetorix ab⁷ rādīcibus collis suōs intrā mūnitiōnēs redūxit. Eō diē militēs sunt paulō minus DCC 15 dēsiderāti.

Cæsar Reproves his Soldiers for too Great Eagerness, but Praises their Courage.

52. Posterō diē Caesar contiōne advocātā temeritātem⁸ cupiditātemque militum reprehendit,⁹ quod sibi ipsi iūdicāvissent quō prōcēdendum aut quid agendum vidērētur, neque signō recipiendī datō cōstitissent neque ā tribūnis militum 20 lēgātisque retinēri potuissent. Exposuit quid iniquitās loci posset, quod ipse ad Avaricum sēnsisset, cum sine duce et sine equitātū dēprehēnsis hostibus explōrātā¹⁰ victōriam dimisisset, nē parvum modo dētrimentum in contentiōne propter iniquitātem loci accideret. Quantō opere eōrum 25 animi māgnitūdinem admīrārētur, quōs nōn castrōrum mūnitiōnēs, nōn altitūdō montis, nōn mūrus oppidi tardāre potuis-

Cf. ¹ iuvāre. — ² auxilium ferre. — ³ potestās. — ⁴ referte. — ⁵ urgērentur. — ⁶ repulsī — ⁷ infimō colle. — ⁸ opp. prūdentiam. — ⁹ incūsāvit. — ¹⁰ certam.

set, tantō opere licentiam¹ adrogantiamque² reprehendere, quod plūs sē quam imperātōrem dē victōriā atque exitū rērum sentire existimārent; nec minus sē ā milite modestiam et continentiam quam virtūtem atque³ animī māgnitudinem
5 dēsiderāre.

After Some Skirmishing, Cæsar Moves towards the Hædui.

53. Hāc habitā contiōne et ad extrēmam⁴ ōrātiōnem cōnfirmātis militibus, nē ob hanc causam animō permovērentur, neu, quod inīquitās locī attulisset, id virtūti⁵ hostium tribuerent; eadem dē profectiōne cōgitāns quae ante sēnserat,
10 legiōnēs ex castris ēdūxit aciemque idōneō locō cōstituit. Cū Vercingetorix nihilō magis in aequum locum dēscenderet, levī factō equestrī proeliō atque eō secundō, in castra exercitum redūxit. Cū hōc idem posterō diē fēcisset, satis ad Gallicam ostentātiōnem⁶ minuendam militumque animōs
15 cōfirmandōs factum existimāns, in Haeduōs mōvit castra. Nē tum quidem insecūtis hostibus, tertiō diē ad flūmen Elaver *vēnit*; pontis refēcit atque exercitum trādūxit.

He is Confirmed in his Suspicion that the Hædui Mean to Revolt,
but Tries to Dissuade them.

54. Ibi ā Viridomārō atque Eporēdorīge Haeduis appellātus, discit cum omnī equitātū Litavicum ad sollicitandōs
20 Haeduōs profectum; opus⁷ esse ipsōs antecēdere ad cōfirmandam civitātem. Etsi multis iam rēbus perfidiam Haeduōrum perspectam habēbat, atque hōrum discessū mātūrārī⁸ dēfectiōnem⁹ civitātis existimābat; tamen eōs retinendōs¹⁰ nōn cēnsuit, nē aut inferre iniūriam vidērētur
25 aut daret timōris aliquam suspiciōnem. Discēdentibus eīs breviter sua in Haeduōs merita exposuit; quōs et quam

Cf. ¹ opp. continentiam. — ² opp. modestiam. — ³ opp. turpitudinem. — ⁴ opp. p̄rimam. — ⁵ fortitudinī. — ⁶ adrogantiam. — ⁷ necesse. — ⁸ opp. tardārī. — ⁹ sēditiōnem. — ¹⁰ opp. dīmittendōs.

humilis¹ accēpisset, compulsōs in oppida, multātōs² agrīs, omnibus ēreptīs cōpiīs, impositō stipendiō, obsidibus summā cum contumēliā extortīs; et quam in fortunam quamque in amplitudinē dūxisset, ut nōn solum in pristinū³ statum redissent, sed omnium temporum dīgnitatem et grātiā 5 antecessisse⁴ vidērentur. His datīs mandātīs eōs ab sē dimisit.

Eporodorix and Viridomarus Kill the Roman Garrison at Noviodunum, Seize and Destroy Cæsar's Stores, and Burn the Town.

55. Noviodūnum erat oppidum Haeduōrum ad ripās Ligeris opportunō locō positum. Hūc Caesar omnis obsidēs Galliae, frūmentum, pecūniam pūblicam, suōrum atque exercitūs impedimentōrum māgnam partem contulerat; hūc māgnū numerum equōrum, hūius bellī causā in Italiā atque Hispāniā cōemptum, miserat. Eō cum Eporēdorix Viridomārusque vēnissent et dē statū civitātis cōgnōvissent, Litavicum Bibracte ab Haeduis receptum, quod est oppidum 15 apud eōs maximae auctoritātis, Convictolitavim magistrātum māgnamque partem senātūs ad eum convēnisse, lēgātōs ad Vercingetorigem dē pāce et amicitīā conciliandā publicē missōs; nōn praetermittendū⁵ tantum commodū⁶ existimāvērunt. Itaque interfectīs Noviodūni custōdibus⁷ quīque 20 eō negōtiandī causā convēnerant, pecūniam atque equōs inter sē⁸ partītī sunt; obsidēs civitātum Bibracte ad magistrātum dēdūcendōs cūrāvērunt; oppidum, quod ā sē tenērī⁹ nōn posse iūdicābant, nē cui esset ūsuī Rōmānis, incendērunt; frūmenti quod subitō potuērunt nāvibus āvexērunt, 25 reliquum flūmine atque incendiō corrūpērunt. Ipsī ex finitimīs regiōnibus cōpiās cōgere,¹⁰ praesidia custōdiāsque ad ripās Ligeris dispōnere, equitātumque omnibus locīs inici-

Cf. ¹ opp. ēlātōs. — ² exūtōs. — ³ priōrem. — ⁴ superāsse. — ⁵ neglegendum. — ⁶ opp. incommodum. — ⁷ praesidiīs. — ⁸ dīvisērunt. — ⁹ dēfendī. — ¹⁰ opp. dīmittere.

endi timōris causā ostentāre coepērunt; sī ab rē frūmentāriā Rōmānōs exclūdere [aut adductōs inopiā in prōvinciam expellere¹] possent. Quam ad spem multum eōs adiuvābat² quod Liger ex nivibus crēverat, ut omninō vadō nōn posse
5 trānsiri vidērētur.

Cæsar Makes a Successful Crossing to the North Side of the Loire.

56. Quibus rēbus cōgnitīs Caesar mātūrandum⁸ sibi cēnsuit,⁴ sī esset in perficiendīs pontibus periclitandum, ut prius quam essent māiōrēs eō coāctae⁵ cōpiæ dīmīcāret. Nam nē commūtātō cōsiliō iter in prōvinciam converteret,
10 ut *nōn* nēmō tum quidem necessāriō faciundum existimābat, cum infāmia⁶ atque indignitās⁷ rei et oppositus mōns Cevenna viārumque difficultās impediēbat; tum maximē quod abiūctō⁸ Labiēnō atque eis legiōnibus quās ūnā miserat vehementer timēbat.⁹ Itaque admodum māgnis diurnis
15 nocturnisque itineribus cōfectīs, contrā omnium opiniōnem ad Ligerim vēnit; vadōque per equitēs inventō prō rei necessitāte opportunō, ut bracchia modo¹⁰ atque umeri ad sustinenda arma liberi¹¹ ab aquā esse possent, dispositō equitātū quī vim flūminis refringeret, atque hostibus primō adspectū
20 perturbātis,¹² incolumem exercitum trādūxit; frūmentumque in agris et pecoris cōpiam nactus, replētō his rēbus exercitū iter in Senonēs facere instituit.

Labienuſ Marches towards Lutetia. Camulogenus Opposes him.

57. Dum haec apud Caesarem geruntur, Labiēnus eō supplēmētō¹³ quod nūper ex Ītaliā vēnerat relictō Agēdinci, ut esset impedimentis praesidiō, cum quattuor legiōnibus
25 Lutetiam proficiscitur. Id est oppidum Parisiōrum positum in insulā flūminis Sēquanæ. Cūius adventū ab hostibus

Cf. ¹ ēicere. — ² opp. impediēbat. — ³ properandum. — ⁴ sēnsit. — ⁵ conlēc̄tae. — ⁶ ignōminia. — ⁷ turpitudō. — ⁸ dētrāctō. — ⁹ metuēbat. — ¹⁰ tantum. — ¹¹ exsertī. — ¹² permōtis. — ¹³ auxiliīs.

cōgnitō māgnae ex finitimis civitatibus cōpiae convēnērunt. Summa imperi trāditur Camulogenō Aulercō, qui prope cōnfectus¹ aetāte tamen propter singulārem scientiam rei mili-

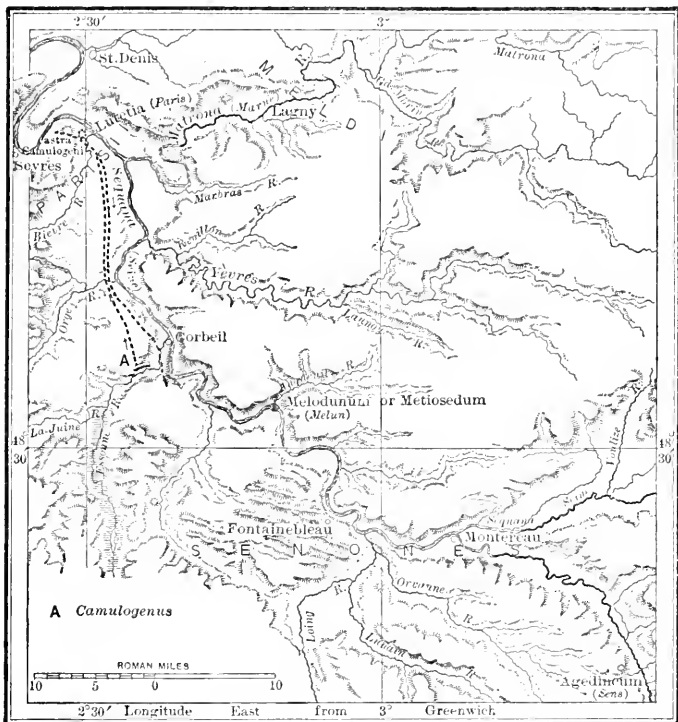

FIG. 99. — EXPEDITIO LABIENI.

tāris ad eum est honōrem ēvocātus.² Is cum animadvertisset perpetuam esse palūdem, quae influeret in Sēquanam atque illum omnem locum māgnopere impediret, hic cōnsēdit nostrōsque trāsitū prohibēre instituit.

Cf. ¹ cōnsūptus. — ² sublātus.

Labienuſ Falls back to Metioſedum, Which he Captures. The Enemy Follow him.

58. Labiēnuſ primō vineāſ agere, crātibus atque aggere palūdem explēre atque iter mūnire¹ cōnābātur. Poſtquam id difficiliuſ fieri animadvertit, ſilentiō ē caſtris tertiā vigiliā ēgreſſuſ, eōdem quō vēnerat itinere Metioſēdum pervēnit.
 5 Id eſt oppidum Senonum in inſulā Sēquanæ poſitum, ut paulō ante dē Lutetiā diximus. Dēprehēnſiſ² nāvibus circiter L celeriterque coniuñctiſ atque eō militibus impoſitiſ³ et rei novitāte perterritiſ⁴ oppidāniſ, quōrum māgnā pars erat ad bellum ēvocāta, ſine contentiōne oppidō potitur.
 10 Refectō⁵ ponte, quem ſuperiōribuſ diēbuſ hoſtēſ reſciderant, exercitum trādūcit et ſecundō⁶ flūmine ad Lutetiam iter facere coepit. Hoſtēſ rē cōgnitā ab eiſ qui ā Metioſēdō profūgerant, Lutetiam incendi,⁷ pontiſque eiſ oppidi reſcindi iubent; ipſi profecti ā palūde in ripā Sēquanæ ē
 15 regiōne Lutetiæ contrā Labiēni caſtra cōſidunt.

Labienuſ Learns of Cæſar's Repulſe at Gergovia and of the Spread of the Gallic Revolt.

59. Iam Cæſar ā Gergoviā diſceſſiſſe audiēbātur; iam dē Haeduōrum dēfectiōne et ſecundō Galliæ mōtū rūmōrēſ adferēbantur; Galli que in conloquiis interclūſum⁸ itinere et Ligeri Cæſarem, inopiā frūmenti coāctum,⁹ in prōvinciam
 20 contendiſſe cōfirmābant. Bellovacī autem dēfectiōne Haeduōrum cōgnitā, qui iam ante erant per ſē infidēlēſ,¹⁰ manūſ cōgere atque apertē bellum parāre coepērunt. Tum Labiēnuſ tantā rerū commūtātiōne longē aliud ſibi capiendum cōſilium atque antea¹¹ ſēnſerat intellegēbat; neque
 25 iam ut aliquid acquireret proeliōque hoſtiſ lacereſſet,¹² ſed ut incolumem exercitum Agēdincum redūceret cōgitābat.

Cf. ¹ *efficere*. — ² *captiſ*. — ³ *iniectiſ*. — ⁴ *perturbātiſ*. — ⁵ *opp. reſciſſō*. — ⁶ *opp. adverſō*. — ⁷ *succendi*. — ⁸ *exclūdō*, with *ab* and the *abl.* — ⁹ *adductum*. — ¹⁰ *perfidī*. — ¹¹ *opp. poſteā*. — ¹² *vezāret*.

Namque alterā ex parte Bellovaci, quae civitās in Galliā maximam habet opiniōnem virtūtis, instābant;¹ alteram Camulogenus parātō atque instrūctō exercitū tenēbat; tum legiōnēs ā praesidiō atque impedimentis interclūsās maximum flūmen distinēbat.² Tantīs subitō difficultātibus ob- 5
iectis ab animi virtūte auxilium petendum vidēbat.

Successful Stratagem of Labienus.

60. Itaque³ sub vesperum cōsiliō⁴ convocātō, cohortātus ut ea quae imperāset diligenter industriēque⁵ administrārent, nāvis quās Metiosēdō dēdūxerat singulās equitibus Rōmānis attribuit; et primā cōnfectā⁶ vigiliā III milia 10
passuum secundō flūmine silentiō prōgredi ibique sē exspectāre iubet. V cohortis quās minimē firmās ad dīmicandum esse existimābat castris praesidiō relinquit; v ēiusdem legiōnis reliquās dē mediā nocte cum omnibus impedimentis adversō flūmine māgnō tumultū⁷ proficisci imperat. Con- 15
quirīt etiam lintris; hās māgnō sonitū rēmōrum incitātās⁸ in eandem partem mittit. Ipse post paulō silentiō ēgressus cum tribus legiōnibus eum locum petit quō nāvis adpelli iusserat.

The Enemy Divide their Forces, as Labienus Desired.

61. Eō cum esset ventum, explōrātōrēs hostium, ut omni flūminis parte erant dispositi, inopinantēs, quod māgna 20
subitō erat coōrta tempestās,⁹ ā nostris opprimuntur; exercitus equitātusque, equitibus Rōmānis administrantibus quōs ei negōtiō praefēcerat,¹⁰ celeriter trāsmittitur.¹¹ Ūnō ferē tempore sub lūcem hostibus nūntiātur in castris Rōmānōrum praeter cōnsuetūdinem tumultuārī,¹² et māgnū ire 25
agmen adversō flūmine sonitumque rēmōrum in eādē parte exaudiri, et paulō infrā militēs nāvibus trānsportārī. Quibus

Cf. ¹ premēbant. — ² opp. coniungēbat. — ³ opp. sub lūcem. — ⁴ cōntiōne. — ⁵ opp. tardē. — ⁶ opp. initā. — ⁷ opp. silentiō. — ⁸ āctās. — ⁹ opp. malacia. — ¹⁰ praeposuerat. — ¹¹ trānsportātur. — ¹² trepidāre.

rēbus auditis, quod existimābant tribus locis trānsire legiōnēs, [atque omnīs perturbātōs dēfectiōne Haeduōrum fugam parāre], suās quoque cōpiās in trēs partis distribuērunt. Nam praesidiō ¹ ē regiōne castrōrum relictō, et parvā manū
 5 Metiosēdum versus missā quae tantum prōgrederētur quantum nāvēs prōcessissent, reliquās cōpiās contrā Labiēnum dūxērunt.

Labiēnus, having Attacked and Routed the Gauls, Joins Cæsar.

62. Primā lūce et nostrī omnēs erant trānsportāti et hostium aciēs cernēbātur.² Labiēnus, militēs cohortātus ut
 10 suae pristināe virtūtis et tot secundissimōrum proeliōrum retinērent memoriā, atque ipsum Caesarem, ³ cūius ductū saepe numerō hostis superāssent, praesentem adesse existimārent, dat sīgnum proeli. Primō concursū⁴ ab dextrō cornū, ubi septima legiō cōstitērat, hostēs pelluntur atque
 15 in fugam coniciuntur⁵; ab sinistrō, quem locum XII legiō tenēbat, cum primī ōrdinēs hostium trānsfixī pilis concidissent, tamen ācerrimē reliquī resistēbant, nec dabat suspiciōnem fugae quisquam. Ipse dux hostium Camulogenus suis aderat atque eōs cohortābātur. At incertō⁶ etiam nunc
 20 exitū victōriae, cum VII legiōnis tribūnis esset nūntiātum quae in sinistrō cornū gererentur, post tergum hostium legiōnem ostendērunt ⁷ sīgnaque intulērunt. Nē eō quidem tempore quisquam ⁸ locō cessit, sed circumventī omnēs interfectique sunt. Eandem fortūnam ⁹ tulit Camulogenus. At eī
 25 quī in praesidiō ¹⁰ contrā castra Labiēni erant relictī, cum proelium commissum audissent, subsidiō suis iērunt collemque cēpērunt, neque nostrōrum militum victōrum impetum sustinēre potuērunt. Sic cum suis fugientibus permixtī, quōs nōn silvae montēsque tēxērunt, ab equitātū sunt inter-

Cf. ¹ adversus, w. acc. — ² perspiciēbātur. — ³ quō duce. — ⁴ impetū. — ⁵ dantur. — ⁶ opp. explorātō. — ⁷ impetum fēcērunt. — ⁸ pedem retulit, sē recēpit. — ⁹ cāsum. — ¹⁰ ē regiōne castrōrum.

fecti. Hōc negōtiō¹ cōfectō Labiēnus revertitur Agēdicum, ubi impedimenta tōtius exercitūs relicta erant. Inde cum omnibus cōpiis ad Caesarem pervenit.

Further Spread of the Revolt. Vercingetorix Appointed Commander-in-chief by a General Vote. The Hædui Dissatisfied.

63. Dēfectiōne Haeduōrum cōgnitā bellum augētur.² Lēgatiōnēs in omnis partīs circummittuntur; quantum grātiā, 5 auctōritāte, pecūniā valent, ad sollicitandās civitātis nituntur. Nactī obsidēs quōs Caesar apud eōs dēposuerat, hōrum supplicio dubitantis territant. Petunt ā Vercingetorige Haeduī ut ad sē veniat ratiōnēsque³ belli gerundī commūnicet. Rē impetrātā⁴ contendunt⁵ ut ipsīs summa imperi trādātur; et 10 rē in contrōversiam dēductā, tōtius Galliae concilium Bibracte indicitur. Conveniunt undique frequentēs.⁶ Multitudinis suffrāgiis rēs permittitur; ad ūnum omnēs Vercingetorigem probant imperātōrem. Ab hōc concilio Rēmī, Lingones, Trēverī āfuērunt: illi, quod amicitiam Rōmānōrum sequē- 15 bantur; Trēverī, quod aberant longius et ā Germānis premēbantur, quae fuit causa quā rē tōtō abessent bellō et neutrīs auxilia mitterent. Māgnō dolōre Haeduī ferunt sē dēiectōs principātū; queruntur fortunae commūtatiōnem et Caesaris in sē indulgentiam requirunt⁷; neque tamen susceptō bellō 20 suum cōsilium ab reliquīs sēparāre⁸ audent. Invitī summae spei adulēscentēs, Eporēdorix et Viridomārus, Vercingetorigi pārent.

Vercingetorix Lays Extensive Plans to Extend the Revolt and Weaken the Romans.

64. Ipse imperat reliquīs civitatibus obsidēs; dēnique eī rei cōstituit diem. Hūc omnis equitēs, xv milia numerō, 25 celeriter convenire iubet; peditātū quem ante habuerit sē fore contentum dicit, neque fortunam temptātūrum aut aciē

Cf. ¹ rē. — ² opp. minuitur. — ³ consilia. — ⁴ opp. recūsātā. — ⁵ postulant. — ⁶ plūrimī. — ⁷ dēsiderant. — ⁸ distinēre.

dīmīcātūrum¹; sed quoniam abundet² equitātū, perfacile esse factū frūmentātiōnibus pābulātiōnibusque Rōmānōs prohibēre; aequō modo animō sua ipsī frūmenta corrumpant,³ aedificiaque incendant; quā rei familiāris iactūrā perpetuum imperium libertātemque sē cōsequī⁴ videant. His cōstitūtis rēbus Haeduis Segusiāvīisque, quī sunt finitimi [eī] prōvinciae, x milia peditum imperat; hūc addit equitēs dccc. His praeficit frātrem Eporēdorīgis bellumque inferri Allobrogibus iubet. Alterā ex parte Gabalōs proximōsque
 10 pāgōs Arvernōrum in Helviōs, item Rutēnōs Cadūrcōsque ad finīs Volcārum Arccomicōrum dēpopulandōs⁵ mittit. Nihilō minus clandestīnis nūntiīs lēgātiōnibusque Allobrogas sollicitat,⁶ quōrum mentis nōndum ab superiōre⁷ bellō resēdisse spērābat. Hōrum prīncipibus pecūniās, civitātī autem
 15 imperium⁸ tōtius prōvinciae pollicētur.

Cæsar Sends to Germany for Cavalry.

65. Ad hōs omnis cāsūs prōvisa erant praesidia cohortium duārum et vīgintī, quae ex ipsā coācta prōvinciā ab L. Caesare lēgātō ad omnis partis oppōnēbantur. Helvii suā sponte cum finitimis proeliō congressi pelluntur, et C. Valerīō Donnotaurō, Caburī filiō, prīncipe civitātis, complūribusque aliis interfectis, intrā oppida mūrōsque compelluntur. Allobrogēs crēbris ad Rhodanum dispositis praesidiis māgnā cum cūrā et diligentīā suōs finīs tuentur.⁹ Caesar, quod hostis equitātū superiōrēs esse intellegēbat, et interclūsīs¹⁰
 25 omnibus itineribus nullā rē ex prōvinciā atque Ītaliā sublevārī¹¹ poterat, trāns Rhēnum in Germāniam mittit ad eās civitātis quās superiōribus annis pācāverat; equitēsque ab his arcessit¹² et levis armātūrae peditēs, quī inter eōs proeliārī cōsuērant. Eōrum adventū, quod minus idōneis equis

Cf. ¹ contentūrum. — ² opp. caret. — ³ perdant. — ⁴ adipīscī. — ⁵ vāstandōs. — ⁶ temptat. — ⁷ vetere. — ⁸ prīncipātum. — ⁹ dēfendunt. — ¹⁰ obsessīs. — ¹¹ iuvārī. — ¹² postulāvit.

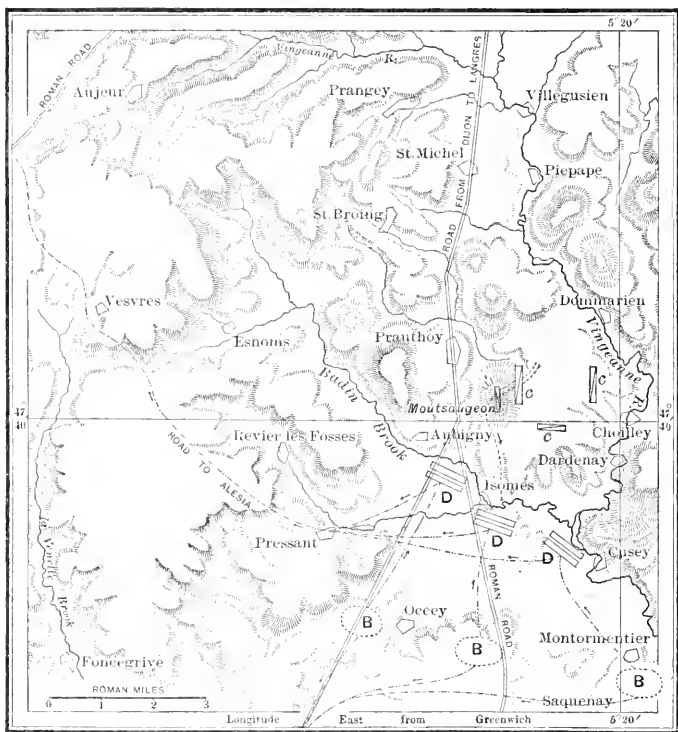

FIG. 100. — DEFEAT OF VERGINGETORIX AT THE VINGEANNE.

- A.* Cæsar's camp the day before the battle.
- B.* The three camps of Vercingetorix.
- C.* Roman column of march at the time the attack was made.
- D.* Gallic lines of infantry.
- E.* Cæsar's camp the night after the battle.
 - a.* Roman cavalry.
 - b.* German cavalry.
 - c.* Gallic cavalry.

ūtēbantur, ā tribūnis militum reliquisque [sed et] equitibus Rōmānis atque ēvocātis equōs sūmit Germānisque distribuit.

Vercingetorix Addresses a Council of Cavalry Officers, Urging an Attack upon the Romans. They Eagerly Assent.

66. Intereā, dum haec geruntur, hostium cōpiae ex Arvernīs, equitēsque quī tōtī Galliae erant imperātī conveniunt. Māgnō hōrum coāctō numerō, cum Caesar in Sēquanōs per extrēmōs Lingonum finis iter faceret, quō facilius subsidium prōvinciae ferre posset, circiter milia passuum x ab Rōmānis trīnis castris Vercingetorix cōnsēdit; convocātisque ad cōsilium praefectis equitum vēnisse tempus victōriae dēmōnstrat¹: ‘Fugere in prōvinciam Rōmānōs Galliāque excēdere. Id sibi ad praesentem obtinendam libertātem² satis esse; ad reliquū temporis pācem atque ōtium³ parum prōfici; māiōribus enim coāctis cōpiis reversūrōs neque finem bellandī factūrōs. Proinde⁴ in agmine impeditōs adoriantur. Si peditēs suis auxilium ferant atque in eō morentur,⁵ iter facere nōn posse; sī, id quod magis futūrum cōfidat,⁶ relictis impedimentis suae salutī cōsulant, et ūsū rērum necessāriārum et dignitāte spoliātum irī. Nam dē equitibus hostium, quin nēmō eōrum prōgredi modo extrā agmen audeat, nē ipsōs quidem dēbēre dubitāre. Id quō māiōre faciant animō,⁷ cōpiās sē omnīs prō castris habitūrum⁸ et terrōri hostibus futūrum.’ Conclāmant equitēs: ‘Sāctissimō iūre iūrandō cōfirmārī oportēre nē tēctō recipiātur, nē ad liberōs, nē ad parentis, nē ad uxōrem aditum habeat, qui nōn bis per agmen hostium perequitārit.’

The Attack is Made, and the Gauls are Defeated with Considerable Loss.

67. Probātā rē atque omnibus ad iūs iūrandum adāctis,⁹ posterō diē in trēs partis distribūtō¹⁰ equitātū duae sē aciēs

Cf. ¹ ostendit. — ² opp. servitūtem. — ³ opp. negōtium. — ⁴ quam ob rem. — ⁵ cunctentur. — ⁶ spēret. — ⁷ virtūte. — ⁸ instrūctūrum. — ⁹ obstrictis. — ¹⁰ dīvisō.

ab duōbus lateribus ostendunt, ūna ā primō agmine iter impedire coepit.¹ Quā rē nūntiātā Caesar suum quoque equitātum tripartitō dīvisum contrā hostem ire iubet. Pūgnātur ūnā omnibus in partibus. Cōsistit² agmen; impedimenta intrā legiōnēs recipiuntur. Sī quā in parte nostri labōrāre aut gravius premī vidēbantur, eō signa inferrī Caesar aciemque cōvertī iubēbat; quae rēs et hostis ad insequendum tardābat et nostrōs spē auxiliī cōfirmābat. Tandem Germānī ab dextrō latere summum iugum nacti
 10 hostis locō dēpellunt³: fugientis ūsque ad flūmen, ubi Vercingetorix cum pedestribus cōpiis cōsēderat, persequuntur complūrisque interficiunt. Quā rē animadversā reliquī, nē circumvenirentur veriti,⁴ sē fugae mandant. Omnibus locis fit caedēs. Trēs nōbilissimī Haeduī captī ad Caesarem per
 15 dūcuntur: Cotus, praefectus equitum, quī contrōversiam cum Convictolitavī proximis comitiis habuerat; et Cavarillus, quī post dēfectiōnem Litavīci pedestribus cōpiis praefuerat; et Eporēdorix,⁵ quō duce ante adventum Caesaris Haeduī cum Sēquanis bellō contenderant.

Vercingetorix Retires to Alesia, Which Cæsar Determines to Invest.

20 68. Fugātō omnī equitātū Vercingetorix cōpiās suās, ut prō castris conlocāverat, redūxit prōtinusque⁶ Alesiam, quod est oppidum Mandubiōrum, iter facere coepit; celeriterque impedimenta ex castris ēdūcī et sē subsequī iussit. Caesar impedimentis in proximum collem ductis, duābus legiōnibus
 25 praesidiō relictis, secūtus hostis quantum diēi tempus est passum, circiter III milibus ex novissimō⁷ agmine interfectis, alterō diē ad Alesiam castra fēcit.⁸ Perspectō⁹ urbis sitū perterritisque hostibus, quod equitātū (quā maximē parte exercitūs cōfidēbant¹⁰) erant pulsī, adhortātus ad labōrem
 30 militēs Alesiam circumvāllāre¹¹ instituit.

Cf. ¹ incēpit. — ² opp. prōgressum est. — ³ dēiciunt. — ⁴ terga vertunt. — ⁵ cūius ductū. — ⁶ continuō. — ⁷ opp. primō. — ⁸ posuit. — ⁹ explorātō. — ¹⁰ opp. diffidēbant. — ¹¹ obsidēre.

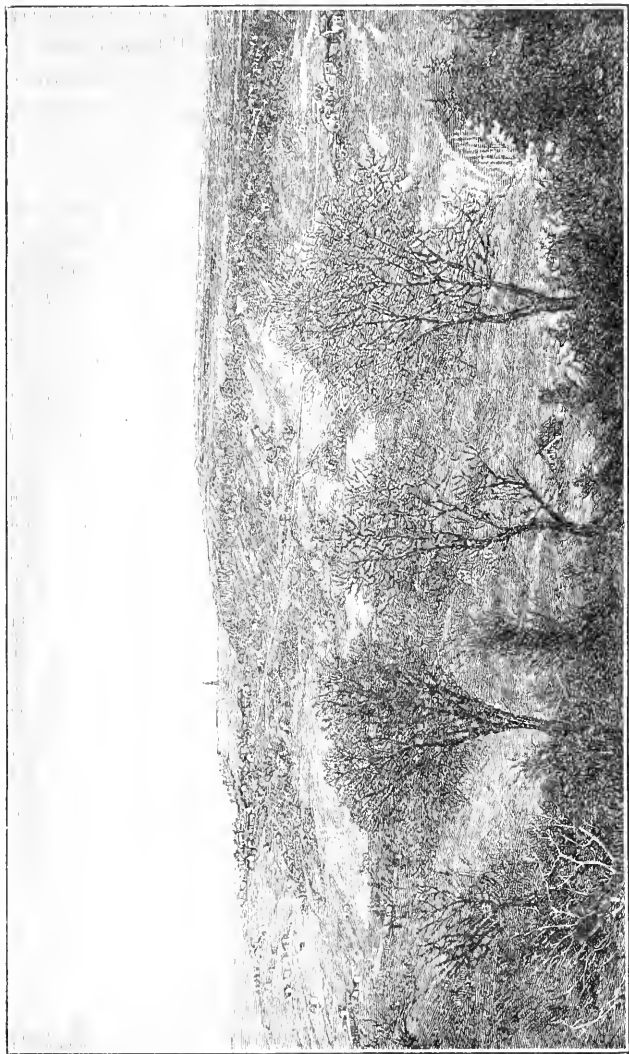

FIG. 101. — ALISE-SAINTE-REINE (*Alesia*).

Description of Alesia and its Defenses.

69. Ipsum erat oppidum in colle summō ¹admodum ēditō locō, ut nisi obsidiōne expūgnārī nōn posse vidērētur. Cūius collis rādicēs duo duābus ex partibus flūmina subluēbant. Ante oppidum plānitiēs circiter milia passuum III in longitudinem patēbat ²; reliquīs ex omnibus partibus collēs, mediocri interiectō spatiō, parī altitudinis fastigiō oppidum cingēbant. Sub mūrō, quae pars collis ad orientem sōlem spectābat, hunc omnem locum cōpiae Gallōrum complēverant, fossamque et māceriam ³ in altitudinem VI pedum praedūxerant. Eius mūnitiōnis quae ab Rōmānis instituēbātur circuitus XI milia passuum tenēbat. ⁴ Castra opportunīs locis erant posita VIII castellaque XXIII facta; quibus in castellis interdiū ⁵ stationēs pōnēbantur, nē qua subitō ēruptiō ⁶ fieret; haec eadem noctū excubitōribus ⁷ ac firmis praesidiis tenēbantur. 15

A Cavalry Battle in the Plain. The Gauls Defeated with Great Slaughter.

70. Opere institūtō fit equestre proelium in eā plānitiē quam intermissam collibus tria milia passuum in longitudinem patēre suprā dēmōstrāvimus. Summā vī ab utrīsque contenditur. Labōrantibus nostris Caesar Germānōs submittit legiōnēsque prō castris cōstituit, nē qua subitō inruptiō ⁸ ab hostium peditātū fiat. Praesidiō legiōnum additō nostris animus augētur; hostēs in fugam coniecti ⁹ sē ipsi multitudine impediunt atque angustiōribus ¹⁰ portis relictis coartantur. Germānī ācrius ūsque ad mūnitiōnēs sequuntur. Fit māgna caedēs; nōn nulli relictis equis fossam trānsire et māceriam trāscendere cōnantur. Paulum legiōnēs Caesar quās prō vāllō cōstituerat prōmovērī iubet. Nōn 25

Cf. ¹ altissimō. — ² pertinēbat. — ³ mūrū. — ⁴ patēbat. — ⁵ opp. noctū. — ⁶ excursiō. — ⁷ vigiliis. — ⁸ incursiō. — ⁹ datī. — ¹⁰ opp. lātiōribus.

minus quī intrā mūnitiōnēs erant Galli perturbantur; veniri ad sē cōfestim¹ existimantēs ad arma conclāmant; nōn nullī perterriti in oppidum inrumpunt. Vercingetorix iubet portās claudī,² nē castra nūdentur. Multis interfectis, com-
5 plūribus equis captis, Germānī sēsē recipiunt.

Vercingetorix Sends Away his Cavalry and Calls for Help from Without.

71. Vercingetorix, priusquam mūnitiōnēs ab Rōmānīs perficiantur, cōsiliū capit³ omnem ab sē equitātum noctū dimittere. Discēdentibus mandat ut suam quisque eōrum civitātem adeat omnisque quī per aetātem arma ferre possint
10 ad bellum cōgant.⁴ Sua in illōs merita⁵ prōpōnūt, obtestāturque ut suae salūtis ratiōnem habeant, neu sē optimē dē commūnī libertāte meritum in cruciātum hostibus dēdant. Quod si indiligentiōrēs⁶ fuerint, milia hominum dēlēcta LXXX ūnā sēcūm interitūra dēmōnstrat. Ratiōne initā frū-
15 mentum sē exiguē diērum xxx habēre, sed paulō etiam longius tolerāre⁷ posse parcendō. His datis mandātis, quā nostrum opus intermissum, secundā vigiliā silentiō equitātum dimittit; frūmentum omne ad sē referrī iubet; capitis poenam eīs quī nōn pāruerint cōstituit; pecus, cūius magna
20 erat cōpia ā Mandubiis compulsa, viritim distribuit; frūmentum parcē et paulātim mētiri instituit; cōpiās omnīs quās prō oppidō conlocāverat⁸ in oppidum recipit. His ratiōnibus⁹ auxilia Galliae expectāre et bellum administrāre parat.

Description of Cæsar's Works of Circumvallation.

25 72. Quibus rēbus cōgnitis ex perfugīs et captivīs Caesar haec genera mūnitiōnis instituit: fossam pedum viginti dirēctis¹⁰ lateribus dūxit, ut ēius fossae solum tantundem

Cf. ¹ prōtinus. — ² opp. aperiri. — ³ init. — ⁴ conquīrant. — ⁵ officia. — ⁶ negligentiōrēs. — ⁷ sustinēre. — ⁸ cōstituerat. — ⁹ modis. — ¹⁰ dirēctē ad perpendiculum.

Fig. 102

SIEGE OF ALESIA

castella

ROMAN MILE

0

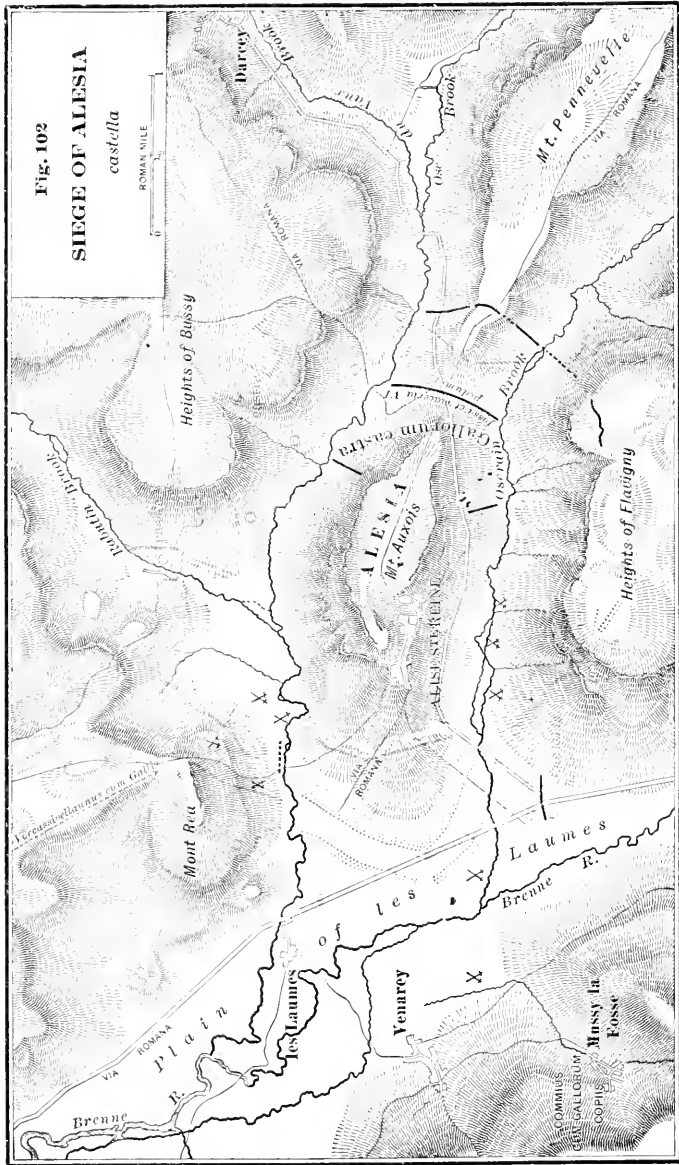

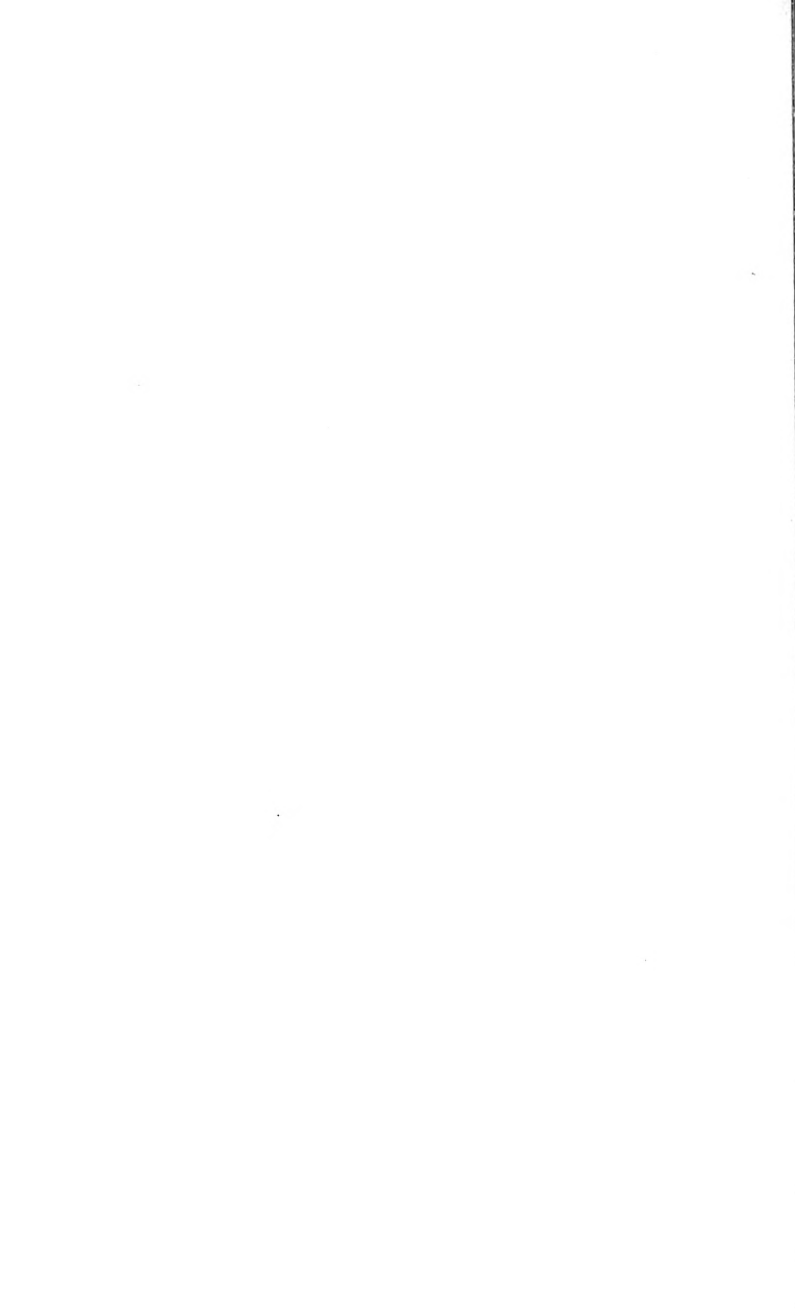

patēret quantum summa labra distārent. Reliquās omnīs mūnitiōnēs ab eā fossā pedēs cccc redūxit: [id] hōc cōnsiliō (quoniam tantum esset necessāriō spatium complexus, nec facile tōtum opus corōnā militum cingerētur), nē dē imprōvisō aut noctū ad mūnitiōnēs multitudō hostium advolāret, aut interdiū tēla in nostrōs ¹operi dēstinātōs conicere possent. Hōc intermissō spatiō duās fossās xv pedēs lātās, eādē altitudīne perdūxit; quārum interiōrem campestribus ac dēmissis ²locis aquā ex flūmine dērivātā ³complēvit. Post eās aggerem ac vāllum xii pedum exstrūxit: huic ¹⁰lōricam pinnāsque adiēcit, grandibus cervīs ēminentibus ad commissūrās pluteōrum atque aggeris, quī ascēsum hostium tardārent ⁴; et turrīs tōtō opere circumdedit quae pedēs lxxx inter sē distārent.

73. Erat eōdem tempore et māteriārī et frūmentārī et tantās mūnitiōnēs fieri necesse, dēminūtis nostris cōpiis, quae longius ⁵ā castris prōgrediēbantur; ac nōn numquam opera nostra Galli temptāre ⁶atque ēruptiōnem ex oppidō plūribus portis summā vī facere cōnābantur. Quā rē ad haec rūsus opera addendum Caesar putāvit, quō minōre numerō militum ²⁰mūnitiōnēs dēfendi possent. Itaque truncīs arborum aut admodum firmīs rāmīs abscisis, atque hōrum dēlibrātis ⁷ac praeacūtīs cacūminibus, perpetuae fossae quīnōs pedēs altae dūcēbantur. Hūc illi stīpitēs dēmissi et ab infimō revincti, ⁸nē revelli possent, ab rāmīs ēminēbant. ⁹Quīnī erant ōrdi- ²⁵nēs coniūcti inter sē atque implicāti; quō quī intrāverant, ¹⁰sē ipsi acūtissimis vāllis induēbant. ¹¹Hōs cippōs appellābant. Ante hōs obliquīs ōrdinibus in quīncūncem dispositis scrobēs in altitudīnem trium pedum fodiēbantur paulātīm angustiōre ad infimum ¹²fastigiō. Hūc teretēs stīpitēs femi- ³⁰nis crassitudīne ab summō praeacūti et praeūsti dēmittēban-

Cf. ¹ in opere occupātōs. — ² humilibus. — ³ dēductā. — ⁴ impedi-
rent. — ⁵ opp. propius. — ⁶ adoriri. — ⁷ exūtis. — ⁸ infixi. — ⁹ exstā-
bant. — ¹⁰ opp. exierant. — ¹¹ trānsfodiēbantur. — ¹² opp. summum.

tur, ita ut nōn amplius digitis IIII ex terrā¹ ēminērent; simul cōfirmandi et stabiliendi causā singulī ab infimō solō pedēs terrā exculcābantur; reliqua pars scrobis ad occultandās² insidiās viminibus ac virgultis integēbātur.

5 Hūius generis octōni ōrdinēs ducti ternōs inter sē pedēs distābant. Id ex similitūdine flōris lilium appellābant. Ante haec tāleae pedem longae ferreīs hāmīs infixis tōtae in terram infodiēbantur,³ mediocribusque intermissis spatiis omnibus locis disserebantur, quōs stimulōs nōminābant.

10 74. His rēbus perfectis, regiōnēs secutus quam potuit aequissimās⁴ prō loci nātūrā, XIV milia passuum complexus paris⁵ ēiusdem generis mūnitiōnēs, diversās ab hīs, contrā exteriōrem hostem perfēcit, ut nē māgnā quidem multitūdine [sī ita accidat⁶ ēius discessū], mūnitiōnum praesidia circum-
15 fundi⁷ possent; nē autem cum periculō ex castris ēgredi cōgātur, diērum xxx pābulum frūmentumque habēre omnis convectum⁸ iubet.

Levy of Troops from All Gaul for the Relief of Alesia.

75. Dum haec apud Alesiam geruntur, Gallī conciliō prīncipum indictō nōn omnis quī arma ferre possent, ut cēnsuit
20 Vercingetorix, convocandōs statuunt, sed certum numerum cuique civitatī imperandum; nē tantā multitūdine cōfūsā nec moderārī⁹ nec discernere suōs nec frūmentandī ratiōnem habere possent. Imperant Haeduis atque eōrum clientibus, Segusiāvis, Ambivaretis, Aulercis, Brannovicibus, [Blanno-
25 viis.] milia xxxv; parem numerum Arvernīs, adiunctis Eleutetis, Cadūrcis, Gabalis, Vellāviis, quī sub imperiō Arvernōrum esse cōsuērunt; Sēquanīs, Senonibus, Biturigibus, Santonis, Rutēnis, Carnutibus duodēna milia; Bellovacis x; totidem Lemovicibus; octōna Pictonibus et Turonis

Cf. ¹ solō. — ² opp. patefaciendās. — ³ dēmittēbantur. — ⁴ opp. iniquissimās. — ⁵ similis. — ⁶ fiat. — ⁷ circumveniri. — ⁸ comportātum. — ⁹ continēre, regere.

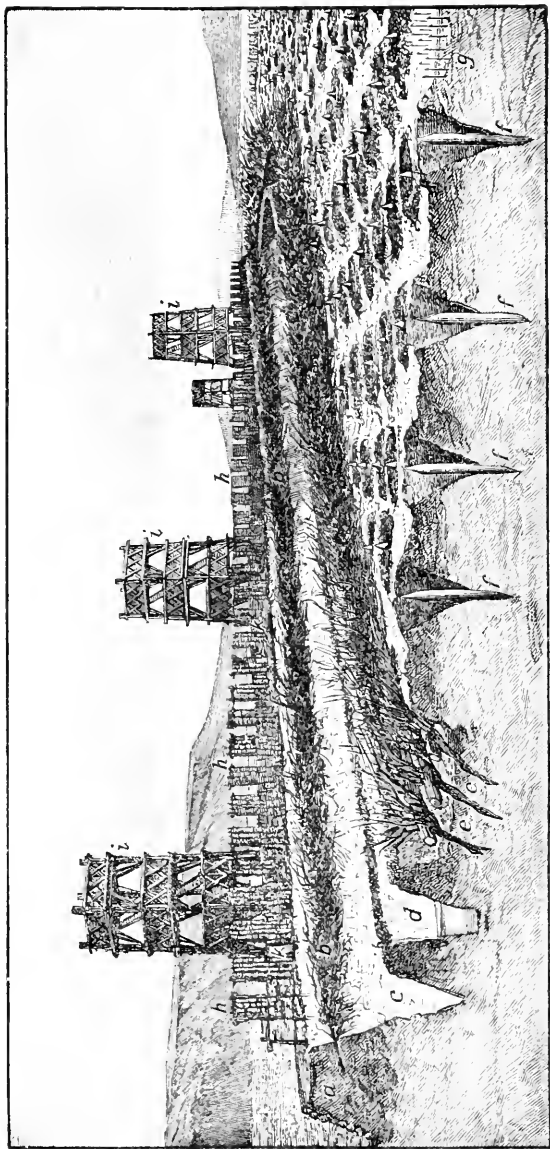

FIG. 103.—VIEW OF CÆSAR'S LINE OF WORKS BEFORE ALESIA.

a, vallum, *b*, cervi; *c*, fossa; *d*, fossa cum aqua; *e*, cippi; *f*, lilia; *g*, stimuli; *h*, pinnac; *i*, turres; *k*, lorica.

et Parisiis et Helvëtiis; sēna Andibus, Ambiānis, Mediomatricis, Petrocoriis, Nervii, Morinis, Nitiobrigibus; quina milia Aulercis Cēnomānis; totidem Atrebātibus; IIII Velio-cassis; [Lexoviis, et] Aulercis Eburovicibus III; Rauracis et Bōiis bina; x ūniversis civitatibus quae Oceanum attingunt 5 quaeque eōrum cōnsuetūdine Aremoricae appellantur, quō sunt in numerō Coriosolites, Redones, Ambibariī, Caletes, Osismi, Venetī, Lexovii, Venelli. Ex his Bellovacī suum numerum nōn contuērunt, quod sē suō nōmine atque arbitriō cum Rōmānis bellum gestūrōs dicerent, neque cūius- 10 quam imperiō obtemperātūrōs¹; rogātī tamen ā Commiō prō ēius hospitiō duo milia mīsērunt.

The Gauls under Commius Approach Alesia with High Hopes.

76. Hūius operā Commī, ut antea dēmōnstrāvimus, fidēli atque ūtili superiōribus annis erat ūsus in Britannia Caesar; prō quibus meritis civitatem ēius immūnem² esse iusserat, 15 iūra lēgēsque reddiderat atque ipsi Morinōs attribuerat. Tanta tamen ūniversae Galliae cōnsēnsiō³ fuit libertātis vindicandae et pristinae belli laudis⁴ recuperandae ut neque beneficiis neque amicitiae memoriā movērētur, omnēsque et animō et opibus in id bellum incumberent.⁵ Coactis equi- 20 tum milibus VIII et peditum circiter CCL, haec in Haeduōrum finibus recēnsēbantur, numerusque inibātur, praefecti⁶ cōstituēbantur; Commiō Atrebāti, Viridomārō et Eporēdorīgi Haeduīs, Vercassivellaunō Arvernō, cōsobrinō Vercingetorigis, summa imperi trāditur. His dēlēcti ex civitatibus 25 attribuuntur quōrum cōnsiliō bellum administrārētur. Omnēs alacrēs et fidūciae plēni ad Alesiam proficiscuntur; neque erat omnium quisquam quī adspectum modo tantae multitudinis sustinēri posse arbitrārētur, praesertim ancipiti proeliō, cum ex oppidō ēruptiōne pūgnārētur, foris tantae 30 cōpiae equitātūs peditātūsque cernerentur.⁷

Cf. ¹ concessūrōs. — ² opp. stīpendiāriam. — ³ opp. dissēnsiō. — ⁴ glōriāe. — ⁵ insisterent. — ⁶ ducēs. — ⁷ cōspicerentur.

A Council is Held in Alesia. Speech of Critognatus and his Desperate Proposal.

77. At eī quī Alesiae obsidēbantur, praeteritā diē quā auxilia suōrum exspectāverant, cōsūptō omnī frūmentō, inscii¹ quid in Haeduīs gererētur, conciliō coāctō dē exitū suārum fortūnārum cōsultābant. Ac variis² dictis sententiis, quārum pars dēditionem, pars, dum virēs suppeterent,³ ēruptionem cēnsēbat, nōn praetereunda⁴ orātiō Critōgnāti vidētur propter ēius singulārem ac nefāriam crudelitātem.⁵

Hic summō in Arvernīs ortus⁶ locō et māgnae habitus auctoritātis: “Nihil,” inquit, “dē eōrum sententiā dictūrus sum
10 quī turpissimam servitūtem dēditionis nōmine appellant, neque hōs habendōs civium locō neque ad concilium adhibendōs cēnsēō. Cum hīs mihi rēs est quī ēruptionem probant; quōrum in cōsiliō omnium vestrum cōsēnsū pristinae residēre⁷ virtūtis memoria vidētur. Animī est ista mollitia,
15 nōn virtūs, paulisper inopiam⁸ ferre⁹ nōn posse. Quī sē ultrō mortī offerant facilius reperiuntur quam quī dolōrem patienter ferant. Atque ego hanc sententiam probārem (tantum apud mē dignitās potest), sī nūllam praeterquam vitae nostrae iactūram fieri vidērem; sed in cōsiliō capi-
20 endō omnem Galliam respiciāmus, quam ad nostrum auxilium concitāvimus.¹⁰ Quid, hominum milibus LXXX ūnō locō interfectis, propinquis cōsanguineisque nostris animī¹¹ fore existimātis, sī paene in ipsis cadāveribus proeliō dēcertāre cōgentur? Nōlite hōs vestrō auxiliō exspoliāre quī vestrae
25 salutis causā suum periculum neglērunt; nec stultitiā ac temeritāte¹² vestrā, aut animī imbēcillitāte, omnem Galliam prōsternere et perpetuae servitūtī subicere. An, quod ad diem nōn vēnerunt, dē eōrum fidē cōstantiāque¹³ dubitātis?

Cf. ¹ ignōrantēs. — ² diversīs. — ³ superessent. — ⁴ praetermittenda. — ⁵ opp. clēmentiam. — ⁶ nātus. — ⁷ manēre. — ⁸ opp. cōpiam. — ⁹ tolerāre. — ¹⁰ convocāvimus. — ¹¹ fortitudinis. — ¹² opp. prūdentia. — ¹³ opp. imbēcillitāte.

Quid ergō? Rōmānōs in illis ulteriōribus mūnitiōnibus animine¹ causā cotidiē exercēri putātis? Si illōrum nūntiis cōfirmārī nōn potestis omni aditū praeseptō, his ūtiminī testibus adpropinquāre eōrum adventum; cūius rei timōre exterritī diem noctemque in opere versantur.

“ Quid ergō mei cōnsili est? Facere quod nostrī māiōrēs nēquāquam parī bellō Cimbrōrum Teutonumque fēcērunt; quī in oppida compulsī ac simili inopiā subāctī, eōrum corporibus quī aetāte ad bellum inūtilēs vidēbantur vitam tolerāvērunt, neque sē hostibus trādidērunt.² Cūius rei sī exemplum nōn habērēmus, tamen libertātis causā institui et posteris prōdī pulcherrimum iūdicārem. Nam quid illī simile bellō fuit? Dēpopulātā Galliā Cimbrī, māgnāque inlātā calamitāte, finibus quidem nostris aliquandō excessērunt atque aliās terrās petiērunt; iūra, lēgēs, agrōs, libertātem nōbis reliquērunt. Rōmānī vērō quid petunt aliud aut quid volunt, nisi invidiā adductī, quōs fāmā nōbilis potentisque bellō cōgnōvērunt, hōrum in agris civitatibusque cōsidere atque his aeternam³ iniungere⁴ servitūtem? Neque enim umquam aliā condiciōne bella gessērunt. Quod sī ea quae in longinquis nātiōnibus geruntur ignōrātis, respicite finitimam Galliam, quae in prōvinciam redācta, iūre et lēgibus commūtātis, secūribus⁵ subiecta perpetuā premitur servitūte! ”

The Mandubii are Compelled to Leave the Town. Cæsar Declines to Receive them.

78. Sententiis dictis cōstituunt ut ei quī valētūdine aut aetāte inūtilēs sint bellō oppidō excēdant,⁶ atque omnia prius experiantur⁷ quam ad Critōgnātī sententiam dēscendant: illō tamen potius ūtendum⁸ cōnsiliō, sī rēs cōgat atque auxilia morentur, quam aut dēditōnis aut pācis subeundam condiciōnem. Mandubiī, quī eōs oppidō recēperant,

Cf. ¹ voluptātis. — ² dēdidērunt. — ³ perpetuam. — ⁴ impōnere. — ⁵ imperiō Rōmānō. — ⁶ exeant. — ⁷ temptent. — ⁸ opp. omittendum.

cum liberis atque uxōribus exire cōguntur. Hī cum ad mūnitiōnēs Rōmānōrum accessissent, flentēs omnibus precibus ōrābant ut sē in servitūtem receptōs cibō iuvārent. At Caesar dispositis in vāllō custōdiis recipi prohibēbat.

Arrival of Commius with the Army of Relief. Joy of the Besieged.

5 79. Intereā Commius reliquique ducēs,¹ quibus summa imperi permissa² erat, cum omnibus cōpiis ad Alesiam perveniunt, et colle exteriōre occupātō nōn longius mille passibus ā nostris mūnitiōnibus cōnsidunt. Posterō diē equitātū ex castris ēductō omnem eam plānitiam, quam in longitudi-
10 nem milia passuum III patēre dēmōstrāvimus, complent; pedestrisque cōpiās paulum ab eō locō abductās in locis superioriōribus cōstituunt. Erat ex oppidō Alesiā dēspectus in campum. Concurrunt hīs auxiliis vīsīs³; fit grātulatiō inter eōs atque omnium animi ad laetitiam excitantur. Ita-
15 que prōductis cōpiis ante oppidum cōsistunt, et proximam fossam crātibus integunt atque aggere⁴ explent, sēque ad ēruptiōnem atque omnīs cāsūs comparant.

A Fierce Engagement Takes Place in the Valley. The Gauls are Defeated.

80. Caesar omni exercitū ad utramque partem mūnitiōnum dispositō, ut, si ūsus veniat, suum quisque locum teneat⁵
20 et nōverit, equitātum ex castris ēdūci et proelium committi iubet. Erat ex omnibus castris, quae summum undique iugum tenēbant, dēspectus; atque omnēs militēs intenti pūgnae prōventum⁶ expectābant. Galli inter equitēs rārōs⁷ sagittariōs expeditōsque levis armātūrae interiēcerant, qui
25 suis cēdentibus auxiliō succurrerent et nostrōrum equitum impetūs sustinērent. Ab hīs complūrēs dē imprōvisō volnerati proelio excēdēbant. Cum suōs pūgnā superioriōres esse

Cf. ¹ praefectī. — ² commissa. — ³ cōspectis. — ⁴ terrā. — ⁵ opp. dēserat. — ⁶ ēventum. — ⁷ opp. dēnsōs.

Galli cōfiderent¹ et nostrōs multitudīne premī vidērent, ex omnibus partibus et eī qui mūnitiōnibus continēbantur et eī qui ad auxiliū convēnerant clāmōre et ululātū suōrum animōs cōfirmābant. Quod in cōspectū omnium rēs gerēbatur, neque rēctē ac turpiter factum cēlārī² poterat; utrōsque 5



FIG. 104. — LIGHT-ARMED SOLDIER.



FIG. 105. — ARCHER.

et laudis cupiditās et timor ignōminiae ad virtūtem excitābat. Cum ā meridiē prope ad sōlis occāsū dubiā victōriā pūgnārētur, Germānī unā in parte cōfertis turmīs in hostis impetum fēcērunt eōsque prōpulērunt. Quibus in fugam coniectis sagittāriī circumventī interfectique sunt. Item ex 10 reliquis partibus nostrī cēdentis ūsque ad castra insecūtī sui conligendī facultātem nōn dederunt. At eī qui Alesiā prō-

Cf. ¹ crēderent. — ² occultārī.

cesserant, maesti¹ prope victōriā dēspērātā sē in oppidum recēpērunt.

The Gauls Make a Night Attack.

81. Ūnō diē intermissō Galli atque hōc spatiō māgnō crātium, scālārum, harpagōnum numerō effectō, mediā nocte
 5 silentiō ex castris ēgressi ad campestris mūnitiōnēs accē-
 dunt. Subitō clāmōre sublātō, quā significātiōne quī in
 oppidō obsidēbantur dē suō adventū cōgnōscere possent,
 crātis prōicere, fundis, sagittis, lapidibus nostrōs dē vāllō
 prōturbāre,² reliquaue quae ad oppūgnātiōnem pertinent
 10 parant administrāre. Eōdem tempore clāmōre exauditō
 dat tubā sīgnum suis Vercingetorix atque ex oppidō ēdūcit.
 Nostrī, ut superiōribus diēbus suis cuique erat locus attri-
 būtus, ad mūnitiōnēs accēdunt; fundis librilibus, sudibusque
 quās in opere disposuerant, ac glandibus Gallōs prōterrent.
 15 Prōspectū tenebris³ adēptō multa utrimque volnera accipi-
 untur; complūra tormentis tēla coniciuntur. At M. Antōnius
 et C. Trebōnius lēgātī, quibus hae partēs ad dēfendendum
 obvēnerant, quā ex parte nostrōs premī intellēxerant, his
 auxiliō ex ulteriōribus castellis dēductōs submittēbant.

They Retire Discomfited.

20 82. Dum longius ā mūnitiōne aberant Galli, plūs multitu-
 dine tēlōrum prōficiēbant; posteāquam propius successērunt,
 aut sē stimulis inopinantēs induēbant aut in scrobis dēlāti
 trānsfodiēbantur aut ex vāllō ac turribus trāiectī pilis mūrā-
 libus interibant. Multis undique volneribus acceptis, nullā
 25 mūnitiōne perruptā, cum lūx adpeteret,⁴ veriti nē ab latere
 apertō ex superiōribus castris ēruptiōne circumvenirentur, sē
 ad suōs recēpērunt. At interiōrēs, dum ea quae ā Vercin-
 getorige ad ēruptiōnem praeparāta erant prōferunt, priōrēs
 fossās explent; diūtius in his rēbus administrandis morāti,

Cf. ¹ trīstēs. — ² prōpellere. — ³ opp. lūce. — ⁴ adīret.

prius suōs discessisse cōgnōvērunt quam mūnitiōnibus adpropinquārent. Ita rē infectā in oppidum revertērunt.

The Army of Relief Makes Another Attempt.

83. Bis māgnō cum dētrimentō¹ repulsi Gallī quid agant cōsulunt. Locōrum peritōs² adhibent; ex hīs superiōrum castrōrum sitūs mūnitiōnēsque cōgnōscunt. Erat ā septentriōnibus collis, quem propter māgnitudinem circuitūs³ opere circumplectī nōn potuerant nostri; necessariōque paene iniquō locō et lēniter dēclivī castra fēcerant. Haec C. Antistius Rēginus et C. Caninius Rebilus lēgātī cum duābus legiōnibus obtinēbant. Cōgnitis per explōrātōrēs regiōnibus ducēs hostium LX mīlia ex omnī numerō dēligunt, eārum civitātum quae māximam virtūtis opiniōnem habēbant; quid quōque pāctō agī placeat occultē inter sē cōstituunt; adeundi tempus dēfiniunt cum meridiēs esse videātur. His cōpiis Vercassivellaunum Arvernum, ūnum ex IIII ducibus, propinquum Vercingetorigis, praeficiunt. Ille ex castris primā vigiliā ēgressus, prope cōfectō sub lūcem itinere, post montem sē occultāvit militēsque ex nocturnō labōre sēsē reficere iussit. Cum iam meridiēs adpropinquāre vidērētur, ad ea castra quae suprā dēmōnstrāvimus contendit; eōdemque tempore equitātus ad campestris mūnitiōnēs accedere et reliquae cōpiae prō castris sēsē ostendere coepērunt.

Vercingetorix Coöperates. Difficulties of the Romans.

84. Vercingetorix ex arce Alesiae suōs cōspicātus ex oppidō ēgreditur: crātis, longuriōs, mūsculōs, falcis, reliquae quae ēruptiōnis causā parāverat prōfert. Pūgnātur ūnō tempore omnibus locis atque omnia temptantur; quae minimē vīsa pars firma est hūc concurritur. Rōmānōrum manus tantis mūnitiōnibus distinētur nec facile plūribus locis occurrit. Multum ad terrendōs nostrōs valet clāmor, quī post

Cf. ¹ caede. — ² opp. imperitōs. — ³ circumvallāre.

tergum pūgnantibus exstitit, quod suum periculum in aliēnā vident virtūte cōnstāre; omnia enim plērumque quae absunt vehementius hominum mentis perturbant.

Fighting Continues with Energy on Both Sides.

85. Caesar idōneum locum nactus quid quāque ex parte gerātur cōgnōscit; labōrantibus *subsidiū* submittit. Utris-
que ad animum occurrit ūnum esse illud tempus quō maximē
contendī conveniat: Gallī, nisi perfrēgerint mūnitiōnēs, dē
omnī salūte dēspērānt; Rōmānī, sī rem obtinuerint, finem
labōrum omnium exspectant. Maximē ad superiōrēs mūni-
10 tiōnēs labōrātur, quō Vercassivellaunum missum dēmōnstrā-
vimus. Inīquum locī ad dēclivitātem fastigium māgnū
habet mōmentum. Alii tēla cōniciunt, alii testūdine factā
subeunt; dēfatigātis in vicem integrī succēdunt. Agger ab
ūniversis in mūnitiōnem coniectus et ascēsum dat Gallis,
15 et ea quae in terrā occultāverant Rōmānī contegit; nec iam
arma nostris nec virēs suppetunt.

Cæsar Personally Encourages his Troops.

86. His rēbus cōgnitis Caesar Labiēnum cum cohortibus
VI subsidiō labōrantibus mittit. Imperat, sī sustinēre nōn
possit, dēductis cohortibus ēruptiōne pūgnet; id nisi neces-
20 sariō nē faciat. Ipse adit reliquōs; cohortātur nē labōrī
succumbant; omnium superiōrum dīmiciatiōnum fructum in
eō diē atque hōrā docet cōsistere. Interiōrēs, dēspērātis
campestribus locis propter māgnitūdinem mūnitiōnum, loca
praerupta [ex] ascēnsū temptant; hūc ea quae parāverant
25 cōferunt. Multitūdine tēlōrum ex turribus prōpūgnantis
dēturbant, aggere et crātibus fossās explent, falcibus vāllum
ac lōricam rescindunt.

His Activity in Various Parts of the Field.

87. Mittit primum Brūtum adulēscēntem cum cohortibus
Caesar, post cum aliis C. Fabium lēgātum; postrēmō ipse,



FIG. 106. — STATUE OF VERCINGETORIX.

cum vehementius pugnārētur, integrōs subsidiō addūcit. Restitūtō proeliō ac repulsis hostibus, eō quō Labiēnum miserat contendit; cohortis IIII ex proximō castellō dēdūcit, equitum partem sē sequī, partem circumire exteriorēs mūnitiōnēs et ā tergō hostis adoriri iubet. Labiēnus, postquam 5 neque aggerēs neque fossae vim hostium sustinēre poterant, coāctis XL cohortibus, quās ex proximis praesidiis dēductās fors obtulit, Caesarem per nūntiōs facit certiōrem quid faciendum exīstimet. Accelerat Caesar ut proeliō intersit.

Utter Defeat of the Gauls with Great Slaughter.

88. Ēius adventū ex colōre vestītūs cōgnitō, [quō insignī 10 in proeliis ūti cōsuērat], turmisque equitum et cohortibus vīsīs quās sē sequī iusserat, ut dē locis superioribus haec dēclivia et dēvexa cernēbantur, hostēs proelium committunt. Utrisque clāmōre sublātō excipit rūsus ex vāllō atque omnibus mūnitiōnibus clāmōr. Nostrī omissis pilis gladiis rem 15 gerunt. Repente post tergum equitātus cernitur; cohortēs aliae adpropinquant. Hostēs terga vertunt; fugientibus equitēs occurrunt; fit māgna caedēs. Sedulius, dux et princeps Lemovicum, occiditur; Vercassivellaunus Arvernus vivus in fugā comprehenditur; signa militāria LXXIIII ad 20 Caesarem referuntur; paucī ex tantō numerō sē incolumēs in castra recipiunt. Cōspicātī ex oppidō caedem et fugam suōrum, dēspērātā salūte, cōpiās ā mūnitiōnibus redūcunt. Fit prōtinus hāc rē auditā ex castris Gallōrum fuga. Quod nisi crēbris subsidiis ac tōtius diēi labōre militēs essent 25 dēfessī, omnēs hostium cōpiae dēlērī potuissent. Dē mediā nocte missus equitātus novissimum agmen cōnsequitur: māgnus numerus capitur atque interficitur; reliquī ex fugā in civitātis discēdunt.

Vercingetorix Surrenders.

89. Posterō diē Vercingetorix conciliō convocātō id bellum sē suscepisse nōn suārum necessitātum sed commūnis libertātis causā dēmōnstrat; et quoniam sit fortūnae cēdendum, ad utramque rem sē illis offerre, seu morte suā Rōmānis satisfacere seu vīvum trādere velint. Mittuntur dē hīs rēbus ad Caesarem lēgātī. Iubet arma trādī, prīncipēs prōdūcī. Ipse in mūnitiōne prō castris cōnsidit; eō ducēs prōdūcuntur. Vercingetorix dēditur; arma prōiciuntur. Reservātis Haeduīs atque Arvernīs, sī per eōs civitātis recuperāre posset, ex reliquīs captivīs tōtī exercitūi capita singula praedae nōmine distribuit.

Cæsar's Distribution of his Forces for the Winter. A Twenty Days' Thanksgiving Decreed at Rome.

90. Hīs rēbus cōfectis in Haeduōs proficiscitur; civitatem recipit. Eō lēgātī ab Arvernīs missī quae imperāret sē factūrōs pollicentur. Imperat māgnūm numerum obsidum. 15 Legiōnēs in hiberna mittit; captivōrum circiter xx milia Haeduīs Arvernisque reddit. T. Labiēnum cum duābus legiōnibus et equitātū in Sēquanōs proficiscī iubet; huic M. Semprōnium Rutilum attribuit. C. Fabium lēgātum et L. Minucium Basilum cum legiōnibus duābus in Rēmīs 20 conlocat, nē quam ā finitimīs Bellovacis calamitatem accipiant. C. Antistium Rēginum in Ambivaretōs, T. Sextium in Biturīgēs, C. Caninium Rebilum in Rutēnōs, cum singulis legiōnibus mittit. Q. Tullium Cicerōnem et P. Sulpicium Cabillōnī et Maticōne in Haeduīs ad Ararim rei frūmentāriae causā conlocat. Ipse Bibracte hiemāre cōstituit.

Hīs rēbus ex Caesaris litteris cōgnitis Rōmae diērum vīginti supplicatiō redditur.

.

NOTES.



FIG. 107. — THE LEGIONARY.

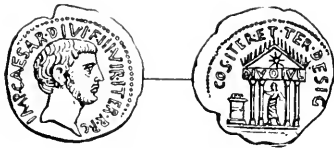

FIG. 108.—COIN OF CÆSAR.

BOOK FIRST. — B.C. 58.

THE HELVETIAN WAR.—Early in the year 58 B.C. the whole population of Helvetia (northern Switzerland), amounting to about 360,000, attempted to pass by an armed emigration through the heart of Gaul, in order to settle somewhere near the shore of the Bay of Biscay, possibly with the hope of becoming masters of the whole country. They were hemmed in by the great natural barriers of the Alps, the Lake of Geneva, and the Jura Mountains on the south and west, and pressed on the north by great hordes of Germans, who kept up a continual border war. Their fields were scant, their harvests insufficient, their people hardy and fearless. Their ambitious chief, Orgetorix, had prepared them so well for this enterprise that his flight and death—when he was charged with guilty conspiracy and put on trial for his life—caused no delay. The attempt was held in check by Cæsar, during a fortnight's parley, till sufficient earthworks had been thrown up along the Rhone to withstand their advance across the river; the advance was then made in force along the narrow pass between that river and the Jura. But the Helvetians did not succeed in getting more than fifty miles beyond the frontier when they were overtaken by Cæsar, who, by a few light skirmishes and two bloody battles, forced them back to their own territories with the loss of more than 200,000 lives. This brief campaign, lasting only from March to June, is called the Helvetian War.

READING REFERENCES ON THE HELVETIAN WAR

- Dodge's Cæsar, pp. 50-81.
 Froude's Cæsar, pp. 214-231.
 Trollope's Cæsar, pp. 35-38.
 Fowler's Julius Cæsar, chap. 8.
 Guizot's Hist. of France, Vol. I. pp. 47-51.
 Holmes's Cæsar's Conquest of Gaul, pp. 26-36.
 Merivale's Hist. of Rome, Vol. I. pp. 237-254.
 Mommsen's Hist. of Rome, Vol. IV. pp. 289-295.
 Napoleon's Cæsar, Vol. II. chap. 3.
 Plutarch's Lives, Cæsar.

N.B. The grammars cited are those of Allen and Greenough (§), Bennett (B.), Gildersleeve (G.), Harkness (H.), and Hale and Buck (H-B.). References in parentheses are to the old editions. Cf. (*confer*) = compare; *sc.* (*scilicet*) = supply; *ff.* = and following; *subjv.* = subjunctive; *impv.* = imperative; *ftn.* = footnote,

PAGE 1. LINE 1. **Gallia**: that is, Transalpine Gaul, excluding the Roman province (*Provincia*) in the southeast, as well as *Gallia Cisalpina*, now northern Italy. It occupied the territory of France, including the country to the Rhine boundary, with most of the Netherlands and Switzerland (see map, Fig. 2).—**omnis** (predicate), *as a whole*.—**est divisa, is divided**: the adjective use of the participle, not the perfect passive; § 495 (291. b); B. 337. 2; G. 250. R.²; H. 640. 3 (550. N.²); H-B. 320. iii.—**unam**: sc. *partem*.

1 2 incolunt: in translation (not in reading the Latin to make out the sense) change the voice to the passive in order to preserve the emphasis in the English idiom. It is well to acquire the habit of making such changes. The natural English form would be: *of which one is inhabited by the Belgians*, etc., but the Latin uses the active voice. The moment you find an accusative beginning a sentence, if it seems from its meaning to be a direct object, you can at once think of it as a subject in the nominative (*at the same time noticing that the Latin does not make it such*). The verb can then be instantly thought of as a passive and the subject as agent. This inversion is so common in Latin for purposes of rhetoric that such a device is a very helpful one, and if properly used from the start need not obscure the Latin construction. The Latin plays upon the position of words to produce all sorts of shades of rhetorical expression, and it is never too early to observe these shades and try to render them in our own idiom.—**Belgae**: probably of the Cymric branch of the Celtic race, allied to the Britons and the modern Welsh; they inhabited the modern Belgium and northern France, and were considerably mixed with Germans (see Bk. ii. ch. 1).—**Aquitani**: of the Spanish Iberians (the modern Basques) inhabiting the districts of the southwest (see Bk. iii. ch. 20).—**aliam**: here *alteram* would be more usual as meaning the second in the list.—**qui . . . appellantur**: notice that in Latin any relative may suggest its own antecedent, as with the indefinite relative (*whoever*) in English. In English we have to supply a demonstrative (*those*) *who*. So here **tertiam qui** = *tertiam partem ei incolunt qui*; see § 307. c (200. c); B. 251. 1; G. 619; H. 399. 4 (445. 6); H-B. 284. 1.—**ipsorum, etc.**: notice that the position of words is so significant in Latin, through its indicated emphasis, that it may allow words to be omitted which must be supplied in the thought. In this case the English idiom is the same: in *their own* tongue . . . in *ours*.

1 3 Celtæ: probably of the Gælic branch, represented by the Irish and the Highland Scotch.—**lingua**: abl. of specification; § 418 (253); B. 226; G. 397; H. 480 (424); H-B. 441.

1 4 differunt: the language of the Aquitani was Basque; of the Gauls proper, Celtic; of the Belgians, another dialect of Celtic mixed with German.

1 4 inter se, *from one another*: the preposition **inter** may be used to show any *reciprocal* relation; § 301. *f* (196. *f*); B. 245; G. 221; H. 502. 1 (448. N.); H-B. 266. — **Gallos**: see note on **incolunt**, l. 2.

1 5 dividit: the verb is singular, because the two rivers make one boundary; § 317. *b* (205. *b*); B. 255. 3; G. 211. R.¹; H. 392. 4 (463. ii. 3); H-B. 331. 3.

1 6 horum: part. gen. with **fortissimi**; § 346. *a*. 2 (216. *a*); B. 201. 1; G. 372; H. 442 (397. 3); H-B. 346. — **propterea quod**, *because*; lit. *because of this, that*, etc. The difference between this and the simple *quod* is only one of greater emphasis — almost as strong as *and the reason is* or *and it is because*.

1 7 cultu, *civilization*, as shown by outward signs, dress, and habits of life. — **humanitate**, *refinement*, of mind or feeling. — **provinciae**: the province of *Gallia Narbonensis*, organized about B.C. 120. Its chief cities were Massilia (*Marseilles*), an old Greek free city, and the capital, Narbo (*Narbonne*), a Roman colony. The name *Provincia* has come down to us in the modern *Provence*.

1 8 mercatores: these were traders or peddlers, mostly from the seaport of Massilia; they travelled with pack-horses, mules, and wagons. A very common article of traffic, as with our Indian traders, was intoxicating drinks, — wines from the southern coast, which, especially, as Cæsar says, “tend to debauch the character.” These people, it is said, would give the traders a boy for a jar of wine. — **commeant**: this verb means, especially, *to go back and forth* in the way of traffic. The main line of trade lay across the country, by the river Liger (*Loire*). — **ea**: object of **important**.

1 9 effeminandos: § 506 (300); B. 339. 2; G. 427; H. 628 (544); H-B. 612. iii. — **proximi**: notice how the three superlatives, **longissime**, **minime**, and **proximi** are arranged. After the emphatic idea of **cultu**, etc., is completed, the superlatives begin each its own phrase.

1 10 Germanis: dat. with an adjective of nearness; § 384 (234. *a*); B. 192. 1; G. 359; H. 434. 2 (391. 1); H-B. 362. iii. — **trans Rhenum**: the Rhine was, in general, the boundary between the Gauls and the Germans, and has so remained till modern times. — **continenter** (adverb from the participle of *contineo*, *hold together*), *incessantly*; strictly, *without any interruption*. The pupil should begin at once to notice the way in which words develop into groups expressing the same idea in the forms of the various parts of speech. See p. 449.

1 11 qua de causa, *and for this reason*: § 308. *f* (180. *f*); B. 251. 6; G. 610; H. 510 (453); H-B. 284. 8; referring back to **proximi**, etc., and further explained by **quod . . . contendunt**. — **Helvetii**: here, it will be noticed, reckoned as Gauls. — **quoque**: i.e. just as the Belgians.

1 12 reliquos, *the rest of*: § 293 (193); B. 241. 1; G. 291. R.²; H. 497. 4 (440. 2. N.^{1, 2}); H-B. 346. *c*; notice the emphasis of position; the *others* as opposed to the Helvetii.—**virtute**, not *virtue*, but *courage*; for construction, see note on *lingua*, l. 3.—**præcedunt**, *excel*; lit. *go ahead of*

1 13 proeliis: abl. of means; **finibus**: abl. of separation.—**cum prohibent**, *while they keep them off* (*pro-habeo*).

1 14 ipsi (emphatic), *themselves*, the Helvetians; **eos** and **eorum** refer to the Germans.

2 1 eorum una pars, *one division of them* (the Gauls or Celts), the people being identified with the country.—**quam . . . dictum est**, *which, it has been* (already) *said, the Gauls hold*. Notice that in direct discourse it would be *Galli obtinent*: the subject nom. is changed to acc. and the indic. to the infin. after the verb of *saying*, **dictum est**; § 561. *a* (272. R.); B. 330; G. 527; H. 613. 2 (535. 1); H-B. 534. 1, 590. 1. Here **quam** is the object and **Gallos** the subject of **obtinere**, while the clause is the subject of **dictum est**; § 560, 561, 566. *b* (329, 330. *a*. 2); B. 330; G. 528; H. 615 (538); H-B. 238, 590. 1. *a*.—**obtinere** (*ob-teneo*), not *obtain*, but *occupy*; strictly, *hold against* all claimants. *Ob* in composition almost always has the sense of *opposing* or *coming in the way of* something. This is one of the many words which have entirely changed their meaning in their descent from the Latin. Always be on your guard against rendering Latin words by the English one corresponding. *Obtineo* does *not* mean *obtain*, nor *occupo*, *occupy*. The corresponding word is often suggestive as a guide to the meaning, but must not be used without careful examination.

2 3 ab Sequanis, *on the side of*, etc., regarded from the point of view of the Province; a very common use of **ab**; § 429. *b* (260. *b*); G. 390. 2. N.⁶; H. 490 (434. 1); H-B. 406. 2.

2 4 vergit, etc., *slopes to the north*; the highlands (Cévennes) are along the southern boundary, and the rivers in that quarter flow in their main course northerly.—**septentriones**

(*septem triones*, "the seven plough-oxen"): i.e. the constellations of the Great and Little Bears. The word is used both in the singular, as below, and in the plural, as here.



FIG. 109.—GALLIC COIN.

2 5 Galliae: i.e. Celtic Gaul, the country just described, not *Gallia omnis*.

2 6 spectant: i.e. considered from the Province, it lies in that direction.

2 8 ad Hispaniam, *next to Spain*, i.e. the Bay of Biscay: § 428. *d* (259. *f*); H. 420. 1 (433. 1).

2 9 **spectat**: cf. **spectant** above.—**inter occasum**, etc., *northwest*, i.e. from the Province.

2 11 **CHAP. 2. nobilissimus**, of *highest birth*. Popular revolutions had, among the Gauls as among the Greeks and Romans, mostly dispossessed the old chiefs, or kings; and they had established an annual magistrate called *Vergobret* (ch. 16). But the heads of the ruling families would naturally be ambitious to recover what they could of the old class power, and Orgetorix is represented as aspiring to create a monarchy in Gaul.

2 12 **M.**=**Marco**. Always read and translate these names without abbreviation.—**Messala**, etc.: this was B.C. 61, three years before Cæsar's first campaign in Gaul. This construction of **consulibus** was the usual way of denoting the year; not so formal in English as *while Messala and Piso were consuls*, but merely *in the consulship of*; abl. abs., § 419. *a* (255. *a*); B. 227. 1; G. 409. 410; H. 489 and 1 (431 and 2); H-B. 421. 1.

2 13 **cupiditate**: abl. of means; § 409 (248. *c*); B. 218; G. 401; H. 476 (420); H-B. 423.—**coniurationem**, a *league* sworn to fidelity by oath (*iuro*).—**nobilitatis**: from the account given in ch. 4, we see how immense was the class power still held by the nobles, and why they would naturally join in such a combination.

2 13 **civitati persuasit**: § 367 (227); B. 187. ii. *a*; G. 346; H. 426. 1 (385. ii); H-B. 362. ftm.³ and 1; the direct object of **persuasit** is the clause **ut . . . exirent**; § 563 (331); B. 295. 1; G. 546; H. 564. i (498); H-B. 502. 3. *a*; translate the latter by the infinitive according to the English idiom. Votes were easily "persuaded" by such means as Orgetorix possessed. For the sequence of tenses in **exirent**, see § 484 (286. *r.*); B. 267; G. 510; H. 545. ii. 1 (493. 1); H-B. 476; and for the plur., see § 280. *a* (182. *a*); B. 254. 4; G. 211. *r.*¹; H. 389 (636. iv. 4); H-B. 325.

2 15 **perfacile**: predicate with **esse**, while its subject is the infin. clause with **potiri**; § 289. *d* (189. *d*); G. 422. 3; H. 394. 4 (438. 3); cf. H-B. 325. *b*; *showing that it was quite easy, since they exceeded all men in valor, to win the empire of all Gaul*.—**esse**: indir. disc., depending on some word implied in **persuasit**; § 580. *a* (336. 2. *n.*²); B. 314. 2; G. 546. *r.*¹, 649. *r.*²; H. 642. 1 (523. i. *n.*); cf. H-B. 534. 1. *a*. Notice that the Latin has the power of putting various dependent clauses after a single verb. Here the idea of persuading takes the thing that was to be done in an *ut*-clause. The facts of which they were persuaded take the indir. disc. Careful attention to this usage will make many difficult passages easy. It is not the verb used, but the meaning, that decides the construction.—**cum praestarent**: subjv. after **cum** meaning *since*; § 549 (326); B. 286. 2; G. 586; H. 508 (517); H-B. 526.

2 16 **imperio**: § 410 (249); B. 218. 1; G. 407; H. 477 (421. i); H-B. 429.

2 17 hoc facilius, *all the easier*: originally degree of difference, as in all ablatives with comparative; but hardly different in sense from the abl. of cause; § 404 (245); B. 219; G. 408; H. 475 (416); H-B. 424. a. — **id**: object of **persuasit**; § 369 (227. f); B. 176. 2. a; G. 345; H. 426. 6 (384. 2); H-B. 364. 4: we should say, *persuaded them of it*. Usually with *persuadere* the dat. and acc. are both used only when the latter is a pronoun. — **loci natura**, *by the nature of the country*.

2 18 una ex parte, *on one side*: cf. **ab Sequanis** above, so **undique**, *on* (lit. *from*) *all sides*; *hinc*, *on this side*, etc. The effect on the senses is supposed to come *from* the direction referred to. — **latissimo**, *very broad*.

2 19 qui takes its gender not from **flumine**, but from **Rheno**; § 306 (199); B. 250. 3; G. 614. 3. b; H. 396. 2 (445. 4); H-B. 326.

2 23 his rebus, etc.: lit. *from these things it was coming about that they roamed about less widely and could less easily make war*, etc. But this is obviously not an English mode of thought, nor a form which any English-speaking person would ever naturally use. So here, *as always*, you must see from this clumsy expression what is meant and then express it in the natural vernacular, something like, *from all this they were getting less free to wander and having less opportunity to make war*, etc. Several other ways of expressing this may be imagined. One of the greatest advantages of classical study is to set the mind free from *forms*, and bring into prominence the possibility of saying the same thing in fundamentally different ways. — **fiēbat**: the imperfect expresses the continued effect of the causes; § 470 (277); B. 260. 1; G. 231; H. 534 (468, 469); H-B. 468. 2; the subject of **fiēbat** is the clause **ut . . . possent**; § 569 (332. a); B. 297. 2, cf. 284. 1; G. 553. 3, 4; H. 571. 1 (501. i); H-B. 521. 3. a.

2 24 qua ex parte: here *in which respect* hardly differs from *from which cause*. — **homines** (a sort of apposition) = *being* (as they were) *men eager for war*.

3 1 bellandi: § 349. a (218. a); B. 338. 1. b; G. 374. 5; H. 626, 451. 1 (542. 1, 399. i. 1); H-B. 612. 1. — **adficiebantur** = *afficiebantur*: for the assimilation of consonants, see § 16 (11); B. 8. 4; G. 9; H. 374. 2 (344. 5); H-B. 51. 2. In this edition the *unchanged* form of the preposition is usually preferred. — **pro**, *in proportion to*; cf. our force of *for*.

3 2 multitudine: their numbers, including some small dependent populations, were 368,000 (see ch. 29).

3 3 angustos finis, *too narrow limits*. So in English such words often suggest a negative idea; cf. a "scant pattern."

3 4 milia passuum, *miles* (1000 paces), the regular way of stating this measure, **milia** being acc. of *extent of space*, and **passuum** part. gen. The *passus* was the *stretch* from heel to heel, i.e. from where one heel is raised

to where it is set down again, and is reckoned at five Roman feet. A Roman mile (*mille passuum*) was about 400 feet less than ours; it measures the distance which a soldier would march in a thousand double paces. — **CCXL** = *ducenta quadraginta*. Always give the Latin words for numerals in reading the text.

3 5 patebant: throughout the latter part of this chapter notice the use of the imperfect of *description* or *general statement*, compared with the perfect of *simple narrative* in **persuasit** above and **constituerunt**, etc., below. This distinction is very marked in Latin, and must always be noticed, though not always translated. Our progressive imperfect is much more limited in its use than the Latin imperfect. But the latter always describes a situation and never advances the narrative of occurrences.



FIG. 110. — GALLIC COIN.

3 7 CHAP. 3. quae . . . pertinerent: dependent clause in indir. disc.; § 592. 3 (341. *d*); B. 323; G. 628; H. 649. i (528. 1); H-B. 535. 1 and *a*. The mood shows that its clause expresses not the writer's statement, but that of the speaker or actor or some other person concerned. Always bear in mind that Cæsar uses the subjunctive to express something different from the indicative, whether you can find the technical rule for it or not. — **comparare . . . confirmare**: these infinitives correspond exactly with our idiom *to prepare*, etc., but the same meaning is oftener expressed by a subjunctive clause with *ut*; § 457 (271. *a*); B. 328. 1; G. 423; H. 607. 1 (533. i. 1); H-B. 586. *e*.

3 8 iumentorum, *beasts of burden*; properly, *yoke-animals* (kindred with *iungo*, *join*, and *iugum*, *yoke*); **carrorum**, a Celtic word, *two-wheeled carts*. See Fig. 55, p. 94. — **quam maximum**, *as great as possible*: § 291. *c*, 321 (93. *b*, 207); B. 240. 3, 177. 3; G. 303; H. 159. 2 (170. 2); H-B. 241. 4.

3 9 coëmere . . . facere . . . confirmare: notice that the Latin more easily dispenses with connectives than we do.

3 11 conficiendas, *completing*: **con** in composition may mean *together*; or, as here, may be simply intensive (cf. *do a thing up*). This word is shown to be a gerundive by having a noun with which it agrees. Cf. **proficiscendum**, **3 7**, where there is no noun; § 503 (296); B. 339. 2; G. 427; H. 623 (544. 1); H-B. 613. 1.

3 13 lege: probably a resolution passed in a public assembly.

3 12 in tertium annum confirmant, *fix for the third year*.

3 14 sibi . . . suscepit, *took on himself*: for construction, see § 370 (228); B. 187. iii; G. 347; H. 429 (386); H-B. 376. Observe the force of **sub**, as if he put his shoulders *under* the load.

3 15 civitatis, *clans*, such as the Hædui, Sequani, etc., each constituting a commonwealth (*civitas*), — about 60 in all. Their territory had no local name, but was known only by that of the clan, which was sovereign and wholly independent, except for voluntary alliances (see ch. 30). The name **Gallia** itself — as was said of Italy a few years ago — was only “a geographical expression,” implying no united political sovereignty. — **persuadet**, *prevails on*: *suadet* would be simply *urges*.

3 16 filio, **Sequano**: appositives with **Castico**.

3 17 obtinuerat, *had held*: see note on **obtinere**, **2 1**. The pluperfect implies that he had held it formerly, but had been ousted by some popular movement.

3 18 amicus: an honorary title given by the Roman Senate to friendly powers; § 283, 284, 393. *a* (185, 239. 1. N.²); B. 168. 2. *b*; G. 206; H. 393. S (362. 2. 2); H-B. 319. ii, 392. *b*. — **ut . . . occuparet**, *to lay hands on*: this clause is the object of **persuadet**; § 563 (331); B. 295. 1; G. 546; H. 565 (498. ii); H-B. 502. 3. *a*; for the sequence of tenses, see § 485. *e* (287. *e*); B. 268. 3; G. 511. R.¹; H. 546 (495. ii); H-B. 491. 2; in English it would be expressed by the infin. — **regnum**: here, not hereditary authority, but personal rule, — what the Greeks called *tyranny*.

3 19 quod: the relative. — **ante**: i.e. before the popular movement. — **Dumnorigi** (dat. after **persuadet**): Dumnorix, a younger brother, restless, ambitious, and strongly attached to the old aristocracy of the clan; therefore a bitter enemy of the Roman supremacy. He afterwards headed a desertion of Cæsar's cavalry just before the second invasion of Britain, but was pursued and killed (Bk. v. ch. 6). It is implied that in the popular movement Dumnorix had come into prominence. It must be borne in mind that the personal rule of a chief (*regnum*) was an entirely different thing from the prominence (*principatum*) which one man or another might have in the national councils, as the latter had no constitutional or official power.

3 20 Diviciaci: this Hæduan chief was of the order of Druids (see pp. 165–168); he had been in Rome where he made the acquaintance of Cicero and other eminent Romans. He was thoroughly impressed with the power and superiority of the Romans, and was a faithful friend and ally of Cæsar. The party of Druids, represented by Diviciacus and Liscus (ch. 16), was in a manner the *popular* party, strong especially in the large towns; it was opposed to the old clan feeling kept up for ambitious purposes by military or tribal chiefs (*principes*) such as Orgetorix and Dumnorix. The former, or popular party, was headed by the Hædui; the latter, or aristocratic, by the Sequani and Arverni. The Druids were a religious or priestly order, jealous of the aristocracy (*equites*) of the tribe or clan, which latter

represented what may be called the patriotic or "native-Celtic" party (see Bk. vi. chs. 12-17). A knowledge of this division helps to clear up many of the events of Cæsar's campaigns. In fact, Gaul was conquered by the strategy underlying the maxim "*divide et impera.*" — **qui**: i.e. Dumnorix. The regular rule is that the relative should refer to the last person named. But this in all languages is often overborne by the prominence of some preceding person. — **principatum**, *highest rank*, as distinct from political power (see above).

3 21 plebi acceptus, *a favorite with the people* (acceptable to the people). — **ut idem conaretur**: i.e. put down the constitutional authority, and establish a rule of military chiefs. The expression here is a striking example of the tendency of the Latin to say things by verbs which we say by nouns; Lat. *attempt the same thing*, Eng. *make the same attempt*.

3 23 perfacile factu: § 510. N.² (303. R.); B. 340. 2; G. 436. N.¹; H. 635 (547); H-B. 619. 1; in predicate agreement with **conata perficere**, which is subject of **esse**, depending on **probat**. — **illis probat**, *undertakes to show them*, i.e. Casticus and Dumnorix: conative present; § 467 (276. b); B. 259. 2; G. 227. N.²; H. 530 (467. 6); H-B. 484. — **propterea quod**: see note on **1 6**.

3 24 ipse, etc., i.e. and so they could count on him for a powerful ally. — **non esse dubium quin**, *there was no doubt (he said) that*: here **esse** is infin. of indir. disc.; for the construction of **quin**, see § 558. a (319. d); B. 284. 3; G. 555; H. 595. 1 (504. 3. 2); H-B. 521. 3. b. For purposes of analysis we may consider the **quin** clause a subject of **esse**, and **dubium** as a predicate adjective in the neuter to agree with the subject.

3 25 Galliae: part. gen. with **plurimum**; § 346. a. 2 (216. a. 2); B. 201. 1; G. 372; H. 442 (397. 3); H-B. 346.

3 26 se suis: begin as soon as possible to master the use of the reflexive in Latin, to which we have nothing that exactly corresponds in English. Our forms with *self* are emphatic and not ordinarily reflexive. The forms of *se* and *suus* refer (without emphasis) to the subject of their clauses, and in indir. disc. to the speaker. They take the place of an *I* or *mine* of the direct. Where no ambiguity would arise in English translate them by *he* and *his*. In case of ambiguity some device must be used to avoid it. Here there is an emphasis on **se**, but it comes from position. — **regna**: translate by the singular. To a Roman each man's power would be a separate *regnum*, hence the plural here. — **conciliaturum**: sc. *esse*, which is often omitted with the fut. infin.

4 1 oratione, *plea*, or *argument* (abl. of means). — **fidem et iusiurandum**: i.e. *assurance confirmed by oath*; hendiadys; § 640 (385); B. 374. 4; G. 698; H. 751. 3. N.¹ (636. iii. 2); H-B. 631. 5.

4 2 regno occupato: abl. abs., expressing *condition*; § 419. 4, 521. *a* (255. 4, 310. *a*); B. 227. 2. *b*; G. 409, 593. 2; H. 489. 1, 638. 2 (431. 2, 549. 2); H-B. 421. 6, 578. 6; *in case they should get in their hands the royal power* = *si occupaverimus* in the direct. — **per tres . . . populos:** i.e. Helvetii, Hædui, and Sequani; a league between these, they hope, will secure their power over all Gaul. — **firmissimos,** *most stable*.

4 3 Galliae: governed by **potiri**; § 410. *a* (249. *a*); B. 212. 2; G. 407. *d*; H. 458. 3 (410. v 3); H-B. 353. — **posse:** equivalent to a fut. infin.; § 584. *b*; B. 270. 3; G. 248. R.; H. 618. 1 (537. N.1); H-B. 472. *d*.



FIG. III.—GALLIC COIN.

4 4 CHAP. 4. ea res, this (i.e. the conspiracy). The word **res** is constantly used in Latin where we use some more specific word in English, as *action, fact, event, estate, etc.*, according to the passage. The conduct of Orgetorix was treated as criminal because, though the Helvetians were prepared to emigrate in a body and subdue the rest of Gaul, they would not give to Orgetorix the power thus acquired. — **moribus suis,** *according to their custom:* abl. of spec.; § 418. *a* and N. (253. N.); B. 220. 3; G. 397; H. 475. 3 (416); H-B. 441, cf. 414 and *a*.

4 5 ex vinculis, *out of chains,* i.e. (standing) in chains; a Latin idiom; cf. *ex equo, on horseback.* — **causam dicere:** a technical expression for being brought to trial. — **damnatum** (sc. *eum*, object of **sequi**), *if condemned* = *si damnatus esset*. The Latin may almost always omit a pronoun of reference, if there is a participle or adjective to show what its form would be if expressed. In this sentence the subject of **oportebat** is the clause **damnatum . . . sequi**; the subject of **sequi** is **poenam**; and **ut . . . cremaretur** is in apposition with **poenam**, defining the punishment: § 562. 1, 571. *c* (329. 2, 332. *f*); B. 294, cf. 297. 3; G. 557; H. 571. 4 (501. iii); H-B. 502. 3. *a. N.* Translate, *he was doomed, if condemned, to be burned by fire* (lit. *it must needs be that the penalty should overtake him, condemned, of being burned with fire*). For the abl. in *i*, see § 76. *b. 1* (57. *b. 1*); B. 38; G. 57. 2; H. 102. 4 (62. iv); H-B. 88. 2. *c*.

4 7 die constituta, *on the day appointed:* § 423 (256); B. 230; G. 393; H. 486 (429); H-B. 439. For the gender of **die**, see § 97 (30. *a*, 73); B. 53; G. 64; H. 135 (123); H-B. 101. — **causae dictionis,** *for the trial* (it would be more usual to say *dicendae*); **dictionis** depends on **die**, and **causae** is the objective gen. after **dictionis**.

4 8 familiam, *clansmen:* ordinarily this word means *slaves*; but it is more probable that it here means all who bore his name or regarded him as their chief. — **ad** (adv.) . . . **milia decem** (in apposition with **familiam**), *to* (the number of) *ten thousand*.

4 9 clientis, retainers: volunteer or adopted followers.—**obaeratos, debtors:** the only class of slaves that seems to have been known in Gaul; see Bk. vi. ch. 13.

4 10 eodem: an adverb.—**per eos, by their means:** § 405. *b* (246. *b*); G. 401; H. 468. 3 (415. i. 1. *N.*¹); H-B. 380. *d*.—**ne . . . diceret:** a purpose clause.

4 12 cum . . . conaretur, when the state attempted. The force of the subjv. here cannot easily be made apparent in translation, and may be disregarded as too subtle for this stage of the pupil's advancement. It is perfectly manifest, however, and can be learned later; § 546 (323); B. 288. 1. B; G. 585; H. 600. ii. 1 (521. ii. 2); H-B. 524.

4 15 quin . . . consciverit (conscisco), that he decreed death to himself (his own death), i.e. committed suicide. The construction of the clause is analogous to that with *non dubito*, etc.; § 558 (319. *d*); B. 284. 3; G. 555. 2; H. 595. 1 (504. 3. 2); H-B. 521. 3. *b*. Observe that *ipse, self*, agrees in Latin rather with the subject; not, as in English, with the object.

4 16 CHAP. 5. nihilo minus (often written in one word, as in English), nevertheless.—constituerant, had resolved: observe the pluperfect, as following not a real but a historical present.

4 17 ut . . . exeant, in apposition with id: as we should say, "namely, to go forth." Clauses thus used in apposition with a noun or pronoun take the form required by the verb on which the appositional word depends. Here *facere* would take a result clause with *ut*, and so this clause has that form.—**ubi . . . arbitrati sunt, when they judged:** observe the regular use of the perfect indic. with *ubi, postquam*, etc., and cf. *cum . . . conaretur* above: § 543 (324); B. 287. 1; G. 561; H. 602 (518. *N.*¹); H-B. 557.

4 18 rem, enterprise; cf. note on ea res, l. 4.—oppida, towns, fortified and capable of defence.

4 19 vicos, villages, i.e. groups of houses about a single spot. The villages and houses were burned; partly to cut off hope of return, partly to prevent their being occupied by the Germans.—**ad:** cf. l. 8 above.—**reliqua, etc.:** i.e. isolated farmhouses not collected in villages.

4 21 portaturi erant, intended to carry: § 194. *a* (129); B. 115; G. 247; H. 236 (233); H-B. 162.—**domum:** following the verbal noun *reditionis*; § 427. 2 (258. *b*); B. 182. 1. *b*; G. 337; H. 410. 1 (380. 2. 1); H-B. 450. *b*.

4 23 molita cibaria, meal. Food for 368,000 people (cf. 26 11) for three months required five or six thousand wagons and about twenty-five thousand draught animals. This would make a line of march of over thirty miles.—**domo:** § 427. 1 (258. *a*); B. 229. 1. *b*; G. 300. 2; H. 462. 4 (412. ii. 1); H-B. 451. *a*.

5 1 Rauracis, etc.: § 367 (227); B. 187. ii. *a*; G. 346; H. 426. 2 (385, ii); H-B. 362 and 1: German tribes from the banks of the Rhine.

5 2 uti: the older form for *ut*, common in Cæsar. — **eodem usi consilio**, *adopting the same plan*: § 410 (249); B. 218. 1; G. 407. N.⁸; H. 477 (421. 1); H-B. 429. — **una cume is**, *along with them*. The use of **eis** avoids ambiguity, though *secum* would be more regular, referring to the subject of the main clause; cf. note on **se**, 3 26. — **oppidis . . . exustis**, *having burned*, etc.: § 493. 2 (113. *c. N.*); B. 356. 2. *b*; G. 410. R.¹; H. 640. 4 (550. N.⁴); H-B. 602. 1.

5 3 Boios (from whom the name *Bohemia* is derived): a Celtic tribe, whom the great German advance had cut off from their kinspeople towards the west, and who were now wandering homeless, some of them within the limits of Gaul.

5 4 Noricum, etc.: now eastern Bavaria and upper Austria. — **oppugnant** = *oppugnauerant*: § 181. *a* (128. *a*); B. 116. 1; G. 131. 1; H. 238 (235); H-B. 163.

5 5 receptos . . . addiscunt: in English, in a sentence like this, we should use a separate verb instead of the participle; § 496. N.² (292. R.); B. 337. 2; G. 664. R.¹; H. 639 (549. 5); H-B. 604. 1. Translate, *they receive the Boii into their own number (ad se), and vote them in as their allies*. They do not merely unite with them, but incorporate them into their own body as a homeless people.

5 6 CHAP. 6. **erant omnino**, *there were in all*, i.e. *only*. — **itineras . . . itineribus**: observe the form of this relative sentence, common in Cæsar, which gives the antecedent noun in both clauses. It is usually omitted in one or the other; in English, almost always in the relative clause; in Latin, quite as often in the other; § 307 (200); B. 251. 3; G. 615; H. 399. 5 (445. 8); H-B. 284. 4.

5 7 possent: subjv. in a relative clause of characteristic; § 535 (320); B. 283; G. 631. 1; H. 591. 1 (503. 1); cf. H-B. 521. 1; i.e. not merely *by which they could*, but *of the sort by which they could*. In such clauses, which describe something by its qualities, the subjv. is regular in Latin. — **Sequanos**: i.e. the region now called *Franche-Comté*, north of the Rhone.

5 8 inter . . . Rhodanum: the pass now guarded by the Fort l'Ecluse, about nineteen Roman (seventeen and a half English) miles below Geneva (see note on 7 13). The Rhone at this part was the boundary of the Roman province. The choice was either to cross the river and go through the country held by the Romans, or to proceed along its northern bank through the friendly Sequani. — **vix qua**, etc., *where carts could scarcely be hauled in single file*: § 137. *a* (95. *a*); B. 81. 4. *a*; G. 97; H. 164. 1 (174. 2, 1); H-B. 133. See Fig. 55, p. 94.

5 9 ducerentur: the same "characteristic subjv." as in **possent**. The distinction is one that we rarely express in English; but a little study will make it appear in most cases. — **autem, then again.**

6 1 possent: § 537 (319); B. 284. 1; G. 552; H. 570 (500. ii); H-B. 521. 2.

6 2 multo facilius (cf. **nihilo minus**, 4 16), *much easier* in itself; but it required them to crush the Roman legion at Geneva, and force their way through about fifty miles of territory occupied by the Roman arms. — **propterea quod:** see note on 1 6.

6 3 nuper pacati erant: a rebellion "of despair" (B.C. 61) had been subdued by C. Pomptinus.

6 4 locis: loc. abl.; § 429. 2 (258. f); B. 228. 1. b; G. 385. N.¹; H. 485. 1 (425. ii. 2); H-B. 436. — **vado:** *by ford* (*wading, vadendo*). The bed of the Rhone must have changed somewhat since Cæsar's time. There is now but one ford between Geneva and the Pas-de-l'Écluse.

6 8 sese persuasuros [esse]: notice that in the fut. infin., used in indir. disc., *esse* is usually omitted (cf. **conciliaturum**, 3 26; in dir. disc. we should have *persuadebimus*), *they thought they should persuade*; its object is **Allobrogibus** (cf. **Rauracis**, etc., 5 1). — **bono animo**, *well disposed*; § 415 (251); B. 224. 1; G. 400; H. 473. 2 (419. ii); H-B. 443. Five years before, their envoys in Rome had intrigued with Catiline's agents, whom they at length betrayed (see Cicero, *Cat.* iii. ch. 9).

6 9 viderentur: § 580 (336. 2); B. 314. 1; G. 650; H. 643 (524); H-B. 535. 2.

6 10 eos: again the demonstrative to avoid ambiguity; see note on **eis**, 5 2. — **paterentur:** the subjv. with *ut* is the regular form of object clause after all verbs of commanding, inducing, and the like; § 563 (331); B. 295. 1; G. 546; H. 564. 1 (498. ii); H-B. 502. 3. a.

6 11 diem . . . die: cf. **itinerā . . . itineribus**, 5 6 and note.

6 12 convenient: the subjv. is used because **diem dicunt** has the force of a command. The indic. would mean "on which they *do* assemble"; this means "on which they *should*." Technically, the clause is a purpose clause; § 529 (317); B. 282. 2; G. 544. ii; H. 590 (497. 1); H-B. 502. 2. — **a. d. v. Kal. Apr. (ante diem quintum Kalendas Aprilis):** nominally March 28; § 631, 424. g (376, 259. e); B. 371 and 6, 372; G. App.; H. 754, 755 (642-644); H-B. 664, 667. But the calendar was in a state of great confusion at this time, and till Cæsar's reform twelve years later. — **L. Pisone**, etc.: notice again the regular Roman method of giving dates; see note on **Messala**, 2 12. Piso was Cæsar's father-in-law.

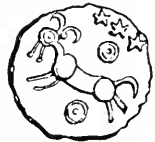

FIG. 112. — GALLIC COIN

6 14 CHAP. 7. **Caesari**: the tendency is so strong in Latin to put the most emphatic word first that it is so placed even when the first clause is a dependent one, as here. We should say: *Cæsar, when it was reported, etc., hastened*; the Latin says: *to Cæsar, when it was reported, etc., [he]* (which in such cases is unnecessary, having already been expressed in a different form) *hastened*. He was at this time at Rome, having laid down his consulship, preparing to set out for his province. Every consul was entitled to the governorship of a province for one year after his term of office, and, by a special law, Cæsar's government (consisting of the three provinces of Cisalpine and Transalpine Gaul and Illyricum) had been conferred for a term of five years. The news of the emigration hastened his movements. — **nuntiatum esset**: the same idiomatic use of the subjv. with **cum** as in 4 12. The relation here, however, is more apparent. The clause gives not the *time* merely, but the *circumstances*, "upon this being," etc. — **id** in apposition with **eos . . . conari** (the real subject of **nuntiatum esset**), *that they were attempting*.

6 15 **maturat**: travelling, his biographers say, one hundred miles in a day, and reaching the Rhone in a week, according to Plutarch. — **ab urbe**: this word, unless some other place is indicated, always means Rome, THE CITY. Cæsar was *near*, but not *in* the city, not being permitted to enter it while holding the military authority (*imperium*) of proconsul. Hence he says **ab**, not *ex*. — **proficisci**: the so-called complementary infin., used like our own with verbs which require another action to complete their sense.

6 16 **quam maximis potest itineribus**: § 291. *c* (93. *b*); B. 240. 3; G. 303; II. 159. 2 (170. 2); II-B. 241. 4; **potest** is usual with Cæsar in this phrase, which is elliptical. In full it would be *tam magnis quam maximis, as great as the greatest, i.e. the greatest possible*. — **ulteriorem**: i.e. beyond the Alps. The northern part of modern Italy was still called *Gallia Cisalpina*, and was a part of Cæsar's province.

6 17 **ad, near to, as far as**. — **provinciae**: dat.; § 369 (227. *f*); B. 187. ii. *a*; G. 346; II. 426. 1 (385. *i*); H-B. 364. 4. — **imperat**: i.e. Transalpine Gaul. Here *impero* is used in what seems to have been its original meaning, *make requisition upon*; see Vocab.

6 18 **erat omnino**: cf. **erant omnino**, 5 6 and note.

6 19 **legio**: the tenth legion, which afterwards became so famous. With reference to the Roman legions, see chapter on military affairs, 1. 1.

6 20 **rescindi**: notice that *iubeo* and *veto*, unlike other verbs of commanding and forbidding, take the acc. and the infin.

6 21 **certiores facti sunt, were informed (made more certain)**: a technical expression for official communication or certain information.

6 23 qui dicerent, *who were* (instructed) *to say*: the same construction as *qua die convenient* above, l. 11, see note. Notice the difference between *obtinebant*, *who did*, etc., and *dicerent*, *who should*, etc. Treat your subjunctives according to the sense, and use the rules only to formulate the usages; § 531 (317); B. 282. 2; G. 544; H. 590 (497. i); H-B. 502. 2.

6 24 sibi . . . liceat: observe carefully the construction of the indir. disc.; § 584, 585 (336. A. B.); B. 317, 318; G. 650; H. 642-653 (523-531); H-B. 534. 1. 2; in dir. disc. it would be: *Nobis est in animo sine ullo maleficio iter per provinciam facere, propterea quod aliud iter habemus nullum; rogamus, ut tua voluntate id nobis facere liceat*. Careful attention to this construction in the beginning will be amply repaid later. — **sibi**: dat. of possession; § 373 (231); B. 190; G. 349; H. 430 (387); H-B. 374; the subject of **esse** is the clause *iter . . . facere*, while the whole passage, **sibi . . . liceat**, is the object of **dicerent**. Render, *that they had* (it was to them) *in mind to march*, etc.

6 26 rogare: of this verb the subject is *se*, understood (often omitted by Cæsar, contrary to the rule), and the object is the object clause **ut . . . liceat**; § 563 (331); B. 295. 1; G. 546 and N.¹; H. 565 (498. 1); H-B. 530. 2. — **voluntate**: abl. in accordance with which; § 418. *a* (253. N.); cf. B. 220. 3; G. 397; cf. H. 475. 3 (416); cf. H-B. 414. *a*.

7 1 L. Cassium . . . occisum [*esse*]: object of **memoria tenebat**, as a phrase of *knowing*; § 459 (272); B. 330; G. 527. 2; H. 613 (535. i. 1); H-B. 589. This defeat happened B.C. 107, in the terrible invasion of the Cimbri or Teutons, to whom the Helvetians were joined as allies. "The army of Cassius was one of six swept away by these barbarians."



FIG. 113.—GALLIC COIN.

7 2 sub iugum, *under the yoke* (hence the word *subjugate*). The *iugum* was made by sticking two spears in the ground and laying another across them above. To pass under this was equivalent to *laying down arms* by a modern army.

7 3 concedendum [*esse*]: impersonal depending on **putabat**, *thought that no concession should be made* (lit. *that it must not be yielded*). — **homines**: subject of **temperaturos** [*esse*], depending on **existimabat**.

7 4 inimico animo: abl. of quality; cf. **bono animo**, 6 8. — **data facultate**: abl. abs., expressing a condition; § 496, 521. *a* (292, 310. *a*); B. 227. 2. *b*; G. 593. 2; H. 575. 9 (507. 3. N.⁷); H-B. 421. 6; cf. 4 2. — **faciundi**: gerundive; § 504 (297, 298); B. 339. 1; G. 428; H. 626 (544. 1); H-B. 612. 1.

7 5 iniuria: not "injury" in our sense, but *wrong, outrage*.

7 6 dum . . . convenirent: notice again the purpose expressed in this clause, *until the men should*, etc. Cf. **qua die convenient**, **6 11**, and **qui dicerent**, **6 23**; § 553 (328); B. 293. iii. 2; G. 572; H. 603. ii. 2 (519. ii. 2); cf. H-B. 507. 5.

7 9 reverterentur: subjv. for inv.; § 588 (339); B. 316; G. 652; H. 642 (523. iii); H-B. 538. In dir. disc.: diem (=time) ad deliberandum sumam; si quid *vultis*, ad. Id. Apr. *revertimini*. Note the changes made, and the reasons for them.

7 10 CHAP. 8. **ea legione**, *with that legion* (abl. of instrum.). In this sentence observe how all the qualifying clauses come first and the direct objects, **murum**, **fossam**, come next before the leading verb **perducit**; § 596 and *a* (343); B. 348, 349; G. 674; H. 664 (560); cf. H-B. 623; while each relative belongs to *the verb which comes next after it* unless another relative intervenes, — a very convenient rule in analyzing a long and difficult sentence.

7 13 milia: acc. of extent of space; cf. **3 4**; § 425 (257); B. 181. 1; G. 335; H. 417 (379); H-B. 387. — **decem novem**, *nineteen*: following the windings of the river (see note on **5 8**). — **murum**: this rampart, or earth-work, was on the south side of the river, leaving the passage undisputed along the northern bank.

The banks of the Rhone in this part are generally rugged and steep, with sharp ravines; there are only five short reaches — a little over three miles in all — requiring defences. The current is in general quite rapid. Some remains of Cæsar's works can still be traced, according to the French engineers who surveyed the ground under the orders of Napoleon III. According to Cæsar's statement the work was continuous (this is the meaning of *perducit*). This undoubtedly means that, after the five accessible points were strengthened by artificial defences, the entire left bank of the Rhone, from Geneva to Pas-de-l'Écluse (17½ English miles), formed a continuous barrier against the Helvetians. The construction of any one of the fortifications may be described as follows: Along the crest of the ridge facing the river the slope was cut so as to be vertical, or nearly so, and then a trench was hollowed. The earth dug out was partly thrown up to increase the height of the wall, and quite likely in part thrown down the hill. At all events, it seems probable that the measure of 16 feet is the distance from the bottom of the ditch to the top of the wall. Thus the work formed really little more than a trench with scarp higher than the counter-scarp. Then the crest was fortified with a breastwork of palisades, behind which the soldiers were protected while hurling their missiles at the enemy. This entire series of works, with the force at Cæsar's command, could not have occupied more than two or three days. See Map, p. 5.

7 14 **pedum**: § 345. *b* (215. *b*); B. 203. 2; G. 365; H. 440. 3 (396. v); H-B. 355.

7 15 **castella** (lit. *little fortifications*), *redoubts*. See treatise on military affairs, v. In them were stationed guards (*praesidia*). The redoubts were sufficiently numerous so that the guard from one or another could quickly reach any point in the lines that might be threatened.—**quo facilius . . . posset**, *that he may the more easily*: the usual construction where a comparative is to be used; without the comparative it would be *ut . . . posset*; § 531. *a* (317. *b*); B. 282. 1. *a*; G. 545. 2; H. 568. 7 (497. ii. 2); H-B. 502. 2 and *b*.

7 16 **se invito** (abl. abs.), *against his will*: **se** is used because this is a part of what Cæsar had in his mind; § 300. 2 (196. *a*. 2); B. 244. ii. *a*; G. 521; H. 504 (449. 1); H-B. 262. 2.—**conarentur . . . posset**: note the sequence of tenses after the historical presents **disponit** and **communit**.

7 17 **ubi . . . vēnit**: notice the difference between this clause and those above noted with **cum** and the subjv. This one expresses a real time and not circumstance like the others. You cannot render it by “upon the coming” or any similar phrase.

7 18 **negat se . . . posse**, *says he cannot*, etc. His words would be: *More et exemplo populi Romani non possum iter ulli per provinciam dare; si vim facere conabimini, prohibebo.*—**more et exemplo**, *according to the custom and precedents*: always constituting the rule of conduct with the conservative Romans.

7 19 **si . . . conentur**: future condition in indir. disc.; see the direct as given in note to l. 18.

7 20 **prohibiturum** [*esse*]: sc. *se* subject and *eos*, object.—**deiecti**, *cast down*: *de* in composition generally has the meaning *down*.

7 22 **non numquam**, *sometimes*: § 326 and *a* (150 and *a*); B. 347. 2; G. 449 and R.⁴; H. 656. 1 (553. 1); H-B. 298. 2.

7 23 **si . . . possent**: practically an indir. quest. depending on **conati**, *trying if* (whether) *they could break through*; § 576. *a* (334. *f*); B. 300. 3; G. 601, 460. 1. (*δ*); H. 649. ii. 3 (529. ii. 1. N.¹); H-B. 582. 2 and *a*.

7 24 **conatu**: abl. of separation, following **destiterunt**; § 400 (243); B. 214; G. 390. 2; H. 462 (414); H-B. 408. 2.

8 1 CHAP. 9. **una**: emphatic.—**via**, *only the way*.—**qua**: abl. of the way by which; § 429. *a* (258. *g*); B. 218. 9; G. 389; H. 476 (420. 1. 3); H-B. 426.—**Sequanis invitis** (abl. abs. expressing a condition), *in case the*, etc.

8 2 **sua sponte**, *by their own influence*: a rare meaning of this phrase, which is generally *of their own accord*.

8 3 **possent**: cf. note on **nuntiatum esset**, 6 14.

8 4 eo deprecatore (abl. abs. denoting means), *by his means as advocate*. — **impetrarent**, *they might obtain* (it): a purpose clause; § 531 (317); B. 282; G. 545; H. 568 (497. ii); H-B. 502. 2.

8 5 gratia, *personal influence*. — **largitione**, *lavish gifts and hospitalities*: like those of old chiefs of the clan. These words are ablatives of cause; § 404 (245); B. 219; G. 408; H. 475 (416); H-B. 444.

8 7 duxerat: this word is used only of the man who marries a wife, i.e. he *leads* her to his own house.

8 8 novis rebus: *revolution*, change in government, dat.; § 368. 3 (227. c. 3); B. 187. ii. a; G. 346, R.²; H. 426. 1 (385. 1); H-B. 362. ii.

8 9 habere obstrictas, *to keep close bound*: § 497. b (292. c); B. 337. 6; G. 238; H. 431. 3 (388. 1. N.); H-B. 605. 5.

8 10 impetrat has for object **ut . . . patiantur**, and **perficit** has **uti . . . dent**, — clauses of result; § 568 (332); B. 297. 1; G. 553; H. 571. 3 (501. ii. 1); H-B. 521. 3. a.

8 11 obsides: these were persons of prominence given by one state to another as security for fidelity. If the compact were broken, the hostages, usually children of prominent persons, would be held responsible and punished.

8 12 ne . . . prohibeant; ut transeant: object clauses of purpose, depending on the idea of agreement implied in **obsides . . . dent**. — **itinere**: abl. of separation; cf. **conatu**, 7 24.

8 14 CHAP. 10. **renuntiatur**, *word is brought back*: i.e. by messengers sent to ascertain, as the prefix **re** implies; the subject is the clause **Helvetiis esse**, etc.; see note on 6 24.

8 15 Santonum: a people north of the Garonne, on the Bay of Biscay. This is so far from the borders of the province as to show that Cæsar was only searching for a pretext. But the conquest of Gaul was already determined upon, and the warlike Helvetii were too dangerous a people to be allowed to add their strength to that of the present inhabitants.

8 16 Tolosatium: the people of Tolosa, the modern Toulouse.

8 17 Id refers to the Helvetii marching into the territory of the Santones. — **fieret**: the subjv. of indir. disc. after **intellegebat**.

8 18 futurum [esse] ut . . . haberet, etc., *it would be to the great peril of the province that it should have*, etc.: § 561. N.¹ (329. N.); B. 294; G. 506; H. 571 (540); H-B. 238. — **ut . . . haberet**: a substantive clause of result used as the subject of **futurum [esse]**; § 537, 569 (319, 332. a); B. 284. 1, 297. 2; G. 553. 4. R.³; H. 571. 1 (501. i. 1); H-B. 521. 3. a. Cæsar's thought would be: "Id si fiet, magno . . . futurum est ut populus Romanus . . . habeat."

8 19 locis (loc. abl.) **patentibus**, *in an open country*: the southwest part of Gaul is a broad river valley, giving easy access to the province.

8 20 **finitimos**: predicate, *have as neighbors*, etc.

8 21 **munitioni** . . . **praeficit**, *he put in command of the fortification*. —

Labienum: this was Cæsar's best officer, a prominent and influential politician of strongly democratic sympathies. He served Cæsar faithfully through the Gallic wars, but when the Civil War broke out he joined what he conceived to be the party of the republic, went over to Pompey, and was killed at Munda, B.C. 45.

8 22 **legatum**, *aide, lieutenant*: no English word exactly translates this word. — **magnis itineribus**: cf. **quam maximis potest itineribus**. 6 16. It is the usual phrase for *forced marches* of an army. The ordinary day's march of the Romans was about 15 miles; a *magnum iter* was from 20 to 25 miles. — **Italiam**: probably only into his province of Cisalpine Gaul, but this was already regarded as a part of Italy.

9 1 **Aquileiam**: an important Roman colony at the head of the Adriatic. It continued to be the chief port of trade for this region till outgrown by Venice. — **qua proximum iter**: i.e. by way of Turin and Susa, by Mt. Genève. Ocelum has been variously identified with Briançon and probably Grenoble.

9 5 **compluribus** . . . **pulsis**: the order is interlocked, *his agreeing with pulsis*; § 597. *h* (344. *h*); B. 350. 11. *d*.

9 7 **Vocontiorum**: this people extended from the Durance to the Isère.

9 8 **Allobrogum**: these extended as far south as the Isère, and had possessions north of the Rhone in the sharp angle at St. Didier.

9 9 **Segusiavos**: these were west of the Rhone in the region of Lyons and opposite Vienne. They probably extended across the Saône above Lyons, so that Cæsar only crossed the Rhone above its junction with the Saône and did not cross the Saône also. He evidently had his camp in the heights above Lyons in the angle of the two rivers. His army amounted to six legions of nearly 25,000 men and an uncertain number of Gallic cavalry. He had doubtless been joined by Labienus with his legion from



FIG. 114.—SIGNIFER.

Geneva, though that fact is not mentioned. Cæsar evidently went beyond his province without the order of the Senate, hence his explanatory tone.

9 11 CHAP. 11. *iam, by this time.* — *angustias*: i.e. the Pas-de-l'Écluse before described; see Figs. 5, 6. The entire train of the Helvetii has been reckoned at 8500 four-horse wagons, extending some fifty miles (cf. note on 4 23). The passage must have been extremely slow. They probably followed in the line of the modern railroad as far as Culoz, then to Amberieu and across the plateau des Dombes to the Saône between Lyons and Macon, a distance of nearly a hundred miles. It is calculated that Cæsar must have been absent two months in Italy, and the march of the Helvetians probably took about the same time. This would make the time of these events about the latter part of June.

9 12 *Haeduorum*: it does not appear that these occupied the left bank of the Saône. But predatory excursions may have been made across the river, and in ch. 12 the Helvetians were engaged in crossing.

9 13 *cum . . . possent, not being able, etc.*

9 15 *rogatum*: supine; § 509 (302); B. 340; G. 435; H. 633 (546); H-B. 618. — *ita se, etc.*: in English supply *saying* or some such word. In Latin, after the idea of speech or thought is suggested, as here by *legatos* and *rogatum*, no further expression of saying is necessary. In dir. disc. this would be, "*Ita [nos] . . . meriti sumus, ut paene in conspectu exercitus vestri, . . . liberi nostri . . . non debuerint*"; i.e. our services have been such, etc., that we did not deserve to have this happen (as it has). Probably the account is somewhat exaggerated.

9 16 *meritos*: "Alone among the Gauls," says Tacitus, "the Hædui claim the name of brotherhood with the Roman people" (Ann. xi. 25). So, also, Cicero calls them *fratres nostri*.

9 17 [*eorum*]: words thus inclosed in brackets are of doubtful authenticity.

9 18 *debuerint*: if this were stated not as a result but independently, the form would be perf. indic., implying that the thing had happened contrary to what ought to be. According to the Latin idiom, the same tense is retained in such cases, contrary to the sequence of tenses; see § 485. c. N.² (287. c. N.); B. 268. 6; G. 513; H. 550 (495. vi); H-B. 478. The English idiom is *that our lands, etc., ought not to have been, etc.*, putting the past idea into the infin.; § 486. a (288. a); B. 270. 2; H. 618. 2 (537. 1); H-B. 582. 3. a. ftm.². — *Haedui Ambarri, the Hædui near the Arar* (or Saône), occupying the angle between that river and the Rhone. They were evidently closely akin to the Hædui and were their allies.

9 19 *necessarii*, bound by *necessitudo*, or community of interests of any kind. — *consanguinei, akin by blood.*

9 20 depopulatis agris . . . prohibere: i.e. their lands were already wasted, and it was with difficulty that they could keep off, etc.; see § 496. N.¹ (292. R.); B. 337. 2; G. 664. R.¹; H. 639 (549. 5); H-B. 421. 4; **depopulatis** is pass., though from a dep. verb; see § 190. *b* (135. *b*); B. 112. *b*; G. 167. N.²; H. 222. 2 (231. 2); H-B. 291. *d*.

9 21 Allobroges: from Culoz the Rhone flows almost south and then makes a very sharp turn to the northwest. It was probably in this angle that the Allobroges overlapped the river.

9 23 sibi: § 373 (231); B. 190; G. 349; H. 430 (387); H-B. 374. — **solum** is a noun. — **nihil esse reliqui**: part. gen., a common usage with neut. adjectives; § 346. *a*. 1 (216. *a*. 1); B. 201. 2; G. 369; H. 440. 5. N. (397. 1); H-B. 346; i.e. they had nothing left, etc.; the land was completely stripped.

9 24 non exspectandum [*esse*]: impers., as this construction is always passive. Translate by the act., *He must not*, etc.; see § 374 (232); B. 189. 1; G. 355. 251. 1; H. 302. 7, 431 (301. 2, 388); H-B. 373. 1.

9 25 sociorum: the Helvetians would be sure to levy upon the allies of the Romans wherever they found them.

9 26 Santonos: cf. **8 15**. — **pervenirent**: § 553 (328); B. 293. iii. 2; G. 572; H. 603. ii. 2 (519. ii. 2); H-B. 507. 5. The subjv. is used because of the idea, *they should come*, technically called purpose.

10 1 CHAP. 12. **flumen**, etc., *the Arar* (Saône) *is a river which flows through*, etc.; not *between*, which would be expressed by *dividit*. The Saône joins the Rhone about seventy-five miles southwest of Lake Geneva.

10 2 lenitate, *sluggish current*, abl. of description.

10 3 in . . . fluat: indir. quest., subject of **iudicari possit**: see § 574. N. (334. N.); B. 300; G. 467; H. 649. ii (529. i); H-B. 537.

10 4 ratibus, *rafts* of logs; **lintribus**, *canoes* of hollowed logs, joined to make a kind of bridge. — **transibant**: notice the imperf.; they were in the act of crossing.

10 5 partis: object of **duxisse**; **flumen**, governed by **trans** in composition; § 395 (239. *b*); B. 179. 1; G. 331. R.¹; H. 413 (376); H-B. 386.

10 7 citra: i.e. on the east side. — **Ararim**: for the acc. in **im**, see § 74. *d*, 75. *a*. 1 (55. *d*, 56. *a*. 1); B. 38. 1; G. 57. 1; H. 102. 2 (62. iii. 1); H-B. 88. 1. It is to be noticed that Gallic names were felt by the Romans as Greek, and were treated accordingly. — **reliquam** = *relictam*: in fact, this adjective is, from its meaning, a kind of participle. — **de tertia vigilia**: the night, from sunset to sunrise, was divided into four equal watches, the third beginning at midnight. This movement took place soon after (**de**) the watch began.

10 10 eos impeditos, etc.: the emphasis gives a force like "while these were hampered and not expecting, he engaged them," etc. In Latin the two sentences are made into one; such telescoping of two coördinate ideas is almost regular in Latin.

10 11 concidit: see Vocab. — **mandarunt** = *mandaverunt*: § 181. *a* (128. *a*); B. 116. 1; G. 131; H. 238 (235); H-B. 163.

10 12 pagus: this "district" (*Tigurinus*) was about the modern Zurich. The inhabitants of the *pagus* probably composed a clan, and formed a division of the force.

10 15 L. Cassium: see 7 1, 2.

10 17 deorum: this reference to a special providence is noticeable in so stern a realist as Cæsar, and was possibly for political effect. Yet he often speaks of fortune as powerful in human affairs (cf. Bk. vi. ch. 42), and mentions divine omens which accompanied his victory over Pompey (Bell. Civ. III. 105). A disbeliever in the superstitions of his day, he yet seems to acknowledge the presence of a controlling power. — **quae pars . . . intulerat . . . ea . . . persolvit**, render *that part which*, etc.: see § 307. *b. N.* (200. *b. N.*); cf. B. 251. 4; G. 620; H. 399. 5 (445. 9); H-B. 284. 6.

10 19 princeps poenas persolvit, *was the first to pay the penalty*: § 290 (191); B. 239; H. 497. 3 (442. *N.*); H-B. 243; referring to the complete overthrow of the rest later. Punishment was regarded among the ancients, not as *suffering* to be *inflicted*, but as of the nature of a *fine* or *penalty* to be *paid*; hence *sumere, capere, to inflict*, and *dare* or *solvere, to suffer*.

In 1862 numerous remains buried in two trenches were discovered near this spot, possibly of those slain in this battle.

11 1 iniurias, wrongs, not simply *damage*, as the word came to mean afterwards. From Cæsar's point of view, an offensive war against Rome is necessarily wrong.

11 2 soceri: L. Calpurnius Piso, father of Cæsar's wife, Calpurnia (Shakespeare's *Calpurnia*), and consul of the present year (see end of ch. 6). — **legatum**: notice how carefully titles are given, a matter of military and social etiquette; cf. **consulem**, 10 15.

11 4 CHAP. 13. reliquas: the emphasis on this word displaces the connective **ut**, which would naturally stand first in its clause.

11 5 consequi, overtake (hence the frequent meaning *acquire*). — **pontem . . . faciendum curat**, *has a bridge made*: § 500. 4 (294. *d*); B. 337. 7. *b. 2*; G. 430; H. 622 (544. 2. *N.*²); H-B. 612. iii. — **pontem**: see chapter on military affairs, VI.

11 7 cum . . . intellegent: § 546 (323, 325); B. 288. 1. *B*; G. 585; H. 600. ii. 1 (521. ii. 2); H-B. 525; cf. notes on 4 12, 6 14, 7 17. Here **cum** may be translated *when*, but the clause gives the state of mind of the

Helvetii as the main feature of the situation, and really expresses no time at all, but circumstance only, hence the subjunctive. — **id**: object of **fecisse**.

11 8 diebus XX, in the course of twenty days: § 423 (256); B. 231; G. 393; H. 486 (429); H-B. 439. — **ut . . . transirent**: this clause is in app. with **id**, but, as it is through that app. the object of **fecisse**, it takes the result construction just as if it depended immediately on the verb of effecting; cf. note on **4 17**; and see § 568 (332); B. 297. 1; G. 553; H. 571. 3 (501. ii. 1); H-B. 521. 3. a. N.

11 9 legatos: a participle of *lego* (*depute*), used as a noun; hence, diplomatically *envoy* or *ambassador*, and in military affairs *lieutenant*.

11 10 Divico: now an old man, since the battle in which he was commander took place forty-nine years before. It was, of course, a piece of arrogance to send him.

11 12 si pacem, etc.: Direct, —

Si pacem p. R. cum Helvetiis faciet, in eam partem ibunt atque ibi erunt Helvetii, ubi eos tu, Caesar, constitueris atque esse volueris (or Caesar constituerit . . . voluerit); sin bello . . . perseverabit, reminiscere et veteris incommodi p. R. et pristinae virtutis Helvetiorum. Quod improvise unum pagum adortus es, cum ei qui flumen transierant suis auxilium ferre non possent, noli ob eam rem aut tuae magnopere virtuti tribuere, aut nos despicere; nos ita a patribus maioribusque nostris didicimus ut magis virtute contenderemus (contendamus) quam dolo aut insidiis niteremur (nitamur). Qua re noli committere ut is locus ubi constitimus ex calamitate . . . nomen capiat aut memoriam producat.

This discourse, as well as Cæsar's answer, is confused by a partial identification of Cæsar and the Roman people. Hence, many of the forms might be either third person as referring to the Roman people, or second or first as addressed to Cæsar, or spoken by him.

The indirect discourse is found in almost all languages, and each one has its own methods of change from the direct. In English it is regularly introduced by *that*. This word, however, is often omitted, in which case only the *persons* and the *tenses* are changed to fit the new relations. Dependent clauses keep their connectives, but change, like others, their *persons* and *tenses*. In long passages, if *that* is omitted, parenthetical phrases are frequently introduced to keep the connection of the thought, like "he said," "he asked," "he urged," "he begged." The passage here may be translated: "If the Roman people would make peace, etc., [that] the Helvetii would go . . . and remain where Cæsar should settle them and desire them to be; but if they (the Roman people) should persist in pursuing them, etc., let him remember [he said] (or he begged him to remember), etc. As to the fact that (because) he had attacked, etc., he should

not ascribe it, etc., or despise them (the Helvetians). [That] they had [he said] been taught rather to contend, etc. Let him therefore not allow that place . . . to be," etc. So in 12 8, num . . . posse, "could they, he asked."

11 13 in eam partem . . . ubi, to whatever part, i.e. of Gaul. They were not, however, to be turned back from their migration.

11 15 bello: note the emphatic position as opposed to emphatic pacem, l. 12. — reminisceretur, subjv. for imv. of the dir.: he should remember, or let him remember.

11 16 incommodi, disaster (lit. inconvenience), a euphemism: cf. "the late unpleasantness" for our Civil War. For the government of the gen., see § 350. c (219); B. 206. 2; G. 376; H. 454 (406. ii); H-B. 350.

11 17 quod: conj., as to the fact that; § 572. a (333. a); B. 299. 2; G. 525. 2; H. 588. 3. N. (516. ii. 2, N.); H-B. 552. 2. — pagum: the Tigurini.

11 18 suis, to their people: § 302. d (190. a); B. 236. 1; G. 204. N.¹; H. 494. 1 (441. 1); H-B. 250. 2. a.

11 19 ne tribueret, he should not ascribe it: cf. reminisceretur, l. 15.

11 21 contenderent, niterentur: subjv. of result. — dolo, craft; insidiis, ambushade. For these ablatives, see § 431 (254. b); B. 218. 3; G. 401. N.⁶; H. 476. 3 (425. ii. 1, N.); H-B. 438. 1.

11 22 ne committeret ut, etc.: § 568. N.¹ (332. e); B. 297. 1; G. 553. 1; H. 566. 1 (498. ii. N.²). — ubi constitissent, where they had taken their stand.

12 1 CHAP. 14. eo sibi, etc.: Direct, —

Eo mihi minus dubitationis datur, quod eas res quas legati Helvetii commemoraverunt (or vos commemorastis) memoria teneo, atque eo gravius fero, quo minus merito populi Romani acciderunt; qui si . . . sibi conscius fuisset, non fuit difficile cavere; sed eo deceptus est, quod neque commissum a se intellegebat qua re timeret, neque sine causa timendum putabat. Quod si . . . oblivisci velit (velim), num etiam recentium iniuriarum, quod me invito iter . . . temptastis, quod Haeduos, . . . vexastis, memoriam deponere potest (possum)? Quod vestra victoria . . . gloriamini, quodque tam diu vos impune iniurias tulisse admiramini, eodem pertinet. Consuerunt enim di immortales quo gravius homines . . . doleant, quos pro scelere eorum ulcisci volunt . . . his . . . impunitatem concedere. Cum ea ita sint, tamen si obsides a vobis mihi dabuntur, uti ea quae pollicemini [vos] facturos intellegam, et si Haeduis de iniuriis quas . . . intulistis . . . satisfaciatis [ego], vobiscum pacem faciam.

12 1 eo (cf. note on quo minus, l. 3) minus . . . dari, he had all the less hesitation. — dubitationis: § 346. a. 2 (216. a. 2); B. 201. 2; G. 369; H. 442 (397. 3); H-B. 346.

12 3 eo gravius . . . quo minus, he was the more incensed . . . in that . . . not, etc.: § 414. *a* (106. *c*, 250. *R.*); B. 223; G. 403; H. 479 (423); cf. H-B. 424 and *a*.

12 4 qui si . . . fuisset, now if they (the Roman people) had been.

12 5 non fuisse (for fuit of dir. disc.): translate as if *futurum fuisse*, it would not have been; and see § 437. *a* (264. *b*, 308 *d. N.*); B. 271. 1. *b*, 322. *b*; G. 597. 3 (*a*); H. 525. 2, 583 (476. 5, 511. 1. *N.*³); H-B. 582. 3. *a. N.*²—**eo deceptum [esse], they had been deceived by this.**

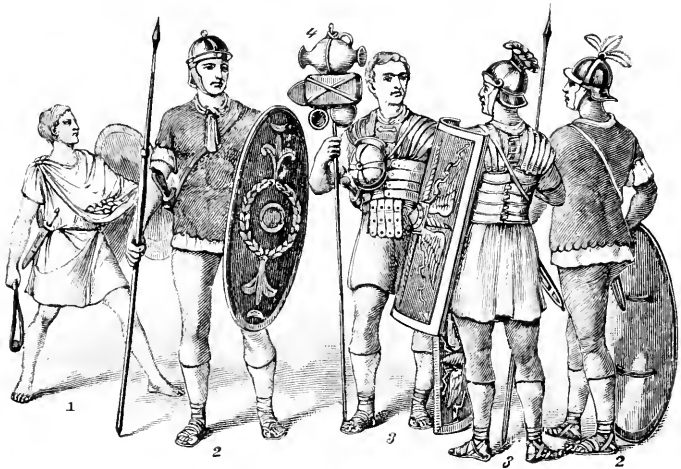

FIG. 115.

1. FUNDITOR.

2, 2. MILITES LEVIS ARMATURAE.

3, 3. LEGIONARIUM.

12 6 quare timeret = propter quod, with quicumque for its understood antecedent. The clause stands as subject of **commissum [esse]**, which in turn depends on **intellegeret**: *because they (the Roman people) did not know they had done anything to cause them to fear.*

12 7 quod si . . . vellet, but if they (or he) should consent to forget, etc.: § 397. *a* (240. *b*); B. 185. 2; G. 333. 1, 610. *R.*¹; H. 510. 9 (453. 6); H-B. 388. *a*.—**contumeliae**: for construction, cf. **incommodi**, 11 16.

12 8 num . . . posse, could they (or he), he asked, etc.: § 586 (338); B. 315. 2; G. 651. *R.*¹; H. 642. 2 (523. ii. 2); H-B. 591. *a*. The infin. is used because the question is not a real one expecting an answer, but a rhetorical one asked for effect, and implying its own answer. Such questions are treated in indir. disc. as declarative sentences.—**iniuriarum** depends on **memoriam** below.

12 9 *eo invito*, *against his will*; we should expect *se*, referring to the subject of *posse*, but *Cæsar's* mind wavers between himself and the Roman people, so that the pronoun does not exactly refer to the subject.

12 10 *quod . . . vexassent* is a clause of *fact*, properly indic.: § 572 (333); B. 286; G. 525; H. 588 (516); H-B. 555; it is subjv. by indir. disc.

12 11 *quod*: cf. note on *quod*, 11 17. — *sua*: i.e. the Helvetians; so *se tulisse*, *that they had committed*. — *quod . . . admirarentur*: the two *quod* clauses are used as the subject of *pertinere*, *as for their boasting*, etc., *and as for their wondering*, etc., *it tended in the same direction*; i.e. it all belonged together in the divine purpose of exalting them expressly to make the fall more marked. “*Divico had not said anything in the way of direct boasting. This eloquent passage was perhaps an answer to his manner, or to the fact that he was the same Divico who had slain Lucius Cassius.*”

12 13 *consuesse*: present in force; § 205. N.² (143. c. N.); B. 262. a; G. 175. 5; H. 299. 2 (297. i. 2); H-B. 487.

12 14 *quo*: cf. note on 7 15.

12 15 *quos . . . his*, *to grant an interval of prosperity and longer impunity to those whom they wish to punish for their guilt*; the relative clause, as usual, preceding: § 308. d (201. c); G. 620; H. 683. 2. N. (572. ii. N.); H-B. 284. 5. Observe the change to primary tenses, when the language of *Cæsar* expresses a general truth.

12 18 *cum*, *though*: § 549 (326); B. 309; G. 587; H. 598 (515. iii); H-B. 526. — *sibi*, *to him*, *Cæsar*.

12 19 *facturos [esse]*: sc. *eos*. — *Haeduis*: dat. after *satisfaciunt* supplied from the next clause, *pay damages*.

12 20 *ipsis* (the *Hædui*): dat. after *intulerint*.

12 22 Write *Divico's* reply in dir. disc.

12 24 *testem*: another allusion to the victory over *Cassius*.

13 2 CHAP. 15. *equitatum*. Who made up the cavalry? See chapter on military affairs, I. 2.

13 4 *coactum habebat*, lit. *had collected*, more strictly *held* (had in hand) *after being collected*: § 497. b (292. c); B. 337. 7; G. 238; H. 431. 3 (388. I. N.); H-B. 605. 5. — *videant*: subjv. of purpose.

13 5 *faciant*: subjv. of indir. quest., *quas* being interrog. — *cupidius*, *too eagerly*: § 291. a (93. a); B. 240. 1; G. 297. 2; H. 498 (444. 1); H-B. 241. 2. — *novissimum agmen*, *the rear*; *agmen* is the army in line of march (*ago*), and its *newest* part is that which comes along last. See chapter on military affairs, VI.

13 6 *alieno loco*, *on unfavorable ground*; so *suo* would be *favorable* (cf. “one’s own ground”). For construction, see § 429. I (258. f. 1); B. 228. I. b; G. 385. N.¹; H. 485. 1 (425. ii. 2); H-B. 436.

13 8 *equitibus*: abl. of means.

13 10 *novissimo agmine* (loc. abl.), *at their rear*. — *proelio*: abl. of manner or means.

13 12 *satis habebat*, *held it sufficient*. — *hostem . . . prohibere*: in a kind of pred. agreement with *satis*, as object of *habebat*. — *rapinis*: § 400 (243); B. 214. 2; G. 390. 2; H. 462 (414. 1); H-B. 408. 2.

13 13 *ita . . . uti*, *in such a way that* (correlative). — *dies*: cf. with *diebus*, **11 8**, and note the difference between the acc. and the abl. of time.

13 15 *quinis aut senis*: distributives, implying that this was the *constant* or *average* daily distance between the two armies. They apparently marched along the Saône, in the direction of Châlon. Their exact route from the Saône towards Autun is uncertain. The country here is very irregular and broken; so that it was impossible for Cæsar to get any advantage by a rapid march or by an attack on the Helvetian rear. He consequently followed them, watching his chance. — *milibus*: § 406 (247); B. 217; G. 296; H. 471 (417); H-B. 416. *d*.

13 17 CHAP. 16. *Haeduos frumentum*, *demanded corn of the Hædui*: § 396 (239 *c*); B. 178. 1. *a*; G. 339; H. 411 (374); H-B. 393.

13 18 *essent polliciti*: subjv. because of the implied indir. disc., *which* (he said) *they had promised*. — *flagitare*: histor. infin.; § 463 (275); B. 335; G. 647; H. 610 (536. 1); H-B. 595. Notice that this construction, like the imperfect tense, only describes a situation, and never advances the narrative. The word expresses an earnest and repeated demand accompanied with reproaches. — *frigora*, *the cold seasons*, or *spells of cold*; not *the cold* in general. The climate of Gaul in Cæsar's day was much colder than that of France now. The change has come from clearing away the forests and draining the marshes, which then covered much of the country.

13 20 *frumenta*: the plur. is regularly used of *standing grain*. The crops of grain were not ripe because it was too early in the season (about the last of June); the green fodder (*pabuli*) was scarce because Cæsar was following in the path of the Helvetians, whose thousands of cattle had almost swept the country bare. — *ne . . . quidem*, *not even*: § 322. *f*. (151. *e*); B. 347. 1; G. 448. 2; H. 569. iii. 2.

13 22 *frumento*: abl. after *uti*. — *flumine*: § 429. *a* (258. *g*); B. 218. 9; but G. 389; H. 476 (420. 1. 3); H-B. 426. — *navibus*: § 409 (248. *c*. 1); B. 218; G. 401; H. 476 (420); H-B. 423. — *propterea . . . quod*: see **1 6**.

13 23 *ab Arari*: i.e. towards the valley of the Loire, westerly, but by what road is unknown.

13 24 *diem*: acc. expressing duration of time. — *ducere*: histor. infin.

13 25 *conferri*, etc. [*frumentum*]: a climax. *They said it was being gathered, it was on the way, it was already at hand*.

14 1 *quo die*: note the repetition of the antecedent in the relative clause, but do not translate it; see § 307. *a* (200. *a*); B. 251. 3; G. 615; H. 399 (445. 8); H-B. 284. 4.

14 2 *metiri, serve*; see chapter on military affairs, IV. *f*.

14 4 *Diviciaco et Lisco*: abl. in apposition with *principibus*. — *summo magistratui praeerat*, held the chief office, of which the Celtic title was *guergbreth*, "executor of judgment," represented in Latin by *vergobretus*.

14 6 *in suos*, over his people.

14 7 *posset*: sc. *frumentum*. For the subjv., see § 593 (342); B. 324; G. 663. 1; H. 652 (529. ii); H-B. 539.

14 8 *propinquus*, with the enemy so near: not attribute, but predicate; an abl. abs.

15 1 *sublevetur*: cf. *essent polliciti*, 13 18, and note; also *sit destitutus* just below; § 592. 3 (341. *d*); B. 323; G. 508. 3; H. 649. 1 (528. 1); H-B. 535. 2. *a*.

15 4 CHAP. 17. *quod*: sc. *id*, object of *proponit*.

15 5 *esse non nullos*, etc.: Direct, —

Sunt non nulli quorum auctoritas . . . valeat, qui privatim plus possint quam ipsi magistratus. Hi . . . multitudinem deterrent ne frumentum conferant quod debent: praestat, si iam principatum . . . obtinere non possunt, Gallorum . . . imperia . . . perferre; neque dubitant quin, si Helvetios superaverint Romani, . . . libertatem sint erepturi. Ab eisdem vestra (or Romanorum) consilia quaeque in castris gerantur (geruntur) hostibus enuntiantur; hi a me coerceri non possunt. Quin etiam, quod necessario . . . coactus Caesari (tibi) enuntiaui, intellego . . . quanto id cum periculo fecerim, et ob eam causam quam diu potui tacui.

15 6 *privatim plus possint*, have more power in private station: see note on 3 20.

15 7 *improba oratione*, reckless talk.

15 8 *ne . . . conferant*, from bringing: § 558. *b* (331. *e*. 2); B. 295. 3; G. 548; H. 506. 2 (505. ii); H-B. 502. 3. *b*.

15 11 *neque dubitare quin*: § 537. *a* (319. *a*); B. 284. 3; G. 555. 2; H. 595. 1 (504. 3. 2); H-B. 521. 3. *b*. — *superaverint*: perf. subjv. — *una*: an adv.

15 12 *Haeduis*: dat.; § 558 (229); B. 188. 2. *d*; G. 347; H. 427 (385. ii. 2); H-B. 371. — *sint erepturi*: the first periphrastic conjugation. It almost equals *eripiant*, but emphasizes the future intention of the Romans.

15 14 *a se*: i.e. by Liscus, as chief magistrate. — *quod . . . enuntiarit*: cf. 11 17, 12 11, and notes.

15 15 *coactus*, on compulsion (lit. being forced).

15 16 quanto . . . fecerit: cf. quas . . . faciant, **13 5** and note. — id: i.e. quod . . . enuntiarit.

15 19 CHAP. 18. pluribus praesentibus, in the presence of many; observe that the abl. abs. will rarely bear a literal translation, but its force must be brought out in various ways.

15 20 iactari, bandied about (frequentative of iacio).

15 21 Liscum retinet, [but] keeps Liscus. The omission of the conj. (asyndeton) is very common in Cæsar's rapid narrative. — ex solo, from him in private.

15 22 secreto (from secerno), each by himself.

15 23 esse vera (sc. haec), that the facts are these. — ipsum esse Dumnorigem, etc.: Direct, —

Ipse est Dumnorigis . . . cupidus rerum novarum. Compluris annos portoria . . . redempta habet, . . . quod illo licente contra liceri audet nemo. His rebus et suam rem . . . auxit et facultatis . . . comparavit; magnum numerum equitatus . . . alit et circum se habet, neque solum domi sed etiam apud . . . civitatis largiter potest; atque . . . matrem . . . collocavit, ipse . . . uxorem habet, sororem . . . collocavit. Favet et cupit Helvetiis . . . odit . . . Caesarem . . . quod . . . frater . . . est restitutus. Si quid accidat Romanis, summam in spem . . . venit; imperio populi Romani . . . de ea quam habet gratia, desperat.

15 24 summa audacia, [a man] of the utmost boldness. The general word is rarely, as here, omitted after a proper name with an abl. of quality.

15 25 rerum novarum: the regular expression for a change of government, revolution, or *coup d'état*. Such overturnings seem to have been frequent in Gaul. — portoria, customs dues or tolls, levied at the frontier; collected, apparently, as by the Romans, through *publicani*, who bid for the contract at public auction and made what they could above the contract price. The Hædui controlled at least a part of the Saône, which was a water-way into the centre of Gaul. It was customary among the ancients to levy tolls or blackmail on goods passing through their territories.

16 1 redempta: agreeing with vectigalia, and taken with habere, had bought in (cf. **8 9**, **13 4**).

16 2 illo licente, when he bid: see note on **15 19**.

16 4 ad largiendum, for bribery, to buy political support: § 506 (300); B. 338. 3; G. 432; H. 628 (541. iii. N.2); H-B. 612. iii.

16 7 causa, for the sake: as always when thus following a gen. — potentiae, power, as an attribute of the person; potestas is power to do anything; facultas, opportunity; imperium, military authority.

16 8 Biturigibus: near the modern Bourges, west of the Hædui.

16 9 uxorem: the daughter of Orgetorix; see **3 22**. — **ex matre**, *on the mother's side* (a half-sister).

16 10 nuptum: supine; § 509 (302); B. 340. 1; G. 435; H. 633 (546); H-B. 618; see Vocab. under *conlocare*.

16 11 Helvetiis: dat.; § 367 (227); B. 187. ii. a; G. 346; H. 426. 1 (385. 1); H-B. 362. ii.

16 12 suo nomine, *on his own account*: a mercantile phrase applying to business debts, etc.

16 14 si quid accidat: a mild phrase, *in case of any disaster*; future less vivid protasis with **venire** as apodosis; § 589 (337); B. 319. B; G. 658; H. 646 (527. ii); cf. H-B. 580.

16 15 obtinendi: gerund or gerundive? See **3 11** and note.

16 16 imperio (abl. of time and cause), *under the rule*.

16 18 quod . . . factum, *in regard to the unsuccessful cavalry skirmish fought the other day*. The idea expressed in English by *whereas*, *as to the fact that*, and the like is regularly expressed in Latin by a *quod*-clause with the indic., almost independent of the rest of the sentence; cf. **11 17**, **12 11**, **15 14**, and notes.

16 19 initium fugæ: it is implied that this action was treacherous.

16 21 auxilio Caesari: § 382. 1 (233. a); B. 191. 2. b; G. 356; H. 433 (390. ii); H-B. 360 and b.

16 24 CHAP. 19. **res, facts**; see note on **4 4**. — **accederent**: § 546 (325); B. 288. 1. B; G. 585; H. 600. ii. 1 (521. ii. 2); H-B. 525. This word is used as a kind of pass. of *addo*. — **quod . . . traduxisset**, *the fact that* (as he learned) *he had led*, etc. The verbs in these *quod*-clauses are in the subjv. on the principle of implied or informal indir. disc.; cf. **13 18**, **15 1**, and notes.

16 25 inter eos: i.e. the Helvetii and Sequani. — **dandos**: cf. **pontem faciendum curat**, **11 5** and note.

16 26 iniussu suo, etc., *without his authority or that of the state*. For form, see § 94. c (71. b); B. 57. 1; G. 70. A; H. 143. 1 (134); H-B. 106. 1; here **suo** is equivalent to a genitive.

16 27 ipsis: himself and the Hædui. — **magistratu**: see **14 4**.

16 28 causæ: gen. depending on **satis**, which is used as a noun. — **in eum . . . animadverteret**, *should proceed against or punish him* (see Vocab.): a clause of characteristic; § 535 (320); B. 283. 1; G. 631. 1; H. 591 (503); cf. H-B. 521. 1.

17 3 quod . . . cognoverat, *that he well knew*, etc. (the present inceptive, *cognosco*, having the meaning *to learn*). This clause, in apposition with **unum** (*only one thing*), might in English be introduced by some such word as *namely*.

17 4 **studium**, *attachment*, as a partisan.

17 5 **voluntatem**, *good will*, as a friend. Note the absence of connectives in vivid narration.

17 6 **eius**: i.e. of Dumnorix. — **supplicio**, *punishment* or *execution*. This word is derived from the adj. *supplex*, *down-bent*, signifying *on the bended knee*; i.e. either as a suppliant for mercy, or, as here, to receive the blow of the executioner.

17 7 **prius quam conaretur**, *before he should attempt*: § 556. b (327); B. 292. 1. a; G. 577; H. 605. ii (520. ii); H-B. 507. 4. a.

17 10 **cui**, etc.: an easier construction would be *cuius fidei omnes res credebat*. — **summam . . . fidem**, *full confidence*.

17 11 **eo**: i.e. Diviciacus. — **commonefacit**, *reminds* or *notifies* (see Vocab.).

17 12 **ipso**: i.e. Diviciacus.

17 13 **apud se**, *in his* (Cæsar's) *presence*.

17 14 **ut . . . statuat**: cf. note on 6 10. — **offensione animi**, *displeasure* (of Diviciacus); **ipse**, which follows, refers to Cæsar: the gist of the request is in **sine eius offensione**. Cæsar hopes, in what steps he takes or orders to be taken against Dumnorix, not to incur the resentment of his brother.

17 17 CHAP. 20. **complexus**: i.e. he embraces Cæsar's knees or falls at his feet.

17 18 **ne quid gravius** (a common euphemistic phrase), *no severe measures*. Notice that **gravius** is an adj., modifying **quid** (*anything*), a subst. — **scire se**, etc.: Direct, —

Scio hæc esse vera, nec quisquam ex eo plus quam ego doloris capit, propterea quod, cum ego gratia plurimum [possem] . . . ille minimum . . . posset, per me crevit; quibus opibus . . . paene ad perniciem meam utitur. Ego tamen et amore . . . commoveor. Quod si quid ei a te acciderit, cum ego hunc locum . . . apud te teneam (teneo), nemo existimabit non mea voluntate factum; qua ex re . . . totius Galliae animi a me avertentur.

17 19 **plus doloris**: except as an adv., this comparative is mostly used, as here, with the part. gen.

17 20 **ipse, se, suam, sese**: all refer to Diviciacus; **ille** to Dumnorix, which is also the subject of **crevisset** and **uteretur**.

17 22 **opibus ac nervis**, *sinews of power*, after **uteretur**: § 410 (249); B. 218. 1; G. 407; H. 477 (421. i); H-B. 429.

17 23 **gratiam**, as well as **perniciem**, takes **suam**.

17 24 **amore fraterno**, *love to his brother*: § 348. a (217. a); B. 353. 5. b; H. 439. 3 (395. N.²); H-B. 354. d.

17 25 **si quid accidisset** (a euphemism; cf. **incommodi**, 11 16 and note): pluperf. representing fut. perf. indic. (*acciderit*) of the direct by sequence

of tenses; a future condition; § 516. *f* (307. *f*); B. 319. B; G. 656, 657; H. 644. 2 (525. 2); H-B. 580. *b* and N. — *ei*: i.e. Dumnorix.

18 1 *futurum* [*esse*] *uti . . . averterentur*, *the hearts of all the Gauls would be turned from him*: periphrastic fut. infin.; § 569. *a* (147. *c*. 3, 288. *f*); B. 115, 270. 3; G. 248; H. 619. 2 (537. 3); H-B. 472. *c*. Cf. **8** 18.

18 4 *rogat* [*ut*] . . . *faciat*: § 565. *a* (331. *f*. R.); B. 295. 8; G. 546. R.²; H. 565. 4 (499. 2).

18 5 *tanti*, *of so great account*: § 417 (252. *a*); B. 203. 3; G. 380. 1; H. 448. 4 (405); H-B. 356. 1.

18 6 *eius . . . precibus*, *in deference to his wish and prayers*. — *condonet* (subjv. of result): this word means to give up a right to some one; here the just resentment of Cæsar was given up to Diviciacus.

18 8 *reprehendat*: why subjv.? cf. **15** 16. Note the same construction in the next clause.

18 10 *praeterita*, *things bygone, the past*.

18 11 *custodes*: i.e. *spies*.

18 15 CHAP. 21. *qualis esset*, etc.: indir. quest. after *cognoscerent*. — *natura*, *character*. — *qualis . . . ascensus*: i.e. what kind of an ascent there was at various points of its circuit. — *qui cognoscerent*: § 531. 2 (317. 2); B. 282. 2; G. 630; H. 589. ii (497. 1); H-B. 502. 2; the antecedent of *qui* is *eos*, *quosdam*, or some such word, to be supplied as object of *misit*, *he sent men to ascertain*. Such a relative may in Latin always imply its own antecedent, as in English the relatives *whoever* and *what*; cf. *qui . . . appellantur*, **1** 2 and note.

18 16 *facilem*: sc. *ascensum*. — *de tertia vigilia*: cf. **10** 7 and note.

18 17 *pro praetore*, *with powers of prætor*. The prætor, like the consul, held the *imperium* or power to command; a *legatus*, not possessing this in his own right, might be temporarily invested with it by his commander. Labienus, and perhaps others of Cæsar's lieutenants, had the *imperium* in their own right, by special grant.

18 18 *ducibus*: a kind of predicate apposition, *as guides*; § 284 (185. *a*); B. 168; G. 325; H-B. 319. 1. — *qui . . . cognoverant*: i.e. who had been of the reconnoitering party.

18 19 *consili*: a predicate gen. after *quid sit*; § 343. *b* (214. *c*); B. 198. 3; G. 366; H. 447 (402); H-B. 340. Such genitives are not rare in Cæsar, but are probably more or less colloquial. — *sit*: cf. *reprehendat*, **1** 8, above.

18 20 *de quarta vigilia*: about 2 A.M., the sun at this season rising here about four o'clock.

18 22 *rei*: § 349. *a* (218. *a*); B. 204. 1; G. 374; H. 451. 1 (399. i. 2); H-B. 354.

18 23 Sullae, Crassi: Sulla, the dictator, had conducted the war against Mithridates about thirty years before (B.C. 88-84), and Crassus that against Spartacus some years later (B.C. 71). — **in:** sc. *exercituum*.

19 1 CHAP. 22. **teneretur:** subjv. after **cum**, describing the situation: cf. **4 12**, **6 14**, **7 17**, and notes.

19 2 ipse: Cæsar.

19 3 passibus: abl. of degree of difference after **abesset**; § 425. *b* (257. *b*); B. 223; G. 403; H. 479 (423); cf. H-B. 424; not after **longius**; § 407. *c* (247. *c*); B. 217. 3; G. 296. R.⁴; H. 471. 4 (417. I. N.²); cf. H-B. 416. *d*.

19 4 aut Labieni: after **adventus** and coördinate with **ipsius**. — **equo admisso**, at full speed (with reins thrown loose).

19 6 armis: the shields and helmets of the Gauls were distinctly different from those of the Romans; see Fig. 11, Fig. 28, Fig. 87, etc.

19 7 insignibus: i.e. *devices* on shields and helmets, — stags' horns, eagles' plumes, etc.; see Fig. 11. The inference from this report would be that Labienus and his force had been cut to pieces, and Cæsar must expect an attack at once. This accounts for his next movement, which was to fall back and wait in line of battle, while Labienus was vainly expecting him.

19 8 ut, as.

19 9 ne . . . committeret . . . essent: subject of **erat praeceptum**; § 566 (331. *h*); B. 295. 1.

19 10 ut . . . fieret, in order that the attack might be made on all sides at once: a purpose clause.

19 11 monte occupato, etc., having seized the height, continued to look out for our men. Observe how the imperfects **expectabat** and **abstinebat** describe the situation; see note on **3 5**.

19 12 multo die: abl. of time, late in the day. — **denique**, not till: see Vocab.

20 2 quod non vidisset. what he had not seen; sc. *id*, object of **renuntiasset**. — **pro viso**, as if seen; **viso** is used here as a noun. — **quo**, sc. *eodem*, at the same interval as usual, i.e. five or six miles; see **13 15**.

20 3 milia: acc. of extent; § 425. *b* (257. *b*); B. 223; G. 335; H. 417 (379); H-B. 387.

20 5 CHAP. 23. **diei:** § 359. *b* (214. *g*); B. 201. 3. *a*; G. 360; H. 446. 5 (398. 5); H-B. 380. *c*; making **postridie** more formal and precise. — **omnino**, in all (i.e. only).

20 6 cum, within which, a common Latin idiom. — **metiri:** cf. **14 2** and note. — **Bibracte**, the modern Mont Beuvray, a considerable hill, about ten miles west of Autun (Augustodunum). The place afterwards became a Roman colony, and contains numerous Roman remains.

20 8 milibus: cf. **19 3** and note. — **rei frumentariae** (dat.), *the supply of corn.*

20 9 prospiciendum: impers.; sc. *esse.* — *itaque:* words in italics are conjectural readings. — **avertit:** towards the north, as the Helvetii were travelling westward to reach the Loire.

20 10 fugitivos, *runaways*, i.e. fugitive slaves.

20 11 decurionis: see chapter on military affairs, I. 2.

20 12 existimarent: the subjv. is here used idiomatically because Cæsar was not sure of the real reason; § 540 (321); B. 286. 1; G. 541; H. 588. ii (516. ii); H-B. 535. 2. a.

20 13 eo magis, *all the more:* cf. note on **2 17.** — **superioribus,** etc.: concessive, i.e. though they had gained an advantageous position, still they did not attack the Helvetii.

20 14 commisissent: see note on **existimarent** above, l. 12. — **eo quod,** etc., *for this reason, because they felt sure that they* (the Romans) *could be cut off from their supplies;* **eo** is abl. of cause, not different in sense from **eo** (**magis**) above, though its origin is different. — **re:** abl. of separation.

20 15 itinere converso: i.e. instead of continuing on their way, by which they might have reached the coast, their vain confidence led them to return and give Cæsar the chance that he had been waiting for.

20 18 CHAP. 24. **id:** governed by **animum advertit** treated as an active compound verb. The tense of the verb is perfect, as usual after **postquam;** cf. note on **arbitrati sunt, 4 17.**

20 19 sustineret: subjv. of purpose; § 531. 2 (317. 2); B. 282. 2; G. 630; H. 589. ii (497. i); H-B. 502. 2.

20 20 ipse: Cæsar himself as opposed to the cavalry, which he had sent elsewhere. — **medio:** see Vocab. and cf. § 293 (193); B. 241. 1; G. 291. R.²; H. 497. 4 (440. 2. N.¹); H-B. 244. — **triplicem aciem:** see chapter on military affairs, VII.

20 21 legionum: gen. of material; § 344 (214. e); B. 197; H-B. 349. The four veteran legions stood side by side, each in three lines; see plan, Fig. 16.

20 22 summo: cf. note on **medio, l. 20.** — **proxime:** these new legions last raised (cf. **8 23**) were not as yet sufficiently steady to bear the brunt of a battle, and so they were set to guard the camp.

20 23 auxilia: see chapter on military affairs, I. 3. — [**ac totum,** etc.]: this clause may well be read in this connection, though many editors omit it; cf. note on **eorum, 9 17.** The force of **ac** is *and thus;* see Vocab.

20 24 sarcinas: see chapter on military affairs, I. 6 and IV. e, and Fig. 14. In a regular battle these were left behind in camp. So here, they were deposited in one spot, which was to be the site of the camp when made

(*muniri*, 21 2) by the less trustworthy troops. Nothing is said of the baggage train (*impedimenta*), but it probably was sent on towards Bibracte.

21 1 eum: i.e. the spot chosen (*locum*, 20 24). — **his**: i.e. the soldiers last mentioned. — **superiore**: i.e. those who were at the top of the hill. — **constiterant**, *were stationed*; cf. § 476 (279. *e*); B. 262. *a*; G. 241. 3. R.; H. 538. 4 (471. 3); H-B. 487.



FIG. 116. — SCUTUM.

21 2 cum omnibus suis carris, etc.: i.e. not sending a force of fighting men, but following with their whole train. It seems to have been the habit of these peoples to go to battle with their families and their carts for encouragement as well as for defence.

21 3 confertissima acie . . . phalange facta: see introductory chapter on Gaul and the Gauls.

21 4 reiecto, etc.: the ancient cavalry were no match for any considerable number of foot-soldiers, and hence were not depended upon for the main engagement. They opened the fight, but were expected

to flee as soon as the foot advanced.

22 1 CHAP. 25. suo [*equo remoto*], etc.: i.e. his own and those of the officers and staff. This was often done before an engagement (cf. *Sail. Cat.* 59). *Cæsar* is reported to have said to his men, "I will mount again when the enemy run." — **omnium**: notice that the poss. gen. and the poss. adj. have the same sense, and so may be coördinated; cf. 19 4 and note.

22 4 pilis: see chapter on military affairs, IV. *d* and Fig. 15.

22 6 Gallis . . . impedimento: dat. of service and of person affected; § 382. I. N.¹ (233. *a*); B. 191. 2. *b*; G. 356; H. 433 (390); H-B. 360 and *b*.

22 7 pluribus, *several*.

22 8 inflexisset: subjv. with *cum* causal; cf. *præstarent*, 2 15. — **sinistra impedita**, *since the left hand was hampered*, which carried the shield.

22 9 multi ut, *so that in the case of many*, **multi** being placed first for emphasis.

22 12 mons: see battle plan, Fig. 16. — **eo**: an adv. — **mille**: acc. of distance.

22 13 capto monte, etc.: i.e. after the Helvetii had gained the mountain and the Romans were going up to attack them.

22 14 agmen claudebant, *brought up their rear*. The Boii or Tulingi, with about 15,000 men, had been in front of the Helvetic line of march,



FIG. 117. — SCUTUM.

and were consequently in the rear when they faced round to attack Cæsar. They now struck at his exposed right flank (*latere aperto*) as they came on the field from the road (hence *ex itinere*).

22 15 novissimis praesidio: cf. *Gallis . . . impedimento*, l. 6.

22 16 circumvenire: sc. *coeperunt*.

22 18 conversa signa . . . intulerunt, *faced about* (lit. *bore their reversed ensigns upon the enemy*), and *charged in two divisions*. The divisions stood not back to back, but at an angle, facing outward, — the two front lines facing forward, while the third met the flank attack of the new-comers (*venientis*), i.e. the Boii and Tulingi. The phrase *conversa signa* refers only to the movement of the third line, while *intulerunt* denotes the action of the entire army. The exact position of this battle is uncertain. It is usually placed at a point between Chides and Luzzy, near the river Alène, and about ten miles south of Mont Beuvray.

23 1 CHAP. 26. ancipiti: i.e. facing in both directions. — **pugnatum est:** *impers. expressions should not be translated literally; here, a contest went on, the fighting continued, or something of the kind.*

23 3 alteri: the Helvetians; **alteri:** the Boii, etc.

23 4 nam: in reference to the previous sentence; i.e. they did not flee, but retired in good order, *for*, etc.

23 5 proelio: abl. of time. — **ab hora septima:** i.e. from a little past 1 P.M.; sunset was about eight, so that each of the twelve daylight hours was about an hour and a quarter of our time. In the Roman reckoning an hour was one-twelfth of the time, whether long or short, between sunrise and sunset, and varied from about forty-five minutes to an hour and a quarter. — **pugnatum sit:** cf. note on l. 1. For mood, cf. *sint*, 12 18.

24 1 aversum hostem, *a fleeing enemy*. — **ad multam noctem**, *till late in the night*.

24 2 pro vallo, *as a barricade*.

24 3 e loco superiore, *from vantage-ground*, i.e. the height of the carts, etc.

24 4 coniciebant, subiciebant, *hurled* (from above), *thrust* (from below) For the form of these words, see § 6. *d* (II. b. 2); B. 9. 3; H. 58. 6 (36. 4); H-B. 30. 1. — **carros redasque:** the former a two-wheeled cart, the latter a four-wheeled wagon. See Fig. 55.

24 5 mataras ac tragulas: these were peculiar forms of pike or lance used by the western nations of Europe, not yet certainly identified.

24 6 impedimentis castrisque: § 410 (249); B. 218. 1; G. 407; H. 477 (421. i); H-B. 429.

24 7 potiti sunt: notice the use of tenses in the above passage. The *narrative* proceeds as far as **pugnatum est** (histor. perfect), then, as it

answering a question why the fight continued thus, Cæsar gives a *description* of the situation with pluperfect and imperfects. "The Gauls *had made* a rampart of their carts and from this they *kept discharging* missiles and using other means of defence." Then the *narrative* is resumed in the clause with **potiti sunt**: cf. note on 3 5. — **captus est**: observe that the agreement is with the nearer subject; § 317. c (205. d); B. 255. 2; G. 285. 1; H. 392 (463. 1); H-B. 329. 2.

24 10 Lingonum: i.e. the southern part of Champagne, towards the north; see map of Gaul, Fig. 2. The chief town of that region, now Langres, is about ninety miles from Mont Beuvray. It is very likely, however, that they reached the Lingones farther west. Napoleon III puts the end of their flight at Tonnerre, sixty miles west of Langres.

24 11 propter, etc.: gives the reason of **morati**. — **cum . . . potuissent**: here the description of the situation (see notes on 6 14, 7 17, 11 7) is so clearly the cause of the main action that we may translate **cum** *since* and refer the subjv. to *cum* causal (cf. **cum praestarent**, 2 15; **cum inflexisset**, 22 8).

24 13 Lingonas: Greek form of the acc. common in these names of tribes; § 81, 82 (63. f, 64); B. 47. 3; G. 66. 4; H. 109. 5 (68); cf. H-B. 95.

24 14 qui si iuvisset, *for if they should*, etc.; the direct would be *si iuveritis*. — **se**, etc. = *se (Lingonas) eodem loco habiturum (esse) quo Helvetios (haberet)*.

24 20 CHAP. 27. **eos**: i.e. *Helvetios*.

24 21 essent: subjv. of integral part or attraction; § 593 (342); B. 324. 1; G. 629; H. 652 (529. ii); H-B. 539. — **iussisset**: i.e. Cæsar; this change of subject, though unusual in Latin, is justified by the mention of **eum** in l. 18.

24 22 qui . . . perfugissent: i.e. fugitive slaves. Cæsar in his demand would say *qui perfugerunt*, but the subjv. is used in the indir. form; § 592. 2 (341. c); B. 323; G. 663. 2; H. 649. 1 (528. 1); H-B. 535. 1. a.

24 24 conquiruntur, conferuntur: to express the pass. it is often better in English to use the act. form, *while they were hunting these up*, etc.; the present tense is regular with **dum**; § 556 (276. c); B. 293. 1; G. 229. R.; H. 533. 4 (467. 4); H-B. 559.

24 25 Verbigenus: from the parts between Berne and Lucerne.

24 26 perterriti: agreeing with the persons referred to in **milia**. — **ne armis**, etc.: i.e. either in sheer desperation or in the hope of escape. Note that after verbs of fearing **ne** is translated by *that* or *lest*.

25 2 occultari, *be hid* from Cæsar; **ignorari**, *unknown* to anybody.

25 3 existimarent: the supposed reason of the Helvetii, hence the subjv.; § 540 (321); B. 286. 1; G. 541; H. 588. ii (516. ii); H-B. 535. 2. a; cf. 20 12 and note.

25 4 contenderunt ad, *made (rapidly) for*.

25 5 CHAP. 28. **quod**: accustom yourself to the common use of the relative, where our idiom expects a demonstrative or personal. — **quorum**: the antecedent is **his** (dat.) following **imperavit**, the dir. object of which is **uti . . . reducerent**.

25 6 **sibi**: dat. of reference; § 378 (235. *b*); B. 188. 1. N.; G. 352; H. 425. 4 (384. 4. N.³); H-B. 370. — **purgati**: perfect participle used as an adj.; § 495 (291. *b*); B. 337. 2; G. 250. R.²; H. 640. 3 (550. N.²); H-B. 320. iii.

25 7 **reductos . . . habuit**: i.e. he massacred them all.

25 8 **in deditionem accepit**: by this act they became formally the subjects of the Republic, and were entitled to its protection, as well as required to obey its requisitions and pay tribute.

25 11 **reverti**, *turn back* (from a march or journey; *redire, go back*, from a place of rest). — **frugibus**: grain and other field produce.

25 12 **tolerarent**: best regarded as a purpose clause like, "nothing [for] to eat," — § 531. 2 (317), — but referred by many grammarians to the "characteristic" use of the relative; B. 283. 2; G. 631. 2; H. 591. 1 (503. i); H-B. 517. 2 and *a*. The two constructions, having grown up side by side in Latin, were very often confounded.

25 13 **ipsos**: the Helvetians and their allies as opposed to the others who were to provide food.

25 14 **ea ratione**, *with this view*.

25 18 **Allobrogibus**: these were within the Province, but the Latin often adds an explanatory word by means of *que*. The Helvetii were thus in the Roman manner stationed as a kind of colony on the frontier towards Germany. The wisdom of the Romans in the defence of their Empire is not less remarkable than their prowess in war.

25 19 **petentibus Hæduis**, *to the Hædui, at their request*: dat. after **concessit**, of which the object is **ut Boios conlocarent**. The Hædui were anxious for this accession to their strength because they were oppressed by the Sequani (cf. **27 21 ff.**). It will be remembered that the Boii were emigrating when they joined the Helvetians and had no proper home to return to. The Hædui gave them land between the Elaver and the Ligeri rivers, and they appear later in several parts of Gaul. Their prowess in war made them valuable allies.

26 1 **parem . . . atque ipsi erant**, *equal with themselves*: § 324. *c* (156. *a*. 4); B. 341. 1. *c*; G. 643; H. 508. 5 (451. 5); H-B. 307. 2. *a*.

26 3 CHAP. 29. **tabulae**, *tablets*, of the shape of a folding slate, with wax spread inside, written on with a pointed instrument called *stilus*. See Fig. 27. — **litteris Graecis**: not in the Greek *language*, but in Greek *letters*. These were probably learned from colonists at Marseilles, as the

Gauls had no alphabet of their own. The Druids made use of Greek letters (Bk. vi. ch. 14), but the Gauls in general seem to have been ignorant of them (Bk. v. ch. 48). Specimens of Gallic names on coins appear in the names DUBNOREX, DIVICIACOS, VERCINGETORIXS. See Fig. 29, Fig. 82.

26 5 ratio, an account: followed by the indir. quest. **qui . . . exisset.**

26 6 possent: not the subjv. of indir. quest., but of characteristic; § 535. *a* (320. *a*); B. 283. 2; G. 631. 2; H. 591. 1 (503. 1); H-B. 521. 1. *a*.

26 10 ad milia XCII, about 92,000. — summa, the sum; fuerunt agreeing with the plur. predicate. Deducting the Boii, who were adopted by the Hædui, this reckoning would show an actual loss, in slain or captives (to be sold as slaves), in this short campaign, of nearly 250,000, including probably about 150,000 women and children or other non-combatants. The carnage seems extraordinary even under the conditions of ancient warfare. But, as in all battles, many more must have escaped than the record showed.

CAMPAIGN AGAINST ARIOVISTUS.— The latter half of this Book is taken up with the expulsion of a military settlement of Germans, which had been made a few years before under Ariovistus, a chief of the Suevi.

The occasion of this new campaign was the following: The Hædui, jealous of the Sequani, who lived a little to the north, had laid excessive tolls on their trade, which consisted chiefly in the export of salted meats for the southern market. This led to a war, in which the Sequani had invited the aid of the Germans under Ariovistus, about three years before the campaign of Cæsar. The Germans, once in Gaul, had exacted a large share of territory and proved to be grasping and oppressive masters. Meanwhile the Helvetian war began to threaten. The Roman Senate, to make safe, passed the decrees before mentioned, promising favor and friendship to the Hædui (ch. 11); and at the same time sent messengers to Ariovistus, saluting him as king and friend (ch. 35), recognizing his claims on Gaul, and, it was said, inviting him to Rome. This was the year before, in Cæsar's consulship. Now, however, that the fear of the Helvetians was passed, Cæsar found himself obliged to take sides in the old quarrel.

READING REFERENCES ON THE CAMPAIGN AGAINST ARIOVISTUS.

- Abbott's Cæsar, pp. 86-93.
- Dodge's Cæsar, pp. 82-99.
- Fowler's Julius Cæsar, chap. 9.
- Froude's Cæsar, pp. 231-238.
- Guizot's Hist. of France, Vol. I. pp. 51-53.
- Holmes's Cæsar's Conquest of Gaul, pp. 46-46.
- Merivale's Hist. of Rome, Vol. I. pp. 254-262.
- Mommsen's Hist. of Rome, Vol. IV. pp. 295-300.
- Napoleon's Cæsar, Vol. II. chap. 4.
- Plutarch's Lives, Cæsar.
- Trollope's Cæsar, pp. 38-44.

26 15 CHAP. 30. *gratulum*: § 509 (302); B. 340. 1; G. 435; H. 633 (546); H-B. 618.

26 16 *intelligere*, etc.: Direct, —

Intelligimus nos, tametsi pro veteribus Helvetiorum iniuriis populi Romani ab his poenas bello *repetisti* (*repetieris*), tamen eam rem non minus ex usu terrae Galliae quam populi Romani accidisse; propterea quod ea consilio florentissimis rebus domos suas Helvetii *reliquerunt*, uti toti Galliae bellum inferrent imperioque potirentur locumque domicilio ex magna copia deligerent, quem ex omni Gallia opportunissimum . . . iudicassent, reliquasque civitatis stipendiarias habent.

26 17 *populi Romani*, *against*, etc. (obj. gen. after *iniuriis*). — *ab his repetisset*, *had inflicted on them*; see *Vocab.*, and cf. **10** 14–18.

26 19 *eo consilio*, *with this design*: explained by the purpose clause *uti . . . habent*; § 531. I. N.¹ (317. *a*); G. 546. N.²; H. 564. iii (499. 3); H-B. 502. 2. *a*. — *florentissimis rebus*: i.e. with no plea of necessity. Translate by a concessive clause.

26 21 *domicilio*, *for habitation*: dat. of service.

26 25 *concilium totius Galliae*: of course Cæsar had no authority either to allow or to prohibit a congress of independent Gaul. But, considering his power and ambition, the Gauls thought it best to secure his countenance (*voluntate*, not *auctoritate*) beforehand. They also had business that specially concerned him.

27 2 *iure iurando . . . sanxerunt*, *ordained under oath* [of secrecy]; the object is *ne quis*, etc.

27 3 *enuntiaret*: subjv. with *ne*, after *sanxerunt*, used as a verb of commanding; § 563. *d* (331. *d*); B. 295. 4; G. 546. 2; H. 565 (498. 1); H-B. 502. 3. *a*; cf. also **6** 10 and note. — *nisi quibus*, etc., *except* (to those) *to whom some commission should be assigned* (pluperf. for fut. perf. in dir. disc.). For omission of the antecedent of *quibus*, cf. note on *qui . . . appellantur*, **1** 2.

27 5 CHAP. 31. *eo concilio dimisso*, *when this assembly had been* (held and) *dissolved*: i.e. after providing for the business now to be described. — *idem* (*eidem*): nom. plur.

27 7 *secreto*, *apart*. — *in occulto*, *in a secret place*. These words are probably genuine.

27 8 *Caesari ad pedes*, *at Cæsar's feet*. *Caesari* is dat. of reference; § 377 (235. *a*); B. 188. 1; G. 350. 1; H. 425. 4. N. (384. 4. N.²); H-B. 368.

27 9 *non minus*, etc.: sc. *dixerunt*: Direct, —

Non minus id contendimus et laboramus, ne ea quae *dixerimus enuntietur*, quam uti ea quae *volumus impetremus*; propterea quod, si enuntiatum erit, summum in cruciatum *nos venturos videmus*.

27 9 *id*: in app. with *ne* . . . *enuntiarentur*.

27 13 *Galliae*, etc.: Direct, —

Galliae totius factiones sunt duae; harum alterius principatum tenent *Haedui*, alterius *Arverni*. Hi cum . . . multos annos contenderent, factum est uti . . . Germani . . . arcesserentur. Horum primo . . . milia . . . *transierunt*; posteaquam agros . . . homines . . . *adamarunt*, *traducti sunt plures*; nunc *sunt* in Gallia ad CXX milium numerum (more probably *ad* . . . *milia numero*). Cum his *Haedui* . . . *armis contenderunt*; magnam calamitatem *pulsi acceperunt*, omnem nobilitatem . . . *amiserunt*. Quibus proeliis . . . *fracti*, qui . . . plurimum ante . . . *potuerant*, *coacti sunt* . . . *obsides dare*, etc. *Unus ego sum ex omni civitate* . . . qui adduci non *potuerim* ut *iurarem* aut *liberos meos obsides darem*. Ob eam rem . . . *profugi* et Romam ad senatum *veni* . . . quod solus neque iure iurando neque *obsidibus tenebar*.

Sed peius victoribus Sequanis *accidit*, . . . quod Ariovistus . . . *consedit* tertiamque partem agri . . . qui *est* optimus . . . *occupavit*, et nunc . . . *decedere iubet*, propterea quod . . . milia hominum XXIII . . . *venerunt*, quibus locus ac sedes *parentur* (possibly *pararentur*). . . . Paucis annis . . . omnes . . . *pellentur* atque omnes Germani Rhenum *transibunt*; . . . neque enim *conferendus est Gallicus* cum Germanorum agro, neque *haec consuetudo* victus cum illa *comparanda*.

Ariovistus . . . ut semel . . . *copias* . . . *vicit*, quod proelium factum *est* ad Magetobrigam, superbe . . . *imperat*, *obsides* . . . *poscit*, et . . . *exempla cruciatusque edit*, si qua res non ad nutum . . . eius *facta est*. *Homo est barbarus, iracundus, temerarius*; non *possunt* eius imperia diutius sustineri.

Nisi quid in Caesare . . . *erit* auxilii, omnibus . . . *idem est* faciendum quod *Helvetii fecerunt*, ut domo emigrent, aliud domicilium . . . *petant* fortunamque, quaecumque *accidat*, experiantur. Haec si *enuntiata* Ariovisto sint, non *dubito* quin de omnibus . . . qui apud eum sint (*sunt*) . . . *supplicium sumat*. *Caesar* . . . *deterreere potest* ne maior multitudo . . . *traducatur Galliamque* . . . *potest defendere*.

27 13 *Galliae totius*: not to be taken literally, but referring to the eastern part of Celtic Gaul.

27 14 *factiones duas*: see note on 3 20. — *alterius*: notice that this word may mean *the one* as well as *the other*. It depends on which one you look at first. — *principatum*, *the head*.

27 15 *Arvernos*: these inhabited the mountainous country southwest of the *Hædui*, the modern Auvergne. They had been conquered in B.C. 121, but not reduced to a province. Before their conquest they had been one of the most powerful tribes. Apparently in the earlier wars the *Hædui* had befriended the Roman people from antagonism to these rivals.

27 16 *contenderent*: translate as if pluperf; § 471. *b* (277. *b*); B. 260. 4; G. 234; H. 535 (469. 2); H-B. 485. — *factum esse uti*, *it came to pass that*, etc.

27 17 *Sequanis*: these were the rivals of the Hædui on the north. — *mercede*: § 416 (252); B. 225; G. 404; H. 478 (422); H-B. 427. 1.

27 19 *copias* (= *opes*). *resources*. — *feri ac barbari*: as to the condition of the Germans, see Introduction.

27 20 *adamassent* (= *adamavissent*): § 181. *a* (128. *a*); B. 116. 1; G. 131; H. 238 (235); H-B. 163. — *traductos pluris* = *pluris* (*Germanos*) *traductos* (*esse*).

27 22 *clientis*: the subject states of the Ambarri, Segusiavi, etc.

27 23 *omnem . . . equitatum*: of course an exaggeration; Diviciacus was himself a noble, probably a senator; while his brother Dumnorix was a commander of the Hæduan cavalry.

27 25 *qui . . . potuissent*, *coactos esse*, (they) *who had once*, etc., *were compelled*.

28 4 *quo minus*: following a verb of refusing; § 558. *b* (317. *b. n.*); B. 295. 3; G. 547; H. 568. 8 (497. ii. 2); H-B. 502. 3. *b*; see also note on 7 15.

28 5 *dicione*: i.e. to do the bidding of the Sequani.

28 6 *potuerit*: the same in dir. disc.; § 535. *b* (320. *b*); B. 283. 2; G. 631. 1; H. 591. 5 (503. ii. 1); H-B. 521. 1. *a* and *ftn.* The tense has been retained, as is usual in result clauses; see note on 9 18.

28 8 *Romam . . . venisse*: see note on 3 20. His application was not successful. See Bk. vi. ch. 12. — *postulatum*: cf. *gratulatum*, 26 15.

28 11 *peius . . . accidisse*, *a worse fate had befallen*. Observe that a misfortune is usually said *accidere*, as if it fell on one, while a good thing is said *evenire*. — *victoribus*: here used as an adj., as often.

28 12 *Ariovistus*: supposed to be the German word *Heerfürst*, "prince of the host."

28 13 *tertiam partem*: i.e. upper Alsace, a part of the German conquest of 1870. This was the same proportion of conquered land taken by the German invaders (Burgundians) in this very territory in the fifth century of the Christian era. Such "annexation" seems to have been the ancient common law of conquest (Liv. II. 41).

28 14 *optimus*: this district (Franche-Comté) is one of the most beautiful in France. — *nunc . . . iuberet*: the same thing was afterwards done by the Burgundians. — *altera*, *a second*.

28 17 *quibus . . . pararentur* = *to be provided with a place for habitation* (subjv. of purpose). — *futurum esse uti* (periphrastic fut.; cf. note on 18 1), *the result would be that*.

28 19 *neque enim* introduces an explanation admitting no doubt: *for you see, for you know, for of course.*

28 20 *Gallicum*: sc. *agrum*. — *hanc* = *nostram*: § 297. *a* (102. *a*); B. 87; G. 305; H. 505 (450); H-B. 271. ii. *a. n.*; said with some feeling of superiority or contempt. The Gauls looked upon the Germans as savages.

28 22 *ut . . . vicerit*: for mood and tense, see dir. disc.; cf. tense of *potuerit*, l. 6, above.

28 23 *Magetobrigam*: somewhere a little northwest of Vesontio (Besançon).

28 25 *exempla cruciatusque*: a so-called hendiadys. The Latin likes to dwell on an idea by giving its parts separately; *edere exempla* means to use every known form of (something) on the victims; *cruciatus edere* would mean to employ tortures. The whole combines the two ideas.

28 27 *barbarum*, etc., *rude, passionate, and hasty.*

29 1 *nisi*, etc., *unless they find some aid.*

29 2 *idem*: in apposition with *ut . . . experiantur*; cf. **4 17**, **11 8**.

29 3 *ut domo emigrent*: i.e. *to forsake their home.*

29 5 *haec*: notice the emphasis, as if he said: "Why! if this very colloquy should be reported," etc. — *dubitare*: sc. *se*, i.e. *Diviciacum*. — *quin . . . sumat*: § 558. *a* (332. *g. r.*); B. 284. 3; G. 555. 2; H. 594. ii (501. ii. 2); H-B. 507. 2. *b*; cf. note on *poenas persolvit*, **10 19**.

29 7 *auctoritate*: i.e. his reputation and the fear it inspires.

29 9 *Rhenum*: acc. after *trans* in *traducatur*; § 395. *N.²* (239. 2. *b. N.²*; B. 179. 3; G. 331. *R.¹*; H. 406 (372); H-B. 386. *a*.

29 13 *CHAP. 32. unos, alone*: § 134. *a* (94. *a*); cf. B. 66; G. 95. *R.¹*; H. 175. *N.¹*. This whole scene is illustrative of the Gallic character.

29 15 *quae esset*: indir. quest. after *miratus*; cf. **13 5**, **15 16**, **18 15**.

29 16 *respondere*: histor. infin.; cf. *flagitare*, **13 18** and note.

29 19 *hoc*: we may translate, *in this respect*, but for the real construction compare *hoc facilius*, **2 17**. — *hoc esse*, etc.: Direct, —

Hoc est . . . gravior fortuna Sequanorum . . . quod soli ne in occulto quidem queri . . . audent; absentisque Ariovisti crudelitatem, velut si coram *adsit, horrent*, propterea quod reliquis tamen fugae facultas *datur*, Sequanis vero, qui . . . Ariovistum *repperunt*, quorum oppida . . . in potestate eius *sunt*, omnes *cruciatus sunt* perferendi.

29 20 *ne . . . quidem*: notice the position of these words before and after the emphatic word or phrase.

29 21 *absentis* (predicate), *even when absent.*

29 22 *crudelitatem*: object of *horrent*; § 274. *b.* (177. *c*); B. 175. 2. *b*; G. 330. *R.*; H. 405. 1 (371. iii. *N.¹*); H-B. 391. 1. — *adesset*: § 524 (312); B. 307. 1. 2; G. 602; H. 584 (513. ii); H-B. 504. 3 and *a*.

29 23 tamen, *after all*, whatever they might have to suffer. — **facultas**: on the force of this word, cf. note on **potentiae**, 16 7.

29 24 Sequanis: dat. of apparent agent with **perferendi**; § 374 (232); B. 189. 1; G. 355; H. 431 (388); H-B. 373. 1; *the Sequani must endure* (changing the voice).

30 2 CHAP. 33. **sibi curae**: dat. of service; § 382. 1 and N.¹ (233. a); B. 191. 2. a; G. 356; H. 433 (390); H-B. 360 and b; cf. 22 6, 22 15.

30 3 et . . . et: construe after **adductum**, *induced by both . . . and*. — **beneficio . . . auctoritate**: the first refers to services which would inspire gratitude, the second to the prestige which would inspire fear in Ariovistus.

30 5 secundum, *in accordance with* (lit. *following*).

30 7 putaret: subjv. after **qua re**, which may be considered equal to *propter quas = ut propter eas*. — **quod**, *because*, or *that*. — **Haeduos**, subject of **teneri** below.

30 8 appellatos (pred.), *who had been often called*.

30 11 quod: relative; the antecedent is the preceding clause **Haeduos . . . Sequanos**.

30 14 periculosum: pred., agreeing with **Germanos consuescere**, etc., *he saw it was dangerous to the Roman people for the Germans, little by little, to get in the way of crossing the Rhine*, etc.

30 15 sibi : : temperaturos . . . quin . . . exirent, *would refrain* (check themselves) *from going forth*. — **sibi**: § 367 (227); B. 187. ii. a; G. 346. 2; H. 426. 4 (385. i); H-B. 362.

30 16 ut, as; **fecissent** being subjv. as dependent on **exirent**; § 593 (342); B. 324; G. 663. 1; H. 652. 1 (529. ii. N.¹. 1); H-B. 539. — **Cimbri Teutonique**: these German tribes had been crushed by Marius (B.C. 102, 101), after having been for several years a terror upon the Italian frontier.

30 17 exirent: § 558 (319. a'); B. 284. 3; G. 555; H. 595. 2 (504); H-B. 502. 3. b.

30 18 [praesertim, etc.]: this clause makes good sense and may be translated.

30 19 Rhodanus = only the Rhone. — **rebus**: dat. following **occurrentum [sibi]**; § 370 (228); B. 187. iii; G. 347; H. 429 (386); H-B. 376; *possibilities which he thought must be met at once*. In this clause two things are to be noticed: first, that the Latin regularly puts an antecedent which is in apposition with something preceding in the relative clause, e.g. "which kind," not "a kind which"; and, second, that a verb which governs the dat. cannot be used in the pass. with a personal subject. In both these respects the form must be altered in translating to suit the English idiom.

30 21 ferendus, etc.: in Latin the negative has an attraction for the main verb. We should say, "seemed unendurable," connecting the negative with the adjective idea.

30 23 CHAP. 34. **ut . . . mitteret**: a purpose clause, subject of **placuit**.

30 24 medium utriusque, *between the two*.

30 25 conloquio (dat.), *for a conference*. — **velle**, etc., depends on the idea of saying in **postulerent**. Give the direct words of Cæsar.

30 27 si quid, etc.: Direct, —

Si quid mihi a Caesare opus esset, *ego ad eum venissem*; **si quid ille me vult**, illum ad *me* venire oportet. [The first condition is contrary to fact; § 589. *b* (337. *b*); B. 321. B; G. 597. R.⁴; H. 647 (527. iii); H-B. 581 and *b. 1*; cf. **12 4**: the second is a simple present condition; § 589. *a. 1* (337. *a. 1*); B. 319. B; G. 595. R.¹; H. 646 (527. i); cf. H-B. 536.] Praeterea *ego* neque . . . in eas partis . . . venire *audeo* quas Caesar *possidet*, neque exercitum . . . in unum locum contrahere *possum*. *Mihi* autem mirum *videtur* quid in *mea* Gallia, quam bello *vici* (*vicerim*), aut Caesari aut omnino populo Romano negoti *sit*.

30 27 opus: § 411. *b* (243. *e. R.*); B. 218. 2. *a*; G. 406; H. 477. iii. N. (414. iv. N.⁴); H-B. 430. 2. *a*. — **ipsi**: dat. of poss.; § 373 (231); B. 190; G. 349; H. 430 (387); H-B. 374. Observe in this sentence that the reflexives **ipse** and **se** refer to Ariovistus; § 298. *e* (195. *k*); B. 249. 3; G. 521. N.³; H. 509. 5 (452. 5); H-B. 263. 1; and that the demonstratives **is** and **ille** refer to Cæsar; cf. also note on **3 26**.

31 1 quid . . . se velit, *wants anything of him* (lit. *wants him for anything*): a colloquial construction; § 390. *d* (238. *b*); B. 176. 2; G. 333. R.²; H. 416. 2 (378. 2); H-B. 397. 1.

31 5 mirum . . . quid . . . esset: a sort of indir. quest.; *it seemed strange to him*, i.e. he wondered, *what business*, etc. — **in sua Gallia**, *in HIS* (part of) *Gaul*. Notice the emphasis of **sua**.

31 7 negoti: part. gen. with **quid**; § 346. *a. 3* (216. *a. 3*); B. 201. 2; G. 369; H. 442 (397. 3); H-B. 346.

31 9 CHAP. 35. **quoniam**, etc.: Direct, —

Quoniam tanto *meo* populique Romani beneficio adfectus, cum in consulatu *meo* rex . . . appellatus *sit*, hanc *mihi* . . . gratiam *refert*, ut in conloquium venire . . . *gravetur* neque de communi re dicendum sibi . . . *putet*, haec *sunt* quae ab eo *postulo*: primum, ne quam multitudinem . . . in Galliam *traducat*; deinde obsides quos *habet* ab Haeduis *reddat*, Sequanisque *permittat* ut quos illi *habent* (*habeant*) voluntate eius reddere . . . *liceat*; neve Haeduos . . . *laccessat*, neve his . . . bellum *inferat*. Si id ita *fecerit*, *mihi* . . . *perpetua gratia* . . . cum eo *erit*; si non *impetrabo*, *ego*, — quoniam

. . . *senatus censuit* uti quicumque Galliam provinciam obtineret . . . Haeduos . . . defenderet, — (*ego*) Haeduorum iniurias non *neglegam*.

31 9 *tanto* . . . *adfectus*: see introductory note to this campaign, p. 287.

31 10 *beneficio* is explained by *cum* . . . *esset*, and *gratiam referret* by *ut* . . . *putaret*; the first *sibi* refers to Cæsar and the second to Ariovistus. In this sentence the causal clause is *quoniam* . . . *putaret*, and the leading verb is *esse*: *Since, though so greatly favored by the Romans, he made such an (ill) return (hanc gratiam referret) as to grudge coming to a conference when invited, and did not consider that he ought to speak or hear about their common business, (therefore) these were the demands he made (the things he required) of him, etc.* Observe that in Latin the significant word, the *verb* (*postularet*), becomes in English the *noun* (*demands*).

31 15 *ne quam*, *not any*.

31 18 *eius*: Ariovistus; *illis*: the Sequani.

31 21 *si non impetraret*: i.e. this pledge or assurance.

31 22 *M. Messala*, etc.: cf. note on **2 12**. This was in B.C. 61.

31 24 *obtineret*, *should hold* (as governor), *not obtain*. Avoid the kindred word in translation. Words are liable to change their meanings in 2000 years. See note on *obtinere*, **2 1**. For construction, cf. note on **6 10**. — *quod*, *so far as*. — *commodo* (abl. of specification) *rei publicae*, *to the advantage of the state*.

31 25 *defenderet*: see the reasons in the note on the campaign against Ariovistus, p. 287. — *se*: a repetition of *sese* above on account of the long parenthesis.

31 27 *CHAP. 36. ius esse*, etc.: Direct, —

Ius est belli ut qui vicerunt eis quos vicerunt quem ad modum velint imperent; item populus Romanus victis non ad alterius praescriptum . . . imperare consuevit. Si ego populo Romano non praescribo quem ad modum suo iure utatur, non oportet me . . . in meo iure impediri. Haedui mihi, quoniam belli fortunam temptaverunt et . . . superati sunt, stipendiarii sunt facti. Magnam Caesar iniuriam facit qui suo adventu vectigalia mihi deteriora faciat. Haeduis (ego) obsides non reddam, neque his . . . bellum inferam, si in eo manebunt quod convenit stipendiumque . . . pendunt; si id non fecerint, longe eis fraternum nomen populi Romani aberit. Quod mihi Caesar denuntiat se Haeduorum iniurias non neglecturum, nemo mecum sine sua pernicie contendit. Cum volet, congregiatur; intellet quid invicti Germani . . . qui inter annos XIV tectum non subierunt (subierint), virtute possint.

32 1 *eis*: governed by *imperarent*. The verbs are in the past by sequence of tenses: § 482, 485 (285, 287. *d*); B. 267; G. 518; H. 548 (495. iv); H-B. 476, 482. 1.

32 2 *victis*: governed by *imperare*. — *alterius*, *any one else's*.

32 5 *suo*: i.e. the Roman people. — *uteretur*: subjv. in an indir. quest.

32 6 *suo*: i.e. Ariovistus. — *sibi . . . stipendiarios*, *tributary to him*.

32 8 *qui faceret*, *in making*: subjv. also in dir. disc.; § 535. *c* (320. *c*); B. 283. 3; G. 633; H. 598 (517); H-B. 523.

32 10 *non . . . neque*, (on the one hand) *he would not restore*, etc., *but* (on the other) *he would not wrongfully*, etc.

32 11 *iniuria*, abl. of manner, § 412. *b* (248. R.); B. 220. 2; G. 399. N.¹; H. 473. 3 (419. iii. N.²); H-B. 445. 1.

32 13 *longe . . . afuturum*, *the name of brothers would be a great way off from them*, i.e. too far to help them.

32 14 *quod*, etc.: the whole clause is construed as an adv. acc.: *as to Caesar's threat*, etc.; cf. note on **16 18**, and § 572. *a* (333. *a*); B. 299. 2; G. 525. 2; H. 588. iii. N. (516. ii. 2. N.); H-B. 552. 2.

32 15 *secum, sua*: observe that these refer, one to Ariovistus, the other to his antagonist; § 300 (196. *a*); B. 244; G. 520; H. 504. 2 (449. 6); H-B. 262.

32 16 *cum vellet, congregederetur*, *he might come on when he would*.

32 17 *inter* refers to something coming between two extremes. Hence, when applied to time, it means the entire interval between the beginning and the end of a given period, and may be rendered *during*.

32 19 *CHAP. 37. eodem tempore*, etc.: in Latin the two actions are made coördinate, but in English we should be more likely to make one subordinate, *at the same time that*, etc.

32 20 *Treveris*: from the region of Treves in the valley of the Moselle. — *questum*: supine (after *veniebant*, supplied from the one preceding); see **26 15**, **28 8**, and notes.

32 21 *qui . . . essent*: § 592. 3 (341. *d*); B. 323; G. 650; H. 643 (524); H-B. 535. 1. *a*. The following passage is a good example of what is called informal indir. disc. The formal indir. disc. introduced by a verb of saying has the main clause in the infin. and dependent clauses in the subjv. But often the verb of saying and the thing said are expressed together in some one word or phrase, as here *questum*. In such cases the dependent clauses have the subjv. just as in formal indir. disc.; cf. **13 17**, **15 2**, **16 24** for similar examples.

32 22 *ne . . . quidem*: cf. note on **29 20**.

32 24 *pagos* (see note on **10 12**): these divisions were those known as *hundreds*, meaning not only the people but the district they occupied. — *Suevorum*: this is a general name, embracing a number of tribes that lived in the interior of Germany. Their habits and customs are described in the opening chapters of Book iv.

32 27 maturandum sibi (*sc. esse*): *impers.*; § 208. *d* (146. *d*); B. 138. iv; G. 208. 2; H. 518. 1 (465. 1); H-B. 600. 3. *a*; cf. **exspectandum**, 9 24 and note.

32 29 minus facile, *not very easily*; i.e. it would be *impossible*; but this is avoided as a word of ill omen. — **resisti**: *impers.*; § 372 (230); B. 187. ii. *b*; G. 217; H. 426. 3 (384. 5); H-B. 364. 2; cf. note on **rebus**, 30 19.

§§ 1 **magnis itineribus**: see chapter on military affairs, vi.

33 2 contendit: the place from which Cæsar started is uncertain. After the destruction of the Helvetian force he appears in the country of the Lingones, sixty to eighty miles north of Bibracte. In that vicinity he held a council of the Gallic chiefs (ch. 30), but whether he remained there is not stated. He probably came towards the north in the direction of Langres.

33 3 CHAP. 38. **tridui**: gen. of measure. — **viam**: § 390 (238); B. 176. 4. *a*; G. 333. 2; H. 409. 2 (371. ii. N.); H-B. 396. 1.

33 4 occupandum: gerundive agreeing with **Vesontionem**. — **Vesontionem**: the modern Besançon, about ninety miles E.N.E. of the former battle ground. There are many Roman remains here.

33 5 quod relates to **Vesontionem**, but agrees in gender with **oppidum**: § 306 (199); B. 250. 3; G. 614. 3. *b*; H. 396. 2 (445. 4); H-B. 326. 1.

33 6 finibus: the country which he had taken from the Sequani (Upper Alsace). — **processisse**, *had advanced*. The bracketed words are probably authentic, and at any rate may be translated. — **ne**, following **præcavendum**: § 558. *b* (331. *c*. 2); B. 295. 3; G. 548; H. 568 (497. ii); H B. 502. 3. *b*.

33 10 ducendum: cf. **occupandum** above, and note.

33 11 Dubis: the modern Doubs. This name is said to mean "black river." — **ut**, *as it were*.

33 12 spatium: object of **continet**.

33 13 pedum: pred. gen. after **est**; for construction with **amplius**, see § 407. *c* (247. *c*); B. 217. 3; G. 296. R.⁴; H. 471. 4 (417. N.²); H-B. 416. *d*. — **sexcentorum**: the real distance is about 1600 feet, but in other respects the present site exactly corresponds to Cæsar's words. See view, Fig. 18. — **qua**, *where*.

33 14 altitudine: abl. of quality or description. — **radices**: object, and **ripae**, subject of **contingant**.

33 15 hunc [*montem*], etc., *this an encompassing wall makes into a fortress*.

33 17 oppido: the town must be regarded as having occupied the lower ground towards the bend in the river.

33 20 CHAP. 30. **moratur**: cf. **24** 24 and note. — **percontatione**, *questions*. — **nostrorum**: i.e. the soldiers who inquired in regard to the enemy.

33 21 **vocibus**, *talk*. — **Gallorum**: these, it would seem, volunteered reports. The whole indicates a great deal of talk on the subject, and to this Caesar attributes the panic. — **mercatorum**: see note on **1** 8. — **magnitudine**: cf. **altitudine**, l. 14. Roman writers frequently speak of the huge size of the barbarians of the north as compared with themselves.

33 24 **congressos**, *having met them*.

33 27 **hic**: i.e. *timor*.

34 1 **reliquis**: i.e. aids or *attachés* (*contubernales, comites*), who attended the governor or commander of a province for the sake of military practice. These were often appointed from mere personal or political motives, and were of small use in the service, as it proved here. See chapter on military affairs, l. 7.

34 2 **quorum** . . . *inlata, these on various pretexts*: § 315, c (203, c); B. 253, 2; G. 319; H. 516, 1 (459, 1); H-B. 279, 3.

34 3 **quam** . . . *diceret, which, they said*: § 592, 3, N. (341, d, R.); B. 323; G. 626, R.; H. 649, 1 (528, 1); H-B. 535, 2, a, N.³. See also note on **qui** . . . **essent**, **32** 21. The verb is singular in Latin on account of **alius**.

34 6 **voltum fingere**, *put on a brave face* (**voltum** refers to the *expression* of the face).

34 7 **tabernaculis**: see Fig. 128.

34 9 **totis castris**: § 429, 2 (258, f, 2); B. 228, 1, b; G. 388; H. 485, 1 (425, ii, 2); H-B. 436, a. — **testamenta obsignabantur**: indicating utter despair.

34 11 **in castris**, *in service*.

34 15 **rem frumentariam** . . . **timere**, *feared (for) the supply of corn, lest it might not be conveniently brought in*: § 564 (331, f); B. 296, 2; G. 550; H. 567 (498, iii); H-B. 502, 4. Observe the force of **ut** after **vereri**.

34 17 **nuntiabant**: what did they say in dir. disc.? — **cum** . . . **iussisset**, for *cum iusseris* (fut. perf.) of dir. disc. — **castra moveri**, *to break camp*; the regular expression.

34 19 **signa latorios**: i.e. *advance*. This is the technical term, as the standards were planted in the ground during a halt.

34 20 CHAP. 40. **omnium ordinum**, *of all ranks*. Was this usual? See chapter on military affairs, l. 7.

34 22 **quam** . . . **ducerentur**: indir. quest.; cf. **10** a.

34 23 **sibi quaerendum**, etc., *that they had a right to inquire* (lit. *it ought to be inquired*) or *consider* (lit. *it ought to be thought*).

34 24 **putarent**: see note on **32** 21. — **Ariovistum**, etc.: Direct, —

Ariovistus me consule . . . populi Romani amicitiam adpetiit; cur hunc . . . quisquam ab officio discessurum iudicet? Mihi quidem persuadetur, cognitis meis postulatis . . . eum neque meam neque populi Romani gratiam repudiaturum. Quod si furore . . . impulsus bellum intulerit, quid tandem vereamini? aut cur de vestra virtute aut de mea diligentia desperetis? Factum (est) eius hostis periculum . . . ; factum (est) etiam nuper in Italia servili tumultu, quos tamen aliquid usus ac disciplina quam a nobis acceperant sublevabant. Ex quo iudicari potest quantum habeat in se boni constantia, propterea quod, quos . . . inermis sine causa timuistis (timueritis), hos postea armatos superavistis.

Denique *hi sunt idem Germani* quibuscum saepenumero Helvetii congressi, non solum in suis sed etiam in illorum finibus, plerumque *superaverunt*; qui tamen pares esse nostro exercitui non *potuerunt*. Si quos adversum proelium . . . *commovet, hi, si quaerent (quaerant), reperire possunt . . . Ariovistum . . . dispersos subito adortum, magis ratione . . . quam virtute vicisse. Cui rationi contra homines barbaros . . . locus fuit, hac ne ipse quidem sperat* nostros exercitus capi posse.

Qui suum timorem in rei frumentariae simulationem . . . *conferunt, faciunt* adroganter, cum . . . de officio imperatoris desperare . . . *videantur (videntur)*. Haec *mihi sunt* curae; frumentum *Sequani, . . . subministrant, iamque sunt . . . frumenta matura; de itinere (vos) ipsi . . . iudicabitis.*

Quod non fore dicto audientes . . . *dicimini* (more probably *dicuntur milites*), nihil (*ego*) ea re *commoveor*; scio enim, quibuscumque exercitus dicto audiens non fuerit, . . . avaritiam esse convictam; *mea innocentia* perpetua vita, *felicitas . . . bello est perspecta.*

Itaque (*ego*) quod . . . conlaturus *fui repraesentabo, et . . . castra movebo, ut . . . intellegere possim* utrum apud *vos* pudor . . . an timor plus *valeat*. Quod si praeterea nemo *sequetur, tamen (ego) cum sola decima legione ibo, de qua non dubito, mihique ea praetoria cohors erit.*

This speech, one of the most remarkable, if not of the most famous, of antiquity, stamps Cæsar as a consummate orator as well as an able general. His whole fortunes may be said to have depended on this campaign, at the outset of which he is confronted with a mutiny. By this skilfully contrived address, in which he glosses over the difficulties of the undertaking, which he must have known well, he contrives to inspire in his soldiers the Roman spirit, which was invincible whenever it was really roused. Cæsar's marvellous conquest of Gaul depended quite as much on the devotion of his soldiers as on his unequalled ability as a general.

34 25 *cur quisquam iudicaret, why should any one think?* For the form of question, see § 586 (338); B. 315. 3; G. 651. R.2; H. 642. 3 (523. ii. N.); cf. II-B. 513. 1 (dir., *iudicet*, dubit. subjv.). For the use of

quisquam, implying a negative, see § 311 (105. *h*); B. 252. 4; G. 317; H. 513 (457); H-B. 276. 7.

34 26 sibi persuaderi: see note on **30 19**; the subject of **persuaderi** is **eum . . . repudiaturum**.

35 1 quod . . . si intulisset, *but if he should*, etc.

35 2 quid tandem, etc., *what, pray should they be afraid of?*

35 3 sua, *their OWN*; **ipsius**, *his; ipse*, used in this way to avoid the repetition of *sua*, is an *indirect reflexive*; § 300. *b* (196. *a. 2. N.*); B. 249. 3; G. 660. 5; H. 509. 5 (452. 5); H-B. 263. 2.

35 4 periculum (root in *experior*), *a trial*. — **Cimbris**, etc.: this was in B.C. 102 and 101, a little more than forty years before, and was the worst danger that had threatened the Romans since the destruction of the city by the Gauls three centuries before. See Roman histories. — **cum . . . videbatur**: although this clause was a part of Cæsar's speech to his officers, yet the indic. is used to emphasize to the reader the *reality* of the fact it asserts; § 583. *a* (336. *d*); B. 314. 3; H. 652. 1 (529. *N.^{1,2}*); H-B. 535. 1. *d*.

35 6 meritus: sc. *esse*.

35 7 servili tumultu (abl. of time): the insurrection of the slaves and gladiators under Spartacus, B.C. 73-71. These consisted, in part, at any rate, of Germans captured by Marius. A war at home, i.e. in Italy or on its borders, was called *tumultus*. — **quos** (referring to *servos* implied in *servili*) . . . **sublevarent** (change to pass. in translation, so as to keep the emphasis), *who yet were considerably helped by the training and discipline which they had got from us*. — **aliquid**: adv. acc.

35 9 quantum . . . boni, etc., *how much advantage firmness has*: § 289. *a* (189. *a*); B. 237. 2. *a*; G. 204. *N.²*; H. 442 (397. 3); H-B. 249. 1; for the tense of **haberet**, see § 485. *d* (287. *d*); H. 549 (495. *v*); H-B. 482. 1.

35 10 quos . . . hos: notice the antecedent following the relative. — **inermis**: i.e. the slaves of Spartacus's force.

35 12 hos esse: the Germans with Ariovistus. — **quibuscum . . . congressi**, etc. (changing the relative clause), *whom the Helvetii had often met and beaten not only on their own ground, but even*, etc.

35 14 qui: i.e. the Helvetii. — **tamen**: i.e. though they were strong enough to beat the Germans, *after all*, etc.

35 15 potuerint: § 485. *c. N.¹* (287. *c. R.*); B. 268. 6; G. 513; H. 550 (495. *vi* and *ftn.²*); cf. H-B. 491; cf. also **9 18** and **28 6**. — **adversum proelium**: see **27 21 ff.** — **si quos . . . commoveret**, *if any were alarmed by* (lit., *if the disastrous battle disturbed any*).

35 17 Ariovistum: subject of **vicisse**.

35 18 neque . . . fecisset, *and had given them no chance at him*.

36 2 adortum agrees with **Ariovistum** and governs **desperantis**, with which a pronoun (*eos*) must be supplied in English. This may always be omitted in Latin if any word appears to show its case.

36 3 cui rationi . . . hac = *hac rationi cui*: the noun being attracted to the relative clause; *by this stratagem, for which there had been room against unskilled barbarians, not even Ariovistus himself hoped that our armies could be taken in*; § 307. *b* (200. *b*); B. 251. 4. *a*; G. 616; H. 399. 5 (445. 9); H-B. 284. 6; cf. note on **30 19**.

36 6 qui . . . conferrent, (those) *who laid their own cowardice to the pretended difficulty about provisions, etc.*

36 8 desperare, etc., *to be discouraged about the commander's doing his duty*. Such words as *officium* have a wider range of meaning in Latin than similar words in English, as *duty, a duty, sense of duty, discharge of duty*. — **praescribere**: sc. *officium*; i.e. that they were dictating to him *what his duty was*.

36 9 sibi . . . curae: cf. **22 6, 22 15**.

36 10 subministrare, *were (now) furnishing*. — *esse, were beginning to be*. — **frumenta, crops**; note the plur. and cf. with meaning of the sing.

36 12 quod . . . dicantur, *as to its being said that they would not, etc.*; cf. **12 11, 15 14, 32 14**. — **dicto audientes, etc.**: cf. **34 18**.

36 13 nihil, no way. — **re**: see note on **4 4**. — **quibuscumque**: dat. after **audiens dicto**; i.e. no one has ever had a mutinous army who has not either been unsuccessful through his own fault, so that his men had no confidence in his ability, or else has been convicted of avarice by some overt act, so that they had no confidence in his integrity.

36 16 suam, his own: emphatic by position; equivalent to *in his case*. — **innocentiam**: the technical word, meaning freedom from the charge of plunder and extortion. In fact, Cæsar's fault lay just the other way, — a lavish and reckless generosity at the expense of subjects or allies. In this sentence, in opposite (chiastic) order, **innocentiam** is opposed to **avaritiam**, and **felicitem** to **male re gesta**; a peculiarly Latin turn.

36 18 quod . . . fuisset, *what he had intended to defer*. — **repraesentaturum**, *he would do at once*. This is a legal term, meaning *to do a thing before the time*.

36 21 officium: cf. note on **36 8**.

36 22 decima legione: this was the legion which had been stationed in the province of Gallia Transalpina (cf. **5 19**); it was distinguished for discipline and courage.

36 23 praetoriam cohortem, body-guard, made up of the bravest men.

36 28 **CHAP. 41. innata est**: agreeing with the last noun; cf. **cap-tus est. 24 7**.

37 1 *optimum iudicium fecisset*, had expressed the very highest opinion (a technical phrase).

37 3 *cum tribunis . . . egerunt*, etc., urged upon the tribunes . . . to apologize.

37 4 *primorum*: see chapter on military affairs, I. 7.

37 6 *summa belli*, the policy of the campaign. — *suum . . . sed imperatoris*: predicates after *esse*; § 343. *b* (214. *c*); B. 198. 3; G. 366; H. 447 (402); H-B. 340.

37 7 *satisfactione*, apology; cf. *satisfacerent*, above.

37 8 *ei*, in him; after the phrase *fidem habere* = *fidere*, which takes the dat. or abl.

37 9 *ut . . . duceret* (result): depends upon *itinere exquisito*; *duceret* refers to *itinere*. The sense is, such (a route) that it led, etc., a road which led. Cæsar might have said *quod duceret* but for the *quod* in the previous line. The valley of the Doubs above Besançon is very narrow and the mountains are precipitous; but, turning first to the north by the railroad coming from Vesoul and then up the valley of the Oignon River, the country becomes tolerably open to Villersexel and to Belfort, which lies in the gap between the Vosges and the Jura. This pass is interesting as having been for ages one of the great avenues from Germany into Gaul. See view, Fig. 20 and map, Fig. 22. — *miliam [passuum]* limits *circuitu*, by a circuit of more than fifty miles. This must be reckoned as the distance to be traversed before coming to the main road again at about Belfort.

37 11 *septimo die*, etc.: at this time Cæsar must have been somewhere near Mühlhausen (Mulhouse), about seventy-five miles from Besançon (see maps, Figs. 3, 22); at any rate, at some point beyond Belfort on the route from Besançon to Strasburg (120 miles), having passed beyond the gap into the valley of the Rhine. Ariovistus was then some twenty-four miles farther on.

37 12 *a nostris*: i.e. forces.

37 15 *CHAP. 42. quod*: a relative; antecedent is *id*. — *per se*, so far as he was concerned (a common expression with *licet*).

37 16 *accessisset*: the subject is Cæsar.

37 17 *non respuit*, etc.: notice the emphasis. Cæsar did not reject the offer (as one might have supposed he would do).

37 18 *iam . . . reverti*, that he was beginning to return. — *arbitratur*: the imperfect indicating the beginning of an action.

37 19 *petenti [Caesari]*, when he asked it. — *ultro*: opposed to *petenti*.

37 21 *fore uti . . . desisteret*: periphrastic future (cf. 18 1, 28 17) following *spem*; that he would cease from his stubbornness.

37 23 **conloquio**: dat. of purpose; § 382. 2 (233. *b*); B. 191; G. 356. N.¹; H. 433 (390. ii); H-B. 361.

37 26 **vereri**: sc. verb of saying from **postulavit**. Note the force of **ne** after **vereri** and cf. **ut**, **34** 16.

37 27 **veniret**: for *veniat* (hortatory) of dir. disc. — **alia ratione**, on any other terms.

37 28 **interposita causa** (abl. abs.), by putting in an excuse.

37 29 **Gallorum equitatus**: he had no other; see chapter on military affairs, 1. 2. They numbered about 4000, about the same as a legion.

38 1 **commodissimum**: pred. adj. after **esse**, whose subject is the infin. clause **eo . . . imponere**.

38 2 **Gallis equitibus**, dat. following **detractis**: § 381 (229); B. 188. 2. *d*; G. 345. R.¹; H. 427 (385. ii. 2); H-B. 371. — **eo** (= *in eos*), upon them.

38 4 **si quid**, etc., if there should be need of any active measures; **quid** is adv. acc.; § 390. *c. d* and N.² (240. *a*); B. 176. 3; G. 333. 1; H. 416. 2 (378); cf. H-B. 387. iii.

38 5 **facto**: § 243. *e. N.*; B. 218. 2. *c*; G. 406; H. 477. iii (414. N.³); H-B. 430. 2. *b*. — **quod cum fieret**, while this was going on. On the use of the rel., see note on **58** 9.

38 7 **pollicitum**: see **36** 23.

38 8 **ad equum rescribere**, he enrolled them among the knights. The word *equites* means not only the cavalry service in war but a special privileged class in Roman society.

38 9 **CHAP. 43. tumulus terrenus**, a smooth (i.e. not rocky) hill.

38 10 **spatio**: abl. of degree of difference.

38 12 **equis**, on horseback, abl. of means. — **passibus ducentis** (abl. of distance, or degree of difference) = 320 yards.

38 15 **se**: plural. — **denos**, ten on each side.

38 18 **appellatus esset**: see note on **32** 21. — **amicus**: sc. *appellatus esset*. — **munera**: according to Livy (xxx. 15), the gifts sent to Masinissa, king of Numidia, were "a golden crown and bowl, a curule chair, an ivory staff, an embroidered toga, and a tunic with palm-leaf figures," such as were worn in triumphal processions.

38 19 **quam rem**, a tribute which; see note on **30** 19.

38 20 **docebat**, showed him. — **illum**: emphatic as opposed to other beneficiaries implied in the preceding.

38 21 **aditum**: i.e. right to approach the Senate.

38 22 **ea præmia consecutum**, had attained these prizes, as if he had eagerly sought them (cf. introductory note to campaign against Ariovistus, p. 287).

38 24 *ipsis* (instead of *sibi*, which might refer to Cæsar alone): the Romans. — *intercederent*, *existed between*, indir. quest.

38 27 *adpetissent*: § 592. I (341. *b*); B. 323; G. 633; H. 652 (529. ii); H-B. 535. 1. *a*. In the dir. this might be either perf. indic. or the same as here. If only priority of time is meant, it would be indic.; if there is any internal relation between the main clause and the time clause, it would require the subjv. In this case the latter seems more probable.

38 28 *populi*, etc.: Direct, —

Populi Romani haec est consuetudo ut socios atque amicos non modo sui nihil deperdere, sed gratia . . . auctiores velit esse; quod vero ad amicitiam populi Romani adtulerunt, id eis eripi quis pati possit?

38 29 *sui nihil*, *nothing of their own* (dignity, etc.); *sui* is used substantively, and is a part. gen.

39 1 *quod . . . adtulissent*, *what they had brought to the alliance*; i.e. the independence and dignity which they had possessed.

39 2 *posset*: § 587 (338. *a*); B. 300. 2; G. 651. R.²; H. 642. 3 (523. ii. 1. N.); cf. H-B. 503. — *postulavit eadem*, *he made the same demands*.

39 3 *ne*, etc.: these clauses are in apposition with *eadem*, and are indirectly quoted from imperative forms of the dir. disc.

39 8 CHAP. 44. *transisse*, etc.: Direct, —

Transii Rhenum (ego) non mea sponte, sed rogatus et arcessitus a Gallis; non sine magna spe . . . domum . . . reliqui; sedis habeo in Gallia ab ipsis concessas, obsides ipsorum voluntate datos; stipendium capio iure belli quod victores victis imponere consuerunt. Non ego Gallis, sed Galli mihi bellum intulerunt; omnes Galliae civitates ad me oppugnandum venerunt ac contra me castra habuerunt; eae omnes copiae a me uno proelio pulsae ac superatae sunt. Si iterum experiri volunt, (ego) iterum paratus sum decertare; si pace uti volunt, iniquum est de stipendio recusare quod sua voluntate ad hoc tempus pefenderunt.

Amicitiam populi Romani *mihi* ornamento et praesidio, non detrimento esse oportet, idque . . . hac spe petii. Si per populum Romanum stipendium remittetur et dediticii subtrahentur, non minus libenter . . . recusabo populi Romani amicitiam quam adpetii.

Quod multitudinem Germanorum in Galliam traduco, id *mei* muniendi, non Galliae impugnandae causa facio: eius rei testimonium est quod nisi rogatus non *veni*, et quod bellum non *intuli*, sed *defendi*. *Ego* prius in Galliam *veni* quam *populus Romanus*. Nunquam ante hoc tempus *exercitus* populi Romani . . . provinciae finibus egressus (est). *Quid tibi vis?* Cur in *meas* possessiones *venis?* *Provincia mea haec est Gallia*, sicut *illa vestra*. Ut *mihi* concedi non oportet, si in *vestros* finis impetum faciam, sic item *vos estis iniqui* quod in *meo* iure *me* interfellitis.

Quod fratres a senatu Haeduos appellatos *dicis*, non (*ego*) tam *barbarus* . . . *sum* . . . ut non *sciam* neque bello Allobrogum proximo Haeduos Romanis auxilium tulisse, neque ipsos, in his contentionibus quas Haedui *mecum* . . . *habuerunt* (*habuerint*), auxilio populi Romani usos esse.

Debeo suspicari simulata *te* amicitia quem exercitum in Gallia *habes* *mei* opprimendi causa habere. *Tu* nisi *decedes* atque exercitum *deduces* . . . *ego* *te* non pro amico, sed pro hoste *habebo*. Quod si *te* *interfecero*, multis (*ego*) nobilibus . . . gratum . . . *faciam*; id (*ego*) ab ipsis . . . compertum *habeo* quorum omnium gratiam . . . *tua* morte redimere *possum*. Quod si *discesseris* et . . . possessionem Galliae *mihi* tradideris, magno *ego* *te* praemio *remunerabo*, et quaecumque bella *geri* *voles* sine ullo *tuo* labore . . . *conficiam*.

39 9 *rogatum* et *arcessitum*: participles expressing cause.

39 10 *sine magna spe magnisque praemiis* = *sine magna spe magnorum praemiorum*; hendiadys, cf. 28 25 and note.

39 11 *obsides*: object of *habere*. Translate the participles *concessas* and *datos* by relative clauses.

39 14 *sibi*, *on him*, referring to the main subject, Ariovistus. — *ad se oppugnandum*: gerundive expressing purpose; cf. 33 4, 33 10.

39 21 *oportere*: *impers.*; its subject is *amicitiam* . . . *esse*. — *id*, not *eam*, because it refers to the idea, *ut amicus populi Romani esset*. — *si remittatur*: fut. cond.; § 516, 589 (307, 337); B. 268. 7; G. 656; H. 573. 1, 646 (507. i, 527. i); H-B. 536, 579. a; the pres. for imperf., contrary to regular sequence, for greater vividness.

39 22 *per*, *through the action of*.

39 23 *subtrahantur*, *are got away* (by underhand means).

39 25 *quod* . . . *traducat*, *as for his bringing over*; made subjv. by indir. disc.

39 26 *impugnandae*: observe the gerundive.

40 4 *provinciam*: emphatic; i.e. he had a right to govern it as the Romans did their provinces. — *hanc Galliam*, *this part of Gaul*.

40 5 *ut* . . . *sic*, *as . . . so*. — *ipsi*: i.e. Ariovistus (used as an *indirect reflexive*); see note on 35 3.

40 8 *quod*, *in that*.

40 9 *imperitum rerum*: i.e. unsophisticated; for construction, cf. 18 22.

40 10 *bello proximo*: i.e. B.C. 62.

40 14 *debere se suspicari*, etc., *he had ground to suspect that Cæsar, in keeping an army in Gaul, kept it under the pretence of friendship, [but really] for the purpose of crushing him* (Ariovistus).

40 15 *sui opprimendi causa*: gerund; § 504. c (298. a); cf. B. 339. 5; cf. G. 428. R.; H. 626. 3 (542. i. N.1); cf. H-B. 614.

40 18 nobilibus . . . gratum: Cæsar was the recognized head of the party opposed to the Senate and nobility. Many of the aristocracy would have been glad of any safe way to be rid of him.

40 20 compertum habere has almost the force of *comperisse*; § 497. *b* (292. *c*); B. 337. 7; G. 238; H. 431. 3 (388. 1. N.); H-B. 605. 5.

The three relatives **qui** (l. 16), **quod** (l. 17), and **quod** (l. 21) illustrate the principle that the relative, serving to connect with the previous proposition, may represent various conjunctions: *if then he should not withdraw* (**qui** = *is igitur*); *and if he should kill him* (**quod**, adv. acc.); *but if he should withdraw* (**quod** = *sed*, etc.).

40 25 CHAP. 45. **in eam sententiam qua re**, *to this effect* (to show) *why*.

40 26 negotio: abl. of separation. — **posset:** indir. quest.; cf. **18 15**, **29 15**, **38 23**. — **neque suam**, etc.: Direct, —

Neque *mea* neque populi Romani *consuetudo patitur* uti optime meritos socios *deseram*, neque *ego iudico* Galliam potius esse Ariovisti quam populi Romani. Bello *superati sunt Arverni et Ruteni* ab Q. Fabio Maximo, quibus populus Romanus *ignovit* neque in provinciam *redegit* neque stipendium *imposuit*. Quod si antiquissimum quodque tempus spectari *oportet*, populi Romani iustissimum *est* in Gallia imperium; si iudicium senatus observari *oportet*, libera *debet* esse Gallia, quam bello victam suis legibus uti *voluerit*

40 28 neque se iudicare, and **HE did not** CONSIDER; notice the emphasis.

41 1 bello superatos: B.C. 121, when the Allobroges also were subdued, and the Province probably organized; notice the emphasis. These peoples had been *conquered*, a fact which gave special rights to the Romans.

41 3 ignovisset: but, in fact, their country lay beyond the naturally strong frontier of the Cévennes, and so could not then be conveniently occupied by the Romans.

41 4 antiquissimum quodque: § 313. *b* (93. *c*); cf. B. 252. 5. *c*; G. 318. 2; H. 515. 2 (458. 1); H-B. 278. 2. *b*; Cæsar, referring to the statement of Ariovistus in **39 28**, claims priority of conquest for the Romans.

41 7 suis, *its own*, referring through **quam** to **Galliam**.

41 8 voluisset: the subject is *senatus* understood.

41 9 CHAP. 46. **geruntur:** for tense after **dum**, cf. **24 24**, **33 19**.

41 10 tumultum: governed by **propius**, which sometimes has the force of a prep.; § 432. *a* (261. *a*); B. 141. 3; G. 416. 22; H. 420. 5 (437. 1); H-B. 380. *b*.

41 14 periculo legionis, *danger to the legion*; notice that in Latin the gen. is the regular form of one noun dependent on another, whatever prep. we may use to express the relation.

41 15 *committendum non putabat, ut dici posset, he thought that no ground should be given for saying.* The subject of *committendum* is the *ut*-clause: § 568. N.¹ (332. *c*); B. 297. 2; G. 553. 1; H. 571. 1 (501. i. 1).

41 16 *per fidem, through (misplaced) trust.*

41 17 *elatum est, it was reported.* Observe the regular mood and tense after *posteaquam*; cf. **4 17** and note.

41 18 *omni Gallia*: abl. of separation with *interdixisset*; § 400 (243); B. 214; G. 390; H. 462 (413); H-B. 408. 3.

41 20 *ut, how, with indir. quest.*

42 2 *CHAP. 47. coeptae*: this verb is regularly pass. when used, as here, with a pass. infin. (*agi*).

42 3 *uti constitueret*: following *velle*; § 563. *b* (331. *b*); B. 296. 1; G. 546; H. 565 (498. i); H-B. 587. *a*.

42 4 *suis*: refers to Cæsar; *se* (l. 5) to Ariovistus.

42 6 *eo magis*: cf. *hoc facilius*, **2 17** and note. — *retineri quin, be kept from*: § 558 (319. *d*); B. 284. 3; G. 554; H. 595. 2 (504. 4); H-B. 502. 3. *b*.

42 7 *legatum [e suis]* = *one of his own (officers) as an envoy.*

42 8 [*e suis*]: this may either be translated or omitted. The meaning is essentially the same. — *magno . . . missurum, it would be at great risk that, etc.* This meaning is given by the emphatic position of *magno*, etc. The Latin often puts into one sentence ideas which we are inclined to express (for emphasis) in two.

42 11 *humanitate*: not *humanity* (cf. note on *obtinere*, **2 1**); the word refers to his education.

42 12 *Flacco*: governor of Gaul B.C. 83. It was customary for slaves or aliens to become clients of the person from whom they received freedom or citizenship and to take his *gentile* name: § 108 (80. *a*); G. p. 493; H. 354 (649); H-B. 678. 1. Thus, here Procillus takes the name (C. Valerius) of his patron Flaccus, retaining his own as *cognomen*. — *civitate donatus erat*: § 364 (225. *d*); B. 187. i. *a*; G. 348; H. 426. 6 (384. ii. 2); H-B. 365. *b*.

42 13 *qua multa . . . utebatur, which Ariovistus spoke freely.*

42 14 *in eo, in him.*

42 15 *peccandi causa, ground of offence*: i.e. the Germans had no reason to commit any outrage on him, as they might on a Roman.

42 16 *hospitio*: the relation of *hospes*, existing between two persons of different cities or nations, made a sacred bond far closer than that of simple *hospitality*; see *Vocab.*

42 18 *quos*: cf. note on **25 5**. — *conspexisset*: note the subjv. and cf. **4 12**, **6 14**, **7 17**, and notes.

42 20 *venirent*: indir. disc. for *venitis*. — *conantis*, etc.: this proceeding was evidently for effect upon the army which was in attendance. Ariovistus cried out aloud and did not allow the messengers to be heard.

42 22 *CHAP. 48. a Caesaris castris*: this camp is placed by Napoleon III at the southern foot of the Vosges Mountains near Cernay (Sennheim), a few miles northwest of Mühlhausen, and thirty miles beyond Belfort (Fig. 20), the fortress which now defends this pass on the frontier between France and Germany. The march of Ariovistus placed him nearer the passage, so as to cut off Cæsar's supplies.

42 25 Whether this camp was between Cæsar and the Vosges Mountains or merely beyond him in the open is uncertain.

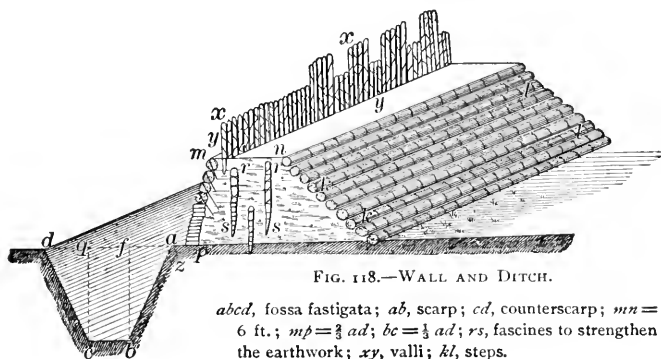

FIG. 118.—WALL AND DITCH.

abcd, fossa fastigata; *ab*, scarp; *cd*, counterscarp; *mn* = 6 ft.; *mp* = $\frac{2}{3}$ *ad*; *bc* = $\frac{1}{3}$ *ad*; *rs*, fascines to strengthen the earthwork; *xy*, valli; *kl*, steps.

42 26 *supportaretur*: § 593 (342); B. 324. 1; G. 629; H. 652 (529. ii); H-B. 539; and cf. **14 7**, **24 21**.

42 28 *instructam habuit*: cf. **40 20** and note.

43 1 *vellet*: for construction, cf. *supportaretur*, **42 26**.

43 3 *castris*: the *place where* may omit the prep. when the idea of means is prominent; § 429 (258. *f*); B. 228. 1; G. 389; II. 485. 2. (425. ii. 1. 1); cf. H-B. 446. 1.

43 4 *hoc*: pointing to the description which follows. — *se exercuerant, were trained*: § 476 (279. *e*); B. 262. A; G. 241. 3. R.; H. 299. 2 (297. i. 2); H-B. 487.

44 1 *singuli* [*equites*] *singulos* [*pedites*]: i.e. one apiece.

44 5 *si quo . . . prodeundum*, if there was occasion for advancing to any place.

44 7 *cursum adaequant*: Tacitus (Ger. 6) says: "They fight in combination [infantry and cavalry], and the foot soldiers, picked out of

the entire body of young men and placed in front of the line, are able to keep up with the cavalry in speed." This method of fighting, peculiar to the Germans, seemed so advantageous to Cæsar that he employed it himself on occasion, notably at the battle of Pharsalia.

44 10 CHAP. 49. **conederant**: cf. **exercuerant**, above.

44 11 **acie triplici**: see chapter on military affairs, VII.

44 13 **castra munire**: the spade and pickaxe were as familiar to the Roman soldier as the sword or javelin. See chapter on military affairs, V, also Figs. 23, 54, 69, 118, 119. In this case Cæsar had one larger camp about two miles east of the Germans, and a smaller one rather more than half a mile to the south of them.

45 8 CHAP. 50. **instituto suo**, according to his previous practice: § 418. *a* (253. N.); B. 220. 3; G. 397; H. 475. 3 (416); H-B. 414.

45 11 **tum**: note the emphasis.

45 13 **quae . . . oppugnaret**: a purpose clause; cf. l. 3 above.

45 14 **pugnatum est**: how translated? Cf. note on **23 1**.

45 19 **matres familiae**: according to Tacitus (*Ger.* 8), it was not matrons only, but women as a class, or most of them, to whom this prophetic power was ascribed.

45 20 **sortibus**: lots of leaves or twigs marked with certain signs and drawn by chance. — **vaticinationibus**: perhaps omens interpreted from the noise of waters, river eddies, etc., or possibly the mere prophetic impressions analogous to "second sight." — **declarant**: § 568 (332); B. 297. 1; G. 557; H. 571. 2 (501. i. 2); H-B. 521. 3. *a*. — **utrum . . . necne**: § 335 (211); B. 162. 4; G. 458; H. 380 (353); H-B. 234. *a*.

45 21 **non esse fas**, it was not fated.

45 22 **novam lunam**: a common superstition among semicivilized peoples (cf. Tacitus, *Ger.* 11); so the Spartans refused to advance to Marathon before the full moon.

45 25 CHAP. 51. **alarios**: the auxiliaries as distinguished from the legionary (Roman) troops. They were usually stationed on the wings of the line of battle; hence their name, from *ala*, a wing.

45 26 **pro**: note the force of the prep. here as distinguished from its meaning in **46 1**; cf. also **3 1**.

46 2 **ad speciem**, to make a show, as if the two legions were still there, while in fact they had joined the other force at the greater camp. — **acie**: of the legionaries alone. The six legions in battle array (**triplici acie**) presented a front of more than a mile in length.

46 3 **necessario**: the necessity seems to have come from the fact that the tactics of the Germans demanded more room than a crowded stronghold could give. Rarely in ancient warfare was a fortified camp

assailed. The usual way was to form two battle lines between the fortified camps.

46 5 *intervallis*: § 412 (248); B. 220. 1; G. 399; H. 473. 3 (419. iii); H-B. 445.

46 8 *eo*, *thereon*, i.e. the carts and wagons; cf. note on **eo**, **38 2**.

46 9 *proficiscentis*, (the men) *as they advanced* (object of *implorabant*).

46 11 CHAP. 52. See chapter on military affairs, VII, for description of a battle.—*singulos legatos*, etc.: i.e. *a legatus in command of each legion*. This was the beginning of a very important reform in the military organization. Cæsar felt so keenly the evil of the command being divided among six tribunes that he detailed one of his *legati* nominally to assist the tribunes. After this time we find the *legatus* as the regular commander of a legion, with the six tribunes under him. On this occasion, having only five *legati*, he also appointed his quartermaster (*quaestor*) to that one of the six legions which was intended to be under his own special command.

46 13 *eam partem*: that, of course, would be the enemy's left.

46 14 *ita acriter . . . ut*, *so fiercely that*.

46 17 *coniciendi*: observe the gerund with a dir. object (*pila*). Give the corresponding gerundive construction.

46 20 *in phalanga*, *upon the phalanx*. This was a compact body of men with shields close locked in front and above, lapping over one another like shingles on a roof. See Fig. 68, the Roman *testudo*.

46 21 *revellerent*, etc.: i.e. they leaped upon the roof of shields, pulled them up, and so thrust their swords down from above (*desuper*).

46 24 **P. Crassus**: son of Marcus Crassus the triumvir. He next appears at the head of an important expedition against the Aquitanians, pp. 88-92.

46 25 *adulescens*: like our *junior*, to distinguish him from his father.—*expeditior*, *more free*.

46 26 *tertiam aciem*: the line of reserves, kept for just such emergencies.

47 1 CHAP. 53. *restitutum est*: contrasted with *laborantibus*, above.

47 2 *prius . . . quam . . . pervenerunt*: see note on **38 27**.

48 1 **Rhenum**: the nearest point on this river was a little below Bâle, somewhat more than five miles distant from the supposed place of the engagement. But the Germans may have fled down the valley of the Ill, reaching the Rhine near Rheinau, some fifty miles from the battlefield.

48 2 *tranare contenderunt*, *by great effort swam across*.

48 5 *reliquos omnis*: said to be 80,000.

48 6 *duae uxores*: only chiefs among the Germans, says Tacitus (Ger. 18), had more than one wife; and this was for the sake of honor and alliances.

48 7 *Sueva*: for character and customs of the Suevi, see Bk. iv. chs. 1-3.

48 8 *duxerat*: cf. note on **8 7**. Observe that *duxerat* in the line above has a different meaning.

48 10 *Procillus*: see **42 10**.

48 11 *trinis catenis*, *three* (sets of) *manacles*.

48 16 *eius calamitate*, *by any harm to him*; *eius* is obj. gen., and refers to Procillus.

48 17 *quicquam*: adv. acc.; § 390. *d* and *N.*² (240. *a*); B. 176. 3; G. 333. 1; H. 416. 2 (378. 2); cf. H-B. 396. 2.

48 18 *se præsente*, *in his presence*. — *ter*: it was the regular usage of the Germans to consult the lot thrice (Tacitus, Ger. 10). This has come down to the present day in sundry games, etc. — *consultum*: *impers.*, sc. *esse*.

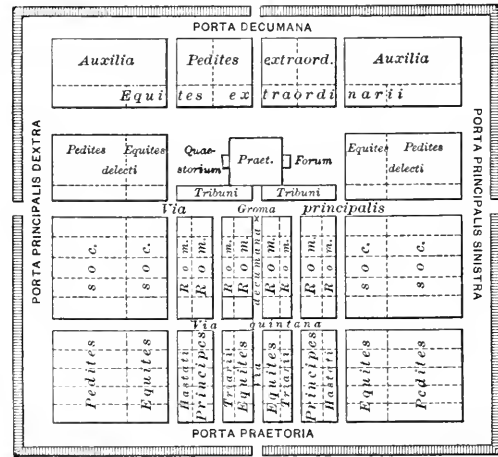

FIG. 119. — CASTRA ROMANA.

48 19 *neicaretur*: indir. quest.; the dir. was a dubit. subjv., *neceretur*. The site of this battle is still very uncertain. The account of Cæsar's march would seem to point to some place from thirty to fifty miles beyond Belfort, and accordingly it has been located by some near Cernay and by others near Gemar, twenty miles farther down the valley. Perhaps it may have been even nearer the gap than Cernay. The plan in the text, that of Col. Stoffel, must be taken, therefore, only as a supposable arrangement. The country is nearly the same in all that region, and a few miles can make no difference. The great point is that for the first time a Roman army ventured beyond one of the natural bounds of Gaul into the valley of the Rhine and defeated a German horde on its own ground, as it were. The campaign against

Ariovistus settled the question of sovereignty over Gaul for several centuries to come. The Germans did not gain possession of it until after the fall of the western Roman empire.

48 24 CHAP. 54. **Ubii**: these lived near the modern Cologne, and were deadly enemies of the Suevi, and therefore generally in alliance with the Romans (Bk. iv. ch. 3).—**Rhenum**: governed by **proximi**; § 432. *a* (261. *a*); B. 141. 3; G. 359. N.¹; II. 420. 5 (391. ii. 2); H-B. 380. *b* and cf. **propius tumulum**, **41 10**.

48 26 **maturius**, *earlier*: the decisive battle with Ariovistus was fought somewhere about the 10th of September.

48 28 **in citeriorem Galliam**: south of the Alps.

48 29 **conventus**: the proconsular courts held for the administration of justice. A further reason for going was to be nearer Rome and to watch political movements there.

BOOK SECOND. — B.C. 57.

THE BELGIAN CONFEDERACY.—The people of northern Gaul, including Flanders and the Netherlands, were far remote from any country hitherto occupied by the Roman arms. They lived amid forests and swamps hard to penetrate; they claimed kindred with the German tribes rather than with the more fickle and effeminate Celts; and they had a fierce and resolute spirit of independence, like that which their descendants, the Dutch, exhibited long after in the same regions against the armies of Spain. The Belgian tribes, and particularly the Nervii, appear to have offered to Cæsar a more formidable and desperate resistance than any he met elsewhere until the great rising of B.C. 52. When their spirit was once broken, the conquest of the whole country was simply a question of time.

READING REFERENCES ON THE CAMPAIGN AGAINST THE BELGIAN CONFEDERACY.

- Dodge's Cæsar, chaps. 7, 8.
 Fowler's Julius Cæsar, chap. 10.
 Froude's Cæsar, chap. 14.
 Holmes's Cæsar's Conquest of Gaul, chap. 3.
 Merivale's Hist. of Rome, Vol. I. pp. 267-281.
 Mommsen's Hist. of Rome, Vol. IV. pp. 300-304.
 Motley's Rise of the Dutch Republic, Vol. I. pp. 11, 12.
 Napoleon's Cæsar, Vol. II. chap. 5.
 Plutarch's Lives, Cæsar.
 Trollope's Cæsar, chap. 3.

49 1 CHAP. 1. **cum esset**, etc., *while Cæsar was*: subjv. with **cum** temporal; § 546 (325); B. 288. 1. B; G. 585; II. 600. ii (521. ii. 2); H-B. 524.

For discussion of the principle, see notes on **6** 14, **7** 17, **11** 7. The verb comes in this emphatic place on account of the close connection of these words with the preceding book; something like *and being thus in*, etc. See translation of this chapter in "Directions for Reading," p. lvii. — **citeriore Gallia**: northern Italy. — **ita uti** (= *ut*), *as*: correlatives; the demonstrative word *so* is often omitted in English: § 323.g (107); G. 110. 3; H. 305; cf. H-B. 144. — **demonstravimus, dixeramus**: the perfect here implies an act done before the time of writing (see end of Bk. i); the pluperf., what took place before the time of **demonstravimus**.

49 2 adferebantur, certior fiebat: imperf. of *repeated action*; § 470 (277); B. 260. 2; G. 231; H. 534. 3 (469. ii); H-B. 484. Translate *kept coming in; he was informed from time to time*.

49 3 litteris, by despatches: abl. of means; § 409 (248. c); B. 218; G. 401; H. 476 (420); H-B. 423. — **Belgas . . . coniurare . . . dare, that the Belgians, etc.**: indir. disc., acc. and infin. following the verbal phrase **certior fiebat**; § 459 (272); B. 331. i; G. 527; H. 613 (535); H-B. 589; direct, — *Belgae coniurant*. Cæsar had not yet advanced farther north than the country of the Lingones, so that the Belgæ were as yet unattacked. — **quam** agrees with **partem**, though the proper antecedent is **Belgas**: § 306 (199); B. 250. 3; G. 614. R.³. b; H. 396. 2 (445. 4); H-B. 326. 1.

49 4 esse: indir. disc. (with subj. acc. **quam**), after **dixeramus**. — **dixeramus** is in the indic. because, though a relative clause, it is parenthetical merely, and not a part of the report of Labienus: § 583 (336. b); B. 314. 3; G. 628. R. a; H. 643. 3 (524. 2. 1); H-B. 535. 1. d.

49 5 coniurare: from the point of view of the Romans, any war against Rome is a "conspiracy"; a nation enslaved by Rome is "pacified." — **obsides**: see note on **8** 11. — **inter se, to one another**: § 301. f (196. f); B. 245; G. 221; H. 502. 1 (448. N.); H-B. 266. — **coniurandi**: gerund; § 504 (298); B. 338. 1. a; G. 428; H. 626 (542. i); H-B. 612. i.

49 6 has esse causas, that the reasons were as follows: the report of Labienus continued, indir. disc. — **quod vererentur, sollicitarentur**: subjv. because subord. clauses in indir. disc.; § 580 (336. 2); B. 314. 1; G. 541; H. 643 (524); H-B. 535. 2. The two clauses introduced by **primum** and **deinde** contain the two reasons for the conspiracy, and so the gist of the sentence. The rest, which makes the whole seem complicated, defines the classes of disaffected Gauls who, though conquered, hoped still to recover their liberty by means of their more warlike neighbors. These classes are two (**partim . . . partim**), but to these are added in Cæsar's words, but in a different construction (**ab non nullis**), some who had personal reasons for wishing to expel the Romans. — **ne . . . adduceretur**: subst. clause, object of **vererentur**; § 564 (331. f); B. 296. 2; G. 550; H. 567 (498).

iii); H-B. 502. 4.—**omni pacata Gallia**: translate the abl. abs. freely, often by an active construction, *having subdued*, etc., or by a temporal, conditional, or such other clause as will best bring out the thought.

49 7 Gallia: i.e. Celtic Gaul, within which the previous campaigns had been conducted; § 521. *a* (310. *a*); B. 305. 1; G. 667; H. 638. 2 (549. 2); H-B. 578. 6.—**exercitus noster**: i.e. to subdue them in their turn.—**ab non nullis Gallis**: § 405 (246); B. 216; G. 401; H. 468 (415. i); H-B. 406. 1.

49 8 partim qui, etc.: not part of Labienus's report, but explanatory remarks added by Cæsar; hence the indic.—**ut . . . ita**: correlatives; § 323. *g* (107); G. 110. 3; H. (305); H-B. 144, 563.—**Germanos . . . versari**: object of **noluerant**; § 457, 563. *b* (271. *a*, 330. 3); B. 295. N., 331. iv; G. 532; H. 614 (535. ii); H-B. 587 and *a*.

49 9 exercitum hiemare, etc., *they took it hard (moleste ferebant) that an army of the Roman people was wintering and getting a foothold (inveterascere, lit. grow old) in Gaul*. The infinitives, with their subj. acc. **exercitum**, are in indir. disc. after **moleste ferebant**: § 572. *b* (333. *b*); B. 331. v; G. 650; H. 642. ii (523. N.); H-B. 594.

49 11 mobilitate: abl. of cause; § 404 (245); B. 219; G. 408; H. 475 (416); H-B. 444.—**novis imperiis studebant** = *were eager for a change of government (lit. new ruling powers)*: dat.; § 367 (227); B. 187. ii. *a*; G. 346; H. 426 (385); H-B. 362. Notice that **novis** is emphatic.

49 12 ab non nullis, *by some also* (sc. *sollicitabantur*); these were petty chiefs of clans.—**quod** (causal) . . . **occupabantur**, *because royal power was (constantly) usurped*. Notice the indic.; Cæsar explains the statement of Labienus (**quod . . . sollicitarentur**) by facts from his own knowledge; § 540 (321); B. 286. 1; G. 540; H. 588 (516); H-B. 555. A clause with the subjv. (*occuparentur*) would indicate that the reason assigned formed part of the letter of Labienus.—**potentioribus**: used substantively; *the more powerful*.

49 13 ad . . . facultatis, *the means to take men into their pay*.—**conduendos**: gerundive in an expression of purpose; § 506 (300); B. 338. 3, 339; G. 432; H. 622 (544. N.²); H-B. 612. iii.

49 14 rem: cf. note on 4 4.

49 15 imperio nostro: strictly a loc. abl., implying time, place, or condition, *under our dominion*.—**consequi**, complementary infin.: § 456 and N. (271 and N.); B. 328. 1; G. 423; H. 607. 2 (533. i. 2); H-B. 586 and *a*.

50 1 CHAP. 2. nuntiis: abl. of cause; cf. **mobilitate**, 49 11.—**duas legiones . . . misit**: these were numbered XIII and XIV, making with the others (VII–XII) eight in all, amounting (with auxiliaries) to perhaps 60,000 men.

50 2 inita aestate: abl. abs., expressing time *when*; § 419 (255); B. 227. 2. *a*; G. 665; H. 489. 1 (431. 1); H-B. 421. 1; *aestas* is the period from the spring equinox to that of autumn.

50 3 qui deduceret (the antecedent is **Q. Pedium**): relative clause of purpose; § 531 (317. 2); B. 282. 2; G. 630; H. 589. ii (497. i); H-B. 502. 2. — **Pedium**: Pedius was Cæsar's nephew, son of his sister Julia. — **legatum**: see note on **8 22**.

50 4 cum primum, etc.: i.e. when grass and young grain began to be abundant, so that the cavalry and baggage animals could subsist. — **inciperet**: cf. note on **esset**, **49 1**. — **ad exercitum**: i.e. to Vesontio, in the country of the Sequani. See Map, Fig. 26.

50 5 Senonibus: these were north of the Hædui, on the upper course of the Seine; their name is preserved in *Sens*. — **reliquis Gallis**, *the rest of the Gauls*: § 293 (193); cf. B. 241. 1; H. 497. 4 (440. N.¹); H-B. 346. *c*.

50 6 Belgis: dat. with **finitimi**; § 384 (234. *a*); B. 192. 1; G. 359; H. 434. 2 (391. i); H-B. 362. — **uti . . . cognoscant**, *to find out*. This is a subst. clause of purpose in apposition with **negotium**; § 563 (331); B. 295. 1; G. 546; H. 564. iii (499. iii); H-B. 502. 3. *a*. — **gerantur**: subjv. as depending on **cognoscant**; § 593 (342); B. 324. 1; G. 629; H. 652 (529. ii); H-B. 539.

50 7 seque . . . faciant, *and inform him* (Cæsar); **se** is here used as the indirect reflexive; § 300. 2 (196. *a*. 2); B. 244. ii. *a*; G. 521; H. 504 (449. 1); H-B. 262. 2. — **constanter**, *consistently* (with one another); their accounts all agreed.

50 8 manus (acc. plur., subject of **cogi**): small *bands* or companies.

50 9 tum vero: see Vocab. and observe the emphatic position. — **dubitandum non** [*esset*], *he must no longer hesitate*; the infin. of the second periphrastic conjugation, here used in indir. disc. after **existimavit**; § 158. *d. N.* (113. *d. N.*); B. 115; G. 251; H. 531 (466. N.); H-B. 162; **dubitandum** is impers.; § 208. *d* (146. *d*); B. 337. 7. *b*; G. 208. 2; H. 192. 1 (195. ii. 1); H-B. 600. 3. *a*. — **quin** can follow only a negative expression, as here **non existimavit**, etc. — **quin . . . proficisceretur**, *to set out* (lit. *but that he should*, etc.): relative clause of result depending on **dubitandum** [*esse*]; § 558. *a* (319. *d*); B. 284. 3; G. 555; H. 596. 1 (505. i. 1); cf. H-B. 502. 3. *b*. In the sense of *hesitate*, *dubito* regularly takes the infin. and not **quin**, but exceptions occur, as here.

50 10 re comparata: on translation of the abl. abs., cf. note on **49 6**.

50 11 diebus: abl. of time *within which*; § 423 (256); B. 231; G. 393; H. 486 (429); H-B. 439. — **finis**: i.e. north of the Matrona (Marne), crossing somewhere between Bois le Duc and Châlons (sur Marne). The march

from Besançon would be about one hundred and forty miles, or ten miles a day. He would so be about thirty-five or forty miles southeast of Durocororum (Rheims), the capital of the Remi.

50 12 **CHAP. 3. eo**: adv. — **omnium opinione**, *than any one expected* (following the comparative **celerius**): § 406. *a* (247. *b*); B. 217. 4; G. 398. N.¹; H. 471. 7 (417. i. N.⁵); H-B. 416. *e*.

50 13 **Remi**: these were friendly to the Romans, who by their victory over Ariovistus (see Bk. i) had made them the second power in Gaul; cf. Bk. vi. ch. 12. — **proximi Galliae**, *nearest to Gaul*; for the dat., see § 384 (234. *a*); B. 192. 1; G. 359; H. 444 (391. i); H-B. 346. *e*. — **ex Belgis**, *of the Belgæ*, for part. gen. *Belgarum*; see § 346. *c* (216. *c*); B. 201. 1. *a*; G. 372. R.²; H. 434. 2 (397. 3. N.³); H-B. 362; translate with **proximi**.

50 14 **legatos**, *as ambassadors*, predicate apposition.

50 15 **qui dicerent**: a relative clause of purpose; § 531. 2 (317. 2); B. 282. 2; G. 630; H. 595. ii (497. i); H-B. 502. 2.

The rest of the chapter consists of the speech of the ambassadors, as reported by Cæsar in indir. disc. Notice that the *principal clauses* are in the infin. with subj. acc., and all *dependent clauses* in the subjv.: § 580 ff. (336 ff.); B. 313 ff.; G. 650; H. 642-644 (522-524); H-B. 534. i, ii. In dir. disc. this speech would read as follows:

Nos nostraque omnia in fidem atque in potestatem populi Romani permittimus; neque [nos] cum reliquis Belgis consensimus neque contra populum Romanum coniuravimus, paratique sumus et obsides dare et imperata facere et oppidis recipere et frumento ceterisque rebus iuvare; reliqui omnes Belgæ in armis sunt, Germanique, qui cis Rhenum incolunt, sese cum his coniunxerunt, tantusque est eorum omnium furor ut ne Suessiones quidem, fratres consanguineosque nostros, qui eodem iure et isdem legibus utuntur (utantur), unum imperium unumque magistratum nobiscum habent (habeant), detertere potuerimus quin cum his consentirent (consentiant).

50 15 **se in fidem permittere**, *put themselves under the protection* (good faith), etc.; more commonly with dat. — **se suaque omnia**, *themselves and all their* (possessions) ("their all"): object of **permittere**. The subj. acc. is regularly expressed in the indir. disc.; but here it is omitted to prevent the awkward repetition **se** (subject) **se** (object). In the next clause **se** is expressed.

50 16 **neque**, *and (had) not*: § 328. *a* (156. *a*); B. 341. 1. *d*; G. 480; H. 657. 1 (554. i. 2); H-B. 307. 3. — **cum Belgis**: accompaniment; § 413 (248. *a*); B. 222; G. 392; H. 473. 1 (419. i); H-B. 419. 1.

50 18 **paratos** (participial adj.), *ready*. — **dare, facere**, etc.: infinitives following **paratos**; § 460. *b* (273. *b*); B. 326. N.; G. 423; H. 608. 4 (533. 3); H-B. 586. *f*.

50 19 oppidis recipere, *receive* [the Romans] *into their strongholds*, **oppidis** is abl. of place without *in*: § 429 (258. *f*); B. 228. 1, cf. 218. 7; G. 389; H. 485. 2 (425. ii. 1); H-B. 436, cf. 446. 1.—**frumento**: abl. of means; cf. **litteris**, **49 3**.—**ceterisque rebus**, *everything else* (necessary); see Vocab.—**recipere, iuvare**: sc. *eos* (i.e. the Romans) as object.

50 20 cis: i.e. the west or Gallic side.

50 21 sese . . . coniunxisse, *had united*; it often happens that a verb used as active in Latin and requiring a reflexive object may be best translated in English by an intransitive. The reverse of this must not be forgotten in writing Latin.—**tantum . . . ut**: correlatives; § 537. 2. N.² (319. R.); B. 284. 1; G. 552; H. 500. ii. N.¹; H-B. 521. 2. *a*.

50 22 furorem, *madness* (blind and unreasoning passion).—**ut . . . poterint**: result clause; § 537 (319); B. 284. 1; G. 552; H. 570 (500. ii); H-B. 521. 2; for tense, see § 485. *c*. N.¹ (287. *c*. R.); B. 268. 7; G. 513; H. 550 (495. vi); cf. H-B. 491; cf. also note on **28 6**.—**ne . . . quidem**: § 322. *f* (151. *e*); B. 347. 1; G. 445; H. 656. 2 (553. 2, 569. iii. 2); cf. H-B. 302. 1.—**Suessiones** (obj. of **detertere**): they occupied territory west of the Remi, about the modern Soissons.

50 23 iure et legibus: *rights and laws*; for case, see § 410 (249); B. 218. 1; G. 407; H. 477 (421. i); H-B. 429.—**isdem**: for *eisdem*.

50 24 unum imperium, etc.: i.e. their close confederacy did not prevent the Suessiones from leaguings with the other party.—**cum ipsis**: i.e. the Remi; in the indir. disc. **se** is regularly used to refer to the speaker, but the oblique cases of *ipse* are occasionally used instead. Here *ipse* is used apparently for emphasis: § 298. *e* (195. *k*); B. 249. 3; G. 311. 2; H. 509. 5 (452. 5); H-B. 263.

50 25 quin . . . consentirent, *from leaguings with*: relative clause of result depending on **detertere**; § 558 (319. *d*); B. 284. 3; G. 555; H. 595. 2 (504); cf. H-B. 502. 3. *b*. (Notice that **detertere** is negated by **ne . . . quidem** above, which make the whole clause negative, though they are attached only to the emphatic word.)

50 26 CHAP. 4. **ab his**: i.e. of the envoys; § 396. *a* (239. *c*. N.¹); B. p. 126, top; G. 339. R.¹; H. 411. 4 (374. N.⁴); H-B. 393. *c*.—**quae . . . essent**: indir. quest.; § 574 (334); B. 300. 1; G. 460; H. 649. ii (529); H-B. 537. *b*.

50 27 quid . . . possent, *what strength they had in war*; **quid** is cognate acc. with adv. force; § 390. *c* and *d*. N.² (240. *a*); B. 176. 3; G. 334; H. 409. 1, 416. 2 (371. ii (2), 378. 2); cf. H-B. 387. iii.—**sic**, *as follows*.—**reperiebat**: for force of the tense, cf. **adferebantur**, **49 2** and note. Observe that the rest of the chapter is in indir. disc., except the words **Remi dicebant**, **51 8**.—**plerosque**, etc.: Direct, —

Plerique Belgae sunt orti ab Germanis, Rhenumque . . . traducti propter loci fertilitatem ibi consederunt, Gallosque qui ea loca incolebant expulerunt, solique sunt qui patrum nostrorum memoria, . . . Teutonos Cimbrosque intra suos finis ingredi prohibuerint; qua ex re fit uti . . . magnam sibi auctoritatem . . . sumant. De numero eorum omnia (nos) *habemus* explorata . . . propterea quod propinquitatibus . . . coniuncti, quantam quisque multitudinem . . . ad id bellum pollicitus sit *cognovimus*. Plurimum inter eos *Bellovaci . . . valent; hi possunt* conficere armata milia centum, *polliciti* ex eo numero electa milia sexaginta, totiusque belli imperium sibi *postulant*. *Suessiones nostri sunt finitimi; finis latissimos feracissimosque agros possident.* Apud eos *fuit rex* nostra etiam memoria *Diviciacus*, totius Galliae *potentissimus*, qui cum magnae partis harum regionum tum etiam Britanniae imperium *obtenuit; nunc est rex Galba; ad hunc . . . summa* totius belli . . . *defertur; oppida habent* numero XII, *pollicentur* milia armata quinquaginta; totidem *Nervii*, qui maxime feri inter ipsos *habentur*, longissimeque *absunt; quindecim milia Atreates, (likewise) Ambiani, Morini, etc. . . Condrosos, Eburones, etc. . . qui . . . Germani appellantur, arbitramur (conficere posse or polliceri)* ad XL milia.

50 27 plerosque, *most of*: § 293 (193); B. 241. 1; H. 497. 4 (440. N.²); H-B. 244; see the end of the chapter, and compare, regarding the Nervii, Tacitus (Ger. 28). The Belgians were, no doubt, chiefly of Celtic blood; but possibly they considered the Germans a more proud and heroic ancestry.

51 1 ab Germanis: abl. of source; § 403. *a. N.*¹ (244. *a. R.*); B. 215. 2; G. 395; H. 469. 1 (415. ii. N.); H-B. 413. *b.* — **Rhenum**: acc. governed by *trans* in **traductos**; § 395 (239. 2. *b*); B. 179. 1; G. 331; H. 413 (376. N.); H-B. 386. *a.*

51 2 traductos: participle agreeing with **Belgas**. — **propter fertilitatem**: construe with **consedissee**.

51 4 qui . . . prohibuerint: rel. clause of characteristic with **solos**; § 535. *b* (320. *b*); B. 283. 2; G. 631. 2; H. 591. 5 (503. ii. 1); H-B. 521. 1. *a* and *ftn.*¹. Note the retention of the perfect tense contrary to tense sequence, and cf. **ut . . . potuerint**, **50 22** and note. — **memoria**: cf. **diebus**, **50 11**. — **Teutonos, etc.**: cf. **35 5**.

51 5 ingredi: the subjv. might have been used; § 457 (271. *a*); B. 295. 1; G. 532. *R.*¹; H. 596. 2 (505. ii. 1, 2); H-B. 587 and *a.* — **qua ex re, in consequence of which (fact)**; abl. of cause; § 404 (245); B. 219; G. 408. *N.*⁷; H. 475. 4 (416. *i*); H-B. 444. *b.*

51 6 fieri uti, it was coming to be the case that: the subject of **fieri** is the clause **uti . . . sumerent**; § 569 (332. *a*); B. 297. 2; G. 553. 3; H. 571. 1 (501. *i.* 1); cf. H-B. 521. 3. *a.* — **memoria**: abl. of cause. — **sibi**: § 376 (235); B. 188. 1. *N.*); G. 352; H. 425. 2 (384. ii. 1, 2); H-B. 366.

51 7 *de numero*, etc.: the rest of the chapter depends on *Remi dicebant*.

51 8 *se habere explorata*, *had found out all about (de)*, etc.: *habere explorata* differs but little in sense from *explorasse*; § 497. *b* (292. *c*); B. 337. 6; G. 238; H. 431. 3 (388. 1. N.); H-B. 605. 5 and *a*; in construction *explorata* agrees with *omnia*, which is obj. of *habere*. See note on *comptertum habere*, 40 20.

51 9 *propinquitatibus*, *ties of blood*.—*adfinitatibus*, *alliances by marriage*.

51 10 *quantam quisque . . . pollicitus sit*: indir. quest., object of *cognoverint*; cf. 50 26.

51 11 *cognoverint*: the primary tense is used in violation of the *sequence of tenses*. The statement is made more vivid by putting it in the same tense that was used by the speakers. They said *cognovimus*, *we know* (lit. *have found out*). The perfect is very often retained in indir. discourse.

51 12 *virtute*, etc.: abl. of specification.

51 13 *armata milia centum* = *armatorum hominum milia centum*. As here expressed, *milia* is the noun with which the adj. *armata* agrees; § 134. *d* (94. *e*); B. 80. 5; G. 293; H. 168 (178); H-B. 131. 3.

51 14 *electa*, *choice troops, picked men*.

51 15 *sibi*: dat. of reference; cf. *sibi*, l. 6, above; it refers to the *Bellovacii*.—*suos*, *their own* (i.e. of the *Remi*); notice that the reflexive regularly refers to the speaker. See note on *cum ipsis*, 50 24.

51 16 *possidere*: sc. *eos*, i.e. the *Suessiones*.—*fuisse . . . esse*: notice the difference of time; *fuisse* (in the dir. disc. *fuit*) refers to time *past*, *esse* (dir. *est*) to time *present*, with respect to the verb of saying (*dicebant*, l. 8).—*regem*: showing that royal power had not yet been overthrown among the *Belgians*.

51 18 *cum . . . tum*, *not only . . . but also*.

51 19 *Britanniae*: the first mention of Britain by a Roman author.—*obtinuerit*, *had held*; in the dir. *obtinnit*, *held*. For tense, cf. note on *cognoverint*, l. 11, above.

51 20 *summam*: subject of *deferri*.

51 21 *voluntate*: abl. of manner; § 412. *b* and N. (248. R.); B. 220. 2; G. 399; H. 474. 1 (419. iii. N.²); H-B. 445. 1.—*habere*: the subject must be supplied from *Suessiones*, above.—*numero*: abl. of specif.; cf. 51 12.

51 22 *Nervios*, etc. (see Map, Fig. 26): the names of several of these tribes are found in the modern towns, as: *Atrebatæ*, *Arras*; *Ambiani*, *Amiens*; *Caleti*, *Calais*; *Viromandui*, *Vermandois*; *Condrusi*, *Condroz*.

52 1 *feri*: pred. after *habeantur*, *are regarded*.

52 5 *Condrusos*, etc.: subjects of *polliceri* or *conficere posse* understood.—*qui . . . appellantur*: the indic. shows that this is an explanatory note

added by Cæsar, and not a part of the indir. disc., while **qui . . . habeantur** above, on the other hand, is a remark made by the Remi, as is shown by the subjunctive.

52 6 Germani: this name seems to belong especially to the four last named (*Condrusi, Eburones*, etc.).—**arbitrari**: in dir., *arbitramur*; in translation we may say *they thought*, parenthetically, as in the English usage in indir. disc.

52 7 CHAP. 5. **cohortatus, prosecutus**: for the tense of these participles, cf. § 491 (290. *b*); B. 336. 5; G. 282. N.; H. 640. 1 (550. N.¹); H-B. 601. 1.

52 9 obsides (pred. appos.), *as hostages*: if the chiefs should break their faith, these boys would probably be sold as slaves; cf. also note on **8 11**.—**quae omnia, and all this**. Latin very frequently connects clauses by a relative where our idiom prefers a conj. with a demonstrative: § 308. *f* (201. *e*); B. 251. 6; G. 610. R.¹; H. 510 (453); H-B. 284. 8.

52 11 quanto opere . . . intersit, *how greatly it concerns both the republic and their common safety*. For the genitives, see § 355 (222); B. 211. 1; G. 381; H. 449. 1 (406. iii); H-B. 345.

52 12 intersit: indir. quest.; cf. **50 26, 51 10**.—**manus** (acc. plur.) . . . **distineri**: infin. clause, subject of **intersit**.—**ne confligendum sit**, *lest they should have to contend*: clause of purpose depending on **distineri**; § 530 (317); B. 282. 1; G. 545. 3; H. 568 (497. ii); H-B. 502. 2.—**confligendum sit** is an impers. 2d periphrastic; § 193, 208. *c* (129, 146. *d*); B. 115, 138; G. 208, 251. 2; H. 237, 302. 7 (234, 301. 2); H-B. 162, 600. 3. *a*.

52 13 id fieri posse, etc., *this, he said, could be done*, etc. Notice that no new word of saying is necessary in Latin, but in English one is usually inserted parenthetically.

52 14 suas copias: the emphatic position opposes the forces of the Hædui to the Roman army.—**Bellovacorum**: these lay farthest west and most remote from Cæsar's field of operations; so that the manœuvre indicated would divide the enemy (cf. **56 21-25**).—**introduxerint . . . coeperint**: fut. condition; in the dir. disc. these would be fut. perf.; § 516. *c* (307. *c*); B. 303; G. 596. 1; H. 574 (508); H-B. 579. *a*, 577. *a*.

52 15 eorum: i.e. **Bellovacorum**.—*datis*: words in the text thus printed in italics are conjectural readings not found in the MSS.

52 16 dimittit: the effect of his mission appears in **56 23**, and he has returned to Cæsar in **59 2**.—**postquam . . . vidit**, *as soon as he saw*: § 543 (324); B. 287; G. 561; H. 508 (518); H-B. 557.

52 17 neque: -**que** connects **vidit** and **cognovit**; **ne-** with **iam** = *no longer*.—[**vidit**]: see note on [**eorum**], **9 17**.

52 18 ab eis: construed with **cognovit**.

52 19 Axonam (apposition), *the Aisne*; here flowing nearly due west, and joining the Seine below Paris, through the Oise.—**in extremis . . . finibus**, *in the remotest part of the territory of the Remi*: § 293 (193); B. 241. 1; H. 497. 4 (440. 2, notes 1 and 2); H-B. 244; the phrase is used in a general sense merely, for Bibrax, a town of the Remi, lay eight miles farther off.

52 20 exercitum is dir. object of **traducere**; **flumen** (l. 19) is secondary object, depending on *trans* (*tra-duco* = *trans-duco*); § 395 (239. 2. *b*); B. 179. 1; G. 331. R.¹; H. 413 (376); H-B. 386.—**castra**: the site of this camp has been made out at Berry au Bac (Fig. 31), a little village about twelve miles north by west of Rheims and about twenty-five miles east of Soissons. Traces of Cæsar's works at this place were discovered in 1862, on a low hill called Mauchamp (see Map, Fig. 32).

52 21 quae res, *this movement* (or *manœuvre*), i.e. his having crossed the river and then pitched his camp where he did. Cæsar's camp was protected in the rear by the Axona, and in front by a small marshy stream.—**ripis**: cf. **frumento**, 50 19.

52 22 post eum quae erant, *the rear of his army* (lit. [*those things*] *which were behind him*).—**tuta**: pred. acc.; § 393. N. (239. a. N.¹); B. 177. 2; G. 340; H. 410. 3 (373. 1. N.²); H-B. 392. *a*; the dir. object is *ea*, the omitted antecedent of **quae**.—**commeatus**: subject of **possent**.

52 23 ut . . . possent: subst. clause of result, object of **efficiebat**; § 568 (332); B. 297. 1; G. 553. 1; H. 571. 3 (501. ii. 1); H-B. 521. 3. *a*; cf. this with the pure result clause, 50 22, and with the subject clause of result, 51 6.

52 24 efficiebat: the subject is still **quae res**; observe the imperfect tenses describing the situation, and cf. note on 3 5.

52 25 in altera parte, *on the other side*, i.e. on the left bank of the Aisne, towards the Remi. Cæsar had crossed the stream and encamped on the side towards the Suessiones.

52 27 pedum xii: gen. of measure, with **vallo**; § 345. *b* (215. *b*); B. 203. 2; G. 365. R.²; H. 440. 3 (396. *v*); H-B. 355. When pronouncing the Latin, always give the Latin words for numerals.—**duodeviginti pedum**: i.e. a moat eighteen feet in width. See chapter on military affairs, v, and Fig. 118.

53 1 CHAP. 6. **nomine**: cf. the ablatives in 51 12.—**Bibrax**: this town has been variously identified as Vieux Laon, about the proper distance to the northwest, and Beaurieux to the west, more probably the latter.

53 2 milia passuum octo, *eight miles*: acc. of extent of space; § 425 (257); B. 181. 1; G. 335; H. 417 (379); H-B. 387. 1; **passuum** is part. gen.; § 346 (216); B. 201; G. 367; H. 440. 5 (397); H-B. 346; cf. note

on 3 4. — **ex itinere**, *on the march*, i.e. turning aside *from* their course to attack the town. — **magno impetu**: abl. of manner; cf. **voluntate**, 51 21.

53 3 **aegre sustentatum est** (impers.), *it was with difficulty that they held out*. In English we are often inclined to put into two clauses what the Latin crowds into one. — **Gallorum . . . haec**, *the attack* (mode of attacking) *of the Gauls, being the same as (atque) that of the Belgians, is this* (the following).

53 5 **circumiecta multitudine** (abl. abs.) . . . **moenibus**, *a host of men being thrown round all the walls*: § 370 (228); B. 187. iii; G. 347; H. 429. 2 (386. 2); H-B. 376. Here the English absolute construction is admissible, though usually to be avoided.

53 6 **iaci**: complem. infin.; cf. **consequi**, 49 15 and note. — **coepti sunt**: the pass. is used with the pass. infin. — **defensoribus**: abl. of separation; § 401 (243. a); B. 214; G. 405; H. 462 (414. i); H-B. 408. 3.

53 7 **testudine facta**, *making a testudo*. See chapter on military affairs, VII (last part), and Fig. 68.

53 8 **quod**, *this*, i.e. the movements just described. — **tum**, *in the present instance*. — **multitudo**, subject of **conicerent**: § 317. d (2) (205. c. 1); B. 254. 4. a; G. 211. Exc. (a); H. 389. 1 (461. 1); H-B. 331. 1. — **cum . . . conicerent**: **cum** describing the situation, but almost causal; see note on 49 1.

53 9 **consistendi**: gen. of gerund with **potestas**; § 504 (298); B. 338. 1. a; G. 428; H. 626 (542. i); H-B. 612. i.

53 10 **nulli**: dat. of poss.; § 373 (231); B. 190; G. 349; H. 430 (387); H-B. 374: *nobody could keep a foothold on the wall* (lit. *power of standing on the wall was to nobody*). — **cum . . . fecisset**: again describing the situation. — **oppugnandi**: gerund; cf. **coniurandi**, 49 5.

53 11 **summa nobilitate et gratia**, [a man] *of the highest*, etc.; abl. of quality; § 415 (251); B. 224; G. 400; H. 473. 2 (419. ii); H-B. 443. — **inter suos**, *among his* [fellow-citizens]. — **oppido**: dat. with **praeerat**; § 370 (228); B. 187. 3; G. 347; H. 429 (386); H-B. 376.

53 12 **unus ex eis**, *one of those*: after numerals **ex** with the ablative is preferred to the part. gen. — **legati**, *as ambassadors*: pred. appos.

53 13 **nisi . . . posse**: indir. disc. depending on the idea of *reporting* contained in **nuntium mittit**. Trans. *unless reënforcements, he said*, etc. — **sibi**: i.e. Iccius; the dat. is used instead of *ad se* with **subsidium submittatur**, because the idea of help (*for him*) is more prominent than that of motion (*towards him*). In the dir. disc. the message of Iccius was:

Nisi subsidium mihi submittetur, (ego) diutius sustinere non possum.

54 1 CHAP. 7. **eo**, *thither, to that place*, i.e. Bibrax. — **isdem ducibus usus**, *employing the same men* [as] *guides*: for the ablative, cf. **iure**, 50 23. Observe that **ducibus** is pred. appos.; cf. **legati**, 53 12.

54 2 Numidas et Cretas: both these (especially the Cretans) were famous bowmen. See Fig. 105.

54 3 Baleares (adj.): the inhabitants of the Balearic Islands, east of Spain, were famous slingers. See Fig. 30. These nations served as auxiliaries in the Roman armies. — **subsidio oppidanis:** dat. of service with dat. of person affected; § 382. 1 and N.¹ (233. a); B. 191. 2. b; G. 356; H. 433 (390); H-B. 360. b.

54 4 et . . . et: see Vocab. — **studium . . . accessit,** *eagerness for a vigorous defence was inspired in the Remi.* — **propugnandi:** obj. gen. of the gerund; cf. **coniurandi**, 49 5.

54 5 hostibus, from the enemy: dat.; § 376 (235); B. 188. 1; G. 352; H. 425. 4 (384. 4. N.³); H-B. 366. — **potiundi oppidi:** gerundive; § 503. N.² (296. R.); B. 339. 4; G. 427. N.⁵; H. 623. 1 (544. 2. N.⁵); H-B. 613. N.

54 6 morati . . . depopulati . . . vicis . . . incensis: observe the change of construction. The Latin can use a perf. part. with active meaning only (as here) of *deponent verbs*. The corresponding construction with other verbs is the abl. abs. with the perf. pass. part.; as here, **vicis incensis**, which is to be translated accordingly. See last note on 49 6.

54 7 quo, to which (or the like).

54 8 omnibus copiis: cf. 50 16, and for the omission of *cum*, see § 413. a (248. a. N.); B. 222. 1; G. 392. R.¹; H. 474. 2 (419. iii. 1); H-B. 420.

54 9 a milibus passuum minus duobus, less than two miles off: a is used adverbially; § 433 (261. d); B. 144. 1; G. 335. N.; H. 417. 3 (379. 2. N.); cf. H-B. 303. c: **milibus** is abl. of degree of difference: § 414 (250); B. 223; G. 403; H. 479 (423); H-B. 424: **minus** does not affect the construction: § 407. c (247. c); B. 217. 3; G. 296. R.⁴; H. 471. 4 (417. I. N.²); H-B. 416. d: **amplius** (l. 10) is acc. of extent of space: § 425 (257); B. 181. 1; G. 335; H. 417 (379); H-B. 387: and **milibus** (l. 10), abl. after the comparative: § 406 (247); B. 217. 1; G. 398; H. 471 (417); H-B. 416. We have here both of the two constructions allowable with these neuter comparatives; see reference under **minus**.

54 13 CHAP. 8. eximiam opinionem virtutis, their high reputation for valor: obj. gen.; § 348 (217); B. 200; G. 363. 2; H. 440. 2 (396. iii); H-B. 354. — **proelio supersedere, to defer the engagement:** for the abl., cf. **defensoribus**, 53 6, and see § 401 (243. a); B. 214. 1; G. 390; H. 462 (414. i); H-B. 408. 3.

54 14 quid . . . posset . . . quid . . . auderent, indir. questions. — virtute. abl. of specif. But the whole is best rendered, *tested the prowess of the enemy, and the daring of our own soldiers*. Notice that the form of thought is entirely different in Latin and in English.

54 15 **periclitabatur**: note the tense and cf. **adferebantur**, 49 2 and note.

54 16 **loco . . . idoneo**: abl. abs. expressing cause. — **ad . . . instruendam**: gerundive expression of purpose; cf. 49 13.

54 18 **tantum**, etc., *spread over as much (tantum) ground as (quantum)*, etc. — **adversus**, *right in front*.

54 19 **in latitudinem**, *in breadth*, i.e. from the camp towards the confluence of the Aisne with a little stream, the Miette, which here makes a swamp. — **loci**: part. gen. with **quantum**, but more conveniently translated with the correlative **tantum**, with which it has to be supplied to complete the sense.

54 20 **lateris deiectus** (acc. plur.), *lateral slopes* (lit. *slopes of the side*).

54 21 **in fronte**, etc., *falling with an easy slope in front* (i.e. to the west), *sank gently to the plain* (see battle plan, Fig. 32).

54 22 **transversam**: i.e. at right angles to his line of battle.

54 23 **passuum quadringentorum**: gen. of measure; cf. **pedum**, 52 27. — **extremas**, *the ends of*: § 293 (193); B. 241. 1; H. 497. 4 (440. N.²); H-B. 244.

54 24 **tormenta**: see chapter on military affairs, I. 5, and Figs. 61, 75, and 95.

54 25 **instruxisset**: subjv. by attraction for fut. perf. ind.; § 593, 547 (342, 325. c); B. 324. 1, 289; G. 662 at end, 580; H. 652, 600 (529. ii, 521. i); H-B. 539. cf. 524. d. — **tantum**: adv. acc.; cf. **quid**, 50 27. — **poterant**: this clause is parenthetical, and hence is not (like **instruxisset**) attracted into the subjv.

54 26 **ab lateribus**, *on the flanks*: § 429. b (260. b); H. (434. i); H-B. 406. 2; modifying **circumvenire**. — **suos**: i.e. Cæsar's, referring back to the subject of **conlocavit**.

55 1 **si quo** (adv.): sc. *duci*, but translate freely *if they were needed anywhere*. — **esset**: protasis of a fut. condition (*si . . . erit*); here in the imperf. subjv. because depending on the final clause **ut . . . possent**; § 593 (342); B. 324. 1; G. 663; H. 652 (529. ii); H-B. 539. — **subsidio**: dat. of purpose or end; cf. note on 54 3.

55 2 **sex**: see note on 50 1. — **suas**: notice the emphatic position, **THEIR forces too**.

55 3 **copias . . . eductas instruxerunt**, *had led out and drawn up*, etc.: the Latin is fond of using a participle for what is practically a coördinate clause, instead of an additional finite verb.

55 4 **CHAP. 9. nostrum**: poss. pron.; poss. gen. could not be used; § 302. a (197. a); B. 243; G. 362. R.¹; H. 440. 1. N.² (396. ii. N.); H-B. 339. a.

55 5 hanc: i.e. *paludem*. — **si . . . transirent**, (*to see*) if our men would cross: § 576. a (334. f); B. 300. 3; G. 460; H. 649. 3 (529. ii. 1. N.¹); cf. H-B. 582. 2.

55 6 si . . . fieret, in case they should begin the passage (lit. a beginning of crossing should be made by them): fut. condition (*si . . . fiet*); here in the subjv. because part of the final clause **ut . . . adgrederentur**; cf. note on **esset**, l. 1.

55 7 adgrederentur: purpose, depending on **parati**, etc.

55 8 contendebatur: impers.; cf. note on **23 1**.

55 9 nostris: § 384 (234. a); B. 192. 1; G. 359; H. 434. 2 (391. i); H-B. 362.

55 11 ad flumen, etc.: evidently somewhat lower down, so that they were concealed by the hills beyond the marsh.

56 1 eo consilio ut, etc.: the final clauses are in apposition with **consilio**; § 531. 1. N.¹ (317. a); G. 545. 1; H. 564. iii (499. 3); H-B. 502. 2. a.

56 2 castellum, the redoubt beyond the river, held by Sabinus (**52 25**). — **cui**: cf. **oppido**, **53 11**.

56 3 pontem: the bridge held at one end by a garrison, at the other by the redoubt (**52 25**). By destroying this, the Belgæ would cut off Cæsar's supplies and hinder his retreat; cf. **52 21-24**. — **si possent** (l. 1), **si minus potuissent**: fut. conditions; **possent** represents the fut., **potuissent** the fut. perf. indic.; for change of mood and tense cf. note on **55 1**. — **minus**, *not*.

56 4 popularentur, prohiberent: in same construction as **expugnarent**. — **magno nobis usui**: cf. note on **subsidio oppidanis**, **54 3**. — **ad bellum gerendum** (gerundive), for carrying on the war; cf. **49 13**.

56 5 commeatu: abl. of separation; cf. **defensoribus**, **53 6**.

56 6 CHAP. 10. **ab Titurio**: abl. of voluntary agent.

56 7 levis armaturæ (gen. of description), of light equipment = light-armed (see chapter on military affairs, I. 3, and Figs. 104, 115). — **Numidas**, etc.: these light-armed troops were trained runners, and so could arrive at the ford in time to stop the passage of the Belgians.

56 8 traducit: with two accusatives; cf. **52 20** and note. — **pugnatum est**: cf. **contendebatur**, **55 8**.

56 11 conantis: with **reliquos**.

56 12 equitatu: considered here as means or instrument; therefore, no prep. — **circumventos interfecerunt**: cf. note on **eductas**, **55 3**.

56 13 ubi . . . intellexerunt: the regular mood and tense with **ubi**; cf. **53 4**. — **de**, with regard to.

56 14 neque, and . . . *not*.

56 15 pugnandi causa: gerund construction, expressing purpose; § 404. *c*, 533. *b* (245. *c*, 318. *b*); B. 338. 1. *c*; G. 373; H. 626 (542. *i*); H-B. 444. *d*, 612. *i*.

56 16 ipsos: i.e. the enemy. The superiority of the Roman commissariat was a most important factor in winning their victories. The enemy could not carry on a long campaign with a large army for lack of provisions, and when they were compelled to disband, the Romans destroyed them piecemeal at their leisure.

56 17 constituerunt here has two objects: (1) **optimum esse**, etc. (indir. disc.), (2) [*ut*] **convenirent** (subst. clause of purpose); § 580. *d* (332. *h*); B. 295. 1 and N.; G. 546. R.¹; H. 565. 5 (498. *i*. N.); H-B. 589. *a*; cf. note on 2 15. The subject of **esse** is the infin. clause **quemque reverti**: § 452 (330); B. 330; G. 422; H. 615 (538); H-B. 585. Thus the confederacy dissolves into a mere defensive alliance, and all the members are cut to pieces in detail. — **domum**: § 427. 2 (258. *b*); B. 182. 1. *b*; G. 337; H. 419. 1 (380. 2. 1); H-B. 450. *b*.

56 18 quorum: the antecedent is *eos*.

56 19 introduxissent stands for the fut. perf., and is attracted into the pluperf. subjv. by being made part of the purpose clause; cf. **potuissent**, **56 3**. — **convenirent**: sc. *ut*; § 565. *a* (331. *f*. R.); B. 295. 8; G. 546. R.²; H. 565. 2 (499. 2); H-B. 502. 3. *a*. ft.².

56 20 suis, alienis, domesticis: notice the emphatic position of the adjectives.

56 23 quod . . . cognoverant: indic. because Cæsar gives the reason on his own authority; cf. **49 12** and note. The clause is in apposition with **haec ratio**. — **Diviciacum . . . adpropinquare**: see **52 14**. — **finibus**: dat. after **adpropinquare**.

56 24 his persuaderi, etc., *these could not be persuaded*, etc. (lit. *it could not be persuaded to these*). Verbs that take the dat. in the act. are used impers. in the pass. and retain the dat. — **ut**, etc.: subst. clause of purpose, depending for its construction on **persuaderi**, but (in the impers. construction) used as subject of **poterat**.

56 25 neque . . . ferrent, *and so fail to carry* (lit. *and not carry*). — **suis**: § 363 (225. *b*); B. 193; H-B. 365. ft. par. 2.

56 26 **CHAP. II. strepitu, tumultu, ordine, imperio**: abl. of manner; cf. **impetu**, **53 2**.

57 1 cum, *where*, describing the situation, but approaching in sense a causal clause: § 549. N.² (326. N.²); B. 288. B; G. 586; H. 598 (517); H-B. 525.

57 2 fecerunt: notice the emphatic position; cf. the English, "the result was." — **ut . . . videretur**: subst. clause of result, object of **fecerunt**;

§ 568 (332); B. 297. 1, G. 553. 1; H. 571. 3 (501. ii. 1); H-B. 521. 3. a. — fugae: § 384 (234. a); B. 192. 1; G. 359; H. 434. 2 (391. i); H-B. 362.

57 3 **per**: the agent, when considered as instrument or means, is generally expressed by **per** with the acc.; § 405. b (246. b); G. 401; H. 468. 3 (415. i. N.¹); H-B. 380. d. — **speculatores**, *spies*: they obtained information by mingling in disguise with the enemy; while the *scouts*, *exploratores*, were squads of cavalry who ranged the country in the vicinity of the army.

57 4 **veritus**, *fearing*; cf. note on 52 7. — **discederent**: indir. quest.; cf. 51 10, 52 11, 55 5.

57 5 **castris**, *in camp*: § 429. f (258. f); B. 218. 7; G. 389; H. 485. 2 (425. ii. 1); cf. H-B. 446. 1.

57 6 **re**: i.e. the fact that the enemy were really retreating. — **ab exploratoribus**: abl. of agent; cf. above, **per speculatores**. — **qui moraretur**: rel. clause of purpose; cf. 50 15.

57 7 **his**: dat. with **praefecit**; cf. construction of **oppido**, 53 11.

57 10 **milia**: cf. 53 2.

57 11 **cum**: causal; cf. 57 1 and note. — **ab extremo agmine**, *in the rear*.

57 12 **quos**: relates to the implied subject of **consisterent**. — **ventum erat**: § 208. d (146. d); B. 256. 3; G. 208. 2; H. 302. 6 (301. 1); H-B. 290. a. 1.

57 13 **priores**: sc. *and* in English. This refers to the van of the retreating enemy. — **quod . . . viderentur**, *because they seemed* (i.e. *they thought themselves*). This word and **continerentur** are subjunctives as being part of the subjv. clause **cum . . . ponerent**. For similar cases of attraction, see 55 1, 55 6, 56 1, 56 19.

57 15 **exaudito clamore**, **perturbatis ordinibus** (abl. abs., the first defining the time of the second), *breaking ranks on hearing the outcry* (of those engaged in the rear).

57 16 **sibi**: § 376 (235); B. 188. I. N.; G. 345; H. 425. 4 (384. 4); H-B. 366. — **ponerent**: same construction as **consisterent** and **sustinerent**.

57 17 **tantam . . . spatium**, *killed as great a number of them as the time* (before night) *allowed* (lit. *as the day was long*); notice the correlatives **tantam . . . quantum**; § 152 (106); G. 642. 1; H. 189 (191); H-B. 144; cf. 54 18-20.

57 20 **CHAP. 12. postridie eius diei**, *next day* (lit. *on the day after that day*): for the gen., see § 359. b (223. e); B. 201. 3. a; H. 446. 5 (398. 5); H-B. 380. c. — **priusquam . . . reciperent**, *before the enemy could recover themselves*: § 551. b (327); B. 292; G. 577; H. 605 (520); H-B. 507. 4. b.

57 21 **in finis . . . duxit**: i.e. following his plan of subduing the tribes one after the other.

57²² **Remis**: cf. **Galliae**, **50** 13. — **magno itinere**: see chapter on military affairs, VI.

57²³ **Noviodunum** (now Soissons): about twenty miles west of Bibrax. Celtic *dunum* = English *town*; hence Noviodunum = *Newton* or *Newburg*. *Soissons* is derived from *Suessiones*. — **ex itinere**: i.e. as soon as he arrived, by filling up the ditch and scaling the walls, without waiting to throw up works or form regular lines of approach; cf. **53** 2.

57²⁴ **esse**: sc. *oppidum* for subject.

57²⁵ **paucis defendentibus** (abl. abs. denoting concession), *though there were few defenders*. — **oppugnare** means *to attack*; **expugnare**, *to take* (by storm). Unable to take the town by storm, Cæsar was obliged to begin a regular siege. See chapter on military affairs, VIII, and Figs. 43, 92, 93, 118, 120.

57²⁶ **quaeque**, etc.: i.e. wood, earth, stones, etc.; the antecedent of **quae**, if expressed, would be *ea*.

57²⁷ **ad oppugnandum**: § 506, 385. *a* (300, 234. *b*); B. 338. 3, 192. 2. N.; G. 432, 359. R.³; H. 628, 435. I (542. iii, 391. ii); H-B. 612. iii, 364. 6.

58² **magnitudine**: i.e. by the extent of these offensive operations. — **quae**, *which* (i.e. *the like of which*).

58³ **ante**: adv.

58⁵ **petentibus Remis**, *at the request of the Remi*. — **ut conservarentur**: subst. clause of result, obj. of **impetrant**; § 568 (332); B. 297. I; G. 553. I; H. 571. I (501); H-B. 521. 3. *a*.

58⁶ **CHAP. 13. obsidibus acceptis primis**, *after he had received as hostages the chief men*, etc.

58⁷ **Galbae**: see **51** 19-21.

58⁹ **Bellovacos**: their territory lay thirty or forty miles due north of Paris, about Beauvais. — **qui cum**, *and when they*. A relative is often used to begin a new sentence where the English idiom would lead us to expect a demonstrative with a connective (here *hi autem*). The relative serves to bind the new sentence more closely to the preceding. — **se suaque omnia**: cf. **50** 15 and note.

58¹⁰ **Bratuspantium**: probably Breteuil, at the head of the Somme valley. Notice that **Bratuspantium** is in *apposition* with **oppidum**, not in the gen. according to the English usage.

58¹¹ **circiter**, etc., [only] *about five miles*. — **milia passuum**: cf. **53** 2. **57** 10.

58¹² **maiores natu**: § 131. *c* (91. *c*); B. 226. I; G. 87. 9; H-B. 122; **natu** is abl. of specification.

58¹³ **voce significare**, *show by the tones of their voice* (of course they could not talk Latin). — **in eius fidem . . . venire**: i.e. surrendered at

discretion; cf. the clause **se in fidem permittere**, 50 15. Notice that the reflexive **sese** refers to the *speakers*, and represents the first person of the dir. disc.; **eius** refers to *Cæsar*, the person spoken to.

58 14 **neque**, and [*that they would*] **not**.

58 16 **pueri mulieresque**, *women and children*.—**ex muro**: English says *on the wall*, from another point of view.

58 17 **ab Romanis**: § 396. *a* (239. *c. N.*¹); B. 178. 1. *a*; G. 339. *N.*²; H. 411. 4 (374. *N.*⁴); H-B. 393. *c*.

59 1 CHAP. 14. **pro his**, *in behalf of these*, i.e. the Bellovaci.

59 2 **eum**: i.e. *Cæsar*.

59 3 **Bellovacos**, etc.: the rest of this chapter is in indir. disc., depending on **facit verba**. Direct,—

Bellovaci omni tempore in fide atque amicitia civitatis Haeduae fuerunt; impulsus ab suis principibus, qui dicebant Haeduos a Caesare in servitutum redactos omnis indignitatis . . . perferre, et ab Haeduis defecerunt et populo Romano bellum intulerunt. Qui eius consili principes fuerant, quod intellegebant quantam calamitatem civitati intulissent, in Britanniam profugerunt. Petunt non solum Bellovaci sed etiam pro his Haedui ut tua clementia ac mansuetudine in eos utaris. Quod si feceris, Haedorum auctoritatem apud omnis Belgas amplificabis, quorum auxiliis atque opibus, si qua bella inciderunt, sustentare consuerunt.

59 3 omni tempore, *always*.—**in fide atque amicitia**: i.e. they had been subject-allies of the Hædui.

59 4 **impulsos** (notice the emphatic position: *not* of their own accord, but *induced* by their chiefs): agreeing with the subject (*eos*) of **defecisse** and **intulisse**, which is to be supplied from **Bellovacos**.

59 5 **dicerent**: this word introduces another clause in the indir. disc., the statement of the chiefs, which is thus reported at second-hand by *Cæsar* as a part of the speech of Diviciacus. The subject is **Haeduos**; the verb, **perferre**.—**omnis**, *all* (kinds of).

59 7 **qui**, (those) *who*.—**eius consili**, *in this design*: § 348 (217); B. 200; G. 363. 2; H. 440. 2 (396. iii); H-B. 354. Notice that the gen. expresses nearly all the relations of one noun to another, and may be translated by *in, to*, and many other forms of speech in English.

59 8 **quantam . . . intulissent**: cf. 50 26 and note.

59 9 **civitati**: § 370 (228); B. 187. iii; G. 347; H. 429 (386); H-B. 376.—**Britanniam**: the support and sympathy which the Gauls received from Britain was *Cæsar's* excuse for his subsequent expedition there.—**profugisse**: the subject is the implied antecedent of **qui**.

59 10 **sua clementia**, *his* (characteristic or well-known) *clemency*: for the case, cf. 50 23, 54 1.

59 11 in eos: but for the interposition of **Haeduos**, this would be *in se*; § 300. *b* (196. 2); B. 244. ii; G. 520, 521; H. 504 (449. 1); H-B. 262. 2, here, as often, the last word or thought governs the construction. — **utatur:** subst. clause of purpose, after **petere**; § 563. *d* (331. *d*); B. 295. 4; G. 546; H. 564. iii (499. 3); H-B. 530. 2. *ftn.*¹; cf. also **6 10** and note. Observe that from this point the present and perfect tenses of the subjv. are used; cf. **cognoverint**, **51 11** and note. — **quod si fecerit:** fut. condition (more vivid); **fecerit** is perf. subjv. for the fut. perf. indic. of the dir. disc. The apodosis is **amplificaturum:** § 516. *a* (307. *a*); B. 302; G. 595; H. 574. 2 (508. 2); H-B. 579. *a*; on the use of **quod**, see note on **qui cum**, **58 9**.

59 13 quorum: the antecedent is **Belgas**. — **si qua bella inciderint, sustentare consuerint:** general condition; see dir. disc. above. For the tenses used in general conditions, see § 518. *b* (309. *c*); G. 594. *N.*; H. 578. 1 (508. 5); cf. H-B. 579, 577. *a*.

59 14 consuerint: present in force; § 205. *b. N.*² (143. *c. N.*); B. 262. *A*; G. 175. 5, 236. *R.*; H. 299. 2 (297. *i. 2*); H-B. 487.

59 15 **CHAP. 15. honoris Diviciaci . . . causa,** *out of respect for Diviciacus* (lit. *for the sake of honor*). — **Diviciaci:** obj. gen.; § 348 (217); B. 200; G. 363. 2; H. 440. 2 (396. iii); H-B. 354. — **causa:** abl. of cause; § 404. *c* (245. *c*); B. 198. 1; G. 373, 408; H. 475. 2 (416. *ftn.*²); H-B. 444. *d*, 339. *d*; used almost like a preposition with the gen., and always following its noun, as here **honoris**.

59 16 recepturum [esse]: the fut. act. infin. commonly omits *esse*, as here. — **quod erat:** the indic. implies that this was the real reason, not merely one given by Cæsar at the time (which would require *quod esset*); cf. **49 12**.

59 17 magna . . . auctoritate: cf. **53 11**. — **multitudine:** cf. **51 12**.

59 20 Ambianorum: about Amiens, near the coast of the Channel.

59 21 eorum finis: notice the emphatic position. *Their territories* reach to the Nervii. — **natura:** i.e. what sort of people they were, like *quales essent*.

59 22 reperiebat: cf. note on **49 2**. — **nullum aditum, etc.:** Direct, —

Nullus aditus est ad eos mercatoribus; nihil patiuntur vini . . . inferri, quod his rebus relanguescere animos . . . existimant; sunt homines ferè magnaëque virtutis; increpitant atque incusant reliquos Belgas, qui se populo Romano dediderint patriamque virtutem proiecerint; confirmant sese neque legatos missuros neque ullam condicionem pacis accepturos.

59 23 mercatoribus (dat. of poss.; cf. **nulli**, **53 10**), *traders have*. — **pati** (subj. *eos* understood): the subj. acc. of the infin. in indir. disc. should regularly be expressed, but occasionally it is omitted when the sense is clear. Cæsar is very free in this respect, because his work is

only brief notes of his campaigns (*commentarii*). — *nihil . . . vini*: § 346. *a*. 1 (216. *a*. 1); B. 201. 1; G. 369; H. 440. 5 (397. 1); H-B. 346.

59 25 relanguescere: an inceptive verb (ending, *-sco*); § 263. 1 (167. *a*): B. 155. 1; G. 133. v; H. 277 (280); H-B. 212. 2. — *esse*, *that they are*.

59 26 magnæ virtutis: § 345 (215); B. 203. 1; G. 365; H. 440. 3 (396. v); H-B. 355. Note that the descriptive gen. has exactly the force of an adj., so that it is even connected with *feros* by a coördinate conj.: § 223. *a* (154. *a*); B. 341; G. 474; H. 657 (554); H-B. 305. i.

59 27 Belgas: object. — *qui . . . dedidissent . . . proiecissent*, *who* [they said] *had surrendered*, etc.: § 592. 3 (341. *d*); B. 323; G. 628; H. 649. 1 (528. 1); H-B. 535. 1. *a*; cf. also note on **32 21**.

60 1 patriam: an adjective.

60 2 missuros . . . accepturos: on the omission of *esse*, cf. note on **59 16**. The subject of the infinitives is *sese*, which refers back to the omitted subject (*eos*) of *confirmare*.

60 3 CHAP. 16. *cum . . . fecisset*: for similar *cum*-clauses, cf. **49 1**, **53 8**, **53 10**. — *eorum*: i.e. of the Nervii. — *triduum*: § 423 (256); B. 181; G. 336; H. 417 (379); H-B. 387.

60 4 Sabim flumen, etc.: Direct, —

Sabis flumen a castris . . . milia passuum x abest; *trans id flumen omnes Nervii consederunt* *adventumque Romanorum expectant* *una cum Atrebatibus . . .* (nam his . . . *persuaserunt* *uti eandem belli fortunam experirentur*); *expectantur* *etiam ab eis Aduatucorum copiae atque sunt in itinere*; *mulieres quique . . . inutiles videbantur in eum locum coniecerunt*, *quo propter paludes exercitui aditus non esset*.

60 4 Sabim: *the Sambre*, which flows northeasterly into the Meuse (Mosa); § 75. *a*. 1 (56. *a*. 1); B. 37; G. 57. R.¹; H. 102. 2 (62. ii. 2. (1)); H-B. 88. 1. The Nervii occupied the basin of this river and of the upper Scheldt. — *non amplius milia*, etc.: *milia* is acc. of extent, and is not affected in construction by *amplius*; cf. a similar construction, **54 9**, and see § 407. *c* (247. *c*); B. 217. 3; G. 296. R.⁴; H. 471. 4 (417. i. N.²); H-B. 416. *d*.

60 7 Atrebatibus, etc.: small tribes to the south and west; modern Arras, Vermandois. — *his*: § 367 (227); B. 187. ii. *a*; G. 346; H. 426. 2 (385. ii); H-B. 362. i.

60 8 experirentur: subst. clause of purpose; cf. **59 10**.

60 9 expectari: note throughout this indir. disc. the variation between pres. and perf. infin., according as the dir. disc. has the pres. or perf. indic.

60 10 quique, *and* (those) *who* (not to be confounded with the plur. of *quisque* with the same form); *qui*, as so often, implies its own antecedent *eos*, the obj. of *coniecisse*.

60 11 *quo* = *in quem*.

60 12 *esset*: already in dir. disc. a rel. clause of characteristic; § 535 (320); B. 283. 1; G. 631. 1; H. 591. 1 (503. i); cf. H-B. 521. 1; cf. 51 4. The emphasis is shown in "to which on account of the MARSHES an *army* could not get access."

60 14 CHAP. 17. *locum . . . idoneum*: see chapter on military affairs, v.—*deligant*: cf. construction of *dicerent*, 50 15.—*ex . . . Belgis*: for part. gen. following *complures*, cf. 50 13, 53 12.

60 15 *deditiis*: i.e. the three states just subdued.

60 16 *una*, *along* (with him).

60 17 *eorum dierum*, *during those days*: see note on *consili*, 59 7.

60 19 *inter singulas legiones*, *between each two legions*.—*impedimentorum magnum numerum*, *a great number of baggage-animals* (i.e. a very long baggage-train). See chapter on military affairs, I. 6.

60 20 *neque*, *and that . . . not* (or *no*); notice that in Latin the connective has a strong attraction for the negative where our idiom separates them.—*negoti*: part. gen.; cf. *nihil vini*, 59 23.

60 21 *cum . . . venisset . . . abessent*: subjv. because subordinate clauses in the indir. disc.; the verbs refer to future time, and represent respectively the fut. perf. and the fut. indic. of the dir. disc.

60 22 *hanc*: i.e. the first legion.—*sarcinis*: see chapter on military affairs, IV. *e*, and Fig. 14.—*adoriri*: subject of *esse* (l. 20), *quicquam* being in the predicate.—*qua pulsa impedimentisque direptis* (abl. abs. = protasis of a future condition), *if this should be routed*, etc.

60 23 *futurum [esse]*: apodosis of the condition.—*ut . . . non audent*: subst. clause of result, subject of *futurum [esse]*; § 569 (332. *a*); B. 297. 2; G. 553. 3; H. 571. 1 (501. i); H-B. 521. 3. *a*; the whole is little more than a roundabout way of expressing the fut. infin.; § 569. *a* (147. *c*. 3); B. 270. 3; G. 248. 2; H. 619. 2 (537. 3); H-B. 472. *c*.—*contra consistere*, *to withstand their attack*.

60 24 *adiuvabat*: the subject is the subst. clause *quod Nervii . . . effecerant*, *the advice of those who reported the matter was REËNFORCED by the fact that the Nervii*, etc. Notice the emphatic position of *adiuvabat*, which may be expressed in English by using the pass. as above.

60 25 *antiquitus*: adv.; the use of the hedges described below was an immemorial custom, and they are still, it is said, common in this region. Traces of such about 400 years old still exist in England.—*cum*: causal.

60 26 *nihil* (adv. acc.) *possent*, *had no strength*.—*neque enim*, *and in fact . . . not*.—*ad hoc tempus*: opp. to *antiquitus*.—*rei*: cf. construction of *imperii*, 49 11.

60 27 quicquid (cf. nihil above) possunt, etc., all the strength they have is in infantry. — quo facilius . . . impedirent, in order to check the more

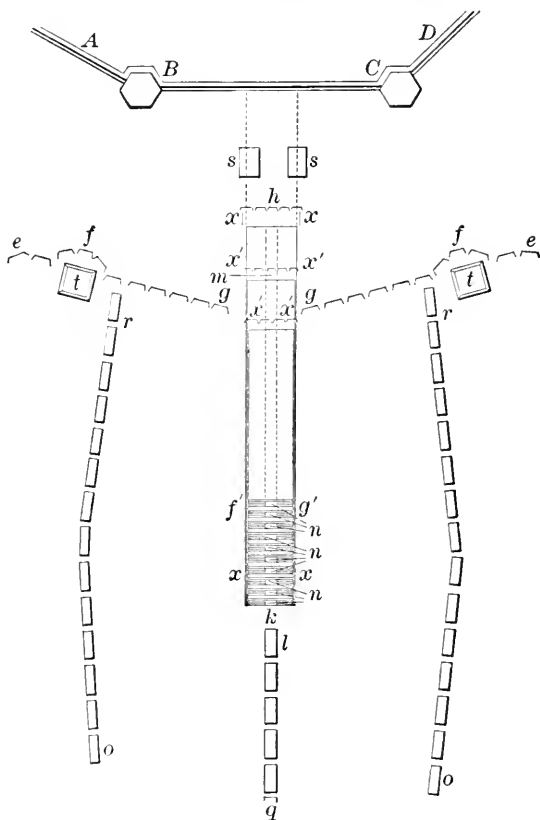

FIG. 120. — GENERAL VIEW OF SIEGE OPERATIONS.

ABCD, hostile wall; *ss*, *testudines aggestitiæ*, protecting those levelling the ground; *hk*, *agger*; *xx*, *x'x'*, etc., *plutei*, protecting those working on the *agger*; *efg*, line of *plutei*, manned with archers and slingers; *tt*, *turres*, also manned with archers and slingers and provided with *tormenta*; *ro*, covered way of *vineae*, giving approach to archers and slingers; *lg*, covered way of *vineae* approaching the point of beginning the *agger*; *f'g'*, position of *plutei*, covering the beginning of the *agger*; *mn*, covered gallery through the *agger*; *nnn*, etc., steps and platforms of the several stories.

easily; **quo** is the regular conj. introducing a purpose clause which contains a comparative; § 531. *a.* (317. *b.*); B. 282. 1. *a.*; G. 545. 2; H. 568 (497. ii); H-B. 502. 2. *b.*

61 1 *praedandi causa*: cf. **56 15.** — **venissent**: attracted from the fut. perf.; § 593 (342); B. 324. 1; G. 663. 1; II. 652 (529. ii); H-B. 539.

61 3 *in latitudinem*, etc.: i.e. when the tree was bent over, shoots sprang from its sides so as to make a thick mass of small branches. Among these were planted briars and thorns. These hedges were of course for the defence of individual farms to hinder cavalry from raiding across country.

61 4 *ut . . . praeberent*: object clause of result, depending on *effecerant*; cf. **57 2.** — *instar muri*: § 359. *b* (214. *g.*); B. 198. 2; G. 373; H. 446. 4 (398. 4); H-B. 339. *d.*

61 5 *quo* (adv.): i.e. *into which*.

61 6 *posset*: result clause.

61 7 *sibi*: dat. of agent with *omittendum* [*esse*].

61 8 CHAP. 18. *loci . . . quem locum*: § 307. *a* (200. *a.*); B. 251. 3; G. 615; H. 399 (445. 8); H-B. 284. 4. — *castris*: the dat. of purpose of concrete nouns is used in prose in a few military expressions; § 382. 2 (233. *b.*); B. 191. 1; G. 356; H. 425. 3 (384. ii. 1. 3); H-B. 361.

61 9 *aequaliter declivis*, with *even downward slope*.

61 10 *quod* agrees in gender with *flumen*. — *vergebat*: imperf. of description; cf. note on **3 5.** — *ab*: i.e. on the other side.

61 11 *pari acclivitate*: abl. of quality; cf. **53 11, 59 17.** Notice the opposition to *declivis*, above. — *adversus . . . contrarius*, *facing this, and on the other side* (of the stream).

61 12 *passus*: cf. **53 2, 57 10.** — *apertus*: i.e. cleared of woods. — *infimus, at the foot*: § 293 (193); B. 241. 1; G. 290. R.²; H. 497. 4 (440. 2. N.²); H-B. 244; opposed to *ab superiore parte, along the upper portion*: § 429. *b* (260. *b.*); G. 390. 1; H. 434. i; H-B. 406. 2.

62 1 *ut non*: observe that a negative result is expressed by *ut non*, while a negative purpose is expressed by *ne*.

62 3 *secundum*: preposition.

62 4 *pedum trium*: gen. of measure, here in the predicate; cf. **54 23.**

62 6 CHAP. 19. *copiis*: cf. **50 16, 54 8.** — *ratio ordoque*: as these two words convey but a single thought, the verb is singular. — *aliter . . . ac*, etc. (see Vocab.), *was different from what the Belgæ had reported* (lit. *had itself otherwise* [than] *as*, etc.): § 324. *c* (156. *a.*); B. 341. 1. *c.*; G. 643; H. 516. 3 (459. 2); H-B. 307. 2. *a.*

62 7 *ad Nervios*: § 363 (225. *b.*); B. 358. 2. *a.*; G. 340. R.²; II. 429. 3 (386. 3).

62 8 *consuetudine sua*, in accordance with his custom.

62 9 *ducebat*: for the order of march, see chapter on military affairs, VI. — *conlocarat*, had put in place [of greatest safety]; this verb (*conloco*) is often confounded by beginners with *conligo*, collect.

62 10 *proxime conscriptae*, latest levied. These were legions XIII and XIV, mentioned in 50 1, 2, which were not yet sufficiently trained to bear the brunt of the fight.

62 11 *praesidio impedimentis*: cf. 54 3, 55 1, 56 4.

62 13 *cum*, etc.: this clause describes the situation, and is shown to be temporal by *interim*, which follows (cf. 53 8, 53 10, 60 3). This movement is important because it allowed time for the main body to arrive and begin the camp, contrary to the expectation of the Nervii.

62 14 *reciperent . . . facerent*, kept retiring, etc. (strengthened by *identidem*).

62 15 *quem ad finem*: the antecedent attracted into the relative clause, according to the Latin idiom. Translate as if it were *ad finem ad quem*, which, however, the Romans would rarely say.

62 16 *cedentis* agrees with *eos*, the understood object of *insequi*. Notice that the Romans can always omit a pronoun if its case is determined by some word in agreement.

62 17 *opere dimenso*, having staked out the works. See chapter on military affairs, v.

62 18 *ubi . . . visa sunt*: cf. 53 4, 56 13. Notice that this is purely temporal. Cæsar might have used *cum* with the subjv., but in that case it would describe the situation. A comparison of this with 62 13 shows the difference clearly.

62 20 *quod tempus*, the moment which. Notice the difference of the Latin and the English idiom; *tempus* is in apposition with the clause *ubi . . . visa sunt*. The attraction of the antecedent into the relative clause is regular when it is in apposition with something preceding (cf. 30 19, 38 19, and notes). — *committendi proeli*: depending on *tempus*. Notice that the gen. is the regular form to connect one noun with another, though we use various prepositions. — *ut (just as) . . . confirmaverant*: i.e. the movement was not a confused sally on the individual impulse of savages, but an organized attack with the united and settled determination to resist the invaders. He may have said this only to enhance the glory of his victory, but he more than once pays tribute to the prowess of the enemy, and he probably does so here.

62 24 *ut*, so that (result).

62 25 [*et iam in manibus nostris*]: i.e. within reach of our weapons. This makes sense, and may be so translated.

62 27 *adverso colle*, etc., *pushed straight up the hill*. The way by which is put in the abl. without a preposition. — *eos*: after *ad*. — *occupati*, *still at work on the fortifications (in opere)*; *occupatus* is regularly used as an adj.

63 1 CHAP. 20. *Caesari*: dat. of agent; cf. *sibi*, **61** 7. Notice the emphatic position of *omnia*. Cæsar had to do *everything at one time*. — *vexillum*: the large banner hoisted at headquarters to announce an engagement impending. See Fig. 121, and chapter on military affairs, II.

63 2 *proponendum* [*erat*]: second periphrastic, like *agenda erant* above; so also *dandum*, etc.

63 3 *tuba*: the signal to take their places in the ranks. See Fig. 37. — *ab opere*, etc.: those who were already detailed must have needed further orders before going into battle.

63 4 *qui* relates to the understood subject (*ei*) of *arcessendi* [*erant*]. — *aggeris*, *materials for a mound*, an unusual meaning. — *arcessendi*: soldiers who were out of hearing of the customary signals would need a messenger.

63 5 *cohortandi*: pass., as always, though from a deponent verb; § 190. *d* (135. *d*); B. 112. *b*; G. 251; H. p. 114, ftn. at end; H-B. 291. — *signum dandum*: the last signal for immediate action; cf.

64 5. This list includes all the functions of the commander, ordinarily extended over a considerable time. In this emergency Cæsar says these needed to be done at once, and this was impossible (cf. *impediebat*). But the difficulty was partially remedied by the good sense and discipline of the soldiers who did what was proper without orders.



FIG. 121. — VEXILLUM.

63 7 *difficultatibus . . . subsidio*: cf. **54** 3. **62** 11.

63 9 *quid . . . oporteret*: indir. quest., object of *praescribere*; cf. **50** 26.

63 10 *quam* connects similar constructions: § 323. *a* (208. *a*); H-B. 305. 1.

63 11 *quod*: i.e. the second of the *two things* mentioned. — *singulos*, etc., *had forbidden the several lieutenants to leave the work and their several legions*.

63 12 *nisi munitis castris*: abl. abs.; see note on **49** 6. The meaning here is *not until after*, etc.

63 13 *nihil*: adv. acc.; § 390. *d*. N.² (240. *a*); B. 176. 3. *a*; G. 333. 1; H. 416. 2 (378. 2); cf. H-B. 387. iii; it is stronger than *non*: *nihil iam*, *no longer*.

63 14 *quae videbantur*, *what seemed best*.

63 16 CHAP. 21. *necessariis*: i.e. such as were (absolutely) *necessary*: observe emphasis. — *ad cohortandos milites*: gerundive of purpose; cf. **49** 13, **54** 16.

63 17 *quam in partem* = *in eam partem in quam*; cf. note on *quem ad finem*, **62** 15.

64 1 *decimam*: *Cæsar's favorite legion*; cf. **36** 24. — *non longiore . . . quam uti*, *with no more words than that they should*, etc.

64 2 *retinerent, perturbarentur, sustinerent*: object clauses of purpose with *ut*, etc., expressing indirectly the commands given in his address.

64 4 *quam quo . . . posset*: rel. clause of characteristic; § 535 (320. c); B. 283. 2. a; G. 298; II. 591. 6 (503. ii. 3); cf. H-B. 521. 1 and 2. c.

64 7 *pugnantibus*: sc. *eis*, and see note on *cedentis*, **62** 16. — *hostium* depends on *animus*.

64 8 *paratus* (adj.) *ad dimicandum*, *ready for battle*.

64 9 *ad insignia accommodanda*, *for fitting on the decorations* (of the helmets, etc.). Some of these indicated the rank of the wearer. Perhaps, too, the different legions were distinguished by the *insignia* of the helmets. At all events, these were considered important and were always put on before an engagement. See chapter on military affairs, VII.

64 10 *scutis*: abl. of separation; cf. **53** 6, **56** 5. On the march helmets were slung upon the breast, shields covered with leather, and ornaments kept in some unexposed place. See Fig. 14. — *defuerit*, *failed*, i.e. there was not time enough to, etc.; for tense, cf. **50** 25, **51** 5. — *quam in partem*, *to whatever place*.

64 11 *ab opere*: i.e. from his position in the work of fortifying. — *quæque*, etc., *and whatever standards he saw first* (*prima*, adj. with *signa*), *he fell in* (lit. *took his stand*) *there*. The Roman soldier was so well drilled that, to whatever part of the legion he found his way, he knew perfectly the duties belonging to it.

64 12 *haec* (*signa*): antecedent to *quæ*, but implying also the antecedent (*in hac parte*) of *quam* above, for which it is really substituted. — *in quaerendis suis* [*signis*]: gerundive. The standards distinguished the different cohorts, and hence they here refer to the place of each soldier in the ranks, as we might speak of a company or platoon. See chapter on military affairs, II; also Figs. 70, 114.

64 14 CHAP. 22. *ut . . . quam ut*: *as . . . than as*. The military science of the ancients was adapted to level, open ground, in which the troops could be drawn up and kept in regular lines.

64 16 *cum*: causal; cf. **57** 1. — *aliae alia in parte*, *some in one position, some in another*: § 315. c (203. c); B. 253. 2; II. 516. 1 (459. 1); II-B. 265. For position of the various legions, see battle plan, Fig. 35.

64 17 *saepibus . . . interiectis*: cf. note on 60 25.

64 18 *ante*: i.e. in ch. 17. — *impediretur*: connected with *resisterent* by *-que* in l. 17.

64 19 *neque*: here begins the main clause, the verb of which is *poterant*.

64 20 *provideri*: complen. infin. with *poterat* supplied from *poterant*. The subject of this *poterat* is the indir. quest. *quid . . . opus esset*. — *ab uno* (emphatic), *by only one man*.

64 21 *fortunae*: emphatic, set off against *rerum*. The *circumstances* were diversified; the *fortune* that attended them consequently had various results.

64 22 *eventus* (nom. plur.): subject of *sequebantur*.

64 23 CHAP. 23. *ut, as*, i.e. in the position in which they were. The clause is nearly equivalent to an English participle, *having taken up their position*: cf. § 493. *d.* 2 (290. *d.*); B. 356. 2. *c*; H-B. 602. 1. Observe that in the sense of *as*, *ut* is not followed by the subjv. — *sinistra*: here Labienus was in command.

64 24 *acie*: gen.; § 98. N. (74. *a*); B. 52. 3; G. 63. N.¹; H. 134. 2 (120); H-B. 100. 2. — *pilis emissis*: see chapter on military affairs, VII, and Fig. 15, p. 22. — *exanimatos*: agrees with *Atrebatas* (object of *complerunt*).

64 26 *ex loco superiore*: i.e. from the higher ground up which the *Atrebatas* had rushed after crossing the river.

65 1 *impeditam, embarrassed* (in their attempt to cross). — *ipsi*: referring to *milites*, 64 23.

65 2 *progressi*: i.e. continuing the charge up the wooded hill on the other side of the river. See description of the ground, ch. 18.

65 3 *rursus resistentis* (acc.), *when they again made a stand*.

65 6 *ex loco superiore*: i.e. starting from, etc. — *in ripis* modifies *proeliabantur* (*were continuing the fight*).

65 7 *totis*: emphatic position (cf. English "exposed *entirely* almost").

65 8 *nudatis, being exposed*, i.e. by the absence of the other legions, which were pursuing the enemy. The only ones left near the camp were VII and XII, *in dextro cornu*.

65 9 *constitisset*: causal, showing why the enemy charged in that quarter; but it is often impossible to say when the description of a *situation* passes over into *cause*. — *magno intervallo, confertissimo agmine*: best regarded as ablatives of manner, though we must remember that the Romans did not trouble themselves about our classifications. The ablative was the proper form for all these ideas; and so they used it for all without distinction, as we should use *in, at, or by*.

65 10 **duce**: abl. abs.; translate *under the leadership of*.

65 12 **aperto latere**: i.e. the right, not protected by shields; for omission of prep., see § 429 (258. *f*); B. 228. 1. *b*.; G. 338; H. 485. 2 (425. ii); H-B. 436.—**legiones**: the twelfth and the seventh.—**castrorum**: not part., but poss. gen. (i.e. the height on which the camp stood).

65 14 **CHAP. 24. levis armaturae**: descriptive gen.; note how it is naturally translated in English by a descriptive adj., *light-armed*. See chapter on military affairs, I. 3, and Figs. 104, 115.

65 15 **una**: adverb.

65 16 **pulsos [esse]**: infin. of indir. disc., with subj. acc. **quos**.—**adversis hostibus**, etc., *met the enemy face to face*: § 370 (228); B. 187 iii; G. 347; H. 429 (386); H-B. 376.

65 17 **occurrerant . . . ferebantur**: these *descriptive* imperfects belong to the side action; the main narrative, which is interrupted by them, is resumed in the perfects **contenderunt**, etc., at the end of the chapter. See note on 3 5.

65 18 **ab decumana porta**: i.e. the rear gate; see chapter on military affairs, v, and Fig. 119. The camp was partly on a slope, and the rear commanded a wide view of the surrounding country.

65 20 **cum respexissent, on looking back**. Notice that this descriptive *cum*-construction has a great variety of translations, but all indicate an inner connection; cf. **cum . . . vidissent**, l. 26, below.

65 21 **praecipites**: adj., agreeing with **calones**, but with the force of an adv., *pell-mell, in utter confusion*; § 290 (191); B. 239; G. 325. 6; H. 497 (443); H-B. 245.

65 22 **qui**, etc.: this refers to the baggage-train which was coming up with legions XIII and XIV as a rear guard; see 62 9–11.

65 23 **oriebatur**: observe the sing. number, and cf. 62 6 and note.—**alii aliam**: § 315. *c* (203. *c*); B. 253. 2; G. 323; H. 516. 1 (459. 1); H-B. 265.—**perterriti**, *frantic with fear, panic-stricken* (thoroughly frightened). Observe the force of **per-** (see Vocab.).

65 25 **quorum** (poss.) **virtutis** (obj.) **opinio**, *whose reputation for valor*: § 348. *b* (217. *b*); B. 200; G. 363. R.²; H. 446. 2 (398. 2); H-B. 354.

65 26 **a civitate**: abl. of agent, the state being thought of as a body of citizens.

65 27 **compleri** (*was filling*) . . . **premi** . . . **teneri** . . . **fugere**: indir. disc. with **vidissent**. The present tenses indicate what they saw *going on* before their eyes (dir. *complentur . . . premuntur . . . tenentur . . . fugiunt*). The beginner should notice that difference of idiom requires a change of tense in translation.

66 2 **domum**: cf. 56 17 and note.

66 3 pulsos superatosque [*esse*]: indir. disc.; the subject is **Romanos**. — **castris**: § 410 (249); B. 218. 1; G. 407; H. 477 (421. i); H-B. 429.

66 4 hostis: acc., subject of **potitos** [*esse*].

66 5 CHAP. 25. **Caesar**: subject of **processit**, **67 9**. In this characteristic example of Latin style notice that the main verb of the sentence is not expressed until the attendant circumstances have been introduced in the form of modifying phrases, dependent clauses, etc. Thus the sense and construction are *suspended*. Such a sentence is called a *Period*: § 600, 601 (346); B. 351. 5; G. 684, 685. 2; H. 685 (573); H-B. 629, 630. An English writer would have used several short, independent sentences, each describing a single act or circumstance; and a really good translation should have that form, thus:—

Cæsar, after addressing the tenth legion, passed to the right wing. Here he saw his men were hard pressed. The standards were all huddled together and the soldiers of the twelfth, massed in a solid body, were in each other's way. All the centurions of the fourth cohort had fallen, the standard-bearer was killed, and the standard lost. In the other cohorts almost all the centurions were either killed or wounded. Among these the first centurion, P. Sextius Baculus, one of the bravest of soldiers, was disabled by many severe wounds so that he could no longer stand on his feet. The rest were showing no spirit, and some in the rear had abandoned the fight and were drawing back to get out of range of the missiles. The enemy meanwhile continued to come up in front from below without cessation, and to press them hard also on both flanks. The situation was desperate. Seeing this, and realizing that there were no reserves that could be sent in, Cæsar snatched a shield from a man in the rear rank—it happened that he had come there without a shield himself—and advanced to the front.

66 6 ubi: construe with **vidit**, l. 8. — **in unum locum**: i.e. the soldiers were so crowded together that they could not keep their alignment, and the standards were bunched in a confused mass in the crowd.

66 7 sibi . . . impedimento, *hindered one another in fighting* (lit. *were for a hindrance themselves to themselves*); cf. **56 4**, **62 11**.

66 8 quartae cohortis: this stood on the left of the front line and so bore the brunt of the attack. See chapter on military affairs, VI and VII. — **omnibus centurionibus occisis**: notice that seven different events are expressed in this sentence by ablatives absolute. See note on **omni pacata Gallia**, **49 6**.

66 9 signo: i.e. the standard of the cohort.

67 1 in his, among these. — **primipilo**: see chapter on military affairs, l. 7. — **Baculo**: this was one of Cæsar's best centurions. His further exploits are mentioned in Bk. iii. ch. 5 and Bk. vi. ch. 38.

67 3 iam . . . non, *no longer*. — **tardiores**, *rather slack* (discouraged): § 291. *a* (93. *a*); B. 240. 1; G. 297; H. 498 (444. 1); H-B. 241. 2.

67 4 ab novissimis, *in the rear*: so below, l. 8. — **deserto proelio**, *withdrawing from the fight* (abl. abs.).

67 5 neque: correl. to **et** = *both . . . not . . . and*.

67 7 vidit: repeated from **66 8** on account of the length of the sentence. — **neque ullum subsidium**: the rear guard, legions XIII and XIV, had not yet arrived.

67 8 posset: rel. clause of characteristic; cf. **51 4**, **64 5**. — **militi**: dat. after **detracto**; cf. construction of **hostibus**, **54 5** and note.

67 11 signa . . . laxare, *to charge and [thus] open out the ranks*, i.e. as they advanced, the space between the ranks would be increased, and so more room obtained for the use of the sword. — **quo . . . possent**: cf. **60 27**.

67 12 gladiis; cf. **castris**, **66 3**. — **militibus**: dat. with **inlata**.

67 14 etiam . . . rebus, *even in his own extreme peril*.

67 16 CHAP. 26. **constiterat** (from *consisto*): *NOT had stood*, but *had taken up a position*, and so *stood*; cf. **consuerint**, **59 14**; § 476 (279. *e*); B. 262. A; G. 241. R.; H. 538. 4 (471. 3); H-B. 487.

67 18 ut . . . coniungerent . . . inferrent: subst. clause, secondary obj. of **monuit**; cf. **6 10**, **59 10**, and notes. — **conversa**, etc., *should face about and charge the enemy in opposite directions* (lit. *bear turned standards against*). The two united thus formed a kind of hollow square. It is not necessary to suppose that the soldiers stood immediately back to back, though this is probable, inasmuch as the attack was on both flanks and in front.

67 19 alii: dat. after a verbal phrase of *helping*; § 367 (227); B. 187. ii. *a*; G. 346; H. 426. 1 (385. i); H-B. 365. ftn.¹. 2d par.

67 20 ne . . . circumvenirentur: cf. **ne . . . adduceretur**, **49 6**. — **aversi**, *in the rear* (lit. *while their backs were turned*). — **ab hoste**: collectively, in which sense the plur. is more common.

67 22 legionum duarum: i.e. XIII and XIV; see plan, Fig. 35.

67 24 colle: i.e. the site of the Roman camp. — **Labienu**s: he, with legions IX and X, had been pursuing the Atrebatcs; see first lines of ch. 23.

67 26 gererentur: indir. quest.

67 27 qui: i.e. the soldiers of the tenth legion.

67 28 esset: indir. quest.

68 1 nihil . . . fecerunt, *left nothing undone in the way of speed* (i.e. *hastened as fast as they could*).

68 2 reliqui: a pred. gen. Various genitives of this sort are used with *facere*: § 343. *b* (214. *c*); B. 198. 3; G. 369. R.²; H. 447 (403); H-B. 340. *a*.

68 4 CHAP. 27. *etiam qui, even such as.* — **procubiissent**, subjv. of characteristic; cf. **67 8.** — **scutis**: abl. with **innixi**; § 431 (254. *b*); B. 218. 3; G. 401. 6; H. 476. 3 (425. i. 1. *N.*); H-B. 438. 2. *a.*

68 6 **inermes armatis**, etc., (though) *unarmed, threw themselves upon the armed* (enemy). — **occurrerent**: result, like **redintegrarent**.

68 7 **deherent, praeferrent**: purpose clauses, but in slightly different relations, dependent on **pugnant**. The use of **quo** as a conj. to introduce a purpose clause when the clause contains no comparative is rare. It is used regularly in **60 27, 67 11.** Here we should expect *ut*.

68 8 at: marks with emphasis the change of the narrative from the Romans to the enemy.

68 9 tantam virtutem praestiterunt: on this clause depend the following subjunctives of result, — **insisterent, pugnarent, conicerent, remitterent**.

68 10 primi, foremost. — **iacentibus** (sc. *eis*, dat. after **insisterent**), *stood upon them as they lay fallen* (lit. *them lying*).

68 12 qui superessent: characteristic clause. — **ut ex tumulo**, *as if from a mound*.

68 13 ut . . . deberet, *so that we may consider* (lit. *it must be judged*) *that not without good hope of success (nequiquam) did men*, etc.; **ut . . . deberet** is a result clause dependent on the whole of the preceding sentence. The subject of **deberet** is the infin. clause **homines ausos esse**.

68 16 quae: the antecedents are the preceding infin. clauses describing the acts of the enemy; translate *deeds which.* — **facilia**: pred. adj.; § 285. 2, 282. *b* (186); B. 233. 2; G. 211; H. 382. 2 (438. 2); H-B. 320. iii.

The battle with the Nervii and their allies was the most desperate of the Gallic War. Their surprise of the Romans was complete, their courage such as to evoke Cæsar's wonder and admiration. Had the Romans come up in the order of march expected, — a legion at a time with intervening baggage, — they could hardly have escaped defeat or even annihilation. As it was, only the steadiness and discipline of the troops and the inspiration of Cæsar's presence and example at a critical moment saved the day.

68 18 CHAP. 28. **prope ad internecionem**: the Nervii were not by any means exterminated. Three years later they revolted again (Bk. v. ch. 38), and two years after that they sent a force of 5000 men to Alesia to relieve Vercingetorix (Bk. vii. ch. 75).

68 20 aestuaria: the country lying to the north, the modern Zealand, is low and marshy, cut up with bays and tide-water inlets.

68 21 dixeramus: for tense, cf. note on the same word, **49 4.** — **cum**: causal; cf. **57 1.** — **impeditum [esse]**, etc., *there was no obstacle in the way of* (lit. *nothing hindered to*) *the conquerors*.

68 24 in . . . calamitate: gerundive construction.

68 26 qui . . . possent: this would naturally be a characteristic subjv. in the dir.; cf. 26 10. — quos: see note on 58 9.

68 27 usus [*esse*]: § 582 (330. *b*); B. 332. *b*; G. 528. 1; H. 611. N.¹ (534. 1. N.¹); cf. H-B. 590. 2. — misericordia (abl.), *mercy*: it has been observed that Cæsar's dealings with the Gauls were comparatively merciful for a Roman dealing with barbarians, but his cruelty seems to us atrocious.

69 2 ut . . . prohiberent: subst. clause of purpose, obj. of imperavit; cf. this construction with that of uti iussit just before.

69 4 CHAP. 29. supra: see 60 9. — cum . . . venirent, *while on the way*. — omnibus copiis: cf. 50 16, 54 8.

69 7 sua omnia: cf. 50 15 and note. — oppidum: often identified with the citadel of Namur, at the confluence of the Meuse and Sambre (see Fig. 41). For a striking description of the locality, see Motley's "Dutch Republic," iii. 224. Others place it more probably at Falhize, opposite Huy, on the Meuse below Namur, though neither place quite agrees with Cæsar's description.

69 8 quod cum: cf. qui cum, 58 9 and note.

70 1 pedum: cf. 52 27.

70 3 conlocabant: notice the change of tense from the pluperf.

70 4 ex Cimbris Teutonisque: abl. of source; cf. 51 1; see note on 7 1.

70 6 impedimentis refers to cattle as well as portable baggage; hence the two verbs, agere and portare. Cf. *ferre et agere, to plunder*.

70 7 custodiam, *a guard*, whose duty it was to keep an eye on the booty, etc.; praesidium, *a garrison*, who were to hold the place. The words are in apposition with milia.

70 8 sex milia: this Teutonic military colony was probably merely adopted into the Celtic tribe of the Aduatuci, thus giving rise to the story that the whole tribe were of Teutonic descent. — una (adv.), *with it*, i.e. the *impedimenta* — hi: i.e. the six thousand. — eorum: i.e. the Cimbri and Teutons.

70 9 obitum, *destruction*: the Teutons were totally defeated by Gaius Marius at Aquæ Sextiæ (*Aix-les-Bains*), B.C. 102; the Cimbri, by Marius and Catulus, the next year, at Vercellæ. — alias: adv.

70 10 inferrent: the regular word for offensive war. — inlatum [*sibi bellum*] defenderent, *defended themselves when attacked*. — consensu eorum omnium, *by mutual agreement*, i.e. between themselves and all their neighbors.

70 11 sibi domicilio: cf. 54 3. — hunc locum: the land between the Meuse and the Scheldt.

70 12 CHAP. 30. **adventu**: abl. of time.

70 13 **faciebant**: notice the tense, and cf. **49 2** and note. — **parvulis**: for the formation of the word, see § 243 (164. *a*); B. 153; G. 189. 6; H. 340 (332); H-B. 207. 1.

70 14 **pedum XII**: i.e. in height. — **XV milium**: fifteen miles (sc. *passuum*) seems large for so small a hill, but no satisfactory explanation has yet been given.

70 15 **oppido**: for the omission of *in*, cf. **castris**, **57 5** and note. For the siege operations, see chapter on military affairs, VIII, and Figs. 43, 92, 93, 120.

70 17 **viderunt**: note the regular mood and tense in the temporal clause with **ubi**; cf. **62 18** and note. — **inridere**: histor. infin.; see note on **13 18**.

70 18 **quod . . . institueretur**: *because* (as they said), etc.: subjv. on the principle of implied indir. disc.; § 540, 592. 3 (321, 341. *d*); B. 286. 1, 323; G. 663. 1; H. 652 (529. ii); H-B. 555. *a*. — **ab tanto spatio**, *so far off* (lit. *away by so great a space*): abl. of degree of difference, **ab** having an adv. force. — **quibusnam**, etc.: the enclitic **nam** gives a sarcastic emphasis to this jeering question of the barbarians, *by what hands, pray, or what strength?*

71 2 **conlocare**: indir. disc.; we should have expected the fut. infin., *conlocaturos [esse]*. Apparently the Gauls thought the Romans meant to lift the tower and set it up on the wall (**in muro**); and such an idea, of course, seemed very amusing. But when the tower began to roll forward they saw their error. •

71 3 CHAP. 31. **moveri**, *that it was actually moving*: for the omission of the subj. acc. *turrim*, see § 581. N.¹ (336. *a*. N.); B. 314. 5; G. 527. 4; H. 642 (p. 296, ftn.²); H-B. 592.

71 5 **locuti**, *speaking*: cf. **52 7**.

71 6 **existimare** (sc. *se*, and cf. **59 23** and note), *that they thought*: depending on **locuti**.

71 8 **possent**: a rel. clause expressing cause; § 535. *c* (320. *c*); B. 283. 3. *a*; G. 633; H. 592 (517); H-B. 523. — **se** (obj.) . . . **permittere**, *that they surrendered themselves*, etc.: depending on **dixerunt**.

71 9 **unum**, *only one thing*; notice the emphatic position of the word. — **pro sua**, etc., *in accordance with his usual*, etc.; cf. **68 27**.

71 10 **quam . . . audirent**, *which they were* [all the time] *hearing of*: repeated action.

71 11 **statuisset**: for the fut. perf. (*statueris*) of the dir. disc.; § 516. *c* (307. *c*); B. 264. *a*; G. 595; H. 540. 2 (473. 2); cf. H-B. 536, 470. ftn.¹ — **ne . . . despoliaret**: subst. clause of purpose, in app. with **unum**, but really depending on **deprecari** for its form; see note on **4 17**.

71 12 inimicos: cf. **70 10.**

71 13 virtuti: § 367 (227); B. 187. ii. *a*; G. 346; H. 426. 2 (385. ii); H-B. 362. — **traditis armis** (= *si arma tradita essent*): abl. abs., equivalent to a protasis; § 521. *a* (310. *a*); B. 227. 2. *b*; G. 593. 2; H. 489. 2 (431. 2); H-B. 578. 6. In the dir. disc. a vivid fut. condition, *si arma tradita erunt, non poterimus.*

71 14 sibi praestare, that it was better for them: impers.; the subject is the following infin. clause. — **si . . . deducerentur** (fut. condition), *if they should be reduced to such an extremity.*

71 15 quamvis: from *quivis*.

71 16 consuessent: for the form, see § 181. *a* (128. *a*); B. 116. 1; G. 131. 1; H. 238 (235); H-B. 163. 1. Give the speech of the ambassadors of the Aduatuci in dir. disc., and also Cæsar's reply, ch. 32.

71 17 CHAP. 32. **consuetudine . . . merito:** cf. note on **65 9.** This is a good example of the free use of the ablative case in Latin. If **consuetudine** were alone we should call it *manner*, "that in accordance," etc.; if **merito** were alone we should call it *cause*. Cæsar in using them both did not think of either category; to him they were both ablatives and needed no classification. We may call them *cause* if we like.

71 19 aries: a long beam with an iron head (like a ram's), suspended from a framework, and swung with great force against a wall, crumbling the strongest masonry (see Fig. 126). — **attigisset . . . dedidissent** stand for *attigerit . . . dedideritis* (fut. perf.) of the dir.: § 551. *c* (327. *a*); B. 291. 1; G. 574; H. 605 (520); H-B. 507. 4. *b*.

71 20 nisi armis traditis: cf. **nisi munitis castris, 63 12.**

71 21 facturum: i.e. in case they came to terms. — **ne quam, lest any:** § 310. *a* (105. *d*); B. 91. 5; G. 315; H. 512. 1 (455. 1); H-B. 142.

71 22 re nuntiata ad suos: the idea of motion causes the use of **ad**; the dat. would refer simply to the utterance of the message, not to its being carried.

71 23 imperarentur: the subjv. shows that this subordinate clause is a part of the indir. disc.; § 580 (336. 2); B. 314. 1; G. 650; H. 643 (524); H-B. 534. 2. — **facere:** sc. *se* as subj. acc., which is very often omitted by Cæsar; cf. **59 23.** We should expect *facturos [esse]*. The pres. infin. standing for *facimus* of the dir. is somewhat colloquial; § 468 (276. *c*); G. 228; H. 533. 2 (467. 5); cf. H-B. 571. — **dixerunt:** i.e. the ambassadors on their return.

71 25 ut prope . . . adaequarent: i.e. the arms filled the ditch and the deep space between the wall and the end of the *agger* almost to the top. See Figs. 43, 118.

72 2 eo die: the day is thought of as fixing the time, not as marking its duration, hence the abl.; § 423 (256); B. 230; G. 393; H. 486 (429);

H-B. 439. — **pace . . . usi**: i.e. they enjoyed the cessation of war and were peaceable, opposed to their later conduct.

72 3 CHAP. 33. **ex oppido exire**: for the repetition of **ex**, see § 402 (243. *b*); B. 214. 2; G. 390; H. 462. 1 (413. N.³); H-B. 408. 1.

72 4 **ne quam**: see note on **71 21**.

72 5 **ante inito consilio**, *in accordance with a plan previously agreed upon*.

72 6 **quod crediderant**: a reason stated on the writer's own authority, hence the indic.; cf. **49 12**, **56 23**. — **praesidia**: i.e. those stationed in the *castella*.

72 8 **ex cortice**: abl. of material; § 403 (244); B. 224; G. 396; H. 470 (415. iii); H-B. 406. 4.

72 9 **viminibus intextis**: in the same construction as **cortice**.

72 10 **pellibus**: abl.; § 364 (225. *d*); B. 187. i. *a*; G. 348; H. 426. 6 (384. ii. 2); H-B. 376. *b*.

72 11 **qua**, *where*; an abl. or instrumental form, used adverbially.

72 13 **celeriter**: note the emphatic position. Cæsar had ordered them to give the signal, in case of any disturbance, and to do it *instantly*. — **ignibus**: this signal was given by stretching out a great flaming torch from the side of a watch-tower.

72 14 **eo**, *to that place*. — **concursum . . . pugnatum**: impers. use of pass.; § 208. *d* (146. *d*); B. 256. 3; G. 208. 2; H. 302. 6 (301. 1); H-B. 290. *a*. 1; see note on **23 1**.

72 15 **ita . . . ut**, *they fought as fiercely as brave men ought to fight*. — **in extrema spe**, *for their last chance* (lit. *in the last hope*).

72 16 **iniquo loco**: § 429. 1 (258. *f*); B. 228. 1. *b*; G. 385. N.¹; H. 485. 2 (425. 2); H-B. 436. — **qui . . . iacerent**: subjv. of characteristic; cf. **51 4**, **68 12**, **68 26**.

72 17 **in una virtute**, *in valor alone*. — **cum . . . consisteret**, *at a time when*, etc.; see note on **62 18**.

72 18 **ad**, *about*.

72 19 **postridie eius diei**: cf. **20 5** and note.

72 21 **sectionem . . . universam**: i.e. the whole people, as slaves, with all their possessions.

72 22 **capitum**: cf. **26 7**. — **milium**: pred. gen., after *esse* understood.

72 25 CHAP. 34. **Venetos**, etc.: the name of the Veneti survives in the modern *Vannes*; that of the Redones, in *Rennes*.

72 26 **maritimæ civitates**: inhabiting the modern Brittany and Normandy; they are spoken of at length in Bk. iii. chs. 7-16.

73 4 CHAP. 35. **perlata**: notice the force of **per**; the news travelled from tribe to tribe.

73 5 incolerent: subjv. of integral part; § 593 (342); B. 324. 1; G. 663. 1; H. 652. 1 (529. ii. n.¹ 1); H-B. 539.

73 6 se . . . daturas: fem. because they were representatives sent by the tribes and spoke for them.

73 7 in Italiam: i.e. Cisalpine Gaul. Cæsar's province extended to the Rubicon.—**Illyricum**: this province formed part of Cæsar's government, but he went there only during the winter season; see **78 9** and **117 14**.

73 9 Carnutes: their country lay between the Seine and the Loire, comprising the modern Orléans, formerly their capital; their name is preserved in the modern *Chartres*.—**Andes** (whence *Anjou*): near the lower Loire.—**Turonos**: preserved in *Tours*. These camps made a cordon from Orléans through Angiers and Tours and probably Vannes along the Loire to the sea-coast.—**quæque civitates**: translate as if *et civitates quæ*.

73 12 supplicatio, a *public thanksgiving*: ten days was the longest time that had ever been granted before, except to Pompey, who was honored with twelve for his victory over Mithridates. But Cæsar's party was now all-powerful at Rome.—**quod**: for *id quod*; § 307. *d. n.* (200. *e. n.*); B. 247. 1. *b*; G. 614. *r.*²; H. 399. 6 (445. 7); H-B. 325. *a.* n.²

BOOK THIRD. — B.C. 56.

ALPINE CAMPAIGN.—The higher valleys of the Alps were inhabited by tribes who got a scanty living by working in mines, and often waylaid and plundered expeditions on the march. The two legions sent by Cæsar under Q. Pedius (Bk. ii. ch. 2) had been attacked by these predatory people while passing into the valley of the Rhone above Lake Geneva; hence this expedition, sent in the fall of 57, which was intended to strike terror into the mountain tribes.

READING REFERENCES ON CÆSAR'S THIRD CAMPAIGN.

- Dodge's Cæsar, chap. 9.
- Fowler's Julius Cæsar, chap. 11.
- Froude's Cæsar, chap. 16.
- Holmes's Cæsar's Conquest of Gaul, chap. 4.
- Merivale's Hist. of Rome, Vol. I. pp. 289-297.
- Mommsen's Hist. of Rome, Vol. IV. pp. 304-309.
- Napoleon's Cæsar, Vol. II. chap. 6.
- Trollope's Cæsar, chap. 4.

74 1 cum in Italiam proficisceretur Cæsar: cf. this with the beginning of the second book, **cum esset Cæsar in**, etc. There the *verb* is made emphatic because the place where he was has been already named, and his

being absent is the most important idea. Here he is going to speak about a road to Italy across the Alps. Hence his *destination* becomes important and so takes the first place. If this were the first book, it would begin with **Caesar**, the principal personage in the narrative. If his going away were the main thing, it would begin with **proficisceretur**. But as it is, the route across, and so his destination, is here the main thing. Hence instantly the Latin order corresponds to the thought, and we have the form here presented. — **proficisceretur**: the familiar use of the subjv. with **cum** in descriptive clauses; cf. **11 7**, **62 13**. — **Galbam**: this officer was one of the assassins of Caesar, his old general. The emperor Galba was his great-grandson.

74 3 qui a finibus, etc.: Geneva seems to have been at the northeast corner of the Allobroges' territory. Between that point and the entrance to the Rhone must have been the country of the Nantuates. On the other side of the Rhone were the Seduni and Veragri. See maps, Figs. 6, 46.

74 5 iter per Alpis: the pass of the Great St. Bernard, which reaches the Rhone valley at Martigny (the ancient Octodurus) at the great bend of the river. This was the shortest route across the Alps at this period. Hannibal is said to have crossed by the Little St. Bernard, and the pass by Mont Genève was also in use. — **magno cum periculo**, *but only with great danger*, referring probably rather to the savage tribes than to the dangers of the way.

74 6 magnis portoriis, *heavy transit-duties*: **portoriis** and **periculo** are ablatives of manner; for meaning, see note on **15 25**. — **mercatores**: see note on **1 8**.

74 7 arbitraretur: informal indir. disc. The form of the original would be *arbitraris* with an imv. in the conclusion, which is absorbed in **permisit** and the following **uti**-clause; see note on **32 21**.

74 8 hiemandi causa: cf. **39 26**, **56 15**.

74 9 secundis . . . factis, etc.: see notes on **15 19**, **49 6** (last note).

74 15 hic, eius: both refer to **vicus**. — **flumine**, the Dranse.

74 17 concessit, etc.: he seems to have deprived the natives of one-half of their village to accommodate his troops, and to have left the rest to them.

75 3 CHAP. 2. concesserat: indic. because not part of the indir. disc.; cf. **qui . . . appellantur**, **52 5** and note.

75 4 montis: not the higher ranges, but the lower heights directly upon the valley.

75 5 id, this, in apposition with **ut . . . caperent**; cf. note on **4 17**.

75 8 neque eam plenissimam, etc., *and that not entirely full*. The twelfth legion had suffered severely in the battle on the Sambre (Bk. ii

ch. 25), and was probably already below the normal strength before the detachments were sent off. — **detractis**: see **74 11**.

75 9 commeatus . . . causa: gerundive of purpose; cf. gerund, **74 8**.

75 10 despiciebant, existimabant, etc.: notice the imperfects describing the situation; see note on **3 5**.

75 11 cum ipsi . . . decurrerent, *when they should charge down from the hills upon the valley*. The imperf. subjv. of indir. disc. with **cum** is here equivalent to the fut. indic. of dir. disc.

75 13 accedebat quod, *and besides (lit. it was added that)*. The subject of **accedebat** is the clause **quod . . . dolebant**; cf. **60 25**.

76 2 Romanos . . . adiungere: indir. disc. after **persuasum habebant** = *they had persuaded themselves (lit. they had it persuaded to themselves)*. With **persuasum habebant** cf. **coactum habebat**, **13 4**, **compertum habere**, **40 20**, **habere explorata**, **51 8**, and notes.

76 6 CHAP. 3. **hibernorum**: see chapter on military affairs, v. In the present case, Galba saved labor by appropriating a part of the Gallic buildings without much ceremony; but he proceeded to lay out the usual fortifications (**munitiones**).

76 7 perfectae: referring both to **opus** and **munitiones**, but agreeing with the nearer; cf. **24 7**.

76 10 consilio: i. e. of tribunes, cavalry officers, and first centurions.

76 11 quo in consilio: cf. **25 5**, **58 9**, and notes.

76 14 subsidio veniri, *that any one should come to their aid*: **veniri** is impers., sc. *posset* implied in **possent**; **subsidio** is dat. of service or end for which.

76 15 non nullae . . . sententiae, *several opinions (or votes)* given by the officers in council.

76 18 maiori . . . placuit, *it was determined by the majority*. — **hoc . . . defendere**, *to reserve this course for the extremity, and meanwhile*, etc.

76 21 CHAP. 4. **rebus . . . administrandis**: dat. of the gerundive, expressing purpose; an unusual construction, the acc. with *ad* or *in* or the gen. with *causa* being much more common. Why is **constituissent** in the subjv.?

76 23 decurrere, conicere, propugnare, mittere, occurrere, ferre, superare: histor. infinitives, describing the scene and implying incessant action; cf. **13 18**, **70 17**, and notes.

76 24 gaesa: Gallic javelins of unknown form. — **integris viribus** (abl. abs.), *as long as their strength was unimpaired*.

76 27 eo: adv. — **occurrere**, *ran to meet* the danger.

76 29 alii, *while others*. — **quarum rerum**, *things of which*; cf. **30 19**, **38 19**, **62 20**, and notes. The gen. is partitive with **nihil**.

77 1 non modo . . . sed ne . . . quidem, *not only not, but not even*, etc.; we should expect another negative after **modo**, but the Latin regularly omits it where both parts have the same predicate. Note the emphasis on **saucio**.

77 3 sui recipiendi: cf. **40 15** and note.

77 5 CHAP. 5. **cum . . . pugnaretur**, *when the fight had been* (and was still) *going on*: § 471. *b* (277. *b*); B. 260. 4; G. 234; H. 535 (469. ii. 2); H-B. 485.

77 7 languidioribus nostris: abl. abs., expressing cause.

77 9 Baculus: see **67 1** and note.

77 13 unam: note the emphasis, *only one*.

77 14 experientur: note that the histor. pres. **docent** has the effect of a secondary tense on the dependent verb.

77 15 intermitterent: a command in indir. disc., following **certiores facit** in the sense of *instructs*.

77 16 tela . . . exciperent: i.e. the Romans were to gather up the spent weapons to use them against the enemy, as their weapons were almost exhausted (l. 6).

77 19 CHAP. 6. **quod** = *id quod*: cf. **73 12**.

77 20 cognoscendi facultatem, *opportunity of finding out*. — **sui conligendi**, *of collecting their wits*: observe that **sui** is plural in meaning; cf. **sui recipiendi**, l. 3, above, and note.

77 23 circumventos interficiunt, *they surround and kill*. — **ex milibus** for part. gen. after **parte**.

77 27 armis: abl. of separation.

77 28 exutis: agreeing with **copiis**; § 364 (225. *d'*); B. 187. i. *a*; G. 348; H. 462 (414. 1); H-B. 408. 3. ftm.²; in their flight they threw their arms away. Of course the Romans did not catch them and strip off their arms.

77 29 fortunam temptare: cf. English "to tempt Providence." — **alio consilio . . . aliis rebus viderat**, *remembered that he had come with one design, and saw that he had met a different state of things*.

NAVAL CAMPAIGN AGAINST THE VENETI. — The Veneti inhabited the peninsula of Aremorica called *Bretagne*, Brittany, or Little Britain, since the emigration from Great Britain to escape the Saxon invasion. It has always been the home of the hardiest, most independent, and most strongly characterized of all the Gallic populations. Its scenery is wild and secluded, the character of its coast being clearly given in Cæsar's narrative. Its language remains Celtic to this day. No one of Cæsar's campaigns shows more strikingly his boldness and fertility of resource than this.

78 8 CHAP. 7. **Germanis**: i.e. under Ariovistus. It will be noticed that the geographical order, and not the order of events, is followed in

this summary. Of the Alpine tribes the *Seduni* are mentioned as the most important. The passage in brackets makes sense, and may be translated.

78 10 *Illyricum*: part of Cæsar's province.

78 12 *Crassus*: see **46** 24-27, **72** 24 ff.; for force of *adulescens*, see note on **46** 25.

78 13 *mare*: following *proximus* with the construction of *prope*; § 432. *a* (261. *a*); B. 141. 3; G. 359. N.¹; H. 435. 2 (391. 2); H-B. 380. *b*.

78 14 *praefectos*: *officers* of cavalry and auxiliaries.

78 15 *compluris* goes with *civitatis*.

78 19 *CHAP. 8. huius civitatis*: i.e. the Veneti, on the southern coast of Brittany, the modern Morbihan.

78 20 *orae*: part. gen. — *regionum*: added to describe and limit *orae*.

78 21 *Britanniam*: at this time an important Celtic country, having close commercial and social relations with the mainland. Doubtless a large part of the shipping trade was in the hands of the Veneti and their allies, whose commerce extended from Ireland to Spain. — *consuerunt, arc accustomed*: § 476 (279. *c*); B. 262. A; G. 236. R.; H. 299. 2 (297. 1. 2); H-B. 487. Cf. **59** 14.

78 23 *in magno . . . aperti*: i.e. on a sea exposed to great and violent storms.

78 24 *omnis . . . habent vectigalis*: i.e. levy tolls upon them all; *vectigalis* is in pred. app. with *omnis*.

78 28 *subita . . . consilia*: this national characteristic of the Gauls is often alluded to by Cæsar and other Roman historians.

79 5 *quam acceperint*: § 592 (341); B. 323; G. 628; H. 643 (524); H-B. 535. I. *a*.

79 6 *quam perferre, than to endure*, following the comparative contained in *malint*.

79 9 *remittat*: subjv. expressing a command in indir. disc., depending on the message implied in *legationem mittunt*. The dir. disc. would be *si vis*, etc., *remitte*.

79 11 *CHAP. 9. aberat longius, was too far off*, i.e. to take command at once in person. — *navis longas, galleys*. See chapter on military affairs, IX, and Figs. 48, 51. The Gallic ships, it seems, used sails alone, without oars; see **84** 25-28.

79 12 *Ligeri*: the *Loire*, on the banks of which Crassus was wintering. — *institui, to be organized*, i.e. in gangs for the several galleys.

80 1 *cum primum*: *the first moment when* (lit. *when first*). Cæsar had spent the winter as usual in Cisalpine Gaul. He reached his army perhaps in April or early in May.

80 3 [*certiores facti*]: omit in translation.

80 4 *admississent*: indir. quest. — *legatos . . . coniectos* (the specific act): in app. with *facinus*, but the construction is determined by *intellegebant*; see note on **4 17**; *legatos*: they were hardly such in the sense of international law. They were only Cæsar's *legati* or lieutenants.

80 5 *quod nomen*: cf. *quarum rerum*, **76 29** and note.

80 8 *hoc*: abl. of degree of difference, approaching the idea of cause.

80 9 *pedestria itinera*, etc., *approaches by land*.

80 10 *concisa, impeditam*: with *esse*. They depend upon *sciebant*.

80 11 *inscientiam*: i.e. the Romans' lack of acquaintance. — *neque . . . confidebant*, and they trusted that our armies could not, etc. Notice that connective and negative have an attraction for each other, though we separate them.

80 13 *ut . . . acciderent*, etc., *granting that*, etc.: *ut* here introduces a concessive clause. This is the only instance in the "Gallic War." Note that when so used the subjv. mood follows; § 440 (266. c); B. 278; G. 608; H. 586. ii (515. iii); II-B. 532. 2. b.

81 1 *posse* and the following infinitives depend upon *perspiciebant*, l. 5.

81 3 *gesturi essent*: subjv. of indir. disc. Observe the first periphrastic conj. referring to future time.

81 4 *longe aliam . . . atque*, *very different . . . from*; cf. *aliter ac*, **62 6**. — *concluso*: i.e. like the Mediterranean, where there is no tide, and which is quiet as compared with the Atlantic.

81 9 *socios*: pred. apposition; cf. *vectigalis*, **78 25**. — *Osismos*, etc.: the coast tribes as far as Flanders. The name *Lexovii* remains in *Lisieux*; *Namnetes* in *Nantes*; *Diablintes* in *Jablins*.

81 14 CHAP. 10. *iniuria retentorum equitum*, *the wrong done by detaining the knights*: § 497 (292. a); B. 337. 5; G. 664. R.²; H. 636. 4 (549. 5. N.²); H-B. 608. 2. — *rebellio*, *renewal of hostilities* (not *rebellion*).

81 16 *ne . . . arbitrarentur*: a new rising was threatened by the Belgians, while the maritime tribes, it is said, were already fearful of a Roman attempt upon Britain. (Observe that this purpose clause is under the same construction as the nominatives *iniuria*, *defectio*, etc., which express other reasons for Cæsar's action, and are all in apposition with *multa*.)

81 17 *idem*: subj. of *licere*.

81 19 *excitari*: the pres. infin. here corresponds to the pres. of a general truth; while *odisse* answers to *oderunt* taken as a pres., *all men naturally hate*.

81 20 *priusquam . . . conspirarent*: see note on **38 27**.

81 24 CHAP. 11. *flumini*: dat. with *proximi*, but cf. **78 13**.

81 25 *adeat*: after *mandat*, a command; cf. **6 10** and note; § 565. a (331. f. R.); B. 295. 8; G. 546. R.²; II. 565. 4 (499. 2); II-B. 502. 3. a.

81 26 **auxilio**: dat. of service or end for which. — **arcessiti** [*esse*] **dicebantur**, were reported to have been invited.

82 2 **Crassum**: cf. **78** 12 and note.

82 3 **Aquitaniam**: in southwest Gaul; see **2** 7–10. These peoples were of different race and language from the other Gauls, and took little interest in their affairs, not even joining in the great revolt described in Book vii.

82 6 **Venellos**, etc.: in Normandy.

82 7 **distinendam**: cf. **pontem faciendum curat**, **11** 5 and note. — **Brutum**: afterwards one of the conspirators against Cæsar, with the more celebrated Marcus Brutus.

82 8 **Pictonibus**, **Santonis**: on the coast south of the Loire (*Poitou* and *Saintonge*).

82 12 **CHAP. 12. eius modi . . . ut**, of such sort that.

82 13 **lingulis**: some of these narrow tongues of land run out to sea several miles.

82 14 **cum . . . incitavisset**: i.e. at high tide. — [**bis**]: apparently an error of the MSS. Some editors read XXIV instead of XII; others refer it to the general ignorance or carelessness of ancient writers.

82 15 **quod . . . adflictarentur**: subjv. as an integral part of the result clause.

82 16 **minuente**, at the ebb: intransitive.

82 17 **utraque re**, in either case.

82 18 **superati**, agreeing with the subject of **coeperant**.

82 19 **his** (aggere ac molibus) . . . **adaequatis**, when these were brought level with the walls.

General von Göler explains the Roman works as follows: "A dike was extended along each side of the isthmus in the direction of the town. While these were building, of course with each rise of the tide the space within would be overflowed. When the dikes were nearly completed, the Romans waited until the ebb had carried off the water, and then rapidly pushed their works to completion before the next turn of the tide. Thus the sea was shut out and the isthmus left dry. Meanwhile the dikes themselves, being raised to the height of the walls, each served the purpose of an *agger* for approach to the town."

82 23 **haec . . . faciebant**, this they continued to do: repeated action.

82 24 **partem**. duration of time.

82 25 **summa**: with **difficultas**; note the emphasis. — **vasto mari**, etc.: in each of these points the ocean is contrasted with the sheltered and tideless waters of the Mediterranean. The words are abl. abs., which in expressions of time is closely related to the locative; see § 419 (255) ftm.; cf. H-B. 421. 4.

82 28 CHAP. 13. **namque**; introduces the reason for the fewer troubles of the Veneti, "(but the Veneti had less trouble) for." — **ipsorum**, *their own*.

82 29 **aliquanto**: abl. of degree of difference.

83 1 **navium**: depending on *carinae* understood. — **quo . . . possent**: cf. **7** 15, **60** 27.

83 2 **atque item puppes**, and the sterns too: **accommodatae** (*being adapted*) standing as an additional predicate.

83 4 **quamvis**: from *quavis*.

83 5 **transtra**, etc., *the cross benches* (for the rowers) *of timbers a foot thick, fastened with iron bolts the thickness of a [man's] thumb*.

83 7 **pelles**: the Romans used sails made of flax, the Veneti of skins untanned (*pelles*) or tanned (*alutae*).

83 11 **tanta onera navium**, *ships of so great weight*. — **non satis commode**, *not very well*

83 12 **nostrae classi**: dat. of possession, but translate, *the encounter of our fleet with*, etc.

83 13 **praestaret**, *had the advantage* (i.e. our fleet).

83 14 **reliqua**. here a neut. plur. substantive, *everything else*.

83 15 **eis**: dat. with **nocere**; § 367 (227); B. 187. ii. a; G. 346; H. 426. 1 (385. i); H-B. 362.

83 16 **rostro**: see Figs. 48, 51.

84 2 **copulis**: the Romans were not very skilful in naval tactics, and they always aimed, by means of grappling hooks and boarding bridges, to get aboard the enemy's ship and reduce the conflict as soon as possible to a hand-to-hand combat, in which they excelled. — **accedebat ut**, *there was this additional advantage that*, followed by the result clauses, **ferrent**, **consisterent**, and **timerent**; cf. **41** 15, **51** 6.

84 3 **se vento dedissent**, *ran before the wind*. The phrase is a nautical one; hence **ventus** is repeated to give the complete expression.

84 4 **consisterent**, *rode at anchor*.

84 5 **ab aestu relictæ**: trans. *if or when*, etc.; § 496 (292); B. 337. 2. a, b; G. 664 ff.; H. 638. 2 (549. 2); H-B. 604. 3. — **nihil**: cf. **63** 13 and note.

84 8 CHAP. 14. **neque**: see note on **80** 11.

84 9 **eis noceri posse**, *they could be harmed*. Observe that the expression is *impers.*, and cf. **56** 24 and note.

84 10 **quae ubi**: cf. note on **qui cum**, **58** 9.

84 11 **paratissimæ**, *fully equipped*; **ornatissimæ**, *thoroughly furnished*. The battle was probably fought in the bay of Quiberon, off the heights of St. Gildas, on which Cæsar was encamped. The fleet of Crassus issued from the Loire and took a northwesterly course. Meanwhile the fleet of

the Veneti came out of the Auray estuary, and passing through the Morbihan entrance to the bay, encountered the Romans directly opposite Cæsar's camp. See Fig. 40.

84 13 *neque satis Bruto . . . constabat*, and *Brutus could not make out*. *agerent* and *insisterent* refer to Brutus and his officers.

84 14 *tribunis militum*, etc.: in the ancient modes of fighting, the fleet was only a part of the army, and was commanded by the military officers, as here.

84 16 *noceri*, etc.: cf. similar phrase above, l. 9.

84 17 *excitatis*, *raised*. The abl. abs. has a concessive force, as is shown by the following *tamen*.

84 18 *ex barbaris navibus*, *on the enemy's ships*; for force of *ex*, cf. *una ex parte*, *ex itinere*, etc.

84 20 *magno usui*, *of great service* (cf. *auxilio*, **81 26**), in fact turning threatened disaster to victory; but Cæsar will not use words that hint at possible defeat.

84 22 *muralium falcium*, *wall-hooks*, long poles with sickle-shaped hooks attached, like those used by hook-and-ladder companies for pulling down walls (see Fig. 126). The gen. limits *formæ* understood, which would be dat., after *absimili*. — *cum* = *whenever*, *as often as*, and the sentence following is a general condition, the verbs *comprehensi adductique erant* being in the protasis, and *prærumpebantur* in the apodosis expressing repeated action, which is regularly expressed in Latin by the indic.; cf. **59 13** and note.

84 24 *prærumpebantur*, etc., *they* [the halyards] *were torn away by driving the ship forward with the oars*.

84 26 *Gallicis navibus*: dat. of reference used for poss. gen.

85 1 *paulo fortius factum*: one of Cæsar's mild expressions for *an act of remarkable daring*.

85 4 **CHAP. 15.** *cum*, etc.: another general condition; see note on **84 22**. — *singulas*, etc.: i.e. two or three ships surround each one of the enemy's.

85 6 *contendebant*, expressing repeated action; cf. with *contenderunt* below, which describes a single act; cf. **75 10**. — *quod postquam*: cf. *quæ ubi*, **84 10** and note.

85 8 *cum . . . reperiretur*: a causal clause: cf. **2 15**, **57 1**.

85 9 *conversis . . . navibus*: i.e. steered so as to run before the wind.

The prevailing winds at present towards the end of summer in this quarter are from the east or northeast, — the precise winds needed for the two fleets to have met as indicated above. Further, when these winds have blown during the morning, it usually falls calm at noon. This is

just what happened on the day of the battle. The calm was probably just after midday.

85 14 *pervenerint*, *came to land*; for the tense, cf. **28 6**, **50 22**, the perf. subjv. being used, as usual, to express past time in a result clause, without regard to sequence of tense.

85 15 *hora IIII (quarta)*: about 10 A.M.

86 2 *CHAP. 16. cum . . . tum*, *while . . . at the same time*.

86 4 *convenerant, coegerant*: i.e. for this war.—*quod ubique*, *all that there were anywhere*, followed by the part. gen. *navium*.

86 5 *quo*, *whither*: i.e. any refuge.

86 8 *eo gravius . . . quo*, *the more severely*, etc., *in order that*.—*vindican-dum [esse]* (impers.), *punishment should be inflicted*.

86 10 *sub corona vendidit*, *sold [as slaves] at public auction*; lit. *under the wreath*, since the captives were crowned like animals to be sacrificed, as indeed they had been in earlier times. Thus the only naval power in Gallia that could be formidable to the Romans was totally destroyed, and neither the Veneti nor their allies gave the proconsul any more trouble.

86 13 *CHAP. 17. Venellorum*: along the Channel coast of Normandy.

86 14 *his*: cf. *classi*, **84 13**.

86 16 *magnas copias*: most likely meaning here irregular troops as opposed to *exercitum*.—*his paucis diebus*: i.e. about the same time.

86 17 *Eburovices*: this branch of the Auleri lived on the south side of the lower Seine.

86 18 *nolebant*: i.e. the Senate.—*clausurunt*: i.e. against the Romans.

86 20 *perditorum, desperate*: there might well be many such, as it was now the third year of constant war in Gaul.

86 23 *loco, castris*: locative ablatives without a prep.; cf. **13 6**, **57 5** and note.

86 24 *cum*: concessive.

87 1 *eo absente*: i.e. Cæsar. A *legatus* regularly had no *imperium*, or independent command, but served under that of his superior.

87 3 *dimicandum [esse]*: impers., with *legato* as dat. of apparent agent.

87 8 *CHAP. 18. pro perfuga*, *in the character of a deserter*.

87 10 *neque longius ab esse quin*: an idiomatic shorthand expression amounting to *that not later than the following night Sabinus would*, etc.

87 14 *iri*: depending on *oportere*.

87 15 *superiorum dierum*, *on the previous days*: see note on *belli*, below.

87 17 *spes . . . belli*: subj. gen. denoting the source; notice that the regular way to express the relation between two substantive ideas is by the genitive. One idea is conceived as belonging to the other in some sense. See note, **62 20**.

- 87** 18 *fere . . . credunt*, *most men are glad to believe*, etc.
87 19 *non prius . . . quam*, *not . . . until*: cf. **81** 20.
87 21 *ut . . . victoria* (abl. abs.), *as if victory were already assured*.
87 22 *sarmentis*, *cuttings*, young growth trimmed off from trees. — *virgultis*, *brushwood*.
87 25 CHAP. 19. *mille*: an indecl. adj. in agreement with *passus*.
88 1 *quam . . . spati*, *as little time as possible*, subj. of *daretur*.
88 2 *que*, *and* (consequently), as often with *-que*.
88 7 Note the emphasis on *primum* and *statim*.
88 8 *quos*: the antecedent is *eorum*.
88 15 *animus*, etc.: cf. **78** 28 and note.

SOUTHERN GAUL. — The campaign in Aquitania was made merely for strategic reasons, was not provoked by any attack or threat of war, and appears to have been quite unnecessary (see note on **82** 3) as well as difficult and dangerous. The Aquitani had no strong military league or combination, but consisted of small, isolated clans, and were besides of more industrious habits than the Gauls, being good miners and engineers. As a mere narrative, however, this is an interesting episode of the war.

- 88** 17 CHAP. 20. *P. Crassus*, etc.: cf. **82** 2-5.
88 18 *ante dictum est*: i.e. in **2** 7-10. Omit bracketed words in lines 18-20.
88 19 *tertia pars*: these statements show extreme ignorance, as would be natural (cf. the account of Britain, Bk. v. chs. 12-14).
88 21 *Praeconinus*, *Manlius*: these defeats were twenty-two years before (B.C. 78), when the Aquitani united with Sertorius, the leader of the Marian party, who held Spain for six years against Rome. (See Plutarch's "Life of Sertorius.")
88 26 *Tolosa et Narbone*: Tolosa was an old Gallic town; Narbo, a Roman colony established by the policy of Gaius Gracchus, B.C. 118. It became the capital of the Roman province, to which it gave its name, *Narbonensis*.
88 27 *his regionibus*: dat. after *finitimæ*, which agrees with *civitates*. Omit [ex].
88 28 *nominatim evocatis*: i.e. veterans who had served their term, but were willing to reënlist. See chapter on military affairs, IV. *a*. — *Sotiatium*: south of the Garonne, southeast of the modern Bordeaux; the name remains in the modern Sôls.

89 5 CHAP. 21. *superioribus victoriis*: i.e. those just related; § 431. *a* (254. *b*. 2); B. 218. 3; G. 401. N.⁶; H. 476. 3 (425. ii. 1. N.); H-B. 424.

89 7 sine imperatore . . . adulescentulo duce: an *imperator* is the chief commander of an army, holding the *imperium*, or power of military command conferred on him by regular formalities; *dux* is a general designation for any person holding a command, and might be given to a subordinate officer, like Crassus, who acted as an agent and under the *imperium* of his superiors.

89 9 perspici: the subject is the indir. quest. **quid . . . possent.**

89 12 vineas turrisque egit: see chapter on military affairs, VIII, and Figs. 33, 43, 92, 93, 120.

89 13 cuniculis, mines (lit. *rabbits*), so called from their likeness to rabbits' burrows. The mine was intended to run under the Roman *agger*. The roof was carefully propped up with wooden posts, and these being set on fire, when they were burned through, the entire mass of Roman works would fall into the pit.

89 15 aerariae secturaeque: this seems to mean *copper mines and quarries* (not entirely underground); but the meaning of the words is not perfectly clear. — **diligentia:** the Romans doubtless met the attack with countermines.

89 18 faciunt, they do (it).

89 21 CHAP. 22. soldurios, paid retainers (hence *soldiers*), a Gallic word. It is related that these *soldurii* were dressed in royal garments like their chief.

89 22 condicio: the same condition of service was found among the Germans (Bk. vi. ch. 23), and was the foundation of feudal vassalage. — **commodis:** abl. with **fruantur**.

89 23 quorum amicitiae, to whose friendship. — **si quid . . . accidat:** a euphemism, cf. **16 14**.

89 24 sibi mortem, etc.: cf. **4 15**.

89 26 qui . . . recusaret: rel. clause of characteristic; cf. **5 6, 51 4**.

89 27 cum his (repeated from **cum devotis**; cf. repetition of **vidit, 67 7**), *with these* (I say).

90 4 CHAP. 23. Vocatium, etc.: these were farther west.

90 7 quibus, within which.

90 8 quoqueversus, in every direction (**quoque**, the adverb of *place* formed from the distributive *quisque*; **versus**, the adverb of *direction* usually connected with prepositions, as *ad-versus*). It is often written *quoquoversum*.

90 10 citerioris: i.e. from the standpoint of Rome; now northern Spain. — **Hispaniae:** these Iberian populations were allied to the Aquitani (Bk. i. ch. 1). Spain had been subject to Rome for more than 150 years, but was always rather mutinous, and had made several attempts at

independence, especially under Sertorius, who defied Rome for ten years, B.C. 82-72; see note on **88** 21. It was also the last stronghold of Pompey's party in the Civil War, till finally subdued at Munda, B.C. 45. — *finitimæ*: pred. adj. agreeing with *quæ*.

90 15 *consuetudine populi Romani*: a custom which they had learned in the service with Sertorius.

90 16 *loca capere*, etc.: i.e. to practise Roman tactics.

90 18 *suas . . . augeri*, etc.: these infin. clauses are in app. with *quod*. — *diduci*, be stationed in various places, to keep track of the enemy and prevent being surrounded.

90 22 *decertaret*: subjv. of result with *quin* after *cunctandum* [*esse*]; § 558 (319. *d*); B. 283. 4; G. 555; H. 595. 2 (504); cf. H-B. 502. 3. *b*; cf. **29** 5, **50** 9, **50** 25.

90 25 CHAP. 24. *duplici*: i.e. two cohorts in depth. His numbers were too few to allow the usual formation of three (*triplex acies*).

90 26 *in mediam aciem*: i.e. where they would be kept steady by his legionaries. Their ordinary position was on the wings.

90 27 *expectabat*, waited (to see) what, etc.

91 1 *obsessis viis . . . potiri*, to block the roads, cut off supplies, and win the victory without a wound.

91 3 *sese recipere*: i.e. to withdraw from Aquitania.

91 4 *infirmiores animo*, dispirited: § 253; B. 226; G. 397; H. 480 (424); H-B. 441. — *adoriri cogitabant*, had in mind to attack; sc. *eos* for obj., and see note on **62** 16.

91 5 *productis copiis*: concessive (= *although*, etc.).

91 6 *sua*, their own.

91 7 *opinione timoris*, the notion (they had given) of their own cowardice.

91 9 *oportere*: depending on some word of *saying* implied in *voces*. — *iretur*: cf. note on *decertaret*, **90** 22. Translate freely, *that they should go to the camp without further delay*.

91 10 *ad hostium castra*: this is the only instance in the Commentaries of an attack by Romans on a fortified Gallic camp. The fight usually took place on a level stretch between the hostile camps. The Romans always chose their battle-ground with great care.

91 11 CHAP. 25. *telis coniectis* (abl. abs.), by hurling weapons.

91 13 *quibus*: abl. with *confidebat*; § 431 (254. *b*); B. 219. 1. *a*; G. 401. 6; H. 476. 3 (425. i. 1. N.); H-B. 437.

91 14 *lapidibus . . . comportandis*: gerundive expression of means. — *aggerem*: i.e. Crassus was building a mound of turf to equal the height of the enemy's rampart, as in the siege of a city.

91 15 *opinionem pugnantium*: i.e. they made an impression as if actually engaged.

92 2 *ex loco*, etc.: i.e. as they stood on the rampart of the camp.

92 4 *ab decumana porta*: i.e. *in the rear*, where this gate was situated (see Fig. 119). The Gauls appear here to have adopted the Roman mode of constructing camps, probably under the instruction of the Sertorian officers.

92 9 CHAP. 26. *praesidio castris*: cf. **22** 6, **54** 3.

92 13 *prius . . . quam*: this is often used with the indic. to show that one actual fact precedes another, just as succession is denoted by *postquam*. Here the subjv. subordinates the temporal clause to the main idea, like the subjv. with *cum*; cf. also **57** 20 and note.

92 14 *videri*: sc. *possent* from the following *posset*. — *rei*: part. gen.

92 18 *per*, *over*.

92 20 *apertissimis campis* (see note on **62** 27): i.e. the broad, treeless plains which abound in this part of the country.

92 21 *quae*: acc. plur.; the antecedent is *milium*. — *Cantabris*: a very hardy people of the western Pyrenees.

92 26 CHAP. 27. *Tarbelli*, etc.: some of the names will be recognized in the modern *Tarbes*, *Bigorre*, *Garonne*.

92 28 *tempore*: cf. note on **91** 13.

93 2 CHAP. 28. *omni Gallia pacata*, *while all the rest of Gaul was subdued*. — *Morini*, etc.: on the islands and low coast lands of Flanders and further north.

93 3 *qui . . . essent*: cf. **89** 26 and note. — *neque*: cf. **80** 11.

93 4 *arbitratus*, *thinking*: the perf. part. of dep. verbs often has a present force.

93 5 *alia . . . ac*: cf. **62** 6.

93 8 *continentis*, *continuous*: i.e. far-stretching.

93 15 *longius*, *too far* (farther than was safe). — *locis*: loc. abl., as usual without a prep.

93 17 CHAP. 29. *deinceps*: i.e. in the days next following.

93 18 *inermibus . . . militibus*: abl. abs.

93 20 *conversam*, *fronting*, i.e. with the boughs turned towards the enemy. — *pro vallo*, *as a palisade*.

93 23 *tenerentur*, etc.: i.e. were just being seized.

93 24 *eius modi . . . uti . . . intermitteretur*, *such that the work was constantly interrupted*.

93 26 *sub pellibus*: the tents were of leather.

93 28 *Aulercis*, etc.: along the Seine, near Evreux and Lisieux.

BOOK FOURTH. — B.C. 55.

CAMPAIGN AGAINST THE GERMANS. — The year B.C. 55 appears to have been marked by a general movement in the migration of the German tribes. An advance, consisting of two tribes, the Usipetes and Tencteri, crowded forward by the more powerful Suevi, crossed the lower Rhine into northern Gaul. Cæsar assumed the defence of the country he had just conquered, drove them back across the Rhine, followed them up by an expedition into their own territories, and fully established the supremacy of the Roman arms. Another brief campaign in Germany two years later confirmed this success, and the Rhine became the military frontier, recognized for many centuries, between the Roman Empire and the barbarian world.

READING REFERENCES ON THE CAMPAIGN AGAINST THE GERMANS.

- Dodge's Cæsar, chap. 10.
 Fowler's Julius Cæsar, chap. 12.
 Froude's Cæsar, chap. 16.
 Holmes's Cæsar's Conquest of Gaul, chap. 5.
 Merivale's Hist. of Rome, Vol. I. pp. 365-375.
 Mommsen's Hist. of Rome, Vol. IV. pp. 309-312.
 Napoleon's Cæsar, Vol. II. chap. 7.
 Plutarch's Lives, Cæsar.
 Tacitus's Germania.
 Trollope's Cæsar, chap. 5.

94 1 *ea quae*, etc.: mark the emphasis as shown by the order and compare the opening of Bk. iii and note. — **Pompeio, Crasso**: i.e. the year B.C. 55. Observe that the usual way of fixing a year is by naming the consuls for that year. The coalition between Cæsar, Pompey, and Crassus, sometimes called the First Triumvirate, had been formed five years before. In carrying out the scheme, Cæsar held the government of Gaul, while the others took into their own hands the whole control of affairs at home (see Introduction, "Life of Cæsar").

94 2 *Usipetes, Tencteri*: beyond the Rhine, a little below Cologne.

94 4 *quo*: adv. = *in quod*.

94 5 *quod . . . prohibebantur*: Cæsar states this reason as his own, therefore the indic. — *Suevis*: this people (the modern *Swabians*) occupied the greater part of central Germany, and was made up of several tribes.

94 6 *premebantur, prohibebantur*: the imperfects here express that which was still going on, *they were being hard pressed*, etc.

94 8 *centum pagos* (see **10 12**): there is probably some confusion here with the ancient German institution of the *Hundred*, a division of the population giving its name to a district of territory. Each *hundred* seems

to have sent 1000 men (*singula milia*) to the army. The term early lost its numerical value, and became a mere local designation.

94 9 bellandi causa: gerund, expressing purpose with *causa*. Observe that *causa* in this use always follows its case; cf. above *causa transeundi*, with a totally different meaning.

94 11 hi . . . illi, *the latter . . . the former*. — **anno post**, *the following year*: § 424. *f* (259. *d*); B. 357. 1; G. 403. N.⁴; H. 488. 1 (430); cf. H-B. 424.

94 12 ratio, *theory* (theoretical knowledge); **usus**, *practice* (knowledge derived from experience).

94 13 sed: i.e. they attended to agriculture systematically, *but*, etc. — **privati . . . agri**: i.e. the land was held in tribal communities.

94 14 longius anno: i.e. the community had no fixed possessions, but was transferred yearly from one tract to another, its place being taken by another community. As is shown in Bk. vi. ch. 22, the community was composed of persons kindred by birth. The annual shifting of occupancy would prevent at once forming local attachments, building up large properties, and too rapidly exhausting the soil.

94 15 frumento (abl. of means), etc.: they were still in a half-nomadic state, though with some little advance in agriculture (cf. Bk. vi. ch. 22, and Tacitus, Ger. 27). — **maximam partem**: adv. acc.; it is worth while to learn the few words that commonly occur in this construction; § 390. *c*, 397. *a* (240. *a*, *b*); B. 185. 1; G. 334. R.²; H. 416. 2 (378. 2); cf. H-B. 388.

94 17 quae res: cf. note on **30 19**.

95 1 quod . . . faciunt: this clause is a parenthesis; *because, having been trained from childhood to no service or discipline, they do nothing whatever against their will*, — a lively contrast of barbarous manners with the severity of Roman family and civil discipline.

95 3 alit: the subject is *quae res*. — **homines [eos] efficit**, *makes [them] men*, etc.

95 4 eam: correl. with **ut**, introducing a clause of result. — **locis** (abl. abs., concessive) **frigidissimis**, *even in their extreme climate*.

95 5 vestitus: part. gen. with **quicquam**. — **habentur**, *have*; **lavarentur**, *bathe*: imperf. by sequence of tenses following **adduxerunt**; § 485. *a* (287. *a*); B. 268. 1; G. 511. R.²; H. 546 (495. *i*); H-B. 481.

95 8 CHAP. 2. **eo ut . . . habeant**, *so (on this account) that they may have (some one) to whom*, etc.

95 9 quam quo . . . desiderent, *than that they want*, etc. For the use of **quo** expressing cause with the implied negative, see § 592. N. (341. R.); B. 323; G. 541. N.²; H. 588. ii. 2 (516. 2); H-B. 535. 2. *b*.

95 11 impenso pretio, *at high cost*. — **importatis non utuntur**, *do not import for use* (lit. *do not use imported*).

95 13 *deformia*, *ill-shaped*. — *summi laboris*, (capable) of great labor (gen. of quality).

95 20 *quamvis pauci*, *however few*. — *vinum*: cf. the description of the Nervii, 59 22–26. They drank a kind of beer, however, and mead made of honey.

95 23 CHAP. 3. *publice*, as a community.

95 26 *una . . . Suevis*, extending from (the territory of) the Suevi in one direction. — *sexcenta*: probably exaggerated. — *agri*, their lands.

95 27 *Ubii*: along the Rhine, opposite Cologne.

96 1 *paulo . . . humaniores*, somewhat more civilized than the others, although they are of the same race (Germans).

96 4 *cum*: concessive, as shown by the following *tamen*.

96 5 *gravitatem*, *importance*, referring to the warlike character and extensive resources of the people; while *amplitudinem* refers to their great numbers.

96 7 *vectigalis*: sc. *eos* referring to the Ubii. — *humiliores* (pred.): in translating sc. *so as to be*.

96 9 CHAP. 4. *in eadem causa*, in the same situation.

96 12 *quas regiones*: North Brabant, with the north bank of the Rhine.

96 13 *ad utramque ripam*, along both banks.

96 14 *multitudinis*: see 102 10.

96 16 *cis Rhenum*: i.e. the west side.

96 18 *vi contendere*, to force a passage.

96 22 *confecto*: with *itinere*.

96 23 *oppresserunt*: not *oppressed*; see note on *obtinere*, 2 1.

97 2 *priusquam . . . fieret*: § 551. *b* (327); B. 292; G. 577; H. 605. ii (520. ii); H-B. 507. 4. *b*; see also note on 38 27.

97 5 *partem*: acc. of time. — *eorum copiis*, on their supplies (cattle and grain).

97 6 CHAP. 5. *infirmiorem*, weakness of purpose = fickleness.

97 8 *nihil . . . committendum*, no confidence should be placed in them. Observe that *committendum* [*esse*] is impers. and *nihil* adv. acc.

97 9 *est . . . consuetudinis*, it is [a point] of Gallic custom: § 343. *c* (214. *d*); B. 198. 3; G. 366. R.¹; H. 439 (401); H-B. 340. — *uti . . . cogant*, etc.: we have here a number of clauses of result in app. with *hoc*.

97 14 *rebus atque auditionibus*, facts and hearsays.

97 15 *quorum eos . . . paenitere*: § 354. *b* (221. *b*); B. 209. 1; G. 377; H. 457 (409. iii); H-B. 352. — *in vestigio*, on the spot: cf. 95 16.

97 16 *serviant*, are slaves to. — *plerique*: i.e. the travellers and traders.

97 17 *eorum*: i.e. the questioners.

97 18 CHAP. 6. *graviori bello*, too serious a war (i.e. unmanageable): § 370 (228); B. 187. iii; G. 347; H. 429 (386); H-B. 376.

97 19 *maturius*, earlier, i.e. in the season. — *ad exercitum*: the army was now in Normandy; see 93 28.

97 20 *facta*: sc. *esse*; so with *missas* below.

97 21 *missas legationes*, etc.: these infin. clauses explain *ea*.

97 22 *uti . . . discederent*: i.e. further into Gaul. The Belgæ, it will be remembered, claimed kindred with the Germans, and were no doubt ready to assist them against the Romans.

97 23 *postulassent*: for fut. perf. of dir. disc.; § 478, 519, 585 (281, 316, 336, B); B. 264, 312. 2, 318; G. 244, 516; H. 644. 2 (525. 2); H-B. 468. 6, 536, 470. ftn.¹ — *fore parata*, should be made ready (used for the fut. infin. pass.). It depends on some word of saying, like *promiserunt*, implied in *invitatos*. Instead of *fore parata*, we might expect *fore ut pararentur*.

97 24 *Eburonum*, etc.: German tribes.

97 27 *permulsis*, calmed from their terror (lit. *soothed by stroking*, like a nervous horse).

98 1 CHAP. 7. *equitibus delectis*: each of the allied states furnished its quota of cavalry.

98 3 *a quibus*: refers to *locis*.

98 5 *priores*, first, or, as aggressors (cf. the language of Ariovistus, Bk. i. ch. 36). — *neque recusare*, they do not decline, followed by *quin* and subjv.; cf. 50 25.

98 7 [*haec*]: may be translated. — *quicumque*: the antecedent is *eis* (dat.) implied with *resistere*.

98 8 *neque deprecari*, and ask no quarter (lit. and not beg off). — *haec tamen dicere*, this however they did say; supply *se* for subj. of *dicere* and following infinitives. For similar instances, see 59 23, 71 6, 71 23.

98 10 *eis*: i.e. to the Romans. — *attribuant*, subjv. in indir. disc. for inv. of the direct.

98 11 *eos*: sc. *agros*.

98 12 *concedere*, yield, as inferior.

98 13 *reliquum . . . neminem*: the position gives a force like, BESIDES THESE there was no one ELSE on earth, etc.

98 15 CHAP. 8. *quae visum est*, what (it) seemed proper (to answer). He probably answered somewhat as in Bk. i. chs. 14 and 43.

98 20 *Ubiorum*: see ch. 3.

98 21 *quorum sint*, etc., whose envoys (he informs them) are now with him to (lit. and) complain, etc.

98 25 CHAP. 9. *post diem tertium* (= *tertio die*), i.e. the next day but one. The first and last days are usually counted in the Roman reckoning.

98 26 *propius se*: cf. 41 10. — *id*: i.e. the two days' delay (expressed by *ne . . . moveret*).

99 1 *trans*: i.e. westwardly.

99 2 *expectari*: change the voice and translate as active, *they were waiting for*.

99 4 CHAP. 10. *Vosego*, the *Vosges*: in fact, the Meuse flows from the plateau of Langres.

99 5 *parte . . . recepta*: the Rhine branches in these low, marshy regions; one branch (*Vacalus*, the modern *Waal*) unites with the Meuse near Bois le Duc (see note, ch. 15).

99 6 Omit the words in brackets.

99 9 *Nantuatum*: cf. Bk. iii. ch. 1, where they are placed upon the Rhone, just above Lake Geneva; this was perhaps a branch or kindred tribe. The list of names here is incomplete.

99 12 *multis . . . effectis*: translate actively, *making many*, etc.

99 13 *feris . . . nationibus*: see the introduction to Motley's "Dutch Republic."

99 15 *capitibus*, *mouths* (more commonly, *sources*).

99 17 CHAP. 11. *ut erat constitutum*, *as had been arranged* (i.e. the return of the envoys). Either this is a careless expression, or *Cæsar's* consent is omitted in ch. 9. It is there stated merely that they said they would return.

99 19 *eos equites* (antecedent to *qui*), *the cavalry who*, etc.

99 20 *antecessissent*: attracted into the subjv. by the *ut*-clause; cf. 73 5. — *praemitteret*: used without an object; translate *send word*.

99 21 *sibi*: i.e. the Germans. — *potestatem*: see note on 16 7.

99 22 *quorum si*, *and if their*: cf. note on *qui cum*, 58 9.

99 23 *condicione . . . usuros*, *would accept the terms*: see ch. 8.

99 25 *daret*: sc. *petebant uti* from l. 19. — *eodem illo pertinere*, *tended the same way* (see ch. 9), i.e. to gain time till the German cavalry should arrive (*eodem* and *illo* are adverbs).

99 28 *aquationis causa*: a small stream (probably the Niers) lay between him and the German encampment.

100 3 *accessisset*: § 553 (328); B. 293. iii. 2; G. 572; H. 603. ii. 2 (519. ii. 2); H-B. 507. 5.

100 5 CHAP. 12. *amplius DCCC*, *more than eight hundred*: § 407. c (247. c); B. 217. 3; G. 296. R.⁴; H. 471. 4 (417. 1. N.²); H-B. 416. d. Tacitus in his "Germania" (chap. 32) says that this tribe was distinguished for cavalry.

100 9 *indutiis*: dat. of the end for which.

100 10 *resistentibus*: sc. *nostris*.

100 11 *subfossis*, etc.: *after stabbing our horses underneath and dismounting several of our men*; observe again, as in **99 12**, that an abl. abs. with a pass. part. is often best translated actively.

100 14 *venissent*: cf. **97 2**.

100 17 *genere*: abl. of source; § 403. *a* (244. *a*); B. 215; G. 395; H. 469. 2 (415. ii); H-B. 413. — *regnum obtinuerat*, *had held supreme power*.

100 20 *quoad*: cf. this use and construction with that in l. 2.

100 25 CHAP. 13. *neque iam*, *no longer*: knowing how little his own cavalry (of Gauls) were to be trusted, and that the arrival of the main body of the Germans would put them at once to flight, Cæsar resolved to attack at the first opportunity, right or wrong.

100 26 *ab eis qui*, *from men who*, etc., followed by the subjv. of characteristic.

101 1 *expectare*: subject of *esse*; note the emphasis of position.

101 2 *penentiae*: pred. gen.

101 3 *quantum . . . auctoritatis*, etc., *how great prestige the enemy had gained by one battle*.

101 5 *quibus*: i.e. the enemy (dat., indir. obj. of *dandum* [*esse*]); on the relative serving as a connective, see note, **40 20**.

101 7 *quaestore*: see Bk. i. ch. 52. — *ne quem*, etc.: cf. **71 21**.

101 8 *res*, in app. with *quod . . . venerunt*.

101 9 *eadem perfidia*: their perfidy Cæsar takes for granted, as the best apology for his own; but the presence of the chiefs and old men looks more as if they came, as they said, to offer amends for the attack of the day before.

101 11 *simul . . . simul*, *partly . . . partly*. — *purgandi sui*: cf. **77 3**, and see § 504. *c* (298. *a*); B. 339. 5; G. 428. R.¹; H. 626. 3 (542. I. N.¹); H-B. 614.

101 12 *contra atque*, *contrary to what*; see Vocab. Observe the subjunctives of implied indir. disc. in this passage.

101 13 *si quid . . . de indutiis*, *whatever* (lit. *if anything*) *they could in the way of truce*.

101 14 *fallendo*: i.e. by another trick. — *quos, illos*: both refer to the same subject. — *quos oblatos* [*esse*] *gavisus*, *delighted that they were put in his power* (*gavisus*, from *gaudeo*). By detaining their chief men, he would at once perplex and disable them.

101 17 *subsequi*, *to follow in the rear*; they usually went in advance (cf. **99 20**), but now he could not trust them in the intended attack.

101 18 CHAP. 14. *acie triplici*: i.e. a march in line of battle; see chapter on military affairs, VI and VII.

101 19 *quid ageretur*, *what was going on*.

101 20 **possent**: cf. 97 2, 100 14.

101 21 **et . . . et**, both . . . and.

101 23 **ne . . . an . . . an**: § 335 (211); B. 162. 4; G. 458; H. 380 (353); H-B. 234; the three infinitives all belong to **praestaret**, *whether it was better*.

101 24 **quorum timor cum**: note the emphatic order.

101 29 **reliqua multitudo**: the presence of women and children shows that it was a migration for settlement, not a mere inroad for plunder.

102 1 **ad quos consecrandos** (freq. of *sequor*), *to hunt them down*. Referring to this massacre of helpless fugitives, Plutarch, in his "Life of Cæsar," writes that when the Senate was voting public thanksgiving and processions on account of the victory, Cato proposed that Cæsar should be given up to the barbarians to expiate that breach of faith, in order that the divine vengeance might fall upon its author rather than upon Rome. Cato was Cæsar's bitter political and personal enemy, but still Cæsar's cruelty and perfidy in this transaction can be justified only on the ground of absolute necessity. To secure the Roman power, he must destroy these Germans in order to establish the Rhine as the Gallic frontier and deter others from crossing.

102 3 **CHAP. 15. Germani**: i.e. those who were fighting. — **clamore**: i.e. of those who were being massacred.

102 4 **signis**: figures of animals carried on poles; see Figs. 11, 70, 127.

102 6 **reliqua fuga**, *further flight*.

This action is usually placed at the junction of the Rhine and the Meuse. There are many reasons against this, but no other location seems possible without doing violence to the text, and for this no sufficient case is made out.

102 9 **ex . . . timore**, (relieved) *from the apprehension of so great a war*.

102 12 **discedendi potestatem**, *permission to depart*. This was a practical acquittal of the charge of treachery.

102 13 **veriti**: regularly pres. act. in force, *fearing*.

102 17 **CHAP. 16. illa**, *the following*.

102 19 **suis**: note the emphasis on this word.

102 20 **cum intellegerent**: here nearly equivalent to a participle.

102 21 **accessit quod**, *and besides*: see Vocab.

102 22 **quam . . . transisse**, *which, as I mentioned above, had crossed*: see 98 27 ff. (the conj. *that* of indir. disc. cannot be used in English to introduce a rel. clause). Observe that Cæsar the *writer* uses the first person (**commemoravi**); Cæsar the *actor* is always in the third.

102 25 **Sugambrorum**: living just north of the Ubü.

102 27 *intulissent*: cf. *antecessissent*, **99** 20. — *dederent*: observe the omission of *ut*; § 565. *a* (331. *f.* R.); B. 295. S; G. 546. R.²; II. 565. 4 (499. 2); II-B. 502. 3. *a.* ftm.².

102 28 *finire*: see introductory note to Bk. iv.

103 1 *aequum*: pred. adj. agreeing with the infin. clause *Germanos . . . transire*.

103 2 *sui . . . imperi*: pred. gen. of possession after *esse*, *under his power*.

103 7 *occupationibus rei publicae*, *by the demands of state affairs*.

103 8 *transportaret*: same construction as *ferret*.

103 9 *futurum [esse]*: sc. verb of saying from *orabant*. l. 5, so, too, for the following sentence.

103 17 *CHAP. 17. dignitatis*: cf. **103** 2.

103 19 *latitudinem*, etc.: Caesar's passage of the Rhine was most probably at Bonn, where the high and rocky banks begin; or at Neuwied, 20 or 25 miles further south, where there is a break in the chain of hills, though here, it is said, the bottom is rock, and not fit for driving piles. The width of the river at either place is about 1,400 feet, and its depth is very variable. It is now crossed in these parts by bridges.

103 21 *rationem, plan.* The brief description which Cæsar gives of his rough-and-ready but very serviceable engineering may be made clearer by giving its different points as follows (see Fig. 59): —

1. A pair of unhewn logs, a foot and a half thick (*tigna bina sesquipedalia*), braced two feet apart and sharpened at the end, are set up by derricks and driven with pile drivers (*fistucis*) into the bottom, sloping a little with the stream.

2. A similar pair is driven in opposite, 40 feet below, sloping a little in the other direction against the stream; the upper ends of the two pairs would thus be some 25 or 30 feet apart, the width of the roadway. It is possible, as Rüstow thinks, that the 40 feet refer to the top and not to the bottom of the piles.

3. A beam of square timber, two feet thick (*trabs bipedalis*), and about 30 feet long, is made fast at the ends by ties (*fibulis*) between the logs of each pair, — which are thus kept at a proper distance apart, while they are strongly braced against the current.

4. A suitable number (probably about 60) of these trestles, or timber-arches, having been built and connected by cross ties, — this part of the structure must be taken for granted, — planks are then laid lengthwise of the bridge (*directa materia*), resting on the heavy floor timbers; and upon these, again, saplings and twigs (*longurii, crates*) are spread, to prevent the jar and wear of the carts and hoofs of the pack-animals on the flooring.

5. Piles (*sublicae*) are then driven in below, resting obliquely against the logs, to which they serve as shores or buttresses (*pro ariete*), and other heavier piles a little way above, to break the force of floating logs or boats sent down to destroy the bridge.

103 22 *tigna*, probably unhewn logs.—*bina*, *two and two*, i.e. in pairs.

103 24 *pedum duorum*: i.e. between the timbers of each pair.—*cum* . . . *defixerat*, etc.: *cum* here equals *whenever* or *as often as* and the clause is equivalent to the protasis of a general condition; hence the use of the pluperf. indic.; cf. 84 22 and note.

103 26 *sublicae modo*, *like a pile*.

103 27 *ut* . . . *procumberent*, *so as to lean forward in the direction of the current*.

103 29 *ab inferiore parte*, *downstream*.—*contra* . . . *conversa*, *slanting against*, agrees with *duo* [*tigna*].

103 30 *haec utraque* . . . *distinebantur*, *these two sets* (or *pairs*) *were held apart by two-foot timbers laid on above, equal* [in thickness] *to the interval left by the fastening of the piles* (*quantum* . . . *distabat*), *with a pair of ties at each end*. For number of *utraque*, see Vocab.

104 2 *quibus* [*tignis*] . . . *revinctis*, *after these were held apart and secured in opposite directions*: i.e. the horizontal beams held the piles (*tigna*) apart, which, sloping in opposite directions, had been secured by the clamps.

104 4 *rerum*, *structure*: see note on 4 4.—*quo maior* . . . *hoc artius*: *the greater* . . . *the more closely*, abl. of degree of difference. The only doubtful part of the description is in *fibulis*, of which the exact meaning is somewhat uncertain. They are thought by some to be cross-ties (as in Fig. 80). But, as the word means properly a kind of clasp exactly like a modern safety-pin, it seems better to suppose they were clamps joining the two piles with perhaps an iron bolt put through, answering to the pin of the *fibula*.

104 5 *haec* . . . *contexebantur*, *these* (the framework of timber) *were covered with boards placed lengthwise*.

104 7 *sublicae* . . . *agebantur*, *piles also were driven on the lower side in a slanting direction*, so as to prop the bridge against the current.

104 8 *pro ariete*, *as a buttress*.

104 10 *aliae item*: other piles a little way above, to serve as a break-water. There is nothing in the text to show whether these were attached to the bridge or not.—*spatio*: abl. of degree of difference.

104 11 *deiciendi operis*, *to throw down the work*: pred. gen. expressing tendency or purpose; § 504. a. N.¹ (298. R.); B. 339. 6; G. 428. R.²; H. 526. 5 (544. N.²); II-B. 616, last example.

104 ¹² *neu . . . nocerent*, and that they [*trunci*, etc.] might not harm the bridge.

104 ¹⁴ *CHAP. 18. diebus X quibus*, within ten days from the time when. — *coepta erat*: pass. because used with the pass. infin.; cf. **53** 6; see also l. 20 below.

104 ¹⁵ *traducitur*: the histor. pres., resumed from **102** 21.

104 ¹⁶ *Sugamborum*: these were a little to the northeast of the bridge.

104 ²¹ *hortantibus eis*, etc.: i.e. the few who had escaped the massacre of ch. 15, and had taken refuge across the Rhine.

104 ²³ *in solitudinem*: notice that the Latin construction is that following verbs of motion, on account of the meaning of *abdiderant*; we say *hid in*, etc.

104 ²⁷ *CHAP. 19. pollicitus*: this word implies a main clause in the infin., *se daturum*, on which the conditional clause would depend. This clause does not appear, but the dependent clause remains in the subjv. according to the rule.

104 ²⁸ *premerentur*: a good example of the subjv. in implied indir. disc.; see note on **32** 21.

105 ¹ *per exploratores*: cf. note on **57** 3.

105 ³ *uti . . . convenirent*: object clauses of purpose, following the verbal phrase *nuntios . . . dimisisse*, which involves an idea of sending orders or advice. The rest of the sentence contains only statements and is therefore in the indir. disc. construction.

105 ⁵ *hunc*, etc., *this had been selected about the middle*, etc.: *medium* is used as a pred. agreeing with *hunc* in preference to an adverbial phrase *in medio*; § 293 (193); B. 241. 1; G. 325. R.⁶; H. 497. 4 (440. N.²); H-B. 244.

105 ⁷ *decertare*: not merely *fight*, but *fight the decisive battle* or *decide the issue*. This force of *de* is very common.

105 ¹⁰ *ut . . . liberaret*, etc.: these clauses are in app. with *rebus*, and their form as result clauses is determined by *confectis*; see note on **4** 17. In English some change of construction is often necessary in such cases. Here. *having accomplished*, etc. (namely), *inspired*, . . . *chastised*, . . . *relieved*.

105 ¹³ *arbitratus*: cf. **52** 7 and note.

FIRST INVASION OF BRITAIN.—What is called the First Invasion of Britain, though it marks an interesting date in history, gave fresh stimulus to Roman curiosity and ambition, and had a significant moral effect, was in itself an affair of small account. It was, in fact, only meant for a reconnaissance, or, perhaps, to open the way to further schemes. Towards the end of summer, Cæsar sailed across to the cliffs of Dover, coasted a few miles towards the west, and established a camp

on the British coast. His cavalry, meanwhile, had been weatherbound in their transports, and then, after crossing, were driven back by rough winds, so that they did not even come to land. After holding an uneasy and perilous position for about three weeks, he returned to Gaul without accomplishing anything beyond a barren display of daring. This expedition was, in fact, only intended for a "demonstration." Yet, as the beginning of the national history of England, the event assumes great interest and importance, so that it has given rise to volumes of comment and discussion both in France and England.

READING REFERENCES ON THE FIRST INVASION OF BRITAIN.

- Abbott's Julius Cæsar, pp. 97-106.
 Dodge's Cæsar, chap. 11.
 Fowler's Julius Cæsar, chap. 12.
 Froude's Cæsar, chap. 16.
 Merivale's Hist. of Rome, Vol. I. pp. 375-383.
 Mommsen's Hist. of Rome, Vol. IV. pp. 312, 313.
 Napoleon's Cæsar, Vol. II. chap. 7.
 Scarth's Roman Britain, chap. 2.
 Tacitus's Agricola.

105 15 CHAP. 20. *exigua . . . reliqua*: abl. abs.; translate by a temporal clause.

105 16 *ad septentriones*, towards the north (see Vocab.): cf. **1 1** ff.

105 18 *omnibus bellis*: abl. of time. — *hostibus*: dat. after *subministrata*.

105 19 *si . . . tamen*, even if time should fail, still, etc.

105 20 *fore*: the subject is practically the clause *si . . . cognovisset*, *he thought it would be of great advantage if*, etc. In all languages the proper subject is often absorbed in some different form of expression; here it is properly "that fact," "that result," implied in the conditional clause. The idiom is the same in English except that we supply "it."

105 21 *adisset*, etc.: the pluperf. represents the fut. perf. *adierit* of dir. disc. Observe in this sentence that while Cæsar's *action* is given in the perf. (*contendit*), his *reasons* are in the imperf. (*intellegebatur, arbitrabatur*); cf. note on **3 5**. The conditional clauses *si deficeret, si adisset*, etc., are strictly fut. conditions carried into the past by the indir. disc.

105 22 *quæ omnia*, all of which: § 346. *e* (216. *e*); B. 201. 1. *b*; G. 370. R.²; H. 442. 2 (397. 2. N.); H-B. 346. *c*. For the order, cf. **94 17**, **30 19** and note.

105 23 *Gallis . . . incognita*: probably they were not so uninformed as they seemed; cf. the relations of Commius, **106 13-17**, and of the Veneti, **78 19**. — *neque enim*: neg. of *etenim*, to be rendered with *quisquam*, for no one; § 324. *h* (156. *d*); cf. B. 341. 2. *d*; G. 498. N.³; cf. H-B. 311. 6. *a* and *b*.

105 24 *illo*: adv.; see Vocab. — *neque . . . quicquam*, and *nothing*: observe that, as usual, the negative combines with the connective. — *eis*: dat. after *notum*; § 375 (232. *a*); B. 189. 2; G. 354; H. 431. 2 (388. 1); H-B. 373. 2.

105 25 *Gallias*: i.e. Celtic and Belgic Gaul.

105 26 *vocatis . . . mercatoribus*, etc., *he called 'the traders, but could not*, etc.

105 27 *quanta . . . portus*: these indir. questions follow *reperire poterat*. Notice that the imperf. *poterat* is used rather than *potuit*, referring to his *repeated* questions to the different traders.

105 28 *quem usum*, *what degree of skill*. — *belli*: cf. note on 41 14.

106 1 CHAP. 21. *faceret*: the subjv. here indicates a purpose or calculation in Cæsar's mind. The perf. ind. would refer only to priority of time; § 551 (327); B. 292; G. 577; H. 605. 2 (520. i. 2); cf. H-B. 507. 4. *a*; see also 38 27 and note. The English idiom expresses this by some such phrase as "before making the attempt."

106 2 *idoneum*: this remark seems to have reference to his actual want of success, as appears later. — *Volusenum*: one of Cæsar's tribunes; see 77 11. — *navi longa*: see chapter on military affairs, IX, and Figs. 48, 51.

106 5 *Morinos*, occupying the nearest point to Britain (Boulogne, Calais, Ostend, etc.): in clear weather the British coast is in sight from these shores.

106 7 *quam . . . classem*: § 307. *b* (200. *b*); B. 251. 4; G. 616; H. 399. 5 (445. 9); H-B. 284. 6. — *Veneticum bellum*: see Bk. iii. chs. 7-16.

106 9 *insulae*: Britain was supposed to be an island, but the fact was not established, so far as we know, until more than a century later, when the Romans sailed around it.

106 10 *qui polliceantur*: a purpose clause, but in English best expressed by the pres. part.

106 11 *dare*: complem. infin., instead of *se dituros [esse]*, a use not uncommon in Cæsar, and apparently somewhat colloquial; § 580. *c. n.* (330. *f. n.*); cf. B. 328. 1; G. 531. *n.*⁴; H. 618. 1 (537. *n.*); H-B. 593. *a.* — *imperio*: § 367 (227); B. 187. ii. *a*; G. 346; H. 426. 1 (385); H-B. 362.

106 14 *Atrebatibus* (see Bk. ii. chs. 4, 16, 23): the same people, it is said, had occupied Berkshire in England, whence the supposed influence of Commius. — *ibi*: i.e. among the Atrebates; § 321. *a* (207. *a*); G. 611. *r.*¹; H. 308. 2 (304. iii. 2).

106 16 *fidelem*, etc.: perhaps Cæsar says this in view of the fact that Commius afterwards turned against him; see Bk. vii. ch. 76.

106 17 magni: gen. of indefinite value; § 417 (252. a); B. 203. 3; G. 380; II. 448 (404); II-B. 356. 1. — **huic**: indir. obj. of **imperat**; the order he gave is the whole clause down to **nuntiet**.

106 18 fidem sequantur, i.e. *accept the protection of*.

106 19 se: i.e. Cæsar, the main subject, as usual in indir. disc.

106 20 quantum (sc. *tantum*) . . . **auderet**, *so far as opportunity could be given to one who did not venture*, etc.

106 22 auderet: subjv. of characteristic.

106 23 perspexisset: for tense, see § 485. e (287. e); B. 268. 3; G. 511. R.¹; H. 546 (495. ii); II-B. 491 and 2; the sequence of tenses does not depend upon the form of statement, but on the time as conceived in the writer's mind.

106 26 CHAP. 22. **superioris temporis**, *of the season before* (see Bk. iii. ch. 28).

106 27 homines barbari, *being* (as they were) *barbarians*. — **consuetudinis**: § 349. a (218. a); B. 204. 1; G. 374; II. 451. 1 (399. i. 2); II-B. 354.

106 28 fecissent: the statement of the ambassadors, hence subjv. on the principle of implied indir. disc.

106 29 pollicerentur: the same construction as **excusarent**, above.

107 1 arbitratus: translate as present, as often with the perf. part. of dep. verbs.

107 2 belli gerendi: obj. gen.; connect with **facultatem**.

107 3 has . . . anteponendas, *that occupation about these little matters should take precedence of* [the invasion of] *Britain*. For the number of **occupationes**, see § 100. e (75. e); B. 55. 4. c; G. 204. N.⁵; II. 138. 2 (130. 2); II-B. 240. 5. b.

107 4 iudicabat: note this and the preceding descriptive imperfects; cf. note on 3 5.

107 6 navibus: see chapter on military affairs, IX. — **coactis**, *gathered from various quarters*; [**contractis**] (which may well be translated), *brought together* into port. This must have been either at Boulogne or a few miles farther north, at Wissant. The port has never been satisfactorily determined, but it must have been between Boulogne and Calais, about twenty miles apart in a straight line, which is near enough to give a definite idea of the place (see map, Fig. 56). This whole coast has suffered enormous alterations since Cæsar's time, and everything is much changed.

107 7 duas legiones: the seventh and tenth.

107 8 quod . . . habebat, *what galleys he had besides*.

107 10 ex eo loco, etc.: this would be at Ambleteuse or at Calais, according to the location of the main port. — **tenebantur quo minus**, *were detained from*, the usual construction after verbs of hindering: § 558. b

(317. *b. N.*¹, 319. *c.*); B. 295. 3; G. 549; H. 568. 8 (499 3. *N.*²); H-B 502. 3. *b.*

107 12 *equitibus*: of these there were 450.

107 18 CHAP. 23. *tertia . . . vigilia, at midnight.* The date was very near August 26, when high water would be about half past seven P.M.; the ships, therefore, could go out at about half-tide. — *solvit, cast off* the ships: a technical phrase used like our *weighed anchor*. — *equites*: these were to embark at Ambleteuse, as stated above.

107 20 *paulo tardius*: they sailed after a delay of three days (ch. 28).

107 21 *hora . . . quarta*: this would be about ten A.M., an hour after high tide. The distance across is about thirty miles, and the landing was near Dover, where he lay at anchor till half past three.

107 24 *montibus anguste, etc.*: i.e. the cliffs came close to the shore.

107 26 *dum . . . convenirent, until the other ships should come up*: § 553 (328); B. 293. iii. 2; G. 572; H. 603. ii. 2 (519. ii. 2); H-B. 507. 5. When is *dum* followed by the indic.? cf. **24 24**, **33 20**, **41 9**.

107 29 *Voluseno*: cf. **106 2** and 19.

108 1 *ut . . . postularent, as military science and especially seamanship require*: rel. clause following *monuit [ut] . . . administrarentur, enjoined that everything should be done promptly.* *Ut* is omitted after *monuit*, as is often the case after verbs of directing or urging. The rel. clause has the subjv. because an integral part of the command.

108 2 *ut quae . . . haberent, since they have, etc.*: the imperf. is used by sequence of tenses; § 535. *e* (320. *e*); B. 283. 3; G. 633; H. 592. 1 (517. 3. 1); H-B. 523 and *b.*

108 4 *his dimissis, when they were sent to their posts* (observe the distributive effect of *di-*). — *aestum . . . secundum*: the tide in this place would not turn east and north until about half past six.

108 6 *progressus*: towards the north.

108 7 *aperto . . . litore*: thought to be somewhere near Deal and Walmer Castle.

108 9 CHAP. 24. *essedariis*: the *essedum* was a two-wheeled war chariot; see Figs. 123, 124. — *quo . . . genere*: i.e. including both cavalry and chariots, as described below, **114 5 ff.**

108 10 *consuerunt*: to be translated by what tense? cf. **59 14** and note. — *egredi*: infin. for the more usual *ne* or *quominus* with the subjv.; cf. **107 10** and note.

108 12 *alto*: here a noun; see Vocab.

108 13 *militibus* (dat. after *desiliendum*), *the men had to leap down.*

108 14 *oppressis* (taken with *militibus*), *weighted as they were.* Notice in this passage the free use of participles and phrases to modify the main

idea, first the abl. of place, then the abl. abs., then a participle agreeing directly with *militibus*.

108 16 *cum . . . conicerent*, *while they* (the Britons), etc.: a good example of *cum* and the subjv. describing the situation; cf. **11 7**, **62 13**.

108 18 *insuefactos*, *trained to it*, i.e. to charge to the water's edge.

108 20 *generis*: gen.; cf. **106 27**.

108 21 *pedestribus*, *on land*, where the main strength lay in infantry.

108 22 CHAP. 25. *navis*: subject of *removeri*; § 563. *a* (330. B. 2); B. 331. ii, 587. *b*; G. 423. N.⁶; H. 613. 2 (535. ii); H-B. 587. *b*.

108 23 *inusitator*, *quite strange*.

108 25 *latus apertum*: i.e. the right, unprotected by their shields.—*inde*: connect with *propelli ac submoveri*.

108 26 *tormentis*: see chapter on military affairs, I. 5, and Figs. 61, 75, 95.—*ac*: notice that this word always adds something with emphasis.

108 27 *quae res*, *a manœuvre which*: cf. **94 17** and see note on **30 19**.

109 2 *qui . . . ferebat*, *the one who carried*: the antecedent of *qui* is the understood subject of *inquit*.—**X legionis**: again the splendid tenth distinguishes itself; cf. **36 24**, **67 26**.

109 3 *obtestatus*, *appealing to*. Such prayers almost always preceded any formal address among the Romans, like "God save the Commonwealth of Massachusetts." The words would be *Quod vobis*

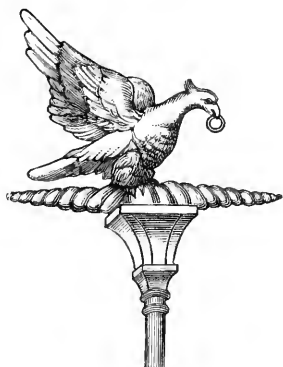

FIG. 122. — AQUILA.

feliciter eveniat, desilite, etc.—**legioni, imperatori**: dat. of reference.

109 4 *nisi voltis*: a present simple condition; § 515 and *a* (306 and *a*); B. 302 and 4; G. 595; H. 574, 580 (508 and 4); H-B. 579, 582. 1.

109 5 *ego certe . . . praestitero*, *I at any rate shall have done*, etc.: § 478. N. (281. R.); B. 264. *a*; G. 244; H. 540 (473); cf. H-B. 494.

109 8 *inter se*, *one another*: § 301. *f* (196. *f*); B. 245. 1; G. 221; H. 502. 1 (448. N.); H-B. 266.—*universi*, *in a body*.

109 9 *ex proximis navibus*, *from the nearest ships*. Omit [*primis*].

109 10 *adpropinquaverunt*: the subject is the soldiers, implied.

109 11 CHAP. 26. *ab utrisque*, *on both sides*: cf. *utraque*, **103 30**.

109 13 *poterant . . . submittebat*: notice the numerous imperfects in this description, implying repeated or continuous action.—*alius alia ex navi*, *men from different ships*: § 315. *c* (203. *c*); B. 253. 2; G. 319; H. 516. 1

(459. i); H-B. 265. — *quibuscumque signis*: dat. after *occurrerat*; the antecedent noun and pronoun (*eis signis*), if expressed, would be dat. after *adgregabat*.

109 15 *ubi . . . conspexerant . . . adoriebantur*, etc.: a general condition, *whenever they saw*, etc.; cf. **84 22**, **103 24**, and notes.

109 16 *singularis*, *scattered soldiers*.

109 17 *adoriebantur*, *would attack*: to express the repeated action. So, too, *circumsistebant* and *coniciebant*.

110 1 *ab latere aperto*: see **108 25**. — *in universos*, *upon the whole body*. This word means not merely *all*, but *all at once*, or *all together*, and the like; cf. *universi*, **109 8**.

110 3 *speculatoria navigia*: swift, light boats for reconnaissance. — *quos . . . conspexerat . . . submittebat*: another general condition, precisely like the one noted above (**109 15**), *quos* equalling *whomsoever*, or *if any*.

110 5 *simul [atque]*, *as soon as*. — *suis omnibus consecutis*, *and all their comrades had joined them*.

110 7 *longius*, *very far*. — *quod equites*, etc.: they were wind-bound at the upper harbor, **107 9-12**.

110 9 *fortunam*: this is not a mere casual remark, but an expression of his belief in "his star," always an important factor in the greatness of a commander; cf. **36 14** and note on **10 17**.

110 12 CHAP. 27. *quae imperasset*, *what he should require* (in dir. disc. *quae imperaveris*).

110 13 *quem . . . praemisum [esse]*: cf. **106 13-19**.

110 15 *hunc*, etc.: it is not unlikely that his imprisonment was a mere pretence. — *oratoris modo*, *in the character of envoy* (or *spokesman*).

110 19 *ut ignosceretur*, *that their act might be pardoned*: *ignosco* may take a dir. obj. of the thing, with an indir. obj. of the person; § 369 (227. f); B. 187. i. a; H-B. 364. 4; hence the word here may be either personal or impersonal.

110 20 *cum ultro*, etc.: cf. **106 10**.

110 21 *bellum . . . intulissent*: these barbarous people might well be pardoned for mistaking Cæsar's expedition for an invasion. — *ignoscere*: for the omission of the subject, cf. note on **59 23**.

110 23 *arcessitam*, *after they had been fetched*.

110 24 *remigrare*, *to move back*, i.e. from the strongholds to their farms.

110 27 CHAP. 28. *post diem quartum quam*, *three days after* (according to English reckoning): § 424. f (259. d); B. 357. 1; G. 403. N.⁴ a; H. 488. 1 (430); H-B. 550. c.

110 28 *naves*, etc.: see **107 9**.

111 3 Britanniae: § 370 (228); B. 187. iii; G. 347; H. 429 (386); H-B. 376, cf. 362. — *tempestatas*: from the northeast.

111 4 aliae . . . aliae, *some . . . others*.

111 6 propius . . . occasum: cf. **98 26**.

111 7 cum . . . complerentur, *since they began to fill*: the imperf. shows that the action was not completed.

111 8 adversa nocte, *in spite of the darkness*.

111 10 CHAP. 29. eadem nocte: this was probably the night of August 30; the moon was then full at 3 A.M.

111 11 aestus maximos, *very high tides*. The ocean tides, rising here between twenty and thirty feet, were a strange phenomenon to those who had known only the tideless waters of the Mediterranean. One is at a loss to understand why the Romans had not learned more about the tides in the war with the Veneti.

111 13 navis: obj. of compleverat. — [quibus, etc.]: an unnecessary explanation, and may be omitted.

111 15 adflictabat (intensive), *dashed about*.

111 16 facultas, etc.: i.e. chance to manage their own ships or help their companions.

112 1 funibus . . . amissis, etc., *from the loss of, etc.*

112 2 id quod: § 307. *d* (200. *e*); B. 247. 1. *b*; G. 614. R.²; H. 399. 6 (445. 7); H-B. 325. *a*. N.².

112 4 quibus = *ut eis*: result.

112 5 quod . . . constabat, *because it was understood*: the subject is oportere, of which the subject is hiemari, *that it was best to winter in Gaul*.

112 7 provisum: see note on **56 16**.

112 8 CHAP. 30. principes: subject of duxerunt in l. 14.

112 12 hoc: abl. of cause, originally degree of difference; see note on **2 17**.

112 13 optimum: in pred. agreement with frumento . . . producere.

112 14 factu: cf. **3 23**. — duxerunt: see Vocab. — frumento commeatuque, *corn and other supplies*.

112 15 rem, *the campaign*. — his . . . interclusis, *if these should be overcome, etc.*: abl. abs. expressing condition.

112 18 rursus: not *a second time*, which would be iterum, but back again from negotiations to hostilities.

112 19 deducere: i.e. from their farms; cf. **110 24**.

112 20 CHAP. 31. at Caesar: emphatic transition to Cæsar from what the soldiers feared and the Britons planned; cf. **68 8**.



FIG. 123.—GALLIC COIN.

112 21 *ex eventu navium, from what had befallen the ships. — ex eo quod, from the fact that.*

112 22 *suspiciabatur, began to suspect.*

112 24 *quae . . . naves, earum, etc., the timber and the bronze of those ships which, etc.: § 307. b (200. b); B. 251. 4; G. 616; H. 399. 5 (445. 9); H-B. 284. 6.*

112 25 *aere:* the Romans used the word *aes* both for copper and bronze. These metals were more common than iron in the Roman ships, as they do not rust. They were employed to sheathe the *rostrum*, or beak, and to make the spikes that held the timbers together.

112 26 *quae . . . usui:* the antecedent of *quae* is *ea*, the understood subject of *comportari*; see note on *qui . . . appellantur*, 1 2.

112 29 *reliquis . . . effecit, he managed so that they could sail (navigari, impers.) tolerably with the rest.*

113 1 *CHAP. 32. geruntur: § 556 (276. e); B. 293. i; G. 229. R.; H. 533. 4 (467. iii. 4); H-B. 559.* Notice that this present is regular with *dum* when there is no contrast of time. Cf. the use of *dum*, 107 26. — *frumentatum:* supine; cf. 26 15.

113 3 *pars hominum, some of the people.*

113 4 *remaneret:* indicating peaceable intentions on the part of the enemy. — *ventitaret, returned from time to time:* freq. or iter.; § 263. 2 (167. b); B. 155. 2; G. 191. 1; H. 364 (336); H-B. 212. 1.

113 5 *statione:* such outposts or pickets were always on duty to guard the camp, usually a cohort at each gate.

113 6 *quam . . . ferret, than usual.*

113 7 *id quod erat, what was the fact.*

113 8 *aliquid . . . consili (part. gen.), that some new design was on foot; infin. clause in app. with id.*

113 11 *armari, to arm:* in verbs thus used reflexively, English prefers the active and Latin the passive form. — *paulo longius, some little distance.*

113 12 *premi . . . sustinere, were getting hard pushed, and hardly held their ground.*

113 13 *conferta legione (abl. abs.), the legion was closely crowded together, while weapons were hurled, etc.* Observe the tendency of Latin to convey a description, as here, by a participial phrase.

113 15 *una, only one. — suspicati, supposing: cf. 107 1 and note.*

114 2 *dispersos, occupatos:* agreeing with *nostros* understood from the preceding line.



FIG. 124. — GALLIC COIN.

114 3 *incertis ordinibus* (abl. abs.), *because the ranks were unsteady.*

114 5 CHAP. 33. *ex essedis*: these chariots held six men (*essedarii*) each besides the driver (*auriga*), and were drawn by two horses.

114 6 *terrore equorum*: obj. gen., *the terror that the horses arouse.*

114 8 *cum se . . . insinuaverunt*, *when they have worked their way between*: the protasis of a general condition, *ex essedis . . . proeliantur*, being the apodosis; cf. **103 24**. The perf. indic. with *cum* is here used as a protasis because a repeated action is spoken of.—*equitum*, the cavalry of the Britons. When the *essedarii* had dismounted, the British line was composed of alternate bodies of horse and foot.

114 10 *illi*: i.e. the fighting men spoken of above.

114 11 *expeditum . . . receptum*, *a ready retreat.*

114 13 *praestant*, *exhibit*. Cæsar was much struck with the efficiency of the German and British horse (see ch. 12), and later made it the basis of important changes in the Roman army. The ordinary cavalry was never able to cope with infantry; cf. Cæsar's stratagem in **38 1**.

114 14 *uti . . . consuerint*: clause of result following *efficiunt*.—*declivi ac praecipiti loco*, *a steep downward slope.*

114 15 *incitatos equos sustinere*, *to check their horses in full gallop* (complem. infin. after *consuerint*).—*brevi*, *within a short space.*

114 16 *iugo*: made of straight or curved wood, resting on the necks of the horses and holding up the pole of the chariot.

114 18 CHAP. 34. *quibus rebus*, *under these circumstances*: abl. of means.—*nostris*: dat. following *auxilium tulit*.—*novitate*: depends on *perturbatis*.

114 22 *alienum*: see note on **13 6**.

114 26 *quae . . . continerent*: note the subjv.

115 1 *quanta . . . facultas daretur*: indir. quest. following *demonstraverunt*.

115 2 *sui liberandi*: cf. **40 15** and note.

115 7 CHAP. 35. *ut . . . effugerent*: a result clause in app. with *idem*, the subject of *fore*, namely, *that if*, etc.

115 8 *effugerent*, *would escape*: the future idea is given by *fore*.—*equites XXX*: these few cavalry would be of no service in an engagement, but only in pursuit. To chase and cut down the beaten army was considered an essential part of the battle.

115 9 *ante*: i.e. **106 13-19**, **110 13-17**.

115 12 *tanto spatio*, *over as much ground*: § 425. *b* (257. *b*); B. 223; G. 389; H. 417. 3 (379. 2); cf. II-B. 426. *c*.

115 19 CHAP. 36. *die aequinocti*, etc. (Sept. 24, always held to be a stormy season), *since the time of the equinox was near and his ships were*

unseaworthy. Napoleon III estimates that the return to Gaul occurred Sept. 11 or 12. This would make the stay about three weeks.

115 23 *eosdem portus*, *the same ports with the others*.

115 24 *paulo infra*: the west current sets in on the French coast, while the east current is still running in mid-channel.

115 28 CHAP. 37. *primo*: adv.; see Vocab.

116 1 *orbe*: the circle was formed by a small body of troops when entirely surrounded by the enemy. It was generally hollow, with officers and baggage in the centre. See chapter on military affairs, VII, last part.

116 5 *horis*: abl. of comparison with *amplius*; the more common construction would be *horas*; cf. note on 54 9.

116 6 *postea vero quam*, *but as soon as*.

116 12 CHAP. 38. *siccitatis*:

see § 100. *c* (75. *c*); B. 55. 4. *c*; G. 204. 5; H. 138. 2 (130. 2); H-B. 240. 5. *b*; the *tempestates* of ch. 34 were apparently merely gusty weather without rain.

116 13 *recipent*: a purpose clause. — *superiore anno*: see Bk. iii. ch. 28.

116 22 *supplicatio*: cf. end of Bk. ii. The crossing of the Rhine strongly impressed the minds of the Romans at home, and so, too, the passage into Britain, though the last was in fact a failure. But, though Cæsar had added nothing to Roman power, he had opened a new world to Roman ambition.

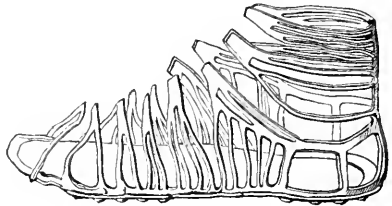

FIG. 125. — CALIGA.

BOOK FIFTH. — B.C. 54.

SECOND INVASION OF BRITAIN. — The landing of the previous year had been only a reconnaissance. Cæsar now determines upon a regular advance and occupation. The earlier part of the season was chiefly taken up with naval preparations. The ships were apparently built on the inland streams, and the rigging and outfit brought from Spain, which was considerably in advance of Gaul in civilization. It abounded in metals, and, in particular, furnished the *esparto*, or Spanish grass, whose long, tough fibre made the best of cordage. Cæsar sails (by the reckoning of Napoleon III) on the 20th of July from *Portus Itius*, at or near Boulogne, drifting first with wind and tide some distance to the northeast, then making his way to his former landing.

READING REFERENCES ON THE SECOND INVASION OF BRITAIN.

- Abbott's Julius Cæsar, pp. 97-106.
 Dodge's Cæsar, chap. 12.
 Fowler's Julius Cæsar, pp. 199-206.
 Froude's Cæsar, last part of chap. 16.
 Merivale's Hist. of Rome, Vol. I. pp. 384-389.
 Mommsen's Hist. of Rome, Vol. IV. pp. 313-315.
 Napoleon's Cæsar, Vol. II. chap. 8.
 Scarth's Roman Britain, chaps. 2 and 3.
 Tacitus's Agricola.
 Trollope's Cæsar, chap. 6.

117 1 CHAP. I. **L. Domitio**, etc.: cf. **94 1** and note. The consuls entered on their office Jan. 1, according to the official calendar; the real date appears to have been Dec. 12. Cæsar's visit to Italy was therefore probably later.

117 2 **ut quotannis**, etc.: cf. **48 28**, **73 7**.

117 4 **navis**: see chapter on military affairs, IX. — **navis . . . curent**, *have as many vessels as possible built during the winter and the old ones repaired*: cf. **82 7**, **11 5** and note.

117 5 **modum formamque**, *style of build*.

117 6 **subductionis**: the vessels of the ancients were usually "beached" and not left at anchor. — **humiliores**: agrees with *eas*, the understood object of *facit*; see note on **62 16**.

117 7 **nostro**: i.e. the Mediterranean.

117 8 **id**: sc. *facit*; § 319 (206. c); B. 166. 3; H. 388. 5 (368. 3. N.¹); H-B. 222. a.

117 9 **minus magnos** seems to refer to the smooth ocean swell, compared with the angry "chopping seas" of the Mediterranean.

117 10 **iumentorum**: not pack-animals so much as horses for his cavalry, the lack of which he felt so seriously the year before; see **110 6-9**.

117 11 **actuarias**, fitted with oars as well as sails. The Gallic ships, it will be remembered, did not have oars. See Bk. iii. ch. 14.

117 12 **humilitas**: as compared with the high-banked galleys.

117 13 **armandas**, *fitting out*: see introductory note.

117 14 **conventibus**, proconsular or provincial courts. These courts were regularly held in the winter; cf. **48 29**.

117 15 **Illyricum**: cf. **73 7**. — **Pirustis**: a tribe long allied with Rome, inhabiting the valley of the Drina.

117 17 **imperat**: in the sense of *to levy, to make requisition for*, *impero* takes the acc. of the thing levied and the dat. of the person upon whom the levy is made.

118 5 *arbitros, arbitrators.*

118 6 *litem, amount of damages.*—*poenam*: i.e. the amount of compensation to be paid.

118 8 *CHAP. 2. Galliam revertitur*: Cæsar's activity during these winter months had been remarkable. He left his troops in Belgium about Jan. 1, travelled all through Transalpine and Cisalpine Gaul, crossed over to Illyricum, and returned to his army again early in the spring. The distance was at least 2000 miles.

118 9 *circumitis, having inspected*: see last note on **49 6**; § 388. *b* (237. *d*); B. 175. 2. *a*; G. 331; H. 406 (372); H-B. 391. 2. *ftn.*

118 10 *studio, etc.*: i.e. the energy of the soldiers in building the vessels under difficulties.

118 12 *neque . . . quin, and are not far from the condition that*; *eo* is antecedent to the vague relative idea in *quin*, etc.

118 15 *Itium*: Boulogne or Wissant, either of which agrees with the account (cf. Bk. iv. ch. 23, and note on **107 6**).

118 17 *XXX*: a little less than 28 English miles.—[*transmissum*]: omit in translation.

118 18 *satis . . . militum, enough soldiers*: part. gen.

118 19 *Treverorum*: a tribe reckoned as Gauls or Celts, but believed to be, in part at least, of German origin. Their name appears in the modern *Trèves*. This, their principal town (*Augusta Treverorum*), was long the seat of Roman power in northern Gaul.

118 20 *concilia, assemblies, held by a province or confederacy for consultation or law-making.* Cæsar seems to have organized such assemblies under his own authority in Belgic Gaul after its conquest.—*veniebant, etc.*: notice the force of the imperf. tense; § 471. *f* (277. *g*); G. 233.

118 22 *dicebantur*: the personal form is regularly used with the tenses of incomplete action.

118 23 *CHAP. 3. Galliae*: part. gen.; § 346. *a. 2* (216. *a. 2*); B. 201. 1; G. 372; H. 442 (397. 3); H-B. 346.

118 24 *ut supra demonstravimus*: cf. Bk. iii. ch. 11.

118 27 *alter, the latter, Cingetorix, the son-in-law of Indutiomarus.*

119 1 *suos*: i.e. clansmen, retainers, etc. Cingetorix offers to bring his nation under Roman authority on condition of ruling them himself as a subject or friend of Rome.

119 3 *at*: marking the transition to the other man.

119 4 *cogere*: with *instituit*, l. 8.

119 5 *Arduennam*: this hilly and forest region makes the natural frontier between Gaul and the Netherlands, and is the seat of the famous Belgian iron mines.

119 11 *petere*: used absolutely (i.e. without an object); *ask* his decision or assistance. — *civitati*, etc.: they were prevented by Indutiomarus from taking any measures for the general good, and so asked favors of Cæsar for themselves individually.

119 12 *possent*: the reason given by these Gauls, hence the subjv.

119 16 *laberetur*, lit. *fall off* (from obedience).

119 17 *se . . . eius fidei permissurum*, *to put . . . under his protection*.

119 22 CHAP. 4. *omnibus . . . comparatis*, *now that*, etc.

119 28 *quod cum*, etc.: Cæsar seems to think this double dealing needs some excuse.

119 29 *cum . . . intellegebat*, *considered on the one hand*. — *cum . . . tum*: see Vocab.; *eius* refers to Cingetorix, *se* to Cæsar. — *merito eius*, *according to his deserts*: § 418. *a* (253. *N.*); cf. B. 220. 3; G. 397; H. 480 (424); cf. H-B. 414. — *magni interesse*: § 417 (252. *a*); cf. B. 203. 3; G. 380; H. 440. 3 (396. *v*); H-B. 356. 1.

120 2 [*suam . . . minui*]: in app. with *id factum*, and may be translated, though not necessary to the sense.

120 3 *qui . . . fuisset*, *while*, etc.: § 535. *e* (320. *e*); cf. B. 283. 3. *b*; G. 634; H. 586. ii (515. iii); H-B. 523.

120 4 *hoc dolore*, *this grievance*; properly, *indignation at this*.

120 6 CHAP. 5. *in Meldis*: these people were on the Marne, near Meaux. The ships were built here, probably for convenience of timber; they were low and of light draft (ch. 1), and proved too frail for the Channel waters (ch. 10; cf. Bk. iii. ch. 9, where sturdier craft are built upon the Loire).

120 8 *eodem* (adv.) = *in eundem locum*.

120 13 *loco*, *in the condition*: § 429. 3 (254. *a*); B. 228. 1. *b*; G. 385. *N.* 1; H. 485. 2 (425. 2); H-B. 436.

120 14 *cum . . . abesset*, *while he should be away*: a fut. idea (*cum abero*) thrown into the past by *verebatur*.

120 15 CHAP. 6. *Dumnorix*: as it appears, he had been kept four years under strict surveillance (18 11).

120 19 *accedebat huc quod*, *to this was added the fact that*: cf. 84 2 for a different construction after *accedebat*.

120 20 *deferri*: the present expresses the action as in process of completion, i.e. that Cæsar was making arrangements, or intended, or the like.

120 21 *neque*, *and yet not*, a very common force of the word; cf. note on 80 11.

120 25 *timeret, diceret*: cf. *possent*, 119 12.

120 26 *religionibus*, *scruples*, perhaps in regard to leaving the country or crossing the sea; among superstitious peoples such ideas are common.

121 2 *territare*: histor. infin.; see **13 18** and note.

121 3 *fieri ut*, etc., *it was coming to pass that*, etc.; or may be translated, *that Gaul was*, etc., compressing the two clauses into one. — *esse*: depending on a verb of saying implied in *metu territare*.

121 6 *interponere*: same constr. as *territare*. — *ex usu*, *to the advantage*.

121 7 *intellexissent*: here represents the fut. perf. of dir. disc.

121 8 *deferebantur*: note the force of the tense.

121 9 CHAP. 7. *quod . . . statuebat*: i.e. the severity shown to Dumnorix was proportioned to the favor and consequence granted by Cæsar to his state.

121 11 *longius*, *too far*.

121 12 *prospiciendum* [*esse*], *that precautions must be taken*: depends on *statuebat*.

121 13 *quid . . . nocere*, *to do some harm to*: *quid* is cognate or adv. acc.; § 390. *d. N.*² (240. *o. N.*); B. 176. 3. *a*; G. 333; H. 409. 1 (371. ii, 378); cf. H-B. 396. 2, cf. 387. iii.

121 14 *commoratus*: i.e. during the delay; cf. **93 4**. — *Corus* (or *Caurus*), the northwest wind.

121 15 *omnis temporis*, *every season* of the year; the windmills on this coast are said to have had their sails set permanently to the northwest.

121 18 *milites*: i.e. the legionary infantry.

121 19 *at*: note its force and cf. **119 3**. — *omnium impeditis animis*, *while the attention of all was occupied*.

121 24 *si vim . . . iubet*: informal indir. disc. The direct would be *si vim facit neque paret, interficite* [*eum*].

121 25 *pro sano*, *rationally*.

121 26 *neglexisset*: the tense depends on *arbitratus*, which is, however, essentially present in meaning; see note on *commoratus*, l. 14.

121 28 *liberum*, etc.: Cæsar takes no pains to conceal the violence of his acts. He had no authority over Dumnorix except that of the stronger.

122 7 CHAP. 8. *pro tempore et pro re*, *to suit the time and circumstance*.

122 8 *pari . . . quem*, *the same . . . as*, etc.: i.e. 2000, as in l. 5.

122 10 *Africo*: the southwest wind.

122 12 *sub sinistra*: i.e. he had drifted to the northeast (see map, Fig. 65).

The voyage has been carefully calculated as follows: Cæsar weighed anchor at sunset (about 8 P.M.). A gentle breeze was then blowing from the southwest; but at the same time a tidal current was setting *towards* the southwest. Under the impulse of these two forces, the fleet kept a northwesterly course until about midnight. The wind then died down, and the current also began to set in the opposite direction (northeast).

With this current the Romans drifted, and at dawn the British coast appeared on their left. They had passed by (*relictam*) the North Foreland, and were drifting farther away from the land. But at about this time (5 A.M.) the tide changed, and the current again began to flow towards the southwest. With its help, and that of the oars, the fleet now began to move towards the land, aiming to reach the same point that had been found in the previous expedition to be the most convenient for debarking. Here they arrived at about noon. (von Göler.)

122 15 *superiore aestate*: cf. Bk. iv. ch. 23.

122 16 *virtus, pluck, spirit.* — *gravibusque, and heavy-laden besides.* — *navigiis*: abl. of means.

122 18 *accessum est* (impers.): the landing was probably near Walmer Castle.

122 20 *cum*: concessive.

122 22 *quae . . . amplius DCCC, more than 800 of which*: subject of *visae erant.* — *annotinis, those built the year before.* — *sui commodi*: pred. gen.: § 343. *b* (214. *c*); B. 198. 3; G. 366. R.¹; H. 447 (403); H-B. 340, here expressing purpose; cf. note on *deiciendi*, 104 11.

These were vessels that the rich members of Cæsar's staff had had built for their own use.

122 27 CHAP. 9. *cohortibus X*: i.e. two from a legion.

123 1 *navibus*: dat.

123 3 *noctu*: not *nocte*; see Vocab.

123 5 *equitatu atque essedis*: abl. of accomp. without *cum*; § 413. *a* (248. *a. N.*); B. 222. 1; G. 392. R.¹; H. 474. 2 (419. iii. 1. 1); H-B. 420. — *flumen*: the Stour, which flows northeasterly through Canterbury. — *superiore*: the north bank is higher ground than the opposite.

123 11 *ipsi . . . propugnabant, they themselves rushed out of the woods in small parties to fight.*

123 12 *testudine facta et aggere . . . adiecto*: from the rapidity with which this *agger* was completed, it is evident that it was not the elaborate structure required in attacking more formidable defences, but more like that described in Bk. iii. ch. 25. We may also infer that the British stronghold was only rudely fortified.

124 5 CHAP. 10. *tripartito*: i.e. following different roads.

124 7 *extremi*: i.e. the rear of the retreating enemy.

124 8 *Atrio*: who had been placed in command of the camp, 123 3.

124 12 *concurso*: referring to the violent driving together of the ships after they had broken from their moorings.

124 15 CHAP. 11. *revocari*: i.e. those who were in advance and out of sight. — *resistere, to halt*: i.e. those who were near.

124 17 coram perspicit: i.e. after a careful and thorough personal examination. Cæsar did not leave important duties of this sort to subordinates. — **sic ut**, etc.: i.e. he sees that the account of the disaster is true *to the extent that*, etc.; **ut** and similar words often have a limiting meaning; cf. *tantum*, meaning *only so much*.

124 19 fabros deligit: a certain number of carpenters (*fabri lignarii*) was attached to the engineer corps of the army; but Cæsar seems to have had no regular engineer corps, except that a *praefectus fabrum* was on his staff. See chapter on military affairs, I. 4.

124 20 legionibus: abl. of means.

124 26 eisdem quas, *the same as*: see **122 27**.

124 27 eodem: i.e. to the British defences on the Stour.; cf. note on **120 8**.

125 4 a mari: probably from Cæsar's place of landing. The distance is reckoned, not in a straight line, but by the roads, as the army marched.

125 5 huic, etc.: "The brave and cautious prince Cassivellaunus (*Caswallon*), who ruled in what is now Middlesex and the surrounding district, — formerly the terror of the Celts to the south of the Thames, but now the protector and champion of the whole nation." (Mommsen.) — **huic . . . cum reliquis civitatibus . . . intercesserant**, *had occurred between him and the other states*; note the idiomatic construction.

125 8 CHAP. 12. natos in insula: they were not, however, indigenous, but a Celtic population following an earlier Iberian race.

125 9 proditum [*esse*]: the subject is **quos natos** [*esse*] **in insula**. — **pars**: sc. *incolitur*.

125 11 eis nominibus: for example, *Atrebates* and *Belgæ*.

126 3 Gallicis: brief references to the Gallic customs of building are made in Bk. v. ch. 43, and Bk. vi. ch. 30; see also introductory chapter on Gaul and the Gauls.

126 4 [aut nummo aereo]: omit in translation.

126 6 plumbum album: Cæsar is mistaken in placing tin mines inland and iron on the coast; it was just the other way. The tin mines of Cornwall were known to the Phœnicians from the earliest times. He does not say whether iron was used in the arts, which, if true, would imply a pretty advanced civilization.

126 7 exigua: the great mineral wealth of England was then unknown.

126 9 fagum atque abietem: another error; the beech and fir are both native to Britain.

126 10 gallinam, etc.: it is of interest to note that these domestic fowls were known to the savage Britons; see Fig. 113.

126 12 frigoribus, *seasons of cold*.

126 17 CHAP. 13. *ad Hispaniam*, etc.: i.e. he places Spain west of Britain on the same side as Ireland. For this crude geography, cf. Tacitus (*Agric.* 34), who says that Ireland is between Britain and Spain. *Cæsar* conceives Britain as lying somewhat in the accompanying form.

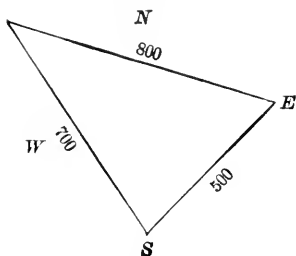

126 20 *atque, as*: § 324. *c* (156. *a*); B. 341. 1. *c*; G. 643; H. 657. 1. N. (554. 1. 2. N.); H-B. 307. 2. *a*; i.e. the distance from Ireland to Britain is the same as that from Britain to Gaul.

126 21 *Mona*: the Isle of Man, or confounded with it; but Tacitus evidently gives this name to Anglesea.

126 25 *ex aqua mensuris*: the *clepsydra*, or water-clock, measured time by the dropping of fixed measures of water through a small pipe or aperture something like a sand-glass. — *breviores*: naturally, as this was in the summer.

127 1 *hoc*: sc. *latus*.

127 6 CHAP. 14. *interiores*: the ruder barbarians here described are probably represented by the later *Picts*, whose name *Picti* (cf. *picti*, *painted*) has been thought to denote their woad-staining. The woad plant, *Isatis tinctoria*, akin to the common *shepherd's purse*, is still used somewhat for dyeing.

127 11 *parte*: § 415 (251); B. 224; G. 400; H. 473. ii (419. ii); H-B. 443.

127 13 *sed qui sunt*, etc., *but the children of these wives are regarded as belonging to the man to whom each maiden was first espoused*.

127 14 *quo* (adv.) here stands for *ad quos*: § 321. *a* (207. *a*); G. 611. R.¹; H. 307. 4 (304. ii. 3. N.); H-B. 284. 10.

127 16 CHAP. 15. *essedarii*: see Bk. iv. ch. 33.

127 18 *fuerint*: for tense, see **85** 14 and note.

127 25 *atque his, and these, too*. — *primis*: the first cohorts had the best soldier; see chapter on military affairs, I. 7 (last part).

127 27 *per medios*: i.e. through the interval between the two cohorts.

128 11 CHAP. 16. [*equestris*, etc.]: this parenthesis may be translated. — *cedentibus et insequentibus* (abl. abs.): with *eis* understood, referring to the Britons. Whether advancing or retreating, the islanders were equally formidable.

128 14 *proeliarentur*: this clause is conceived as a result, and hence is expressed by *ut* with the subjv. instead of the usual construction with *quod* and indic.; cf. **120** 19 and note. — *stationes*, *supports*. It will be observed that the Britons showed considerable military skill, and that their

mode of battle somewhat resembled that of the Romans themselves. They used an open and flexible array, rather than the dense masses (*phalanges*) of the Gauls and Germans.

128 24 CHAP. 17. *quoad*: followed by the indic.; cf. **100** 2 and note.

128 25 *subsidio confisi*: cf. **91** 13.

128 27 *sui conligendi*: cf. **77** 3, **115** 2.

129 1 *facultatem*: cf. note on **16** 7. — *ex*, directly after.

129 5 CHAP. 18. *uno loco*: somewhere between Brentford and the mouth of the Wey. The details of Cæsar's march are here uncertain.

129 13 *capite solo*: a most hazardous depth. By the rule for modern infantry, a ford should not be more than three feet deep. But, says Merivale, "the swimming and fording of rivers were among the regular exercises of the Roman legionary. Though immersed up to his chin in water, he was expert in plying his hatchet against the stakes which opposed his progress, while he held his buckler over his head not less steadily than on dry land. Behind him a constant storm of stones and darts was impelled against the enemy from the engines which always accompanied the Roman armies."

130 1 CHAP. 19. *supra*: i.e. **129** 1-3.

130 3 *servabat, excedebat*, etc.: note the imperfects, expressing customary and repeated action, *he used to*; cf. **121** 8.

130 4 *locis, regionibus*: loc. abl. — *locisque impeditis ac silvestribus*: from this description we must infer that the British chariots were very narrow, to pass through the forest roads, and had high wheels, to go easily over rough ground.

130 7 *cum . . . eiecerat*: a general condition; see note on *cum*, **84** 22. Other instances of general conditions occur in **103** 24, **109** 15, **110** 3.

130 9 *emittebat, conflagabat, prohibebat*: the subj. is *Cassivellaunus*.

130 10 *hoc . . . prohibebat*, by fear of this kept them [sc. *eos*] from roving too widely.

130 11 *relinquebatur ut*, the consequence was that.

130 12 *discedi*: impersonal.

130 13 *tantum . . . quantum*: correlatives; see *Vocab.*

130 14 *noceretur*: impers., governs the dat. *hostibus*; cf. note on **56** 24.

130 16 CHAP. 20. *Trinobantes*: in Essex. Their chief place was *Camulodunum*, later *Colonia Castrum*, now Colchester. This defection was soon followed by the break-up of the Briton confederacy.

130 18 [*Galliam*]: omit in translation.

130 23 *mittat*: sc. *aliquem*.

130 24 *his imperat obsides*: see note on **117** 17.

131 2 CHAP. 21. *Cenimagni*, etc.: these were petty populations of the vicinity.

131 4 oppidum Cassivellauni: thought to be the modern St. Albans.

131 6 oppidum, etc.: the Britons, like the Germans, did not live in towns, but used these strongholds simply for defence against attack.

131 7 cum, *whenever*, another general condition: cf. **130 7** and note. The preceding case refers to repeated action in past time, this to the present of a general truth. Notice the difference between these cases and the regular descriptive **cum** in narration.

131 9 consuerunt: what tense in translation?

131 14 multi: i.e. the people, not the cattle.

131 17 CHAP. 22. *supra*: see **127 5**.

131 18 regionibus: implying that Kent (*Cantium*) was divided into four recognized military commands.

131 20 castra navalia: i.e. the fortified camp on the beach, surrounding the beached ships; see **124 21-25**.

131 28 neque multum aestatis: Cæsar had now been in Britain about two months (cf. ch. 23). The dates assigned by Napoleon III for his sailing and return are July 20 and Sept. 21.

131 29 extrahi, *protracted*, i.e. wasted. Besides, Cæsar had just learned of the death of his daughter Julia, Pompey's wife, which threatened the dissolution of the triumvirate and gave him strong reason for wishing to be nearer home.

132 1 vectigalis (part. gen.): this was mere form, as no means were left to enforce the tribute.

132 7 CHAP. 23. **commeatibus**: has its original meaning; see *Vocab.*

132 8 accidit uti, etc.: cf. **130 11** for a similar construction.

132 10 portaret, remitterentur: subjv. of characteristic.

133 1 [et]: omit. — **prioris commeatus**, etc., *after the soldiers of the first trip had been landed*.

133 2 quas: refers back to **ex eis**. — **faciendas curaverat**, *had had made*: cf. **82 7**, **11 5**. Labienus had been ordered to build these directly after the big storm; see **124 20**.

133 3 locum: i.e. Britain. — **caperent, reicerentur**: in the same construction as **desideraretur**.

133 6 aequinoctium: cf. **115 19** and note.

FRESH RISINGS OF THE GAULS. — The remaining events of this campaign are among the most critical of the entire Gallic War, and show to what extreme peril Cæsar had exposed his conquests by his expedition across the Channel. They serve, besides, to bring out in very marked relief the personal qualities of his several lieutenants. As a series of episodes, this Book is, in fact, the most interesting of the eight. The Romans did not visit Britain again till A.D. 43, in the reign of Claudius.

READING REFERENCES ON THE GALLIC REBELLIONS.

Dodge's *Cæsar*, chap. 13.

Fowler's *Julius Cæsar*, chap. 13 (first part).

Froude's *Cæsar*, chap. 17.

Holmes's *Cæsar's Conquest of Gaul*, pp. 76-93.

Merivale's *Hist. of Rome*, Vol. I. pp. 390-398.

Mommsen's *Hist. of Rome*, Vol. IV. pp. 317-323.

Napoleon's *Cæsar*, Vol. II. chap. 8 (last part); see also Appendix D on *Cæsar's Lieutenants*.

Trollope's *Cæsar*, chap. 6 (last part).

133 10 CHAP. 24. **Samarobrivæ** (locative): the chief town of the Ambiani, whose name is found in the modern *Amiens*.

133 12 **aliter ac**: i.e. distributing them where supplies were most abundant, not where there was most danger of disturbance, as in previous years.

The location of these camps has been much disputed. The most common view puts Fabius at St. Pol, Cicero at Charleroi (or possibly Namur), Roscius at Séez in Normandy, Labienus on the Ourthe (in Luxembourg), Crassus, Plancus, and Trebonius not far from Amiens, Sabinus and Cotta at Tongres. These places do not quite agree with the description unless we take the hundred mile limit (**133 29**) as the radius of a circle, a meaning which seems improbable. But this division is perhaps near enough.

133 15 **ducendam**: gerundive expressing purpose; cf. **faciendas**, l. 2; § 500. 4 (294. *d*); B. 337. 7. *b*. 2; G. 430; H. 622 (544. 2. *N*.²); H-B. 605. 2. — **Q. Ciceroni**: the younger brother of the orator, and a man of tougher fibre and of great military and executive ability. He had joined *Cæsar's* army that very year and had taken part in the expedition to Britain. Quintus, like his brother Marcus, sided with Pompey in the Civil War, and met a similar fate in the same year (B.C. 43) at the command of the triumvirs.

133 20 **proxime, latest.** This was the 14th legion, enrolled in B.C. 57.

133 21 **cohortis**: these must have been troops not organized into a legion, probably provincials.

133 25 **inopiae**: dat. with **mederi**; § 367. *b* (227. *b*); G. 346. *N*.⁴; H. 385. ii. *N*.³; H-B. 364. 5.

133 29 **quoad . . . cognovisset**: cf. **128 24**. Why is the indic. used there and the subjv. here?

134 3 CHAP. 25. **Carnutibus**: in the vicinity of Chartres.

134 4 **huic**: indir. obj. of **restituerat**.

134 7 **restituerat**: this act of restoring chiefs exiled by the democracy of the tribes was peculiarly odious to the Gauls, as here appears.

134 8 **auctoribus** (abl. abs.): i.e. either at their instigation, or, at any rate, with their consent.

134 12 *quorum*: the antecedent is *hos*.

134 13 *comprehensos . . . mittere*: cf. 5 5, 55 3, and notes.

134 14 [*legatis quaestoribusque*]: omit in translation.

134 17 CHAP. 26. *diebus . . . quibus*, *within a fortnight after*, etc.

134 19 *cum*: concessive; cf. 122 20. — *Sabino*: § 367. *a*. N.² (227. N.²); H-B. 362. *ftn.*³ *b*.

134 20 *praesto*, *in attendance upon*, as obedient subjects.

135 1 *Indutiomari*: for the bitter offence given him by Cæsar, see above, ch. 4.

135 2 *subitoque*, etc., *and after suddenly surprising the wood-cutters*.

135 7 *aliqui*: the usual form is *aliquis*; § 151. *e* (105. *d*); B. 252. 2: G. 107; H. 187. N.¹ (190. N.²); H-B. 142.

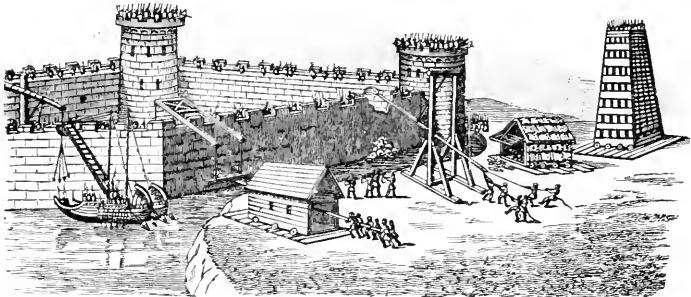

FIG. 126. — OPPUGNATIO.

NOTE.—This cut represents an attack both by land and water, in which no *agger* is employed. While in these respects unlike the attack on the Gallic towns, it shows very clearly some siege implements in active use.

135 12 CHAP. 27. *eques*, a *knight*, a member of the equestrian order the commercial aristocracy of Rome.

135 19 *Aduatuci*: subject of *tenuissent*.

135 20 *fecerit*: by sequence of tense we should have *fecisset*, but see note on 51 11. Note several similar cases in this speech.

135 22 *imperia*, *sovereignty*. The word is used in English abstractly, referring to all cases; while in Latin each act of sovereignty is regarded as a separate *imperium*. Observe the emphasis on *sua*, *that HIS OWN sovereignty was of such a nature*.

135 26 *humilitate*, *weakness*.

135 27 *rerum*: § 349. *a* (218. *a*); B. 204. 1; G. 374; H. 451. 1 (399. i 2); H-B. 354.

135²⁸ omnibus . . . oppugnandis: dat. of gerundive expressing purpose; see 76²¹ and note.

136¹ non . . . potuisse, *that Gauls could not easily say "no" to Gauls.*

136⁴ pro pietate: *pietas* implies the love of a child to a parent; here, of course, to his native land, *patriotism.*

136⁵ rationem officii, *regard to his duty.*

136⁸ hanc: i.e. manum. — ipsorum, etc.: i.e. it was for themselves to consider.

136¹³ quod cum faciat, *in so doing*, subjv. merely because of indir. disc.

136¹⁴ hibernis: i.e. the burden of providing grain for the soldiers.

136²¹ CHAP. 28. ausam [*esse*], with civitatem. — consilium: as the two legates had one and one-half legions under their command, the council of war contained, besides the legates, nine military tribunes, and either nine or six centurions, according as the half legion did or did not include the first cohort. Thus there were in the council either twenty or seventeen persons.

136²⁶ [magnas]: may be omitted.

136²⁷ quod . . . sustinuerint: in apposition with rem.

137² quid esse, etc.: see note on 12⁸. — auctore hoste, *on the advice of the enemy.*

137⁶ CHAP. 29. proximis, *nearest.* This camp was farthest off from the main body, and hence if the nearest camps should be taken, the forces could not easily withdraw in safety.

137⁷ se: i.e. Titurius.

137⁹ fuisse capturos: in direct, *cepissent*, a contrary-to-fact apodosis; § 517 (308); B. 304; G. 597; H. 579 (510); H-B. 581.

137¹⁰ nostri: obj. gen.; § 295. *b* (194. *b*); B. 242. 2; G. 304. 2; H. 500. 4 (446. N.³); H-B. 254. *a*. — venturos esse: for *venirent* of the direct, the apodosis of a pres. condition contrary to fact. We should expect *venturos fuisse*: § 589. N.² (337. *b*. N.³); B. 321. 1. *a*; G. 659; H. 647 (527. iii); H-B. 581. *b*. 1.

137¹¹ auctorem: cf. auctore hoste, l. 2.

137¹² Ariovisti mortem: he had, however, escaped after the battle (Bk. i. ch. 53).

137¹³ ardere, *is in a blaze.*

137¹⁶ persuaderet: direct, *persuadeat*, a deliberative question.

137¹⁸ esset: direct, *erit*, a fut. protasis; § 516. *a* (307. *a*); B. 302. 1; G. 595; H. 574 (508); H-B. 579. *a*.

137²⁰ consentiret: pres. ind. in direct, a simple condition. — esse . . . positam: direct, *est posita*, a past apodosis with a pres. protasis.

137²² habere: cf. esse, l. 2.

137 23 *esset*: direct, *est*.

137 26 CHAP. 30. *primis ordinibus* = *primorum ordinum centurionibus*.

137 27 *id*: sc. *he said* from preceding *inquit*.

138 2 *ex vobis*: instead of a part. gen. after *gravissime*. — *hi*: i.e. the *magna pars militum* who were listening.

138 3 *acciderit*, etc.: a more vivid fut. condition; for the tense, see § 516. *c* (307. *c*); B. 303; G. 244; H. 540. 2 (473); cf. H-B. 577. *a*.

138 4 *liceat*, etc.: a less vivid fut. condition.

138 8 CHAP. 31. *comprehendunt*: i.e. the centurions. — *utrumque*: i.e. Sabinus and Cotta.

138 12 *res disputatione perducitur*, *the question is debated at length*.

138 13 *dat manus* (a formal sign of surrender), *gives in*.

138 14 *pronuntiatur*, *word is given out*.

138 15 *ituros* [*esse*]: sc. *eos*; see second note on 59 23.

138 18 [*omnia*, etc.]: this passage has been questioned, but it seems to mean that all the measures taken were devised as if on purpose to make it dangerous to remain, and to increase the danger of departure through the fatigue and demoralization of the men.

138 20 *ut quibus*, etc., *as if they were convinced that*: § 535. *e*, 372 (320. *e*, 230); B. 283. 3. *a*, 187. ii. *b*; G. 634, 217; H. 586. ii, 426. 3 (515. iii, 334. 5); H-B. 523, 364. 2.

138 22 [*Ambiorige*]: omit in translation. — *longissimo*: the line of march was very long, as it might well be under a guaranteed safe conduct, and consequently very weak.

138 24 CHAP. 32. *at*: note the force and cf. 119 3, 121 19. — *fremitu vigiliisque*: almost a hendiadys, i.e. the noise caused by the soldiers who took no rest; cf. 28 25 and note.

138 26 *a milibus*, etc., *about two miles off*. On this use of *a*, cf. 54 9.

138 28 *convallem*: a valley inclosed on all sides. In such a place of course the Romans were at a disadvantage.

139 1 *ex utraque*, etc.: at each end, attacking the advance which was coming up out of the glen, and the rear from the heights at the other end.

139 5 CHAP. 33. *tum demum*: implying, as always, "not till then"; here with the further idea that he ought to have roused himself before. — *providisset*: a rel. clause of cause; § 535. *c* (320. *e*); B. 283. 3; G. 633; H. 592 (517); H-B. 523. — *trepidare*: histor. infin.; for use, cf. note on *flagitare*, 13 18.

139 9 *cogitasset*: cf. *providisset*, l. 5.

139 14 *quoque*: from *quisque*.

139 15 *possent*: the subj. is Cotta and Titurius.

139 16 in orbem: see note on **116 1**. A modern army would form a hollow square. The *orbis* also was hollow, having room within for the higher officers, the non-combatants, the wounded, etc.

140 5 accidit . . . ut, etc. (cf. **132 8**): this clause is divided into three parts with the verbs **discederent**, **properaret**, **complerentur**, the first two being connected by **-que** (**quaeque**).

140 8 fletu: not from cowardice. These men fought with splendid courage. It was their way of showing their feelings.

140 9 CHAP. 34. at barbaris, etc.: showing the contrast with the behavior of the Romans about their valuables.

140 13 existimarent: for inv. of dir. disc.; § 588 (339); B. 316; G. 652; H. 642 (523. iii); H-B. 538. — [**erant, etc.**]: these bracketed words may be omitted, as also in the passage below.

140 14 a fortuna: i.e. the goddess fortune, as is shown by the preposition.

140 15 quotiens . . . procurrerat, . . . cadebat: a general condition referring to past time; cf. **130 7, 131 7**.

140 21 ad signa recipientis: the standards remained fixed during these sorties, thus indicating the alignment of the circle.

140 22 CHAP. 35. cum . . . excesserat, as often as, etc., equivalent to a general condition; cf. note on l. 15 above; § 518. *b* (309. *c*); B. 288. 3; G. 584; H. 601. 4 (521. ii. 1), with last example.

140 24 eam partem, etc.: when the soldiers from one side of the *orbis* made a sally, that side, of course, had no defenders.

140 27 proximi, etc.: only those immediately opposite the sally had fled, and so the party on its return was attacked at once by the enemy remaining on both flanks and also by the late fugitives.

141 1 vellent: not contrary to fact, but a future condition thrown into the past; § 516. *f* (307. *f*); H-B. 580. *b*.

141 4 resistebant, they kept on fighting. Note the force of the tense.

141 6 esset: characteristic subjv.

141 7 Balventio: connect with **femur**; dat. of reference where we might have expected a gen. of possession. — **qui . . . duxerat:** as he *had been* chief centurion the year before, we infer that he was now serving in the corps of veterans called *evocati*; see chapter on military affairs, IV. *a*.

141 15 CHAP. 36. rogatum: supine; cf. **26 15**.

142 18 ipsi vero, etc., that to him, certainly, no harm will be done; **nihil** is acc. of specif. and **nocitum iri impers.** Instead of the latter we should expect *fore ut noceatur*.



FIG. 127.—SIGNUM.

141 21 *sperare se*, etc., *that he hopes to be able to obtain a request from him so far as pertains to their own safety and that of the soldiers.*

141 24 CHAP. 37. *quos . . . tribunos militum* = *eos tribunos militum quos.*

141 26 *Ambiorigem*: cf. **41** 10 and note.

142 1 *condicionibus*: i.e. of surrender.

142 8 *aquilam*: he thus saved the standard from disgrace,—a characteristic and truly heroic act.

142 11 *se interficiunt*: a death worthy of Roman soldiers.

This was the most serious loss that Cæsar sustained during the Gallic War. There must have been at least 5000 men in the ill-fated command of Cotta and Sabinus. From this time on Cæsar makes it his duty to avenge his massacred legion, and he carries on a relentless warfare against the Eburones and Ambiorix, until the former are exterminated and the latter becomes a hunted fugitive.

142 17 CHAP. 38. *neque noctem neque diem intermittit*: Ambiorix marched only one night and one day. More than that would have been expressed by *nocturnis diurnisque itineribus*: cf. **33** 16.

142 19 *in Nervios*: see introductory note to Bk. ii and note on **68** 18.

142 23 *nihil esse negoti*, *that it was a matter of no difficulty.*—*oppressam . . . interfici*: render by two verbs, *to be surprised and slain*; § 496. N.² (292. R.); B. 337. 2; G. 664. R.¹; H. 639 (549. 5); H-B. 604. I.

142 27 CHAP. 39. *qui omnes*: why not *omnes qui*? See note on **30** 19.

143 1 *advolant*: note the speed expressed in this verb.

143 3 *ut non nulli*, etc.: cf. **135** 2.

143 13 CHAP. 40. *pertulissent*: for the fut. perf. implied indir. disc.

144 2 *turres*: these were open at the sides and behind, solidly timbered towards the enemy, and their object was, like that of the modern bastion, to shorten the length of wall to be occupied by the defence as well as to give the soldiers a still higher position from which to throw their missiles. In this case they were probably not more than three stories, or perhaps thirty feet, high. Each story was floored with a platform on which the soldiers stood. The front and sides of each platform were protected by a parapet (*loricæ*) of hurdles, to the height of about four feet. Above this projected a sort of battlement of stakes (*pinnae*), or of hurdles standing erect, with spaces at intervals, through which the spears were hurled. The structure was square, of about ten feet on a side. Of these towers it appears that on the first night only the framework was erected. On succeeding nights they were completed. Cf. Fig. 103.

144 10 *praeustae sudes*: heavy stakes or piles of wood, sharpened at the end, and charred to harden the point. They were hurled by the *tormenta*; see Fig. 61.—*muralium pilorum*: javelins heavier than usual for the defence of the wall.

144 11 *contabulantur*, were floored with plank. Possibly also the towers were connected by galleries, one for each story.

144 12 *cum*: concessive.

144 14 *concurso ac vocibus*, by the spontaneous movement and entreaties.

144 18 CHAP. 41. *potestate*: see note on **16** 7.

144 23 *errare . . . si . . . sperent*: simple condition, indir. disc.; cf.

137 19.—*qui*: referring to *eis*.

144 24 *hoc*: with *animo*.

144 25 *ut*, etc.: i.e. they will be friends, but not subjects; they only refuse to admit a standing military force.

145 2 *se adiutore utantur* (for the inv. of dir. disc.), they may use him as an advocate.

145 5 CHAP. 42. *hac spe*: i.e. of betraying Cicero as they had betrayed Sabinus.—*fossa pedum quindecim*: a ditch 15 ft. wide would be 11 ft. deep.

145 8 *ab his*: i.e. the captives.—*nulla . . . copia*, having no supply, etc. (a sort of abl. abs.). "They were not yet used, like the Romans, to fight with the spade."

145 10 *manibus sagulisque . . . exhaurire*, to dig out with their hands, and [carry] in their cloaks. A kind of *zeugma*, § 640 (385); B. 374. 2. *a*; G. 690; H. 751. 2. N. (636. ii. 1); H-B. 631. 7; but, as usual in such cases, the meaning of the verb really covers the thought by implication.

145 13 **XV**: probably an error, as a circuit of fifteen miles seems out of the question; perhaps *pedum*, or else **V**, instead of **XV**.

145 14 *falcis*, hooks: see note on **84** 22.—*testudines*: wooden galleries or sheds, to protect the undermining (see Figs. 33, 126).

145 16 CHAP. 43. *ferventis . . . glandis*, red-hot balls of clay.

145 18 *casas*: the huts of the encampment, thatched with straw.

145 20 *distulerunt*: sc. *ignem*.

145 21 *clamore*: see **142** 4.

145 26 *non modo*, etc.: needs a "pulpit" paraphrase, which, after all, would be, like many, less forcible than the original. Omit the bracketed words.

146 2 *pugnarent*: same construction as *respiceret* and *decederet*.

146 5 *ut*, etc.: this use of *ut*, *as*, is almost precisely parallel to the English causal, *as*, *inasmuch as*. In fact, the expressions have really the same origin.

146 6 *intermissa*, etc.: while the flames were raging, such exploits of attack and defence were of course impossible.

146 7 *turri*: this advance of a tower was quite in the manner of Roman attack.

146 10 *vellent*: implied indir. disc.; in their words, *si . . . vultis*, cf. **121 24**; § 592. 2 (341. *c*); B. 323; G. 662; H. 652 (529. ii); H-B. 536. a.

146 11 *deturbati*: i.e. the enemy.

146 13 CHAP. 44. *erant*, etc.: this superb bit of narrative, marvellous for its matter and its manner, shows the kind of soldiers with which the Romans conquered the world. Everywhere, where great deeds are done in personal prowess, you will find this mixture of rivalry and common spirit. These are the conditions of the great feats of the world.

146 14 *primis ordinibus*: see chapter on military affairs, I. 7.

147 1 *habebant*, used to have.

147 2 *de loco*, for promotion or rank.

147 5 *locum*, opportunity.

147 8 *sese vallo continet*, remain within the wall.

147 15 *hic casus*, etc.: i.e. the javelin, piercing his sword belt, twisted the scabbard of his sword out of his reach.

147 18 Translate the bracketed words.

147 21 *in locum deiectus*, etc., slipping into a hollow, he fell.

147 24 *in contentione*, in their rivalry.

147 28 CHAP. 45. *quanto . . . gravior . . . tanto crebriores*, the more severe . . . the more frequent.

148 5 *a prima obsidione*, at the beginning of the siege.

148 8 *in iaculo*: i.e. the shaft of the spear was probably hollow and the letter was inserted in it.

148 9 *versatus*, going about.

148 12 CHAP. 46. *hora XI*: i.e. about five or six o'clock. In this chapter and the following note the wonderful celerity of Cæsar's movements and the quick obedience of his officers.

148 14 *milia passuum XXV*: i.e. from Amiens to (probably) Montdidier.

148 18 *rei publicae*, etc.: cf. **31 24** and last note.

148 19 *reliquam partem*: the detachments under Roscius and Plancus were too far away.

148 23 CHAP. 47. *antecursoribus*: the vanguard of Crassus's cavalry, or his scouts.

149 1 *non ita*, etc., not delaying for a moment.

149 4 *veritus ne*: § 564 (331. *f*); B. 296. 2; G. 550. 2; H. 567 (498. iii); H-B. 502. 4.

149 5 quos . . . sciret = *cum eos sciret*: a causal clause.

149 6 quanto . . . esset: indir. quest. depending on the verb of *telling* implied in *litteras remittit*.

149 7 rem: i.e. the loss of Sabinus and Cotta.

149 12 CHAP. 48. duas: Cæsar thus had only his own legion and that of Fabius, — a very small force to face the multitude of the enemy.

149 17 Graecis litteris: i.e. *in Greek letters*. The Gauls were well acquainted with the Greek characters (26 4-6, 167 6). According to Polyænus, the despatch contained merely the words, "Cæsar to Cicero. Be of good courage. Expect aid."

149 20 amentum: the *amentum* was a small strap fastened to the middle of a light spear, in some cases, at any rate, giving it a whirling motion, like the rifle-ball of modern times. By its use the spear could be thrown twice as far and with better aim than without it, as has been proved by experiment.

149 25 biduo, *for two days*: § 424. c (259. c); cf. B. 231. 1; G. 393; H. 486 (429); H-B. 439.

149 26 perlectam . . . recitat, *having read it through* (to himself), he then *recited it aloud* in the assembly of the soldiers.

150 3 CHAP. 49. Gallum . . . repetit, *asks again for the Gaul*.

150 4 supra: see 148 4-6.

150 6 faciat: *ut* omitted; cf. note on 108 1. — se . . . eum: notice the difference in meaning.

150 9 animo: abl. of specification.

150 14 aequo animo, etc., *he thought that he might well be content to slacken his speed*.

150 16 haec: referring to *castra*, and obj. of *contrahit*. — hominum: a pred. gen. after *erant*.

150 17 milium VII: these legions averaged, then, 3500 men each, and this was somewhat less than the normal strength; see chapter on military affairs, I. 1.

150 18 angustiis viarum: i.e. narrow paths or streets within the camp; *angustiis*, a loose use of abl. of means, a very elastic construction. The abl. in Latin contains three different cases, *from*, *with* or *by*, and *at*, so that its range of meaning is very wide.

150 19 hostibus: dat. of reference.

150 23 CHAP. 50. Galli: sc. *sese continent*.

150 24 Caesar, etc.: translate as if *Caesar sese continet ut, si*, etc. — si . . . posset: future protasis of *ut . . . contenderet*, which, expressing a purpose, has a future force; § 516. d (307. d); G. 595; cf. H-B. 582. 2. The same construction is repeated in the next sentence.

151 3 equites . . . castra: notice that with *iubeo* and *veto* either the person or the thing may be the subject of the dependent infin., or the verb may even be used impersonally, as in *conkursari*.

151 12 CHAP. 51. velit: direct, *volet*.

151 16 ea: an adverb.

151 21 exuit: i.e. by forcing them to throw their arms away as they fled.

151 23 CHAP. 52. Omit the bracketed words.

151 27 decimum quemque, *one man in ten*.

152 6 certius: the letter of Labienus had given him the first news of this calamity; see **149 7**.

152 7 rem gestam [esse]: i.e. the destruction of Sabinus and Cotta.

152 8 quod detrimentum = *detrimentum quod*; observe that a rel. clause standing first usually incorporates its antecedent.

152 9 hoc: the usual abl. of cause (properly degree of difference) with comparatives.

152 10 beneficio deorum: see **10 17** and note.

152 15 CHAP. 53. eo: i.e. at Cicero's camp. Cæsar arrived there about three o'clock, and the news of his victory reached Labienus, sixty miles away, before midnight. See **187 24-27** for the Gallic method of sending news across the country.

152 19 Indutiomarus: see **120 2-4**, **135 1**.

153 2 trinis: § 137. *b* (95. *b*); B. 81. 4. *b*; G. 97. R.³; H. 164. 3 (174. 2. 3); H-B. 247. 1. *a*.

153 4 ad exercitum manere: contrary to his usual course, which was, for political reasons, to keep in near communication with Italy.

153 7 quid . . . caperent: *what future plan they should adopt*.

153 10 quin . . . acciperet: result clause after *neque . . . intercessit*; § 558 (319. *d*); B. 284. 3; G. 554; H. 570 (500. ii); cf. H-B. 521. 2.

153 11 in his: i.e. *consiliis* or *nuntiis*.

153 12 L. Roscio: see **133 16**.

153 13 [Gallorum]: may be translated.

153 14 Aremoricæ: i.e. the natives along the coast of the Atlantic.

153 15 afuisse: notice the tense, *they had been, but*, etc.

153 19 CHAP. 54. alias . . . alias: see Vocab. — *cum . . . denuntiaret*, *by announcing*, etc. The descriptive *cum*-clause admits a great variety of translations.

153 22 Cavarinum: obj. of *interficere*.

153 23 Moritasgus: sc. *regnum obtinebat*, from *regnum obtinuerant* in the next line.

153 24 adventu (abl. of time), *at the time of*, etc.

153 25 *publico consilio*, by general consent, or on the authority of the people, not a private act of revenge, or the like. — *conati*: agreeing with Senones. — *ille*: i.e. Cavarinus.

153 26 *regno domoque*: i.e. as a king and as a citizen as well.

154 1 *valuit . . . attulit*: these verbs have for their subject *esse*, etc.; and such an influence did it have that some had been found, etc. . . . and such a change did this fact produce that, etc.

154 4 *alteros . . . alteros*: see Vocab.

154 6 *adeo* (emphatic), in fact.

154 7 *cum . . . tum maxime quod*, not only for several other reasons, but especially because.

154 8 *praeferebantur*, used to be held superior.

154 12 CHAP. 55. *quin . . . mitterent*, etc.: cf. **153** 10.

154 15 *ulli civitati*, etc.: cf. **56** 24.

154 16 *cum . . . dicerent*: a common periphrasis for our pres. part. — *bis*: see Bk. i. chs. 31-54; Bk. iv. chs. 1-15.

154 20 *tota Gallia*, throughout Gaul: see note on **150** 18.

154 25 CHAP. 56. *ultra veniri*: i.e. that there was a spontaneous rising for his support.

154 26 *Senones, Carnutes*: about *Sens* and *Chartres*. The latter are not mentioned before, but seem to have taken part against Cavarinus (ch. 54).

154 28 *defore si . . . coepisset*: a fut. condition. What would it be in direct discourse?

155 1 *hoc*: subj. of *est*.

155 2 *quo*, at which (lit. *whither*).

155 6 *supra*: see **118** 25 ff.

155 10 *huc*: i.e. on his way to the Senones and Carnutes he will go through the territory of the Remi.

155 26 CHAP. 58. *in dies*: see Vocab.

156 1 *arcessendos curaverat*: cf. **117** 4.

156 10 *praecipit*: refers to *petant*; *interdicit* to *neu volneret*. — *pro-territis hostibus*, etc.: translate by a temporal clause, *when*, etc.

156 13 *mora reliquorum*: lit. *the delay of the others*. The regular way of expressing the relation between two nouns is by the use of the genitive. Here the delay caused by the pursuit of the others is characteristically looked upon as belonging to them. Translate, *by waiting to attack the others*.

156 14 *spatium nactum*, gaining time.

156 18 *redeuntis*: i.e. from the pursuit of Indutiomarus.

BOOK SIXTH. — B.C. 53.

SECOND PASSAGE OF THE RHINE. — The last campaign had been a series of disappointments and reverses. The expedition to Britain had been only moderately successful and led to no permanent results; Cæsar's return found the Gauls in a state of unrest, which culminated in open revolt and in the annihilation of the division of Sabinus and the attacks upon the winter quarters of Quintus Cicero and of Labienus. Cæsar, to be sure, rescued Cicero in the nick of time and Labienus was successful against Indutiomarus; but, on the whole, the advantage had been with the Gauls, and they had gained fresh hope in their desperate struggle for independence. The strength of their resistance was in the north and east, where they had the support of raids from across the Rhine, — a danger which it was especially the business of Cæsar to check by a daring blow; hence the policy of this new, but idle, advance into Germany. It may be borne in mind that this campaign was the more critical, as it followed closely upon the defeat and destruction of the Roman armies under Crassus in the East.

READING REFERENCES ON CÆSAR'S SIXTH CAMPAIGN.

- Dodge's Cæsar, chap. 14.
 Fowler's Julius Cæsar, chap. 13.
 Froude's Cæsar, chap. 17 (last part).
 Holmes's Cæsar's Conquest of Gaul, chap. 6.
 Merivale's Hist. of Rome, Vol. I, pp. 398-405.
 Napoleon's Cæsar, Vol. II, chap. 9.
 Plutarch's Lives, Cæsar.
 Tacitus's Germania.
 Taylor's Hist. of Germany, chaps. 1 and 2.
 Trollope's Cæsar, chap. 7.

157 1 **CHAP. 1. multis de causis:** viz. the profitless expedition to Britain, the desertion of Dumnorix, the loss of Cotta and Sabinus, and the sudden revolt led by Indutiomarus (see Bk. v. chs. 55-58).

157 2 **per Silanum:** the regular construction of the means when it is a person; cf. **57** 3 and note.

157 3 **delectum:** i.e. in Italy.

157 4 **proconsule:** Pompey had been consul B.C. 55. He was now *nominally* proconsul of Spain, with six legions; but he remained in Italy, ruling his province through *legati*. — **ad urbem** (not *in urbe*): as long as he was in military command (*cum imperio*) he could not enter the city.

157 5 **rei publicæ causa:** this business was the superintending of the corn supply (*cura annonæ*). — **quos . . . rogavisset**, *whom he had enlisted from Cisalpine Gaul when consul*; the verb *rogare* is used of a commander

who exacts an oath of allegiance from his men; hence *sacramento rogare* means *to enlist*; **quos**: sc. the antecedent **eos** as obj. of **iuberet** and subj. of **convenire** and **proficisci**. — **Cisalpinga Gallia**: this was Cæsar's own province. But Pompey and Crassus had received authority to raise troops where they pleased, and in whatever number.

157 7 iuberet: subjv. of purpose, with **ut** omitted, following **petit**; cf. **108 1**. — **magni**: cf. **52 11** and note. — **etiam**, etc.: i.e. not merely for this campaign, but for the Roman prestige in future.

157 8 opinionem Galliae: subj. gen.

158 2 augeri: does not refer to **detrimētum**, but to Cæsar's forces (implied). This linking of different ideas with a word that properly belongs only to one is called *zeugma*.

158 3 quod: i.e. the loan of the legion. — **amicitiæ**: Cæsar and Pompey were still openly friends, though by the recent death of Julia, Cæsar's daughter and Pompey's wife, as well as by the death of Crassus, the political coalition which united them had been dissolved, and an open rupture soon followed. The legion now forwarded to Cæsar was demanded back two or three years later.

158 5 constitutis et adductis: i.e. two levied and one borrowed.

158 6 duplicato: fifteen cohorts had been lost under Sabinus (Bk. v. chs. 26-37). The three legions now received had of course thirty cohorts. The new legions were known as I, III, and XIV, the last taking the place of the legion and a half that had been lost under Sabinus at Aduatuca. Cæsar now led ten legions.

CHAP. 2. In the details of this chapter, notice the formidable appearance, but the really long, weak, and broken line of the Gallic confederacy.

158 9 ut docuimus: see Bk. v. ch. 58.

158 13 civitatibus: i.e. of the Germans. — **inter se**, *each other*, a common use of the phrase in any reciprocal relation.

158 14 obsidibus . . . cavent, *by hostages give security for the money*, i.e. the money promised the Germans for their help. — **Ambiorigem**: the clever chief of the Eburones, who had entrapped and destroyed Sabinus.

158 20 maturius: i.e. earlier than usual.

158 22 CHAP. 3. nondum, etc.: notice that it is the promptness and dash of Cæsar's operations that win the victory in almost every case.

158 23 Nerviorum: see note on **68 18**.

158 24 possent: for mood, see § 551. *b* (327); B. 292; G. 577; H. 605. 2 (520. i. 2); H-B. 507. 4. *b*; cf. **38 27** and note. Here, as with *cum*, there is an inner connection between the two clauses. It is not merely before they *were in a position* to gather, but before they *could get a chance* to gather.

158 25 *praeda, as booty*; *ea* (referring to *magno . . . numero*) agrees by attraction with the appositive: § 296. *a* (195. *d'*); B. 250. 3; G. 211. R.⁵, H. 396. 2 (445. 4); H-B. 326. 1.

158 27 *coegit*: sc. *eos*.

159 2 *ut . . . videretur*: i.e. to show that he was determined to put down the rising at once.

159 3 *Lutetiam*: the first mention in history of *Paris*, which was a place of no great importance until its occupation as a royal town by the Franks in A.D. 502. The original place of meeting had perhaps been Samarobriua (Amiens). Cæsar apparently considered Lutetia a point nearer the scene of operations, and proceeded at once to the affected district.

159 4 *civitatem . . . coniunxerant*: i.e. with the Senones. This was a close political union, not a mere military league (*foedus*).

159 5 *hoc consilio*: the new confederacy (cf. Bk. vii. ch. 75).—*hac re*: the removal to Lutetia.—*pro suggestu, in front of the platform*; i.e. by public announcement, not special notification to the commanders. See chapter on military affairs, v.

159 9 CHAP. 4. *conantibus* (sc. *eis*, abl. abs.), *while they were attempting* to effect the gathering.

159 12 *quorum in fide, under whose protection*; i.e. of the Hædui, whose supremacy had once extended over the greater part of Gaul.

159 13 *libenter, etc.*: but Acco was afterwards put to death; see ch. 44.

159 15 *instantis belli* (pred. gen.): i.e. the war against the Treveri and Ambiorix.

159 16 *custodiendos*: gerundive expressing purpose; § 500. 4 (294. *d'*); B. 337. 7. *b.* 2; G. 430; H. 622 (544. 2. N.²); H-B. 605. 2; cf. also **117** 4, **156** 1.

159 19 *equites*: the cavalry of the Roman armies was wholly furnished by the subject-allies.

159 22 CHAP. 5. *Cavarinum*: a chief appointed at Cæsar's dictation, and odious to his tribe (**153** 21-29). Hence came his animosity (*iracundia*) against the state which had driven him into exile.

159 24 *meruerat*: implying a harsh and tyrannical rule, which had aroused the hatred of the state. Either the old odium of Cavarinus or his new animosity against the state might cause a disturbance.

159 25 *pro explorato habebat, he considered certain*.

159 26 *reliqua, etc.*: i.e. what else Ambiorix would be likely to do.

160 4 *venisse*: understand *eum* (Ambiorix).

160 5 *haec . . . auxilia*: i.e. both the Menapii and the Germans.—*prius, with quam*. Notice that the parts of this word are very often

separated. — *illi*, a dat. rendered by *from*, instead of the abl. of separation: § 381 (229); B. 188. 2. *d*; G. 345. R.¹; H. 427 (385. ii. 2); H-B. 371.

160 6 *lacesseret*: subjv. in indir. disc., following *existimabat*.

160 7 *congregedi*, to form an alliance with.

160 14 CHAP. 6. *tripartito*: in three columns, on different roads.

160 20 *Commium*: appointed king of the Atrebatas by Cæsar (106 13-17). He served as Cæsar's friend and ally in Britain and elsewhere, but finally joined in the great revolt against him (Bk. vii. ch. 76). — *custodis loco*, as a guard.

160 23 CHAP. 7. *dum geruntur*: the regular construction with *dum*; cf. 113 1 and note.

160 25 *in eorum finibus*: see Bk. v. ch. 24.

160 26 *via*: abl. after *longius*. — *cum . . . cognoscunt*: not like the descriptive *cum*, but really the main proposition; § 546. *a* (325. *b*); B. 288. 2; G. 581; H. 600. i. 1; H-B. 566. *a*.

160 27 *a* (adverbial), away.

161 1 *impedimentis*: i.e. the greater part of the heavy baggage. He took a small baggage-train with him (see 161 28); but probably only what was necessary.

161 4 *flumen*: probably some stream flowing into the Meuse (*Mosa*).

161 5 *transire, transituros*: notice the regular use of these two constructions side by side; the first verb (*habebat in animo*) expresses intention and has the simple complem. infin.; the second (*existimabat*) is a verb of thinking and takes the indir. disc. This is one of the most important distinctions in Latin grammar.

161 6 *augebatur*: i.e. in the minds of the Treveri.

161 7 *spes, their* (the Treveri) *hope*. — *loquitur*: i.e. Labienus. — *palam, freely or openly*, on purpose to be heard, but not in a set speech.

161 10 *castra moturum*: of course to withdraw.

161 12 *natura*: i.e. their natural attachment to their own land.

161 13 *consili*: pred. gen.; cf. 18 19.

161 20 CHAP. 8. *cum*: see note on 160 26.

161 21 *longum esse, it would be tedious*: § 437. *a* (264. *b*); B. 271. i. *b*; G. 254. R.¹; H. 525. 2 (476. 5); H-B. 582. 3 and *b*.

162 4 *imperatoris*: Cæsar, who alone had the *imperium*, or military authority. Labienus was only *dux*.

162 6 *derigi*: i.e. to be formed and aligned; the verb properly has only the latter meaning, the former is only implied.

162 8 *celeriter*, etc.: see chapter on military affairs, VII.

162 14 *recepit, recovered* to obedience. — *auxilio*: dat. of service.

- 162** 16 *comitati eos, in company with them* (the Germans).
- 162** 18 *demonstravimus*: see Bk. v. chs. 3, 4, and 56.
- 162** 24 CHAP. 9. *paulo supra, a little above, or to the south.*
- 162** 25 *nota . . . ratione, on the plan already tried and approved* (cf. Bk. iv. ch. 17).
- 163** 1 *purgandi sui*: § 504. *c* (298. *a*); B. 339. 5; G. 428. R.¹; H. 626. 3 (542. i. N.¹); H-B. 614; cf. **77** 3, **115** 2.
- 163** 5 *cognita, having inquired into.*
- 163** 9 CHAP. 10. *paucis post diebus*: § 424. *f* (259. *d*); B. 357. 1; G. 403. N.⁴; H. 488. 1 (430); H-B. 424.
- 163** 10 *eis . . . imperio*: subject tribes, not confederate allies. Tacitus, however (Ger. 38), represents the Suevi as a confederacy; its former subjects may, after Cæsar's time, have been admitted to alliance.
- 163** 18 *quæque*: -*que* connects *mittant* and *cognoscant*.
- 163** 22 *silvam*: this was the natural frontier and defence (*pro nativo muro*) of the north German plain towards the south. A range of wooded hills still borders the Saxon duchies on the north. The Cherusci held the valleys of the Weser and Elbe.
- 164** 1 CHAP. 11. *locum, etc.*: here there is really nothing to tell, as Cæsar found the country deserted (ch. 29), and returned at once to Gaul. We owe to this void in the narrative a most curious and entertaining glimpse into the geographic and ethnographic knowledge of the time. See the introductory chapters on Gaul and Germany.
- 164** 7 *existimantur*: is only explanatory, hence the indicative.
- 164** 8 *quorum*: the antecedent is *principes*.
- 164** 9 *redeat*: is characteristic; § 535 (320); B. 283; G. 631. 1; H. 591. 1 (503. i); cf. H-B. 521. 1. The idea seems to be: It is the chief men of these factions (those namely who are regarded as most influential) who have the supreme authority. Hence the effort of each of the chieftains to look out for his dependents.
- 164** 10 *ne . . . egeret*: in app. with *eius rei*, the past tense (*egeret*) taking its time from *institutum* [*esse*]: § 485. *j*; 585. *a* (287. *i*, 336. B. N.²); B. 268. 7. *b*, 268. 2; G. 518; H. 548 (495. iv); H-B. 483.
- 164** 13 *haec . . . Galliae, this same state of things exists in general throughout entire Gaul.*
- 164** 14 *divisæ*: adj. use of the participle; cf. *divisa*, **1** 1.
- 164** 15 CHAP. 12. *cum . . . venit*: notice the difference between this and the *cum* in descriptive clauses (cf. **11** 7, **49** 1). Here it means merely "at the time when," and there is no inner connection with the main clause.
- 164** 16 *Sequani*: these succeeded to the domination of the Arverni (see Bk. i. ch. 31). — *hi, the latter.*

164 17 **antiquitus**: really only a little while before, as the Hædui had risen by favor of the Romans.

164 18 **clientelae**, *dependencies*. These were the petty tribes which grouped themselves about one or the other of the great rival states.

164 24 **iurare**: i.e. the Hædui.

164 25 **nihil . . . consili**, *no plans*, part. gen. — **et**: connects **cogent** and **possiderent**.

164 27 **Diviciacus**: cf. **27** 13.

165 1 **infecta re**, *without effecting his object*.

165 2 **adventu Caesaris . . . dimiserant**: this long Latin periodic sentence should in our idiom be rendered by several coordinate sentences (cf. note on **66** 5). — **facta commutatione**: i.e. by his friendship to the Hædui and the defeat of Ariovistus (Bk. i. chs. 31-53).

165 4 **ei**: subj. of **videbant**.

165 6 **reliquis rebus**: abl. of specification.

165 8 **adaequare**, *were equal*; i.e. to the Hædui. (The infin. clause **quos adaequare** is the subj. of **intellegebatur**, which is used impersonally.)

165 9 **gratia**: abl. of specification.

165 11 **dīcabant**: distinguish from *dīcebant*.

165 13 **statu**: loc. abl.

165 16 **CHAP. 13. plebes**: here a noun of the fifth declen.; cf. *plebs*.

165 18 **cum . . . premuntur**: a general condition expressing repeated action, **cum** meaning *whenever* or *as often as*. The perf. indic. would be more usual; cf. **59** 13, **131** 7.

165 21 **quae dominis** (dat. of poss.), *as masters have*.

165 22 **druidum** (pred. gen.), *that of the druids*. — **illi**: *the former*.

165 25 **hi**: i.e. the druids.

165 26 **eos**: i.e. the Gauls.

165 27 **quod facinus**, *any crime*.

166 1 **idem**: nom. plural.

166 2 **qui**: why not **quis**? Observe also **si qui** in l. 10 below.

166 3 **sacrificiis**: abl. of separation; understand **eos** with **interdicunt**. — **poena**: like an excommunication, taboo, or boycott.

166 5 **decidunt** (with dat.): sc. *de via* (i.e. "make way for" them in the street).

166 6 **incommodi**: part. gen. following **quid**.

166 13 **Carnutum**: this central spot was at or near the modern town of Dreux, where, it is said, traces of these assemblies may still be found.

166 16 **disciplina**, *system of doctrine*; cf. meaning of the same word in **165** 25. — **Britannia**: many think that druidism originated in Gaul and

was carried thence to Britain, where it still flourished, but that it had declined for various political reasons in the mother country.

166 21 CHAP. 14. The bracketed words merely repeat the thought of the preceding sentence and may be omitted.

167 2 **numerus versuum**: i.e. their lore was put into verse to assist the memory.

167 4 **fas**: the words *fas* and *nefas* refer to what is *religiously* right and wrong; *ius* and *iniuria* refer to *human* obligations only.

167 8 **litteris confisos**, *by trusting to written words*, a useful hint to teachers.

167 11 **hoc** (acc.), more usually *illud*, refers to what follows; *hoc* (abl.) to what has just been said.

167 12 **transire**: the belief in the transmigration of souls was common to many ancient peoples, and is still a tenet of some Eastern religions, especially of the Buddhists.

167 15 **mundi**, *the universe* (system of things); **terrarum** (cf. *orbis terrarum*), *the world*.

167 17 CHAP. 15. **equitum**: these made a sort of military nobility. It is interesting to compare the two "upper classes" here described with the ecclesiastics and feudal *noblesse* of France before the Revolution. — **cum est**: notice the force of the indicative. See note on **cum . . . premuntur**, **165** 18. — **usus**: a noun; see Vocab.

167 21 **ut quisque . . . amplissimus, ita plurimos**, *the more powerful . . . the greater number*: § 313. *b* (93. *c*, at end); G. 642. R.²; H. 515. 5 (458. 2).

167 22 **ambactos**: this Celtic word was known as the equivalent of *servus*, "slave," as early as the time of Ennius, 150 years before. Cf. **165** 16–21.

167 27 CHAP. 16. **homines immolant**: it is not certain that the practice of human sacrifice existed so late as this in Gaul. Cæsar appears not to have known any actual instances of it.

168 3 **placārī**: distinguished from *placere*. — **publice**: as opposed to the private ones just referred to.

168 4 **habent instituta**: cf. **40** 20, **51** 8, and notes.

168 9 **cum . . . deficit**: cf. **cum est**, **167** 17.

168 12 CHAP. 17. **Mercurium**: the gods had no such names, nor were they, in fact, the same gods; but they were identified with similar Roman divinities as nearly as possible. The name of the god whom the Romans identified with Mercury is lost (*Teutates* ?); but it appears from inscriptions and images that his worship was very widespread and important throughout the period of the Empire. The other deities here mentioned appear

under numerous epithets. Jupiter was probably the Gallic *Taranis*, whose name appears to indicate that he was a god of thunder. He has been identified by some with a statuette bearing in its hand a long hammer or mallet like the Scandinavian *Thor*.

168 20 *cum*, etc.: see **165** 18 and note.

168 21 *ceperint*: subjv. of informal indir. disc., for the fut. perf. ind. of the direct.

169 2 *neglecta religione*: i.e. in violation of his vow. — *capta*, taken as spoil. — *apud se*, at his house.

169 3 *posita*, consecrated as a gift.

169 5 CHAP. 18. *Dite*, *Pluto*, the god of Darkness, or of the Underworld, meaning that they believe themselves to have sprung from the soil, the world below them: see § 403. a. N.¹ (244. a. R.); B. 215. 2; G. 395; H. 469. 1 (415. ii. N.); H-B. 413. b.

169 7 *noctium*, etc.: this usage is common to many primitive peoples; e.g. the Germans (Tac. Ger. 11). Our word "fortnight" is a relic of it. It doubtless had its origin in keeping time by the changes of the moon.

169 9 *ut . . . subsequatur*: i.e. the calendar day began at sunset.

169 10 *fere* (with *hoc*): i.e. speaking loosely. — *suos liberos*, etc. The Romans, on the other hand, accustomed their sons to public life, and in early times even took them with them into the Senate. Again *cum* with the perf. ind. expressing repeated or customary action; cf. **168** 20. Observe that this perf. becomes a present in our idiom, expressing repeated action or a general truth.

169 13 *turpe ducunt*, they consider it disgraceful, *turpe* being pred. adj. agreeing with the infin. clause.

169 14 CHAP. 19. *quantas . . . communicant*: i.e. the husband deposits, in a common fund, an amount equal to the wife's marriage portion.

169 16 *ratio habetur*, a reckoning is kept.

169 17 *fructus*, revenues or profits. — *vita*: abl. of specification.

169 19 *viri in uxores*, etc.: cf. the Roman *patria potestas*; the rank of the wife was much higher among the Germans.

169 22 *de uxoribus*: this would seem to imply polygamy among the Gauls. Probably it was limited to the chiefs, as among the Germans; see note on **48** 6. — *in servilem modum*, after the manner of slaves, i.e. by torture.

169 23 *compertum est*: i.e. that there has been foul play.

169 24 *excruciatas interficiunt*: cf. **5** 5, **55** 3, and notes. — *pro cultu*, considering the degree of civilization.

169 27 *hanc = nostram* (cf. **51** 17), i.e. a generation ago.

170 1 *dilectos*: distinguish from *delectos*. — *iustis, regular*, by conventional rule. When these had been fulfilled, the sacrifice of dependents was added. These usages are in accordance with the belief of the Gauls in immortality, which is fully attested.

170 3 CHAP. 20. *quae civitates* = *æe civitates quæ*; a relative clause standing first generally incorporates its antecedent.

170 4 *legibus sanctum*, *established by law*, agreeing with the sentence *si . . . communicet* (obj. of *habent*); cf. **40 20**, **51 8**.

170 6 *neve*, *and that not*, the regular connective for a negative purpose clause. — *quo*: indef., *any one*.

170 7 *quod sæpe*, etc.: cf. the lively account **97 9–17**.

170 9 *quae visa sunt*, *what they think fit* to conceal (understand *occultanda*).

170 11 *per concilium*, *by means* (or, *in the proceedings*) of the public assembly.

170 14 CHAP. 21. *neque druides habent*: i.e. this particular hierarchy. They had, however, both priests and priestesses, with religious forms public and private.

170 15 *deorum numero*, etc. In this, Cæsar's testimony is directly contradicted by Tacitus, who speaks (Ger. 9) of their worship of Mercury, Mars, and Hercules. This is almost the only contradiction between these writers, in whose accounts of political and other institutions there is a striking agreement. This is all the more remarkable when we bear in mind that Cæsar went but little beyond the German frontier and had relatively little to do with them. This description of the Germans may be profitably compared with Cæsar's account of the Suevi in the opening chapters of Bk. iv.

170 19 *a parvis*, *from childhood*. — *qui . . . permanserunt*: i.e. "who are slowest to outgrow" their boyhood. Cf. Tacitus: *sera juvenum venus, eoque inexhausta pubertas*; and contrast the premature debaucheries of the Roman youth.

170 20 *hoc*: abl. of cause.

170 23 *nulla occultatio*: like the English *there is no hiding*.

170 25 *renonum*: i.e. small cloaks of hide. — *magna . . . nuda*: abl. abs.

170 26 CHAP. 22. *agri culturae*: as to this chapter, cf. what is said in the general Introduction to the volume and in Bk. iv. ch. 1, where it is shown that the soil was tilled, not by the labor of old men, women, or slaves, but by that of the fighting men. In other words, the Germans were, though "barbarians," not (in one sense) a barbarous people.

170 27 *neque quisquam*, etc.: this temporary and shifting occupation

of land, as well as the holding of it by the family or clan (*cognationibus*), is characteristic of a primitive society. Cf. the Introduction, as above.

171 1 *finis proprios*, *private lands*.

171 2 *gentibus*, etc.: in the general gathering for this assignment each clan must have met by itself, and have been represented by its chief.

171 3 *quantum agri*, *as much land*; *agri* is part. gen.

171 6 *agri cultura*: notice the use of the abl. here to be rendered *for*; § 416 (252); B. 225; G. 404; H. 478. 4 (422. N.²); H-B. 427. 1, cf. 431. — *ne . . . expellant*: this was a flagrant evil in Italy, which Cæsar in his own consulship had attempted to check, following the precedent of the Gracchi. There the *potentiores* had already succeeded in ousting the *humiliores*, and enormous plantations, cultivated by slaves, had taken the place of the earlier peasant freeholds.

171 11 *cum . . . videat*: this looks as if the land was portioned in equal shares to rich and poor alike. But on this question there are many and various opinions, and, at any rate, the words do not prove a division to each man as a freehold.

171 13 *CHAP. 23. maxima laus*: so in Bk. iv. ch. 3.

171 14 *virtutis*: § 385. *c* (234. *d*); B. 204. 2; G. 359. R.¹; H. 435. 4 (391. ii. 4); H-B. 339. *c*.

171 16 *prope*, *near*; *consistere*, *to stay or settle*. The infin. clauses are in app. with *hoc*.

171 17 *cum . . . infert*: note the force of pres. indic. with *cum*; cf. **165 18** and note.

171 18 *magistratus . . . deliguntur*: by lot, according to the Saxon Bede, from among existing magistrates. The Goths, Burgundians, Franks, and Lombards, on the other hand, had real kings.

171 19 *praesint, habeant*: subjv. of characteristic.

171 21 *principes . . . pagorum*: these local and village chiefs, forming a sort of governing body, were probably the natural leaders each of his own district. They are said, however, to have been elected, no doubt for life, by an assembly of the tribe or nation (Tac. Ger. 12).

171 22 *latrocinia . . . extra finis*: as with the "cattle-lifting raids" of the Scottish Borderers.

171 25 *ubi quis*, etc., *whenever any one*, equivalent to the protasis of a general condition. This is the manner in which volunteers were mustered for the raids in question.

171 26 *profiteantur*: representing an imv. form in the dir. disc.

172 2 *omnium rerum fides*, *confidence in anything*.

172 3 *qui . . . venerunt*: again the perf. indic. in the protasis of a general condition, — *whoever comes to them for any reason whatsoever*.

172 6 CHAP. 24. *cum . . . superarent*: a clause of characteristic, *such that*, etc.; see § 535. a. N.³ (322. R.); G. 631. 2; H. 591. 4 (503. i. N.²); H-B. 521. 1.

172 7 *superarent, inferrent, mitterent*: asyndeton, i.e. omission of connectives.

172 10 *Hercyniam silvam*: the great wooded range extending from the Black Forest to the Bohemian Highlands. — *Graecis*: i.e. other Greeks, as Eratosthenes was a Greek, though not of Greece proper.

172 11 *Volcae Tectosages*, etc.: occupying the southern part of Gaul, about Narbonne or Toulouse. A portion only had migrated to Germany; or, perhaps, had stayed behind from an early Celtic migration westward.

172 16 *Gallis*: indir. obj. of *largitur*, *multa* being the dir. obj.

172 22 CHAP. 25. *iter*: acc. of extent; cf. **98 3**. — *expedito* (dat.): i.e. to a man unencumbered with baggage. — *non . . . noverunt*: i.e. the Germans who live there. So at the present day, in the mountain regions of Germany and Switzerland, distance is measured by "hours" (*stunden*) instead of miles.

172 24 *Nemetum*, etc.: along the middle course of the Rhine, where it flows northward from Bâle. — *recta regione*: i.e. parallel.

172 25 *Dacorum*, etc.: occupying the eastern and western portions of Hungary.

172 26 *sinistrorsus*: in reality it is the river which leaves the course of the forest or highland, bending abruptly to the⁸ right, or southward.

173 1 *huius*: that familiar to the Romans, viz. *western*.

173 2 [*aut audisse*]: may be omitted in translation. — *initium*: as we should say *the end*, eastward, where it is lost in the Carpathian range. Its extent, in a direct line, is stated as 1600 miles.

173 3 *processerit*: subjv. as an intermediate clause in ind. disc. for perf. indic.

173 4 *acceperit*: subjv. of characteristic.

173 5 *quae*, *such as*, followed by the subjv. of characteristic.

173 6 *differant*: subjv. of characteristic.

173 8 CHAP. 26. *bos*: this name seems to have been given loosely to any large-horned, unfamiliar beast, and even to the elephant; here it is perhaps the *reindeer*, which had anciently a wide-scattered range.

173 9 *unum cornu*: this description is unintelligible.

173 10 *palmae ramique* (hendiadys; cf. note on **28 25**), *branching antlers*, evidently comparing the horns to a flat hand with branches like fingers.

173 13 CHAP. 27. *alces*: this name is undoubtedly *elks*, but the description is widely unlike and quite unrecognizable.

173 15 *crura . . . habent*: for the same story, cf. Pliny, H. N. viii. 16, 39.

173 17 *si . . . conciderunt*: cf. **172** 3 and note. By what tense should this perfect be rendered? The same construction occurs below in l. 20, *cum est animadversum*, and in l. 23, *cum reclinaverunt*.

173 21 *omnes*: with *arbores*.

173 22 *ab radicibus*, at the roots. — *accidunt*, cut into. — *tantum ut*, etc.: lit. *so far that the perfect appearance of them standing is left*; translate, *so that to all appearances they are standing firmly*.

173 26 CHAP. 28. *uri*: this name is generally understood to refer to the German *Urochs* (the primitive or wild ox, probably *buffalo*), said still to be found in the forests of Lithuania. Cæsar evidently describes a very different animal, with spreading horns like those of a reindeer or moose; but the whole description must have been derived from a confused account.

174 6 *quæ sint testimonio*, to serve as evidence, a purpose clause.

174 7 *ne . . . excepti*, not even when caught quite young.

174 12 CHAP. 29. *Caesar*, etc. This chapter directly follows ch. 10 in the narrative, the intervening passage being a digression.

174 14 *supra*: see **170** 26.

174 16 *ne . . . tolleret*: as would be done by completely destroying the bridge. — *barbaris*: dat.; § 381 (229); B. 188. 2. *d*; G. 345. R.¹; H. 427 (385. ii. 2); H-B. 371. — *atque*, and at the same time. — *ut tardaret*: which he did by making the bridge practically useless.

174 17 *auxilia*: i.e. which the Germans might send to aid the Gauls.

174 19 *in extremo ponte*. There seems to have been an island in the river at this place, so that the bridge was in two sections. The section between the island and the east bank was destroyed, and at what was now the end of the bridge (*extremo*), on the island, the tower was built. There was probably a redoubt, as usual, at the entrance to the bridge on the mainland; see Fig. 59.

174 20 *cohortium*: these were auxiliaries, as it appears in ch. 33 that he took all his legions with him.

174 23 *cum maturescere*, etc.: i.e. early in August.

174 24 *Arduennam*: the modern Ardennes.

174 27 *D*: an obvious mistake, possibly of some copyist. The distance is about 150 miles. — *Basilum*: afterwards one of the conspirators against Cæsar.

174 28 *si . . . possit*, (to see) *whether he can*, etc.: see § 576. *a* (334. *f*); B. 300. 3; G. 460. (*b*); H. 649. 3 (529. ii. 1. N.¹); H-B. 582. 2 and *a*.

175 1 *qua*: why not *quæ*?

175 2 *subsequi*: notice the pres. for the fut.

175 7 CHAP. 30. *multum potest*, has great power; see note on **10** 17.

175 8 *nam ut*, etc., *for as it happened by a remarkable chance that*, etc.; the following clause being subj. of *accidit*. — *ipsum*: referring to Ambiorix; so too in l. 12.

175 9 *prius . . . quam*: render as one word, *before*; in English we omit the relative particle. — *eius*: i.e. *Basili*.

175 10 *videretur*: in the same construction as *incideret*. — *adferretur*: cf. **158 24** and note.

175 11 *magnæ fortunæ* (pred. gen.), *a great piece of luck*.

175 13 *hoc*: abl. of means, explained by *quod*, etc.

175 14 *sunt fere*, *generally are*.

175 16 *propinquitatis*: use the singular in English; § 100. *c* (75. *c*); B. 55. 4. *c*; G. 204. N.⁵; H. 138. 2 (130. 2); H-B. 240. 5. *b*.

175 18 *his pugnantis*: notice the force of the Latin order. *While these were fighting*, time was given for the chief to be placed on horseback by some of his followers, and, *as soon as he actually got away*, he was covered by the woods.

175 21 CHAP. 31. *iudicione . . . an*, *whether by design . . . or*, etc.

176 2 *quas aestus*: i.e. islands only at high tide.

176 3 *alienissimis*, *entire strangers*.

176 4 *Catuvolcus*: see **133 20-23**, **134 17-19**.

176 6 *precibus detestatus*, *cursing with formal imprecations*, which, from a dying man, were thought to have efficacy with the gods.

176 7 *fuisset*: informal indir. disc. — *taxo*: perhaps with a decoction of yew leaves, as the berries are said to be harmless.

176 12 CHAP. 32. *neve*: see note on **170 6**.

176 12 *unam esse causam*, *that the case was the same*; i.e. that they were all included in the league.

176 16 *convenissent, reducerentur*: in dir. disc. *convenerint, reducantur*.

176 19 *id castelli nomen est*, *that is the (German) name of a stronghold*. It will be remembered that the Aduatuci were of German descent, and it is thought that *Aduatuca* is an old German word, meaning *a stronghold*. Then the *Aduatuci* would be the people who held such a place of safety. There were several towns of this name, which fact adds force to the conjecture.

176 21 *Titurius*, etc. (Sabinus and Cotta): see **133 20-24**.

176 24 *laborem*: i.e. of making a new fortified camp.

176 25 *unam ex his*, etc.: see **158 4 ff**.

176 26 *Q. Ciceronem*: see Bk. v. chs. 39-52.

177 2 CHAP. 33. *ad . . . versus*, *towards*.

177 5 *Scaldim, the Scheldt*. There seems to be some confused

geography here, but the many and confused mouths of these rivers doubtless gave rise to this idea.

177 8 vii=septimum. Cf. a different idiom, **163 9**. —quam ad diem: cf. **179 2** (*quem ad diem*). Observe that *dies* is often fem. when it means *time*.

177 9 frumentum deberi: see chapter on military affairs, IV. f.

177 11 commodo (abl.), *to* (properly *in accordance with*) *the advantage*. etc.—rei publicae: gen.; cf. **31 24**, **148 18**.

177 14 CHAP. 34. supra: in ch. 31.

177 15 quod se defenderet, *capable of*, etc. (subjv. of characteristic).

177 16 cuique, *to each*; notice the Latin idiom. We should put the distributive with the leading verb (*consederat*), *each had taken position where*, etc.

177 21 universis, *to men gathered in one body*.

177 23 ex parte, *in a measure*.

177 26 hominum sceleratorum, *those scoundrels*; an expression of temper which Cæsar does not often permit himself towards his foes. It shows his bitter hatred against the hapless Eburones, who had destroyed his officers and legion.

177 27 vellet: not contrary to fact, but in both cases a future protasis thrown back into past time; cf. note on **141 1**.

178 4 ut in, etc., *considering that it was in*, etc.; a not uncommon use of *ut*.

178 6 ut potius, etc.: we may translate *so that some opportunities for doing injury were neglected*, though the clause is properly one of purpose. Connect *potius* with *quam*. The thought is that Cæsar's plan was to save the lives of his soldiers, even at the expense of neglecting to punish the enemy, and to employ others to carry out his vengeance.

178 7 ulciscendum: i.e. to avenge the destruction of the force of Sabinus and Cotta (Bk. v. chs. 27-38).

178 8 noceretur (impers.), *harm should be done* to the enemy.

179 4 CHAP. 35. fortuna: cf. **175 7**. —possit, adferat: present tense to express a general truth; though usually in Latin such expressions follow the sequence of tenses.

179 8 ultro, *freely*; i.e. any that would; as a general invitation, extending beyond those immediately concerned.

179 10 supra docuimus: see **102 21-25**.

179 13 primos finis, *the nearest limits*.

179 16 paludes: subj. of morantur.

179 18 profectum: i.e. *cum profectum esse*.

179 22 **Aduatucam** : i.e. where Cicero with a single legion was guarding the baggage of the whole army ; see ch. 32.

179 23 **tantum**, *only so much*, really, *so feeble*.

179 24 **cingi**, *surrounded* ; i.e. *manned* (with a line of defenders).

179 27 **duce**, *as guide* (pred. app.).

180 1 **CHAP. 36. Cicero** : up to this time he had shown himself to be an unusually discreet and courageous officer.

180 2 **continuisset** (concessive subjv.), *though he had*, etc.

180 4 **vii = septimo**. — **de numero** : construe with **fidem servaturum**.

180 5 **progressum** : cf. **profectum**, 179 18.

180 7 **illius**, etc., *who called his quiet waiting a blockade*.

180 8 **si quidem**, *since* : with subjv., indicating the ground of their complaint.

180 9 **quo** (following **eius modi**, *of such sort that*), with **posset** as subjv. of result. — **oppositis**, *had gone to meet the enemy* ; the abl. abs. expresses cause.

180 10 **in milibus passuum tribus** : i.e. within three miles of his camp.

180 11 **offendi** (impers.), *an attack could be made*.

180 12 **quas inter** : several prepositions sometimes follow their cases.

180 14 **hoc spatio** : i.e. since Cæsar's departure.

180 15 **sub vexillo** : here the *vexillum* was a little scarlet flag (quite distinct from the metal *signum*), used by small bodies detached for some special service. The name *vexillarii* was given to the soldiers of such a corps ; see chapter on military affairs, II, and Figs. 121, 127.

180 16 **calonum** : i.e. officers' servants and grooms for the horses. These were slaves. — **iumentorum** : to bring in the expected supplies.

180 17 **subsederat**, *had remained behind* when Cæsar left. — **facta potestate**, *obtaining leave*.

180 18 **CHAP. 37. [et]** : omit in translation.

180 19 **ab decumana porta**, *at the rear gate* (see Fig. 119). The camp fronted in the direction where the enemy were supposed to be, i.e. towards the Gallic tribes, so that its more exposed part lay nearest the German attack.

180 20 **nec prius . . . quam**, *and not till* ; for the mood following, see 158 24 and note.

180 21 **silvis** : it was considered bad generalship to place a camp so near the woods as to conceal the approach of the enemy. The pickets, too, must have been either very carelessly stationed or very negligent.

180 22 **usque eo**, *so close*. — **qui . . . mercatores**, *the traders who spread their booths (tentoria) under the shelter of the wall*. — **recipiendi sui** : for construction, see § 504. c (298. a) ; B. 339. 5 ; G. 428. R.¹ ; H. 626. 3 (542. i. N.¹) ; II-B. 614 ; cf. 40 15, 77 3, 77 20.

180 24 *in statione*: i.e. before the gate.

180 25 *circumfunduntur*: the middle or reflexive use of the passive, rendered in English by the active intransitive form; *pour in or about*.

180 26 *si*: interrog., [to see] *whether*; cf. **174** 28.

181 1 *signa*, etc.: i.e. as the whole camp was in confusion the soldiers could not tell in which direction the line was to be formed (*signa ferantur*) nor where each man should rally (*quisque conveniat*). It is noticeable that Cicero is not spoken of after the beginning of ch. 36. Ordinarily this would be just the moment when a commander would be most active. It seems to show that he shared in the general panic.

181 3 *imperatore*: Cæsar. Observe the force of *atque*: *and the general, too!*

181 4 *novas religiones*, a sudden superstition, as if the spot itself were unlucky to the Romans (see **176** 20-22).

181 5 *qui occiderint*, *who* (as they recalled; hence subjv.) *had fallen*.

181 7 *barbaris*: dat. of reference.

181 12 CHAP. 38. *apud Caesarem*, with Cæsar.

181 13 *proeliis* (abl. of time): see Bk. ii. ch. 25; Bk. iii. ch. 5.

181 17 *consequuntur hunc*: as *primus pilus*, he had authority to command all other centurions; although generally, as here, he really only formed a rallying point. See chapter on military affairs, 1. 7.

181 18 *cohortis*: cf. **180** 23-25.

181 19 *relinquit animus*, *his breath* (or consciousness) *fails him* (he faints).

181 20 *per manus traditus*, *passed along from hand to hand* by his comrades. — *hoc*

spatio: i.e. the time gained by this short resistance.

181 25 CHAP. 39. *hic*: i.e. in the open field.

181 26 *modo . . . expectant*: the Roman discipline was so perfect that, in general, every man knew just what to do in any emergency (as in the fight with the Nervii, Bk. ii. ch. 21); but these new levies (see **176** 24-27) were helpless till the exact order had been given, even the boldest of them (*nemo est tam fortis*, etc.).

182 2 *legiones*: those of Cæsar and his *legati*: see ch. 33.

182 4 *paucitate*: i.e. five cohorts and the 300 convalescent veterans.

182 6 CHAP. 40. *in signa manipulosque*, *among the cohorts and maniples*. In their panic the servants rushed among the ranks of the cohorts (*signa*) and the maniples.

182 7 *alii . . . alii*: these seem to have had some presence of mind, as is implied in the expression *censent*, the regular expression for voting in a public assembly.

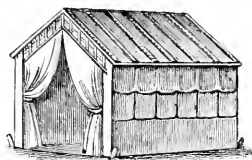

FIG. 128.—TABERNACULUM.

182 8 *quoniam . . . sint*, *since* [as they say], etc.

182 10 [*confidunt*]: may be omitted in translation, the infin. *posse* depending on the idea of saying involved in *censent*. — *alii*: sc. *censent*.

182 11 *hoc*: the latter counsel, which was that of the raw recruits. — *docuimus*: cf. 180 13–15.

182 13 *C. Trebonio*: this can hardly be the man referred to in ch. 33. He was away with the three legions intrusted to him, as there recorded.

183 2 *militum virtute*: i.e. of the infantry; the cavalry, it will be remembered, were not Romans, but Gauls and other allies.

183 3 *nullo usu percepto*, *having gained no experience*; i.e. even after seeing the successful action of the veterans.

183 4 *eo consilio*: with *ut . . . defenderent* in app. — *permanere*: compl. infin. with *potuerunt*.

183 5 *quam*: the antecedent is *eam vim celeritatemque*.

183 7 *demiserunt*: *se* has already been expressed with *recipere*.

183 8 *ex inferioribus ordinibus*: the officers of a new legion were usually obtained in this way, being promoted from the lower grades of veteran cohorts.

183 10 *ne ante partam*, etc.: notice again the *esprit de corps* of the Roman soldier; cf. 109 1–9, 142 7–11, 146 13 ff.

183 13 *pars periiit*: two cohorts; see 184 26.

183 16 *CHAP. 41. constitisse*, etc., *had now gained a position*.

183 17 *praeda*: see 179 26.

183 20 *fidem non faceret*, *could not make them believe*.

183 22 *alienata mente*, *beside themselves* with terror. — *deletis . . . recepis*: after *dicerent*.

183 23 *neque*: the negative belonging with *oppugnatu* *fuisse* is, as often in Latin, combined with the general connective of the sentence. — *incolumi exercitu* (abl. abs. denoting condition), *in case the army were safe*.

183 24 *oppugnatu* *fuisse*: the regular form in indir. disc. for *oppugnassent*, a contrary-to-fact apodosis.

“ Brave as they were, the Roman soldiers seem to have been curiously liable to panics of this kind. The faith with which they relied upon their general avenged itself through the completeness with which they were accustomed to depend upon him. He returned on the day which he had fixed, and not unnaturally was displeased at the disregard of his orders. He did not, or does not in his Commentaries, professedly blame Cicero. But the Ciceros perhaps resented the loss of confidence which one of them had brought upon himself. Quintus Cicero cooled in his zeal, and afterwards amused the leisure of his winter quarters with composing worthless dramas.” — *Froude's “Cæsar.”*

183 26 CHAP. 42. *eventus* (acc. plur.) *belli*, the fortune of war (in general). — *unum*, only one thing.

183 28 *casui*: dat. with *relinqui*. — *relinqui debuisse*: § 486. *a* (283. *a*); B. 270. 2; H. 618. 2 (537. 1); H-B. 582. 3. *a. ftn.*²: as usual added without any other word of saying beyond that involved in *questus*.

183 29 *multum fortunam . . . potuisse*: cf. 175 7 II.

184 1 *avertisset*: sc. *fortuna*.

184 2 *rerum*: part. gen. with *maxime*. — *videbatur*: the subj. is *quod . . . obtulerunt*.

184 5 *beneficium*: i.e. by giving him opportunity to escape. He was never captured. In honor of his splendid resistance to the invader a colossal statue has lately been erected to him at Tongres; see Fig. 83.

184 10 CHAP. 43. *agebatur*: i.e. especially cattle. — *frumenta*: distinguish from *frumentum*.

184 11 *anni tempore*: it was now late in the fall, but the unfortunate people had not been able to harvest their crops.

184 13 *his . . . pereundum [esse]*, that these must needs perish; *his* is dat. of agent.

184 14 *in eum locum ventum est*, matters were brought to such a pass, i.e. they were so close upon him.

184 16 *ut ([non] omit) . . . contenderent*, that prisoners who were brought in looked round among their number for *Ambiorix*, whom they had just seen in flight — supposing that he must have been taken also — and insisted that he was not yet quite out of sight.

184 20 *paene . . . vincerent*: i.e. almost surpassed the bounds of nature in their eagerness.

184 21 *summam felicitatem*: i.e. complete success. — *atque*: almost equals *but*.

184 22 *eriperet, peteret*: in the same construction as the preceding verbs depending on *ut*.

184 26 CHAP. 44. *damno*: abl. of manner. The reference is to those killed by the German raid, chs. 37-40.

184 27 *coniuratione*: see chs. 3 and 4.

185 1 *more maiorum*: the ancient Roman mode of punishment was to flog the criminal to death, after which he was beheaded, — an extraordinary sentence to pronounce on a prisoner of war. It was this mode of punishment that was symbolized directly by the lictors' *fasces*. Concerted resistance (*coniuratic*) had come to be regarded as a flagrant crime, and its penalty was more and more bloody as time went on — as we see in the two succeeding Books.

185 2 *aqua . . . interdixisset*: i.e. banished them, forbade them to return to Gaul.

185 4 *Agedinci*: locative.

185 6 *ad conventus agendos*: cf. 48 28.

BOOK SEVENTH. — B.C. 52.

WAR OF VERCINGETORIX.—The last three campaigns had been conducted wholly in the north, with a view either to crush the bolder and more restless northern populations, or to overawe the more barbarous Britons and Germans beyond the frontier. It is not quite clear why the discontented spirits of the south did not seize the occasion to join forces with the formidable Belgian revolt. At all events, they seemed quiet and submissive after their defeats in the earlier campaigns, and might have continued so but for the execution of Acco (Bk. vi. ch. 44), which had aroused the spirit of all the Gallic nobility, and the news from Rome, where the hostile aristocracy had long been waiting for some opportunity to check Cæsar in his career of conquest and call him home.

This opportunity seemed to offer in the disorders which followed the death of Clodius. Clodius was a bully and professional politician belonging to the popular party, a bitter enemy of Cicero, whom he had succeeded, a few years before, in driving into exile. He was killed in a street brawl on the 20th of January of this year by Milo, a ruffian of the senatorial or aristocratic party. For the time, all regular and orderly government was at an end, till at length Pompey was invested with dictatorial powers, and quiet was restored. The news of these events coming to Gaul gave the native leaders reasonable ground to hope that a new uprising might be successful. Their plan, it will appear, was, by a sudden movement, to cut off Cæsar's communications with his military posts in the north, which would thus be speedily starved into surrender. This plan Cæsar foiled by striking, with his usual rapidity, through their line, and through the neutral or hostile populations of Central Gaul, and so advancing upon his assailants with the support of his legions from the north. His campaign of this year was the most fiercely contested, as well as the most important and decisive, of the entire war.

N. B.—In this book the editors have purposely abstained from grammatical comment except such as seemed necessary for the interpretation of the text, in order that the student might have one book of Cæsar's Commentaries, and that one of the finest pieces of simple narrative in literature, to enjoy without trying to see how the words were parsed. Grammar is absolutely necessary for Latin, but there is much in Latin besides grammar. Intelligent reading presupposes that, but does not always have it uppermost.

READING REFERENCES ON THE UPRISING OF GAUL UNDER VERGINGETORIX.

- Dodge's Cæsar, chaps. 15-20.
 Fowler's Julius Cæsar, chap. 13.
 Froude's Cæsar, chap. 19.
 Guizot's Hist. of France, Vol. I, pp. 56-65.
 Holmes's Cæsar's Conquest of Gaul, chap. 7.
 Merivale's Hist. of Rome, Vol. II, chap. 12.
 Mommsen's Hist. of Rome, Vol. IV, pp. 323-340.
 Napoleon's Cæsar, chap. 10.
 Plutarch's Lives, Cæsar.
 Trollope's Cæsar, chap. 8.

186 1 CHAP. I. *quieta Gallia*: cf. **73** 3, **93** 2. — *in Italiam*: i.e. Cisalpine Gaul.

186 3 *Clodi*: see note above. — *ut . . . coniurarent* (clause depending on *senatus consulto*): this was not an ordinary conscription, but a levy *in mass*, in which the entire population of Italy of military age took the oath. In addition, Cæsar orders a levy throughout his own province, in which were included *Gallia Cisalpina*, *Gallia Transalpina*, and *Illyricum*.

186 7 *quod videbatur*: it naturally seemed to them impossible for Cæsar to quit Italy at this crisis (*urbano motu*).

186 9 *qui dolerent*: trans. by pres. part., *being indignant*, etc.; the characteristic subjv. constantly has this meaning; cf. the use of *cum*. It approaches a causal relation, but has properly no notion of cause. — *ante*: adv. modifying *dolerent*.

186 11 *principes Galliae*: subj. of *queruntur*. — *locis*: loc. abl., without a prep., as usual.

186 13 *Acconis*: see Bk. vi. ch. 44.

186 15 *qui*: sc. *eos*, i.e. some state to begin hostilities.

187 1 *capitis*, of *their lives*; the sing. is idiomatic in Latin.

187 3 *ut . . . intercludatur* (see introductory note): depends on *rationem*, a *plan* (of campaign).

187 9 CHAP. 2. *Carnutes*: this name is represented by *Chartres*.

187 12 *cavere inter se*, *take security from each other*. — *ne res effertur*: as the exchange of hostages would be a conspicuous and public act.

187 13 *conlatis*, etc.: an armed or symbolically armed council seems to have been the most binding form of public ratification of concerted measures. Here the standards were gathered in a sheaf and the oath was taken by this symbol of unity.

187 15 *deserantur*: it seems to have needed the most solemn forms of agreement to bind the discordant and jealous Gauls.

187 19 CHAP. 3. *Cenabum*: now Orléans, on the Loire.

187 20 negotiandi: their business was money-lending, the farming of taxes, purchase of slaves or corn, and the like. Cicero had said, some years before, that business affairs in Gaul were wholly controlled by Roman citizens.

187 21 constiterant, *had settled.*

187 24 maior atque inlustrior: i.e. than usual.

187 25 clamore: a sort of vocal telegraph, by which, as also by signal-fires, messages were conveyed, it is said, from towers 500 yards apart.

187 27 Cenabi: locative.

187 28 ante . . . vigiliam: between nine and ten at night; the sending of the message thus occupying about sixteen hours. — **Arvernorum:** i.e. the country now called Auvergne, a region always noted for the vigor and hardihood of its people, who now became leaders in the great revolt, and furnished its dauntless chief Vercingetorix.

188 1 CHAP. 4. **Vercingetorix:** a name or title explained as meaning "very brave lord," and well calculated (says the historian Florus) to inspire terror.

188 2 principatum, etc.: see **27 14** and last note on **2 1**.

188 3 totius Galliae: i.e. all Celtic Gaul.

188 5 incendit: sc. *eos*.

188 6 prohibetur: conative present; i.e. they try to prevent him. This discouragement of the elders was of evil omen to his enterprise from the start.

188 8 Gergovia: the chief town of the Arverni, on an eminence near Clermont.

188 9 perditorum: men of ruined fortunes, desperate. This is the usual course of things and the usual accusation. The well-to-do are rarely ardent patriots. When trouble comes, they either make terms or flee to the provinces.

188 15 Senones, etc.: several of these names are preserved in the modern *Sens, Paris, Poitiers, Tours, Limoges*. The league included all Celtic Gaul south of the Seine and west of the loyal (or doubtful) Hædui and Bituriges, who were drawn into it later on.

188 19 imperat, *he levies,* with acc. and dat.

188 20 quantum armorum, *how many arms.*

188 21 quod (interrog.): agrees with **tempus,** *and before what time.*

188 25 necat: i.e. the offenders.

189 3 CHAP. 5. **Rutenos:** these, as well as the Cadurci, lay between the Arverni and the Roman province. It was important, therefore, to secure them as a frontier defence.

189 6 de consilio, *by the advice.*

189 8 **qui**: agrees with the persons implied in *equitatus peditatusque*; § 280. *a* (182. *a*); B. 235. B. 2. *c*; G. 211. R.¹; II. 397 (445. 5); H-B. 325.

189 11 **veritos**: translate by a causal clause.

189 12 **quibus id**, etc., *who they knew had this plan*.

189 13 **ipsi**: i.e. the Bituriges. — **id eane**, etc., *whether they did this for the reason which*, etc.

189 15 **quod** (adv. acc.), *because* (the reason for **non videtur**, etc.).

This is a bit which goes to show that the commentaries, notwithstanding their aim at political effect, are substantially true. Cæsar was too great a man to deceive others except when he deceived himself.

189 19 CHAP. 6. **virtute** = *vigor*. This word is in Latin often used in a vague sense equivalent to our 'thanks to' or the like.

189 21 **qua . . . posset**: indir. quest. following *difficultate*, which implies doubt.

189 23 **se absente**: Cæsar knew well his own influence over his army. See also introductory notes. — **dimicaturas** [esse]: sc. *cas*, i.e. the legions.

189 24 **ipse**, etc.: the most submissive Gauls at such a time were not to be depended upon, if they had the slightest chance to capture him. — **eis**: indir. obj. of **committi**, the subj. of which is **suam salutem**.

190 1 CHAP. 7. **Lucterius**, etc.: an officer of Vercingetorix; see

189 1. He endeavored to rouse the border tribes against the Romans, but was checked by the promptness and farsightedness of Cæsar.

190 2 **Nitiobriges et Gabalos**: these completed the Arvernian frontier, the *Volcae* and *Helvii* being within the limits of the Province.

190 4 **Narbonem**, *Narbonne*, the chief town of *Gallia Narbonensis*, founded by C. Gracchus.

190 5 **antevertendum** [esse] has for its subj. **ut . . . proficisceretur**, and is followed by the dat. **consiliis**.

190 7 **provincialibus**: a portion of the Ruteni had been incorporated in the Province.

190 14 CHAP. 8. **quod . . . putabat**: referring to Lucterius.

190 15 **Cevenna**: the pass crossing this range is about 4000 feet high.

190 16 **durissimo**, etc.: Pompey was put in authority February 25 (by the *old calendar*, which was now about six weeks ahead of the actual time); Cæsar, who left Italy directly after, probably crossed the Cevennes about the middle of January.

190 18 **summo labore**: "these admirable soldiers were worthy of the genius of their chief," but such men as Cæsar and Napoleon make that kind of soldiers.

190 21 **singulari homini**, *a solitary wayfarer*, to say nothing of an army.

191 1 CHAP. 9. *at*: marks a transition as usual; translate *mean-while*.

191 2 *usu* . . . *praeceperat*, *had suspected would come to pass*. — *per causam*, *on the pretext* (so elsewhere in Cæsar): his real motive was to join his force.

191 4 *Brutum*: Decimus Junius Brutus, afterward one of Cæsar's assassins. This same officer had command of the fleet in the famous battle with the Veneti; see **82** 7-10.

191 6 *triduo*: this was a pretence, and was given out to conceal his real design.

191 8 *Viennam*, *Vienne*, a little below Lyons on the Rhone. — *recentem*: i.e. they were well rested and in good condition for a forced march.

191 11 *hiemabant*: see Bk. vi. ch. 44. His route would lie due north up the Saône along the eastern line of the Hædui. The distance of this rapid winter journey was above 300 miles. — *quid*: with *consili*.

191 12 *de sua salute*, *affecting his own safety*; opposed to any design on his forces.

191 13 *reliquas*, etc.: two of them were somewhere near Luxembourg, and six at Sens, about 140 miles apart.

191 14 *prius*: with *quam*. — *unum locum*: evidently Sens.

191 17 *Gorgobinam*: this was situated probably on the Allier, a southern confluent of the Loire.

191 18 *Haeduis attribuerat*: see **25** 19 ff.

191 20 *difficultatem*: the dilemma in which Cæsar finds himself is expressed by the two parallel conditions, *si . . . contineret*, *ne . . . deficeret*, and *si . . . educeret*, *ne . . . laboraret*.

192 1 CHAP. 10. *stipendiariis*: i.e. the Boii, who were tributaries of the Hædui.

192 2 *amicis*, etc., *since his friends would find there was no help for them in him*.

192 4 *ab*, *in respect to* his supply of corn.

192 10 *Agedinci*: now Sens, the chief town of the Senones.

192 12 CHAP. 11. *altero die*, *on the second day* of the march. — *Vellaunodunum*: the position of this town is somewhat uncertain, but Cæsar apparently did not march directly towards Gorgobina, but made a detour towards the north in order to cross the Loire at Orléans.

192 13 *quo*, *in order that*.

192 15 *circumvallavit*: the circumvallation consisted of a line of wall and trench surrounding the town.

192 18 *iter*: i.e. to the relief of the Boii at Gorgobina.

192 19 *qui tum primum*, etc.: i.e. they had just heard of the invest-

ment of Vellaunodunum and, thinking the siege would last longer, were raising a force to defend their chief town about 120 miles off.

192 20 **eam rem** : i.e. the siege.

192 21 **quod mitterent**, *to send*, giving the purpose of **comparabant**.

192 24 **in posterum** : sc. *diem*.

192 25 **militibus imperat**, *he orders the soldiers to prepare*. The dir. obj. of **imperat** being a demonstrative antecedent of **quae**, not expressed in Latin, and in Eng. absorbed in 'what.'

192 26 **contingebat**, *touched* : i.e. led directly to. The town being on the north bank, the bridge would allow its defenders to cross to the friendly Bituriges.

193 3 **desideratis quin**, etc. : a loose use of the *quin*-construction ; *all, with very few exceptions, were captured*.

193 5 **diripit** : cf. the fate of Avaricum, ch. 28.

193 8 CHAP. 12. **ille** : i.e. Cæsar.

193 9 **Noviodunum** : the position is uncertain. Cæsar's march, however, was certainly to the south up the Loire. This town is to be distinguished from Noviodunum of ch. 55, a city of the Hædui.

193 11 **celeritate** : we may supply in Eng. a demon. as antecedent to **qua**.

193 20 **novi aliquid consili**, *some new design*.

193 22 **omnis incolumis** : see l. 15 above ; construe with **receperunt**, *got their men all back safe* to Cæsar's camp.

193 24 CHAP. 13. **Germanos** : this force was much superior to the Gallic cavalry, and was destined to turn the battle in Cæsar's favor at many critical times ; see chs. 67, 70, 80. The tactics of the German cavalry are described **43** 4 ff.

193 25 **ab initio** : the meaning of this is not clear. He had no German cavalry at the beginning of his campaigns. He may have obtained them after his struggle with Ariovistus.

194 2 **quibus**, *and these* (the Gallic horse).

194 3 **eos** (obj. of **perdixerunt**) : i.e. the leaders in the sudden movement described above, ch. 12.

194 5 **Avaricum** : the modern Bourges, an important town of 40,000 inhabitants, the geographical centre of France.

195 3 CHAP. 14. **longe alia ratione atque**, *in a way quite different from*, etc. ; by purely defensive or guerilla war.

195 6 **anni tempore** : i.e. scarcely yet spring, long before harvest ; all supplies must be got from granaries or storehouses (**aedificia**), which might easily be destroyed.

195 8 **hos omnis** : i.e. *hostis*.

195 10 **incendi** : cf. the course of the Helvetians, Bk. i. ch. 5.

195 11 **hoc spatio**: explained by **quo**, etc., i.e. the range of the Roman foraging parties. — [a Boia]: omit.

195 13 **quorum**: the antecedent is **eorum**.

195 15 **neque interesse**, and it makes no difference [he says]. — **ne . . . an, whether . . . or**.

195 19 **sint receptacula**, serve as retreats.

195 20 **neu**, and lest, sc. *sint* from preceding clause. — **proposita**, offered to be captured by the Romans. The method of warfare here advised by Vercingetorix and afterwards consistently followed by him stamps him as a general of first-rate ability. We may fitly compare Fabius Maximus harassing and weakening the army of Hannibal, and the burning of Moscow by the Russians to drive out Napoleon.

195 26 CHAP. 15. **urbes**: Cæsar more commonly calls them *oppida*. Rome alone is always *urbs*.

196 2 **solaci**: part. gen. with **hoc**.

196 3 **amissa**, all they had lost (obj. of **recuperaturos**).

196 4 **incendi**, etc.: a double indir. quest., *whether . . . or*.

196 9 **flumine**: the city was just above the junction of the Auron with the Yèvre.

196 12 **volgi**: obj. gen.; i.e. his compassion for the poor people, who would be turned out of house and home in the winter, if the town should be burned.

196 16 CHAP. 16. **longe**, distant. — **certos** (*cerno*), regular.

196 17 **in . . . tempora**, from hour to hour.

196 21 **etsi**, etc., although so far as skilful planning (**ratione**) could provide (against this danger), our men took the precaution of going at uncertain times and in different directions.

196 22 **ut . . . iretur**: a clause of purpose, taking its construction from **provideri**, though not immediately connected with it. The verbs are used impersonally.

196 24 CHAP. 17. **quae . . . habebat**: i.e. the neck of the peninsula on which the town was situated (196 8 ff.).

196 25 **intermissa**, left free. — [a]: omit.

196 26 **aggerem**, etc.: see chapter on military affairs, VIII.

Between the Yèvre and the Auron was a plateau, some 1200 to 1600 feet high, with rather steep banks. As this plateau approached the town, it narrowed to a ridge only about 400 feet wide, with the Auron on one side and a swampy brook, the Yévrette, on the other. From the Yévrette to the Yèvre extended a morass. At a distance of about 300 feet from the city wall the ridge was intersected by a sudden depression like a trench, perhaps 50 feet deep (see plan, Fig. 90). Cæsar pitched his camp on the

plateau just back of the ridge, a little over half a mile from Avaricum. Along the ridge, right across the intersecting ravine, he built the *agger*.

196 29 *alteri*: the Hædui, already wavering in their allegiance; *alteri* (next line): the Boii, a fragment of the defeated Helvetians (Bk. i. ch. 28).

197 8 *ab eis*: the source of *vox*, not the agent of *audita*. Notice again in this passage the invincible endurance of these soldiers.

197 14 *ignominiae loco*, in the place of (i.e. *as*) a disgrace.

197 16 *Cenabi*: locative.

197 17 *parentarent* = *ut parentarent*, the natural construction. As one might say irregularly in English, "It is better to suffer anything than not avenge our comrades," omitting "to."

197 23 CHAP. 18. *qui . . . consuessent*: see Bk. i. ch. 48.

198 2 *sarcinas*, etc.: the regular preparation for battle.

198 5 CHAP. 19. *difficilis*, hard to cross; *impedita*, embarrassing.

198 7 *fiducia loci*, trusting to the strength of the position.

198 8 [*in civitatis*]: omit. — *vada [ac saltus]*, fords and open spaces, where the way seemed practicable.

198 10 *haesitantis*, struggling in the mud or bushes. — *premerent*: a purpose clause, taking its construction from *sic animo parati*, determined; cf. 199 3, where the same words take a result clause. The two constructions approach each other, but the first refers to future time, the last to present.

198 11 *propinquitatem*: i.e. the armies were separated only by the swamp. — *videret*: the contrast is between the casual observer and the careful inspector (*qui . . . perspiceret*). — *prope*, etc., on nearly equal terms; *iniquitatem* (next line), unfair advantage, showing that their offering battle was *inanis simulatio*.

198 14 *quod . . . possent*: follows *indignantis*, chafing that, etc. — *conspectum suum*, the sight of them.

199 2 *necesse sit*, etc., a victory must needs cost, with the abl. of price.

199 4 *iniquitatis*: § 352 (220); B. 208. 2. a; G. 378; H. 456 (409. ii); H-B. 342.

199 8 CHAP. 20. *proditionis*: see last note.

199 10 *discessisset* and *venissent* refer to the action in ch. 18. — *imperio* = *imperatore*.

199 12 *non haec*, etc., all these things could not [they said].

200 1 *illum*: connect with *malle . . . habere*.

200 2 *ipsorum*: sc. *concessu*.

200 5 *persuasum [esse]*: *impers.*, that it had been recommended. — *qui se . . . defenderet*, which was its own defence (ch. 19).

200 12 *fortuna* (dat.): as well as *nuic* (referring to *alicuius*), to be construed with *habendam gratiam*, *thanks were due*.

200 16 *imperium*: the same as *regnum Galliae* above.

200 18 *quin etiam*, *nay even*. Distinguish carefully from *quin* introducing a neg. result. — *remittere*, *is ready to resign*; in dir. disc., *remitto*, *I resign*. — *si* = [*to see*] *whether* (indir. quest.).

200 27 *nec iam viris*, etc., *that no one any longer has sufficient strength*; *viris* is from *vis*.

200 28 *posse*: sc. *quemquam*, supplied from *cuiusquam*.

200 30 [*Vercingetorix*]: may be omitted.

201 2 *quem*: construe with *ne . . . recipiat*, subj. of *provisum est*, and as it basely flees from this spot, I have provided that no state shall receive it within its boundaries.

201 4 CHAP. 21. *suo more*: cf. Tacitus (Ger. 11), *si placuit sententia, frameas concutiunt*.

201 5 *in eo*, *in the case of him*.

201 6 *summum*: this word is often used where we should say "a great."

201 7 *maiore ratione*, *with better generalship*.

201 11 *si . . . retinissent*: in app. with *eo* (*that condition*).

201 14 CHAP. 22. *genus*: i.e. the Gauls.

201 15 *atque . . . aptissimum*: cf. Bk. iv. ch. 5; *atque* connects the descriptive gen. *summae sollertiae* and the descriptive adj. *aptissimum*.

201 16 *laqueis*, etc.: see Fig. 126.

201 17 *cum destinaverant*, . . . *reducebant*: a general condition expressing repeated action in past time; cf. 130 7.

201 19 *ferrariae*: so of the copper mines of the Aquitani; see 89 11–18.

201 25 *cotidianus agger*: i.e. the daily increase in the height of the *agger*. — *commissis malis*, *by splicing the upright timbers*; these were the high corner beams of the towers, by which they were raised in successive stages, so that each increase in the height of the Roman works was met by a corresponding increase in the height of the defences. The towers on the walls were probably connected by covered galleries, one for each story.

201 26 *apertos cuniculos . . . morabantur*, etc.: this refers to the obstructions put by the Gauls in the way of the *open passage ways* which ran through the *agger*, and which the soldiers used in carrying material for its advance and completion; *morabantur* has the force of *blocked* or *obstructed*. See Figs. 92, 93, 120, and chapter on military affairs, VIII.

202 2 CHAP. 23. *directae*, *at right angles* with the course of the wall. — *perpetuae in longitudinem*, *along the whole length*.

202 4 *revinciuntur*, *are fastened* by beams some forty feet in length, running lengthwise of the wall.

202 5 *intervalla*: i.e. the two feet between each two of the beams in the lower tier (*ordo*).

202 7 *ut idem*, etc., in such a way that the same space (between the beams) is preserved, and that the beams do not touch each other; but, placed at equal intervals, the individual beams are firmly bound together by the corresponding stones placed between them; i.e. so alternating in the successive layers that beams rested on stone, and stone on beams.

202 11 *cum*: correlative with *tum* below.

202 15 *quadragesimum*: note the distributive, *forty each*.

203 1 *introrsus revincta*: i.e. the beams were mortised together at some distance from the exposed ends, making it next to impossible to force them apart; see Fig. 94.

203 4 *CHAP. 24. frigore*: it was still very early in the year, scarcely spring; see **208 10**.

203 6 *latum*: as a width of over 300 feet is incredible, some have supposed that this is an error for *longum*; others, that the numeral should be *xxxx*.—*altum pedes lxxx*: it must be remembered that the height of the *agger* had to equal the depth of the ravine it crossed, and also the height of the Gallic wall. The latter may have been thirty feet.

203 11 *cuniculo*: i.e. a mine running under the *agger*. It should be remembered that the *agger* was built largely of wood.

203 13 *turrium*: the Roman towers, mounted on wheels or rollers, and here referring to those flanking the *agger*; see Figs. 43, 92, 126.

203 19 *partitis temporibus*: i.e. in their turn.

203 20 *reducerent*: i.e. out of reach of the fire.

203 21 *interscinderent*: i.e. they cut away the unfinished end of the *agger*, which was in flames. Thus the rest was saved.

203 25 *CHAP. 25. pluteos*: here the high wooden bulwarks (*loricae*) protecting each story of the tower; see note on **144 2**.

203 26 *nec . . . animadvertabant*, and noticed that the exposed men did not readily approach to give assistance.

204 2 *accidit*, etc., an incident occurred before my eyes, which, seem-

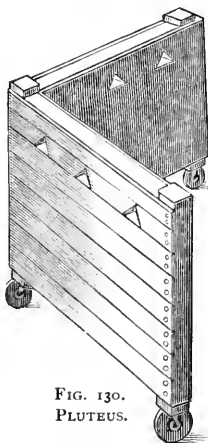
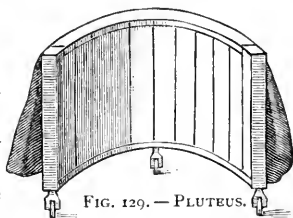

FIG. 130.
PLUTEUS.

ing worthy of record, I thought ought not to be omitted. Observe the use of the plural pronoun, the 'editorial *we*,' extremely common in Latin.

204 4 **per manus traditas**: i.e. his companions passed them to him to throw.

204 5 **scorpione**: this was a powerful cross-bow, for hurling darts or bolts; see chapter on military affairs, 1. 5 and Fig. 95.

204 18 **palus**: probably the watery valley of the Auron.

205 3 CHAP. 26. **suorum**, *their husbands*.

205 5 **quos**: refers to **se** as well as to **liberos**.

205 8 **quo timore**: the regular Latin idiom where we should expect *cuius rei timore*.

205 16 CHAP. 27. [**intra vineas**]: it would be impossible for *legions* to find room *inside* the *vineae*. Either **legiones** here refers to the storming columns, or **intra vineas** means within the line of the sheds, and so out of sight. Many editors omit the words altogether. — **expeditis**, *put in fighting order*.

205 18 **adscendissent**: informal indir. disc. for the fut. perf. of the direct.

205 22 CHAP. 28. **cuneatim**, *in a compact body*; (lit. *wedge-fashion*) implying tactics like those of the Romans.

205 23 **si qua . . . veniretur**, *if an attack should be made from any side*; [**contra**] may be omitted; **veniretur** is impersonal.

205 25 **circumfundi** (impers. pass.) = *that men were pouring in*.

205 27 **continenti impetu**, *without stopping*.

206 1 **exitu**: abl. of cause.

206 3 **quisquam**: i.e. *Romanorum*. — **Cenabensi caede**: see ch. 3.

206 10 [**ut**]: omit. — **procul in via**, etc., *placing his friends and the chiefs of the states at intervals for some distance along the road, he took care that they [the fugitives] should be separated and conducted to their own people*.

206 12 **quae . . . pars** = *ad eam partem . . . quae* and refers to the persons implied by **suos**, and is explained by 198 7, where it is said that the Gallic forces were arranged *generatim*.

206 14 CHAP. 29. **consolatus cohortatusque**: the fall of Avaricum must have been a crushing blow to Vercingetorix, but he meets the disaster with a magnificent courage.

206 18 **errare si qui** = *that those were mistaken who*, etc.

206 19 **sibi numquam placuisse**: see 196 3-13.

206 23 **quae . . . dissentirent**: i.e. the states that had not yet joined the rebellion.

206 27 **effectum habere**: see notes on 13 4, 40 20, 51 8.

206 28 **impetrari**, etc.: i.e. he had a right to ask them to proceed to fortify, etc.; notice the modesty of these words, appropriate to the great disaster just suffered.

207 5 **CHAP. 30. re integra**, *before anything had happened* (see ch. 15).

207 6 **ut . . . sic**: correlatives.

207 9 **de reliquis**, etc.: follows **in spem**, *hope of*, etc.

207 11 **homines insueti**: an appositive expressing concession; translate by *although*.

207 18 **CHAP. 31. capere**, *gain over* (the neutral states).

207 19 **armandos vestiendosque**: gerundives expressing purpose, agreeing with the understood obj. [*eos*] of **curat**; cf. **11** 5, **82** 7.

207 21 **quem**: sc. **numerum**.

208 1 **sagittarios**: apparently the Gauls had trusted too much, especially during the siege, to hand-to-hand fighting.

208 6 **quos conduxerat**, *whom he had hired*; i.e. mercenaries.

208 11 **CHAP. 32. confecta**: it was now about the end of March, or a little later. — **tempore**: i.e. the time was suitable for campaigning.

208 12 **sive . . . sive**: understand *to try*, or some such phrase to introduce these clauses which are treated as indir. questions.

208 15 **maxime necessario tempore**, *in an extreme emergency*.

208 23 **proximo anno**, *the year before*.

208 24 **suas . . . clientelas**, *that each of them had his own* [armed] followers (see Bk. vi. ch. 15).

208 25 **quod si**, *but if*; see second note on **40** 20.

208 27 **positum** [esse], *depended on*.

209 6 **CHAP. 33. minus [sibi] confideret**, *felt itself weakest*.

209 8 **eis**: dat. with **liceret**.

209 11 **quos inter** = *cos inter quos*.

209 14 **atque**, *than*, as often after *alius*. — **oportuerit**: for *oportuit* of the direct, implying the nonfulfilment of the duty, see § 522. a (311. c); B. 304. 3. a; G. 597. R.³; II. 583 (511. 1. N.³); II B. 582. 3. a.

209 15 **renuntiatum**: *renunciare* is the technical term for the act of a magistrate who, after an election, formally declares the result, and thus "creates" the new official. In this case one brother had declared the other elected after a sham election by an illegal convention. — **vivo utroque**, *when both are living*.

209 18 **intermissis magistratibus**, *there being a vacancy in the magistracy*; this phrase signifies that an interval occurred between the term of one magistrate and the due election of his successor. Valetiacus (**208** 22) had illegally appointed his brother Cotus to be his successor. The priests

promptly declared the office vacant and appointed Convictolitavis to fill the position until a regular election could again be held. In such a case at Rome (as had recently occurred twice, B.C. 55 and 52), the patrician senators appointed an *interrex* by virtue of the sacred authority residing in them. Cæsar here, accordingly, recognizes the likeness to a Roman precedent.

209 19 *obtinere*, to hold against (ob) the rival claimant. See note on 21.

209 22 CHAP. 34. [his]: makes sense and may be translated.

209 25 *quae* = *ut ea*: purpose.

209 27 *ducendas*: cf. 206 12.

210 1 *secundum flumen*, along the stream (construe with *duxit*).

210 4 *ab altera parte*: Cæsar being on the right or eastern bank, Vercingetorix on the western, on which the town of Gergovia lay.

210 6 CHAP. 35. *e regione*: see vocab.; cf. 204 5. — *castris*: dat. of reference.

210 9 *partem*: acc. of extent of time.

210 12 *rescindendos*: cf. 209 27.

210 14 *distractis*, etc.: this means that Cæsar made up two sham legions by taking cohorts from the others, so that there might appear to be six full legions as before.

210 18 *perventum* [esse] (impers.): i.e. that the four legions that had gone on ahead had reached their camping ground. — *pars inferior*: the lower end of the piles, which (being under water) was not burned or cut away, served as a support to the new bridge hastily constructed for the crossing.

210 22 *magnis itineribus*: see note on 8 22.

210 24 CHAP. 36. *quintis castris*, at the fifth encampment, or end of the fifth day's march.

210 26 *situ*: see plan, Fig. 97.

210 27 *oppugnatione*, taking (it) by storm, without a formal siege. — *de obsessione*, etc.: i.e. he concluded not to invest it regularly until supplies had been provided.

211 5 *qua despici poterat*, where a view could be had from above.

211 8 *seu quid*, etc., in case any communication or orders should seem necessary.

211 10 *quid*: with *animi ac virtutis* (part. gen.).

211 12 *collis*: the so-called Roche Blanche (White Rock), at whose foot flows the only sufficient stream of water (see plan, Fig. 97). Cæsar's larger camp, it will be observed, lay toward the southeast of the town, and the smaller towards the south; while the forces of the Gauls lay on the

gentler southern slopes of the hill (measuring nearly a mile from east to west, and a third as much from north to south) on which the town was built (see ch. 46).

211 13 quem si, etc. : fut. condition, indir. disc.

211 14 et . . . et : correlatives.

211 16 tamen : opposed to the whole description, not to the last part merely.

211 17 posset : see note on **158 24**. The verb is here impersonal.

211 23 CHAP. 37. demonstravimus : see **209 17-19**.

211 27 praedium communicat : i.e. the money from the Arverni.

211 28 imperio natos, *born for command* (dat.). — unam, etc., *was the only thing*, etc., though unam as usual agrees with the pred.

212 1 traducta, *carried over* to the patriotic party.

212 3 beneficio, *a friendly act* : i.e. deciding the magistracy in his favor. — sic . . . obtinuerit : i.e. this (he claimed) was only his due and not a special favor.

212 8 vel principes, *even leaders*, not mere followers or adherents.

212 11 placuit, *it was decided*. — milibus : this refers to the troops that Cæsar had asked for against Vercingetorix ; see **209 23-25**.

212 12 ea ducenda curaret, *that he should have charge of their march*.

212 13 reliqua : subj. of agi, the whole clause being the obj. of constituunt.

212 18 CHAP. 38. principes civitatis : see ch. 39.

213 1 consili res, *a matter for deliberation*. — sit : for mood and tense, see § 524 (312) ; B. 307 ; G. 602 ; H. 584 (513. ii) ; H-B. 504. 3.

213 4 concurrent : § 558. a (319. d) ; B. 284. 3 ; G. 555 ; H. 595. 1 (504. 3. 2) ; H-B. 521. 3. b.

213 8 una (adv.), *with him*. — frumenti : i.e. which these Romans were taking to Cæsar under the protection of the Hæduan guard.

213 15 CHAP. 39. genere dispari, *of lower birth*.

213 16 traditum : here equivalent to commendatum, — *presented* as suited for public service.

213 17 nominatim, etc. : i.e. he had sent them a personal summons.

213 23 quod . . . provideat, *which he foresees will be the consequence*.

213 25 levi momento, *of light account ; momentum* (from moveo) is strictly the weight which "moves" the balance scale.

214 3 CHAP. 40. contrahenda : as only two legions were left behind, the camp should have been "contracted," so that these few might be equal to the task of keeping and relieving guard. The danger to which the situation exposed them is related in the next chapter, — propter magnitudinem castrorum, l. 26.

214 5 fratres: these had gone to Cæsar in advance of the Hæduan force; see **212 13**. They seem to have suspected, or to have been warned, that the plot had been betrayed.

214 7 necessario . . . labore, *by the hardship of a forced march*. It is worth while to notice the frank terms on which Cæsar stands with his citizen-soldiers. This was an essential element of his success.

214 12 quos . . . existimabant: owing to the falsehoods of Litavicus, **212 17-20**.

214 16 quibus nefas est, *for whom it is wrong*; see Bk. iii. ch. 22.

214 21 CHAP. 41. [noctis]: if this word is authentic, it must refer to the early part of the night, for Cæsar marches back to his camp, a distance of twenty-five miles, before sunrise.

214 26 quibus isdem: dat. of apparent agent after **permanendum esset**. The thought is that the soldiers were so few that the same men had to do all the fighting and could not be relieved.

214 29 tormenta: see chapter on military affairs, I. 5. — **discessu eorum**: at the suspension of their attack when night came on; his messengers had apparently set out about midnight.

215 1 obstruere, etc.: these pres. infinitives show that his preparations were still going on. — **pluteos vallo addere**: to make a defence behind which the soldiers could stand while manning the wall.

215 4 ante ortum solis, etc.: Cæsar left his camp a little after midnight, marched twenty-five miles, gave his soldiers a rest of three hours, and marched back twenty-five miles, reaching camp before sunrise, having been away but little more than twenty-four hours; truly a remarkable display of energy.

215 9 CHAP. 42. levem auditionem: see **97 6-9**. — **pro re comperta**, *as an ascertained fact*.

215 11 proclinatam: "leaning forward" like a wall just ready to fall = *perilous as it was* (in itself).

215 14 fide data, *giving pledges of security*.

215 15 idem facere: i.e. to come out and put themselves in their power.

215 19 CHAP. 43. omnis eorum milites: i.e. the contingent sent under Litavicus, ch. 38.

215 24 suorum: i.e. their soldiers.

215 25 capti, etc., *tempted* (as they had been) *by the profit of the plunder*. — **ea res**: i.e. responsibility for it.

216 2 nihil se gravius de civitate iudicare, *that he thought none the worse of the state*.

216 6 a, *away from* (the neighborhood of).

216 7 **contraheret**: i.e. join his forces with the four legions of Labienus, **209** 26.

217 8 **CHAP. 44. dorsum**, etc. : the hill (*collis*) was southwest of the town and northwest of Cæsar's smaller camp (see plan); while from it a narrow wooded ridge (*dorsum*), nearly level, gave easy access to the town at its western side. Most of the Gallic force had been transferred to that side from the eastern and southern defences. This left the Gallic camps and the part of the city opposite the Romans bare of defenders.

217 11 **uno . . . occupato**: see **211** 11-21.

217 12 **quin . . . viderentur**: after **aliter sentire** (= *dubitare*); cf. **213** 3.

217 13 **hunc**: i.e. **alterum collem**.

217 18 **CHAP. 45. impedimentorum** (= *iumentorum*) *beasts of burden*.

217 19 **stramenta**, *the pack-saddles*, which would prevent the animal from being ridden conveniently.

217 20 **collibus** (loc. abl.) **circumvehi**: i.e. towards the westerly side. All these movements were designed to make the Gauls fear an attack from the west or northwest. Cæsar's real design was to make a sudden dash from the south and east and surprise their camps.

217 22 **easdem regiones**: i.e. in the vicinity of the hill which the Gauls were fortifying.

218 5 **ut contineant**, etc. : i.e. the design was not to hold the camp, but simply to sweep through it by a sudden and daring raid.

218 9 **ab dextra parte**: i.e. from the larger camp to the east.

218 11 **CHAP. 46. recta regione**, *in a straight line*.

218 12 **si . . . intercederet . . . aberat**: cf. § 517. *c* and N.² (308. *c* and N.²); B. 304. 3. *a*; G. 597. 3; H. 583 (511. 1. N.³); H-B. 581, 582. 3. *a*. N.¹.

218 13 **huc**, *to this amount*.

218 14 **in longitudinem ut . . . ferebat**, *lengthwise of the hill*.

218 16 **murum**: traces of this wall are still found, at some distance down the slope, parallel with the town wall.

218 17 **inferiore omni**, etc. : i.e. the space below the six-foot wall to the bottom of the ascent, a distance of about half a mile, was vacant; an equal space above to the city wall was filled with the Gallic encampments.

218 18 **castris**: the separate camps of the several Gallic states, set close together, of which three (*trinis*) were taken.

218 19 **ad munitionem**: i.e. *ad murum a medio colle*.

218 20 **trinis**: § 137. *b* (95. *b*); B. 81. 4. *b*; G. 97. R.³; H. 164. 3 (174. 2 3). H-B. 247. 1. *a*.

218 26 **CHAP. 47. legionis**: with **signa**. Observe that Cæsar is found, as usual, with his favorite legion; cf. **36** 21-25. This legion, it will

be remembered (217 25), was first stationed some distance away from the others. It seems to have returned and taken a prominent part in the assault.

218 27 *reliquarum*: i.e. those engaged in the assault just described.

219 3 *retinebantur*: conative; the officers tried to hold them back.

219 13 *Avarici*: see 206 3-5.

219 16 *quem . . . constabat*, *who, it was certain, said that day in the presence of his soldiers*. The subj. of *constabat* is *quem . . . dixisse*.

219 17 *prius quisquam*, *any body before him*.

219 21 CHAP. 48. *supra*: see 217 26 ff.

219 23 *oppidum . . . teneri*: depends on *nuntiis* as a word of *telling*.

219 25 *sub muro*: i.e. below and outside of the city wall.

220 2 *cursu*: they had run about a mile up a steep ascent.

220 8 CHAP. 49. *sub infimo colle*: at the foot of the hill on which was the smaller Roman camp (211 11-21), see Fig. 97 (Sextius, 1st position). — *ab . . . hostium*: i.e. on the Roman left; Cæsar, meanwhile, was posted considerably to the right (eastward).

220 10 *hostes*: translate as if the obj. of *terreret*. — *quo . . . insequentur*: expresses the purpose of *terreret*.

220 11 *progressus*: it was rather a retreat than an advance; see plan, Fig. 97 (Leg. X, 2d position).

220 15 CHAP. 50. *latere aperto*, *the exposed flank* of the Romans; i.e. the right flank.

220 16 *manus distinendae causa*: i.e. to make a diversion.

220 18 *insigne pactum*, *the signal agreed upon*. The Hædui had their Gallic arms and standards, so that the mistake was a natural one, especially at such a time of excitement.

220 23 *excidere*, *to cut away*; i.e. from within, to gain his escape.

221 9 CHAP. 51. *aequiore loco*, *on more level ground*, farther back from the town; see plan, Fig. 97 (Leg. X, 3d position).

221 12 *locum superiore*, *higher ground*, in the direction of the larger camp; see plan, Fig. 97 (2d position of Sextius). The retreat was made in good order, as is shown by what immediately follows.

221 18 CHAP. 52. *cupiditatem*, *eagerness* for battle.

221 22 *ad Avaricum*: referring to the operations in that neighborhood described in ch. 19.

221 25 *quanto opere . . . tanto opere*: correlatives.

222 9 CHAP. 53. *eadem*, etc.: i.e. that the wisest course would be to join his forces with those of Labienus, in view of all the troubles that were threatening; cf. 216 4-8.

222 11 *nihilo magis*: Vercingetorix was far too wary and skilful to

put himself at such disadvantage. He knew that he was no match for Cæsar on level ground. A parallel might be drawn between the tactics of Vercingetorix and those of Fabius the Delayer against Hannibal.

222 12 secundo, *favorable* to the Romans. By this slight success and the refusal of Vercingetorix to meet him in the plain on even terms, Cæsar avoids the appearance of a compulsory retreat. Still, it is evident that Cæsar's operations against Gergovia were far from being as successful as he himself had hoped or wished. It was the only city that successfully defied his assault, and its victorious resistance must have been a great encouragement to the Gallic patriots.

222 18 CHAP. 54. **Viridomaro**, etc.: see **213 13-17**. These young Hæduan nobles had decided to desert Cæsar, and so, as soon as they reached the frontier of their country, on the east side of the Allier, they invented an excuse for leaving him.

222 21 perfidiam . . . habebat: see note on **coactum habebat, 13 4**.

222 25 discedentibus (dat.), *as they were setting out*.

222 26 quos et quam humilis, *in what a state* (lit. *whom*) *and how humbled*; shortly before Cæsar's arrival in Gaul the Sequani with the Germans as their allies had conquered the Hædui and imposed heavy conditions on them. See Bk. i. ch. 31.

223 6 mandatis: this word implies that what he has just said to them is to be repeated to their countrymen at home.

223 8 CHAP. 55. **Noviodunum**: the modern Nevers, on the right bank of the Loire (*Liger*), just above its junction with the Allier (*Elaver*). The Noviodunum of ch. 12 is probably Sancerre.

223 14 civitatis: the Hæduan commonwealth. The *status* is described in the clause which follows, down to **missos**.

223 15 Bibracte: loc. abl.

223 19 tantum commodum: i.e. of taking the town, seizing the Roman stores, and especially of capturing the hostages, whose possession was all important to Cæsar for keeping the tribes in subjection.

223 23 deducendos: § 500. 4 (294. *d*); B. 337. 7. *b. 2*; G. 430; H. 622 (544. 2. *N.*²); H-B. 612. iii.

223 24 cui: indef. pron. with **usui**.

224 2 in provinciam: Cæsar was now on the western or further bank of the Loire, which he would thus be obliged to follow up towards its source, thence crossing over to the province. The bracketed words may be translated.

224 4 nivibus: it was still spring, perhaps about May.

224 7 CHAP. 56. **si esset**, etc., *in case* (i.e. *lest*, *he might have to risk a battle while the bridge-building was under way*).

224 8 *eo*: i.e. on the Loire. *Cæsar* felt that to effect a union with Labienus as soon as possible was vitally important.

224 9 *ne . . . converteret*: depending on *impediebat*.

224 10 *ut non nemo, as many a one*.

224 11 *cum*: correl. with *tum*.

224 13 *Labienu, legionibus*: datives following *timebat*. For the facts, see **209** 26 ff. The situation was extremely critical, and it is not strange that many thought *Cæsar* would have to desert Labienus and seek safety for himself in the province. Most men would have done so, but *Cæsar* was a man apart, an extraordinary military genius.

224 14 *admodum*, etc.: these marches must have been extraordinary, to judge from the expression.

224 16 *pro rei necessitate, considering the emergency*, difficult and hazardous as it was.

224 18 *disposito equitatu*: i.e. just above the ford a line of cavalry was formed in the water, reaching across the river. By this barrier the violence of the current was checked. Another line also was stationed below the ford to catch any that were swept away.

224 23 CHAP. 57. *eo supplemento*: see **186** 3-5, **190** 9-12.

224 26 *Lutetiam*: see **159** 3 and note.

225 2 *Aulerco*: this tribe was the next westerly, south of the Seine (see map, Fig. 88).

225 4 *is*: i.e. *Camulogenus*.

225 5 *perpetuam paludem*: the marsh ground along the little river *Essonne*, which flows into the *Seine* on the south a little above *Paris*. Labienus was proceeding on the left or southerly bank of the *Seine*. See plan, Fig. 99.

226 1 CHAP. 58. *aggere, a mass of earth* for a causeway.

226 4 *Metiosedum* (or *Melodunum*) *Melun*: here Labienus crosses to the north or right bank.

226 7 *eo, aboard (= in eas)*.

226 11 *secundo flumine, following the river-course* down the right bank. Having boats or pontoons, he would easily cross the *Marne* just above *Paris*.

226 14 *palude*: a marshy ground south of the river.

226 20 CHAP. 59. *confirmabant, kept asserting*.

226 21 *qui* refers to *Bellovaci*. — *per se*: i.e. without this example of the *Hædui*.

226 24 *neque*: connects *intellegebat* and *cogitabat*. The latter verb is here followed by two clauses of purpose. The infin. would be more usual.

227 1 *altera, alteram*: the Bellovaci were on the north of the Seine; Camulogenus (ch. 57) was on the south. — *quae civitas*: the defection of this tribe might well cause Labienus uneasiness. They were a nation of warriors and could put 100,000 men in the field. When the tribes of Belgic Gaul conspired against Cæsar, the Bellovaci, because of their importance, were placed at the head of the league; see **51** 11-15.

227 4 *praesidio*: at Agedincum (Sens) on the other side of the Seine; see **224** 23-26.

227 6 *ab animi virtute*: a truly Roman quality, of which, fortunately, Labienus had a good supply.

227 9 CHAP. 60. *equitibus*: not *cavalrymen*, but unattached officers of equestrian rank (*tribuni militum, comites imperatoris*, etc.) put in charge each of a single vessel.

227 15 *adverso flumine*: a feint, the real attack being made below. — *imperat, gives orders* (followed by the acc. and infin. instead of the usual *ut*-clause).

227 21 CHAP. 61. *exercitus equitatusque*: thought of as one body, hence with a sing. verb.

227 25 *tumultuari*: the *magno tumultu* of l. 15.

227 27 *paulo infra*: about four miles below.

228 2 Omit the bracketed words.

228 4 *castrorum*: the Roman camp.

228 6 *naves*: i.e. the *lintris* of **227** 16, not the ships, for they had gone the other way.

228 22 CHAP. 62. *ostenderunt*: sc. *tribuni*.

228 27 *neque potuerunt, but could not*. Much of Cæsar's success was due to the excellence of his officers. In this case, for example, Labienus does not supinely wait for Cæsar to come and extricate him from his difficulties, but by a military exploit of the first rank rescues himself and goes to the help of his chief.

229 5 CHAP. 63. *circummittuntur, etc.*: these are the acts of the Hædui.

229 7 *quos Caesar, etc.*: see **223** 9, 22. — *supplicio*: i.e. by threats; cf. **188** 22-28.

229 9 *rationes communicet*: not simply consult, but share the direction of affairs.

229 15 *illi*: i.e. the Remi (see Bk. ii. ch. 5; **154** 3-5) and the Lingones.

229 20 *requirunt* = *recall with regret*.

229 21 *summae spei, of high ambition* (**213** 13-20).

229 24 CHAP. 64. *ipse*: i.e. Vercingetorix.

229 25 *huc*: at Bibracte, the capital of the Hædui.

230 2 *factu*: supine after *perfacile*; § 510 (303); B. 340. 2; G. 436; H. 635. 1 (547); H-B. 619. 1.

230 3 *aequo animo*, *without complaint*. — *modo . . . corrumpant*, *only let them*, etc.: a hortatory subjv. expressing a kind of proviso.

230 6 *finitimi*: see map, Fig. 2.

230 7 [ei] may be omitted.

230 9 *Allobrogibus*: these and the peoples mentioned in the next sentence were allies or subjects of Rome, and would look to Cæsar for protection if attacked; see **231 5 ff.** — *altera ex parte*: as the Roman frontier was bent into an irregular curve by the line of the Cévennes, the Gauls would strike the Province in two directions, the Hædui from the north, the Ruteni, etc., from the west; see map, Fig. 2.

230 13 *superiore bello*: the war of eight years before, in which the Allobroges had been subdued by Pomptinus (Bk. i. ch. 6).

230 16 CHAP. 65. *cohortium*: not legionary troops, but auxiliaries levied in the Province.

230 17 *L. Caesare*: a cousin of Julius, consul B.C. 64.

230 18 *ad omnis*, etc., *were arrayed against the enemy in every quarter*.

230 20 *Donnotauro*: a brother of Procillus (**42 10**); the Roman name (*C. Valerius*) is regularly taken in compliment to his Roman *patronus* (see also **17 9**, **48 10-20**).

230 21 *muros*, *strongholds* — not simply the walls of the *oppida*.

230 24 *interclusis*, etc.: from this we see how much Cæsar was hampered by the plan of campaign that Vercingetorix employed against him.

230 27 *equites*: the German cavalry were far superior to the Gallic; see **193 23 ff.** and note.

230 28 *inter eos proeliari*: see **43 4 ff.**, **95 15-20**.

230 29 *equis*: for a description of these, see **95 10-14**.

231 1 [*sed et*]: these words should probably be omitted.

231 4 CHAP. 66. *equites*: see **229 25**.

231 6 *per . . . finis*: bearing from near Agedincum (where he had been joined by Labienus, ch. 62) toward the east, and so leaving the hostile Hædui to the south. This movement, checked by the attack of Vercingetorix, explains how the crisis of the campaign came to be the siege and capture of Alesia (see map, Fig. 88).

231 13 *parum profici*, *that little advantage was gained*. — *reversuros [esse]*: i.e. *Romanos*.

231 15 *adoriantur*: for *adoriamur* in dir. disc., *let us charge upon them*. — *si pedites*, etc.: the attack was to be made on the baggage train, which was guarded by cavalry.

Vercingetorix knew Cæsar's weakness in this arm, and did not suspect the German reinforcement. If the infantry stopped to assist the cavalry (suis) the march would be delayed.

231 16 *magis futurum*, *is more likely*.

231 18 *dignitate*, etc. : i.e. the dishonor of retreat with loss of baggage. — *nam de equitibus*, etc. : i.e. even the Gauls whom he was addressing could not suppose that the Roman cavalry would wish an engagement.

231 19 *quin . . . audeat* follows *ne . . . dubitare* : i.e. even they themselves would admit that, etc.

231 20 *id quo . . . animo*, *that they* (i.e. the Gauls) *may do so* (i.e. attack the Romans) *with greater courage*.

231 21 *pro castris*, *in front of the camp*, by way of defiance, to support by a demonstration the attack of the cavalry.

231 23 *confirmari oportere*, *that they ought to bind themselves*.

232 1 CHAP. 67. *a primo agmine*, *at the front of the* (Roman) *line of march*.

232 7 *aciem converti* : by a change of front, turning the line of march to a line of battle.

232 9 *Germani* : it is evident that the victory was due to them ; cf. ch. 13.

232 10 *flumen* : the Vingeanne, and its tributary the Badin, about which many ornaments, weapons, etc., have been found.

232 15 *Cotus*, etc. : see 208 14-23, 209 12-19.

232 16 *proximis comitiis* : i.e. of the Hædui for chief magistrate.

232 18 *quo duce*, etc. (see Bk. i. ch. 31) : this was seemingly another Eporedorix, not the rival of Viridomarus.

232 21 CHAP. 68. *Alesia* : this famous fortress (now called Alise Ste. Reine) was on the territory lying just north of the Hæduan frontier. Its natural advantages — summed up in the succeeding chapters — are thus described :

“Alesia, like Gergovia, is on a hill sloping off all round, with steep and, in places, precipitous sides. It lies between two small rivers, both of which fall into the Brenne, and thence into the Seine. Into this peninsula, with the rivers on each side of him, Vercingetorix had thrown himself with 80,000 men. Alesia as a position was impregnable except to famine. The water supply was secure. The position was of extraordinary strength. The rivers formed natural trenches. Below the town, to the west, they ran parallel for three miles through an open alluvial plain before they reached the Brenne. In every other direction rose rocky hills of equal height with the central plateau, originally perhaps one wide tableland, through which the water had ploughed out the valley. To attack Ver-

cingetorix where he had placed himself was out of the question; but to blockade him there, to capture the leader of the insurrection and his whole army, and so in one blow make an end with it, on a survey of the situation seemed not impossible." — *Freude's "Cæsar."* See plan, Fig. 103.

233 2 **CHAP. 69.** **loco**: in app. with **colle**; cf. § 282. *d* (184. *c*); B. 169. 4; G. 411. 3; H. 393. 7 (363. 4. 2); H-B. 319. i.

233 7 **sub muro**, etc.: this sentence is an excellent example, at the same time, both of the natural precedence of the relative in Latin and of the freedom of all real language from grammatical trammels. The student should first translate it literally thus: *Under the wall, which side of the hill (i.e. the side which) faced the east, all this space the forces of the Gauls had filled, and had carried along a ditch*, etc. The meaning of this is obvious, but it is not at all in accordance with our English idiom. Indeed, it is not strictly *grammatical* in any language. After the student has seen what it means, he should try to put it into some form that is allowable in English idiom, say: *Under the wall, the side . . ., all this space the forces . . ., and had made there*, etc.

233 10 **munitionis**: Cæsar constructed a line of *contravallation*; i.e. a series of works entirely surrounding the town, so as to resist a sortie.

233 11 **milia**: acc. of extent; **tenebat** having here the force of *pertinebat*. — **castra**, etc.: in the remains of these works traces have been found of four infantry and four cavalry camps (see plan, Fig. 102).

233 13 **stationes**, etc.: in the daytime a mere picket-guard occupied each redoubt; at night it was necessary to station in them strong garrisons with numerous sentries (**excubitoribus**) on their walls.

233 18 **CHAP. 70.** **supra**: i.e. l. 4.

233 19 **Germanos**: cf. **232** 9 and note.

233 20 **pro castris**: these were on the high ground south of the city (see plan, Fig. 102); **castris** is plural, = *campis*.

233 23 **angustioribus**, *too narrow*, either from unskilful construction or more easily to prevent the enemy's entrance. The gates referred to were in the stone wall (**maceria**); see plan.

233 24 **acrius**, *with all the more vigor*.

234 1 **veniri . . . existimantes**, *thinking that an immediate attack is to be made upon them*.

234 4 **portas**, *town gates*; these were closed, lest those who manned the exterior defences (the **fossa** and **maceria**) should rush into the town in a panic.

234 7 **CHAP. 71.** **perficiantur**: for mood, cf. **57** 20 and note.

234 11 **suæ, se**: i.e. Vercingetorix. — **neu**, *and not*, the regular way

of continuing a negative purpose. We say 'and not'; the Romans said 'nor,' which is the real meaning of *neu*.

234 14 *ratione inita*, *having made a calculation*.

234 17 *opus*: i.e. the Roman works of contravallation, still unfinished.

234 21 *copias omnis*: not those that held the fortification east of the town (**233** 7-10), but the outlying pickets on all the other sides.

234 26 *CHAP. 72. pedum viginti*: i.e. in breadth.

234 27 *directis*, *vertical*, the bottom (*solum*) being as broad as the top. The ditch was usually dug with sloping sides; the object here was (as it was probably shallow) to make it harder to cross. This was the interior line of defence against the town.—*solum*: notice the quantity of the first syllable.

235 2 [*id*] may be omitted.—*hoc consilio*, *with this design*, followed by the app. clauses of purpose, *ne . . . possent*.

235 3 *quoniam . . . ne*, *that, since, etc., not, etc.*—*esset complexus* and *cingeretur* are subjv. because integral parts of his purpose, *ne . . . possent*.

235 4 *nec* = *et non*, as usual.—*totum opus*, *the entire work*, eleven miles in extent, according to **233** 11.

235 6 *operi*: take with *destinatos*.

235 8 *eadem altitudine*, *of equal depth*.—*quarum interiorem*: i.e. the one nearer the town.—*campestribus . . . locis*: loc. abl. describing the situation.

235 10 *aggerem*: here not the technical approach used in a siege, but a *bank of earth* serving as a rampart, on top of which was placed the *vallum* of stakes, twelve feet in height.

235 11 *loricam, pinnas*: see Bk. v. ch. 40. These were to raise higher the defence of the *vallum*.—*cervis*: stumps with roots, or trunks with branches, projecting like stags' horns.—*ad commissuras*, *at the joining*, i.e. the place where these *plutei* were fixed in the *agger*, which would be at their lowest part.

235 12 *pluteorum*: the *lorica* was really a series of *plutei*, arranged side by side on a wall and bound together.

235 13 *turris*: if these were ten feet wide at the base, there must have been at least 400.—*quae . . . distarent*: not *which were distant* (this would be indic.), but *so placed as to be, etc.*, hence subjv.

235 15 *CHAP. 73. erat*: with *necesse*; its subj. is the infinitives.—*materiari*: i.e. to get timber; *lignari* would mean to get firewood.

235 16 *copiis*: Cæsar had about 50,000 men.

235 20 *quo*, *in order that*.

235 21 *truncis arborum*, etc.: trunks of trees or very stiff boughs

were cut down; then the boughs were trimmed and sharpened at the ends, and then planted in five rows in trenches each five feet deep (*quinos pedes*), and perhaps one and a half feet wide.

235 24 *huc . . . eminebant*, those boughs being sunk in these (*huc*, i.e. the trenches) and being securely fastened at the bottom so that they could not be torn up, projected from the ground only with their branches.

235 25 *quini . . . ordines*: these five rows of *chevaux-de-frise*, intertwined so as to be continuous, covered a space perhaps twenty-five feet wide, so that, even with the help of a pole, an enemy could not easily leap over them.

235 26 *quo qui intraverant*, whoever entered within them; protasis of a past general condition.

235 27 *cippos*: i.e. boundary-stones, so called jestingly by the troops; see Fig. 103.

235 29 *scrobes*, little pits, with sloping sides, three feet deep, dug in eight rows, arranged, as we should say, in diamond-pattern, or as trees were planted in an orchard (*in quincuncem*), so that each should be equally distant from the six adjacent. A stout, sharp stake was set in each, packed with a foot depth of earth, its point projecting four inches, the pit being then loosely filled with twigs and brush. This funnel-shaped trap for man or beast the soldiers called a "lily-cup" (*lilium*); see Fig. 131. — *paulatim . . . fastigio*, sloping gradually towards the bottom.



FIG. 132.
STIMULUS.

235 30 *teretes*, round, like a cylinder, while the word *rotundus* means round like a ball. — *huc*, in these; cf. same word in l. 24.

235 31 *praeusti*: to harden the point.

236 2 *singuli . . . exculcabantur*, a foot of each [stake] was packed down with earth at the bottom.

236 7 *taleae*: blocks of wood or stakes with iron barbed points fixed in them. Several of these hooks have been found in excavations on this site; see Fig. 132. — *totae*, their whole length, so that only the hooks projected.

236 10 *CHAP. 74. regiones . . . aequissimas*: the line of circumvallation (see plan, Fig. 102) was parallel with the works just described, and distant from it about 700 feet. It was protected by a single ditch.

236 11 *xiv milia*: of course the works of circumvallation included all the Roman camps, and must have had a greater circuit than the inner line of contravallation (see **233** 11).

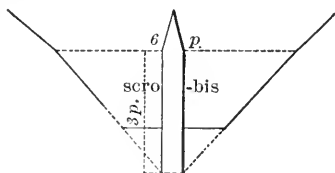

FIG. 131. — LILIUM.

- 236 12 *diversas*, facing the other way.
- 236 14 Omit the bracketed words.
- 236 16 *habere . . . convectum*: see note on *compertum habere*, Bk. i. ch. 44.
- 236 19 CHAP. 75. *omnis*: subj. of *convocandos* [*esse*].
- 236 24 [*Blannoviis*]: this name is doubtful.
- 236 25 *milia*: dir. obj. of *imperant*, the datives being the indir. obj. The same construction is continued in the next sentences, where *imperant* is to be supplied.
- 237 4 The bracketed words may be omitted.
- 237 6 *quo in numero*: cf. Bk. iii. ch. 7.
- 237 12 *pro*, in consideration of.
- 237 13 CHAP. 76. *Commi*: cf. 106 13-19, 110 13-14, 115 9, 131 26.
- 237 15 *civitatem*: i.e. the Atrebates. — *immunem*, free from tribute.
- 237 16 *attribuerat*, had assigned to him as a prince.
- 237 19 *moveretur*: i.e. *Gallia*.
- 237 23 *Viridomaro et Eporedorigi*: these Hæduan nobles had been among Cæsar's most faithful friends; see chs. 38, 39, 40, 54.
- 237 24 *Vercassivellauno*: in this word, as in *Vercingetorix*, the prefix *Ver* is probably a title, like the modern "Sir" or "Lord."
- 237 25 *his*: indir. obj. of *tribuuntur*.
- 237 29 *ancipiti*, with double front, having to be fought behind and before.
- 237 30 *cum . . . foris*, etc., [in a case] where they would fight in a sally from the town, and on the outside, etc.
- 238 1 CHAP. 77. *at*: to mark the change of scene.
- 238 7 *crudelitatem*: perhaps so in a Gaul, but in a Roman it would be *constantiam*.
- 238 10 *deditionis*: a mere "laying down of arms."
- 238 12 *cum . . . est*, I have to do with those.
- 238 14 *animi est*, etc.: the infin. clause following is in app. with *ista*. From the English idiom we should expect *istud*, but in Latin such pronouns agree with the predicate.
- 238 16 *offerant, ferant*: subjv. of characteristic.
- 238 17 *atque, and yet*. — *probarem . . . viderem*: apodosis and protasis in a contrary-to-fact supposition; § 517 (308); B. 304; G. 597; H. 579 (510); H-B. 581.
- 238 18 *tantum potest*: see Vocab. — *dignitas*: i.e. of those who advocate making a sally.
- 238 19 *vitæ nostræ*: depending on *iacturam*, to be supplied according to the Latin idiom.

238 21 **quid animi**, *what heart*.

238 22 **propinquis, consanguineis**: dat. of poss. after **fore**.

238 27 **prosternere, subicere**: connected by **nec** with **exspoliare**.

239 2 **animi causa**, *for the pleasure of it*. — **illorum**: the Gauls; **his**: the Romans. — **exerceri**, *are toiling*.

239 4 **testibus**, *as witnesses*, pred. app.

239 6 **consili**: pred. gen. — **facere**: sc. *meum consilium est*, from the preceding.

239 7 **Cimbrorum**: see note on 7 1. They did great damage in laying waste Gaul and Spain before they turned to Italy.

239 12 **pulcherrimum**: in pred. agreement with the two preceding infinitives. — **quid**, etc., *what was there in that war like this?*

239 17 **quos**: the antecedent is **horum**.

239 21 **finitimam**: "over the border,"—the Province.

239 22 **securibus**: the lictor's axes, the sign not simply of military rule, but of bloody execution (as a servile insurrection would be revenged).

239 27 CHAP. 78. **illo**: observe the emphasis. — **potius**, with **quam**. — **utendum** [esse]: impers., governing the abl.; § 500. 3 (294. c. N.); B. 337. 7. b. 1; G. 427. N.⁴; H. 623. 1 (544. N.⁵); H-B. 600. 3. a.

240 4 **prohibebat**: one of the cruel necessities of war. The wretched creatures must have perished miserably between the city walls and the Roman lines.

240 7 CHAP. 79. **colle**: this hill is southwest from Alesia, beyond the Brenne; see plan, Fig. 102.

240 10 **demonstravimus**: see 233 4.

240 13 **concurrunt**: i.e. the Gauls in Alesia.

240 16 **fossam**: see 234 26 ff., and plan, Fig. 102.

240 23 CHAP. 80. **Galli**, etc.: the Gauls here adopt the German cavalry tactics; see Bk. i. ch. 26.

240 26 **complures**: i.e. of the Roman cavalry.

241 5 **neque . . . ac**, etc. (perhaps a misreading for *neque . . . nec*), *and because neither a brave nor a cowardly action*, etc.

241 8 **Germani**: for the fourth time in this campaign the Germans decide the day for Cæsar; cf. 232 9 and note.

241 12 **at**: what is its force here? Cf. 240 4, 238 1, and note.

242 3 CHAP. 81. **atque**, *and even*.

242 4 **harpagonum**: iron hooks fastened to poles, for tearing down the defences; see Fig. 126.

242 5 **campestris munitiones**: *the works in the plain*; i.e. the line of circumvallation in the Plain of the Laumes, southwest from Alesia; see plan, Fig. 102.

- 242 6 **qua** = *ut ea* : introducing a clause of purpose.
- 242 8 **cratis**, *hurdles* of woven twigs, to cover the trenches.
- 242 13 **fundis librilibus** : heavy stones fastened to a thong, by which they were hurled with great force.
- 242 14 **glandibus** : leaden bullets.
- 242 18 **his auxilio** : two datives.
- 242 19 **deductos** : sc. *milites*. The thought is that men were withdrawn from the more distant redoubts to defend those that were in greatest danger.
- 242 22 CHAP. 82. **stimulis** : cf. 236 7-9. — **scrobis** : cf. 235 28 ff.
- 242 23 **pilis muralibus** : large darts perhaps hurled by the engines.
- 242 26 **superioribus** : on the higher ground to the north and south (see next chapter).
- 242 29 **fossas** : this word should probably be *fossam*. It seems to refer to the ditch twenty feet wide ; see 234 26 ff. and plan. — **explant** : coördinate with **proferunt**.
- 243 6 CHAP. 83. **collis** : see plan ; the camp of these two legions was on the southern slope of Mont Rea.
- 243 13 **quoque pacto**, *and in what manner*.
- 243 15 **Vercassivellaunum** : see 237 23-25.
- 243 29 CHAP. 84. **multum valet**, *tends greatly*.
- 244 1 **quod . . . constare** : as the attack is both from without and within, the Romans in their fortifications have enemies both in front and in the rear, and the shouting of those in their rear tends to disconcert them. As they face the enemy they feel that their safety depends on the valor of those who are defending their rear.
- 244 4 CHAP. 85. **idoneum locum** : i.e. where he can see everything.
- 244 5 **utrisque**, etc., *the thought is present to the minds of both parties that this is the time of all others best suited for the greatest exertion*.
- 244 8 **si rem obtinuerint**, *if they (shall) gain the day*.
- 244 11 **iniquum . . . fastigium**, *the unfavorable downward slope of the ground* (see 243 8). The Romans always aimed to have their camp where no higher ground could command it.
- 244 13 **agger** : i.e. earth, stones, or anything else handy.
- 244 15 **occultaverant** : i.e. the *stimuli*, *scrobes*, etc., described in ch. 73.
- 244 17 CHAP. 86. **Labienum** : he was encamped on the heights of Bussy. See plan.
- 244 19 **deductis . . . pugnet**, *to draw off his cohorts and make a sally*.
- 244 22 **interiores** : i.e. the Gauls within the town.
- 244 23 **loca praeurpta** : probably the Heights of Flavigny.
- 244 24 [**ex**] : may be omitted.

244 26 *vallum ac loricam*: see 235 10 ff.

245 1 CHAP. 87. *integros*: i.e. troops that had not yet been engaged. The cohorts of Brutus and Fabius were probably of those that had been defending the works in the plain.

245 2 *eo*, etc.: i.e. to the works on Mont Rea.

245 10 CHAP. 88. *ex colore*: the purple or scarlet *paludamentum*. The bracketed words may be omitted.

245 12 *de locis superioribus*, *from the high ground* occupied by the Gauls.

245 13 *declivia*, *the downward slopes*. — *cernebantur*, *were in plain sight*.

245 14 *excipit clamor*: i.e. the shout of the combatants is taken up and re-echoed all along the lines. Notice the vividness and power of the following description, the short quick sentences, the absence of connectives, and the rapidity of the whole.

245 16 *equitatus*: who had been sent for that purpose as told above.

245 22 *conspicati*: agrees with the subj. of *reducunt*; sc. *Galli*.

245 24 *quod*: lit. *as to which*, referring to the preceding sentence; § 397. a (240. b); B. 185. 2; G. 610. R.²; H. 510. 9 (453. 6); cf. H-B. 388. a. N.; translate *and*.

245 25 *crebris subsidiis*, *constant service in relief parties*.

246 8 CHAP. 89. *Vercingetorix deditur*: the fate reserved for this gallant and ill-fated chieftain was to be kept for six years in chains, and then, after being led in Cæsar's triumphal procession, to be put to death. Plutarch in his "Life of Cæsar" describes the surrender as follows: "Vercingetorix, who was the chief author of all the war, putting on his best armor, and adorning his horse, came out of the gate, and rode round Cæsar as he sat, then dismounted from his horse, threw off his armor, and remained sitting quietly at Cæsar's feet until he was led away to be reserved for the triumph."

246 9 *si* [to try], *whether*, indir. quest.

246 10 *capita singula*, *one apiece*.

246 17 CHAP. 90. *huic*: i.e. Labienus.

246 25 *Bibracte*: loc. abl.

246 26 Cf. the close of Bks. ii and iv.

From 1862 to 1865 careful excavations were made under direction of the emperor Napoleon III on the site of the works at Alesia. The discoveries that resulted were most interesting. There were found the remains of Cæsar's four infantry camps and of his four cavalry camps. Of the twenty-three redoubts, remains of only five could be traced. It is likely that the rest were mostly of wood, so that they had crumbled entirely away.

The trench twenty feet wide remains in its entirety. Of the pits (*scrobes*) in which the sharp stakes were buried, more than fifty were discovered. They are all three feet deep, two feet wide at the top, and one foot wide at the bottom. Of course they do not retain the original dimensions. In the trenches were found a great number of coins, Roman and Gallic, swords, daggers, spear-heads, and the like. The result of these researches was a very striking corroboration of Cæsar's narrative.

CLOSE OF THE CAMPAIGN.— If Cæsar was merciless in war, he was wise and humane in victory. Even in the moment of the fall of Alesia, he uses his prisoners to make terms with the more important states (*si per eos*, etc.). His aim was "not to enslave the Gauls, but to incorporate them in the Empire; to extend the privileges of Roman citizens among them, and among all the undegenerate races of the European provinces. He punished no one. He was gracious and considerate to all, and he so impressed the central tribes by his judgment and his moderation that they served him faithfully in all his coming troubles, and never more, even in the severest temptation, made an effort to recover their independence."

Cæsar's own narrative closes with the great and decisive victory at Alesia. The short remainder of the story is told by his faithful officer and friend, Hirtius Pansa, in the Eighth Book. A rising of the Carnutes and Bituriges in the west, undeterred by the fate of Avaricum, was crushed by a rapid winter march across the Loire. The Remi in the north, who alone of the Gauls had been steadily true to Rome, were attacked by the Belovaci under Commius, but the latter were crushed in a single battle, and Commius fled to Germany. The final rally of the patriot party was made at the stronghold of Uxellodunum, on a branch of the Garonne, in the southwest; but this was also reduced by a siege of extreme difficulty, and the one act of vindictive barbarity which stains Cæsar's record was inflicted after its fall by cutting off the hands of the desperate defenders who had held out to the last for the independence of Gaul. Cæsar then "invited the chiefs of all the tribes to come to him. He spoke to them of the future which lay open to them as members of a splendid imperial state. He gave them magnificent presents. He laid no impositions either on the leaders or their people; and they went to their homes personally devoted to their conqueror, contented with their condition, and resolved to maintain the peace which was now established,—a unique experience in political history."

GROUPS OF RELATED WORDS.

N.B. — These lists are not intended to be exhaustive, and pupils may do well to add to them as they increase their vocabularies.

1

acer, *sharp, violent.*
acriter, *violently.*
acerbus, *bitter, cruel.*
acerbe, *bitterly.*
acerbe ferre, *take hard.*
acerbitas, *bitterness, suffering.*
acervus, *heap.*
acies, *sharp edge, line.*
[acus, *needle.*]
acuo, *sharpen.*
acutus, *sharp.*

2

alacer, *lively.*
alacriter, *promptly.*
alacritas, *readiness.*

3

aedes, *fireplace, house.*
aedificium, *building.*
aedifico, *build.*
aestas, *heat.*
aestivus, *hot.*
aestus (boiling), *tide.*
aestuarium, *tide-way.*

4

aequus, *even, level.*
iniquus, *uneven, unfavorable.*
iniquitas, *unfavorableness.*

aequitas, *fairness.*
aequalis, *equal.*
aequaliter, *evenly.*
aequinotium, *equinox.*
aequo, *equalize.*
adaequo, *make equal.*

5

ago, *drive.*
actuarius, *fast sailing.*
agmen, *line of march.*
ager, *field.*
cogo, *compel.*
cogito, *think.*
adigo, *force.*
agito, *pursue.*
examino, *weigh.*

6

alo, *foster.*
altus, *grown high.*
altitudo, *height.*

7

alius, *other.*
alienus, *of another.*
alieno, *alienate.*
alias, *elsewhere.*
aliter, *otherwise.*
alio, *elsewhither.*

8

animus (*breath*), *soul*, *mind*.
 anima, *breath*.
 animal, *animal*.
 exanimis, *out of breath*.

9

ante, *before*.
 antea, *before*.
 antiquus, *ancient*.
 antiquitus, *anciently*.

10

ars, *art*.
 articulus, *joint*.
 arma, *arms*.
 armo, *equip*.
 armamentum, *rigging*.
 armatura, *equipment*.

11

arx, *citadel*.
 arceo, *keep off*.
 co-erceo, *restrain*.
 exerceo, *exercise*.
 exercitus, *training*, *army*.
 exercitatio, *exercise*.

12

augeo, *increase*.
 auctor, *responsible party*.
 auctoritas, *influence*.
 autumnus, *harvest season*.
 auxilium, *help*.
 auxiliaris, *helping*.
 auxiliior, *assist*.

13

cado, *fall*.
 casus, *fall*, *chance*.
 cadaver, *body*.
 caedo, *fell*.
 caedes, *murder*.

accido, *befall*.
 accido, *cut into*.
 concido, *fall down*.
 concido, *cut down*.
 incido, *happen*.
 incido, *cut into*.
 occido, *fall*.
 occasio, *occasion*.

14

capio, *take*.
 captus, *capacity*.
 captivus, *captive*.
 accipio, *receive*.
 decipio, *deceive*.
 excipio, *take up*.
 excepto, *catch up*.

15

caput, *head*.
 capillus, *hair*.
 anceps, *double-headed*.
 praeceps, *head-foremost*.

16

cerno, *separate*, *distinguish*.
 certus, *fixed*, *certain*.
 crimen, *charge*.
 certe, *surely*.
 [certo, *decide by contest*.]
 certamen, *contest*.
 concerto, *contend*.
 decerno, *decide*.
 decerto, *decide by contest*.
 decretum, *decision*, *decree*.
 discerno, *decide*.
 discrimen, *decision*.

17

circum, *around*.
 circa, *circiter*, *about*.
 circinus, *compasses*.
 circuitus, *circuit*.

18

colo, *till*.
 cultus, *cultivation*.
 cultura, *cultivation, culture*.
 [colonus, *husbandman*.]
 colonia, *colony*.
 incolò, *inhabit*.
 incola, *inhabitant*.

19

consciùs, *conscious*.
 [consciens, *being conscious*.]
 conscientia, *conscience*.
 conscisco, *resolve*.
 insciùs, *not knowing*.
 insciens, *unknowing*.

20

consto, *be established (stand firm)*.
 constans, *firm*.
 constanter, *firmly*.
 constantia, *firmness*.
 consisto, *take a stand*.
 constituo, *establish*.

21

consul, *consul*.
 consulatus, *consulship*.
 consulo, *consult*.
 consilium, *plan*.
 consultum, *decree*.
 consulto, *by determination, de-*
signedly.
 consulto, *consult*.

22

cresco, *grow*.
 creber, *thick*.
 crebro, *frequently*.
 creo, *make to grow, create*.
 [Ceres, *goddess of growth*.]

23

curro, *run*.
 currus, *chariot*.

cursus, *course*.
 concurro, *run together*.
 concursus, *rush*.
 concursò, *rush together*.
 decurro, *run down*.
 excursio, *sally*.
 incurro, *rush upon*.
 incursio, *attack*.
 incursus, *rush*.
 percurro, *run along*.
 succurro, *run to help*.

24

de, *down from*.
 desuper, *from above*.
 deinde, *then*.
 demum, *at last (farthest down)*.
 denique, *at last*.
 deterior, *worse*.

25

defatiscor, *give out (cf. 'busted')*.
 defessus, *tired out*.
 defatigo, *wear out*.
 defatigatio, *exhaustion*.

26

dico, *say*.
 indico, *ordain*.
 index, *informer*.
 indicium, *information*.
 indico, *give information*.
 iudex, *judge*.
 iudicium, *trial*.
 [vindex, *avenger*.]
 vindico, *avenge*.
 dictum, *thing said*.
 dictio, *pleading*.
 dīco, *adjudge*.
 dīcio, *sway ('say so')*.
 condicio, *terms*.

27

dies, *day*.

diu, *long, all day*.

interdiu, *by day*.

diutinus, *long continued*.

diurnus, *by day, daily*.

diuturnus, *long*.

diuturnitas, *length of time*.

biduum, *two days*.

triduum, *three days*.

28

dies, *day*.

cotidie, *every day*.

cotidianus, *daily*.

hodie, *to-day*.

pridie, *the day before*.

postero die, *the next day*.

postridie, *the day after*.

[perendie, *day after to-morrow*.]

perendinus (adjective).

29

do, *give*.

dedo, *give over*.

editus, *devotion*.

editio, *surrender*.

editicius, *surrendered*.

reddo, *give back*.

trado, *hand over*.

donum, *gift*.

dono, *present*.

30

duo, *two*.

bis, *twice*.

bini, *two apiece*.

bellum, for duellum, *war*.

dubius, *doubtful*.

dubium, *doubt*.

dubito, *doubt*.

dubitatio, *doubt*.

duplex, *double*.

duplico, *double*.

31

emo (*take*), *buy*.

eximius, *exceptional*.

exemplum, *specimen*.

32

equus, *horse*.

eques, *horseman*.

equester, *of cavalry*.

equitatus, *cavalry*.

[equito], *ride*.

adequito, *ride up*.

perequito, *ride over*.

33

ex, *out*.

exter, *outer*.

extra, *outside*.

extremus, *last*.

34

facio, *make, do*.

beneficus, *well doing, beneficent*.

facilis, *easy (to do)*.

facultas, *facility*.

difficilis, *difficult*.

difficultas, *difficulty*.

difficulter, *with difficulty*.

factio, *employment, party*.

facies, *face (the 'make')*.

factum, *deed*.

facinus, *deed (usually evil)*.

artifex, *artist*.

conficio, *make up*.

perficio, *accomplish*.

35

fides, *faith*.

fidelis, *faithful*.

perfidus, *faithless*.

perfidia, *perfidy*.

fiducia, confidence.

foedus, treaty.

infidelis, unfaithful.

confido, trust.

36

finis, bound, boundary.

fines, country.

finio, set bounds.

finitimus, neighboring.

adfinis, connection.

adfinitas, connection (by marriage).

confinis, adjacent.

confinium, neighborhood.

definio, set limits, fix.

37

fors, chance.

fortuito, accidentally.

fortuna, fortune.

fortunatus, fortunate.

38

fruor, enjoy.

fructus, enjoyment.

fructuosus, fruitful.

fruges, grain.

frumentum, grain.

frumentor, forage.

frumentatio, foraging.

frumentarius, of grain.

39

fugio, fly.

fuga, flight.

fugo, put to flight.

fugitivus, a runaway.

effugio, escape.

perfuga, refugee.

perfugio, escape to.

perfugium, refuge.

profugio, flee forth.

refugio, run away.

40

gero, carry, carry on.

res gestae, exploits.

[*aggero, heap up.*]

agger, earthworks.

congero, heap together.

suggestus, raised mound.

41

iacio, throw.

iaculum, javelin.

iaceo, lie.

iactura, loss.

iacto, toss about.

42

is, this.

item, likewise.

ita, so.

itaque, therefore.

iterum, again.

idem, the same.

ideo, therefore.

ipse, himself.

eo, thither.

ea, that way.

43

iubeo, order.

iussu, by order.

iniussu, without orders.

44

ius, right.

iudex, judge.

iudicium, judgment.

iudico, judge.

adiudico, assign.

deiudico, decide (between).

iniuria, wrong.

iustus, just.

iustitia, justice.

iuro, swear.

coniuro, *conspire.*
coniuratio, *conspiracy.*

45

[lego, *choose.*]
legio, *levy, legion.*
delectus, *levy.*
legionarius, *soldier.*
lex, *law.*
[lēgo, *assign by law.*]
legatus, *lieutenant.*
legatio, *embassy.*
deligo, *select.*
diligō, *love.*
intellego, *understand.*

46

[libet], *it pleases.*
libenter, *willingly.*
liber, *free.*
liberi, *children.*
libertas, *freedom.*
liberalis, *generous.*
liberaliter, *generously.*
liberalitas, *generosity.*
libero, *set free.*

47

mane, *in the morning.*
maturus, *early, ripe.*
mature, *early.*
maturo, *make haste.*
maturesco, *ripen.*

48

memini, *remember.*
mens, *mind.*
[demens], *mad.*
dementia, *madness.*
mentio, *mention.*
[memor], *mindful.*
memoria, *memory.*
moneo, *remind.*

reminiscor, *remember.*
commemoro, *mention.*

49

moveo, *move.*
motus, *motion.*
mobilis, *mobile.*
mobiliter, *easily.*
mobilitas, *mobility.*
momentum, *means of motion*
commuto, *change.*

50

nascor, *be born.*
natus, *birth.*
natalis, *of birth.*
nativus, *native.*
natura, *nature.*
natio, *race.*

51

navis, *ship.*
navicula, *boat.*
navalis, *naval.*
nauta, *sailor.*
nauticus, *of a sailor.*
navigo, *sail.*
navigium, *vessel.*
navigatio, *voyage.*

52

nosco, *learn.*
novi, *be acquainted with.*
notus, *known.*
notitia, *acquaintance.*
ignotus, *unknown.*
nobilis, *famous.*
ignobilis, *ignoble.*
nobilitas, *nobility.*
nomen, *name.*
nomino, *name.*
nominatim, *by name.*
ignominia, *disgrace.*

cognosco, *investigate.*
ignosco, *pardon.*

53

nuntius, *messenger, news.*
nuntio, *announce.*
denuntio, *warn.*
enuntio, *report.*
renuntio, *bring back word.*
pronuntio, *make known.*

54

obses, *hostage.*
obsideo, *blockade.*
obsidio, *blockade.*
obsessio, *blockade.*

55

[Ops], *goddess of abundance.*
opes, *resources.*
copia, *abundance.*
copiae, *resources.*
copiosus, *well supplied.*
inops, *poor.*
inopia, *want.*

56

[paciscor, *agree.*]
pango, *join.*
pactum, *agreement.*
pax, *peace.*
paco, *pacify.*
pacatus, *subject.*

57

pario, *acquire.*
parens, *parent.*
parento, *sacrifice to ancestors.*

58

ex-prior, *try.*
peritus, *experienced.*
periculum, *danger (trial).*

periculosus, *dangerous.*
periclitor, *be in peril.*
aperio, *open.*
reperio, *find.*

59

paro, *prepare.*
impero, *order.*
imperium, *power.*
pareo, *be on hand, obey.*

60

parum, *too little.*
parvus, *small.*
parvulus, *very small.*
paucus, *few.*
paucitas, *small number.*
paulus, *small.*
paulatim, *little by little.*
paulum, *a little.*
paululum, *a very little.*
paulo, *a little.*
paulisper, *a little while.*

61

[pasco, *feed.*]
pabulum, *forage.*
pabulor, *forage.*
pabulatio, *foraging.*
pabulator, *forager.*
pater, *father.*
patrius, *belonging to a father.*
patronus, *patron, protector.*
patruus, *uncle (on the father's side).*

62

pes, *foot.*
pedes, *footman (man on foot).*
peditatus, *infantry.*
pedester, *of men on foot.*
pedalis, *a foot long, etc.*
impedio, *entangle.*
impedimentum, *hindrance.*

impeditus, *hampered*.
 expedio, *disentangle*.
 expeditus, *unincumbered*.
 expeditio, *expedition*.

63

pleo, *fill*.
 compleo, *fill up*.
 expleo, *fill out*.
 plenus, *full*.
 plene, *fully*.
 plerique, *most of*.
 plerumque, *for the most part*.
 completus, *filled up*.
 expletus, *filled out*.
 plus, *more*.
 plurimus, *most*.
 complures, *very many*.

also

plebs, *the populace*.
 populus, *people*.
 publicus, *of the people*.
 publice, *publicly*.
 publico, *confiscate*.

64

porta, *gate*.
 porto, *carry*.
 adporto, *bring in*.
 comporto, *bring together*.
 deporto, *carry away*.
 exporto, *carry off*.
 reporto, *bring back*.
 supporto, *bring up*.
 transporto, *carry over*.
 portus, *harbor*.
 portorium, *customs*.

65

[putus], *clean*.
 puto, *clean up, reckon, think*.
 [purus, *clean*.]

purgo, *clear, excuse*.
 computo, *reckon*.
 disputo, *discuss*.
 disputatio, *discussion*.

66

pro, *before*.
 probus, *good*.
 improbus, *bad*.
 prope, *near*.
 propinquus, *neighboring*.
 propinquitas, *nearness*.
 protinus, *straight away, 'right away'*.
 propter, *near by, on account of*.
 propterea, *for this reason*.

67

prae, *in front*.
 praeustus, *burnt at the end*.
 praeter, *along side, beside*.
 praeterea, *besides*.
 praeterita, *bygone*.
 prior, *before*.
 primus, *first*.
 pridie, *the day before*.

68

rego, *direct, rule*.
 rectus, *straight*.
 regio, *direction*.
 regnum, *kingdom*.
 regno, *reign*.
 rex, *king*.
 regius, *royal*.
 [regula, *rule*.]
 dirigo, *direct*.
 directus, *straight*.
 directe, *straight*.
 pergo, *keep on*.

69

sancio, *bind*.
 sacer, sanctus, *sacred*.

sacerdos, *priest*.
 sacramentum, *oath*.
 sacrificium, *sacrifice*.

70

seco, *cut*.
 sectio, *a cutting, a lot*.
 sectura, *mine*.
 securis, *axe*.

71

sequor, *follow*.
 secundus, *second*.
 secus, *otherwise*.
 secius, *less*.
 sector, *pursue*.
 socius, *companion*.
 societas, *society*.

72

[sero, *bind*.]
 servus, *bondman*.
 servio, *be a slave*.
 servo, *guard*.
 conservo, *preserve*.
 servilis, *servile*.
 servitus, *slavery*.
 sermo, *speech* (connected discourse).
 praesertim, *especially* (at the head
 of the row).

73

similis, *like*.
 simul, *at the same time*.
 simultas, *quarrel*.
 simulo, *pretend*.
 dissimulo, *pretend not*.
 simulatio, *pretence*.
 similitudo, *likeness*.
 simulacrum, *image*.

74

species, *appearance*.
 conspicio, *behold*.
 conspectus, *sight*.

conspicor, *espy*.
 adspectus, *view*.
 specto, *gaze at*.
 exspecto, *expect*.
 speculor, *watch*.
 speculator, *spy*.

75

sto, *stand*.
 statio, *station*.
 statim, *forthwith*.
 status, *position*.
 statuo, *set up*.
 constituo, *establish*.
 stabilis, *stable*.
 stabilitas, *steadiness*.
 stabilio, *make firm*.

76

sub, *under, up*.
 superus, *above*.
 super, *over*.
 superior, *superior*.
 supero, *overtop*.
 supra, *over*.
 summus, } *highest*.
 supremus, }
 summa, *total*.
 superbus, *proud*.
 superbe, *arrogantly*.

77

tam, *so*.
 tamen, *nevertheless*.
 tametsi, *although*.
 tandem, *at last*.
 tantus, *so great*.
 tantulus, *so little*.
 tantum, } *only* (so much and
 tantummodo, } *no more*).

78

tango, *touch*.
 contingo, *touch, happen*.

contagio, *contact*.
 contamino, *taint*.
 integer, *untouched, whole*.
 redintegro, *renew*.

79

tempus, *time*.
 tempestas, *weather*.
 tempero, *control*.
 temperantia, *self-control*.

80

teneo, *hold*.
 tener, *tender*.
 tenuis, *thin*.
 tenuitas, *scantiness*.
 tenuiter, *scantily*.
 contineo, *hold together*.
 continens, *continuous (a continent)*.
 continenter, *without stopping*.
 continentia, *self-control*.
 continuus, *continuous*.
 continuo, *forthwith*.
 continuo, *continue*.
 continuatio, *continuance*.

also

tendo, *stretch*.
 tento, *try*.
 contendo, *contend*.
 contentio, *contest*.
 intendo, *strain*.
 ostendo, *show*.
 ostentatio, *ostentation*.

81

[tribus, *tribe*.]
 tribunus, *tribune*.
 tribuo, *assign*.
 tributum, *tribute*.
 distribuo, *distribute*.
 attribuo, *assign*.

82

utor, *use*.
 utilis, *useful*.
 utilitas, *advantage*.
 usus, *use*.
 usitor, *use*.
 usitatus, *customary*.

83

verto, *turn*.
 versus, *towards*.
 versus, *verse*.
 universus, *all together*.
 verso, *deal with*.
 versor, *engage in*.
 avertor, *turn aside*.
 adverto, *turn to*.
 adversus, *turned towards, opposed*.
 adversarius, *opponent*.
 animadverto, *attend to*.
 converto, *turn about*.
 reverto, *turn back*.
 rursus, *back, again*.
 transversus, *across*.

84

vetus, *old*.
 veteranus, *veteran*.
 inveterasco, *grow old in*.

85

vir, *man*.
 virgo, *maiden*.
 virtus, *manliness*.
 viritim, *man by man*.

86

volo, *wish*.
 voluntas, *will*.
 voluntarius, *volunteer*.
 voltus, *countenance*.
 voluptas, *pleasure*.
 malo, *wish more*.
 nolo, *not wish, wish not*.

ENGLISH PRONUNCIATION OF PROPER NAMES.

KEY TO DIACRITICAL MARKS.

ā as in fāte	ē as in mēte	ī as in ĭt	û as in ûnite
ă “ senăte	ĕ “ ĕvent	ō “ ōld	ũ “ ũp
ǎ “ făt	ě “ mět	ô “ ôbey	û “ fûr
ǎ “ ärm	ĕ “ hĕr	ö “ nôt	u “ rŭle
ǎ “ ăll		ô “ côrk	u “ pŭll
á “ ăsk	ī “ ĭce		
ạ “ whạt	ĭ “ ĭdea	ũ “ ũse	ÿ “ babÿ
c as in call		g as in go	qu as in quit
ç “ çity	ġ “ caġe	ş “ hiş	
eh “ sehool	ŋ “ iŋk		

All other unmarked consonants have their usual English sounds. Silent letters are italicized. Primary accents are heavy, secondary accents light.

Ăc' cŏ	Ă năr'tĕş	Ăr'pĭ nĕ'iŭs
Ăd'ĭ á tŭn'nŭs	Ăn căl'i tĕş	(y)
Ăd'ŭ ăt'ŭ cá	Ăn'dĕş	Ăr vĕr'nĭ
Ăd'ŭ ăt'ŭ çĭ	Ăn'dĭ	Ăt'rĕ bā'tĕş
Ăĕ mĭl'i ũs	Ăn'dŏ cŏm bŏ'ġĭ ũs	Ătrĭ ũs
Ăf'rĭ cŭs	Ăn tĭs'tĭ ũs	Ău lĕr'çĭ
Ăġ'ĕ dĭn'cŭm	Ăn tŏ'nĭ ũs	Ău'lŭs
Ă lĕ'sĭ á	Ă pŏl'tŏ	Ău rŭn'cŭ lĕ'iŭs
(sh)	Ăp'pĭ ũs	(y)
Ăl lŏb'rŏ ġĕş	Ăq'uĭ lĕ'riá	Ău'scĭ
Ăm băr'ri	(y)	Ă văr'i çĕn'sĕş
Ăm'bĭ ā'nĭ	Ăq'uĭ tā'nĭ á	Ă văr'i cŭm
Ăm'bĭ bār'ĭ ĭ	Ă'rār	Ăx'tŏ ná
Ăm'bĭl ĭ ā'tĭ	Ăr'dŭ ĕn'ná	Bă çĕ'nĭs
Ăm bĭ'tŏ rĭx	Ăr'ĕ cŏm'i çĭ	Băc'ŭ lŭs
Ăm'bĭ văr'ĕ tĭ	Ăr'ĭ ŏ vĭs'tŭs	Băl vĕn'tĭ ũs
Ăm'bĭ văr'ĭ tĭ	Ă rĭs'tĭ ũs	(sh)
		Băs'ĭ lŭs

Băt'ă vî	Căt'ă vől'eūs	Dô mĩ'tĩ ũs (sh)
Běl'găē	Căv'ă rîl'lūs	Dôn'nô tăt'urūs
Běl'gî ũm	Căv'ă rî'nūs	Dũ'bîs
Běl lōv'ă ċî	Çel'taē	Dũm'nô rix
Bî brăc'tē	Çel til'lūs	Dũ'rô cōr'tô rŭm
Bî' brăx	Çen'ă bēn'sēs	Dũ'rūs
Bîb'rô ċî	Çen'ă bŭm	
Bî ġēr'rî ô'nēs	Çen'î măg'nî	Ëb'ă rō'nēs
Bit'ă rî'gēs	Çen'ô mă'nî	Ëb'ă rô vî'çēs
Bōd'ă ôg nă'tūs	Çeũ'trô nēs	Ël'ă vēr
Bō'jă (y)	Çē vēn'nă	Ë leũ'tē tî
Bō'jî (y)	Çhē rŭs'cî	Ël'ă sâ'tēs
Brăn'nô vî'çēs	Çim bē'rî ũs	Ëp'ô rēd'ô rix
Brăn nō'vî î	Çim'brî	Ër'ă tōs'thē nēs
Brăt'ă spăn'tî ũm (sh)	Çim ġēt'ô rix	Ë sũ'vî î
Brî tăn'nî	Çis'rhē nă'nî	
Brî tăn'nî ă	Çi'tă	Fă'bî ũs
Bry'tūs	Çlău'dî ũs	Flăc'eūs
	Clō'dî ũs	Fũ'fî ũs
	Cōc'ô sâ'tēs	
Căb'il lō'nŭm	Cōm'mî ũs	Găb'ă lî
Că bũ'rūs	Cōn cōn'nē tō dũm'nūs	Gă bî'n'î ũs
Că dău'çî	Cōn drŭ'sî	Gă'ĩūs (y)
Çăc' rō'sî	Cōn sîd'î ũs	Găl'bă
Çăc'şar	Cōn vîc'tô lî'ă vîs	Găl'li
Căl'tē tēs	Cōr'î ô sōl'î tēs	Găl'li ă
Căl'tē tî	Cō'rūs	Găl'lūs
Căm'ă lōġ'c' nūs	Cōt'ă	Gă rŭm'nă
Că nŭm'î ũs	Cōt'ă ă'tūs	Gă rŭm'nî
Căn'tă brî	Cō'tūs	Gă'tēs
Căn'tî ũm (sh)	Crăs'sūs	Ġeî dũm'nî
Căr'nă tēs	Crî'tôg nă'tūs	Ġēr gō'vî ă
Căr vîl'î ũs		Ġēr mă'nî ă
Căs'sî	Dă'çî	Ġnăē'ūs
Căs'sî ũs	Dă nŭ'vî ũs	Gō'băn nî'tî ô (sh)
Căs'sî věl lău'nūs	Dē çē'tî ă (sh)	Gōr gōb'î nă
Căs'tî cūs	Dî'ă blî'n'tēs	Gră'jōç'c' lî (y)
Căt'ă măn'tă loē'dēs	Dîv'î cî ă'eūs (sh)	Grŭ'dî î
Căt'ă rî'gēs	Dîv'î cō	

Haëd'ú i	Măn'li ũs	Ôr gët'ô rix
Hâ rŭ'dëş	Mär'cô măn'nî	Ô eis'mî
Hël vë'tî i (sh)	Mär'cũs	
Hël'vî i	Mâ'rî ũs	Pâ'dũs
Hî bër'nî á	Märş	Paê mâ'nî
Hîs pâ'nî á	Mâ tis'cô	Pâ ris'î i (sh)
Ïc'cî ũs (sh)	Mă't'rô ná	Pë'dî ũs
Ïl lÿ'rî cûm	Măx'î mûs	Pët'rô cõ'rî i
Ïn dũ'tî ô mâ'rũs (sh)	Mëd'î ô măt'rî çî	Pê trõ'nî ũs
Ï'tî ũs (sh)	Mê nâ'pî i	Pët'rô sid'î ũs
Iû'nî ũs (j)	Mës sâ'lá	Pic'tô nëş
Iûp'pî tër (j)	Më'tî ô sç'dũm (sh)	Pi rûs'taê
Iû'râ (j)	Më'tî ũs (sh)	Pi'sô
Lâ bër'rî ũs	Mî nër'vá	Plăn'cũs
Lâ'bî ë'nũs	Mî nër'vá	Pleñ mõx'î i (ksh)
Lăt'ô brî'gî	Mî nũ'cî ũs (sh)	Póm pë'îũs (y)
Lëm'ô vî'çëş	Mõ'nâ	Præ'cô ni'nũs
Lê pön'tî i (sh)	Mõr'î nî	Prô çel'lũs
Leû'çî	Mõr'î täs'gũs	Ptî â'nî i
Lëv'â çî	Mõ'sá	Pũb'lî ũs
Lëx ô'vî i	Mũ nâ'tî ũs (sh)	Pul'lô
Lî'gër	Nãm mē'îũs (y)	Quad rā'tũs
Lîñ'gô nëş	Nãm'nê tëş	Quin'tũs
Lîs'cũs	Năn'tũ â'tëş	
Lî't'â vî'cũs	När'bô	Raŭ'râ çî
L.ũ cā'nî ũs	Näs'ñ á (sh)	Rëb'î lũs
Lũ'cî ũs (sh)	Nëm'ê tëş	Rëd'ô nëş
Lũc tē'rî ũs	Nër'vî i	Rê gî'nũs
Lũ gõt'ô rix	Nî'tî õb'rî gëş (sh)	Rë'mî
L.ũ tē'tî á (sh)	Nô rē'îá (y)	Rë'mũs
Măg'ê tõb'rî gâ	Nõ'vî ô dũ'nũm	Rõs'cî ũs (sh)
Măn dũ'bî i	Öç'ê lũm	Rŭ'fũs
Măn'dũ brâ'cî ũs (sh)	Öc'tô dũ'rũs	Rŭ tē'nî
	Öl löv'î cõ	Rŭ'tî lũs
	Ôr çÿn'î á	Sâ bî'nũs
		Sâ'bîs

Săm à rồ bri'va	Tär bël'li	Văn gũ'ồ nêş
Săn'tồ nêş	Tär'ủ sã'têş	Vê lã'nĩ ùs
Săn'tồ nĩ	Tãs gẽ'tĩ ùs (sh)	Vêl'ĩ ồ cãs'sêş
Scãl'dĩs	Tãx'ĩ mǎg'ủ lूस	Vêl lã'u'nồ dũ'nũm
Sê dũ'li ùs	Têc tỗ's'ã gẽş	Vêl lã'vĩ i
Sê dũ'nĩ	Tênc'tê ri	Vê nê'lĩ
Sê dũ'sĩ i (sh)	Têr'ra sĩd'ĩ ùs	Vên'ê ti
Sêg'nĩ	Teủ tòm'ã tूस	Vê nê'tĩ á (sh)
Sêg'ồ nãx	Teũ'tồ nêş	Vêr'ã grĩ
Sê gõn'tĩ ã'sĩ (sh)	Tĩg'ủ ri'nĩ	Vêr bĩg'ê nूस
Sê gũ'sĩ ã'vĩ (sh)	Tĩ tũ'ri ùs	Vêr cãs'sĩ vêl lã'u'nूस
Sêm prồ'nĩ ùs	Tĩ'tूस	Vêr'çĩn gêt'ồ rĩx
Sên'ồ nêş	Tồ lỗ'sã	Vêr'tĩ cồ
Sêq'uã nã	Tồ lỗ's'ã têş	Vêr'ủ dồc'tĩ ùs (sh)
Sêq'uã nĩ	Trãns rhê nã'nĩ	Vê sỏn'tĩ ồ (sh)
Sêr tồ'ri ùs	Trê'bĩ ùs	Vĩ ên'nã
Sêr'vĩ ùs	Trêv'ê ri	Vĩr'ĩ dồ mã'rूस
Sêx'tĩ ùs	Trĩb'ồ çêş	Vĩ rĩd'ồ vĩx
Sĩb'ủ sã'têş	Trĩn'ồ bãn'têş	Vĩr'ồ mãn'dũ i
Sĩ lã'nूस	Tủ lĩn'gĩ	Vồ cã'têş
Sĩl'ĩ ùs	Tủl'li ùs	Vồc'cĩ ồ (sh)
Sồ'tĩ ã'têş (sh)	Tủl'lूस	Vồ cỏn'tĩ i (sh)
Suês'sĩ ồ'nêş (w)(sh)	Tũ'rồ nêş	Vồl'çãê
Suê'vĩ (w)	Ū'bĩ i	Vồl cã'nूस
Sủ gãm'brĩ	Ū sĩp'ê têş	Vồl cã'tĩ ùs (sh)
Sủl'lã	Vãc'ã lूस	Vồl'ủ sê'nूस
Sủl pĩ'cĩ ùs (sh)	Vã lê'rĩ ùs	Vồ rê'nूस
	Vãl'ê ti ã'cूस (sh)	Vồs'ê gूस

VOCABULARY
TO
CÆSAR'S GALLIC WAR.
COVERING SEVEN BOOKS.

abrip̄iō, -ripere, -ripuī, -reptus, [ab-rapio, *seize*], 3. v. a., *carry off* (with violence), *drag away*.

abs, see **ab**.

absc̄idō, -c̄idere, -c̄idī, -c̄isus, [absc̄aedo], 3. v. a., *cut off, lop off, tear off, tear away*.

absc̄isus, p. p. of **absc̄idō**.

absēns, -entis, see **absum**.

absimilis, -e, [ab-similis, *like*], adj., *unlike*.

absistō, -sistere, -stitī, no p. p., [ab-sisto], 3. v. n., *stand off, stand away, withdraw*.—Fig., *leave off, keep aloof*.

abstineō, -tinēre, -tinuī, -tentus, [absteneo], 2. v. n., *hold* (one's self) *off*.—Fig., *refrain, spare*: proelio (*refrain from giving*); mulieribus (*spare*).

abstrāctus, p. p. of **abstraho**.

abstrahō, -trahere, -trāxī, -trāctus, [abstraho], 3. v. a., *drag off, drag away*.

absum, -esse, -fuī (āfuī), -futūrus, [ab-sum], irr. v. n., *be away, be absent, be off* (at a distance).—Fig., *suspicio* (*be wanting*); *nomen* (*be far from helping*); *ab eo quin* (*be far from being*); *multum quin* (*lack much of, etc.*); *longius quin* (*be farther off than that*); *a bello* (*keep aloof, take no part in*); *ab hoc consilio* (*not be concerned in*).—**absens**, p. as adj., *absent, in one's absence*.

abundō, -āre, -āvī, -ātūrus, [† abundō, lost adj. st., *abounding*; cf. *abunde, abundantly*], 1. v. n., *overflow*.—Fig., *abound*.—Transf. (of the place, etc., containing the thing), *be strong in, be rich in, abound in*.

ac, see **atque**.

accēdō, -cēdere, -cessī, -cessūrus, [ad-cedo, *go or come*], 3. v. n., *move towards, draw near, approach, come up, come (to), advance to, advance*.—Fig., *come to*: Remis studium (*be inspired in, cf. discedo*).—Esp., *be added*, where often an explanatory word is necessary in Eng.: *huc accedere, be in addition to this*; *huc accedebat ut, there was also this* (disadvantage) *that*; so with **quod**, *there was also the fact that, there was also the reason that*, or simply *moreover, then again*.

accelerō, -āre, -āvī, -ātus, [accelero, *hasten*; cf. *celer, swift*], 1. v. a. and n., *hasten*.

acceptus, p. p. of **accipio**.

accessus, p. p. of **accedo**.

accidō, -cidere, -cidī, no p. p., [ad-cado], 3. v. n., *fall to, fall upon, fall. tela gravius* (*strike*).—Fig., *happen, befall, occur, present itself, turn out, arise*.—Often euphemistically for death, defeat, etc.: *si quid Romanis; gravius a Caesare* (*be done, severe measures be taken*).

accidō, -cidere, -cidī, -c̄isus, [ad-caedo], 3. v. a., *cut into, partly cut*.

accipiō, -cipere, -cēpī, -ceptus, [ad-capio] 3. v. a., *take, receive*: exercitum (*take command of*).—Less exactly, *volnus*; *incommodum* (*suffer, meet with*).—Fig., *accept, learn, hear, get, take*: *excusationem*; *usus* (*acquire*); *aliquid fama* (*hear of*).—**acceptus**, -a, -um, p. p. as adj., *acceptable*.

acclivis, -e, [ad-clivus, *slope* (weakened)], adj., *sloping towards, rising, sloping, ascending*: *collis; aditus*.

acclivitās, -tātis, [acclivi- + tas], F., *slope (upward), inclination, steepness*.

Accō, -ōnis, [Celtic], M., one of the Senones, who stirred up his people against the Romans.

accommodātus, p. p. of **accommodo**.

accommodō, (adc-) -āre, -āvī, -ātus, [accommodō-*fitting*, or ad-*commodo*], I. v. a., *fit on, fit: insignia (put on, adjust)*. — **accommodātus**, -a, -um, p. p., *fitted, adapted*.

accūrātē, [old case-form of **accuratus**, *done with care*], adv., *with care, carefully*.

accurrō, -currere, -currī (-cucurrī), no p. p. [ad-*curro*], 3. v. n., *run to, run up (on foot), rush up (on horseback), ride up*.

accūsō, -āre, -āvī, -ātus, [ad-*causo*, *assign as a reason or charge*], I. v. a., *accuse, blame, find fault with*.

ācer, -cris, -cre, [AC, *sharp* (cf. **acus**, *needle*), + *ris*], adj., *sharp*. — Fig., *keen, active, violent*. See **acriter**.

acerbē [acerbis], adv., *bitterly*. — Fig. (of the mind), *ferre inopiam (suffer severely from, etc.)*.

acerbitās, -tātis, [acerbō- + tas], F., *bitterness*. — Concrete in plur., *sufferings* (with a change of point of view in Eng.).

acerbis, -a, -um, [acer (treated as st.) + *bus* (cf. **superbus**)], adj., *bitter* (to the taste). — Fig. (to the mind), *bitter, hard to bear, cruel*.

ācerimē, superl. of **āceriter**.

acervus, -ī, [acer (shortened as st.) + *vus*], M., (*pointed?*), *a heap, a pile*.

aciēs, -ēī, [AC (*sharp*) + *ies* (cf. **materies**)], F., *point, sharp edge, edge: oculorum (keen glance, glare)*. — Esp., *line, battle line, array, army* (in battle array, cf. **agmen**), *rank* (of an army in several ranks): *acie instructa depugnare, fight a pitched battle*.

acquirō, see **adquiro**.

ācriter [acri- + *ter*], adv., *sharply*. — Fig., *fiercely, violently, hotly* (of fighting), *with spirit: acriter pugnatum est, a fierce battle was fought, there was hot fighting*.

āctūārius, -a, -um, [actu-, *movement* (AG in ago) + *arius*], adj., *fast sailing* (provided with both sails and oars).

āctus, p. p. of **ago**.

acuō, -uere, -uī, -ūtus, [acu-, *sharp* (in **acus**, *needle*)], 3. v. a., *sharpen*. — **acūtus**, -a, -um, p. p. as adj., *sharpened, sharp*.

acūtus, p. p. of **acuō**.

ad [?], adv. (in comp.). — Prep. with acc. With idea of motion, *to, towards, against*. — Where the idea of motion is more or less obliterated, *to, towards, for, at, on, against, in, near, in regard to*. — Of time, *till, at, on; ad diem, on the day*. — With numerals, *about*. — Esp., *deferre ad, lay before; recepti ad se (among); ad fortunam Caesari defuit (Caesar lacked to complete, etc.); contendere ad occupandam (to, for), and often with the gerund or gerundive expressing purpose; ad certum pondus (up to, i.e. of); ad modum (in); commeare ad, visit; ad impedimenta (by); ad auxilium*

(to give assistance); **ad arbitrium** (according to); **proficisci ad** (for); **ad unum**, to a man; **ad celeritatem** (for, in the way of); **ad speciem**, for show; **ad extremum**, at last, finally. — In comp., to, towards, up to, up against, in, by, in addition, and the like.

a. d., see ante.

adāctus, p. p. of **adigo**.

adaequō, -āre, -āvī, -ātus, [**adaequo-**, make equal; cf. **aequus**], 1. v. a., make equal to: **moles moenibus** (make as high as). — More commonly with the verb neuter and the acc. or dat. depending on the combined idea, become equal to, equal: **altitudinem muri** (reach up to); **cursum** (keep up with).

adamō, -āre, -āvī, -ātus, [**adamo**, love], 1. v. a., take a fancy to, fall in love with, covet, become attached to.

addō, -dere, -didī, -ditus, [**ad-do** (1 and 2)], 3. v. a., give to. — Also, place to, add (with acc. or absolutely).

addūcō, -dūcere, -dūxī, -ductus, [**ad-duco**], 3. v. a., lead to, draw to, bring in (of persons), bring, draw in (towards one), drive, force. — Fig., induce, drive.

adductus, p. p. of **adduco**.

adēmpus, p. p. of **adimo**.

adeō, -ire, -ī (īvī), -itus, [**ad-eō**], irr. v. a. and n., go to, visit, get at, come to, come up, go to (a place), get in (to a place), advance (somewhere), attack, approach (speak with), accost: with **ad**, come into the presence of.

adeō [**ad-eō** (thither)], adv., to that point. — Less exactly, to that degree,

so much so: **discessisse adeo ut** (so speedily that). — Still weaker, in fact, at all, exactly.

adeptus, p. p. of **adipiscor**.

adequitō, -āre, -āvī, no p. p., [**adequito**, ride, cf. **eques**], 1. v. a. and n., ride up, ride against, skirmish with (of cavalry).

adfectus, p. p. of **adfacio**.

adferō (aff-), -ferre, -tulī, -lātus, [**ad-fero**], irr. v. a., bring to, bring: **litteras**. — Fig., cause, bring forward, allege, report, announce: **fortuna casus** (bring about, give).

adficiō (aff-), -ficere, -fēcī, -fectus, [**ad-facio**], 3. v. a., do to, affect. — With acc. and abl., affect with, inflict upon, produce in, cause to, visit with, fill with. — In passive, suffer, receive, be in (a condition), be afflicted by, suffer from: **beneficio adfectus**, having received favors; **magno dolore adfici**, be greatly distressed.

adfigō (aff-), -figere, -fixī, -fixus, [**ad-figo**, fix, fasten], 3. v. a., fasten to (by insertion or the like).

adfiŋgō (aff-), -fiŋgere, -fiŋxī, -fiŋtus, [**ad-fiŋgo**], 3. v. a., make up in addition. — Of rumors, invent more, add.

adfinitās (aff-), -tātis, [**adfini-** (close to, fr. **finis**, boundary) + **tas**], F., nearness. — Esp. of relation by marriage, relationship, alliance, connection. — Concretely, a connection: **adfinitatibus coniuncti** (marriages).

adfirmātiō (aff-), -ōnis, [**adfirmatio**, cf. **adfirmo**, assert], F., assurance. — Concretely, an assertion.

adfixus (aff-), p. p. of **adfigo**.

adfectō (aff-), -āre, -āvī, -ātus, [**ad-**

flicto, cf. **adfligo**], 1. v. a., *dash against, dash upon, dash to the ground*. Hence, *overthrow, overwhelm, wreck*.

adflīctus (aff-), p. p. of **adfligo**.

adflīgō (aff-), -flīgere, -flīxī, -flīctus, [ad-fligo], 3. v. a., *dash upon*. Hence, *overthrow, wreck, overturn*: **navis** (*shatter, damage*); **arbores** (*throw down*).

adfore (aff-), see **adsum**.

adgredior (agg-), -gredi, -gressus, [ad-gradior, *step, go*], 3. v. dep., *go towards, go to, march against, attack*.

adgregō (agg-), -āre, -āvī, -ātus, [ad-grego, *flock*, cf. **grex**, *flock*], 1. v. a., *unite in a flock, gather*: **se** (*gather around, flock to*); **se ad amicitiam** (*attach one's self to*).

adhaerēō, -haerēre, -haesi, -haesūrus, [ad-haereo], 2. v. n., *stick (to), cling (to), get caught (in)*.

adhaerēscō, -ere, [ad-haeresco], 3. v. n., same meaning as **adhaereo**.

adhibeō, -ēre, -uī, -itus, [ad-habeo], 2. v. a., *have in*. Hence, *call in, admit, bring with (one)*. — Fig., *employ, use*.

adhibitus, p. p. of **adhibeo**.

adhortor, -ārī, -ātus, [ad-hortor], 1. v. dep., *encourage, address, urge, rally* (soldiers).

adhūc [ad-huc, *hither*], adv., *hitherto* (of place). — Of time, *up to this time, till now, to this day*.

adiaceō, -iacēre, -iacuī, no p. p., [ad-iaceo], 2. v. n., *lie near, border on, be adjacent*.

Adiatunnus, -ī, [Celtic], M., chief of the Sotiates.

adiciō (adiic-), -icere, -iēcī, -iectus,

[ad-iacio], 3. v. a., *throw to, hurl, fling*: **telum adici** (*be thrown to, i.e. reach*); **aggerem** (*throw up*). — Fig., *join to, add*: **adiecta planities** (*with the addition of*).

adigō, -igere, -ēgī, -āctus, [ad-ago], 3. v. a., *drive to, drive up* (of cattle, etc.). — Less exactly, *drive in, drive home* (of piles), *move up* (of towers), *shoot* (of weapons). — Fig., *force, bind* (by oath.)

adimō, -imere, -ēmī, -ēemptus, [ad-emo, *take*], 3. v. a., *take away* (the action being looked upon as done to somebody, usually in the dat.). — Fig., *destroy, cut off*, **spem**; **prospectum** (*intercept, cut off*).

adipīscor, -ipīscī, -eptus, [ad-apiscor, *lay hold of*], 3. v. dep., *obtain, secure*: **victoriam** (*win, gain*).

aditus, -ūs, [ad-itus, cf. **adeo**, *go to*], M., *approach, arrival, coming, access*: **defugere** (*contact, intercourse*). — Concretely, *an avenue* (of approach), *access* (excuse for approaching), *admission, means of approach, means of access, way of approach, approach* (in military sense); **sermonis** (*occasion for intercourse*); **ad uxorem** (*intercourse*).

adiectus, p. p. of **adicio**.

adiūdicātus, p. p. of **adiudico**.

adiūdicō, -āre, -āvī, -ātus, [ad-iudico, cf. **iudex**, *judge*], 1. v. a., *adjudge, assign* (by deliberation).

adiungō, -iungere, -iūnxī, -iūnctus, [ad-iungo], 3. v. a., *join to, unite to, attach, unite with*.

adiūtor, -tōris, [ad-+iutor, cf. **adiuvo**, *help*], M., *helper, assistant, abettor*.

adiūtus, p. p. of **adiuvo**.

adiuvō, -iuvāre, -iūvī, -iūtus, [ad-iuvo, *help*], 1. v. a., *assist, help, help on, be of advantage, be an assistance to*; ad spem (*encourage*).

adlātus (all-), p. p. of **adfero**.

adliciō (all-), -licere, -lēxī, -lectus, [ad-lacio], 3. v. a., *allure to, invite, entice, attract*.

admāturō, -āre, -āvī, -ātus, [ad-maturo, fr. *maturus, early*], 1. v. a., *hasten: defectionem (bring to a head more quickly)*.

administer, -trī, [ad-minister, *servant*], M., *servant, minister: ad sacrificia (priest, celebrant)*.

administrō, -āre, -āvī, -ātus, [ad-ministro, *serve*], 1. v. a., *carry into execution, perform, execute, carry out, carry on (war), attend to (duties): imperia (give, carry out the duties of a commander)*.

admīrātus, p. p. of **admiror**.

admīror, -ārī, -ātus, [ad-mirror, *wonder*], 1. v. dep., *be surprised, wonder at, admire*. — **admīrandus**, -a, -um, as adj., *surprising*. — **admīrātus**, -a, -um, p. p. in pres. sense, *being surprised, wondering*.

admissus, p. p. of **admitto**.

admittō, -mittere, -mīsī, -missus, [ad-mitto], 3. v. a., (*let go to*), *let go: admisso equo, at full speed*. — Fig., *allow* (cf. **com-** and **per-mitto**): in se *facinus (commit a crime)*; *dedecus (permit to be incurred, incur)*. — Also pass. without in se, *be committed*.

admodum [ad-modum, *measure, limit*], adv., *to a degree*. Hence, *very, very much, greatly, exceedingly, so (very) much*.

admoneō, -ēre, -uī, -ītus, [ad-moneo], 2. v. a., *warn, urge*.

adolēscō, -olēscere, -olēvī, -ultus, [ad-olesco, *grow*], 3. v. n., *grow up (to maturity), mature*. See also **adulescens**.

adorior, -orīrī, -ortus, [ad-orior], 4. v. dep., (*rise up against*), *attack, assail*.

adortus, -a, -um, p. p. of **adorior**.

adparō (app-), -āre, -āvī, -ātus, [ad-paro, *make ready*, cf. **pareo**, *be on hand*], 1. v. a. and n., *prepare, get ready, make preparations*.

adpellō (app-), -pellere, -pulī, -pulsus, [ad-pello, *drive*], 3. v. a. and n., *land (ships), bring to land*.

adpetō (app-), -petere, -petīvī, -petītus, [ad-peto, *aim at*], 3. v. a. and n., *seek to gain, desire, aim at*. — Abs., *approach*.

adplicō (app-), -plicāre, -āvī (-uī), -plicātus (-plicitus), [ad-plico, *fold*], 1. v. a., (*bend towards*). With reflex., *lean against*.

adportō (app-), -āre, -āvī, -ātus, [ad-porto, *carry*], 1. v. a., *bring in, bring (to some place)*.

adprobō (app-), -āre, -āvī, -ātus, [ad-probo, *esteem good*, cf. **probus**, *good*], 1. v. a., *approve of, agree with (an opinion or action)*.

adpropinquō (app-), -āre, -āvī, no p. p., [ad-propinquo, cf. **propinquus**, *near*], 1. v. n., *approach, come nearer, come near*.

adpulsus (app-), p. p. of **adpello**.

adquirō (acq-), -quīrere, -quīsivī, -quīsītus, [ad-quaero, *seek*], 3. v. a. (*get in addition*), *acquire: aliquid (gain some advantage)*.

adripiō (arr-), -ripere, -ripuī, -reptus, [ad-rapio], 3. v. a., *snatch up, seize*.

adroganter (arr-), [adrogant- (st. of p. of **adrogo**, *assume*) + ter], adv., *with presumption, presumingly, with insolence*.

adrogantia (arr-) -ae, [adrogant- (see preceding) + ia], F., *insolence, insolent conduct, presumption*.

adscendō, see **ascendo**.

adscēsus, see **ascensus**.

adsciscō (asc-), -sciscere, -scivī, -scītus, [ad-scisco, *approve*, fr. **scio**], 3. v. a., *attach* (by formal decree). — Less exactly, *attach to* (one's self), *unite with* (one's self).

adsiduus (ass-), -a, -um, [ad-†siduus (SED in **sedeo**, *sit*) + uus], adj., (*sitting by*), *constant, continued, incessant*.

adsistō (ass-), -sistere, -stitī, no p. p., [ad-sisto, *place* (one's self)], 3. v. n., *stand by, attend, assist*: in **conspectu patris** (*appear*).

adspetus (asp-), -ūs, [ad-†spetus, cf. **adspicio**, *look at*], M., *a looking at*. — Transf., *an appearance, aspect*.

adsuēfaciō (ass-), -facere, -fēcī, -factus, [†adsuē- (cf. **suesco**, *become accustomed*) -facio, *make*], 3. v. a., *accustom, train*. — Pass., *be accustomed*.

adsuēfactus (ass-), -a, -um, p. p. of **adsuēfacio**.

adsuēscō (ass-), -suēscere, -suēvī, -suētus, [ad-suesco, *become accustomed*], 3. v. a. and n., *accustom, become accustomed, become wonted* (of animals).

adsuētus (ass-), -a, -um, p. p. of **adsuesco**.

adsum, -esse, -fuī, -futūrus, [ad-sum], irr. v. n., *be near, be by, be present, be at hand, be there, appear*.

Aduatuca, -ae [Celtic, *a fortress?*], F., *a fortress of the Eburones* (prob. *Tongres*), near the Meuse.

Aduatucī, -ōrum [Celtic], M., pl., *a tribe of the Belgæ* (originally Germans) living on the west bank of the Meuse (later, *Tongri*).

adulēscēns (adol-), -entis [p. of **adolesco**, *grow up*], adj., *young*. — As noun, *a youth, young man*. — With proper names, *the younger* (Jr., to distinguish one from his father).

adulēscēntia (adol-), -ae, [adulescent- + ia], F., *youth*.

adulēscētulus (adol-), -ī, [adulescent- + ulus, dim. end.], M. (often as adj.), *a mere boy, very young*.

adventus, -ūs, [ad-†ventus, cf. **advenio**, *come to*], M., *a coming, arrival, approach*.

adversārius, -a, -um, [adversō- (reduced) + arius], adj., (*turned towards*), *opposed*. — As noun, *opponent, adversary, foe, enemy*.

adversus, p. p. of **adverto**, in various uses.

adversus, prep. with acc., see **adverto**.

advertō, -vertere, -vertī, -versus, [ad-verto], 3. v. a., *turn towards*: **animum** (*turn the attention, notice*, see **animadverto**), *turn against, turn* (to anything). — **adversus**, -a, -um, p. p. as adj., *in front, opposed, opposite, in opposition, adverse, un-*

favorable, in the face of: proelium (*unsuccessful*); hostibus adversus occurrebant (*right against, in their front*); in adversum os, *right in the face*; flumine (*up, cf. secundo*); res adversae, *adversity, want of success*. — adversus [petrified as adv., cf. versus], prep. with acc., *against*.

advocō, -āre, -āvī, -ātus, [ad-vocō], I. v. a., *call (to one), summon*.

advolō, -āre, -āvī, -ātūrus, [ad-volo], I. v. n., *fly to, fly at*. — Less exactly, of cavalry, *rush at, fly at, charge upon*.

aedificium, -ī, [†aedific- (cf. aedifico) + ium], N., *building*. — Esp. buildings standing singly, opposed to villages, *farm houses*.

aedificō, -āre, -āvī, -ātus, [†aedific- (aedes, *house*, FAC in facio)], I. v. a., *build (of houses)*. — Less exactly, of ships.

aeger, -gra, -grum, [?], adj., *sick, disabled*.

aegerrimē, superl. of aeger.

aegrē [old case-form of aeger], adv., *feebly*. Hence, *with difficulty, hardly, scarcely, barely*.

Aemilius, -ī, [?], M., (Lucius), a Gaul, a subaltern in Cæsar's Gallic cavalry. Probably named from some Roman Aemilius from whom he had received the citizenship.

aequāliter [aequali- (fr. aequus, *even*) + ter], adv., *evenly, uniformly*.

aequinoctium, -ī, [as if aequinoct-, indirectly fr. aequo-, *equal*, nox (*night*) + ium], N., *the time of the equinox, the equinox*.

aequitās, -tātis, [aequō- (*even,*

equal) + tas], F., *evenness*. Hence (cf. aequus), *fairness, justice*. — Esp., aequitas animi, *evenness of mind, contentment, resignation*.

aequō, -āre, -āvī, -ātus, [aequō-, *equal*], I. v. a., *make equal, equalize*.

aequus, -a, -um, [?, perh. akin to unus, formed with -cus instead of -nus], adj., *even, level, equal*. Hence, *fair, just, equitable*. — Esp., aequus animus, *equanimity, contentment, resignation*; aequo animo aliquid facere (*be resigned to, be satisfied to, be content to*); contentio (*on equal terms*); aequo Marte, *on equal terms, with equal success*.

aerārius, -a, -um, [aer- (as st. of aes, *copper*) + arius], adj., (*having to do with copper*). — Fem. as noun, *a mine*.

aereus, -a, -um, [aer- (as st. of aes, *copper*) + eus], adj., *of copper, copper* (as adj.).

aes, aeris, [?], N., *copper* (as metal for ships, or as money). Hence, *money*. — Esp., alienum (*debt, another man's money*).

aestās, -tātis, [st. akin to aedes (*hearth*) + tas], F., (*heat*), *summer* (the season for military operations).

aestimātiō, -ōnis, [aestimā- (st. of aestimo, *value*) + tio], F., *valuation, estimation, value*.

aestimō, -āre, -āvī, -ātus, [aestimō-, *assayer*], I. v. a., *value, estimate*. — Less exactly, *regard*: grāvius (*consider more serious, of calamities*).

aestivus, -ā, -um, [†aestu- (cf. aestus, *heat*) + ivus], adj., *hot*. Hence, *summer* (as adj.): tempus.

aestuārius, -a, -um, [aestu- (cf. *aestus*, *tide*) + *arius*], adj., (*relating to the tide*). — Only in neut., as noun, *creek, estuary, marsh*.

aestus, -tūs, [AID (in *aedes*, *hearth*) + *tus*], M., *heat* (plur. in same sense). Hence, *boiling, tide*.

aetās, -tātis, [for *aevitas*, fr. *aevo-* (st. of *aevum*, *age*) + *tas*], F., *age* (of old or young): *aetate confectus*, *oppressed with years*.

aeternus, -a, -um, [*aevo-* (st. of *aevum*, *age*) + *ternus*], adj., (*relating to age*), *eternal, lasting*.

aff-, see **adf-**.

Āfricus, -a, -um, [Afro- (st. of *Afer*, *African*) + *cus*], adj., *of Africa*. — Esp., sc. *ventus*, *the S.W. wind* (blowing from Africa to Italy).

āfuisse, **āfutūrus**, see **absum**.

Agēdincum, -ī, [Celtic], N., chief town of the Senones, on the Yonne; now *Sens*.

ager, **agrī**, [AG in **ago** (*drive*?) + *rus*, akin to Eng. *acre*], M., *land* (cultivated), *fields, country* (opposed to city), *territory* (country), *cultivated lands, fields* (as opposed to woods).

agger, -eris, [ad-ger (for GES in *gero*, as st.). M., (*that which is carried to a place*), *earth* (for a wall), *earth of a wall, a mound of earth, a wall, a rampart, a mole, a dike* (either the regular earthwork of the Romans for an entrenched camp or line of circumvallation, or the dike of approach, a long sloping mound leading up to the height of the walls): *cotidianus* (*daily addition to the dike or walls*).

agg- (except **agger**), see **adg-**.

agitō, -āre, -āvi, -ātus, [agitō- (freq. of *ago*, *put in motion*)], I. v. a., *drive, chase*. Hence, *vex, trouble*. — Fig., *turn over* (in mind), *propose, discuss, purpose*.

agmen, -minis, [AG (in *ago*, *put in motion*) + *men*], N., *a moving, a march*. — Concretely (of bodies in motion), *a body in motion, a column, an army, a line* (of troops in march), *a train, a fleet*. — Less exactly, *an army* (not in march). Phrases: *primum* (*the van*); *novissimum* (*the rear*); *claudere* (*bring up the rear*); *conferto agmine*, *in close order*; *agmine*, *on the march*; *agmen legionum* (*the main column*); *extremo agmine*, *in the rear*.

agō, **agere**, **ēgī**, **āctus**, [AG, *put in motion*], 3. v. a., *drive* (apparently from behind, cf. *duco*, *lead*): *sublicas* (*drive down*); *vineas, turres*, etc. (*set in motion, move on, advance*); *cuniculos* (*extend*); *ac portare* (of live stock as booty, *drive off*). — Loosely, *do* (cf. “carry on”), *act, treat, discuss, plead*. — Phrases: *conventum* (*hold*); *gratias* (*render, give, express*, cf. *habere* and *referre*); *quid agit*, *what is one about?*; *quid agitur*, *what is going on?*; *de obsessione agere* (*do anything about, engage in*).

agricultūra, see **cultura**.

alacer, -cris, -cre, [?], adj., *active, eager, spirited*.

alacritās, -tātis, [alacri- (*eager*) + *tas*], F., *eagerness, readiness, spirit, promptness*.

ālārius, -a, -um, [ālāri- (st. of

ala, *wing*, + ris] + ius], adj. (*belonging to the wings*). Hence, of the *allies* (who held the wings of the army). — M. plur. as noun, *allies, auxiliaries*.

albus, -a, -um, [?, cf. **Alpes**], adj., *white* (pale, opp. to **ater**, cf. **candidus**, *shining white*, opp. to **niger**): **plumbum album**, *tin*.

alcēs, -is, [Teutonic, cf. *elk*], F., *the elk* (a large beast of the deer kind, resembling the moose).

Alesia, -ae, [Gallic], F., a city of the Mandubii, west of Dijon; now *Alise Ste. Reine*.

aliās [unc. case-form of **alius**, but cf. **foras**], adv., *elsewhere*. — Of time, *at another time*: *alias . . . alias, now . . . now* (cf. **alius . . . alius**).

aliēnātus, p. p. of **alieno**.

aliēnō, -āre, -āvi, -ātus, [**alienō**, *another's*], I. v. a., *make another's*. — Also, *make strange, alienate, estrange*: *alienata mente, in a frenzy*.

aliēnus, -a, -um, [unc. st. akin to **alius**, *other*, (prob. imitated from verb-stems of 2d conj.) + **nus**], adj., *another's, of others, other people's*: **fines** (*others'*); **aes** (*debt*). Hence, *strange, foreign, unfavorable* (cf. **suus**), *foreign to the purpose*. — Superl., M. plur. as noun, *perfect strangers*.

aliō [old case-form of **alius**], adv., *elsewhither, elsewhere* (of end of motion).

aliquamdiū [**aliquam-diu**, cf. **quam diu**], adv., *for some time, some time, a considerable time*.

aliquandō [ali- (in **alius**, *other*) -**quando**, *when*], *at some time*. —

Emphatically, *at last* (at some time, though not before).

aliquantō, see **aliquantus**.

aliquantus, -a, -um, [ali- (in **alius**, *other*) -**quantus**, *how great* (cf. **aliquis**)], adj., *considerable*. — Neut., as noun, *a good deal, a considerable part*. — **aliquantō** (as abl. of measure), *by considerable, considerably, a good deal*.

aliquis (-**quī**), -qua, -quid (-quod), [ali- (in **alius**, *other*) -**quis**, *any*], indef. pron. (more forcible than **quis**; not universal, like **quisquam**), *some, any*. — Emph., *some* (considerable), *any* (important). — As noun, *some one, any one, something, anything*.

aliquot [ali- (in **alius**, *other*) -**quot**, *how many*], indecl. adj., *several, some* (more than one, but not conceived as many).

aliter [ali- (in **alius**, *other*) + **ter**], adv., *otherwise, differently*. — Often rendered by a noun or adjective implied in the context, *aliter se habere ac, be different from what*, etc.; *nec aliter sentire quin, have no other idea but that*.

alius, -a, -ud, [unc. root (cf. *else*) + **ius**], adj. pron., *another* (any one, not all), *other, different, else, another* (of the second of three or more). — Repeated (either in separate clauses or in same), *one . . . another, one another, one one* (thing), *another another*: **alius alia causa illata**, *alleging different reasons*; **alius ex alio** (*from different, etc., one from one, another from another*). — Esp. in a partitive use, **ex aliis** (with superl., *most of all others*, cf. "the

fairest of her daughters, Eve");
 alius atque (see atque).

all-, see adl-.

Allobroges, -um, [Celtic], M. plur., a Celtic people (of Gaul), living between the Rhone, the Isère, the Lake of Geneva, and the Alps (in *Dauphiny* and *Savoy*). They were conquered in B.C. 121 by Fabius Maximus.

alō, alere, aluī, altus, [AL, *nourish*], 3. v. a., *cause to grow, feed, nurse, support* (supply with food), *foster, raise, keep* (of animals): *staturam* (*increase*).— Fig. *foster, foment, feed*.

Alpēs, -ium, [Celtic form, (cf. *albus*) + *is*], F. pl., *the Alps*, more or less loosely used of the whole mass of mountains between Italy (Cisalpine Gaul), Gaul, and Germany.

alter, -era, -erum, [AL- (in *alius*, *other*) + *ter* (for -*terus*, compar. suffix)], adj. pron., *the other* (of two).— In plur., *the other party*.— Repeated (cf. *alius*), *one the other, one another* (of two), *one . . . the other*.— In plur., *one party . . . the other*.— Also, *the second* (of more than two), *another* (the second of three): *dies* (*the second*).— Also (esp. with negatives), *another* (beside one's self, where all are conceived as two parties, one's self and all the rest).

alternus, -a, -um, [alter- (as st.) + *nus*], adj., *alternate, reciprocal, mutual, alternating*.

altitūdō, -inis, [altō- (*high*) + *tudo*], F., *height, depth* (cf. *altus*), *thickness* (of a timber).

altus, -a, -um, [p. p. of *alo* (*nour-*

ish), as adj.] (*grown high by nourishing*), *high*.— From opposite point of view, *deep*.— Neut., as noun, *the sea, the deep*: in *alto*, *in deep water*; ex *alto*, *from the sea*.

alūta, -ae, [? cf. *alumen, alum*], F., *leather* (of a fine sort, like *morocco*?).

amb- [akin to *ambo*, *both*], prep. only in comp., *about, round about*.

ambactus, -ī, [prob. German], M., *a retainer, a vassal*.

Ambarriī, -ōrum, [Celtic], plur. of adj., a tribe of Gaul, on the Saône. They seem to have been clients of the Hædui, and are called Hædui Ambarri.

Ambiānī, -ōrum, [Celtic], M. plur. of adj., a Belgian tribe, whose chief town, Samarobriva, is now called from their name, *Amiens*.

Ambibariī, -ōrum, [Celtic], M. plur. of adj., an Aremoric tribe living in a part of Normandy.

Ambiliāti, -ōrum, [Celtic], M. plur. of adj., a tribe on the Somme (possibly part of the preceding).

Ambiorix, -īgis, [Celtic], M., an able prince of the Eburones. He caused a revolt of his nation against Cæsar, which was partially successful, and came near being entirely so. He caused Cæsar uneasiness for several years, and eluded every effort to capture him.

Ambivaretī (**Ambila-**), -ōrum, [Celtic], M. plur. of adj., a Gallic tribe, dependents of the Hædui.

Ambivaritī, -ōrum, [Celtic], M. plur. of adj., a Belgic tribe on the west bank of the Meuse.

ambō, -ae, -ō (-ōrum), [akin to **amb-**, *round about*], num. adj., *both* (together, cf. **uterque**, *both separately*).

āmēns, -entis, [ab-mens], adj. (*having the mind away*), *mad, crazy*.

āmentia, -ae, [ament- (*mad*) + ia], F., *madness, frenzy*, (*mad*) *folly*.

āmentum, -i, [? unc. root + mentum], N., *a thong* (attached to a javelin, and wound around it to give it a twisting motion in throwing, as with rifle balls).

amīcītia, -ae, [amicō- (*friendly*) + tia], F., *friendship, friendly relations, alliance*. — Opp. to **hospitium**, *personal friendship*.

amīcus, -a, -um, [unc. st. fr. AM (in **amo**, *love*) + cus], adj., *friendly, well disposed*: **praesidium** (*devoted*). — As noun, M., *a friend, an ally*.

āmissus, p. p. of **amitto**.

āmītō, -mittere, -mīsī, -missus, [ab-mitto], 3. v. a., *let go (away), let slip, let pass*. Hence, *lose* (esp. of military losses).

amor, -ōris, [AM (in **amo**, *love*) + or (for os)], M., *love, affection*.

amplē [old case-form of **amplus**], adv., *widely, largely*. — **amplius**, compar., *farther, more, longer*: **amplius quingenti**, *five hundred and more*; **ne quis**, . . . **amplius** (*any more*); **amplius obsidum** (see **amplus**); **munera amplissime missa** (*generous gifts*).

amplificātus, p. p. of **amplifico**.

amplificō, -āre, -āvī, -ātus, [amplificō-, (amplō-) with FAC, *make*], 1. v. a., *increase, enlarge, extend, heighten*.

amplitūdō, -inis, [amplō- (*large*) + tūdō], F., *size, extent, greatness*: **cornuum** (*spread*).

amplus, -a, -um, [?, perh. amb- (*about*) + st. akin to **plus, plenus**], adj. Of size and extent, lit. and fig., *large, wide, great*. — Esp., *prominent, of consequence, splendid, noble, distinguished*: **munera** (*lavish, valuable*); **dimissis amplioribus copiis** (*the greater part of*). — **amplius**, neut. comp. as noun (cf. **plus**), *more, a greater number*: **amplius obsidum**.

an, [?], conj. introducing the second member of a double question, *or, or rather*. — Often with the first member only implied, *or*: **quid venirent, an speculandi causa** (*(or) was it*).

Anartēs, -ium, [?], M. plur., a people in Dacia (*Transylvania*), on the river Theiss, at the eastern end of the Hercynian forest.

Ancalites, -um, [Celtic], M. plur., a nation of Britain.

anceps, -cipitis, [amb-, *about, caput, head*], adj., (*having a head on both sides*), *double-headed*. — Less exactly, *twofold, double*: **proelium** (*on both fronts*, of an army facing in two ways).

ancora, -ae, [Gr.], F., *anchor*: **in ancoris**, *at anchor*.

Andēs, -ium, [Celtic], M. plur., a tribe of Gaul north of the Loire, in modern *Anjou*.

Andī, -ōrum, the same as the **Andes**.

Andocombogius, -ī, [Celtic], M., a chief man of the Remi.

ānfractus (ām̄f-), -ūs, [am(b)-,

†*fractus*, fr. FRAG (in *frango*, *break*), M., a *bending round*. Hence, a *winding, a circuit, a deviation* (from a straight line).

angulus, -ī, [prob. ancō- (st. of *ancus*, *bent*) + *lus*], M., (a little hook), a *corner*.

angustē [old case-form of *angustus*], adv., *narrowly, in narrow quarters* (closely). — Fig., *sparingly* (cf. *ample*), *in small quantity*.

angustiae, -ārum, [angustō- (*narrow*) + *ia*], F. plur., *narrowness* (prop. concrete, *narrows*); *itinerum* (*a narrow pass*); *propter angustias* (*narrowness of the passage*). — Fig., *straits* (difficult position, etc.), *hard straits, difficulties*: *angustiis premi*, *to be hard pushed*.

angustus, -a, -um, [angor (*squeezing*) + *tus*], adj., *narrow, confined*: *angustiora castra* (*less extensive*); *angustiore fastigio* (*narrowing, sloping, drawing in*). — Fig., in *angusto res est*, *the position is critical* (cf. 'in a tight place').

anima, -ae, [ani- (treated as root, fr. AN, *blow*) + *ma* (F. of *mus*), cf. *animus*], F., *breath*. Hence, *soul*. — Plur., *the soul* (of man, abstractly).

animadvertō, -vertere, -vertī, -versus, (also *animum adverto*), [animum *adverto*], 3. v. a., *turn the mind to, attend to*: *in aliquem* (*punish*, cf. the domestic "attend to"). — Less exactly, *observe, notice, learn*.

animal, -ālis, [anima- + *lis*, N. of adj.], N., (*a creature endowed with life*), *an animal* (including man), *a living creature* (opp. to *booty*).

animus, -ī, [ani- (st. as root, fr.

AN, *blow*) + *mus*], M., *breath, life, soul* (vital). — Usually (the above meanings being appropriated to *anima*, wh. see), *soul* (as thinking, feeling), *mind, feelings, feeling, intellect* (but cf. *mens*), *spirit*: *effeminare*; *levitas animi* (*disposition, nature, or together, want of constancy*); *animus relinquit aliquem*, *one faints, loses consciousness*; *animi mollitia*, *want of energy or endurance*; *animo paratus*, *resolute*; *animus advertere* (see *animadverto*). — Esp. (in a good sense, often in plur.), *spirit, constancy, courage, resolution*: *confirmare* (*encourage any one*); *relanguescere*; *promptus*; *paratus ad aliquid*. — Also (as opp. to *mens*, wh. see), *the moral powers, will, desires, affections, etc., the heart, the feelings, the disposition*: *bono animo esse*, *be well disposed, be of good cheer*; *esse in animo alicui*, *to have in mind*, as a purpose; *offendere* or *avertere* (*feelings*); *magni animi*, *of great ambition*. — Also, *animus magnus*, *courage, magnanimity, lofty spirit*; *animi magnitudo*, *lofty spirit*; *permulcere* (*angry spirit*); *mentes animosque perturbare* (*minds, as thinking, and hearts, as feeling, etc.*); *animi virtus*, *nobleness of soul*; *animi causa*, *for pleasure, for amusement, for fancy*.

annōtinus, -a, -um, [some form of *annō-* (*year*) + *tinus* (cf. *diutinus*)], adj., *last year's, old* (of ships made the year before).

annus, -ī, [?], M., *a year* (as a point of time, as the course of the year, or as a period).

annuus, -a, -um, [annō- (*year*) + us], adj., *annual*: magistratus creatur (*annually*).

ānser, -eris, [for **hanser**, akin to *goose*], M., a *goose*.

ante [old case-form], adv., *before* (of place and time), *in front*: ante dictum (*above, before, previously*); ante habuerat (*formerly, once*); iam ante, *already before, already*; paucis ante diebus, *a few days before*. — Prep. with acc., *before* (of place or time): ante se mittit (*in advance of*). — In dates, ante diem (a. d.) (*on such a day before*). — In comp., before (of place, time, and succession).

antēā [ante eā, case-form of is], adv. (of time), *before, previously, once*.

antecēdō, -cēdere, -cessī, -cessus, [ante-cedo], 3. v. n. and a. (fr. force of prep.), *go forward, advance, surpass* (in size, etc.), *exceed, precede, go in advance of*.

antecursor, -ōris, [ante-cursor, runner], M. (*a forerunner*). — Esp. of the army, a *scout, pioneer*.

anteferō, -ferre, -tulī, -lātus, [ante-fero], irr. v. a., *place in advance, prefer*. — Pass., *be preferred, be the first, have the superiority*.

antemna, -ae, [?], F., a *yard* (for sails).

antepōnō, -pōnere, -posuī, -positus, [ante-pono], 3. v. a., (*place in advance, cf. antefero*), *think of more importance*.

antevertō, -vertere, -vertī, -versus, [ante-vertō], 3. v. a., (*turn in front, cf. antepono*), *prefer*.

antīquitus [antiquō- + tus], adv.,

from ancient times, from early times. — Less exactly, *long ago, in early times, anciently*.

antīquus, -a, -um, [anti- (cf. ante) + cus], adj., *old* (existing from early times, not so much in reference to present age as to former origin. cf. **vetus**), *ancient*.

Antistius, -ī, [antisti- (*antistes, overseer*) + ius], M., a Roman gentile name. — Esp., *Gaius Antistius Reginus*, a legatus of Cæsar.

Antōnius, -ī, [?], M., a Roman family name. — Esp.: 1. *Marcus*, Mark Antony, the famous triumvir, a legatus of Cæsar in Gaul; also 2, his brother, *Gaius*, a legatus of Cæsar.

Ap., for **Appius**.

aperiō, -perire, -peruī, -pertus, [ab-pario, *get off, cf. operio, cover*], 4. v. a., *uncover, open*. — **apertus**, -a, -um, p. p. as adj., *open, exposed, uncovered, unobstructed, unprotected*: latus (*the right side, not covered by the shield*); collis (*without trees*); loca (*open country*); impetus maris (*unbroken*).

apertē [old case-form of **apertus**]. adv., *openly*.

Apollō, -inis, [?], M., the son of Jupiter and Latona and twin brother of Diana, god of the sun, of divination, of poetry and music, and president of the Muses. He was also god of archery, of pestilence, and, on the other hand, of healing. He is identified by Cæsar with some Celtic divinity.

apparō, see **adparo**.

1. **appellō**, see **adpello**.

2. **appellō** (adp-), -āre, -āvī, -ātus, [†ad-pellō-, cf. **compello**], 1. v. a., *call, name, address, call upon, style* (declare one something or address in a certain character).

app-, see **adp-**.

Appius, -ī, [?, a Sabine word?], M., a Roman prænomen.

Apr., for **Aprilis**.

Aprilis, -e, [prob. akin to **aperio**, *open*], (*the month which opens the ground*), adj., of *April*.

aptus, -a, -um, [AP (in **apiscor**, *lay hold of*) + **tus**], adj., (*fitted to*), *suited, adapted, fit, apt*.

apud [akin to **ab**], prep. with acc., *at, among, with, before, on one's part, in relation to* (a person); *in one's house* (company, possession).

aqua, -ae, [?], F., *water, a water-course*: **aqua atque igni interdicere** (a form of banishment among the Romans); **mensurae ex aqua**, *by the water-clock* (a contrivance like an hour-glass for telling time by the running of water).

aquātiō, -ōnis, [aquā- (st. of **aquor**, *fetch water*) + **tio**], F., *getting water* (cf. **pabulatio**).

aquila, -ae, [F. of **aquilus**, *dark gray*, perh. remotely akin to **aqua**], F., *an eagle*. — Esp., the standard of the Romans, consisting of an eagle on a staff.

Aquilēia, -ae, [Aquila- + **eius**], F., a city of Cisalpine Gaul (*Venetia*), founded by a Roman colony in B.C. 182 as an outpost on the northeast.

aquilifer, -erī, [aquila-fer (reduced fr. -ferus, FER (in **fero**, *bear*) + **us**)], M., *a standard bearer* (of the eagle).

Aquitānia, -ae, [F. of adj. developed fr. **Aquitanus**], F., the part of Gaul between the Province, the Pyrenees, the Garonne, and the ocean (see I. 1).

Aquitānus, -a, -um, [?], adj., of *Aquitania*. — Plur., as noun, *the people of Aquitania*. — Sing., *a man of Aquitania, an Aquitanian*.

Arar, -aris, [?], M., *the Saône*, a river of Gaul rising in the Vosges and flowing into the Rhone at Lyons.

arbitr, -trī, [ad-bito (*go*) + **trus**, cf. -trum], M., (*a bystander*), *a witness*. — Less exactly, *a referee, an arbitrator*.

arbitrium, -ī, [arbitrō- (*umpire, judge*) + **ium** (cf. **iudicium**)], N., *judgment, will, pleasure* (what one sees fit to do).

arbitror, -ārī, -ātus, [arbitrō-, *umpire, judge*], 1. v. a. and n., *think, suppose* (*judge*).

arbor, -oris, [?], F., *a tree*.

arcessō, -sere, -sīvī, -sītus, [akin to **accedo**, but the exact relation uncertain], 3. v. a., *summon, invite, send for* (persons), *call in*: **aliquem mercede** (*call in to serve for pay*).

ārdeō, ārdēre, ārsī, ārsus, [prob. aridō-, *dry*], 2. v. n., *be hot, be on fire*. — Fig., *be excited, be in a blaze, burn*.

Arduenna, -ae, [?], F., *the Ardennes* (a very large forest region in northeastern Gaul).

arduus, -a, -um, [?], adj., *high, steep, difficult* (of ascent).

Arecomici, -ōrum, [?], M. plur., a branch of the **Volcae**.

Aremoricus (**Arm-**), -a, -um, [Celtic **are**, *near*, and **mor**, *the sea*].

adj., only F. plur., *Aremoricān* (of the states of Gaul near the ocean in Normandy and Brittany).

argentum, -ī, [akin to *arguo*, *make bright*], N., (*the shining metal*), *silver*. Also, of things made of the metal, *silverware*, *silver*.

argilla, -ae, [dim. akin to *arguo*, *make bright*, F., (*white clay*)], *clay*: *fusilis* (some vitrifying earth, such as porcelain is made of).

āridus, a-, -um, [†*arō*- (wh. *areo*, *be dry*) + *du*s], adj., *dry*. — Neut. as noun, *dry land*.

ariēs, -ietis, [?], M., *a ram*. — Fig., *a battering ram* (a long timber armed at the end with metal for demolishing walls). — Less exactly, *a buttress* (piles driven down in a stream to brace a bridge).

Ariovistus, -ī, [?], M., a chief of the Germans, called in by the Gauls in their domestic quarrels, who conquered and ruled them until he was himself crushed by the Romans.

Aristius, -ī, [?], M., a Roman gentile name. — Esp., *Marcus*, a tribune of the soldiers in Cæsar's army.

arma, -ōrum, [AR, *fit* (cf. *armus*, *the shoulder joint*) + *mus*], N. plur., *arms*, *equipment*: *armis ius exsequi* (*by force of arms*): *in armis esse*, *to be under arms*, *to be ready for service*, *to be in service*; *parati in armis*, *armed for war*; *ab armis discedere*, *to abandon hostilities*; *in armis*, *in battle*; *armis congressi* (*in battle*), and the like.

armāmenta, -ōrum, [armā- (st. of *armo*) + *mentum*], N. plur., *implements*. — Esp., *rigging*, *tackle*.

armātūra, -ae, [armā- (st. of *armo*) + *tura*], F., *equipment*: *levis armaturae Numidae* (*light armed*, without the heavy defensive armor of the legionary).

armātus, -a, -um, p. p. of *armo*.

armō, -āre, -āvī, -ātus, [armō- (st. of *arma*)], I. v. a., *equip*, *arm*. — Pass., *arm* (one's self). — **armātus**, -a, -um, p. p. as adj., *armed*, *in arms*, *equipped*.

Arpinēius, -ī, [Arpinō- (st. of *Arpinum*) + *eius*], M., a Roman gentile name. — Esp., *Gaius*, a Roman knight in Cæsar's army, possibly of Gallic origin, of a family enfranchised by Marius, who came from Arpinum.

arr-, see **adr**-.

ars, *artis*, [AR (*fit*) + *tis* (reduced)], F., (*skill in fitting*), *skill*, *art*. — Plur., *the arts*, *the useful arts*.

artē [old case-form of *artus*], adv., *closely*, *tightly*.

articulus, -ī, [artu- (*joint*) + *cu*lus], M., *a little joint*. — Less exactly, *a joint*.

artificium, -ī, [artific- (*artificer*) + *ium*], N., *a skilful contrivance*, *an artifice*, *a trick*. Also, *a trade* (opp. to *ars*, *a higher art*).

artus, -a, -um, [p. p. of *arceo* (*shut up*)], as adj., *tightly bound*, *close*: *silva* (*thick*).

Arvernus, -a, -um, [Celtic], adj., *of the Arverni* (a powerful Gallic tribe west of the Cevennes in modern Auvergne). — M. plur., *the Arverni*.

arx, *arcis*, [ARC (in *arceo*, *shut up*), + *is* (reduced)], F., *a stronghold*, *a fortress*, *a citadel*.

ascendō (ads-), -scendere, -scendī, -scēsus, [ad-scando, *climb*], 3. v. a. and n., *climb up, climb, ascend*: *valium* (*mount, scale*).

ascēsus (ads-), -ūs [ad-†scansus, cf. *ascendō*], M., *a climbing up, an ascent, a going up*.—Concr., *a way up, a means of ascent*: *prohibere ascensu* (*from climbing up*).

asciscō, see *adscisco*.

aspectus, see *adspectus*.

asper, -era, -erum, [?], adj., *rough, harsh*.—Fig., *fierce, violent*.

ass-, see *ads-*.

at [prob. form of *ad*], conj., *but, but yet, at least*.

atque (ac), [ad-que], conj., *and* (generally introducing some more important idea), *and even, and especially*.—Also, *as, than*: *par atque, idem atque, the same as*; *simul atque, as soon as*; *similis atque, just like*; *aliter ac, otherwise than, different from what, etc.*; *aliud atque, differ-ent from, etc.*

Atrebās, -ātis, [Celtic], adj., *Atrebatian, of the Atrebates* (a people of Belgic Gaul), rarely sing. of one.—Plur., *the Atrebates*.

Ātrius, -ī, [atrō- (st. of *ater, black*) + *ius*], M., a Roman gentile name.—Esp., *Quintus*, a soldier in Cæsar's army.

attexō (adt-), -texere, -texuī, -textus, [ad-texo], 3. v. a., *weave on, make on* (by weaving).

attingō (adt-), -tingere, -tigī, -tāctus, [ad-tango], 3. v. a., *touch upon, touch, reach, join* (of a nation's boundaries).

attribuō (adt-), -buere, -buī, -būtus,

[ad-tribuo], 3. v. a., *allot to, assign*.

attulī, see *adfero*.

auctor, -ōris, [AUG (in *augeo, increase*) + *tor*], M., *a voucher* (for any act or statement), *an authority, an adviser*: *defectionis* (*leader*); *auctor esse, approve, advise*; *eis auctoribus, with their approval*; *auctore hoste, on the authority of the enemy*.

auctōritās, -tātis, [auctor- (as if *i-st.*) + *tas*], F., *influence, prestige, authority* (not military or political, cf. *imperium* and *potestas*).

auctus, -a, -um, p. p. of *augeo*.

audācia, -ae, [audac- (*bold*) + *ia*], F., *daring, boldness, effrontery*.

audācter, [audac- (*bold*) + *ter*], adv., *with daring, boldly, fearlessly* (but of an enemy): *audacissime, with the greatest daring*.

audāx, -ācis, [audā- (as if st. of *audeo*) + *cus* (reduced)], adj., *daring, bold*.—See *audacia* and *audacter*.

audeō, audēre, ausus, [prob. *avido-, eager*], 2. v. a. and n., *dare, venture, risk, dare to try* (or *do*).—ausus, -a, -um, p. p. in pres. sense, *daring*.

audiō, -dire, -divī, -ditus, [prob. akin to *auris, ear*], 4. v. a., *hear, hear of*.—audiēns, -entis, p. as adj., *obedient* (with *dicto*).

auditiō, -ōnis, [audi- (st. of *audio*) + *tio*], F., *a hearing, hearsay, report*.

augeō, augēre, auxī, auctus, [AUG (causative or fr. unc. noun-stem)], 2. v. a., *increase, magnify, enhance. add to* (something).—Pass., *increase*.

Aulercus, -a, -um, [Celtic], adj.,

of the *Auleri* (a widespread people of several tribes in the interior of Gaul). — Plur., *the Auleri*.

Aulus, -ī, [?], M., a Roman praenomen.

aurīga, -ae, [poss. akin to *auris* and *ago*, cf. *aurea*, *headstall*], C., a *charioteer*, a *driver*.

auris, -is, [akin to *ear*, st. †*auri-* (cf. *audio*)], F., an *ear*.

Aurunculēius, -ī, [Aurunculō- (dim. of *Auruncus*, name of an Italian tribe) + *eius*], M., a Roman gentile name. — Esp., *Lucius Aurunculeius Cotta*, a *legatus* of *Cæsar*.

Auscī, -ōrum, [Celtic], M. plur. of adj., a tribe of *Aquitania*.

ausus, -a, -um, p. p. of *audeo*.

aut [?, but cf. *autem*], conj., or (regularly exclusive, cf. *vel*). — Repeated, *either . . . or*.

autem [?, akin to *aut*], conj., *but* (the weakest degree of opposition, cf. *sed*), *on the other hand*, *then again*, *now* (explanatory), *whereas* (in slight opposition to something preceding).

autumnus (*auct-*), -ī, [for †*auct-* (*auctō-* (cf. *augeo*) + *minus*)], M., *autumn* (the season of increase).

auxiliāris, -e, [auxiliō-, *help* (as if *auxiliā*) + *ris*], adj., *auxiliary*. — Plur. as noun, *auxiliaries*, *auxiliary troops* (not Roman legionaries).

auxilior, -ārī, -ātus, [†auxiliō-, *help*], I. v. dep., *give assistance*.

auxilium, -ī, [†auxili- (akin to *augeo*, *increase*) + *ium*], N., *assistance*, *aid*, *remedy*, *relief*: *extremum* (*the last resource*); *ferre* (*to assist*, *to aid*); *auxilio* (*as a reinforcement*); *quos auxilio causa habebat* (*as auxiliaries*, etc.). — Plur., *auxiliaries* (as opp. to the regular heavy-armed infantry); *reinforcements*: *auxilia tardare*, *hinder from rendering assistance*.

Avaricēnsis, -e, [Avaricō- + *ensis*], adj., of *Avaricum*. — Plur., *the people of Avaricum*.

Avaricum, -ī, [Celtic], N., a town of the *Bituriges*, now *Bourges*.

avāritia, -ae, [avarō- (*greedy*) + *tia*], F., *covetousness*, *greed*, *avarice*.

āvehō, -vehere, -vĕxī, -vectus, [ab-veho], 3. v. a., *carry off*, *carry away*.

āversus, -a, -um, p. p. of *averto*.

āvertō, -vertere, -vertī, -versus, [ab-vertō], 3. v. a., *turn aside*, *turn off*, *push aside*. — Fig., *alienate*, *estrangle*. — **āversus**, -a, -um, p. p. as adj., *turned away*. Hence, *flying*, or, with a change of point of view in translation, *in the rear* (of that to which the word is applied): *ne aversi ab hoste circumvenirentur* (*by the enemy getting in their rear*, etc.).

avis, -is, [unc. root + *is*], F., a *bird*.

avus, -ī, [?], M., a *grandfather*.

Axona, -ae, [Celtic], F., a river of Gaul (now *Aisne*), a tributary of the *Isara* (*Oise*).

B

Bācenis, -is, [Teutonic], F., with *silva*, a forest of Germany between the Cherusci and the Suevi.

Baculus, -ī, [baculus = baculum, staff], M., agnomen of Publius Sextus Baculus, a centurion in Cæsar's army.

Baleāris, -e, [?], adj., *Balearic* (belonging to the *Baleares insulæ* in the Mediterranean, now *Iviza*, *Majorca*, and *Minorca*, famous for their slingers).

balteus, -ī, [?], M., a belt, a baldric (for the sword, passing over the shoulder, but sometimes also, a belt encircling the waist).

Balventius, -ī, [?], M., a Roman gentile name, only with *Titus*, a centurion in Cæsar's army.

barbarus, -a, -um, [prob. fr. imitation of unintelligible speech, cf. *balbus*, stammering], adj., *foreign* (not Greek or Latin), *uncivilized*, *savage*, *barbarian*, of the barbarians. — Plur., *the barbarians* or *savages* (used of the Gauls).

Basilus, -ī, [?], M., agnomen of *Lucius Minucius Basilus*, an officer in Cæsar's army.

Batavī, -ōrum, [Celtic], M. plur., the *Batavi* or *Batavians*, a nation occupying the region about the mouths of the Rhine.

Belgae, -ārum, [?], M. plur., the *Belgæ* or *Belgians*, a nation occupying the northern part of Gaul. — Perh. also a small tribe of that nation with this special name.

Belgium, -ī, [Belga- + ium], N., the country of the Belgæ.

bellicōsus, -a, -um, [bellicō- (of war) + osus], adj., *warlike*.

bellicus, -a, -um, [bellō- (war) + cus], adj., *of war*, *in war*.

bellō, -āre, -āvī, -ātus, [bellō-, war], I. V. N., *fight*, *make war*: *studium bellandi*, a passion for war.

Bellovacī, -ōrum, [?], M. plur., a Gallic tribe between the Seine, Somme, and Oise, about modern Beauvais.

bellum, -ī, [old duellum, (fr. duo), a strife between two], N., *war*, a war: *bello persequi*, etc. (*in arms*); *bellum inferre*, *make war* (offensive); *bellum defendere*, *defend one's self from war*: *parare bellum*, *make warlike preparations*.

bene [old case-form of *bonus*, good], adv., *well*: *bene gerere negotium*, *be successful in*, etc.

beneficium, -ī, [benefico- (reduced) (cf. *bene*, FAC in *facio*) + ium], N., *well-doing*, *a service*, *a favor*, often rendered by Eng. plur., *services*, *favors shown*, *services rendered*: *sortium beneficio*, *thanks to the lot*; *beneficio suo adductus*, *by gratitude for his favors*.

benevolentia, -ae, [benevolent- (cf. *bene*, VOL in *volo*) + ia], F., *goodwill*, *kindness*.

Bibracte, -is, [Celtic], N., the chief town of the Hædui (Mont Beuvray) near Autun, which was founded later.

Bibrax, -ctis, [cf. last word], F., a town of the Remi.

Bibrocī, -ōrum, [Celtic], M. plur., a tribe of southeast Britain.

bīduum, -ī, [bi- (= dvi-, akin to duo, -duum (akin to dies)], N., *two days' time, two days*.

biennium, -ī, [bienni- (bi, akin to duo, -annō-, year) + ium], N., *two years' time, the space of two years, two years*.

Bigerriōnes, -um, [Celtic], M. plur., a tribe of the Pyrenees (cf. *Bigorre*).

bīnī, -ae, -a, [bi- (= f̄dvi, akin to duo) + nus], distrib. num. adj., plur., *two each, two sets of, two* (of things in pairs or sets).

bipartītō, [abl. of bipartitus, *parted in two*], adv., *in two divisions*: bipartito conlocatis insidiis (*in two places*).

bipedālis, -e, [biped- (bi-ped-, in pes, foot) + alis], adj., *of two feet* (in measure), *two feet* (long, wide, etc.).

bis [for dvis, unc. case-form of duo], adv., *twice*.

Biturīges, -um, [Celtic], M. plur., a tribe of Celtic Gaul, in two branches, Vibisci (around Bordeaux) and Cubi (around Bourges).

Boduōgnātus, -ī, [Celtic], M., a leader of the Nervii.

Bōia, F. sing. of Bōii, *Boia*.

Bōiī, -ōrum, [Celtic], M. plur., a Celtic nation, of which a part occupied lands in Cisalpine Gaul, a part settled in Pannonia, and a part joined the Helvetii in their emigration.

bonitās, -tātis, [†bonō- (*good*) +

tas], F., *goodness*: agrorum (*fertility*).

bonus, -a, -um, [?], adj., *good*: bono animo esse, *to be well disposed*; optimum est, *it is best*; optimum iudicium facere, *express so high an opinion*. — Neut. as noun, *good, advantage*; plur., *goods, property, estate*.

bōs, bovis, [akin to cow], C., *a bull, a cow, an ox*. — Plur., *cattle*.

bracchium (brāch-), -ī, [?], N., *an arm*.

Brannovīces, -um, [Celtic], M. plur., a division of the Auleri living near the Hædui.

Brannovīi (Bl-), -ōrum, [Celtic], M. plur., a Celtic tribe, dependents of the Hædui.

Bratuspantium, -ī, [Celtic], N., a fortified town of the Bellovaci, not certainly identified.

brevis, -e, [for bregus, (BRAGH, break) + us], adj., *short* (of space or time): brevi, *in a short space*.

brevitās, -tātis, [brevis- (*short*) + tas], F., *shortness, short stature*: brevitās temporis, *want of time*.

breviter [†brevis- (*short*) + ter], adv., *briefly*.

Britannī, -ōrum, [Celtic], M. plur., *the Britons* (including all the tribes of Britain).

Britannia, -ae, [†Britannō- + ia (F. of ius)], F., *Britain*.

Britannicus, -a, -um, [†Britannō- + cus], adj., *of Britain, Briton*: bellum (*with Britain*).

brūma, -ae, [†brevis- (*short*) + ma (superl.), sc. dies], F., *the winter solstice*.

Brūtus, -ī, [brutus, *heavy*], a family name at Rome. — Esp., *Decimus Junius Brutus Albinus*, a legatus of Cæsar. He distinguished himself in command of Cæsar's fleet off the coast of Gaul, and afterwards

in the civil war on the side of Cæsar. But he joined the conspiracy against Cæsar with Marcus Brutus, and was one of Cæsar's assassins. He was afterwards killed in Gaul by order of Antony.

C

C, for centum, *hundred*.

C., for Gaius.

Cabillōnum, -ī, [Celtic], N., a town of the Hædui on the Saone (*Chalon-sur-Saône*).

Caburus, -ī, [Celtic], M., the personal name of *Gaius Valerius Caburus*, a Gaul, made a Roman citizen by C. Valerius Flaccus, and father of C. Valerius Procillus and C. Valerius Donnotaurus.

caçūmen, -inis, [?], N., *the top* (of trees, mountains, etc.).

cadāver, -eris, [akin to *cado*, *fall*], N., *a corpse, a body* (dead).

cadō, cadere, cecidi, cāsūrus, [CAD, *fall*], 3. v. n., *fall, be killed*.

Cadūrcus, -a, -um, [Celtic], adj., *of the Cadurci* (a tribe of Aquitania). — Plur., *the Cadurci*.

caedēs, -is, [†caed (as if root of *caedo*, *kill*) + is or es], F., *a murder, massacre, slaughter, killing*.

caedō, caedere, cecidi, caesus, [prob. causative of *cado*, cf. *fall, fell*], 3. v. a., *strike, strike down, cut, fell, cut down, slay*.

caelestis, -e, [†caelit- (st. of *caeles*, fr. *caelum*) + tis], adj., *heavenly*. — Plur., *the gods*.

caelum, -ī, [?], N., *the sky, the heavens, heaven*. — See **caelestis**.

caerimōnia, -ae, [?], F., *a rite, a ceremony*.

Caerōsī, -ōrum, [?], M. plur., a tribe of Belgic Gaul.

caeruleus, -a, -um, [perh. akin to *caesius*, *bluish*], adj., *dark blue*.

Caesar, -aris, [?], M., a family name in the gens Iulia. — Esp.: 1. *C. Iulius Caesar*, the conqueror of Gaul and the author of the *Commentaries*. — 2. *L. Iulius Caesar*, a kinsman of the former, acting as his legatus in Gaul.

caespes, -itis, [?], M., *a sod* (used in fortification).

caesus, -a, -um, p. p. of *caedo*.

calamitās, -tātis, [?], F., *disaster* (orig. to crops?), *defeat, misfortune* (also euphemistically for death): *ejus* (*any accident to him*).

Caletes, -um, [Celtic], M. plur., a tribe in Normandy, on the Seine.

Caletī, -ōrum, same as the preceding.

callidus, -a, -um, [†callō- (cf. *callum*, *thick skin*) + dus], adj., (*tough?*), *shrewd, cunning, skilful*.

cālō, -ōnis, [?], M., *a servant* (of a soldier), *a camp follower*.

campester, -tris, -tre, [campō- (*plain*) + ster, as if †campet + tris

(cf. *equestris*), adj., of the plain: *loca* (level plains).

campus, -i, [?], M., a plain.

Camulogenus, -ī, [Celtic], M., a chief of the Aulerici.

Caninius, -ī, [?], M., a Roman gentile name.—Esp., *C. Caninius Rebilus*, a legatus of Cæsar.

canō, canere, cecinī, cantus, [CAN], 3. v. a. and n., sing, sound (with voice or instrument).

Cantaber, -bra, -brum, [Celtic], adj., of the *Cantabri* (a warlike people in the north of Spain, allied with the Gauls of Aquitania).—Plur., the *Cantabri*, the *Cantabrians*.

Cantium, -ī, [Celtic], N., *Kent* (the southeast corner of Great Britain).

caper, -prī, [?], M., a goat, F., **capra**, -ae, a she-goat.

capillus, -ī, [adj. form akin to *caput*, head], M., the hair (collectively).

capīō, capere, cēpī, captus, [CAP], 3. v. a., take, capture, take possession of, get, acquire, seize: **stipendium**; **nomen**; **arma** (take up); **montem** (occupy).—Less exactly, choose, select: **locum**.—So also (esp. of ships, etc.), reach: **portus** (arrive at, make).—Fig., take in (deceive), captivate, beguile, also experience: **dolorem**; **coniecturam** (make); **quietem** (take, enjoy); **fugam** (take to flight).

caprea, -ae, [†*caprō*- (reduced) (cf. *caper*, goat) + *ea* (F. of -eus)], F., a roe (a small animal of the deer kind). Another reading for *capra* in VI, 27.

captīvus, -a, -um, [as if †*capti-*

(imaginary st. of *capto*, fr. *capio*) + **vus**], adj., captive.—Masc. as noun, a captive, a prisoner.

captus, -a, -um, p. p. of *capio*.

captus, -ūs, [CAP (in *capio*) + **tus**], M., a seizing. Hence, what one can grasp.—Fig., capacity, character, nature.

caput, -itis, [?, akin to *head*], N., the head: **capite demisso**; **capite solo ex aqua exstare**, have only the head above water.—Less exactly, person (cf. “head of cattle”); mouth (of a river).—Fig., life: **poenam capitis** (of death); **capitis periculo** (of life).

careō, -ēre, -uī, -itūrus, [?], 2. v. n., be without, go without.

carīna, -ae, [?], F., keel, bottom (of a ship).

Carnutes, -um, [Celtic], M. plur., a Gallic people between the Loire and the Seine, about Orléans.

carō, carnis, [akin to *crudus* and *raw*], F., flesh, meat.

carpō, -pere, -psī, -ptus, [akin to *harvest*], 3. v. a., pluck.—Fig., find fault with (cf. “pick at”).

carrum, -ī, [Celtic], N., a cart (of the Gauls).

carrus, -ī, M., another form for *carrum*.

cārus, -a, -um, [?], adj., dear, precious, valuable.

Carvilius, -ī, [?], M., a Roman gentile name.—Also, a king of part of Kent.

casa, -ae, [?], F., a cottage, a hut.

cāseus, -ī, [?], M., cheese.

Cassī, -ōrum, [Celtic, cf. *Velio-*

casses and Cassivellaunus], M. plur., a British tribe.

Cassiānus, -a, -um, [†Cassiō- (reduced) + ānus], adj., of Cassius: bellum (the war in B.C. 107, in which L. Cassius Longinus was defeated by the Tigurini, near Lake Geneva, and killed).

cassis, -idis, [?], F., a helmet (of metal, for horsemen, cf. galea).

Cassius, -i, [?], M., a Roman gentile name. — Esp., L. Cassius Longinus, consul B.C. 107 (see Cassianus).

Cassivellaunus, -ī, [Celtic], M., a British chief ruling north of the Thames, who took command of the general resistance of his countrymen to Cæsar, but was finally reduced to submission.

castellum, -ī, [†castrō- (fortress) + lum (N. of -lus)], N., a fortress, a fort, an outwork, a redoubt.

Casticus, -ī, [Celtic], M., a chief of the Sequani.

castrum, -ī, [SKAD (cover) + trum], N., a fortress. — Plur., a camp (fortified, as was the manner of the Romans): in castris, in camp, also in service; castra ponere, pitch a camp; castra movere, break camp, move; quintis castris, after five days' journey, as the Romans encamped every night.

cāsus, -ūs, [CAD (in cado, fall) + tus], M., (what befalls), an accident, a chance (good or bad), a mischance: hoc ipso tempore et casu (emergency); casu, by accident, by chance; casu devenit, chanced to, etc.; quarum rerum casus (the occurrence, the

happening, the possibility); eundem casum ferre (fate); belli casum sustinere (take the chances); in eiusmodi casu (a case); ad extremum casum, to the most critical position; ad omnes casus, against all accidents; in eum casum deduci (that pass).

Catamantāloedēs, -is, [Celtic], M., a chief of the Sequani.

catēna, -ae, [?], F., a chain (for prisoners), a cable: in catenas coniecit (into prison); in catenis tenere.

Caturīges, -um, [Celtic], M. plur., a people in Roman Gaul (Provincia).

Catuvolcus, -ī, [Celtic], M., a chief of the Eburones.

causa, -ae, [?], F., a cause, a reason, an excuse, grounds, a motive (for an act), a right (to anything): satis causae, sufficient reason. Abl. after a gen., for the sake of, for the purpose of, for, on behalf of: libertatis causa; potentiae causa (to gain); praedandi causa (to, etc.); insidiarum causa, for an ambush; animi causa, for amusement, for fancy. — Also, a cause (in law), a case: causa cognita, after trial; causa indicta (unheard); causam dicere, plead one's cause, stand a trial, be tried; causae dictio (a trial). Hence, also, a situation, a case: Germanorum unam esse causam (the case . . . the same); in eadem causa, in the same situation, also, on the same side.

cautē [old case-form of cautus], adv., with caution, cautiously.

cautēs, -is, [akin to cos, whetstone], F., a rock (sharp or jagged), a reef.

cautus, p. p. of caveo.

Cavarillus, -ī, [Celtic], M., a prince of the Hædui.

Cavarinus, -ī, [Celtic], M., one of the Senones, made their king by Cæsar.

caveō, cavēre, cāvī, cautus, [perh. SKV, *cover*], 2. v. n. and a., *be on one's guard, guard against* (something), *take or give security*.

cēdō, cēdere, cessī, cessūrus, [?], 3. v. n., *make way* (in any direction). — Esp., *give way, retreat, retire*: *cedentes, the flying*; *cedere loco, abandon a position*, a military term. — Fig., *yield*: *fortunæ*.

celer, -eris, -ere, [CEL (in *cello, rush*) + ris], adj., *swift, quick, speedy, fast*: *motus (sudden)*.

celeritās, -tātis, [celerī (in *celer*) + tas], F., *swiftness, activity, speed, promptness*: *ad celeritatem onerandi, to secure quick loading*; *itineris (quick marching)*.

celeriter [celerī- (in *celer*) + ter], adv., *quickly, speedily, very soon, soon*.

cēlō, -āre, -āvī, -ātus, [?, akin to *clam, secretly*, and *caligo, mist*], 1. v. a., *conceal, hide*: *arma*. — Pass., *pass unnoticed*.

Celtae, -ārum, [Celtic], M. plur., a great race in Gaul and Britain. — More particularly, *the Celts* (in a narrower sense, occupying the interior of Gaul).

Celtillus, -ī, [Celtic], M., one of the Arverni, father of Vercingetorix.

Cēnabēnsis, -e, [Cenabō- + ensis], adj., *of Cenabum, of the Cenabenses*, the people of Cenabum.

Cēnabum (Gēn-), -ī, [Celtic], N.,

the chief city of the Carnutes, now *Orléans* (from its later name, *urbs Aurelianensis*).

Cēnimāgnī, -ōrum, [Celtic], M. plur., a British tribe.

Cēnomānī, -ōrum, [Celtic], M. plur., a division of the Auleri.

cēnseō, cēnsēre, cēnsuī, cēnsus, [?], 2. v. a., (perh. *fine*), *reckon, estimate*. — Less exactly, *give one's opinion, advise, decree* (of the Senate), *determine*.

cēnsus, -ūs, [akin to *censeo*], M., *a numbering, a count, a census*.

centum (C), [akin to *hund-red*], indecl. num. adj., *a hundred*.

centuriō, -ōnis, [†centuria- (*century*) + o], M., *a centurion*. A subaltern officer from the ranks, commanding a *century*, originally a hundred men.

cernō, cernere, crēvī, crētus, (*sifted*), certus, (*determined*), [CER-, *separate*], 3. v. a., *separate*. Hence, *distinguish, see, behold, descry*. — Also, *determine*.

certāmen, -inis, [†certā- (in *certo, fr. cerno*) + men], N., *a struggle, a contest, rivalry*.

certē [old case-form of *certus*], adv., *certainly, surety, at least* (surely what is mentioned, if nothing more).

certus, -a, -um, p. p. of *cerno* as adj., *determined, fixed, certain* (of the thing as well as the person), *sure, established, regular*: *certiorem facere, inform, order*; *certissimæ res, absolutely certain facts*; *dies certa, an appointed day*; *certa subsidia (regular, as organized beforehand)*; *certum in locum (particular)*.

cervus, -ī, [root of *cornu* (*horn*) + *vus*], *M.*, a *stag*; plur., in military language, a *structure of forked stakes* (like *stags' horns*), *chevaux-de-frise*.

(*cēterus*), -a, -um, [CE (in *ecce*, *behold*, *hic*, *this*) + *terus* (cf. *alter*)], adj., *the rest of* (cf. *alius*, *other*, not including all). — Usually plur., *the rest, the remaining, the others*; *frumento ceterisque rebus* (*everything else necessary, where aliis would mean some other things*).

Centrones (*Cent-*), -um, [Celtic], *M. plur.*: 1. A tribe in the Graian Alps (in modern Savoy). — 2. A Belgic tribe.

Cevenna, -ae, [Celtic], *F.*, the *Cévennes* (a woody mountain region on the west side of the lower Rhone valley).

Chēruscī, -ōrum, [?], *M. plur.*, a tribe of the Germans between the Weser and the Elbe.

cibārius, -a, -um, [cibō-, *food* (reduced) + *arius*], adj., *pertaining to food*. — Neut. plur. as noun, *provisions*: *molita* (*ground corn*).

cibus, -ī, [?], *M.*, *food*.

Cicerō, -ōnis, [cicer (*chickpea*) + *o*, orig. a nickname, possibly from excrescences on the nose], *M.*, a name of a Roman family from Arpinum. — *Esp.*: 1. *Marcus Tullius*, the great orator. — 2. *Quintus (Tullius)*, his brother, in Cæsar's service in Gaul as *legatus*.

Cimberius, -ī, [akin to *Cimbri*], *M.*, a prince of the Suevi.

Cimbri, -ōrum, [?], *M. plur.*, a German tribe living in Jutland, who

overran Gaul and made a successful inroad into the Roman dominions in the second century B.C. They were conquered at Aquæ Sextiæ and Vercellæ by Marius and Catulus, B.C. 102 and 101.

Cingetorix, -īgis, [Celtic], *M.*: 1. A leader of the Treveri, brother-in-law of his rival, Indutiomarus. — 2. A British prince in Kent.

cingō, *cingere*, cīnxi, cīnctus, [?], 3. *v. a.*, *surround, encircle*: *flumen oppidum* (*run around*). — Less exactly, *man* (occupy in a circuit, of walls).

cippus, -ī, [?], *M.*, a *stake, a pillar, a post*. — Plur., apparently jocosely used of a peculiar form of palisades, *boundary-posts* (?), *chevaux-de-frise*.

circā [case-form (instr.?) of *circus* (cf. *circum*)], adv. and prep. with acc., *about, around*. — See *circiter*.

circinus, -ī, [circō- (cf. *circum*) + *nus*], *M.*, a *pair of compasses, a compass*.

circiter [circō- (*around*) + *ter*], adv. and prep. with acc., *about*. — *Fig.* (of time, number, and quantity), *about* (in the neighborhood of), *near, not far from*.

circuitus, -a, -um, *p. p.* of *circumeo*.

circuitus, -tūs, [circum-itus], *M.*, a *circuit* (a going round), a *circuitous route, a circumference*: *in circuitu*, *all around*.

circum [acc. of circō-, *around* (cf. *curvus*)], adv. and prep. with acc., *about, around*.

circumcīdō, -cīdere, -cīdī, -cīsus, [circum-caedo], 3. *v. a.*, *cut around*,

cut (the idea of *around* being implied in the context). — circumcīsus, -a, -um, p. p. — Fig., *isolated*: collis.

circumclūdō, -clūdere, -clūsī, -clūsus, [circum-claudō], 3. v. a., *enclose around, encircle, place a band around*.

circumdatus, -a, -um, p. p. of circumdo.

circumdō, -dare, -dedī, -datus, [circum-do], 1. v. a., *put around*: murus circumdatus (*encircling, thrown around*). — By a confusion of ideas, *surround, encircle*: aciem rhedis.

circumdūcō, -dūcere, -dūxī, -ductus, [circum-duco], 3. v. a., *lead around*. — Less exactly, of a line, *draw around*.

circumductus, -a, -um, p. p. of circumduco.

circu(m)eō, -īre, -iī, -itus, [circum-eo], irr. v. n., *go around*. — Becoming active, *visit, make a tour of*: hiberna.

circumfundō, -fundere, -fūdī, -fūsus, [circum-fundo], 3. v. a., *pour around*. — Pass. (as reflexive), *pour in, rush around, rush in on all sides*. — Also (cf. circumdo), *surround*: multitudo praesidia (*surround with a swarming multitude*).

circumiciō, -icere, -iēcī, -iectus, [circum-iacio], 3. v. a., *throw around*. — Esp. in a military sense, *hurl around, throw around*: circumiecta multitudo (*assailing on all sides*).

circumiectus, -a, -um, p. p. cf. circumicio.

circummittō, -mittere, -mīsī, -mis-

sus, [circum-mitto], 3. v. a., *send around*.

circummūniō, -īre, -īvī, -ītus, [circum-munio], 4. v. a., *fortify around, throw fortifications around, fortify, protect* (by a fortification).

circummūnītus, -a, -um, p. p. of circummunio.

circumplector, -plēctī, -plexus, [circum-plecto, *twine*], 3. v. dep., *embrace, surround*.

circumsistō, -sistere, -stetī, no p. p., [circum-sisto, *place (one's self)*], 3. v. a., *stand around, flock around, rally around, surround, hem in, beset*.

circumspiciō, -spicere, -spēxī, -spectus, [circum-specio], 3. v. a., *look about for*. — Fig., *think over, consider, cast about for*: animo consilia (by way of investigating or divining).

circumstō, -stāre, -stetī, no p. p., [circum-sto, *stand*], 1. v. a., *surround*.

circumvāllātus, -a, -um, p. p. of circumvallo.

circumvāllō, -āre, -āvī, -ātus, [circum-vallo, *intrench*], 1. v. a., *surround with walls, blockade, invest*.

circumvectus, p. p. of circumveho.

circumvehō, -vehere, -vēxī, -vectus, [circum-veho], 3. v. a., *carry around*. — Esp. pass. as dep., *ride around, sail around*.

circumveniō, -venire, -vēnī, -ventus, [circum-venio, *come*], 4. v. a., *surround*. — Fig. (cf. 'get round'), *impose upon, defraud, betray, circumvent*.

circumventus, -a, -um, p. p. of circumvenio.

cis [case-form of ce (cf. ec-ce, cetera)], adv. and prep. with acc., *this side, this side of*.

Cisalpinus, -a, -um, [cis Alpes (as if cisalpi-) + nus], adj., *being this side the Alps, Cisalpine*. Gallia (that part of Gaul on the Italian side of the Alps).

Cisrhēnānus, -a, -um, [cis Rhenum (as if cisrhēnā-) + nus], adj., *being this side the Rhine, this side the Rhine* (as adj. phrase). — Plur. as noun, *the people this side the Rhine* (i.e. towards Gaul).

Cita, -ae, [perh. ci (in cicio) + ta (cf. nauta)], m., a Roman family name. — Only, *C. Fufius*, a Roman knight doing business in Cenabum.

citātus, -a, -um, p. p. of cito.

citer, -ra, -rum, [CE (cf. cis) + terus (reduced, cf. alter)], adj., *on this side* (rare and antiquated). — Usually *citerior* (compar.), *nearer, hither* (as adj.): provincia, Gallia (Gaul on the Italian side of the Alps as opp. to Farther Gaul, cf. Cisalpinus); Hispania (the eastern part of Spain).

citō, -āre, -āvi, ātus, [citō- (fr. cicio, *put in motion*)], i. v. a., *urge on, hurry*. — citātus, -a, -um, p. p. as adj., *in haste*: citatus fertur, *runs very rapidly*.

citō [abl. of citus (fr. cicio, *put in motion*)], adv., *quickly*: citissimē (*very rapidly*).

citrā [case-form F. of citer], adv. and prep. with acc., *this side, within* (as opp. to beyond).

citrō [dat. of citer], adv., *to this side*: ultro citroque, *back and forth, to and fro*.

cīvis, -is, [C1 (in quies, rest) + vis (weakening of -vus)], c., a citizen, a fellow-citizen.

cīvitās, -tātis, [civi- + tas], f., *the state of being a citizen, citizenship*. — Esp., *Roman citizenship, the Roman franchise*. — Less exactly, *a body of fellow-citizens, the citizens* (as a body), *one's fellow-citizens, a state* (composed of citizens), *a city* (because the city was the state), *a nation, a tribe* (politically): expellit ex civitate (*from the country*).

clam [case of st. akin to caligo, mist, etc.], adv. and prep. with abl., *secretly*.

clāmitō, -āre, -āvi, -ātus, [freq. of clamo], i. v. a., *keep crying out, vociferate, cry out*.

clāmor, -ōris, [clam (as if root of clamo) + or], m., *a shouting, a shout, a cry, an outcry*.

clandestīnus, -a, -um, [unc. st. (perh. manufactured from clam) + tinus], adj., *secret, clandestine*.

clārus, -a, -um, [CLA (in clamo, cry out) + rus], adj., *bright, clear*. — Fig., *famous*. — Also (of sound), *loud, distinct*.

classis, -is, [CLA (in clamo, cry out) + tis], f., (*a summoning*). — Less exactly, *the army* (called out). — Esp., *an army* (called out for duty at sea), *a fleet* (the most common later meaning).

Claudius, -ī, [claudō- (*lame*) + ius], m., a Roman gentile name, probably borrowed from the Sabines. — Esp.,

Appius Claudius, consul with L. Domitius in B.C. 54.

claudō, claudere, clausī, clausus, [of unc. form., akin to *clavis*, *key*], 3. v. a., *close, shut, fasten*. — Esp., *claudere agmen, close the line of march, bring up the rear*.

clausus, -a, -um, p. p. of *claudo*.

clāvus, -i, [CLAU- (cf. *claudo*) + *us*], M., *a nail, spike*.

clēmēns, -entis, [perh. CLA (in *clarus, bright*) + *mens* (cf. *vehemens*)], adj., (*bright?*), *gentle* (of weather). — Fig., *gentle, kind, merciful*. — See *clementia*.

clēmēntia, -ae, [clement- + *ia*], F., *kindness, gentleness, humanity, clemency*.

cliēns, -entis, [= *cluens*, p. of *clueo, hear, obey*], C., (*a hearer*), *a dependant, a vassal, a retainer*.

clientēla, -ae, [client- + *ēla* (imitating *suadela*, etc.)], F., *vassalage* (as condition of a *cliens*). Hence (viewed fr. the other side), *protection*. — Phrases: *magnae clientelae, many vassals* (extensive relations of "clientage"); *Remis in clientelam se dicaverunt* (*surrendered themselves as vassals to*, etc.).

clīvus, -ī, [CLI (*lean*) + *vus*], M., *a slope, a declivity, an acclivity*; *ad molliendum clivum, to make the ascent easier*.

Clōdīus, -ī, [the popular form of *Claudius*], M., *a Roman gentile name, belonging to the plebeian branch of the gens Claudia*. — Esp., *P. Clodius*, *a most bitter enemy of Cicero*. He was killed in a fray by T. Annius Milo, who was defended

by Cicero in a famous oration still extant.

Cn., for *Gnaeus*.

coacervō, -āre, -āvī, -ātus, [con-acervo], 1. v. a., *heap up, mass together, heap on top* (of others).

coāctus, -a, -um, p. p. of *cogo*.

coāctus, -tūs, [con-actus (cf. *cogo, force*)], M., *compulsion*.

coagmentō, -āre, -āvī, -ātus, [coagmentō-, *joint*], 1. v. a., *fasten together*.

coartō (-arc-), -āre, -āvī, -ātus, [con-arto], 1. v. a., *press together, confine*.

Cocosātes, -um, [Celtic], M. plur., *a people of Aquitania*.

coemō, -emere, -ēmī, -ēemptus, [con-emo], 3. v. a., *buy up*.

coeō, -īre, -īvī (-īī), no p. p., [con-eo], irr. v. n., *come together, unite, meet*.

coepī, -isse, coeptus, [con-†api (perf. of †apo, cf. *apiscor*)], def. v. a., (*have taken hold of*), *began, undertook, started*. — **coeptus**, -a, -um, p. p. used in same sense as the active with pass. infinitives.

coeptus, -a, -um, p. p. of *coepi*.

coerceō, -ercēre, -ercuī, -ercitus, [con-arceo], 2. v. a., *confine, keep in check*.

cōgitō, -āre, -āvī, -ātus, [con-agite (in sense of *revolve, discuss*)], 1. v. a., *consider, think over*. — Esp. (as to some plan of action), *think about, discuss* (what to do), *have an idea of, intend, consider* (that something may happen), *expect* (contemplate the possibility): *cogitare ne, see that not, think how not, plan to prevent*; *nihil cogitare de bello* (*have no thought of*, etc.).

cōgnātiō, -ōnis, [con-(g)natio, *birté*], F., *connection by birth*. — Concretely, *a family, a clan*: *magnae cognationis, having connections* (by blood).

cōgnitus, -a, -um, p. p. of *cognosco*.

cōgnōscō, -gnōscere, -gnōvī, -gnitus, [con-(g)nosco, *learn*], 3. v. a., *learn, find out, find, become aware*. — Esp., *investigate, inquire into, learn about, study*. — In perf. tenses (cf. *nosco*), *know, be aware*: *cognitum est de aliqua re (something was known)*; *causa cognita, upon a full investigation, after trial*; *egregia virtute erant cogniti (had been found to be of, etc.)*; *ad cognoscendum, for inquiry*.

cōgō, *cōgere, coēgī, coāctus*, [con-ago], 3. v. a., *bring together, collect, assemble, get together*. Hence, *force, compel, oblige*: *coactus, by compulsion*.

cohors, -hortis, [con-†hortis (reduced), akin to *hortus, garden*] F., *an enclosure*. Hence, *a body of troops, a cohort* (the tenth part of a legion, corresponding as a unit of formation to the company of modern tactics, and containing from 300 to 600 men).

cohortātiō, -ōnis, [con-hortatio (cf. *cohortor*)], F., *an encouraging, encouragement*. — Esp. (to soldiers), *an address* (almost invariably a preliminary to an engagement).

cohortor, -ārī, -ātus, [con-hortor], 1. v. dep., *encourage, rally, address* (esp. of a commander): *cohortati inter se, encouraging, urging one another*.

coll- (except *collis*), see **conl-**.

collis, -is, [?], M., *a hill*.

colō, *colere, coluī, cultus*, [?], 3. v. a., *till, cultivate*. — Fig., *attend upon, court, cultivate* (as a friend), *pay court to, worship* (of divinities).

colōnia, -ae, [colonō- (cf. *colo*) + ia], F., (*state of a colonist*). — Concretely, *a colony* (both of the establishment and the persons sent). The Roman colonists were and continued to be Roman citizens, and served as armed occupants of the soil where they were sent in the interests of the mother country.

color, -ōris, [prob. akin to *cāligo*, as opp. to *white*], M., *color*.

com- (con-, co-) [the same as *cum*], adv. in comp., *with, together, up*. Often intensifying the meaning without definite translation.

combūrō, -ūrere, -ūssī, -ūstus, [con-†buro (?), relation to *uro* very uncertain, cf. *bustum, funeral pyre*], 3. v. a., *burn up, consume*.

comes, -itis, [con-†mitis (MA in *meo, go*) + tis], C., *a companion* (esp. an inferior as attendant or follower).

cōminus [formed by some false analogy from *con manus*], adv., *hand to hand* (cf. *ēminus, at a distance*), *in close combat, at short range*.

comitātus, -a, -um, p. p. of *comitor*.

comitium, -ī, [?, perh. *comit-* (see *comes*) + *ium*, the *assemblage of followers* (cf. *servitium*)], N., a part of the Forum at Rome. — Plur., *an election* (assembly of the people for voting).

comitor, -āri, -ātus, [comit-, *companion*], 1. v. dep., *accompany*. — **comitātus**, -a, -um, p. p. in pres. sense, *accompanying*.

commeātus, -tūs, [con-meatus, cf. **commeo**, *go to and fro*], M., *a going to and fro, an expedition* (back and forth), *a trip*. Hence, *communications* (of an army). — So also, *supplies* (of an army), *provisions*.

commemorō, -āre, -āvī, -ātus, [con-memoro, *call to mind*], 1. v. a., *remind one of*. Hence, *speak of, mention, state* (in a narrative).

commendō, -āre, -āvī, -ātus, [con-mando, *commit*], 1. v. a., *intrust, commend, recommend, surrender*.

commeō, -āre, -āvī, -ātūrus, [con-meo], 1. v. n., *go back and forth*. — With *ad*, *visit, resort to*.

commilitō, -ōnis, [con-milit- (*soldier*) + o], M., *fellow-soldier, comrade*.

comminus, see **cominus**.

commissūra, -ae, [con-†missura (cf. **committo**)], F., *a joint, a seam*.

commissus, -a, -um, p. p. of **committo**.

committō, -mittere, -mīsī, missus, [con-mitto], 3. v. a., (*let go*) (*send together or altogether*). Hence, *join, unite, attach*: **proelium** (*engage, begin the engagement*). — Also, *trust*: **se barbaris committere** (*put one's self in the hands of, etc.*); **nihil his committere** (*place no confidence in, etc.*). — Also, *admit, allow* (to happen), *commit* (suffer to be done, cf. **admitto**), *perpetrate*: **neque commissum a se, nothing had been done by them**; **committere ut posset, leave it**

possible; **nihil committebant, did nothing**.

Commius, -ī, [Celtic], M., a leader of the Atrebrates.

commodē [old case-form of **commodus**], adv., *advantageously, conveniently, fitly, readily, to advantage*: **satis commode, to much advantage**; **non satis commode, not very easily**.

commodum, see **commodus**.

commodus, -a, -um, [con-modus, *measure, adj.*, (*having the same measure with*), *fitting, suitable, convenient, advantageous*]: **commodissimum est, it is the best thing, most advantageous**. — Neut. as noun, *convenience, comfort, advantage, interest*: **commodo rei publicae, without prejudice to the public interests**; **omnibus in vita commodis, all the blessings of life**; **rei familiaris commodum, the interests of one's property**; **quas sui quisque commodi fecerat** (*for his own convenience*).

commonefaciō, -facere, -fēcī, -factus, [unc. case-form (of st. akin to **moneo, warn**) -facio], 3. v. a., *remind*.

commorātus, -a, -um, p. p. of **commoror**.

commoror, -ārī, -ātus, [con-moror], 1. v. dep., *delay, stay, linger*.

commōtus, -a, -um, p. p. of **commoveo**.

commoveō, -movēre, -mōvī, -mōtus, [con-moveo], 2. v. a., *move, stir, agitate*. — With reflex., or in pass., *be moved, move* (intrans.), *stir*. — Fig., *disturb, agitate, affect, alarm, influence* (with idea of violent feeling).

commūnicātus, -a, -um, p. p. of *communico*.

commūnicō, -āre, -āvī, -ātus, [†communicō- (st. of †communicus, communi- + cus)], 1. v. a., (*make common*), *share, communicate, consult* (with a person about a thing, and so make it common), *add* (a thing to another), *put in along with* (something else).

commūniō, -īre, -īvī, -ītus [*communio*], 4. v. a., *strongly fortify, fortify, intrench, build* (make by fortification).

commūnis, -e, [con- + munis (cf. *munia, duties*)], adj., (*having shares together*), *common, general, in common*: *ex communi consensu*, *by general agreement*; *consilium* (*general plan, concerted action*); *res* (*the common interest*).

commūtātiō, -ōnis, [con-mutatio (cf. *commuto*)], F., *change*: *aestus* (*turn*).

commūtātus, -a, -um, p. p. of *commuto*.

commūtō, -āre, -āvī, -ātus, [commuto], 1. v. a., *change, exchange*: *studium belli agriculturā* (*exchange the pursuits of war for agriculture*).

comparātus, -a, -um, p. p. of 1 *comparo*.

1. comparō, -āre, -āvī, -ātus, [comparo], 1. v. a., *get ready, prepare, procure, gain, get together, prepare for* (with a different view of the object in English): *omnibus rebus comparatis*, *having made all arrangements*.

2. comparō, -āre, -āvī, -ātus, [con-

paro], 1. v. a., (*pair together*), *compare*.

compellō, -pellere, -pulī, -pulsus, [con-pello], 3. v. a., *drive together* (or *altogether*), *drive in, force, drive*.

compendium, -ī, [com + pendium], N., (*a weighing in*, cf. *expendo, weigh out*), *a saving, profit*.

comperiō, -perire, -perī, -pertus, [con-pario], 4. v. a., (*get together*), *find out* (by inquiry), *ascertain, discover*. — *compertus*, -a, -um, p. p. as adj., *certain* (cf. *exploratus*).

compertus, -a, -um, p. p. of *comperio*.

complector, -plectī, -plexus, [con-plecto, fold], 3. v. dep., *embrace, include, enclose*.

compleō, -plēre, -plēvī, -plētus, [con-pleo], 2. v. a., *fill up, fill*. — With a different conception of the action from Eng., *cover, man* (of walls).

complexus, -a, -um, p. p. of *complector*.

complūrēs, -plūra (-ia), [con-plus], adj. plur., *very many, a great many, a great number of*.

comportō, -āre, -āvī, -ātus, [conporto], 1. v. a., *bring together, collect*.

comprehendō, -hendere, -hendī, -hēnsus, [con-prehendo], 3. v. a., *seize, catch, arrest, capture, grasp* (one by the hand or clothing). — *Fig., take, catch* (of fire).

comprehēnsus, -a, -um, p. p. of *comprehendo*.

comprobō, -āre, -āvī, -ātus, [conprobo], 1. v. a., *prove, approve*: *consilium fortuna* (*justify*).

compulsus, -a, -um, p. p. of **com-
pello**.

cōnātum, -ī, [N. p. p. of **conor** as
pass.], N., *an attempt, an under-
taking*.

cōnātus, -tūs, [conā- (st. of **conor**)
+ **tus**], M., *an attempt, an effort*.

cōnātus, -a, -um, p. p. of **conor**.
concedō, -cēdere, -cessī, -cessus,
[con-**cedo**], 3. v. a. and n., (*give up
a thing to one*), *allow, grant, assign*
(leave, where the rest is taken
away), *permit, yield the palm* (to
a superior), *yield, make a conces-
sion*.

concertō, -āre, -āvī, -ātūrus, [con-
certo], 1. v. n., *contend*.

concessus, -sūs, [con-+**cessus** (cf.
concedo)], M., *a concession, a
permission*.

concidō, -cidere, -cidī, no p. p.
[con-**cado**], 3. v. n., *fall down, fall*.

concidō, -cīdere, -cīdī, -cīsus,
[con-**caedo**], 3. v. a., *cut to pieces,
cut down* (kill), *cut up* (land by
estuaries).

conciliō, -āre, -āvī, -ātus, [con-**ciliō**-,
assembly], 1. v. a., *bring together*.
Hence, *win over, secure* (even by
force), *win, gain*.

concilium, -ī, [con-+**cilium** (CAL
call) + **ium**, cf. **Kalendae**], N.,
a meeting.—Esp., *an assembly* (of
war or state), *a council, a confer-
ence*: *per concilium, in council*.

concisus, -a, -um, p. p. of **concīdo**.

concitātus, -a, -um, p. p. of **con-
cito**.

concitō, -āre, -āvī, ātus, [con-**cito**,
freq. of **cīeo**, *stir*], 1. v. a., *arouse, stir
up, call out* (and so set in motion).

conclāmātus, -a, -um, p. p. of
conclamo.

conclāmō, -āre, -āvī, -ātus, [con-
clamo, *cry out*], 1. v. n., *cry out,
shout*: *victoriam* (cogn. acc.), *shout
victory*.

conclūdō, -clūdere, -clūsī, -clūsus,
[con-**claudo**], 3. v. a., *shut up, en-
close*: *mare conclusum* (*enclosed,
inland*).

conclūsus, -a, -um, p. p. of **con-
cludo**.

Conconnetodumnus, -ī, [Celtic],
M., a leader of the Carnutes.

concrepō, -crepāre, -crepuī, -crepi-
tūrus, [con-**crepo**], 1. v. n., *rattle,
clash*: *armis* (*clash their arms, of
soldiers*).

concurrō, -currere, -currī (-**cucurrī**),
cursus, [con-**curro**], 3. v. n., *run
together, rush up, rush in, rush*
(advance), *flock to, hasten in*: **con-
cursum est**, *there was a rush*.

conkursō, -āre, -āvī, -ātūrus, [con-
curso, freq. of **curro**, *run*], 1. v. n.,
rush to and fro: **conkursari iubet**,
*orders a noise of running to and fro
to be made*.

conkursus, -a, -um, p. p. of **con-
curro**.

conkursus, -sūs, [con-**cursus** (cf.
concurro)], M., *a rushing to and fro,
a dashing together* (collision).—
Esp., *a charge, onset, a crowd run-
ning, a crowd*.

condemnātus, -a, -um, p. p. of
condemno.

condemnō, -āre, -āvī, -ātus, [con-
damno, *condemn*], 1. v. a., *condemn,
find guilty*.

condiciō, -ōnis, [con-**DIC**, *say* (cf.

condīco, agree], F., terms, condition, terms of agreement, terms (of fighting), state (of slavery): ad iniquam condicionem pugnandi, to fight on unequal terms.

condōnō, -āre, -āvī, -ātus, [con-dono], I. v. a., give up, pardon for the sake of.

Condrūsī, -ōrum, [Celtic], M. pl., a Belgic tribe on the Meuse, clients of the Treveri.

condūcō, -dūcere, -dūxī, -ductus, [con-duco, lead], 3. v. a., bring together, bring up (soldiers), hire: manus conducta, a band of mercenaries.

cōnfectus, -a, -um, p. p. of conficio.

cōnferciō, -fercīre, -fersī, -fertus, [con-farcio], 4. v. a., crowd together. — cōnferthus, -a, -um, p. p. as adj., close, crowded, dense, closely crowded, in close order, in a solid body.

cōnferō, -ferre, -tulī, -lātus, [con-fero], irr. v. a., bring together, get together, bring in, gather, collect. — With or without culpam, lay the blame on, charge. — With reflexive, betake one's self, remove, take refuge. — So with other words, fortunas, (remove, transfer). — Also, postpone, delay.

cōnferthus, -a, -um, p. p. of confercio.

cōnfestim [acc. of †con-festis (cf. festino, hasten)], adv., in haste, immediately, at once.

cōnficiō, -ficere, -fēcī, -fectus, [con-facio], 3. v. a., (do up), accomplish, complete, finish up, carry out, finish, perform. — Also, make up, write up (of a document), work

up, dress (of skins). — Also (cf. Eng. "done up"), finish up, exhaust, wear out: nondum confecta hieme, when the winter was not yet spent, before the end of, etc. — See also confio.

cōnfidō, -fidere, -fisis sum, [con-fido, trust], 3. v. n., (trust fully), be confident, trust, trust to, have confidence in, rely on, feel assured. — cōnfishus, -a, -um, p. p. in act. sense, trusting in.

cōnfigō, -figere, -fixī, -fixus, [con-figo, fix], 3. v. a., fasten together, fasten.

cōnfinis, -e, [con-finis], adj., having boundaries together, adjacent: confines Senonibus, neighbors of the Senones.

cōnfinium, -ī, [confini- + ium], N., neighborhood, confines, common boundaries.

cōnfiō, -fierī, -fectus, [con-fio], irr. v. n. (used rarely as pass. of conficio), be accomplished, etc. (see conficio).

cōnfirmātiō, -ōnis, [con-firmatio, cf. confirmo], F., (positive) assurance, confirmation.

cōnfirmātus, -a, -um, p. p. of confirmo.

cōnfirmō, -āre, -āvī, -ātus, [con-firmo, make firm], I. v. a., strengthen. — Fig., strengthen, establish (pacem), reassure, encourage, confirm, assure (by oath): se (resolve). Hence (of things and statements), confirm, declare.

cōnfishus, -a, -um, p. p. of confido.

cōnfiteor, -fitērī, -fessus, [con-

fateor, *confess*], 2. v. dep., *confess, acknowledge, admit*.

cōfixus, -a, -um, p. p. of *configo*.

cōflagrō, -āre, -āvī, -ātus, [*conflagro, blaze*], 1. v. n., *be on fire, burn*.

cōflictātus, -a, -um, p. p. of *conflicto*.

cōflictō, -āre, -āvī, -ātus, [*conflicto, cf. configo*], 1. v. a., *dash against* (one thing against another), *assail, harass*.

cōnflīgō, -flīgere, -flīxī, -flictus, [*confligo, strike*], 3. v. a. and n., *dash against, contend, fight*.

cōnfluēns, -entis, [pres. p. of *confluo*], M., *a meeting of two rivers, confluence*.

cōnfluō, -ere, -fluxī, no p. p. [*confluo*], 3. v. n., *flow together*. — Less exactly (of persons), *flock together*.

cōnfugiō, -fugere, -fūgī, no p. p. [*con-fugio*], 3. v. n., *flee, take refuge*.

cōnfundō, -fundere, -fūdī, -fūsus, [*con-fundo*], 3. v. a., *pour together*. — Less exactly, *mingle, mix indiscriminately, unite without distinction, unite, combine*.

congregior, -gredī, -gressus, [*congrador, step*], 3. v. dep., *come together*. — In peace, *unite with*. — Esp. in war, *come in contact with, engage, fight*.

congressus, -a, -um, p. p. of *congregior*.

congressus, -sūs, [*con-gressus, cf. congregior*], M., *an engagement, encounter*.

coniciō (-iicio), -icere, -iēcī, -iectus, [*con-iacio*], 3. v. a., *throw together, hurl, cast, discharge: se conicere,*

throw one's self, rush. — Less exactly (esp. in a military sense), *throw* (into prison), *put* (to flight), *place, station* (cf. military *throw* troops into, etc.), *force*. — Fig., *put together* (of ideas).

coniectūra, -ae, [*con-iacura, cf. conicio*], F., *a guess* ("putting two and two together"), *a conjecture: coniecturam capere, form a conjecture, infer*.

coniectus, -a, -um, p. p. of *conicio*.

coniūctim [acc. of †*coniunctis* (iung (as root) + tis, cf. *coniungo*)], adv., *unitedly, in common, altogether*.

coniūctus, -a, -um, p. p. of *coniungo*.

coniungo, -iungere, -iūnxī, -iūnc-tus, [*con-iungo, join*], 3. v. a., *unite, connect, fasten together*. — In pass., or with reflexive, *unite* (neut.), *connect one's self, join*. — *coniūctus, -a, -um, p. p. as adj., united, closely connected*.

coniūnx, -iugis, [*con-tiux* (IUG, yoke, as st., with intrusive n from *iungo*)], C., *a spouse*. — Esp., F., *a wife*.

coniūratiō, -ōnis, [*con-iuratio, cf. coniuero*], F., *conspiracy, a confederacy*.

coniūrō, -āre, -āvī, -ātus, [*con-iuro*], 1. v. n., *swear together, take an oath* (together), *swear mutual oaths*. Hence, *conspire, plot*.

conlātus (coll-), -a, -um, p. p. of *confero*.

conlaudātus (coll-), -a, -um, p. p. of *conlaudo*.

conlaudō (coll-), -āre, -āvī, -ātus,

[con-laudo], I. v. a., *praise* (in set terms).

conlĕctus (coll-), -a, -um, p. p. of conligo.

conligō (coll-), -ligere, -lēgī, -lēctus, [con-lego], 3. v. a., *gather together, gather, collect, acquire* (by accumulation). — With reflexive, *collect one's self, recover*.

conligō (coll-), -āre, -āvī, -ātus, [con-ligo], I. v. a., *bind together, fasten together: scuta* (lock together).

conlocātus (coll-), -a, -um, p. p. of conloco.

conlocō, -āre, -āvī, -ātus, [con-loco, place], I. v. a., *place, set, station* (of troops, etc.): *angustius milites* (stow, in a vessel). — Esp. (with or without nuptum), *give in marriage, marry* (of a father or guardian). — Fig., *settle: rebus conlocandis, making dispositions*.

conloquium (coll-), -ī, [con-floquium, cf. conloquor], N., *a conference, an interview, a parley*.

conloquor (coll-), -loquī, -locūtus, [con-loquor], 3. v. dep., (talk together), *confer, hold an interview* (or parley), *parley, converse*.

cōnor, -ārī, -ātus, [? con-, st. akin to onus, burden], I. v. dep., *attempt, try, endeavor: idem conari, make the same attempt*.

conquiēscō, -quiēscere, -quiēvī, -quiētūrus, [con-quieto, rest], 3. v. n., *rest, repose*.

conquīrō, -quīrere, -quīsvī, -quīsitus, [con-quaero, seek], 3. v. a., *search for, seek for, hunt up*.

conquīsītus, p. p. of conquiro.

cōnsanguineus, -a, -um, [con-sanguin- (blood) + eus], adj., *akin* (by blood). — As noun, *a kinsman*.

cōnscendō, -scendere, -scendī, -scēnsus, [con-scando, climb], 3. v. a., *climb, climb upon: navīs* (in navis) (*go on board*); *vallum* (*man, mount*).

cōnscientia, -ae, [con-scientia, cf. conscius], F., *consciousness, privity, conscience, knowledge*.

cōnsciscō, -sciscere, -scīvī, -scītus, [con-scisco, decree], 3. v. a., *resolve*. Less exactly, with dat. of reflex., *take to one's self: mortem* (*commit suicide*).

cōnscius, -a, -um, [con-†scius, SCI (in scio, know) + us], adj., *knowing* (with one's self or another), *conscious, aware of*.

cōnscrībō, -scrībere, -scrīpsī, -scrīptus, [con-scribo], 3. v. a., *write down*. — Esp., *enrol, conscribe, levy, enlist*.

conscrīptus, -a, -um, p. p. of conscribo.

cōnsecrātus, -a, -um, p. p. of consecro.

cōnsecrō, -āre, -āvī, -ātus, [con-sacro, make sacred], I. v. a., *hallow, consecrate*. — cōnsecrātus, -a, -um, p. p. as adj., *consecrated, sacred*.

cōnsector, -ārī, -ātus, [con-sector, freq. of consequor], I. v. dep., *overtake, follow up*.

cōnsecūtus, -a, -um, p. p. of consequor.

cōnsēnsiō, -ōnis, [con-†sensio, cf. consentio], F., *agreement, unanimity*.

cōnsēnsus, -sūs, [con-sensus, cf. consentio], M., *agreement, consent, harmonious* (or *concerted*) *action*.

cōnsentiō, -sentīre, -sēnsī, -sēn

sūrus, [con-sentio, *feel*], 4. v. n., *agree, conspire, make common cause, act with* (some one).

cōnsequor, -sequī, -secūtus, [consequor], 3. v. dep., *follow* (and stay with), *overtake*. Hence, *obtain, secure, attain, succeed in* (some purpose).—Also, *follow close upon, succeed, ensue*.

cōnservō, -āre, -āvī, ātus, [con-servo, *save*], 1. v. a., *save, preserve, spare*.—Also, *observe* (law, right), *regard*.

Cōnsidius, -ī, [con-†sidius (akin to sedeo, *sit*)], a Roman name.—Esp., *Publius*, a Roman soldier.

cōnsidō, -sidere, -sēdī, -sessūrus, [con-sido], 3. v. n., *sit down* (in a place).—Less exactly, *take a position, halt, encamp, settle*.

cōnsilium, -ī, [con-†silium (cf. consul, akin to salio, in some earlier unc. meaning)], N., *deliberation, a council* (of war, more commonly concilium).—Esp., *wise counsel, prudence, discretion*. Hence, *a plan, counsel, design, purpose*.—And so (design carried out), *course, measure, conduct*.—Phrases: *ipsorum esse consilium* (a matter for them to decide); *quasi consili sit res*, as if it were a matter for consultation; *commune consilium*, concerted action; *publicum consilium*, action of the state, official action; *barbaris consilium non defuit* (an intelligent plan of action).

cōnsimilis, -e, [con-similis], adj., *very like, just like*.

cōnsistō, -sistere, -stitī, no p. p., [con-sisto, *place (one's self)*], 3. v.

n., *take a stand, take a position, stand, keep one's position, form* (of troops).—In perf. tenses, *have a position, stand*. Hence, *stop, halt, make a stand, hold one's ground, run aground* (of ships), *remain, stay*.—With *in*, *occupy, rest on*.—Fig., *depend on, rest on*.

cōnsobrīnus, -ī, [con-sobrinus, cf. soror, *sister*], M., *first cousin* (on the mother's side).—Less exactly, (any) *cousin german*.

cōnsōlātus, -a, -um, p. p. of con-solor.

cōnsōlor, -ārī, ātus, [con-solor, *comfort*], 1. v. dep., *console, cheer*.—cōnsōlātus, -a, -um, p. p. as pres., *consoling*.

cōnspectus, -a, -um, p. p. of con-spicio.

cōnspectus, -tūs, [con-spectus, cf. conspicio], M., *sight*.—in conspectu, *in one's presence*; in conspectum proferre (*display*).

cōnspicātus, -a, -um, p. p. of con-spicor.

cōnspiciō, -spicere, -spexī, -spectus, [con-specio, *look at*], 3. v. a., *catch sight of, espy, see*.

cōnspicor, -ārī, ātus, [†conspic-, cf. SPEC, *see*], 1. v. dep., *catch sight of, espy, see*.

cōnspīrō, -āre, -āvī, -ātus, [con-spiro, *breathe*], 1. v. n., *sound together*.—Fig., *harmonize, agree*.—Also, *conspire, league together*.

cōnstanter, [constant- (standing firm) + ter], adv., *consistently, uniformly, steadily, with constancy, firmly*.

cōnstantia, -ae, [constant- (stand-

ing firm) + ia], F., *firmness, constancy, undaunted courage.*

cōsternātus, -a, -um, p. p. of *consterno.*

cōsternō, -āre, -āvī, -ātus, [con-†sternō (cf. *sternax, prostrating*)], I. v. a., *overwhelm.*—Fig., *dismay, alarm.*—cōsternātus, -a, -um, p. p., *stricken with fear.*

cōsternō, -sternere, -strāvī, strātus, [con-sterno], 3. v. a., *strew over* (both of the thing thrown and that over which): *navis constrata* (*decked, full decked*, as opposed to ships only covered at the ends).

cōnstīpō, -āre, -āvī, -ātus, [con-stipo, *press*], I. v. a., *crowd, cram.*—In pass. or with reflexive, *crowd together.*

cōnstituō, -stituere, -stitūī, -stitūtus, [con-statio], 3. v. a. and n., *set up, raise, put together, make up.* Hence, *establish, station, arrange, draw up* (*aciem*).—Fig., *determine, appoint, agree upon, determine upon, fix, decide upon*: *praemia* (*offer*).

cōnstō, -stāre, -stitī, -stātūrus, [con-sto], I. v. n., *stand together.*—Fig., *agree* (esp. of accounts): *numerus* (*be complete*). Hence, *be established, appear, be agreed upon, be evident.* (Esp. *constat, it appears*, etc.)—Also (from accounts), *cost.*—Also (with *in*), *depend upon.*

cōnstrātus, -a, -um, p. p. of *consterno.*

cōnsuēscō, -suēscere, -suēvī, -suētus, [con-suesco], 3. v. n., *become accustomed.*—In perf. tenses, *be accustomed, be wont.*—cōnsuētus, -a, -um, p. p., *accustomed, wont, used.*

cōnsuētūdō, -inis, [con-†suetudo (prob. †suetu- + do), cf. *consuesco*], F., *habit, custom, habits* (collectively), *manners, customs, practice*: *victus* (*customary mode of living*); *itineris* (*usual manner of marching*).

cōnsuētus, -a, -um, p. p. of *consuesco.*

cōnsul, -ulis, [con-sul (cf. *praesul, exsul*), root of *salio* in some earlier unc. meaning], M., *a consul* (the title of the chief magistrate of Rome, cf. *consilium*).—With proper names in abl., the usual way of indicating dates: M. *Messala et M. Pisone consulibus*, *in the consulship of*, etc.; *se consule*, *in his consulship*, as a date or occasion.

cōnsulātus, -tūs, [†consulā- (cf. *consul*) + tus], M., *consulship.*

cōnsulō, -sulere, -suluī, -sultus, [prob. *consul*, though poss. a kindred or independent verb], 3. v. a. and n., *deliberate, consult, take counsel, decide.*—With acc., *consult, take the advice of.*—With dat., *take counsel for, consult the interests of, consult for the welfare of, look out for, do a service to*: *vitae* (*spare*).—Phrase: *sortibus consultum* (*est*), *lots were drawn to decide.*

cōnsultō, -āre, -āvī, -ātus, [con-sultō-, *decision*], I. v. n., *consult*: *de bello* (*take measures for*).

cōnsultō, [prob. like abl. abs. used impersonally], adv., *with deliberation, purposely, designedly.*

cōnsultum, -ī, [N. p. p. of *consulo*], N., *a decision, an order, a decree.*—Esp., *senatus consultum*, *an order of the senate.*

cōnsūmō, -sūmere, -sūmpsī, -sūmp-
tus, [con-sumo], 3. v. a., (*take out
of the general store*). Hence, *waste,
consume, destroy, spend, exhaust*.

cōnsūmptus, -a, -um, p. p. of
consumo.

cōnsurgō, -surgere, -surrēxī, -sur-
rēctus, [con-surgo, rise]. 3. v. n., *rise,
rise up*. — Esp. of a session, *break up*.

contabulō, -āre, -āvī, -ātus, [con-
tabulo, cf. tabula, board], 1. v. a.,
build up (with floors in stories), *floor
with planks*. — Also, *build up* (gen-
erally, as of a wall with towers).

contāgiō, -ōnis, [con-†tagio, fr.
TAG in tango, touch, cf. contingo],
F., *contact*. — Esp. with something
noxious, implying *contagion*.

contāminātus, -a, -um, p. p. of
contamino.

contāminō, -āre, -āvī, -ātus, [con-
tamin- (st. of con-tāmen, i.e. TAG
(touch) + men)], 1. v. a., *bring into
contact, unite*. — Esp. with notion
of contagion (cf. contagio), *contami-
nate: facinore contaminatus* (*impli-
cated in*).

contegō, -tegere, -tēxī, -tēctus,
[con-tego], 3. v. a., *cover up, cover*.

contemnō, -temnere, -tempsī,
-temptus, [con-temno, slight], 3. v.
a., *despise, disregard, hold in con-
tempt*.

contemptiō, -ōnis, [con-†temptio,
cf. contemno], F., *contempt, scorn*:
*in contemptionem venire, incur the
contempt, etc.*

contemptus, -tūs, [con-†temptus,
cf. contemno], M., *contempt, scorn*:
*contemptui est, is a matter of ridi-
cule*.

contendō, -tendere, -tendī, -ten-
tus, [con-tendo, stretch], 3. v. n.,
*strain, struggle, strive, try, endeavor,
exert one's self, attempt, be zealous*:
*id contendere et laborare, strive and
exert one's self for, etc.* — Esp. with
verbs of motion, *press on, hasten*. —
Also, *fight, contend, wage war*. —
With *ad* and in like constructions,
hasten, march, start to go (in haste):
vi contendere, to force a passage;
petere contendit, seek earnestly.

contentiō, -ōnis, [con-†tentio, cf.
contendo], F., *struggle, efforts*. — Esp.,
contest, fighting, dispute.

contentus, -a, -um, p. p. of *con-
tendo* and *contineo*.

contexō, -texere, -texuī, -textus,
[con-texo], 3. v. a., *interweave, weave
together*. — Also, *weave* (make by
weaving).

contextus, -a, -um, p. p. of *con-
texo*.

continēns, -entis, pres. p. of *con-
tineo*, wh. see.

continenter [continent- (*holding
together*) + ter], adv., *continually,
without stopping, continuously, inces-
santly*.

continentia, -ae, [continent- (*hold-
ing together*) + ia], F., *self-restraint,
moderation*.

contineō, -tinēre, -tinuī, -tentus,
[con-teneo], 2. v. a., *hold together,
hold in*. Hence, in many fig. mean-
ings, *restrain, hold in check, keep*
(within bounds), *hem in, retain* (in
something). — Pass. or with reflex.,
*keep within, remain, be included in,
be bounded, consist in* (be contained
in). — Also, *hold on to, join*. — **con-**

tinēns, -entis, pres. p. as adj., (*holding together*), *continual, contiguous, continuous*. — Also, *restraining one's self, continent*. — As noun, *the continous land, the continent*. — **contentus**, -a, -um, p. p. as adj., *satisfied, content*.

contingō, -tingere, -tigī, -tāctus, [**con-tango**, *touch*], 3. v. a. and n., *touch, reach, join*. — With dat., *happen*.

continuātiō, -ōnis, [**continuā**- (cf. **continuō**) + **tio**], F., *continuation: continuatio imbrum, incessant rains*.

continuō [abl. of **continuus**], adv., *immediately, straightway, forthwith*.

continuus, -a, -um, [**con-†tenuus** (TEN in **teneo** (*hold*) + **uus**)], adj., *continuous, successive: dies (successive)*.

contiō, -ōnis, [prob. for **conventio**], F., *an assembly*. — Less exactly, *an address, a harangue* (to an assembly or to soldiers).

coniōnātus, -a, -um, p. p. of **conionor**.

coniōnor, -ārī, ātus, [**contion-**, *address*], 1. v. dep., *harangue, address* (an assembly or an army).

contrā [unc. case-form (instr.?) of **†conterus** (**con-** + **terus**, comp. ending)], adv. and prep. with acc., *opposite, contrary to, against, in opposition, on the other hand: contrā atque, contrary to what, etc.*

contrahō, -trahere, -trāxī, -trāctus, [**con-traho**], 3. v. a., *draw together, draw in, bring together, gather together, contract, narrow, make smaller, bring into smaller compass*.

contrārius, -a, -um, [**†conterō**- (see **contra**) + **arius**], adj., *opposite* (lit.

and fig.), *contrary: ex contrario, on the contrary; in contrariam partem, in the opposite direction*.

contrōversia, -ae, [**controversō**- (*opposite*) + **ia**], F., *a dispute, a quarrel*. — Plur., *grounds of quarrel*.

contumēlia, -ae, [unc. form., akin to **contumax** and **tumeo**, *swell*], F., (*swelling pride?*), *an outrage, an insult, an affront*. — Fig., *violence* (of waves), *buffeting*.

convalescō, -valēscere, -valuī, no p. p., [**con-†valesco**, cf. **valeo**, *be well*], 3. v. n., *recover, get well*.

convallis, -is, [**con-vallis**], F., *a valley* (enclosed on all sides). — Less exactly, *a defile, a valley* (of any kind).

convēctus, -a, -um, p. p. of **conveho**.

convehō, -vehere, vēxī, vectus, [**con-veho**], 3. v. a., *bring together, bring in, collect*.

conveniō, -venīre, -vēmī, -ventus, [**con-venio**], 4. v. a. and n., *come together, meet, assemble, come in, arrive, agree upon, agree*. — With acc., *meet, come to*. — Also, of things, *be agreed upon, be fitting, be necessary* (in a loose sense in Eng.).

conventus, -tūs, [**con-†ventus** (cf. **convenio** and **adventus**)], M., *an assembly, a meeting*. — Esp., *an assize, court* (the regular assembly of Roman citizens in a provincial town on stated occasions, at which justice was dispensed).

conversus, -a, -um, p. p. of **converto**.

convertō, -vertere, -vertī, -versus, [**con-verto**], 3. v. a., *turn about, turn*.

— Fig., *change*: *signa* (*change front, wheel*); *conversa signa bipartito intulerunt*, *wheeled and charged the enemy in two directions*; *conversa signa in hostes inferre*, *face about and charge, etc.*; in *fugam conversa*, *put to flight*; *conversam [materiam] ad hostem collocabat*, *placed [fallen trees] with their tops towards the enemy*; *contra vim fluminis*, *against the current*; *itinere converso*, *altering his course*; *mentes conversae sunt*, *their state of mind was changed*.

Convictolitavis, -is, [Celtic], M., a young Hæduan nobleman.

convictus, -a, -um, p. p. of **convinco**.

convincō, -vincere, -vīcī, -victus, [con-vinco, *conquer*], 3. v. a., *prove, make good* (a charge, etc.): **avaritia convicta**, *found guilty of avarice* (changing the point of view for the Eng. idiom).

convocō, -āre, -āvī, -ātus, [con-voco], 1. v. a., *call together, summon, call* (a council).

coōrior, -orīrī, -ortus, [con-orior, *rise*], 3. (and 4.) v. dep., *arise, spring up, break out* (of a war).

coōrtus, -a, -um, p. p. of **coorior**.

cōpia, -ae, [†cōpi- (con-ops, aid) + ia, cf. **inopia**, **inops**], F., *abundance, plenty, supply* (both great and small), *quantity, number*. — Esp., *luxury* (abundance of everything). — Plur. (esp. of forces), *forces, resources, supplies*. — Phrases: **copiam facere**, *afford a supply, give an opportunity*; **magna copia locorum** (*choice*); **copia atque usus**, *necessary supplies*.

cōpiōsus, -a, -um, [copia (reduced) + osus], adj., (*abounding in wealth*), *well supplied, wealthy*.

cōpula, -ae, [con-†apula (from AP, lay hold of)], F., (*holding together*), a *grappling-hook*.

cor, cordis, [root as st. (akin to Eng. heart)], N., *the heart*. — Phrase: **cordi esse**, *be dear*.

cōram [unc. case, formed from con and os, *face*], adv. and prep. with abl., *face to face, present, in person*.

Coriosolites, -tum, [Celtic], M. plur., a people of Aremoric Gaul.

corium, -ī, [?], N., *a hide, a skin*.

cornū, -ūs, [?], N., *a horn*. — Fig., a *wing* (of an army).

corōna, -ae, [?], F., *a garland*. — Fig., *a circle* (*line*, of soldiers). — Phrase: **sub corona**, *at auction* (the garland being the symbol of a captive for sale at auction).

corpus, -oris, [unc. root + us], N., *the body, the person*. — Also, *a body* (dead). — Less exactly, *extent* (of a camp). — Phrase: **magnitudo corporis**, *size, stature*.

corrumpō, -rumpere, -rūpī, -ruptus, [con-rumpo, *break*], 3. v. a., *spoil, ruin*.

cortex, -icis, [?], M. (also F.), *bark*.

Cōrus (Caurus), -ī, [?], M., *the northwest wind*.

cōtēs, -is, (cau-) [akin to cos, *whetstone*], F., *a rock* (sharp or jagged), *a reef*.

cotidiānus (quo-), -a, -um, [cotidie + anus], adj., *daily*: **cotidiano labore**.

cotidiē (quo-), [quot (*how many*)

-die, loc. of *dies*], adv., *daily, every day*.

Cotta, -ae, [?], M., a Roman family name. — Esp., *Lucius Aurunculeius Cotta*, a legatus of Cæsar.

Cotuātus, -ī, [?], M., a chief of the Carnutes.

Cotus, -ī, [Celtic], M., a young Hæduan nobleman.

crassitūdō, -inis, [crassō- + tūdō (as if *crassitu-* + *do*)], F., *thickness*.

Crassus, -ī, [crassus, *fat*], M., a Roman family name. — Esp.: 1. *Marcus (Licinius) Crassus*, consul with Pompey, B.C. 55; one (with Cæsar and Pompey) of the combination called the First Triumvirate. — 2. *Publius Crassus* (called *Adulescens, the Younger*, only as distinguished from his father), son of the Triumvir, serving with Cæsar in Gaul as commander of cavalry. — 3. *Marcus Crassus*, another son of the Triumvir, quæstor, B.C. 54, in Cæsar's army.

crātēs, -is, [?], F., *a hurdle, a fascine* (a hurdle used to hold up earthworks in fortification). — Also, *wicker* (for hurdles).

creātus, -a, -um, p. p. of *creo*.

crēber, -bra, -brum, [crē- (in *creo, bring forth*) + *ber*], adj., *thick, close, numerous, frequent*: *arbores* (*thickly growing*); *praesidia* (*continuous, not far apart, at short intervals*).

crēbrō, [prob. abl. of *creber*], adv., *frequently, constantly, in rapid succession, at short intervals*.

crēdō, *crēdere, crēdidī, crēditus*, [†*cred-*, *faith* (of unc. formation) + *do, place*], 3. v. a. and n., *trust, entrust, believe, suppose*.

cremō, -āre, -āvī, -ātus, [?], 1. v. a., *burn, consume*: *igni cremari, be burned alive, be burned to death*.

creō, -āre, -āvī, -ātus, [unc. form., akin to *cresco*], 1. v. a., (*cause to grow*), *create*. — Esp., *elect, choose, appoint*.

Crēs, *Crētis*, [Gr.], M., *a Cretan*. — As adj., *Cretan*.

crēscō, *crēscere, crēvī, crētus*, [st. *crē-* (also in *creo, bring forth*) with -*sco*], 3. v. n., *grow, increase, swell* (of a river), *be swelled, increase in influence* (of a man), *grow great, grow powerful*.

Critōgnātus, -ī, [Celtic], M., a chief of the Arvernī.

cruciātus, -tūs, [cruciā- (st. of *crucio, torture*) + *tus*], M., *crucifying*. Hence, *torture*. — With a change of relation, *suffering* (of the person tortured).

crūdēlis, -e, [†*crudē-* (in *crudescō*, akin to *crudus, bloody*) + *lis*, cf. *Aprīlis, animālis*], adj., (*bloody?*), *cruel*. — See the following.

crūdēlitās, -tātis, [*crudeli-* + *tas*], F., *cruelty*.

crūdēliter [*crudeli-* + *ter*], adv., *cruelly, with cruelty*.

crūs, *crūris*, [?], N., *the leg*.

cubīle, -is, [†*cubī-* (st. akin to *cumbo*) + *lis* (cf. *crudelis*)], N. of adj., N., *a couch, a resting-place, a bed, a lair*.

culmen, -inis, [unc. root (in *cello?*, *rise*) + *men*], N., *a height, a top, a summit, a roof*.

culpa, -ae, [?], F., *a fault, blame, guilt*.

cultūra, -ae, [*cultu-* (cf. *colo, till*)

+ ra (F., of rus)], F., *cultivation, culture*: *agri cultura*, or *agricultura*, *the cultivation of the soil, agriculture*.

cultus, -tūs, [COL (in colo, *till*) + tus], M., *cultivation*. — Esp. of one's self, *care*. Hence, *civilization, manner of life, state of civilization*.

cum [?], prep. with abl., *with*.

cum (quom), [case-form of **qui**], conj., *when, while, whenever*. — Often rendered by a different construction in Eng.: **cum non possent**, *not being able*; **cum prohibent**, *while defending*. — Of logical relations (usually with subjv.), *when, while, since, inasmuch as, though, although*: **cum . . . tum**, *while . . . so also*; **cum . . . tum maxime**, *not only . . . but especially*; **cum primum**, *as soon as*.

cumulus, -ī, [†cumō + lus], M., *a mass, a heap, a pile*.

cunctātiō, -ōnis, [cunctā- (st. of **cunctor**) + tio], F., *hesitation, reluctance, indisposition to fight*.

cunctor, -ārī, -ātus, [?], 1. v. dep., *hesitate, hang back, be reluctant*: **non quin** (*have no hesitation in, etc.*).

cūctus, -a, -um, [for **coniūctus** ?], adj., *all, all together*.

cuneātim [cuneō-, *wedge* (reduced) + atim, as if acc. of †cuneatis], adv., *in the shape of a wedge*. — Esp. of soldiers, *in* (a peculiar wedge-shaped) *column of attack*.

cuneus, -ī, [akin to **cōnus**, *cone*], M., *a wedge*.

cuniculus, -ī, [Gr], M., (*a cony*). — Transf., *a burrow*. Hence, *a mine* (esp. in a military sense).

cupidē [old case-form of **cupidus**], adv., *eagerly, zealously, earnestly*.

cupiditās, -tātis, [cupidō + tas]. F., *desire, eagerness, greed*. **cupiditate adductus**, *through over zeal*.

cupidus, -a, -um, [noun st. akin to **cupio** + dus], adj., *eager, desirous, longing (for), fond of, ambitious (for), with a passion (for)*.

cupiō, -pere, -pivī, -pitus, [partly root verb, partly from †cupi- (cf. **cupidus**)], 3. (and 4.) v. a. and n., *be eager (for), be anxious, desire*, (stronger than **volo**). — With dat., *wish well to, be zealous for*. — Phrase: **cupientibus signum dat**, *gives the signal to his impatient soldiers*.

cūr (quōr), [perh. for **qua re**], adv., *why* (rel. and interr.).

cūra, -ae, [akin to **caveo**, *beware*], F., *care, anxiety, attention*: **curae alicui esse**, *be one's care, object of one's attention*.

cūrō, -āre, -āvī, -ātus, [cura], 1. v. a. and n., *take care, provide for*. — With gerundive, *cause (to be done), have (done)*.

currus, -ūs, [CUR (?) + us, cf. **curro**, *run*], M., *a chariot (= essedum)*.

cursus, -sūs, [CUR (?) + tus, cf. **curro**, *run*], M., *a running, running, speed, a run* (in concrete sense), *a course* (space or direction run): **cursum adaequare** (*keep up with*); **cursum incitato** or **magno**, *at full speed*; **eodem cursu**, *with the same impetus, without stopping*; **in hoc medio cursu**, *midway of this passage, from Britain to Ireland*.

custōdia, -ae, [custod- (*guard*) + ia], F., *custody, guard* (state of being guarded). — Plur. (concretely), *guards, keepers*.

custōdiō, -ire, -ivī, -itus, [custod-, *guard*, as if *custodi-*], 4. v. a., *keep under guard, guard*.

custōs, -tōdis, [unc. st. + *dis* (cf. *merces, -ēdis, palus, -ūdis*)], c., *a guard, a watchman, a keeper, a spy*.

D.

D, [half of CIO = M], 500.

D., for Decimus.

Dācus, -a, -um, [?], adj., *Dacian* (of the Dacians, a people of Thrace, north of the Carpathian Mountains, occupying parts of Hungary, Gallicia, Wallachia, etc.).—Plur., *the Dacians*.

damnātus, -a, -um, p. p. of *damno*.

damnō, -āre, -āvī, -ātus, [damnō-, *loss*], 1. v. a., (*fine*), *find guilty, condemn*.

damnum, -ī, [?, DA (*give*) + *menus* (cf. *alumnus*)], n., (*fine*), *loss*.

Dānuvius (-bius), -ī, [?], m., *the Danube*, the great river flowing from the mountains of Germany eastward to the Black Sea.

datum, -a, -um, p. p. of *do*.

dē [unc. case-form of pron. st. DA (in *idem, dum*)], adv. (only in comp.) and prep. with abl., *down from, off from, from, away from*. Hence, *qua de causa*, *for which reason*; *de populo mereor* (*deserve well or ill of, properly win from*); *de consilio* (*by, cf. ex*).—Esp. in partitive sense, *out of, of*: *pauci de nostris*.—Also (cf. Eng. *of*), *about, of* (about), *in regard to, concerning, for*: *de regno desperare*; *nihil de bello timere, have no fear of war*; *de potentatu contendere*; *de iniuriis satisfacere*.—In expressions of time, *just after, about*: *de tertia vigilia*.—

Often with verbs of sense which may take acc.: *sentio de, learn, discover*.—Phrases: *de improvviso, of a sudden, unexpectedly*.—In comp., *down, off, away, through* (cf. *debeo, decerto*).

dēbeō, -bēre, -buī, -bitus, [de-habeo], 2. v. a., (*have off of one's possessions*), *owe, be bound, ought, must, cannot help*: *iudicari debere* (*might well be, etc.*).—Pass., *be due, be owing*.

dēcēdō, -cēdere, -cessī, -cessūrus, [de-cedo], 3. v. n., (*make way off, cf. cedo*), *retire, withdraw, withdraw from, shun*.—Esp. (from life), *die*.

decem, [?], indecl. num. adj., *ten*.

dēceptus, -a, -um, p. p. of *decipio*.

dēcernō, -cernere, -crēvī, -crētus, [de-cerno], 3. v. a. and n., (*decide off, so as to clear away*), *decide, determine, decree, order* (as a result of determination).

dēcertō, -āre, -āvī, -ātus, [de-certo, *fight*], 1. v. a. and n., *contend* (so as to close the contest, cf. "*fight it out*"), *decide the issue, try the issue* (of war), *carry on war, fight* (a general engagement): *risk a decisive battle* (with or without *pugna*).

dēcessus, -sūs, [de-cessus, cf. *cedo* and *incessus*], m., *withdrawal, departure*: *austus* (*ebb, fall*).

Decetia, -ae, [Celtic], f., a city of the Hædui, on the Loire, *Decise*.

dēcidō, -cidere, -cidi, no p. p., [de-cado], 3. v. n., *fall off* (or down), *fall* (from one's horse).

decimus, -a, -um, [†deci- (as st. of decem) + mus], adj., *tenth*. — Masc. as noun, a Roman prænomen (see Brutus).

dēcipiō, -cipere, -cēpī, -ceptus, [de-capio], 3. v. a., (*take off, catch*), *beguile, deceive*.

dēclārō, -āre, -āvī, -ātus, [de-claro], 1. v. a., (*clear off*), *make plain, declare* (decide and state).

dēclīvis, -e, [de-clivis (or clivus, slope)], adj., *sloping down, inclined*. — Plur. as noun, *slopes*.

dēclīvitās, -tātis, [declivi- + tas], F., *slope*: ad declivitatem, *downward*.

dēcrētum, -ī, [prop. N. of decre-tus], N., *a decree, a decision*.

dēcrētus, -a, -um, p. p. of decerno.

decumānus, -a, -um, [decumō- (reduced) + anus], adj., *belonging to the tenth*: porta (*the rear gate*, of a camp, where the tenth cohort was posted).

decuriō, -ōnis, [decuria- (reduced) + o], M., *a commander* (of a decuria of cavalry, a small squadron).

dēcurrō, -currere, -currī (cucurrī), -cursūrus, [de-curro], 3. v. n., *run down, run away, hurry off*.

decus, -oris, [unc. root (cf. decet, it becomes) + us], N., *honor, glory*.

dēdecus, -oris, [de-decus], N., *disgrace, dishonor*.

dēditicius, -a, -um, [deditō- (reduced) + cius], adj., *surrendered*. — Plur. as noun, *prisoners* (taken by surrender), *subjects, persons surrendered*.

dēditiō, -ōnis, [de-datio, cf. dedo], F., *surrender*: in deditioem accipere, *receive one's surrender*; in deditioem venire, *to surrender*.

dēditus, -a, -um, p. p. of dedo.

dēdō, -dere, -didī, -ditus, [de-do], 3. v. a., *give over, surrender, give up, devote*. — In pass. or with reflex., *surrender one's self, submit*.

dēdūcō, -dūcere, -dūxī, -ductus, [de-duco], 3. v. a., *lead down or off, lead away, withdraw, draw off* (præsidia), *take away* (of men), *bring away, lead* (from one place to another), *bring* (into a situation). — Fig., *induce, bring, lead*. — Esp. of ships, *launch* (draw down); of women, *marry* (used of the man, cf. nubo); of things, *bring, draw, turn*. So, *raise* (a man to fortune). — Also, *rem in periculum* (*cause a perilous situation*); *re in controversiam deducta* (*coming to, etc.*); *deduci milites* (*march out, led by their commander*).

dēductus, -a, -um, p. p. of deduco.

dēfatigātiō (-fet-), -ōnis, [de-fatigatio], F., *exhaustion*.

dēfatigātus (-fet-), -a, -um, p. p. of defatigo.

dēfatigō (-fet-), -āre, -āvī, -ātus, [de-fatigo], 1. v. a., *wear out, exhaust, worry, tire out*.

dēfectiō, -ōnis, [de-factio, cf. deficio, fail], F., *falling off, defection, falling away, revolt*.

dēfendō, -fendere, -fendī, -fēnsus, [de-fendo, strike], 3. v. a., *ward off, defend one's self against*. — Also, with changed relation, *defend, protect*.

dēfēnsiō, -ōnis, [de-†fensio, cf. **defendo**], F., a defence.

dēfēnsor, -ōris, [de-†fensor, cf. **defendo**], M., a defender. — Also, a means of defence, a defence, a buffer. — Phrase: **speciem defeusorum**, a show of defence.

dēferō, -ferre, -tulī, -lātus, [de-fero], irr. v. a., carry down, carry away, bring, land (of ships). — Pass., be borne down or on, drift (of ships), turn aside: **delati in scrobes** (falling). — Fig., confer upon, put in one's hands, hand over, report, lay before.

dēfessus, -a, -um, p. p. of **defetiscor**.

dēfetiscor, -fetisci, -fessus, [de-fatiscor, *gape*], 3. v. dep., crack open. — Fig., become exhausted. — **dēfessus**, -a, -um, p. p. as adj., exhausted: **dēfessus**, an exhausted man.

dēficiō, -ficere, -fēcī, -fectus, [de-facio, *make*], 3. v. a. and n., fail, fall away, revolt, fall off, abandon (with ab): **animo** (*despond*).

dēfigō, -figere, -fixī, -fixus, [de-figo, *fasten*], 3. v. a., fix (in or down), plant, set, fasten, drive down.

dēfiniō, -ire, -ivī, -itus, [de-finio, *end*], 4. v. a., set limits to, fix, appoint.

dēfixus, -a, -um, p. p. of **defigo**.

dēfluō, -fluere, -flūxī, -fluxūrus, [de-fluo], 3. v. n., flow down, flow apart, divide (of a river).

dēfore, see **desum**.

dēformis, -e, [de-forma (*shape*)], weakened and decl. as adj., adj., uncomely, unshapely, ugly, bad-looking.

dēfugiō, -fugere, -fūgī, no p. p.,

[de-fugio], 3. v. a. and n., fly from, avoid, fly, flee.

dēiciō (dēiic-), -icere, -iēcī, -iectus, [de-iacio], 3. v. a., cast down, throw down, drive off, drive out, dislodge, kill (pass., fall), overthrow, throw on shore (of ships), deprive, reduce: **ea spe deiecti**, disappointed in this hope.

dēiectus, -a, -um, p. p. of **deicio**.

dēiectus, -tūs, [de-iactus, cf. **iacio**, throw], M., a declivity, a slope.

dēinceps, [dein- (cf. **deinde**) + cept, cf. **CAP** in **capio**], adv., in succession.

dēinde (dein) [de-inde, *thence*], adv., then, next.

dēlātus, -a, -um, p. p. of **defero**.

dēlectō, -āre, -āvī, -ātus, [de-†lecto, cf. **delicio**], 1. v. a., delight. — Pass., take delight, delight.

dēlēctus (dī-), -tūs, [de-lectus, cf. **deligo**, select], M., a levy, a conscription.

dēlēctus, -a, -um, p. p. of **deligo**.

dēleō, -lēre, -lēvī, -lētus, [de-†leō (akin to **lino**)], 2. v. a., (*smear out*), blot out, wipe out (of a disgrace). — Fig., annihilate, destroy.

dēlētus, -a, -um, p. p. of **deleo**.

dēlēberō, -āre, -āvī, -ātus, [de-†libero, perh. akin to **libra**, balance], 1. v. a. and n., discuss, consult, deliberate: **re deliberata**, after discussing the matter.

dēlibrō, -āre, -āvī, -ātus, [†de-librō-, bark (adj. **de-liber**)], 1. v. a., peel, strip (of bark).

dēlictum, -ī, [N. p. p. of **delinquo**], N., thing left undone, failure, offence.

dēligātus, -a, -um, p. p. of *de-ligo* (-āre).

dēligō, -ligere, -lēgī, -lēctus, [*de-lego*], 3. v. a., *choose out, select*. — dēlēctus, -a, -um, p. p. as adj., *chosen, picked*.

dēligō, -āre, -āvī, -ātus, [*de-ligo, bind*], 1. v. a., *tie down, moor, tic*.

dēlitēscō, -litēscere, -lituī, no p. p., [*de-latesco, cf. lateo, hide*], 3. v. n., *hide away, hide, skulk, lurk*.

dēmentia, -ae, [*dement- + ia*], F., *madness, folly*.

dēmessus, -a, -um, p. p. of *de-meto*.

dēmetō, -metere, -messuī, -messus, [*de-meto, reap*], 3. v. a., *reap, cut down*.

dēmigrō, -āre, -āvī, -ātūrus, [*de-migro, depart*], 1. v. n., *move away (change residence), move one's effects, emigrate*.

dēminuō, -uere, -uī, -ūtus, [*de-minuo, cf. minus*], 3. v. a. and n., *diminish, curtail, lessen, detract: de voluptate quicquam (make any diminution of): quid de legibus (disregard in any manner); de sua benevolentia (lessen his good-will)*.

dēminūtus, -a, -um, p. p. of *de-minuo*.

dēmittō, -mittere, -mīsī, -missus, [*de-mitto*], 3. v. a., *let go down (cf. mitto), let down, stick down (at the bottom of a ditch)*. — In pass. or with reflex., *let one's self down, descend, set one's self down*. — Fig., *despond (se animo), be discouraged*. — dēmīssus, -a, -um, p. p. as adj., *low-hanging, bowed (of the head)*.

dēmō, dēmere, dēmpsi, dēmpus,

[*de-emo, take*], 3. v. a., *take down, take off, remove, take away*.

dēmōnstrātus, -a, -um, p. p. of *demonstro*.

dēmōnstrō, -āre, -āvī, -ātus, [*de-monstro, show*], 1. v. a., *point out, show, represent, mention, state, speak of, make known*.

dēmōror, -ārī, -ātus, [*de-moror*], 1. v. dep., *delay, retard*.

dēmpus, -a, -um, p. p. of *demo*.
dēmum [acc. of †dēmus (superl. of *de*), *nethermost, last*], adv., *at last, at length (not before)*.

dēnegō, -āre, -āvī, -ātus, [*de-nego*], 1. v. a. and n., *deny, refuse, say not*.

dēnī, -ae, -a, [for *decnī, decem* reduced + *nus*], distrib. num. adj. plur., *ten each, ten (on each side), ten (in sets of ten)*.

dēnique [†*denō-* (*de* + *nus*, cf. *demum*) *que*], adv., *at last: multo denique die, not till late, etc.* — Of order, *finally, in a word, in short*. — Of preference, *at any rate (if no better, etc.)*.

dēnsus, -a, -um, [?], adj., *thick, crowded, dense*.

dēnūntiō, -āre, -āvī, -ātus, [*de-nuntio*], 1. v. a., *announce (with notion of threat), threaten, declare, warn, order*.

dēpellō, -pellere, -pulī, -pulsus, [*de-pello*], 3. v. a., *drive off, drive (away), dislodge, avert*.

dēperdō, -dere, -didī, -ditus, [*de-perdo*], 3. v. a., *lose, be deprived of: tantum opinionis (forfeit)*.

dēpereō, -perīre, -perīī, -perītūrus, [*de-pereō*], irr. v. n., *be lost*.

dēpōnō, -pōnere, -posuī, -positus, [de-pono], 3. v. a., *lay down, lay aside, deposit*. — Fig., *lose, abandon* (hope), *blot out* (memory), *resign*.

dēpopulātus, -a, -um, p. p. of depopulor.

dēpopulor, -ārī, -ātus, [de-populor], 1. v. dep., *ravage, lay waste*; p. p., pass., *laid waste*.

dēportō, -āre, -āvī, -ātus, [de-porto], 1. v. a., *carry off, carry away, remove*.

dēposcō, -poscere, -poposcī, no p. p., [de-posco], 3. v. a., *demand earnestly, demand, call for, claim*.

dēpositus, -a, -um, p. p. of depono.

dēprecātor, -ōris, [de-precator, cf. deprecor], M., *a mediator* (to beg off something for somebody): eo *deprecatore, by his mediation*.

dēprecor, -ārī, -ātus, [de-precor], 1. v. dep., *pray to avert something, pray* (with accessory notion of relief), *beg, beg off, pray for pardon, pray to be spared, resort to prayers, ask for quarter, beseech*.

dēprehendō, -hendere, -hendī, hēnsus, [de-prehendo, *grasp*], 3. v. a., *capture, catch, seize, take possession of*. — As in Eng., *catch* (come upon), *surprise*.

dēprehēnsus, -a, -um, p. p. of deprehendo.

dēpūgnō, -āre, -āvī, -ātus, [de-pugno], *fight decisively, fight it out*.

dēpulsus, -a, -um, p. p. of depello.

dērēctē (dī-) [old case-form of dērectus], adv., *straight*: ad *perpendicularum* (*perpendicularly*).

dērēctus (dī-), -a, -um, p. p. of derigo.

dērigō (dī-), -rigere, -rēxī, -rēctus, [de-rego], 3. v. a., *straighten out, direct: aciem* (*form*); *opera* (*set in order, arrange*). — dērēctus, -a, -um, p. p. as adj., *straight, straight up and down, perpendicular*.

dērīvātus, -a, -um, p. p. of derivo.

dērīvō, -āre, -āvī, -ātus, [perh. immediately fr. de-rivus (*brook*), prob. through adj. st.], 1. v. a., *draw off* (water), *divert*.

dērogō, -āre, -āvī, -ātus, [de-rogo, in its political sense], 1. v. a., *take away, withdraw*.

dēscendō, -scendere, -scendī, -scēnsūrus, [de-scando], 3. v. n., *climb down, descend*. — Fig., *resort to, have recourse to, adopt* (with ad).

dēsecō, -secāre, -secuī, -sectus, [de-seco], 1. v. a., *cut off*.

dēserō, -serere, -seruī, -sertus, [de-sero, *join*], 3. v. a., *disunite*. — Esp., *abandon, forsake, give up, leave in the lurch*. — dēsertus, -a, -um, p. p. as adj., *deserted, solitary*.

dēsertor, -ōris, [de-†sertor, cf. desero], M., *a deserter*.

dēsertus, -a, -um, p. p. of desero.

dēsiderātus, -a, -um, p. p. of desidero.

dēsiderō, -āre, -āvī, -ātus, [?, cf. considero], 1. v. a., *feel the want of, desire, miss, need, desire* (want to see), *lose* (of soldiers). — Pass., *be missing* (*lost*): *perpauci desiderati quin cuncti, etc.* (*all with very few exceptions*).

dēsīdia, -ae, [desid- (st. of deses, de- SED AS ST.)], F., *idleness, sloth*.

dēsīgnātus, -a, -um, p. p. of de-signo.

dēsīgnō, -āre, -āvī, -ātus, [de-signo], I. v. a., *mark out, indicate, mean*.

dēsīliō, -silīre, -siluī, -sultus, [desalio], 4. v. n., *leap down, leap (down), jump overboard, dismount*.

dēsistō, -sistere, -stitī, -stitūrus, [de-sisto], 3. v. n., *stand off, cease, stop, desist from, abandon: fuga (cease flying)*.

dēspectus, -a, -um, p. p. of despicio.

dēspectus, -tūs, [de-†spectus, cf. despicio], M., *a view down, view (from a height): oppidum haberet despectūs (sheer precipices)*.

dēsperātiō, -ōnis, [de-†speratio, cf. despero], F., *despair, desperation*.

dēsperātus, -a, -um, p. p. of despero.

dēsperō, -āre, -āvī, -ātus, [despero, cf. spes, hope], I. v. n. (but see below), *cease to hope, despair*. — dēsperātus, -a, -um, as pass., *despaired of*. — Also as adi., (*hopeless?*, perh. orig. *despaired of*), hence *desperate*.

dēspicīō, -spicere, -spexī, -spectus, [de-specio], 3. v. a. and n., *look down, look down upon*. — Fig. (cf. Eng. equivalent), *look down upon, despise*.

dēspoliō, -āre, -āvī, -ātus, [despolio], I. v. a., *strip off*. — With change of relation, *strip* (also fig., as in Eng.).

dēstinātus, -a, -um, p. p. of destino.

dēstinō, -āre, -āvī, -ātus, [perh. dēstinā-, a prop (fr. de-STA-nus)], I. v. a., *fasten, make fast, make firm, get fast hold of, catch firmly*. Hence, fig., *fix upon, appoint, choose, destine*.

dēstituō, -tuere, -tuī, -tūtus, [de-stātuo], 3. v. a., *set apart (from one's self), abandon, desert*.

dēstitūtus, -a, -um, p. p. of destituo.

dēstrictus, -a, -um, p. p. of destringo.

dēstringō, -stringere, -strīnxī, -strictus, [de-stringo], 3. v. a., *strip off*. — Also (cf. despolio), *strip, draw* (of swords, stripping them of their scabbards).

dēsum, -esse, -fuī, -futūrus, [desum], irr. v. n., (*be away*), *be wanting, be lacking, fail*. — Esp., *fail to do one's duty by*, etc. — Often, *lack* (changing relation of subj. and following dat.), *be without, not have*.

dēsuper [de super], adv., *from above*.

dēterior, -ius, [compar. of †deter (de + terus, cf. interior)], adj., (*farther down*), *inferior, worse: deteriora vectigalia facere (impair)*.

dēterreō, -terrēre, -terruī, -territus, [de-terreo], 2. v. a., *frighten off, deter, prevent* (esp. by threats, but also generally).

dētestātus, -a, -um, p. p. of detestor.

dētestor, -ārī, -ātus, [de-testor], I. v. a., (*call the gods to witness to prevent something*), *entreat* (from a thing). — Also, *curse*.

dētīnēō, -tinēre, -tinuī, -tentus,

[de-teneo], 2. v. a., *hold off, detain, delay, stop.*

dētrāctō (-trecto), -āre, -āvī, -ātus, [de-tracto], 1. v. a., (*hold off from one's self*), *avoid, shun.*

dētrāctus, -a, -um, p. p. of *de-traho.*

dētrahō, -trahere, -trāxī, -trāctus, [de-traho], 3. v. a., *drag off, snatch (away).*—With less violence, *take away, take off, withdraw* (with no violence at all).

dētrectō, see *detracto.*

dētrīmentōsus, -a, -um, [detrīmentō- (reduced) + osus], adj., *detrīmental, hurtful.*

dētrīmentum, -ī, [de-†trīmentum (tri- in *tero, rub, + mentum*), cf. *detero*], n., (*a rubbing off*), *loss, injury.*—Esp., *defeat, disaster.*

dēturbātus, -a, -um, p. p. of *deturbo.*

dēturbō, -āre, -āvī, -ātus, [de-turbo, *disturb*], 1. v. a., *drive off* (in confusion).

deūrō, -ūrere, -ūssī, -ūstus, [de-uro], 3. v. a., *burn off, burn up.*

deus, -ī, [akin to *divus, Iovis, dies*], m., *a god.*

deūstus, -a, -um, p. p. of *deuro.*

dēvehō, -vehere, -vēxī, -vectus, [de-veho], 3. v. a., *carry away, bring (to a place), bring along.*

dēveniō, -venīre, -vēnī, -ventūrus, [de-venio], 4. v. n., *come away, land (come down from the sea), come (from one place to another).*

dēvexus, -a, -um, [prop. a p. p. of *deveho*], adj., *sloping.*—Neut. plur. as noun, *slopes, hillsides.*

dēvictus, -a, -um, p. p. of *devinco.*

dēvincō, -vincere, -vīcī, -victus, [de-vinco], 3. v. a., *conquer* (so as to prostrate), *subdue* (entirely).

dēvocō, -āre, -āvī, -ātus, [de-voco], 1. v. a., *call down* (or away).—Esp., fig., *invite, bring: fortunae in dubium (risk).*

dēvōtus, -a, -um, p. p. of *de-voceo.*

dēvoveō, -vovēre, -vōvī, -vōtus, [de-voceo], 2. v. a., *vow (away).*—Less exactly, *devote.*—dēvōtus, -a, -um, p. p. as noun, *a devoted follower* (sworn to die with his companion).

dexter, -era, -erum, (-tra, -trum), [unc. st. (perh. akin to *digitus*) + *terus*], adj., *right* (in the right hand).—*dextra*, f., (sc. *manus*), *the right hand* (esp. used as a pledge of faith, as with us).

Diablintes (-tres), -um, [Celtic], m. plur., a Gallic tribe, a branch of the Aulerici.

dicīō (less correctly *dit-*), -ōnis, [st. akin to *dicō* + *o*, cf. *legio*], f., (*command*, cf. Eng. "*say*"), *dominion, sway.*

dicō, -āre, -āvī, -ātus, [†dicō- (cf. *causi-dicus*)], 1. v. a., *adjudge, assign* (in some legal manner).—Less exactly (esp. with reflex.), *assign, make over: se in clientelam (bind one's self, attach one's self); se in servitutum (surrender).*

dicō, dicere, dīxī, dictus, [DIC, in *dicō* and *dicus*], 3. v. a. and n., (*point out?*), *say, speak, name.*—Esp., with authority, *name, appoint, fix: ius (administer, cf. dīco); sententiam (give).*—Special uses: *dicunt, they*

say: *causam dicere*, *plead one's cause*, hence *be tried, be brought to trial*. — See also *dictum*.

dictiō, -ōnis, [dic (as root of dico) + tio], F., a speaking, a pleading (cf. dico): *causae* (*pleading one's cause, trial*).

dictum, -ī, [N. p. p. of dico], N., a thing said, a statement, a remark, a command: *dicto audiens esse alicui* (*be obedient, obey*).

dīdūcō, -dūcere, -dūxī, -ductus, [dis-duco], 3. v. a., *draw apart, lead apart, separate, divide*.

dīēs, -ēī, [prob. for dives, DVU + AS], M. (rarely F. in some uses), a day (in all Eng. senses). — Also, time: *in dies*, *from day to day*, with idea of increase or diminution: *diem ex die ducere*, *put off a thing day after day*; *ad diem*, *on the day*; *dies longior*, *a later time*.

differō, *differre*, *distulī*, *dilātus*, [dis-fero], irr. v. a. and n., *bear apart, spread*. — Also, *postpone, defer, differ*.

difficilis, -e, [dis-facilis, easy], adj., *not easy, difficult*: *iter* (*hard to pass over*).

difficultās, -tātis, [difficili- (weakened) + tās], F., *difficulty*: *magna difficultate adiciebatur*, *was much troubled*; *rei frumentariae* (*difficulty of supplying grain*).

difficulter [difficili- (weakened) + ter], adv., *with difficulty*; compar., *with greater difficulty*.

diffidō, -fidere, -fusus sum, [dis-fido], 3. v. n., *distrust, not have confidence*.

diffisus, -a, -um, p. p. of *diffido*.

diffundō, -fundere, -fūdī, -fūsus, [dis-fundo], 3. v. a., *spread out*.

digitus, -ī, [?], M., a finger: *pollex* (*the thumb*). — As in Eng., a finger's breadth, a finger (as a measure).

dignitās, -tātis, [dignō- + tas], F., *worthiness, worth, dignity, prestige, position* (superior); *tribuere* (*have respect for*).

dignus, -a, -um, [?, perh. root of dico + nus], adj., *worthy*.

dīiudicō, -āre, -āvī, -ātus, [dis-iudico, judge], 1. v. a. and n., *decide* (between two).

dilēctus, -a, -um, p. p. of *diligo*.

diligenter [diligent- + ter], adv., *carefully, with care, with exactness, exactly, with pains*: *conservavit* (*took pains to save*); *parum diligenter*, *too carelessly*.

diligentia, -ae, [diligent- + ia], F., *care, pains, painstaking, diligence*: *remittere* (*cease to take pains, take less care*).

diligō, -ligere, -lēxī, -lēctus, [dis-lego], 3. v. a., (*choose out*), *love, be fond of*. — See also *diligens*.

dīmēnsus, -a, -um, p. p. of *dīmetior*.

dīmētiōr, -mētīrī, -mēnsus, [dīmetior], 4. v. dep., *measure* (in parts), *measure out* (esp. of camp). — *dīmēnsus*, -a, -um, *measured*.

dīmīcatiō, -ōnis, [dīmico], F., *fight, contest*.

dīmīcō, -āre, -āvī, -ātūrus, [dīmico], 1. v. n., (*brandish swords to decide a contest?*), *fight* (a decisive battle), *risk an engagement*.

dīmīdius, -a, -um, [dis-mediū],

adj., (*divided in the middle*), *half*.
— Neut. as noun, *the half*.

dīmittō, -mittere, -mīsī, -missus, [dis-mitto], 3. v. a., *let go away, let slip, let pass, let go, give up, relinquish, abandon*: **oppugnationem** (*raise*); **victoriam** (*let go, on purpose*). — Also, *send in different directions, send about, despatch, detail, disband, dismiss*.

dīrēctus, -a, -um, see **derectus**.

dīreptus, -a, -um, p. p. of **diripio**.

dīrigō, see **derigo**.

dirimō, -emere, -ēmī, -ēemptus, [dis-emo, *take*], 3. v. a., *take apart, break up* (a conference).

diripiō, -ripere, -ripuī, -reptus, [dis-rapio], 3. v. a., *seize* (in different directions), *plunder, pillage, ravage*.

dis-, **dī-** (**dir-dif-**), [akin to **duo**?], inseparable prep. (adv.), in compounds, *apart, asunder, in different directions, not, un-*. — Cf. **discedo**, **discerno**, **dirimo**, **diffundo**.

Dīs, **Dītis**, [akin to **dives**, *rich*, as the earth is the source of riches], M., *Pluto* (the god of the under world, and so of death).

discēdō, -cēdere, -cessī, -cessurus, [dis-cedo, *go*], 3. v. n., *withdraw, depart, retire, leave* (with **ab**), *go away*: **locus unde discesserant**, *the place which they had left*; **ab officio** (*fail in one's duty*); **spes hostibus** (*forsake, fail*); **ab signis** (*leave the ranks*); **ab armis** (*lay down one's arms*).

disceptātor, -tōris, [disceptā- (st. of **discepto**, *decide*) + **tor**], M., *a judge, an arbiter, umpire*.

discernō, -cernere, -crēvī, -crētus, [dis-cerno, *separate*], 3. v. a., *separate, distinguish*.

discessus, -sūs, [dis-+cessus, cf. **discedo**], M., *a departure, a withdrawal*.

disciplīna, -ae, [discipulō- (reduced) + **ina**, cf. **rapina**], F., (*pupillage?*), *discipline, instruction, a system* (of doctrine, etc.), *a course of instruction*.

disclūdō, -clūdere, -clūsi, -clūsus, [dis-claudo], 3. v. a., *shut apart, keep apart, separate, divide*.

discō, **discere**, **didici**, **discitūrus**, [for +**discisco** (**DIC** + **sco**)], 3. v. a. and n., *learn*: **discendi causa**, *for instruction*.

discrīmen, -inis, [dis-crimen, cf. **discerno**], N., *a separation, a decision*. Hence, *a moment of decision, a crisis, critical condition, danger*.

discussus, -a, -um, p. p. of **discutio**.

discutiō, -cutere, -cussī, -cussus, [dis-quatio, *shake*], 3. v. a., *strike* (or *shake*) *apart, beat away, drive away, clear away, dislodge, shatter*.

disiciō, -icere, -īcī, -iectus, [dis-iacio], 3. v. a., *hurl apart, break up* (a phalanx), *disperse, tear off* (yards). — **disiectus**, -a, -um, p. p. as adj., *scattered, broken, in disorder*: **pabulatio** (*in widely scattered places*).

disiectus, -a, -um, p. p. of **disicio**.
dispār, -paris, [dis-par], adj., *unequal, inferior, ill-matched, different*.

disparō, -are, -āvī, -ātus, [dis-

paro], 1. v. a., *scatter, separate*, (cf. *disiungo*).

dispērgō, -spērgere, -spērsī, -spērsus, [dis-spargo, *scatter*], 3. v. a., *scatter, disperse*.

dispersus, -a, -um, p. p. of *dispergo*.

dispōnō, -pōnere, -posuī, -positus, [dis-pono], 3. v. a., *place about* (in various places), *station* (variously), *array* (at several posts).

dispositus, -a, -um, p. p. of *dispono*.

disputātiō, -ōnis, [dis-putatio, cf. *disputo*], F., *discussion, dispute*.

disputō, -āre, -āvī, -ātus, [dis-puto, *reckon*], 1. v. n. and a., *discuss, investigate*.

dissēnsiō, -ōnis, [dis-†sensio (cf. *dissentio*)], F., *difference of opinion, disagreement, dissension*.

dissentiō, -sentīre, -sēnsī, -sēnsūrus, [dis-sentio, *feel*], 4. v. n., *differ in opinion* (cf. *sentio*), *be at variance, disagree* (ab, with).

disserō, -ere, [dis-sero], 3. v. a., *plant here and there, place at intervals*.

dissimulō, -āre, -āvī, -ātus, [dis-simulo, *make like*], 1. v. a. and n., (*pretend something is not*), *conceal* (what is), *dissemble*.

dissipātus, -a, -um, p. p. of *dissipo*.

dissipō, -āre, -āvī, -ātus, [dis-†supo, *throw*], 1. v. a., *scatter, disperse*: *dissipati, straggling troops*.

dissuādēō, -suādēre, -suāsī, -suāsūsus, [dis-suadeo], 2. v. a., *advise to the contrary, oppose* (in argument), *dissuade*.

distineō, -tinēre, -tinuī, -tentus, [dis-teneo], 2. v. a., *keep apart, hold asunder, keep from uniting, cut off* (in military sense), *isolate*.

dīstō, -stāre, [dis-sto], 1. v. n., *stand apart, be distant*: *quantum iunctura distabat* (*as far as the distance between, etc.*); *quantum summa labra distabant* (*the width [of the ditch] at the top*).

distrahō, -trahere, -trāxī, -trāctus, [dis-traho], 3. v. a., *drag asunder, separate*. Hence, *distract*.

distribuō, -buere, -buī, -būtus, [dis-tribuo, *assign*], 3. v. a., *assign* (to several), *distribute, divide*.

dītissimus, -a, -um, superl. of *dives*.

diū [prob. acc. of st. akin to *dies*], adv., *for a time, a long time, for some time, long*: *tam diu, so long*; *quam diu, how long, as long, as long as*; *diutius, any longer*; *diutissime, for the longest time, longest*.

diurnus, -a, -um, [†dius, akin to *diu* and *dies*, + nus], adj., *of the day, daily* (as opposed to *nightly*): *nocturnis diurnisque itineribus* (*by night and day*).

diūtinus, -a, -um, [diu + tinus], adj., (*long in time*), *long continued*.

diūturnitās, -tātis, [diuturno- + tas], F., *length of time, long continuance, length* (in time).

diūturnus, -a, -um, [diu + turnus, cf. *hesternus*], adj., *long continued, long* (in time).

dīversus, p. p. of *diverto*.

dīvertō, -vertere, -vertī, -versus, [dis-vertō], 3. v. a. and n., *turn aside* (or *apart*), *separate*. — *dīver-*

sus, -a, -um, p. p. as adj., *separate, distant, diverse, different.*

dīves, -itis, [?], adj., *rich.*

Dīviciācus, -ī, [Celtic], M.: 1. A leader of the Hædūi, brother of Dumnorix.—2. A leader of the Sussions.

Dīvicō, -ōnis, [Celtic], M., a leader of the Helvetii.

dīvidō, -videre, -vīsī, -vīsus, [dis- + vido, VIDH (?), cf. **vidua**, *widow*], 3. v. a., *divide, separate.*—**dīvīsus**, -a, -um, p. p. as adj., *divided*: Gallia divisa est.—Also, *spread out.*

dīvīnus, -a, -um, [divō- (as if divi) + nus], adj., *of the gods, divine*: res divinae, *matters of religion, religion.*

1. **dō**, dare, dedī, datus, [DA, *give*, cf. 2. **dō**], 1. v. a., *give, afford, offer, allow, concede, assign, grant*: responsum (*answer, reply*); sibi minus dubitationis dari, *that he had less hesitation*; filiam in matrimonium (*marry*); se vento (*run before the wind*); mānus (*submit, yield, from holding out the hands to be bound*); hostes in fugam (*put to flight*); operam (*take pains, exert one's self, see to it that, etc.*); negotium uti (*employ one to, etc., engage one to, etc.*); suspicionem (*afford, make a show, but also have an appearance*); arbitros (*assign referees, a judicial function*).

2. **dō** [DHA, *place*], confounded with 1. **dō**, but appearing in comp., *place, put*, as **abdō**, **condō**.

doceō, docēre, docuī, doctus, [unc. formation akin to **dico** and **disco**], 2. v. a., *teach, show, inform, repre-*

sent, state (in the course of the narrative).

documentum, -ī, [docu- (?) (as st. of **doceo**) + **mentum**], N., *a means of teaching, a proof, a warning, an example.*

doleō, dolēre, doluī, dolitūrus, [perh. **dolō-** (st. of **dolus**, *craft*)], 2. v. n., *feel pain, suffer.*—Esp. mentally, *be pained, grieve.*

dolor, -ōris, [dol- (as root of **doleo**) + **or**], M., *pain* (physical or mental), *distress, indignation, chagrin, vexation*: magno dolore ferre, *be very indignant, feel much chagrin*; magno esse dolori, *to be a great annoyance or sorrow*; almost concrete, *a grievance.*

dolus, -ī, [perh. akin to **doleo**, originally *stroke?*], M., *an artifice, deceit, tricks, a stratagem.*

domesticus, -a, -um, [domō- (as if domes-, cf. **modestus**) + **ticus**], adj., (*of the house*), *of one's home, one's own, at home*: bellum (*domestic, internal, intestine*).

domicilium, -ī, [perh. **domō-** + **†cilium** (fr. root of **colo**)], N., *an abode, a house, a dwelling-place, a house* (as a permanent home).

dominor, -ārī, -ātus, [dominō-], 1. v. dep., *rule, be master.*

dominus, -ī, [†domō- (*ruling*) + **nus**], M., *a master, an owner.*

Domitius, -ī, [domitō- (*reduced*) + **ius**], M., a Roman gentile name.—Esp., *Lucius Domitius Ahenobarbus*, consul in B.C. 54.

domus, -ī (-ūs), [DOM (*build?*) + **us** (-os and -us)], F., *a house, a home*: domī, *at home*; domum, *home*,

to one's home; domo, from home; domo exire, go away, emigrate.

dōnātus, -a, -um, p. p. of dono.

Donnotaurus, -ī, [Celtic], M., a Gallic name. — Esp., Gaius Valerius Donnotaurus, a chief of the Helvetii, son of C. Valerius Caburus, and brother of C. Valerius Procillus. The first two names of these persons are Roman, taken from the name of their patron.

dōnō, -āre, -āvī, -ātus, [donō-], I. v. a., present, give (as a gift). — Also, honor with a gift, present (one with a thing); civitate aliquem donare, give one the rights of citizenship.

dōnum, -ī, [DA (give) + nus], N., a gift.

dorsum (-us), -ī, [?], N. (and M.), the back. — Less exactly, a summit (of a long ridge).

dōs, dōtis, [DA (give) + tis (reduced)], F., (a gift). — Esp., a marriage gift, a dowry, a portion (given at marriage).

druides, -um, [Celtic], M., the Druids, the priests of the Gallic religion.

Dubis, -is, [Celtic], M., the Doubs, a river of Gaul, flowing from the Jura into the Saône.

dubitātiō, -ōnis, [dubitā- (st. of dubito) + tio], F., doubt, hesitation: alicui minus dubitationis dari, to feel less doubt or hesitation.

dubitō, -āre, -āvī, -ātūrus, [†dubitō- (partic. of lost verb dubo?, cf. dubius)], I. v. n., doubt, have doubt, feel doubtful. — Also (absolutely, or with inf., rarely with quin), hesitate, feel hesitation, vacillate.

dubius, -a, -um, [duo + bius, cf. superbus and dubito], adj., doubtful: est dubium, there is doubt, it is doubtful.

ducentī, -ae, -a, [duō-centi (plur. of centum)], adj., two hundred.

dūcō, dūcere, dūxī, ductus, [DUC (in dux)], 3. v. a., lead: draw, bring (of living things): primum pilum (be first centurion). — Esp. of a general, lead, march. — With or without in matrimonium, marry (of the man). — Less exactly, run (a line, a ditch), draw, make. — Fig., prolong, drag out. — As mercantile word, and so fig., reckon, consider.

ductus, -tūs, [DUC + tus], M., lead, command.

dum [pron. DA, prob. acc., cf. tum], conj., at that time. — Also, while, so long as. Hence, till, until.

Dumnorīx, -īgis, [Celtic], M., a leader of the Hædii, brother of Diviciacus.

duo, -ae, -o, [dual, of st. †dvō-, cf. bis], num. adj., two.

duodecim [duo-decem], indecl. num. adj., twelve.

duodecimus, -a, -um, [duo-decimus], num. adj., twelfth.

duodēnī, -ae, -a, [duo deni], num. adj., twelve (in a set).

duodēvīgintī [duo de viginti, twenty], indecl. num. adj., eighteen.

duplex, -plicis, [duo-†plex, cf. plico, fold], adj., two-fold, double: acies (in two divisions, arranged for successive attacks in the same direction, or for the same tactical purpose).

duplicō, -āre, -āvī, -ātus, [duplic-], I. v. a., *double, increase two-fold.*

dūritia, -ae, [durō- + tia], F., *hardness, hardship.*

dūrō, -āre, -āvī, -ātus, [durō-], I. v. a., *harden, toughen, make hardy.*

Dūrocortorum, -ī, [Celtic], N., the chief city of the Remi, now *Rheims.*

dūrus, -a, -um, [?], adj., *hard.* — Fig., *hard, severe, difficult*: *si quid erat durius (any severe contest) : si nil esset durius, if no accident happened.*

Dūrus, -ī, [durus], M., a Roman family name. — Esp., *Quintus Laberius Durus*, a military tribune in Cæsar's army, killed in Britain.

dux, ducis, [DUC (*lead*) as st.], C., *a leader, a guide, a commander.*

E

ē, shortened form of **ex** (esp. in composition), which see.

eā [instr. or abl. of is], adv., *this way, that way, thus, in that direction, in that quarter.*

Eburōnes, -um, [Celtic], M. plur., a Belgian tribe, dependents of the Treveri, living north of these between the Meuse and the Rhine.

Ebuovīces, -um, [Celtic], M. plur., a Gallic tribe, a branch of the Auleri living in the region of modern *Perche.*

ēdiscō, -discere, -didicī, no p. p., [ex-disco], 3. v. a., *learn off, learn by heart, commit to memory.*

ēditus, -a, -um, p. p. of **edo**.

ēdō, -dere, -didī, -dītus, [ex-do], 3. v. a., *put forth, give forth*: *exempla cruciatusque (make an example by inflicting severe torture).* —

ēditus, -a, -um, p. p. as adj., *elevated, raised, high.*

ēdoceō, -docēre, -docuī, -doctus, [ex-doceo, teach], 2. v. a., *show forth, explain, inform, tell, instruct.*

ēdūcō, -dūcere, -dūxī, -ductus, [ex-duco]. 3. v. a., *lead out, lead*

forth, draw (a sword), bring out (baggage-train).

ēductus, -a, -um, p. p. of **educō**.

effarciō (-ferc-), -farcīre, -farsī, -fertus, [ex-farcio], 4. v. a., *stuff out, fill in (solid).*

effēminō, -āre, -āvī, -ātus, [ex-†femino, or perh. †effeminō- (or -i), in either case from **femina**], I. v. a., *make into a woman.* — Less exactly, *(make like a woman), enervate, weaken*: *animos (enfeeble, debauch).*

effērō, efferre, extulī, ēlātus, [ex-fero], irr. v. a., *carry out, bring out, carry away.* — Less exactly and fig., *spread abroad, make known, publish abroad, puff up, elate* (cf. Eng. "carried away"). — Also (cf. **edo**), *raise up.*

efficiō, -ficere, -fēcī, -fectus, [ex-facio], 3. v. a., *make out, make, enable, accomplish, cause, produce, cause to be, make into, make out (furnish)*: *ut praeberent (make them afford)*; *ut sint laboris (make capable of)*; *ut posset (make possible)*; *classem (get together, construct).*

effodiō, -fodere, -fōdī, -fossus.

[**ex-fodio**], 3. v. a., *dig out, gouge out*.

effossus, -a, -um, p. p. of **effodio**.

effugiō, -fugere, -fūgī, -fugitūrus, [**ex-fugio**], 3. v. a., *escape, flee* (absolutely), *fly from*.

egēns, pres. p. of **egeo**.

egeō, egēre, eguī, no p. p., [tegō- (cf. **indigus**, *in want*)], 2. v. n., *want, need, be in want*. — **egēns**, -entis, pres. p. as adj., *needy, destitute*.

egestās, -tātis, [unc. st. (perh. **egent-**) + **tas**], F., *poverty, destitution*.

ego, meī, [cf. Eng. *I*], pron., *I* (*me*, etc.). — Plur., nōs, *we, us*, etc.

egomet, nōsmet, etc., pron. emph., with encl. -met, *I, we*.

ēgredior, -gredī, -gressus, [**ex-gradior**, *step*], 3. v. dep., *march out, go out, move beyond*: **finis** (*pass beyond*); **navi** (*land, disembark*); **unde erant egressi**, *the place they had left*; **ex oppido** (*evacuate*).

ēgregiē [old case-form of **egregius**], adv., *remarkably, finely, extremely well*.

ēgregius, -a, -um, [e grege (*out of the herd*) + **ius**], adj., *out of the common, remarkable, superior, excellent, uncommon, special*.

ēgressus, -a, -um, p. p. of **egredior**.

ēgressus, -sūs, [e-gressus, cf. **ingressus** and **egredior**], M., *a landing*.

ēiciō, -icere, -iēcī, -iectus, [**ex-iacio**], 3. v. a., *cast out, drive out, cast up* (cf. **edo**). — With reflex., *rush out, rush*.

ēiectus, -a, -um, p. p. of **eicio**.

ēiusmodī [**eius modi**], as adj. phrase, *of this kind, of such a kind, such, of such a nature, of this nature*.

ēlābor, -lābī, -lāpsus, [**ex-labor**], 3. v. dep., *slip out, escape*.

ēlāpsus, -a, -um, p. p. of **elabor**.

ēlātus, -a, -um, p. p. of **effero**.

Elaver, -veris, [Celtic], N., a tributary of the Loire, now *Allier*.

ēlēctus, -a, -um, p. p. of **eligo**.

elephantus, -ī, [Gr. acc. ἐλέφαντα, declined], M., *an elephant*.

Eleutetī, -ōrum, [Celtic], M. plur., a people dependent on the Arverni.

ēliciō, -licere, -licuī, -licitus, [**ex-lacio**], 3. v. a., *entice out, draw out*.

ēligō, -ligere, -lēgī, -lēctus, [**ex-lego**], 3. v. a., *pick out, select*. — **ēlēctus**, -a, -um, p. p. as adj., *picked* (troops).

Elusātēs, -ium, [Iberian], M. plur., a people of Aquitania.

ēmigrō, -āre, -āvi, -ātūrus, [**ex-migro**], 1. v. n., *remove* (permanently), *emigrate*. — With **domo** (in same sense).

ēmineō, -nēre, -nuī, no p. p., [**ex-†mineo**, *project*], 2. v. n., *stand out, project*.

ēminus [**ex manu**, *hand*, cf. **cominus**], adv., *at a distance, at long range*.

ēmittō, -mittere, -mīsī, -missus, [**ex-mitto**], 3. v. a., *let go, drop, send out, throw, hurl, discharge*. — Pass., or with reflex., *rush out*.

emō, emere, ēmī, ēmptus, [EM?, orig. *take*], 3. v. a., (*take*, only in compounds). — Esp., *buy* (cf. Eng. *sell*, orig. *give*), *purchase*.

ēnāscor, -nāscī, -nātus, [ex-nāscor],
3. v. dep., *spring out, grow out.*

ēnātus, -a, -um, p. p. of **enāscor**.

enim [prob. e (in **en**, **ecce**) + **nam**], (always postpositive) conj., *really*. — Esp. as explanatory, *for, but, now, for in fact*: **neque enim, for of course . . . not, for you see . . . not.**

ēnūntiātus, -a, -um, p. p. of **enuntio**.

ēnūntiō, -āre, -āvī, -ātus, [ex-nūntio, *announce*], 1. v. a., *make known, report, disclose, reveal*: **hostibus enuntari**, (*that*) *the enemy were informed of.*

eō, īre, īvī (īi), itūrus, [root 1], irr. v. n., *go, pass, march, advance, proceed*. — Pass. inf. **īrī** used with verbs to form the fut. pass. inf.

eō [old dat. of **is**], adv., *thither, there* (in sense of *thither*). — Often translated by more def. expressions in Eng., *to the place* (where, etc.), *on them* (*it, him*, etc.): **usque eo ut**, *to that degree that, so far that.*

eō, abl. neut. used as the abl. of degree of difference; see **is**.

eōdem [old dat. of **idem**, cf. **eo**, *thither*], adv., *to the same place, in the same place* (cf. **eo**), *there also*: **eodem conduxit** (*to the same place* [as himself]); **eodem pertinere**, *look in the same direction, tend the same way*; **eodem illo pertinere . . . ut**, *favoured the same idea . . . that, belonged to the same design . . . that.*

ephippiātus, -a, -um, [ephippiā- (as if st. of verb, cf. **auratus**) + **tus**, see **ephippium**], adj., *saddled, capar-*

isoned: *equites* (*riding on saddles*, as a less manly form of *horsemanship*).

ephippium, -ī, [Gr. ἐπίππιον (*ἐπί*, *upon*; *ἵππος*, *a horse*)], N., *a horse-cloth, caparison, housing.*

epistula (**epistola**), -ae, [Gr.], F., *a letter, a note, a message* (in writing), *a despatch.*

Eporēdorix, -īgis, [Celtic], M.: 1. A nobleman of the Hædui. — 2. Another, VII, 67.

epulum, -ī, plur., -ae, -ārum, [?], N. (sing.), F. (plur.), *a feast, a banquet.*

eques, -itis, [equō- + **tis** (reduced)], M., *a horseman, a rider*. — Plur., *cavalry*. — Esp. (as orig. serving on horseback), *a knight* (one of the moneyed class at Rome, next in rank to the senate). — So also, *a knight* (of Gaul, of a corresponding class).

equester, -tris, -tre, [equit- + **tris**], adj., *of knights, of cavalry.*

equitātus, -tūs, [equitā- (as st. of **equito**, *ride*) + **tus**], M., *cavalry, horse* (troops serving on horseback).

equus, -ī, [AK (*swift*) + **vus**], M., *a horse.*

Eratosthenēs, -is, [Gr.], M., a Greek philosopher and mathematician of Alexandria, born at Cyrene B.C. 276. He was famous for his investigations in geography and astronomy.

ērēctus, -a, -um, p. p. of **erigo**.

ēreptus, -a, -um, p. p. of **eripio**.

ergā [prob. instr. of same st. as **ergo**], prep. with acc., *towards* (of feeling and conduct): **fides erga aliquem**.

ergō (-ō rarely) [unc. form, perh. dat., cf. erga], adv., *therefore, then*.

ērigō, -rigere, -rēxī, -rēctus, [ex-rego, *make straight*], 3. v. a., *set up straight, raise up*. — With reflex., *get up*. — ērēctus, -a, -um, p. p. as adj., *high, high and straight*.

ēripiō, -riperē, -ripiū, -reptus, [ex-rapio], 3. v. a., *snatch away, wrest (a thing from), deprive (one of a thing, changing the relation in Eng.), take from, rescue*: *se eripere ne, save one's self from doing a thing*.

errō, -āre, -āvī, -ātūrus, [?], 1. v. n., *wander, go astray, err, be mistaken*.

ērumpō, -rumpere, -rūpī, -ruptus, [ex-rumpo], 3. v. a. and n., *burst out, sally out, make a sally*.

ēruptiō, -ōnis, [ex-ruptio, cf. erumpo], f., *a breaking out, a sally, a sortie*.

essedā, -ae (-um, -ī), [Celtic], f. (and n.), *a war chariot (of the Gauls)*.

essedārius, -ī, [essedō- (-a) (reduced) + arius], m., *a charioteer (a warrior fighting from an essedum)*.

Esuvii, -ōrum, [Celtic], m. plur., *a Gallic tribe in the region of Normandy*.

et, conj., *and*: et . . . et, *both . . . and*.

etiam [et iam], conj., *also, even, even now, yet*: *quin etiam, nay more*.

etsī [et si], conj., *even if, although, though*.

ēvādō, -vādere, -vāsī, -vāsūrus, [ex-vado, go], 3. v. n., *escape*.

ēvellō, -vellere, -vellī (-vulsī),

-vulsus, [ex-vello], 3. v. a., *pull out, pluck out*.

ēveniō, -venire, -vēnī, -ventūrus, [ex-venio], 4. v. n., *come out, turn out, happen*.

ēventus, -tūs, [ex-†ventus, cf. conventus and evenio], m., *result, issue, fate, success*.

ēvocātus, -a, -um, p. p. of evoco.

ēvocō, -āre, -āvī, -ātus, [ex-voco], 1. v. a., *call out, call forth, summon, challenge (ad pugnam), carry away (cupiditas longius), invite (omnes ad se spe praedae)*. — ēvocātus, -a, -um, p. p. as adj. and noun, *veteran (of soldiers who have served their time and are only called out in emergencies), veterans (almost equal volunteers)*.

ēvolō, -āre, -āvī, -ātūrus, [ex-volo], 1. v. n., *fly out, rush out*.

ex (ē) [?], adv. (in comp.) and prep. with abl., *out of (cf. ab, away from), out*. — Less exactly, *from (lit. and fig.), of (made of)*: *facilia ex difficillimis redegerat, had made easy instead of most difficult, as they were. Hence, after*. — Also, *on account of, in accordance with, by means of*. — Also, *above (raised from)*. — Also (cf. ab), *in, on*: *una ex parte, on one side*; *ex itinere, on the march, starting from it*; *ex vinculis, in chains, doing something from them*; so, *ex equis, on horseback*; *ex eorum corporibus*; *ex ea civitate, from that nation, belonging there*; *ex fuga, in their flight*. — Other phrases: *ex commutatione dolere, suffer from the change*; *diem ex die, day after day*; *magna ex parte,*

in a great degree, for the most part; quaerere ex, *ask of, ask, cf. ab*; ex eo plus doloris capere (*on this account, etc.*); ex cratibus (*of, made of*); unus e filiis (*one of, etc.*); ex communi consensu, *by common consent*; ex percontatione, *by inquiry, from one which was made*; ex Hispania (*a man from*); ex eo die quintus (*from, after*); ex usu, *for the advantage, cf. "of use"*; ex planitie editus (*above, raised out of*); e regione, *opposite*; ex litteris (*in accordance with, from facts stated in, etc.*); ex tertia parte aestimare (*as a third, cf. heres ex asse*), ex contrario, *on the contrary*.—In comp., *out, completely (cf. "out and out")*, *off, up, after, from, un-*.

exāctus, -a, -um, p. p. of exigō.

exagitō, -āre, -āvī, -ātus, [ex-agito, freq. of ago, *drive*], 1. v. a., *pursue, drive, harass, persecute*.

exāminātus, -a, -um, p. p. of ex-amino.

exāminō, -āre, -āvī, -ātus, [ex-amin- (st. of examen, *tongue of the balance*)], 1. v. a., *weigh*.

exanimātus, -a, -um, p. p. of ex-animo.

exanimō, -āre, -āvī, -ātus, [ex-animō-], 1. v. a., *deprive of breath (life), kill*.—exanimātus, -a, -um, p. p. as adj., *out of breath, exhausted*.

exārdescō, -ārdescere, -ārsī, no p. p., [ex-ardesco, cf. ardeo, *burn*], 3. v. n., *blaze up*.—Fig., *become enraged, become excited*.

exaudiō, -īre, -īvī, -ītus, [ex-audio], 4. v. a., *hear (from a distance), hear distinctly*.

excēdō, -cēdere, -cessī, -cessūrus, [ex-cedo], 3. v. n., *go out, leave (with abl.), withdraw, retire*.—Absolutely, *leave the fight*.

excello, -ere, -ui, -sus, [ex-†cello], 3. v. a. and n., *raise, rise, surpass, excel*.—excelsus, -a, -um, p. p. as adj., *high, elevated*.

excelsus, -a, -um, p. p. of excello.

exceptō, -āre, -āvī, -ātus, [ex-capto, cf. excipio], 1. v. a., *catch up, take hold of*.

exceptus, -a, -um, p. p. of excipio.

excidō, -cidere, -cidī, -cīsus, [ex-caedo], 3. v. a., *cut out, cut off, break down (gates)*.

excipiō, -cipere, -cēpī, -ceptus, [ex-capio], 3. v. a., *take off, take up, pick up, receive, catch (of animals)*. Hence, *follow, come after, come next*: vada (*stand, of vessels*); vim fluminis (*break*); alios alii (*succeed*); hunc alii (*follow, take up the cry in shouting*).

excitātus, -a, -um, p. p. of excito.

excitō, -āre, -āvī, -ātus, [ex-cito, cf. exciteo, *call up*], 1. v. a., *call out, rouse, stimulate (induce)*.—Also, *raise (towers), kindle (fire)*.

exclūdō, -clūdere, -clūsī, -clūsus, [ex-claudio], 3. v. a., *shut out, cut off (from doing a thing), prevent*.

exclūsus, -a, -um, p. p. of excludo.

excogitō, -āre, -āvī, -ātus, [ex-cogito], 1. v. a., *think out, devise*.

excruciātus, -a, -um, p. p. of excrucio.

excrucio, -āre, -āvī, -ātus, [ex-crucio, cf. crux, *cross*], 1. v. a., *torture, torment*.

excubitor, -tōris, [as if **ex-†cu-**bitor, cf. **excubo**], M., *a sentinel* (as lying out of the camp or tent).

excubō, -cubāre, -cubūi, -cubitūrus, [**ex-cubo**], I. v. n., *lie outside*. — Esp. of camp, *stand guard, keep a night-watch, watch*.

exculcō, -āre, -āvī, -ātus, [**excalco**], I. v. a., *tread down, trample down*.

excurrō, -currere, -curri, (-cucurri), -cursūrus, [**ex-curro**], 3. v. n., *run out, make a sally*. — See **excursio**.

excursiō, -ōnis, [**ex-†cursio**, cf. **ex-curro**], F., *a sally, a sortie*.

excūsātiō, -ōnis, [**ex-†causatio**, cf. **excuso**], F., *an excuse, an apology*.

excūsō, -āre, -āvī, -ātus, [**ex-†causo**, cf. **causa**, *reason*], I. v. a., *give as an excuse*. — Also (with change of relation), *excuse, exculpate*.

exemplum, -ī, [**ex-†emplum**, EM (in **emo**, *take*) + **lus** with parasitic p], N., (*something taken out*), *a sample, a copy, a precedent, an example*.

exeō, -īre, -īvī (-īi), -itus, [**ex-eo**], irr. v. n., *go forth, go out, emigrate, march out, remove*.

exerceō, -ercēre, -ercuī, -ercitus, [**ex-arceo**, *drive off*], 2. v. a., *train, practise, exercise*.

exercitātiō, -ōnis, [**exercitā-** (st. of **exercito**) + **tio**], F., *practice, exercise*.

exercitātus, -a, -um, p. p. of **exercito**.

exercitō, -āre, -āvī, -ātus, [**exercitō-**, cf. **exerceo**], I. v. a., *train, practise*. — **exercitātus**, -a, -um, p. p. as adj., *trained*. — Superl., *very well trained*.

exercitus, -tūs, [as if **ex-arcitus**, cf. **exerceo**], M., (*a training*). — Concretely, (*a body trained or in training*), *an army* (large or small, acting independently), *a force*.

exhauriō, -haurīre, -hausī, -hausitus, [**ex-haurio**], 4. v. a., *drain off*. — Less exactly, *carry off* (earth).

exigō, -igere, -ēgī, -āctus, [**ex-ago**], 3. v. a., (*lead out*), *pass, spend, finish, complete*: *exacta hiems, the end of winter*; *aestas exacta erat* (*was ended*).

exiguē [old case-form of **exiguus**], adv., *scantily, meagrely*: *exigue habere frumentum* (*have a scanty supply of, etc.*).

exiguitās, -tātis, [**exiguo-** + **tas**], F., *scantiness, meagreness*: *temporis* (*short time, want of time*); *pellium* (*small size*); *castrorum* (*narrowness, small size*).

exiguus, -a, -um, [**ex-†aguus** (AG + **uus**), cf. **exigo**], adj., (*exact?*), *narrow, scanty, small, meagre*.

eximius, -a, -um, [**ex-†emius**, EM + **ius**, cf. **eximo**, *take out*], adj., (*taken out*), *exceptional, remarkable, very high* (*opinio*).

exīstimātiō, -ōnis, [**ex-aestimatio**, cf. **existimo**], F., *estimate, opinion*.

existimō, -āre, -āvī, -ātus, [**ex-aestimo**, *reckon*], I. v. a. and n., *estimate, believe, think, suppose, imagine*.

exitus, -tūs, [**ex-itus**, cf. **exeo**], M., (*a going out*), *a passage* (out, concretely). Hence, *an end, the last part*: *quem habere exitum* (*what is the result of, etc.*). — Fig., *a result, a turn* (of fortune), *an issue*.

expediō, -īre, -īvī, -ītus, [prob. **expedi-** (st. of adj. **ex-pes**, *foot-free*)], 4. v. a. and n., *disentangle, disencumber, set free* (cf. **impedio**). — Less exactly and fig., *set in order, get ready, arrange, station* (of troops). — **expeditus**, -a, -um, p. p. as adj., *unincumbered, easy* (iter), *not difficult, quick, active, light-armed* (of troops), *in light marching order* (of troops without baggage), *mobile* (of troops), *ready*.

expeditiō, -ōnis, [as if **ex-†pedi-** + **tio**, cf. **expedio**], F., (*light-armed service* ?), *a getting ready, a despatching*. Hence, *an expedition: misit in expeditionem* (*detached*).

expeditus, p. p. cf. **expedio**.

expellō, -pellere, -pulī, -pulsus, [ex-pello], 3. v. a., *drive out*. — Fig., *dispel*.

experior, -perīri, -pertus, [ex-†perior, pass. of **pario**, *get*], 4. v. dep., (*get for one's self* ?), *experience, try: fortunam* (*risk, try, bear, endure*).

expertus, -a, -um, p. p. of **experior**.

expiātus, -a, -um, p. p. of **expio**.

expiō, -āre, -āvī, -ātus, [ex-pio], 1. v. a., (*purify*), *expiate*. — Transferred to the signs of divine wrath, *expiate: incommodum* (*wipe out, i.e. make good, retrieve*).

expleō, -plēre, -plēvī, -plētus, [ex-pleo], 2. v. a., *fill out, fill up, make up* (filling the required measure).

explōrātor, -tōris, [as if **ex-†plo-** + **rator**, cf. **exploro**], M., *a scout, a pioneer* (as a means of reconnoitring, cf. **speculator**, *a spy*).

explōrātus, -a, -um, p. p. of **exploro**.

explōrō, -āre, -āvī, -ātus, [ex-ploro, prob. *search* by calling or crying], 1. v. a., *investigate, explore, search, examine, reconnoitre*. — **explōrātus**, -a, -um, p. p., *assured, certain: explorata victoria, being assured of victory: habere omnia explorata, know certainly*.

expōnō, -pōnere, -posuī, -positus, [ex-pono], 3. v. a., *place out, set out: exercitum* (*disembark, also draw up, array*). — Fig., *set forth* (in speech), *state*.

exportō, -āre, -āvī, -ātus, [ex-porto], 1. v. a., *carry out, carry away, export*.

expōscō, -poscere, -poposci, no p. p., [ex-posco], 3. v. a., *demand* (with eagerness).

expriō, -primere, -pressī, -pressus, [ex-premo], 3. v. a., *press out, force out: vocem* (*elicit, get out of one, extort*). — Also (cf. **edo**), *raise up: turris agger* (as the mound of circumvallation rose with the towers on it as it approached the city).

expūgnātiō, -ōnis, [ex-pugnatio, cf. **expugno**], F., *a storming* (of a city), *taking* (of a city by storm).

expūgnātus, -a, -um, p. p. of **expugno**.

expūgnō, -āre, -āvī, -ātus, [expugno, *fight*], 1. v. a., *take* (by storm), *capture* (by storming a city or boarding a ship): *stipendiariis expugnatis, the cities of their tributaries sacked*.

expulsus, -a, -um, p. p. of **expello**.

exquirō, -quīrere, -quīsivī, -quīsī-

tus, [ex-quaero, seek], 3. v. a., search out, inquire, ask for.

exquisitus, -a, -um, p. p. of ex-
quiro.

exsequor, -sequi, -secutus, [ex-
sequor], 3. v. dep., follow out, follow
up: ius (enforce).

exserō, -serere, -serui, -sertus, [ex-
sero], 3. v. a., (disentangle), thrust
out, uncover.

exsertus, -a, -um, p. p. of exsero.

existō, -sistere, -stiti, -stiturus(?),
[ex-sisto], 3. v. n., stand out, rise up,
come out: malacia (ensue); motus
(break out); cornu (grow out, project).

expectō, -āre, -āvī, -ātus, [ex-
specto], 1. v. a. and n., look out for,
wait for, wait, wait to see (si,
whether, etc.), expect, anticipate.

exspoliō, -āre, -āvī, -ātus, [ex-
spolio], 1. v. a., strip off.—Also,
strip of (cf. despolio).—Fig., de-
prive, rob (of, abl.).

extinctus, -a, -um, p. p. of ex-
stinguo.

extinguō, -stinguere, -stinxī,
-stinctus, [ex-stinguo], 3. v. a.,
(punch out, as a fire in the woods?),
extinguish (lit. and fig.), destroy, put
an end to.

extō, -stāre, -stiti, -stāturus(?),
[ex-sto], 1. v. n., stand out: ex
aqua (be above).

extructus, -a, -um, p. p. of ex-
struo.

exstruō, -struere, -struxī, -structus,
[ex-struo], 3. v. a., heap up, build
up, pile up.

exsul, -ulis, [ex-SAL (of salio),
as st., with some lost connection of
meaning, cf. consul], C., an exile.

exter, -tera, -terum, [ex + terus
(reduced)], adj., outer, outside.—

extrēmus, -a, -um, superl., farthest,
extreme, last: extremi, as noun, the
rear; in extremis lingulis (at the
extremity of, etc., and often in this
sense); ad extremum, till the last,
at last; ad extremum producta casum
(to the last extremity); ab extrema
parte, at the very end; in extrema
spe, almost in despair; in extremis
suis rebus, in the last extremity;
extrema fames, the last extremity of
hunger.

exterreō, -terrere, -terruī, -territus,
[ex-terreo], 2. v. a., frighten away,
frighten greatly, terrify.

exterritus, -a, -um, p. p. of ex-
terreo.

extimēscō, -timēscere, -timuī, no
p. p., [ex-timesco], 3. v. a. and n.,
fear greatly, fear (much), dread.

extorqueō, -torquere, -torsī, -tor-
tus, [ex-torqueo, twist], 2. v. a.,
wrench from, wrest from, force from.

extortus, -a, -um, p. p. of extor-
queo.

extrā [abl. or instr. (?) of exter,
cf. supra], adv. and prep. with acc.,
outside, out of.

extractus, -a, -um, p. p. of ex-
traho.

extrahō, -trahere, -trāxī, -tractus,
[ex-traho], 3. v. a., drag out: mul-
tum aestatis (drag out, waste).

extrūdō, -trudere, -trūsī, -trūsus,
[ex-trudo], 3. v. a., thrust out, push
out, shut out (by dikes).

exuō, -uere, -uī, -ūtus, [ex- unc.
verb, cf. induo], 3. v. a., strip off:
armis exutis, deprived of arms.—

Also (cf. *despolio*), *strip, deprive, despoil*: *Romanos impedimentis*.

exūrō, -ūrere, -ussī, -ūstus, [*exuro*], 3. v. a., *burn up*.

exūtus, -a, -um, p. p. of *exuo*.

F

faber, -brī, [FA (in *facio*) + *ber* (for *brus*)], (M. of *faber, skilful*), a *mechanic, an engineer* (in an army).

Fabius, -ī, [? *faba-* (*bean*) + *ius*, cf. *Cicero*], M., a Roman gentile name. — Esp.: 1. *Quintus Fabius Maximus* (Allobrogicus), who conquered the Arverni in B.C. 121 on the Rhone. — 2. *Gaius Fabius*, a legatus of Cæsar in Gaul. — 3. *Lucius Fabius*, a centurion.

facilis, -e, [†*facō-* (cf. *beneficus*) + *lis*], adj., *easy* (to do, cf. *habilis*), *convenient, without difficulty, easy* (generally). — **facile**, N. as adv., *easily, conveniently, without difficulty*.

facinus, -oris, [†*facin-* (as if root of †*facino*, longer form of *facio*) + *us*], N., a *deed* (of any kind). — Esp. (as in English), a *deed* (of crime), a *misdeed, a crime, guilt* (referring to some particular act), *criminal conduct*. See *admitto*.

faciō, *facere*, *fēcī*, *factus*, [FAC + *io*], 3. v. a. and n., *make, do, act*. — Used in a great variety of senses as in Eng.: *coniurationem* (*form*); *sementes* (*do planting*); *iter* (*march, travel, proceed*); *vim* (*use violence, force a passage, offer resistance*); *rates* (*build*); *testudinem* (*form*); *ea* (*perform*); *pacem* (as in Eng.); *finem orandi* (*put an end to, stop, etc., cease, etc.*); *phalangem* (*form*); *fidem* (*give assurance, also gain be-*

lief, gain credence); *gratum* (*do a favor*); *senatus consultum* (*make, pass*); *verba* (*speak, act as spokesman*); *potestatem* (*give an opportunity, permit, allow*); *satisfacere* (*do enough, satisfy*). — Esp. with clause of result, *cause* (to), *do* (omitting in Eng. the connective *that*, and expressing the thing done in the indicative). — So in pass., *be done, be caused, happen, result, ensue, occur, turn out, be*: *non sine causa fit, it is not without reason*; *fit ut, the result is that*; *fieri posse, be possible*; *quid fit, what is going on*; *fit gratulatio, one is congratulated*. — Often with two accs. (or with adj. corresponding to second acc.), *make, render*: *vectigalia deteriora* (*make less, diminish*). — Esp.: *certiorem facere, inform*. — So with pred. gen.: *nihil reliqui, leave nothing undone, leave no further possibility*; *sui commodi naves* (*make for his convenience*). — **factum**, -ī, N. of p. p., half noun and half participle, and to be translated by either, *act, thing done, etc.*: *id factum graviter tulit, took this action much to heart*; *recte factum, good conduct*, (but notice the adverb); *si quid opus facto, if anything was necessary to be done*. — **fiō**, *fieri*, as pass. in all senses.

factiō, -ōnis, [prob. †*facti* + *o*, but treated as FAC + *tio*, cf. *co-*

hortatio], F., a business, an employment. — Also, a party, a faction.

factum, -i, see facio.

factus, -a, -um, p. p. of facio.

facultās, -tātis, [facul (for facili cf. simul) + tas], F., ease, facility. — So, chance, power, opportunity. quantum facultatis dari potuit, so far as opportunity was offered; sui conligendi (chance to, etc.). Hence, concretely, means, resources, supply: navium; facultates ad largiendum.

fāgus, -i, [prob. BHAG, eat, + AS (-us), from the fruit], F., a beech, beech (of the timber).

fallō, fallere, fefellī, falsus, [? SPHAL, trip up], 3. v. a. and n., deceive: spes aliquem (disappoint); fallendo, by deceit. — falsus, -a, -um, p. p., deceived. — Also (transferred to things), false, unfounded.

falsus, -a, -um, p. p. of fallo.

falx, falcis, [?], F., a sickle, a pruning-hook. — Also, a hook (of similar form for demolishing walls).

fāma, -ae, [FA (in for, speak) + MA], F., speech, common talk, reputation. — Concretely, a rumor, a story.

famēs, -is, [?], F., hunger, starvation: famem tolerare, keep from starving, appease hunger.

familia, -ae, [famulō-, servant (reduced), + ia], F., a collection of attendants, a household. — Applied to Gaul, a clan, retainers.

familiāris, -e, [prob. familiā- + ris, but treated as famili- + aris (cf. animalis)], adj., of the household: res (estate, property). — Esp. as noun, a friend.

familiāritās, -tātis, [familiari- + tas], F., intimacy (with, genitive).

fās [FA (in for, speak) + as], indecl. N., right (in conscience, or by divine law): non est fas (permitted, allowed).

fastigātē [old case-form of fastigatus], adv., sloping.

fastigātus, -a, -um, p. p. of fastigo.

fastigium, -ī, [†fastigō- (unc. form akin to fastus, scorn, cf. castigo) + ium, cf. fastigo], N., elevation, slope, descent (of a slope).

fastigō, -āre, -āvī. -ātus, [†fastigō- (cf. fastigium)], 1. v. a., bring to a point. — Esp. fastigātus, -a, -um, p. p. as adj., inclined, sloping: leniter (with an easy slope).

fātum, -ī, [N. of fatus, p. p. of for], N., (what is spoken, cf. fas), fate, lot, destiny.

faveō, favēre, fāvī, fautūrus, [?], 2. v. n., favor, be favorable to.

fax, facis, [?], F., a torch, a fire-brand, fire (lighted missiles).

fēlicitās, -tātis, [felic- (as if felici-) + tas], F., good fortune, good luck, lucky star: summa (perfect success).

fēliciter [felic- (as if felici-) + ter], adv., happily, fortunately, luckily, successfully.

fēmina, -ae, [FE, nurse, + mina, cf. alumna], F., a woman, a female.

femur, -oris (-inis), [?], N., the thigh.

fera, see ferus.

ferāx, -ācis, [reduced noun-st. (akin to fero) + ax, as if †ferā + cis (reduced)], adj., fertile.

ferē [?, old case-form of st. {ferō- (akin to fero)], adv., almost, about. — Also, almost always, generally, usually, for the most part. — With negatives, hardly.

ferō, ferre, tulī, lātus (for tlātus), [BHAR, bear, and TOL (TLA) in tollo], irr. a. and n., bear, carry, endure, tolerate, stand, withstand, carry off, win. — Often in a loose sense, translated by various special words in Eng., *commit*, *offer*, etc. — With reflex. or in pass., *rush*, *pass*, *proceed*, *roll* (of a river). — With advs. indicating manner of receiving anything, *suffer*, *bear*, *take it*, *feel*: *acerbius ferre inopiam* (*suffer severely from*); *magno cum dolore ferre*, *be much pained or indignant at*; *moleste (graviter) ferre*, *be annoyed at, take hard, be indignant at*. — Special uses: *responsa* (*carry away, receive*); *auxilium* (*carry aid, assist*); *arma* (*bear arms, fight*); *condicionem* (*propose*); *signa* (*bear on the standards, march*); *ventus ferebat* (*carried the ships, blew*); *consuetudo fert* (*is*); *opinio fert* (*goes*); *ut natura montis ferebat*, *according to the outline of the mountain*.

ferrāmentum, -ī, [as if ferrā- (st. of verb from ferrum) + mentum], N., a tool (of iron).

ferrāria, -ae, [F. of ferrarius, cf. ferrum], F., an iron mine.

ferreus, -a, -um, [ferrō- + eus], adj., of iron, iron (made of iron).

ferrum, -ī, [?], N., iron, steel, sword.

fertilis, -e, [†ferti- + lis, (as if FER + tilis)], adj., fertile, fruitful.

fertilitās, -tātis, [fertili- + tas], F., fertility, productiveness.

ferus, -a, -um, [FER (*rush*) + us, cf. deer], adj., wild, ferocious. — Fem. as noun, wild beast, game.

fervefaciō, -facere, -fēcī, -factus, [†ferve- (case-form akin to ferveo) + facio], 3. v. a., heat, heat red-hot (iacula).

fervefactus, -a, -um, p. p. of fervefacio.

ferveō, fervēre, ferbuī (fervi), no p. p., [noun-st. akin to febris], 2. v. n., be hot, be red-hot.

fībula, -ae, [FIG (in figo, fasten) + bula], F., a clasp, a buckle.

fictus, -a, -um, p. p. of fingo.

fidēlis, -e, [fidē- (st. of fides) + lis], adj., faithful.

fidēs, -eī, [FID (*bind*) + es], F., a promise, a pledge: *laedere* (*break faith*); *fidem facere*, *give assurance*: *fidem praestare*, *keep faith, perform one's duty*. — Also, *good faith, fidelity*. — Transferred, *confidence, faith* (in); *fidem facere*, *gain credence*. — Esp. of promised protection, *protection, dependence, alliance*: *quorum in fide erat civitas* (*to whom . . . was subject, under whose protection*); *Caesaris fidem sequi* (*come under, surrender one's self to*); *in fidem se permittere* (*venire*), *place themselves under protection of*, etc.

fidūcia, -ae, [†fiduc- (†fidu-, faithful, + cus, reduced) + ia], F., confidence, reliance.

figūra, -ae, [†figu- (FIG, in figo, + us) + ra, F. of rus], F., shape, form.

filia, -ae, [F. of filius], F., a daughter.

filius, -ī, [?], M., *a son*.

ūngō, fingere, fīnxī, fictus, [FIG, cf. figura]. 3. v. a., *mould*; *voltum* (*compose*).—Fig., *invent, contrive*.—fictus, -a, -um, p. p. as adj. and noun, N. pl., *fictions*: *ficta respondent, make up answers*; *sibi* (*conjure up*).

fīniō, -īre, -īvī, (-iī), -ītus, [fīni-], 4. v. a., *set bounds to, limit, bound, measure* (ending a division).

fīnis, -is, [?], M., *a limit, an end*: *finem facere, put an end to, cease*; *quem ad finem, as far as*.—Plur., *boundaries, limits, territories, country*.

fīnitimus, -a, -um, [fīni- + timus], adj., *on the borders, neighboring, adjacent, neighbors* (of).—Plur. as noun, *neighbors*.—Also, *finitumus*.

fīō [FU in fui], as pass. of *facio*, which see.

fīrmīter [fīrmō- + ter], adv., *firmly, stoutly, steadily*.

fīrmitūdō, -inis, [fīrmō- + tudo], F., *solidity, strength* (of resistance).

fīrmō, -āre, -āvī, -ātus, [fīrmō-], 1. v. a., *make strong, strengthen, fortify*.

fīrmus, -a, -um, [DHAR, hold, + mus], adj., *strong* (for resistance), *firm, steady*: *minime firma, weakest*.

fīstūca, -ae, [?], F., *a pile-driver*.

Flaccus, see *Valerius*.

fīlāgitō, -āre, -āvī, -ātus, [as if †flagitō-, p. p. of †flago, akin to flagro, blaze], 1. v. a., *ask* (in heat?), *demand earnestly*: *Haeduos frumentum, grain of the Hæduans*.

flamma, -ae, [FLAG (blaze) + ma], F., *flame, fire*.

flectō, flectere, flēxī, flexus, [?], 3. v. a., *bend, turn*.

fleō, flēre, flēvī, flētus, [?], 2. v. a. and n., *weep*: *flentes, in tears*.

flētus, -tūs, [fle- (st. of fleo as root) + tus], M., *weeping, lamentation*: *magno fletu, with many tears*.

flō, flāre, flāvī, flātus, [?], 1. v. n. and a., *blow*.

flōrēns, -entis, [pres. p. of floreo, bloom], as adj., *blooming*.—Fig., *flourishing, prosperous, influential* (iuvenis): *florentissimis rebus, in most prosperous circumstances*.

flōs, flōris, [?], M., *a flower*.—Fig., *the flower* (of troops).

fluctus, -tūs, [FLU (G) (in fluo, cf. fluxi) + tus], M., *a wave*.

flūmen, -inis, [FLU (in fluo) + men], N., *a river*.

fluō, fluere, flūxī, fluxus, (fluxūrus, fluctūrus, fluitūrus), [FLU], 3. v. n., *flow*.

fodiō, fodere, fōdī, fossus, [?], 3. v. a., *dig*.

foedus, -eris, [FID (in fides, cf. fidus) + us], N., *a treaty, a league, a compact*.

fore, for futurum esse; see *sum*.

forem, for essem; see *sum*.

foris [abl. plur. of †fora], as adv., *out of doors*.—Less exactly, *outside* (of anything, as beyond the siege lines).

forma, -ae, [DHAR (in firmus) + ma], F., *shape, form*.

fors, fortis, [FER (in fero) + tis (reduced)], F., *chance*.—forte, abl. as adv., *by chance, perchance, accidentally, as it happened*.

forte, see **fors**.

fortis, -e, [akin to **firmus**], adj., *strong, brave, courageous*: **vir fortis**, *a man of courage*.

fortiter [**forti-** + **ter**], adv., *bravely, stoutly, undauntedly*: **fortius factum**, *any deed of prowess*.

fortitūdō, -inis, [**forti-** + **tudo**], F., *bravery, prowess*.

fortuitō [abl. of †**fortuitus**, p. p. of verb in -uo, cf. **fortuna**], adv., *by chance, accidentally, fortuitously*.

fortūna, -ae, [†**fortu-** (FER + **tus**, cf. **fortuito**) + **na**, F. of -nus], F., *fortune, chance, fate, lot* (one's *fortune*), *chances (belli), success* (good or bad). — Plur., *fortunes, resources, chances (means) of success*. — Esp., *good fortune, success*: **fortunam temptare**, *try one's chances*.

fortūnātus, -a, -um, [p. p. of **fortuno**], as adj., *fortunate, prosperous*.

forum, -ī, [akin to †**fora**], N., (*an open place*), *a market-place*.

fossa, -ae, [F. of **fossus**, p. p. of **fodio**, *dig*], F., *a ditch, a trench*.

fovea, -ae, [?, perh. akin to **foveo**, as a pit for storage], F., *a pitfall*.

frāctus, -a, -um, p. p. of **frango**.

frangō, **frangere**, **frēgī**, **frāctus**, [FRAG], 3. v. a., *break* (as a solid body). — Esp. of ships, *wreck*. — Fig., *break down, crush*.

frāter, -tris, [prob. FER + **ter**, cf. **pater**], M., *a brother*.

frāternus, -a, -um, [**frater** + **nus**], adj., *of a brother, fraternal*: **nomen** (*the name of brothers*).

fraus, **fraudis**, [?, akin to **frustra**], F., *loss*. Hence, *treachery, deceit*.

fremitus, -tūs, [**fremi-** (st. of

fremo, *roar*) + **tus**], M., *a murmur, a confused noise, a roar*.

frequēns, -entis, [orig. pres. p. akin to **farcio**, *stuff*], adj., *crowded, numerous, in great numbers*.

frētus, -a, -um, [root akin to **firmus** + **tus**], adj., *relying on, confident in* (on account of).

frīgidus, -a, -um, [†**frigō-** (whence **frigeo**, *be cold*) + **dus**], adj., *cold*.

frīgus, -oris, [FRIG (in **frigeo**, etc.) + **us**], N., *cold*. — Plur., *cold* (cold "snaps," frosts).

frōns, **frontis**, [?, akin to **brow**], F., *brow, face*: **a media fronte**, *from the middle of the forehead*. — Less exactly, *front, brow*: **a fronte**, *in front*.

frūctuōsus, -a, -um, [**fructu-** + **osus**], adj., *fruitful*.

frūctus, -tūs, [FRU(G) + **tus**], M., *enjoyment*. Hence, (*what one enjoys*), *fruit, crops, income, profit, interest* (from money): **victoriae** (*advantages of victory*).

frūmentārius, -a, -um, [**frumentō-** (reduced) + **arius**], adj., *of grain*: **loca** (*fruitful in grain*); **res** (*grain supply, provisions*); **inopia** (*scarcity of grain*).

frūmentātiō, -ōnis, [**frumentā-** (st. of **frumentor**) + **tio**], F., *foraging, gathering grain, harvesting, foraging expedition*.

frūmentor, -tārī, -tātus, [**frumentō-**], I. v. dep., *forage, gather grain, get supplies*.

frūmentum, -ī, [FRU (in **fruor**) + **mentum**], N., *grain* (cf. **fructus**). — Plur., *standing grain, crops*.

fruor, **frui**, **frūctus**, [FRU, cf. **fructus**], 3. v. dep., *enjoy*.

frūstrā [abl. or instr. of st. akin to **fraus**, *loss*], adv., *to no purpose, without effect*.

[**frūx**], frūgis, [FRU(G) in **fruor** as st.], F., *fruit*. — Plur., *crops*.

Fūfius (-sius), -ī, [?], M., a Roman gentile name. See **Cita**.

fuga, -ae, [FUG + a], F., *flight*: **fit fuga**, *a rout ensues*; **fugae mandare se**, *take to flight*; **in fugam dare**, *put to flight*; **fugam petere**, *seek safety by flight, escape*; **ex fuga evaserat**, *had escaped from the flying crowd*.

fugātus, -a, -um, p. p. of **fugo**.

fugiō, fugere, fūgī, fugitūrus, [FUG (in **fuga**)], 3. v. a. and n., *fly, fly from, run away*. — Fig., *shun, avoid*.

fugitīvus, -a, -um, [fugi- (st. of **fugio**?) + **tivus**], adj., *runaway*. — Plur. as noun, *runaway slaves*.

fugō, -āre, -āvī, -ātus, [fuga-], 1. v. a., *put to flight, rout*.

fūmō, -āre, -āvī, -ātus, [fūmō-], 1. v. n., *smoke*.

fūmus, -ī, [FU (DHU) + **mus**, akin

to *dust*], M., *smoke*. — Plur., *smoke* (in several columns).

funda, -ae, [akin to **fun-do**], F., *a sling*.

funditor, -tōris, [funda (as if verb-st.) + **tor**], M., *a slinger*.

fundō, fundere, fūdī, fūsus, [FUD], 3. v. a., *pour*. — Less exactly, *scatter*. — Esp. of battle, *put to rout, rout*.

fūnebris, -e, [cf. **funus**], adj., *of a funeral*. — N. plur. as noun, *funeral rites*.

fungor, fungī, fūnctus, [?], 3. v. dep., *perform, discharge* (abl.).

fūnis, -is, [?], M., *a rope*.

fūnus, -eris, [unc. root + **us**], N., (*murder?*), *death, a funeral*.

furor, -ōris, [FUR (cf. **furo**, *rage*) + **or**], M., *madness, frenzy, fury*.

fūrtum, -ī, [N. p. p. of lost verb akin to **fur**, *thief*], N., *theft, a theft*.

fūsilis, -e, [fuso- (p. p. of **fun-do**) + **lis**, cf. **flexilis**], adj., (*capable of being poured*), *molten* (of metals), *vitri-fied, red-hot*.

futūrus, see **sum**.

G

Gabalī, -ōrum, [Celtic], M. plur., a Gallic people, dependants of the Arverni.

Gabīnius, -ī, [Gabinō- (cf. **Gabii**) + **ius**], M., a Roman gentile name. — Esp., *Aulus Gabinius*, consul with Lucius Piso in B.C. 58.

gaesum, -ī, [Celtic], N., *a javelin*.

Gāius (**Cāius**, C.), -ī, [?], M., a Roman prænomen.

Galba, -ae, [Celtic, meaning *fat*], M., a Gallic and Roman family name.

— Esp.: 1. *Servius Sulpicius Galba*, a legatus of Cæsar. — 2. A king of the Sussions.

galea, -ae, [?], akin to **galerus**, *leather cap*], F., *a helmet* (of leather, worn by cavalry).

Gallia, -ae, [F. of adj. in **-ius**, **Gallo-** + **ius**], F., *Gaul*, including all the country bounded by the Po, the Alps, the Rhine, the ocean, the Pyrenees, and the Mediterranean, thus occupying all northern Italy, France, and Belgium.

Gallicus, -a, -um, [Gallō- + cus], adj., of the Gauls, Gallic.

gallīna, -ae, [gallo- (cock) + ina], F., a hen.

Gallus, -a, -um, [Celtic], adj., of Gaul, Gallic. — As noun, a Gaul, the Gauls. — Also, as a Roman family name. See **Trebius**.

Garumna, -ae, [Celtic], c., a river of S. W. Gaul, now the *Garonne*.

Garumnī, -ōrum, [Celtic], m. pl., a Gallic tribe in the Pyrenees, on the head waters of the *Garonne*.

Gatēs, -ium, [Celtic], m. pl., a Gallic people of Aquitania.

gaudeō, gaudēre, gāvisus, [†ga-vidō-, cf. avidus], 2. v. n., be delighted, rejoice.

gāvisus, -a, -um, p. p. (neut. pass.) of gaudeo.

Geidumnī, -ōrum, [Celtic], m. pl., a Belgian tribe, dependants of the Nervii.

Genāva, -ae, [Celtic], F., a city of the Allobroges, at the outlet of Lake Lemman, now *Geneva*.

gener, -erī, [?], M., a son-in-law.

generātīm [as if acc. of †generatis (generā- + tis)], adv., by tribes.

gēns, gentis, [GEN, beget, + tis (reduced)], F., a family, a tribe, a clan, a people.

genus, -eris, [GEN, beget, + us], N., a generation, a race, a family (stock), a nation, a tribe. — Less exactly, a kind, a sort, a class. — Also, abstractly, kind, character, nature, method (pugnae): **genus hominum**, the character of the inhabitants.

Gergovia, -ae, [Celtic], F., a city in the lands of the Arverni.

Germānia, -ae, [F. of adj. in -ius, cf. Gallia], F., Germany, the whole country between the Rhine, the Danube, the Vistula, and the sea.

Germānicus, -a, -um, [Germanō- + cus], adj., of the Germans, German, Germanic.

Germānus, -a, -um, [?], adj., German (of the country of Germany or its people. The name of the people is the original, but as usual is an adj.). — Plur. as noun, the Germans.

gerō, gerere, gessī, gestus, [GES, of unc. kin], 3. v. a., carry (indicating a more lively action than fero), carry on, manage, wage (war), hold (a magistracy), do (any business). — Pass., be done, go on (of operations): **rem bene** (male) (operate successfully or otherwise, carry on operations, succeed well or ill); **negoti bene gerendi**, of successful action; **his rebus gestis**, after these operations; **res gestae**, exploits, operations, a campaign.

gestus, -a, -um, p. p. of gero.

gladius, -ī, [?], M., a sword.

glāns, glandis, [?], F., a nut, an acorn. — Also, a ball (for shooting).

glēba (glae-), -ae, [?], F., a clod (of earth), a lump.

glōria, -ae, [akin to **inclutus**, renowned], F., fame, glory.

glōrior, -ārī, -ātus, [gloriā-], 1. v. dep., glory in, boast of (abl.).

Gnaeus (Cnēius, Cn.), -ī, [akin to **gnavus**, active], M., a Roman praenomen.

Gobannitiō, -ōnis, [Celtic], M., one of the Arverni, uncle of Vercingetorix.

Gorgobina, -ae, [Celtic], F., a city in the territory of the Hædúi, founded by the Boii emigrating from Cisalpine Gaul.

Graecus, -a, -um, [Gr.], adj., of the Greeks, Greek. — As noun, a Greek, the Greeks. Cf. **Germanus** for relation of noun and adj.

Grāiocelī, -ōrum, [?], M. plur., a people of the Alps, near Mt. Cenis.

grandis, -e, [?], adj., large, of great size.

grātia, -ae, [gratō- (reduced) + ia], F., "gratefulness" (in both Eng. senses of *grateful*), *gratitude* (that one has from others or towards others), *good-will*, *favor*. Hence, *influence*, *friendship*, *source of influence*, *ground of friendship*. — Esp.: *gratias agere*, express gratitude, render thanks, thank; *gratias habere*, feel gratitude, be grateful; *gratias [gratiam] referre*, make a grateful return, pay off an obligation, requite; *gratiam inire*, secure the gratitude of any one, conciliate. — With gen., for the sake of, on account of, for, to (for the purpose of): *sui purgandi gratia*, to excuse one's self.

grātulātiō, -ōnis, [gratulā- + tio, cf. *frumentatio*], F., a congratulation (of others or one's self), *rejoicing*: *fit gratulatio*, there is great rejoicing.

grātulor, -ārī, -ātus, [†gratulō-

(gratō + lus)], I. v. dep., *congratulate*.

grātus, -a, -um, [p. p. of lost verb], adj., *pleasing*, *grateful*: **gratum facere**, do a favor.

gravis, -e, [for †garvis, †garus], adj., *heavy*. — Fig., *serious*, *severe*, *hard*: *gravioris aetatis*, of more advanced years; *si gravius quid acciderit*, if anything serious should occur; *caerimonia* (*solemn*, *binding*); *ne quid gravius statueret*, that he would not pass any very severe judgment.

gravitās, -tātis, [gravi- + tas], F., *weight*. — Fig., *importance*, *power*.

graviter [gravi- + ter], adv., *heavily*, with great weight, with force. — Fig., *severely*, *seriously*: *graviter ferre*, take to heart, suffer from; *premere* (*press hard*); *multo gravius exarsit* (*more violently*).

gravō, -āre, -āvi, -ātus, [gravi- (as if gravā-)], I. v. a., *make heavy* (cf. *levo*). — Pass. as dep., (*make heavy for one's self*), *be reluctant*, *be unwilling*, *object*.

Grudīi, -ōrum, [Celtic], M. plur., a Belgian people, dependants of the Nervii.

gubernātor, -tōris, [gubernā-, *steer*, + tor], M., a pilot, a helmsman.

gustō, -āre, -āvi, -ātus, [†gustō- (st. akin to *gustus*, Eng. *choose*)], I. v. a., *taste*, *eat*.

H

habeō, habēre, habuī, habitus, [?], 2. v. a. and n., *have*, *hold*, *keep*, *occupy*, *possess*: *sedes*; *equitatum*

circum se; *aditum* (*have in itself*, and so *offer*); *castra* (*occupy*); *se habere*, *be*; *quantum in se habet* (*as*

there is in, etc.); **secum habere** or **apud se**, *have with him*, also *detain*; **censum** and the like (*hold, conduct*); **contentiones** (*carry on*); **orationem** (*deliver*).—Esp. with p. p. as a sort of continued perfect (whence the perf. of modern languages), *have, hold, keep*: **redempta habere**, *buy up and hold*; **civitates obstrictas** (*keep under obligation*); **equitatum coactum** (*get and keep*).—Also, *treat*: **pro amico**. Hence, *consider* (cf. *hold*): **pro explorato** (*consider certain*).—Esp.: **rationem habere**, *keep an account, take an account of, have regard for, consider, regard, act in view of*: **satis habere**, *be satisfied, be content*; **habere quemadmodum oppida defenderent** (*have any means of, etc.*).

Haeduus (Aed-), -a, -um, [Celtic], adj., *of the Hædui*, a powerful Gallic tribe between the Loire and the Saône.—As noun, *a Hæduan, the Hædui*.

haesitō, -āre, -āvī, -ātūrus, [freq. of **haereo**, *stick*, cf. **dictito**], I. v. n., *get caught, stick, struggle (caught in a marsh)*.

hāmus, -ī, [?], M., *a hook*.

harpagō, -ōnis, [Gr. ἀρπάγη (Latinized) + o], M., *a hook* (esp. for walls, like a fire-hook), *a grappling-iron*.

Harūdes, -um, [Teutonic], M. plur., a German tribe originally from Jutland, remaining from the great expedition of the Cimbri.

haud [?], adv., *not* (negating single words), *not at all*.

Helveticus, -a, -um, [Helvetiō-

(reduced) + **cus**], adj., *Helvetian* (see **Helvetius**).

Helvētius, -a, -um, [Celtic], adj., *of the Helvetii* (a tribe between Lake Geneva, the Rhone, and the Rhine). Cf. **Germanus** for the form.—Plur. as noun, *the Helvetii*.

Helviī, -ōrum, [Celtic], M. plur., a Gallic tribe in the Roman province.

Hercynius (Orcyn-), -a, -um, [Teutonic], adj. (only with **silva**), *Hercynian* (the great forest embracing all the mountain country of Germany).

hērēditās, -tātis, [hered-, *heir* (as if heredi-), + **tas**], F., *inheritance, an inheritance*.

Hibernia, -ae, [?], F., *Ireland*.

hibernus, -a, -um, [hiem- + **ernus**, cf. **nocturnus**], adj., *of winter, winter* (as adj.).—Neut. pl. (sc. **castra**), *winter quarters, a winter encampment*.

hic [†hi- (loc. of hi-c) **ce**], adv., *here in this place, there* (of a place just mentioned).

hic, **haec**, **hōc**, **hūius**, [hi- (pron. st.) + **ce**, cf. **ecce**, **cetera**], dem. pron., (pointing to something near the speaker in *place, time, or interest*), *this, these, he, they, this man (woman or thing)*.—Referring to things before mentioned (but with more emphasis than **is**): **hic pagus unus**, *this one canton*; **ex his qui arma ferre possent** (*of these [before enumerated], those who, etc.*).—Less commonly, of what follows: **his mandatis** (*the following, as follows, these*).—Esp.: **haec memoria**, *the present generation*: **tempus** (*the*

present); his paucis diebus, *within a few days*. — hoc, neut. abl., used adverbially, *in this respect, on this account, by so much*. — Often where a more definite word is used in Eng.: his ita respondit (*to this embassy*). — Often hic . . . ille, *the one . . . the other, this (near by) . . . the other (farther off), this last (nearer on the page) . . . the other, the latter . . . the former*.

hiemō, -āre, -āvī, -ātūrus, [hiem- (as if hiema-)], 1. v. n., *winter, pass the winter*.

hiems (-mps), -emis, [?], F., *winter*.

hinc [†him (loc. of †hi) + ce], adv., *from here, hence*.

Hispania, -ae, [Hispanō- + ia (F. of -ius)], F. (of adj., cf. Gallia), *Spain*.

Hispanus, -a, -um, [?], adj., *Spanish*.

homō, -inis, [prob. humō- (*the earth*) + o], C., *a human being* (cf. vir, *a man, as a male, a man* (including women)).

honestus, -a, -um, [honos- (orig. st. of honor) + tus], adj., *esteemed, respected, worthy, honorable*.

honor (-ōs), -ōris, [unc. root + or], M., *honor, respect*: honoris causā, *out of respect*. — Also, *honorable position*.

honōrificus, -a, -um, [honor (as if honori) + fīcus (cf. benefīcus)], adj., *honorable, (giving honor)*.

hōra, -ae, [Gr.], F., *an hour* (of the day). — The Romans divided their day into twelve hours from sunrise to sunset, which were not of equal length at all times of the

year, but were always so many twelfths of the solar day.

horreō, horrēre, horrui, no p. p., [HORR, (orig. HORS, *bristle*) + us, prob. used orig. of the sensation called "goose pimples," where the hair seems to stand on end], 2. v. n. and a., *bristle* (see above). Hence, *shudder at, dread*.

horribilis, -e, [horrō- (as if st. of horreo) + bilis], adj., *to be shuddered at, frightful, dreadful*.

horridus, -a, -um, [†horrō- (cf. horreo) + dus], adj., *bristling, horrible, dreadful, frightful*.

hortātus, -a, -um, p. p. of hortor.

hortor, -tārī, -tātus, [for horitor, freq. of old †horior, *urge*], 1. v. dep., *encourage, urge on, urge, address*. — Less exactly, of things, *urge, move, prompt*.

hospes, -itis, [prob. GHAS-PATIS, orig. *host* (*lord of eating*)], M., *a host*. — Also, *a guest, a stranger*. Hence, *a guest-friend* (in the peculiar relation of hospitium, which was a kind of hereditary friendship between persons of different countries, not personal, but of a family or state), *a friend* (of the kind above mentioned): familiaris et hospes, *a personal and family friend*.

hospitium, -ī, [hospit- + ium], N., *the relation of host* (or guest). Hence (cf. hospes), *friendship*: hospitium atque amicitia, *alliance and friendship, family and personal friendship*; hospitio Ariovisti utebatur, *was in friendly relations with Ariovistus*.

hostis, -is, [GHAS (cf. hospes) +

tis], c., (orig. *guest*), a *stranger, an enemy* (of the state), *the enemy* (collectively, either sing. or plur.).

hūc [ho- (dat. of hi-, see hīc) + ce], adv., *hither, here* (in sense of *hither*), *to this* (*place, etc.*, cf. eo): huc accedebant, *to these* [*ships* before mentioned], *were added* (see accedo); accedebat huc, *to this was added the fact that, etc.*

hūiusmodī, see hic and modus.

hūmānitās, -tātis, [humanō- + tas], F., *humanity* (as opp. to bru-

tishness), *civilization, cultivation, refinement, courtesy.*

hūmānus, -a, -um, [st. akin to homo, *man*, + nus], adj., *civilized, cultivated, refined.*

humilis, -e, [humō- (*ground*) + lis], adj., *low, shallow* (cf. altus, *deep*). — Fig., *low, humble, poor*: Ubios humiliores redegerunt (*humiliated, rendered less important*).

humilitās, -tātis, [humili- + tas], F., *lowness, shallowness.* — Fig., *humble position, insignificance.*

I

I., for unus, etc., *one.*

iaceō, -cēre, -cuī, -citūrus, [?, cf. iaculum], 2. v. n., *lie, lie dead*: iacentes, *the slain.*

iaciō, iacere, iēcī, iactus, [?, cf. iaceo], 3. v. a., *throw, hurl, cast*: aggerem (*throw up*); ancoras (*cast, drop*).

iactō, -āre, -āvī, -ātus, [iactō-], 1. v. a., (freq. of iacio), *toss, toss about, bandy about* (of talk), *discuss.*

iactūra, -ae, [iactu- + ra (F. of rus)], F., *a throwing away, a loss, a sacrifice* (of men in war), *an offer* (of reward).

iactus, -a, -um, p. p. of iacio.

iaculum, -ī, [†iacō- (akin to iacio, *throw*)], N., *a javelin.*

iam [acc. of pron. st.], adv., *now* (of progressive time, cf. nunc, *emphatic and instantaneous*), *by this time, at last, already, at length*; iam non, *no longer*; iam ante, *some time before, even before*; iam utebatur, *was getting to use*; iam reverti (*was*

at last, etc.; *was beginning to, etc.*); nihil iam, *no longer*; also with no idea of time, *even, in fact.*

ibi [old case-form of is (cf. tibi)], adv., *there* (in a place before mentioned).

Iccius, -ī, [?], M., a nobleman of the Remi.

ictus, -tūs, [IC (in ico, *strike*) + tus], M., *a stroke*: ictus scorpionis (*a shot of, etc.*).

Īd., for Idus.

idcirco [id (N. acc. of is) -circo (case-form of same st. as circa, circum)], adv., *for that reason, for this reason, therefore.*

Idem, eadem, idem, [is dem, cf. dum], dem. adj. pron., *the same.* — Often as noun, *the same thing* (*things*), *the same*: eadem quaerit, *makes the same inquiries*; idem castellum, *this very fort.*

identidem [cf. idem and tandem], adv., *repeatedly, again and again.*

idōneus, -a, -um, [?, akin to

idem?], adj., *fit, suitable, adapted*: homo (*capable*); tempestas (*favorable*).

Īdūs, -uum, [?, perh. akin to aestus], F. plur., *the Ides* (a day of the lunar month falling at the full moon, conventionally on the 15th of March, May, July, October, and the 13th of the other months, and used by the Romans to reckon dates).

Īgnis, -is, [?, same word as Sk. agnis, *the god of fire*], M., *fire*: igni necari, *to be burned to death*. — Plur., *camp-fires*.

Īgnōbilis, -e, [in- (g) nobilis], adj., *not famous, obscure*.

Īgnōminia, -ae, [†ignomin- (in- (g)nomen, name) + ia], F., *want of fame, disgrace*. — Almost concretely, *disgraceful defeat*.

Īgnōrō, -āre, -āvī, -ātus, [ignarō-, *ignorant*], I. v. a., *fail to notice, not know, be ignorant of*. — Pass., *be unobserved*: non ignorans, *not unaware of*.

Īgnōscō, -nōscere, -nōvī, -nōtus, [in- (unc. which meaning) (g)nosco, *know*], 3. v. n. and a., *overlook, pardon*.

Īgnōtus, -a, -um, [in- (g)notus], adj., *unknown, strange*.

ille, -a, -ud, [old ollus, fr. pron. root + lus (?)], dem. pron., *that* (of something remote, cf. hic). — Often as noun (opposed to some other emphatic word), *he, she, it, they*: hic . . . ille, *this . . . that, the other, the latter . . . the former*.

illic [loc. of ille + ce, cf. hic], adv., *there* (more remote, opposed to hic, near by), *in that place* (na-

tion, country, etc.): illic . . . quo, *in the place to which*, (but with more emphasis than ibi . . . quo).

illō [dat. of ille, cf. eo], adv., *thither, there* (in sense of *thither*), *that way*.

Īllyricum, -ī, [?, N. of adj.], N., *Illyria* (the country east of Venetia and the Adriatic, and west of Macedonia and Thrace. It belonged to Cæsar's province along with the two Gauls).

imbēcillitās, -tātis, [imbecillō- (*weak*), + tas], F., *weakness, feebleness*: animi (*feebleness of purpose, pusillanimity*).

imber, imbris, [?], M., *a rain-storm, a rain*.

imitor, -tārī, -tātus, [†imitō-, p. p. of timo (cf. imago)], I. v. dep., *imitate, copy*.

immānis, -e, [in-†manus, *good*?], adj., (*"uncanny"*?), *monstrous, huge, enormous*.

immineō, -minēre, no perf., no p. p., [in-mineo], 2. v. n., *overhang, project*. — Fig., *threaten*.

immissus, p. p. of immitto.

immittō, -mittere, -misī, -missus, [in-mitto], 3. v. a., *let in, let down* (into), *insert, throw* (upon), *send against*.

immolō, -āre, -āvī, -ātus, [†im-mola- (in-mola, *meal*)], I. v. a., (*sprinkle with the sacred meal*), *sacrifice*.

immortālis, -e, [in-mortalis], adj., *immortal*.

immūnis, -e, [in-†munis, cf. communis and munia], adj., *free from tribute*.

immūnitās, -tātis, [immuni- + tas], F., *freedom from public burdens*.

imparātus, -a, -um, [in-paratus], adj., *unprepared, not ready*.

impedimentum, -ī, [impedi- + mentum], N., *a hindrance: esse impedimento, to hinder*. — Esp. in plur., *baggage, a baggage train* (including the beasts of burden), *pack-horses*.

impediō, -īre, -īvī, -ītus, [timped- (in-pes, foot, as if impedi-)], 4. v. a., *entangle, hamper, interfere with*. — Fig., *hinder, embarrass, impede: in iure* (*hinder in exercise of*). — impedītus, -a, -um, p. p., *hindered, entangled, occupied, difficult* (navigatio), *impassable* (loca): *esse victoribus nihil impeditum* (*there is no obstacle in the way of, etc.*); *prospectus* (*interrupted*).

impeditus, p. p. of *impedio*.

impellō, -pellere, -pulī, -pulsus, [in-pello], 3. v. a., *drive on*. — Fig., *instigate, incite, impel*.

impendeō, -ēre, [in-pendeo, hang], 2. v. n., *overhang*.

impēnsus, -a, -um, [p. p. of impendo, expend], adj., *expensive, very high* (of price).

imperātor, -tōris, [imperā- + tor], M., *commander* (in chief), *general*.

imperātum, -ī, [N. p. p. of impero], N., *an order, a command: ad imperatum, at one's command*.

imperātus, -a, -um, p. p. of *impero*.

imperfectus, -a, -um, [in-perfectus], adj., *unfinished: re imperfecta, without accomplishing one's purpose, unsuccessful*.

imperītus, -a, -um, [in-peritus, skilled], adj., *unacquainted with, ignorant, unversed in*.

imperium, -ī, [timperō- (whence impero, cf. pario, get) + ium], N., *command, supreme authority, control, supremacy, supreme power, power* (military), *rule, sway* (both sing. and plur.). — Concrete, *an order, a command*. — Esp.: *novis imperiis studere* (*new forms of government*); *nullo certo imperio* (*command of any particular person*); *imperi aut potestatis, military or civil authority*.

imperō, -āre, -āvī, -ātus, [timperō- (in-tparus, cf. pario, get)], 1. v. a. and n., *demand* (*make requisition for, prob. orig. meaning*), *require* (in same sense). Hence, *order* (in military sense), *rule, command, give orders: illo imperante, under his command*.

impetrō, -āre, -āvī, -ātus, [in-patro, bring to pass], 1. v. a., *accomplish* (anything by a request), *succeed in* (obtaining), *obtain* (a request): *impetro a, prevail upon, persuade; ab iis impetrari ut, they be persuaded to; ea re impetrata, this being granted; si non impetraret, if his request was not complied with; impetro ut, etc., obtain a request to, be allowed to, etc., succeed in having; impetrari posse, could be granted*.

impetus, -tūs, [in-tpetus (cf. peto, aim at)], M., *a rush, an attack, an onset, a charge, an assault, violence, fury: facere* (*inroad, charge, invasion*); *is impetus, such fury, etc.; impetus gladiatorum exceperunt, re-*

ceived the charge of the enemy with drawn swords.

impīus, -a, -um, [in-pīus], adj., *impious* (offending divine law).

implicātus, -a, -um, p. p. of **implico**.

implico, -āre, -āvī (-uī), -ātus (-itus), [in-plico, *fold*], 1. v. a., *entangle, interweave, entwine*.

implōrō, -āre, -āvī, -ātus, [in-ploro, *cry out*], 1. v. a., *implore, beseech*.

impōnō, -pōnere, -posuī, -positus, [in-pono], 3. v. a., *place upon, mount* (men on horses), *place, impose* (fig.).

importātus, -a, -um, p. p. of **importo**.

importō, -āre, -āvī, -ātus, [in-porto, *carry*], 1. v. a., *import*.

impositus, -a, -um, p. p. of **impono**.

imprimīs [in primis], adv., *among the first, especially, particularly* (more than anything else).

improbus, -a, -um, [in-probus, *good*], adj., *bad, wicked, unprincipled*.

imprōvisus, -a, -um, [in-provisus], adj., *unforeseen: improvised* (de improviso), *on a sudden, unexpectedly, unawares*.

imprūdēns, -entis, [in-prudens, *foreseeing*], adj., *not expecting, incautious, unsuspecting, off one's guard, unguarded, not being aware*.

imprūdētia, -ae, [imprudent- + ia], f., *ignorance, want of consideration, want of forethought*.

impūbēs, -eris (-is), [in-pubes], adj., *beardless, immature*. Hence, *chaste, unmarried*.

impūgnō, -āre, -āvī, -ātus, [in-pugno, *fight*], 1. v. a. and n., *attack, invade, charge, fight* (in an offensive warfare).

impulsus, -a, -um, p. p. of **impello**.

impulsus, -sūs, [in-pulsus, cf. **impello**, *drive on*], m., *impulse*. — Fig., *instigation*.

impūne [N. of **impunis** (in-poenā, *punishment*, weakened and decl. as adj.)], adv., *with impunity*.

impūnitās, -tātis, [impuni- + tas], f., *freedom from punishment, impunity*.

īmus, -a, -um, superl. of **inferus**.

1. **in-** [cf. Eng. *un-*], neg. particle, only in composition.

2. **in** [?, cf. Eng. *on*; cf. also **inde**], prep. **a**. With acc., of motion, having its terminus within or on (cf. **ad**, with terminus at or near), *into, upon, within, to, against, among*: in **volgus elatum est** (*spread abroad among*). — Of time, *for, to, till*. — Fig., without actual motion, but only direction, *towards, against, upon*: in **eos exempla edere** (*visit upon*); in **se voluntas** (*good-will towards*). — Often where Eng. has a different conception, *in, on*: **abdere in silvas**, *hide in the woods*; in **civitatibus collocasse** (*had married in, etc.*); in **utram partem fluat** (*in which direction, etc.*); in **conspicuum venire** (*in sight*). — In adverbial expressions where no motion appears, *in, according to, with, to*: **mirum in modum** (cf. **quem ad modum**); in **eam sententiam**, *to this purport*; in **speciem**, *with the appearance*; in

altitudinem, in height, cf. to the height of. — Esp.: in Caesarem incidit, happened to meet Caesar; in perpetuum, for ever; in Morinos (into the country of, etc.); in catenas conicere, throw into prison; in fugam conicere, put to flight.

b. With abl., of rest (lit. and fig.), in, on, among, within: in tanta propinquitate (under circumstances of, in a case of); in tanto imperio P. R., when the R. people had such dominion. — Often, in the case of, in respect to: in eo, in his case, in regard to him. — Esp.: in Meldis (in the country of); in ancoris, at anchor; in eo manere, abide by, etc.; in praesentia, for the present; in potestate, under the power; in opere esse, to be engaged in the work; in illo vestigio temporis positum (depending on, etc.); in eo constare (depend upon, etc.). — In comp. as adv., in, upon, towards, and the like.

inānis, -e, [?], adj., empty. — Fig., empty, vain, idle, mere, bare.

incautē [old case-form of incautus], adv., incautiously, carelessly.

incautus, -a, -um, [in-cautus, p. p. of caveo], adj., incautious, off one's guard.

incendium, -ī, [in-+candium, cf. incendio], N., a burning, a fire: incendia aedificiorum, the burning of buildings, each one being conceived as a separate burning, as is usual in Latin.

incendō, -cendere, -cendī, -cēnsus, [in-+cando, cf. candeo, glow], 3. v. a., set fire to, burn. — Fig., rouse, excite, fire.

incēnsus, -a, -um, p. p. of incendio.

inceptus, -a, -um, p. p. of incipio

incertus, -a, -um, [in-certus], adj., uncertain, dubious, untrustworthy, (rumores): itinera (obscure, blind); ordinibus (in disorder).

incidō, -cidere, -cidī, -cāsūrus, [in-cado], 3. v. n., fall upon. — Less exactly and fig., fall in with, meet, occur, happen.

incidō, -cidere, -cidī, -cīsus, [in-caedo], 3. v. a., cut into, half cut down (trees).

incipiō, -cipere, -cēpī, -ceptus, [in-capio, take], 3. v. a. and n., begin, undertake.

incīsus, -a, -um, p. p. of incidō.

incitātus, -a, -um, p. p. of incito.

incitō, -āre, -āvī, -ātus, [in-cito], 1. v. a., set in motion (in some particular direction) (lit. and fig.), urge on, drive, impel, excite, rouse. — incitātus, -a, -um, p. p., excited to anger, angered, spurred on: incitato equo, at full gallop; incitato cursu, at full speed. — Esp.: se aestus incitare (rush in).

incōgnitus, -a, -um, [in-cognitus], adj., unknown.

incolō, -colere, -coluī, no p. p., [in-colo], 3. v. a. and n., inhabit, live, dwell: incolendi causa, for a permanent abode.

incolumis, -e, [?], adj., unharmed, unhurt, preserved, safe, safe and sound, uninjured.

incommodē [old case-form of incommodus], adv., inconveniently, unfortunately, badly, ill.

incommodus, -a, -um, [in-commodus], adj., inconvenient, unfortunate.

— Esp., *incommodum*, N. as noun, *disadvantage, misfortune*, euphemism for *defeat, loss, disaster, harm*.

incrēdibilis, -e, [in-credibilis], adj., *incredible, marvellous, extraordinary*.

increpitō, -āre, -āvī, -ātus, [increpitō- (cf. increpo)], I. v. a., *upbraid, taunt, revile*.

incumbō, -cumbere, -cubuī, -cubitūrus, [in-cumbo], 3. v. n., *lie upon*. — Esp., fig., *bend to, exert one's self: animo et opibus in* (*bend one's mind and energies to*).

incursiō, -ōnis, [in-†cursio, cf. incurro, *rush upon*], F., *an inroad, an attack, an invasion, a raid*.

incursus, -sūs, [in-cursus, cf. incurro, *rush upon*], M., *an inroad, an attack*.

incūsō, -āre, -āvī, -ātus, [in-†causo, cf. causa, *cause*], I. v. a., *upbraid, rebuke, chide*.

inde [†im (loc. of is, cf. interim, hinc) -de (form akin to -dem, dum, cf. indu, old form of in)], adv., *from there, thence, from the place* (which, etc.), *after that, then*.

indiciūm, -ī, [indic- + ium], N., *information: per indicium, through an informer*.

indīcō, -dicere, -dixī, -dictus, [indico, *say*], 3. v. a., *order, proclaim, appoint*.

1. *indictus*, -a, -um, p. p. of *indico*.

2. *indictus*, -a, -um, [I. in-dictus], adj., *unpleaded* (causa, cf. dico), *untried, unheard*.

indīgnē [old case-form of indignus], adv., *unworthily, shamefully*

(unworthily of one's self or of the circumstances).

indīgnitās, -tātis, [indigno- + tas], F., *unworthiness, disgrace* (cf. indigne), *outrage, an indignity*.

indīgnor, -ārī, -ātus, [indignō-], I. v. dep., *be indignant* (deem unworthy of one's self).

indīgnus, -a, -um, [in-dignus], adj., *unworthy*.

indīligēns, -entis, [in-diligens], adj., *negligent, careless, heedless*.

indīligenter [in-diligenter, cf. indiligens], adv., *carelessly, negligently*.

indīligentia, -ae, [indiligent- + ia], F., *carelessness, want of care, want of energy* (application).

indūcō, -ducere, -dūxī, -ductus, [in-duco], 3. v. a., *draw on*. Hence, *cover: scuta pellibus*. — Also, *lead on*. Hence, *induce, instigate, impel*.

inductus, -a, -um, p. p. of *induco*.

indulgentia, -ae, [indulgent- (pres. p. of indulgeo) + ia], F., *indulgence, favor, clemency*.

indulgeō, -dulgēre, -dulsī, -dultus, [?, perh. st. compounded of in-dulcis, *pleasant towards*], 2. v. n., *favor, treat with indulgence*.

induō, -duere, -duī, -dūtus, [?, cf. exuo], 3. v. a., *put on*. Hence, fig. with reflex., *pierce, impale* (one's self): *se vallis; se stimulis* (*be pierced by*).

industriē [old case-form of industrius, *active*], adv., *actively, promptly, with energy*.

indūtia (indūc-), -ārum, [?], F. plur., *a truce, an armistice*.

Indūtiomārus, -ī, [Celtic], M., a chief of the Treveri.

ineō, -ire, -ivī (-iī), -itus, [in-eo], irr. v. a., *enter upon, go into*. — Fig., *adopt, make, begin, gain, secure*. — Esp.: *inita aestate, at the beginning of summer; inire rationem, take an account; inire consilium, form a plan; inire numerum, enumerate*.

inermis, -e (-us, etc.), [in-arma], adj., *unarmed, defenceless*.

iners, -ertis, [in-ars, skill], adj., *shiftless, cowardly, sluggish, unmanly*.

infāmia, -ae, [infami- (*disreputable*) + ia], F., *dishonor, disgrace: latrocinia nullam habent infamiam (bring no dishonor, are not held dishonorable); infamia et indignitas, shame and disgrace*.

infāns, -antis, [in-fans, pres. p. of *for, speak*], C., *a child, an infant, an infant child*.

infectus, -a, -um, [I. in-factus], adj., *not done*. — Esp.: *re infecta, without success, cf. imperfectus; re infecta discedere (without accomplishing one's purpose)*.

inferō, -ferre, -tulī, -lātus, [in-fero], irr. v. a., *bring in, import, put upon: in equum (mount one on horseback); bellum (make, of offensive war); signa (make a charge, advance); vulnera (inflict)*. — Fig., *cause, inflict, commit: periculum (create, cause); spem (inspire); causam (ad-duce, assign, allege)*.

inferus, -a, -um, [unc. st. + rus (cf. *superus*)], adj., *low: inferior pars, the lower end; ab inferiore parte, down below, of a river*. — Superl., **infimus** (*imus*), *lowest, the bottom of, at the bottom: infimus*

collis, the foot of the hill, ad infimum, at the bottom. — Neut. as noun, *the bottom*.

infēstus, -a, -um, [in-festus, fr. *fendo, strike*], adj., *hostile, in hostile array: infestis signis, arrayed for fight, in a charge, in order of attack*.

inficiō, -ficere, -fēcī, -fectus, [?, in-facio], 3. v. a., (*work into?*), *dye, stain*.

infidēlis, -e, [in-fidelis], adj., *unfaithful, wavering in faith*.

infigō, -figere, -fixī, -fixus, [2. in-figo], 3. v. a., *fasten in, fix in, fix on*.

infimus, see *inferus*.

infinitus, -a, -um, [in-finitus], adj., *unbounded, countless, endless, numberless, infinite*.

infirmitās, -tātis, [infirmō- + tas] F., *feebleness, unsteadiness, inconstancy, fickleness*.

infirmus, -a, -um, [in-firmus, *strong*], adj., *weak, feeble: animus (feeble courage, want of courage); arbores (unsound, weakened); infirmior, less powerful; naves (unseaworthy)*.

infixus, -a, -um, p. p. of *infigo*.

inflectō, -flectere, -flēxī, -flexus, [in-flecto], 3. v. a., *bend down*. — Pass., or with reflex., *become bent*.

inflexus, -a, -um, p. p. of *inflecto*.

influo, -fluere, -flūxī, -fluxūrus, [in-fluo], 3. v. n., *flow into, empty into*.

infodiō, -fodere, -fōdī, -fossus, [in-fodio], 3. v. a., *dig in, bury*.

infrā [instr. (?) of *inferus*], adv. and prep. with acc., *below, farther down, less than*.

ingēns, -entis, [in-gens, *not be-*

longing to the kind (?)], adj., *huge, enormous, very large.*

ingrātus, -a, -um, [in-gratus], adj., *unpleasing.*

ingredior, -gredi, -gressus, [in-gradior, *step*], 3. v. dep., *march into, enter, march in.*

iniciō, -icere, -iēcī, -iectus, [in-iacio], 3. v. a., *throw into, throw upon.* — Less exactly, *place in, put on, embark.* — Fig., *inspire.*

iniectus, -a, -um, p. p. of *iniciō.*

inimicitia, -ae, [inimicō- + tia], F., *enmity, hostility.*

inimicus, -a, -um, [in-amicus], adj., *unfriendly, hostile.* — As noun, *an enemy* (personal, or not in war, cf. *hostis, an enemy of the state, or an enemy at war*), *a rival, an opponent.*

iniquitās, -tātis, [iniquō- + tas], F., *inequality, irregularity, unevenness.* — Fig., *unfairness, unequal nature, unfavorableness.*

iniquus, -a, -um, [in-aequus], adj., *uneven.* — Fig., *unjust* (of persons and things), *unfavorable, unfair, disadvantageous.* — Compar., *iniquior locus, less favorable position.*

initium, -ī, [in-īitium (itō- + ium), cf. *ineo*], N., *a beginning, the first of:* *initium capere, facere, begin, start; transeundi* (*the initiative, the first steps, the first attempt to, etc.*); *initium fit ab, the start is first made at* (also lit.); *fugae factum* (*the first tendency to fly was shown*); *retinendi* (*the first detention*); *silvarum* (*the edge*); *Remorum* (*boundary*); *artificiorum initia* (*the first principles, the first knowledge of, etc.*).

iniungō, -iungere, -iūnxī, -iūnctus, [in-iungo], 3. v. a., *attach to.* — Fig., *impose upon* (*his . . . servitutem*).

iniūria, -ae, [in-ius (*right*) + ia, cf. *iniurius*], F., *injustice, outrage, wrong, violence* (as opposed to right), *abuse.*

iniūssū [in-iussu, abl. of *iussus*], adv., *without orders.*

inlātus (ill-), -a, -um, p. p. of *infero.*

inligātus (ill-), -a, -um, p. p. of *inligō* (ill-), -āre, -āvi, -ātus, [in-ligo, *bind*], 1. v. n., *bind on, attach, fasten to.*

inlustris (ill-), -e, [in-lustrō- (or kindred st.), cf. *lustrō, light*], adj., *distinguished, renowned, remarkable, famous:* *inlustriore loco natus, of any prominence.*

innāscor, -nāscī, -nātus, [innascor], 3. v. dep., *grow in, spring up in.* — Fig., *be inspired, be excited.* — *innātus*, p. p. as adj., *natural, innate.*

innātus, -a, -um, p. p. of *innascor.*
innitor, -nīti, -nīsus (-nīxus), [innitor], 3. v. dep., *lean upon, support one's self on.* — *innīxus*, p. p. in present sense, *leaning on.*

innīxus, -a, -um, p. p. of *innitor.*
innocēns, -entis, [in-nocens, p. of *noceo, injure*], adj., *harmless, guiltless, innocent.*

innocentia, -ae, [innocent- + ia], F., *blamelessness, integrity.*

inopia, -ae, [inop- (*need*) + ia], F., *scarcity, dearth, destitution, want, privation, want of supplies.*

inopināns, -antis, [in-opinans], adj., *unsuspecting, not suspecting.*

inquam, [?], def. v. n., *say*.

inrīdeō (irr-), -rīdēre, -rīsī, -rīsum, [in-rideo, *laugh*], 2. v. n., *ridicule, laugh at*.

inrīdiculē (irr-), [old case-form of inridiculus], adv., *without humor*.

inrumpō (irr-), -rumpere, -rūpī, -ruptus, [in-rumpo], 3. v. n. and a., *break in, break into, storm*.

inruptiō (irr-), -ōnis, [in-†ruptio, cf. eruptio and inrumpo], F., *a breaking in, an attack* (on a fortified place), *raid, incursion*.

insciēns, -entis, [in-sciens], adj., *not knowing, unaware*: *insciente* Caesare, *without C.'s knowledge*.

inscientia, -ae, [in-scient- + ia], F., *ignorance, lack of acquaintance with*.

inscius, -a, -um, [in-†scius, cf. conscius and scio], adj., *not knowing, unaware, ignorant*.

insecūtus, -a, -um, p. p. of *insequor*.

insequor, -sequī, -secūtus, [insequor], 3. v. dep., *follow up, pursue*.

inserō, -serere, -seruī, -sertus, [insero, *join*], 3. v. a., *insert, stick in*.

insidiae, -ārum, [†insid- (cf. insideo, *sit in*) + ia], F. plur., *an ambush, a stratagem, a trick, a plot, a trap, treachery*: *per insidias, with deception, treacherously*.

insidiōr, -ārī, -ātus, [insidiā-], 1. v. dep., *lie in wait, make treacherous attacks*.

insignis, -e, [in-signō-, *mark*, decl. as adj.], adj., *marked, memorable, signal*. — **insigne**, N. as noun, *signal, sign, decoration* (of soldiers).

insiliō, -silīre, -siluī, -sultus, [insalio], 4. v. a., *leap upon*.

insimulātus, -a, -um, p. p. of *insimulo*.

insimulō, -āre, -āvī, -ātus, [insimulo, *make like*], 1. v. a., *charge, accuse*.

insinuō, -āre, -āvī, -ātus, [insinuo], 1. v. a. and n., *wind in*. — With reflex., *work one's way into, slip in*.

insistō, -sistere, -stitī, no p. p., [in-sisto], 3. v. a. and n., *stand upon, set foot upon, stand, keep one's footing*. — Fig., *adopt* (rationem pugnae), *devote one's self* (in bellum).

insolenter [insolent- (cf. soleo, *be wont*) + ter], adv., (*in an unusual manner*), *insultingly, insolently*.

inspectō, -āre, -āvī, -ātus, [inspecto], 1. v. a. and n., *look upon, look on*: *inspectantibus nobis, before our eyes*.

instābilis, -e, [in-stabilis, cf. sto], adj., *unsteady*. — Fig., *changeable, uncertain*.

instar [instā + ris (?), reduced], N. indecl., (*an image*), *in the likeness of* (with gen.), *like, in the manner of*.

instīgō, -āre, -āvī, -ātus, [†in-stigō- (STIG (*goad*) + us)], 1. v. a., *goad, stimulate, drive on, urge on*.

institūō, -tuere, -tuī, -tūtus, [instatuo], 3. v. a., *set up, set in order, array*: *opus* (*finish*). — Also, *provide, procure, get ready*. — Also, *set about, undertake, begin to practice, adopt* (a plan, etc.), *begin, set on foot*. — So, *teach, train, habituate*.

institūtum, -ī, [N. p. p. of *instituo*], N., *a habit, a practice, an institution, a custom*.

instō, -stāre, -stitī, -stātūrus, [in-sto, stand], I. v. n., *be at hand, press on.*—Fig., *threaten, impend, menace*: tempus instantis belli, *time of active, immediate war.*

instrūctus, -a, -um, p. p. of instruo.

instrūmentum, -ī, [instru- (cf. instruo) + mentum], N., *furniture, equipment, tools and stores* (of soldiers).

instruō, -struere, -strūxī, -strūctus, [in-struo, build], 3. v. a., *build, fit up, fit out, array, draw up* (of troops).

insuēfactus, -a, -um, [p. p. of †insuefacio], p. p., *trained.*

insuētus, -a, -um, [in-suetus], adj., *unaccustomed, unused.*

insula, -ae, [akin to in-salio?], F., ('tussocks' in a swamp) *an island.*

insuper [in-super, above], adv., *on the top, above, at the top.*

integer, -gra, -grum, [in-†teger (TAG, in tango, touch, + rus)], adj., *untouched, unimpaired, unwearied, fresh*; as noun, *fresh troops.*—Esp., *not entered upon* (of business); *re integra*, *before anything was done, before being committed to any course of action.*

integō, -tegere, -tēxī, -tēctus, [in-tego], 3. v. a., *cover over, face* (turris coriis).

intellegō, -legere, -lēxī, -lēctus, [inter-lego], 3. v. a., (*pick out* [distinguish] between), *learn, know, find out, discover, see plainly, be aware.*

intendō, -tendere, -tendī, -tentus, [in-tendo], 3. v. a., *stretch, strain.*—Esp. of the mind or eyes, *be intent,*

be absorbed: oculis intentis, *with eyes intent*; animis intentis in ea re, *with their minds absorbed in this.*

intentus, -a, -um, p. p. of intendo.

inter [in + ter, cf. alter], adv. (in comp.) and prep. with acc., *between, among*: arbitros inter civitatis dat (to decide between); inter aciem, *in the line.*—Of time, *within, for.*—Often in a reciprocal sense: inter se, *with, to, from, etc., each other, one another*; cohortati inter se, *encouraging each other, one another*; obsides inter eos dandos curavit, *caused them to exchange hostages.*

intercēdō, -cēdere, -cessī, -cessūrus, [inter-cedo], 3. v. n., *come between, go between, lie between, intervene, exist between, occur between, be, pass* (of time): ipsis cum Hæduis intercedere, *exist between them and the Hædui.*

interceptus, -a, -um, p. p. of interceptio.

intercipiō, -cipere, -cēpī, -ceptus, [inter-capio, take], 3. v. a., *intercept, cut off.*

interclūdō, -clūdere, -clūsī, -clūsus, [inter-claudo, shut], 3. v. a., *cut off, shut off, block* (roads): fugam (stop, cut off).

interdicō, -dicere, -dixī, -dictus, [inter-dico], 3. v. a., (*intervene by an order*), *forbid, prohibit*: Gallia Romanis interdici (*exclude the Romans, etc., by order*); aqua atque igni (*expel, by forbidding fire and water, the regular form of exile*); interdicere ne, *forbid to, order not to.*

interdiū [inter-diu (acc. or abl.)?

akin to dies)], adv., *in the daytime, by day.*

interdum [inter dum (orig. acc.)], adv., *for a time, sometimes.*

intereā [inter ea (prob. abl.)], adv., *meanwhile, in the meantime.*

intereō, -ire, -ivī (-iī), -itūrus, [inter-eo (*go into pieces?*, cf. interficio)], irr. v. n., *perish, die, be killed.*

interfectus, -a, -um, p. p. of interficio.

interficiō, -ficere, -fēcī, -fectus, [inter-facio], 3. v. a., (*cut to pieces*, cf. intereo), *kill, put to death.*

intericiō, -icere, -iēcī, -iectus, [inter-iacio], 3. v. a., *throw in (between).*

— Pass., *lie between, intervene*: spatio interiecto, *intervening*, i. e. *leaving a short interval*; portubus interiectis (*lying at intervals*); sagittariis (*thrown in at intervals*).

interiectus, -a, -um, p. p. of intericio.

interim [loc. of †interus, cf. inter, interior], adv., *meanwhile.*

interior, -us, [comp. of †interus (in-terus, cf. alter)], adj., *inner, interior.*— Masc. as noun: interiores, *men in the interior, men in the town.*

interitus, -tūs, [inter-itus, cf. intereo], *destruction, death.*

intermissus, see intermitto.

intermittō, -mittere, -mīsī, -missus, [inter-mitto], 3. v. a. and n., (*let go between*), *leave off, discontinue, stop, interrupt, cease*: neque diem neque noctem (*not cease day or night*); spatiis intermissis, *leaving intervals*; brevi tempore intermisso, *waiting a short time*; spatio intermisso, *after*

a time; triduo intermisso (*leaving an interval of, etc.*); nocte intermissa, *a night intervening*; flumen intermittit (*discontinue, leave a vacant place*); subeuntes non intermiserunt (*did not cease, etc.*); intermissa profectione (*delaying*); vento intermisso (*ceasing, failing*); nocturnis temporibus ad laborem intermissis, *ceasing their toil in the night time*; tempus ab opere, *at any time cease the work*; diem quin, etc. (*let a day pass without, etc.*); intermissae trabes (*separated*); intermissis magistratibus, *passed over for a year*; pars oppidi intermissa a flumine (*left unprotected*); planities intermissa collibus (*broken by, lying between*).

interneciō, -ōnis, [inter-†necio, same root as neco, kill], F., *extermination, annihilation (exercitus).*

interpellō, -āre, -āvī, -ātus, [inter-†pello, cf. appello, -āre], 1. v. a., *interrupt, interfere with.*

interpōnō, -pōnere, -posuī, -positus, [inter-pono], 3. v. a., *put in between (lit. and fig.), interpose, allege (an excuse to break off something)*: nulla suspicione belli interposita, *no suspicion of war appearing to hinder*; fidem reliquis interponere (*give a promise not to do something*); decretum (*put in, introduce, into the affairs of the Gauls*); nulla dubitatione interposita, *with no hesitation to prevent, etc.*

interpres, -pretis, [inter-†pres (akin to pretium?)], c., *a mediator, an interpreter.*

interpretor, -ārī, -ātus, [inter-pret-], 1. v. dep., *interpret, explain.*

interrogātus, -a, -um, p. p. of **interrogo**.

interrogō, -āre, -āvī, -ātus, [**interrogo**], 1. v. a., (*ask at intervals*), *question, interrogate, ask*.

interrumpō, -rumpere, -rūpī, -ruptus, [**inter-rumpo**], 3. v. a., *break off* (between two points), *break down* (bridges), *destroy*.

interscindō, -scindere, -scidī, -scissus, [**inter-scindo**], 3. v. a., *cut off* (between two points), *break down, tear down*.

intersum, -esse, -fuī, -futūrus, [**inter-sum**], irr. v. n., *be between, be among, be in, be engaged in*: **non amplius intersit**, *there is an interval of not more than, etc.*; **proelio, divinis rebus** (*be engaged in, take part in*).—Esp., impers., *it is of importance, it interests, it concerns*; with neg., *it makes no difference*.

intervāllum, -ī, [**inter-vallus**, distance between stakes in a rampart], n., *distance* (between two things), *distance apart, interval*.

intervenīō, -venīre, -vēnī, -ventūrus, [**inter-venio**], 4. v. n., *come between, come up* (at a particular juncture), *arrive*.

interventus, -tūs, [**inter-†ventus**, cf. **eventus** and **intervenio**], m., *a coming* (to interrupt something), *intervention*.

intexō, -texere, -texuī, -textus, [**in-texo**], 3. v. a., *weave in, weave together*.

intextus, -a, -um, p. p. of **intexo**.

intoleranter [**intolerant-** (*not enduring*) + **ter**], adv., (*with no pa-*

tience or restraint over one's self), *fiercely, violently*.

intrā [**instr.** (?) of †**interus**, cf. **inter** and **extra**], adv. and prep. with acc., *into, within, inside*.

intrītus, -a, -um, [**in-tritus** (p. p. of **tero**, *wear*)], adj., *unworn*.—Fig., *unexhausted, unwearied*.

intrō, -āre, -āvī, -ātus, [**†interō-**], 1. v. a., *enter, go in*.

intrōdūcō, -dūcere, -dūxī, -ductus, [**intro-duco**], 3. v. a., *lead in, bring in, march in* (troops).

introeō, -īre, -īvī (-īī), -itus, [**introeo**], irr. v. a. and n., *enter, come in*.

introitus, -tūs, [**intro-itus**, cf. **introeo**], m., *an entrance, an approach* (means of entrance).

intrōmissus, -a, -um, p. p. of **intromitto**.

intrōmittō, -mittere, -mīsī, -missus, [**intro-mitto**], 3. v. a., *let go in, send in*.—With reflex. or in pass., *rush in*: **intromissus**, *rushing in*.

intrōrsus [**intro-vorsus** (petrified nom., p. p. of **verto**, *turn*)], adv., *into the interior, inside, within*.

intrōrumpō, -rumpere, -rūpī, -ruptūrus, [**intro-rumpo**], 3. v. n., *break in; burst in*.

intueor, -tuērī, -tuitus (-tūtus), [**in-tueor**], 2. v. dep., *gaze upon, gaze at, cast one's eyes upon*.

intulī, see **infero**.

intus [**in + tus**], adv., *within*.

inūsitātus, -a, -um, [**in-usitatus**], adj., *unwonted, unaccustomed*: **in-usitator**, *less familiar*.

inūtilis, -e, [**in-utilis**], adj., *of no use, unserviceable*.—In a pregnant sense, *unfavorable*.

inveniō, -venīre, -vēnī, -ventus, [in-venio], 4. v. a., *find*, (come upon, cf. *reperio*, *find by search*), *learn*.

inventor, -tōris, [in-†ventor, cf. **invenio**], M., a discoverer, an inventor.

inventus, -a, -um, p. p. of **invenio**.

inveterāscō, -rāscere, -rāvī, -rātūrus, [in-veterasco], 3. v. n., *grow old in*, *become established in*.

invictus, -a, -um, [in-victus], adj., *unconquered*. — Also, *unconquerable*, *invincible*.

invidēō, -vidēre, -vidī, -vīsus, [in-video, *see*], 2. v. n. and a., (*look askance at*), *envy*, *be jealous of*, *grudge*.

invidia, -ae, [invidō- (*envious*) + ia], F., *envy*, *odium*.

inviolātus, -a, -um, [in-violatus], adj., *inviolated*. — Also (cf. **invictus**), *inviolable*, *sacred*.

invīsus, -a, -um, p. p. of **invideo**.

invītātus, -a, -um, p. p. of **invito**.

invītō, -āre, -āvī, -ātus, [?], 1. v. a., *invite*, *request*, *attract*.

invītus, -a, -um, [?], adj., *unwilling*. — Often rendered as adv., *against one's will*.

ipse, -a, -um, [is-potis (?)], intens. pron., *self*, *himself*, etc. (as opp. to some one else, cf. **sui**, reflex., referring to the subject), *he*, etc. (emph.), *he himself*, etc.: *hoc ipso tempore*, *at this very time*; *ipse per se*, *in and of itself*; *inter se* (regular reciprocal), *each other*, *with each other*, *by each other*, etc.

irācundia, -ae, [iracundō- + ia], F., *wrath* (as a permanent quality,

cf. **ira**, a temporary feeling), *irascibility*, *anger*, *passion*, *animosity*.

irācundus, -a, -um, [ira + cundus], adj., *of a violent temper*, *passionate*, *irascible*.

is, ea, id, [pron. 1], dem. pron., *this* (less emph. than **hic**), *that* (unemph.), *these*, *those*, etc., *the*, *a*, *he*, *she*, *it*: *quae pars ea*, etc., *the part which*, etc.; *eo deceptus quod*, etc. (*by the fact that*, etc.); *et id*, *and that too*; *ea quae*, *the things which*, *what*; **Rhodanus influit et is transitur** (*and this river*, etc.); *cum ea ita sint*, *since this is so*; *is locus quo*, *a place where*; *neque eam plenissimam*, *and that not a very full one*; *manere in eo quod*, etc., *abide by what*. — Abl. N., **eo**, *the* (old Eng. instrumental), *so much*, *on that account*, *therefore*; **eo magis**, *all the more*; **eo gravius**, *so much the more severely*.

iste, -a, -ud, [is-te (cf. **tum**, **tantus**, etc.)], dem. pron., *that*, *that of yours*.

ita [I + ta (instr. (?) of TA)], adv., *so*, *in such a way*, *in this way*, *thus*, *to such an extent*, *as follows*: **ut . . . ita**, *as . . . so*, *though . . . yet*, *both . . . and*; **ita . . . ut**, *in proportion as*, *as*; **non ita**, *not so very*, *not very*.

Italia, -ae, [†Italō- (reduced) + ia (F. of ius)], F., *Italy*.

itaque [ita que], adv., *and so*, *accordingly*, *therefore*.

item [I-tem (acc.?, cf. **idem**)], adv., *in like manner*, *so also*, *in the same way* (before mentioned).

iter, itineris, [st. fr. I (*go*) + unc. term.], N., *a road*, *a march*, *a way*, *a route*, *a course*, *a journey*: **in**

itinere, on the road; in eo *itinere*, on the way; *iter facere*, march, travel; *iter dare*, allow to pass; *itinere prohibere*, forbid to pass, keep from passing; *magnis itineribus*, by forced marches; *tutum iter*, a safe passage.

iterum [I + *terus*, cf. *alter*], adv., a second time, again: *semel atque iterum*, again and again.

Itius [Celtic], adj., (with *portus*), the port where Cæsar embarked for Britain the second time; either *Wissant* or *Boulogne*.

iuba, -ae, [?], F., the mane.

iubeō, *iubere*, *iussī*, *iūssus*, [prob. *ius-habeo*, cf. *praebeo*], 2. v. a., order, command, bid.

iudicium, -ī, [*iudic-* (in *iudex*, judge) + *ium*], N., a judgment, (judicial), a trial, an opinion (expressed officially); an opinion (generally), advice: *optimum iudicium facere*, express (by some act) a very high opinion; *iudicio*, by design; often translated by *court*.

iudicō, -āre, -āvī, -ātus, [*iudic-* (in *iudex*, judge)], 1. v. a., formally decide, decide, judge, adjudge, think, consider: *nihil gravius de civitate* (I think nothing harsh about, etc.).

iugum, -ī, [*IUG* (in *iungo*) + *um*], N., a yoke; *sub iugum mittere* (an insult inflicted on a conquered army). Hence, a ridge, a crest (of a row of hills).

iumentum, -ī, [*IUG-* (?) + *mentum*], N., a beast of burden, a pack-horse, a horse.

iunctūra, -ae, [*iunctu-* + *ra* (F. of -rus)], F., a joining, a joint: *quan-*

tum distabat iunctura, as far as the distance apart, of two things joined.

iūctus, -a, -um, p. p. of *iungo*.

iungō, *iungere*, *iūnxī*, *iūctus*, [*IUG*], 3. v. a., join, unite, attach together. — In pass. or with reflex., unite with, attach one's self to.

iūnior, comp. of *iuvenis*.

Iūnius, -ī, [?], prob. *iuveni-* + *ius*, but cf. *Iuno*], M., a Roman gentile name. — Esp., *Decimus Iunius Brutus*, see *Brutus*. — Also, *Quintus Iunius*, a Spaniard in Cæsar's service.

Iuppiter, *Iovis*, [*Iovis-pater*], M., the god of the visible heavens and the atmosphere, who was regarded as the supreme divinity of the Romans.

Iūra, -ae, [Celtic], M., a chain of mountains in Gaul, running N. E. from the Rhone to the Rhine, separating the Sequani and the Helvetii.

iūrō, -āre, -āvī, -ātus, [*iur-* (st. of *ius*)], 1. v. n., swear, take an oath.

iūs, *iūris*, [*YU* (akin to *IUG*) + *us*], N., justice, right, rights (collectively), rights over (anything), claims.

iūs iūrandum, *iūris iūrandī*, [see the two words], N., an oath.

iūssū [abl. of *iūssus*], used as adv., by order, by command.

iūstitia, -ae, [*iusto-* + *tia*], F., justice (just behavior), sense of justice, fair dealing.

iūstus, -a, -um, [*ius* + *tus*], adj., just, lawful. — Also, complete, perfect, regular: *populi Romani iustissimum esse imperium*, that the Romans were best entitled to dominion

iuvenis, -e, [?], adj., *young*. — As noun, a *young man* (not over 45), a *youth*: *iuniores*, the *younger soldiers*.

iuventūs, -tūtis, [iuven- (orig. st. of *iuvenis*) + tus], F., *youth*. — Concretely, *the youth, the young men*.

iuvō, iuvāre, iūvī, iūtus, [?], I. v. a., *help, aid, assist*.

iūxtā [instr. (?) of *iuxtus*, sup. of *iugis* (IUG + is)], adv. and prep. with acc., *next, near, near by*.

K

Kal., for **Kalendae** and its cases.

Kalendae (Cal-), -ārum, [F. plur. of *calendus*, p. of verb akin to *calo*, *call*], F. plur., *the Calends* (the first

day of the Roman month, when, as it would seem, the times of the moon were *announced* to the assembled people).

L

L., for **Lucius**.

L (Ψ), [a corrupt form of the Greek letter ψ (prop. χ), originally used for 50, and retained in the later notation], a sign for *quīnquāgintā*.

Laberius, -ī, [?], M., a Roman gentile name. — See **Durus**.

Labiēnus, -ī, [?, perh. *labia* (*lips*) + *enus*], M., a Roman family name. — Esp., *Titus Atius Labienus*, a violent partisan of Cæsar, a *legatus* under him in Gaul, but afterwards in the civil war on the side of Pompey.

labor, -ōris, [RABH (*seize*) + or (for -os)], M., *toil, exertion* (in its disagreeable aspect), *labor* (as painful), *trouble, hardship*.

lābor, lābī, lāpsus, [unc., cf. *lābō*, *totter*], 3. v. dep., *slip, slide, fall*. — Fig., *commit an imprudence, go wrong, be disappointed*.

labōrō, -āre, -āvī, -ātus, [labor-], I. v. n., *toil, exert one's self*: *id contendere et laborare ne*, *strive and be anxious not to have*, etc.; *animo*

laborare, *contrive, revolve in one's mind anxiously*. — Also, *suffer labor, be hard pressed, labor*.

labrum, -ī, [LAB (in *lambo*, *lick*, cf. *labia*, *lips*) + rum], N., *the lip*. — Less exactly, *the edge* (of a horn, of a ditch), *the rim* (of a cup).

lāc, lactis, [?], N., *milk*.

laccessō, -cessere, -cessivī, -cessitū, [st. akin to *lacio* (*entice*) + unc. term], 3. v. n., *irritate, provoke*. — Esp., *attack, harass, assail, skirmish with*: *iniuriā Haeduos* (*wantonly harass*).

lacrima, -ae, [†dakru- + ma], F., *a tear*.

lacrimō, -āre, -āvī, -ātus, [lacrima-], I. v. a. and n., *weep, shed tears*.

lacus, -ūs, [?], M., *a reservoir, a lake*.

laedō, laedere, laesī, laesus, [unc.], 3. v. a., *wound, injure*. — Fig., esp., *break* (one's word, etc.), *violate*.

laesus, -a, -um, p. p. of *laedo*.

laetitia, -ae, [laetō- + tia], F., joy, gladness (cf. laetus).

laetus, -a, -um, [unc. root (perh. akin to *glad*) + tus], adj., joyful (of the inner feeling), rejoicing, glad.

languidē [old case-form of languidus], adv., with little energy, feebly.

languidus, -a, -um, [cf. languere, *be weary*], adj., spiritless, listless, languid: languidior, with less spirit.

languor, -ōris, [LANG (in languere, *be weary*) + or], M., want of spirit, listlessness, weariness.

lapis, -idis, [?], M., a stone (to throw, etc.). — Collectively, stone, stones.

lāpsus, -a, -um, p. p. of labor.

laqueus, -ī, [LAC (in lacio, *entice*) + eus], M., a slip-noose.

largior, -īrī, -ītus, [largō-, abundant], 4. v. dep., give lavishly, bestow upon, supply with. — Also, give bribes, give presents.

largiter [largō- (*abundant*) + ter], adv., lavishly: largiter posse, possess abundant influence.

largitiō, -ōnis, [largī- (st. of largior) + tiō], F., lavish giving, bribery.

lassitūdō, -dinis, [lassō- (*weary*) + tūdo, cf. fortitūdo], F., weariness, exhaustion.

lātē [old case-form of latus], adv., wide'ly: latius, too far; longe lateque, far and wide.

latebra, -ae, [latē- (in lateo) + bra], F., a hiding-place.

lateō, latēre, latuī, no p. p., [?], 2. v. n., lie concealed, lurk, be concealed, pass unnoticed.

lātitūdō, -dinis, [latō- + tūdo] F., breadth, width.

Latobrigī, -ōrum, [Teutonic], M. plur., a German tribe, neighbors of the Helvetii.

latrō, -ōnis, [prob. st. borrowed fr. Greek + o], M., a mercenary (?), a robber.

latrōcinium, -ī, [latron- + cinium, cf. ratiocinor], N., freebooting, robbery, highway robbery.

lātus, -a, -um, [prob. for †platus, cf. Eng. *flat*], adj., broad, wide, extensive.

latus, lateris, [prob. latō-], N., the side (of the body). — Also, generally, a side, a flank, an end (of a hill).

lātus, -a, -um, [for †latus, TLA (cf. *tollo, tuli*) + tus], p. p. of fero.

laudō, -āre, -āvī, -ātus, [laud-], I. v. a., praise, commend.

laus, laudis, [?], F., praise, credit, glory, merit (thing deserving praise).

lavō, -āre (-ere), -āvī (lāvī), -ātus (lautus, lōtus), [?], I. v. a., wash. — In pass. used reflexively, bathe.

laxō, -āre, -āvī, -ātus, [laxō-, loose], I. v. a., loosen, open out, extend.

lēgātiō, -ōnis, [legā- (*despatch*) + tiō], F., (a sending or commission), an embassy, an embassy (message of ambassadors).

lēgātus, -ī, [prop. p. p. of lēgo, commission, despatch], M., an ambassador, envoy. — Also, a lieutenant, a legatus. To a Roman commander were assigned (legare) one or more subordinate officers capable of taking command in his absence or en-

gaging in independent operations under his general direction. These were the *legati*, and with the *quæstor* composed a kind of staff.

legiō, -ōnis, [LEG (*select*) + io], F., (*a levy*); hence, *a legion* (originally the whole levy, later the unit of army organization, numbering from 3000 to 6000 men, divided into ten cohorts).

legiōnārius, -a, -um, [legion- + arius], adj., *of a legion, of the line, legionary* (the Roman heavy infantry of the legion as opposed to all kinds of auxiliary troops).

Lemannus, -ī, [?], M., (with *lacus* either expressed or implied), *the Lake of Geneva, Lake Leman*.

Lemovices, -um, [Celtic], M. pl.: 1. A Gallic tribe in modern Limousin. The name is preserved in *Limoges*.

lēnis, -e, [?], adj., *gentle, smooth*.

lēnitās, -tātis, [leni- + tas], F., *gentleness, gentle current* (of a river).

lēniter [leni- + ter], adv., *gently*: **lenius**, *with less vigor*.

Lepontiī, -ōrum, [Celtic], M. plur., a tribe of the Alps on the Italian side of St. Gothard.

lepus, -oris, [?], M., *a hare*.

Leuci (**Levaci**), -ōrum, [Celtic], M. pl., a Gallic tribe on the Moselle.

Levacī, -ōrum, [Celtic], M. plur., a tribe of Belgian Gaul, dependents of the Nervii.

levis, -e, [for †*leghvis*, LAGH (*jump*) + us (with inserted *i*, cf. *brevis*), Eng. *light*], adj., *light, slight, unimportant, of no weight*: **auditio** (*mere hearsay without foun-*

dation).— Also (cf. *gravis*), *inconstant, fickle, wanting in character*: **quid esset levius** (*less dignified*).

levitās, -tātis, [levi- + tas], F., *lightness*.— Also (cf. *levis*), *inconstancy, fickleness*.

levō, -āre, -āvī, -ātus, [levi- (as if *levō-*)], 1. v. a., *lighten*. Hence, *free from a burden, relieve*.

lēx, **lēgis**, [LEG (in *lego*, *select*)], F., *a statute, a law*.

Lexoviī, -ōrum, [Celtic], M. plur., a Gallic tribe in modern Normandy.

libenter [libent- (*willing*) + ter], adv., *willingly, with pleasure*.— With a verb, *be glad to*, etc.

liber, -bera, -berum, [†*libō-* (whence *libet*, *it pleases*) + rus (reduced)], adj., *free* (of persons and things), *unrestricted, undisturbed, unincumbered*.

liberālītās, -tātis, [liberali- + tas], F., *generosity, liberality*.

liberālīter [liberali- + ter], adv., *generously, kindly* (**respondit**): **oratione prosecutus** (*addressing in generous language*).

liberātus, -a, -um, p. p. of **libero**.

liberē [old case-form of **liber**], adv., *freely, boldly, without restraint*: **liberius**, *with too little restraint*.

liberī, -ōrum, [prob. M. plur. of **liber**, *the free members of the household*], M. plur., *children*.

liberō, -āre, -āvī, -ātus, [liberō-], 1. v. a., *free, set free, relieve* (from some bond); **liberare se**, *secure one's freedom*.

libertās, -tātis, [liberō- (reduced) + tas], F., *liberty, freedom, independence*.

librīlis, -e, [libra- (*pound*) + ilis], adj., of a pound weight: fundae (*heavy missiles from slings, one-pounders*)

licentia, -ae, [licent- (cf. licet) + ia], F., *lawlessness, want of discipline*.

liceor, licēri, licitus, [prob. pass. of licet], 2. v. dep., *bid* (at an auction).

licet, licēre, licuit (licitum est), [†licō-, cf. delicus, reliquus], 2. v. n., *be allowed*: id sibi, etc. (*that they be allowed*); per te licet, *you allow, you do not hinder*; licet conspicari, *one can see*; quibus esse licet, *who may be, who have a chance to be*; petere ut liceat, *to ask permission*.

Liger, -eris, [Celtic], M., a river of Gaul between the Hædui and the Bituriges, the *Loire*.

lignātiō, -ōnis, [lignā- (cf. lignum, wood) + tio], F., *getting wood*.

lignātor, -tōris, [lignā- (cf. lignum, wood) + tor], M., *wood-forager, wood-cutter*.

lilium, -ī, [?], N., a *lily*. The name is applied jocosely to a peculiar kind of *chevaux-de-frise*.

līnea, -ae, [linō- (*flax*) + ea (F. of -eus)], F., a *line*.

Lingones, -um, [Celtic], M. plur., a Gallic tribe in the Vosges Mts.

lingua, -ae, [?], F., *tongue*. Hence, *language*.

lingula, -ae, [lingua- + la (F. of -lus)], F., a *little tongue, a tongue of land*.

linter (lunt-), -tris, [?], F. (?), a *trough, a skiff, a boat*.

līnum, -ī, [prob. borr. fr. Gr.], N., *flax*.

lis, litis, [for †stlis, cf. locus and Eng. *strife*], F., a *suit at law*. — Also, *the amount in dispute, damages*.

Liscus, -ī, [Celtic], M., chief magistrate of the Hædui in the year 58 B.C.

Litavicus, -ī, [Celtic], M., a Hæduan chief.

littera (līt-), -ae, [?, akin to lino, smear], F., a *letter* (of the alphabet). — Plur., *letters, writing, an alphabet, a letter* (an epistle), *records*.

lītus, -oris, [?], N., a *shore, a beach*.

locus, -ī, [for †stlocus (*place*) STLA + cus], M. (sing.), N. (generally pl.), a *place, a spot, a position, a region* (esp. in plur.), a *point, the ground* (in military language), *space, extent* (of space), *room*. — Fig., *position, rank, a point, place* (*light, position, character*), *an opportunity, a chance*: obsidum loco, *as hostages*.

locūtus, -a, -um, p. p. of loquor.

longē [old case-form of longus], adv., *far, too far, absent, far away, distant*: non longius mille (*not more than*); longe afuturum, *would be far from helping*; longius prodire (*any distance*); longius aberat, *was rather far away*; longe nobilissimus (*far, altogether*).

longinquus, -a, -um, [case-form of longus (perh. loc.) + cus], adj., *long* (of time and space), *distant, long-continued*.

longitūdō, -diuis, [longō- + tudo], F., *length*.

longurius, -ī, [longō- + urius], M., a *long pole*.

longus, -a, -um, [?], adj., *long* (of space and time); in longiorem

diem, to a more distant day; navis longa, a ship of war, a war galley, (opposed to the broader naves onerariae); longum est exspectare, it is too long to wait, it would take too long to, etc.

loquor, loquī, locūtus, [?], 3. v. dep., *speaking, talking, converse.*

lōrica, -ae, [lorō- (*strap*) + ica], F., *a coat of mail* (orig. of leather thongs). — Also, *a breastwork, a rampart* (on a wall).

Lūcānius, -ī, [Lucanō- + ius], M., a Roman gentile name. — Esp., *Quintus Lucanius*, a centurion in Cæsar's army.

Lūcius, -ī, [luc- (in lux) + ius], M., a Roman prænomen.

M., for **Marcus**.

M [corruption of CIO (orig. Φ) through influence of mille], 1000.

māceria, -ae, [†mācerō- (whence macerō, *soften*) + ia], F., (*mortar?*), *a wall*.

māchinātiō, -ōnis, [machinā- + tio], F., *contrivance* (mechanical). — Concretely, *a contrivance, an engine, a derrick*.

maestus, -a, -um, [p. p. of mæreo, MIS (in miser, *wretched*) + tus], adj., *sad, sorrowful, dejected*.

Magetobriga, -ae, [Celtic], F., a town in Gaul where Ariovistus defeated the Gauls. Position uncertain.

magis [MAG (in magnus) + ius (N. comparative)], adv., *more, rather: eo magis, so much the more, all the more*. See also **maxime**.

Luclerius, -ī, [?, perh. Celtic], M., a Gallic name, perh. borrowed from the Romans. — Esp., *Luclerius Cadurcus*, a commander under Vercingetorix.

Lugotorīx, -īgis, [Celtic], M., a British prince.

lūna -ae, [LUC (in luceo, *shine*) + na], F., *the moon*. Also personified, **Luna**, *the Moon*.

Lutetia, -ae, [?], F., a city of the Parisii, on the island of modern Paris.

lūx, lūcis, [LUC, *shine*, as st.], F., *light, daylight: prima luce, orta luce, or luce, at daybreak*.

lūxuria, -ae, [†luxurō- (luxu- (*excess*) + rus) + ia], F., *luxury, riotous living*.

M

magistrātus, -tūs, [magistrā- (as if st. of †magistro, cf. magister, *master*) + tus], M., *a magistracy* (office of a magistrate). — Concretely, *a magistrate* (cf. "the powers that be").

māgnificus, -a, -um, [magnō- + ficus (FAC (in facio) + us)], adj., *splendid, grand, magnificent*.

māgnitūdō, -dinis, [magnō- + tudo], F., *greatness, great size, size, extent, stature, force* (venti), *severity* (supplici): *silvarum* (*immense woods*); *corporum* (*size, stature*).

māgnopere, see **opus**.

māgnus, -a, -um, [MAG (*increase*) + nus, cf. magis], adj., *great* (in any sense, of size, quantity, or degree), *large, extensive, important, serious* (motus), *heavy* (portoria), *high* (aestus), *loud* (vox): *magni habere, to*

value highly, make much account of; magni interest, it is of great importance. — **māior**, compar. in usual sense. — Also, **māior** (with or without **natu**), *elder, older*. — In plur. as noun, *elders, ancestors*. — **maximus**, superl., *largest, very large, greatest, very great*, etc.: **maximis itineribus**, *by forced marches*. See also **Maximus**.

māiestās, -tātis, [maios- (orig. st. of maior) + tas], F., (*superiority*), *majesty, dignity*.

māior, see **magnus**.

malacia, -ae, [borr. fr. Greek], F., (*soft weather*), *a calm*.

male [old case-form of **malus**], adv., *badly, ill, unsuccessfully*. — **peius**, compar. — **pessime**, superl.

maleficium, -ī, [maleficō- (*mischievous*) + ium], N., *harm, mischief*.

mālō, mälle, mālūī, no p. p., [mage- (for magis) volo], irr. v. a. and n., *wish more, wish rather, prefer, prefer rather*.

malus, -a, -um, [?], adj., *bad* (in all senses), *ill*. — **pēior**, compar. — **pessimus**, superl.

mālus, -ī, [Gr.], M., (*apple-tree*), *mast, beam* (upright).

mandātum, -ī, [N. p. p. of **mandō**], N., *a trust* (given to one), *instructions* (given), *a message* (given to some one to deliver).

mandō, -āre, -āvī, -ātus, [?, †mandō- (manu-do)], I. v. a., *put into one's hands, entrust, instruct* (*give instructions to*), *commit*: *se fugae* (*take to*); *quibus mandatum est*, *who had been instructed*.

Mandubii, -ōrum, [Celtic], M. plur., a tribe north of the Hædui.

Mandubracius, -ī, [Celtic], M., a Briton, prince of the Trinobantes.

māne [old case-form of †manis (?), ma + nis, cf. **Matuta**, *goddess of dawn*], adv., *in the morning*.

maneō, manēre, mānsī, mānsūrus, 2. v. n., *stay, remain, stay at home* (absolutely, opp. to **proficiscor**). — Fig., *continue, stand by* (in eo quod).

manipulāris, -is, [manipulō- + aris, prop. adj.], M., *comrade* (of the same maniple or company).

manipulus, -ī, [manu-†pulus (PLE + us)], M., (*a handful*, esp. of hay, used as an ensign), *a maniple* (two centuries, a third of a cohort).

Manlius, -ī, [?], M., a Roman gentile name. — Esp., **Lucius Manlius**, as proconsul, beaten by the Aquitani in B.C. 78.

mānsuēfaciō, -facere, -fēcī, -factus, [†mansuē- (cf. **mansuesco**, *grow tame*, and **calefacio**) -facio], 3. v. a., *tame*. — Pass., **mānsuēfiō**, *be tamed*.

mānsuētūdō, -dinis, [†mansue- (cf. **mansuefacio**) + tūdo], F., *tame-ness, gentle disposition, kindness*.

manus, -ūs, [?], F., *the hand*: in **manibus nostris**, *just at hand, within reach*; **manu defendere** (*by arms*); **dat manus**, *hold out the hands to be bound, acknowledge one's self conquered, give in*. — Also (cf. **manipulus**), *a company, a band, a troop*.

Marcomannī, -ōrum, [Teutonic, akin to **march** and **man**, "the men of the marches"?], M. plur., a supposed German tribe in the army of Ariovistus.

Mārcus, -ī, [*the hammer, akin to marceo, be soft, and morior, die*], M., a Roman prænomen.

mare, -is, [?], N., *the sea*: **mare oceanum**, *the ocean*; **nostrum** (i.e. the Mediterranean).

maritimus, -a, -um, [mari- + timus, cf. finitimus], adj., *of the sea, sea-, maritime, naval, on the sea*: **aestus** (*in the sea*); **ora** (*the sea-shore*).—Also, **maritumus**.

Marius, -ī, [?], M., a Roman gentile name.—Esp., *Gaius Marius*, the opponent of Sulla and the champion of the popular against the aristocratic party. He conquered the Cimbri and Teutones (B.C. 101) and freed Rome from the fear of a Northern invasion.

Mārs, **Mārtis**, [?], perh. MAR (in *morior, die*) + tis, *the slayer*, but more probably of wolves than of men in battle], M., *Mars*, originally probably a god of husbandry defending the sheep, but afterwards identified with the Greek *Ἄρης* and worshipped as the god of war. Cæsar again identifies him with the Celtic *Hesus*.—See **aequus**.

mās, **maris**, [?], adj., *male*.—Noun, *a male*.

matara, -ae, [Celtic], F., *a javelin* (of a peculiar kind, used by the Gauls).

māter, -tris, [?, prob. MA (*create*) + ter], F., *a mother, a matron*.

māter familiās (old gen. of *familia*), F., *a matron*.

māteria, -ae (-es, -ēī), [?, prob. *mater* + ia (F. of -ius)], F., *wood*

(cut, for material), *timber*, (cf. **lignum**, *wood for fuel*).

māterior, -ārī, -ātus, [materia-], 1. v. dep., *get timber, bring wood*.

Maticō, -ōnis, [Celtic], F., a city of the Hædui, now *Macon*.

mātrimōnium, -ī, [mater- (as *in matri*) + monium], N. (*motherhood*), *marriage, matrimony*: **in matrimonium ducere**, *marry*.

Matrona, -ae, [Celtic], M., a river of Gaul, joining the Seine near Paris, the *Marne*.

mātūrē [old case-form of **maturus**], adv., *early, speedily*.

mātūrēscō, -tūrēscere, -tūruī, no p. p., [maturē- (cf. **matureo**) + sco], 3. v. n., *get ripe, ripen*.

mātūrō, -āre, -āvī, -ātus, [maturō-], 1. v. a. and n., *hasten, make haste*.

mātūrus, -a, -um, [†matu- (MA, (*in mane*) + tus) + rus], adj., *early*.—Also (by unc. conn. of ideas), *ripe, mature*.

maximē [old case-form of **maximus**], adv., *in the greatest degree, most, very, in the highest degree, especially*: **ea maxime ratione**, *in that way more than any other*; **maxime confidebat**, *had the greatest confidence*.

Maximus [sup. of **magnus**, as noun], M., a Roman family name.

medeor, -ērī, no p. p., [†medō- (whence **medicus**, **remedium**), root unc., cf. **meditor**], 2. v. dep., *attend* (as a physician), *heal*.—Fig., *remedy, relieve*.

mediocris, -cre, [mediō- + cris], adj., *middling, moderate*: **spatium** (*a little, no great*); **non mediocris**, *no little, no small degree of*.

mediocriter [mediocri- + ter], adv., *moderately*: non mediocriter, *in no small degree*.

Mediomatricī, -ōrum, (-um), [Celtic], M. plur., a Gallic tribe between the Meuse and the Rhine, about Metz.

mediterrāneus, -a, -um, [mediō-terra (land) + aneus], adj., *inland*.

medius, -a, -um, [MED (cf. Eng. mid) + ius], adj., *the middle of* (as noun in Eng.), *mid*: in colle medio (*half way up*); locus medius utriusque (*half way between*); de media nocte, *about midnight*.

Meldī, -ōrum, [Celtic], M. plur., a tribe of Gaul.

melior, compar. of bonus.

Melodūnum, -ī, [Celtic], N., a city of the Senones, on an island in the Seine, now *Melun*; see **Metiosedum**.

membrum, -ī, [prob. formed with suffix -rum (N. of -rus)], N., *a limb, a part of the body*.

meminī, -isse, [perf. of MAN, in mens, etc.], def. verb a., *remember*.

memoria, -ae, [memor + ia], F., (*mindfulness*), *memory, recollection, power of memory*: memoria tenere, *remember*; memoriam prodere, *hand down the memory* (of something just mentioned); memoriam deponere, *cease to remember*; memoria proditum, *handed down by tradition*; supra hanc memoriam, *beyond the memory of this generation*; dignum memoria, *worthy of remembrance*; nostrā memoriā, *within our memory, in our own time*.

Menapiī, -ōrum, [Celtic], M. plur.,

a Gallic tribe between the Meuse and the Scheldt.

mendācium, -ī, [mendac- (*false*) + ium], N., *falsehood, a falsehood*.

mēns, mentis, [MAN + tis (reduced)], F., (*a thought?*), *the intellect* (as opposed to the moral powers, cf. **animus**), *the mind, a state of mind*: mentes animosque, *minds and hearts*; oculis mentibusque, *with eyes and thoughts*.

mēnsis, -is, [unc. form fr. MA, *measure* (cf. *moon, month*)], M., *a month*.

mēnsūra, -ae, [†mensu- (MA, *measure*, as if man, + tu) + ra (F. of -rus)], F., *measure*: ex aqua mensurae, *measures by the water-clock*; itinerum (*accurate length*).

mentiō, -ōnis, [as if MAN (in meminī) + tio (prob. †menti + o)], F., *mention*.

mercātor, -tōris, [†mercā- (cf. mercor, *trade*) + tor], M., *a trader* (who carries his own wares abroad).

mercātūra, -ae, [†mercātu- + ra (F. of rus)], F., *traffic, trade, commercial enterprise*.

mercēs, -ēdis, [mercē- (cf. merx, *merchandise*) + dus (reduced)], F., *hire, pay, wages*.

Mercurius, -ī, [unc. form, akin to merces, etc.], M., *Mercury*, the Roman god of gain, traffic, etc. Afterwards, identified with the Greek Hermes, he was considered also the god of eloquence as well as of trade, the messenger of the gods, and the god of roads, etc. He is identified by Cæsar with a Celtic divinity, probably Teutates.

mereor, -ēri, -itus, (also **mereo**, active), 2. v. dep., *win, deserve, gain*. — Also (from earning pay), *serve*: **mereri de**, *serve the interests of*.

meridiānus, -a, -um, [meridiē- + anus], adj., *of midday*: **tempus (noon)**.

meridiēs, -ēi, [prob. medio- (reduced) -diēs], M., *midday, noon*. — Also, *the south*.

meritum, -i, [N. p. p. of **mereo**], N., *desert, service*. — **meritō** (abl. as adv.), *deservedly*: **minus merito**, *without the fault*; **magis . . . quam merito eorum**, *more than by any act of theirs*; **merito eius a se fieri**, *that he deserved that he should do it*.

meritus, -a, -um, p. p. of **mereo**.

Messāla, -ae, [?], M., a Roman family name. — Esp., *Marcus Valerius Messala*, consul, B.C. 61, with Marcus Piso.

mētior, mētīri, mēnsus, [†meti- (MA + tis ?)], 4. v. dep., *measure, measure out, deal out (rations), distribute*.

Metiosēdum, -i, [Celtic], N., earlier name of **Melodunum**.

Mētius, -i, [?], M., a Gaul in relations of hospitality (see **hospes**) with Ariovistus.

metō, metere, messuī, messus, [?], 3. v. a., *cut, reap, gather*.

metus, -tūs, [unc. root + tus], M., *fear*. — Often superfluous with other words of fearing: **metu territare**, *terrify*. — Esp.: **hoc metu**, *fear of this*.

meus, -a, -um, [MA (in **me**) + ius], poss. adj. pron., *my, mine*.

mihī, see **ego**.

mīles, -itis, [unc. st. akin to **mille** as root + tis (reduced)], C., *a soldier, a common soldier* (as opposed to officers), *a legionary soldier* (*heavy infantry*, as opposed to other arms of the service). — Collectively, *the soldiers, the soldiery*.

militāris, -e, [milit- + aris], adj., *of the soldiers, military*: **signa** (*battle-standards*). See **res**.

militia, -ae, [milit- + ia], F., *military service, service* (in the army).

mīlle, indecl. **mīlia**, -ium, [akin to **miles**], adj. in sing., noun in plur., *a thousand*: **mille passuum**, *a thousand paces, a mile*.

Minerva, -ae, [unc. form akin to **memini**, etc.], F., *Minerva*, the goddess of intellectual activity, and so of skill and the arts, identified with the Greek *Athene*.

minimē [old case-form of **minimus**], adv., *in the smallest degree, least, very little, not at all*.

minimus, -a, -um, [lost st. (whence **minuo**) + **imus** (cf. **infimus**), superl. of **parvus**], adj., *smallest, least*. — Neut. as noun and adv., *the least, least, very little*.

minor, -us, [lost st. (cf. **minimus**) + **ior** (compar. ending)], adj., compar. of **parvus**, *smaller, less*: **dimidio minor**, *half as large*. — Neut. as noun and adv., *less, not much, not very, not so much, not so*: **quo minus**, *in order that . . . not*; **si minus**, *if not*; **minus valebat** (*not so strong, less, etc.*); **minus uti** (*not so well*); **minus magnus fluctus** (*less violent, smaller*).

Minucius (**Minut-**), -i, [perh. akin

to **minus**], M., a Roman gentile name. See **Basilus** and **Rufus**.

minuō, -uere, -uī, -ūtus, [†**minu-** (cf. **minus**)], 3. v. a. and n., *lessen, weaken, diminish*: **aestus** (*ebb*); **vim** (*break the force*, etc.); **controversias** (*settle*); **desidiam** (*cure, correct*); **ostentationem** (*humble*).

mīrātus, -a, -um, p. p. of **miror**.

mīror, -ārī, -ātus, [**mīrō-**], 1. v. dep., *wonder, wonder at, be surprised*. — **mīrātus**, -a, -um, p. p. in pres. sense, *surprised*.

mīrus, -a, -um, [?, SMI (cf. *smile*) + **rus**], adj., *surprising, marvellous, wonderful*: **mirum in modum**, *in a surprising manner*.

miser, -era, -erum, [**MIS** (cf. **maereo**) + **rus**], adj., *wretched, pitiable, miserable, poor*.

misericordia, -ae, [**misericord-** (*merciful*) + **ia**], F., *mercy, pity, clemency*.

miseror, -ārī, -ātus, [†**miserō-**], 1. v. dep., *bewail, complain of*.

missus, -a, -um, p. p. of **mitto**.

missus, -sūs, [**MIT** (? , root of **mitto**) + **tus**], M., *a sending*: **missu Caesaris**, *despatched by Caesar, under orders of Caesar*.

mītissimē [old case-form of **mītissimus**], adv., superl. of **mite** (N. of **mitis**), *very gently, very mildly, in very gentle terms*.

mittō, **mittere**, **mīsī**, **missus**, [?], 3. v. a., *let go* (cf. **omitto**), *send, despatch, discharge, shoot*: **sub iugum mittere**, *send under the yoke*. See **iugum**.

mōbilis, -e, [prob. **movi-** (as if st. of **moveo**, or a kindred st.) + **bilis**],

adj., *easily moved, movable, mobile, fickle, hasty*.

mōbilitās, -tātis, [**mobil-** + **tas**], F., *mobility, activity* (of troops), *inconstancy, fickleness*.

mōbiliter [**mobil-** + **ter** (prob. **terum**, reduced)], adv., *easily* (of motion), *readily*.

moderor, -ārī, -ātus, [†**moder-** (akin to **modus**, cf. **genus, genero**)], 1. v. dep., *control, regulate, restrain*.

modestia, -ae, [**modestō-** + **ia**], F., *moderation, self-control, subordination* (of soldiers).

modō [abl. of **modus**], adv., (*with measure* ?), *only, merely, just, even, just now, lately*: **paulum modo** (*just, a very*); **non . . . modo**, *not only*; **aspectum modo**, *the mere sight*.

modus, -ī, [**MOD** (cf. **moderor**) + **us**], M., *measure, quantity*. Hence, *manner, fashion, style, method*: **ad hunc modum**, *after this fashion*; **nullo modō**, *in no way*. See **eiusmodi**.

moenia, -ium, [**MI** (*distribute* ?) + **nis** (cf. **communis**) (orig. shares of work done by citizens?)], N. plur., *fortifications, walls of a city*.

mōlēs, -is, [?, cf. **molestus**], F., *a mass*. — Esp., *a dike, a dam*.

molestē [old case-form of **molestus**, *troublesome*], adv., *heavily, severely*: **moleste ferre**, *take hardly, be vexed at*.

mōlimentum, -ī, [**moli-** (st. of **moliō**, *strive*) + **mentum**], N., *trouble, difficulty, exertion*.

molitus, -a, -um, p. p. of **molo**.

mollis, -ire, -ivī, -ītus, [**moll-**], 4. v. a., *soften*. — Fig., *make easy*: **clivum**.

mollis, -e, [?], adj., *soft, tender*. — Fig., *weak, feeble, not hard, not firm*: animus ad resistendum; litus (*gently sloping*).

mollitiēs, -ēi (also, -a, -ae), [mollī- + ties (cf. -tia)], F., *softness*. — Fig., *weakness*: animi (*feebleness of purpose, weakness of character*).

molō, -ere, -uī, -itus, [?], 3. v. a., *grind*. See **cibarius**.

mōmentum, -ī, [movi- (as st. of **moveo**, *move*) + mentum], N., *means of motion, cause of motion*. — Fig., *weight, importance, influence*: habere (*be of importance*).

Mona, -ae, [Celtic], F., the Isle of Man, off the coast of Britain, but confounded with Anglesea.

moneō, -ēre, -uī, -itus, [causative of MAN (in **memini**) or denominative fr. a kindred st.], 2. v. a., *remind, warn, advise, urge*.

mōns, montis, [MAN (in **mineo**, *project*) + tis (reduced)], M., *a mountain, height*.

mora, -ae, [prob. root of **memor**, *mindful*, + a], F., *delay, grounds of delay*.

morātus, -a, -um, p. p. of **moror**.

morbus, -ī, [MAR (in **morior**, *die*) + bus], M., *sickness, illness*.

Morinī, -ōrum, [Celtic], M. plur., a tribe of the Belgæ on the coast of Picardy.

morior, morī (morīrī), mortuus (moritūrus), [MAR (cf. **mors**)], 3. v. dep., *die*.

Moritasgus, -ī, [Celtic], M., a chief of the Senones.

moror, -ārī, -ātus, [mora-], 1. v.

dep., *retard, hinder, check* (the advance of), *delay, wait, stay*.

mors, mortis, [MAR (cf. **morior**) + tis], F., *death*: sibi mortem consciscere, *commit suicide*.

mortuus, -a, -uni, p. p. of **morior**.

mōs, mōris, [?], M., *a custom, a usage, a way* (of acting). — Plur., *customs, habits, character* (as consisting of habits, cf. **ingenium** and **indoles**, of native qualities).

Mosa, -ae, [Celtic], M., a river in Belgic Gaul, now the *Meuse*, or *Maas*.

mōtus, -a, -um, p. p. of **moveo**.

mōtus, -tūs, [movi- (as st. of **moveo**) + tus], M., *a movement, a disturbance, an uprising*: expeditior (*movement of ships*); celer atque instabilis (*changes, of the passage of events in maritime warfare*); siderum (*revolutions*).

moveō, movēre, mōvī, mōtus, [?], 2. v. a., *set in motion, move, stir*: castra (*move from a place to another; also, absolutely, break camp*).

mulier, -eris, [?], F., *a woman*.

mūliō, -ōnis, [mulō- + o], M., *a muleteer, a driver*.

multitūdō, -dinis, [multō- + tūdo], F., *a great number, great numbers, number* (generally). — Esp., *the multitude, the common people*.

multō, see **multus**.

multō, -āre, -āvī, -ātus, [multa-, *fine*], 1. v. a., *punish* (by fine), *deprive* (one of a thing as a punishment).

multum, see **multus**.

multus, -a, -um, [?, poss. root of **mille**, *miles*, + tus], adj., *much*,

many: multo die, *late in the day*; ad multam noctem, *till late at night*. — multum, neut. as noun and adv., *much*. — Also, plur., multa, *many things, much, a great deal*. — Abl., multo, *much, far*: multo facilius. — As compar., plūs, plūris, N. noun and adv.; plur. as adj., *more, much, very*: as noun, *several, many*. — As superl., plūrimus, -a, -um, *most, very many, very much*: quam plurimi, *as many as possible*; quam plurimos possunt, *the most they can*; plurimum posse, *have most power, be very strong or influential*; plurimum valere, *have very great weight*.

mūlus, -ī, [?, perh. akin to molo, grind], M. (*the mill-beast*), a mule.

Mūnātius, -ī, [prob. akin to munus], M., a Roman gentile name. — Esp., *Lucius Munatius Plancus*, a legatus in Cæsar's army.

mundus, -ī, [?], M. (orig. adj., *well ordered*, a translation of Gr. κόσμος), *the universe, the world*.

mūnimentum, -ī, [munī- + mentum], N., *a fortification*. — Plur., *a defence*.

mūniō, -ire, -ivī (-īi), -itus, [muni- (st. of moenia)], 4. v. a. and n.,

fortify. — Less exactly, *protect, defend, furnish* (by way of protection), *make* (by embankment), *construct*: castra; iter. — munitissima castra (*very strongly fortified*).

mūnitiō, -ōnis, [munī- + tio], F., *fortification* (abstractly). — Concretely, *a fortification, works, fortifications, defences*: munitio operis, *building works of defence*; munitio nis causa, *to build works*, etc.

mūnītus, -a, -um, p. p. of munio.

mūnus, -eris, [min (as if root of moenia) + us, orig. share (cf. moenia)], N., *a duty, a service, a task*: munus militiae, *military service*. — Also, (*a contribution*), *a tribute, a gift, a present*.

mūrālis, -e, [murō- + alis], adj., *of a wall, wall*: pila (heavy javelins for service in siege operations).

mūrus, -ī, [?], M., *a wall* (in itself considered, cf. moenia, defences).

mūsculus, -ī, [mus + culus, dimin.], M., (*little mouse*), *a shed* (small and very strong, for covering besieging soldiers).

mutilis, -a, -um, [?], adj., *mutilated*: cornibus (*with short broken horns*, of the elk).

N

nactus, -a, -um, p. p. of nanciscor.

nam [old case-form, cf. tam, quam], conj., *for*.

Nammēius, -ī, [Celtic], M., a Helvetian sent as ambassador to Cæsar.

Namnetes, -um, [Celtic], M. pl.,

a Gallic tribe on the Loire around Nantes.

namque [nam-que], conj., *for* (a little more emphatic than nam).

nancīscor, -cīscī, nactus (nactus), [NAC], 3. v. dep., *find, get, procure, light upon, get hold of, obtain*.

nactus, -a, -um, p. p. of nanciscor.

Nantuātes, -um, [Celtic], m. pl., a tribe of Gaul of uncertain position, probably in Savoy.

Narbō, -ōnis, [Celtic], m., a city of the Roman province of Gaul, early made a Roman colony, now *Narbonne*.

nāscor, nāscī, nātus, [GNA, cf. *gigno*], 3. v. dep., *be born, arise, be produced, spring up, be raised* (of beasts), *be found* (**plumbum**). — **nātus**, p. p., *sprung, born*.

Nasua, -ae, [?, Germanic], m., a leader of the Suevi.

nātālis, -e, [natu- (reduced) + alis], adj., *of birth: dies natalis, a birthday*.

nātiō, -ōnis, [GNA (cf. *nascor*) + tio, perh. through intermediate st.], f., (*a birth*), *a race, a nation, a tribe, a clan*.

nātīvus, -a, -um, [natu- (reduced) + ivus], adj., *native, natural*.

nātūra, -ae, [natu- + ra (f. of -rus)], f., (*birth*), *nature, character* (of living creature), *character, nature* (of inanimate things); *ea rerum natura, such the state of the case; secundum naturam fluminis, down stream; natura triquetra (in form); natura cogebat, must necessarily; de rerum natura (physical science); eadem feminae marisque (form, organization); naturam vincere (human nature); natura loci, nature of the ground*.

nātus, -a -um, p. p. of *nascor*.

nātus, -tūs, [GNA (cf. *nascor*) + tus], m., *birth: maiores natu, elders*.

nauta, -ae, [borrowed from Gr. ναύτης], m., *a sailor, a boatman*.

nauticus, -a, -um, [nauta- + cus], adj., *of a sailor (or sailors), naval*.

nāvālis, -e, [navi- (reduced) + alis], adj., *of ships, naval: navalis pugna, sea-fight*.

nāvicula, -ae, [navi- + cula], f., *a boat, a small vessel, a skiff*.

nāvigātiō, -ōnis, [navigā- + tio], f., *a sailing, a voyage, travelling by sea, a trip (by sea)*.

nāvigium, -ī, [†navigō- (? navi + tagus) + ium], n., *a vessel (general), "a craft," a boat*.

nāvigō, -āre, -āvī, -ātus, [†navigō- (see *navigium*)], 1. v. n., *sail*.

nāvis, -is, [(s)NU, *float* (increased), with added i], f., *a ship, a vessel, a boat: oneraria (a transport); longa (a war galley); navi egredi, land*.

nāvō, -āre, -āvī, -ātus, [(g)navō-, *busy*], 1. v. a., *do one's best: operam (do one's best)*.

nē [NA, unc. case-form], conj., *lest, that . . . not, not to* (do anything), *from* (doing anything), *so that . . . not, for fear that*. — After verbs of fearing, *that*. — Also adv., *ne . . . quidem, not . . . even, not . . . either; ne Vorenius quidem, nor Vorenius either; Vorenius, too, did not, etc.*

-ne (enclitic) [prob. same as **nē**, orig. = **nonne**], conj., *not?* (as a question, cf. **nonne**), *whether, did* (as question in Eng.), *do, etc.* — See also **necne, nec**.

nec, see **neque**.

necessārius, -a, -um, [†necessō- (reduced) + arius], adj., (*closely bound?*), *necessary: tempus (critical); causa (pressing, unavoidable):*

res (*absolutely necessary, needful, indispensable*).—Also, as noun, *a connection* (a person bound by any tie), *a kinsman, a close friend*.—Abl. as adv., **necessariō**, *of necessity, necessarily, unavoidably*.

necesse [?, **ne-cessō-**, cf. **cedo**], indecl. adj., *necessary*.—With **est**, *one must, one cannot but, one must inevitably*.

necessitās, -tātis, [†**necessō-** + **tas**], F., *necessity, constraint, compulsion: temporis (exigency); suarum necessitatum causa (interests)*.

necessitūdō, -dinis, [†**necessō-** + **tudo**], F., *close connection* (cf. **necessarius**), *intimacy, close relations*.

necne [**nec ne**], conj., *or not* (in double questions).

necō, -āre, -āvi (-uī), -ātus (-tus), [**nec** (st. of **nex**, *death*)], I. v. a., *put to death, kill, murder* (in cold blood).

nēcubi [**ne cubi** (? for **quobi**, see **ubi**)], conj., *that nowhere, lest anywhere, that not . . . anywhere*.

nefārius, -a, -um, [**nefas** + **ius**], adj., *wicked, infamous, abominable*.

nefās, [**ne-fas**], N. indecl., *a crime* (against divine law): **nefas est**, *it is not allowable*.

neglegō (necl-), -legere, -lēxī, -lēctus, [**nec** (= **ne**) -**lego**], 3. v. a., *not regard, disregard, neglect: iniurias (leave unavenged, leave unpunished); hac parte neglecta (leave unnoticed); metu mortis neglecto (careless of, etc.)*.

negō, -āre, -āvi, -ātus, [?, poss. **ne-aiō**], I. v. a. and n., *say no, say . . . not, refuse*.

negōtiōr, -ārī, -ātus, [**negotiō-**], I. v. dep., *do business* (on a large scale, as in money, etc.).

negōtium, -ī, [**nec-otium, ease**], N., *business, occupation, an undertaking*.—Less definitely, *a matter, a thing*.—Also, *difficulty, trouble: in ipso negotio, at the moment of action; negotium conficere, make a thorough business of a thing, finish a thing up; quid negoti, what business? cf. Eng. "what business have you here?"*; **dare negotium alicui**, *employ one, give in charge to*.

Nemetes, -um, [Teutonic], M. pl., a German tribe on the Rhine

nēmō, †nēminis, [**ne-homo, man**], C., *no one, nobody: non nemo, many a one*.

nēquāquam [**ne-quaquam, anyway** (cf. **eā, quā**)], adv., *in no way, by no means*.

neque (nec) [**ne-que**], adv., *and not, and yet . . . not, nor: neque . . . neque, neither . . . nor*.

nēquī(d)quam (nēquic-), [ne . . . qui(d)quam, anything], adv., *to no purpose, in vain, not without reason*.

Nervicus, -a, -um, [**Nerviō-** (reduced) + **cus**], adj., *of the Nervi; Nerviān*.

Nervius, -a, -um, [Celtic], adj., *Nerviān*.—M. plur., *the Nervii*, a powerful tribe of Belgic Gaul.

nervus, -ī, [prob. for †**nevrus**], M., *a sinew*.—Fig., in plur., *strength, vigor*.

neu, see **neve**.

neuter, -tra, -trum, [**ne-uter, which** (of two)], adj. pron., *neither*.—Plur., *neither party, neither side*.

nēve (neu) [ne-ve], conj., *or not, and not, nor.*

nex, **necis**, [?], F., *death, violent death, execution.*

nihil, see **nihilum**.

nihilum, -ī (nihil), [ne-hilum, *trifle, whit?*], N. (also indecl.), *nothing*: **nihil reliqui**, *nothing left*; **nihil respondere**, *make no answer*. — **nihilō**, abl. as adv., *none, no*. — **nihil**, acc. as adv., *not at all*: **non nihil**, *somewhat*.

nimius, -a, -um, [nimi- (?), st. of **nimis**, *too much*] + **ius**], adj., *too much, too great*.

nisi [ne-si], conj., (*not . . . if*), *unless, except, except in case*: **nisi cum**, *until*; **nisi rogatus**, *without being asked*.

nīsus, -a, -um, p. p. of **nitor**.

Nitiobriges (-broges), -um, [Celtic], M. plur., a tribe of Aquitania, on the Garonne.

nītor, **nīsus** (nīxus), **nīti**, [prob. **genu**, *knee*], 3. v. dep., (*strain with the knee against something*), *struggle, strive, exert one's self*: **niti insidiis** (*rely upon*).

nix, **nivis**, [?], F., *snow*.

nōbilis, -e, [as if (g)no (root of **nosco**, *know*) + **bilis**], adj., *famous, noble, well-born* (cf. "notable"). — Plur. as noun, *the nobles*.

nōbilitās, -tātis, [nobili- + **tas**], F., *nobility*. — Concretely, *the nobility, the nobles*.

nocēns, see **noceo**.

noceō, **noceŕe**, -uī, no p. p., [akin to **nex**, *death*], 2. v. n., *do harm to, injure, harm, harass*. — **nocēns**, -entis, p. as adj., *hurtful, guilty* (of some harm).

noctū [abl. of †**noctus** (noc- + **tus**)], as adv., *by night*.

nocturnus, -a, -um, [noc- + **tur-nus**, cf. **diuturnus**], adj., *of the night, nightly, nocturnal, in the night, by night*: **tempus** (*night-time*).

nōdus, -ī, [?], M., *a knot, a joint*: **nodi et articuli**, *protuberant joints*.

nōlō, **nōlle**, **nōluī**, [ne-volo], irr. v. a. and n., *not wish, be unwilling, wish not, not like to have*: **noli**, **nolite**, *do not* (with infin.).

nōmen, -minis, [(G)NO (root of **nosco**, *know*) + **men**], N., *a name* (what one is known by), *name* (fame, prestige). — As a name represents an account, *an account*: **nomine dotis** (*on account of, as*); **suo nomine**, *on his own account*; **nomine obsidum**, *under pretence of hostages*.

nōminātīm [acc. of real or supposed †**nominatis** (**nominā-** + **tis**)], adv., *by name* (individually).

nōminō, -āre, -āvī, -ātus, [**nomin-**], I. v. a., *name, mention, call by name*.

nōn [ne-oenum (**unum**)], adv., *not*: **non est dubium**, *there is no doubt*; **non mediocriter**, *in no small degree*.

nōnāgintā, indecl., num., *ninety*.

nōndum (see **đum**), *not yet*.

nōnnūllus (see **nullus**), *some*.

nōnnumquam (see **numquam**), *sometimes*.

nōnus, -a, -um, [†**novi** (?) + **nus** (**mus**)], num. adj., *ninth*.

Nōrēia, -ae, [Teutonic], F., a city of the Norici, in modern Styria.

Nōricus, -a, -um, [st. akin to **Noreia** + **cus**], adj., *of the Norici, Norican*.

nōs, **nōsmet**, see **ego**, **egomet**.

nōscō, nōscere, nōvī, nōtus, [(G)NA, know], 3. v. a., learn, become acquainted with. — In perf. tenses, know. — **nōtus**, -a, -um, p. p. as adj., known, familiar, well-known: **notis vadis** (being acquainted with, etc.).

noster, -tra, -trum, [prob. nos (nom. plur.) + ter], poss. adj. pron., our, ours. — In plur., our men (the Romans), our forces.

nōtitia, -ae, [notō- + tia], F., acquaintance with, knowledge.

nōtus, p. p. of nosco.

novem [unc. reduced case-form], indecl. num. adj., nine.

Noviodūnum, -ī, [Celtic], N.: 1. A town of the Bituriges, on the Loire. — 2. A town of the Hædui. — 3. A town of the Suessiones.

novitās, -tātis, [novō- + tas], F., novelty, strangeness, strange character: **rei** (novelty, unexpected occurrence).

novus, -a, -um, [?, cf. Eng. new], adj., new, novel, fresh: **res novae**, a change of government, revolution. — **novissimus**, -a, -um, superl., latest, last: **agmen** (the rear).

nox, noctis, [akin to noceo, harm], F., night: **prima nocte**, in the early part of the night; **multa nocte**, late at night.

noxia, -ae, [NOC (in noceo, harm) + unc. term.], F., crime, guilt.

nūbō, nūbere, nūpsī, nūptus, [akin to nubes, cloud], 3. v. n., veil one's self (of the bride), marry (of the woman).

nūdātus, -a, -um, p. p. of nudo.

nūdō, -āre, -āvī, -ātus, [nudō-], 1. v. a., lay bare, expose, strip. —

Less exactly, clear (murum defensoribus).

nūdus, -a, -um, [?, root (akin to naked) + dus], adj., naked, bare, unprotected, exposed.

nūllus, -a, -um, [ne-ullus], adj., not any, no. — As noun, no one. — **nōn nūllus**, some. — Plur. as noun, some, some persons.

num [pron. NA, cf. tum], adv., interrog. particle, suggesting a neg. answer, does, is, etc., it is not, is it? and the like: **num posse** (in indirect discourse, could he, etc.).

nūmen, -inis, [NU (in nuo, nod) + men], N., (a nod), will, power. Hence, divinity.

numerus, -ī, [†numo- (cf. nummus, Numa) + rus], M., a number, number: **in hostium numero habuit** (in the place of, etc., euphemism for slaughtered); **totidem numero**, the same number; **impedimentorum** (quantity, i.e. number of pack-horses); **ad numerum**, to the required number; **aliquo numero**, of some account.

Numida, -ae, [?], M., a Numidian (employed in the Roman army as cavalry, cf. Zouave, Turco).

nummus, -ī, [akin to numerus], M., a coin: **pro nummo**, for coin.

numquam (nun-) [ne-umquam], adv., never.

nunc [num-ce, cf. hic], adv., now (emphatic, as an instantaneous now, cf. iam, unemphatic and continuous): **etiam nunc**, even then (of the past considered as present).

nūntiātus, -a, -um, p. p. of nuntio. **nūntiō**, -āre, -āvī, -ātus, [nuntiō-],

i. v. a., *send news, report, make known*: *nuntiatum est ei . . . ne* (*he was ordered not to, etc.*).

nūntius, -ī, [†novent- (p. of †noveo, *be new*) + ius], **M.**, (*new-comer*), *a messenger*. Hence, *news*: *nuntium mittere* (*send word*); *per eorum nuntios* (*agents*).

nūper [for *novi-per*, cf. *parum per*], **adv.**, *lately, recently, not long ago*.

nūsquam [*ne-usquam*], **adv.**, *nowhere, in no case* (almost equal *never*).

nūtus, -tūs, [NU + tus], **M.**, *a nod, a sign*: *ad nutum*, *at one's beck, at one's command*; *nutu*, *by signs*.

O

ob [unc. case-form], **adv.** (in comp.), and **prep.** with **acc.** (*near*), *against*. Hence, *on account of, for*: *ob eam rem*, *for this reason, on this account*.—In comp., *towards, to, against, over*.

obaerātus, -a, -um, [ob-†aeratus, as if p. p. of †aero, cf. *aes, money*], **adj.**, *bound in debt* (to some one).—As **noun**, *a debtor, a servant for debt*.

obdūcō, -dūcere, -dūxī, -ductus, [ob-ducō], **3. v. a.**, *lead towards, lead against*: *fossam* (*throw out, in a military sense, carry along*).

obeō, -īre, -iī, -itus, [ob-eo], **irr. v. a.**, *go to, go about, attend to*.

obicio, -icere, -iēcī, -iectus, [ob-iacio], **3. v. a.**, *throw against, throw in the way, present, throw up* (against the enemy, etc.), *set up, expose*.—**ob-iectus**, -a, -um, **p. p.** as **adj.**, *lying opposite, lying in the way*.

obitus, -tūs, [ob-itus, cf. *obeo*], **M.**, *a going to*.—**Esp.**, *a going to death* (cf. *obire mortem*), *destruction, annihilation*.

obiectus, -a, -um, **p. p.** of *obicio*.

oblātus, -a, -um, **p. p.** of *offerō*.

obliquē [old case-form of *obliquus*], **adv.**, *obliquely, slanting*.

obliquus, -a, -um, [ob-†liquus, cf. *li(c)mus, aslant*], **adj.**, *slanting*.

oblīvīscor, -līvīscī, -lītus, [ob-†livio, cf. *liveo*], **3. v. dep.**, (*grow dark against?*), *forget*.

obsecrō, -āre, -āvī, -ātus, [manufactured from *ob sacrum* (*near or by some sacred object*)], **1. v. a.**, *entreat, adjure, implore*.

obsequentia, -ae, [obsequent- (*yielding*) + *ia*], **F.**, *compliance, deference*: *nimia obsequentia*, *too ready compliance*.

observātus, -a, -um, **p. p.** of *ob-servo*.

observō, -āre, -āvī, -ātus, [ob-servo], **1. v. a.**, (*be on the watch towards?*), *guard, maintain, keep*: *iudicium* (*follow, comply with*); *dies natalis* (*keep, celebrate*).

obses, -idis, [ob-†ses, cf. *praeses* and *obsideo*], **C.**, (*a person under guard*), *a hostage*.

obsessio, -ōnis, [ob-†sessio, cf. *obsideo*], **F.**, *a blockade, a siege, a state of siege* (cf. *oppugnatio*, of actual siege operations).

obsessus, -a, -um, p. p. of *obsideo*.
obsideō, -sidēre, -sēdī, -sessus, [ob-sedeo], 2. v. a., (*sit down against*), *blockade, beset, guard*.

obsidiō, -ōnis, [obsidiō- (reduced) + o], F., *a siege* (cf. *obsessio*), *a blockade: obsidione liberare* (*from besetting enemies*).— Also, *the art of siege*.

obsignātus, -a, -um, p. p. of *obsigno*.

obsignō, -āre, -āvī, -ātus, [ob-signo], 1. v. a., *seal up, seal*.

obsistō, -sistere, -stitī, no p. p., [ob-sisto], 3. v. n., *withstand, resist*.

obstinātē [old case-form of *obstinatus*, fr. *obstino*, *persist*], adv., *persistently*.

obstrictus, -a, -um, p. p. of *obstringo*.

obstringō, -stringere, -strīnxī, -strictus, [ob-stringo], 3. v. a., *bind* (lit. and fig.): *habere obstrictas* (*under obligation*).

obstrūctus, -a, -um, p. p. of *obstruo*.

obstruō, -struere, -strūxī, -strūctus, [ob-struo, *pile*], 3. v. a., *block up, barricade*.

obtemperō, -āre, -āvī, -ātūrus, [ob-tempero], 1. v. n., (*conform to*), *comply with, submit to*.

obtestātus, -a, -um, p. p. of *obtestor*.

obtestor, -ārī, -ātus, [ob-testor, cf. *testis*, *witness*], 1. v. dep., *implore* (*calling something to witness*).

obtineō, -tinēre, -tinuī, -tentus, [ob-teneo], 2. v. a., *hold* (*against something or somebody*), *retain, maintain, occupy, possess: provinciam*

(*have control of as praetor*); *iustissimam apud eum causam obtinere*, *be entirely free from obligation towards him*, as having a perfect right to benefits conferred.

obtulī, perf. of *offero*.

obveniō, -venire, -vēnī, -ventūrus, [ob-venio], 4. v. n., *come to, come in one's way, fall to* (by lot).

obviam [ob-viam], adv., *in the way of, to meet* (any one): *obviam venire, come to meet*.

occāsiō, -ōnis, [ob-+casio, cf. *occido*], F., *opportunity: occasio brevis, a short time; rem occasionis, a matter of opportunity*.

occāsus, -sūs, [ob-casus, cf. *occido*], M., *a falling, a setting* (of the sun): *solis* (*the sunset, the west*).

occidō, -cidere, -cidī, -cāsūrus, [ob-cado], 3. v. n., *fall, be slain, set: sol occidens, the west*.

occidō, -cidere, -cidī, -cīsus, [ob-caedo, *cut*], 3. v. a., *kill, massacre: occisi, the slain*.

occīsus, -a, -um, p. p. of *occidō*.

occultātiō, -ōnis, [occulta- + tio], F., *concealment*.

occultātus, -a, -um, p. p. of *occulto*.

occultē [old case-form of *occultus*], adv., *secretly*.

occultō, -āre, -āvī, -ātus, [occultō-], 1. v. a., *conceal, hide*.

occultus, -a, -um, [p. p. of *occulo*], as adj., *concealed: in occulto, in secret; ex occulto, from an ambush, in ambush; in occulto sese continere, keep themselves hidden; insidiandi ex occulto, of attacking from an ambush*.

occupātiō, -ōnis, [occupā- + tio], F., *occupation* (engagement in business), *business affairs* (of business): *occupationes tantularum rerum*, *engagement in such trifling matters*.

occupātus, -a, -um, p. p. of **ocupo**.

ocupo, -āre, -āvi, -ātus, [†occupō- or †ocupo-, ob and st. akin to **capio**], 1. v. a., *seize, take possession of, seize upon, occupy* (only in military sense): *regna (usurp)*; *in opere occupati (engaged, employed)*.

occurrō, -currere, -currī (-cucurrī?), -cursūrus, [ob-curro], 3. v. n., *run to meet, meet, come upon, find, fall in with, meet*. Hence in pregnant sense, *thwart, baffle, frustrate*: *eo (run, to meet an enemy)*; *ad animum (occur)*.

Oceanus, -ī, [Gr.], M., *the ocean* (with or without *mare*).

Ocelum, -ī, [Celtic], N., a town of the Graioceli in Cisalpine Gaul (prob. *Oulx* in Piedmont).

octāvus, -a, -um, [octo + **vus**, poss. †octau + us], num. adj., *eighth*.

octingentī, -ae, -a, [st. akin to octo + centum], num. adj., *eight hundred*.

octō [?], indecl. num. adj., *eight*.

octōdecim [octo-decem], indecl. num. adj., *eighteen*.

Octodūrus, -ī, [Celtic], M., a town of the Veragri, now *Martigny*.

octōgintā [octo + ?], indecl. num. adj., *eighty*.

octōnī, -ae, -a, [octo + nus], adj., *eight at a time, eight each, eight*.

oculus, -ī, [†ocō- (cf. AK, see) +

lus], M., *the eye*: *sub oculis, in sight, before the eyes*.

ōdī, ōdisse, [perf. of lost verb (with pres. sense), akin to **odium**], def. v. a., *hate, detest*.

odium, -ī, [VADH (*spurn*) + ium], N., *hatred*.

offendō, -fendere, -fendī, -fēnsus, [ob-fendo], 3. v. a. and n., *dash against, hurt*: *animum (hurt the feelings, alienate, shock)*. — Absolutely, *suffer a mishap*.

offēnsiō, -ōnis, [ob-†fensio, cf. **defensio** and **offendo**], F., *striking against*. — Fig., *offence*: *sine offensione animi, without wounding one's feelings*.

offerō, offerre, obtulī, oblātus, [ob-fero], irr. v. a., (*bring to*), *throw in one's way, offer*: *se hostibus (throw themselves upon)*; *se morti (expose one's self to)*; *quos sibi oblatos (placed in his power)*; *beneficium (confer, render)*.

officium, -ī, [ob-†facium, cf. **beneficium**], N., (*doing something to one*), *a service, performance of a duty*. — Transf., *a duty, allegiance, an obligation*: *discedere ab officio, fail of one's duty*.

Ollovicō, -ōnis, [Celtic], M., a king of the Nitiobriges.

omittō, -mittere, -mīsī, -missus, [ob-mitto], 3. v. a., *let go by*: *consilium (leave untried, neglect)*; *omnibus omissis rebus, leaving everything else*.

omnīnō [abl. of †omninus (omni + nus)], adv., *altogether, entirely, only, utterly, in all, at all, any way, only just, whatever* (with negatives).

omnis, -e, [?], adj., *all, the whole* of (as divisible or divided, cf. *totus* as indivisible or not divided). — In sing., *every* (without emphasis on the individuals, cf. *quisque*, *each*, emphatically); *celerius omni opinione* (*of any one*); *omni tempore*, *on all occasions, always*; *omnes preces*, *every form of prayers*; *omnibus rebus*, *everything, everything else*; *per omnia*, etc. (*through nothing but, etc.*). — In plur. as a short expression for *all others*.

onerārius, -a, -um, [oner- (as st. of onus) + arius], adj., *for burdens: naves* (*transports*).

onerō, -āre, -āvī, -ātus, [oner- (as st. of onus)], 1. v. a., *load*: *celeritas onerandi* (*of ships*), *facility of loading*.

onus, -eris, [unc. root + us], N., *a burden, a load, a freight, a cargo*. — Abstr., *weight*. — Esp.: *tanta onera navium*, *ships of such weight*.

opera, -ae, [oper- (as st. of opus) + a (F. of -us)], F., *work, pains, attention*: *operam navare*, *do one's best*; *operam dare*, *devote one's self, exert one's self, take pains*. — With *ut*, *try, take care*: *opera uti* (*services, help, etc.*); *quorum opera interfectus* (*through whose means, agency*).

opiniō, -ōnis, [opinō- (cf. *nec-opinus*) + o], F., *notion, expectation*: *celerius omni opinione*, *quicker than any one would suppose*; *opinio virtutis* (*reputation for, etc.*); *tanta opinio huius belli* (*impression*); *tantam opinionem timoris praebeuit* (*gave such an idea, impression*); also, *opinio timoris* (*display, cause for an*

impression); *speciem atque opinionem pugnantium praebere*, *make a show and give an impression of being combatants*; *nomen atque opinio* (*reputation*); *ut fert illorum opinio*, *as their notion is*; *ad opinionem Galliae*, *for an impression on the Gauls*; *opinionem praecipere*, *to anticipate*.

oportet, -ēre, -uit, no p. p., [noun-st. from ob and st. akin to *porto*, cf. *opportunus*], 2. v. impers., *it behooves, it ought, it is best*: *poenam sequi* (*the punishment was to follow*); *frumentum metiri* (*he ought, etc.*); *alio tempore atque oportuit* (*than it should have been*).

oppidānus, -a, -um, [oppidō- (reduced) + anus], adj., *of a (the) town*. — Plur. as noun, *the townspeople*.

oppidum, -ī, [ob- + pedum (*a plain?*)], N., (the fortified place which, according to ancient usage, commanded the territories of a little state), *a stronghold, a town* (usually fortified).

oppōnō, -pōnere, -posuī, -positus, [ob-pono], 3. v. a., *set against, oppose* (something to something else): *novem oppositis legionibus*, *with nine legions opposed to the enemy*. — *oppositus*, -a, -um, p. p. as adj., *opposed, lying in the way, opposite*.

opportūnē [old case-form of *opportunus*], adv., *opportunately, seasonably*.

opportunitās, -tātis, [opportunō- + tas], F., *timeliness, fitness* (of time or circumstance), *good luck* (in time or circumstance), *favorable chance*,

convenience (of a means of fortification).

opportūnus, -a, -um, [ob-portunus, cf. *portus*, harbor, and *Portunus*], adj., (*coming to harbor?*), *opportune, advantageous, lucky*.

oppositus, -a, -um, p. p. of **oppono**.

oppressus, -a, -um, p. p. of **opprimo**.

opprimō, -primere, -pressī, -pressus, [ob-premo], 3. v. a., (*press against*), *overwhelm, crush, overpower, overtake (surprise)*.

oppugnatio, -ōnis, [oppugnā- + tio], F., *a siege* (of actual operations, cf. *obsidio, blockade*), *besieging, an attack* (in a formal manner against a defended position).

oppugnō, -āre, -āvī, -ātus, [ob-pugno, *fight*], 1. v. a., *attack* (formally, but without blockade), *lay siege to, carry on a siege, assail* (a defended position).

[**ops**, cf. **Ops**, the goddess], **opis**, [?] F., *help, aid*. — Plur., *resources, means, strength, blessings*. — Also, *help* (from several sources).

optātus, -a, -um, [p. p. of **opto**, *wish*], as adj., *desired, desirable, wished for, welcome*.

optimē, superl. of **bene**.

optimus, -a, -um, [op (cf. **ops**?) + **timus** (cf. **finitimus**)], superl. of **bonus**.

opus, **operis**, [OP + us], N., *work, labor* (as accomplishing its purpose, cf. *labor*, as tiresome). — In military sense, *a work, works, fortifications*: *natura et opere munitus* (*by nature and art*); *operum atque arti-*

ficiarum (*trades, handicrafts*). — In abl., **magno** (**quanto**) (**tanto**) **opere**, *very much, very, greatly*: (*how much*), (*so much, so, so earnestly*): often as one word, **magno-pere**, **quantopere**, **tantopere**.

opus [same word as preceding], N. indecl., *need, necessity*: **si quid ipsi a Caesare opus esset**, *if he needed anything of Caesar*; **si quid opus facto**, etc., *if anything needs to be done*.

ōra, -ae, [?], F., *a shore, a coast*.

ōrātiō, -ōnis, [orā- (*speak*) + tio], F., *speech, words, talk, address, discourse, argument*.

ōrātor, -tōris, [orā- (*speak*) + tor]. M., *a speaker, an ambassador, envoy*.

orbis, -is, [?], M., *a circle* (a circular plane): **orbis terrarum**, *the circle of lands, the whole world*. — Less exactly, *a hollow square* (in military language), *a circle*.

Orcynia, -ae, [Teutonic or Celtic], F., see **Hercynius**.

ōrdō, -inis, [akin to **ordior**, *begin a web*], M., *a series, a row, a tier, a rank* (of soldiers), *a grade* (of centurions, as commanding special *ordines* of soldiers, also the *centurions* themselves), *an arrangement, an order*: **perturbatis ordinibus**, *the ranks being broken*; **ratio ordoque agminis**, *the plan and arrangement of the march*; **ordines servare**, *to keep their places*, (of soldiers, also of anything laid in rows or tiers, *preserve the arrangement*, not deviating from it).

Orgetorix, -igis, [Celtic], M., a nobleman of the Helvetii.

orior, orīrī, ortus, [?], 3. (and 4). v. dep., *arise, spring up*: orta luce, at daybreak. — Fig., *begin, start, spring from, arise, be started, have its source*. — oriēns, -entis, p. as adj., *rising*: sol (*sunrise, the east*).

ōrnāmentum, -ī, [ornā- + mentum], N., *an adornment*. — Fig., *an honor* (an addition to one's dignity), *a source of dignity*.

ōrnātus, -a, -um, p. p. of orno.

ōrnō, -āre, -āvī, -ātus, [unc. noun-st.], 1. v. a., *adorn, equip, furnish*. — Fig., *honor*. — ōrnātus, -a, -um, p. p. as adj., *furnished, well-equipped, honored*.

ōrō, -āre, -āvī, -ātus, [or- (as st. of os, mouth)], 1. v. a. and n., *speak*. — Esp., *pray, entreat*.

ortus, -a, -um, p. p. of orior.

ortus, -tūs, [OR (in orior) + tus], M., *a rising*: solis (*sunrise, the east*).

ōs, ōris, [?], N., *the mouth, the face*: ora convertere, *turn the eyes*.

Osismī, -ōrum, [Celtic], M. plur., *a people of Gaul* (in Brittany).

ostendō, -tendere, -tendī, -tentus, [obs-tendo], 3. v. a., (*stretch towards*), *present, show, point out, make known, state, declare*: copias (*discover, unmask*).

ostentātiō, -ōnis, [ostenta- + tio], F., *a showing, a display*: ostentationis causa, *for display*; ostentationem comminuere, *humble the pride*.

ostentō, -āre, -āvī, -ātus, [ostento-], 1. v. a., *display, exhibit*.

ōtium, -ī, [?], N., *repose, inactivity, quiet* (freedom from disturbance).

ōvum, -ī, [perh. avi- + um], (*belonging to a bird?*), N., *an egg*.

P

P., for Publius.

pābulātiō, -ōnis, [pabulā- + tio], F., *a foraging, getting fodder*: pabulationis causā, *for forage*.

pābulātor, -tōris, [pabulā- + tor], M., *a forager*.

pābulor, -ārī, -ātus, [pabulō-], 1. v. dep., *forage, gather fodder*.

pābulum, -ī, [PA (in pasco, feed) + bulum], N., *fodder* (for animals, including the stalk as well as the grain), *green fodder*.

pācātus, -a, -um, p. p. of paco.

pacīscor, -īscī, pāctus (also pacīscō, -ere) [paci (as st. of pāco, agree) + sco], 3. v. a. and dep.,

bargain. — Esp., pāctus, -a, -um, p. p., *agreed upon, settled*.

pācō, -āre, -āvī, -ātus, [pac-, in pax, peace], 1. v. a., *pacify, subdue*. — pācātus, -a, -um, p. p. as adj., *peaceable, quiet, subject* (as reduced to peace).

pāctum, -ī, [see pactus], N., (*a thing agreed*), *an agreement, an arrangement*. Hence, *a method, a way* (of doing anything): quo pacto, *in what way, how*.

pāctus, -a, -um, p. p. of pacīscor and pango.

Padus, -ī, [Celtic], M., *the Po, the great river of Northern Italy* (Cisalpine Gaul).

Paemānī, -ōrum, [Celtic], M. pl., people of the Belgians.

paene [?], adv., *almost, nearly*.

paenitet, -ēre, -uit, [†poenitō- (perh. p. p. of verb akin to **punio**, *punish*)], 2. v. a., impers., *it repents* (one), *one repents, one regrets*.

pāgus, -ī, [PAG (in **pango**) + us (with unc. conn. of ideas)], M., *a district, a canton* (cf. **vicus**, a smaller collection of dwellings).

palam [unc. case-form, cf. **clam**]. adv., *openly, publicly, without concealment*.

palma, -ae, [Gr.], F., *the palm* (of the hand).

palūs, -ūdis, [?], F., *a marsh*.

palūster, -tris, -tre, [palud- + tris], adj., *marshy, swampy*.

pandō, *pandere*, *pandī*, *passus*, [akin to **pandus**, *bent*], 3. v. a., *spread out* (perh. orig. of the hands, bending back the wrist): *passis manibus, with outstretched hands*; *passis capillis, with dishevelled hair*.

pār, *paris*, [perh. akin to **paro**, *pario* (through the idea of barter or exchange)], adj., *equal, alike, like*: *intervallum (the same)*. — Esp., *equal in power, a match for*.

parātus, -a, -um, p. p. of **paro**.

parcē, [old case-form of **parcus**], adv., *sparingly, frugally*.

parcō, *parcere*, *pepercī* (*parsī*), *parsūrus* (*parcītūrus*), [akin to **parcus** (PAR + **cus**), *acquisitive*, and so *frugal*?], 3. v. n., *spare*. — Esp., *save alive*: *parcendo, by economy, by frugality*.

parēns, -entis, [PAR (in **pario**) + **ens**], C., *a parent*.

parentō, -āre, -āvi, -ātus, [**parent-**], 1. v. n., *make a funereal offering* (to deceased relatives, esp. parents). Hence, *avenge* (making an offering of the wrong-doer).

pārēō, *pārēre*, *pārui*, *pārītūrus*, [parō- (cf. **opiparus**)], 2. v. n., *be prepared, appear, obey, submit to*.

pariō, *parere*, *peperi*, *partus* (*parītūrus*), [PAR, *procure* (perh. orig. by barter, cf. **par**)] 3. v. a., *procure, acquire, secure*.

Parisiī, -ōrum, [Celtic], M. plur., a Celtic tribe around modern Paris, whose town Lutetia takes its modern name from them, cf. *Rheims*, (**Remi**), *Trèves* (**Treveri**).

parō, -āre, -āvi, -ātus, [parō-, cf. **opiparus**, and **pareo**], 1. v. a., *procure, provide, prepare, get ready for* (bellum used concretely for the means of war), *arrange*. — **parātus**, -a, -um, p. p. as adj., *ready, prepared*: *animo parato* (with mind resolved), *resolute, determined*; *paratus in armis, armed for war*.

pars, *partis*, [PAR + **tis** (reduced), akin to **portio**, and perh. to **par** through idea of barter], F., (*a dividing*), *a portion, a part, a share*. — Often of position or direction merely, *side, direction, region*: *una ex parte, on one side*; *in utram partem, in which direction*; *ex utraque parte, on both sides*; *sinistra pars, the left flank*; *pars fluminis (bank)*; *maior pars, the majority*. — Fig.: *qua ex parte, in which respect*; *omnibus partibus, in all respects*; *in utramque partem, in both respects, both ways, (of a plan)*; in

utramque partem, *on both sides* (of a discussion). — Esp.: tres partes, *three quarters*, (three parts out of four); ex parte, *in part*; ad inferiorem partem fluminis, *down the river*; ab inferiore parte fluminis (*further down*, etc.). — partim, acc. as adv., *in part, partly, some . . . others*.

partim, see pars.

partior, -īri, -itus, [parti-], 4. v. dep., *divide*: partitis temporibus, *alternately*.

partitus, -a, -um, p. p. of partior.

partus, -a, -um, p. p. of pario.

parum, [akin to parvus, perh. for parvum], adv., *not very, not much, not sufficiently*: parum diligenter, *too carelessly, without sufficient care*.

parvulus, -a, -um, [parvō- + lus], adj., *small, slight, insignificant*: ab parvulis, *from infancy*.

parvus, -a, -um, [perh. for paucus, cf. paucus], adj., *small, slight, little*.

passim [acc. of passis (pad (in pando, spread) + tis)], adv., *in all directions, all about*.

passus, -a, -um, p. p. of pando.

passus, -a, -um, p. p. of partior.

passus, -sūs, [PAD (in pando) + tus], M., (*a spreading of the legs*), *a stride* (of both feet), *a step, a pace* (esp. as a measure, about five Roman feet): mille passuum, *a Roman mile*, five thousand feet.

patefaciō, -facere, -fēcī, -factus, [noun-st. akin to pateo + facio], 3. v. a., *lay open, open*.

patefactus, -a, -um, p. p. of patefacio.

patefiō, pass. of patefacio.

pateō, -ēre, -uī, no p. p., [?], 2. v. n., *be extended, lie open, spread, extend, be wide, be open*. — patēns, -entis, p. as adj., *open, exposed*.

pater, -tris, [PA (in pasco?) + ter], M., *a father*. — Plur., *ancestors*.

patienter, [patient- + ter], adv., *patiently*.

patientia, -ae, [patient- + ia], F., *patience, endurance, forbearance* (in refraining from fighting).

patior, pati, passus, [?], 3. v. dep., *suffer, endure, allow, permit*: vim tempestatis (*endure, stand*).

patrius, -a, -um, [patr- + ius], adj., *of a father, ancestral, of one's fathers*.

patrōnus, -ī, [fr. pater, for form cf. colonus + nus], M., *a patron, a protector*.

patruus, -ī, [pat (e) r- + vus?], M., *an uncle* (on the father's side, cf. avunculus, on the mother's).

paucitās, -tātis, [paucō- + tas], F., *small number*.

paucus, -a, -um, [PAU (cf. paulus and parvus) + cus], adj., almost always in plur., *few, some few* (but with implied *only* in a semi-negative sense): paucis (pauca) respondit (*in a few words, briefly*).

paulātim [paulō- (reduced) + atim, as if acc. of † paulatis († paulā + tis)], adv., *little by little, a little at a time, gradually, few at a time*.

paulisper [paulis (abl. plur. of paulus?) per], adv., *a little while*.

paulō [abl. of paulus, *little*], as adv., *a little, slightly*.

paululum [acc. of paululus, dim. of paulus], as adv., *a very little*.

paulum [acc. of paulus (PAU + lus, cf. paucus)], as adv., *a little, a short distance, somewhat*.

pāx, pācis, [PAC (*fix*), as st.], F. (*a treaty?*), *peace, favor*.

peccō, -āre, -āvī, -ātūrus, [?], I. v. n., *go wrong, commit a fault*.

pectus, -oris, [perh. pect (as root of pecto, *comb*) + us, from the rounded shape of the breast, cf. pectinatus], N., *the breast*.

pecūnia, -ae, [† pecunō- (pecu- (*cattle*) + nus, cf. Vacuna) + ia], F., *money* (originally *cattle*), *wealth*.

pecus, -oris, [PEC (*tie?*) + us], N., *cattle* (especially sheep and goats): pecore vivere (*flesh of cattle*). — Pl., *cattle, flocks and herds*.

pedālis, -e, [ped- + alis], adj., *of a foot* (in thickness), *a foot thick*.

pedes, -itis, [ped- (as if pedi) + tis (reduced)], C., *a footman, a foot-soldier*. — Collectively, *the infantry*.

pedester, -tris, -tre, [pedit- + tris], adj., *of infantry, of persons on foot*: itinera (*journeys on foot, marches, land routes*); proelium (*on land*); copiae (*the foot, the infantry*).

peditātus, -tūs, [pedit- + atus, cf. consulatus], M., *foot, infantry*.

Pedius, -ī, [?], M., a Roman gentile name. — Esp., *Quintus Pedius*, a nephew of Cæsar and a legatus under him in Gaul. He sided with Augustus, and was afterwards made consul by Augustus's patronage.

pēior, see malus.

pēius, see male.

pellis, -is, [?], F., *a hide, a skin* (either on or off the body of an animal): sub pellibus, *in tents*, i.e. *in the field*.

pellō, pellere, pepulī, pulsus, [?], 3. v. a., *strike, beat, drive, defeat, repulse, rout*.

pendō, pendere, pependī, pēnsus, [?], 3. v. a., *hang, weigh, weigh out*. Hence (since money was earlier weighed, not counted), *pay, pay out*. — Esp. with words of punishment, *pay* (a penalty), *suffer* (punishment, cf. dare and capere).

penes [prob. acc. of st. in -os akin to penitus], prep. with acc., *in the power of*.

penitus [st. akin to penes, penus, etc., + itus, cf. antiquitus], adv., *far within, deeply, entirely, utterly*: penitus ad extremos finis (*clear to, all the way to*).

1. per [unc. case-form], adv. (in composition) and prep. w. acc., *through, along, over, among*. — Fig., *through, by means of* (cf. ab, by, directly), *by the agency of*. — Often accompanied by the idea of hindrance: per anni tempus potuit, *the time of the year would allow*; per te licere, *you do not prevent, you allow*; per aetatem non poterant (*on account of*). — Often in adv. expressions: per fidem, *in good faith*, in reference to a deception on the other side; per concilium, *in council*; per insidias, *treacherously*; per cruciatum, *with torture*; per vim, *forcibly*; locus ipse per se (*in and of itself*).

2. per [prob. a different case of

same st. as **per**], adv. in comp., *very, exceedingly, completely*.

perāctus, -a, -um, p. p. of **perago**.

peragō, -agere, -ēgī, -āctus, [1. **perago**], 3. v. a., *conduct through, finish, accomplish*: **concilium** (*hold to the end*); **conventus** (*finish holding*).

perangustus, -a, -um, [2. **perangustus**], adj., *very narrow*.

perceptus, -a, -um, p. p. of **percipio**.

percipiō, -cipere, -cēpī, -ceptus, [1. **per-cipio**], 3. v. a., *take in* (completely), *learn, acquire, hear*. — Esp. of harvests, *gather*. Hence, fig., *reap*: **fructus victoriae**.

percontātiō, -ōnis, [percontā- (*inquire*) + **tio**], F., *inquiry, inquiries* (though sing. in Latin).

percurrō, -currere, -cucurrī, (-currī), -cursus, [1. **per-curro**], 3. v. n. and a., *run along*.

percussus, -a, -um, p. p. of **percutio**.

percutiō, -cutere, -cussī, -cussus, [1. **per-quatio**, *shake*], 3. v. a., *hit, strike, run through*.

perdisco, -discere, -didicī, no p. p., [1. **per-disco**], 3. v. a., *learn thoroughly, get by heart*.

perditus, -a, -um, p. p. of **perdo**.

perdo, **perdere**, **perdidī**, **perditus**, [1. **per-do**], 3. v. a., *destroy* (cf. **interficio**), *ruin*. — **perditus**, -a, -um, p. p. as adj., *ruined, desperate, abandoned*.

perducō, -ducere, -dūxī, -ductus, [1. **per-duco**], 3. v. a., *lead through, lead along, bring over, carry along, make* (**fossam**), *march* (**legionem**). — Fig., *prolong, win over, bring*: **rem ad extremum casum** (*reduce*).

perductus, -a, -um, p. p. of **perduco**.

perendinus, -a, -um, [perendie (†peren-die, cf. **postridie**) + **inus**], adj., (*of the day beyond*, cf. **per**), *of day after to-morrow*: **perendino die**, *day after to-morrow, in two days*.

pereō, -īre, -iī (-īvī), -itūrus, [1. **per-eo**, *go*], irr. v. n., *perish, be killed* (in battle).

perequitō, -āre, -āvī, -ātus, [1. **per-equito**, cf. **eques**], 1. v. a. and n., *ride over* (or *around*).

perexiguus, -a, -um, [2. **per-exiguus**], adj., *very small*.

perfacilis, -e, [2. **per-facilis**], adj., *very easy*.

perfectus, -a, -um, p. p. of **perficio**.

perferō, -ferre, -tulī, -lātus, [1. **per-fero**], irr. v. a., *carry through* (or *over*): **opinionem** (*spread among*); **consilium** (*carry over*); **famam** (*bring*). — Also, *bear through* (to the end), *endure, suffer, submit to*.

perficiō, -ficere, -fēcī, -fectus, [1. **per-facio**, *make*], 3. v. a., *accomplish, complete, finish, make* (complete). — With **ut** (**uti**), *succeed* (in doing or having done), *cause to*.

perfidia, -ae, [perfidō- + **ia**], F., *perfidy, treachery, faithlessness*.

perfringō, -fringere, -frēgī, frāctus, [1. **per-frango**], 3. v. a., *break through*.

perfuga, -ae, [1. **per-†fuga** (**FUG** + **a**, cf. **scriba**)], M., *a refugee, a fugitive, a deserter*.

perfugiō, -fugere, -fūgī, no p. p., [1. **per-fugio**], 3. v. n., *run away, flee* (to a place), *escape to*.

perflugium, -ī, [1. per-†flugium, cf. **perflugio**], N., a place of refuge, refuge.

pergō, *pergere*, *perrēxi*, *perrēctus* (?), [1. per-*rego*, keep straight], 3. v. n., (keep one's direction?), keep on, continue to advance, advance.

periclitōr, -ārī, -ātus, [†*periclitō*- (as if p. p. of *periclor*, cf. *periculum*)], 1. v. dep., try, make a trial, be exposed, be put in peril.

periculōsus, -a, -um, [*periculō*+*osus*], adj., dangerous.

periculum (-clum), -ī, [†*peri-* (cf. *experior*, try) + *culum*], N., a trial, an attempt. Hence, *peril*, *danger*, *risk*.

perītus, -a, -um, [†*peri-* (cf. *experior*, try) + *tus*], p. p. as adj., (tried), experienced, skilled, skilful.

perlātus, -a, -um, p. p. of *perfero*.

perlēctus, -a, -um, p. p. of *perlego*.

perlegō, -legere, -lēgī, -lēctus, [1. per-*lego*], 3. v. a., read through, read (a letter aloud).

perluō, -luere, -luī, -lūtus, [1. per-*luo*], 3. v. a., wash all over. — Pass. (as reflex.), *bathe*.

permāgnus, -a, -um, [2. *permagnus*], adj., very great, very large.

permaneō, -manēre, -mānsī, *mānsūrus*, [1. per-*maneo*], 2. v. n., remain (to the end), continue, hold out, persist: in *eadem libertate* (continue to live, etc.).

permisceō, -miscēre, -miscuī, -mixtus (-mistus) [2. per-*misceo*], 2. v. a., mix (thoroughly), mingle.

permissus, -a, -um, p. p. of **permitto**.

permittō, -mittere, -misi, -missus, [1. per-*mitto*], 3. v. a., (give over), grant, allow, give up, entrust: *fortunas* (trust); *summam imperi* (place in the hands of, etc.); *suffragiis rem* (leave the matter to, etc.).

permixtus, -a, -um, p. p. of **permisceo**.

permōtus, -a, -um, p. p. of **permoveo**.

permoveō, -movēre, -mōvī, -mōtus, [1. per-*moveo*], 2. v. a., move (thoroughly), influence, affect. — **permōtus**, -a, -um, p. p., much affected, much influenced, overcome.

permulceō, -mulcēre, -mulsī, -mulsus, [1. per-*mulceo*], 2. v. a., smooth over. Hence, *soothe*, *pacify*.

perniciēs, -ēī, [?, akin to *nex*, death], F., destruction, ruin.

perpaucus, -a, -um, [2. *perpaucus*], adj. — Plur., very few, but very few, only a very few.

perpendiculum, -ī, [*perpendi-* (st. of *perpendo*, hang down) + *culum*], N., a plumb line: ad *perpendiculum*, *perpendicularly*.

perpetior, -petī, -pessus, [1. *perpatior*], 3. v. dep., suffer, endure.

perpetuus, -a, -um, [1. per-†*petuus* (PET (*aim*) + *vus*)], adj., (keeping on through), continuing, continued, continuous, without interruption, lasting, permanent: *vita* (whole); *paludes* (continuous); in *perpetuum*, forever, permanently. — Abl. as adv., **perpetuō**, forever, constantly, continually.

perquirō, -quirere, -quisivī, -quisitus, [1. per-*quaero*], 3. v. a., search for, inquire about.

perrumpō, -rumpere, -rūpī, -ruptus, [1. per-rumpo], 3. v. a. and n., *break through, force one's way through, break, force a passage.*

perruptus, -a, -um, p. p. of **perrumpo**.

perscribō, -scribere, -scripsī, -scriptus, [1. per-scribo], 3. v. a., *write out* (in full).

persequor, -sequī, -secūtus, [1. persequor], 3. v. dep., *follow up, pursue, attack: mortem, iniurias (avenge).*

perseverō, -āre, -āvī, -ātūrus, [perseverō, very strict], 1. v. n., *persist.*

persolvō, -solvere, -solvī, -solūtus, [2. per-solvo], 3. v. a., *pay* (fully). — Esp. (cf. **pendo**) of penalties, *pay, suffer* (punishment).

perspectus, -a, -um, p. p. of **perspicio**.

perspicio, -spicere, -spexī, -spectus, [1. per-†specio], 3. v. a., *see through, see, inspect, examine.* — Also, *see thoroughly.* — Fig., *see clearly, see, understand, learn, observe, find, discover.*

perstō, -stāre, -stitī, -stātūrus, [1. per-sto], 1. v. n., *stand firm, persist, remain firm, be firm.*

persuadeō, -suādēre, -suāsī, -suāsus, [1. per-suadeo, advise], 2. v. a. and n., *induce, persuade: hoc volunt persuadere (make people believe).* — Pass. (impers.), *be persuaded* (dat. of person), *be satisfied, believe.*

perterreō, -terrēre, -terruī, -territus, [1. per-terreo], 2. v. a., *terrify, alarm: perterritus equitatus (put in a panic); timore perterritus, struck with terror; quos perterritus (panic-stricken, flying in terror).*

pertinācia, -ae, [pertinac- + ia], F., *obstinacy, stubbornness.*

pertineo, -tinēre, -tinuī, no p. p., [1. per-teneo], 2. v. n., (*hold a course towards*), *tend, extend.* — Fig., *have to do with, tend: eodem illo ut, etc. (have the same purpose, look in the same direction); res ad plures pertinet (more are implicated in, etc.).*

pertulī, see **perfero**.

perturbātiō, -ōnis, **perturbā- + tio**], F., *disturbance, alarm, panic, demoralization.*

perturbātus, -a, -um, p. p. of **perturbo**.

perturbō, -āre, -āvī, -ātus, [1. perturbo, disturb], 1. v. a., *disturb, throw into confusion, confuse, throw into disorder, alarm, terrify.*

pervagor, -ārī, -ātus, [1. pervagor], 1. v. dep., *roam about, scatter.*

pervenio, -venire, -vēnī, -ventus, [1. per-venio], 4. v. n., (*come through to*), *arrive at, get as far as, reach, come.* — Fig., *arrive: ad hunc locum (come to this point); pars (of property, come, fall).*

perventus, -a, -um, p. p. of **pervenio**.

pēs, pedis, [PAD, *tread*, as st.], M. *the foot.* — Also, as a measure, *a foot.* — Esp.: **pedem referre**, *draw back, give way; pedibus proeliari* (on foot); **ad pedes desilire** (*to the ground, from on horseback, etc.*); **pedibus aditus**, *approach by land.*

petō, petere, petivī, petitus, [PAT], 3. v. a. and n., (*fall?, fly?*), *aim at, attack, make for, try to get, seek, go to get, go to.* Hence, *ask, request,*

look for, get: **petentibus Haeduis** (at the request of, etc.); **fugam** (take to).

Petrocoriī, -ōrum, [Celtic], M. pl., a tribe on the Garonne (*Perigord*).

Petrōnius, -ī, [?], M., a Roman gentile name. — Esp., *Marcus Petronius*, a centurion in Cæsar's army.

Petrosidius, -ī, [?], M., a Roman gentile name. — Esp., *Lucius Petrosidius*, a standard-bearer in Cæsar's army.

phalanx, -angis, [Gr. φάλαγξ], F., a *phalanx* (properly an arrangement of troops in a solid mass from eight to twenty-four deep, but applied also to other bodies of troops), *an array*.

Pictones (Pect-), -um, [Celtic], M. plur., a Celtic tribe south of the Loire (*Poitou*).

pietās, -tātis, [piō-, *dutiful*, + *tas*], F., *filial affection, affection* (for the gods or one's country, etc.), *patriotism*.

pilum, -ī, [?], N., a *pestle*. — Also, a *javelin* (the peculiar weapon of the Roman legion, with a heavy wooden shaft about 4 ft. long, and an iron head on a long iron shank, making a missile more than 6 ft. long): **pilum murale**, a heavier missile of the same kind for use in siege works.

pīlus, -ī, [pilum], M., a *century* (of soldiers, a name applied to indicate the rank of centurions, see *centurio*). — Also, a *centurion* (of a particular rank). — Phrases: **primi pili centurio** (*of the first century or rank*); **primum pilum duxerat**, *had commanded in the first century of the first cohort, been first centurion*.

pinna, -ae, [= *penna*, *feather*

(*PET (fly) + na*)], F., *an artificial parapet* (of osier or the like run along the top of a wall).

Pīrustae, -ārum, [?], M. plur., a tribe of Illyria.

piscis, -is, [?], M., a *fish*. — Collectively, *fish*.

Pisō, -ōnis, [pisō (*pease*) + *o*], M., (a man with a wart like a pea?, cf. **Cicero**), a Roman family name. — Esp.: 1. *Lucius Calpurnius Piso*, a legatus in the army of Cassius which was defeated by the Helvetii B.C. 107, and grandfather of No. 2. — 2. *Lucius Calpurnius Piso Caesonius*, father of Calpurnia, Cæsar's wife. — 3. *Marcus Pupius Piso Calpurnianus*, consul with M. Messala in B.C. 61. — 4. *Piso*, an Aquitanian (probably enfranchised by one of the above named).

pix, picis, [?], F., *pitch*.

placeō, -ēre, -uī, -itus, [†*placō*- (cf. *placo*, and *placidus*)], 2. v. n., *please*. — Esp. in third person, *it pleases* (one), *one likes*, *one determines*, *one decides*.

placidē [old case-form of **placidus**, *quiet*], adv., *quietly, calmly*.

plācō, -āre, -āvī, -ātus, [st. akin to **placeo**], 1. v. a., *pacify, appease*.

Plancus, -ī, [perh. akin to **planus**], M. (*Flat-foot*), a Roman family name. — See **Munatius**.

plānē [old case-form of **planus**], adv., *flatly, clearly, entirely*.

plānitiēs, -ēī, [planō- + *ties*, cf. -*tia*], F., a *plain*.

plānus, -a, -um, [unc. root + *nus*], adj., *flat, level, even*: *carinae planiores* (*less deep, less rounding*).

plēbs (**plēbēs**), -is (-ēī), [PLE (in **plenus**) + unc. term. (cf. **turba**)], F., *the populace, the multitude, the common people.*

plēnē [old case-form of **plenus**], adv., *fully, entirely, completely.*

plēnus, -a, -um, [PLE (in **pleo, fill**) + **nus**], adj., *full*: luna; legio.

plērumque, see **plerusque**.

plērusque, -aque, -umque, [PLE (in **pleo, fill**) + **rus-que** (cf. **-pletus, plenus**)], adj. only in plur., *most of, very many.* — Acc. sing. as adv., **plērumque**, *generally, usually, for the most part, very often.*

Pleumoxiī, -ōrum, [Celtic], M. plur., a people of Belgic Gaul, clients of the Nervii.

plumbum, -ī, [?], N., *lead.* — **plumbum album**, *tin.*

plūrimus, see **multus**.

plūs, [akin to **pleo, fill**], see **multus**.

pluteus, -ī, [?], M., *a mantelet, a cover* (movable, for defence). — Also, *a bulwark, a defence, a breastwork.*

pōculum, -ī, [root (or st.) PO- (in **potus, drink**) + **culum**], N., *a drinking-cup.*

poena, -ae, [perh. † **povi-** (PU) + **na** (cf. **punio, punish**)], F., *a penalty.* Hence, *a punishment* (see **persolvo, repeto**).

pollex, -icis, [?], M., *the thumb* (with or without **digitus**).

polliceor, -licēī, -licitus, [† **por-** for **pro** (cf. **portendo**) -liceor, *bid*], 2. v. dep., *offer, promise* (voluntarily): *liberaliter* (*made liberal offers*).

pollicitātiō, -ōnis, [pollicitā- + **tio**], F., *an offer, a promise.*

pollicitus, -a, -um, p. p. of **polliceor**.

Pompēius, -ī, [† **pompe-** (dialectic form of **quinque**) + **ius**], M., a Roman gentile or family name. — Esp.: 1. *Gnaeus Pompeius Magnus*, the great rival of Cæsar, consul with Marcus Crassus in B.C. 58. — 2. *Gnaeus Pompeius*, an interpreter of Quintus Titurius, probably a Gaul enfranchised by one of the Pompeys.

pondus, -eris, [PEND (in **pendo, weigh**) + **us**], N., *weight.*

pōnō, pōnere, posuī, positus, [prob. † **por-sino** (cf. **polliceor**)], 3. v. a., *lay down, place, put*: **posita tollere** (*things laid up, consecrated*); **ponere custodes** (*set*); **castra** (*pitch*); **praesidium** (*station*, but see below). — Fig., *place, lay, make, depend on*: in fuga **praesidium**; **spem salutis in virtute** (*find, found, seek*). — **positus**, -a, -um, p. p., *situated, lying, depending on*: **posita est, lies**; **positum est** in, etc., *depends on, etc.*

pōns, pontis, [?], M., *a bridge.*

populātiō, -ōnis, [populā- + **tio**], F., *a plundering, a raid.*

populor, -ārī, -ātus, [populō-], 1. v. dep., (*strip, of people?*, cf. Eng., *skin, shell, bark a tree*), *ravage, devastate.*

populus, -ī, [PAL? (in **pleo, fill**), reduplicated + **us**], M., (*the full number, the mass, a people* (in its collective capacity), *a nation, a tribe* (as opposed to individuals): **populus Romanus** (the official designation of the Roman state).

por-, **port-**, [akin to **pro**], obs. prep., only in comp., *forth.*

porrēctus, -a, -um, p. p. of por-rigo.

porrigō, -rigere, -rēxi, rēctus, [†por- (cf. polliceor), -rego], 3. v. a., stretch forth: porrecta loca pertinent (stretch out in extent).

porrō [?, akin to †por (cf. por-rigo)], adv., furthermore, further, then (in narration).

porta, -ae, [POR (go through) + ta], F., (way of traffic?), a gate.

portō, -āre, -āvī, -ātus, [porta-?], 1. v. a., carry (perh. orig. by way of traffic), bring, convey.

portōrium, -ī, [?, porta (reduced) + orium (N. of -orius), perh. orig. †portor + ius], N., (gate-money? or carrier's money?), a duty (an impost), a toll.

portus, -tūs, [POR (cf. porta) + tus], M., (a place of access), a harbor, a haven, a port.

poscō, poscere, poposcī, no p. p., [perh. akin to prex, prayer], 3. v. a., demand (with some idea of claim, stronger than peto, weaker than flagito), require, claim.

positus, -a, -um, p. p. of pono.

possessiō, -ōnis, [†por-†sessio (cf. obsessio)], F., possession, occupatio. — Concretely (as in Eng.), possessions, lands (possessed).

possideō, -sidēre, -sēdī, -sessus, [†por-sedeo], 2. v. a., (settle farther on?), occupy (in a military sense), possess (lands, of a people), hold possession of.

possum, posse, potuī, [pote- (for potis) -sum], irr. v. n., be able, can, etc.: plurimum posse, be most powerful, have very great influence; tan-

tum potest, has so much weight, power, influence; largiter posse, have great influence; multitudo posse, be strong in numbers; equitatu nihil posse, have no strength in cavalry; quicquid possunt, whatever power they have; quid virtute possent, what they could do by valor; fieri posse, be possible; ut spatium intercedere posset (might intervene); quam maximum potest, the greatest possible.

post [?, prob. abl. of st. akin to postis (cf. ante, antes, rows, and antae, pilasters)], adv. and prep. with acc., behind, after: post diem tertium, three days after; post se, in their rear; post hunc, next to him.

postea [post ea], adv., afterwards.

posteaquam [postea quam], conjunctive adv., (later than), after (only with clause).

posterus, -a, -um, [post- (or st. akin) + terus (orig. compar.)], adj., the next, later: postero die, the next day; in posterum, the next day. Plur. as noun, posterity. — postrēmus, -a, -um, superl., last. — postrēmō, abl., lastly, finally.

postpōnō, -pōnere, -posuī, -positus, [post-pono], 3. v. a., place behind, postpone: omnibus rebus postpositis, disregarding everything else.

postpositus, -a, -um, p. p. of post-pono.

postquam, [post quam], conjunctive adv., (later than), after.

postrēmō, see posterus.

postrēmus, see posterus.

postridiē [†posteri- (loc. of pos-

terus) -die], adv., *the next day*: *postridie eius diei, the next day after that*.

postulātum, -ī, [N. p. p. of *postulo*], N., *a demand, a requirement, a request, a claim*.

postulō, -āre, -āvī, -ātus, [?], I. v. a., *claim* (with idea of right, less urgent than *posco*), *ask, request, require*: *tempus anni (require, make necessary)*.

potēns, -entis, [p. of *possum* as adj.], adj., *powerful*: *homo (influential)*; *potentiores, men of influence*.

potentātus, -tūs, [potent- + atus, cf. *consulatus*], M., *the chief power, supremacy*.

potentia, -ae, [potent- + ia], F., *power* (political influence), *authority* (not official or legal).

potestās, -tātis, [potent- + tas], F., *power* (official, cf. *potentia*, and civil, not military, cf. *imperium*), *power* (generally), *control, ability, opportunity, chance*: *sui potestatem facere, give a chance at them, give an opportunity to fight them*; *se potestati alicuius permittere (surrender, etc.)*; *consistendi potestas erat nulli (chance, possibility)*; *discedendi potestatem facere (give permission, etc.)*; *facta potestate, having obtained permission*; *imperium aut potestas, military or civil power*; *deorum vis ac potestas, the power and dominion of the gods*.

potior, potiri, potitus, [poti-, cf. *potis, able*], 4 v. dep., *become master of, possess one's self of, get the control of*: *imperio (secure)*; *castris (capture)*.

potior, -us, -ōris, (compar. of *potis*), adj., *preferable*. — *potius*, acc as adv., *rather, preferably*.

potitus, -a, -um, p. p. of *potior*.

prae [unc. case-form of same st as *pro*], adv. (in comp.) and prep. with abl., *before, in comparison with*. — Esp. with words implying hindrance, *for, on account of* (some obstacle). — In comp., *before others, very, before, at the head of*.

praeacūtus, -a, -um, [prae-acutus (p. p. of *acuō*)], p. p. as adj., *sharpened to a point, pointed*.

praebeō, praebēre, praebuī, praebitus, [prae-habeo], 2 v. a., (*hold before one*), *offer, present, furnish*: *munitimenta (furnish, and so afford, make)*.

praecaveō, -cavēre, -cāvī, -cautus, [prae-caveo], 2. v. n., *take care beforehand, take precaution, be on one's guard*.

praecēdō, -cēdere, -cessī, -cessus, [prae-cedo], 3. v. a., *go before*. — Fig., *excel, surpass*.

praiceps, -cipitis, [prae-caput], adj., *headlong, in haste*: *locus praiceps, a steep incline*.

praecceptum, -ī, [p. p. of *praecipio*], N., *an instruction, an order*.

praecceptus, -a, -um, p. p. of *praecipio*.

praecipio, -cipere, -cēpī, -ceptus, [prae-capio], 3. v. a., *take beforehand, anticipate*. — Also, *order, give instructions*.

praecipitō, -āre, -āvī, -ātus, [prae-cipit-], I. v. a., *throw headlong*: *se (plunge headlong)*.

praecipuē [old case-form of *praecipuus*], adv., *especially*.

praecipuus, -a, -um, [prae-†cap-
aus (CAP + vus)], adj., (*taking the
first place*), *special*.

praecūdō, -clūdere, -clūsī, -clūsus,
[prae-claudō], 3. v. a., (*close in front
of some one or something*), *shut off,
barricade*.

praecō, -ōnis, [?], M., *a herald*.

Praecōninus, -ī, [praecon- + inus],
M., a Roman family name. — See
Valerius.

praecurrō, -currere, -cucurrī (-cur-
rī), -cursūrus, [prae-curro], 3. v. n.,
*run on before, hasten on before, has-
ten in advance, hurry on before:*
*equites (ride on in advance); celerita-
tate (get the start of, etc.)*.

praeda, -ae, [prob. prae-†hida
(root of -hendo, *seize*, + a)], F.,
booty, prey, plunder.

praedicō, -āre, -āvī, -ātus, [†prae-
dicō- (or similar st. from prae with
DIC)], 1. v. a. and n., *make known*
(before one), *proclaim, assert, de-
scribe, boast, vaunt one's self*.

praedor, -ārī, -ātus, [praeda], 1. v.
dep., *plunder, take booty*.

praedūcō, -dūcere, -dūxī, -ductus,
[prae-ducō], 3. v. a., *lead (etc.), be-
fore: murum (carry out, draw
round)*.

praefectus, -a, -um, p. p. of prae-
ficio. — As noun, see **praeficio**.

praefērō, -ferre, -tulī, -lātus, [prae-
ferō], irr. v. a., *place before, esteem
above, prefer to (with quam): se
alicui (show one's self better than)*.

praeficiō, -ficere, -fēcī, -fectus,
[prae-facio], 3. v. a., *put before,
place in command of, set over*. —
praefectus, p. p. as noun, *a cap-*

*tain (esp. of cavalry), a commander,
an officer*.

praefigō, -figere, -fixī, -fixus,
[prae-figo], 3. v. a., *fix in front, set
on the edge (of something)*.

praefixus, -a, -um, p. p. of prae-
figo.

praemetuō, -metuere, no perf., no
p. p., [prae-metuo], 3. v. a. and n.,
fear beforehand, be anxious.

praemittō, -mittere, -mīsī, -mis-
sus, [prae-mitto], 3. v. a., *send for-
ward, send on, send ahead*.

praemium, -ī, [prae-†emium (EM,
in emo, buy, + ium)], (taken before
the general distribution or disposal
of booty?), N., *a reward, a prize,
distinction (as a reward or prize):
magno praemio remunerari (a great
price)*.

praeeoccupō, -āre, -āvī, -ātus,
[prae-occupō], 1. v. a., *take in oppo-
sition or beforehand: timor animos*
(take complete possession of, to the
exclusion of everything else); *vias*
(close against one), *preoccupy*.

praeeoptō, -āre, -āvī, -ātus, [prae-
optō], 1. v. a., *wish in preference,
choose rather, prefer*.

praeparō, -āre, -āvī, -ātus, [prae-
paro], 1. v. a., *prepare beforehand*.

praepōnō, -pōnere, -posuī, -posi-
tus, [prae-pono], 3. v. a., *put in com-
mand, set over*.

praerumpō, -rumpere, -rūpī, -rup-
tus, [prae-rumpo], 3. v. a., *break off*
(at the end or in front). — **praerup-
tus**, -a, -um, p. p. as adj., *precipitous*.

praeruptus, -a, -um, p. p. of prae-
rumpo.

praesaepiō (-sēp), -saepire, -saepsī,

saepus, [prae-saepio], 4. v. a., *hedge in, wall off.*

praesaepus, -a, -um, p. p. of praesaepio.

praescribō, -scribere, -scripsī, -scriptus, [prae-scribo], 3. v. a., (*write down beforehand*), *prescribe, order, direct, give directions.*

praescriptum, -ī, [N. p. p. of praescribo], N., *an order, orders.*

praescriptus, -a, -um, p. p. of praescribo.

praesēns, -entis, p. of praesum.

praesentia, -ae, [praesent- + ia], F., *presence, the present moment: in praesentia, for the moment, at the moment.*

praesentiō, -sentīre, -sēnsī, -sēnsus, [prae-sentio], 4. v. a., *see beforehand, find out in time, find out (beforehand).*

praesertim [as if acc. of †praesertis (SER, in sero (*join*) + tis)], adv., *especially, particularly.*

praesidium, -ī, [prae-†sidium (SED + ium), cf. obsidium], N., (*a sitting down before*), *a guard, a garrison, a force (detached for occupation or guard): intra praesidia, within the lines.—Fig., protection, assistance, support: praesidio litterarum (with the assistance of, etc.); in fuga praesidium ponere, seek safety in flight.*

praestō [?, perh. “praesto,” *I am here* (as if quoted)], adv., *on hand, ready, waiting for, in attendance upon: praesto esse, be waiting for, meet.*

praestō, -stāre, -stitī, -stātus (-stitus), [prae-sto], 1. v. a. and n.,

stand before, be at the head, excel, be superior: praestat, it is better.—Also, causatively (bring before), furnish, display: officium (discharge, perform); stabilitatem (afford, possess); fidem (keep, perform one's duty).

praesum, -esse, -fuī, [prae-sum], irr. v. n., *be in front, be at the head of, be in command: magistratui (hold).—praesēns, -entis, p., present, immediate: pluribus praesentibus, in the presence of many; praesens adesse, be present in person.*

praeter [compar. of prae (cf. inter)], adv. and prep. with acc., *along by, past, beyond.—Fig., except, beside, contrary to.*

praetereā [praeter-ea (abl.)?], adv., *furthermore, besides: si nemo praeterea, if no one else.*

praetereō, -īre, -īi, -itus, [praeter-eo], irr. v. a. and n., *go by, pass by, pass over.—praeteritus, -a, -um, p. p. as adj., past.—Esp. N. plur., praeterita, the past (cf. “bygones”).*

praeteritus, -a, -um, p. p. of praetereō.

praetermittō, -mittere, -mīsi, -missus, [praeter-mitto], 3. v. a., *let go by, let slip, omit, neglect.*

praeterquam [praeter-quam], conjunctive adv., *except, besides.*

praetor, -tōris, [prae-†itor, (1, go + tor)], M., (*a leader*), *a commander.—Esp., a praetor, one of a class of magistrates at Rome. In early times two had judicial powers and the others regular commands abroad. Later all during their year of office had judicial powers, but like the*

consuls (who were originally called praetors) they had a year abroad as proprætors: *legatus pro praetore* (*lieutenant in command*, acting as a praetor).

praetōrius, -a, -um, [praetor- + ius], adj., of a praetor (in all its senses); *praetoria cohors*, the body guard, of a commander (see praetor).

praetūrō, -ūrere, -ūssī, -ūstus, [prae-uro], 3. v. a., burn at the end (in front); *praestae sudes* (burnt at the point, to harden them).

praestūsus, -a, -um, p. p. of praeturo.

praevērtō, -vertere, -vertī, -versus, [prae-vertō, turn], 3. v. a., anticipate, forestall, attend to first.

prāvus, -a, -um, [?], adj., crooked. — Fig., wrong, vicious.

premdō, premere, pressī, pressus, [?], 3. v. a., press. — Esp., press hard, attack fiercely, harass, oppress: *se ipsi*, crowd, impede, embarrass each other.

prendō (prehendo), prendere, prendī, prēnsus, [prae-† hendo], 3. v. a., seize (against some one else?), seize (generally), take, grasp.

pretium, -ī, [?], N., a price, cost, value.

† **prex**, precis (dat., acc., and abl. only; plur. entire), [?], F., a prayer, an entreaty, an imprecation.

prīdiē [loc. of st. of pro (prae?) -die, cf. postridie], adv., the day before.

prīmipīlus [primō-pīlus], M., the first centurion. See centurio and pilus.

prīmō [abl. of primus], adv., at first (opposed to afterwards, cf. primum).

prīmum [acc. of primus], adv., first (in order of incidents, opposed to next, etc.), in the first place: *cum primum*, as soon as; *quam primum*, as soon as possible.

prīmus, -a, -um, see prior.

prīnceps, -ipis, [primō- (reduced) -† cept (CAP as st.)], adj., (taking the lead), first, chief, foremost: *principes belli inferendi* (leaders in, etc.); *locus* (chief, highest); *ea princeps persolvit* (was the first to). — Often as noun, leading man, leader, chief man, chief: *legationis* (head).

prīncipātus, -tūs, [princip- + atus, cf. consulatus], M., foremost position, first place, highest place, the lead (in power and influence among states), leadership.

prior, -us, -ōris, [compar. of st. of pro], adj., former, before: *priores*, those in front; *non priores inferre* (not the first to, etc.). — **prius**, N. as adv., before (see also priusquam). — **prīmus**, -a, -um, superl., first: *agmen* (front); *primos civitatis* (the best men); *a prima obsidione*, from the beginning of the siege: *in primis*, especially. — See primo and primum.

prīstinus, -a, -um, [prius-tinus, cf. diutinus], adj., (of former times), old, former: *pristinus dies*, the day before.

prius, see prior.

priusquam [prius-quam], conj. adv., earlier than, before. Often separated.

privātīm [as if acc. of † priva-

tis (privā- + tis)], adv., *privately*, as *private persons* (opp. to *magistratus*): *de suis privatim rebus* (*their own private affairs*); plus *posse privatim* (*in their own name*, opposed to official action).

privātus, -a, -um, [p. p. of *privo*, *deprive*], adj., (destitute of official character), *private*, *personal*.

prō [for *prod*, abl. of st. akin to *prae*, *prior*, etc.], adv. (in comp.) and prep. with abl., *in front of*, *before*. Hence, *in place of*, *instead of*, *for*, *as*, *on behalf of*: *nihil pro sano*, *nothing prudent*; *pro explorato*, *ascertained, as certain*. — Also, *in view of*, *in accordance with*, *in proportion to*, *according to*, *considering*, *in return for*, *for*. — In comp., *before*, *forth*, *away*, *for*, *down* (as falling forward).

probātus, -a, -um, p. p. of *probo*.

probō, -āre, -āvī, -ātus, [*probō-*], I. v. a., (*make good*, *find good*), *approve*, *test*, *prove*, *show*, *be satisfied with*, *favor* (a plan), *adopt* (a measure).

prōcēdō, -cēdere, -cessī, -cessus, [*pro-cedo*], 3. v. n., *go forward*, *advance*, *proceed*: *longius* (*go to a distance*).

Proculus, -ī, [*Proculō-* + *lus*], M., a Roman family name. — See *Valerius*.

prōclīnātus, -a, -um, p. p. of *proclino*.

prōclīnō, -āre, -āvī, -ātus, [*pro-clino*], I. v. a., (*bend forward*), *throw down*: *res proclinata* (*falling, ruined*).

prōcōnsul, -ulis, [*pro-consul*, on account of the phrase *pro consule*],

M., a *proconsul*, an *ex-consul* (during his term of service abroad).

procul [?, †*procō-*, “off” (pro + *cus*) + *lus* (reduced, cf. *simul*)], adv., *at a distance* (not necessarily great), *at some distance*, *afar*, *from afar*.

prōcumbō, -cumbere, -cubui, no p. p., [*pro-cumbo*, *lie*], 3. v. n., *fall* (forward), *fall* (generally), *sink down*, *lie down* (for rest), *become lodged* (of grain). — Less exactly, *incline*, *slope*, *lean*.

prōcūrō, -āre, -āvī, -ātus, [*pro-curo*], I. v. a., *care for*, *have charge of*, *attend to*.

prōcurrō, -currere, -curri, (-*curri*), -*cursurus*, [*pro-curro*], 3. v. n., *run forward*, *charge*, *rush out*.

prōdeō, -īre, -īvī (-*ii*), -itus, [*prod* (see *pro*) -*eo*], irr. v. n., *go forth*, *come forth*, *come out*, *go forward*: *longius* (*go to any distance*).

prōdesse, see *prōsum*.

prōditiō, -ōnis, [*pro-†ditio*, cf. *prodo*], F., (*a giving away*), *treason*, *treachery*.

prōdītor, -tōris, [*pro-dator* (cf. *prodo*)], M., a *traitor*, a *betray*.

prōditus, -a, -um, p. p. of *prodo*.

prōdō, -dere, -didī, -ditus, [*pro-do*], 3. v. a., (*give forward*), *give forth*, *publish*, *betray* (*give away*), *transmit*, *hand down*: *memoriam* (*preserve*, by handing down to posterity); *memoria proditum*, *told in tradition*, *handed down*.

prōdūcō, -dūcere, -dūxī, -ductus, [*pro-duco*], 3. v. a., *lead forth*, *lead out*, *bring out* (*iumenta*), *draw up* (troops). — Fig., *protract*, *prolong*.

prōductus, -a, -um, p. p. of pro-
duco.

proelior, -ārī, -ātus, [proeliō-],
i. v. dep., *fight* (in war).

proelium, -ī, [?], N., a battle (a
single encounter, great or small), a
*contest, an engagement, a general
engagement, a skirmish*: commi-
tere (*engage, join battle, risk a bat-
tle, begin an engagement, begin the
fight, fight*).

profectiō, -ōnis, [pro-factio (cf.
proficiscor)], F., a *setting out, a de-
parture, retreat* (the special idea
coming from the context), *starting,
evacuation*.

prōfectus, -a, -um, p. p. of pro-
ficio.

prōfectus, -a, -um, p. p. of pro-
ficiscor.

prōferō, -ferre, -tulī, -lātus, [pro-
fero], irr. v. a., *bring forth, bring
out*.

prōficiō, -ficere, -fēcī, -fectūrus,
[pro-facio], 3. v. n., (*make way for-
ward*), *advance* (cf. proficiscor).
— Fig., *gain advantage* ("get on"),
gain (much or little), *accomplish*
(something): *satis ad laudem pro-
fectum est, enough has been done
for glory; ad pacem parum pro-
fici, not much was doing towards
peace; plus multitudine telorum pro-
ficere (have the advantage in)*.

proficīscor, -ficiscī, -fectus, [pro-
†faciscor (cf. proficio)], 3. v. dep.,
(*make way forward*).— Esp., *start,
leave, depart, set out, withdraw,
march out, go out, come out, sail out*:
*quo proficiscimur, whither we are
going; unde erant profecti, whence*

*they had come; ad proficiscendum
pertinere (to a journey, etc.)*.

profiteor, -fītērī, -fessus, [pro-
fateor, confess], 2. v. dep., *declare
publicly: se (offer one's self, volun-
teer as, declare one's self)*.

prōflīgātus, -a, -um, p. p. of pro-
fligo.

prōflīgō, -āre, -āvī, -ātus, [†pro-
fligō- (pro-†fligus, FLIG + us)], i. v.
a., (*dash to the ground*).— Esp.,
put to rout, rout.

prōfluō, -fluere, -flūxī, no. p. p.,
[pro-fluo], 3. v. n., *flow forth, rise*.

profugiō, -fugere, -fūgī, -fugitūrus,
[pro-fugio], 3. v. n., *flee forth, flee,
escape, make one's escape*.

prōgnātus, -a, -um, [pro-(g)natus],
p. p. as adj., *sprung from: prognati
ex, descendants of*.

prōgredior, -gredī, -gressus, [pro-
gradior, step, go], 3. v. dep., *go for-
ward, march forward, march out,
come out*.— Also, fig., *proceed, go*:
amentia longius (go).

prōgressus, -a, -um, p. p. of pro-
gredior.

prohibeō, -hibēre, -hibuī, -hibitus,
[pro-habeo], 2. v. a., *hold off, keep
off, repel, stop, prevent, restrain,
hinder from, forbid*.— Also (by a
change of relation of the two things
concerned), *protect: aliquem ab omni
militum iniuria* (keeping one pro-
tected from the assailant).

prohibitus, -a, -um, p. p. of pro-
hibeo.

prōiciō, -icere, -iēcī, -iectus, [pro-
iacio], 3. v. a., *throw forward, throw
away, cast* (down, cf. pro), *abandon*:
aquilam intra vallum (throw over);

proiectae, *casting themselves*; **se ex navi** (*leap*).

proinde [pro-inde], adv., (*from there forward*), *therefore, hence*.

prōminēns, -entis, p. of **promineo**.

prōmineō, -minēre, -minuī, no p. p., [pro-†mineo (cf. *minor, project*)], 2. v. n., *lean forward, lean over*.

prōmiscuē [old case-form of **promiscuus**], adv., *in common*.

prōmissus, -a, -um, p. p. of **promitto**.

prōmittō, -mittere, -mīsī, -missus, [pro-mitto], 3. v. a., (*let go forward*), *let grow* (of the hair): **promisso capillo sunt**, *they wear long hair*.

prōmōtus, -a, -um, p. p. of **promoveo**.

prōmoveō, -movēre, -mōvī, -mōtus, [pro-moveo], 2. v. a., *move forward, advance, push forward*.

prōmptus, -a, -um, [p. p. of **promō**, *bring forth*], as adj., (taken out of the store *ready* for distribution), *ready, quick, active*.

prōmunturium, (-mon-), -ī, [akin to **promineo**], N., *a headland*.

prōnē [old case-form of **pronus**, *leaning*], adv., *with a slope*.

prōnūntiō, -āre, -āvī, -ātus, [pronuntio], 1. v. a., (*publish forth*), *make known, communicate, declare, give orders, make proclamation*.

prope [?, akin to **pro**, cf. **procul** and **proximus**], adv. and prep. with acc., *near*. — Fig., *almost, nearly*. — Compar., **propius**, *nearer*: **propius tumultum** (as prep.). — Superl., **proximē**, *lately, last*.

prōpellō, -pellere, -puli, -pulsus, [pro-pello], 3. v. a., *drive away* (cf. **pro**), *repulse, rout, dislodge, force back* (changing the point of view).

properō, -āre, -āvī, -ātus, [properō-, *quick*], 1. v. a. and n., *hasten, be in haste, make haste*.

propinquitās, -tātis, [propinquō- + tas], F., *vicinity, a being near, a position near*: **propinquitates fluminum** (*positions near, etc.*). — Esp., *nearness in blood, relationship, a relation* (by blood).

propinquus, -a, -um, [st. akin to **prope** (or case-form) + **cus**], adj., *near at hand, near*. — Esp. by blood, *related*. — As noun in plur., *relatives*.

propior, -us, -ōris, [compar. of st. of **prope**], adj., *nearer*. — **proximus**, superl. (of st. †**procō**, cf. **procul**), *nearest, next, neighboring*: **bellum (last)**. — With force of prep. (cf. **prope**): **proximi Rhenum**, *nearest the Rhine*.

prōpōnō, -pōnere, -posuī, -positus, [pro-pono], 3. v. a., *place before, set before, lay before*: **vexillum (hang out)**. — Less exactly, *offer, put in the way, present* (difficulty), *make known, state, represent*.

prōpositus, -a, -um, p. p. of **pono**.

proprius, -a, -um, [?, akin to **prope**?], adj., *of one's own*: **fines (particular)**; **hoc proprium virtutis** (*a peculiar property, a mark*).

propter [prope + ter, cf. **aliter, praeter**], adv. and prep. with acc., *near by*. — Also, *on account of* (cf. "all along of").

proptereā [propter-ea (prob. abl. or instr. of is)], adv., *on this account*. — With **quod**, *because, inasmuch as*.

prōpūgnātor, -tōris, [pro-pugnator (cf. propugno)], M., *a defender*.

prōpūgnō, -āre, -āvī, -ātūrus, [propugno], I. v. n., (*rush forward to fight, or fight in front*), *rush out* (fighting), *discharge missiles* (ex silvis).

prōpulsō, -āre, -āvī, -ātus, [propulso (cf. propello)], I. v. a., *repel, keep off, drive off, defend one's self against*.

prōra, -ae, [Gr.], F., *the prow* (of a ship).

prōruō, -ruere, -ruī, -rutus, [proruo], 3. v. a., *dash down, overthrow, demolish*.

prōrutus, -a, -um, p. p. of proruo.

prōsecūtus, -a, -um, p. p. of prosequor.

prōsequor, -sequī, -secūtus, [prosequor], 3. v. dep., *pursue, follow* (on one's way), *escort*. — Fig. (from escorting), *address, take leave of one* (with some kind of attention).

prōspectus, -tūs, [pro-spectus (cf. prospicio)], M., *outlook, view*: in prospectu, *in sight*; prospectu tenebris adempte, *the view cut off by the darkness*.

prōspiciō, -spicere, -spēxī, -spectus, [pro-†specio], 3. v. a., *look forward, look out*. — Fig., *provide for, take care, look out*.

prōsternō, -sternere, -strāvī, -strātus, [pro-sterno], 3. v. a., *dash to the ground, overthrow* (lit. and fig.).

prōsum, prōdesse, prōfuī, prōfūtūrus, [pro(d)-sum], irr. v. n., *be for the advantage of, benefit*: quod alicui prodest, *by which one profits*.

prōtegō, -tegere, -tēxī, -tēctus, [pro-tego], 3. v. a., (*cover in front*), *protect, cover*.

prōterreō, -terrēre, -terruī, -territus, [pro-terreo], 2. v. a., *frighten away, drive away in fright*.

prōterritus, -a, -ūm, p. p. of proterreo.

prōtinus (-tensus), [pro-tenus, *as far as*], adv., *forward, straight on*. Hence, *straightway, forthwith, at once, instantly* (keeping right on).

prōturbātus, -a, -um, p. p. of proturbo.

prōturbō, -āre, -āvī, -ātus, [proturbo, disturb], I. v. a., *drive in confusion, drive off, dislodge*.

prōvectus, -a, -um, p. p. of proveho.

prōvehō, -vehere, -vēxī, -vectus, [pro-veho], 3. v. a., *carry forward*. — In pass., *be carried forth, sail out, set sail*: leni Africo proventus (*sail with, be driven by*).

prōveniō, -venire, -vēnī, -ventūrus, [pro-venire], 4. v. n., *come forward*. — Esp. of fruits, *come up, grow*.

prōventus, -tūs, [pro-†ventus, cf. eventus and provenio], M., *an issue* (a coming forth), *success, a result*.

prōvideō, -vidēre, -vidī, -vīsus, [pro-vidéo], 2. v. a., *foresee, see beforehand, take care, make provision, provide, arrange beforehand*: satis est provisum, *sufficient provision has been made*.

prōvincia, -ae, [†provincō- (vinc-

as root of **vinco** (*conquer*) + **us** + **ia**], F., (office of one extending the frontier by conquest in the field), *office* (of a commander or governor), *a province* (in general), *a function*. — Transf., *a province* (governed by a Roman magistrate). — Esp., *The Province* (of Gaul); so with **nostrā**, **ulterior**, **citerior** (the province, as opposed to the unconquered parts of Gaul).

prōvinciālis, -e, [provincia- + **lis**], adj., *of a province*. — Esp., *of the province* (of Gaul).

provīsus, -a, -um, p. p. of **pro-
video**.

prōvolō, -āre, -āvī, -ātūrus, [pro-
volo], I. v. n., *fly forth*. — Less exactly, *rush forth, rush out, fly out* (of cavalry, etc.).

proximē, see **prope**.

proximus, see **propior**.

prūdētia, -ae, [prudent-, *foreseeing*, + **ia**], F., *foresight, discretion*.

Ptiāniī, -ōrum, [Celtic], M. plur., *a people of Aquitania*.

pūbēs (**pūber**), -eris, [?, prob. same root as **puer**], adj., *adult*. — Plur. as noun, *adults, grown men, young men of age*.

pūblicē [old case-form of **publicus**], adv., *publicly, in the name of the state, as a state, on behalf of the state*: **publice iurare** (*for the people, making the oath bind them*).

pūblicō, -āre, -āvī, -ātus, [publicō-], I. v. a., (*make belong to the people*), *confiscate*.

pūblicus, -a, -um, [populō- + **cus**], adj., *of the people* (as a state), *of the state, public*: **consilium** (*a*

state measure, a public measure, action by the state, action by general consent); **res publica**, *the commonwealth, the state, the interests of state, public business*; **relatis in publicum cornibus** (*publicly displayed*); **mulieres in publicum procurrere** (*abroad into the streets*).

Pūblius, -ī, [prob. populō- + **ius**, cf. **publicus**], M., a Roman prænomen.

puDET, **puDēre**, **puDUit** (**puDitum** est), [?], 2. v. impers., (*it shames*), *one is ashamed* (translating the accusative as subject).

puDor, -ōris, [PUD (in **puDET**) + **or**], M., *shame, a sense of shame, a sense of honor*.

puer, -ī, [?], M., *a boy*. — Plur., *children* (of either sex); *a pueris*, *from childhood*.

puerīlis, -e, [puerō- (reduced) + **ilis**], adj., *of a child*: **aetas** (*of childhood*).

pūgna, -ae, [PUG (in **pugno**) + **na**], F., *a fight* (less formal than **proelium**): **ad pugnam**, *for fighting*; **genus pugnae** (*of fighting*).

pūgnō, -āre, -āvī, -ātus, [pugna-], I. v. n., *fight, engage*. — Often impers. in pass., **pugnatum est**, etc., *an engagement took place, they fought, the fighting continued*. — Esp.: **pugnandi potestatem fecit**, *offered battle*; **pugnantes**, *those engaged*.

pulcher, -chra, -chrum, [?], adj., *beautiful, handsome, fine*. — Fig., *fine, noble, splendid*.

Pullō, -ōnis, [?], M., a Roman family name. — Esp., **Titus Pullo**, a centurion in Cæsar's army.

pulsus, -a, -um, p. p. of pello.

pulsus, -ūs, [PEL (in pello) + tus], M., a stroke, a beat: pulsus remorum praestare (the working, etc.).

pulvis, -eris, [?], M., dust.

puppis, -is, [?], F., the stern.

pūrgātus, -a, -um, p. p. of purgo.

pūrgō, -āre, -āvī, -ātus, [†purigō- (purō- + †agus, cf. ago)], I. v. a.,

clean, clear. — Fig., excuse, exonerate, free from suspicion, exculpate.

putō, -āre, -āvī, -ātus, [putō- (st. of putus, clean)], I. v. a., clean up, clear up. — Esp.: rationes (clear up accounts). Hence alone, reckon, think, suppose.

Pyrēnaeus, -a, -um, [?], adj., only with montes, the Pyrenees mountains, between France and Spain.

Q

Q., for Quintus.

quā [abl. or instr. (?) of qui], rel. adv., by which (way), where.

quadrāgēnī, -ae, -a, [quadraginta (reduced) + nus], distrib. num. adj., forty each, forty (each often omitted in Eng.).

quadrāgintā [akin to quattuor], indecl. num. adj., forty.

quadringenti, -ae, -a, [akin to quattuor], num. adj., four hundred.

quaerō, quaerere, quaesivī, quaesītus, [?, with r for original s], 3. v. a., search for, look for, inquire about, inquire, ask: eadem (make the same inquiries).

quaestiō, -ōnis, [quaes (as root of quaero) + tio], F., an investigation: habere de aliquo (examine, as witnesses, usually by torture).

quaestor, -tōris, [quaes (as root of quaero) + tor], M., (investigator, or acquirer, perh. both). — Esp., a quaestor (the Roman officer who had charge of the finances of an army).

quaestus, -tūs, [quaes (as root of quaero) + tus], M., acquisition.

quālis, -e, [quō- (st. of quis) +

alis], inter. adj., of what sort? qualis ascensus (what is the nature of? etc.).

quam [case-form of quis and qui, cf. tam, nam], adv. and conj.: 1. Interrog., how? — 2. Rel., as, than: praefere quam (rather than). — Often with superlatives, as much as possible: quam maximus, the greatest possible; quam maxime, very much. — See also postquam, posteaquam, priusquam (often separated), which are best translated by a single word, omitting the relative part, according to the common English idiom.

quamdiū (often written separately), adv. (see diu): 1. Interrog., how long? — 2. Rel., as long, as long as (with antecedent omitted).

quam ob rem (often found together), adv. phrase: 1. Interrog., why? — 2. Rel., on which account, for which reason.

quamvis [quam vis], adv., as you please, however, no matter how.

quandō [quam + unc. case-form akin to de], adv., at any time: si quando, if ever, whenever.

quantō, see quantus.

quantus, -a, -um, [prob. for ka- (root of qua) + vant + us], adj.:

1. Interrog., *how great? how much?*
quantum boni, how much good?
quantae civitates (how important?).

— 2. Relative, *as great as, as much as*: *tantum . . . quantum, so much . . . as*; *so quanta . . . tanta pecunia.*

quantusvis, -avis, -umvis, [quantus-vis (from volo)], *however great, as great as you please.*

quā rē, adv. phrase, *by which thing, wherefore, therefore, on account of which* (circumstance, etc.), *why*. — The relative and interrogative senses are not always distinguishable; *neque commissum qua re, nothing had been done for which, etc.*; *res hortabantur qua re, etc. (many reasons for doing so urged, etc., to).*

quartus, -a, -um, [quattuor- (reduced) + tus], num. adj., *fourth*: *quartus decimus, fourteenth.*

quasi [quam (or quā) -si], conj., *as if*: *quasi vero, as if forsooth* (ironical).

quattuor [?, reduced pl.], indecl. num. adj., *four*.

quattuordecim [quattuor-decim], indecl. num. adj., *fourteen*.

-que [unc. case-form of qui], (always appended to the word or to some part of the phrase which it connects), conj., *and*. — Sometimes connecting the general with the particular, *and in general, and other*.

quem ad modum, phrase as adv., *how, just as, as*.

queror, querī, questus, [?, with r for original s], 3. v. dep., *complain,*

complain of, find fault, find fault with, bewail, lament.

questus, -a, -um, p. p. of **queror**.
quī, quae, quod, cūus, [prob. quō- + i (demon.)], rel. pron., *who, which, that*. — Often where a demon. is used in Eng., *this, that*. — Often implying an antecedent, *he who, etc.*: *ea quae, things which, whatever*; *qua de causa, for this reason*; *qui patebant (though they, etc.)*; *qui videant, men to see, scouts*; *qui, and they*; *habere sese quae, with subjv. (something to, etc.)*; *qui potuissent (men who)*; *qui postularent, to demand*; *haec esse quae, this was what*; *qui faceret, in that he, etc.*; *paucis diebus quibus (after)*; *idem quod, the same as*. — **quō**, abl. of degree of difference as adv., *the (more, less, etc.)*. — See also **quis**, **quod**, 2 **quo**, and 3 **quo**.

quicquam, see **quisquam**.

quicumque, quae, quod-, [quicumque (cf. quisque)], indef. rel. pron., *whoever, whichever, whatever*.

quīdam, quae, quod- (quid-). [qui-dam (case of DA, cf. nam, tam)], indef. adj. pron., *a (possibly known, but not identified), a certain, certain, a kind of* (referred to as belonging to the class, but not exactly the thing spoken of): *artificio quodam, a kind of trick*; *quīdam ex militibus (one)*.

quidem [unc. case-form of qui + dem (fr. DA, cf. tandem, idem)], adv., giving emphasis, but with no regular English equivalent: *ne . . . quidem, not . . . even, not . . . either*; *vestrae quidem certe, yours at least,*

with emphasis; *si quidem, if at least, in so far as, since.*

quiēs, -ētis, [quiē- (st. of *quiesco*, *keep quiet*) + *tis* (reduced)] *F., rest, sleep, repose.*

quiētus, -a, -um, [quiē- (st. of *quiesco*, cf. *quies*) + *tus*], *p. p. as adj., at rest, quiet, peaceable, settled, at peace, free from disturbance.*

quīn [qui (abl. or instr. of *qui*) + *ne*], *conj., interrog., how not? and rel., by which not: quin etiam, nay even, in fact.* — After negative verbs of hindrance and doubt, *so but that, but that, that, from* (doing a thing), *to* (do a thing); *non dubito quin, I doubt not that; also, rarely, I do not hesitate to; non aliter sentio quin, I have no other idea than that; non exspecto quin, I do not delay doing, etc.; nec abest ab eo quin, it is not far from being the case that, etc.*

quīnam (*quis-*), *quae-, quod-* (*quid-*), *cūius-*, [qui-*nam*], *interr. pron., who? etc. (emph.): quibusnam manibus (with what possible? etc.).*

quīncūnx, -ūncis, [*quinque-uncia, ounce*], *F., (an arrangement of dots in the form marked on the five-ounce piece of copper, ⋆:⋆), a quincunx: in quincuncem dispositis (in quincuncial or alternate order).*

quīndecim [*quinque-decem*], *indecl. num. adj., fifteen.*

quīngentī, -ae, -a, [*quinque-centum*], *num. adj., five hundred.*

quīnī, -ae, -a, [*quinque + nus*], *distrib. num. adj., five at a time, five (at a time).*

quīnquāgintā [*quinque + unc. st.*], *indecl. num. adj., fifty.*

quīnque [?], *indecl. num. adj., five.*

quīntus, -a, -um, [*quinque + tus*]. *num. adj., fifth.* — *Esp. as a Roman prænomen (orig. the fifth-born?).*

Quīntus, -ī, *see quintus.*

quis (*quī*), *quae* (*qua*), *quid* (*quod*), *cūius* [st. *quī-* and *quō-*]: 1. *Interrog. adj. pron., who? which? what? — 2. Indef., one, any one, any thing: ne quid, that nothing; ubi quis, when any one; si quis, if any one.*

quisnam, *see quīnam.*

quispiam, *quae-, quid-* (*quod-*), *cūius-*, [*quis-piam* (*pe-iam*, cf. *quippe, nempe*)], *indef. adj. pron., any, any one, any thing.*

quisquam, *no fem., quid-* (*quic-*), *cūius-*, [*quis-quam*], *indef. pron. used substantively (cf. ullus), only with negatives and words implying a negative, making a universal negative, any one, anything.* — *As adj., any.*

quisque, *quae-, quid-* (*quod-*), *cūius-*, [*quis-que*], *indef. adj. pron. (distrib. universal), each, each one, every.* — *Esp. with superlatives, implying that things are taken in the order of their quality: nobilissimus quisque, all the noblest, one after the other in the order of their nobility; antiquissimum quodque tempus, the most ancient times in their order; decimus quisque, every tenth, the tenth part of, one in ten.* — With *ut*, and *ita*, a proportion is indicated, *in proportion as . . . so, the more . . . the more.*

quisquis, *quaequae, quicquid* (*quidquid*), *cuiuscuius, [quis,*

doubled], indef. rel. pron., *whoever, whatever, every one who, all who.*

quīvis, quae-, quid- (quod-), cuius-, [qui-vis], indef. adj. pron., *who you please, any one, any whatever* (affirmative), *any* (whatever).

1. quō, see quī.

2. quō [old dat. of qui], adv.:

1. Interrog., *whither?*—2. Rel., *whither, into which, as far as* (i.e. to what end): *quo intrare* (*which*); *habere quo* (*have any place to go to, or the like*).—3. Indef., *anywhere.*

3. quō [abl. of qui], as conj., *in order that* (with comparatives), *that: magis eo quam quo* (*than that, than because*).—Esp., quō minus, *that not, so that not: recusare quominus, refuse to.*

quoad [quo-ad], conj., (*up to which point*), *as far as, until, as long as.*

quod [N. of qui], conj., (*as to which*), *because, inasmuch as, in that, as for the fact that, the fact that, that, as for* (with clause ex-

pressing the action): *quod si, now if, but if.*

quō minus, see 3 quo.

quoniam [quom (cum) -iam], conj., (*when now*), *inasmuch as, since, as, seeing that.*

quoque [?], conj., following the word it affects, (*by all means?*), *also, as well.* Cf. *etiam* (usually preceding).

quōque, see quisque.

quōque, quo with enclitic.

quōqueversus, see versus.

quot [akin to quis], adj. pron. indecl.: 1. Interrog., *how many?*—2. Rel., *as many, as many as* (with implied antecedent), *the number which.*

quotannis [quot-annis], adv., (*as many years as there are*), *every year, yearly.*

quotiēns [quot + iens, cf. quinquiens], adv.: 1. Interrog., *how often? how many times?*—2. Rel., *as often, as often as* (with implied antecedent).

R

rādīx, -īcis, [?], F., *a root.*—Plur., *the roots* (of a tree), *the foot* (of a mountain).

rādō, rādere, rāsī, rāsus, [?], 3. v. a., *shave, scrape.*

rāmus, -ī, [?], M., *a branch, a bough, a prong* (of antlers).

rapiditās, -tātis, [rapidō- + tas], F., *swiftness, rapidity.*

rapīna, -ae, [rapī- (as if st. of rapio, seize) + na (F. of -nus)], F., *plunder.*—Plur., *plundering.*

rārus, -a, -um, [?], adj., *thin, scattered, singly, in small bodies* (of soldiers), *a few at a time, few* (as being wide apart).

rāsus, -a, -um, p. p. of rado.

ratiō, -ōnis, [†rati- (ra, in reor, + ti) + o], F., *a reckoning, an account, a roll.*—Also, *calculation, reason, prudence, terms, a plan, science* (or art, or knowledge, as systematic), *a reason* (as consisting in a calculation), *a manner, a method,*

a consideration: *rationem habere*, take an account, take account of, have regard to, take into consideration, take measures, take care of, a mercantile term, cf. *account*; *rei militaris* (art, also nature); *omnibus rationibus*, in all ways, in all respects; *proeli* (character); *repscere* (demand an account, make one responsible); *rationem habere ut*, take care that, etc.; *rationem habere frumentandi* (take measures for, etc.).

ratis, -is, [?], F., a raft.

Rauraci, -ōrum, [Celtic], M. plur., a tribe on the upper Rhine.

re-, *red-*, [abl. of unc. st. perh. akin to -rus], inseparable prep., back, again, away, out, un-. — Esp. implying a giving or taking something which is due, or which creates an obligation by the taking, see *recipio*, *refero*.

rebelliō, -ōnis, [rebelli- + o], F., a renewal of war, an uprising, a rebellion.

Rebilus, -ī, [?], M., a Roman family name. — See *Caninius*.

recēdō, -cēdere, -cessī, -cessūrus, [re-cedo], 3. v. n., make way back, retire, withdraw.

recēns, -entis, [prob. p. of lost verb *treceo*, be back, (cf. *recipero*)], adj., (? just coming back?), new, fresh, late.

recēnsēō, -cēnsēre, -cēnsuī, -cēnsus, [re-censeo, estimate], 2. v. a., review, inspect (of troops).

receptāculum, -ī, [receptā- + culum], N., a retreat, a place of refuge.

receptus, -a, -um, p. p. of *recipio*.

receptus, -tūs, [re-captus, cf. *recipio*], M., a retreat, a way of retreat, a refuge: *receptui canere*, to sound a retreat.

recessus, -sūs, [re-cessus (cf. *recedo*)], M., a retreat: *recessum dare* (a chance to retreat).

recidō, -cidere, -cidī, -cāsūrus, [re-cado], 3. v. n., fall again, fall back, fall upon (one after some one else).

recipiō, -cipere, -cēpī, -ceptus, [re-capio], 3. v. a., take back, get back, recover, take in, receive, admit: *misericiordiam* (admit of); *tela recipi*, be exposed to missiles; *ad se* (attack). — With reflexive, retreat, fly, return, retire, get off, withdraw, resort: *se ad aliquem* (rally on).

recitō, -āre, -āvī, -ātus, [re-cito], 1. v. a., read (aloud).

reclinātus, -a, -um, p. p. of *reclino*.

reclinō, -āre, -āvī, -ātus, [re-clino], 1. v. a. and n., lean back, lean over, lean: *reclinatus*, leaning.

rēctē [old case-form of *rectus*], adv., straight, right, rightly: *recte factum*, a good action.

rēctus, -a, -um, [p. p. of *rego*], adj., (directed), straight: *recta regione*, in a straight direction, parallel with.

recuperō (-cip-), -āre, -āvī, -ātus, [†reciperō-, from *recō*- (cf. *recens*) + *parus* (cf. *pario*)], 1. v. a., get back, recover, regain.

recūsō, -āre, -āvī, -ātus, [re-†causo (cf. *excuso*)], 1. v. a. and n., (give an excuse for drawing back), refuse, reject, repudiate, object to; abs., make

objections: de stipendio (*refuse to pay*, etc.); quin (*refuse to*); quominus (*refuse to*); periculum (*refuse to incur*).

rēda (rhēda), -ae, [perh. Celtic form akin to *rota*], F., a wagon (with four wheels).

redāctus, -a, -um, p. p. of *redigo*.

redditus, -a, -um, p. p. of *reddo*.

reddō, -dere, -didī, -ditus, [re (red) -do], 3. v. a., *give back, restore, pay* (something due, cf. *re*), *render*: supplicatio (*offer*).

redēptus, -a, -um, p. p. of *redimo*.

redeō, -īre, -iī (-īvī), -itūrus, [re- (red-) -eo], irr. v. n., *go back, return, come down again* (collis ad planitiem): eodem unde redierat (*come*); summa (*be referred*).

redigō, -igere, -ēgī, -āctus, [re- (red-) -ago], 3. v. a., *bring back, reduce, render, bring* (sub imperium Galliam), *make* (one thing out of another).

redimō, -imere, -ēmī, -ēptus, [re- (red-) -emo], 3. v. a., *buy back, redeem, purchase, buy*.

redintegrātus, -a, -um, p. p. of *redintegro*.

redintegrō, -āre, -āvī, -ātus, [re- (red-) -integro], 1. v. a., *renew* (again), *restore, revive* (spem).

reditiō, -ōnis, [red-itiō (cf. redeo)], F., a return.

reditus, -tūs, [re- (red-) -itus], M., a return.

Redones, -um, [Celtic], M. plur., a tribe of Brittany.

redūcō, -dūcere, -dūxī, -ductus, [re-duco], 3. v. a., *lead back, bring*

back, draw back, draw in, extend back.

refectus, -a, -um, p. p. of *reficio*.

referō, -ferre, -ttulī, -lātus, [refero], irr. v. a., *bring back, return, bring* (where something belongs), *report*. — Esp.: ad senatum (*lay before for action*); de re publica (*consult in regard to*); gratiam (*make return, show one's gratitude*); pedem (*retreat, draw back*).

reficiō, -ficere, -fēcī, -fectus, [refacio], irr. v. a., *repair, refresh*: se ex labore (*rest*); exercitum (*allow to recover*).

refrāctus, -a, -um, p. p. of *refringo*.

refringō, -fringere, -frēgī, -frāctus, [re-frango], 3. v. a., *break away, break in* (portas): vim fluminis (*break, opposite to its direction*).

refugiō, -fugere, -fūgī, -fugitūrus, [re-fugio], 3. v. n., *run away, escape*.

Rēgīnus, -ī, [akin to *rex*], M., a Roman family name. — See Antistius.

regiō, -ōnis, [REG + io, but cf. ratio], F., a *direction, a part* (of the country, etc.), a *region, a country, a district*: recta regione, *straight, along, parallel*; e regione, *over against, just opposite*.

rēgius, -a, -um, [reg- + ius], adj., of a king, *regal, royal*.

rēgnō, -āre, -āvī, -ātūrus, [regnō-], 1. v. n., *rule, be in power, reign*.

rēgnum, -ī, [REG + num (N. of -nus)], N., a *kingdom, royal power, a throne*. — Plur., *the royal power* (of several cases).

regō, regere, rēxī, rēctus, [akin to **rex**], 3. v. a., *direct, manage, rule, have control of.*

rēiciō, -icere, -iēcī, -iectus, [re-iacio], 3. v. a., *throw back, hurl back, drive back, throw away, drive off.*

rēiectus, -a, -um, p. p. of **reicio**.

relanguēscō, -languēscere, -languī, no p. p., [re-languesco], 3. v. n., *languish away, be relaxed, be weakened, be deadened.*

relātus, -a, -um, p. p. of **refero**.

relēgātus, -a, -um, p. p. of **relego**.

relēgō, -āre, -āvī, -ātus, [re-lēgo, *depute*], 1. v. a., *remove, separate.*

relictus, -a, -um, p. p. of **relinquo**.

religiō, -ōnis, [?, re-legio (cf. **religo**)], F., (the original meaning unc.), *a religious scruple, a religious observance, the service of the gods, a superstition, a superstitious terror, religion.* — Plur., *religious matters* (of all kinds).

relinquō, -linquere, -līquī, -lictus, [re-linquo], 3. v. a., *leave behind, leave, abandon: obsidionem (raise).* — Pass., *be left, remain.*

reliquus, -a, -um, [re-+liquis (LIQ (leave) + us)], adj., *left, remaining, the rest, the other, other* (meaning all other), *the others, all other, future* (of time), *remaining: nihil est reliqui, there is nothing left; nihil ad celeritatem sibi reliqui fecerunt, made the greatest possible speed.*

remaneō, -manēre, -mānsī, -mānsūrus, [re-maneo], 2. v. n., *remain behind, remain, stay.*

rēmex, -igis, [remō- with unc. term. (perh. †agus)], M., *an oarsman, a rower.*

Rēmī, -ōrum, [Celtic], M. plur., a tribe of the Belgæ about Rheims, which was their capital.

rēmigō, -āre, -āvī, -ātūrus, [re-mig-], 1. v. n., *row.*

remigrō, -āre, -āvī, -ātūrus, [re-migro], 1. v. n., *move back, return.*

reminīscor, -minīscī, [re-+miniscor (MAN, in **memini**, + isco)], 3. v. dep., *remember.*

remissus, -a, -um, p. p. of **remitto**.

remittō, -mittere, -mīsī, -missus, [re-mitto], 3. v. a., *let go back, send back, throw back.* — Fig., *relax, cease to use, give up: remissioribus frigoribus (less intense).*

remollēscō, -mollēscere, no perf., no p. p., [remollesco], 3. v. n., *soften away, soften, become feeble.*

remōtus, -a, -um, p. p. of **removeo**.

removeō, -movēre, -mōvī, -mōtus, [re-moveo], 2. v. a., *move back, move away, send away, remove, draw away, get out of the way.* — **remotus**, -a, -um, p. p. as adj., *far away, remote.*

remūneror, -ārī, -ātus, [re-munero], 1. v. dep., *repay, requite.*

Rēmus, -ī, [?], M., one of the Remi.

rēmus, -ī, [?], M., *an oar.*

rēnō, -ōnis, [?], M., *a skin, a pelt.*

renovō, -āre, -āvī, -ātus, [re-novo, fr. **novus**, *new*], 1. v. a., *renew.*

renūntiātus, -a, -um, p. p. of **renuntio**.

renūntiō, -āre, -āvī, -ātus, [renuntio], 1. v. a., *bring back word, report, proclaim.*

repellō, -pellere, -ppulī, -pulsus, [re-pello], 3. v. a., *drive back, repel, repulse*: ab hac spe repulsi, *disappointed in this hope*.

repente [?], adv., *suddenly*.

repentīnus, -a, -um, [repente + inus], adj., *sudden, hasty*. — **repentīnō**, abl. as adv., *suddenly*.

reperiō, reperire, repperī, reper-tus, [re- (red-) pario], 4. v. a., *find out, discover, find* (by inquiry, cf. **invenio**): reperti sunt multi, *there were many*.

reper-tus, -a, -um, p. p. of **reperio**.

repetō, -petere, -petivī, -petitus, [re-peto], 3. v. a., *try to get back, demand back, ask for*: poenas (*inflict, exact*, cf. **sumo**).

repleō, -plēre, -plēvī, -plētus, [re-pleo], 2. v. a., *fill up, supply well*.

replētus, -a, -um, p. p. of **repleo**.

reportō, -āre, -āvī, -ātus, [re-porto], 1. v. a., *carry back*.

reposcō, -poscere, no perf., no p. p., [re-posco], 3. v. a., *demand back, demand* (something due).

repraesentō, -āre, -āvī, -ātus, [re-praesento], 1. v. a., *make present, do at once*.

reprehendō, -hendere, -hendī, -hēnsus, [re-prehendo], 3. v. a., *drag back, seize hold of, find fault with, blame, censure*.

repressus, -a, -um, p. p. of **re-primō**.

reprimō, -primere, -pressī, -pres-sus, [re-premo], 3. v. a., *check*.

repudiō, -āre, -āvī, -ātus, [repudiō-], 1. v. a., (*spurn with the feet*, cf. **tripudium**), *spurn, refuse, reject*.

repugnō, -āre, -āvī, -ātus, [re-pugno, fight], 1. v. n., *resist*. — Fig., *be in opposition*.

repulsus, -a, -um, p. p. of **repello**.

requirō, -quirere, -quisivī, quisitus, [re-quaero], 3. v. a., *search out*. Hence, *request, require, demand, need*.

rēs, rei, [akin to reor, reckon], F., *property, business, an affair, a matter, a thing* (in the most general sense), *a fact, an occurrence, an event, a case, an action, an act*. —

Often to be translated from the context: ob eam rem, *for this reason*; quam ob rem, *for which reason, wherefore*; his rebus, *by these means, for these reasons, on this account*; ea res, *this*, (often equivalent to a pronoun); qua in re, *in which*; eius rei, *of this*; his rebus cognitis (*this*); qua ex re futurum, *the result of which would be*; huic rei, *for this purpose, for this*; alia re iurare (*in any other way*); nihil earum rerum quas, etc., *nothing of what, etc.*; sine certa re, *without certain grounds*; omnibus rebus, *in every respect, in all ways*; his omnibus rebus unum repugnabat (*considerations, reasons, arguments*); quibus rebus occurrendum esse (*dangers*); rem deferre, *lay the matter before, not for consultation, bring information*, cf. rem referre; rerum omnium casus, *all accidents*; rem gerere, *operate, conduct operations*, in war, *succeed well or ill*; his rebus gestis, *after these operations, events*; male re gesta, *want of success*; rerum natura, *nature, also, state of the case*;

imperitus rerum, ignorant of the world; **omnium rerum summa** (of the whole, of all the forces); **ei rei student** (this branch, cavalry); **cuius rei**, of which, ships. — Esp., the affairs (of a person), position, interests, condition, fortunes, circumstances: **Gallicis rebus favere** (the interests of Gaul); **rem esse in angusto** (affairs, things); **commutatio rerum**, change of fortunes. — Esp.: **res secundae**, or **adversae**, success, prosperity, or adversity, want of success; **res publica**, the commonwealth, the state, the general interests, public business, politics; **res communis**, the common interest; **de re publica**, in regard to the welfare of the state, about politics; **res divinae**, divine worship, and everything pertaining to it, religion; **res familiaris**, property; **res militaris**, warfare, the art of war; **res frumentaria**, grain supply, grain; **res alicui est**, one has business with, has to do with, and the like; **one's affair is**; **res est**, it is a fact, it is so; **novae res**, a new form of government, revolution.

rescindō, -scindere, -scidī, -scissus, [re-scindo], 3. v. a., cut away, tear down, break down, destroy.

resciscō, -sciscere, -scivī, -scītus, [re-scisco, inquire], 3. v. a., find out, learn, discover.

rescribō, -scribere, -scripsī, -scrip-tus, [re-scribo, write], 3. v. a., transfer (by writing).

reservātus, -a, -um, p. p. of **reservo**.

reservō, -āre, -āvī, -ātus, [re-servo], 1. v. a., keep back, reserve, hold in reserve.

resideō, -sidēre, -sēdī, no p. p., [re-sedeo], 2. v. n., sit back, sit down, remain behind, remain.

residō, -sīdere, -sēdī, no p. p., [re-sido], 3. v. n., sink down, become calm, subside.

resistō, -sistere, -stitī, no p. p., [re-sisto], 3. v. n., stand back, stop, withstand, make a stand, resist, remain.

respicō, -spicere, -spexī, -spectus, [re-īspecio], 3. v. a. and n., look back, look back at, look behind one, see behind one, consider.

respondeō, -spondēre, -spondī, -spōnsus, [re-spondeo, promise], 2. v. n., reply, answer.

respōnsum, -ī, [N. p. p. of respondeo], N., a reply. — Plur., a reply (of several parts).

rēs pūblica, see **res**.

respuō, -spuere, -spuī, no p. p., [re-spuo], 3. v. a., spit out. — Fig., spurn, reject.

restinctus, -a, -um, p. p. of **restinguo**.

restinguō, -stinguere, -stīnxī, -stīnctus, [re-stinguo, quench], 3. v. a., extinguish.

restituō, -stituere, -stituī, -stitūtus, [re-statuo], 3. v. a., set up again, replace, restore, make anew.

restitūtus, -a, -um, p. p. of **restituō**.

retentus, -a, -um, p. p. of **retineo**.

retineō, -tinēre, -tinuī, -tentus, [re-teneo], 2. v. a., hold back, restrain, (quin, from doing something), detain, retain: **memoriam** (preserve); **Gallos** (arrest).

retrahō, -trahere, -trāxī, -trāctus,

[re-traho], 3. v. a., *drag back, bring back* (a person).

revellō, -vellere, -velli, -vulsus, [re-vello, *pull*], 3. v. a., *tear away, pull away*.

reversus, -a -um, p. p. of revertō.
revertō, -vertere, -vertī, -versus, [re-vertō], 3. v. n., *return* (in perf. tenses). — Pass. as deponent in pres. tenses, *return, go back, come back*.

revinciō, -vincire, -vinxī, -vinctus, [re-vincio], 4. v. a., *bind back* (to something), *make fast, fasten, bind*.

revinctus, -a, -um, p. p. of revincio.

revocātus, -a, -um, p. p. of revoco.
revocō, -āre, -āvī, -ātus, [re-voco], 1. v. a., *call back, call away, call off, recall*.

rēx, rēgis, [REG, *rule*, as st.], M., *a king*.

Rhēnus, -ī, [Celtic?], M., *the Rhine*.

Rhodanus, -ī, [Celtic?], M., *the Rhone*.

rīpa, -ae, [?], F., *a bank*.

rīvus, -ī, [akin to Gr. *ῥέω*], M., *a brook, a stream* (not so large as flumen).

rōbur, -oris, [?], N., *oak*.

rogātus, -a, -um, p. p. of rogo.

rogō, -āre, -āvī, -ātus, [?], 1. v. a.

and n., *ask, request, ask for*: *sacramento rogare milites* (*bind by an oath, enlist under oath*).

Rōma, -ae, [?], F., *Rome*.

Rōmānus, -a, -um, [Roma- + nus], M., *Roman*. — As noun, *a Roman*.

Rōsciū, -ī, [?], M., a Roman family name. — Esp., *Lucius Roscius*, a legatus of Cæsar.

rōstrum, -ī, [ROD- (in *rodo*, *gnaw*) + trum], N., *a beak*. — Esp. of a ship, *the beak, the ram* (used as in modern naval fighting).

rota, -ae, [?], F., *a wheel*.

rubus, -ī, [?, perh. rub- (in *ruber*) + us], M., (*red?*), *a bramble*.

Rūfus, -ī, [prob. dial. form = *rubus, red*], M., a Roman family name. See *Sulpicius*.

rūmor, -ōris, [?], M., *a rumor* (confused report), *report*.

rūpēs, -is, [RUP (cf. *rumpo*) + unc. term.], F., *a cliff, a rock* (in position).

rūsus [for *reversus*], adv., *back again, back, again, in turn*.

Rutēnī, -ōrum, [Celtic], M. plur., a tribe on the borders of Provence.

Rutilus, -ī, [prob. akin to *ruber*], M., *red*. — As a Roman family name. — Esp., *Marcus Sempronius Rutilus*, a cavalry officer under Cæsar.

S

Sabīnus, -ī, [unc. st. (cf. *sabulus, sand*) + inus], M., (*Sabine*). — As a Roman family name. — See *Titurius*.

Sabis, -is, [Celtic], M., a river of Gaul flowing into the Meuse, now *Sambre*.

sacerdōs, -dōtis, [sacrō-dos (DA + tis)], C., (*arranger of sacred rites?*), *a priest*.

sacrāmentum, -ī, [sacrā-, *hallow*, + mentum], N., *an oath*.

sacrificium, -ī, [†sacrificō- (*sacrō-*

†*facus*, cf. *beneficus*) + *ium*], N., a *sacrifice*.

saepe [N. of †*saepris* (perh. same as *saepe*)], adv., often: *minime saepe*, most rarely. — *saeplus*, compar., many times, repeatedly.

saepenumero [*saepe*, *numero*], adv., oftentimes, many times.

saepēs, -is, [akin to *saepio*, *hedge in*], F., a *hedge*.

saeviō, -ire, -iī, -itūrus, [*saevō*-, *raging* (as if *saevi*-)], 4. v. n., be angry, rage, be violent.

sagitta, -ae, [?], F., an *arrow*.

sagittarius, -ī, [*sagitta*- + *arius*], M., an *archer*, a *bowman*.

sagulum, -ī, [*sagō*- (*cloak*) + *lum*], N., a *cloak* (military).

saltus, -tūs, [?, perh. SAL (in *salio*, *leaf*) + *tus*], M., a *wooded height*, a *glade*, a *pass* (in the mountains).

salūs, -ūtis, [*salvō*-, (?) *safe*, + *tis* (cf. *virtus*)], F., *health*, *well-being*, *welfare*, *safety*, *preservation*, *deliverance*, *life* (as saved or lost); *salute desperata*, *despairing of saving one's self*; *salutis suae causa*, *to protect one's self*; *ad salutem contendere* (a *place of safety*).

Samarobrīva, -ae, [Celtic], F., a city of the Ambiani, now *Amiens*.

sanciō, *sancire*, *sānxī*, *sānctus*, [SAC (in *sacer*)], 4. v. a., *bind* (in some religious manner), *make sacred*, *solemnly establish* (by law). — *sānctus*, -a, -um, p. p. as adj., *holy*, *sacred*, *solemn*, *inviolable*.

sānctus, -a, -um, p. p. of *sancio*.

sanguis, -inis, [?], M., *blood* (as the vital fluid, generally in the body, cf. *cruur*).

sānitās, -tātis, [*sanō*- + *tas*], F., *soundness*, *sound mind*, *good sense*.

sānō, -āre, -āvi, -ātus, [*sanō*-], I. v. a., *make sound*, *make good*, *repair*.

Santones, -um, (-ī, -ōrum), [Celtic], M. plur., a tribe between the Loire and the Garonne.

Santonī, see *Santones*.

sānus, -a, -um, [SA- (akin to *salvus*) + *nus*], adj., *sound* (in body or mind), *sane*, *discreet*: *nihil pro sano facere* (*nothing discreet*).

sapiō, -ere, -iī (-īvi), no p. p., [?, SAP], 3. v. a. and n., *taste* (actively or passively). Hence, *be wise*, *understand* (what to do).

sarcina, -ae, [*sarci*- (as if st. of *sarcio*, or a kindred noun-st.) + *na* (F. of *nus*)], F., a *pack* (sewed up?). — Plur., *baggage* (soldiers' *packs*, cf. *impedimenta*, *baggage not carried by soldiers*).

sarciō, *sarcire*, *sarsī*, *sartus*, [?], 4. v. a., *mend*, *patch*. — Fig., *restore*, *repair*.

sarmentum, -ī, [perh. SARP, *prune* (but cf. *sarcina*) + *mentum*], N., (either *prunings* or *tied fagots*), only in plur., *fagots*, *fascines*.

satis [?], adv., *enough*, *sufficiently*. — Often with partitive, equivalent to a noun or adj., *enough*, *sufficient*: *satis habere*, *consider sufficient*, *be satisfied*; *neque . . . satis commode* (*not very*, etc.); *satis grandis*, *rather large*, *tolerably large*. — Often a mild expression for *very* and the like.

satisfaciō, -facere, -fēcī, -factūrus, [*satis facio*], 3. v. n., *do enough for*, *satisfy*, *make amends*, *excuse one's self*, *apologize*.

satisfactiō, -ōnis, [satis-factio (cf. satisfacio)], F., *amends, excuses, an apology.*

satus, -a, -um, p. p. of sero.

saucius, -a, -um, [?], adj., *wounded.*

saxum, -ī, [?], N., *a rock* (as movable), cf. *rupes.*

scālae, -ārum, (sing. rare), [perh. scad- (in scando, *climb*) + la], F., *a ladder, a scaling ladder.*

Scaldis, -is, [?], M., *a river of Gaul, the Scheldt.*

scapha, -ae, [Gr., orig. a "dug-out"], F., *a skiff, a boat.*

scelerātus, -a, -um, [as if (perh. really) p. p. of scelero (*stain with crime?*)], adj., *villainous, accursed.*

scelus, -eris, [?, perh. orig. "crookedness," cf. pravus and 'wrong'], N., *crime, wickedness.*

scienter [scient- (cf. scio) + ter], adv., *knowingly, skilfully.*

scientia, -ae, [scient- (cf. scio) + ia], F., *knowledge, acquaintance with* (thing in the genitive), *skill.*

scindō, scindere, scidī, scissus, [SCID, *split*], 3. v. a., *tear, tear down.*

sciō, scīre, scīvī, scītus, [?], 4. v. a., (*separate?*), *distinguish, know.*

scorpiō, -ōnis, [?], M., *a scorpion; a machine for throwing darts.* Hence, *a shot from an engine* (of that kind).

scribō, scribere, scripsī, scriptus, [?], 3. v. a. and n., *write, give an account* (in writing).

scrobis, -is, [prob. akin to scribo], M. and F., *a ditch, a pit.*

scūtum, -ī, [?], N., *a shield*, of the Roman legion, made of wood, con-

vex, oblong (2½ by 4 ft.), covered with leather.

sē- sēd- [old abl. of unc. st.], prep., mostly as adv. in comp., *apart, away, aside, off, un-.*

sē, see sui.

sēbum, -ī, [?], N., *tallow.*

secō, secāre, secuī, sectus, [prob. causative of SEC], I. v. a., *cut, reap.*

sēcrētō [abl. of secretus, p. p. of secerno, *separate*], adv., *in private, privately.*

sectiō, -ōnis, [SEC (in seco) + tio], F., *a cutting.* Hence (prob. from dividing in lots), *a lot of booty, booty.*

sector, -ārī, -ātus, [prob. sectā (SEQU + ta, cf. moneta)], I. v. dep., *pursue, chase after.*

sectūra, -ae, [prob. sectu- (SEC + tus) + ra, F. of -rus], F., *a cutting, a mine, a shaft, a gallery.*

secundum, see secundus.

secundus, -a, -um, [part. in -dus of sequor], adj., *following.* Hence, *second.* — Also (as not opposing), *favorable, successful: secundoiores res, greater prosperity; proelium secundum nostris (in favor of); secundo flumine, down the stream; secunda acies, the second line of battle, the second division.* — Neut. acc. as prep. with acc., *along, in the direction of, in accordance with; secundum ea, besides that.*

secūris, -is, [SEC + unc. term.], F., *an axe.* — Esp., *the axe of the iictor* (as a symbol of the power of life and death).

sēcus, [SEQU (in sequor) + unc. term.], adv., (*inferior*), *otherwise.* —

Compar., *sēcius* (*sētius*), *less*: *nihilo secius*, *none the less*, *nevertheless*.

secūtus, -a, -um, p. p. of *sequor*.

sed [abl. of unc. st., cf. *re*], conj., *apart* (cf. *seditio*, and *securus*), *but* (stronger than *autem* or *at*), *but yet*.

sēdecim [*sex-decem*], indecl. num. adj., *sixteen*.

sēdēs, -is, [*SED* + *es* (M. and F. term. corresponding to N. -us)], F., *a seat*. Hence, *an abode* (both in sing. and plur.), *a settlement*: *locus ac sedes*, *a place of abode*.

sēditīō, -ōnis, [*sed-titio* (1 + *tio*)], F., *a secession*, *a mutiny*, *an uprising*.

sēditīōsus, -a, -um, [*sedition-* + *osus*], adj., *seditionous*, *factionous*.

Sedulius, -ī, [?], M., a leader of the Lemovices.

Sedūnī, -ōrum, [Celtic], M. plur., a tribe of the Alps.

Sedusiī, -ōrum, [Teut.], M. plur., a tribe of Germans.

seges, -etis, [unc. st. + *tis*], F., *a crop of grain* (growing), *a field* (of grain).

Sēgnī, -ōrum, [Celtic], M. plur., a people of Belgic Gaul.

Segonax (-*ovax*), -actis, [Celtic], M., a British king.

Segontiācī, -ōrum, [Celtic], M. plur., a tribe of Britain.

Segusiāvī (-*ānī*), -ōrum, [Celtic], M. plur., a people west of the Rhone, near modern Lyons.

semel [prob. N. of adj., akin to *similis*], adv., *once*: *semel atque iterum*, *more than once*, *again and again*; *ut semel*, *when once*, *as soon as*.

sēmentis, -tis, [*semen* (*seed*) +

tis, cf. *Carmentis*, *virtus*], F., *a sowing*: *sementis facere*, *sow grain*.

sēmita, -ae, [*se-* (*sed-*) + *imita* (MI, in *meo*, *go*, cf. *comes*)], F., *a side path*, *a by path*, *a path* (over the mountains).

semper [†*semō*- (?)] (in *semel*) -*per* (cf. *parumper*), adv., *through all time*, *all the time*, *always*.

Semprōnius, -ī, [?], M., a Roman gentile name. — See *Rutilus*.

senātor, -tōris, [†*senā-* (as if verb-st. akin to *senex*, perh. really so, cf. *senatus*) + *tor*], M., (*an elder*). Hence, *a senator*.

senātus, -tūs, [†*senā-* (as if, perh. really, verb-st. akin to *senex*)], M., *a senate* (council of old men). — Esp., *the senate* (of Rome, the great body of nobles acting as an administrative council).

senex [*seni-* + *cus* (reduced)]. — Gen., *senis*, [?, cf. *seneschal*], adj. (only M.), *old*. — Esp. as noun, *an old man* (above forty-five).

sēnī, -ae, -a, [*sec(s)* + *ni*], distrib. num. adj., *six each*, *six* (where *each* is implied in Eng. by the context).

Senones, -um, [Celtic], M. plur., a tribe of Gaul on the Seine, near *Sens* (their chief town, anciently *Agedincum*).

sententia, -ae, [†*sentent-* (p. of simpler pres. of *sentio*) + *ia*], F., (*feeling*, *thinking*). Hence, *a way of thinking*, *an opinion*, *a view*, *a determination*, *a sentiment*, *a feeling*, *a purpose*, *a design*. — Esp., officially, *a judgment*, *an opinion*, *a sentence*, *a vote*: *in ea sententia permanere*

{of that mind}; in eam sententiam, to this purport.

sentiō, sentiō, sēnsī, sēnsus, [?], 4. v. a., *perceive* (by the senses), *know, see, think* (of an opinion made up), *learn about, learn*: unum sentiunt ac probant, *hold the same opinion, etc.*

sentis, -is, [?], M., *a briar.*

sēparātim [as if acc. of †separatis (separā- + tis)], adv., *separately, privately* (apart from others).

sēparātus, -a, -um, p. p. of separo.

sēparō, -āre, -āvī, -ātus, [se- (sed-) paro], 1. v. a., (*get apart?*), *separate.* — Esp. sēparātus, -a, -um, p. p. as adj., *separate.*

septem [?], indecl. num. adj., *seven.*

septentrionēs (septem, triones), -um, M. plur., *the seven plough oxen* (the stars of the Great Bear). — Hence, *the north.* — Also (by an error), in the sing., septentrio, -ōnis, *the north*: a septentrionibus, *in the north*; sub septentrionibus, *in the north, towards the north.*

septimus, -a, -um, [septem + mus, cf. primus], adj., *the seventh.*

septingentī, -ae, -a, [septem (in some form) -centum (?)], num. adj., *seven hundred.*

septuāgintā [from septem, in some unc. manner], indecl. num. adj., *seventy.*

sepultūra, -ae, [†sepultu- (cf. sepelio, *bury*) + ra (F. of -rus)], F., *burial, burying.*

Sēquana, -ae, [Celtic], F., *the Seine.*

Sēquanus, -a, -um, [Celtic], adj.,

of the Sequani (a tribe of Gaul, on the Rhone, N. of Macon). — Masc. sing., *one of the Sequani, a Sequanian.* — Masc. plur., *the Sequani.*

sequor, sequī, secūtus, [SEQU], 3. v. dep., *follow, accompany*: damnatum poena (*be inflicted upon, the penalty following the condemnation*); eventus (*ensue*); hiems quae secuta est (*the following*); fidem (*hold to, remain under, come under, surrender one's self to, etc.*); aestus commutationem (*take advantage of*).

Ser., for Servius.

sermō, -ōnis [SER (in sero, *twine*) + mo (prob. -mō- + o)], M., (*series?*). Hence, *conversation* (continuous series of speech), *talk, intercourse, conversation with* (genitive).

serō, serere, sēvī, satus, [SA, redupl.], 3. v. a., *plant, sow.*

sērō [abl. of serus], adv., *too late.*

Sertōrius, -ī, [sertor (*garland-maker?*) + ius], M., a Roman gentile name. — Esp., Q. Sertorius, a partisan of Marius, who held a command in Spain against the party of Sulla from B.C. 80 to B.C. 72.

servilis, -e, [servi- (as if st. of servus or akin, cf. servio) + lis], adj., *of slaves, of a slave, servile*: in servilem modum, *as with slaves, (i.e. by torture)*; tumultus (*the servile war, the revolt of the slaves under Spartacus in B.C. 73*).

serviō, -īre, iī (-īvī), -ītūrus [servi- (as if st. of servus or akin)], 4. v. n., *be a slave* (to some one or something); rumoribus (*be blindly guided by, follow*); bello (*devote one's self to*).

servitūs, -tūtis, [†servitu- (servō

+ tus) + tis, cf. *iuventus*, *sementis*], F., *slavery, servitude*.

Servius, -ī, [servō- + ius], M., a Roman prænomen.

servō, -āre, -āvī, -ātus, [servō-], I. v. a., *watch, guard, keep, preserve*: *praesidia* (*hold, maintain*); *ordines* (*keep*); *fidem* (*keep one's word*).

servus, -ī, [unc. root (SER, bind?) + vus], M., *a slave*.

sēsē, see *sui*.

sēsquipedālis, -e, [†sesquiped- (*a foot and a half*) + alis], adj., *of a foot and a half, eighteen-inch* (beams, etc.).

seu, see *sive*.

sevērītās, -tātis, [severō- + tas], F., *strictness, harshness, severity*.

sēvocō, -āre, -āvī, -ātus, [se (sed) -voco], I. v. a., *call aside, call out* (aside).

sex [?], indecl. num. adj., *six*.

sexāgintā [sex + unc. term.], indecl. num. adj., *sixty*.

sexcentī (ses-), -ae, -a, [sex-centum], num. adj., *six hundred*.

Sextius, -ī, [sextō- + ius], M., a Roman gentile name. — Esp.: 1. *Titus Sextius*, a legatus of Cæsar. — 2. *Publius Sextius Baculus*, a centurion in Cæsar's army.

sī [loc. prob. akin to *se*], conj., (*in this way, in this case, so, cf. sic*), *if, in case*. — Esp., *to see if, whether*: *id si fieret, should this happen*, etc.

sibi, see *sui*.

Sibusātes, -um, [Celtic], M. pl., a people of Aquitania, near the Pyrenees.

sīc [si-ce, cf. *hic*], adv., *so, in this manner, in such a manner*,

thus: sic . . . ut, so . . . that, so well . . . that; *sic reperiebat* (*this*). — *sīcutī*, as conj., *just as, just as if*.

siccītās, -tātis, [siccō- + tas], F., *dryness, drought, dry weather*. — Plur. in same sense, of different occasions.

sīcut (*sīcutī*), see *sic*.

sīdus, -eris, [SED + us], N., (*position?*), *a heavenly body*.

sīgnifer, -ferī, [signo-fer (FER (bear) + us)], M., *a standard-bearer*.

sīgnificātiō, -ōnis, [significā- + tio], F., *a making of signs, a signal, an intimation, a warning*.

sīgnificō, -āre, -āvī, -ātus, [†significō- (signō-ficus, cf. *facio*)], I. v. n., *make signs, indicate, make known, spread news, give an intimation, give information, show: hac re significari, this is an indication; de fuga; deditionem* (*make signs of*).

sīgnum, -ī, [unc. root + num (N. of -nus)], N., (*a device?*), *a sign, a signal*. — Esp., *a standard* (for military purposes, carried by any body of men, consisting of some device in metal on a pole). — Phrases: *signa convertere, wheel, change front, face about*; *signa inferre, advance to attack, charge*; *conversa signa inferre, change front and charge*; *infestis signis* (*for an attack, at charge*); *signa ferre, move, move on, march*; *signa subsequi, keep the line of march*; *signa relinquere, leave the ranks*; *se continere ad signa, keep the ranks*; *a signis discedere, desert, leave the ranks*; *ad signa convenire, join the army*; *ad signa consistere, rally around the standard*; *signa constituere, halt*.

Silānus, -ī, [?], M., a Roman family name. — Esp., *Marcus Silānus*, a legatus of Cæsar.

silentium, -ī, [silent- + ium], N., *stillness, silence*. — **silentiō**, abl., *in silence, silently*.

Silius, -ī, [?], M., a Roman gentile name. — Esp., *Titus Silius*, a military tribune in Cæsar's army.

silva, -ae, [?], F., *a forest, woods, forests*. — Plur. in same sense.

silvester (-tris), -tris, -tre, [silva- (as if silvus-, cf. palustris) + tris], adj., *woody, wooded*.

similis, -e, [†simō- (cf. simplex, semper) + lis], adj., *like, similar*.

similitūdō, -inis, [simili- + tūdō], F., *likeness, resemblance (to, genitive)*.

simul [N. of similis, cf. facul], adv., *at the same time*: **simul atque** (or without atque), *as soon as*; **simul . . . simul**, *both . . . and*.

simulācrum, -ī, [simulā- + crum], N., *an image, a likeness*.

simulātiō, -ōnis, [simulā- + tiō], F., *a pretence, a show, deceit*.

simulātus, -a, -um, p. p. of **simulo**.

simulō, -āre, -āvī, -ātus, [simili- (as if, perh. orig., †simulō)], I. v. a., *pretend, make a show of (something), feign*.

simultās, -tātis, [simili- (cf. simul) + tas], F., (*likeness?, equality?*), *rivalry*.

sīn [si-ne], conj., (*if not*), *but if*.

sincērē [old case-form of sincerus], adv., *honestly, truly, frankly*.

sine [?], prep. with abl., *without*.

singillātīm (singul-), [as if singulā- (singulus) + tim (acc of

-tis)], adv., *singly, one by one, individually*.

singulāris, -e, [singulō- + aris], adj., *solitary, single*. Hence, *unique, extraordinary, unparalleled, unequalled, marvellous*.

singulī, -ae, -a, [sim (in similis) + unc. term.], adj., *one at a time, single, each, one by one, several (severally)*. — Often to denote distribution, *one to each*: **singuli singulos**, (with verb), *one . . . each*; **singulis legionibus singulos legatos** (*one over each*); **ab singulis legionibus singulos legatos discedere** (*each from his*); **inter singulas legiones** (*between each two, one to each*); **navis singulas Romanis equitibus** (*severally, separately, one to each*); **sevocare singulos** (*individuals, one by one*).

sinister, -tra, -trum, [?], adj., *left*: **sub sinistra (manu)**, *on the left*.

sinistrōrsus [sinistro-vorsus (versus)], adv., *to the left*.

sinō, **sinere**, **sīvī**, **situs**, [si (of unc. meaning)], 3. v. a., (*lay down*, cf. **pono**), *leave*. Hence, *permit, allow*.

situs, -tūs, [si + tus], M., (*a laying, a leaving*), *situation, position, site*.

sive, seu, [si-ve], conj., *if either, or if*: **sive . . . sive**, *either . . . or, whether . . . or*.

socer, -erī, [?], M., *a father-in-law*.

societās, -tātis, [sociō- + tas], F., *an alliance*.

socius, -ī, [sequ (follow) + ius], M., *a companion, an ally, a comrade*

sōl, **sōlis**, [?], M., *the sun*. — Also personified, *Sol, the Sun*. — See also under **orior**, **occido**, **occasus**.

sōlācium (sōlāt-), -ī, [solacō- + ium], N., a consolation, a comfort.

soldurius, -ī, [Teutonic], M., a retainer, a follower.

soleō, solēre, solitus, [?], 2. v. n., be wont, be accustomed.

sōlitūdō, -inis, [solō- + tudo], F., loneliness. Hence, a wilderness.

sollertia, -ae, [sollert- (sollō- + ars, with complete skill, cf. sollicito) + ia], F., skill, ingenuity, shrewdness.

sollicitātus, -a, -um, p. p. of sollicito.

sollicitō, -āre, -āvī, -ātus, [sollicitō- (sollō-citus, entirely roused)], 1. v. a., stir up, instigate, make overtures to, tamper with, approach (with money, etc.), offer bribes to, tempt.

sollicitūdō, -inis, [†sollicitu- (st. akin to sollicitus) + do], F., anxiety, apprehension.

solum, -ī, [?], N., the soil, the foundation, the bottom: solum agri, the bare ground; ab infimo solo, from the very bottom.

sōlus, -a, -um, [?], adj., alone, only.—sōlum, N. as adv., alone, only.

solūtus, -a, -um, p. p. of solvo.

solvō, solvere, solvī, solūtus, [prob. se-luo, loose], 3. v. a., unbind, loose.—Esp. with navis, weigh anchor, set sail.—Also without navis, absolutely, set sail.

sonitus, -tūs, [soni- (as st. of sono) + tus], M., a sound, noise.

sonus, -ī, [SON + us], M., a sound.

soror, -ōris, [?], F., a sister: soror ex matre, a half-sister.

sors, sortis, [perh. SER (in sero) + tis, but the orig. sense is unc.], F., a lot (for divination), chance.

Sōtiātes, -um, [Celtic], M. pl., a people of Aquitania.

spatium, -ī, [?], N., space, extent, a space, a distance.—Transf., time, space of time, lapse of time.—Phrases: quantum fuit diei spatium, as much as there was time for; intermisso spatio, after an interval; spatia omnis temporis, the whole course of time.

speciēs, -iēi, [SPEC + ies (akin to -ia)], F., (a sight, prob. both act. and pass.).—Passively, a sight, a show, an appearance: summa species earum stantium, a perfect appearance of standing trees (lit. of them standing); ad speciem, for show.

spectō, -āre, -āvī, -ātus, [spectō-]. 1. v. a. and n., look at, regard, have regard to, lie towards (of a country), face.

speculātor, -tōris, [speculā- + tor] M., a spy, a scout.

speculātōrius, -a, -um, [speculator + ius], adj., (of a scout), scouting, reconnoitring (navigia).

speculor, -ārī, -ātus, [speculō-, cf. specula, watch-tower], 1. v. dep., spy, reconnoitre: speculandi causa, as a spy.

spērātus, -a, -um, p. p. of spero.

spērō, -āre, -āvī, -ātus, [spes- (prob. orig. st. of spēs) with r for s], 1. v. a. and n., hope, hope for, expect.

spēs, -eī, [?], F., hope, expectation: summam in spem venire, have the greatest hope.

spīritus, -tūs, [spiri- (as st. of spiro, breathe) + tus], M., breath.—Also, spīrit. Hence, in pl., pride arrogance, temper.

spoliō, -āre, -āvī, -ātus, [spoliō-, booty], I. v. a., *despoil, strip*. — Fig., *rob, deprive, despoil*.

spontis (gen.), **sponte** (abl.), [prob. akin to *spondeo, promise*], F., only with poss. or (poetic) gen., *of one's own accord, voluntarily, on one's own account*. — Rarely, *by one's influence*.

stabiliō, -īre, -ivī (ii), -ītus, [stabilī-], 4. v. a., *make firm*.

stabilitās, -tātis, [stabilī- + tas], F., *steadiness, firmness*.

statim [acc. of †statis (sta- + tis)], adv., *(as one stands, on the spot), at once, forthwith, immediately*.

statiō, -ōnis, [apparently STA + tio, prob. †stati- + o, whence the common -tio used as ending without regard to its origin], F., *(a standing), a position, a post, a picket: in statione, on guard*.

statuō, -uere, -uī, -ūtus, [statu-], 3. v. a., *set up*. Hence, *establish, resolve upon, determine, consider (make up one's mind), take measures*. — Euphemistic for, *punish (de eo causa cognita)*.

statūra, -ae, [statu- + ra, F. of -rus], F., *(a standing), stature, size*.

status, -tūs, [STA + tus], M., *(a standing), a position, a condition, a state, a situation*.

stimulus, -ī, [†stigmō- (STIG + mus) + lus], M., *a goad, a spur*. — As name of a caltrop or instrument of defence, "*spurs*."

stipendiārius, -a, -um, [stipendiō- + arius], adj., *tributary, under tribute, subject to tribute*.

stipendium, -ī, [stipi-, gift, and st. akin to *pendo* (perh. †pendus, cf. *pendulus*) + ium], N., *a tribute*.

stīpes, stīpitis, [?], M., *a trunk (of a tree)*.

stirps, stirpis, [?], M. and F., *a stock, a stem*. — Fig., *a race: stirpem hominum interfici, men to be killed root and branch*.

stō, stāre, stetī, statūrus, [STA], I. v. n., *stand, be placed: decreto (stand by, abide by)*.

strāmentum, -ī, [STRA (form of root of *sterno*) + mentum], N., *(something strewn), straw, thatch*. — Also plur., *saddle-cloths*.

strepitus, -tūs, [strepī- (as st. of *strepo, roar*) + tus], M., *a noise, a confused din*.

studeō, studēre, studuī, no p. p., [†studō- (or †studa-), cf. *studium*], 2. v. n., *be eager for, be devoted to, pay attention to, attend to, desire (a thing in the dat.)*.

studiōsē, [old case-form of *studi- osus*], adv., *eagerly, zealously*.

studium, -ī, [prob. †studō- + ium, cf. *studeo*], N., *eagerness, zeal, devotion, fondness (for a thing), enthusiasm*. Hence, *a pursuit (to which one is devoted), an occupation*.

stultitia, -ae, [stultō- (*foolish*) + tia], F., *folly*.

sub [unc. case, prob. abl., akin to *super*], adv. (in comp.) and prep.:

a. With abl. (of rest in a place), *under: sub oculis, before the eyes*. — Also, *just by: sub monte (at the foot of); sub sinistra, at the left; sub vallo, just under the wall*.

b. With acc. (of motion towards

a place), *under, close to*. — Of time, *just at, just before*: sub vesperum.

c. In comp., *under, up* (from under), *away* (from beneath), *secretly* (underhand), *in succession, a little, slightly*.

subāctus, -a, -um, p. p. of subigo.

subdolus, -a, -um, [sub-dolus, *artifice*], adj., *cunning, wily*.

subdūcō, -dūcere, -dūxī, -ductus, [sub-duco], 3. v. a., *draw up, lead up*: navis (*beach, draw up*).

subductiō, -ōnis, [sub-ductio, cf. subduco], F., *a drawing up, a beaching* (of ships).

subductus, -a, -um, p. p. of subduco.

subeō, -īre, -iī, -itus, [sub-eo], irr. v. a., *go under, undergo, encounter, come up, approach*.

subfodiō (suff-), -fodere, -fōdī, -fossus, [sub-fodio], 3. v. a., *dig under, stab* (underneath).

subfossus, -a, -um, p. p. of subfodio.

subiciō, -icere, -iēcī, -iectus, [sub-iacio], 3. v. a., *throw under, place below, place under, subject, expose to*. — Also, *throw up*. — subiectus, -a, -um, p. p. as adj., *lying near*.

subigō, -igere, -ēgī, -āctus, [sub-ago], 3. v. a., *bring under, subject*.

subitō, see subitus.

subitus, -a, -um, [p. p. of subeo], adj., (*coming up secretly from under*), *sudden, suddenly* (as if adv. taken with the verb), *quick, hasty*. — subitō, abl. as adv., *suddenly, of a sudden*.

sublātus, -a, -um, [sub- (t) latus], p. p. of tollo.

sublevātus, -a, -um, p. p. of sublevo.

sublevō, -āre, -āvī, -ātus, [sublevo], 1. v. a., *lighten up, lighten, raise, raise up, assist, render assistance*. — With reflexive, *rise up*. — sublevātus, p. p., *supporting one's self*.

sublica, -ae, [?], F., *a pile*.

subluō, -luere, no perf., -lūtus, [sub-luo], 3. v. a., *wash underneath, wash*: flumen collis radices.

subministrō (sum-), -āre, -āvī, -ātus, [sub-ministro], 1. v. a., *supply* (as needed), *furnish* (from time to time), *provide*.

submittō (sum-), -mittere, -mīsī, -missus, [sub-mitto], 3. v. a., *send up, send to one's assistance, send as reinforcements, send* (as help), *reinforce*.

submōtus, -a, -um, p. p. of submoveo.

submoveō (sum-), -movēre, -mōvī, -mōtus, [sub-moveo], 2. v. a., *drive off, dislodge*.

subruō, -ruere, -ruī, -rutus, [sub-ruo], 3. v. a., *dig under, undermine*.

subsequor, -sequī, -secūtus, [subsequor], 3. v. dep., *follow up, follow on, follow, succeed to*.

subsidiūm, -ī, [sub-†sedium (SED + ium)], N., (*a sitting in reserve*), *a reserve, a reinforcement, help, relief, support, assistance, resources, provisions*: subsidio mittere, *send assistance*; subsidium ferre, *rescue*: subsidium comparare, *make provision*.

subsīdō, -sīdere, -sēdī, -sessūrus, [sub-sido], 3. v. n., *sit down, remain behind*.

subsistō, -sistere, -stitī, no p. p., [**sub-sisto**], 3. v. n., *stop behind, halt, make a stand: ancorae (hold)*.

subsum, -esse, -fuī, -futūrus, [**sub-sum**], irr. v. n., *be under, be near, be close by (a certain distance off), be near at hand, approach*.

subtrahō, -trahere, -trāxī, -trāctus, [**sub-traho**], 3. v. a., *take away (underneath), carry away, take away (generally)*.

subvectiō, -ōnis, [**sub-vectio**, cf. **subveho**], F., *bringing up, transportation, conveyance*.

subvehō, -vehere, -vēxī, -vectus, [**sub-veho**], 3. v. a., *bring up*.

subveniō, -venīre, -vēnī, -ventūrus, [**sub-venio**], 4. v. n., *come under, come to the support of, come to the assistance of, assist*.

succēdō, -cēdere, -cessī, -cessūrus, [**sub-cedo**], 3. v. n., *come up, advance, come in place of, succeed to, take the place of, come next*. — Also, *be successful, prosper*.

succendō, -cendere, -cendī, -cēnsus, [**sub-†cando** (cf. **candeo**, *glow*)], 3. v. a., *set on fire (as if beneath)*.

succēnsus, -a, -um, p. p. of **succendo**.

successus, -ūs, [**sub-cessus** (cf. **succedo**)], M., *a coming up, an advance, a close approach*.

succidō, -cidere, -cidī, -cīsus, [**sub-caedo**], 3. v. a., *cut under, cut down*.

succīsus, -a, -um, p. p. of **succido**.

succumbō, -cumbere, -cubūī, -cubitūrus, [**sub-cumbo**], 3. v. n., *lie down (under), give way, succumb*.

succurrō, -currere, -currī, -currēsū-

rus, [**sub-curro**], 3. v. n., *rush to support, rush to one's rescue, run to help, succor*.

sudīs, -is, [?], F., *a stake*.

Suessiōnes, -um, [Celtic], M. pl., a tribe of the Belgians between the Marne and the Isère. Their town Noviodunum was later called from them *Soissons*.

Suēvī (**Suēbī**), -ōrum, [Teutonic], M. plur., name of the tribes in habiting a large part of Germany, *Swabians*.

Suēvus, -a, -um, [see **Suevi**], adj., *Swabian*. — As noun, *a Swabian (man or woman)*.

sufficiō, -ficere, -fēcī, -fectus, [**sub-facio**], 3. v. a., *make in place of, supply the place of*. Hence, *suffice, be sufficient, be adequate*.

suffrāgium, -ī, [akin to **suffringo**, *break up*], N., (*a pastern bone, or a potsherd, either used as a ballot*), *a ballot, vote*.

Sugambrī (**Sig-**), -ōrum, [Teutonic], M., a German tribe between the Sieg and the Lippe.

suggestus, -tūs, [**sub-gestus**, cf. **suggerō**], M., (*earth brought up*), *a raised mound, a tribunal, a platform (whence the Roman commander addressed his troops)*.

sui (prop. gen. N. of **suus**), *sibi sē*, [SVA], reflex. pron., *himself, etc.* — Often to be translated by the personal, *he, etc.*, also *each other*. — Esp.: *inter se, from, with, by, etc., each other; inter sese dant, give each other, exchange; per se, of himself, etc., (without outside influence or excitement); see ipse*.

Sulla, -ae, [?], M., a Roman family name. — Esp., *Lucius Cornelius Sulla*, the great partisan of the nobility and opponent of Marius, called the Dictator Sulla.

Sulpicius, -ī, [?], M., a Roman gentile name. — Esp.: 1. *Sulpicius Rufus*, a legatus of Cæsar. — 2. *Servius Sulpicius Galba*, a legatus of Cæsar.

sum, esse, fuī, futūrus, [AS, cf. *am, is*], irr. v. n., *be (exist)*. — Also, with weakened force, *be* (as a mere copula). — Phrases: *erant duo itinera (there were)*; *sibi esse in animo, that he had in mind, intended*; *pars quae est ad Hispaniam (lies)*; *eorum est, they have*; *multum sunt in venationibus (much engaged)*.

summa, -ae, [F. of **summus** as noun], F., (*the top*), *the sum, the total, the main part*: *summa omnium rerum, the whole amount*; *belli, (the general management, the chief control)*; *imperi (the chief command)*; *imperi bellique administrandi (the chief management, etc.)*; *rerum consiliorumque (chief control)*; *summa exercitūs, the main body, etc.*; *summam victoriae, the whole victory*.

summus, see **superus**.

sūmō, sūmere, sūmpsī, sūmptus, [sub-emo, *take*], 3. v. a., *take away, take, get, assume*: *supplicium de (inflict, cf. capere)*; *laborem (spend)*.

sūmptuōsus, -a, -um, [sumptu- + osus], adj., *expensive, costly*.

sūmptus, -tūs, [sub-temptus, cf. **sumo**], M., (*a taking out of the stock on hand*), *expense*.

superātus, -a, -um, p. p. of **supero**.

superbē [old case-form of **superbus**], adv., *haughtily, arrogantly, with arrogance*.

superior, see **superus**.

superō, -āre, -āvī, -ātus, [superō-], 1. v. a. and n., *overtop*. Hence, *get the upper hand of, overcome, conquer, defeat, be superior to, prevail, overmatch, survive (vita)*.

supersedeō, -sedēre, -sēdī, -sessūrus, [super-sedeo], 2. v. n., *sit above*. Hence, *be above, decline, refrain from*.

supersum, -esse, -fuī, -futūrus, [super-sum], irr. v. n., *be over and above, remain, survive*.

superus, -a, -um, [tsupe- (st. akin to **sub**, perh. same) + rus (cf. **inferus**)], *higher, being above* (of space only). — Compar. (in wider meanings), **superior**, *higher, upper, preceding* (of time), *past, before, superior, victorious*. — Superl., **suprēmus** [supra- (?) + imus (?)], *highest*. — Also, **summus** [sup- + mus], *highest, the highest part of, the top of*. — Fig., *greatest, most important, very great, most perfect, perfect, supreme, most violent*: *ab summo, from the top, at the end*; *summis copiis, with all the forces, in force, with all one's might*.

suppetō, -petere, -petīvī, -petitūrus, [sub-peto, *aim at*], 3. v. n., (?), but cf. **sufficio** and **subvenio**), *be on hand, be supplied, be to be found, hold out*.

supplēmentum, -ī, [supplē- (as st. of **suppleo**, *fill up*) + **mentum**], N., *a supply* (to fill up), *a reinforcement*.

supplex, -icis, [sub-plex (PLIC

(fold), as st., cf. duplex], C., a suppliant.

supplicātiō, -ōnis, [supplicā- + tio], F., a supplication. — Esp., a thanksgiving (prayer to the gods upon any signal success, decreed by the senate).

suppliciter [supplici- (as st. of supplex) + ter], adv., in the guise of suppliants, as suppliants.

supplicium, -ī, [supplic- (st. of supplex) + ium], N., a supplication, a sacrifice. — Also, esp., a punishment (usually of death).

supportō, -āre, -āvī, -ātus, [sub-porto], 1. v. a., bring up, convey, supply, furnish.

suprā [instr. (?) of superus], adv. and prep. with acc., above, before.

susceptus, -a, -um, p. p. of suscipio.

suscipiō, -cipere, -cēpī, -ceptus, [sub(s)-capio], 3. v. a., take up, take upon one's self (sibi), assume, undertake, engage in, undergo.

suspectus, -a, -um, p. p. of suspicio.

suspiciātus, -a, -um, p. p. of suspicor.

suspiciō, -spicere, -spexī, -spectus, [sub-specio], 3. v. a. and n., look up, look up at, look askance at. Hence, suspect: suspecta nobis, an object of suspicion to us.

suspīciō (-spītiō), -ōnis, [sub-

†specio, cf. suspicio], F., suspicion. an imputation (timoris), an indication: dabat . . . fugae (endeavor to excite a suspicion); neque abest suspicio, and there is a suspicion abroad, not without suspicion.

suspīcor, -ārī, -ātus, [†suspīc- (cf. suspicio)], 1. v. dep., suspect: p. p. as adj., under suspicion.

sustentātus, -a, -um, p. p. of sustento.

sustentō, -āre, -āvī, -ātus, [sub(s)-tento (cf. sustineo)], 1. v. a. and n., sustain, hold out: bella (hold out against); aegre is dies sustentatur, with difficulty they hold out for that day; pecore famem (keep from starvation by means of, etc.).

sustineō, -tinēre, -tinuī, -tentus, sub(s)-teneo], 2. v. a. and n., hold up under, withstand, endure, hold out, bear, stop, rein in (horses); sustinere se, stand up.

sustulī, see tollo.

suus, -a, -um, [sva + ius, cf. se], adj. pron. (reflex., referring back to subject), his, hers, its, theirs, etc. — Sometimes emphatic, his own, etc., sua clementia, his characteristic clemency. — Often without noun, suī, their (his) men, countrymen, their friends; sua, their (his) possessions, their property: se suaque omnia, themselves and all they had.

T

T., for Titus.

tabernāculum, -ī, [taberna- + culum], N., (a hut of boards), a tent.

tabula, -ae, [†tabō- (TA (stretch)

+ bus?) + la], F., a board. Hence, a record (written on a board covered with wax), a document, a list.

tabulātus, -a, -um, [tabulā- (as

if st. of †tabulo) + tus], adj., *made with boards*. — tabulātum, N., *a flooring, a story*.

taceō, tacēre, tacuī, tacitus, [†tacō- (TAC + us)], 2. v. a. and n., *be silent, be silent about, keep secret, conceal, say nothing about*. — tacitus, p. as adj., *silent, in silence*.

tacitus, -a, -um, p. p. of taceo.

tālea, -ae, [perh. akin to tālus, *ankle-bone*], F., *a rod, a bar*.

tālis, -e, [TA (akin to *that*) + alis], adj. pron., *such, so great*.

tam [unc. case of TA (cf. quam, nam)], adv., *so* (as indicated in the context), *so much*.

tamen [unc. case-form of TA (locat.?)], adv., (introducing a thought opposed to some preceding concession expressed or implied), *yet, nevertheless, still, however, for all that, notwithstanding, after all, at least*.

Tamesis, -is, [Celtic], M., *the Thames*.

tametsī, [tamen (or tam?) -etsi], adv., (*still although*, anticipating the thought to which tamen properly belongs), *although, though*.

tandem [tam-dem, cf. idem], adv., (*just so, even so?*), *at last*. — In questions, to add emphasis, *pray, tell me*, or trans. only by emphasis.

tangō, tangere, tetigī, tāctus, [TAG], 3. v. a., *touch, border on*.

tantopere, see opus.

cantulus, -a, -um, [tantō- + lus], adj., *so small, so little, so trifling*.

tantum, see tantus.

tantummodo [tantum modo], adv., (*so much only*), *only, merely, only just*.

tantundem (tantum-dem, cf. idem), adv., *just so far*.

tantus, -a, -um, [prob. TA + vant (adj. term.) + us], adj., *so much, so great, such* (of magnitude): *tanti est, is of so much weight; tanta exiguitas temporis, so little time*. — Esp., *so much* (and no more), *only so much: tantum progredi (so far as)*. — tantum, N. as adv., *only, merely*.

Tarbellī, -ōrum, [Celtic], M. pl., a tribe of Aquitania.

tardātus, -a, -um, p. p. of tardō.

tardē [old case-form of tardus], adv., *slowly, tardily, with delay*.

tardō, -āre, -āvī, -ātus, [tardō-], 1. v. a., *retard, check, hinder: Romanos ad insequendum (hinder from pursuing, retard the pursuit of, etc.)*.

tardus, -a, -um, [?], adj., *slow, slack, sluggish, without alacrity*.

Tarusātēs, -ium, [Celtic], M. pl., a tribe of Aquitania.

Tasgetius, -ī, [Celtic], M., a prince of the Carnutes.

taurus, -ī, [perh. STAV + rus, akin to *steer*], M., *a bull*.

Taximagulus, -ī, [Celtic], M., a prince of Britain.

taxus, -ī, [?], F., *a yew-tree*. — Also, *yew* (the berries used as poison).

Tectosages, -um, [Celtic], M. pl., a branch of the Volcae, which see.

tēctum, -ī, [N. p. p. of tego], N., *a roof, a house*.

tēctus, -a, -um, p. p. of tego.

tegmentum (tegu-), -ī, [tegi- (st. of tego) + mentum], N., *a covering*.

tegō, tegere, tēxī, tēctus, [TEG], 3. v. a., *cover, thatch, hide, conceal*.

tēlum, -ī, [?], N., a weapon (of offence), a missile, a javelin, a spear.

temerārius, -a, -um, [†temerō- + arius], adj., reckless, rash, hasty.

temerē [old case-form of †temerus], adv., blindly, without reason, without cause. Hence, recklessly, hastily.

temeritās, -tātis, [†temerō- (hasty) + tas], F., blindness, thoughtlessness, recklessness, hasty temper.

tēmō, -ōnis, [?], M., a pole (of a wagon, etc.).

temperantia, -ae, [temperant- + ia], F., self-control, prudence.

temperātus, -a, -um, p. p. of tempero.

temperō, -āre, -āvī, -ātus, [temper- (st. of tempus)], I. v. a., (divide), mix properly. Hence, control, control one's self, refrain, restrain one's self from (quin).—Esp., temperātus, -a, -um, p. p. as adj., temperate, mild.

tempestās, -tātis, [tempes- (st. of tempus) + tas], F., a season, weather.—Esp., bad weather, a storm, a tempest.

temptō (tentō), -āre, -āvī, -ātus, [tentō-, p. p. of teneo, hold], I. v. a., handle. Hence, try, attempt, make an attempt upon, tempt: iter (try to force).

tempus, -oris, [TEM (cut, with root determinative or accidental p) + us], N., (a cutting).—Esp., a division of time, a time, time (in general), a season, an occasion, an emergency, a crisis: tam necessario tempore, at so critical a moment; omni tempore, at all times, always; in reliquum tempus, for the future; uno

tempore, at once; tempore exclusus, cut off by the want of time.

Tencterī (-therī), -ōrum, [Teu- tonic], M. plur., a branch of the Usi- petes, which see.

tendō, tendere, tetendī, tēnsus (tentus), [TEN + do (of unc. origin)], 3. v. a., stretch, stretch out.—Esp., stretch a tent, encamp.

tenebrae, -ārum, [?, perh. akin to temere], F. plur., darkness.

teneō, tenēre, tenuī, tentus (?), [†tenō- (TEN + us)], 2. v. a., hold, retain, keep, possess, occupy: circuitus milia (occupy, extend).—Also, restrain, detain: tenere obsidibus (bind); se tenere, remain; memoriā tenere, remember.

tener, -era, -erum, [TEN + rus], adj., (stretched, thin), delicate, tender, young.

tenuis, -e, [TEN + us, with accidental i, cf. gravis], adj., thin, delicate, feeble, meagre, poor.

tenuitās, -tātis, [tenui- + tas], F., thinness, weakness, poverty.

tenuiter [tenui- + ter], adv., thinly, slightly.

ter [prob. mutilated case of tres], num. adv., three times, thrice.

teres, -etis, [tere- (as st. of tero) + tis], adj., (rubbed), smooth and round, tapering.

tergum, -ī, [?], N., the back: terga vertere, turn and fly; a tergo, in the rear.

ternī, -ae, -a, [tri- + nus], distrib. num. adj., three each, three at once.

terra, -ae, [TERS (?) + a, cf. torreo, dry up], F., (the dry land), the earth, the land.—Also, a land, a

region.—Also, *the ground.*—Plur., *the world.*

Terrasidius, -ī, [Celtic], M., a Roman gentile (?) name.—Esp., *Titus Terrasidius*, a military tribune in Cæsar's army.

terrēnus, -a, -um, [terra- (as if terrē-) + nus], adj., *of earth.*

terreō, terrēre, terruī, territus, [†terrō- (?)], 2. v. a., *frighten, alarm, frighten off, deter.*

terrītō, -āre, no perf. or p. p., [terrītō-], 1. v. a., *frighten: metu (alarm with fears, keep alarmed).*

terror, -ōris, [TERR + or], M., *fright, alarm, terror, dread, panic.*

tertius, -a, -um, [prob. tri- + tius], num. adj., *third (in order); pars (one-third).*

testāmentum, -ī, [testā- (*witness*) + mentum], N., *a will.*

testimōnium, -ī, [testi- + monium], N., *proof, evidence.*

testis, -is, [?], C., *a witness.*

testūdō, -inis, [†testu- (akin to *testa, tile*) + do], F., *a tortoise.*—Esp., *a covered column* (made by lapping the shields of one rank over those of another).—Also, *a shelter* (a small roof over attacking soldiers).

Teutomatus, -ī, [Celtic], M., a king of the Nitiobriges.

Teutones, -um, (-ī, -ōrum), [Teutonic], M. plur., a great German people in Jutland who overran Gaul in B.C. 113 along with the Cimbri. They were defeated by Marius in B.C. 102 at Aquæ Sextiæ (*Aix*).

tīgnum, -ī, [?], N., *a log, a timber, a pile.*

Tigurīnus, -a, -um, [Celtic], adj.,

of the Tigurini.—M. pl., *the Tigurini*, a canton or division of the Helvetii.

timeō, -ēre, -uī, no p. p., [†timō- (cf. *timidus*)], 2. v. a. and n., *be afraid, fear.*—With dat., *be anxious for, be anxious about: nihil (have nothing to fear); timentes*, as noun, *the timid, the fearful.*

timidē [old case-form of *timidus*], adv., *with timidity: non timide, fearlessly.*

timidus, -a, -um, [†timō- (cf. *timeo*) + dus], adj., *cowardly, frightened, timid.*

timor, -ōris, [tim- (cf. *timeo*) + or], M., *alarm, fear, dread.*

Titūrius, -ī, [?], M., a Roman gentile name.—Esp., *Quintus Titurius Sabinus*, a legatus of Cæsar.

Titus, -ī, [?], M., a Roman prænomen.

tolerō, -āre, -āvi, -ātus, [†toler- (TOL + us)], 1. v. a. and n., (*raise up*), *bear, endure, hold out, support: famem (keep from starvation).*

tollō, tollere, sustulī, sublātus, [TOL], 3. v. a., *raise, carry, carry off.* Hence, *remove, take away, destroy: conloquium (break off).*—Esp., **sublātus**, -a, -um, p. p., *elated.*

Tolōsa, -ae, [Celtic], F., *Toulouse*, a city of the Volcæ Tectosages.

Tolōsātēs, -ium, [Tolosa- + tis], M. plur., *the people of Toulouse.*

tormentum, -ī, [TORQU + mentum], N., (*means of twisting*), *torture.*—Also, *an engine* (for throwing missiles by twisted ropes). Hence, *a shot from an engine, a missile.*

torreō, torrēre, torruī, tostus,

[torrō- (cf. *torrus*, *firebrand*)], 2. v. a., *scorch, burn*.

tot [TA + ti], indecl. adj., *so many*.

totidem [toti- (cf. tot) + dem], indecl. adj., *just as many, as many, the same number*.

tōtus, -a, -um, [TA + tus], adj., *the whole, the whole of, all, entire*. — Often translated by an adverb, *entirely, throughout*.

trabs (trabēs), trabis, [?], F., *a beam, a timber*.

trāctus, -a, -um, p. p. of traho.

trādītus, -a, -um, p. p. of trado.

trādō, -dere, -didī, -ditus, [trans-do], 3. v. a., *hand over, give up, give over, deliver up, surrender, commend, recommend*. — Also, *pass along, hand down, teach, communicate*.

trādūcō, -dūcere, -dūxī, -ductus, [trans-duco], 3. v. a., *lead over (with two accusatives), lead across, bring over, lead through, transport, draw over, win over, transfer, lead (along)*.

trāgula, -ae, [?], F., *a javelin* (perh. with a barb, like a boat-hook) used by the Gauls.

trahō, trahere, trāxī, trāctus, [TRAH (for †TRAGH)], 3. v. a., *drag, drag along, drag in, draw in*.

trāciō, -icere, -iēcī, -iectus, [trans-iacio], 3. v. a., *throw across, throw over*. — Also, *strike through, transfix, pierce*.

trāiectus, -a, -um, p. p. of traicio.

trāiectus, -tūs, [trans-iactus, cf. traicio], M., (*a throwing across*), *a passage, a route*.

trānō, -āre, -āvī, -ātus, [trans-no], 1. v. a. and n., *swim across*.

tranquillitās, -tātis, [tranquillō- + tas], F., *stillness, calm*.

trāns [?, akin to *terebra*, *auger*], adv. (in comp.) and prep. with acc., *across, over*. Hence, *on the other side of*. — In comp., *over, across, through*.

Trānsalpīnus, -a, -um, [trans-Alpes + inus], adj., *Transalpine* (lying beyond the Alps from Rome).

trānsceḍō, scendere, -scendī, -scēnsūrus, [trans-scando], 3. v. n., *climb across, board (ships)*.

trānsdūcō, see traduco.

trānseō, -īre, -iī, -itus, [trans-eo], irr. v. a. and n., *go across, cross, pass over, go over, pass through, pass, migrate, pass by*.

trānsferō, -ferre, -tulī, -lātus, [trans-fero], irr. v. a., *carry over, transfer, change the place of*: *ad se bellum* (*direct against*, transferring from somewhere else).

trānsfigō, -figere, -fixī, -fixus, [trans-figo], 3. v. a., *pierce through*.

trānsfodiō, -fodere, -fōdī, -fossus, [trans-fodio], 3. v. a., *dig through*. — Also, *pierce through, wound* (by stabbing).

trānsgridior, -gredi, -gressus, [trans-gridior], 3. v. dep., *step across, step over, cross*.

trānsgressus, -a, -um, p. p. of transgridior.

trānsitus, -tūs, [trans-itus, cf. transeo], M., *a crossing*: *difficili transitu*, *of difficult passage, difficult to cross*.

trānslātus, -a, -um, p. p. of transfero.

trānsmarīnus, -a, -um, [trans-mare (sea) + inus], adj., *foreign*.

trānsmissus, -ūs, [trans-missus, cf. transmittō], M., a crossing, a distance across: *pari spatio transmissūs*, with a passage of the same length.

trānsmissus, -a, -um, p. p. of transmittō.

trānsmittō, -mittere, -mīsī, -missus [trans-mitto], 3. v. a., send over.

trānsportātus, -a, -um, p. p. of transporto.

trānsportō, -āre, -āvī, -ātus, [transporto], 1. v. a., bring over (with two accusatives), transport, carry over: *milites navibus transportari* (were crossing, being taken over).

Trānsrhēnānus, -a, -um, [trans-Rhenum + anus], adj., living across the Rhine.—Plur. as noun, the people across the Rhine.

trānstrum, -ī, [trans (trant-?) + trum], N., a thwart, cross-beam.

trānsversus, -a, -um, [p. p. of transverto], as adj., across, athwart, oblique, transverse: *fossa* (a cross-ditch).

Trebius, -ī, [?], M., a Roman gentile name.—See Gallus.

Trebōnius, -ī, [?], M., a Roman gentile name.—Esp., Gaius Trebonius: 1, a Roman knight; 2, a legatus in Cæsar's army.

trecentī, -ae, -a, [tri-centum], num. adj., three hundred.

tredecim [tres-decem], indecl. num. adj., thirteen.

trepidō, -āre, -āvī, -ātūrus, [trepidō-], 1. v. n., bustle about, hurry: *totis trepidatur castris*, there is a bustle throughout the camp.

trēs, tria, gen. trium, [st. tri-], num. adj., three.

Trēverī (-virī), -ōrum, [Celtic], M. plur., a people in Gaul, originally German, on the Moselle. Sing., Trevir.

Triboces, -um (-ī, -ōrum), [Celtic], M. plur., a German tribe on the Rhine, about Strasburg.

tribūnus, -ī, [tribu- + nus], M., (a chief of a tribe). With or without plebis, a tribune (one of several magistrates elected in the assembly of the plebs voting by tribes, to watch over the interests of the commons).—With militum or militaris, a tribune of the soldiers, a military tribune.

tribuō, -uere, -uī, -ūtus, [tribu-], 3. v. a., (distribute by tribes), distribute. Hence, grant, render, assign, attribute: *tantum dignitatis* (pay such respect); *magnopere virtuti* (attribute it so very much to valor); *rei publicae* (grant out of regard to); *plus libertati* (have more regard for).

tribūtum, -ī, [N. p. p. of tribuo], N., a tribute.

trīdium, -ī, [tri- + st. akin to dies, cf. biduum], N., three days' time, three days.

triennium, -ī, [trienni- (tri-annus) + ium], N., three years.

trīgintā, indecl. num. adj., thirty.

trīnī, -ae, -a, [tri- + nus], distrib. num. adj., three each, three sets of, three (of things in sets).

Trinobantes, -um, [Celtic], M. plur., a people of southern Britain, in the region of Colchester.

tripartitus (tripert-), -a, -um,

[tri-partitus, p. p. of *partio*], adj., *divided in three*. — Esp., *tripartitō*, abl. as adv., *in three divisions*.

triplex, -icis, [tri-plex (PLIC as st.)], adj., *threefold*: *acies* (*in three divisions or lines*), *triple*.

triquetrus, -a, -um, [tri-†*quatus* (*quattuor*), cf. "three-square"], adj., *three-cornered, triangular*.

tristis, -e, [unc. root + *tis*], adj., *sad, gloomy, dejected*.

tristitia, -ae, [tristi- + *tia*], F., *sadness, a gloomy state* (of mind).

truncus, -ī, [?], M., *a trunk*.

tū, *tuī*, [TVA], plur. *vōs* [VA], pron. 2d person, *you* (sing.), *you* (plur.).

tuba, -ae, [?], F., *a trumpet* (a straight instrument for infantry).

tueor, *tuērī*, *tūtus* (*tuitus*), [?], 2. v. dep., *watch, guard, protect*. See also *tūtus*.

tulī, perf. of *fero*.

Tulingī, -ōrum, [Teutonic], M. plur., a German tribe.

Tullius, -ī, [Tullo- + *ius*], M., a Roman gentile name. — See *Cicero*.

Tullus, -ī, [?], M., a Roman family name. — See *Volcatius*.

tum [prob. acc. of TA], adv., *then* (at a time indicated by the context), *at this time*: *cum . . . tum*, see *cum*; *tum vero* (*then, with emphasis, of the decisive point of a narrative*); *tum maxime*, *just then, but especially*.

tumultuor, -ārī, -ātus, [tumultu-], 1. v. dep., *make an uproar*. — As impersonal, *there is an uproar*.

tumultuōsē [old case-form of

tumultuosus], adv., *with disorder, noisily*.

tumultus, -tūs, [tumulō- (perh. reduced) + *tus*], M., (*a swelling, an uprising?*), *an uproar, confusion, a commotion*. — Esp., *an uprising, a commotion* (of revolt, or a war not regularly declared). — See *servilis*.

tumulus, -ī, [†*tumō*- (whence *tumeo, swell*) + *lus*], M., (*a swelling?*), *a hill, a mound*.

tunc [tum-ce, cf. *hic*], adj., *just then, then, at that time*.

turma, -ae, [TUR (cf. *turba, turbo*) + *ma*], F., (*a throng?*), *a squadron, a troop* (of horse, consisting of thirty men).

Turones, -um (-ī, -ōrum), [Celtic], M. plur., a tribe of Gaul on the Loire. Their city became afterwards *Tours*.

turpis, -e, [?], adj., *ugly* (in appearance). Hence, *unbecoming, disgraceful, base, dishonorable*.

turpiter [turpi- + *ter*], adv., *dishonorably*: *turpiter factum*, *an inglorious deed*.

turpitūdō, -inis, [turpi- + *tudo*], F., *baseness*. Hence, *disgrace*.

turris, -is, [?], F., *a tower*.

tūtē [old case-form of *tutus*], adv., *safely, with safety*.

tūtus, -a, -um, [p. p. of *tueor*], as adj., *protected, safe, secure*: *victis nihil tutum*, *no safety for the conquered*. — *tūtō*, abl. as adv., *in safety, safely*.

tuus, -a, -um, [TVA + *ius*], adj. pron., *your, yours*.

U

ubi [supposed to be *quō* (dat. of *quō*-) + *bi*], adv., *where, in which*: *ibi ubi, in the place where*. — Also, of time, *when*: *ubi primum, as soon as*.

Ubiī, -ōrum, [Teutonic], M. plur., a German tribe on the Rhine, opposite Cologne, near which city they were afterwards settled.

ubique [*ubi-que*, cf. *quisque*], adv., *everywhere, anywhere*.

ulcīscor, *ulcīscī*, *ultus*, [?], 3. v. dep., *punish* (an injury, or the doer), *avenge* (an injury), *take vengeance* (absolutely).

ūllus, -a, -um; gen. -īus, [unō- + *lus*], adj., *a single* (with negatives), *any*. — As noun (less common), *nobody, any one*.

ulterior, -us, -ōris, [comp. of *ulterō*-, cf. *ultra*], adj., *farther, more remote*: *ulteriores, those farther off*. — Superl., **ultimus**, -a, -um, [ul- + *timus*], *farthest*: *ultimi, those in the rear*.

ultrā [unc. case, perh. instr., of *†ulter*], adv. and prep. with acc., *beyond*.

ultrō [dat. of *†ulter* (*us*)], adv., *to the farther side, beyond*: *ultra citroque, this way and that, back and forth*. — Esp. *beyond what is expected or required, voluntarily, without provocation, freely, besides*: *sibi parcere cogi (in spite of himself)*; *ad se venire (without his asking it)*.

ultus, -a, -um, p. p. of *ulcīscor*.

ululātus, -tūs, [ululā- (*yell*) + *tus*], M., *a yell, a loud cry*.

umerus, -ī, [?], M., *the shoulder*.

umquam (*unquam*), [supposed to be for *cum-quam* (cf. *quisquam*)], adv. (with neg.), *ever*: *neque . . . umquam, and never*.

ūnā, [instr. (or abl.?) of *unus*], adv., *together, along with them, etc., at the same time, in the same place, also*.

unde [supposed to be for *†cunde* (*cum*, cf. *umquam*, + *de*, cf. *inde*)], adv., *whence, from which*.

ūndecim [*unus-decem*], indecl. num. adj., *eleven*.

ūndecimus, -a, -um, [*unus-deci-mus*], num. adj., *eleventh*.

undique [*unde-que*, cf. *quique*], adv., *from every side, from all quarters*. — Also (cf. *ab*), *on every side*.

ūniversus, -a, -um, [unō-*versus*], adj., *all together, all* (in a mass). *entire*.

ūnus, -a, -um; gen. -īus, [?, old *oenus*], adj., *one, a single, the same, alone* (as adv.): *una celeritate (alone)*; *unum se esse, that he was the only one*; *ad unum, to a man*.

urbānus, -a, -um, [urbi- (reduced) + *anus*], adj., *of a city*. — Esp., *of the city* (Rome), *in the city*.

urbs, *urbis*, [?], F., *a city*. — Esp., *the city* (Rome).

urgeō (*urgueō*), *urgēre*, *ursī*, no p. p., [VARG, *press*, cf. *volgus*], 2. v. a., *press, press hard, urge*.

ūrus, -ī, [Teutonic], M., *a wild ox*.

Usipetes, -um, [Teutonic]. M. pl. a German tribe who migrated from eastern Germany to the lower Rhine

ūsītātus, -a, -um, p. p. of usitor.

ūsitor, -ārī, -ātus, [†usitō- (as if p. p. of †uso, freq. of utor)], i. v. dep., *practise*. — ūsitātus, -a, -um, p. p. in pass. sense, *used, practised, customary, much practised*.

ūsque [unc. case of quō (cf. usquam) -que (cf. quisque)], adv., (*everywhere*), *all the way, even to, to that degree* (with eo ut), *all the time, till, even till*.

ūsus, -a, -um, p. p. of ūtor.

ūsus, -ūs, [UT (in utor) + tus], M., *use, practice, experience*. Hence, *advantage, service*. — Esp.: *usus est, it is necessary, there is need, is necessary* (with personal subject); also, *ex usu, usui, of advantage, of service, advantageous, to the advantage*; *usu venire, happen, occur, turn out, come to pass* (on trial, in practice); *usum navium eripi, be deprived of all use of the ships*; *quae sunt usui, which are serviceable, are needed, are of use*.

ut (utī), [supposed to be for quoti (quō- + ti?)], adv. and conj.: *a. Interrog., how?* — *b. Rel., as, so as, when, inasmuch as, considering that it was*. — Esp. with subjv., *that, in order that, to, so that, so as to, although, granting that*. — Often with object-clause compressed in Eng. into some other form of speech: *poenam ut, etc. (of being)*, etc.; *id facere ut, do this, namely*. — Esp.: *ut semel, when once, as soon as*;

timere ut, fear that not; *ut quisque est . . . ita (in proportion as)*.

uter, -tra, -trum; gen. -trīus [quō (cf. ubi) + terus (reduced), cf. alter], adj.: *a. Interrog., which (of two)?*: *uter utri, which to the other*. — *b. Relative, whichever (of two), the one who (of two)*. — Neut., *utrum*, adv., (*which of the two*), *whether*.

uterque, -tra, -trum; gen. utrius-, [uter-que, cf. quisque], adj., *both*: *medium utriusque, between the two*. — Plur., of sets: *utraque castra, both camps*; *utrique, both parties*. — Rarely of single things: *utraeque, both women*.

utī, see ut.

ūtilis, -e, [futi- (st. akin to utor) + lis], adj., *useful, of use, helpful*.

ūtilitās, -tātis, [utili- + tas], F., *advantage, benefit, service*.

ūtor, utī, ūsus, [?, old oetor, akin to aveo?], 3. v. dep., *avail one's self of, use, exercise, practise, enjoy, adopt, employ, have* (in sense of enjoy or employ), *possess, show* (qualities which one exercises), *occupy* (a town), *navigate* (a sea): *pace (remain at peace)*. — Esp. with two nouns, *employ as, have as*, and the like: *aliquo adiutore (have one's services)*. — *usus*, p. p., often merely *with*.

utrimque [unc. case of uter (cf. interim) + que (cf. quisque)], adv., *on both sides*.

utrum, see uter.

uxor, -ōris, [?], F., *a wife*.

V

∇, for *quīnque*, *five*.

Vacalus, -ī, [?], M., the west branch of the Rhine, at its mouth.

vacātiō, -ōnis, [vacā- + tio], F., *freedom* (from something), *exemption*, *immunity*.

vacō, -āre, -āvī, -ātūrus, [prob. †vacō- (cf. *vacuus*)], I. v. n., *be vacant*, *be free from*, *be unoccupied*, *lie waste*.

vacuus, -a, -um, [prob. VAC (*empty*) + vus], adj., *free*, *unoccupied*, *vacant*, *destitute of* (ab or abl.).

vadum, -ī, [VAD (in *vado*, *go*) + um], N., *a ford*. — Plur., *a ford*, *shoals*, *shallows*: *vado*, *by fording*.

vagātus, -a, -um, p. p. of *vagor*.

vāgīna, -ae, [?], F., *a sheath*.

vagor, -ārī, -ātus, [vagō-, *roving*], I. v. dep., *roam about*, *roam*, *wander*.

valeō, valēre, valuī, valitūrus, [?], prob. denominative, cf. *validus*, *strong*], 2. v. n., *be strong*, *have weight*, *have influence*, *be powerful*.

— Often with N. pron. or adj. as cog. acc.: plurimum valere, *be very strong*, *have great weight*, *have great influence*; minus valet, *is not very strong*; quicquid possunt pedestribus copiis valent, *whatever strength they have is in infantry*; tantum valebat, *had such weight*; pudor valet, *self-respect controls*.

Valerius, -ī, [akin to *valeo*], M., a Roman gentile name. — Esp.: 1. *Gaius Valerius Flaccus*, proprætor in Gaul, B.C. 83. — 2. *Lucius Valerius Præconinus*, a legatus under some unknown proprætor in Gaul.

He was defeated and killed in Aquitania. — 3. *Gaius Valerius Caburus*, a Gaul who received the Roman citizenship prob. from No. 1. — 4. *Gaius Valerius Procillus*, and (5) *Gaius Valerius Donnotaurus*, sons of No. 3, who fought for Cæsar in the war against Vercingetorix.

Valetiācus, -ī, [?], M., a noble of the Hædui.

valētūdō, -inis, [prob. *valent-* + *tudo*], F., *health*. — Also, *ill health*.

vallēs, -is, [?], F., *a valley*.

vāllum, -ī, [N. of *vallus*], N., *a palisade*, *a rampart* (the regular fortification of the Romans, made of stakes and built up with earth), *a wall*.

vāllus, -ī, [?], M., *a stake*.

Vangiones, -um, [Teutonic], M. plur., a German tribe on the west bank of the Rhine, about modern Worms.

varietās, -tātis, [variō- + *tas*], F., *diversity*, *variety*: *pellium* (*different colors*).

varius, -a, -um, [prob. akin to *vārus*, *bent*], adj., *various*, *diverse*.

vāstātus, -a, -um, p. p. of *vastō*.

vāstō, -āre, -āvī, -ātus, [vastō-]. I. v. a., *lay waste*, *devastate*, *ravage*.

vāstus, -a, -um, [?], adj., *waste*. — Also, *immense*, *vast*.

vāticinātiō, -ōnis, [vaticinā- (*foretell*) + *tio*], F., *divination*.

-ve [?], conj. enclit. or.

vectigal, -ālis, [N. of *vectigalis*]. N., *an impost*, *tribute*. — Plur., *revenues* (of a state).

vectīgālis, -e, [†vectigō- (vectis, akin to veho, + unc. term., cf. castigo) + alis], adj., *tributary*: vectigālis habent, *make tributary*.

vectōrius, -a, -um, [vector- (cf. veho, carry) + ius], adj., *carrying*: navigia (transports).

vehementer [vehement- (violent) + ter], adv., *violently, severely, strongly, hotly, exceedingly*.

vel [prob. imperat. of volo, wish], conj., *or*: vel . . . vel, *either . . . or*. — As adv., *even*.

Velānius, -ī, [?], M., a Roman gentile name. — Esp., *Quintus Velanius*, a tribune of the soldiers in Cæsar's army.

Veliocassēs, -ium, (-ī, -ōrum), [Celtic], M. plur., a Gallic tribe of Normandy, about Rouen.

Vellaunodūnum, -ī, [Celtic], N., a town of the Senones.

Vellāviī, -ōrum, [Celtic], M. pl., a tribe of Gaul in the Cevennes mountains.

vēlōcitās, -tātis, [veloci- + tas], F., *swiftness, fleetness, speed*.

vēlōciter [veloci- + ter], adv., *swiftly, quickly*.

vēlōx, -ōcis, [st. akin to volo (cf. colonus) + cus (reduced?)], adj., *swift, quick*.

vēlum, -ī, [?, cf. vexillum], N., *a curtain, a veil*. — Also, *a sail*.

velut [vel-ut], adv., *even as, just as*: velut si, *just as if, as if, no less than if*.

vēnātiō, -ōnis, [venā- (hunt) + tio], F., *hunting, the chase*. — Plur., *hunting, hunting excursions*.

vēnātor, -tōris, [venā- (hunt) + tor], M., *a hunter*.

vēndō, -dere, -didī, -ditus, [venum do], 3. v. a., *put to sale, sell*.

Venellī (Unellī), -ōrum, [Celtic], M. plur., a tribe of Gaul in modern Normandy.

Venetī, -ōrum, [Celtic], M. plur., a tribe of Gaul in modern Brittany.

Venetia, -ae, [venetō- + ia (F. of -ius)], F., *the territory of the Veneti*.

Veneticus, -a, -um, [Venetō- + cus], adj., *of the Veneti*.

venia, -ae, [?], F., *indulgence, favor, pardon*: petentibus veniam dare, *grant their request*.

venīō, venīre, venī, ventūrus, [GAM (for gvenio)], 4. v. n., *come, go*: in spem (*have hopes*). — See also usu.

venitō, -āre, -āvī, -ātūrus, [as if venitō- (from vento, old freq. of venio)], 1. v. n., *come often, visit*.

ventus, -ī, [?], M., *the wind*: vento se dare, *run before the wind*.

vēr, vēris, [for †vasar, VAS, burn], N., *spring*.

Veragrī, -ōrum, [Celtic], M. pl., a Gallic people of the Alps, on the upper Rhone.

Verbigenus, -ī, [Celtic], M., a canton of the Helvetii.

verbum, -ī, [?, cf. morbus], N., *a word*: pluribus verbis, *at great length*; animos verbis confirmavit (*with encouraging words*); facit verba, *speak for, etc.*; magna contumelia verborum, *with most insulting words*.

Vercassivellaunus, -ī, [Celtic], M., one of the Arverni, the uncle of Vercingetorix.

Vercingetorix, -igis, [Celtic], M., a noble of the Arverni. Being

chosen king, he made a stout resistance to Cæsar, but was finally overpowered by the Romans and surrendered by his followers.

vereor, -ēri, -itus, [prob. †verō- (akin to *wary*)], 2. v. dep., *fear, be afraid, dread*. — **veritus**, p. p. in pres. sense, *fearing*.

vergō, -ere, no perf., no p. p. [?], 3. v. n., *incline, slope, look towards* (of an exposure), *lie towards*.

vergobretus, -ī, [Celtic], M., Celtic title of the chief magistrate among the Ilaedui.

vērīsimilis, -e, [veri similis], adj., (*like the truth*), *probable, likely*.

veritus, -a, -um, p. p. of **vereor**.

vērō [abl. of **vērus**], adv., *in truth, in fact, certainly*. — With weakened force, *but, on the other hand, however*. — Often untranslatable, expressing an intensive (emphatic) opposition, or pointing to the main time, circumstance, fact, or agent in a narrative.

versō, -āre, -āvī, -ātus, [versō-], 1. v. a., *turn* (this way and that), *deal with* (some one or some thing). — Esp. in pass. as dep., *turn one's self, engage in, be, fight* (as indicated by the context).

versus, -a, -um, p. p. of **verto**.

versus (**versum**), [orig. p. p. of **verto**], adv. and prep. with acc., *towards, in the direction of*: **quoque versus** (or as one word), *in every direction, all about*.

versus, -ūs, [VERT + tus], M., *a turning*. — Esp., *a verse* (of poetry, where the rhythm turns and begins anew), *a line*.

Verticō, -ōnis, [Celtic], M., one of the Nervii.

vertō, vertere, vertī, versus, [VERT], 3. v. a., *turn*: *terga* (*turn and flee*).

Verudoctius, -ī, [Celtic], M., a noble of the Helvetii.

vērus, -a, -um, [?, VER (in **vereor**) + us], adj., (? *seen, visible*), *true*. — Neut. as noun, *the truth*: *repperit esse vera*, *found the truth to be*. — Also, *just, right*. — See also **vero**.

verūtum, -ī, [veru (*a spit*) + tum], N., *a spear* (of a light kind), *a dart*.

Vesontiō, -ōnis, [Celtic], M., the chief town of the Sequani, now *Besançon*.

vesper, -erī, [?], M., *the evening*.

vester, -tra, -trum, [ves- + ter (us)], poss. adj. pron., *your, yours*.

vestigium, -ī, [†vestigō- (cf. **vestigio**) + ium], N., *the footstep, the footprint, a track*. — Esp.: **e vestigio**, *forthwith* (from one's tracks ?); **eodem vestigio**, *in the same spot*; **in illo vestigio temporis**, *at that instant of time*.

vestiō, -īre, -īvī (-iī), -ītus, [vesti-], 4. v. a., *clothe, cover*. — Pass., *clothe one's self with* (with thing in abl.). *wear*.

vestis, -is, [VES (*cover*) + tis], F., *clothing, garments*.

vestītus, -tūs, [vestī- + tus], M., *clothing, garments*.

veterānus, -a, -um, [veterā- (as if st. of **vetero**) + nus], adj., *vet-eran* (long in service).

vetō, vetāre, vetuī, vetitus, [st. akin to **vetus**], 1. v. a., *forbid*.

vetus, -eris, [?], adj., *old, former, of long standing*: **milites** (*old soldiers, veterans*).

vexātus, -a, -um, p. p. of **vexo**.

vēxillum, -ī, [?, apparently a dim. of **velum**], N., *a flag*: **sub vexillo**, *in a detachment, without any signa, which were carried only in the regular corps*.

vexō, -āre, -āvī, -ātus, [†**vexō**- (as if p. p. of **veho**)], I. v. a., (*carry this way and that*), *harass, annoy, commit depredations on, overrun* (a country), *ravage* (lands).

via, -ae, [for **veha**? (**veh-** + **a**)], F., *a road, a way, a route, a march*: **tridui viam**, *three days' journey*.

viātor, -tōris, [†**viā**- (as st. of †**vio**) + **tor**], M., *a traveller*.

vīcēnī, -ae, -a, [akin to **viginti**], distrib. num. adj., *twenty* (apiece).

vīcēsīmus, -a, -um [akin to **viginti**], num. adj., *twentieth*.

vīciēs (-ēns), [akin to **viginti**], num. adv., *twenty times*: **vicies centum milia passuum**, *two thousand miles*.

vīcīnitās, -tātis, [**vicinō**- (*neighbor-ing*) + **tas**], F., *neighborhood, vicinity*. — Plur., *neighbors*.

vīcis, gen. (nom. not found), *change, turn*: **in vicem**, *in turn*.

vīctīma, -ae, [akin to **vinco**, perh. going back to the sacrifice of prisoners], F., *a victim, a sacrifice*.

vīctor, -tōris, [**VIC** (in **vinco**) + **tor**], M., *a victor*. — Often as adj., *victorious, triumphant*.

vīctōria, -ae. [**victor**- + **ia**], F., *victory, success* (in war)

vīctus, -a, -um, p. p. of **vinco**.

vīctus, -tūs, [**VIG** (?), (cf. **vixi**) + **tus**], M., *living, life*. — Also, *means of living, food*: **domus victusque**, *intercourse, life in common*.

vīcus, -ī, [**VIC** (*enter*) + **us**], M., (*a dwelling*), *a village* (a collection of dwellings).

vīdeō, **vīdēre**, **vīdī**, **vīsus**, [**VID**, perh. through a noun-st.], 2. v. a., *see, observe, examine* (reconnoitre), *take care* (see that). — In pass., *be seen, appear, seem, seem best*.

Vienna, -ae, [**Celtic**], F., a town of the Allobroges, on the Rhone, now *Vienne*.

vīgilia, -ae, [**vigil**- (*awake*) + **ia**], F., *a watch, watching*. The Romans divided the night into four watches, and reckoned the time thereby.

vīgīntī [**dvi**- (st. of **duo**) + form akin to **centum** (perh. the same)], indecl. num. adj., *twenty*.

vīmen, -inis, [root (or st.) **vi** (*twine*) + **men**], N., *a twig* (flexible, for weaving), *osier*.

vīnciō, **vīncīre**, **vīnxī**, **vīnctus**. [perh. akin to **vinco**], 4. v. a., *bind, fetter*.

vīncō, **vīncere**, **vīcī**, **vīctus**, [**VIC**], 3. v. a. and n., *conquer, defeat, prevail*: **naturam** (*outdo*).

vīnctus, -a, -um, p. p. of **vincio**.

vīnclum (**vinclum**), -ī, [†**vīncō**- (st. akin to **vincio**, perh. primitive of it) + **lum** (N. of **lus**)], N., *a chain*: **ex vinculis**, *in chains*, see **ex**: **in vincula**, *into prison, into confinement*.

vīndicō, -āre, -āvī, -atus, [**vīndic**-, *defender*], I. v. a., *claim, claim one's rights against, defend*: **in aliquem** (*punish*); **Galliam in libertatem**

(*establish the liberty of*, a phrase derived from the formal defence of freedom in a Roman court).

vīnea, -ae, [vinō- + ea (F. of -eus)], F., a *vineyard*, a *vine arbor*. Hence, a *shed* (defence, for a besieging party, made like an arbor).

vīnum, -ī, [?], N., *wine*.

violō, -āre, -āvī, -ātus, [?], I. v. a., *abuse*, *violate* (a sacred object), *lay waste*: *hospites* (*injure*, a guest being held sacred).

vir, virī, [?], M., a *man*, a *husband*.

vīrēs, see *vis*.

virgō, -inis, [?], F., a *maiden*, a *maid*, a *virgin*.

virgultum, -ī, [†virgula- (?) + tum, cf. tumultus], N., only in pl., *shrubbery*, a *thicket*, *bushes* (cut for military purposes).

Viridomārus, -ī, [Celtic], M., a noble of the Hædui.

Viridovīx, -īcis, [Celtic], M., a prince of the Venelli.

virītim [vir + itim, as if acc. of verbal in -tis], adv., *man by man* (of distribution), *to each individual*.

Viromandūi, -ōrum, [Celtic], M. plur., a Gallic tribe in modern Picardy.

virtūs, -tūtis, [virō- (reduced) + tus], F., *manliness*, *valor*, *prowess*, *courage*. — Also, *merit* (generally), *noble conduct*, *virtue*: *virtute* (with gen.), *thanks to*. — Plur., *virtues*, *merits*, *good qualities*.

vīs, vīs (?), [?], F., *force*, *might*, *violence*. — Esp.: *vi cogere* (*forcibly*); *vim facere*, *use violence*; *vim hostium prohibere* (*violent attack*); *vi fluminis oppressi*, *overcome by the*

violent current. — Plur., *strength*, *force*, *powers*, *bodily vigor*.

vīsus, -a, -um, p. p. of *video*.

vīta, -ae, [root of *vivo* + ta], F., *life*, *the course of life*.

vītō, -āre, -āvī, -ātus, [?, *vita*-?], I. v. a., (*escape with life*, *live through*?), *escape*, *avoid*, *dodge*.

vitrum, -ī, [?], N., *woad* (a plant used by the Britons for dyeing blue).

vīvō, vīvere, vīxī, vīctus, [VIC (*vigor*?)], cf. *victus*], 3. v. n., *live*: *lacte* (*live on*).

vīvus, -a, -um, [VIGOR (?) + us], adj., *alive*, *living*.

vix [poss. VIC (in *vinco*)], adv., *with difficulty*, *hardly*, *scarcely*, *barely*. — Also, of time, *hardly* (. . . *when*).

Vocātēs, -ium, [Celtic], M. plur., a people of Aquitania, on the Garonne.

Vocciō, -ōnis, [Celtic], M., a king of Noricum.

vocō, -āre, -āvī, -ātus, [voc- (st. of *vox*)], I. v. a., *call by name*, *call*, *summon*, *invite*.

Vocontii, -ōrum, [Celtic], M. pl., a tribe between the Isère and the Durance.

Volcae, -ārum, [Celtic], M. plur., a people of Gaul in the Roman province. — See *Tectosages* and *Arecomici*.

Volcānus (Vul-), -ī, [?], M., *Vulcan* (the god of fire and metals).

Volcātius, -ī, [?], M., a Roman gentile name. — Esp., *Gaius Volcatius Tullus*, a young man in Cæsar's suite.

volgus (vul-), -ī, [VOLG (*press*) + us], N., *the crowd*, *the common people*, *the mass*: in *volgus efferri*,

be spread abroad; *militum* (the common soldiers, the army).—*volgō*, abl. as adv., commonly, generally, everywhere.

volnerātus, -a, -um, p. p. of *volnero*.

volnerō (*vul-*). -āre, -āvī, -ātus, [*volner-*], 1. v. a., wound, hurt.

volnus (*vul-*), -eris, [prob. akin to *vello*, pluck], N., a wound.

volō, velle, voluī, [*VOL*], irr. v. a. and n., wish, be willing, want: velle aliquem aliquid, want one for anything, want anything of one; quid sibi vellent, what they wanted, or meant, or intended to do, what the business they had.

voltus (*vul-*), -tūs, [*VOL* + *tus*], M., (wish, expression of countenance), look, countenance, face: *voltūs fingere*, compose one's countenance, conceal one's feelings; *alicuius voltum ferre*, dare to look in one's face.

voluntārius, -a, -um, [*volent-* (p. of *volo*) + *arius*], adj., voluntary. — As noun, a volunteer.

voluntās, -tātis, [*volent-* (p. of *volo*) + *tas*], F., willingness, good-will, consent, desire, will, approval, an inclination: *voluntates alienare* (good-will).

voluptās, -tātis, [*volup-* (akin to *volo*) + *tas*], F., pleasure, delight.

Volusēnus, -ī, [?], M., a Roman family name.—Esp., *Gaius Volusenus Quadratus*, a military tribune in Cæsar's army.

Vorēnus, -ī, [?], M., a Roman family name.—Esp., *Lucius Vorenus*, a centurion of Cæsar's army.

vōs, see *tu*.

Vosegus, -ī, [Celtic], M., the Vosges Mountains, running north-erly from the Jura along the Rhine

voveō, vovēre, vovī, vōtus, [?], 2. v. a., vow, make a vow.

vōx, vōcis, [*VOC* as *st.*], F., a voice, a word, an expression, a shout.—Collectively, cries, words, talk.—Plur., talk, reports: *nulla vox audita* (not a word); *militum vocibus carpi* (taunts); *concurso ac vocibus cogi* (outcries).

X

X, for decem, ten.

XX, for vīgintī, twenty.

