

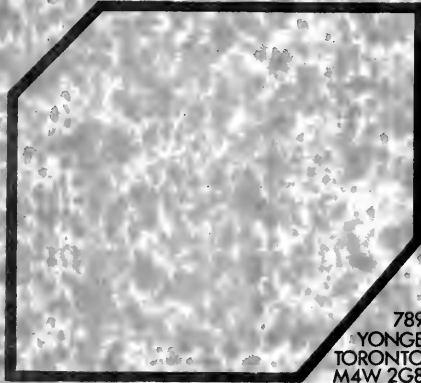

METROPOLITAN  
TORONTO  
LIBRARY



789  
YONGE  
TORONTO  
M4W 2G8

M

METROPOLITAN  
TORONTO  
CENTRAL  
LIBRARY

---

Science and Technology

SC



SR



OCT 25 1974

THE  
**Canadian Horticulturist**

PUBLISHED BY THE

FRUIT GROWERS' ASSOCIATION OF ONTARIO.

---

---

VOLUME XIX.

---

---

*Editor* . . . . . LINUS WOOLVERTON, M.A.



PUBLISHED AT TORONTO. OFFICE AT GRIMSEY.

1896.

116 682

INDEX TO VOLUME XIX.

OF

THE CANADIAN HORTICULTURIST.

<b>A</b>		PAGE.	PAGE.	
Absorbents, The best .....		78	Apples, Best Red Winter .....	324
Abutilon, The.....		429	“ Commercial Varieties of.....	138
African Queen Gooseberry.....		296	“ Cold Storage for.....	306
Alkaline Wash for Pear Trees .....		71	“ for New York, Canadian.....	235
Alpha Chestnut.....		175	“ in Hamburg, Price of.....	435
American Blackberries.....		373	“ in Edinburgh.....	34
American Wonder Pea.....		161	“ in England, Canadian.....	232
Ammonia as a Tree Wash.....		322	“ Liverpool.....	34
Ammonia in Spraying, Use of.....	372, 408		“ in Montreal .....	113
Anemone Fulgens.....		1	“ Iron-clad .....	384
Annual Meeting, The.....	31, 72, 397,	438	“ Low Prices for.....	370
Apple as Medicine, The.....		17	“ Packing.....	261
“ Barrel, Legal.....		68	“ Profitable Market Varieties of.....	84
“ Blight.....		302	“ Seedlings Examined in 1895... ..	115
“ Bulletin.....		442	“ Small, Useless.....	439
“ Crop.....	280, 281, 282,	288	“ Superiority of Canadian.....	373, 374
“ Crop, Dominion.....		434	“ Stock, Feeding.....	421, 422
“ Crop, European.....	311, 312,	313	“ Varieties to Plant.....	441
“ Crop in Nova Scotia.....		378	“ Where to Ship.....	371
“ Crop of 1896.....		441	“ Wholesomeness of.....	410
“ Crop, Utilizing the.....		436	Apricots, Russian.....	140
“ Culture, Causes of Failure in 79,		119, 147, 198	Army Worm.....	281, 300
“ Dwarf.....		283	Asclepias, The.....	169
“ Exhibit from Bay of Quinte Ex-		382	Ashes, The use of .....	81, 130, 227
“ Export Trade, Losses in.....		122	Ash Heap, Utilizing the.....	428
“ Market.....	353, 404,	420	Asparagus .....	163, 207
“ Market in Great Britain.....	399, 400	409, 410	Aster, New Branching.....	191
“ Orchard, Quantity of Fertilizer		139	Australia as an Apple Market.....	64
“ for.....		139		
“ Picker, A Hand.....		349	<b>B</b>	
“ Picking and Packing.....		353	Baldwin Apple, The.....	65
“ Pruning the.....	89, 119		Barberry, The.....	217
“ Scab, Spraying for.....	83, 136		Baruyard Manure, .....	54, 90
“ Shipment to Australia.....		64	Barrels, Unloading from Wagons.....	14
“ Tree Borer, Flat Headed.....		154	Barren Orchards, Cause of .....	44, 65
“ Tree Borer in Muskoka.....		351	Beeches, The.....	392
“ Trees, Blossoming Period and		140	Bees in the Orchard, Importance of....	38
“ and Habit of.....		140	Begonias, Tuberous Rooted.....	138
“ Trees, When to Plant.....		371	Belle Strawberry.....	4
“ Worm, A New.....		266	Ben Davis Apple.....	114
Apples, Barreling.....		38	Berry Cart, Home Made.....	134
			Bessarabian Cherry, The.....	128
			Beurre Giffard Pear .....	10
			Blackberries, Cultivation of.....	8, 163

	PAGE.
Blackberries for Home Use .....	180
“ “ Land for .....	118
“ “ Planting .....	126
“ “ Pruning .....	90
“ “ Varieties of .....	103
“ “ Yields and Profits of .....	209
Black Currants, Novel way of Pruning	198
Black Raspberries, Culture of .....	40
Blight on the Apple and Pear .....	302
Bloom of Fruit Trees .....	211
Bone Meal, How to Apply .....	212
Bordeaux Mixture .....	104, 153
Borer of Apple Tree .....	351
Boxes vs. Barrels for Apples .....	65
Brandygag Plum .....	321
Breekenridge Apple .....	115
Budding Cherries, Stock for .....	140
Bud Moth .....	163
Bulbs for House and Window Culture .....	395
Bulbs for Spring Flowering .....	350
Burbank Plum .....	144
Bushel Box, The .....	243

## C

Calceolaries, Care of .....	94
Calla Lily, The .....	432
Campbell's Early Grape .....	87
Canadian Apples, Superiority .....	373, 374
Candytuft .....	169
Canker Worm .....	218
Canna, The .....	61, 171, 188
Canna Indica, Varieties of .....	316
Canning and Evaporating, Co-operative	346
Cardinal Flower .....	169
Carnations .....	402
Carnie's Yellow Gooseberry .....	263
Cart for Grapes and Berries .....	134
Case for Apples .....	380
Cauliflowers not Heading .....	403, 440
Cedar of Lebanon .....	70
Celery under Irrigation .....	203
Cherries, Bigarreau .....	255
“ for the Home Garden .....	180
“ Stock for Propagating .....	140, 259
Cherry Currant .....	136, 226
Chestnuts .....	265
Chestnuts, Japan .....	142, 175
China Asters .....	133
Chrysanthemum Culture .....	93, 306
Chrysanthemum Show at Guelph .....	437
Chrysanthemums, How to Succeed with	57
Cider .....	280, 354
Cider Making, Improved Process in .....	389
Cigar Case Bearer .....	45
Clarksburg Spray Nozzle .....	210
Clematis Virginia .....	360
Clyde Strawberry .....	294
Coal Ashes .....	103, 179, 433
Codling Moth, Paris Green for the .....	147
Cold Storage .....	12, 97, 304, 306, 368
Colorado Blue Spruce .....	77
Columbian Raspberry .....	304, 324
Commercial Fertilizers, How to Apply	180

	PAGE.
Conservatories, Private .....	18
Copper Sulphate Solution .....	153
Corn Cobs, Fertilizing with .....	181
Cranberry, Medicinal use of .....	48
Crimson Beauty Apple .....	117, 381
Crimson Clover .....	78, 233, 278, 286
Crocuses for Spring Flowering .....	350
Cross Fertilization .....	69
Crown Grafting .....	197
Crown Imperial, The .....	350
Cucumbers for Pickling .....	201
Cucumbers under Glass .....	204
Cultivation, Importance of .....	53, 80, 126, 129, 239
Cultivation, Late .....	55
Cupid Sweet Pea .....	190
Cureulio, Gas Tar for .....	141
Cureulio, Salt and Sulphur for .....	72
Currants .....	226
“ for the Home Garden .....	180
“ Pruning .....	90
“ Uses of .....	219
Cyclamen, A Plea for the .....	193

## D

Dahlias .....	131, 133
Dahlias, Wintering .....	403
Darwin Tulip .....	95
Delaware Red Winter apple .....	99
Della K. Strawberry .....	292
Downing Gooseberry .....	139
Downing's Winter Maiden Blush Apple .....	86
Drives and Walks in Private Grounds .....	364
Dry Rot .....	97
Dyehouse Cherry .....	303

## E

Early Purple Cherry .....	224
Early Victor Grape .....	418
Early Winter Wilson Blackberry .....	321
Egg Plant and its Cultivation .....	165
Egg Plant, Varieties of .....	166
Elberta Peach .....	423, 358
Elberta Peach in Michigan .....	268
Empress Apple .....	116
English Sparrow .....	67, 72, 143
Equinox Strawberry .....	3
Errata .....	64, 137, 434
Eudamus Tityrus .....	325
Evergreens, Planting .....	103
Export Trade in Fruits .....	383, 399, 410
Export Trade, Losses in .....	122
Export Trade, Value of Canadian .....	68

## F

Fameuse Apple for the United States .....	443
Fameuse for Montreal in England .....	6
Farmers' Institutes, Speakers for .....	435
Fellemburg Plum .....	37
Fence, Improved .....	276



	PAGE.
Fence for the Orchard.....	191
Fern Lunch Party.....	187
Fertilizers.....54, 81, 90, 100, 102, 179,	180
Fertilizers for Flower Beds.....	430
Fertilizers for Small Fruits.....	260
Fertilizers, How to apply Commercial..	180
Fertilizing the Orchard.....	388
Fitzgerald Peach.....	426
Flat-headed Apple Tree Borer.....	154
Floral Decorations.....194,	244
Floral Love Story.....	279
Floral Notes.....	169
Flower Beds, Artistic Arrangement of	192
Flower Beds, Manure for.....	430
Flowers, Dried.....	319
Flower Shows.....	283
Flower Trade in Scilly Islands.....	144
Four-lined Leaf Bug.....	285
Frozen Fruits, Thawing.....	419
Fruit and Fruit Trees in England, Can-	287
nadian.....	158
Fruit as Food.....	106
“ at Oakville.....	336
“ Attractive.....	237, 311
“ Crop.....	434
“ Depot in Germany.....	344
“ Exhibit at the Industrial Fair.....	137
“ Experiment Stations, List of.....	136
“ Experiment Stations in Cali-	264
fornia.....	374
“ Garden, The.....	139
“ Good Prices for Fancy.....	72
“ Growing for Profit.....	34
“ Growing in East Middlesex.....	398
“ Growing in Scotland.....	208, 376
“ Growing in the North-west.....	173
“ House.....	29, 156
“ Medicinal value of.....	288
“ Packages.....	304
“ Prospects.....	438
“ Storage.....	47
“ Tariff on.....	225
Fruits for Europe.....	
Fruits in England, Tender.....	

**G**

Gabriel Luizet Rose.....	183, 243
Gandy Strawberry.....	3
Gano Apple.....	99
Garden, Cultivation of the.....	129
Garden Netting.....	29
Gas Tar for the Curculio.....	141
Geneva Grape.....	175
Geraniums.....	131, 317
Gladiolus, Degeneration and Reversion	216
of the.....128, 171,	216
Gladiolus, How to grow the.....132,	192
Gladiolus, Propagating the.....	214
Gladiolus, The.....	62
Gladiolus Bulbs, Digging and Caring for	316
Gooseberries for the Home Garden... 180	180
Gooseberries, Large.....	286

	PAGE.
Gooseberries Mildew Proof.....	374
“ “ Notes on.....263	295
“ “ Pruning.....	90, 101
“ “ Some New.....	268
“ “ Training.....	178
Gooseberry, A Seedling.....	280
Gooseberry Mildew.....	102
Grafting Apples.....	197
Grape Cart, Home Made.....	134
Grape Juice.....	359
Grape Phylloxera.....	308
Grapes for Home Garden.....	180
“ in England.....	225
“ Marketing.....	323
“ Picking and Packing.....	297
“ Pruning and Trellising.....49,	90
“ The Value of our Native.....	51
Grape Vine Leaf Hopper.....	28
Grape Vine Sphinx.....	307
Grape Vines, Layering.....	231
Grape Vines, Trellising.....32,	143
Gregg Raspberry.....	15
Greenhouse, An Amateur's.....	20
Greenhouse, The.....	94
Grimsby Horticultural Society.98,	175
	326
	367

**H**

Hall's Honeysuckle.....	440
Hamburg Horticultural Exhibition... 398	398
Harvesting Fruit.....196,	379, 399
Haverland Strawberry.....	294
Hellebore Mixture.....	154
Hen Manure, Utilizing.....	428
Hens in the Orchard.....	301
Herbaceous Plants.....	186
Himalayan Apricot.....	106
Hollyhocks, Protecting.....	96
Horticultural Exhibition in Hamburg.. 434	434
Horticultural Societies .27, 29, 30,	175, 347
	367, 400, 437
Horticultural Societies, Forming..... 141	141
Horticultural Societies, Lecturers to	234
to.....137, 162, 199,	234
Horticulture as an Occupation.....	174
Hotbeds, How to Make and Operate.. 91	91
House Plants, The Cultivation and Man-	24
agement of.....	24
House Plants, Pruning.....	170
Howell Pear.....	411
Humboldt Blackberry.....	373
Hyacinths.....23, 350,	432
Hydrangea, Wintering the.....	373

**I**

Ice Harvest, The.....	17
Ice House and Cold Storage.....12,	286
Ice House, How to Build an.....	43
Ice House, Sawdust for.....	177
Ice Harvest, The.....	17
Ice Tools.....	17

	PAGE.		PAGE.
Ideal Spray Pump.....	105	Monstreuse de Mezel Cherry.....	257
Industry Gooseberry.....	295	Mount Tacoma.....	296
Insects, Some Destructive.....	218	Muskingum Strawberry.....	3
Inspection of Fruit.....	434	Myrtle, The.....	365, 440
Inspection of Nursery Stock.....	438	McGowan Spray Nozzle.....	104
Irrigation.....	78, 202, 285, 326, 352		
Irrigation in the East.....	277		
		<b>N</b>	
<b>J</b>		Napanee Horticultural Society.....	347
Japanese Chestnuts.....	142, 175	Napoleon Bigarreau Cherry.....	257
Japan Plums.....	157	Narcissus and the Tulip.....	95
Japan Plums, Hardiness of.....	213	New Fruits Committee.....	283
Jersey Queen Strawberry.....	4	New York as a Market for Canadian Apples.....	235, 405, 406, 407
Jordan Apple.....	116	Niagara Falls South Horticultural Society.....	28
Journal, A Dominion.....	425	Nitrate of Soda, How to Apply.....	213
Judging at Exhibitions.....	105, 220	Nitrogen in Manure.....	90
Judging Fruit, English Rules for.....	378	North Star Currant.....	226
Judging, Score Cards for.....	275	Nova Scotia School of Horticulture.....	66
		Nozzle, A New Canadian.....	135
<b>K</b>		Nursery Stock, Buying.....	270
Kerosene Emulsion.....	154	Nursery Stock, Inspection of.....	438
Kieffer Pear.....	300	Nut Culture.....	142
Kieffer Pears for the English Market..	424		
Knotty Growth.....	284	<b>O</b>	
		Oak Trees.....	15
<b>L</b>		Ontario Apple.....	39
Labels for Trees.....	32	Orchard Crops.....	191
La France Rose, Fragrance of.....	186	Orchard Culture.....	55, 87
Lancashire Lad Gooseberry.....	295	Orchard, Setting and Cultivating the..	53
Lawn, Care of the.....	224	Orchards, Cause of Barrenness in....	44, 65
Lawn, Grading a.....	393	Orchards in Great Britain, Damage to..	399
Lawn, How to Improve a.....	429	Ornamental Tree.....	71
Lawn Making.....	195	Orr, W. M.....	111
Lawn Table, A Pretty.....	278	Onllin's Golden Gage Plum.....	321
Lawrence Pear.....	387	Our Book Table.....	34, 73, 169, 144, 181, 216, 327, 374, 408, 443
Lawver Apple.....	77, 91	Oyster Shell Bark Louse.....	155
Leaf Roller of Strawberry.....	240		
Lily of the Valley.....	22	<b>P</b>	
Lindsay Horticultural Society.....	66	Packages for Apples.....	65, 261
Living in Paris, Price of.....	106	Packages for Fruit, Size of.....	29, 277
London Fruit Market.....	442	Packages for Tender Fruits.....	156
Lovett's Best Blackberry.....	180	Packing Apples.....	329
		Packing Apples for the London Market	271
<b>M</b>		Pansies, Protecting.....	96
Magnolia.....	70, 372	Paris Green Mixture.....	153
Mahaleb Cherry Seedlings.....	259	Parker Earle Strawberry.....	3
Manitoba Fruits.....	429	P. Parry Pear.....	56, 281
Manure, Old.....	431	Peach with the Apple, Planting the..	391
Maple Bank Strawberry.....	4, 294	Peach Trees, Manure for.....	203
Maple Tree Borer.....	255	Peach Trees, Wash for.....	260
Marguerite Carnation.....	187	Peaches, Best Varieties of.....	11
Melon Culture.....	201	"    Best Six Varieties of.....	314
Merscreau Blackberry.....	118	"    for East Middlesex.....	71
Mexican Strawberry.....	326	"    from Seed, Propagating.....	63
Mice, Protection against.....	401	"    in England.....	225
Middlemen, The.....	67	"    Season of Ripening.....	70
Mikado Tomato.....	327	Pear, A New.....	33
Mincer Plum.....	372	"    Blight.....	302
Missouri Mammoth Quince.....	262		

	PAGE.
Pear, Pruning the	90
"    Scab, Bordeaux for	136
Pears in England, Price of	434
"    in Montreal	113
"    Picking and Ripening	85, 305
"    Russian	315
"    Sowing Seeds of	72
Pearl Gooseberry	72
Peas, Garden	161
Phoenix Gooseberry	263
Phylloxera of Grape	301, 308
Picking Apples	349, 353
Pinks, Japan	170
Plant Distribution	33
Planting Apple Trees	124
Planting, Distance in	372
Plants, Device for Transplanting	134
Plaster, Uses of	359
Plowing with Three Horses	241
Plum, An Early	321
"    Basket	213
"    Growing in the Cold North	230
"    Knot	402
"    Leaf Fungus	221
"    Orchard, Mr. Cline's	375
"    Propagating the	212
"    Pruning the	103
"    Scale	168
Plums for East Middlesex	71
"    for Southern Ontario, Commercial	104
"    for the Home Garden	180
"    Hardy	286
"    Russian	211, 267
"    Varieties of Hardy	214
Port Colborne Horticultural Society	97
Potato, An Early	372
Potato Bug Killer	156
Potatoes, Good	401, 441
Potato Rot	210
Powdery Mildew in the Greenhouse	179
Preservative Fluids	322
Prince Albert Currant	226
Prince of Wales Black Currant	139
Prominent Canadian Horticulturists	
Or, W. M.	111
Stevenson, Rev. E. B.	289
Prune d'Agén	37
Pruning Fruit Trees	89, 119
Pruning Grapes in Winter	354
Pyrethrum Powder Mixture	154

**Q**

Quality of Fruit, Selling on the Basis of	54
Queen Charlotte Canna	189
Queen of the Prairie Rose	400
Quince Culture	386
Quinces, Hardiness of	213
Quinces, Sowing Seeds of	72

**R**

Raspberries, Close Pruning and Tying	
of	266

	PAGE.
Raspberries, Fertilizers for	102, 200
"    for the Home Garden	100, 180
"    in the Peach Orchard	281
"    Pruning	90
"    Varieties of	103
"    Yield of	26
"    Yield of Unpruned	174
Raspberry Canes, Affected	324
"    Canes, Pruning Back	321
"    Culture	15, 42
"    First and Best	287
"    Root Gall Fly	69
Red Cross Currant	26, 99, 226, 282
Refrigerator Service	433
Rex Begonia, How to Treat the	33
Ripe-rot of Plums	220
Roads, Our Country	412, 417
Robena Peach	135
Rochelle Apple	426
Rose Beetle	284
"    Bed, Exposure for a	186
"    Influence of a	185
"    The	242
Roses, Budding	427
"    Compost for	184
"    in the Window Garden	173
"    Outdoor	173
"    Pruning	177
"    Pruning Climbing	324
"    Varieties of	163
"    Wintering Climbing	370
Russian Pears	315
Russian Plums	211, 260
Russian Salvia	317

**S**

San José Scale	164
Saunders Black Currant	139
Saunders Plum	214, 322
Scarlet Oak	15
Scarlet Pippin Apple	117, 381
Score Cards for Judges	221, 275
Secretary, Lady's	16
Secley Fruit Basket	156, 216
Selling Fruit on the Basis of Quality	54
Shaffer Raspberry	304
Shot Hole Fungus	221
Shrubbery Borders	239
Shrubs	443
Sierra Crimson Plum	405
Simcoe Experiment Station	303
Skids for Sliding Loads for Wagons	14
Small Fruits, Pickers for	99
Smith's Giant Black Cap	269
Snow Apple as a Dessert Fruit	400
Soubegian Raspberry	15
Specked Apples (poem)	444
Spraying	284
"    Advantages of	149
"    Calendar	150
"    Experiments in 1896	136
"    for Fungi	29

	PAGE.		PAGE.
Spraying, Small Cost of.....	263		
“ Trees, Frame Work for.....	135		
Spray Pump Contest.....	145		
Spruce Hedges, Pruning.....	101		
Squashes.....	169		
Starling, The.....	353		
Stock, Apples for.....	421, 422		
Stoddard Plum.....	145		
Strawberries, Crossing.....	113, 293		
Strawberries, Fertilizers for.....	200		
“ from Seed.....	326		
“ in November.....	33		
“ Planting.....	264		
“ Report on Late Varieties of.....	2		
“ Varieties of.....	6		
Strawberry Culture, Essentials in.....	202		
“ Culture, The New.....	157		
“ Leaf Roller.....	240		
“ Plants, Mulch for.....	101		
“ Sawfly.....	219		
“ The Ideal.....	26		
Success Black Currant.....	408		
Sudduth Pear.....	126		
Sweet Peas, Cultivation of.....	190		
Sweet Peas, Mulching.....	246		
<b>T</b>			
Table Decoration.....	194		
Tannery Refuse, Manurial Value of..	1 00		
Tariff on Fruit.....	438		
Tetofsky Apple.....	358		
Timbrell Strawberry.....	2		
Tomato, A Huge.....	260		
Tomatoes in England.....	225		
Transplanting, Care of Plants after....	394		
Transplanting Young Plants.....	134		
Trellising Grape Vines.....	33, 49, 143		
Tree Paeonia.....	7		
Trees, Frozen.....	100		
Trees, Weeping Ornamental.....	71		
Trees worth Planting.....	373		
Triumph Gooseberry.....	295		
Triumph Peach.....	52		
Tuberous Rooted Begonia.....	138		
Tulip and Narcissus.....	95		
Tulips for spring Flowering.....	350		
Tulips from Seed.....	323		
<b>U</b>			
United States a Market for Canadian Apples.....	271, 322		
<b>V</b>			
Vegetables for Winter, Storing.....	431		
Vegetables, Value of.....	267		
Vick's Early Pea.....	161		
Victoria Currant.....	227		
Vinegar and Cider.....	354		
Violets.....	363		
Vladimir Cherry.....	303		
<b>W</b>			
Walks and Drives in Private Grounds..	364		
Walter Apple.....	88		
Waterloo Horticultural Society.....	65, 66, 97, 326, 348		
Weeds.....	48		
Weigelia, Hardiness of.....	371		
Western New York Fruit Growers.....	75, 156		
Whaley's Favorite Peach.....	326		
Wheelbarrow, Increasing the Capacity of.....	236		
White Cannas—Humbug.....	60		
White Gooseberry.....	297		
White Horned Mapie Tree Borer.....	285		
Whitesmith Gooseberry.....	296		
Wild Flowers and their Culture.....	244		
Wild Flower Trade.....	96		
Willard Plum.....	214		
Window Gardening, Preparation for.....	205, 317, 394		
Wine, Unfermented.....	351, 359		
Wire Fence without Barbs.....	276		
Wisteria, An Insect Affecting the.....	325		
Wolf River Apple.....	440		
Wood Ashes.....	81, 130, 227		
Woolverton Strawberry.....	2		
Words of Commendation.....	385		
World's Fair Medals.....	71, 139, 281		
<b>Y</b>			
Yellows of Peach.....	176, 367		
Yellow Spanish Cherry.....	256		
Yellow St. John Peach.....	366		
York Imperial Apple.....	84, 343		
Yucca, A Belt of.....	363		

## INDEX TO ILLUSTRATIONS.

	PAGE.		PAGE.
Anemone Fulgens.....	1	Army Worm.....	300
Apple Case.....	380	Army Worm, Parasite of.....	300
Apple Picker.....	349	Aroma Strawberry.....	2
Apple, Pruning the.....	120, 121	Asparagus.....	207
Apple Tree Borer, Flat Headed.....	154	Aylmer Spray Pump.....	148
Apples, Feeding.....	422	Barry, The Late Patrick.....	76
Apples, Package for.....	261	Bartlett Pears, Shipping.....	375

	PAGE.		PAGE.
Bartlett Pear, Sprayed.....	149	Grape Vine Sphinx.....	307
Bartlett Pear, Unsprayed.....	149	Greenhouse, An Amateur's.....	20
Bay of Quinte Exp. Station, Apples from.....	382	Greenhouse, Section of.....	21
Belle Strawberry.....	4, 5	Happy New Year.....	36
Berry Cart, Home Made.....	134	Harvester, A Berry.....	41
Berry Harvester.....	41	Haverland Strawberry.....	293
Beurre Giffard Pear.....	10	Hotbed.....	92
Breckenridge Apple, Section of.....	115	Howell Pear.....	411
Calla Lily.....	206	Ice Chisel.....	17
Canker Worm.....	218	Ice Hook.....	17
Canna.....	61	Ice House, cheap.....	43
Cart for Grapes and Berries.....	134	Ice House, common.....	13
Cart, Home Made.....	276	Ice House, Knickerbocker model.....	12
Chrysanthemum, Mrs. Craig Lippin- cott.....	59	Ice House, Sectional plan of.....	13
Chrysanthemums.....	57, 58, 93	Ice House, pit.....	12
Cigar Case Bearer.....	45	Ice saw.....	17
Cigar Case Bearer at Work.....	46	Ice tongs.....	17
Clarksburg Spray Pump.....	147	Ideal Spray Pump.....	146
Clematis, Porch Covered with.....	360	Ignotum Tomato.....	260
Cline, Residence of Mr. G. W.....	378	Italian Prune.....	146
Clyde Strawberry.....	292	Jersey Queen Strawberry.....	4
Colorado Blue Spruce.....	77	Jordan Apple, section of.....	116
Crimson Beauty Apple, Section of.....	118, 381	Knife System of Pruning.....	32
Crimson Clover.....	233	Lily of the Valley.....	22
Crown Grafting.....	97	Lily of the Valley Pip.....	22
Cyclamen.....	193	Lord Aberdeen.....	344
Della K. Strawberry.....	291	Madame Gabriel Luizet Rose.....	183, 243
Downing's Winter Maiden Blush Apple	86	Maplebank Strawberry.....	4, 294
Early Purple Cherry, Branch of.....	223	Monstreuse de Mezel Cherry.....	258
Early Victor Grape.....	418	Monstreuse de Mezel, packed for ship- ment.....	259
Eclipse Spray Pump.....	150	Mount Hope Nursery, View of.....	75
Empress Apple, Section of.....	117	Mount Tacoma.....	299
Equinox Strawberry.....	3	Mrs. Craig Lippincott Chrysanthemum	59
Felleberg Plum.....	37	Muskingum Strawberry.....	3
Fence, Improved Wire.....	276	Napoleon Bigarreau Cherry.....	257
Fence, View of Orchard.....	191	Ontario Apple.....	39
Flat Headed Apple Tree Borer.....	154	Ontario Plant Exhibit at World's Fair..	110
Flowers, Dried.....	320	Orr W. M.....	112
Frontispieces--		Packages for Apples.....	261, 380
Anemone Fulgens.....	1	Packing-table for Apples.....	379
Felleberg Plum.....	37	Pansies, basket of.....	363
Fruit Farm of W. M. Orr.....	111	Parker Earle Strawberry.....	3
Gabriel Luizet Rose.....	183	Parrot Tulip.....	350
Howell Pear.....	411	P. Barry Pear.....	56
Nurseries of Ellwanger & Barry... ..	75	Peach Yellows.....	176
Purple Barberry.....	217	Phylloxera.....	309
Shipping Bartlett Pears.....	375	Phylloxera galls on Brighton Vine....	308
Spray Pump Contest at Grimsby.. ..	145	Picker for Apples.....	349
Stevenson Homestead at Guelph, The.....	289	Picking apples in Mr. Cline's orchard..	376
Yellow Spanish Cherry.....	255	Plants for Winter blooming.....	394
York Imperial Apple.....	343	Plants, Pruning-house.....	170
Fruit at the Industrial Fair, Bottled... ..	345	Plants, Transplanting of.....	134
Fruit Crop.....	237	Plum, Propagating the.....	212
Fruit Farm of W. M. Orr.....	111	Plum Scale.....	168
Fruit House.....	377	Potato-bug Killer.....	156
Gandy Strawberry.....	3	Poultry-house, movable.....	301
Grape Cart, Home Made.....	134	Pruning.....	32, 50, 120, 121, 143
Grapes, Pruning and Trellising.. ..	143	Purple Barberry.....	217
		Raspberry Pruning.....	40, 41
		Red Cross Currant.....	26
		Refrigerator-house.....	14

	PAGE.		PAGE.
Ripe-rot of Plum.....	220	Timbrell Strawberry.....	2
Road Badly Constructed.....	416	Tradescantia.....	206
Road at St. Thomas, View of.....	413, 414	Transplanting Young Plants.....	134
Road, Cross section of.....	412	Tulip.....	95
Roots of Apple tree in sod.....	388	Tulip Greigi.....	96
Roses Budding.....	427, 428	Virgin's Bower Clematis, Bunch of.....	361
Roses, Planting and Pruning budded..	176	“ “ “ Carpules of.....	363
Russian Salvia.....	310	“ “ “ Porch covered with.....	360
Scarlet Gladioli and White Astor.....	192	Walter Apple.....	88
Secretary, Lady's.....	16	Walter Apple, section of.....	88
Seeley Fruit-basket.....	156	Wheelbarrow, Increasing capacity of..	236
Shipping Bartlett Pears.....	375	Whiffletree for three horses.....	241
Shot-hole Fungus.....	221	White Aster and Gladioli.....	192
Skids for Sliding loads from Wagons..	14	Whitesmith Gooseberries.....	296
Smith's Giant Black Cap.....	269	Woolverton Strawberry.....	2
Spramotor Pump.....	153	Yellows of Peach.....	176
Spray Pumps.....	146, 147, 148, 150	Yellow St. John Peach.....	366
Stevenson Homestead at Guelph, The..	289	Yellow Spanish Cherry.....	255, 256
Stevenson, Rev. E. B.....	291	Yellow St. John Peach, section of....	367
Strawberry Saw-fly.....	219	Yellow-tailed Tachina fly.....	300
Stub System of Pruning.....	143	York Imperial Apple.....	84, 343
Sudduth Pear.....	125		
Sudduth Pear tree.....	126		

## LIST OF CONTRIBUTORS, VOL. XIX.

	PAGE.		PAGE.
Arnaud, E. D.....	352	Porter, F. W.....	295
Beall, Thos.....	122, 348	Race, T. H.....	162, 199, 234
Brodie, Wm.....	351	Rose, Angus.....	129
Cameron, A. H.....	15, 53, 85, 169, 231, 432	Roy, Frank.....	425
Caston, G. C.....	303	Searff, Jas. S.....	24
Craig, Prof. J.....	115, 240, 302, 426	Shepherd, R. W.....	261
Fletcher, Prof. J.....	307, 308	Spillett, S.....	114, 263
Graham, J. E.....	352	Stevenson, E. B.....	2
Groff, H. H.....	60, 62, 128, 171	Turner, W. S.....	311
Hoskins, T. S.....	267	Ward, A. H.....	429
Karn, D. W.....	18	Webster Bros.....	57
J. C.....	270	Woolverton, L.....	1, 10, 28, 29, 31, 37, 39, 45, 49, 53, 54, 56, 64, 65, 66, 67, 75, 79, 84, 86, 87, 97, 98, 111, 119, 131, 135, etc.
Morden, E.....	11, 42, 55		
Pattison, Wm. Mead.....	158		
Pike John.....	188		

## CONTRIBUTORS TO OPEN LETTERS.

	PAGE.		PAGE.
Beall, Thos.....	33	Morris, E.....	253
Bessey, M. W.....	73	Morton, J. A.....	105
Brooks, W. E.....	108, 251, 286, 374	Parkinson, J.....	252
Brown, Alf.....	180	Penman, John.....	108
Burson, E. H.....	286	Saunders, Wm.....	33
Cameron, A. H.....	372, 373	Scott, Robt.....	34
Caston, G. C.....	253	Seeley, I. B.....	216
Craig, Prof. J.....	381, 408	Shepherd, R. W.....	287
Dempsey, W. H.....	253	Shroup, W. H.....	33
Glenn, F. W.....	235, 271, 273, 374, 405, 406, 407, 442	Shutt, Prof. F.....	143, 253
Groff, H. H.....	216	Simmers, Anton.....	327
Gruenbeck, J.....	143	Spillett, S.....	252
Heaven, A. G.....	108	Watkins, S. L.....	287, 327, 373, 405
Holtermann, R. F.....	180	Wismer, J. H.....	286
Hunter, W. J.....	143	Wood, Ormerod & Co.....	34
J. P. D.....	181	Wragg & Son.....	143
McAinsh, J.....	72	Wright, C. R.....	73
McCallum, J. S.....	327	Young, C. W.....	408

## CONTRIBUTORS TO QUESTION DRAWER

	PAGE.		PAGE.
Clossom, B. F.....	441	Shutt, Prof. F.....	100
Craig, Prof. J. . . . .	70, 140, 179, 250, 284, 371	Spillett, S.....	178
Fletcher, Prof. J.....	141, 285, 325, 440	Stevenson, Rev. E. B.....	326
Gordon, J. K.....	214	Willard, S. D.....	104
Groff, H. H.....	215	Woolverton, L. . . . .	32, 68, 69, 70, 71, 72, 99, 100, 101, 102, 103, 104, 105, 138, 138, 140, 141, 142, 176, etc.
Hutt, Prof. H. L . . . . .	33, 180, 213, 323, 402, 403		
Panton, Prof. J. H.....	325		

---

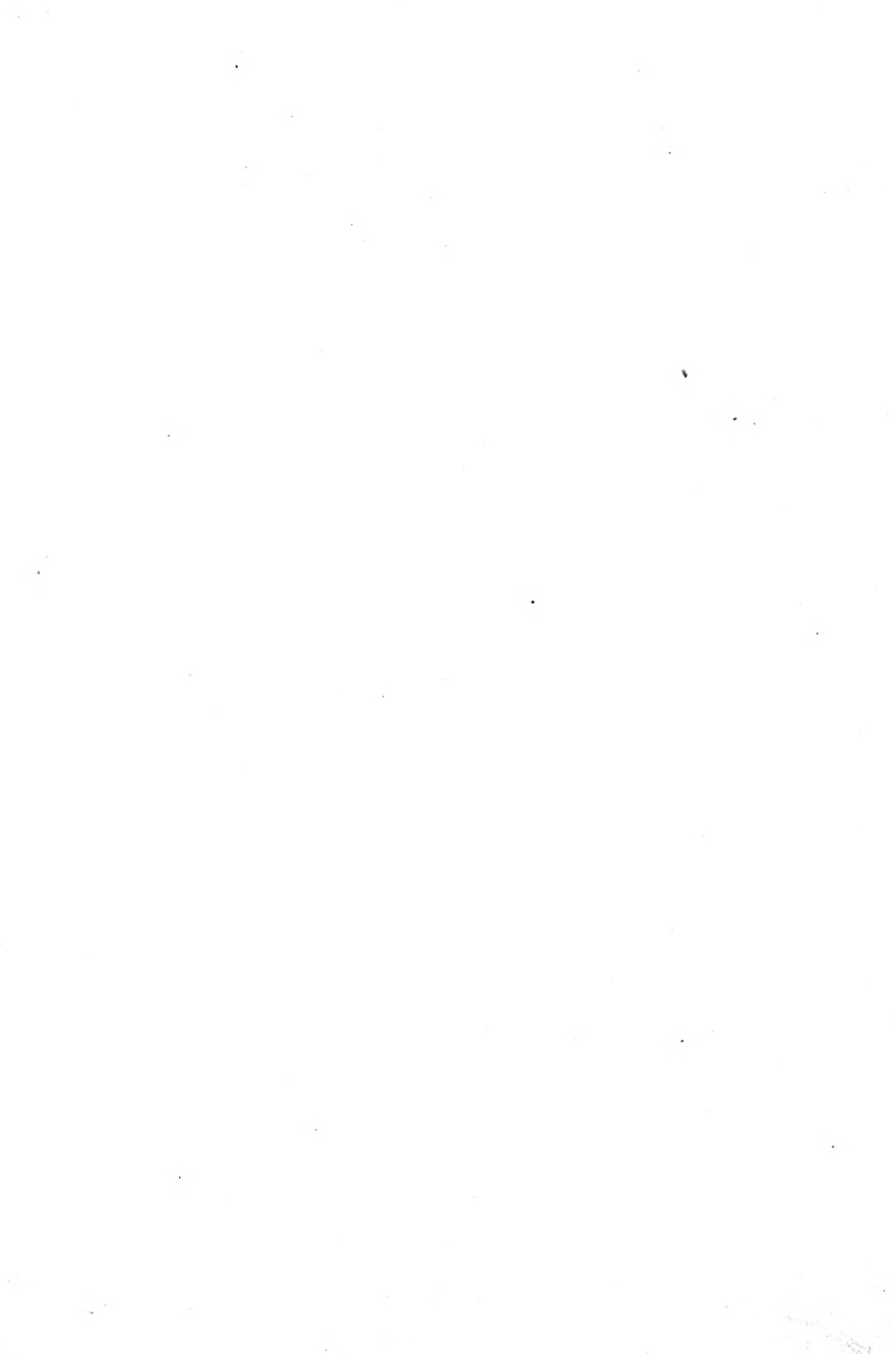







STECHER LITH CO. ROCHESTER N.Y.

NEW DOUBLE WHITE ANEMONE,  
WHIRLWIND.

THE  
Canadian Horticulturist

VOL. XIX.

1896.

No. 1.

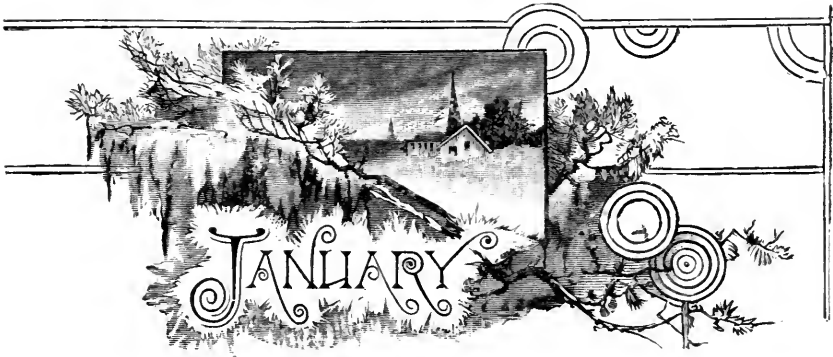

ANEMONE FULGENS.



THE Anemones, or Woodflowers, form a large family of hardy and showy plants for the border. They are easily propagated from the seed, and by sowing at intervals a succession of bloom may be had for the whole season. Forty-nine cultivated varieties of this genus are described in Nicholson's Dictionary of Gardening, of which *Anemone fulgens*, commonly known as the Double White anemone, is one of the most showy. It is a native of Greece in Southern Europe, whence it was introduced in 1865 to England, and it is now generally sought for. The flowers are "of a dazzling vermilion, with a black central patch of stamen about two inches across." The following remarks from Wood's Hardy Perennials will be of interest in this connection :

"It may be grown in pots for conservatory or indoor decoration. Borders or the moist parts of rock work are suitable for it ; but perhaps it is seen to greatest advantage in irregular masses in the half shade of trees in front of a shrubbery ; and, after all, it is impossible to plant this wrong as regards effect. To grow it well, however, it must have a moist situation and good loam."

## STRAWBERRIES—REPORT ON LATE VARIETIES.



FIG. 871 —AROMA.



FIG. 872.—TIMBRELL.

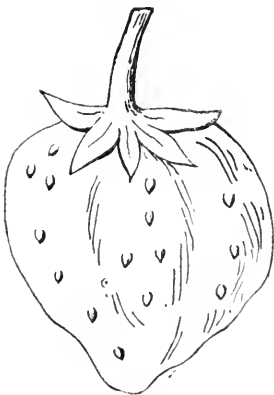

FIG. 873.—WOOLVERTON.

**I. Aroma (S).**—A seedling of Cumberland from Kansas, by E. W. Cruse. A good vigorous grower; no rust; season of fruit late; size of berry large; fine quality; quite firm; very good color; a good looking berry, and fairly productive; keeps its size well to the last picking; a good pollenizer for large late pistillates. It seems to do well in all soils and climates; good reports come from all quarters of the Aroma. The plant is strong and very healthy. Third year of fruiting.

**II. Timbrell (P).**—A chance seedling from New York, by H. S. Timbrell. The plant is a clean, healthy, vigorous grower. No rust whatever so far. The season of fruiting is late to very late. I picked Timbrells on July 24th, 1895; fine, beautiful berries. The size is medium to large; the quality is of the very best, and quite firm; will carry well to market, and is very productive. The only objection anyone could have against the Timbrell here is its color; it is mottled, red, pink and white, but the fine flavor of the berry makes up for the color. It is a fine berry; seems to stand the frost well. Second year of fruiting.

**III. Woolverton (S).**—A seedling, by Mr. Little, of Ontario. The plant is large, strong and healthy; stands the hot, dry weather with the best; the season of fruit is late; size of berry one of the largest; quality fair; color dark crimson; it is firm for so large a berry, and productive. Although the berry is among the late ones in ripening, it is one of the first to bloom; it is rich in pollen, and so one of the very best to plant with the large pistillates; the flesh is white. It is one of the best among the staminates. Fourth year of fruiting.

**IV. Muskingum (S.)**—A seedling grown in Ohio, by G. Kearns. The plant is a good healthy grower; the season of fruit is late; size of berry medium to large; quality is good; it is firm, and medium in productiveness; it is a very fair variety. It did not do as well this year as in 1894, the frost hurt it very much this year. Second year of fruiting.

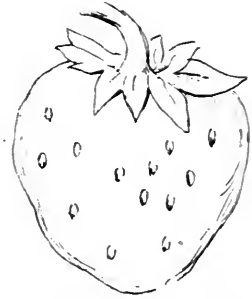

FIG. 874.—MUSKINGUM.

**V. Parker Earle (S.)**—A seedling from Texas, from the Crescent, crossed with Munson's No. 8, by J. Nimon. The plant makes very few runners, rusts somewhat, the plant stools out; the season is late; the size of berry is small to medium; the quality is fair and the berry is firm; it is very productive, the plant is not able to mature the great mass of fruit it sets; if it were in a deep rich, moist soil it might do so, but in the soil here it is not worth growing. I have seen the berries just dry up before coloring; then in such hot dry weather the berries are small and sour, unless under above conditions of soil. I would not advise any one to plant largely of Parker Earle. Fourth year of fruiting.

FIG. 875.—  
PARKER EARLE.

**VI. Equinox (S.)**—A seedling of Mount Vernon, by M. T. Thompson, Va. The plant is a good strong grower, healthy; little or no rust; season of fruiting very late; size of berry medium to large; quality good; color crimson; the berry is quite firm and the plant is very productive, in fact one of the most productive I had; I expect to hear very good accounts of the Equinox in the future. First year of fruiting.

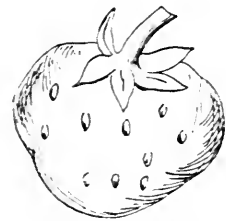

FIG. 876.—EQUINOX.

**VII. Gandy (S.)**—A seedling of Jersey Queen and Glendale. The plant is a strong and vigorous grower, quite healthy; season of fruit is late; size of berry medium to large, quality of fruit is good; a good looking and shapely berry; color dark crimson, roundish conical, a very firm berry, but a shy bearer; this is its greatest fault; it gives one grand picking, then is done. Third year of fruiting.



FIG. 877.—GANDY.

**VIII. Jersey Queen (P).**— The plant is very healthy, a fair grower, of beautiful green foliage, very often as fresh a green after fruiting as before. The season of fruit is very late; has been the standard late berry for some years. Size of fruit large to very large, of fine glossy appearance, that brings the highest price in the market. It makes a better growth of plants the second year than the first; the berry is firm and good quality, medium in productiveness. I consider it valuable, as it extends the fruiting season sometimes a week or more. Sixth year of fruiting.

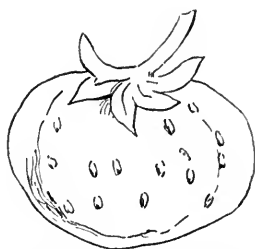

FIG. 878.—JERSEY QUEEN.

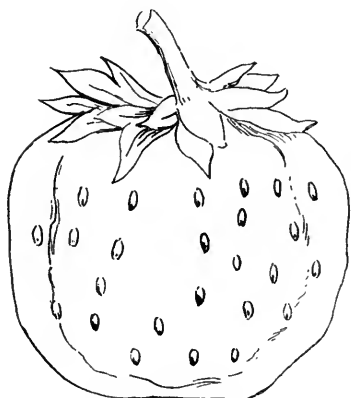

FIG. 879.—MAPLE BANK.

**IX. Maple Bank (P.)**— A seedling by William Stevenson, of Guelph, Ont.; thought to be a cross of Crescent and Wilson. The plant is a strong vigorous grower, making wide matted row. Season medium to late; size of berry large, quality best, very firm and productive. Third year of fruiting.

**X. Belle, or Crawford's No. 51 (S).**— A seedling of unknown parentage, by M. T. Thompson, of Va. The plant is a strong grower and healthy; season of fruit very late, none ripe on 4th July, when other kinds were almost over fruiting. Size of berry large, long and often irregular, some fan-shaped. Quality of fruit good and berry is firm and plant quite productive. Second year of fruiting.



FIG. 880.—BELLE.

The above have done the best this year; but there are other varieties, that under other conditions would be quite as profitable as many of the above. This has been a very exceptional year in strawberry growing, from two causes; first, the week of hard frost in blooming time, and then the very hot and dry season when the fruit was maturing. So it would be hardly fair to take the results of this year as a criterion of what the various varieties are able to do. Some of the kinds, that in an average year are among the best, this year were caught at a most critical time in their blooming, and did not recover. Some of the kinds sent up a full second set of fruit stalks, notably among these was the Clyde. I think this is the coming variety for Ontario as a market berry.

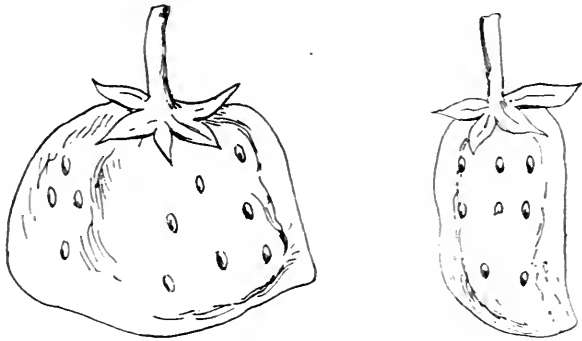

FIG. 881.—SOME SHAPES OF THE BELLE.

I have the report of thirty strawberry experts as to the five best sorts for market purposes—these were all scattered over the United States and Canada. Twenty of them name Bubach; 15 of them name Warfield; 13 name Haverland; 11 name Lovett; 10 Parker Earle; 9 Crescent; 7 Greenville; 6 Timbrell; 4 Gandy; 3 Van Deman; 3 Saunders. These seem to be the most popular sorts that have been generally disseminated; therefore, one commencing to grow for market could not go far wrong if he planted the five which received the most votes, viz.: Bubach, Warfield, Haverland, Lovett and Parker Earle.

I should place Woolverton and Saunders before Lovett; and Greenville in place of Parker Earle; and I should put Clyde among the first three; but, of course, Clyde was not grown by any of the thirty voting on the five best market sorts, as it is only offered for sale for the first time this fall, although I have fruited it for three seasons.

Some growers make little or no distinction between the kinds intended for market and those for the table. I think this distinction should be made, because it is very seldom that the finest flavored varieties will produce the most boxes or get to market in the best condition.

The variety that is best for the table, may be of poor color (*i. e.* Timbrell) and a light yielder (*i. e.* Gillespie), or poor in firmness.

The majority of those who buy in the market want size first of all, then color and freshness of look, and are not at all particular as to the flavor or quality, perhaps never testing a single berry, but buying by the eye alone; while with some people looks go for very little, and they want quality alone. Quite a number of varieties that stand high in quality of fruit, and are the very best for the table, cannot be got to market in good shape, and so should not be marked high as a market variety, except it may be for a very near market.

It may be of benefit to those who have not grown any great number of the later varieties to give a list, pointing out the different points in which they excel, as follows:

*Early Sorts.*—Van Deman, Margaret, Nichol's Early, Rio, Stone's Early, Beder Wood, Clyde, Cyclone, Haverland, Crescent, Meek's Early, Dayton.

*Mid Season.*—Bubach, Warfield, Greenville, Leader, Saunders, Tennessee Prolific, Mary, Enhance, Bisel, Brandywine, Lovett, Williams, Longfield.

*Late.*—Aroma, Timbrell, Woolverton, Muskingum, Gandy, Parker Earle, Equinox, Jersey Queen, Maple Bank, Belle and others.

*Quality.*—Iowa Beauty, Brunette, Leader, Van Deman, Banquet, Timbrell, Jessie, Gillespie, Auburn, Saunders.

*Size, Large.*—Aroma, Bubach, Brandywine, Belle, Briggs, Clyde, Dew, Enhance, Greenville, Saunders, Maple Bank, Haverland, Edith (largest), Gandy, Wm. Belt, Mary, Howard's No. 41, Jucunda Improved, Woolverton, Jessie, Jersey Queen, Muskingum, Marshall, No Name, Ohio Centennial, Van Deman, Timbrell, Eureka, Hunt's No. 3.

*Market Sorts.*—Clyde, Saunders, Bubach, Haverland, Greenville, Van Deman, Warfield, Aroma, Brandywine, Longfield, Cyclone, Robinson, Tennessee Prolific, Lovett, Mary, Beder Wood, Enhance, Williams.

There are other varieties that have good qualities worthy of trial, some that have not been fully tested as yet and so are not placed in the lists of the varieties that, after full trial, have secured recognition over a wide extent.

Below is a list of kinds having many good points, some of them not fully tested:

Phillips, Beverley, Magnate, Barton's Eclipse, Afton, Gertrude, Howard's No. 25, Hiawatha, Jurabolo, Kansas Prolific, Princess, Smith's, Sunnyside, Scarlet Ball, Springdale, Huntsman, Splendid, Thompson's No. 40, Gandy, Bell, Vera, Plow City, Beauty, Richmond, Hutch Ex. Station 24, Effie May, Charlie, Ivanhoe, Epping, Judsonia, Oberholtzer, America, Snowball.

The following are of little merit, and I have decided they are not worth growing:

Anna Forrest, Auburn, Dayton, Dew, Edwards' Favorite, Eureka, Farnsworth, Gillespie, Accomac, Bessie, Stevens, Westbrook, Alabama, Clark's E., Middlefield, Mrs. Cleveland, Prize, Martha, Crimson Cluster, Beebe, Parker Earle, Price, Lady Rusk, Swindle, Regina, [E. P. Roe, Idaho, Pawnee, Stand-



ard, Belle of Lacrosse, Primate, Gen. Putnam, Alpine, Hull's No. 6, Hull's No. 8, Jessie, Kossuth, Stone's No. 7, and No. 16, also No. 15, Shuster's Gem.

I have the following new varieties to fruit in 1896 for the first time :

	SEX.		SEX.		SEX.
Apache.....	S.....	Gardner.....	S.....	Reihl's No. 5.....	P.....
Aug. Nicaise.....	S.....	Glen Mary.....	P.....	Shawnee.....	S.P.....
Allen.....		Giant.....	S.....	Sharpless Improved.....	S.....
Allen's No. 6.....	P.....	Hersey.....	S.....	Sunrise.....	P.....
Allen's No. 13.....	P.....	Homestead.....		Triumph de Gand.....	S.....
Avery's Seeding.....	P.....	Hull's No. 3.....	S.....	Tubbs.....	
Black Prince.....	S.....	H. W. Beecher.....	S.....	Thompson's 40.....	P.....
Berlin.....	P.....	Howard's 501.....	S.....	Thompson's 104.....	
British Queen.....	S.....	Howard's 23.....	P.....	Victor Hugo.....	S.....
Beede's No. 2.....	S.....	Holland.....	P.....	West Lawn.....	P.....
Banquet.....	S.....	Knicks.....	S.....	Weston.....	P.....
Brunette.....	S.....	Laxton's No. 1.....	S.....	Yahoo.....	S.....
Bouncer.....	S.....	Lady Thompson.....	S.....	Zula.....	S.....
Cardinal.....	S.....	Leviathan.....	S.....	Huntsman.....	S.P.....
Columbia.....	S.....	Lady Franklin.....	P.....	Buster.....	S.....
Champion of England.....	S.....	Lord Sheffield.....	S.....	Onward.....	S.....
Carrie.....	P.....	Murray.....	S.....	Dora.....	P.....
Eleanor.....	S.....	Paris King.....	S.....	Sargeant.....	S.....
Enormous.....	P.....	Pet.....	S.....	Howard's No. 6.....	P.....
Erie.....	S.....	Pine Hill No. 20.....	P.....	Hunn.....	P.....
Fountain.....	S.....	Raser.....	S.....		
Gunton Park.....	S.....	Reihl's No. 6.....	S.....		

My report would be incomplete without mentioning the seedlings in the trial plots ; one plot is Howard's No. 41 crossed with Marshall and Brandywine ; another plot is Timbrell crossed with Brandywine and Marshall ; another plot is Marshall Seedlings ; I have another plot, Howard's No. 25 and other seedlings—both these seedlings are from Haverland crossed with Belmont ; amongst the above seedlings are some very fine strong healthy plants giving promise for the future. Very vigorous ; the size of the fruit is often indicated by the size of the leaf, if this holds good I shall have some large ones among them. Hoping that we may have a more favorable season for strawberries in 1896, I will close.

E. B. STEVENSON.

*Freeman, Ont.*

*Exp. in Strawberries for Ontario.*

**Montreal Fameuse in England.**—Fameuse apples have done extraordinarily well this season in the English market, bringing as much money as Kings in some instances ; but owing to the comparatively small crop of choice fruit in the orchards around Montreal this year, no large quantities were available for shipment. Still, what went forward did remarkably well. Some sales of Fameuse in Liverpool netted the shippers here \$3 75 per bbl. and over. The Montreal Fameuse has a very delicate flavor, and is much appreciated wherever introduced.—Trade Bulletin.

## BLACKBERRIES.



**S**OIL.—A deep, mellow, clay loam which contains considerable humus and crumbles rather than bakes in the furrow, is the best for the blackberry. Open, gravelly lands are too dry, and since the plants need much water it is important to plow all hard lands deep so that the roots can reach permanent moisture. On flat lands with a high subsoil, unless tile-drained, the bushes will suffer in winter and the fruit will be injured by summer droughts. Strong yearling plants from suckers or root-cuttings are best to begin with and should be planted in the spring.

*Planting.*—The plants are set in the furrow six or seven inches deep, two to three feet apart in the rows, which are eight feet apart. This gives space enough for two horses and a spring-tooth cultivator, which is the best means of keeping the plantation in good condition. Potatoes may be grown between the rows the first year, and it is possible by high cultivation to obtain two crops of strawberries before the blackberries smother them. Three or four canes should be allowed to grow the first year, and they will bear some fruit the following season. They should be headed back when they reach the height of two or three feet.

*Training.*—The canes springing from the root one year bear fruit the next, and then their usefulness is ended. These canes can be cut in August or September, or the operation can be delayed to a less busy season, but they should always be cut off before the following spring close to the ground, so that other canes will sprout from the root to take their places. A strong root may send up from ten to twenty shoots, but only a few of them should be allowed to remain, the number being determined by the vigor of the plant, the closeness of planting, etc. Five or six canes will usually suffice, and if the very best fruit is desired this number may be reduced. The strongest canes should be left, the others pulled out when they are four or five inches high, and the superfluous shoots should be removed several times during the season. When the growing canes are two and a half or three feet high a couple of inches of their tips are cut off, and the plantation should be gone over three or four times as the different canes reach the desired height. The vigorous laterals should be allowed to push out and grow their full length and should not be shortened in until the next spring. How much they should be cut depends on various circumstances. Some, like Wilson's Early, bear fruit close to the cane; others should be left longer. Some growers delay the pruning until the blossoms appear, and the laterals are left from twelve to twenty inches in length. As these bear most of the fruit it is important that they make strong, well-matured growth and that the grower shall familiarize himself with their habits. It is important, generally, that the main cane should be headed in early so that

the laterals should have time to make a hard growth and start down low so as to prevent the cane from tipping over with its load of fruit. Plants thus managed will need no stakes or trellises, although a simple wire may be stretched along each side of the row and secured to stakes to keep them from lopping. Along the Hudson River plants are trained after the manner of grapes on two-wire trellises. The young canes are headed just above the upper wire and are tied to it where they will least interfere with the ripening fruit. The canes may remain on the wires all winter, or they may be lain down for protection and tied securely to both wires the following spring. This necessitates one summer tying for the young canes and one spring tying for the bearing canes. It is not the best practice to tie them to a single stake, as the fruit will be too much massed in the foliage, although dewberries can be profitably handled this way.

*Winter Protection*—Hardy varieties, judiciously grown and pruned, do not need this in Western New York. In colder climates the bushes are tipped over and covered late in the fall. One man goes ahead with a round-pointed shovel and digs the earth six inches deep from the roots, a second man places a fork against the plant a foot or so above the ground, and by pushing it and stamping against the roots with his feet lays it over, the third man covers the plant with the earth that has been removed or marsh hay. If the variety is a tender one the whole bush is covered two or three inches deep. Hardy varieties only need a few shovelfuls of earth on the tops of the canes. If frosts are feared they may be left under this covering until corn-planting time, but the bushes must be watched in spring and raised before the buds become soft and white. This method of laying down the plants costs less than ten dollars an acre, and the slight breaking of roots is no disadvantage. The operators must be careful not to crack or split the canes, and the method should be varied, as the canes of some varieties are stiffer than others.

*Cultivation*—Surface tillage should be begun early in the spring to preserve the water. If plowed early, a spring-toothed cultivator should be run through the plants every week, especially after rain, before the soil bakes. After the crop is harvested one cultivation is given to loosen up the ground which has been tramped down by the pickers, say, about the middle or last of August. Frequently light cultivations are the cheapest, because the weeds never get a chance to grow, and little hoeing is necessary. If a patch becomes foul with thistles or other weeds it is best to mow it over, plow it up thoroughly and crop with corn for a season. Suckers will come up among the corn along the old rows, and the next year the plantation will be completely renewed. Stable manure is the popular fertilizer, although, if the tillage is good, nitrogen will scarcely be needed, so that potash and phosphoric acid can be applied alone.

*Yield; and Profits.*—The year after the planting the yield should pay the cost up to that time, the third year should give a large crop, and since there seems to be no limit of the profitable age of a blackberry plantation, every good year should give a good crop thereafter. Of course, a plantation will not endure

when the land becomes hard and foul, or the plants full of dead and diseased wood. A crop of two hundred bushels an acre year after year is possible, unless very unfavorable seasons intervene. With good varieties well cared for, the blackberry is one of the most profitable of small fruits, but the golden harvest only comes to those who work for it, and think while they work.

*Accidents and Diseases.*—Frosts occasionally injures the crop in Western New York, when a severe one comes late. The four most dangerous diseases are the red rust, the root gall, anthracnose and cane knot. The first is incurable, and the affected bush should be pulled out and burned as soon as discovered. The same is true of the root gall. The anthracnose is less serious, and can be kept in check by spraying with Bordeaux mixture, but the best treatment is to cut out and burn the old canes as soon as the fruit is off, and examine the bushes frequently for the disease, and cut out the diseased shoots. If the patch is seriously affected it is best to mow the bushes off close to the ground in the fall and early spring, clean out the crowns, spray them and start a wholly new top. The treatment of the cane knot is deferred to another bulletin.

Blackberries deserve attention as the last of the small fruits and the luscious desert of midsummer. They are only luscious, however, when left on the bush until fully ripe and eaten soon after they are picked. The blackberry is not ripe because it is black; it must be soft and drop into the hand when the cluster is shaken, to get its full sweetness and aroma. But, since the fruit deteriorates soon after picking, blackberries never get to market in their best condition, and those who want exceptionally fine fruit must raise it in their home garden.—From Bulletin 99, Cornell Univ.

---

### BEURRE GIFFARD.

At Maplehurst we top-grafted some old trees with this variety, and we are much pleased with the result. The wood has grown vigorously and soon made a fine top; the yield is quite large, and the fruit large and handsome. Most of the early August pears we grew are rather small, as for example, Doyenne d'Ete, Rostiezer, and Orband's Summer; but the Giffard is of good size and takes on a handsome yellow color, with red cheek. The pear ripens about the middle of August and will not keep long after maturity.

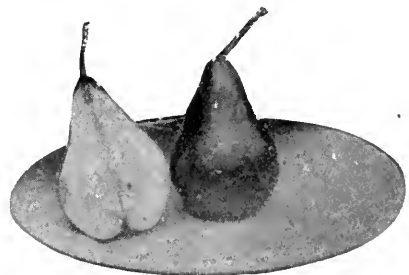

FIG. 882.—BEURRE GIFFARD.

## PEACHES—BEST VARIETIES.



N Cornell University Bulletin No. 74, seventeen leading peach growers of Western New York, give lists of peaches for market. These lists vary from two varieties to fourteen varieties. Forty-three varieties in all are recommended, and the effect is rather confusing. To rectify this difficulty as far as is possible I have summarized the lists with the following results :

	TIMES.
Early Crawford is mentioned.....	14
Late Crawford.....	13
Salway.....	7
Mountain Rose.....	6
Foster.....	6
Brigdon or Garfield.....	6
Elberta.....	6
Old Mixon Free.....	5
Wheatland.....	5
Steven's Rareripe.....	5
Early Rivers.....	5
Wager.....	4
Yellow St. John'.....	4
Hill's.....	4
Smock.....	4
Alexander.....	3
Hynes' Surprise.....	3
Red Cheek Melocoton.....	2
Early Rivers.....	2
Stump.....	2
Reeve's Favorite.....	2
Globe.....	2

Horton's Rivers, Millet, Atlanta, Peter Lamont, Crosby, Longhurst, Early York, Early Michigan, Hale's Early, Michigan Chili, Barnard, Yellow Alberge, Honest John, Morris' White, Ward's Late White, Chair's Choice, Beer's Smock, Gary's Holden and Billyer's Late, receive honorable mention only once. The ascendancy of the Crawfords is significant, although they lack productiveness. Many good and productive peaches are not much grown because buyers demand yellow fleshed varieties.

Consumers in some places are learning that cheese is no better when colored yellow by annata. Those who grow peaches for home use can avail themselves of the productive and delicious white varieties. It will be seen that very early clingstone varieties, like Alexander, are rapidly sinking in public estimation.

Elberta is mentioned six times, largely because of faith in its merits as advertised. Globe is mentioned once, which is often enough. It is a very large late yellow, unproductive peach, that rots almost as fast as it ripens.

### FARM ICE HOUSES AND COLD STORAGE.



WO classes of farm ice houses are practicable. If high dry ground or a hillside is available, a pit or submerged house can be constructed. Make a hole in the ground of the desired size, the bottom highest in the middle, so that the water from melting will drain toward the walls. At each side place a line of tile leading from the house to the side of the hill, or to another drain or ditch. Drainage must be perfect, or results will not be satisfactory. For walls, put

in a frame made much like that of an ordinary corncrib, with the boards close together and on the inside of the uprights. The joists should be 2 x 6 pine or hardwood, depending upon which is the cheapest. Stone may also be used. The roof is best if 2 x 6 studding is used, boarded on both sides; but any kind of a roof will serve, especially if covered with hay, straw or stalks to keep out the heat. If the pit is in a shady place—which is always desirable—the gables may be left open for ventilation. If sun strikes the roof, ordinary ventilators must be provided. Drainage must be perfect and the ventilation adequate, but it is best to have as little circulation of air as possible. A door must be made for taking

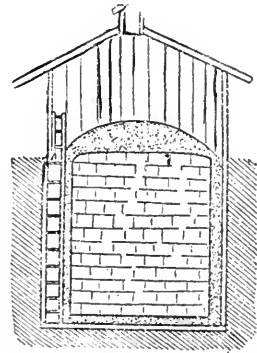

FIG. 883.—PIT ICE HOUSE.

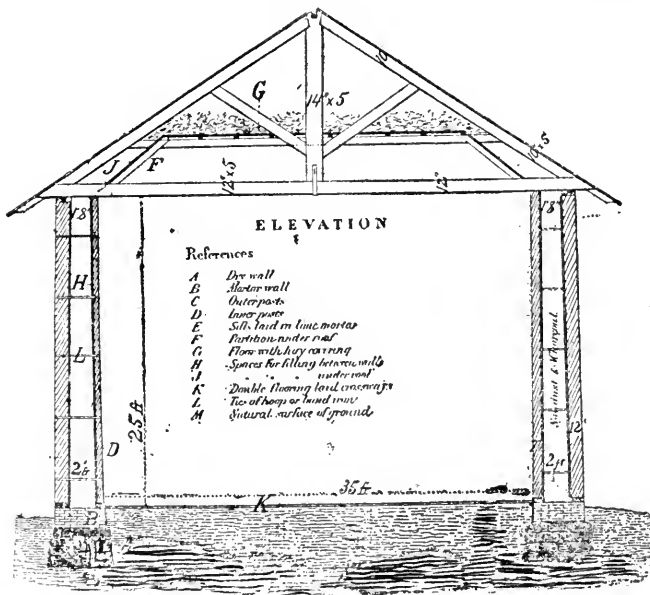

FIG. 884.—KNICKERBOCKER MODEL ICE HOUSE.

out ice, and as the supply is lowered a ladder becomes necessary. Fig. 883 shows such a pit.

If water stands near the surface of the ground, admitting of a possibility of its rising in the pit, the safest way is to build the house entirely above ground, taking the precautions outlined above as to location, drainage and ventilation. A floor is not absolutely necessary, although desirable. A cheap shed with rough posts, carefully double boarded and the air space filled with sawdust or chaff, will be better than nothing, and if a straw stack or heap of corn stalks



FIG. 885.—SECTIONAL PLAN OF MODEL ICE HOUSE.

could be built over it, such an affair would keep ice fairly well. But thrifty farmers believe in building a durable ice house that will last. The common type is shown in Fig 886. A six-inch dead-air space is not sufficient, even if the outer boards are matched and the inner square-edged, with tarred paper underneath both. Some think the paper is hardly necessary under the inside boards if they are matched, but square-edged boards may be used on both sides with paper on both sides of studding. Fig. 884 shows a plan submitted by the Knickerbocker Ice Co. of New York (one of the largest and most experienced firms in the ice trade), which they say embodies "all of the essential particulars necessary for a perfect ice house, unless it be deemed desirable to put in a ventilator to carry off the heated air radiating from the roof in midday." This would be much improved by having the inner wall slant inward (Fig. 887), the drippings from the ice thus falling away from the rest of the sides and not rotting the boards.

Ice men are also using a double air space, the inner one filled with sawdust, the outer not filled, and four or six inches studding used for it. The idea is that this outer wall still further excludes heat from the inner filled space. In such cases an eight or ten-inch board is left off at top and bottom of the house inside to permit a circulation of air. This idea is carried still further in the Gerish plan where there is a six-inch wall outside with no filling, then a 24-inch space filled with planer shavings or hay, then an eight-inch dead-air space. This makes a veritable refrigerator, and while more expensive than the ordinary farmer

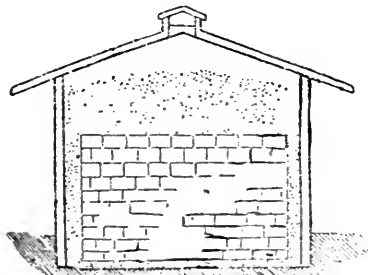

FIG. 886.—COMMON ICE HOUSE.

need use, it is advised for country cold storage warehouses, etc., especially when a little ice has to go a good way. Filling for the dead-air space in ice-house walls is not needed, the air space being the best non-conductor of heat, or insulator, is the view held by some, but practical icemen of longest and largest experience insist on filling, even if the space is air-tight. Perfectly dry sawdust is usually preferred for filling, but it must be dry, as moisture renders it a good conductor, and the moist surface will readily convey the heat to the ice. Fine planer shavings, that do not pack quite as closely as sawdust, are also used, and spent tan bark where it can be had dry for the hauling; fine chaff is better than nothing. Pounded charcoal is best of all when it can be had cheap enough, "and as it is antiseptic it does not decay the wood with which it comes in contact, as does sawdust. Indeed, charcoal is perhaps the only thing that could reasonably answer for a single partition of but six or eight inches thickness." For cold storage, place the ice room above the storage room, with apertures for the cold air to pass down through. This melt from the ice may be utilized for washing butter, cooling milk, or other purposes for which ice water is needed. All these purposes can be subserved in one building by a little planning.—Amer. Agriculturist.

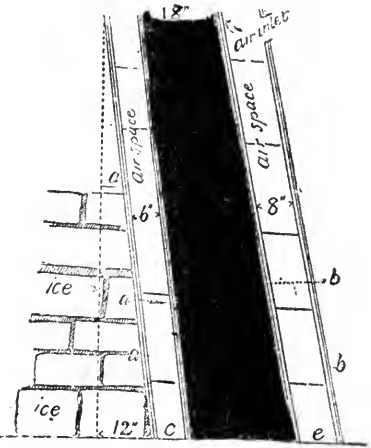

FIG. 887.—REFRIGERATOR HOUSE.

*a* Matched boards both sides inner air space, with tarred paper underneath; *b*, ditto, outer air space. Intervening black space filled with shavings, hay or sawdust.

**Unloading Barrels from Wagons.**—Farmers frequently have cider, vinegar, molasses, and other bulky matter in hogsheads and barrels which have

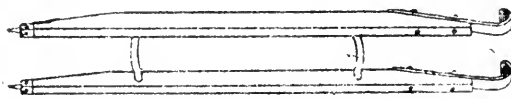

FIG. 888.—SKIDS FOR SLIDING LOADS FROM WAGONS.

to be removed from a wagon. The skids in so common use by storekeepers are invaluable where much heavy trucking occurs. For construction take two pieces of ash or other strong wood 2 x 3 inches and seven to nine feet long. With iron bolts fasten about one foot apart. The iron bolt should be from one-half to one inch in diameter and bent crescent from between the side pieces of wood. Plane one end of each stick to an acute angle running back about 10 inches. Put a piece of plate iron on each stick, fasten with bolts tightly clinched, and turn the end over so as to catch on the platform of the wagon. The ends resting on the ground should likewise be planed and covered with iron bands. For removing casks, stand the barrel on end and tip over the skids, and it will slide down to the ground with but little effort on the part of the driver.—A. C. LAKE, American Agriculturist.



## RASPBERRY CULTURE.



EVERY farmer living within ten or twelve miles of a town of 1,000 or more people can well afford the time and ground required to produce raspberries. The soil should be well pulverized, and the plants placed six feet apart each way, or if the land is scarce they may be planted as near as 3 x 6 feet. When planted close the cultivation is more expensive, for after the canes are grown it is more difficult to get among them. Having placed a plant, cover it an inch or more in the ground, and firm the earth thoroughly around it. During the first year the plants should be hoed and cultivated often enough to keep down all weeds, and make the field as clean as if corn were planted.

The second year, the crop if it sell well should pay all expenses connected with it. The cultivation should continue the second year until the fruit begins to set, when it should cease. Late cultivation not only injures the fruit, but is likely to induce growth that will winter-kill in the cold weather.

A common method of pruning the black raspberry is to go through the bushes as the plants approach the desirable height, and with a sharp knife cut off the top of each sprout. This prevents long arching branches, and causes the plants to send out laterals on every side which balance the main stem. These laterals will be found to fruit largely during the next season.

In the fall with a one-horse plough throw a couple of furrows towards the plants to keep them from heaving out with the frost in the following spring. In the early spring these furrows should be levelled back again. For early fruiting the Souhegan is by many considered the best, and should be set on a hillside facing the south. For late bearing the Gregg is an excellent variety, and may be planted on a northern slope.

During the first season vegetables may be planted between the rows. This will force cultivation to about the amount desired for the good of the raspberry canes.

Tiverton, Ont.

A. H. CAMERON.

**Oak Trees of Beautiful Foliage.**—In late autumn, sometimes weeks after many other beautiful leaved trees have lost their foliage, the scarlet oak (*Quercus coccinea*) presents a superb appearance. It can be identified by its retaining its foliage long after other oaks, hickories, chestnuts, sour gum and tulip trees have lost theirs, and singularly too, it at times does not take on its scarlet attire until other trees are bereft of foliage. It is the best of all for autumn color. The red oak is pretty, so is the pin, the white, the laurel-leaved, the post and the Spanish oaks. The red oak takes on a reddish color, the pin oak mingles considerable scarlet with its green, so does the laurel-leaved oak (*imbricaria*), the post oak (*obtusiloba*), and the Spanish (*falcata*) oak. A pretty purplish shade spreads over the green of the white oak.—Gardening.

## THE LADIES' SECRETARY.



WRITING materials must be collected from their various hiding places about the house, and when at last the busy mother sits down at the table with pen, ink, blotter, paper, envelopes and stamps about her, she is pretty sure to find that the children have been trying her pen and spoiled it, or that the ink has grown thick and dry. Then somebody joggles the table, and she makes a great blot on the very first page; she forgets what she wanted to say, and by the time the letter is finished and the envelope stamped and addressed, the discouraged woman hopes she may never have to write another letter.

Now in this age of the world, it ought to be as easy for any woman to write a letter as to make a bed. But, in order to do this, she needs convenient arrangements for writing; not a portfolio or little desk which she must hold on her lap and bend over till her back aches, but an *escritoire* of good size and just the right height.

All the large furniture dealers keep on hand a variety of beautiful *escritoires*, or will make to order just such a one as any particular person may fancy; so that with a full pocket-book, there is no difficulty in suiting one's self exactly. But the impression seems to prevail that such an article of furniture is beyond the range of possibilities for poor people, or those who have very little money to spend. So they put up with all sorts of inconveniences, not knowing that a pretty and convenient secretary may be had for a few dollars, while a home-made one, equally serviceable, need not cost much more than the labor of construction.

We urge every one of our readers to claim for herself the privilege of owning one of these useful articles which she will soon consider indispensable. For the benefit of those who must study economy, we give an illustration of a desk which may be easily made.—  
Orchard and Garden.

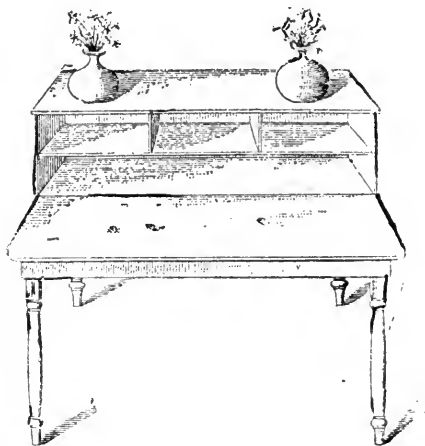

FIG. 889.

“You will fall in love,” they said. In affright  
I fled from each chasm to peaks above.  
And when I attained the Heavenmost height  
I found they were wrong—I had climbed to love!

—MARJORIE SCOTT, in January Ladies' Home Journal.

## THE FARM ICE HARVEST.

The tools absolutely necessary where only a limited amount of ice is put

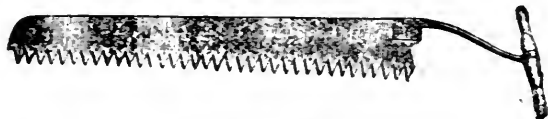

FIG. 890.—ICE SAW.

up consist simply of an ice saw, tongs, hook, chisel, and a wagon, or sled. The saw does not cost much, and the tongs, hook and

chisel can be made by a local blacksmith at a very small expense, and will last almost a lifetime. An ice plow is very desirable, but unless considerable is to



FIG. 891.—TONGS.



FIG. 892.—ICE HOOK.

be put up is not essential, as a large saw will answer the purpose. Devices for cleaning snow from the ice field can be easily made should they be needed. In filling the ice-house, first put in 18 or 24 inches of sawdust, then set the first layer of ice cakes on edge, allowing 12 or 18 inches of sawdust at the sides. The other layers may be laid flat, breaking joints; if practicable, pour in water to fill up the interstices, and make a solid block of the whole mass that will keep out air. When the house is filled, cover the ice with two feet or more of sawdust.



FIG. 893.—ICE CHISEL.

**The Apple as Medicine.**—The apple is such a common fruit that very few persons are familiar with its remarkably efficacious medicinal properties. Everybody ought to know that the very best thing they can do is to eat apples just before retiring for the night. Persons uninitiated in the mysteries of the fruit are liable to throw up their hands in horror at the vision of dyspepsia which such a suggestion may summon up; but no harm can come to even a delicate system by the eating of ripe and juicy apples just before going to bed. The apple is an excellent brain food, because it has more phosphoric acid in easily digested shape than other fruits. It excites the action of the liver, promotes sound and healthy sleep, and thoroughly disinfects the mouth. This is not all. The apple helps the kidney secretions and prevents calculus growths, while it obviates indigestion and is one of the best preservatives known of diseases of the throat. Everybody should be familiar with such knowledge.—DR. SEARIES, in Bulletin of Pharmacy.



## ‡ The Garden and Lawn. ‡

### PRIVATE CONSERVATORIES.\*

**I** HAVE had the above subject assigned to me for a short paper. In opening this question for discussion to-night, I feel myself utterly incompetent to deal with the subject, having no knowledge or experience apart from the little I have obtained in connection with my own home life, therefore I shall only speak of it from the standpoint of growing and producing flowers, shrubs and foliage plants for private use.

Most modern houses to-day, especially in our towns and cities, are lighted by gas, and when this is the case it is almost impossible to succeed in the cultivation of flowers, as the gas is a deadly element to all plant life. The only means to overcome this difficulty is to erect conservatories or greenhouses adjoining the house, but so separated as to exclude all the blighting effects of gas.

In designing a conservatory, light, heat, air and water have to be considered. The simplest form of constructing a conservatory is a lean-to, so built as to face the south if possible. This can be made ornamental if so desired, by means of architectural embellishments.

Heating is a very important item. The best and most approved method is hot water. There are numerous styles of hot water boilers, but they are all built upon the same principle, each inventor striving to expose the greatest possible heating surface to the action of the fire.

It is preferable to heat the conservatory independently of the house, as during very severe weather it is necessary to force the fire in order to maintain a proper degree of heat, which in many instances would give too much heat in the house.

Ventilation is accomplished in various ways. In small houses by lifting or sliding the sashes placed in the roof for that purpose. Shading is required as spring approaches, when the rays of the sun increase in power and light. This can be accomplished by washing the glass with lime-wash, or with whiting and milk, but, if you prefer, you can use a screen of muslin or thin cotton.

A conservatory covering some 550 feet of surface measurement and some 5000 cubic feet of air space, can be sufficiently heated in all kinds of

\* A paper read before the F. G. A. at Woodstock.

weather, with a hot water boiler costing from \$50 to \$75, and will consume from five to six tons of coal a season ; so that with an outlay of \$250 or \$300, apart from the running expenses, anyone may have a conservatory, together with all the enjoyment and pleasure of being surrounded during the dreary months of winter with beautiful flowers and green foliage. To love and cultivate flowers is one of the few pleasures that improve alike the mind and heart, and make every true lover of these beautiful creations of Infinite love wiser, purer and nobler. It is a pleasure that brings no pain, a sweet without a snare. If we would develop and increase the appreciation of the beautiful and our ability to enjoy the marvellous beauty which is everywhere around us, we must have the educating and refining influence of plants and flowers in the home. Our homes must be made attractive, so that lasting influence for good may be thrown around those entrusted to our care. The Creator doubtless could have made a world without a flower, but He in His wisdom did not do so ; and after creating man in His own image, He placed him in a beautiful garden, in which was every plant that was pleasant to the sight or good for food. When man became a law breaker he was expelled from this garden and had to work for food among the thorns and thistles. In all parts of the civilized world to-day, the refinement, innocence and happiness of the people may be measured by the flowers they cultivate.

The conservatory places within our reach at all times, plants and flowers for the decoration of our parlors and dining rooms. There is nothing to my mind that lends so much charm and beauty to any home, as a tasteful disposition of plants and flowers. The amount of genuine satisfaction, rest and pleasure that a business man receives and enjoys in spending a few minutes in the conservatory each and every day, more than repays him for the additional expense incurred in maintaining the same. I am convinced that many who could afford the expense of a conservatory, if they would only try the experiment, would be loud in their praises of the pleasure and satisfaction derived therefrom.

The necessary materials used in building a conservatory can be purchased already manufactured to shape, so that any ordinary carpenter can easily construct and complete the work. The putting in position of the hot-water pipes is only the work of a few hours, by some competent steam or pipe fitter. With the conservatory thus completed, you are in a position to cultivate successfully, plants and flowers, native and otherwise.

Now, Gentlemen, I have trespassed long enough upon your valuable time, and only have to regret that some one else, more competent, should have been selected to have placed this matter more intelligently before you.

*Woodstock, Ont.*

D. W. KARN.

## AN AMATEUR'S GREENHOUSE.



AFTER reading Mr. Karn's excellent paper on the Amateur Greenhouse, our readers will read with interest the following description of a very inexpensive one, taken from *Gardening*, one of our valuable exchanges, published at Chicago: My greenhouse (if such it may be called), cost me but sixty-five dollars complete, including the Domestic Water Heater, piping, etc. As the illustration will show it is a lean-to, built at the side of my house with an eastern exposure, it is 12 feet 6 inches long by 6 feet four inches wide. It is built on posts set in the ground, four feet apart, along the outer edge; the posts are covered on the outside with rough boards, over which is paper, and again weather boards, or matched siding, which thoroughly excludes the cold and makes a nice finish; upon this rests the framework and glass sides. The top or roof is made of sash, which can be raised or removed entirely at pleasure. Along the top, next to the house, is a row of ventilators on hinges which are raised or lowered from the inside. The entrance is from the cellarway, as the ground was excavated to the cellar floor level, to permit of head room and allow the roof to come under the dining room window. The bench on which the plants, or rather the pots rest, is four by twelve feet, and it also extends across one end.

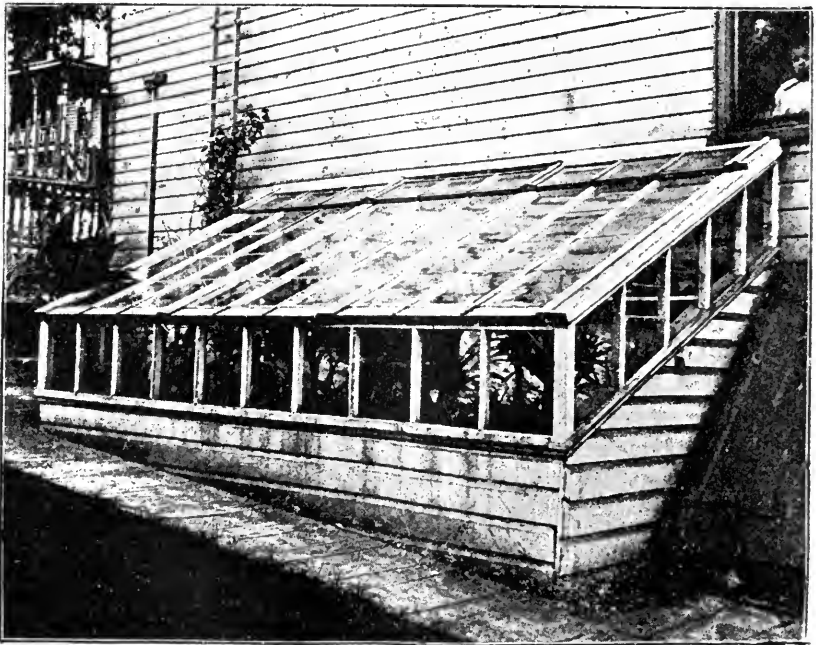

FIG. 893.—AN AMATEUR'S GREENHOUSE.

When I first built the greenhouse I was at a loss to know how to heat so small a space, as I did not like the idea of using an oil stove, which is so often recommended. I therefore utilized a small coal stove, placed the same in the cellar, and made a coil of 1-inch wrought iron pipe, for the inside of the stove, then ran 75 feet of 1½ inch pipe through the cellar wall, and under the bench, up to a small expansion tank in the corner, as shown in the cross section, making a complete hot water system, the same as is used in the kitchen for domestic purposes. The stove part was not very satisfactory; when the fire would leave the pipes the water would not heat properly to maintain the temperature during the night. The second year I looked around for something better to heat with, and found it in Hitching & Co.'s Domestic Water Heater, a small inexpensive affair which did the work to perfection with little or no trouble, and which I could leave for ten or twelve hours without attention, and feel satisfied the temperature would not fall below 60°. I have since sold the heater, and am now using one of the same firm's base-burning heaters, No. 23; in addition to heating my greenhouse I heat two rooms in my dwelling. I mention the fact as it reduces the cost of heating the greenhouse to a very nominal figure.

The friend to whom I sold the Domestic Water Heater uses it to heat a greenhouse (exposed on all sides) ten by fifteen feet, in a very satisfactory manner. He uses it under one end of the bench, which is bricked off, about four feet square, covers the brick work with iron, on which he puts sand and uses same as a propagating bench, the door of the fireplace opens outside, and he finds it works splendidly, with no dust or gas in the house.

I would add that the 1½ inch pipe I used under the bench was second-hand material, purchased at scrap iron prices.

The question naturally arises, what can a person grow in so small a place? I will tell you. With the aid of the cellar, which I use as a sort of cold storage place, I am enabled to bring into bloom a fine display of flowering bulbs, or some specimen plants, and there is scarcely a day during the winter when one of the windows in my dwelling is without a plant or plants in bloom. It may be quite a pretentious display of hyacinths, narcissus, jonquils or freesias, or it may be a single plant of epiphyllum truncatum, azalea, rhododendron, or an amaryllis of some choice variety. In addition to these I grow a few plants of heliotrope, ageratum, sweet alyssum and other soft wooded plants, from which my dining table is frequently supplied with cut flowers. From the blooming of the Roman hyacinths and narcissus, just before the Christmas holidays, until late in the spring, I am never without some blooming plant or bulb from my small and inexpensive greenhouse.

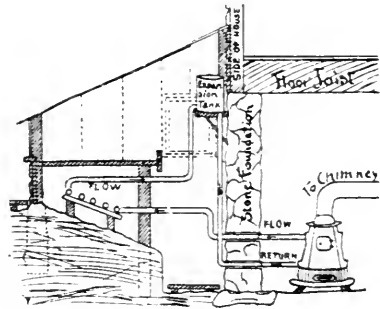

FIG. 894 —SECTION OF GREENHOUSE.

## LILY OF THE VALLEY.

WHILE we see hyacinths, crocuses, daffodils, and all kinds of narcissi blooming in our friends' windows in winter, we seldom see lilies of the valley. Writers in floral magazines almost always insist that they cannot be made to blossom in an ordinary window, saying that even florists find it hard to succeed with them. My experience has been somewhat different, and so far I never had a complete failure with them. Sometimes, to be sure, they do better than at others, but I can usually trace it to some fault of my own.

When I take pips from my own garden I do not have as good success usually as when I procure them from a florist quite late in the season. I have had them as late as January and they blossomed all right.

I plant the pips closely in a large pot or box with the head of the pip a trifle above the soil. Then I put a layer of sphagnum over the soil, water them well and set them away in a dark place where they will freeze a little. After a while I bring them out into a warm atmosphere but do not give them the full heat of a sunny window for several days. Gradually they are



FIG. 895.

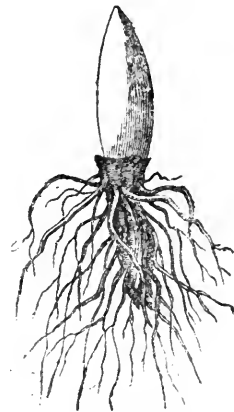

FIG. 896.—LILY OF THE VALLEY PIP.

brought to it, and soon the buds appear. The moss is left on and is always kept moist, as a florist once told me that if the heads of the pips ever becomes dry all hope of blossoms is gone. Nothing can be sweeter than the dainty little white bells, and as they are general favorites it is a pity they are not more generally seen in our windows in winter.—Vicks' Magazine.



## HYACINTHS.



FOR pot culture the bulbs do best when given a compost consisting of two-thirds turfy loam, one third well decayed manure of leaf mold, and a fair sprinkling of sharp sand ; mix well and use the compost rough. In potting see that the pots are properly drained and let the bulbs be so placed in the soil that the upper surface will just be visible. A four-inch pot is the best size for the successful growth of the bulbs, one in a pot.

After planting they should be well-watered and placed in a dark cellar to make root, giving them water whenever it may be necessary. In about eight or ten weeks the pots will be well filled with roots, and a vigorous top growth will begin to set in ; then a few of the most forward can be brought into a light, sunny situation, where an average temperature of  $55^{\circ}$  is maintained. Water should be given whenever necessary, and an abundance of fresh air whenever possible ; keep the plants free from dust and support the flower spikes with neat stakes, if it becomes necessary to keep them erect. If the plants are placed in a low temperature when in bloom the flowers will remain in perfection a long time. After the flowers commence to fade the stalks can be removed, and as soon as the foliage commences to decay the bulbs can be removed to the cellar, placing them in a light situation, and the supply of water gradually reduced. When the leaves have fully ripened, the bulbs can be removed from the pots and packed away in bags or boxes for planting in the fall. Bulbs that have bloomed inside are altogether useless for another season's use in the same manner ; they may be planted out in the border where they will give a good account of themselves the ensuing spring. A fresh supply should be obtained for potting. Hyacinths differ in habit very much, some varieties throwing up a strong flower spike with a loose truss, others have a short stem with a compact truss ; the robust-growing kinds have large bells, while those less robust have an immense number of small bells. The bright red colors are all of a compact habit. There are so many varieties listed in catalogues that it is quite difficult to select a few of the best, but one will not go astray in selecting any or all from the following list :

*Single*.—Amy, Baron Von Thuyll, Chas. Dickens, Gigantea, Grandeur a Merveille, Herman, Ida Jesckko, La Pluie d'Or, Mt. Blanc, Norma, Veronica.

*Double*.—A la Mode, Anna Maria, Bouquet Royal, Czar Nicholas, Goethe, Jenny Lind, L'Esperance, La Tour d'Auvergne, Blocksberg, Noble par Merite, and King of Wurtemberg.

It may be well to mention that the named varieties should always be used for pot culture, as the mixed varieties which are offered at a much lower price seldom produce as satisfactory results when grown inside.—Vick's Magazine.

## THE CULTIVATION AND MANAGEMENT OF HOUSE PLANTS.



THE cultivation of flowers is an occupation that improves alike the body, mind and heart. It is an almost certain indication of purity and refinement. We can afford to cultivate and study flowers, if for no other reason than their cheerful surrounding. Many do without flowers because they think they cost too much time and trouble, but all things worth having cost considerable and anything worth having is worth working for. Oftentimes the partial success, or in many instances, total failure in the cultivation of flowers is due to the fact that we try to do too much. No one should have more plants than one can fairly manage or take care of; too often do we see many plants crowded together in a poorly lighted window, compelling each plant to take on a form never intended by nature, and foliage quite different from that desired by the owner. One of the chief requisites in the management of house plants is plenty of sunshine, next an atmosphere neither too dry nor close, and a uniform temperature, lower during the night than during the day. As the days become longer and brighter, more room between the plants must be given; for nothing detracts more from the appearance of plants than standing too close when growing rapidly. More careful attention should also be given to proper ventilation on all suitable occasions. This is absolutely necessary to the health of plants.

With regard to the soil best adapted for pot culture: Soil for pot plants should always be carefully prepared. For this there is no better foundation than well decayed turf that is full of root fibres. Many plants would need nothing more; strong feeders should have manure added. Perhaps the soil that will best suit the majority is two parts decayed turf to one part of well rotted manure and one part sand, which will make a soil that will not bake.

*Watering.*—Rain water is better than spring or well water. Hard water may be greatly improved by adding a drop or two of ammonia, or a little soda, a small piece about the size of a pea to every gallon of water used. Morning is the best time to give water, and evening next. Never water house plants when the sun is shining brightly on them. The supply of water must be regulated according to the demands of the plants. Apply when needed; but never in excess. The condition of plants and soil is the best guide. Never give water when the soil is moist to the touch. The leaves of all large-leaved plants should be thoroughly sponged off at least once a week with tepid water. This tends to keep the plants in health and free from dust. Nearly all plants require more water when in bloom than at any other time, more in a warm temperature than in a cold, and more when in a state of active growth than when at rest. Plants

in open rooms usually require water once a day and some demand it twice. Drainage in the pots must always be attended to, as stagnant water at the roots will result in diseased plants and impoverished flowers.

*Gas.*—Its use for illuminating is a drawback to plant culture in the same rooms. Plants are better off for being in rooms that are never lighted much artificially. If the plants can at night be cut off by partitions, or moved to unlighted rooms, it should be done. If not, harm may largely be prevented by covering them with paper covers, while the gas is lighted.

*General Management.*—Pay strict attention to airing, give air when opportunity offers; try to secure a uniform temperature without draught. All the light obtainable at this dark season is needed. Roll up the curtains clear to the top during the day. Give extra protection to plants during severe cold nights. Plants coming direct from the florist's often fail when set in a window at this time of the year, because the tender green house plants is not used to the exposure in the much colder window. Be sure to get plants that are thoroughly hardened, and to warm the rooms where such plants are in the window, sufficiently to carry them over this change in a gradual way. Be sure to give all plants in the window the space they require. Crowding is in no case desirable. For the better protection of plants near the window, in severe cold nights the plants may be taken from the window, placed upon the table in the centre of the room, and covered with paper.

I have frequently been asked the cause of plants dropping the leaves, whenever this occurs, we may be sure, the health of the plant is impaired in some way. The plants may have been kept too warm, or too cold, given too much water or not enough of it; it may have been injured by crowding or with strong stimulants, or allowed to become pot bound. The first thing to be done is to make a thorough examination. Knock the plant out of the pot and see if the soil is too dry or too wet, or whether the feeding roots are destroyed.

Injudicious watering or applications of strong liquid manure. The treatment usually given without further examination may result in the death of the plant. Re-potting in light and rich, rather dry soil, especially if a new or freshly cleaned pot is used, will give relief in most cases. The pot need not be larger than to give about an inch of soil around the ball of the roots, putting it into a half shady place, water enough to settle the soil around the roots, and give no more water until new, vigorous growth commences; the soil should be kept moist all through but never wet for any length of time. Never use pots of a larger size than is absolutely necessary, and plunging them in cool ashes encourages root formation. One may readily enjoy a succession of flowers all winter long, by forcing a few at a time, and replenishing as the bloom fades away. Hardy plants of every description dislike strong heat, preferring a cool moist atmosphere, with plenty of air in mild weather, and free access to the sun's rays.

For window culture, the plants should be started either in a cool greenhouse or sunny window in the domestic departments, whence they may be removed to

the living room as the bloom begins to appear. Give plants as much light as possible during the day, and darkness with a lower temperature at night. A uniform temperature of 60 to 70 degrees in the day time and 40 to 45 degrees at night, will give the best results. Turning the plants towards the light should not be done, unless done regularly.

Besides light, house plants require a good supply of fresh air. Ventilation is absolutely necessary.

*Woodstock.*

S. S. SCARFF.

### THE IDEAL STRAWBERRY.

The "ideal strawberry" is often mentioned when horticulturists get together, and there is a tolerably unanimous expression of the conclusion that this much-desired fruit has not yet made its advent. What qualities must a strawberry (plant and fruit) have to entitle it to this distinction? The plant must be a vigorous grower, with a thick, stocky leaf, and it must be a free producer of runners. It must be perfect flowered—we must not be compelled to plant others with it to insure its fruitfulness. It must be productive, fully as much so as the most productive varieties now under cultivation—more so if possible. The berry should be large—not monstrous in size—and it must be symmetrical in shape—not like Sharpless, Bubach and other lobe-shaped fruits. Color is not so important—it should be of solid color, either scarlet or crimson, and colored throughout the berry. It must be solid and firm enough to bear shipment a reasonable distance, and last, but not least, it must be of high quality, say, somewhat better than the Gandy, which is a very good berry. We have no such berry yet, but it is not unreasonable to believe that we will achieve it. Whether we are to get it as a chance seedling or whether it will come as a result of careful and scientific crossing, none can say.—*American Agriculturist.*

**Yield of Blackcaps.**—How much will an acre of raspberries produce, taking the average of three crops? Opinions differ widely. We could begin with zero on the one hand, and rise to 6,000 quarts. In an enquiry made here in 1893, says a recent Cornell Station Bulletin, the average of 58 replies of berry growers was 2,493 quarts. One gave his yield (which must have been on a small patch and amply multiplied) as 9,600 quarts, whilst another confessed to but 576 quarts. A good yield for the second crop is 3,000 quarts, or 90 to 100 bushels per acre. Willis P. Rogers tells me that his largest field crop of Ohio, the third year after planting, was 16,000 quarts on four acres, and a half acre of this land was not up to the standard. From extensive inquiries of evaporator men, however, I find it to be a general opinion that the average crops of the country, one year with another, will not exceed 1,200 quarts per acre, or 300 pounds of dried product.

RED CROSS CURRANT.

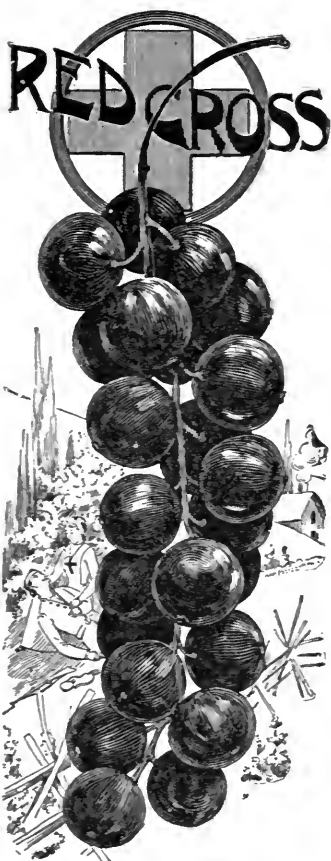

FIG. 897.—RED CROSS CURRANT.

We have for many years been looking for a new currant which would be an improvement upon older varieties; we have looked in vain until we heard of the experiments made by Jacob Moore, and accepted an invitation to call at his place. There we saw some twenty or more seedling currants all in full bearing, all produced by crossing flowers of different selected varieties in the most scientific manner. All of these varieties of currants were exceedingly productive, the difference being that some varieties were larger or better quality than any others—longer clusters, longer fruit stems, brighter color, etc. One variety in particular was larger than any of the others, and of superior quality; also exceedingly vigorous in growth and very productive, with long fruit stem. This variety we have purchased of Mr. Moore, paying him \$1,250 cash for it, and have named it the Red Cross currant. The cut given above was drawn from a photograph made at the Geneva Experiment Station. Notice that the berry is peculiar in shape and that the blossom end of the currant is almost imperceptible, which we consider a remarkable feature. Red Cross is a marked and distinct variation from all other currants.

HORTICULTURAL SOCIETIES.—It is encouraging to note that the horticultural societies that were formed last year are for the most part prosperous, especially those who have been wise enough to choose officers that have a real interest in the prosperity of the society. Here is a line just received from Mr. James Lockie, the enthusiastic president of the Waterloo Horticultural Society. He says: "We hope to have nearly, if not quite, 100 members in our Horticultural Society the coming year. These will not be persons who have to be urged to join, but who seek to join. This is what makes an enthusiastic society. From all appearances our society is likely to be a permanent one and productive of much good."



## The Canadian Horticulturist

SUBSCRIPTION PRICE, \$1.00 per year, entitling the subscriber to membership of the Fruit Growers' Association of Ontario and all its privileges, including a copy of its valuable Annual Report, and a share in its annual distribution of plants and trees.

REMITTANCES by Registered Letter are at our risk. Receipts will be acknowledged upon the address label.

### ↻ Notes and Comments. ↻

CREDIT.—On page 437, last year, article on Bank Forcing House should be credited *American Agriculturist*.

---

THE SECOND REPORT of the Ontario Fruit Experiment Stations will be a very valuable one and contains a large number of illustrations. It will be bound in with the report of our Association, and all members will receive it as soon as it is issued.

---

GRAPE VINE LEAF HOPPER.—Professor Fletcher writes he has had no trouble in treating grape vine leaf hopper and rose leaf hopper with kerosene emulsion. This is an insect so widespread and so injurious, that a general persevering attempt should be made to prevent its ravages.

---

NIAGARA FALLS SOUTH Horticultural Society had a fine exhibition about the middle of September. There were about 450 entries of fruits, flowers, etc., and an attendance of about 600 people. A list of the exhibits was published but no money prizes were given, the Society's money being spent in the interests of the whole membership, rather than in paying a few prize winners. We would like frequent letters from the various affiliated Horticultural Societies, that we may know of their progress.

---

PLANT DISTRIBUTION.—Under open letters Mr. Saunders, Director of the Central Experimental Farm, Ottawa, kindly offers us such ornamentals as can be spared for distribution in 1896 among our members. At the Woodstock meeting he exhibited a pressed specimen of a new *Ampelopsis* resembling *A. Veitchii*,

otherwise known as Japan Ivy, but much hardier than the latter. It is a native of Northern Ontario, but has some of the habits of growth of *A. Veitchii*. Mr. Saunders hopes to be able to propagate this hardy form and, if successful, will donate a large number of these plants to our Association in 1897.

---

GARDEN NETTING.—Birds are so destructive of cherries that the use of garden netting for special varieties might well repay the expense. Mr. Henry R. Boardley, Lowestoft, England, is engaged in handling this line of goods, and writes giving us the following low quotations :—

100 yds. long, 1 yd. wide, per 1,000 yards.....	£1 3s. 9d.
“ “ “ 2 “ “ “ “ “ “ .....	2 7 6
“ “ “ 3 “ “ “ “ “ “ .....	3 11 3
50 “ “ 4 “ “ “ “ “ “ .....	4 15 0
“ “ “ 6 “ “ “ “ “ “ .....	5 2 6
25 “ “ 8 “ “ “ “ “ “ .....	5 0

Or any other lengths or widths at proportionate prices. Term, 5% for prompt cash, F. O. B. here.

---

SPRAYING FOR FUNGI was little needed in 1895, but that is no guarantee that it will also be unnecessary in 1896. We would advise all orchardists who aim at producing yearly crops of first grade fruit, to be prepared for most faithful work this season. The first warm days of spring, before the leaves open, should be taken advantage of for applying sulphate of copper. Prof. Taft, of Michigan, writes as follows in the *American Agriculturist* on this point : “ It is now about three years since a strong solution of copper sulphate first came into use as a fungicide upon the bare branches of trees before the buds opened, and the results obtained from its application have been so favorable that it is recommended by nearly, if not all, of the spraying calendars. When used at the rate of from one pound to fifteen or twenty-five gallons of water, it destroys the mycelium of such fungi as winter upon the branches, and prevents the germination of such spores as may come in contact with it ; but at this strength it will destroy the foliage, hence it cannot be used later in the season.”

---

UNIFORM SIZES OF FRUIT PACKAGES.—Perhaps it does not matter what the sizes are, but it is important that all growers should adopt uniform sizes in shipping fruit. Peaches and plums are commonly shipped from the Niagara district in a handle basket, supposed to hold twelve quarts, and usually called the twelve quart basket ; but some makes of these baskets hold only eleven quarts. Now there is no objection to an eleven quart basket, but the fault consists in selling it for a twelve quart basket. The following standard packages adopted by the Capetown Board of Horticulture may be of interest in this connection, though not just suitable to our needs. The standards, we understand, are as follows :—Grapes, apricots, and plums, 12, 14, and 48 lb.; apples, pears, and peaches, 10, 20, and 40 lb.; cherries, 1 and 12 lb.; guavas, 12, 24,

and 48 lb.; loquats, 10, 20, and 40 lb.; strawberries, 1 and 10 lb. This resolution has been communicated to the Capetown Corporation, with the request that these standard packages be adopted for the sale of fruit on the Capetown market, such standard not to contain less than the weight above mentioned, and to be known as whole, half, and quarter, and pointing out also the necessity of very stringent market regulations about the grading of fruit, which should be of uniform quality in the package.

---

HORTICULTURAL SOCIETIES.—Our readers will be interested in knowing that new horticultural societies affiliated with the Fruit Growers' Association continue to be formed in many parts of the province. There were nine of these societies formed early in January of 1895, and we have reports of six more that will be formed in January, 1896, namely, Dunnville, Leamington, Windsor, Simcoe, Chatham and Hagersville. These societies, to a great extent, have been formed through the agency of Mr. Thos. Beall, of Lindsay, our Director for District No. 5, who has taken a great interest in thus extending the work of our Association.

Mr. Beall writes with regard to these societies as follows:—"The objects in view by those who are supporting me in organizing new horticultural societies are various, but the main object is to cultivate in the community a greater love for the science of horticulture in all its branches, and to do this mainly by inducing its members to expend its funds in holding meetings for discussion, and for hearing lectures on the theory and practice of improved horticulture; in promoting the circulation of horticultural periodicals, in distributing among its members new and valuable kinds or varieties of plants, shrubs, bulbs, seeds, etc., or in offering prizes for essays on questions of scientific inquiry relating to horticulture, but not for holding fairs or exhibitions as generally understood, because such fairs are generally so conducted that a large portion of the funds of the society is thereby expended in encouraging the growth or production of things that should be discouraged, and also because comparatively few of the subscribing members receive any direct benefit whatever from such fairs. Hence the unpleasant and tedious task devolving upon a few of the directors every year of collecting the annual subscriptions.

"By conducting the affairs of horticultural societies on the plan faintly indicated above, and which plan is practised by most of the new societies, every member receives an equal share of the advantages secured by the expenditure of its fund (excepting any small amount which may have been paid for essays), and, by pursuing this plan, the unpleasant task of dunning the old members, and of soliciting for new ones for their subscription fees for succeeding years becomes unnecessary, as the old members and many new ones do voluntarily call upon the treasurer, or at some appointed place, and pay their subscriptions, in most cases, before the new year commences."



OUR MEETING AT WOODSTOCK was a good one. The local Society, under the presidency of Mr. T. H. Parker, took a great deal of trouble to ensure our comfort. The Board of Control of Experimental Stations spent all day Tuesday discussing the work of the Stations; Wednesday was a day full of work; Thursday morning was spent in visiting the town, and in the afternoon the Hon. John Dryden gave the Association a very interesting and valuable address, indicating the lines upon which he desired the aid of the Association in advancing the fruit interests of the Province. Thursday evening was given to Horticulture. An interesting paper on House Plants, by Mr. Scarff, of Woodstock, we give in this number. On Friday morning Mr. Shuttleworth, representing the Fruit Growers' Association, spoke at considerable length upon varieties of apples for export; grading, packing and selling apples. His views of apple grading coincided with those of the many growers present, who believed that the grades as defined by the Dominion, were those most desirable, not only for export but also in our home markets. The meeting closed at noon on Friday, the same officers having been re-elected for the year 1896. There are three new names on the directorate, viz., J. L. Huggard, Whitby; J. S. Scarff, Woodstock; and John Stewart, Ben Miller. The discussion was taken verbatim by our official reporter, Mr. Thomas Bengough, of Toronto; and our annual report will be placed in the hands of the Department for publication, at as early a date as possible.

THE MICHIGAN HORTICULTURAL SOCIETY was well represented by Messrs. L. B. Rice and L. D. Watkins. The latter gentleman has a private park of 65 acres, and frequently brings a carload of poor children from the city to enjoy the shade while he feasts them with peaches, an illustration of the way wealth and philanthropy may unite in making the world happier. These gentlemen both contributed much valuable information.

THE CENTRAL EXPERIMENTAL FARM was well represented by Director Saunders and Horticulturist Craig, both of whom materially contributed to the success of our meetings. The subject of the blossoming period of our fruit trees, dealt with by Mr. Craig, is a most important one, pointing out that orchards were often rendered barren on account of infertile bloom, which needed other varieties planted near, and blooming at the same time, to ensure fruitfulness.

GUELPH AGRICULTURAL COLLEGE was well represented by President Mills and Horticulturist Hutt. In his address the former explained that their work was educational rather than experimental; yet much experimental work was in progress.

MR. D. W. KARN, President of the Board of Trade, Woodstock, has extensive factories, pianos and organs. He has a beautiful home on the street leading to Woodstock College. His paper read on Thursday evening, on Private Conservatories, well deserves careful perusal, and will be published in this journal.

## ❖ Question Drawer. ❖

### Labels for Trees.

**772.** SIR,—A short time ago I picked up in my garden a zinc tree label marked “Washington, 1871. Beadle.” I well remember marking all my trees with these labels, with ink made from a recipe given in the CANADIAN HORTICULTURIST, but have lost the copy. Could you give it me? The label has been exposed to the weather ever since, and is as good as ever.

F. W. FEARMAN, *Hamilton.*

Zinc labels are excellent for outdoor use. Even lead pencil marks on zinc are indelible. Some that were written ten years ago, are as legible as at the first. An ink for writing on zinc may be prepared as follows :—Verdigris, 1 oz. ; salammoniac, 1 oz. ; rain water,  $\frac{1}{2}$  pint ; mix in an earthen jar. Mr. Hutt, of Guelph, uses celluloid labels, and writes with an ink made of varnish, drop black and turpentine.

---

### Trellising Grape Vines.

**773.** SIR,—Regarding trellises or espaliers for grape vines, I venture to suggest that the best has not yet been attained, and that a more convenient form of support than any of those generally seen would possibly increase the number of vines planted by making the culture easier and the vines more prolific.

M. LEPPER, *Picton, Ont.*

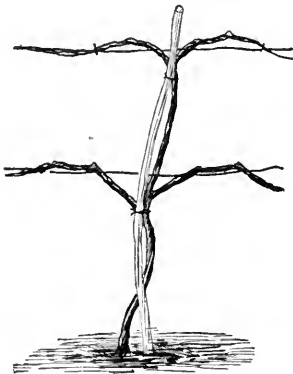

FIG. 897.

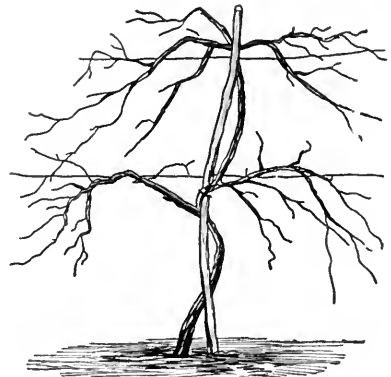

FIG. 898.

.Probably no simpler contrivance for supporting the vines than the Kniffen system, shown in the accompanying illustrations, can be devised. Two wires only are needed as supports, and posts may be planted twenty feet apart, with lighter poles between. Every spring the wood is pruned back to four arms, two on each wire ; no summer pruning or tying is needed, because the young growth simply hangs down from the horizontal arms.

## How to Treat Rex Begonia.

**774.** SIR,—I have some Rex Begonia five years old. They did well for four years, but after that they lost the leaves, and almost stopped to grow. What is the best way to treat them and what soil is the best?

JUSTUS ROEDLER, *Milton, Ont.*

*Answered by H. L. Hutt, O. A. C., Guelph.*

It is not advisable to try and keep Rex Begonias after they are three or four years old. Propagate new plants from leaf-cuttings, and have enough of these coming on every year to take the place of the old ones. The begonia thrives best in a soil in which there is good admixture of leaf-mould and sand.

---

## ✻ Open Letters. ✻

### Strawberries in November.

SIR,—At the meeting held November 30th, to consider the feasibility of organizing a horticultural society, Mr. C. Curtis, a noted grower of strawberries in this town, exhibited a small box of strawberries which had been gathered in his garden on the previous afternoon. The berries were Wilson Albany, of fair size and in good condition. This speaks well for this locality as a fruit growing district. The berries were grown in the open air without protection.

THOS. BEALL, *Leamington.*

---

### A New Pear.

SIR,—I wish to bring before your notice a new pear. Seeds were planted twenty years ago and when they were large enough they were grafted, but one of those not grafted turned out to be the finest pear we ever saw. Two fruit growers who saw it said the flavor is the very best, and think it ought to be introduced. Probably I will send you a sample next season. I think it originated from the seed of either Flemish Beauty or Bartlett. It resembles the former somewhat in shape, but is longer and a trifle more watery. It ripens about the 20th of September. The color on one cheek is deep red and shades out to a rich yellow on the other side. We have no better pear for cooking.

W. H. SHOUP, *Cheapside.*

---

### Our Plant Distribution for 1896.

SIR,—With regard to your next distribution of trees and plants, I will discuss the subject with Mr. Craig, but I doubt if we shall have anything in quantity this year which would be of value to you. We have some young cotoneasters, such as *Acutifolia* and *Vulgaris*, but they are only one year old seedlings, and would, I fear, be too small. They would, however, come in another year. We have a few *Acer glabrum* from British Columbia, but could not spare more than 25 or 50. We might also spare you 50 to 75 *Picea pungens*. We could let you have 100 to 150 of a dense form of *Rhamnus frangula*, if you thought that was sufficiently ornamental. We have grown them for hedge purposes, and the plants we have are strong two year seedlings. We could also spare 100 plants of *Bignonia radicans* raised from seed ripened at Windsor, Ont. I expect these seedlings

would be hardier than any plants which could be purchased from nurserymen, as they are usually grown from seed ripened farther south. I think we also have 40 or 50 plants of *Asclepias tuberosa* we could spare you. This, although native in Western Ontario, is very little known in gardens, and it is very ornamental. We also have a few *Berberis Thunbergi* two year old seedlings of which we could spare probably 40. Beyond this we have nothing which I can suggest.

WM. SAUNDERS, *Central Experimental Farm, Ottawa.*

### Apples in Edinburgh.

SIR,—The cases of apples which you sent are very nice, and we will, no doubt, make a satisfactory price for you. The Cranberry Pippin, however, is by no means a favorite here. Baldwins, Spys and Kings are much more likely to maintain good prices year after year.

Mr. John Penman's letter in the *CANADIAN HORTICULTURIST* is just to hand. Mr. Penman omits to say that the prices he paid were for the choicest home hothouse grapes and tomatoes and for French pears, we presume Glout Morecau.

Honesty in packing is certainly very essential to success, but we do not know of any prejudice existing as to American goods, certainly not apples, as after they come to hand, other apples have little sale. Grapes, we fear, will never succeed, if the parcel we had from a Canadian grower is a fair sample of the flavor; not to speak of the condition in which they landed. Plums we are almost sickened of by the time our own crop is exhausted, but we see no reason why pears should not do well.

We recommend the French mode of packing, which is unknown with you. We shall be pleased to explain fully. It saves the fruit and helps the price, besides making it attractive, a very strong point, we assure you.

We noticed a letter, copied, we think, from a Glasgow paper, published in the *CANADIAN HORTICULTURIST* some little time since, about packages, Barrels vs. Cases. It is a pity that people who have no practical knowledge of the trade take it upon them to write to papers, as they generally mislead the public. For general purposes, nothing beats the Canadian apple barrel, though where fancy fruit is exported, a smaller package, not the half barrel, however, which does not take, but such a package as the case you use, holding fifty-six pounds net, is desirable. Yet since the demand for these, at figures to pay for the extra labor and expense, must always be limited comparatively, it follows that to make this the rule would only be to bring down the price of the case to the ordinary level, and all the extra labor and expense would be lost.

The British public generally do not use apples for the table or dessert, except to a fraction of the extent that they use them for culinary purposes, and for the latter they are keen enough to combine quantity with quality to the greatest possible extent. We are fully convinced that any attempt to materially increase the number of packages, except in the case of fancy packages, would be resented by the whole trade, unless it brought relatively increased profit or commission. We venture these remarks, thinking they might be of service to you and other fruit growers.

WOOD, ORMEROD & Co., *Edinburgh, Scotland.*

### Small Fruits in Scotland.

SIR,—The samples of Canadian strawberry plants you sent me arrived in very fair condition. The most promising of all is your namesake, the Woolverton. We had a few fruits on it, and they were good in flavor, color and consistency. The best strawberry I grew last season was the Sir Joseph Paxton. Some of the berries were simply magnificent, and my highest price was 15 cents per pound in the market. My farm, just three years old, yielded forty-five tons of strawberries, eight tons of raspberries, fourteen tons of gooseberries, besides odds and ends of red and black currants, and a few apples and plums. Within the next year or two I expect better crops of the latter, including pears, as I have planted 5500 trees which are growing well. This year we had a bumper crop of apples and pears in Scotland, but nearly all was cleared off before yours appeared in the market. Scotch stuff sold very cheaply, although the quality were very good. For good, fruit exporters on your side may secure extra prices, but, as the preserve makers get their stock pretty well made up with Scotch apples, slacks and inferior fruit will not bring much on this side.

ROBT. SCOTT,  
*Clydesdale Preserve Works, Carluke, Scotland.*

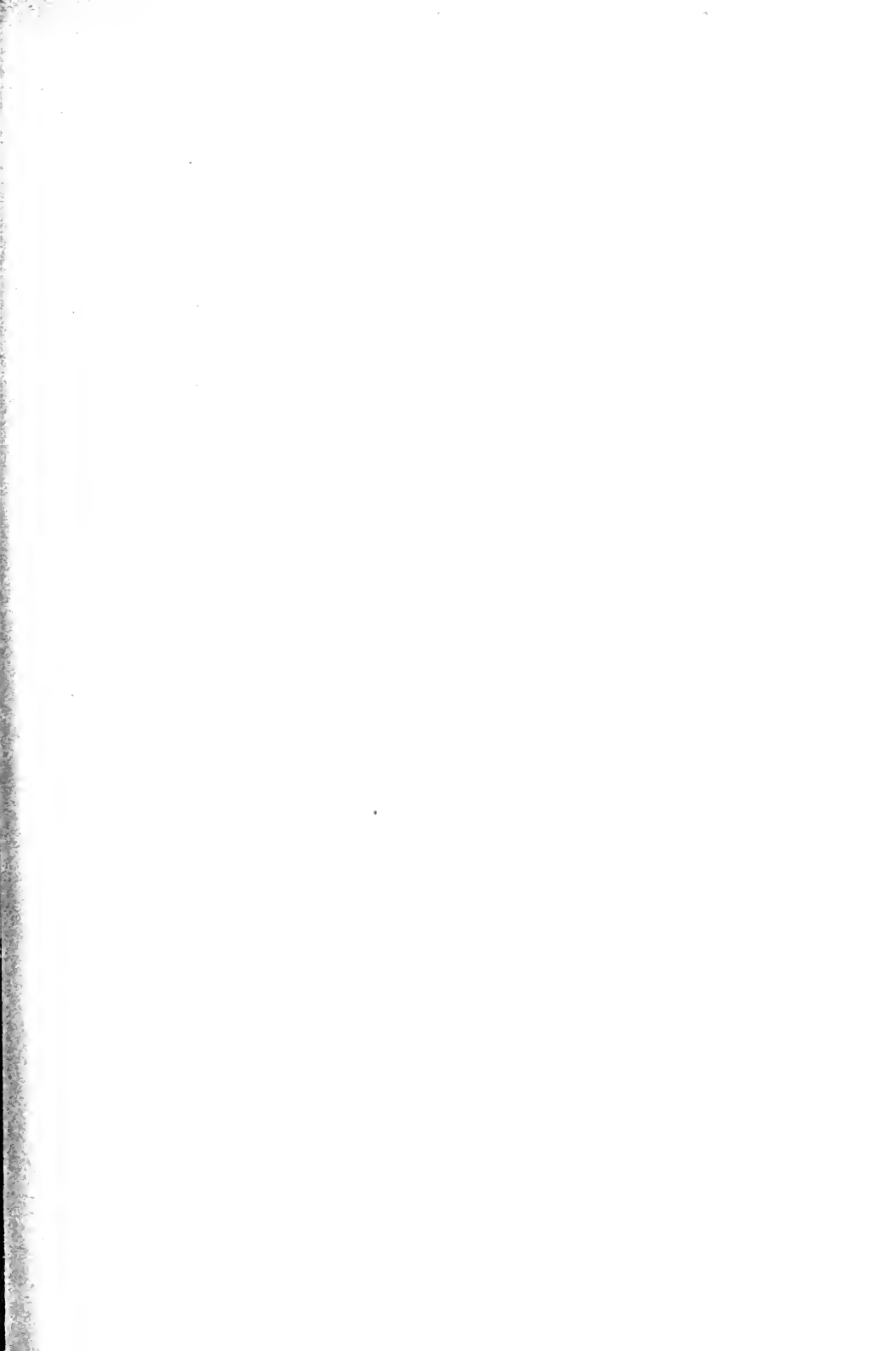



STEECHER LITH CO ROCHESTER N.Y.

FELLEMBURG.

THE  
Canadian Horticulturist

VOL. XIX.

1896.

No. 2.

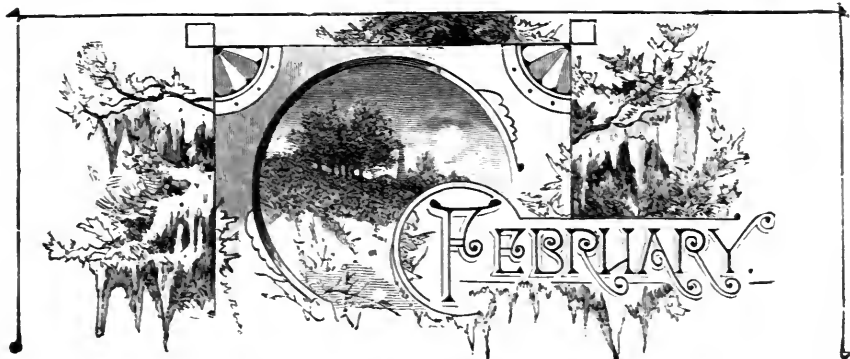

THE ITALIAN PRUNE.



HE plum is a favorite in many of the commercial orchards of Ontario, especially in some districts bordering on Lake Ontario and on the Georgian Bay. Much more hardy than the peach, it will yield good crops almost annually and, the fruit being firmer, it can be shipped a longer distance and marketed to better advantage.

For a long time the curculio and plum knot were the bugbears which prevented fruit growers from growing plums to any great extent, but the curculio is less formidable of late since we have found that spraying with Paris green, just before the blossoms open and again just after they fall will, to some extent, destroy the parent beetles, while by careful attention to jarring the crop may be protected almost completely. The plum knot too can easily be kept in subjection by united effort among plum growers in cutting out and burning the knots as they appear. With the difficulties thus lessened, plum growing in Canada is of late receiving a fresh impetus and promises to be one of our most important industries.

That class of plums, known in commerce as prunes, is especially well adapted for cultivation in such localities as are situated at a distance from the great markets, for by reason of their firmness and keeping qualities, they will bear shipping well.

The drying of these prunes is an important industry and the prunes of Provence are well known in commercial circles. The Prune d'Agen is a favorite variety for this purpose and the German Prune is very highly valued in Ontario for profit, especially in the vicinity of Collingwood.

The Italian Prune (Felleberg) is another of this class. Our colored plates shows the very finest samples that

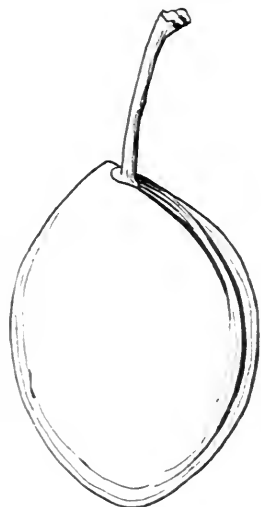

FIG. 899.  
ITALIAN PRUNE.

could be chosen, while our engraving shows this plum as it may be expected to grow under ordinary conditions. The following description of the Italian plum is according to Chas. Downing: Tree, vigorous, spreading; branches, smooth; fruit, medium, oval; suture, moderate; skin, dark plum color, with a bloom; an inch long, rather stout, inserted in a small cavity; flesh, dark yellow, juicy, sweet, good; separates from stone; quality, good; October.

---

**Barreling Apples.**—Many of the most profitable operations in commercial life depend in the first instance upon very simple facts. Most persons would pass by without observing the barreling of apples as a case in point. If apples were placed loosely in barrels they would soon rot, though passing over but a very short distance of travel; and yet when properly barreled they can be sent thousands of miles, even over the roughest ocean voyage, in perfect security. This is owing to the fact discovered years ago, without any one knowing particularly of the reason, that an apple rotted from a bruise only when the skin was broken. An apple can be pressed so as to have indentations over its whole surface, without any danger of rotting, provided the skin is not broken. In barreling apples, therefore, gentle pressure is exercised, so that the fruit is fairly pressed into each other, and it is impossible for any one fruit to change its place in the barrel on its journey. Apples are sometimes taken out of barrels with large indentations over their whole surface, and yet no sign of decay. In these modern times we understand the reason. The atmosphere is full of microscopic germs which produce fermentation, and unless they can get an entrance into the fruit, rot cannot take place. A mere indentation without a rupture of the outer skin does not permit the action of these microbes. This is a simple reason why the early observation enabled the barreling of apples to be so successful.—*Meehan's Monthly*.

---

**Importance of Bees in the Orchard.**—In a series of experiments at the Oregon United States Experiment Station, in the pollination of the peach, the trees were forced under glass to bloom in November. A colony of bees was placed in the house when the trees commenced to bloom. A heavy fog prevailed for fifteen days, and although the flowers were constantly opening, not a bee showed itself. During the night of the 15th, the fog lifted, and the next morning was bright and clear causing the pollen to burst. Then the bees came from the hive and kept up their work for eight or nine days. The result was that not a single peach was observed to drop at the stoning season. So great was the amount of fruit on the trees that it was necessary to thin it. One tree in the house was securely protected, so that the bees could not gain access to it, and all of the fruit dropped at the stoning period. Mr. George Coote, horticulturist of the station, says that these facts show the value of bees to the horticulturist, and that no fruit grower should be without them.



## THE ONTARIO APPLE.



FIG. 900.—ONTARIO APPLES.



OUR readers may be interested in seeing a photogravure of some samples of this apple, because it is a variety which has of late been kept quite prominently before the public. The variety was raised by Mr. Chas. Arnold, of Paris, Ont., from seed of Northern Spy crossed with Wagener, and the fruit has some of the characteristics of both parents. It is not claimed for this apple that it is hardy in northern portions of Ontario, where hardiness is a necessary characteristic, but where the Spy and the Wagener flourish, this variety is a most desirable one. Indeed it is thought to be more abundant than the Spy.

The tree is a fine grower, and an early, abundant bearer. The fruit is large, whitish-yellow, nearly covered with a rich red color; and the flesh is fine, tender, juicy and of good quality. It sells well in the English market, and being productive of even sized fruit, promises to be a profitable orchard variety. At Mr. W. H. Dempsey's, Trenton, in 1894, we saw a fine orchard of Ontario apples laden down with the fruit, of large and even size. From all appearances this apple is destined to take the place of the Spy in our commercial orchards.

---

A LECTURER FOR OUR SOCIETIES.—Should the number of affiliated Horticultural Societies continue to increase, it is proposed to engage some competent lecturer to visit each society once a year, and give a lecture on some topic connected with either fruit or flower culture.

## BLACK RASPBERRIES.

### Pruning.



LACK raspberries are usually headed back when from  $1\frac{1}{2}$  to 2 feet high. It is important that this heading-in be done about as soon as the canes reach the desired height rather than to leave them until considerably higher and then to cut them off to the required point, for the laterals then start low and the bush becomes stout and self-supporting. It is a very general mistake to head back raspberries too late or too high, causing the laterals to start nearer the top of the cane and thereby making it top-heavy. Fig. 000 is a good cane, and Fig. 000 shows several undesirable canes. The laterals are cut back the following spring to a length of 12 to 18 inches, the same as blackberries are. This treatment also applies to the purple-cane varieties, like Shaffer, but not to the reds, for these are rarely headed-in at all.

The red raspberries are very seldom evaporated, and only the Cuthbert is used for that purpose, so far as I know. The red berries generally pay better when given to the open market. Of the purple berries, only the Shaffer is dried in Western New York, and it is doubtful if it is profitable when thus handled, for it loses too much in drying, and the market for dried red and purple berries is very small.

There are really only two important varieties in the evaporating industry in Western New York, the Ohio and the Gregg.



FIG. 901.—A GOOD CANE WITH LOW LATERALS.

### Yield of Raspberries.

How much will an acre of raspberries produce, taking the average of three crops? Opinions differ widely. We could begin with zero on the one hand, and rise to 6,000 quarts. In an inquiry made here in 1893, the average of 58

replies of berry growers was 2,493 quarts. One gave his yield (which must have been on a small patch and amply multiplied) as 9,600 quarts, whilst another confessed to but 576 quarts. A good yield for the second crop is 3,000 quarts, or 90 to 100 bushels per acre. Willis P. Rogers tells me that his largest field crop of Ohio, the third year after planting, was 16,000 quarts on four acres, and a half acre of this land was not up to the standard. From extensive inquiries of evaporator men, however, I find it to be a general opinion that the average crops of the country, one year with another, will not exceed 1,200 quarts per acre, or 300 pounds of dried product.

#### Harvesting.

The harvesting of the crop costs too much. The price paid by evaporating men this year for Ohios and Greggs was  $4\frac{1}{2}$  and 5 cents a quart, yet the grower generally had to pay 2 cents a quart for picking. Here is an advantage of the Gregg, for pickers can generally do as well in picking it for  $1\frac{1}{2}$  cents as in picking the Ohio for 2 cents. To lessen the cost of harvesting and to overcome the difficulty of securing pickers in remote



FIG. 902.—POOR CANES, WITH HIGH LATERALS.



FIG. 903.—BERRY HARVESTER.

places, the berry harvester has come into use. This is a canvas tray, made by stretching the cloth over a light wooden frame about three feet wide and four or five feet long. At the bottom, the frame projects upwards at right angles to the body of the frame to a distance of five or six inches, to catch the berries as they fall upon the canvas. A wooden shoe or runner is placed on the bottom of the apparatus to allow the

operator to slide it along from bush to bush, as shown in Fig. 903. A long wire hook is used to pull the bushes over the tray or to lift up the fallen canes, whilst with the other hand the operator deftly cuffs off the berries with a paddle of wood or of wire covered with canvas and about the size of a butter ladle.

The harvester is used only for the gathering of berries which are to be evaporated. The berries are allowed to become fully ripe, so that they fall easily, and the patch is gone over about three times. Much litter falls with the berries, but this is easily removed by running the dried fruit through a fanning mill. Few growers use the harvester exclusively. It is often brought into requisition at the last picking and it also has a most stimulating effect upon a lot of disaffected berry pickers.—PROFESSOR BAILEY, in Cornell Bulletin, No. 100.

## RASPBERRY CULTURE IN SOUTHERN ONTARIO.



N article on "Raspberry Culture at Tiverton in Northern Ontario" appears in the January Number of 1896. I do not know how extensive the raspberry fields are at Tiverton, but the practice there differs from ours. Plants 6 x 6 feet might give plenty of fruit, but their cultivation would be dearer, not cheaper. Canes at smaller distances will often shade the whole ground, and this keeps down weeds. We shorten the laterals if they interfere too much with cultivation. We plant deeper than one inch. We use a furrow and plant two, three or four inches deep at the outset; cultivation increases the depth. Mr. Cameron, the writer, ceases to cultivate when the fruit begins to set. As this occurs pretty early in June, and in a late wet spring the cultivator would not start till late in May, the expense for cultivation must be very light. The crop of fruit would be light too. The crop of weeds would make up the deficiency. With us, if the land was any good, a firm sod would soon be established.

Mr. Cameron will find that the cultivation which is good for the canes the first year is good for the canes each succeeding year. In my own case I cultivate until the fruit ripens. During the few weeks of the picking season cultivation is not practicable. So soon as picking is done cultivation is resumed. We always stop cultivating in November or December when the ground freezes hard. A shallow, late autumn plowing is admissable. The cultivator, in passing across the rows, as well as the outward pull of the hoe, will soon restore the level which is desirable. I plant 4 x 6 feet; with frequent cultivation lengthwise and crosswise of the rows, not much hoeing is needed. After August or early September I do not shorten in the canes while the season of growth lasts. They may be shortened in during November when the growth has ceased, if they interfere with plowing.

## HOW TO BUILD A SERVICEABLE ICEHOUSE AT MODERATE COST.



N icehouse need not be a costly structure, but if it is to be an attractive addition to the farm or in keeping with other attractive buildings it cannot be built at a small cost. I shall charge the cost against the efficiency as a preserver of ice. The requirements of an icehouse are that it will hold sawdust around the ice to keep the rain off and drain water. The materials used in its construction may be of the cheapest and rudest character and yet keep the ice as well as if it cost \$150 or \$200. A neighbor has an icehouse erected at a very small cost, and yet his ice is preserved perfectly. The sides are of poles laid up into a pen twelve feet wide, eighteen feet long and ten feet high, the poles being notched slightly where they cross, to prevent rubbing and to lessen the cracks between them. The gables are left open to give ventilation. A floor is made and proper drainage acquired by laying rails together a foot thick. The roof projecting three feet at each end, is of clapboards nailed to cross pieces resting upon pole rafters. All the material except the nails and the material for the door were worked out of the farm timber.

In filling this house the blocks are laid within eighteen inches of the holes and the spaces between them filled with sawdust as the ice is built up. Where timber is not so plentiful a serviceable structure can be built at a cost but little greater than the cost of this one. Refuse boards or slabs can be used for the sides, nailing them up or down and putting on a board roof. The house should be built on high ground that surface water may not enter. It is well to cut a shallow ditch around the building. In filling cut the blocks as large as possible and pack closely. All crevices should be filled. In

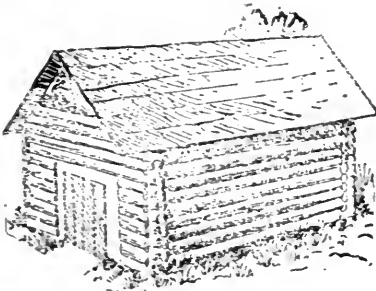

FIG. 904.—CHEAP ICEHOUSE.

the spring watch for holes and close them as soon as found. Even in March the air will often be warm enough to make holes and if the air is allowed to circulate through holes it melts ice rapidly. When a stream is fed by a spring or brook, clear pure ice can be procured. A pond, unless it is quite large and stock have been kept from it for some time, will not yield ice fit to be used. No amount of freezing will make purely wholesome ice out of foul water. It is quite as essential that water for the ice supply should be as pure as for the ordinary family water supply.—R. H. MCCREADY, in *Farm and Home*.

**A Kansas** Populist is at work on a new scheme to increase the sum of human happiness. He is trying to cross the milkweed and the strawberry, so that people may raise strawberries and cream together.—*New York Tribune*.

## INFERTILE BLOSSOMS THE CAUSE OF BARRENNESS.



THE cause of barren orchards was under discussion at our meeting at Woodstock, and Horticulturist Craig, of Ottawa, gave his opinion that in many cases this state of our orchards is due to infertility of blossom. With a view of further investigating the subject, Mr. Craig read a very interesting paper on The Blossoming Period of Fruit Trees, which showed (1), the time of blossoming of the different varieties in the same locality, and (2), the different times of blossoming of the same variety in different parts of our country. Evidently if it is necessary to have the blossom of our varieties fertilized by the pollen of another variety for fruitfulness, the varieties must be such as bloom at the same period. In this connection the following extract from Bulletin 102 of Cornell University will interest our thoughtful readers :—

In late years it has been observed that some varieties are commonly infertile with themselves ; that is, the pollen of one variety is more or less impotent upon flowers of the same variety. The subject is very little understood, and it is not yet safe to generalize upon it ; but it is a good practice to plant varieties in alternate rows or only two rows together, to insure free fertilization. Some of the varieties of apples and pears which have been studied in this respect (by Waite and Fairchild) are as follows :—

**Apples.**

*Varieties more or less self-sterile.*—Bellfleur, Chenango, Gravenstein, King, Spy, Norton, Melon, Primate, Rambo, Red Astrachan, Roxbury Russet, Spitzenburg, Talman Sweet,

*Varieties generally self-fertile.*—Baldwin, Codlin, Greening.

**Pears.**

*Varieties more or less self-sterile.*—Anjou, Bartlett, Boussock, Clairgeau, Clapp, Columbia, Easter, Gray Doyenne, Howell, Jones, Lawrence, Louise Bonne, Mount Vernon, Sheldon, Souvenir du Congres, Superfin, Colonel Wilder, Winter Nelis.

*Varieties mostly self-fertile.*—Angouleme, Bosc, Buffum, Diel, Flemish Beauty, Kieffer, Le Conte, Manning's Elizabeth, Seckel, Tyson, White Doyenne.

*It is probable that many trees fail to bear because propagated from unproductive trees.*—We know that no two trees in any orchard are alike, either in the amount of fruit which they bear, or in their vigor and habit of growth. Some are uniformly productive, and some are uniformly unproductive. We know, too, that cions or buds tend to reproduce the characters of the tree from which they are taken. A gardener would never think of taking cuttings from a rose bush or chrysanthemum or a carnation which does not bear flowers. Why should a fruit grower take cions from a tree which he knows to be unprofitable ?

The indiscriminate cutting of cions is too clumsy and inexact a practice for these days, when we are trying to introduce scientific methods into our farming. I am convinced that some trees cannot be made to bear by any amount of treatment. They are not the bearing kind.

## THE CIGAR CASE BEARER.



HILE at Mr. Harold Jones' fruit farm, at Maitland, on the St. Lawrence, last summer, we were shown this insect in large numbers, infesting his apple foliage. Under the direction of Mr. Fletcher, our friend Mr. Jones has been conducting numerous experiments for its destruction; and last May a Bulletin was published by Mr. Slingerland, of Cornell, upon this insect. The most effectual remedy seems to be a spray of kerosene emulsion early in June, when the little cases begin moving about, and the buds are opening; and a second application about a week later. Where the Bordeaux mixture is being used for apple scab

as buds open, Paris green may be added, and this spray will check the cigar case bearer, and the apple bud moth, which also needs treating at that time.

The emulsion should be made by dissolving half a pound of hard soap in one gallon of boiling water, to which, while hot, add two gallons of kerosene.

In order that our readers may be prepared for this new insect enemy we may briefly summarise its history by stating that the eggs, which are laid in June, hatch out in July, and mine the leaves until September, when they make a winter case in which they hibernate, attached to a twig (Fig. 905). Here the insect remains until about the middle of April, when it attacks the opening buds, the young leaves, the flower and fruit stems and the young fruit.

The accompanying engraving (Fig. 906) from the bulletin above mentioned gives a very correct idea of the appearance of the cigar case bearer at work, just as we saw him in Mr. Jones' orchard, and it can easily be imagined that the leaves would soon be well skeletonized and the trees sadly debilitated by his work. Towards the end of May the winter case is discarded for a large one, which the insect manufactures from bits of the leaves, as shown in Fig. 907, after which it begins the most damaging period of its existence. Protruding from its case, it eats through the skin of the leaf and mines out the tissue as far as it can reach and still hold to its case. Towards the end of June they pupate, and soon the moth emerges and begins its work by oviposition.



FIG. 905.—Small curved cases in which insect hibernates— one old case on right side. Twigs magnified to twice natural size, after Slingerland.



FIG. 906.—CIGAR-CASE BEARERS AT WORK ; NATURAL SIZE.

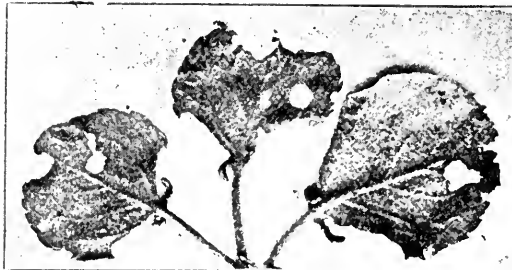

FIG. 907.—Leaves whose basal portions were used by caterpillars in making cigar-shaped cases ; natural size.



## FRUITS FOR EUROPE.



PROBABLY England offers the best possible market for American fruits if they can be shipped there in proper condition, and at an expense not so great as to absorb all profits. Comparatively few fruits of any kind are raised there, except in the gardens of the wealthy, and the markets are supplied with a limited number of apples, pears, peaches and apricots by a few professional fruit growers. The English public like fruits as well as the American, but the supply has never been large enough to satisfy the demand. Some of the smaller fruits, such as strawberries, gooseberries, currants and raspberries are raised by all of the poor farmers, and they supply the market pretty well. But outside of these small berries, the English markets seldom display for sale the great varieties of fruits so commonly raised in America.

Australia has lately entered the market to supply England with fruits, and fast steamers are engaged in carrying apples from that island to the home country. With the steady growth of Australian horticulture, it will be only a short time before large quantities of other fruits will be sent to England, Horticulture has developed faster in the former country than the population, and the growers have to seek foreign markets to dispose of their goods. Americans have been slow to avail themselves of markets outside of their own towns and cities. This has been partly due to the large home consumption of fruits. Our towns and cities have absorbed most of the crops in the past, and growers had no reason to go elsewhere to effect profitable sales. But we are rapidly reaching a time when the markets will have to be enlarged, or fruit culture restricted. In nearly every fruit growing region the surplus of goods is increasing rapidly, and even the canning and evaporating factories cannot use up all that are raised.

The question naturally arises, What can we do to increase the demand? The answer to this question was satisfactorily made years ago when apples were first exported successfully. Since then our shipments of apples to Europe has been enormous, and the trade has been placed on a secure foundation. There is no experiment about the matter. American and Canadian apples shipped to Europe command prices sufficiently satisfactory to the growers and shippers to induce them to continue the practice. During the last few winters several attempts were made to ship Florida oranges to Europe in the same way. The results were not entirely satisfactory, but when the methods of packing and shipping are better understood, there is no doubt but our orange shipments will be nearly as large as our present export trade in apples.

Our pears and peaches have been exported only in a very limited way, and yet the market is as good for these abroad as it is for apples. American pears, peaches, plums and grapes are the finest in the world, and the English consumers would be ready buyers if they could be shipped there in the proper

condition. Nearly all of these fruits are raised in superabundance in this country, and the hardy varieties will stand shipment well enough to enable merchants to place them upon sale abroad in excellent condition. Our fast steamers enable shippers to place the fruits on the English stands within seven and eight days from the time of picking.

Australia is rapidly coming to the front as a rival agricultural country to this, and it is time that fruit growers of the United States made some concerted action to place the great variety of our fruits in the English market. Only the soundest, freshest and properly picked and packed fruits will do for this trade, but these under the direct control of a good fruit association could be made profitable. Fruit growers need to combine together for such a work far more than they do for political purposes. On the whole the American farmer and horticulturist is far behind the manufacturer in introducing his goods in foreign markets. He has been so absorbed in the work of raising fine fruits that he has forgotten to exercise his Yankee genius in disposing of them to the best advantage.—Germantown Telegraph.

---

**Weeds** always have been and still are the closest friends and helpmates of the farmer. It was they which first taught the lesson of tillage of the soil, and it is they which never allow the lesson, now that it has been partly learned, to be forgotten. The one only and sovereign remedy for them is the very tillage which they have introduced. When their mission is finally matured, therefore, they will disappear because there will be no place in which they can grow. It would be a great calamity if they were now to disappear from the earth, for the greater number of farmers still need the discipline which they enforce. Probably not one farmer in ten would till his lands well if it were not for these painstaking school-masters, and many of them would not till at all. Until farmers till for tillage sake, and not to kill the weeds, it is necessary that the weeds shall exist; but when farmers do till for tillage sake, then weeds will disappear with no effort of ours. Catalogues of all the many iniquities of weeds with the details given in mathematical exactness, and all the botanical names added, are of no avail. If one is to talk about weeds he should confine himself to methods of improving the farming. The weeds can take care of themselves.—L. H. BAILEY.

---

**All Fruits** have a medicinal value, and the cranberry ranks as an anti-scorbutic. It is a blood cleanser; bruised and heated, not cooked, it has a healing effect on humors. One cut in half and bound on a corn will cure it in one or more applications. It will be equally efficacious in the case of pimples. As an article of food the cranberry is too little known. Many families know it only in the form of sauce, but it may be served in many other ways. A cool, refreshing drink may be made by boiling the berries in water double the measure of berries. Boil until the juice has been thoroughly extracted, sweeten with one half-pound of sugar to the pint of juice, and bottle hot.—Greengrocer.

## PRUNING AND TRELLISING GRAPES.

SIR,—Reading in your January No. regarding trellising grape vines, I would recommend poles only and no wires, and planting the vines five feet apart. I think Figs. 897 and 898 are very poor examples of the pruning system. I would recommend stub pruning only, and only three buds on each stub.

JEAN GRUENBECK, *Cayuga*.

Our correspondent is correct in saying that the manner of pruning represented in figures referred to are not the best methods of pruning the grape. We did not intend to recommend the Kniffen system as the best method, but only as the method most easily followed out by grape growers in Canada. Our correspondent, who we take it is a German, evidently has in mind the methods of growing grapes that are employed along the banks of the Rhine, where the vines are trained upon poles and no wires are used. For that country where labor is cheap, no doubt his method is the best, but for us in Ontario, where labor is expensive, and the seasons are rather short, the saving of labor is a very important consideration. If we plan on a method of pruning that requires constant tying and attention in the summer season, we will be very sure to neglect it, and it is on that account that we follow a different system from those employed on the continent. Besides this, the varieties which we cultivate for market purposes are mostly very strong growers, and it is difficult to keep them within bounds which is possible with the slower growing varieties. With the Kniffen system it is possible for the vineyardist to prune and tie his vines in the spring and allow them to grow for themselves during the rest of the season. For those who are able to give more attention to the pruning and tying of the vines as they grow during the summer season, we would recommend the Fuller system as far more adapted to our country than trellising upon single poles as recommended by Mr. Gruenbeck. We have often explained this method of pruning in this journal, but, as the question seems to be one that comes up almost annually, and as there are so many new members who have recently united with our Association, it may not be out of place for us to again present to our readers the illustrations which show the Fuller method, together with a repetition of what we said in explanation of it in a previous volume.

The first year after planting allow only one stem to grow (Fig. 908), and at the end of the first year, cut this back to within about one foot from the ground. The second year allow two buds to grow, producing two branches as in Fig. 909.

At the end of the second year, bend these two branches to form two arms, and these should be trained each way four or five feet along the lower wire, forming what are known as the "two arms." From these uprights are grown about every foot apart, as in Fig. 910, and every year these are cut back to within one or two buds of the old wood of these two arms.

It is a great temptation to do longer pruning, or to leave many of the uprights uncut, but the result seems always to be disastrous, for the growth will go to these higher parts to the almost entire abortion of the buds below. Then when it becomes very desirable to cut back, there are no buds left on the main arms to renew the growth for the following season.

With this system the only pruning needed in the summer, is simply to rub off superfluous sprouts when they are just beginning to push, and to stop the young growth about a leaf or two beyond the last bunch of grapes.

The tying up is very important and often neglected. Three wires are sufficient, and to these the uprights should be kept tied, as they grow, or the vineyard will present a very untidy appearance.



FIG. 908.

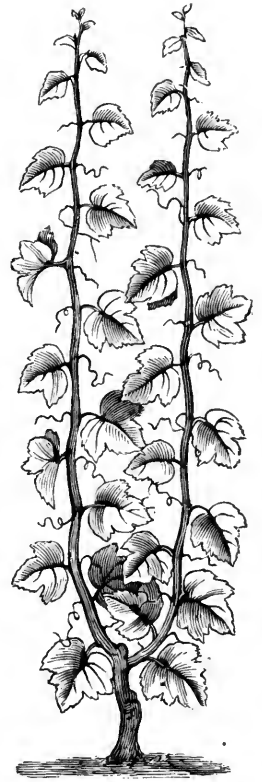

FIG. 909.

The experiment of shipping grapes from Chautauqua County, N.Y., to England has for the second time turned out to be a failure. The grapes spoiled before reaching their destination.

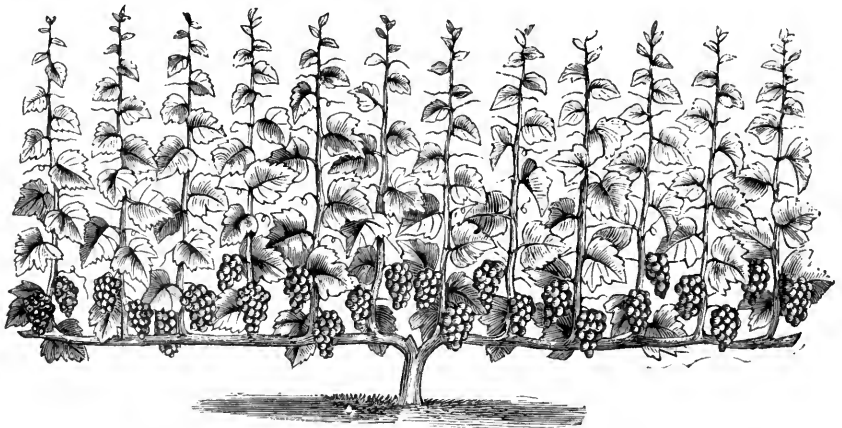

FIG. 910.

## THE VALUE OF OUR NATIVE GRAPES.



IN deciding on the value of a grape for home use, or for commercial purposes, the principal point to be determined is, whether our location and climate are adapted to the growth of the vine as well as the perfecting of the variety we intend to plant, as under certain conditions some varieties grow to perfection and some do not. Yet no matter what varieties we plant, we may make a mistake, since it is a well established fact that vineyards of the same variety in close proximity do not succeed equally well, though we shall be more sure to succeed if we choose varieties from species natural to our climate. Mr. W. Barns, Orange Co. N. Y., has a vineyard of Moore's Early which is wonderfully prolific, while on his brother's farm, not a quarter of a mile distant, the same variety has proved a practical failure. On my own farm in Yates Co., N. Y., I can show equally marked conditions. A vineyard of Catawbas planted seventeen years ago, under the advice of several of the then best vinyardists, had to be torn out, or grafted, while almost within a stone's throw this variety grows and ripens to perfection; hence we may say, be careful in selections both of variety and location, but do not condemn entirely because you fail once or twice.

After repeated trials of European vines, under the supervision and efforts of European vineyardists, and after European methods, this class of vines, the *Vitis vinifera*, had to be abandoned; up to this time, at any rate, they refuse to adapt themselves to our environments. Whether they ever will do so, remains to be proven. Through the earnest efforts of some of our vineyardists, such as Ricketts, Rogers, Caywood, Jacob Moore and others, the effort has been made to get some of the benefits, if such they be, of the *Vinifera* by hybridizing, using some of our native species with the Hamburg and other *Vinifera* varieties. For a time it seemed as if success was assured, but apparently only to a certain extent; and the assertion will not be contradicted that many varieties so obtained and promising well for a time, are being gradually relegated to the experimental vineyards. Commercial vineyardists feel safer with the pure native varieties. Some experts say, But what about quality? Well, let me ask, Are we quite sure about this apparently uncertain factor? Pomologists have tried to make a standard and have failed. Now, the people have made it without their help—at least it is fair to assume that they buy what they like best—and the natives are the grapes for the millions. Take the four varieties mostly grown east of the Mississippi—Concord, Delaware, Catawba and Niagara—each a pure *Labrusca*, or so nearly pure that no one can positively say they are not. Ninety-five per cent. of the total acreage, or more properly

ninety-five per cent. of the total production, are of these varieties. The principal reasons for this are: First, because we can grow them; and, secondly, because they come nearest to the standard of quality established by mutual consent.

Not many years since, the Concord was spoken of as poor in quality, among grape growers, but they must have been mistaken. It was quite the correct thing to say: "The Niagara is fine to look at, but it is off in quality"; but nevertheless, after having stood the test for some years, we seem to be wrong again, for the Niagara as well as the Concord is a good seller. The Concord, without a doubt, establishes the price of grapes east of the Rockies. The Delaware is more particular in its habitat, while the Catawba is still more particular, though both are successful vineyard varieties, and very much better in quality than Concord and Niagara. Yet the money test is bringing them more and more to a level, without regard to the opinions of the fruit men.

One reason why the natives succeed best is that they are self-fertile, or partly so, while most of the hybrids of *Labrusca* and *Vinifera* are imperfect, or the ovaries start to develop but soon fall away or persist as abortive fruits. This demonstrates one grave source of the failure of the foreign hybrids. Of the new varieties which have been introduced during recent years may be named: Worden, Moore's Diamond, Green Mountain, Eaton, Elvira, Early Ohio, Jefferson, Moore's Early, Moyer, Ironclad, Pocklington, Poughkeepsie Red, Vergennes, Superb, all pure natives or nearly so, and each one has proved of value. These facts necessarily lead to the presumption, at least, that we must look to the native stock for our hardy grapes.—American Agriculturist.

---

**The Triumph Peach** was highly spoken of at the recent meeting of the Ohio Horticultural Society. In the report it is spoken of as follows: The Triumph is a yellow free-stone peach from Georgia, which ripened with the Early Alexander and was about the same size. This is the first and only early free-stone yellow peach in existence. Notwithstanding fears that it would not succeed in Ohio, from having originated in Georgia, it has proved to be all that could be desired in an early peach and is bound to become very popular.

---

**Germany**, for purposes of her own, has almost cleared the whole of France of apples, besides having taken all the common fruit obtainable in Belgium and Holland. What she requires them for is a mystery, and one can only conjecture. It may be for cider, or syrup, or it may be that she requires them for the new kind of champagne which it is rumored she has discovered the secret to; at any rate, whatever the purpose for which they are intended, the German merchants have taken between 60,000 and 100,000 tons of apples from France alone.—Fruit Trade Journal.

## SETTING AND CULTIVATING THE ORCHARD.



WHEN the trees are taken from the nursery, the roots should be all dug out as long as convenient, and with as little mutilation as possible. Better have a crooked top or no top at all than to have bad roots. The roots should not be allowed to dry, either before setting out or after. The orchard land, however, should be dry, either naturally or by drainage. If the soil be sandy and dry it will need the more mulching. Leached ashes on sandy soil is a

good thing.

The trees, if apple, should be planted not less than 25 feet apart, the rows in the square form. If the ground is very rich, the subsoil should be mixed with the surface soil. The trees should be set in moist, compact soil, neither too muddy nor too dry, as the roots need both water and air.

If the roots are likely to suffer from drought, dig the earth away till it is mostly removed from the upper roots, then apply enough water to wet the roots to the bottom. One pail of water thus applied is better than five thrown on the surface. After the water has all soaked into the ground, the earth should be replaced about the tree. A good mulching of straw, hay, or strawy manure to keep the sun from drying the ground around the tree, should be applied when the trees are set. The sun both summer and winter often damages the south side of young trees.

While the orchard is young it should be planted with some crop that requires cultivation, such as corn or roots. After a few years it may be seeded down and pastured. There is a great variety of opinion as to the best time for pruning. Probably as good a time as any is at the close of winter, just before the sap begins to run.

*Tiverton, Ont.*

A. H. CAMERON.

NOTE BY EDITOR.—Twenty-five feet is too close to set apple trees; thirty feet is the minimum distance, and that only for the weaker, such as Early Harvest, or upright growers like the Northern Spy. And yet on rich land even these would require more room. For strong growers, on rich land, forty feet apart each way is quite near enough. Some Greening apple trees at Maplehurst, set forty feet apart, are interlacing their branches, and would bear a still greater distance to advantage.

Regarding the seeding down and pasturing of the apple orchard, a good deal might be said, and we will discuss the subject fully at another time. But briefly we must say that in general it is a bad practice to leave an orchard in grass more than a year or two at a time. Pasturing with sheep, which eat the fallen apples, and which will not gnaw the trees if fed a daily ration of grain, is about the only condition under which an apple orchard will thrive without cultivation. One of the reasons why apple orchards in Ontario have been so unfruitful in past years is want of cultivation; the apple tree needs and will pay for as good treatment as corn or potatoes, and indeed it will yield far better returns for the labor put upon it. Only this season, Mr. D. J. McKinnon, a fruit grower at Grimsby who who is an excellent cultivator, reports an average yield of five barrels per tree of marketable apples from his bearing trees, which, at the lowest calculation, are worth \$5 per tree. True, next year may not be a bearing year, but would not even \$50 per acre be a sufficient return to warrant the best care and cultivation?

## SELLING FRUIT ON THE BASIS OF QUALITY.

SIR,—The meeting at Woodstock seems to have been the most useful one that we have yet held. Several points would bear discussion in *THE HORTICULTURIST*. For example: Does the consumer pay for quality as determined by the variety of any fruit, or, to express it more clearly, does it pay to grow varieties of the best qualities? It is my opinion that prolific varieties of fair quality give money in almost every case. The extra quality that can be secured by the best culture pays, as the quantity is rather increased than otherwise by such treatment; not so with the quality that comes by variety.

A. McNEILL, *Windsor, Ont.*

The subject touched upon by our correspondent is a very important one, but at the same time outside the province of growers to control. If we could hold our fruit at our own figures, and place prices upon it according to its real value, something might be worked out that would be satisfactory under this head, but, as it is, we are at the mercy of the buyers, and, in the case of apples which are slaughtered mercilessly, especially at Liverpool, there seems to be little chance for us very speedily to attract that attention to any special varieties which we may desire on account of their quality. The King apple, for instance, has been selling at the top prices in the English market, often bringing \$5 to \$6 a barrel in Liverpool, but it is noticeable that during this season Baldwins, which had attained a high color, and a large size, so that they presented an equally good appearance on the exterior with the King, brought almost the same money in the Liverpool market. Now there is no comparison between the quality of the Baldwin and the King. The latter stands at the top of the list for quality, while the Baldwin ranks only about medium. The King is an apple which cannot be grown without great expense, because of its being comparatively unproductive; and, unless it gradually reaches so high a price as to make up for this lack of unproductiveness, it will not be profitable for Canadians to grow. It is to be hoped that sooner or later we may be able to sell our fruit on the basis above suggested. If, for instance, a barrel of Greenings is worth \$1.50 at the orchard, then surely a barrel of Kings ought to be worth at least \$3.

---

**Barnyard Manure Suffers much Loss** in leaching and drying. Prof. Roberts shows that horse manure when thrown out in a pile unsheltered from the weather, loses nearly half its value in six months; mixed barnyard manure when piled in a close pile so that fermentation is very slow but without protection from rainfall, loses about one-tenth of its value; while the loss if thrown under the eaves to be leached by rains and thaws of the winter, is much greater. At the N. Y. Experiment Station, fresh manure piled in conical heaps in January shrank 65 per cent. in weight by April, and the loss of its fertilizing ingredients was equal to \$3 per cord of manure.—*American Agriculturist*.



## LATE CULTIVATION.



ANY writers on fruit culture have advocated the cessation of cultivation early in the season. Some stop in September, some in August, some in July, and some in June. Some zealous champions have made the assurance doubly sure by refusing to cultivate at all. This early closing doctrine may have done good in northern regions. It certainly has done much harm further south.

The short period cultivators have been the short crop gatherers. The longer the period, the longer the growth, and the greater the product, as a rule. The man who cultivates for a short period and then tries to recover his place on the following season, gets more work than the man who cultivates the season through.

For over twenty years I have cultivated all ordinary fruits and nursery stock the season through, and have traced no losses from the extra growth produced thereby.

I have watched other plantations where every degree of cultivation prevailed. The early closing man has some advantages at times. He grows a crop of weeds which cover the ground and make a mulch which prevent the frost from penetrating the ground to the damage of the grape vines or peach trees. A large growth of weeds sometimes prevents the early frosts from taking all the strawberry blossoms.

Personally, however, I am willing that others shall enjoy all the blessings that weeds can confer on them ; I prefer to use some other mulch or take my chances. If there really is an objection to early autumn cultivation because of late growth, thereby promoted, there cannot, from the same reason, be any objection to cultivation after the leaves have fallen. I believe that a late autumn stirring of the soil is very useful in most cases ; it kills the many perennial weeds and grasses that sprout in autumn, and get firmly established in the spring, before the cultivation starts. It loosens up the soil, and thus prevents the frost from penetrating deeply.

To the novice I say, cultivate early, often, and *late*. If you chance to plow under a few advocates of non-cultivation you will get the utmost good out of them.

E. MORDEN.

---

**There** are four fundamental operations upon which all permanent success in most kinds of orchard culture depend, and I think that their importance lies in the order in which I name them, tillage, fertilizing, pruning, spraying. Spraying is the last to be understood, but this fact should not obscure the importance of the other three.—L. H. BAILEY.

## \* Novelties \*

### THE P. BARRY PEAR.

Among the new fruits before the public, which should be well tested at all our Ontario Experiment Stations, the Barry pear stands prominent. The Anjou is a fine and profitable winter pear, coming to its best in January. Then we have Winter Nelis, Easter Beurre, Josephine de Malines, and others, but there is room for something superior to ripen towards spring, and that is what the introducers claim for the Barry.

By courtesy of Messrs. Ellwanger and Barry, we present an engraving of this pear, with the following remarks concerning it: "Another of the 'late-keeping Fox seedlings. Large, pyriform; skin orange-yellow, covered with russet spots and blotches; flesh very juicy, buttery, fine grained; flavor sprightly, rich, excellent. The best late winter pear. Resembles Anjou in texture of flesh, and Winter Nelis in color of skin and juiciness of flesh. Tree a good grower, and must be top grafted. Ripe in April. We exhibited fine specimens of this pear at the World's Fair latter part of May."

This pear was exhibited at the meeting of the Western N.Y. Hort. Society at Rochester on the 23rd ult. in fine condition, a sample of which the writer was allowed to bring home for description. The same variety was shown by Messrs. Ellwanger & Barry, at the World's Fair, Chicago, in May, 1893.

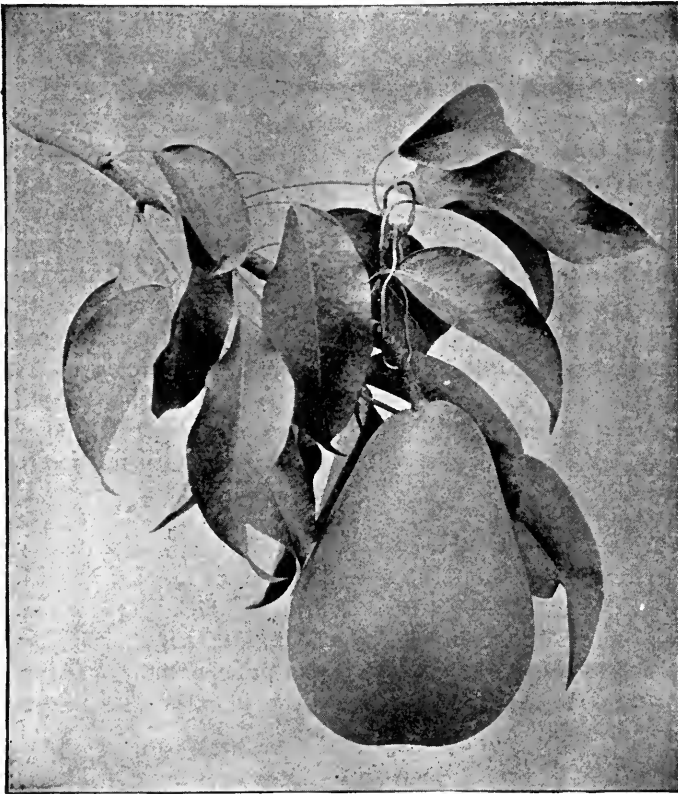

FIG. 911.—THE P. BARRY PEAR.

## HOW TO SUCCEED WITH CHRYSANTHEMUMS.



**T**HE wonderfully increased demand for this now justly popular flower has been attended by a corresponding enquiry for information regarding its cultivation and treatment. And, as may be easily understood, we are often unable from lack of time to reply to enquiries upon this subject as fully as we would wish to.

### Propagation.

Chrysanthemums are perhaps the easiest of all flowering plants to propagate; while there are several methods of increasing them, propagation by rooted cuttings is the method generally practised. In order to have healthy plants that will produce fine bloom, the cuttings must be taken from healthy plants, and be stocky and short jointed, the joints of the

shoots make the best cuttings. A number of cuttings may be placed around the side of a well drained pot, filled with clean sand and kept constantly moist, where they will root in about two weeks. As soon as they are rooted, remove and place separately in two and one-half inch pots filled with fairly rich soil. Never allow them to suffer for want of water.

### Large Specimen Plants

May be produced in several different ways; the method most favored by growers for exhibition requires a greenhouse to insure the best results. The cutting should be rooted not later than February, and should be a vigorous cutting to begin with. As soon as rooted, place in about a three inch pot, and a few days later pinch out the point to induce a side growth, which in turn must be pinched again, by this means the plant is made to produce many branches. Give a larger pot as soon as the first is nicely filled with roots, thus using four or even five sizes, until the blooming pot is reached, which will be 10 or even 12 inches in diameter. A number of stakes will be required to spread the branches, and give the plant the desired form. Another plan is to group three or more plants in a large pot; this plan is, however, usually discontinued at exhibitions. Last year's plants, if well wintered, are some-

times grown into specimen plants the second year, but the bloom is rather inclined to be small.

### General Purpose Plants.

One way that plants may be satisfactorily grown without a great deal of trouble is to plant out the small plants, without the pots, in good garden soil, as soon as the weather permits. Pinch off the end of the shoot or shoots soon after planting, and again in June and July. If pinched after Aug. 1st they will probably be somewhat late in flowering. If kept fairly moist they will be fine large plants by September, in the early part of which month they should be carefully lifted and potted, then stood in a shady place for several days, and the foliage kept moist by sprinkling or syringing until they have recovered the check received in lifting. Many growers, however, now keep their plants in pots the whole summer through.

### To Obtain Very Large Flowers.

The method usually practised to obtain very large flowers is to root the cuttings late in May or in June, then place in a small pot, and in two or three



FIG. 912.

weeks put in a five or six inch pot, the side growth being carefully kept nipped off in order to throw all the vigor into the main stem, which must be supported by a stake, and tied. As soon as buds appear, select the largest and most perfectly formed one, and the plant should never be allowed to produce another bud to even the size of a pea. Thus with all the strength of the plant concentrated in one flower, and with all conditions favorable, flowers are produced that will measure six, eight and even ten inches across.

### Disbudding.

One of the first facts for the chrysanthemum grower to realise is that more buds are invariably produced than can be perfected. Fully one-half of the buds should be removed from all plants. The crown or terminal buds are always the best and should be left, while the buds produced on the short side growths never attain any size and are better removed. Disbudding cannot be performed at one operation, but must be done from time to time as the buds appear.

### Watering.

Chrysanthemums should never be allowed to become dry. From the time that the cutting is rooted until the perfect bloom is ready to cut, no check should be permitted, or the bloom will suffer in quality. Plants growing in the open ground do not require as much water as those in pots. The pots should be plunged to their full depth, care being taken not to allow the plants to root out over the pot. During the hot season plants in pots require water more than once a day.

### Insects.

The black aphid is the only insect that seriously troubles the chrysanthemum, and these will sometimes infest even the healthiest plants in great numbers. Syringing with a decoction of tobacco will keep the plants perfectly clean. The refuse stems from tobacco factories are excellent for this purpose. Plants in the greenhouse are perhaps easiest kept clean by means of fumigating with tobacco smoke. Plants in the window may be kept clear of aphid by placing a cone made of strong paper over the plant and filling it with tobacco smoke. Tobacco should always be moist when used, to prevent it blazing. Where tobacco cannot be conveniently had, some extract of tobacco, of which there is several brands, should be used, sulpho-tobacco soap is probably the best, but any of them are clean, easy to prepare and quite effectual.



FIG. 913.—SPECIMEN FLOWERS OF MRS. CRAIG-LIPPINCOTT.

### Manure Water

May be prepared from hen, cow, or sheep manure ; after mixing it should be allowed to settle and only the clear liquid applied. Great care should be observed in applying all forms of liquid manure, to avoid an over dose. A good plan is to begin with quite a weak solution and gradually increase it as the plant becomes accustomed to it. Its use may be commenced as soon as the final or blooming pot is well filled with roots and continued until the buds begin to show color, after which nothing but clear water should be used. The use of manure water is objected to by some, being sometimes unpleasant to apply. However chrysanthemums demand strong food, and the best results cannot be obtained without a stimulating diet.

### Albert's Horticultural Manure.

We have found this to be an excellent fertilizer, not only for chrysanthemums but for all blooming plants. After having carefully tested its merits with those of several other well-known fertilizers we have found none to afford us as good results.

*Hamilton, Ont.*

WEBSTER BROS.

### WHITE CANNAS—HUMBUG.



HERE is no class of people on earth who are more the victims of misrepresentation and humbug than the confiding, unsuspecting, and great hearted tiller of the soil ; from the agriculturist with his broad acres, to the amateur in his garden plot and greenhouse. Every year brings the wish and hope for some meritorious advance in favorite lines, so where such advance is not possible, the "novelty" must be provided just the same, the fakir gets in his annual work, reaps his harvest, and injures the grand cause of progressive horticulture.

Some years ago I tested the *Hedychium coronarium* as a possible white companion to the canna. It was obtained from Florida at a trifling cost ; but after two years of failure to induce bloom, I threw it into the "dump," and have since learned that it failed in Washington, under the care of one of the leading experts of America.

The coming season of 1896 already sees offered to the trade and amateur, the old *hedychium*—but under the new name of *Myriosma cannæfolia*, and urged as a companion to the canna, which is absurd, for with successful treatment it will only bloom under glass, and that in the autumn at the time when bedded cannas are affected by the frost.

So-styled "true" white cannas,—in truth sun-bleached yellows, are common among hybrid seedlings of the new dwarf strain, this "novelty" in color showing the second day, shortly before the bloom falls.

There is a pure white canna, *Canna liliflora*, a species growing wild in Veragua, Central America, long known to botanists ; it is, however, of weak, slow growth, under the most favorable greenhouse treatment ; and of no practical value except to the hybridist, crosses having already been obtained with the dwarf hybrids, the utility of which is not yet claimed.

H. H. GROFF.

## THE CANNA.



SINCE we have decided upon sending out a certain number of Cannas to those of our readers wishing an ornamental plant, it will not be out of place to give a few lines regarding it, written by our friend, Mr. H. N. Groff, of Simcoe, who, in his spare hours from banking, is making a special study of the *Canna* and *Gladiolus*. He says:

These peerless plants are without question the finest we have for summer bedding, their rich tropical foliage and brilliant flowers are indispensable for lawn decoration. They flower the whole season in the open ground, and when potted make grand house and conservatory plants, giving masses of flowers all the year with slight winter heat.

Their musa-like foliage, in various shades of green and bronzy-purple, affords a striking contrast to the enormous spikes of flowers of every shade in scarlet, yellow, crimson and orange, including blotchings, spots and borders in great variety. The size of their flowers been wonderfully improved during the past few years; due chiefly to the labors of M. Crozy, the eminent French hybridizer, until among the new introductions many are fully six inches across. The *Canna* is bound to take the lead in tropical bedding, massed or in borders, as a back-ground for other plants, for which purpose they have no equal in our climate.

Plant after danger from frost, in well enriched soil, watering freely in the evening of hot dry days, and they will bloom from June until cut down by the late frosts; after which cut off stalks within four inches of the ground, store the clumps as lifted, in sand, in a warm dry place, water slightly at intervals during winter. Divide in early spring and start in pots or boxes.



FIG. 914.—CANNA.

## THE GLADIOLUS.



**T**HIS extensive genus comprising some ninety species, natives mostly of Central Europe and West Africa, is now the most popular of summer and autumn flowering bulbs, constituting one of the finest features of the flower garden, for diversity of color, and general effect, either in masses or in border decoration, backed by the new French Cannas, with their tropical foliage, and large flowers of unequalled and dazzling brilliancy.

They are of easy culture and will thrive in ordinary garden soil, prepared in the autumn and liberally enriched with well-rotted cow manure. Change their location as often as possible, or fertilize with hardwood ashes. Plant in open ground two inches or more between the bulbs, in drills six inches apart, or in masses, four to six inches deep (small seedlings two inches), avoiding contact with the manure. Water freely when dry and you may expect plants four to six feet high with flowers over four inches across. For the best results cut the spike when the first flower opens, and bloom in the house, this will also strengthen the bulb. Planting may begin with the earliest garden work, and where your collection embraces all sections, as in my mixtures and seedlings you will get without repeated plantings, a succession of bloom from July until frost. Dig the bulbs before the ground freezes, cut off the stalk close to the bulb, and after drying for a short time in the open air, store in baskets or shallow boxes, in a cool dry place. The old corn may be removed a month later, and if desired the bulblets collected and stored until planting time, when if peeled and planted in drills they will make blooming bulbs with one or two seasons' culture. Varieties are increased in this way. New varieties are originated from seed, and can be grown as easily as onions, care being taken to water during hot weather.

The original *Gladiolus Gandavensis*, the variety in general cultivation, is a hybrid between the Cape species *G. psittacinus* and *G. oppositiflorus* and was offered first to the trade fifty years ago, since then the varieties have been increased by thousands, this cross overcoming the difficulty experienced in getting the many species to hybridize, and every cross between selected varieties of merit in most cases tends to improve the beauty and size of the flower and vigor of the plant.

*Hybrids of purpureo-auratus, Lemoinei or Large spotted gladioli.*—The first hybrid of this section was the result of crossing *G. gandavensis* on *G. purpureo-auratus*. An immense variety of colors and blotches are the characteristic of this race which is increasing in favor with the amateurs of every country. The newer varieties are almost free from crooked stems, and the beauty of their



individual flowers will always compensate for the lack of that full and regular spike seen only in the *Gandavensis* section. It is the earliest to bloom, thus lengthening the season, and should be found in every collection.

*Nanceianus Hybrids*.—The result of crossing *G. Lemoinei* on the species *G. Saundersii* by M. Lemoine of France, imparting to this new strain a great variety of colors and enormous broad and open flowers, with a profusion of dots and blotches of every color. Being of comparatively weak growth is its most objectionable feature, but this is fully compensated for by the rich and gorgeous colors of its enormous orchid-like flowers, and further hybridizing will tend to increase the vigor of the plant.

*Childsi and Turicensis*.—Hybrids of *G. Gandavensis* and *G. Saundersii*. Childsi the best-known of this class, originated in Germany, was improved in France, and developed in America before coming into possession by purchase of Mr. J. L. Childs, the introducer. While lacking the rich coloring of the *Nanceianus* section they possess the merit of rank, growth and vigor. Though few flowers open at one time they are of great substance and the largest size. Further hybridizing will overcome the objection felt by all experienced growers, in the unequal proportion of red shades and my work in crossing with *G. Gandavensis* has been with this object in view.

H. H. GROFF.

**Peach Trees from Pits**.—The Barnard, one of well-known peaches, is quite likely to produce seedlings that bear some resemblance to itself, but the chances are that most of them will be more or less inferior, so that it is far better to rely upon budded stock. The same can be said of seedlings from the Crawfords, although there is even less likelihood that the seedlings will equal the parent varieties. In selecting varieties for planting, it is best to choose kinds of known hardiness, and if for market as well as for home use, they should be such as will afford a succession throughout the season. Of the kinds that have shown themselves of most value in Michigan, and it is probable that they will also be desirable kinds in the neighboring States, are a number that have originated here. A good list would include Hale, Lewis, Early Michigan, St. John, Barnard, Richmond, Jacques Rareri, Hill's Chili, Kalamazoo, Gold Drop, Smock, and perhaps Salway if in favorable locations in the southern part of the State. For very early, a few trees of Alexander or Waterloo might be planted.—L. R. TAFT, Horticulturist, Mich. Experiment. Station.





## The Canadian Horticulturist

SUBSCRIPTION PRICE, \$1.00 per year, entitling the subscriber to membership of the Fruit Growers' Association of Ontario and all its privileges, including a copy of its valuable Annual Report, and a share in its annual distribution of plants and trees.

REMITTANCES by Registered Letter are at our risk. Receipts will be acknowledged upon the address label.

### ✦ Notes and Comments. ✦

ORCHIDS.—An Ottawa paper reports that sixteen varieties of orchids are in bloom at the Central Farm greenhouse.

THE SAN JOSE SCALE was at one time reported in British Columbia, but upon diligent inquiry the Board of Horticulture has found that this pest does not exist in the Province.

ERRATA.—On page 1 for Woodflower read "Windflower." Note also, that two varieties of anemone, are confused in the description. *Anemone fulgens* proper has vermilion flowers.

HOW DOES PARIS GREEN KILL CODLING MOTH?—According to Prof. Bailey, the insect begins eating the moment he emerges from the egg, which is usually deposited just outside the calyx. Sometimes he eats quite a noticeable amount of the skin just around the calyx, but at any rate he must eat some in order to gain entrance, and ever so little will kill him.

OUR APPLE SHIPMENT TO AUSTRALIA was a valuable experiment according to news just received. Though the heat of the tropics ruined a large part of them, those which came out in good order, notably the Cranberry Pippins, sold as high as \$3 75 per bushel case. It looks as if the experiment would be worth repeating. The expense of freight is only \$1 per case, and if we could get perfect cold storage there would be a fortune in it for Canadian apple growers. We will give a full report later on.

THE BALDWIN holds a remarkably high place in the British market, notwithstanding that its quality is only ordinary. No doubt its fine color, and its excellent shipping quality, showing so little the effects of rough usage, combine to give it the precedence which it commands. In the month of December it was only excelled in price by the King, an apple of far superior quality, but not its equal in keeping qualities. On the 21st of December last Kings were sold in Liverpool at 18/ to 23/, and Baldwins at 16/6 to 22/6 per barrel.

---

BOXES VS. BARRELS FOR APPLES.—The Secretary of the Ontario Fruit Growers' Association has been experimenting with an apple box for fancy apples, shipping 100 of them to Liverpool, 100 to Glasgow, and 200 to Edinburgh. The Liverpool dealers oppose it as a novelty, and declare in favor of the barrel. They say no package is equal to the barrel for apples, and that the multiplying of the number of the packages in this way would mean a disadvantage to the shipper. Glasgow and Edinburgh, however, seem to think that for a special fancy grade of apple, the apple box is a good package, and would pay for the additional cost incurred.

---

WATERLOO HORTICULTURAL SOCIETY.—Mr. James Lockie, the President of the Waterloo Horticultural Society, is evidently determined to make their Society a grand success. He writes: "We are getting out a circular regarding the premiums which we are offering for the next year. When we get our list completed, we will ask several florists and nurserymen for tenders guaranteeing healthy good stock. We will get them in bulk and to distribute them will be a good deal of trouble for some of us, but we are bound to have our Horticultural Society the best of its kind. 'No prizes' is the key-note of our success. I will send you a report of our annual meeting which is to be held on the 8th of January."

---

CARE OF FRUIT TREES is the subject of two bulletins from Cornell, Nos. 102 and 103. The first by Professor Bailey, particularizes, from general observation, that lack of tillage and fertilizers must be the chief reasons why our apple orchards are barren; he also suggests that propagating with cions cut from unproductive trees, may increase the trouble.

Prof. Roberts writes the latter bulletin, and generalizes the same conclusions from careful and particular analysis. By careful weighing and analyzing of wood, fruit and leaves, he finds "that the value of the nitrogen, phosphoric acid and potash which would be removed from one acre of bearing orchard in twenty years, would be about \$400, while the value of these fertilizers removed by grain crops in the same length of time, would not amount to over one-third that sum. It is evidently, therefore, more important to annually fertilize a bearing apple orchard than a grain crop, and no one would think of neglecting the latter.

NOVA SCOTIA SCHOOL OF HORTICULTURE.—Prof. E. E. Faville sends out a circular regarding the winter course in horticulture which opened there on January 8th. The course is adapted to the needs of the young farmers of the Province, to those intending to go into farming and fruit growing. It extends over a period of four months of practical and theoretical work, consisting of lectures on all phases of fruit growing, marketing, fertilizers, soils, the relation of dairying to fruit growing, etc. The well equipped fruit house, together with a root cellar, grafting and budding room, makes it possible to do all kinds of practical work. The laboratory shows a full set of microscopes used in identifying insects and fungus growth, the study of plant construction, and experiments in methods of crossing fruits can be made. The manual work embraces carpentry, blacksmithing, and fitting the students for ordinary farm practices.

---

LIBERAL DISTRIBUTION OF PLANTS.—The Waterloo Horticultural Society promises its members for 1895, not only membership with us, THE CANADIAN HORTICULTURIST, the report of our Association, and our plant package, but also a choice of the four following packages, purchased with their own funds:—

Package No. 1 contains Wilder pear, McLaughlin plum, and Montmorency cherry.

Package No. 2 contains Spiræa Van Houtti, Jacqueminot rose, and Clematis.

Package No. 3 contains 6 Cannas, 20 Gladioli, and 2 Dahlias.

Package No. 4 contains 12 House plants, assorted.

In addition to this they will import hyacinths from Holland in the fall, free of charge to the members.

---

LINDSAY HORTICULTURAL SOCIETY.—The Lindsay Horticultural Society seems to be a leading one in the province for the liberal distribution of plants and bulbs to the members. In response to an inquiry how the money is raised to buy so many bulbs, and if any show is held, Mr. Beall writes: “We get our money to conduct the affairs of our Society in the same way that all Horticultural Societies get theirs, by individual subscriptions of \$1, and our Government grant, which is less per member than in some other cases. We hold one, and sometimes several shows in a year, but money is not lost thereby, because no prizes are given. The exhibits are simply object lessons for the benefit of those who attend our meetings, and for the advancement of horticultural knowledge in the community. The public is always invited to all such meetings. The principle underlying these organizations is that every member shall receive equal profit or advantage. When prizes are given a few only share the money which should be expended for the advancement of horticulture. The holding of exhibitions at which money prizes are offered has ruined scores of societies in this province, and will surely destroy every Horticultural Society indulging in that species of gambling.”

THE ENGLISH SPARROW.—We have a letter from Mr. George Goodhue, of Danville, Me., regarding the English sparrow. He encloses an extract written by him some years ago for the "Forest and Stream," proposing a plan for the extermination of the sparrow, namely, inducing the governments of our provinces and the northern and western States to pay a small bonus on sparrows destroyed between November 1st and March 15th. During these dates our native birds are absent, and it would be safe to carry out his proposed plan for the destruction of the sparrow. Food being scarce at this time of the year, the sparrows could easily be decoyed and cheaply killed by the use of poisoned seeds. He is of opinion that there are poisons which would be effectual when first exposed, but which would be dissipated by the rains of early spring, and thus rendered innocuous to our native birds, should any stray seeds escape the sparrows. He thinks the Department of Agriculture might prepare such seeds and have them distributed at the proper time of the year. He asks, "Could not our scientific men at the Experimental Stations here in Canada experiment with the different kinds of poisoned seeds with sparrows during the remaining portion of this winter, and report the result at the next convention of fruit growers, with a view of uniting upon the best plan for a vigorous crusade next fall and winter upon our undesirable and pugnacious little emigrant, who, although he seems to have neither protection or friends, has abundantly proved his ability to thrive to an alarming extent without either?"

---

THE MIDDLEMEN.—With the beginning of January, 1896, a new journal begins its publications in London, England, called "The Greengrocer, Fruiterer and Market Gardener." This Journal is particularly in the interests of retail fruit merchants of Great Britain and, therefore, reaches a class of shop keepers with whom it has long been the desire of Canadian fruit growers to open up some connection. As it is now, the profits of our fruit are largely consumed by middlemen. The retail price of apples, for example, is very high, but the grower in Canada usually receives a very small part indeed. Now, if it were possible for us to bring about some closer connection with these small dealers in Great Britain, we would be able to save a large amount of the profits which now go into the hands of the middlemen. By middlemen we refer to the apple buyers and shippers in Canada and the large wholesale apple houses in the great markets of Britain who dispose of our fruit on arrival by auction sales at, sometimes very low prices. Also in this manner, the fruit grower of Canada is to a large extent at the mercy of these middlemen and the whole risk of loss rests with him. Now it is possible that through this journal, "The Greengrocer and Fruiterer," which is published at 1, 2 and 3 Salisbury Court, Fleet St., London, Eng., we may be able to get into some kind of communication with retail dealers in Great Britain to our mutual advantage. Mr. Geo. Tucker, editor of this journal, replying to a letter from the Secretary of the Ontario Fruit Growers' Association, writes: "I beg to assure you that I shall at all times be very

pleased to do anything I can in the interests of Canadian fruit growers. With regard to the question of middlemen, this is a most difficult matter with which to deal. Many attempts in the direction you suggest have been made, but have been in almost every case abandoned. My own personal opinion is that a most important thing for the consignors is that they should know what their consignments bring in the wholesale markets. This information we are endeavoring to give and you may depend upon it that this is the direction in which the most satisfactory results will for the present accrue. I hope we shall be able to work to further our mutual satisfaction and interests, and I shall be pleased to receive information from you at any time which shall have my careful consideration."

## ↔ Question Drawer. ↔

### Value of Canada's Export Trade.

**775.** SIR,—Would you please give me some idea of the value of and the quantity of fruit annually exported by the Dominion?

A SUBSCRIBER.

In reply to our special request, the Dominion Department of Agriculture has furnished us with the following:

#### Statement of the Quantity and Value of Fruits (the Produce of Canada) Exported from Canada during the years ended 30th June, 1891-'95.

FRUITS.	1891.		1892.		1893.		1894.		1895.	
	Quan.	Value.	Quan.	Value.	Quan.	Value.	Quan.	Value.	Quan.	Value.
Apples, dried, lbs.....	800650	\$ 49029	256729	\$ 14392	3476337	\$ 199699	1429846	\$ 98924	4176950	\$ 250320
“ green or ripe, bbl.....	450836	1389714	690951	1444888	1187665	2731223	278238	808473	853268	1821463
Berries, all kinds.....		64849		93398		96219		103240		107817
Fruits, canned or preserved		30772		62140		47057		22369		109122
“ all other N.E.S.....		32773		19369		25760		24884		40602
“ dried, other N.E.S.										
lbs.....	832	79	2400	174	518	234	1049	102	26629	1940
.....		\$1567216		\$1634356		\$3100192		\$1057992		\$2331264

↔

### The Legal Apple Barrel.

**776.** SIR,—What is the correct size for apple barrels: 1st, length of stave; 2nd, size or diameter of head?

HAROLD JONES, *Maitland, Ont.*

In order to give a certain reply to our correspondent, the editor wrote to the Department of Agriculture at Ottawa, asking for the dimensions of the

Canadian apple barrel, and in return received the following, being Section 18 of the "Weights and Measures Act."

18. All apples packed in Canada for sale by the barrel shall be packed in good and strong barrels of seasoned wood made as nearly cylindrical as may be; the staves of such barrels shall be twenty seven inches in length from croe to croe, with heads from sixteen and one-half to seventeen inches in diameter; and such barrels shall be sufficiently hooped, with a lining hoop within the chimes, the whole well secured by nails:

2. Every person who offers or exposes apples for sale by the barrel, otherwise than in accordance with the foregoing provisions of this section, shall be liable to a penalty of twenty-five cents for each barrel of apples so offered or exposed for sale.

---

### Cross-Fertilization.

**777.** SIR.—Is there any method of cross-fertilization of fruit trees besides planting them close together and leaving the blossoms to take their chance of a cross?

S. T. PETTIT, *Belmont.*

Yes. By artificial crossing, much more certain results are obtained. One should have a definite purpose in plant-breeding, and should select the parents with a certain special object in view. The blossom to be treated is first robbed of its stamens just before maturity, and pollen from the flower of another variety applied to the pistil, with a camel's-hair brush. The blossom is then wrapped in a muslin bag to prevent any other pollen from reaching it. An excellent work on the subject of Plant Breeding, by Prof. L. H. Bailey, has recently been published by MacMillan & Co., New York City.

---

### Raspberry Root Gall-Fly.

**778.** SIR.—Would you kindly inform me through the HORTICULTURIST, what is the cause of warts growing on the roots of raspberries? My Cuthberts grew well and had two good crops, but after that they stopped bearing, although the bushes still seemed to do well, and after trying them two years dug them up and found all the roots badly covered with warts some as large as a moderate sized bean.

A. J. C., *Listowel.*

Probably this is the work of the raspberry root gall-fly, *Rhodites radicum*. Mr. Saunders in his excellent work on "Insects Injurious to Fruits," says:

"The swelling is composed of a yellow, pithy substance, scattered throughout which are a number of cells, each enclosing a small white larva, the progeny of the gall-fly. These soon change to papæ and they then produce after a time the perfect insect, which eat their way out through the substance of the gall, leaving small holes to mark the place of exit. This gall chiefly affects the black raspberry; it also occurs on the blackberry and sometimes on the roots of the rose."

Wherever these excrescences are found they should be collected and burned.

### Those Missing World's Fair Medals.

**779.** SIR,—Could you give us any information regarding those missing World's Fair Medals, for which we have been so long patiently waiting?

J. W. BIGEWLOW, *Wolfville, N.S.*

We referred this inquiry to the Department of Agriculture, Ottawa, and in response have received the following letter from A. L. Jarvis, for Deputy Minister :

SIR,—In reply to your letter of the 8th instant, making inquiry respecting medals and diplomas awarded at the "World's Columbian Exposition," I have to inform you that the latest intimation received from the Washington authorities is to the effect that the medals of award are finished and waiting the completion of the diplomas, after which they will be delivered to the "World's Columbian Commission," who will distribute the same. I may add that the letter containing the above information was of recent date, the 14th ultimo.

---

### Peaches.

**780.** SIR,—When do the following varieties of peaches ripen in the Niagara district, viz. :—Alexander, Early Rivers, Hill's Chili, Elberta, Triumph, Foster, and Yellow St. John?

S. T. PETTIT, *Belmont.*

We have not fruited Elberta or Triumph.

The others ripen about as follows :—Alexander last of July; Early Rivers, early part of August; Hill's Chili and Yellow St. John, latter part of August; Foster, first part of September.

---

### Magnolia, Cedar of Lebanon.

**781.** SIR,—What winter protection is necessary to grow the *Magnolia grandiflora*, Cedar of Lebanon and the Deodar cedar, in the open ground in this Province of Ontario?

JOHN M. McAINSH, *Belton, Ont.*

*Reply by Horticulturist Craig, of Ottawa.*

I do not think that *Magnolia grandiflora*, Cedar of Lebanon or the Deodar Cedar could be grown successfully in the open ground in any portion of Ontario, even with the best kind of winter protection that could be advised. It is possible that they could be grown for a time as small plants in favored portions, such as Essex and the Niagara Peninsula by wrapping them carefully in the autumn with a heavy swathing of evergreen boughs and protecting the roots by heavy mulching. But this could only be carried on while the tree was small. Those who wish to grow these, especially the cedars, I would advise to plant them in tubs, which could be moved into a cold cellar during winter. These plants could be renewed when the trees reached a size too large to allow of convenient handling.



### Peaches and Plums for East Middlesex.

**782.** SIR,—Please give me a list of six peaches and six plums best adapted to the climate of East Middlesex, the thermometer dropping to 25 below zero.

G. H. NIXON, *Hyde Park.*

We could not recommend any variety of peach for such a temperature. The plums are hardier, and you should succeed with such varieties as Lombard, Bradshaw, Green Gage, German Prune, Italian Prune, Yellow Egg, etc.

---

### The Lawver Apple.

**783.** SIR,—Please give me a description of the Lawver apple. I have some trees bearing, which I purchased for that variety, but which I fear are not true to name.

G. H. N.

The following is the description:—*Tree* vigorous, spreading, an early and annual bearer. *Fruit* large, roundish, oblate. Color, dark bright red, covered with small dots. Stalk medium, cavity deep, regular. Calyx small, closed. Basin medium, furrowed. Flesh white, firm, crisp, sprightly aromatic, mild, sub-acid. January to May.

---

### Alkaline Wash for Pear Trees.

**784.** SIR,—If the bark is first scraped off pear trees, would strong lye wash injure them?

G. H. N.

If too strong it would. One pound concentrated lye to three gallons water is strong enough.

---

### Weeping Ornamental Trees.

**785.** SIR,—How are weeping ornamental trees propagated?

D. B. H.

The weeping varieties of a tree are usually top grafted upon standard upright growing varieties either of the same or some allied kind of tree.

---

### Tree Pæonia.

**786.** SIR,—How are tree pæonies propagated, by slips, or root sprouts.

D. B. HOOVER, *Almira.*

The shrubby, or Tree pæonia, is sometimes propagated by layers, but usually by grafting slips or scions upon the stout fleshy roots of the herbaceous pæonia. This kind does not succeed as well in Canada as in Europe. Our summers are not so favorable, and our early spring frosts injurious to their best success.

### The English Sparrow.

**787.** SIR,—I notice the sparrows at my fruit buds. Will they do any permanent injury?  
G. H. N.

The sparrows are injurious birds, and no doubt will destroy fruit buds along with the leaf buds. Still, unless very numerous, the injury will scarcely be traceable in fruit season.

---

### Salt and Sulphur for Curculio.

**788.** SIR,—Have you ever heard of salt and sulphur for the plum curculio in the proportion, 3 lbs. sulphur and 2 lbs. of salt sprinkled over the grounds under the trees in the spring of the year. Please answer in the HORTICULTURIST.

A. W. WALKER, *Clarksberg.*

We have not heard of this remedy, and would be pleased to have any experience any of our readers may offer.

---

### Sowing Seeds of Pear and Quince.

**789.** SIR,—When should pear and quince seed be sown?

A. E. MORDEN, *Vernon, B.C.*

These are usually sown in the fall, soon after maturity; but if kept mixed with earth in cellar till spring, they can be sown then.

---

### Strawberry and Gooseberry Plants.

**790.** SIR,—Where can I get Clyde and Vandeman strawberry plants? What are good and bad points of the Chautauqua gooseberry?

A. E. M.

---

### Cider.

**791.** SIR,—Is cider made in Canada for export; if so, in what localities is it produced, and who are those who manufacture and ship it?

J. R., *Ottawa.*

Will cider makers send in their addresses.

---

### Horticultural Books.

**792.** SIR,—Like many other fruit growers, I am occasionally asked for the names of books, which would enable a novice to get a good general knowledge of fruit and fruit culture, as far as books can do it. On this, as on other subjects, doctors agree to differ, but I believe it would be a timely and a useful thing if, in your next issue, you would give a short list of such works, with, where possible, prices and publishers' names.

M. BURRELL.

We will from time to time give a list of the best books on horticulture. Many of the older works are a little out of date, and are gradually being replaced by new productions.

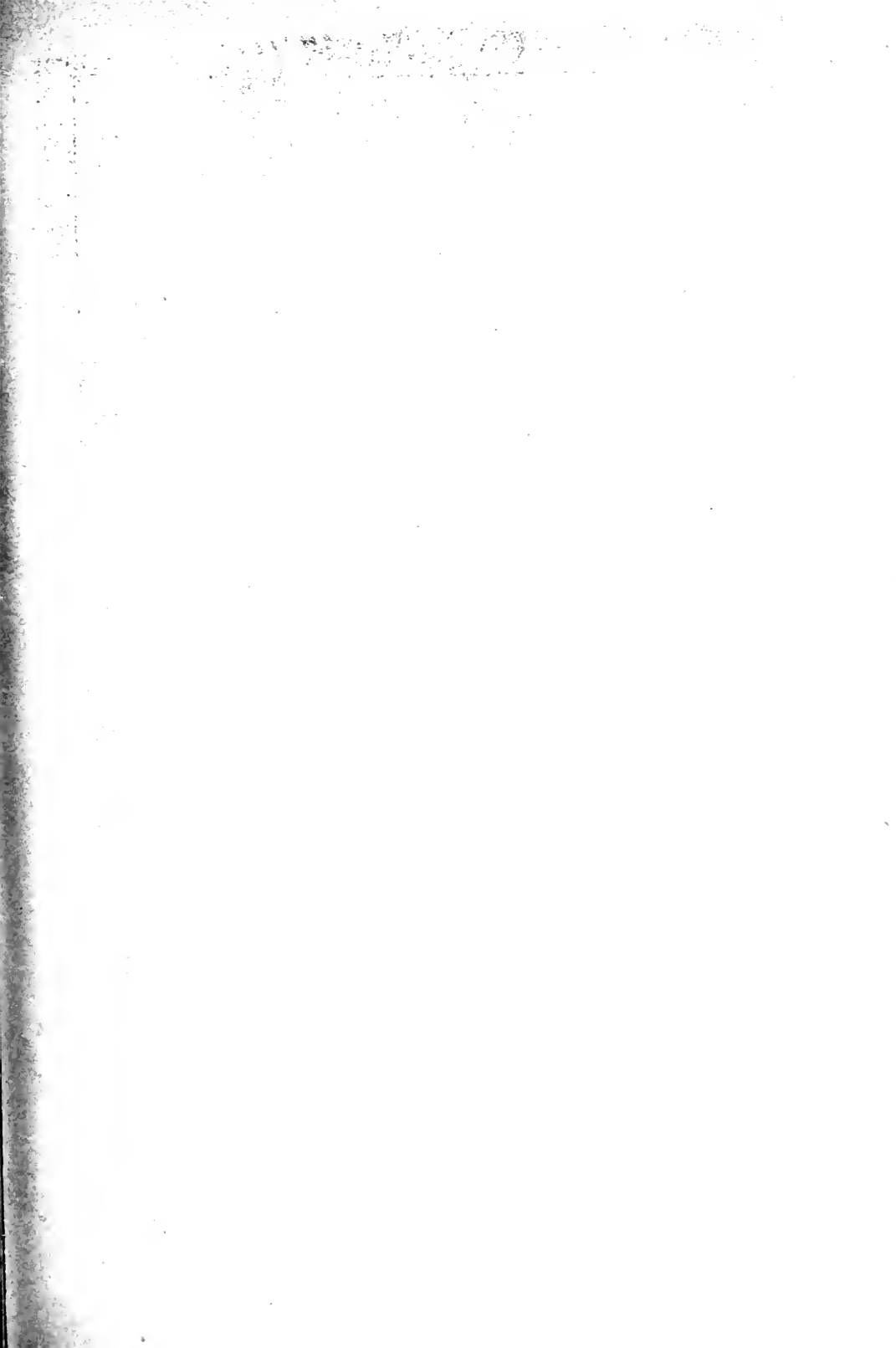

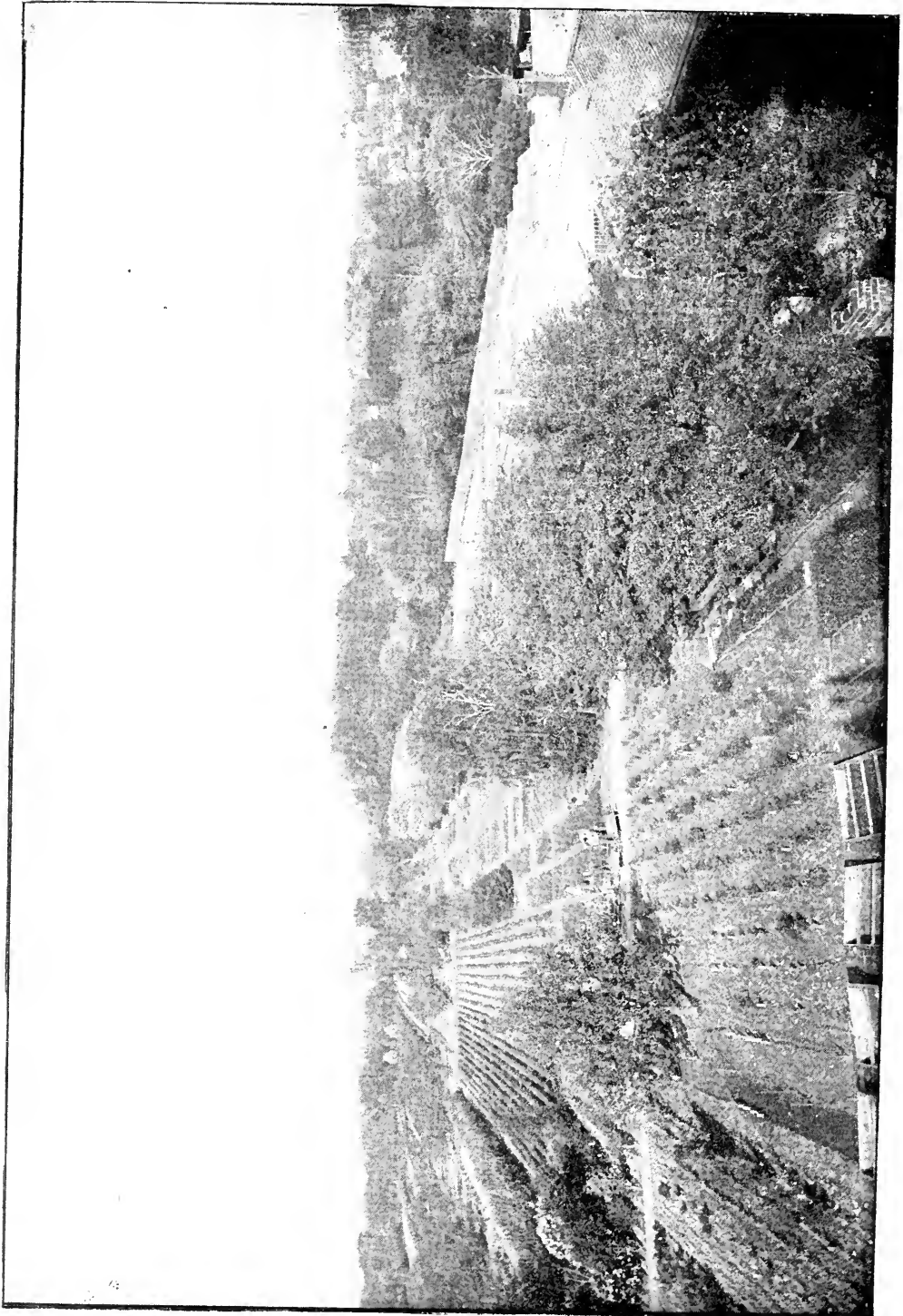

A VIEW OF ELLWANGER & BARRY'S NURSERIES AT ROCHESTER, N. Y.

THE  
Canadian Horticulturist

VOL. XIX.

1896.

No. 3.



WESTERN NEW YORK FRUIT GROWERS.

**T**HE meetings of the Western New York Horticultural Society bring together the largest and most enthusiastic gathering of fruit growers to be found anywhere in the world. Probably no country in the world contains so many enterprising fruit growers and nurserymen, as Western New York. All this is due in a great measure to the persevering industry of the late P. Barry, the author of that excellent work entitled "Barry's Fruit Garden," and one of the heads of the firm, so familiar to fruit growers all the world over, Messrs. Ellwanger & Barry. For so many years was Mr. Barry the president, and the guiding hand in the conduct of this large Society, that we feel justified in giving him that prominence in our journal, which he deserves as one of the direct benefactors of the present generation of fruit growers. At our special request, therefore, we have secured from his son, Mr. W. C. Barry, the cuts which illustrate this article.

The frontispiece is an admirable photograph of the nursery, in the suburbs of Rochester, which was first established about fifty-six years ago, on about 15 acres of ground, and has since grown to cover over 500 acres.

One important feature of Mr. Barry's work was in experimental fruit growing, a work which we in Ontario, are just beginning to undertake, under the beneficent patronage of the Ontario Department of Agriculture. So long ago as 1846, Mr. Barry wrote: "Our purpose is, and has been since the formation of our establishment, to make here in Western New York, a collection of fruits unsurpassed by any in the country, embracing every valuable variety of either native or foreign origin, adapted to our soil and climate; with this end in view,

we have been gathering from time to time from every quarter, such varieties as we have found to be held in high esteem in their respective localities. Two years hence we shall have a superb list of American fruits; our extensive personal acquaintance with the principal fruit growers and nurserymen in England and on the Continent has enabled us to make arrangements to receive *annually any new and valuable fruits* that may be brought to notice. Our practice is to *plant a specimen tree of every variety cultivated in order* to test it under our own observation; our specimen grounds now contain upwards of *two hundred varieties of apples, one hundred and fifty of pears, sixty of cherries and fifty of small fruits, and so on.*"



FIG. 915.—THE LATE PATRICK BARRY.

In addition to the trial of fruits, much attention has also been given to specimen ornamental trees and shrubs, which have always been kept correctly labelled and open to the inspection of the public.

The accompanying engraving showing a fine specimen of *Picea pungens*, or Colorado Blue Spruce, is grown upon the grounds of Messrs. Ellwanger and Barry. The tree on the left is a fine specimen of cut-leaved Weeping Birch,

and on the right are shrubs of various kinds, forsythias, herbaceous pæonias in flower, etc. This Blue Spruce will be interesting to many of our readers because so many trees of this evergreen have been sent out to the members of our Association during the last few years. The tree is a native of the mountains of Colorado, and is now widely distributed throughout the U. S. and Canada as an ornamental evergreen. Mr. Wm. Saunders, of Ottawa, says of it, "Among the Spruces none is so striking and beautiful as the Colorado Blue Spruce, and more especially those specimens with a distinct steely blue color to the foliage. This color varies in intensity from a faint hue to one of a very decided and striking character. The blue color is most pronounced in the new growth in the spring, and as the summer advances it becomes softened and mellowed to a pale bluish green which contrasts strongly with the bright new growth when it pushes out the following season."



FIG. 916.—COLORADO BLUE SPRUCE.

The subject of *irrigation* for fruit crops was introduced at the meeting by Mr. J. H. Hale, who has recently experimented in a large way, and will soon be able to speak confidently of results. He believes irrigation in fruit growing can be made to pay 25% on investment. Windmill power is too uncertain, except for gardens; fruit growers should co operate, and use steam power, or large hydraulic cranes to lift the water to elevated positions, whence it can be conducted in pipes or hose. Mr. Van Deman said that the Jucunda strawberry, with irrigation, was a grand success in Colorado. One member said he had doubled his cherry crop by irrigation, and saved his pear crop, when otherwise it would have been a total loss. On peaches, however, irrigation seemed to have very little effect.

*The Sowing of Crimson Clover* was advocated in a paper by G. P. Powell, who advised the covering of every acre of cultivated soil with it in August, or even late in July. Even if it did not survive the winter at the North, the soil would be much enriched by its summer growth. Mr. Hale said he sowed about 40 acres of his orchard to Crimson clover every year; it continues to grow the following spring until he is ready to turn it under. In Delaware, all the peach orchards are sown with Crimson clover, and, as a result of the nitrates thus furnished, the trees grow wonderfully; but many forget that a tree also needs phosphoric acid and potash. Since growing the Crimson clover, he had not found it necessary to purchase any nitrates, and in this way, his fertilizer bill had been very much reduced.

Prof. Roberts cautioned against over-stimulating the wood growth of a young orchard, at expense of reproductive organs; because it might be difficult to teach it bearing habits. He would, therefore, avoid too much nitrate, with too little potash and phosphoric acid.

---

**The Best Absorbents** for use in stables are comparatively little known. It is a fact, however, that the low grade potash salts, especially kainit, which is sold by all agricultural dealers, and kieserit (which is not so common), if sprinkled in the stable daily or on the manure pile, will absorb the ammonia or nitrogen, preventing its escape while also adding considerable potash to the manure pile. Kainit contains about 12 lbs. of actual potash to the hundredweight. Acid phosphate is also a good absorbent if not too wet, and where the fine-ground rock phosphate can be had cheaply, it may be freely used in the stable. The decomposition in the manure pile may assist in making the phosphoric acid of this raw product available. Fine-ground land plaster or gypsum (sulphate of lime) is also a splendid absorbent and can be had almost everywhere. Where manures are to be applied to land that seems to require the use of lime, plaster should be freely used as an absorbent in the stable. These absorbents keep the stable free from odor, making them healthful, and also assist in preventing the manure from heating.—Mass. Agl. Exp. Station.



## CAUSES OF FAILURE IN APPLE CULTURE.

SIR,—I am thinking of setting an apple orchard, and would like some information as to soil, planting, cultivating, fertilizing, spraying, varieties for English market, etc.

C. C. ARTHUR, *Cobourg*



N reply we will give, in a series of two or three numbers, an address on this subject, given by Mr. L. Woolverton, the Secretary of the Fruit Growers' Association of Ontario.

Properly cared for, the apple orchard is, comparatively speaking, one of the most valuable portions of the farm, even if it is only large enough for home uses. Situated as some farmers are, at a long distance from a railway station, or a good market, the expenses of teaming the crop might make the odds against growing a commercial orchard; but otherwise, taking one year with another, I believe the apple crop can be made to pay twice as well, acre for acre, as a grain crop.

I am aware that I am courting opposition on this point, and grant that facts, in many instances, are against me. Even in the Niagara district, in the very centre of fruit culture, in the very best of soil and location, apple orchards just in their prime, beautiful thrifty trees of the best varieties, are being mercilessly cut down and sacrificed on each side of me. The owners declare that they are unprofitable. They say that the trees will not bear, that the apples of laie are smaller than they used to be, that the worms destroy the most of them, and that the small proportion remaining for the owner to harvest, bring no price in the markets. They have therefore resolved to cut down their orchards, and dig them out by the roots, in order to devote their ground to the growing of grain and root crops which they claim will pay them better.

I grant them honesty in their statements; I myself have observed the unproductiveness of the orchards, which are no doubt duplicated in every part of Ontario, and I venture to say that one or all of the following causes will explain the unfortunate condition of affairs.

### 1. The Unfavorable Location of the Orchard

A common notion is that any place will answer for the apple trees, and therefore very often a stoney corner that cannot be worked, or a very heavy clay which one does not want to work up, is set out to an apple orchard. That such an orchard will never be a success goes without proving.

But a more common fault for the location is a wet soil, left without under-draining. Trees in such situations may grow well in summer, but are almost sure to become winter-killed, or at least so injured by the cold in winter, that they become enfeebled and unproductive. The remedy is plain. A thorough system of under-draining is of the first importance.

Another evil of the situation is exposure to high winds. Those who have

had almost their whole crop strewed upon the ground in the autumn by wind-storms, know how to appreciate the favoring protection of a dense woods of deciduous, fir and evergreen trees. This cannot be quickly remedied, but a windbreak of a double row of Norway spruce trees will, in twenty years, be of inestimable value in this respect.

## 2. Lack of Cultivation.

The second cause of failure, and one of the most common, is lack of cultivation. Somehow or other, the idea has got abroad that the apple orchard needs no cultivation. True, there is no growth of wood, the fruit is small, and imperfect of its kind; but it never seems to occur to the owner that the trees would grow any better for being cultivated; or if he does believe in it, he does not sufficiently value his apple crop, to give it the same attention as he would his corn or potatoes. There is need of a general waking up on this question. I must confess to having been once of this opinion myself, but I have been converted. I have found that where the orchard is in an unthrifty condition, so that the leaves are of a light green or yellowish tint and ripen early, and the fruit is scant and poor, cultivation is the surest and speediest cure, and will accomplish what pruning and manure will utterly fail in doing without it. Cultivation of the soil so exposes it to the action of the air as to make available the plant food which is already there in store; and, besides, has a most important influence in counteracting the serious drouths to which our country is of late so subject.

One of my orchards which had been planted some twenty-five years, was in the condition above described. It had been left seeded down for about ten years, and had become unthrifty and unfruitful. In the summer of 1886 I broke up thoroughly one-half of it, applied wood ashes and pruned it carefully; while the other half was pruned and manured, but not cultivated. The same treatment was continued during 1887, and the result was plain enough to the most casual observer. The cultivated portion resisted the drouth of that year completely. Its dark green foliage was a remarkable contrast to the light sickly green of the other part, and more important still, the cultivated trees were laden to the very ground with such a load of fine Baldwins, Greenings and Golden Russets, were not equalled in any other orchard on my fruit farm.

## 3. Lack of Manure.

Who ever thinks of giving his apple orchard an annual dressing of manure? All the manure is put on the field crops; no farmer would expect to grow fine potatoes, or a paying crop of grain, without a heavy coat of manure; but the apple orchard must shift for itself, without either cultivation or manure; and then if it does not yield a paying crop it is condemned as worthless, and ought to be cut down because it does not pay. Is it the fault of the orchard, or of the orchardist? Why should it be expected to do what no other farm crop could possibly do?

Why, the farm was perhaps cropped for years before the orchard was planted, and the fertility of the soil well-nigh exhausted ; trees have been drawing on the soil for years, and now are blamed for unproductiveness. Is this reasonable, I ask ?

But, says one, " I cannot spare the manure from my other crops." Very well ; you must put it where it will pay best, but I claim that place is the orchard.

I find that farmers generally in Canada quite under-estimate one of the most valuable of orchard fertilizers, and either let it waste, or sell it for a mere song. I refer to our wood ashes, which are so undervalued in Canada, that Canada ashes have become an article of export, to enrich the fruit farms of our Yankee neighbors, who purchase them by the car-load.

The following is an advertisement clipped from an American paper :—

" Canada hardwood unleached ashes, by rail, in car-load lots, furnished on short notice. Ashes guaranteed to be of best quality, and are especially adapted for all grass and fruits. Pamphlets and prices sent on application. M., J. & S., Oswego, N.Y."

This is only one of many. Such quantities have been imported from Canada into the United States, that a special Bulletin has been published by the Connecticut State Experiment Station, showing the analysis of the various brands. The market value is 25 cents a bushel, although their real value is much higher.

The following table shows the value of wood ashes compared with stable manure, and with a commercial fertilizer which we may call a complete manure :

**Comparative Value of Wood Ashes.**

In 1000 lbs. of wood ashes there are, say,—

60 lbs. of potash, at 7 cts. per lb . . . . .	\$4 20
20 " phosphoric acid, at 5 cts. per lb . . . . .	1 00
700 " carbonate of lime. . . . .	_____
Amounting to . . . . .	\$5 20

About ½ ct. per lb. The remainder consists of magnesia, insoluble matter and moisture. One bushel weighs about 60 lbs., and is therefore worth about 30 cts.

In 1000 lbs. of a complete fertilizer there are,—

70 lbs. of nitrogen, at 20 cts. per lb . . . . .	\$14 00
30 " potash, at 7 cts. per lb . . . . .	2 10
60 " phosphoric acid, at 5 cts. per lb . . . . .	3 00
Amounting to . . . . .	_____
	\$19 10

Or nearly 2 cts. per lb.

In 1000 lbs. of stable manure there are, say,—

5 lbs. of nitrogen, at 20 cts. per lb.....	\$1 00
6 " potash, at 7 cts. per lb.....	42
2½ " phosphoric acid, at 5 cts. per lb.....	12

Amounting to ..... \$1 54

Or one-seventh of a cent per lb.

Now potash is a most important fertilizer for the orchard ; (1) it promotes growth, (2) it improves the flavor of the fruit, by causing an increase of sugar and a decrease of acid, and (3) it improves the color of the fruit, and this is very important in apples intended for the market. Apples draw heavily on the soil, and especially upon this element. It has been stated on very good authority that 100 barrels of apples draw more heavily on the soil than a crop of 50 bushels of wheat.

By reference to a table showing the constituents of the apple, the reason will be obvious.

#### Analysis of the Apple Constituents.

1-1000 parts of apple contains :

Water.....	831.
Nitrogen.....	.06
Ash.....	2.2
Potash.....	.8
Soda.....	.6
Lime.....	.1
Magnesia.....	.2
Phosphoric acid.....	.3
Sulphuric acid.....	.1
Silicic acid.....	.1

From this it is evident that of the most important elements, potash is one while the two other important elements, nitrogen and phosphoric acid, present in small quantities are also supplied in wood ashes.

With regard to the action of ashes upon the soil, it is important to notice that a heavy application of unleached wood ashes to a heavy soil is damaging to its texture, rendering it heavier still, more tenacious, and inclined to be cloddy on account of the potash. But for this very reason its action on light soils is highly beneficial, rendering it more compact, filling up the pores and keeping it moist.

It also tends to correct "sourness" in the soil by precipitating the soluble iron salts which are sometimes over abundant.

Another benefit is that it promotes nitrification, or the process by which nitrogenous matters in the soil are rendered available for the tree growth.

It is thus evident that ashes have more value than simply for the amount

of potash and phosphoric acid they contain, on account of their mechanical action, especially for light soils.

I have a hundred acres in orchard, and was almost in despair about fertilizing it properly, until I found I could buy ashes from farmers all about me for a mere song, and as much as I wanted. And now every winter I keep my team engaged collecting ashes for miles around, and apply it to my orchard. The results are evident, apples in abundance, and of such a size as astonished those who saw them; Baldwins often as large as Kings.

My soil is chiefly a sandy loam, and consequently of just the character to be most benefited by wood ashes. The quantity applied is about one-half to one ton per acre, or about one-half a bushel to a bushel per tree.

### SPRAYING FOR APPLE SCAB.



THE best proof that the apple scab fungus is the immediate cause of the greater part of the apple failures of Western New York is afforded, according to the Cornell Experiment Station Bulletin, by the fact that thorough spraying with Bordeaux mixture is usually followed by a great increase in the productiveness of the orchard; and it may be said that the indifferent results which occasionally follow the spray are equal proofs that there may be other causes than the fungus for the failures. Much of the failure with the Bordeaux mixture, however, is due to careless or hasty application. If the Bordeaux mixture is properly made—using an excess of lime—no injury may be expected to follow its use, and it should be applied with great thoroughness. The operator should endeavor to completely cover all the leaves and shoots.

A mere sprinkling, such as most persons give, is of little good. One thorough application which drenches the tree is better than several of this ordinary kind. Then people are always waiting for fair weather. Now it is the rainy weather when the fungi spread most seriously, and it is then that the spray is most needed. With plenty of lime, the mixture adheres well. Spray between the showers, even when the trees are wet, if you can do no better. To delay is to fail. It is better to spray in the rain than not to spray at all. There is abundant proof that two to four applications of Bordeaux mixture are capable of keeping the fungus almost completely in check. It is not known what value there is in an application before the buds open, but it can do no harm, and it is probable that it is very serviceable in most seasons. At the latest, spraying should begin as soon as the blossoms fall. Make the Bordeaux mixture with six pounds of copper sulphate, four pounds (or more if the lime is air-slacked) of lime, and about forty gallons of water. It is always advisable to add Paris green for various insects—one pound to every 250 gallons of the mixture. Then take up your position near the tree, with a strong pump, and apply the mixture until the tree is soured.

## PROFITABLE MARKET APPLES.



HIS was one of the questions in debate at the recent meeting of the Western New York Horticultural Society. The irrepressible *Ben Davis* came forward as usual, and its great productiveness, its freedom from scab, and good appearance amplified by its friends; while others condemned it on account of its poor quality, and claimed that in a few years it would have to give place to some variety of better quality. The old story, fought over just as it so often is at our own meetings in Ontario.

The writer conveyed the greetings of the Ontario Association, and gave his experience in shipping *Cranberry Pippins* to Australia during the past season. He claimed the apple was superior both in appearance and in quality to the *Ben Davis*, but, of course, by no means good enough in quality to be recommended as the ideal apple for the commercial orchard. Our Mr. Morris, called attention to the excellence of the *Ontario*, as being an ideal apple in many respects, while some New Yorkers commended the *Sutton Beauty*, as the most excellent apple for market purposes.

It was Mr. Van Deman, U. S. ex-Pomologist, who mentioned the *York Imperial* as the most desirable of market apples. The *Ben Davis*, he said, should not be grown outside of the Mississippi Valley, where it was at home, and attained its highest excellence. He condemned the *Stark* because of its dull color, while *Lawver* and *Gano* were not needed at all. In Chicago *York Imperial* was now quoted at \$4.50 per barrel, and *Ben Davis* at \$2.50. He believed the *York Imperial* would stand second only to the *Newtown Pippin* in the British market.

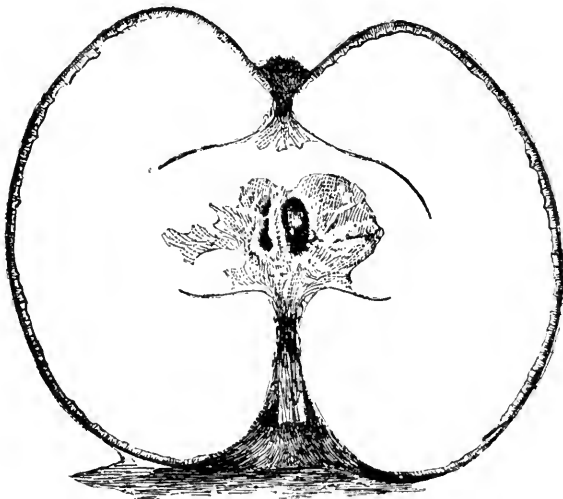

FIG. 917.--CROSS SECTION YORK IMPERIAL.

The American Agriculturist says of this apple :

The York Imperial is an apple which came into favor recently by reason of the demand for it in the English markets, where it sells at a price close to that realized for the Newtown and Albemarle Pippins. The apple is believed to have had its origin in York County, Pa., from which locality it takes its name. Downing describes the apple as being a "sub-acid"—as a matter of fact, however, it is practically devoid of acid and would pass for a sweet at any time. The specimen from which the accompanying photographic picture was made came from the New York Experiment Station at Geneva, and is doubtless genuine.

We describe the apple as follows : Fruit medium, oblate oblique, yellowish, a light crimson over a good part of the apple, which is splashed with crimson of a deeper shade. Stalk very short, inserted in a narrow deep cavity covered with a greenish russet. Calyx closed, in a deep, narrow and irregular basin. Flesh yellowish, fine grained, firm, pleasant, sweet, or nearly so, and very good. The obliqueness of this apple is its most marked characteristic. In almost every specimen, a perpendicular line from the calyx would fall far outside the stem. It is an exquisitely beautiful fruit, and even if of poor quality, would find a ready sale. It is a good keeper, rivalling any of the long-keeping sorts. We should think it a good variety to plant for market purposes.

---

## PICKING AND RIPENING PEARS.



It is the opinion of most nurserymen that pears should be picked while green and ripened indoors. The sunny side of the tree should be picked first and the rest later on. The greener the pear the higher the temperature should be to ripen it. The atmosphere should be moist to keep the pears from shriveling.

The tasteless pear is the result of too early picking, and should have received more sun and less artificial heat. Such a pear is flavorless, and unfit to eat.

As pears absorb odors readily, much care should be taken that the boxes and papers in which they are packed are kept fresh and clean. Pears not being so elastic as apples, require straw, paper or some such material to keep them from being injured by the sides of the box or barrel. Early pears and those nearly ripe should be packed in shallow, well-ventilated boxes. French gardeners generally pack this fruit in layers with the spaces filled up with powdered charcoal. The largest and greenest fruit is in the bottom, and all so snugly packed that no movement is possible, and that one pear does not press against another.

## DOWNING'S WINTER MAIDEN'S BLUSH.



HIS is one of the comparatively new apples which we are sending out to our apple experimenters this spring, in order that we may know its true value for Canadian planters. Very many of these newer varieties are very excellent in their native places, and deserving of all the introducers say; but when removed to other districts are utter failures. We hope in time to give a faithful account of the adaptability of this apple to the Province of Ontario.

The following account of this apple from the New York Farmer, will interest our readers:—

In the spring of 1874, Mr. Jason Downing, of Darke County, Ohio, planted seed of the popular Fall Maiden Blush. One of these seedlings turned out to be very similar to its parent in appearance, but being a winter apple the originator was pleased to call it Downing's Winter Maiden's Blush. The length of the name is objectionable. Prof. H. G. Van Deman, who is highly pleased with the apple, suggests that it be changed to "Greenville," and the introducer, Mr. E. M. Beuchly, is ready to adopt such name should the American Promological

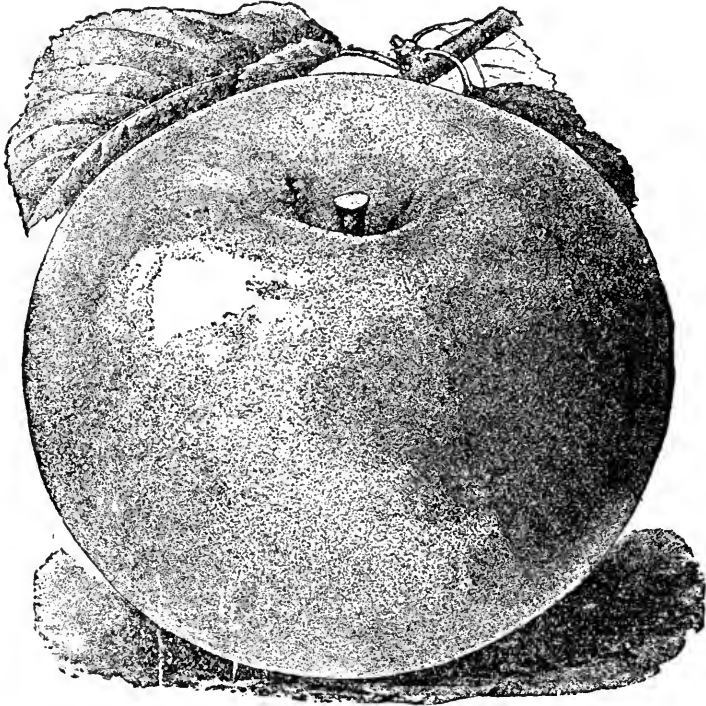

FIG. 918.—DOWNING'S WINTER MAIDEN BLUSH.



Society endorse it at its next meeting. This fine apple is rapidly becoming popular, and there are already large commercial orchards of it planted by the introducer. It has been a success at the experiment station at Geneva, N. Y., where a fine crop of the fruit was grown the past season. The original tree bore some excellent fruit at the age of seven years. The tree is hardy and a fine grower.

*Description.*—Fruit large, irregular, sometimes flattened and at others slightly elongated, inclining to conic; skin light waxen yellow, with a red cheek in the sun; stem medium length, inserted in a rather deep cavity, often surrounded with russet; calyx small, basin of moderate depth; flesh yellowish white, crisp, very fine grained, juicy, with a very pleasant sub-acid flavor, and a very fragrant and agreeable aroma; season November to late winter.—N. Y. Farmer.

### CAMPBELL'S EARLY GRAPE.



EVER since the introduction of the Concord, which has marked the most important epoch in the development of native American grapes, innumerable seedlings have been raised from it, with the hope of improving upon their parent. Many of these have become standard varieties of the present day, and yet none of them is quite free from one or more objections. Campbell's Early is the most recent competitor in this class.

It originated with George W. Campbell, of Ohio, and is a seedling of Moore's Early, a seedling of Concord. When we first saw the grape, at the meeting of the American Pomological Society at Washington, D.C., we became at once so favorably impressed with its good qualities that we predicted for it a grand future. We are, therefore, pleased to learn that so soon as a sufficient stock of it has been raised it will be offered for sale by George S. Jocelyn, in whose hands the entire stock has been placed by the originator. It is described as earlier than Moore's Early, with no tendency to shell off or fall from the stem, as it can remain on the vine from four to six weeks after ripening. It is free from foxiness and has a delicious and sprightly flavor, far superior to that of the Concord. Its growth and foliage are all that can be desired, the leaf being thicker than that of the Concord. The skin is thin but tenacious; the pulp has no acidity, is a little mealy, and sweet from the skin to the centre, and the seeds part readily from the pulp. From what we have seen of this new grape we consider it a decided improvement over the Concord, to which it will no doubt become a strong competitor after its introduction.—American Agriculturist.

The entire soil where an orchard is growing should be either mulched, or cultivated, or hoed over so frequently during the growing season, that all vegetation will be completely subdued.—S. E. TODD, *The Apple Culturist*, 1871.

## WALTER APPLE.

A new seedling apple of fine appearance and excellent quality, originated by the late P. C. Dempsey, of Trenton, Ont., and named Walter, after his son, our experimenter.

Fruit, large, roundish, one-sided; skin green, suffused and striped with bright red; stem slender, an inch long in a narrow cavity; calyx closed in a narrow basin of moderate depth; core small; flesh creamy white; tender, crisp, juicy; flavor, sub-acid, rich, agreeable, aromatic. Season, September, October. Not yet tested except by the originator. Sample grown by Mr. W. H. Dempsey.

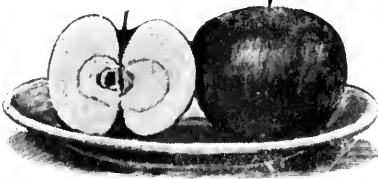

FIG. 919.—WALTER APPLE.

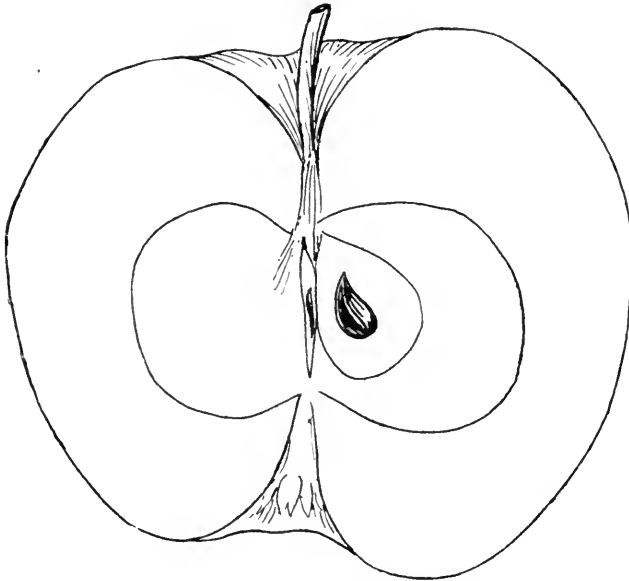

FIG. 920.—SECTION OF WALTER APPLE.

**Grain** crops should never be planted among trees, as they deprive them of air to a very injurious extent. If no root crops are cultivated, the ground should be kept clean and mellow with the one-horse plow and cultivator. . . . Every third or fourth year, the trees should receive a dressing of a well-decomposed manure or compost.—PATRICK BARRY, *The Fruit Garden*, 1st Edition, 1860.

## PRUNING FRUIT TREES.



ABOUT the first kind of out-door work that the fruit grower finds to do in spring is pruning his trees. As soon as hard freezing weather is past, generally early in March, in Western New York, the fruit grower should examine his fruit trees to see if they need pruning. It is claimed by experts that where a tree is properly attended to every year from the time it is transplanted, it will rarely require the use of saw or hatchet, as no large branches will need to be removed; that where the proper spring and summer pruning is done annually, the thumb and finger, with occasional use of knife, will keep the tree in good shape, with the top properly thinned. This is probably true if the conditions are strictly fulfilled, but in ordinary apple orchards it is necessary to make some use of a fine saw. To grow good, fully developed apples, richly colored, it is necessary to have the tops of the trees so thin that the sunlight shall fall on every leaf and every individual fruit, and the air circulate freely among them. The leaves and the rind of the fruit are the great perfecters and colorists of fruit, through the absorption of light and gases. Some apple trees are naturally so inclined to make thick heads that a considerable proportion of the apples never attain to proper size and color, unless the branches are kept thoroughly thinned. Witness, for example, the difference between the pale green, tasteless, or bitter, Northern Spys, grown on the inside of an unpruned tree and the large, highly colored specimens grown on the outside, fully exposed to air and sunlight. To properly prune a fruit tree is an intellectual exercise, requiring sharp observation and considerable thought. I never cut off a branch without being able to give a good reason for it and why I cut it in preference to an adjoining one. Where the branches rub together there is generally a good reason why one should be removed in preference to the other. Avoid sawing off large limbs wherever possible. It is great tax on the vitality of a tree to cut off large limbs. It is generally less exhausting to remove two or three small ones than one large one.

We seldom practice cutting back the last year's growth of the apple tree, for inasmuch as the apple is of rather slow growth seldom adding more than twelve to eighteen inches of new growth annually, it is hardly necessary to shorten in that growth. Moreover, the new growth of the apple generally matures to the terminal bud. With the pear and the peach it is different. When thrifty the peach seldom matures to the tip, and as it forms fruit buds on the new wood, cutting back one-half or one-third of that wood would cut off but a little more than the weaker, frost-bitten buds, and the remaining buds would develop into larger, better fruit and more in bulk than if all that would grow were suffered to grow.

The same rule applies to the pear, especially the drawf pear. I visited several times one of the finest, best cultivated dwarf pear orchards in Western New York. The varieties were Angouleme and Howell. Every year the new

growth was headed back, the soil kept well fertilized and cultivated and the trees were regular, heavy bearers. One year I visited this orchard and, after passing through many rows well loaded with fruit, came to a few rows that were entirely barren. Asking the proprietor for a solution of the mystery, he said that the preceding year they had cut back the new growth, as usual, up to where the barren rows commenced when something occurred to prevent further pruning and the result was a complete vindication of the efficacy of pruning. At the recent annual meeting of the Western New York Horticultural Society, an object lesson of the effects of pruning the Angouleme was exhibited. Some branches of last year's growth were shown that had made a luxuriant growth of wood without a single fruit bud, but other branches had been stopped in June, when about a foot in length, and they were filled with blossom buds. A good way of pruning pears to promote fruitfulness is to stop the growth of branches by pinching off the leading bud.

Grapes should be pruned quite early in March, if not attended to in the autumn, and should they be neglected until after the middle of April, I should prefer to leave them until the new growth had started one or two inches, when I would cut back the previous year's growth, leaving one or two of the new shoots. I have tried this practice as an experiment and found that the vines bled but little—much less than when pruned in March or April—and they bore heavy crops of fruit and made a good growth of vine.

Raspberries and blackberries should be thoroughly pruned, either before or soon after the buds start into growth. If the leading canes were stopped last summer, as they should have been, by pinching off leading buds, then you have but to shorten in the laterals to within a foot or so of the upright canes. This will remove the weaker buds, giving those remaining opportunity to develop into good large berries. Currants and gooseberries should be kept thinned out by cutting out superfluous new sprouts and occasionally removing an old branch when past its greatest vigor and productiveness. No fruit tree or shrub or cane can do as well when allowed to exceed its proper limit of growth as when kept within due bounds. All modern fruit growing is something of an artificial process, as we have departed quite widely from nature's methods in order to reduce it to subserviency to our wants.—P. C. REYNOLDS, in *New York Tribune*.

---

**Nitrogen in Manure.**—The nitrogen voided in manures is contained mainly in the urine, and therefore the liquid manure should be saved even more carefully than the solid, although not one farmer in ten fully realizes this fact. We are also learning that the nitrogen (ammonia) in stable manure is something of an uncertain factor. Wagner, the careful German experimenter, holds that less than half of the nitrogen in manure is immediately available for plant growth. This explains the advisability of absorbents in stables to keep what nitrogen there is in the manure, and also the wisdom of adding ammonia in the form of commercial fertilizers or by plowing under alfalfa, clover, etc.—*Mass. Agl. Exp. Station*.

## HOT BEDS—HOW TO MAKE AND OPERATE THEM SUCCESSFULLY.



NE of the most convenient and profitable luxuries in the spring is a well managed hot bed from which one can daily gather lettuce, radish, spinach, etc., and forward plants, such as cabbage, tomato, pepper, cauliflower, for outside planting. Also it makes a desirable and very satisfactory place for starting flower seeds and early flowering plants for outside planting. Make the frame "box shaped" to fit sash (any size sash you happen to

have on hand), though the standard size is about 3x7 feet. At the bottom, boards should be about 12 inches high; the top or back, 18 inches; the back being higher than the front gives a declivity to the sash, thus casting off the rain and gives proper slant to receive the sun's rays.

Select a well drained location and one never flooded by rain. In preparing a hot bed fresh horse manure should be piled up, which will heat in about six days. It should then be turned and well tramped down; the second fermentation will then take place in four or five days. It is now ready for the bed --should be packed one foot deep and banked up on all sides to the top. Five or six inches of rich and finely sifted soil must be spread over the manure, then cover the frame with sash, after standing six days, or until the rank steam has passed off; seeds may then be sown.

Keep the temperature as even as possible, from 45 to 50 degrees Fahrenheit at night and not over 75 to 80 degrees during the day. In keeping up the above temperature, (cold weather will give some draw backs) it will be necessary in many instances to cover the sash with straw, mats, light manure, etc., on cold and frosty nights. (This covering, however, should be removed as soon as possible.) Remove the covering every morning when weather permits, at 9 o'clock, or as soon as the sun rests upon the glass, as every effort should be made to give the plants all the sunlight possible, as its rays are vivifying to a degree beyond the amount of its heat, it having a chemical and physiological effect beyond explanation.

Even dull light is better than no light, consequently it is a bad plan to cover the sash with mats, except for the direct purpose of keeping out cold. Give a little air about 10 o'clock; cut off the air in the afternoon as soon as it (the air) becomes the least chilly, then if necessary cover with mats, etc., about sunset to retain heat. Care should be taken to keep the cold winds from blowing in upon the plants when sash are removed to admit air. Great care should be taken in watering hot beds. Do not give too much water, for if this be done, the soil is apt to become soggy and sour. Success depends upon bottom heat

from the manure, top heat from the sun, water from the daily application, and air at midday. Without plenty of air the other requisites will be fruitless.

All seedlings should be transplanted into other hot beds, cold frames or intermediate beds when two inches high. For fear that there may be localities where stable manure for hot beds cannot readily be obtained, we give the following simple formula for "artificial heat" for the production of a moderate and continuous heat, the quantities named being sufficient for a space 8x12 feet.

Take as the crude materials, 500 pounds of straw, three bushels powdered quicklime, six pounds muriatic acid, six pounds saltpetre. Having prepared the

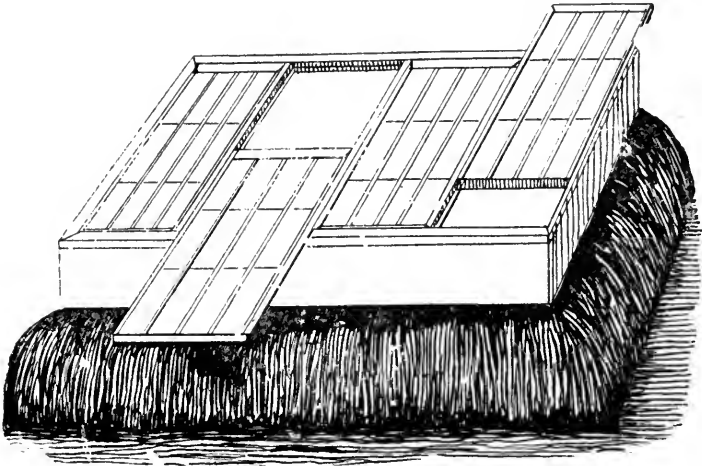

FIG. 921—HOT BED.

excavation of proper dimensions, spread three or four inches of forest leaves or old hay in the bottom: Upon that spread eight inches of the straw, tramp it down and sprinkle with one-third part of the quicklime. Dilute the six pounds of muriatic acid with twenty gallons of water and, by means of an old broom sprinkle the bed with one-third part of the solution. Make another layer of eight inches of the straw, applying quicklime and the solution as before. Repeat for the third layer. Upon this make a fourth layer of straw, and upon it sprinkle the four pounds of saltpetre dissolved in 30 gallons of water. Place the box in position, bank up outside, within the box spread three inches rich, finely pulverized earth, and then put on the sash. A heat will soon be generated which will continue for two or three weeks. The same methods as to location and care will apply to this as in the above.—Indiana Farmer.

### CHRYSANTHEMUM CULTURE.



**F**EBRUARY or March is a good time to put in cuttings. Select the short shoots from the base of the plant, bare the leaves well, of the cuttings,—insert them into flats of half-leaf-mould and sand,—place the flats on a bench near the glass with no bottom heat, temperature 45 by night. If the sun is too strong during the middle of the day, slight shading will be beneficial. They should be well rooted in four weeks ; then they should be potted into three inch pots,—compost one-third loam, one leaf-mould and one sand. When the pots are filled with roots, shift into six-inch pots of two-thirds rotten sod and one-third rotten cow manure that has been dried and rubbed down. They should be fit, by the middle of June, to be put into their flowering pots. The vigorous growing kinds need larger pots than the more delicate ones. The soil for this potting should consist of two-thirds rotten sod and one-third rotten cow manure. To each bushel of the compost, add a six-inch pot.full of bonemeal. The soil should be firmly pounded down against the sides of the pots, with a stick, as firm potting insures firm growth. Stake your plant while you have it on the potting bench. After this operation has been gone through with plunge the pots into beds of coal ashes,



FIG. 922.

three feet between the lines. To keep the plants from being destroyed by wind, run a wire on posts along each line, to which tie the stakes. Do not allow the plants to suffer for want of water ; but be sure they require it before you give it to them, as careful watering is very important. When the pots are fairly filled with roots, give weak liquid manure once a week until the first of August,—then twice a week until they show color, when it should be stopped. Disbud twice a week, whether for standard or bush plants, throughout the growing season. House them by the early part of October,—ventilate freely,—keep the temperature about 40° by night,—keep mildew in check by dusting the affected parts with sulphur. To kill Brown Fly, dust them with tobacco powder.— Meehans' Monthly.

---

### THE GREENHOUSE.

Get all manner of plants that require it repotted and ready for a good summer's growth. Use clean pots, drain them effectively ; in repotting have the ball of the plant deep enough that the fresh soil will completely cover it, but not so deep that an inch or so of the stem will be buried. In potting ram the soil very firm. A loose soil when well watered becomes a mud puddle ; a very firmly packed soil, no matter how much watered, retains its firmness, and the plants in their short jointed firm wood soon show which is the better practice. The soil used in potting while somewhat moist should not be wet ; in fact it should be very free and mellow. Never use a large pot for a small plant ; overpotting is very injurious. Newly potted plants should be kept only moderately moist at the root till young roots begin to grow into the fresh soil ; they enjoy a moist atmosphere though, and in the case of fine-leaved plants like dracænas, crotons, marantas, aralias, anthuriums, alocasias, and the like, syringing them overhead twice a day, say in the morning and again in the early afternoon, does them much good. The blossoms of plants, however, should never be syringed overhead.

Put in some cuttings of all manner of plants increased in this way, such as carnations, begonias, libonias, eupatoriums, marguerites, stevia, streptoso'en, fuchsias, habrothamnus, cytissus, asparagus (*tenuissimus*), myrtles, double petunias, plumbago, passion flowers, and many others. Bouvardias, if they have been kept rather dry at the root since flowering, may now be shaken out of their pots and their fleshy roots cut up into short pieces, say two inches long. If these are inserted as cuttings they throw out adventitious eyes that soon grow into nice little plants. If some clumps of *Anemone Japonica* are lifted and treated in the same way we can get up a nice stock of them flowering next August and September.

Keep calceolarias cool, faintly shaded, but near the glass, and give them lots of water and plenty of room. Don't wet them much overhead.—Gardening.



## THE NARCISSUS AND THE TULIP.



NO garden seems to be complete in the early spring without a selection of narcissus, and taking the best, there are no more reliable bulbs for garden use. Many new kinds have been lately introduced, among which those of Spanish origin, after flowering once, dwindle away and rarely succeed in gardens. But among those of hybrid and garden origin, there are few that will not succeed in American gardens, and these hybrids and garden varieties are by far the best kinds. There is a phase of narcissus cultivation that is too rarely seen here, that is their naturalization among grass in wild or shady places. The Poet's narcissus and those allied to it, and the *Incomparabilis* section, and, in fact, all those of starlike forms are most eligible for this purpose. For cutting for indoor decoration there are few to excel *Empress*, *Horsfieldt*, *Michael Foster*, and *William Wilks*, all of which are bi colors and bloom in succession. Countess of *Annesley*, *Emperor*, *Sir Watkin*, and *Princess*, all belong to the larger yellow flowered section, and to these may be added the *Incomparabilis* and *Barrii* sections, which are well adapted to our climate. It is preferable not to plant these in a mixed or herbaceous border, but to keep them in a separate border, which in summer is planted with annuals that shade the soil from the burning sun. The narcissi are planted in rows, sixteen inches apart, and the annuals, such as stocks, asters, mignonette, etc., are set between. When the annuals are cleared off in the fall, a top-dressing is given over all in the beds, and this is all the fertilizer they seem to require. They should be lifted and re planted every three years. It is quite in keeping with a herbaceous border to have clumps of narcissus mixed here and there, along the margin, and, where few are grown, this is perhaps the best way, but if the number of varieties is large it is better to have them where labels will not be disturbed, and where each kind is near the other for comparison.



FIG.—923.

There are a number of species of tulips other than those generally used for massing for color effects, which are most beautiful in the mixed border, and they have also greater vigor and taller habit, and grow on for any number of years without deterioration. *Tulipa Gesneriana* may be taken as the type of these late-flowering kinds, and there are few bulbs that give such rich coloring as this, without being gaudy. Other species are the horned tulip (*T. cornuta*) with petals narrowing to a point: *T. Greigi*, FIG. 923 with rich colors and prettily spotted leaves; *T. vetillina*, pure yellow, and many others not often seen cultivated, some of which are real gems in the rock garden. The so-called Darwin tulips are the "breeders of the Flemish and English raisers; the lovely colors of this

section give them a peculiar charm—rich, dark and velvety colors predominate; yellows are absent, and no two in a mixture are alike. Their stems are erect and stiff, and they are admirably adapted for cutting. They like a soil that is not liable to dry out, or the quality of the blooms suffers. They should be planted in groups of six or eight, and each year the quantity of bloom will be about doubled from each clump.—Rept. Mass. Hort. Soc.

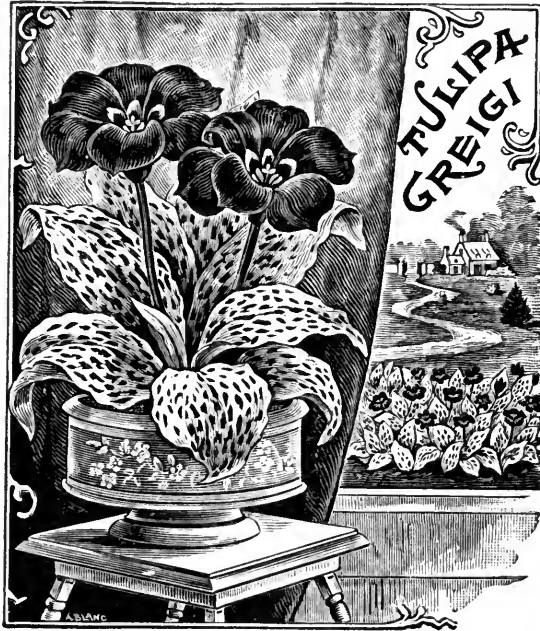

FIG. 924.

**Hollyhocks and Pansies.**—An excellent covering for the hollyhock is a nail keg, with both ends knocked out. Place one over each plant, and fill in about it with leaves. Then put something over the top, to keep out the rain. When snow comes, bank up well about the keg. Plants come through the winter, when protected in this way, in splendid condition, and give early and fine flowers. Unprotected, half the hollyhock plants die off in spring, at the north. A close, heavy covering is almost sure death to a pansy. The ideal covering for pansies is leaves scattered loosely among the plants, with large branches of evergreens laid over them. These keep the leaves in place.—Am. Agriculturist.

**Wild Flower Trade.**—The trade in cut wild flowers is beginning to be an important business in the large cities. Wild ferns, especially those with leathery leaves, are an especial feature. The Christmas fern, *Aspidium acrostichoides*, is largely drawn on. It is estimated that five millions of fronds of this fern were sold in Philadelphia last year.—Meehans' Monthly for December.



## The Canadian Horticulturist

SUBSCRIPTION PRICE, \$1.00 per year, entitling the subscriber to membership of the Fruit Growers' Association of Ontario and all its privileges, including a copy of its valuable Annual Report, and a share in its annual distribution of plants and trees.

REMITTANCES by Registered Letter are at our risk. Receipts will be acknowledged upon the address label.

### ↻ Notes and Comments. ↻

WATERLOO HORTICULTURAL SOCIETY has now sent in to us 121 names for 1896.

THE DRY ROT has seriously affected the quality of the Baldwins and Kings in Southern Ontario during the past season.

THE PORT COLBORNE HORTICULTURAL SOCIETY has elected the following officers for 1896: President, E. O. Boyle, 1st Vice, L. G. Carter, 2nd Vice, W. W. Knisley, Secretary, D. W. McKay, Treasurer, A. E. Augustine, and nine Directors.

THE MCINTOSH RED was shown at the Rochester Fruit Growers' Meeting for Princess Louise. Evidently these two varieties have become mixed by some of our nurserymen.

MORE ABOUT FLOWERS.—Since we have so many Horticultural Societies in affiliation it seems important that we give a little more space in the journal to floriculture. We have, indeed, received requests from some of the societies that we should do so. We shall be glad to comply, but we must always place the cultivation of the fruit garden first, because the larger portion of our readers are more interested in fruit than in flower growing.

COLD STORAGE FOR SHIPBOARD.—Ice storage is apparently too precarious for use on shipboard for any long voyage, besides being very expensive. Dr. Perkins, of California, has invented a process called the "Perkins' Sterilized Air

Process," by which fruit can be preserved from decay at one-eighth the cost of the usual cold storage.

We made enquiry at Rochester regarding the process, and were informed, by Mr. Hale, that the patents protecting Dr. Perkins were not yet received—and until that was completed, the process would not be available.

---

THE DIRECTORS OF THE GRIMSBY HORTICULTURAL SOCIETY met on the 18th February, at the Mechanics' Institute Rooms. It was unanimously agreed to give each member THE CANADIAN HORTICULTURIST, the Fruit Growers' Report, and the following excellent list of bulbs, seeds and plants, viz.: Two cannas, one named gladiolus, one named begonia, two named chrysanthemums, and an ounce of Burpees' best mixed sweet peas. The ladies on the Board were made a committee to prepare a programme for the next public meeting of the Society, and the gentlemen agreed to give any needed assistance. At this meeting choice house plants and art work will be shown; an interesting programme will be given, and the packages of plants distributed.

---

CALIFORNIAN PEARS reach England in good condition by cool chambers on ships; why cannot Canadian pears be handled equally well? Speaking of foreign fruits in Covent Garden, a writer in *The Garden* says:—Cool-chambered ships and cool cars in trains bring such sorts as Bartlett, Beurré Hardy and Doyenné du Comice by thousands of cases in perfect condition from California, and if it can be made to pay by reducing freight, the supply from there seems enormous, and will run the French very close as well as the English. At present the freight of a case weighing 40 lbs. fruit is over 4s., and unless temperature is very carefully regulated, they turn very quickly when exposed, and do not keep so long as the French. Some very fine plums have also come from there in good condition. California has a great advantage over England in regard to pears travelling, and that is, they seldom get rain while the fruit is ripening, and that of course is greatly in favor of any fruit standing a journey as well as the hotter climate ripening them more thoroughly. Easter Beurré coming in winter does not need cool chambers, and therefore comes at a lower freight. A great many peaches came from California this last autumn, but were of very poor quality, being mostly clingstones and were only fit for costermongers. In September this year there were weekly shipments received in our market of about 6000 cases pears and peaches. At the present time the quantity is about 1000 weekly, principally Easter Beurré.



## ❧ Question Drawer. ❧

### Small Fruits—Information Wanted.

**793.** SIR,—I find it hard to get good help at garden work, such as hoeing, cultivating, etc. How should I set about to obtain good berry pickers? What are the usual prices paid pickers at Grimsby? Are any hired by the season, and at what price? Do you think it advisable to advertise; and what is the best medium? Any information will be thankfully received.

G. FINDLAY, *Walkerville, Ont.*

Our subscriber does not say how large an acreage of small fruits he has to harvest, but in a neighborhood like Walkerville, there should be no need of advertising for pickers. We usually find that the women and children in workmen's homes are always ready to earn some extra money in the berry field; and it is easy to gather a few dozen pickers in any small village. For strawberries we usually pay 1 cent a quart; for raspberries and blackcaps 1½; blackberries, currants, and gooseberries, 1 cent. Of course there are often exceptional cases where additional pay should be given, but with a first class crop, the above will answer. Pickers are never hired for the season, but it should be agreed that a picker would remain throughout the season with the one employer, when needed unless a week's notice, more or less, be given of a change.

---

### Red Cross Currant.

**794.** SIR,—Do I understand from January number that you have the control of the stock of the Red Cross Currant?

W. H. PARKER, *Mimico.*

No, we know nothing of this currant, except what the introducer says on page 27. By mistake the article appeared in the body of the Journal instead of in advertising columns. You will need to write to Chas. Green, Rochester, the introducer, for stock.

---

### Lawver and Delaware Red Winter.

**795.** SIR,—Are these two apples identical?

W. C. REID, *Belleville.*

They are too near alike to be worth distinguishing. Plenty of better varieties for Ontario.

---

### Gano and Arctic.

**796.** SIR,—Do you know these apples?

W. C. R., *Belleville.*

The Gano we met at the World's Fair. It is of little account for Ontario. The Arctic we do not know.

### Frozen Trees.

**797.** SIR,—Since last spring frost, some of my apple trees are dead some four or five feet down the branches, to where they are an inch or so in diameter. Do you think they will recover?

JOHN DALGARNO, *Sullivan.*

If not injured farther, cut off the dead wood, and the trees will no doubt grow up from below, and make good trees much sooner than planting new ones.

---

### Raspberries for Home Use.

**798.** SIR,—I want to plant a patch of raspberries for home use, two or three varieties. Quality not to be the chief consideration?

J. D., *Sullivan.*

Of red raspberries, try Marlboro', Turner, and Cuthbert; of black caps, Gregg, and Hilborn; and for canning, the Shaffer.

---

### Abundance and Burbank Plums.

**799.** SIR,—Are these hardy enough for Northumberland County?

W. C. R.

---

### Muriate of Potash.

**800.** SIR,—Where can I buy muriate of potash, and at what price?

J. S., *Henrysburg.*

---

### Manurial Value of Tannery Refuse.

**801.** SIR,—Would you kindly inform me, if convenient, what the manurial value of the refuse from a tannery is for fruit trees, and how much it would be advisable to apply per acre to light soil not very rich, *i. e.*, worked out considerably; and for peaches and blackberries? Would it pay to give 25c. per load, assuming the hauling cost nothing? What is the highest price it would pay to give for it?

L. G. MORGAN, *Port Dover, Ont.*

*Reply by F. T. Shutt, Chemist Central Experimental Farm, Ottawa.*

I have your communication of the 13th inst., requesting information respecting tannery refuse. Tannery refuse consists of scrapings and trimmings from the hides, pieces of flesh, hair, etc., and, consequently, is an organic manure. Its chief fertilizing constituent is nitrogen, and the agricultural value of any particular sample will depend not only upon the percentage of this element present, but also upon the condition in which the nitrogen occurs. Thus, the nitrogen of flesh is *much more available* for plant food than that of hair; hence, the proportion of flesh to hair in the refuse must be taken into account when considering the value of this material.

We have not as yet made any analysis of refuse from Canadian tanneries. Most probably the fresh material would contain from 75% to 85% of water, the nitrogen approximating 3%. Without examining the sample referred to by your correspondent, I could not say exactly what it is worth, but in all probability the price mentioned by your correspondent of 25 cents per load is not too high.

I should advise the composting of the refuse before application to the soil. By so doing a more immediate effect would be obtained than by applying the material directly to the soil. Stable manure or good soil might be used to advantage as a composting material. There are also other substances, such as wood ashes and lime, that can be used for this purpose.

For general fruit culture, the compost of tannery refuse should be supplemented by fertilizers containing potash and phosphoric acid, more especially the former. Wood ashes, kainit and muriate of potash are forms in which the potash may be applied; bone meal and superphosphate more especially furnish phosphoric acid.

Sandy soils are especially benefited by an application of organic manure. Some add humus, and by this means improve the soil's absorbent capacity for moisture. From this standpoint, I consider that the compost of tannery refuse would be a highly desirable form in which to supply nitrogen for soils of a light character.

Occasionally I have known the spent tan bark of tanneries to be called tannery refuse. This material is hemlock bark from which the "tan" has been extracted. It is essentially woody fibre. A sample that we examined some years ago contained .167% of nitrogen. As a fertilizer, I am of the opinion that this material is almost valueless, since it contains very little plant food, and is of such a nature that it resists decomposition in the soil for a very long time.

---

### Pruning Gooseberry Bushes and Spruce Hedges.

**802.** SIR,—Should gooseberry bushes, and a spruce hedge be pruned in March: if not, when?  
THOS. H. ALTON.

The gooseberries may be pruned in March, but the evergreens would heal better if pruned about the 1st of June, when young growth is pushing forward.

---

### Mulch for Strawberry Plants.

**803.** SIR,—What is the best kind of mulch to use on strawberries, and when should it be applied?  
T. H. A.

If for winter protection, evergreen boughs, or a coarse strawy manure, applied as soon as the ground is frozen; if to keep fruit clean, straw or sawdust applied just as the fruit begins to ripen. The following remarks on mulching the strawberry patch, by Mr. Rice, before the Bullville, N. Y., Farmers' Institute, will be interesting in this connection:—

“Where manure from the house stables is used—which is excellent, except where it is full of weed-seed or from timothy—there is little danger of its blowing away, because it is so moist. The same is true of the litter from poultry houses, which is also good because, like the horse-manure, it contains such valuable fertilizing material as well as being a good mulch.

“Where clean straw is used, it may be put over the entire patch to a depth of four inches, and if it is likely to be blown away, a little brush, and an occasional clot of earth or stones can be put on, until the straw has been wet by rain or held down by the snow.

“The mulch may be put on at any time after growth ceases, but usually after the ground freezes, because at this time less injury is done to the plants by the wagon and horses running over them.

“A good mulch has a fourfold benefit: 1st. To protect the crowns from freezing and thawing. 2nd. Holds buds back from late frosts in the spring. 3rd. Makes a fine protector for the fruit, keeping the berries from getting sanded when rains come during the picking season. 4th. It serves to retard the growth of weeds, and also conserves moisture during the drouth.

“It will be necessary in the spring to loosen up the mulch, and let the plants push up through. If this is not done, the plants may be unduly retarded and perhaps smothered out entirely.

---

### Barn Manure.

**804.** SIR,—Is barn manure good for raspberries?

T. H. A.

Yes, the best possible fertilizer.

---

### Gooseberry Mildew.

**805.** SIR,—What is best to keep mildew off gooseberries?

T. H. A.

Persistent spraying with Bordeaux mixture, made with four pounds of lime, four of sulphate of copper, and forty gallons of water. Give four applications, two before blooming and two after. Mr. Morton, of Wingham, has excellent success with even the English varieties, by this treatment.

---

### Summer Pruning of Grape Vines.

**806.** SIR,—Should grape vines be cut back in June or July, and if so how much?

T. H. A.

Summer pruning is little practised in Canada. If the vines are properly pruned in fall or spring, little more is needed than to rub off useless sprouts to direct growth, and to stop the ends of bearing branches just beyond the last bunch of grapes.



### Coal Ashes.

**807.** SIR,—Are coal ashes any use around gooseberry bushes ?

T. H. A.

As a mulch, yes ; as a fertilizer, very little.

---

### Strawberry Crossing.

**808.** SIR,—How are strawberries crossed ?

T. H. A.

The stamens, if any, must be cut out of the blossom, and the emasculated flower treated with pollen from the variety you wish to cross it with. For this work a camel's hair pencil is a convenient tool. The flower must be protected by a little bag from any other pollen both before and after the operation. The seed from the fruit thus operated upon will produce a cross between the two varieties.

---

### Planting Evergreens.

**809.** SIR,—When is the time to plant evergreens ?

T. H. A.

Evergreens may be transplanted almost anytime, providing the roots are not allowed to become the least dried by exposure to sun or air. To this kind of injury evergreens are more susceptible than other trees, and if roots once become dry, it is impossible to make the tree survive its removal. An excellent time for removing them is about the 1st of June, when they are beginning to push out new growth. August is advocated by some planters, because the drought of summer is over.

---

### Varieties of Raspberries and Blackberries.

**810.** SIR,—What are the best varieties of red raspberries, black caps, and blackberries ?

T. H. A.

That depends on the purpose for which they are wanted. If for the general market, we would commend Marlboro and Cuthbert, red raspberries ; Hillborn and Gregg, black raspberries, and Agawam and Snyder, blackberries. Where it is hardy enough, and does not rust, the Kittatinny is the finest blackberry.

---

### Pruning Plums.

**811.** SIR,—Should plum trees be pruned ?

T. H. A.

Yes, (1) to direct growth and (2) to thin out cross branches and (3) to shorten in sprawling limbs.

### What Nozzle?

**S12.** SIR,—I intend purchasing an Ideal spray pump. What nozzle would you advise? We have between three and four hundred apple and pear trees, besides a few plum and cherry. Would a McGowan reach the top of good sized pear trees?

W. H., *Medina, Ont.*

The McGowan will give you excellent satisfaction. For high trees the nozzle should be elevated on a long light pole—a bamboo is excellent for the purpose. The pump should have fifteen feet of hose to allow the elevation of the nozzle.

---

### The Bordeaux Mixture.

**S13.** SIR,—Is the Bordeaux mixture good to spray upon plum trees? Last year I sprayed nine with it, and thought they fell more than usual.

A. S. CROSBY, *Compton, Que.*

If properly made the Bordeaux mixture is perfectly safe upon the foliage of all trees and plants. It should have an excess of lime rather less than prescribed. Milk of lime should always be added to the dissolved copper sulphate until a drop of cyanide of potassium remains unchanged in color when dropped in the mixture. A few cents worth of this latter substance will last the season, and it is a convenience, because no weighing of substances is necessary. The usual formula now for the Bordeaux mixture is four lbs. copper sulphate, four lbs. lime, and forty gallons of water; the simplest method of making is first to dissolve say twelve lbs. copper sulphate in a barrel of water, and in another barrel as much lime as convenient. Then dip out one-third the liquid copper sulphate, which would be four pounds dissolved, into the spraying cask; then add milk of lime until the potassium ferrocyanide will not change color when dropped in the mixture.

---

### Commercial Varieties of Plums for Southern Ontario.

**S14.** SIR,—I am wishing to set out 400 to 600 plum trees this spring, on Pelee Island, and will feel very much obliged to you to give me the names of six or eight varieties that will give me the earliest and also the latest, and the others to fill in the time, to give me a continuous supply to ship. The soil is rich clay loam, on a limestone base. I want large and showy ones—plums good to ship.

JAMES SPRIGLEY, *Pelee Island, Ont.*

*Reply by Mr. S. D. Willard, Geneva, N. Y.*

My list of plums for the section you refer to would be as follows:—Field, which is ten days earlier than Bradshaw, of same size and general appearance, being a seedling of the Bradshaw. Then Burbank, Black Diamond, Fellenburg, Grand Duke, Monarch, and Archduke. If I wanted yet another, I do not know but what I would take the Prince of Wales. Please note one fact, that the Grand Duke and Fellenburg are much the best when they are top-

worked on some other varieties, like the Lombard. They want something to impart more vigor and growth than they get when they are bottom-budded. This gives additional surface to the tree, rather earlier bearing and very much greater productiveness. As I grow older, I am impressed with the idea that many varieties of apples, plums, pears, etc., are very greatly improved by working upon some other sort.

---

### The Ideal Spray Pump.

**815.** SIR,—What do you think of the Ideal Spray Pump manufactured at Brantford?  
A SUBSCRIBER.

Our foreman, Mr. P. Blanchard, who used this pump last season almost constantly for some weeks, says he is much pleased with it, indeed, that it gave excellent satisfaction, especially with the McGowan nozzle.

---

### Best Blackberries.

**816.** SIR,—What blackberry do you consider the best? for I want to plant a few. I see Lovetts' advertise some new ones; have you tried any of them? Are the June Berries any good? Have you tried the Pawpaw, "Northern Banana" and Persimmon?

EDWARD WILSON, *Bright, Ont.*

---

### Judging at Exhibitions.

SIR,—I think we should follow up the very excellent work we have done in listing fruit for exhibition purposes, and extend our work to descriptions of garden fruits and vegetables. I have been unable to obtain the list which the Michigan Society issued, but, in my opinion, the idea is an admirable one. Any one who visits our fall fairs, and more particularly the township fairs, must be convinced that the biggest sample is, in the estimation of the judges, the best. Within certain limitations, this is correct, but who would prefer an overgrown potato one sees at exhibitions to a medium sized one for his own particular use? What earthly use is a beet as big as your head for table purposes? I have seen long beets that could only be cooked in a washtub without being cut—which spoils the beet—awarded first prize as table beets. There is great confusion, too, as to what is a squash and what is a pumpkin. At Goderich the judge of vegetables awarded first prize for winter squash to what six of us, practical men at that, considered a variety of pumpkin; botanically they are the same species. Some of you who have the reports of other societies to assist you in its preparation, might take up this matter. I cannot without a great deal of labor, as I am not in possession of material such as I have indicated.

J. A. MORTON, *Wingham.*

## \* Open Letters. \*

### Cost of Living in Paris, France.

I do wish something could be done to bring Canadian fruit and other products more before the British public than is the case now. Here in Paris we find things very high. The following will give you some idea of what the cost of living is: Meat 26c. ; butter 35c. ; milk 8c. a quart ; coal oil 56c. a gallon ; coffee, best, 70c. a lb. ; tea \$1.20 a lb. ; sugar 12c. a lb. ; bread 3½c. a lb. ; pork 24c. to 26c. a lb. ; this is given you in our currency. I notice you are having cold weather in Canada ; here we have not had it very cold, but we feel the cold, damp air more than your severe dry cold.

JOHN PENMAN, *Paris, France.*

---

### Last Season's Experience with Fruit.

Our land here lies immediately on the northern margin of lake Ontario, the influence of which appears to make vegetation at least ten days more backward than on land even only half a mile further back. This told largely in our favor when the sharp frosts between May 13th and 22nd (on four nights of which the thermometer, 5 feet from the ground dropped to 25°, 29°, 27° and 29°) come upon us ; as our apple, pear and plum trees and grape vines suffered less than those even a short distance inland, where the crops were almost entirely destroyed owing to their more advanced state. On our pear and plum trees the blossom afterwards opened apparently all right, but close inspection of the more exposed showed many of the fertilizing organs blackened, thus thinning the crop considerably. Though a sheltered block of Lombard plum trees, afterwards fruited so heavily that notwithstanding attempts at supporting the branches many of them gave way under the weight of fruit ; and many pear trees, especially Flemish Beauty, offered a good crop in the neighbourhood. A few of the shoots on the lower branches of the grape vines were damaged, but still we harvested at least three quarters of a crop of unusually fine grapes. Strawberries, usually a leading crop here, suffered largely. From a plot which the previous year gave us close on 7,000 quarts, we picked this year an additional 2,000 quarts. Raspberries and blackcaps produced a fair crop of fine fruit. The few bearing peach trees, which the last year had given us a fair crop, had not a fruit. As for apples the orchards in this neighborhood for a mile or so from the lake shore, have seldom yielded so good a crop of perfect fruit, while in orchards a few miles further north there was practically none. The result of spraying plum trees and grape vines was very satisfactory. I cannot agree with Mr. E. B. Stevenson, in your January issue, as to Parker Earle strawberry. Here, of Parker Earle, Bubach, Jessie, Warefield, Haverland, Michel's Early, Williams, Woolverton, Burt, Enhance, Gandy and Lovett, the first two named gave the best result. Sturdy old Crescent made a good showing with Michel's Early substitute for Wilson as a fertilizing companion in several neighboring patches, and appears to be an old reliable variety under adverse circumstances.

ARTHUR G. HEAVEN, *Oakville.*

---

### Himalayan Apricot.

In the CANADIAN HORTICULTURIST for 1892, page 106, is an account of the Urduick Apricot. This must be the same little apricot I found so common at the villages among the Himalayan Mountains in Cashmere, and up the Upper Ganges Valley, between Mussorie and Gangootrie. It is about an inch or so in diameter and of pleasant flavor and ripens early. I had ripe fruit in June. I remember when coming out of Cashmere, I found both mulberries and apricots ripe. This was about the 3rd week in June. As the winters are severe in these mountainous regions (it was at a 10,000 ft. elevation I saw them at one place), I think they would be suitable for Canada. I think the natives only propagate them by sowing the seed, and if you could get the stones of the fruit it would be worth while trying them here. Through the Canadian Government and the Indian Government, this might be done, and they would be readily sent through such application. The dealers from Afghanistan bring down lots of dried apricots, whether the same or some other species,

I don't know. But they are good. I suppose the stones of these dried ones would grow. They bring also green oval grapes, almonds, and such like things, also dried plums. I seldom saw a village in the hills without its apricot orchard, I suppose a sort of common property for the whole village.

The Indian Government has its summer quarters at Simla, about 8,000 ft. elevation. Here the apricots grow to some extent, but there are much more further in the interior. The summer there is not at all warm: I was nearly two months there, (July and August), and never saw a greater temperature than 65. But this was during the rainy season, and in May and early June it may have been warmer. They cannot grow apples there, I suppose on account of the great dampness and little sunshine, when apples most require it.

Perhaps you have some of these Bokharian apricots on trial. If there are any to spare I should be glad of one. The "Siberian Apricot" I have, has been winter killed more or less, and it is a sort of low thick bush now but it does not blossom. I suppose it is one of the common kind which is from a far warmer country than Canada.

W. E. BROOKS, *Forest, Ont.*

## Wintering the Hydrangea.

*Answer to Question 771.*

SIR,—Noticing this question asked by "Iroquois," relative to the wintering of the hydrangea, I may state that I have probably the largest and finest flowering Hydrangea in the Ottawa valley. Each year it is covered with a mass of large full blooms. It requires no winter protection even here where that season is always severe, the mercury often falling to 40° and 42° below zero. It is not protected from the wind which sweeps against it from the north with terrible force. The snow that falls round it through winter is all the protection it gets, but it comes out better each year.

## ↗ Our Book Table. ↖

VEGETABLES FOR THE HOME GARDEN, a Valuable Manual for the Million, published by W. Atlee Burpee. This book is a very handy book of reference for the amateur vegetable grower. It treats of the location and management of the garden, and gives Cultural directions for Culinary vegetables. Will be given to subscribers in place of a plant if desired.

### CATALOGUES.

Catalogue of Fruit and Ornamental Trees, Small Fruits, Roses, etc., 1896. Fred. E. Young, Nurseryman, Rochester, N.Y., U.S. Illustrated... Lovetts' Guide to Horticulture, Spring 1896, well illustrated. The Lovett Co., Little Silver, N.J., U.S.... Catalogue of Green's Nursery Co., Spring 1896. Chas. Green, Proprietor, Rochester, N.Y., U.S.... Price List and Descriptive Catalogue for 1896, of choice seed Potatoes, Grains, Bulbs, etc. Closson Bros., Highland Creek, Ont.... Trees, Plants and Vines, 1896. A. G. Hull & Son, Central Nurseries, St. Catharines, Ont.... Descriptive List of Chrysanthemums, Pansies, etc. E. W. Bowslaugh, Kingsville, Ont.... Catalogue of Fruit Trees, Vines, etc., for 1896. Lewis Roesch, Fredonia, N.Y.... Illustrated Catalogue of Flower and Vegetable Seeds, 1896. Ed. Mautner, Budapest, Hungary.

THE SPRAYING OF PLANTS, a succinct account of the history, principles and practice of the application of liquids and powders to plants for the purpose of destroying insects and fungi, by Prof. E. S. Lodeman, of Cornell University. Published by McMillan & Co., New York. Price \$1.00.

This is the fourth volume of the Garden Craft Series, published by this firm, under the general editorship of Prof L. H. Bailey; a series which promises to be of especial value to every enterprising horticulturist. This work contains the history of spraying in foreign countries, in America and in Canada; the materials and formulas used in spraying; spraying devices and machinery; action of insecticides and fungicides; specific directions for spraying. It may be ordered through this office.

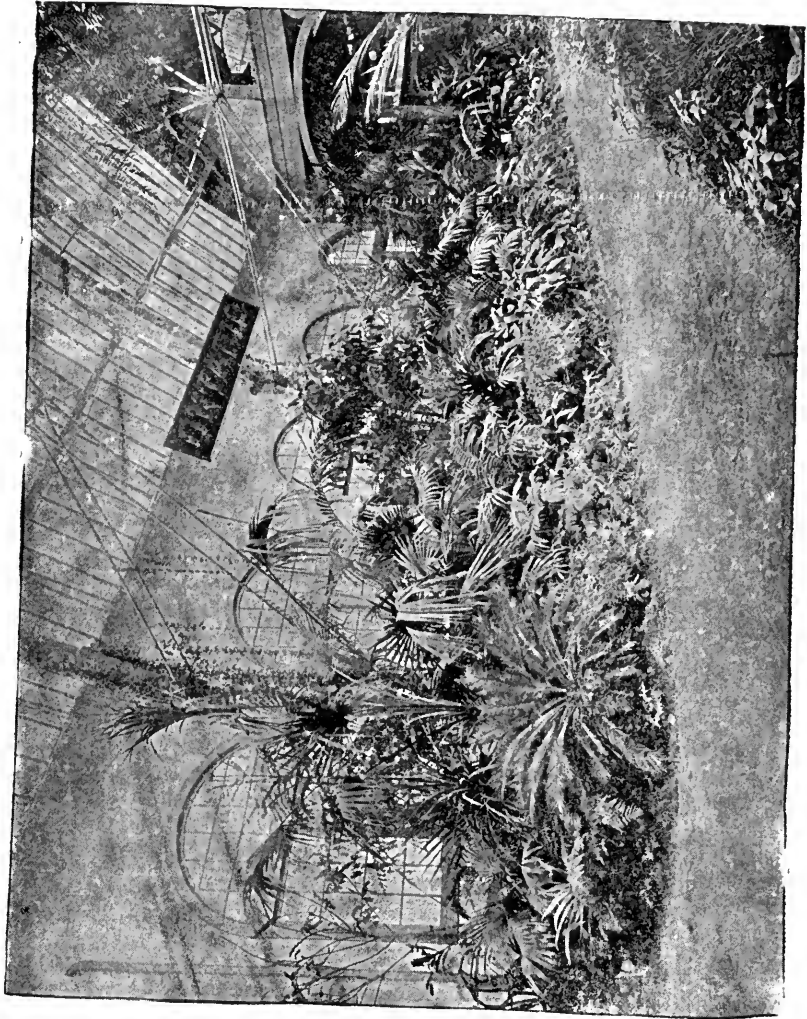
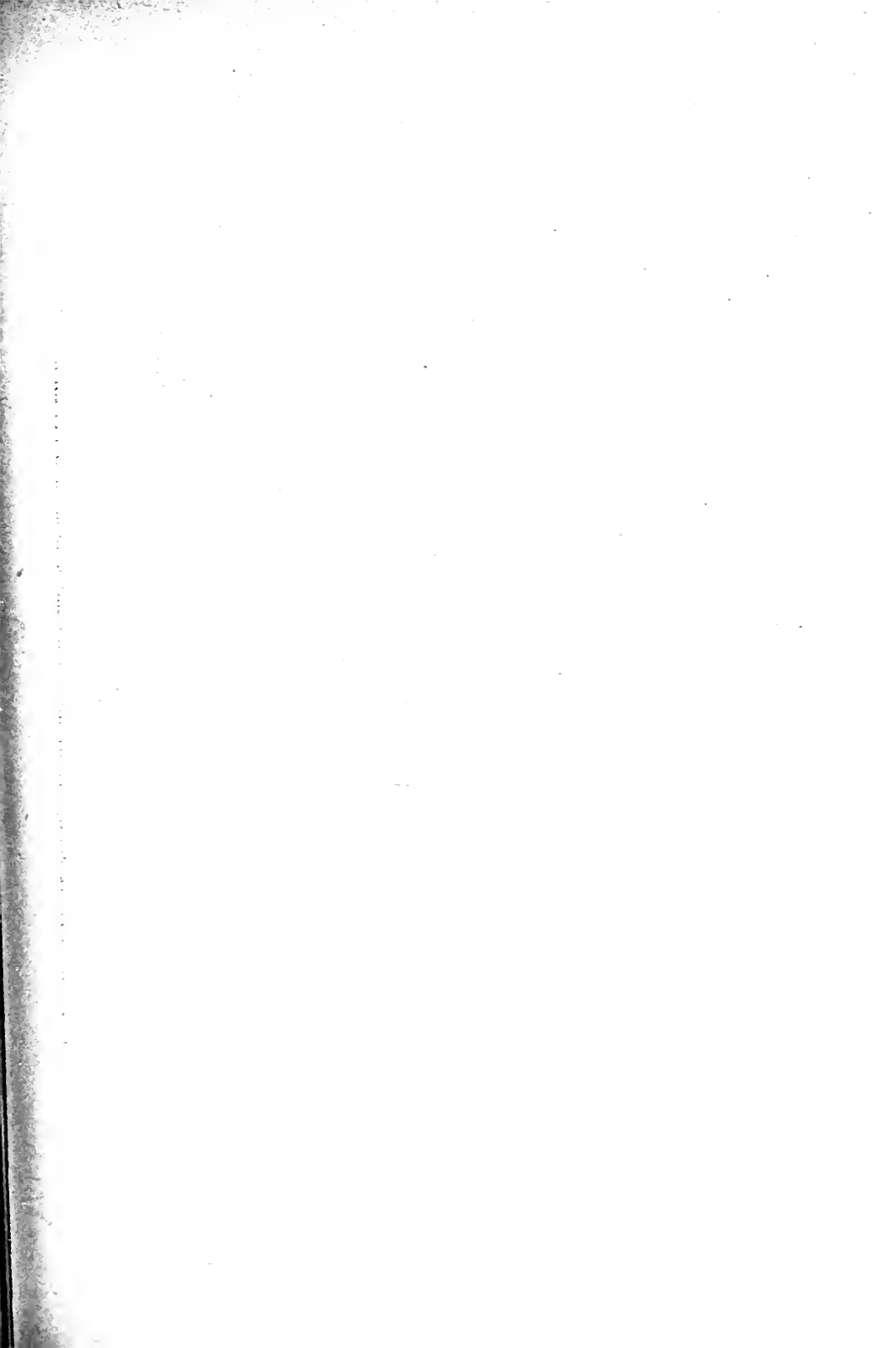
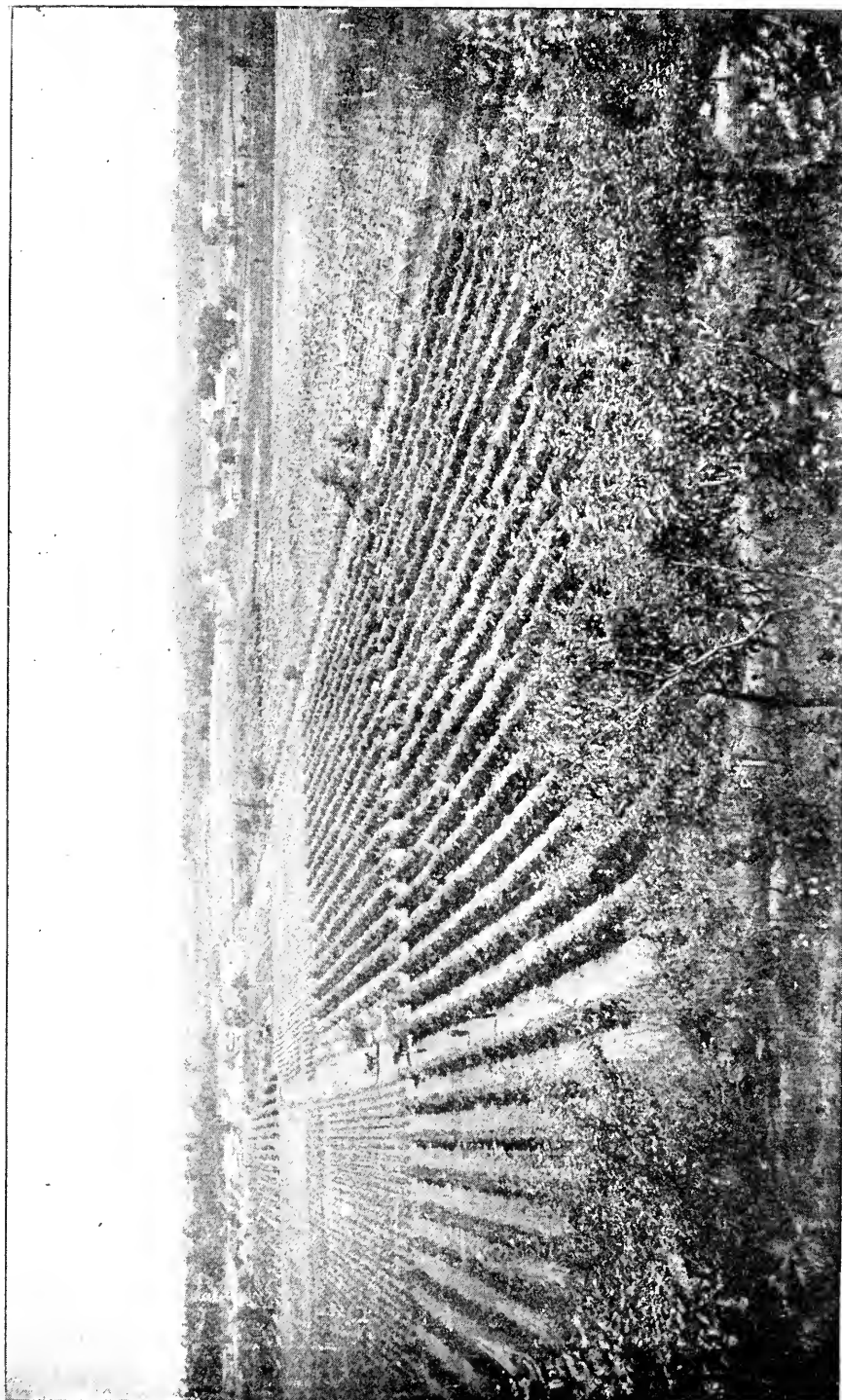

FIG. 925. — ONTARIO FRUIT EXHIBIT AT WORLD'S FAIR.





W. M. ORR'S FRUIT FARM, "FRUITLAND," BETWEEN GRIMSBY AND HAMILTON.



THE  
Canadian Horticulturist

VOL. XIX.

1896.

No. 4.

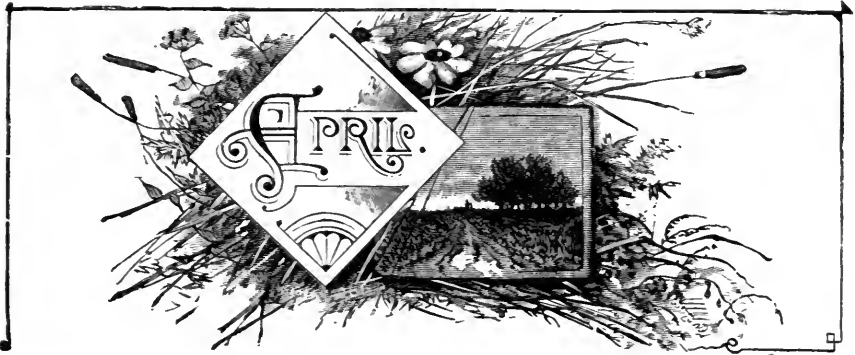

PROMINENT CANADIAN HORTICULTURISTS.—XXV.

W. M. ORR, Fruitland.



SEVENTY years ago, Mr. W. M. Orr was engaged in successful commercial life. His duties had been such as to lead him to visit many parts of Ontario, Quebec and the Eastern Provinces; and he had improved his opportunities to note the most favorable localities. Passing frequently through the Niagara Peninsula, he was so enamoured with its beauty of situation and its productive fruit farms, that he resolved to make a total change in his life work, and settle down on a farm in this famous fruit region, at a place now known as "Fruitland." The farm of ninety acres in extent, protected from frost by the mountain on the south side, and the ameliorating influence of the water on the north, is favorably located for the growth of tender plants.

When Mr. Orr began to plant fruit, his friends predicted failure. What could he do with a fruit farm, having no experience? But he did not fail. He gradually extended his plantations of fruit. A small vineyard, then ten years planted, was soon enlarged to cover fourteen acres of ground, and included the following varieties: Champion, Niagara, Vergennes, Concord, Rogers 3, 9, and 22, Worden and Delaware. These varieties have all been profitable, but if compared in this respect, they would stand about in the order named. This has been his experience, yet he would not advise others to plant Champions. The Niagara has been a favorite variety with him, and he has planted one-third of his whole vineyard to that variety. The Vergennes keeps so well that he

ranks it highly for profit. He keeps this variety in perfect condition until grapes come in again; packing the fruit in cork dust, and storing in a dry cool cellar.

The Rogers' grapes he holds for a late fall market, and ships them on orders, because they always give the consumer such excellent satisfaction. The average yield from his vineyard Mr. Orr places at about three tons, and this he considers quite enough for an annual yield of the vines. Grapes have been grown on this farm for thirty years, and have never failed to yield a crop from the effects of frost, or from any other cause.

Plums have also been a favorite fruit for profit with Mr. Orr. His orchard comprises about 1,400 trees, nearly half of which were planted twelve years ago.



FIG: 926.—W. M. ORR, ESQ.

The principal varieties are Lombard, Bradshaw, Quackenbos, Pond's Seedling, Washington, Reine Claude and St. Lawrence, and these he considers a good selection for profit. The largest yields have been from the Lombard, but as a rule he has had regular crops from all, partly as a result of regular and per-

sistent spraying with Paris green and Bordeaux mixture. The fruit from one tree of Reine Claude yielded him a gross amount of \$10.80 during the past season.

While highly prizing the apple, and believing that it is destined to become a still more important source of revenue to Ontario fruit growers than it has in the past, he does not consider them as profitable in his section as other fruits, and therefore has taken out the greater part of his orchard of apple trees.

Of pears the principal varieties planted are Bartlett and Kieffer. Clapp's Favorite blights badly with him, and Flemish Beauty suffers considerably from scab. Of peaches he has about 800 trees, and of cherries about 200.

Mr. Orr has found black currants profitable, and has planted about 1,500 bushes, principally Black Naples. Ninety bushes planted in 1884, has for some years past yielded him a gross average income of from \$22.00 to \$26.00 per year; they usually sell for \$1.00 per basket, and he pays his pickers about 25c. per basket.

Our frontispiece is a fine photogravure of Mr. Orr's fruit farm, taken from "The Mountain" which borders the south end. From the old Laurentian rocks which underly this district, he has named it "The Laurentian Fruit Farm," and this naming of places is becoming popular with many fruit growers.

Mr. Orr is one of the directors of the Fruit Growers' Association of Ontario, and was Assistant Superintendent of the Ontario Fruit Exhibit at Chicago in 1893, where he obtained three diplomas and medals, two on grain, and one on fruit. He also received from the board of lady managers, a beautifully engrossed diploma, together with a congratulatory letter from the chairman of the committee, with regard to the excellence of his services rendered in connection with the Ontario Fruit Exhibit.

We have thus given prominence to another successful fruit grower, believing that the success which has attended his enterprising spirit, may encourage others whose hopes may have become somewhat blighted by the discouragements of the past few seasons.

**Pears and Apples in Montreal.**—The first receipts of Anjou pears were received this week, and are selling at from \$5 to \$7 per bushel box. Fresh supplies of tomatoes have been received, and are bringing \$4 to \$4.50 per carrier. First receipts of Havana potatoes arrived this week, and are selling at \$8 per bbl.

Farmers are still bringing in heavy supplies of potatoes from the surrounding districts, and are selling them in any quantity at 30c. per bag, while jobbers are asking 40c. per bag by the load, and 45c. in jobbing lots.

Apples .....	\$2.00 to \$2.75 per bbl.
“ Fancy .....	\$3.50 to \$4.00 per bbl.
“ Famuese .....	\$2.50 to \$4.00.
“ Dried .....	35-8c. to 4c. per lb.
“ Evaporated.....	6c. to 7c. per lb.

—Montreal Trade Bulletin, Feb. 96.

## THE BEN DAVIS APPLE.



SEND you by this mail a sample of Ben Davis Apple as grown in Simcoe. The apple is a small specimen but you will be able to pronounce upon its flavor. Now, that this variety has got into condition, which it is always late in doing, hence its superb keeping quality, it is in my opinion a very good apple, quite as good as the Baldwin. Some persons here who were prejudiced against this variety and who have lately tasted it for the first time in condition, could hardly credit the evidence of their senses, and declared it to be as good as the Spy.

During the fall and early winter this apple is certainly not eatable, and for that matter neither is the Spy and some others of our best keepers, and this the English, American, and even the Canadian consumer knows, as its price through a period of years testifies. This preference cannot all be attributed to color, as the Baldwin is a beautifully colored apple.

A great many of the people here who have the notion that the Ben Davis is a very poor apple don't grow it themselves and their opinion of it has been formed from hearsay.

We must not forget that the public got its first impressions of this apple from those grown in Kansas and the adjacent States; which, if they do grow very large apples, have never been noted for the superior quality of their apples.

Farmers here are waking up to the possibilities of apple growing and some two thousand or more will be set out in the spring within a radius of three miles.

We have three varieties which have been pretty thoroughly tested here and found to possess the requisite qualities for the commercial orchard, these are the Ben Davis, Pewaukee and Ontario. What are considered the essential qualities of a variety for this purpose are given below in the order of their importance: 1, Productiveness; 2, early bearing; 3, hardiness; 4, good solid trunk with good foliage; 5, shipping qualities; 6, shape and color; 7, quality.

*Nantyre.*

S. SPILLETT.

---

NOTE BY THE EDITOR.—We cannot agree with our correspondent in placing quality last in order of importance for a market apple. On the other hand we would place it at the very beginning of the list of essential qualities. That the specimen of Ben Davis sent us on the 20th of February by Mr. Spillett, is equal in quality to the Baldwin is not saying a great deal; for the Baldwin is not an apple of high quality. Both these apples at the present time stand among the most profitable of apples, just as Mr. Spillett says, on account of the color and productiveness; but in the near future when apples are ten times as plentiful in our market, quality will surely command the top prices. If then a first class apple, with quality equal to King or Spy, can be originated, which is also healthy, hardy and productive, that will be the apple to recommend to planters.

## SEEDLING APPLES EXAMINED DURING 1895



DURING the past season a large number of seedling apples and other fruits of greater or less merit have been received at this office. It is always gratifying to feel that growers take an interest in this work and realize the efforts which this Department is making towards the improvement of our present list of commercial fruits to such an extent as to forward these new and untried varieties for examination.

Many of the samples received, however, have not been of sufficient value to warrant a detailed description. They have in each case been acknowledged, and a brief record entered upon the books of this Division. Among the most prominent apples received the following varieties are noted:—

From A. McD. Allan, Goderich, Ont.

*Breckenridge*.—Description: In a general way this apple resembles Northern Spy; but perhaps less regular in form; size medium to large; form, approaching oblong, ribbing very obscure, sometimes wanting; skin, yellowish green, thick and tough, partly covered with stripes and splashes of red. Stem slender. Cavity deep and broad, calyx open; basin shallow, almost wanting. Flesh white, flaky, juicy, sub-acid with a distinct Northern Spy flavor; promising and worthy of further trial. Mr. Allan says: "Grown by John Breckenridge here (Goderich); it is a greater bearer, long keeper and, towards spring, is of excellent quality."

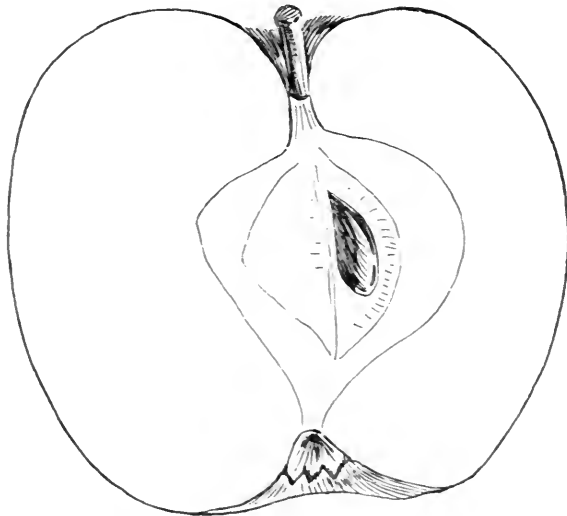

FIG. 927.—SECTION OF BRECKENRIDGE APPLE.

*Jordan*.—Russet type ; medium size, by measurement eight and three quarters in circumference by two and a half inches in length ; form regular, roundish oval. Skin, greenish yellow, thinly covered with light russet, which is laid on in light patches varying in density and sparsely sprinkled with gray dots. Stem three quarters of an inch long, moderately stout. Cavity varies from broad and shallow to deep narrow and lipped. Calyx prominent and closed, occasionally open, however, with broad segments. Basin shallow, smooth. Flesh a greenish yellow, fine grained, breaking, moderately juicy, mild sub-acid, rich, pleasant and of good quality. Season, late winter. This variety is also worthy of attention. Mr. Allan says that this is grown by F. Jordan, of Goderich, that it is of fine quality when ripe ; and that it will easily keep till June.

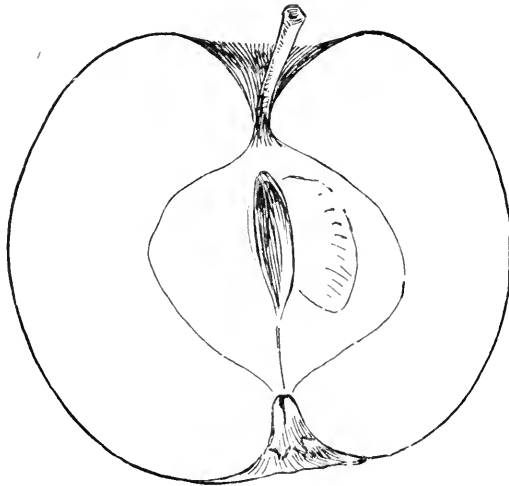

FIG. 928.—SECTION OF JORDAN APPLE.

From FRANKLIN CRANDELL, Lindsay, Ont.

*Empress*.—Seedling apple. Mr. Crandell says, that the tree appeared on the spot where a Baldwin was once growing "it is now 15 years old, has been in bearing 10 years, bears every year. In 1894 the crop was three barrels ; in 1895 it was seven barrels. It is a free grower and extremely hardy." Description : Fruit above medium size, varying from ten to eleven inches in circumference. Form oblate, flattened at both ends. Skin greenish yellow, with a solid carmine blush where exposed, splashed with deeper shade, and thickly sprinkled with minute, dark brown specks, margined with green. Stalk very short and stout. Cavity broad, of moderate depth, slightly russetted around the base of the stalk, outline irregular with a slight lip. Calyx open, segments broad and short. Basin broad and deep, not wrinkled but somewhat irregular and precipitate. Flesh nearly white, almost fine grain, mild sub-acid, juicy, pleasant flavor, quality very good. Core small.

From JOHN MILLER, Markham, Ont.

*Seedling Apple*.—Mr. Miller says the tree is 40 years old and was growing on the farm when he came into possession of it 28 years ago. It is healthy and a regular bearer. Description: Medium size; form roundish oblate. Skin smooth, yellow, red on one side, and splashed all over with bright red. Stem very short moderately thick. Cavity deep, narrow, smooth, lightly russeted. Calyx closed, segments broad and short. Basin shallow and uneven. Flesh greenish white, fine grained, juicy, mild sub-acid, pleasant in flavor and good in quality. Core of medium size, seed very plump. Season, December to January. An attractive apple, no better in quality perhaps than others of the same season now in cultivation, but yet one which may prove valuable in some sections on account of the reported hardiness and productiveness of the tree.

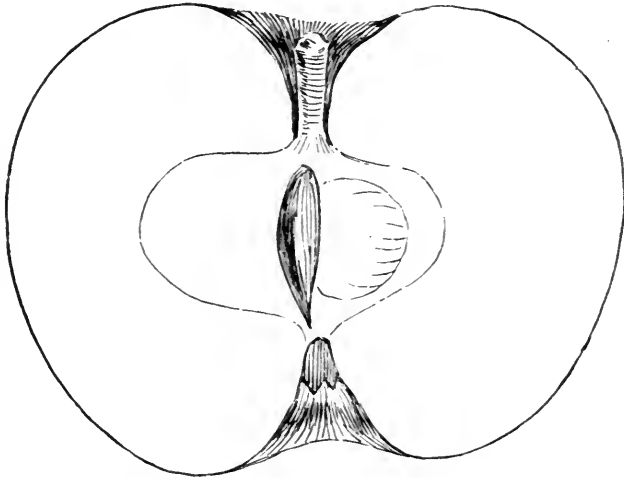

FIG. 929.—SECTION OF EMPRESS APPLE.

From HAROLD JONES, Maitland, Ont.

*Crimson Beauty*.—This apple was exhibited by Mr. Jones at the meeting of the Ontario Fruit Growers' Association at Woodstock last December, who reported it as having been cultivated in the vicinity of Brockville for a number of years past where it is highly prized. Description: Medium size, oblate, regular. Skin smooth, shiny, covered with bright red to dark crimson, interspersed with large dots. Cavity, broad, open, slightly russeted. Stem three-quarters of an inch long, moderately stout; basin slightly irregular. Eye open. Flesh, white, firm, juicy, mildly sub-acid. Fameuse-like flavor, with a slight suggestion of astringency. Season, December to January. A handsome apple of good quality.

I trust that owners of promising seedling apples will be good enough to send samples by mail to this office so that they may be described, figured and recorded by the committee appointed for that purpose by the Association.

*Experimental Farm, Ottawa.*

JOHN CRAIG.

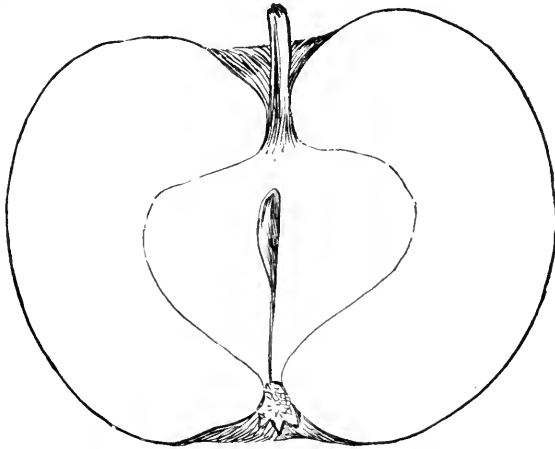

FIG. 930.—SECTION OF CRIMSON BEAUTY APPLE.

**Land for the Blackberry.**—The best blackberry land is a deep, mellow, clay loam; that is, a soil of which the body is clay,—and which, originally, might have been very hard,—but which contains considerable humus and crumbles rather than bakes in the furrow. Loose, gravelly lands are too deficient in water for the blackberry. It is very important to plow all hard lands deep and to fit them with much care before setting the plants, for, if the plants are to escape the effects of droughts, the roots must go deep and there must be a liberal reservoir for water upon the foundation or hard-pan. Flat lands with high subsoil should always be tile-drained before blackberries are set upon them, else the bushes will generally suffer in winter, and the fruit is also more liable to injury from mid-summer droughts. It is generally best to set blackberries in the spring, and strong yearling plants are commonly used. One may use the suckers which spring up about blackberry bushes for setting, or he may grow them from root cuttings.—Cornell B. 99.

**The Mersereau Blackberry.**—A variety resembling the Snider, and derived from it, but not yet generally disseminated. Its advantages over Snider are its larger size, less tendency to turn red after being picked, better quality, and a stronger habit of perfecting some of its fruits as late as the first of September. Its ordinary season is that of the Snider. This variety originated with J. M. Mersereau, Cayuga, New York, for whom I am glad to name it.



## CAUSES OF FAILURE IN APPLE CULTURE.—II.

AN ADDRESS BY THE SECRETARY.

## 4. Bad Pruning,



IN his mistaken zeal for promoting the vigor of his apple orchard, many a farmer does it irreparable injury. The great stumps of large limbs, eating their way with rottenness into the interior, bear witness to the truth of my statement. I wholly condemn the common method of butchering apple trees.

On Maplehurst Fruit Farm, my oldest orchard, though over seventy-five years of age, would be in prime condition for another twenty-five years only for this practice.

Indeed those trees which, on account of inferiority of kind, were most neglected by the pruner, are now the healthiest and finest in the orchard; while the others are rotten at heart, or hollow, from the great wounds made in pruning.

Many people always insist on removing the leading centre branch, to let in the sun as they say. We wholly object to this system, and would commend somewhat of the pyramidal form, as the ideal for the pruner. This is produced by encouraging the growth of a strong, leading shoot, about which all others are allowed to grow as symmetrically as possible. The annual pruning will then consist simply in thinning out all superfluous small branches which tend to cross each other.

Probably there is no subject upon which more confused notions exist than with regard to the time and manner of pruning trees and vines. Some who pretend to know give such definite advice as, "Prune when your knife is sharp," and others advocate no pruning at all. Some say prune in the winter, some in summer, and others in the fall. In the multiplicity and contrariety of the advice, who wonders that we see so many slovenly kept trees throughout our country?

First, with regard to the TIME of pruning We have under this head a very old adage, which it is well to remember, viz.: "Prune in winter for wood, in summer for fruit," and probably no better general rule could be given. The philosophy of this is explained by the fact that anything which checks the wood growth of the tree, tends to the metamorphosis of leaf-buds into fruit-buds; and, on the contrary, that which favors wood growth, lessens that tendency. Thus while a tree is young and growing rapidly, it produces no fruit; but when it has attained a certain degree of maturity, and grows less vigorously, it begins to produce fruit. On the same principle it is that a tree that has been girdled will often be overloaded with blossoms, though not yet of the usual bearing age, or limbs which are artificially bent down will yield fruit before the other limbs of the same tree. Now, summer pruning checks the growth of the tree, and therefore tends to increase its fruitfulness. By it we remove the foliage just when it

is in active operation, taking in from the atmosphere carbon, and otherwise transforming the crude sap into a suitable liquid for building up the cellular tissues of the tree. To a limited extent this may be done in safety, but if done too freely the tree will be some time in recovering its strength.

On the other hand, early spring pruning, being done when the tree is dormant, does not affect the vigor of the tree so much, and consequently strong growth results in order to maintain the equilibrium between the roots and the branches.

In favor of the summer time, it is urged that wounds made then heal more readily than when made in winter. This is true, for the growth at that time begins to cover the wounds while they are yet fresh; but perfect healing will also follow the winter pruning, provided the wound is properly protected from the air by paint or varnish.

To a limited extent, then, summer pruning is advisable, especially where trees are growing thriftily, and need a check to induce fruitfulness; and the proper time for it is when the first growth is completed, and the terminal bud formed, for by that time the cambium is sufficiently matured to perform nature's cure of the wounded portions. Generally speaking, this period is from the middle of June until the middle of July.

Winter pruning is generally adopted because it is the season of the greatest leisure, and the naked limbs enable the operator to judge best which should be removed; but the term is misleading, for it must never be done when the wood is frozen, and hence either the fall, the early spring, or only the mild days of winter, are at all suitable.

Another caution must here be given, and that is, never to prune in spring after the buds begin to swell and the first growth is pushing, for the sap, being active and not yet sufficiently matured for healing the cut, will leak, and this so-called "bleeding" will continue perhaps for a long time.

So much concerning the time of pruning; now concerning the MANNER. We wholly condemn the common custom of neglecting to prune until the limbs are very large, or cutting them out in such a way as to leave a stump sticking out from the trunk. We copy from the *American Garden* an illustration, Fig. 931, showing the evil effects of such faulty pruning, where the dead stubs are gradually introducing decay into the heart of the tree, soon to cause a hollow trunk, and early death; and Fig. 932, where at *d* a limb has been lopped off closely, and so healed that the scar is scarcely observable; while at *e* some have been removed in such a way as to leave open basins almost beyond the power of nature to heal. Large limbs should never be removed, if possible to avoid it, but, if necessary, they should immediately be covered with some pre-



FIG. 931.

paration which will exclude the air. For this purpose various preparations have been recommended, as a coating of thick paint, or of coal tar of such a consistency that it may be applied with a brush. Mr. Downing recommends the following composition, viz. : Take a quart of alcohol and dissolve in it as much green shellac as will make a liquid of the consistency of paint. Apply with brush. Keep it in a well corked bottle, sufficiently wide-mouthed to admit the brush, and it will always be ready for use.

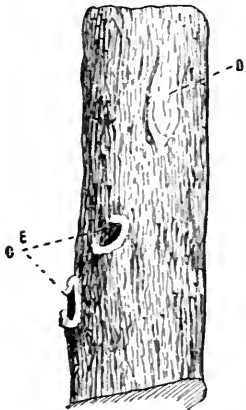

FIG. 932.

Neither do we believe in removing the large limbs in the centre of the tree to let in the sunlight. The right and the wrong ideal of the form the pruner should have in mind when at his work are well shown in Figs. 933 and 934, in the first of which the limbs have been removed according to the reckless butchery so often performed upon our helpless apple orchards, and which is one cause of the decrepit, half-dead appearance such orchards usually present.

The second represents a tree which has been allowed to grow according to its natural inclination, and the pruning has been simply an annual thinning of such small branches as threaten to cross others, or thicken the head too closely, and in this way the removal of large limbs is altogether avoided. Such a tree will live in health and vigor to almost twice the age of the former. The pruner should study the natural growth of the tree and prune to favor that ; thus the Spy and the Rambo are upright growers, and with them one leading branch should be encouraged in the centre, and side branches at suitable intervals. The Greening and the Roxbury Russet have spreading heads, and hence should have several main branches so trained as not to interfere with each other.



FIG. 933.



FIG. 934.

But of all barbarisms, that of cutting out the leading branches in the centre of a tree, should be avoided, for numerous sprouts will spring up, decay will ensue from the large wound, and, worse than all, the tree will in time be apt to split apart when heavily laden with fruit.

## LOSSES IN THE EXPORT APPLE TRADE.



HE cost of production of any article of commerce generally governs the price which the consumer pays for that article. There is one notable exception to this rule. The price paid for the production of the finest winter apples in this country, has no apparent relation to the price paid by the consumers of the fruit in Great Britain.

Canada is noted for producing the best winter apples placed on the British market. The prices obtained for such fruit on the wharves or docks in Great Britain has varied but little for several years past from an average of \$5 per bbl., and there is good cause for believing that the demand, even at this price, will continue for a long time to come, and for an unlimited quantity. Now, if we allow \$1.50 per bbl. for freight and incidental expenses, we have \$3.50 left as the amount received by the middleman for his apples. From this we should deduct about \$1.25 per barrel as the first cost of the apples; the remainder, about \$2.25 is the net profit on each \$1.25 paid the apple grower.

It will be observed that I have mentioned three parties to this transaction; the producer, the middleman, and the consumer. (The word "consumer" in this case applies only to the purchaser of the apples on the English docks.) And it will also be observed that the profit made by the middleman is (apparently) about \$2 25 per barrel. Now, if this profit was really assured, there would very soon be such competition in the business that apple growers would receive double the amount per barrel now paid for them. But these middlemen assure us that the business is of such an uncertain character that but little profit is made, taking one year with another. Yet the fact remains that the margin between the price paid to the grower and the price at which the fruit is sold after deducting all necessary expenses, is too wide for a reasonable profit, but, as we are assured, by independent and undoubted evidence, that the business, as now conducted, is one of unusual risk, and that not more than a fair profit is made by apple exporters, it becomes evident that a serious leak must somewhere occur. This leakage should be a subject for careful enquiry by experts or those having practical experience in the export business.

Many causes may contribute to this great loss of more than the present value to the producer of the crop every year, such as, improper handling of the fruit in the orchard while being gathered, barreling too soon or too late, packing too tightly or not sufficiently tight; not kept sufficiently cool after being gathered or in transit; rough handling during transshipment *en route*; being frozen or subjected to great changes in temperature; rough or improper handling when being re-packed before shipping, and many other preventable causes of which I may have no knowledge.

A short time ago, when looking over a sale sheet issued by Woodall & Co.,

of Liverpool, my attention was arrested by the great difference in the prices obtained for different parts of the same shipment of fruit, and for the same variety. These ranged from  $4/9$  to  $22/3$  per barrel. This great difference in price was because of the difference in the *condition* in which the fruit arrived at the market, not in the *inequality* of the fruit. The lot was all of the same quality but of several different varieties, and all must have been of excellent quality originally, or the portion that was in good condition would not have sold for  $23/3$  per barrel. I therefore determined to examine this and several other sheets critically. The following are the conclusions arrived at :—

First—That individual shipments to Great Britain, containing the same varieties, are equal in quality, and would sell at the same price if placed on the docks in the same condition.

Second—That the varying conditions of the fruit on its arrival at the docks was owing to some defect in packing, injury in transit or other means unknown to me.

Third—The *condition*—not the quality—of each variety was classified under several headings.

Fourth—That all quantities arriving in first class condition, without regard to variety, were tested under the first heading, those that were slightly injured under the second. Those more injured, under the third, and so on down to the worst.

Fifth—That those arriving in first-class condition amounted to only 23 per cent. of the whole.

Sixth—That the price obtained for the remaining grades combined—about 77 per cent. of the whole—averaged about  $4/6$  per barrel less than the first grade.

Now, if every shipment of apples sent from Canada arrived in Great Britain in like condition, it follows that the loss when spread over the shipments for the whole season, is equal to 77 cents on every barrel exported. This certainly accounts for a large portion of the original loss of \$2.25 per barrel before referred to. I fail to see any necessity for this loss, but I must leave the full solution of this problem to those having practical experience in that line.

It may be, and probably will be said, that this loss is unpreventable; to such a statement the answer is, that when the same rule is applied to the shipments of apples from Boston and New York, as reported in the same sheets, it is found that the loss is only about 24 per cent. Surely a Canadian should be able to prepare and pack a barrel of apples as well as a Yankee. But judging by these English sale sheets, he is a long way behind in his ability to handle apples profitably. Doubtless this is the reason why shippers pay the growers a much better price per barrel in New York State than here, notwithstanding that their apples are inferior to ours in quality; their barrels smaller, and that they obtain for the same varieties a lower price in the English markets

The loss sustained every season by Canada (mostly by Ontario), in this branch of industry, is very large. I have no means at hand wherewith I may compute the total, but some idea may be obtained by applying the average loss per barrel to the shipments from Montreal for one week ending November 7th, which amounted to 27,126 barrels. The preventable loss on this lot would be \$21,000, while the loss on the same quantity if shipped from Boston or New York, would hardly have exceeded \$6,500.

If this subject is thoroughly investigated by intelligent business persons who are practically acquainted with the apple buying and shipping business, I am convinced that this grievous loss to our people, can, to a great extent, be saved. Then, if the present English prices are maintained, the middlemen will secure for themselves a better because a more certain profit than at present, after paying to the growers from fifty to one hundred per cent. more than they have done of late years for our own winter apples.

*Lindsay.*

THOS. BEALL.

### PLANTING APPLE TREES CLOSE TOGETHER.

Some time since a writer in your paper advised planting apple trees 35 to 45 ft. apart, as this will prevent rot, permit the apples to color up better, etc. In part he was right, but in my opinion he was on the whole wrong. In order to make an orchard profitable, it is necessary to have more trees on a given amount of land than when placed 35 to 45 ft. apart. If we can do this and not injure the lands, trees or fruit, I think we have made a fair start toward profitable commercial orcharding.

While a tree is young we get the best crops. The fruit is larger, more perfect, and less liable to rot. In this locality a tree begins to fruit at the age of five or six years from planting. The next 10 or 12 years the orchard is in its prime, and if during this time we can get one-third more trees and have one-third more fruit to market we are just that much better off. The accompanying plan shows my method of setting an orchard which will increase the number of trees one-third and still give ample room for hauling and gathering until the orchard is 17 or 18 years old. If they then interlap, remove every other one and you will still have as many as by planting 45 apart in squares, and besides you will have had 12 years' use of the trees removed. I have given much observation to and had some experience in this matter, so if I were to plant 50 orchards I would follow the scheme above outlined. My advice to every young man is, plant in this manner, cultivate well for five or six years, branch the trees low, give them an annual topdressing and the orchard will pay, other things being equal.—American Agriculturist.

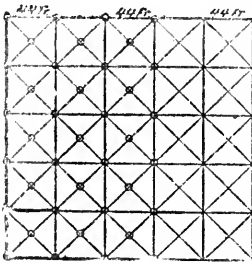

FIG. 935

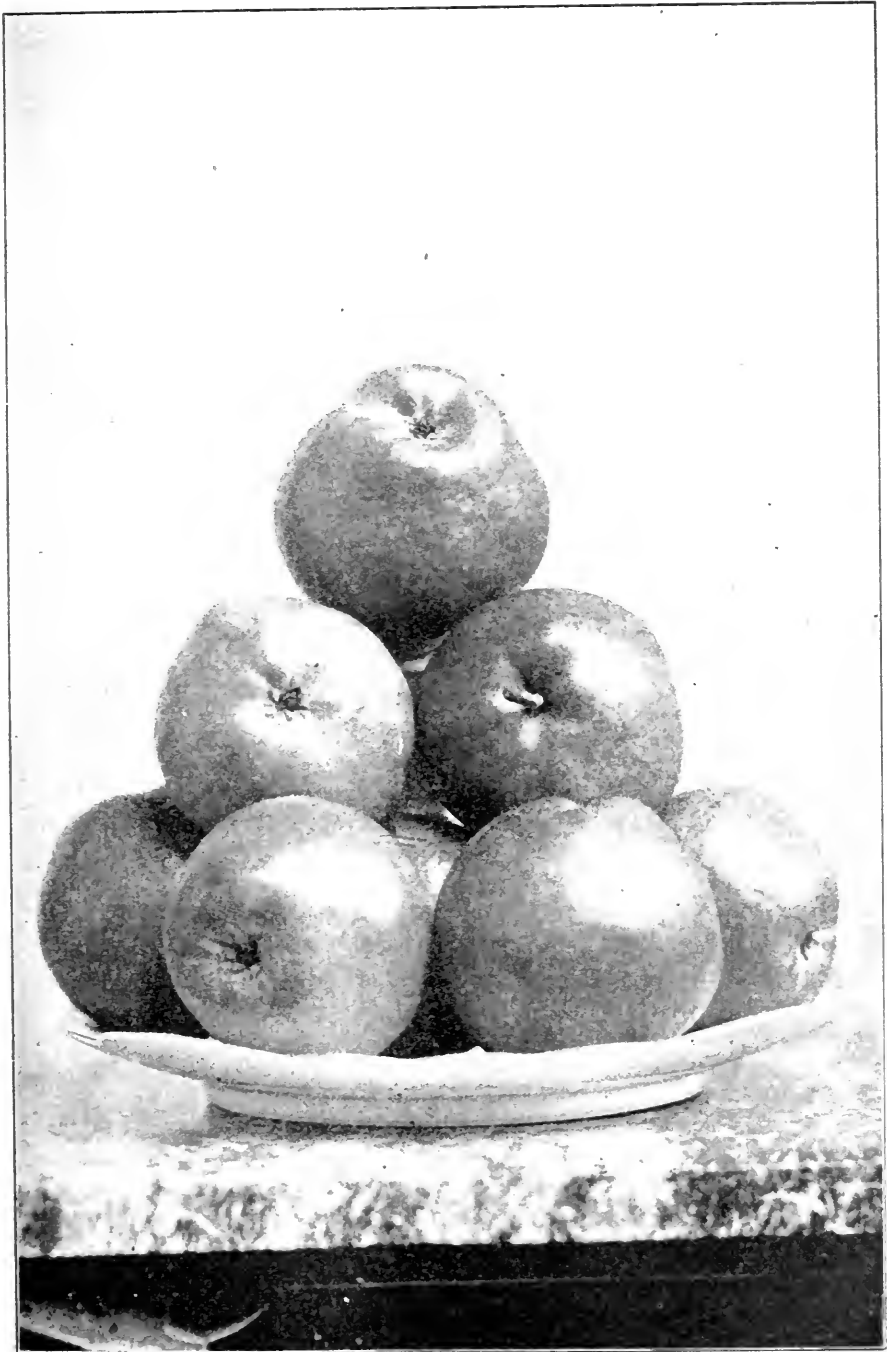

FIG. 936.—A PLATE OF SECKEL PEARS.

## ❖ Novelties ❖



NEW pear is being brought before the public by Messrs. Augustine & Co., of Normal, Ill., who kindly send us the accompanying photogravures of the fruit and of the tree. Fig. 936 shows a plate of the fruit, which the introducers state is only one-third natural size. It is claimed for the fruit that it is excellent in quality, seedless, uniform in shape and size, and not subject to insects.

Fig. 937 shows the original Sudduth pear tree which is now seventy-five years of age, about 75 feet high, and ten feet in circumference. This is to show the remarkable size and age which the tree attains. The apple trees alongside are Rawle's Janet, forty years old.

---

**Planting the Blackberry.**—The plants are usually set in a furrow six or seven inches deep, and if the land is thin, stable manure may be scattered in the furrow. For all the ordinary large-growing varieties, eight feet between rows is enough. This allows of easy cultivation. For myself I like them far enough apart to admit two horses in cultivating, as shown in the picture in our plantation, on the title-page. Two horses and a spring-tooth cultivator are the most efficient means which I have yet found of keeping a blackberry plantation in condition. In large plantations, it is well to leave out a row occasionally, to allow of a roadway. In the row, the plants are set from two to three feet apart. They will soon spread and fill the row. There are some growers who prefer to set the plants six or seven feet apart in the row in order to cultivate both ways, but this is profitable only where it is possible to give extra attention to tillage and pruning for the purpose of producing fine dessert fruit.

The year the plants are set, potatoes or other crops may be grown between the rows, and the yield should be sufficient to pay for the use of the land. Some growers plant strawberries, not only between the rows but sometimes in the row between the plants; and it is possible, by good cultivation, to obtain two good crops of strawberries before the blackberries smother them.

Three or four canes may be allowed to grow the first year if the plants put out vigorously, and these will bear some fruit the following year. As soon as the canes have reached a height of two or three feet they should be headed back.—Cornell B. 99.

---

**The** looser the ground is kept for the first, and indeed for several succeeding years, the more certain and more vigorous will be the growth of the orchard—in the luxuriance and color of the foliage of contiguous plantations, I have found every stage of cultivation strongly marked; these orchards which have been two years under cultivation, exhibit a striking superiority over those which have been but one year under the plow; while these, in turn, surpass the fields in clover or in grain, both in the quantity and size of the fruit.—WILLIAM COXE. *A View of the Cultivation of Fruit Trees*, 1817.





FIG. 937.—THE ORIGINAL SUDDUTH PEAR TREE.

## ‡ The Garden and Lawn. †

### THE DEGENERATION OF THE GLADIOLUS.



REFERRING to a recent article on the gladiolus, in which the late Mr. Such is quoted as saying. "Overrich soil and too much moisture, have much to do with the degeneration of this fine flower," one is led to conclude that the gladiolus had been generally subjected to excessive quantities of fertilizer and moisture.

It is common experience that in field culture, where contact with the manure cannot be easily avoided, as in small spaded plots, that the gladiolus does better following a previous crop, for which the ground had been fertilized with stable manure. Now, while no plant is benefited by the application of more food than it can consume, if this food is in the proper condition, it will not use more, nor be injured by it. Excessive moisture should be provided against by drainage.

Now, Mr. Such, speaking in 1880, referred to the Gandavensis section, and that high culture is given as the cause of its degeneration. In 1895 this degeneration is even more pronounced, but we will surely not give high culture as the cause; if so, why is this injurious effect not apparent in all branches of horticulture, as all lines are worked for maximum results.

The gladiolus of to-day is quite different from the gladiolus of 1880, except the section referred to, which has been inbred for years, resulting in so serious an impairment of its vitality, that many varieties will not produce characteristic flowers for two successive seasons. This excessive incrossing is the cause of its degeneration, which is amply proven by contrast with varieties having the least infusion of new blood from species.

During the past season my greatest failure was in Gandavensis, growing on sandy loam manured for the previous season's crop (new hybrids here grew over six feet high). My greatest success in the same section was in a block where the water stood in the drills at planting time, and the soil was never dry.

Well fertilized moist soil, with plenty of atmospheric moisture will produce results obtainable under no other conditions.

*Simcoe, Ont.*

H. H. GROFF.

**The Bessarabian Cherry** is a Russian variety that was fruited at the Iowa exp. sta. the past summer. The fruit is as large as the Early Richmond, roundish, irregular and somewhat flattened. The stem is long and slender. Skin a fine, very dark red. Flesh a rich red, somewhat firm, moderately juicy, sub-acid, juice colored. The quality is good, excellent for culinary purposes and the table. The tree is a strong grower, somewhat spreading, with dense foliage, and fruiting the last week in June. The variety is a true ironclad for north Iowa. The trees the past season were a picture of health and vigor. The summer's sun and the winter's storm do not seem to affect it. —Farm and Home.

## CULTIVATION OF THE GARDEN.



VERY man or woman who has in his possession a piece of land, should plant a garden. The work is healthful, very interesting and usually very profitable. One reason why gardens are not more profitable is that the great majority of people do not know when to plant, and this is information that is difficult to give, from the fact that our country is large—very large—bigger than the United States—(that is what we like to tell our neighbors), and what suits one section of the country does not suit another. For example, the people in the Hamilton valley can safely plant seed from two to three weeks before we can; and again, we can usually plant with safety before people but a few miles north of us. No date can be fixed, and no rule can be laid down, and it is only by experience that we can intelligently go to work—and this seems to be what is seldom done. It is true that the seed catalogues give much valuable information, but as they are intended for general circulation over the whole of this big country, the value of their information is greatly lessened. I have thought that our local papers could help forward this information; they could save their subscribers much loss and disappointment; but even here it will not always do. For example, our own Sentinel Review circulation is much too wide to be a safe guide in this respect. I think we are not making much progress in this matter; there seems to be as many tender seeds sown too soon, and hardy seeds sown too late, as there was twenty-five years ago. I am asked as often in the middle of May if “it is time to sow onion seed,” and told that my “balsam seed was no good,” and the “pansy and verbena plants set out on the first of June, did not do well,” showing that in this respect we are not making progress. And it seems to me that we as a Society should endeavor to help our fellows by each one helping his neighbor, telling him when to sow seed or plant.

As soon as the young plants appear cultivation must commence at once. Some cultivators sow with their flower seeds a few radish seed, which quickly come up and show the rows, and cultivation can be commenced before seeds for the crop have come up. A few days ago I saw in a horticultural journal that claims to be fifty years old, this plan spoken of as an original idea; when such standard authors as Henderson, Quin, and Carpenter, recommended the plan twenty-five years ago. I wish I could impress on every person the importance of early cultivation; it is much easier and far more profitable to hoe the ground over three times than once. I am always sorry when I see a man, or worse, a boy, or worse yet, a woman, struggling with a hoe to destroy weeds that are from three to six inches high, and at the same time trying to bolster up a weak, sickly vegetable or flower plant that has been ruined by the shade of the weeds. If the ground is raked over or hoed over when the weeds first show their seed leaf, the rest of the work is comparatively easy—try it.

But I think the greatest drawback to successful gardening (and it was to draw attention to this that this paper was written) is, that the continued growing of vegetable and flower plants in the same ground, and the incessant hoeing and cultivating has a tendency to make the soil dead and compact; and not in the best condition for the development of plant-life. I was very much struck with this a few years ago. I came into possession of a piece of old pasture-land which was supposed to be very poor; it was given a heavy coat of manure and planted to early vegetables, but to be certain of results I planted on the same day a few of all the seeds on a piece of land that had been heavily manured every year for fifteen years; there was a marked difference in the crops, that on the pasture land was two weeks earlier, and by far the finer vegetables. Wood ashes are a great help to such land; and here I might be permitted to remark that it is a disgrace to the cultivators of the soil of this section of country, that wood-ashes are exported out of this town at from 3 to 4½ cents a bushel, and sent to the United States, where our American friends (who are generally supposed to know what they are about), pay from 25 to 35 cents a bushel for them. Last spring I was up through my native township of West Zorra, and saw an ashman get one and a-half bushels of fine wood ashes (an ashman's bushel usually contains five pecks), and in return give a paltry piece of inferior soap that even a gardener would scarcely like to use to clean his hands. Some agricultural papers, recommend an export duty on ashes. I am strongly of opinion that where cultivators of the soil will not use wood ashes at 3 or 4 cents a bushel, the only kind of legislation they require is an act to compel them to go in when it rains. I might also remark that a good coat of wood ashes is almost a preventive of potato scab. But, though ashes are a help, they are only a help. Cats eat mice, in some countries men eat men, and there is nothing that vegetation seems to delight to feed on so much as on the decaying roots of their fellows; and so to obtain the best results we must occasionally fill the soil with the roots of some plants for this purpose. Clover is the best, the roast beef as it were of vegetable life, but clover roots are expensive. It takes two years to get the soil well filled with them; and where land is worth two or three hundred dollars an acre it does not pay to grow clover. It has devolved upon the Pres. of the Ontario Bee-keepers' Assocn., Mr. O. B. Hall, of our town, a close observer and careful cultivator, to let us out of the difficulty, and it is simply a question of rye—not "old rye," but the rye plant. As soon as the crop is gathered, be it vegetables or flowers, the ground is sown to rye—the rye makes a vigorous growth, and by spring the soil is a mass of roots; it can be dug or ploughed under, and you have a seed-bed, in the best possible condition, for almost any kind of seeds or plants.

ANGUS ROSE.

*Woodstock, Ont.*

## GERANIUMS.

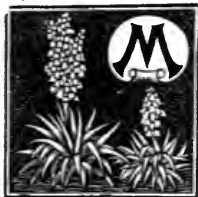

R. A. McNEILL'S lecture before the Grimsby Horticultural Society on the evening of March 9th, was very interesting. A large number of the members were present and were ready with their questions in order to elicit as much information as possible. Mr. McNeill in the course of his lecture gave the names of such plants as he believed the amateur might grow in the house

with the greatest success, as, for instance, geraniums, which will endure a great deal of hard usage and yet give a large amount of bloom. They are easy of propagation either from seed or cuttings. In making cuttings he advises taking points and breaking them off where the wood is sufficiently mature, that is, where it will bend a little and then snap off with a square break. These cuttings should be placed in moist earth at a temperature of about 60 degrees. An easy way to start cuttings is to take a glass filled with lake sand saturated with water and insert the cuttings as thick as they will stand. Place them in the shade and in a few weeks you will have well rooted cuttings. When the roots are about three-quarters of an inch long, you may plant the cuttings in good soil. The best soil is made by mixing one-third sand, one-third garden soil and one-third of the bulk of barn manure. Soil is very important to the best success. The cuttings should be first planted in small thumb pots, if you want the best success. Fill the pot about half full of soil, place the plant on this and add soil until nearly full, firming it well. In such little pots drainage is unnecessary for geraniums. It is a good plan to bed the pots of plants in boxes of sand, as in such a condition they are not so apt to dry out. The plants should be transplanted to larger pots when the roots have well filled the smaller ones. If the first pots are say two and half inches in diameter, the next size should be three and a half inches. It is never well to use too large a pot. The season of blooming can be regulated by the time of propagation. If plants are required for winter blooming, propagate them early in July and do not give them very much water until late in the fall, and then in October give them additional heat and moisture and they will start into a vigorous growth and be in a condition for winter blooming.

Mr. McNeill gave these details with regard to cuttings, because he had been asked to make his lecture as elementary as possible, and the methods which are suitable for propagating geraniums are also applicable to other plants. In his list of plants with which the amateur might expect success, he named the following, in addition to the geranium viz:—fuchsias, begonias, palms, calla lilies, coleuses, and dahlias.

## DAHLIAS.

In his address, Mr. McNeill referred to the propagation of the dahlia. He said that usually amateurs plant too many buds and it was a mistake to

plant them in the open ground without first starting them in the house. He would advise cutting the tubers apart as soon as the buds have started and allow only one bud to grow with a bit of tuber attached. He found clay soil well suited for dahlias, especially when charcoal is added. The charcoal is useful where early bloom is wanted. We mention this just now in order to give a hint to our amateur flower growers that the time has come for starting dahlias in boxes indoors, in order to have them ready for planting out toward the end of May.

---

### HOW TO GROW GLADIOLI.

Over-rich soil and too much moisture have much to do with the degeneration of this fine flower. For fifteen years or more I have been a wholesale grower of the gladiolus, and at the present time—September, 1880—I have many hundreds of thousands of these bulbs nearly ready to be dug up, and for a certainty, hardly one in a thousand will show the slightest trace of disease.

My soil is extremely sandy, so much so that it has the appearance of being really nothing but sand. For the gladiolus I use no strong manure whatever, in fact, if a pretty well manured crop of corn, or some other rank grower has occupied the land during the previous season, I have the ground merely plowed up in the spring, and have the bulbs planted without additional preparation. Planting begins about April 1, and is usually ended by May 1. From early in June till the end of August we have a tropical heat, the thermometer ranging from 70° to 85° and 90°. This, however, does not disagree with the gladiolus, unless the weather happens to be very dry as well as hot, in that case the plant suffers, especially if the flower stalk is showing, at which time a soaking rain is of great benefit. Towards the end of September, or indeed sooner with some varieties, the leaves begin to change from a lively green color to a yellowish brown, showing that the season's growth is at an end. Then digging up begins, each digger being followed by a boy who cuts off the stalks as soon as the plants are taken from the ground. The bulbs are dried, not in the sun, but on airy shelves, and the roots are cleaned off during rainy days, or any time during the winter, whenever that is convenient.

I am by no means in favor of keeping the stalks attached to the bulbs after they have been dug up.

Gladiolus bulbs, to come out in good order in the spring, should be kept cool and dry during winter. If the bulbs are in a damp place, or heaped together before they are fully dried, the roots will start in a short time, and a top growth will be likely to show itself as well. But no matter how cool and dry they may be kept, some varieties are almost sure to throw out a shoot in early spring, of which fact I may mention that the kind named Shakespeare is a notable example.—Gardening.

## THE DAHLIA.



HIS flower is not grown as successfully as it might be, because its wants are not properly understood. The tubers should be started into growth in March or April, in the house. Much of the success to be aimed at in the cultivation of this plant depends on an early start. Keep the started tubers in boxes till the weather becomes warm, for a slight frost will kill the tender growth, and a cold spell will so check the development of the plant that it will take it a long time to recover. Therefore, do not be in a hurry to put your plants in the open ground. Have the soil very rich. It can hardly be too rich, for the dahlia is a great eater. As soon as the stalks begin to reach up set three stout stakes in a triangle about the plant, about a foot apart each way, and be sure to tie the main branches to them, for they are very brittle and easily broken by the wind. On washing days pour the wash-water about them, and see that they never lack for moisture. If you start them early in the season, provide rich earth for them, and keep them moist at the roots, you will have splendid flowers from them. As a general thing, they are started into growth in the open ground, are not given a rich soil, and are never watered. Under these conditions they never give satisfaction. But, when properly cared for, they are simply magnificent. They come in all colors of the richest shades, and the variety seems almost endless. Of late years the single sorts have come into favor, and they are deserving all the popularity they enjoy. They are really more graceful than the double kinds, as their blossoms are borne on long and slender stems, well above the foliage, and have the appearance, at a little distance, of a flock of butterflies hovering over the plant.—Christian Union.

---

**China Asters.**—Respecting the cultivation of China asters, little need be said. If early flowers are wanted or if the plants are to be grown in pots as specimens for exhibition, the seeds should be sown indoors or in a frame as early as the middle of April, in this latitude. But if the plants are to be grown in borders, it is quite as well to sow the seed in the ground where the plants are to grow. The China aster is essentially an autumn flower, and I have no desire, from the amateur's standpoint, to force it ahead of its season and to make it compete with the flowers of midsummer. We sowed the seeds of about fifty varieties on the 4th of June last year. The soil was rich and kindly—a good loam—and the plants came on with vigor, and, notwithstanding a prolonged drought, every variety gave a profuse bloom throughout September and October, and a few sorts—like Queen of the Market—spent themselves and died before frost came.—H. BAILEY, in Bulletin 90.

## HOME-MADE GRAPE AND BERRY CART.



VERY handy cart for use in vineyards and berry-fields is easily constructed from the wheels and shaft of a worn-out mowing machine, with the simple addition of a box of proper size and thills, which any one handy with tools can easily construct. The general form and arrangement is shown in the sketch. The box should be six feet in length, at least one foot in height, and rather wide—the width, of course, depending upon the length of the axle. Thills can be of any straight, strong material, and to bring the outer ends together, a two-inch block can be placed between them and the box where they meet at the back end. A strip of board, to which the swingletree is attached, is connected with both thills at the front end of box.

This is a very handy one-horse rig for hauling fertilizer or other material in the vineyard or berry-field; also is used in transporting the fruit from field to

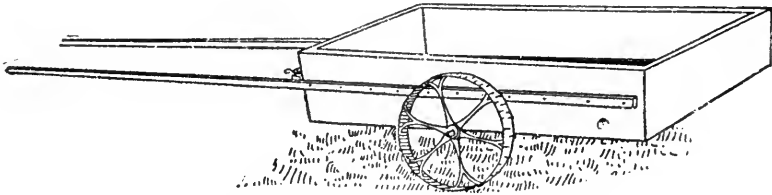

FIG. 938.—HOME-MADE GRAPE AND BERRY CART.

packing-house or evaporator, and for many other purposes about the place. It costs but little, for if you do not have the wheels and shaft, you can obtain them of some farmer at the price of old iron.

During winter is a good time to fit up such a rig, and when once made you will put it to many uses not now thought of.—New York Farmer.

**Device for Early Plants**—Those who start early garden or flower plants in the house will do well to consider the plan shown in the accompanying sketch.

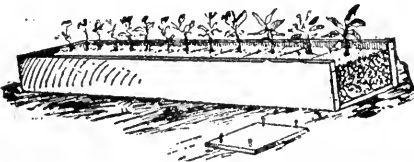

FIG. 939.

The seeds are planted in a very long and narrow box, one end of which is tacked upon the outside so that it may be easily removed. Then with a sharp shingle of the right width, cut the earth between each plant, and beginning at the end lift each one out by sliding the

shingle in under each square of earth in succession. In this way the earth will not be disturbed at all, an important point.—American Agriculturist.





## The Canadian Horticulturist

SUBSCRIPTION PRICE, \$1.00 per year, entitling the subscriber to membership of the Fruit Growers' Association of Ontario and all its privileges, including a copy of its valuable Annual Report, and a share in its annual distribution of plants and trees.

REMITTANCES by Registered Letter are at our risk. Receipts will be acknowledged upon the address label.

### ❖ Notes and Comments. ❖

CUTTING PRICES.—Canadians will be glad of the success of one of our members, Mr. H. H. Groff, of Simcoe, in winning the Florists' Exchange prize of \$5 in gold, for the best essay on Cutting Prices on new and valuable varieties of plants.

---

NEW CANADIAN NOZZLE.—The Holmes & Halliday spray pump makers have sent us a sample of their new nozzle, which appears to combine several good points and is very easy of adjustment. It will receive a test at the Spray Pump exhibition at Grimsby, on April 2nd.

---

THE ROBENA PEACH was recommended by the U. S. pomologist ; so we wrote to the originator, Dr. Taylor, of Washington about it. He says he had no thought until recently of propagating it, and has no trees for sale. He further states that the parent tree is but six years old. It bears profitably ; is loaded down with delicious fruit, freestone, and of rich color, each autumn.

---

FRAME WORK FOR SPRAYING TREES.—An illustration is going the rounds of the press which shows two sprayers caged on an elevated platform, while one man below drives the team. Surely the inventor has never been in an orchard or he would be aware of the difficulty of getting such a tower through among the limbs of an orchard of large trees, and the danger to the men should the horses take flight at the spray. The picture represents an absurd idea, and light bamboo poles to elevate the nozzle such as are used at Maplehurst are much safer and more practicable.

THE CHERRY CURRANT.—Notwithstanding the tremendous flourish with which the Fay Currant was introduced, and the fortune which has been made out of it by its introducers, it would appear that it is little, if any, superior as a market currant to the Cherry. At the N. Y. Experiment Station, the Cherry has proved itself superior to the Fay in productiveness and in vigor of bush, though the latter has longer bunches and more uniformly large fruit. The Cherry Currant should be marketed early, as the fruit will not hang as late as some other varieties. At Maplehurst this has been the favorite market current for twenty years. The best late varieties of red currants are Prince Albert and Victoria, both of which are productive, and the former, when well grown, will pass for a large currant.

---

SPRAYING EXPERIMENTS will be conducted throughout the Province of Ontario during the summer of 1896, on the same basis as last year; only in thirty totally different points, in order to interest and instruct the fruit growers in as many parts of Ontario as possible. This work is in charge of Mr. A. H. Pettit, who was last year director of these experiments, and whose faithful work bears witness to his eminent fitness for his position.

This plan of experimenting in the very orchards of our fruit growers is one of the best ways of spending the peoples' money; for when confined to one or two orchards, the people may read about the results, and know nothing about the proper methods of operation. In the plan which was adopted by our Board, under approval of our Minister of Agriculture, the people are being taught how to do it, as well as that it pays to do it.

---

BORDEAUX FOR APPLE AND PEAR SCAB.—At the New York Agricultural Experiment Station Prof. Beach has been experimenting to see how many treatments will produce the best results, in proportion to the cost. From his experience in 1894, he has concluded that the best results were gained by three thorough treatments, viz., (1) after buds break, but before blossoming; (2) immediately after blossoming; (3) from ten to fourteen days after the second treatment. Now, if this is so, it is much to our advantage to know it, for so far we have been taught that it is necessary to give at least six applications, covering almost the entire season; an undertaking so great that many fruit growers feel discouraged over it. As to the benefit, Prof. Beach writes "The sections sprayed after blossoming had on an average 1.06 more fruit per tree, *and more than four times as much first class fruit per tree* as did the unsprayed sections."

---

EXPERIMENT STATIONS IN CALIFORNIA.—From the exhaustive report of these stations just received it is evident that the cost of their maintenance is over four times that of the Ontario Fruit Experiment Stations, with probably less practical results. They are under the control of the University of California,

much as ours are under the Ontario Agricultural College at Guelph, only that ours has the additional advantage of the advice of three prominent fruit growers on the Board of Control. Their work is mostly in fruit testing, for which they have five sub-stations, and the expenditure per annum is \$15,000 per annum, one-third of which goes for salaries and one-third for labor. In addition to these they are undertaking to control the two Forestry Stations, for which, however, there is separate additional allowance of \$2,000. This will be \$17,000 per annum for seven stations, while we only expend \$2,500 per annum on our twelve stations and probably obtain better results.

LECTURERS TO AFFILIATED SOCIETIES.—For the first time, lecturers have been sent out by the Ontario Fruit Growers' Association, to speak on the "Fruit and Flower Garden," before the affiliated Horticultural Societies. The following is a list of lecturers and societies addressed :

*Alexander McNeill, Windsor* ; subject, "Window Garden and Flowers for Busy People" ; societies visited, Grimsby, Niagara Falls South, Port Colborne, Hagersville, Port Dover, Leamington.

*T. H. Race, Mitchell* ; subject, "The Fruit and Flower Garden" ; societies visited, Port Hope, Trenton, Belleville, Napanee, Lindsay.

*D. W. Beadle, Toronto* ; subject, "The Fruit, Flower, and Vegetable Garden" ; societies visited, Freeman, Paris, Woodstock, Chatham, Windsor, Brampton, Waterloo.

THE following is a list of the Ontario Fruit Experiment Stations as now established :—1. Southwestern, peaches ; W. W. Hilborn, Leamington, Ont. 2. Niagara District, tender fruits ; Martin Burrill, St. Catharines, Ont. 3. Wentworth, grapes ; M. Pettit, Winona, Ont. 4. Burlington, blackberries and currants ; A. W. Peart, Freeman, Ont. 4½. Halton Sub-station, strawberries ; E. B. Stevenson, Freeman, Ont. 5. Lake Huron District, raspberries and commercial apples ; A. E. Sherrington, Walkerton, Ont. 6. Georgian Bay District, plums ; John G. Mitchell, Clarksburg, Ont. 7. Simcoe Station, hardy apples and hardy cherries ; G. C. Caston, Craighurst, Ont. 7½. Simcoe Sub-station, gooseberries ; Stanley Spillett, Nantyr, Ont. 8. East Central Station, pears and commercial apples ; R. L. Huggard, Whitby, Ont. 9. Prince Edward District, apples ; W. H. Dempsey, Trenton, Ont. 10. St. Lawrence District, hardy pears and hardy plums ; Harold Jones, Maitland, Ont. Secretary for Stations, L. Woolverton, Grimsby, Ont.

THE SUDDUTH PEAR, which is illustrated in this number, is being tested at our Station. The Fruit Growers' Journal, published in Illinois, the State in which it originated, says there is a great diversity of opinion regarding its value. Our readers will do well to wait the reports of our Ontario Stations before investing in this or any other novelty.

ERRATA.—On page 110 for "Fruit Exhibit," read "Plant Exhibit."

## ⇒ Question Drawer. ⇐

### Varieties of Apples for Commercial Orchard.

**S17.** SIR,—I am about to plant an apple orchard near Palermo, and would like your advice concerning the best varieties for profit.

DR. H., *Brampton.*

A hard question, considering the varying conditions in different sections. For export purposes, the following would be an excellent list for Southern Ontario, in order of their season:—

Blenheim, Gravenstein, Wealthy, Ontario, Cranberry, Baldwin.

These are all showy and salable varieties, and grow to perfection in the section indicated, between Burlington and Oakville.

---

### Quantity of Fertilizer for Apple Orchard.

**S18.** SIR,—I have an old, old orchard, some of it one hundred years in bearing. A considerable part of it has been new topped in recent years, and doing fairly well. Soil, a loose and friable clay-loam. Last November, I gave it a very moderate dressing of stable manure and turned in with the plough. I propose to apply some mineral fertilizer and harrow in spring. What would you recommend, and in what quantities per acre? Do you recommend ploughing bearing orchards in the fall?

JOHN KILLAM, *North Kingston, N.S.*

For an apple orchard, the following quantities per acre of the different fertilizers are recommended by Prof. Van Slyke, viz. :—

Nitrogen, 8 to 16 lbs, furnished by 50 to 100 lbs. nitrate of soda, or by 1600 to 3200 lbs. stable manure.

Available phosphoric acid, 30 to 60 lbs., furnished by 300 to 600 lbs. bone meal, or 250 to 500 lbs. dissolved rock.

Potash, 50 to 100 lbs., furnished by 100 to 200 lbs. muriate, or by 1000 to 2000 lbs. wood ashes.

Fall ploughing, as a rule, is beneficial, opening the ground to the action of the frost.

---

### Tuberous-Rooted Begonias.

**S19.** SIR,—What is the best way to grow the tuberous-rooted begonia?

F. F., *Lindsay.*

We cannot reply better than by quoting from "House Plants." Tuberous begonias for the summer window are started in a gentle heat in the spring. Put the tubers in three-inch pots, barely covering the crowns. Water very moderately at first, increasing the amount as they grow. In six weeks from the time the crowns start, shift the plants into five-inch pots to bloom. A little shade from the hottest sun will please them.

### World's Fair Medals.

**820.** SIR,—We sent some White Clover Honey to the World's Fair at Chicago, and it took the only prize given for that kind of honey for Ontario, we have been waiting patiently for a medal or diploma, and was promised that by the Commissioners at Washington who wrote us about it. As you are our Secretary I thought to take this liberty of writing to you, we thought that we could expect something good from a nation that can afford to spread its mighty wings over North and South America. Please give us some information.

GEO. HARRIS & SON, *Dungannon, Ont.*

It would certainly appear that there is more "red tape" required to run a Republic than a Dominion, or even than a Monarchy. We are assured that the Department of Agriculture at Washington is slowly but surely, signing the diplomas which are sometime to be distributed, along with the medals.

---

### Whitesmith or Downing.

**821.** SIR,—Which of these varieties is the most profitable?

J. P. L., *Owen Sound.*

The Downing would be as the rule most profitable, because it is more productive, and not so subject to mildew.

---

### Most Productive Black Currant.

**822.** SIR,—Which is the best black currant for productiveness?

J. P. L., *Owen Sound.*

At the New York Experiment Station the Prince of Wales gave the best yield, during the past three years. Saunders is also a valuable variety.

---

### What Pays Best ?

**823.** SIR,—I am superintendent of John St. Garden in this town. We have 2½ acres, filled with apple and plum trees, 500 currant, and 300 gooseberries. My place is drained as no other garden in Canada, and I am preparing to set out a large quantity of the small fruits. I want to know what kind will give me best success?

J. B., *Stayner.*

It is impossible to answer such a question because conditions are so varying. One man makes most from strawberries, another from currants, another from raspberries, another from grapes, simply because he is growing the fruit that suits his soil and his market.

### Stock for Budding Cherries.

**824.** SIR,—I purpose planting a quantity of seedling cherry stocks for budding. Is any one kind of stocks suitable for both the Heart and Duke classes, and which is best? I can get French imported stocks which I intended doing. Thinking you can furnish me the desired information, I inclose card for reply. The recent cold snap does not appear to injure the peach buds, and I hope next fall to be able to show you some better specimens of my seedling.

H. L. McCONNELL, *Gravesend.*

The Mazzard is the best stock for budding both Heart and Duke cherries upon. It is a fine, thrifty grower. Where dwarf trees are wanted the Mahaleb is used. Seedling stock of both these should be easily procured in this country.

---

### Russian Apricots.

**825.** SIR,—I have three Russian apricot trees, the Alix, Budd, and Alexander, which I think will never bear fruit here in the County of York. Is there any other fruit I could graft on them with success?

R. J. WOOD, *Thisletown.*

*Reply by Mr John Craig, Ottawa.*

I cannot speak from experience on this matter. On general principles I do not think, however, it would pay him to graft peach or apricots upon Russian apricot stocks. If the trees have not blossomed so far, or show no indication of bearing fruit, I would endeavor rather to bring them into bearing by trying some experience in the way of "ringing" a branch or two of each tree. This might be done by removing a ring of the outer bark or by twisting a piece of wire tightly about the base of the branch. Peach trees are grown so quickly and they are so liable to "gum" and make bad joints when grafted that I do not think it would be advisable to try stock grafting.

---

### Blossoming Period and Habits of Apple Trees.

**826.** SIR,—Kindly place the following varieties in groups: 1, those that blossom at the same time; 2, according to habit of growth? Varieties: Pewaukee, Wealthy, Mann, Roxbury Russet, Golden Russet, Blenheim Orange, Hurlburt, King, Ben Davis, Walbridge, Canada Baldwin.

W. LOUCH, *Wellburn, Ont.*

*Reply by Mr. John Craig, Ottawa.*

The varieties mentioned above, according to records secured last year, would fall into three groups, the classification being based upon the period at which they blossomed: *Early Blooming*—Blenheim, Ben Davis. *Middle Group*—Pewaukee, Wealthy. *Late Group*—Roxbury Russet, Canada Baldwin, Golden Russet. The same varieties might be grouped under three heads, the

grouping this time being based upon their habits of growth: *Round Tops*--Pewaukee, Wealthy, Blenheim. *Spreading*--King, Golden Russet, Rox. Russet, Hurlburt. *Upright*--Ben Davis, Walbridge, Canada Baldwin, Mann.

### Forming Horticultural Societies.

**827.** SIR,—Will you kindly inform me, through the CANADIAN HORTICULTURIST, on what conditions local horticultural societies may join the Provincial Society?

C. FIRTH, *Durham.*

By reading sections 6, 7, 8 and 9 of the Agricultural and Arts Act, our readers will understand how to organize and become entitled to a grant for their encouragement. Many societies find the best mode of carrying out the objects of their society is to become affiliated with the Ontario Fruit Growers' Association, see section 9, paragraph 2 *a* and *b*. This Society will then furnish each member, free of further charge, the CANADIAN HORTICULTURIST, the Annual Report, and send a lecturer on Horticulture to the society once a year.

### Gas Tar for Curculio.

**828.** SIR,—Can you or any of your readers tell me how much gas tar can be used to a barrel of water without danger to the foliage of fruit trees if sprayed? I have an idea that the disagreeable odor might drive away curculio.

G., *St. Thomas.*

*Reply by Prof. Fletcher, Central Experimental Farm, Ottawa.*

Your post card to Mr. Shutt, with reference to the use of tar water as an insecticide, has been referred to me. I have never tried this remedy myself, but it is a remedy which has been tried, I believe, by a good number of fruit growers and farmers during the last ten years or so. In the first report of the United States Entomological Commission, 1878, page 382, will be found an account of the method of using coal tar in the irrigating ditches in Colorado, which consists of dropping coal tar on the running water with which the irrigating ditches are supplied. A few drops dropped into the stream give off their oils, which float on the surface and destroy any insects with which they come in contact. It is stated that a single drop floating on the water is capable of causing the death of a large number of insects. Dr. J. A. Lintner, in his first report, 1882, says as follows: "A convenient method of using coal tar for the destruction of many of the smaller insects that infest our gardens is to procure a coal tar barrel with a few gallons of tar remaining in it, fill with water and use from it as needed with a sprinkler. It may be refilled a number of times, if the tar be stirred occasionally with a stick to disengage the oil. Used in this manner, it is also a valuable deterrent from insect attack. It has been stated—

Country Gentlemen, XLI, 1876, p. 262—that a gallon of coal tar mixed with a pound of sulphur, placed in a frying pan and set on fire, and passed under plum trees in the morning while wet with dew, every morning during the curculio season, made the trees black with soot and effectually prevented the attack of the curculio.” With regard to this last method mentioned by Dr. Lintner, it might be well for it to be tried by some of those who profess not to have succeeded in controlling the curculio with Paris green, and I shall be much obliged if anyone who tries it will let me know of their experience.

---

### Nut Culture.

**829.** SIR,—In looking over an American Nurseryman's Catalogue for 1896, I find he speaks very highly of growing chestnuts and hazelnuts for profit. He speaks of great profits—as high as \$25 and \$50 from individual trees. Of varieties, he mentions Japan, Early Reliance, Giant Japan, Advance Japan, and Japan Mammoth, and American Sweet. Reported profits seems very highly colored, but I am getting four Japan Mammoths and four Filbert trees to try them.

Could you tell me, through the journal, the best varieties to plant; which are most hardy and profitable in a locality where the thermometer drops in some cases to 30° below zero? I live about 20 miles west of Stanley Spillet's Gooseberry Station.

JOHN REED, *Everett, Ont.*

In Ohio and Pennsylvania, south of the Alleghany Mountains, doubtless it would pay to grow the Japan chestnuts for profit. They are very large, but inferior to the common American sweet in quality; the trees are productive and bear early. The great difficulty is in transplanting, for they are very sensitive. But it is not at all probable that these Japanese chestnuts would endure our Canadian winters, for they are sometimes injured in Northern Pennsylvania. We notice that one year old trees of some of them are quoted as high as \$2.50 each, and we fear our correspondent will only throw away his money in buying them. We have ordered some varieties of chestnuts to be tested at our Fruit Experimental Stations, and should any of them prove hardy, we will report for the general good. The American Sweet succeeds as far north as Southern Ontario, on dry sandy knolls, but it is not productive enough for profit.

---

### ✱ Open Letters. ✱

#### The Stoddard Plum.

SIR,—We notice what you say on page 17 of the Twenty-sixth Annual Report of your Association, regarding the Stoddard plum. We are the introducers of this plum, and we receive many words of commendation from those best qualified to judge, and who have seen the fruit. Prof. Bailey says of it: “Fruit very large and fine color, excellent quality; tough, sweet skin, which I consider a strong point in its favor.” Prof. Budd, of Ames, Iowa, has often spoken in the highest praise of it, and others whom we might mention. It is a true native, originated from native seed planted in Buchanan County, Iowa, and is named in honor of its discoverer. The tree has been pretty fully tested, and, so far, has



proved strictly hardy, and a very prolific bearer. The original trees are now about fifteen years old, and bearing annually. Young trees in the nursery row have often been found with considerable perfectly developed fruit. It has never been troubled with any insect or disease. The fruit is wholly unlike Hawkeye. It took first premium for the largest native plum at the World's Columbian Exposition, and has always taken premiums at our State fairs. At the last fair it took the premium for the largest and best plum introduced since 1885, and that is just what we claim for it.

We have also introduced a red raspberry, something like the Shaffer's Colossal, only more stalky in growth. It throws out numerous fruit-stalks, and bears its fruit more along the cane. It blooms late, thus escaping late frosts. The fruit is lighter in color than the Shaffer and has less bloom, but is firm enough to bear shipping. It is of excellent quality, and the bush is a prodigious bearer. So far, it appears hardier than the Shaffer, and better able to stand drought. We consider it one of the best of its class yet introduced, and would be glad to have you try it at your Station.

J. WRAGG & SON, *Waukee, Iowa.*

### Poisoned Grain for the Sparrow.

SIR,—Your letter to Mr. Fletcher, enclosing a communication to Mr. Goodhue respecting the extermination of the English sparrow, has been referred to me.

Undoubtedly, grain poisoned with strychnine is very effective, but the danger in using such about the farm buildings would lead me to hesitate before advising its general adoption.

Sparrows may often be collected in large numbers by scattering grain for several days in the same place. If for this purpose a small and enclosable part of one of the farm buildings be selected, the destruction of the birds is an easy matter. Large numbers of sparrows have been killed on the Central Experimental Farm in this way during the past few seasons. When the grain is spread outside, the shot-gun proves a very effective method of destruction.

FRANK T. SHUTT, Chemist, Expl. Farms.

### The English Sparrow.

SIR,—I notice in your February number an article written by Mr. Goodhue, of Danville, Que., regarding the English sparrow. I would say to that gentleman that we could not do well without them. I claim that they are the best cabbage-worm destroyer that we have. Being very active, they are great feeders, and they destroy millions of seeds of noxious weeds in the winter. I know they are a pest to the citizens, but they can buy cabbage much cheaper, owing to the work of these birds. Where they are a constant pest, use wheat through your iron rod (gun) and they will soon leave you, but do not kill one of them.

W. J. HUNTER, *Orangetville, Ont.*

### Growing and Trellising Grapes.

SIR,—In regard to what you say in February number about grape trellising; I think that we Germans, who have been growing grapes for one thousand or more years, should know more about vineyards than Canadians do.

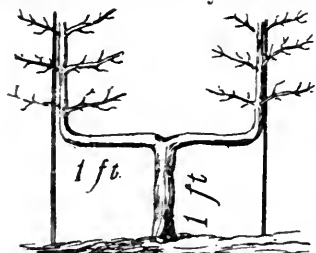

FIG. 940.—STUB SYSTEM.

In making a vineyard, I would recommend the following varieties only: Concord, Delaware and Niagara. I would plant the vines five feet apart, and for every vine stock I would set two poles; that is according to the Stub system (see Fig. 940).

In this way the vines want only tying twice during the summer, and cutting off on top of the poles. This method only needs one man for ten acres. (But the Kniffen method needs no summer tying at all.—ED.)

T. N. GRUENBACK, *Cayuga.*

## ❖ Our Book Table. ❖

### CATALOGUES.

Roses, Plants and Flower Seeds is the title of the bright 72 page illustrated catalogue issued by Messrs. Webster Bros., of Hamilton, Ont. This firm have made roses their specialty... Illustrated Catalogue of Spraying Pumps and Nozzles, manufactured by the Deming Co., Salem, Ohio, U.S.... Illustrated and Descriptive Catalogue of Fruit and Ornamental Trees, Small Fruits, Vines, Shrubs, Roses, Plants, etc., grown and for sale by J. Wragg & Sons, Waukee, Iowa, U.S.... Catalogue of Fruit and Ornamental Trees, Plants, etc., for sale by Edwin Hersee, Bloomsdale Nursery, Woodstock, Ont.... "From a Push-cart to the Trolley-car in Fruit Growing." Illustrated Catalogue of Fruit Trees. G. H. & J. H. Hale, South Glastonbury, Conn., U.S.... 1896. Catalogue of Hardy Northern Fruits, Evergreens, etc., grown and for sale by J. V. Cotta, Nursery, Ill., U.S.

### BOOKS.

**HORTICULTURE.** A new monthly journal on Fruits, Flowers and Plants. 25 cents a year. M. Crawford, Cuyahoga Falls, Ohio, U.S.

---

**PRIZES FOR BEST ORCHARDS** in East Simcoe are offered by The Orillia Horticultural Society. The points to be considered are such as site, soil, cultivation, varieties, pruning, general condition, etc. The two prizes aggregate the sum of \$50.

---

**THE BURBANK PLUM**, which is counted about the best of the Japan varieties, is said, by Prof. Bailey, to be about a week or more later than Abundance, with firmer flesh and better flavor. The tree is of sprawling habit, requiring shortening in, and it is enormously productive.

---

**THE SCILLY FLOWER TRADE.**—The West Briton of Truro, Eng., says: "The Scilly flower trade is flourishing just now, growers reaping great benefit from the recent mild weather. On Monday the S.S. 'Lyonesse' brought across to Penzance the largest quantity of flowers ever landed at one time—4,849 boxes, weighing about 30 tons. Last Saturday the same steamer brought 3,730 boxes, and on the previous Thursday 4,258 boxes. Only eight tons were sent last year for the whole of February, as the frost seriously affected the flowers.

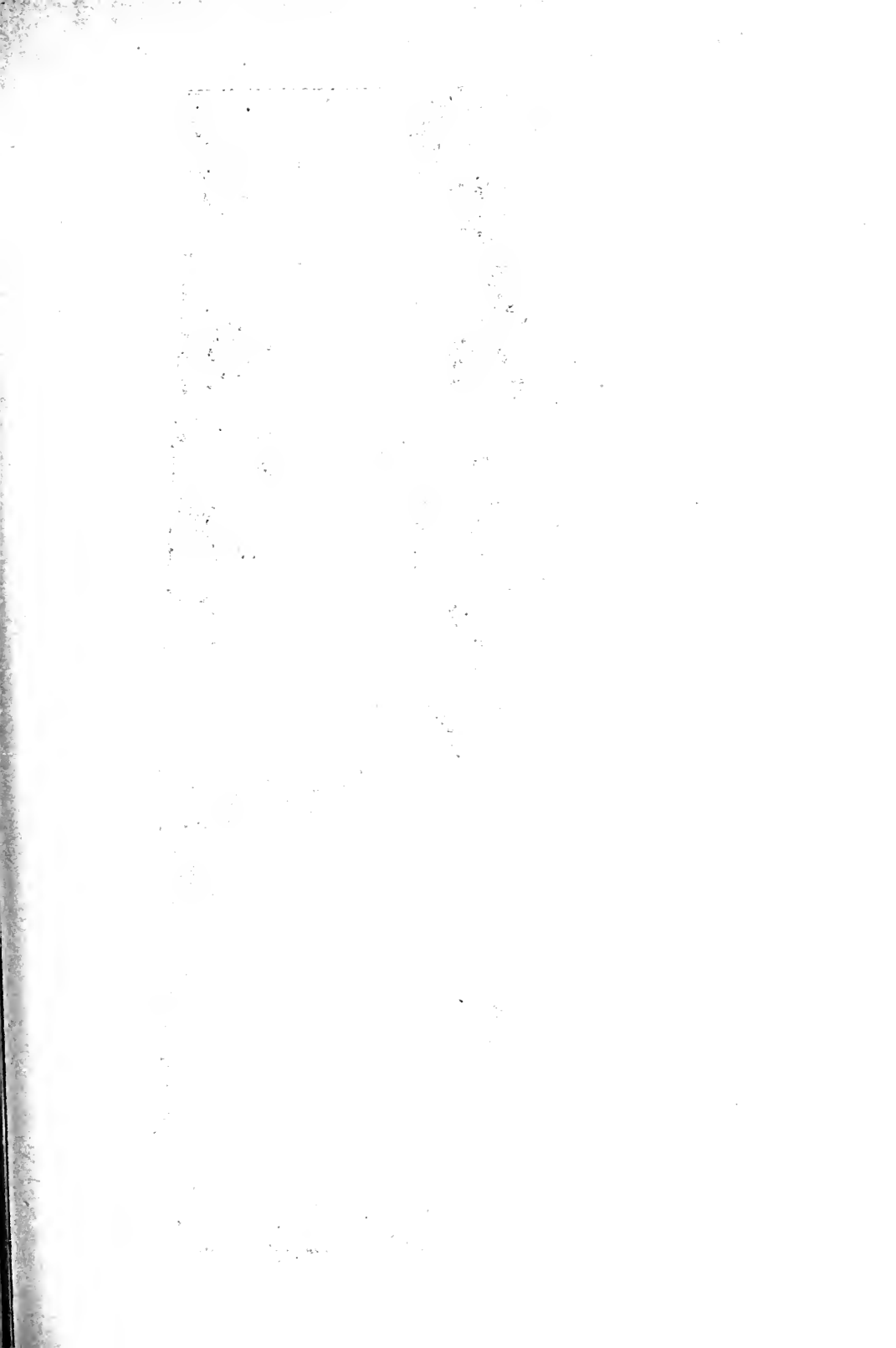

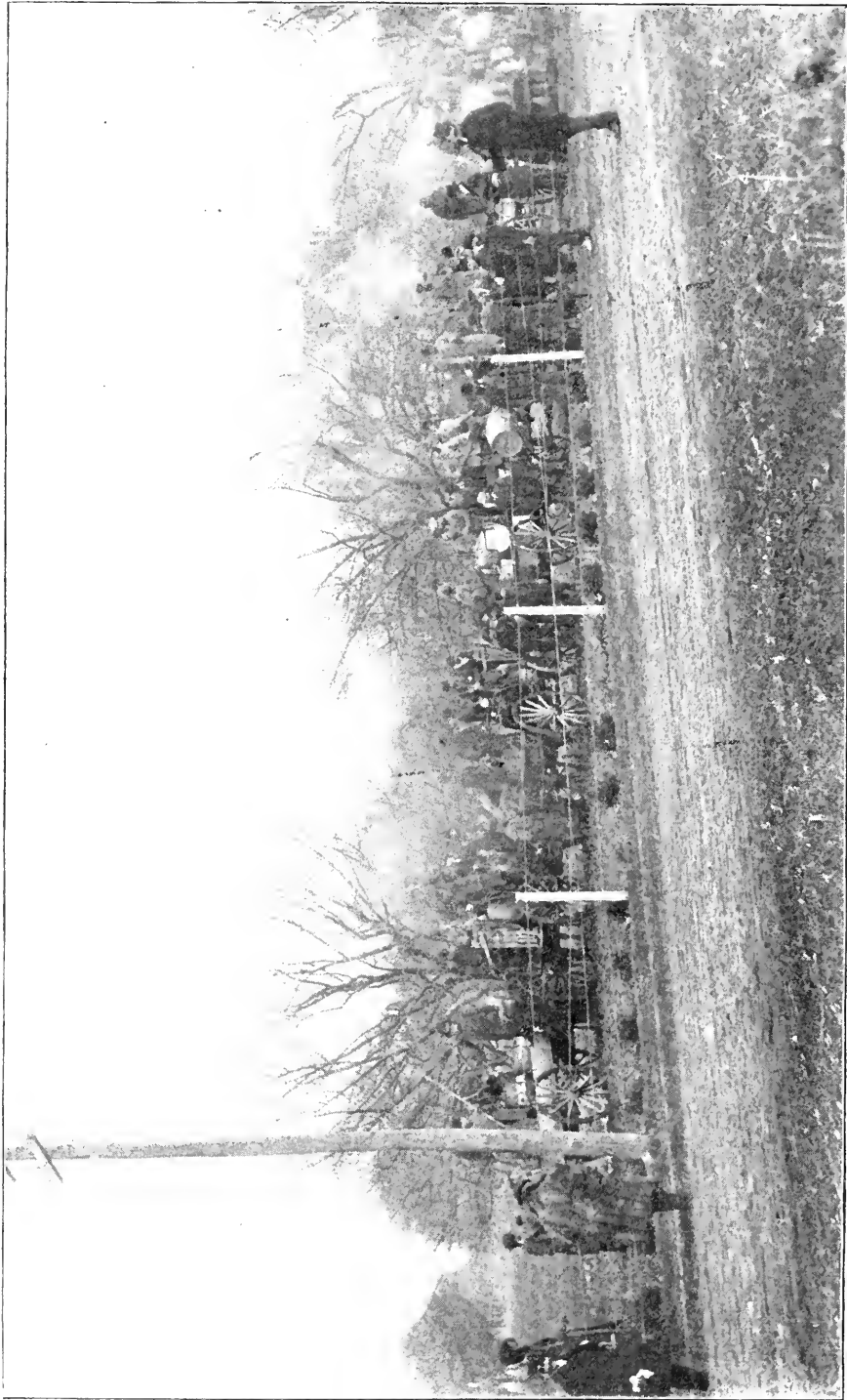

**THE SPRAY PUMP CONTEST AT GRIMSBY.**

ECLIPSE. IDEAL. CLARKSBURG. EMPIRE. REID'S. ROTARY. ANDERSON. POMONA. SPRAYMOTOR. DEFENDER. GEM.

THE  
Canadian Horticulturist

VOL. XIX.

1896.

No. 5.

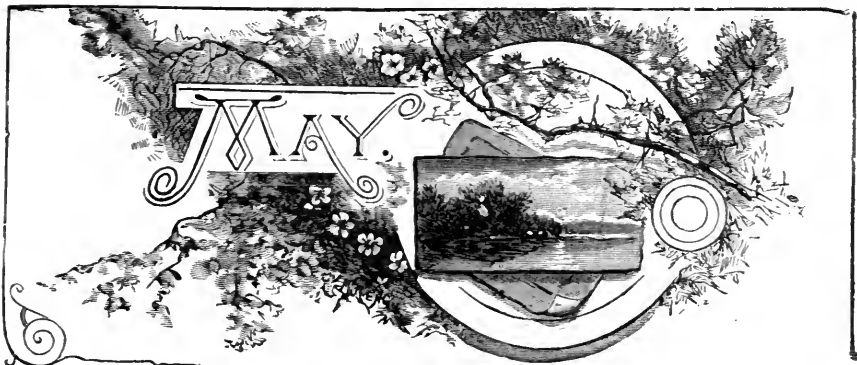

THE SPRAY PUMP CONTEST.



THE illustration heading this article is a little snap-shot of the camera, showing a novel and unique pump exhibit, the first of the kind ever held, so far as we are aware, in the world.

The importance of spraying our fruit orchards and gardens having been so plainly demonstrated to the public, by the Department of Agriculture of Ontario, through Mr. A. H. Pettit, director of spraying experiments, the Board of Control shouldered the responsibility of testing and reporting upon the merits of the various spraying pumps, all of which claimed to hold the highest place.

The judges were Prof. Hutt, Horticulturist O. A. C., Guelph, and Mr. M. Pettit, of Winona, our president. The appointed day, Thursday, April 2nd, was a cold stormy day, and yet the trial proceeded.

There were eleven exhibitors, and eleven rows of apple trees in Mr. E. J. Woolverton's orchard were selected. Each man drew his number of row, mixed his Bordeaux and proceeded in order to the orchard, followed by the judges and an interested crowd of fruit growers. Each exhibitor had to put his pump to a practical test, by applying about forty gallons of the mixture to the orchard. The second day each exhibitor was required to take his pump in parts, for the information of the judges.

The points on which the judgment was based were :—

Ease of operation . . . . .	15
Evenness of distribution . . . . .	10
Compactness and general style . . . . .	15
Durability . . . . .	15

Power .....	10
Agitator .....	10
Accessories (including hose, extension rods, stop-cocks, barrel, nozzle, strainer).....	25
	— 100

The following is the list of pumps tested, named in order of standing, as found by the judges:—

Spraymotor, of London ; Eclipse, of Benton Harbor, Mich. ; Anderson, of Aylmer ; Pomona, of Seneca Falls, N. Y. ; Clarksburg, of Clarksburg, Ont. ;

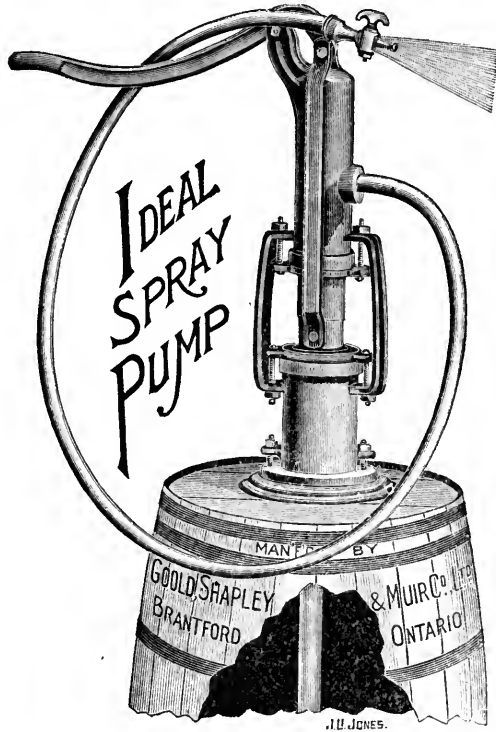

FIG. 941.—THE IDEAL.

Ideal, of Brantford ; Empire King, of Lockport, N. Y. ; Gem, of Toronto, Ont. ; Reid's pump, of Hamilton ; Defender, of Catskill, N. Y. ; The Wilson Garden Pump.

Of course some of the pumps of medium standing are much lower in price, and might be the choice of many on that account, for they do excellent work. The report, which will be published at once, will describe each pump, and give prices ; and so it will form a very reliable guide to our fruit growers, when buying a spray pump. The report may be obtained on application to the Department of Agriculture.

## CAUSES OF FAILURE IN APPLE CULTURE—III.

FROM AN ADDRESS BY THE SECRETARY.

## 5. The Ravages of Insects.



THE ravages of insects is no less important a factor in producing failure in apple growing for profit, than the others I have mentioned. The man who neglects to spray his apple orchard in June, with Paris green, must expect his crop to be thinned out one-half by the Codling Moth in September.

Some people, even yet, need to be convinced of the importance of this; but those who have given it careful trial agree in its benefits. I have tried spraying for the Codling Moth for ten successive years, and where carefully done and repeated if washed by rains, I have found a great saving of my apples, and a general improvement in their quality.

Few of us growers are exact enough with our experiments to say precisely



FIG. 942.--CLARKSPURG PUMP.

what proportion of the crop is saved by spraying. A careful experiment was made on one occasion, at the Geneva Experiment Station, N. Y. The trees were mostly Fall Pippins, and every alternate tree was treated twice in the month of June, first about the 3rd, and then again about the middle. The total number of apples was carefully counted, also the total number of sound and of wormy apples, and the percentage of wormy apples was carefully estimated for both sets of trees. The result showed 13 per cent. of wormy apples on the sprayed trees, and 35 per cent. of those not sprayed. This would amount to 22 barrels out of a hundred saved by spraying; and estimating the value at \$1 per barrel, the gain would be somewhere about \$22 per acre of orchard.

Judging from my own experience, I do not believe that this estimate is too high.



FIG. 943.—AYLMER PUMP.

While packing my apples and pears last season, I was more than ever convinced of the great benefit of spraying with Paris green. In some portions inaccessible to the waggon, this treatment was neglected, and, as a result, an immense crop of Codling moths was harvested, and innumerable apples wasted; while those trees carefully treated were almost free from this mischief-maker. And that is not the only benefit; indeed, quite as important is the perfection of form of the sprayed fruit. A Duchess apple tree always bore knotty fruit previously, but since being treated by Paris green its fruit has been perfect.



The Codling moth also attacks the pear, and therefore the pear orchard should also be sprayed in the same way as the apple for its destruction.

The Bartlett pear is especially subject to produce knotty specimens, due to the work of the curculio, and other insects. Indeed, fully half the crop has to be thrown out for seconds on this account. But for two seasons now, I have sprayed them carefully, and as a result, have had comparatively few knotty pears. The editor of the *Country Gentleman*, in a recent number, gives his experience in spraying Bartlett pears, and it corresponds with our own as given above. We copy from that journal, outlines of two specimens, showing the effect of the treatment as described above, but with us the disfigurement has averaged greater than is here represented.

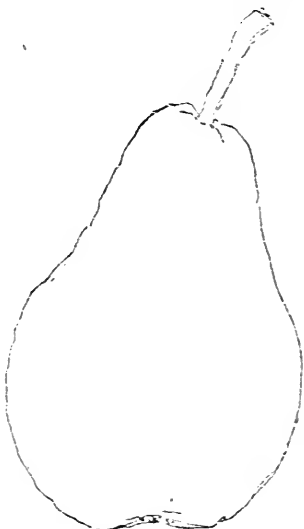

FIG. 944.—SPRAYED BARTLETT,  
 $\frac{2}{3}$  NATURAL DIAMETER.



FIG. 945.—UNSPRAYED BARTLETT.  
 $\frac{2}{3}$  NATURAL DIAMETER.

But the advantages of spraying for insect pests having been once proved, it did not take long to find that it was of almost universal application. Our Experiment Stations soon discovered the benefits of copper sulphate for destroying fungi, and of kerosene emulsion for such insects as did not eat the foliage but only sucked their nourishment from the leaves. These discoveries are creating a revolution in fruit growing, and making possible the highest success for those fruit growers who will use to the best advantage the prescribed remedies. I will read a few lines on this point from bulletin No. 101, by Prof. Bailey, of Cornell, on *Spraying Trees*.

He says: Spraying is of some value every year, upon apples, pears, plums and quinces. Nearly all the sprayed orchards are carrying a better foliage than those which are untreated, and where the codling-moth, bud-moth, case-bearer,

and other insects are plenty, it is of decided benefit. So, wholly aside from the idea of insuring against risk, it is advisable to spray for those insects which are more or less abundant every year. Some insects and diseases appear late in the season, so that the spray may be needed at some epoch in the season. Spray thoroughly, or not at all. I should say that fully half the spraying which I have seen in Western New York in the last two or three years is a waste of time and material. Squirting a few quarts of water at a tree as you hurry past it, is not spraying. A tree is thoroughly and honestly sprayed when it is *wet all over*, on all the branches and on both sides of all the leaves. An insect or

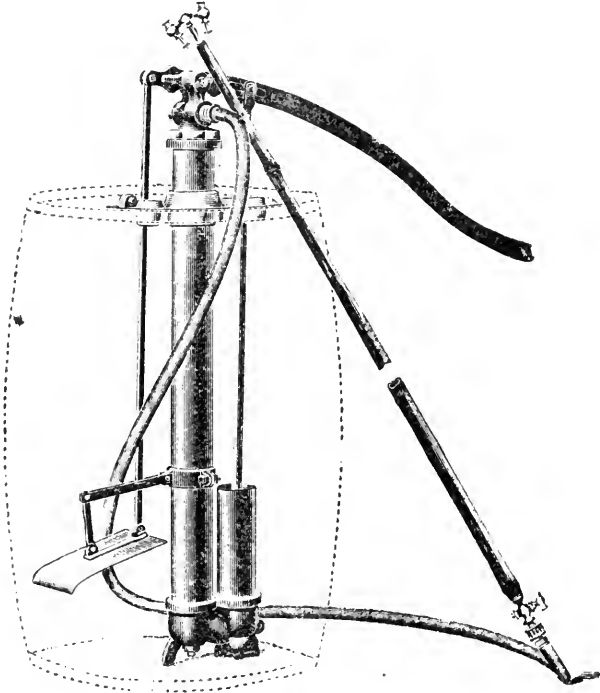

FIG. 946.—THE ECLIPSE PUMP.

fungus is not killed until the poison is placed where the pest is. Bugs do not search for the poison, in order that they may accommodate the orchardist by committing suicide. The one spot which is not sprayed may be the very place where a bud-moth is getting his dinner. On the other hand, there are many fruit-growers who spray with the greatest thoroughness and accuracy, and they are the ones who, in the long run, will get the fruit."

Prof. Pantou, of the O. A. C., Guelph, has issued a most convenient spraying calendar, which every fruit-grower should have (a copy of which is here appended), which may be had on application to the Department of Agriculture, Toronto.

## SPRAYING CALENDAR.

PLANT.	FIRST APPLICATION.	SECOND APPLICATION.	THIRD APPLICATION.	FOURTH APPLICATION.	FIFTH APPLICATION.
1. <i>Apple</i> . . . . . Scab, codling moth, bud moth.	Copper sulphate about the time buds are swelling.	Bordeaux just before blossoms open; Paris green for bud moth, when buds open.	Bordeaux and Paris green, when bloss- oms have fallen.	Bordeaux 9-12 days after Bor- deaux and Paris green.	Bordeaux 10-15 days later.
2. <i>Pear</i> . . . . . Leaf blight, scab, cod- ling moth.	Copper sulphate when buds are swelling.	Bordeaux just before blossoms open.	Bordeaux and Paris green, after bloss- oms have fallen.	Bordeaux 9-12 days after Bor- deaux and Paris green.	Bordeaux 10-15 days later.
3. <i>Plum</i> . . . . . Rot, etc., and curculio	Copper sulphate be- fore buds open.	Bordeaux and Paris green as soon as bloss- oms fall.	Bordeaux 9-12 days after Bor- deaux and Paris green.	Bordeaux 10-20 days later.	Ammoniacal copper carbonate 10-20 days later.
4. <i>Cherry</i> . . . . . Rot, aphid, slug.	Bordeaux as the buds are breaking. If aphid appears, kero- sene emulsion.	Bordeaux when fruit has set; for slugs dust leaves with air- staked lime. Helic- one is good against slug.	Bordeaux, 10-15 days after, if rot appears.	Ammoniacal copper carbonate 10-15 days later.	
5. <i>Peach</i> . . . . . Rot, mildew.	Copper sulphate be- fore buds swell.	Bordeaux before flow- ers open.	Bordeaux when fruit has set.	Ammoniacal carbon- ate when fruit is nearly grown.	Repeat fourth 5-10 days later.

SPRAYING CALENDER.—(Continued).

6. <i>Grape</i> ..... Mildew, etc., flea beetle.	Copper sulphate when buds swell. Paris green for flea beetle.	Bordeaux when leaves 1½ inches in diameter; Paris green for beetle.	Bordeaux when flowers have fallen; Paris green for beetle.	Bordeaux 10-15 days later.	Bordeaux 10-15 days later if disease still appears.*
7. <i>Raspberry</i> ..... Anthracnose, rust.	Copper sulphate before buds break.	Bordeaux if rust appears during summer.	Bordeaux if the trouble appears to continue.	The only remedy, as yet, for orange rust is to cut out diseased plants.	
8. <i>Currant</i> ..... Worms and mildew.	Paris green or hellebore for worms.	Hellebore 10 days later for worms; Bordeaux for mildew.	Hellebore if necessary for worms.		
9. <i>Gooseberry</i> ..... Mildew and worms.	Bordeaux as soon as leaves expand for mildew, hellebore for worms.	Bordeaux 10-15 days later. Worms as before.	Ammoniacal copper carbonate 10-15 days later.	If further treatment required for mildew repeat third 10-15 days later.	
10. <i>Tomato</i> ..... Rot, blight.	Bordeaux as soon as rot or blight appears.	Bordeaux if trouble continues.	Bordeaux if necessary.		
11. <i>Strawberry</i> ..... Rust.	Bordeaux when first fruits are setting.	Ammoniacal copper carbonate when first fruits are ripening.	Bordeaux when fruit is taken off.	Bordeaux if trouble continues.	
12. <i>Potato</i> ..... Blight, beetles.	Paris green as soon as beetles appear.	Bordeaux when plants are about six inches high.	Bordeaux 10-15 days later.	Repeat if necessary in 10-15 days.	
13. <i>Cabbage</i> .....	Pyrethrum may be applied in solution or dusted on, 1 part pyrethrum to 6-8 parts flour.				

## Solutions Recommended.

*Copper Sulphate Solution.*

Copper sulphate.....	1 pound.
Water .....	20 gallons.

To be used only before the buds burst, and never to be applied on the foliage. When applied to peach trees, use 25 gallons of water instead of 20 gallons.

*Bordeaux Mixture.*

Copper sulphate.....	5 pounds.
Lime (fresh) .....	4 pounds.
Water.....	40 gallons.

Prof. Bailey advises a stock solution of copper sulphate, in case of large orchards, as follows: A simple method is to dissolve 40 or 50 pounds of the sulphate in as many gallons of water, pulverizing the material and hanging it in a coffee-sack in the top of the barrel. A gallon of water, therefore, means a pound of sulphate. The lime may also be slaked and kept in readiness for use. Slake it into the creamy condition familiar to masons, cover lightly with water, and then close the box or vessel to prevent the water from evaporating. When making the Bordeaux mixture, pour the requisite quantity of the stock solution of sulphate of copper into the barrel, and then dilute with four or five times the quantity of water. Now add the lime, and then add enough water to complete the formula.

Suspend the copper sulphate in five gallons of water. This may be done by putting it in a bag of coarse material and hanging it so as to be covered by the water. Slake the lime in about the same quantity of water. Then mix the two and add the remainder of the 40 gallons of water. Warm water will dissolve the copper sulphate more readily than cold water. If the lime is at all dirty, strain the lime solution. Use wooden vessels.

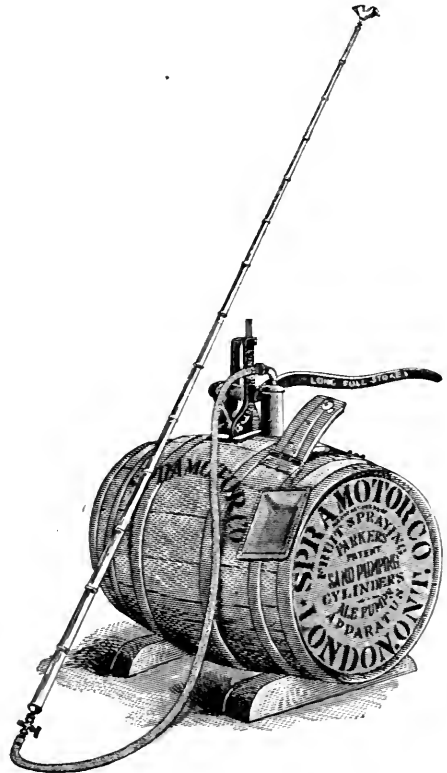

FIG. 947.—THE SPRAYMOTOR.

*Paris Green Mixture.*

Paris green . . . . .	1 pound.
Water . . . . .	200 to 300 gallons.

Use about 200 gallons of water for apple trees, 250 for plum trees and 300 for peach trees. When used upon peach trees, add 1 pound of lime to the mixture. When Paris green is added to the Bordeaux mixture to form a combined insecticide and fungicide, add 4 ounces to every 50 gallons of the Bordeaux mixture.

*Hellebore.*

White hellebore (fresh) . . . . .	1 ounce.
Water . . . . .	3 gallons.

*Kerosene Emulsion.*

Hard soap . . . . .	½ pound.
Boiling water . . . . .	1 gallon.
Coal oil . . . . .	2 gallons.

After dissolving the soap in the water, add the coal oil and stir well for 5 to 10 minutes. A syringe or pump will assist much in this work. Dilute with from 9 to 15 parts of water.

*Pyrethrum.*

Pyrethrum powder (fresh) . . . . .	1 ounce.
Water . . . . .	4 gallons.

The Flatheaded Apple tree Borer is a most formidable enemy to the apple orchard. The months of June and July constitute the season when the parent beetle is most active in her search for a place under the scaly bark, or in the crevices of the trunks of the apple trees. When an orchard is growing vigorously the young larvæ seems to be outwitted by the rapid growth of the wood, but when an orchard is grass bound and growing very slowly, the trees are almost sure to suffer, and oftentimes, if neglected, will be wholly destroyed.

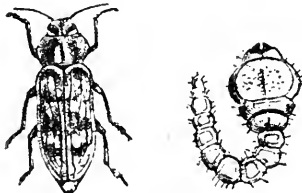

(a) FIG. 948. (b)

The beetle is about half an inch long, of a shining greenish black above, and like burnished copper underneath, and will be readily recognized from the engraving. It is said to sometimes attack the pear and plum trees, but we have never been troubled with it except in our apple trees, where it was trouble enough until we knew how to fight against it. The presence of the larvæ may be detected by the rough, dark and sometimes cracked state of the bark, usually on the northwest side of the trunk, or by the fine chips which they exude from their holes when quite young. A sharp

pointed knife will soon discover the hateful intruder, which will be at once seen to be truthfully represented in Fig. 948 *b*, with its great flat head, which is altogether out of proportion to its body. Washing the trunks of the trees at this season with some alkaline solution of washing soda and water, the latter in the proportion of a quarter of a pound to a gallon.

Another formula—Take one quart of soft soap boiled in two gallons of water, and while hot stir in one pint of carbolic acid.

The Oyster Shell Barklouse is insignificant in size, but terrible by reason of its numbers. Very few have any idea how common a pest this is in our Canadian orchards. Many people are wondering why their orchards are so unfruitful, and why they are so stunted in growth, and look so sickly, when the whole trouble is due to this pernicious little louse, which, unnoticed by them, is preying upon the bark of their apple trees in immense numbers, sucking out their strength and life.

Once toward the end of May a neighbor brought in to the writer a branch of a young tree from his orchard asking, "What is the matter with this tree?" The tree would not grow, and he had discovered that the bark was curiously rough with numerous tiny scales about one-sixth of an inch in length, Upon lifting one of these scales and using a hand glass the question was soon solved. To his astonishment, there were revealed nearly one hundred wee little lice, too small to be readily seen by the naked eye, and which ran about with the greatest speed over the bark as if delighted at their liberation from the confinement of the material shell. No wonder the tree was stunted!

This louse belongs to the genus *Coccidae*, and is allied to the aphid, bedbug, and body-louse. It was introduced into this country some eighty years ago from Europe, and although the female cannot fly, and hence migrates slowly, it has now become more or less distributed throughout our whole country.

The time to destroy these bark lice is early in the month of June, because at that time the younger brood escape from under the scales where they hibernate, and which are actually the dead bodies of the mother lice. The loose bark should first be scraped off with a hoe, because the cunning youngsters hide away carefully beneath it, as if they were trying to escape discovery.

The trunks and large limbs must be washed with a strong solution of soft soap and washing soda, with enough water to enable one to apply it with a paint brush, or scrubbing brush. If the lice have spread over the limbs, the whole tree must be sprayed with a solution of washing soda and water in the proportion of half a pound to a pailful, or potash and water, two pounds to seven quarts. Caustic soda and water is recommended as still more effective.

There are several insects which prey upon the bark louse, as also some insectivorous birds, but unfortunately this hateful insect increases out of all proportion to the number of its destroyers, and unless vigorous remedial measures are employed, some of our best orchards will die of premature old age.

## WESTERN NEW YORK HORTICULTURISTS.—II.



N entering the hall of meeting one is surprised at the variety of spray pumps and other requisites for the fruit grower on exhibition. The pumps we need not speak of now, as our own trial of sprayers on the 2nd of April affords the best of all proofs of their efficiency, and the result will be fully published.

Among other appliances was a potato bug killer, which consists of a bellows with long handles, which puffs out the Paris green through the spout in a blast, scattering it in such fine particles that one pound answers for an acre of potatoes. The inventor is Charles Mills, Fairmount, New York.

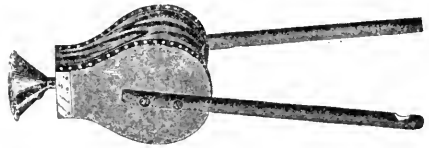

FIG. 949.—POTATO BUG KILLER.

THE SEELEY FRUIT BASKET was shown by Mr. J. B. Seeley, 1027 Walnut Street, Philadelphia; apparently a handy package for choice tender fruit. It is packed from the bottom, allowing fine display facing on top; admits of shipping without crating; convenient for transportation, and is a convenient and acceptable package for the consumer.

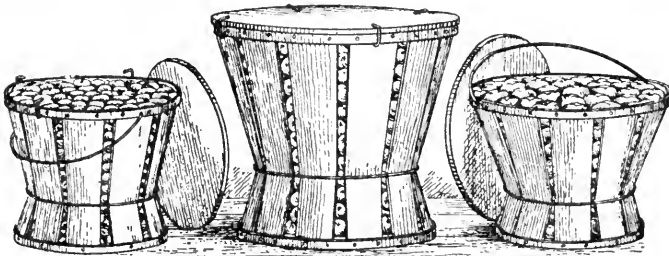

FIG. 950—THE SEELEY FRUIT BASKET.

THE PEACH BUDS are largely destroyed in New York State. In reply to an inquiry concerning them, growers from various parts of the State reported a temperature below  $15^{\circ}$  on the 6th of January, and blackened buds. In Southern Ontario the weather has not been so severe, and the prospects of the Grimsby and Niagara peach growers is better than those of their New York State cousins. On examination since coming home, and after the cold days of February and March, the writer finds that fully one-half the buds are alive at Grimsby, and this ensures a crop. Peach growers in Essex say they have not lost any buds through cold weather this season.



THE NEW STRAWBERRY CULTURE was the subject of a paper by L. J. Farmer, of Polaski. Following the principle of the New Onion Culture, he aims at planting out as late as possible to save weeding. He takes his plants at the usual time in spring, and trenches them till June 1st, laying them against the earth side of a furrow about 24 to a foot. One man can trench 10,000 per day. All this time he cultivates the plot for which they are intended, getting it into as excellent a condition as possible, setting the plants about the beginning of June. The plants so treated are better than potted plants, and will grow right along. He uses a sort of adze in planting, with two motions for each plant set, and in this way one man can set about 2,000 plants per day.

JAPAN PLUMS were not spoken very well of by Mr. Nelson Smith. His experience had not been satisfactory, and he would advise that fruit growers be cautious in planting them. They came in when the market was not yet ready for plums, and no one was ready for canning them. The Abundance he counted unprofitable in an open market. He had shipped several hundred baskets, and his returns were unsatisfactory. The Burbank was better than Abundance.

Mr. Hale believed there was a future for Japanese plums, for they were vigorous, hardy and healthy. They would prolong the season by beginning the plum harvest earlier.

The cost of growing a pound of grapes was discussed by Mr. Spencer. According to the Garden, he said:—"The cost of the various processes of cultivation, such as cutting the curls, stripping brush from the wires, stretching wires, tying, tillage, etc., from spring up till the time of harvest, is about \$9 an acre. How much a nine-pound basket costs depends on the man and his soil. In vineyards where there are no missing vines, and all are thrifty and even, an acre will yield a thousand baskets, and often twelve hundred, but the average grape grower of the region does well if he gets five hundred baskets, and the careless vine dresser gets all he deserves if he gets two hundred and fifty. With five hundred baskets to the acre each one will cost one and eight-tenths cents. But this nine dollars which has been expended since early spring does not take the grapes to the freight car, and, indeed, it pays for only one-quarter of the journey. The cost of baskets, handling, picking, packing, attendance in various ways and hauling is yet to be met, so that harvesting the grapes cost \$27 more an acre, making a total of \$36. In 1894 grapes were 11¾ cents a basket at the car door, or \$58.75 an acre, which left \$22.75 of profit. Out of this must be taken the taxes, wear of implements, posts, crates, and sometimes fertilizers, which, of course, vary in individual instances. Fruit-growing is every year becoming more and more a profession, which combines skill and science, and the man who is best paid is he who raises the most difficult products. Fifty men are competent to produce crops where there is one competent to raise mushrooms, but mushrooms bring fifty times as much a pound as grapes. The exceptionally skilled horticulturist can find a better business than growing grapes."

## THE USE OF MORE FRUIT IN OUR DIET.\*



HIS subject has pressed itself for some time upon my attention, from the fact that few realize from practical experience the benefits to be derived from eating less meat and a larger use of fruit in our diet. Anyone who will make a canvass through the country, will find that more than half of our farmers raise no small fruit, and many who have orchards sell their crop of apples and leave their families, in too many instances, destitute of the very food conducive to their healthfulness.

Now in support of the attitude taken in the premises, it is important, you will say, that the highest testimony should be adduced, and we will call in the medical profession.

At the convention of the "Australian Federated Fruit Growers' Association," in April last, Dr. Benjafield delivered a lecture on "Fruit as a Food and Medicine," which appeared in Appleton's Popular Science Monthly for September, and was reproduced in medical and other journals in the United States.

The introductory remarks in this very able lecture would be of value for us to consider here. The Doctor says: "From Solomon, all down through the succeeding ages, poets have sung the praises of the luscious grape and peach, and painters have sought to outvie each other in depicting the attractions of the apple and plum; and away deep down below all this, we see through the whole animal creation a developed instinct which teaches all to long after these beautiful fruits. Is this instinct wrong? Is nature a fool thus to make her creatures voice their needs? When you see the whole insect family swarming over and devouring our choicest fruits, shall we say that they do not know what is good for them? When we see pigs, horses, cows and sheep breaking down our fences, need we ask how they learned to love fruit? Aye, more, note the baby in the arms who screams for the rosy apple, and bites away at it even with toothless gums, and, as the baby grows into the boy, how he will defy canes and even police, so that he can get what he loves and longs for.

"The Creator is so anxious that this very necessary food shall be eaten by His creatures, that He makes it beautiful to look upon, sweet and attractive in smell, and gives to it such varieties of flavor, that the most fastidious can be satisfied. And yet, in spite of all this, the great mass of the people look upon fruit as a luxury upon which they can only spend odd pennies for the amusement of their children. Many parents will more readily spend money on injurious or even poisoned sweets, than they will on good healthy fruit; and fashionable society will spend pounds on cakes, wines and brandies, while they spend as many shillings on the very thing they need to keep them healthy—fruit.

\* From a paper read before the Pomological and Fruit Growing Society of the Province of Quebec, at their winter meeting in the Theatre Royal, St. Johns, Que.

And as for the amount of drugs swallowed, which should be replaced in a great measure by fruit, it is beyond my power to calculate. Millions upon millions of pounds are spent annually upon mercurial and other purgatives, most of which would be quite unnecessary if the people would but look upon fruit as a necessary article of diet. The fruit grower of the future must try to so educate the public mind, that this state of things will be altered."

Another physician, Dr. Caldwell, writes, in the *Memphis Medical Journal*, of fruit as an agency in preserving health and putting off old age and physical decay: "In man there is a tendency, from the cradle to the grave, of a gradual process of ossification from earthy deposits, consisting primarily of phosphates and carbonates of lime combined with other calcareous salts. After middle age the tendency becomes more marked and ends in senile decrepitude. The majority of all who pass sixty-five years suffer from these deposits, the structure of each organ is altered, and elasticity gives way to senile rigidity, and, sooner or later, a vital part becomes involved. In considering the possibility of suspending the advent of old age, it is consequently a matter of the highest moment to ascertain what foods contain the smallest comparative quantity of those salts which tend to accumulate in the system and obstruct the vital processes." The cereals, he contends, are found to be the richest in them and should be used in moderation. "Hence a diet composed principally of fruit, is best adapted for preventing or suspending ossification."

Dr. Benjafield tells us that "Garrod, the great London authority on gout and rheumatism, advised his patients to take oranges, lemons, grapes, apples and pears. Tardieu, the great French authority, maintains that the salts of potash found so plentifully in fruit, are the chief agents in purifying the blood from rheumatism and gouty poisons."

That at this period fruit forms a larger part of our food than earlier in the century, we owe to the more general knowledge of the laws which govern man's organism and the necessity of obedience to them to avoid sickness, which is, sooner or later, the punishment nature imposes for their disregard. Perhaps, some present may remember when, over the medical world, Calomel was king and the *Lancet* his prime minister, fruit was regarded more as a supplement to a dinner, or to serve as an embellishment to our tables in the relation which flowers occupy at present, very few knew its tonic properties when eaten before breakfast or other meals. The most eminent physicians of our day now scoff at many of the remedial agencies of the past and claim, as we have seen, that in fruit we have a substitute more beneficial in its results, if regularly and judiciously used. As the popular knowledge of natural laws extended, fruit began to assert its proper place, hence the demand for it called for a larger supply. In furtherance of the fruit growing industry, organizations, like the present, unknown early in the century, rapidly came into existence throughout the civilized world. Yet, what a work is still to be done! When we see the great multitude

of nostrums advertised for human ailments and sold, and the large fortunes accumulated thereby, we must admit that there is still a cloud of ignorance to be dissipated, and the work of Fruit Growers' Associations in this direction can be made in the highest sense philanthropic.

Now, the question presents itself: What fruits successfully raised in our Province are of the greatest utility for food? The apple, undoubtedly, claims the first place; with varieties of good keeping qualities, it can be made to supply our wants the entire year. The pear and plum come in to supply a change over a limited period. The grape can be made available half the year, by precautions in storing it for winter use, and stands second to no fruit for its delicious qualities and healthfulness. Fortunately, it is not, as formerly, an expensive luxury, but within the means of all our population, if they do not choose to raise it.

What higher testimony can be adduced that fruit was intended by the Creator to be used to a large extent in sustaining life, than the regularity in which it comes in season? When we are satisfied with one variety, another comes in with its tempting special properties to gratify our desires. Thus, in order, the strawberry is looked forward to with delight, so that when the season arrives, we deplore its brevity. The raspberry, blackberry, currant and gooseberry supplying variety, and each its special flavor to satisfy the animal craving for fruit. The procession moves with regularity and freighted with abundance, and, as you have seen, science tells us why. Besides, wherever man's lot is cast, he finds nature has placed by his side the food intended to supply his wants. We see, at the equator, fruit flourishes in the greatest abundance and luxuriance, which signifies that this was intended for his main food. The supply seems to be wisely graduated till we reach the Arctic circle, where warmth-giving food is demanded to sustain life. I think it should appear to us all, that our lot has been happily cast in a climate where nature's supply at hand seems to indicate that, to sustain our bodies in the highest degree of health, our diet should be proportioned in this order: fruit, vegetables, and, lastly, meat. Nature gives us fruit in tempting forms, and in greater variety, in the summer, when meat is less called for, and its grateful juices the most beneficial.

We will now consider the order in which fruit should be eaten at our meals, and, perhaps, the innovation suggested may meet with criticism. Nevertheless, I propose to reverse the present order of things, and place fruit at the beginning of each and every meal! Why has it been so general to begin breakfast with an apple, an orange, or a pear? Because those who practise it find it beneficial. Then what is good for one meal is equally applicable to all.

To again allude to the apple, which holds the pre-eminence as a health-giving article of food, I believe we should use more and export less. Could the laboring and poorer classes, who now consume comparatively few, be encour-

aged to look upon it as a cheap and necessary food, rather than as a luxury, their condition would improve in many respects. It now rests with our fruit growers to so educate the public mind, that the present state of things will be altered.

*Clarenceville, Que.*

WM. MEAD PATTISON.

## ABOUT GARDEN PEAS.

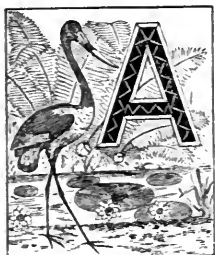

AFTER numerous trials with various sorts of the extra-early peas, I have discarded the whole lot, with one exception, and that is Vick's Extra early, and as this needs sticks or supports I do not plant it every year, as the Wonder usually gets round by the last days of June. After trying a score or more of varieties, within the last dozen years, I have settled down upon the following sorts :

I will let Vick's Early head the list because it is one of the finest of the extra early sorts—generally the small early peas are of rather poor quality, but the Vick's is very good quality, and quite prolific, with long pods always well filled.

The American Wonder is yet the stand-by, although it has a strong rival in Nott's Excelsior, which is one of the best peas of recent introduction. The claim that it is earlier than the Wonder does not prove true with me, but it comes along about the same time ; it is a strong grower and fully prolific as the one it rivals. In quality it ranks with the best.

From a single season's experience I am inclined to name the Heroine as the next medium early pea. It is a strong grower and fairly prolific, but what it lacks in number of pods it surely makes up in size, the pods often being over four inches long, bearing 10 to 12 peas. This is a green wrinkled pea, grows about 2½ ft. high and is of a rich marrow-like flavor.

Bliss's Abundance comes next in my plans this year, although some might prefer to omit this for the Champion of England, an old and good sort when the vines do not mildew.

The three last-named varieties of peas may best occupy the ground exclusively, but with the Dwarf Wonder and Excelsior I have found it convenient to alternate the rows with strawberry plants, making the strawberry rows 2½ feet apart with two rows of peas intervening. By the middle of July the pea haulm is raked off the ground and the strawberry plants will begin to put out runners. Thus there is no great loss of ground in waiting for the first year's development of the strawberry plants.—American Agriculturist.

## NOTES ON A LECTURE TOUR.—I.



It is not an uncommon thing to hear a complaint that the HORTICULTURIST does not give enough space or attention to the cultivation of the æsthetic or ornamental side of home life. In other words, while it devotes its pages to the interests of those of its readers who are engaged in practical fruit growing, it does scant justice to those whose only interest is in the cultivation of the fruit and flower garden and the ornamentation of the home. While it must be remembered that the very large majority of the readers of the HORTICULTURIST are interested in it because they are fruit growers, and value it only for its practical information in that department, it cannot be forgotten that the Ontario Fruit Growers' Association has made special efforts in recent years to widen its influence among other classes, by the formation of affiliated societies in the towns and cities throughout the Province, and increase the circulation of its publication through these organizations. To this end our director, Mr. Beal, of Lindsay, has within the past two years visited many towns, and has been very successful in his efforts. And it is a matter which may be reasonably questioned whether Mr. Beal's successful efforts in this direction have been followed by a corresponding effort on the part of the HORTICULTURIST to meet there quirements and gratify the tastes of those urban readers and affiliated members of our Association. At all events it is from those classes that the complaints have come of which I speak above.

Having just returned from a lecture tour to a number of those local Horticultural Societies, I may be permitted to claim that I speak with authority on this point. I may indeed say, that I promised, on behalf of those making the complaints, that I would draw the attention of the board of directors to the defect, and have it remedied as far as possible by giving larger space and more attention in future to floriculture and home ornamentation.

It is a mistake to suppose, as many have done, that the functions of the Ontario Fruit Growers' Association are limited to fruit growing, and that it has no other aim or purpose than to advance the interests of that industry. Though it is true that the large majority of its members are only interested in fruit growing, the Association has always given considerable of its attention to floriculture, to the beautifying of the home and to the cultivation of the beautiful in nature. That it has not given more attention to this department in the HORTICULTURIST is owing more to the lack of space than to a lack of interest or proper appreciation of its functions and obligations. But now that it has affiliated with it so many largely urban societies, aiding it, as they must, in the cultivation of the finer or picturesque side of nature, it will, until it can afford to enlarge its pages, have to ask the indulgence of the majority of its members while it devotes a little more space and attention to the "minority interests."

In a future number I will give you a few notes on my visit to the towns of Port Hope, Trenton, Belleville, Napanee and Lindsay, and my meeting with the Horticultural Societies of those different points. In the meantime, as I promised many of those I met, I will name a list of roses suitable for our own climate for outdoor planting. For one dozen hybrid perpetuals, take two Gen. Jacqueminot, one Fischer Holmes, one Charles Lefebvre, all dark; for pink or rose, take two Magna Charta, one Glory of Mosses, and one Gracilis Moss; for light, one Madam Plantier, two Merville de Lyon, and one Perpetual White Moss, the latter only for its buds. These must be all cut back every spring to twelve or eighteen inches according to the strength of the shoots. For monthly bloomers to plant out in the open ground as early in the spring as possible, take Pierie Guillot, Catharine Mermet, Camdens, Etoile de Lyon, Maria Guillot, Sappho, Princess Logan, and Grace Darling.

*Mitchell.*

T. H. RACE.

### THE BUD MOTH.—(*Tmetocera ocellana*.)



HIS insect is becoming a very serious pest in our Canadian orchards, and are difficult to overcome. About the first of May the caterpillars begin eating into the buds. It also continues to eat the leaves and flowers as they open, tying them together with silken threads. At first the little caterpillar is only about the one-sixth part of an inch in length, with black head and thorax; but about a month later they are about half an inch in length, and look brown in color. Fig. 952 shows one of these moths magnified three diameters, after Slingerland, who also describes and figures the moth itself as follows:—It is about three-fifths of an inch across its expanded wings. It is of a general dark ash-grey color, with a



FIG. 951.



FIG. 952.

broad cream white band across the front wings. The moth is a near relation of the Codlin Moth. It received its name, *Ocellana*, in Austria, in 1776, from somewhat eye like marks on each front wing; hence its common name, Eye-spotted Bud Moth.

**The asparagus** is a native of Europe, growing in rich, sandy soil, in meadows, and along the banks of rivers. It has been much improved by cultivation, and in its wild state grows only about a foot high, and as thick as a goose quill. In its cultivated state it attains a height of three to four feet. The plant when only a few days old is cut as it sprouts from the ground, tied in bunches and brought to the market. It was a favorite vegetable of the ancient Romans. The seeds have been used for coffee, and are recommended for that purpose in Europe at the present day. A kind of fermented spirit is made from the berries.—Greengrocer.

## CULTIVATION OF THE BLACKBERRY.



NO fruit profits more from careful tillage than the blackberry. This is largely because the fruit requires so much water, if it reaches its full capabilities, and the crop matures in the driest part of the season. The moisture of the soil can be well conserved only when tillage is begun very early in the spring. We generally plow our patches in the spring, and thereafter keep the land in fine shape by running over it every week with a cultivator. We generally prefer a spring-tooth cultivator. It is especially important to cultivate as soon after a rain as the soil is in condition, before it bakes. This tillage is continued until within a day or two of picking time. After the crop is harvested, one good cultivation is given to loosen up the ground which has been tramped down by the pickers and to fit it for winter. With us, this last cultivation occurs about the middle or last of August. In the drier summers west of New York, blackberry growers often mulch with freshly cut clover or manure close about the plants, leaving the center of the rows open for cultivation ; but this is rarely, if ever, necessary in this State.

These frequent light cultivations are really cheaper than one or two, because the weeds never get a chance to grow and little hoeing is necessary. If a patch becomes foul with thistles and other weeds, the best procedure is to mow it off, plow it up thoroughly and crop it with corn for a season. Suckers will come up in the corn along the old rows, and the following year the plantation will be completely renewed.

Stable manure is the most popular fertilizer for blackberries. In general, it may be said that if the tillage is good, nitrogen will rarely be needed on good lands. Potash and phosphoric acid as advised for orchards may, no doubt, be applied to advantage.—Cornell B. 99.

---

**San Jose Scale.**—The wide distribution of the San Josè scale, by nurseries since 1887, has called attention to the fact that much harm has unwittingly been done for many years past, by nurseries, in causing the spread of other insect pests as well. As a result, however, of the appearance of this destructive scale, nurserymen will be more careful in the future, but yet fruit growers will not be able absolutely to rely on the clean condition of any stock which they buy, and it has been suggested that the purchaser should demand a guarantee that stock has not been infested with injurious insects, and further, that if it is found to be infested after purchase, that it should be replaced: though even then the purchaser would have no redress for the introduction of injurious insects and their spread to older trees, and it is here that we must look for legislative aid.—Rept. Mass. Hort. Soc.



## THE EGG-PLANT AND ITS CULTIVATION.



THE chief difficulty in growing the Egg-plant in the north is the shortness of the seasons. It is only by starting plants early and maintaining a vigorous growth that we can succeed in fruiting the large sorts satisfactorily. The plants should be started under glass from the middle of March to the middle of April in a warm house. In the cold and small house used in our early tests the plants grew slowly, and when set out-of-doors they were not of sufficient size and vigor to begin bearing at once. We sow in "flats" or boxes and when the first true leaves are about a half inch in diameter—which is about a month after the seed is sown—the plants are pricked off into two-inch pots. As soon as the pots are filled with roots the plants are shifted into four-inch pots. We have had indifferent success in transplanting into other flats, as the plant is more severely checked when placed in the field from the greater injury to the roots. It is imperative that the plants should not become "drawn." The plants are transferred from the four-inch pots to the garden from the first to the middle of June. The early sorts, as Early Dwarf Purple, are not so seriously injured by a check in growth as the large and late sorts, and they can therefore be handled with less care. These sorts can be started two weeks later than the others and receive but one transplanting. The effects of early and late setting are shown in the following experiment :

Seeds of several varieties were sown March 27th and May 15th. On the 7th of September they presented the following differences : Long Purple, Giant Round Purple and Long White from early sowing were productive, but few or no fruits had formed on the plants from late sowing. Early Long Purple and Round White from the late sowing were fully as productive as those from the early sowing. Early Dwarf Purple gave best results from plants started April 15th. This shows that there is little or no gain in productiveness in the small early sorts from very early sowing, while the large sorts profit by it. The Black Pekin, which is one of the large varieties, proved an apparent exception, however. Plants started May 1st gave better results than those started earlier, but neither lot was satisfactory. The unsatisfactory results from the early sowing may have been due to the loss of the first flowers because of the transplanting. Transplanting usually has the effect of keeping plants growing to the detriment of the flowers ; and egg-plants which are in bloom when removed to the field are apt to drop the flowers. It is important in the large sorts to induce the first flowers to set.

The best soil for Egg-plants is a rich sandy loam—not too light—which

contains an abundance of humus and retains moisture. Manure heavily. Large kinds should be set three feet apart each way. The ground should be thoroughly cultivated throughout the season. We run lightly through the land with the cultivator twice a week. The worst enemy of the egg-plant is the Potato beetle, which preferd egg-plants to potatoes. The egg-plant grows slowly, and any injury to the young plant is with difficulty overcome. If the plants are seriously injured when first set there will be little use in attempting to fruit the large kinds. Paris green, at the rate of one pound to one hundred gallons of water, is destructive to the beetle. Very rarely do plants in a large plantation of the late varieties all mature fruit, and such kinds as Black Pekin, New York and Giant Round Purple rarely mature more than two large fruits to the plant in this latitude, and often only one. Some of the early and medium varieties mature from four to eight fruits. The value of any late variety depends largely on the uniformity with which all the plants set and mature fruit. The New York Improved possess this advantage over the old New York Purple. The value of long and careful selection to this end was illustrated in our large planatation of crosses last year. A large percentage of the plants were entirely unfruitful, showing that a promiscuous lot of seedlings is likely to be unproductive, and in this case these seedlings were crosses between productive parents. Breeding plants of uniform productiveness is the most important field in experiments with the egg-plant now.

The varieties are not numerous, and vary widely in habit, pubescence, spininess, color of plant and fruit, size, shape and season of fruit. The larger varieties are most popular in market, but some of the earlier and smaller kinds are better. The white varieties find little demand in the market, and there is an impression that they are unwholesome, but they possess no other fault than a hardness of flesh and rind in the case of the smaller varieties. The White Chinese is as good as any for table use.

Besides a record of experiments in crossing different varieties, the Bulletin contains an interesting study of the botany of the plant, by Professor Bailey. A summary of the Bulletin is given as follows :

1. Egg-plants are adapted to cultivation in the north. The requisites of success in growing them are these : early starting ; warm quarters ; vigorous plants ; rather late transplanting to the field ; warm, rich and rather moist soil ; constant attention to Potato-beetles ; frequent cultivation.

2. The best varieties for private use are Early Dwarf Purple, Early Long Purple, White Chinese, with perhaps Black Pekin for late.

3. The best market varieties are New York Improved and Black Pekin, with perhaps Early Long Purple for the first demands.

4. In crossing different races of egg-plants, the purple-fruited types appear to be stronger in their power to transmit color to offspring than do the white-fruited types ; and this appears to hold whêther the purple type is used as the staminate or the pistillate parent.

5. The white-fruited types appear stronger in the power to transmit form and productiveness.

6. Fewer seeds are produced by flowers artificially pollinated than by those left to mature, even though an excess of pollen is used.

7. It is possible that the egg-plant may be included among those plants which are capable of producing fruit without the aid of pollen.—Bulletin 10, Cornell Expt. Station.

## SQUASHES.



SQUASHES may be grown on any soil suitable for a garden, if it receives proper cultivation. The ground needs a good dressing of decomposed stable manure spread on every spring, about an inch thick, and turned under with a spade or plow to a depth of five or six inches. This is sufficient depth after the garden has been tilled ten or twelve inches deep, and the stones gathered out. If the ground is spaded more than five or six inches, more manure must be applied. The Warty Crookneck and the Scalloped squash are best summer varieties, and the former is the better of the two. They are not great runners, and may be planted in any plot of the garden, in hills at a distance of six feet from each other. Twelve to fifteen seeds to the hill are sufficient, and when six inches high thin them down to four plants to the hill.

Winter squashes are tremendous runners and must be planted on one side or another of the garden, arranged with design to make the garden beautiful. Winter squashes should be planted ten feet from the edge or border of the garden, and in hills ten feet from each other, with ten seeds to the hill, and then thin down to four plants when six inches high.

There are seven varieties of winter squash that are grown for market or home use: Hubbard, Butman, Marrow, Boston Marrow, Turban, Crookneck, and Canada Crookneck. The Hubbard is the richest and best keeper of all the squashes. The Butman is the next best, and is a hybrid of the Hubbard and the Boston Marrow. The Boston Marrow is the pure Marrow squash, and in richness of flavor may be rated next to the Hubbard and Butman. The Marrow is a hybrid of the Boston Marrow and the pumpkin, and will produce the greatest yield of the squashes; the flavor is not so rich as those previously named and the grain is not so fine. The Turban is not a favorite squash. The grain is fine, flavor is fair, but it does not cook dry; the yield is smaller than any of the above named. The Crooknecks have but little to recommend them but their antique character.

*Tiverton.*

A. H. CAMERON.

## THE PLUM SCALE.—(Lecanium.)

This insect, which was first noticed in 1894, and has been attacking the plum orchards of the Niagara district, must not be neglected. Its size, nearly a quarter of an inch in length, renders it easily discernable, and therefore we have no excuse for allowing it to increase in our orchards. Fortunately severe winters destroy large numbers of them at the North, and it may be that in Canada they will never become the serious enemy they are farther South. In

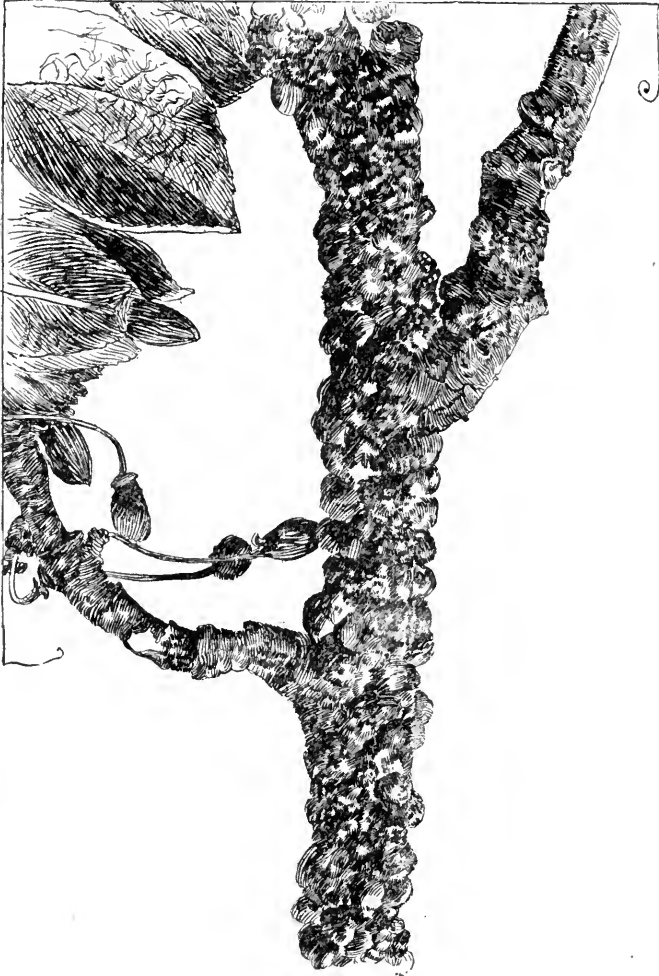

FIG. 953.

order that our readers may be able to recognize them we insert again a cut from Garden and Forest, showing a branch of Bradshaw seriously infested. Underneath these scales are masses of eggs from which the young lice issue early in May; they crawl about till they find a suitable location, usually on the under side of a limb, where they attach themselves to the bark. Infested trees should be sprayed with kerosene emulsion, diluted four times; apply once in fall and twice in spring, before leaves open.



## ❖ The Garden and Lawn. ❖

### FLORAL NOTES.



THE Asclepias is a very showy flower. Patches which are found growing along the railroads and elsewhere, are quite brilliant and noticeable. It is equally fine when cultivated.

— Cardinal Flower, which is difficult to find in the wild state, has a splendid shade of scarlet which is rivalled by very few flowers. Plants make but little growth the first year, but the second summer the flower stems will grow four feet high.

The Candytuft is a popular flower, the pure white being in much demand for bouquets. Several new sorts have been lately introduced. The Dwarf Hybrid, first sent out from France, has seldom been over praised. The plants are of excellent habit and flower profusely. From this strain we get some new shades of color. From England we have got Carter's New Carmine and White Tom Thumb, the first being a fine pink color, but we have the same shade in Dwarf Hybrid, which is superior in habit and vigor. The weak constitution of Carter's is proved by the scarcity and high price of its seeds. The White Tom Thumb is very distinct. Well-grown plants will cover a foot in diameter and not be more than a foot high. They are a mat of white flowers.

For a budding geranium in a sunny position nothing can surpass the Queen of the West. Some of the best roots under glass, such as Jealousy, Wonderful, and Harry King, are quite worthless when planted outside. New Life is novel and distinct and very popular as a window flower.

The late perennial phloxes present an endless assortment of colors, and a bed of old roots will produce so many spikes that one can pick without any feeling of regret. The improvement of late has been so great that many new colors have been produced with flowers and spikes double the size of the old ones.

The Wall flower leaved stocks are of the greatest value on account of their flowering so early and surely. The colors are not as numerous as in some other

classes, but the foliage is a bright fresh green and the plants are of excellent habit.

Single Japan pinks are not as highly prized by most persons as the double, but the improvement in them has kept pace with the double varieties. In the *Heddenigii*, the plants are rather dwarf, and the flowers are large, smooth and circular, and very rich in color. In the *Laciniatus* the flowers are tall and they are the most showy of all. The flowers are very deeply fringed and present an elegant appearance. The single sorts that always come with the double seeds, are not to be compared with those from pure strains.

*Tiverton.*

A. H. CAMERON

### PRUNING HOUSE PLANTS.

The average plant grower does not seem to understand the advantage that comes from the free pinching back of thrifty plants, to induce them to break into a greater number of shoots and to keep them compact in form. For a little convincing experiment in this line, I know of no better subject to begin on at this season than the German ivy, a plant found in almost every collection. One calculates on the use of these plants in the vases or window boxes to be started several months later, and for that purpose it is much more satisfactory to have a plant in the style of Fig. 955, than a sprawler supported by trellis and twine, as at Fig. 954.

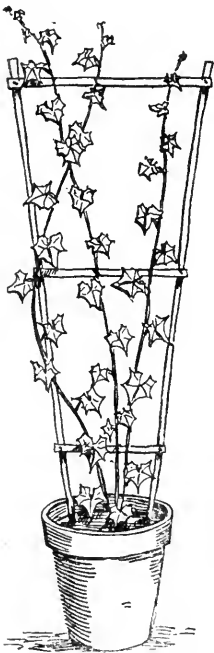

FIG. 954.



FIG. 955.

The latter form is the one most usually met. To produce the more desirable shape, it is only necessary to cut the plant back to within three inches of the ground setting aside the trellis also. One branch, however, had better be left for ten days longer in order that the check to growth be not over severe at one time. As new shoots appear, cut these back one-third when they have reached a length of eight or ten inches.—*American Gardening.*

## THE GLADIOLUS: DEGENERATION AND REVERSION.



N all the articles on these questions, the term gladiolus only is used. This was sufficiently comprehensive five years ago, but to-day there are several sections, and in giving experience, the amateur would be better enlightened, if sections to which such remarks apply were stated. Assuming that the old Gandavensis section is referred to, I claim that degeneration is due to the exhaustion of the vital forces necessary from reproduction, this exhaustion showing after blooming, and more particularly after seed raising, and also that this weakness is caused by excessive incrossing, thereby minimizing the power of resistance against the weakening effect of even attempted reproduction.

Reversion is quite another thing ; all hybrids are liable to this result, until they are "fixed," that is, their individuality established by the proper balancing of the vital forces in their composition. Change of soil or climate may effect this unbalancing, with a consequent reversion to the most potent species from which they originally descended.

Now, as to the advice given in American Gardening of 21st March, "that where such failure does occur, growing gladiolus should be abandoned." This means practically that growing the gladiolus in America should cease, and for that matter, everywhere else, for from Europe comes the same cry, and from the Atlantic to the Pacific in America, but all in the Gandavensis section. Do not understand that I am condemning this section as a whole; by no means, but here the general failure is found.

In support of my contention in this respect, let me say that many varieties of Gandavensis which bloomed with me several years ago, have not done so since, or, if so, they have degenerated, or reverted, beyond recognition. The block devoted to them is an eyesore in my trial grounds, so many failing to bloom, or even to grow at all.

As a decided contrast to this, stands a block of new hybrids, practically all growing with the greatest vigor, and blooming year after year, from old corms, to a degree satisfying beyond expression.

My advice to the lover of the gladiolus is, do not discontinue its cultivation, but test the various sections, and make choice suited to your taste and locality. Grow yearly from seed representing the greatest advance, as this places you far ahead in quality of bulbs available at low prices. If you will pay the price by all means get the bulbs, but raise your seed as well.

*Simcoe, Ont.*

H. H. GROFF.

**Cannas** should be started in boxes in the house and then planted out when all danger of frost is over. Good results are not likely to be got by starting them in the open ground.

## OUT-DOOR ROSES.



HERE are two distinct classes of roses for out-door use, namely, hybrid remontants, or hardy roses, such as Gen. Jacqueminot and Baroness Rothschild, and secondly the more tender, or monthly roses, as they are generally termed. The monthlies are not nearly as large or attractive in general appearance as the remontants, but they produce flowers much more freely, in fact some of the varieties are never out of flower from early June until late fall, and to the beginner they are likely to give the best satisfaction. In either case the preparation of the ground would be the same.

Select an open spot, free from the shade of trees, and at least thirty to forty feet from any large tree either way. If the soil is poor or has been used for roses before remove it entirely to the depth of eighteen inches, replacing it with a compost of good fresh loamy soil three parts and one of manure, well mixed up. Where the fresh soil is good enough add manure to it liberally and dig it over eighteen inches deep. If sod ground is used turn the grass down to the bottom, and thoroughly incorporate the manure with the soil as the work goes on.

Monthly varieties can be planted somewhat closer than hardy varieties. A circular bed six feet in diameter will take about seventeen or eighteen strong plants, that is ten in a circle, ten inches in from the margin, six in the next and one in the centre, or you may plant them in some part of the garden where a differently shaped bed is more desirable. In many places the entrance to the vegetable garden can be improved in appearance by planting a few flowers near it, particularly where blossoms are wanted for decorating the house; and such a place is a desirable one for monthly roses and leaves the beds on the lawn unmolested. As roses are generally cut pretty freely for table decoration it may be advisable not to place them in a conspicuous spot, and in that case a square bed or border would be better than a prominent flower bed. I would advise planting the roses in rows two feet apart and fifteen to eighteen inches asunder. Planted in this way anyone can readily estimate how many plants it will take to fill the space at disposal. In planting with a garden trowel dig out a hole deep enough to place the roots in, so that the ball of earth adhering to them is buried about half an inch below the surface. Press the soil firmly around the ball, leaving a shallow dish around each plant to hold water, which should now be given. Should it be very dry weather at the time, the plants should not only be well watered at the time of planting, but should have two or three good soakings of water within the next week or ten days; at the end of that time they will have started new roots and begin to show new leaves also. As soon as this occurs rake the surface of the soil level and cover the surface of the beds with any loose litter at hand. In case there should not be anything else available excelsior



packing makes one of the very best mulchings I know of, it is clean and neat in appearance, and fifty to one hundred pounds put on one and a half inches thick will cover a large bed. This keeps the soil in a moist condition, thereby inducing free root action, with rapid growth, which means an abundance of roses. Should very dry weather continue the bed should have a good watering at least every ten days. There is another important thing in favor of the excelsior mulching, having no weed seeds in it they will grow if the soil is kept covered with it. Cut off all decaying blooms as fast as they show signs of going past their prime.

Good sized plants such as would be in 4-inch pots at the time of planting should always be used. Very small plants are hardly ever satisfactory, as the season is nearly over before they produce anything like a crop of flowers. The best time to plant such a bed is about the first week in May.—Ex.

---

**Roses in Window Gardens.**—To have healthy roses in the house the plants should be washed and syringed frequently, and they must have plenty of light and sun. They have to be watered whenever the soil becomes dry. Then they should have enough water to saturate the entire ball of soil, but not so much that the water stands around their roots in the saucers beneath them, which is a rule to be observed with all house plants except aquatics. Fading flowers have to be removed at once. Straggling branches should be cut off. Few plants bear pruning better than the rose. Keep a constant look-out for insects.

---

**All Fruits** have a medicinal value, and the cranberry ranks as an anti-scorbutic. It is a blood cleanser; bruised and heated, not cooked, it has a healing effect on humors. One cut in half and bound on a corn will cure it in one of more applications. It will be equally efficacious in the case of pimples. As an article of food the cranberry is too little known. Many families know it only in the form of sauce, but it may be served in many other ways. A cool, refreshing drink may be made by boiling the berries in water double the measure of berries. Boil until the juice has been thoroughly extracted, sweeten with one half-pound of sugar to the pint of juice, and bottle hot. Greengrocer.

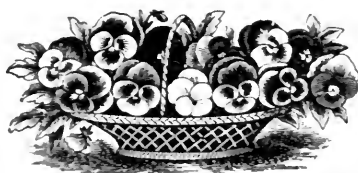

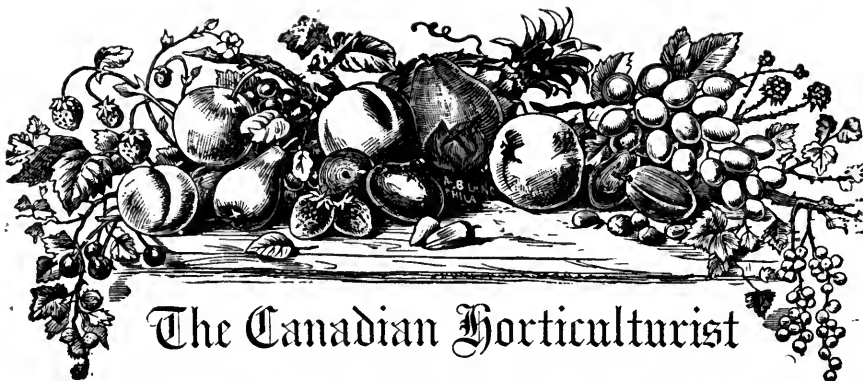

## The Canadian Horticulturist

SUBSCRIPTION PRICE, \$1.00 per year, entitling the subscriber to membership of the Fruit Growers' Association of Ontario and all its privileges, including a copy of its valuable Annual Report, and a share in its annual distribution of plants and trees.

REMITTANCES by Registered Letter are at our risk. Receipts will be acknowledged upon the address label.

### ↻ Notes and Comments. ↻

THE FRUIT PROSPECTS in Ontario are unusually bright at present ; apples, pears and cherries are full of fruit buds, and even the peach tree in the Grimsby district shows an abundance of live buds. But

“There's many a slip  
'Tween the cup and the lip.”

and who knows what killing frosts may succeed the abnormal heat of April ?

---

HORTICULTURE AS AN OCCUPATION is the subject of an excellent article by Prof. Hutt, in the February number of the O. A. C. Review, in which the author believes that the prospects of fruit growers, notwithstanding the many discouragements, are growing brighter every year. In his opinion the increased shipping facilities, the improved varieties in fruit, the discovery of successful methods of overcoming fungi and insects, all combine to open out an improved era of successful fruit growing.

---

UNPRUNED RASPBERRIES, that is those not shortened in summer, were found by Mr. Craig to yield more fruit than those which were pruned. For example, a row of Cuthberts, 330 feet long, pruned, yielded only 35 quarts, while an unpruned row of the same length yielded 70½ quarts.

This agrees with our experience at Maplehurst, where we have noticed that summer pruning of both blackberries and red raspberries seems to lessen the crop. The blackberries however, seem to do better if pinched back in the growing season.

THE REPORT OF THE DOMINION EXPERIMENTAL FARMS is very extended, and shows what enormous amount of work is in hand. The work of the Fruit Experimental Stations of Ontario will supplement and extend the good work undertaken by the Dominion Horticulturist, by testing the adaption of various good varieties of fruits to different localities of the province.

---

THE GENEVA GRAPE is a new variety of white grape, of good size, and fine quality; a good keeper. The vine is said to be hardy. We have sent out this grape to a large number of our subscribers this season, and we hope it will prove valuable.

The supply of this grape is now exhausted, and those still desiring the grape will receive the Colerain another new white grape, a seedling of Concord. It is also an early grape of good quality, and a very vigorous and healthy grower.

---

CHESTNUT GROWING promises to become an important industry in certain sections. The European varieties, such as Paragon and Ridgeley are the most profitable so far tested. One grower in Pennsylvania has 40 acres of wild chestnut sprouts grafted to Paragons. The tree bears yearly and the nuts are large.

The Japan chestnuts are not quite so good in quality, but are very precocious in bearing and very productive. The Alpha is supposed to be the earliest variety in existence; nuts large, two to three in a burr. The Giant and the Superb are two other Japan varieties of promise. The trees are from \$2 to \$5 each, but will soon be cheaper. In the meantime the Ontario Fruit Experiment Stations are setting these varieties at St. Catharines, Grimsby, Burlington, and Whitby, in order to ascertain whether they will endure our climate.

---

THE GRIMSBY HORTICULTURAL SOCIETY held their spring meeting in the Town Hall on Friday evening, the 17th of April. The managing committee had secured a large number of beautiful house and greenhouse flowers from the members, and filled a long table with them reaching down the centre of the hall. There were palms, hydrangeas, begonias, double fringed petunias, callas, oxalis, fuchias, geraniums, pelargoniums, coleus, Nile grasses, etc. The first hour was given to social greetings and viewing the flowers. Then the president called all to order and proceeded with the programme. Papers were read on the improvement of the lawn and on the cultivation of sweet peas, chrysanthemums, and begonias, besides some delightful instrumental and vocal music, and a recitation by Miss Pettit, the daughter of the President of our Association. At the close, the secretary gave to each member an ounce of sweet peas, two cannas, two chrysanthemums, two begonias and a special named variety of gladiolus. The membership now is 67.

## ❖ Question Drawer. ❖

### Peach Yellows.

**830.** SIR,—I would like some information concerning the peach Yellows, and peach Rosette; also the Brown Scale.

M. G. BRUNER, *Olinda.*

This is one of the most mysterious of the diseases of fruit trees, and one that is also the most destructive. It spreads throughout a whole orchard, and

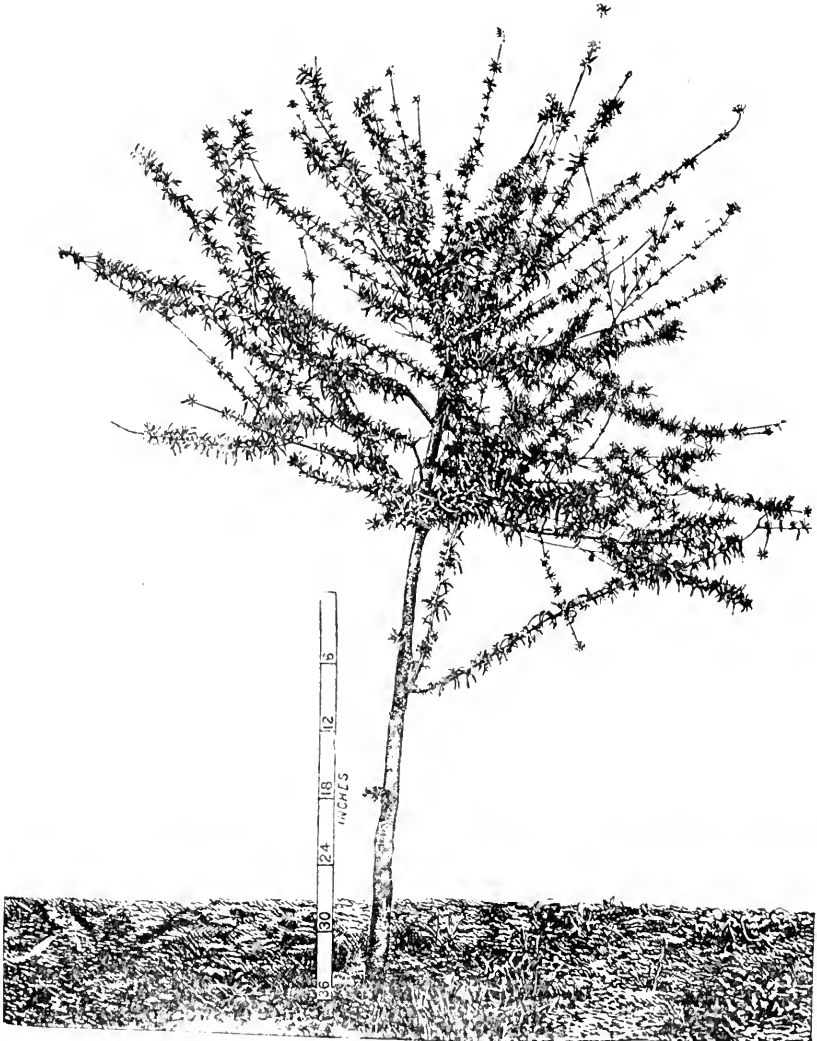

FIG. 956.—PEACH YELLOWS.

thence throughout a whole district, soon ruining all the peach orchards, no matter how young or how vigorous. No large peach growing centre is long safe from the disease. When it first appeared in Ontario, some twenty years ago, we thought the affected trees were some extra early variety, which was worthy of propagation. Imagine our disappointment to see the precious trees die within a year or so after displaying this wonderful earliness of season.

The first symptom of yellows of the peach is in the fruit, which ripens prematurely, and is marked with bright red spot on the skin, and red streaks in the flesh, often running to the pit. Another symptom, usually among the first to be observed is the appearance in the fall, of short yellowish tips, bearing a whorl of small, narrow, yellowish leaves. Abnormal branches also frequently appear on the main portions of the tree, leaving short narrow leaves, and often branching in to several fine branchlets forming a bunched growth. The peach rosette is a common form of yellows, which is readily distinguished from the natural growth, and at once marks a tree as diseased. The form is shown in the accompanying engraving from Bulletin 9, U. S. Dept. of Agriculture, and is only too familiar to many Canadian peach growers.

The yellows first appeared in Canada about 1876, as near as we can remember, and quite discouraged peach culture in some localities. Of late, however, since we have become familiar with its appearance and its dangerous nature, we have been able to keep it under control by adopting vigorous treatment. Every year during fruit season we go through the orchard with a large knife, and blaze every tree showing the least symptom of yellows, as a mark of doom, and as soon as pressing work of harvesting is over, we destroy these trees root and branch. This is the only way to save one's orchard from total ruin, for in some mysterious manner, either by spores or by bees, the disease spreads rapidly throughout a whole orchard.

---

### Ice House Sawdust.

**831.** SIR,—Can too much sawdust be put around and over ice in an ice house, and does it heat?  
A. B. CORMAN, *Iroquois*.

No doubt there would be danger of heating if too much sawdust were used. A foot thick around and over the ice is sufficient, and six inches deep underneath.

---

### Pruning Roses.

**832.** SIR,—Please tell me how to prune roses?  
M. D., *Peterboro'*.

We quote in reply from CANADIAN HORTICULTURIST, 1893, p. 119, where Webster Bros. advise as follows :

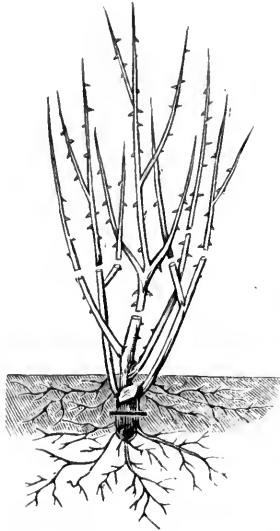

FIG. 957.—Showing depth to plant and how to prune budded Roses.

PRUNING.—Hybrid Perpetual roses should be pruned in the spring, when growth has nicely started, because if pruned too early and vegetation is checked by a cold day or night, the sap will fail to reach the extremities of the canes and it will be necessary to again prune back two or three buds, or leave unsightly dead ends on the canes; by delaying to prune till the weather is settled this trouble is obviated. A good rule to observe, in pruning Hybrid Perpetual roses, is to trim the weakly growing varieties back closely, while those of a stronger growth should not be cut so close.

The accompanying cut will give a good general idea as to planting and pruning. Mosses require only to be slightly shortened and the oldest of the canes removed, also any weakly growth cut away. Hardy climbers require the old wood removed, as it loses vigor, together with a judicious thinning out of young wood, cutting away what cannot be neatly tied into place. The tender or ever-blooming roses require a method of pruning peculiar to themselves. In the spring they should be carefully pruned, all dead or weakly wood being removed, and from time to time during the season, as blooms are cut, the wood should be shortened to a strong eye with a view to induce the growth of strong shoots from near the ground, or even from below the surface. This wood will be found to produce the finest roses.

### Gooseberry Training.

**S33.** SIR,—Would you form the crown of your gooseberry bushes above, or below the surface?

*Reply by Stanley Spillett, Nantyr.*

In planting a bush, I should keep the crown above, but in renewing from year to year, I would give preference to a good strong shoot starting from below the surface.

**S34.** SIR,—If the second form is preferred, would you remove the earth so as to cut the old stem at its junction with the main stem, and, if cut at the surface, would not a great growth of weak sprouts be the result?

*Reply by Stanley Spillett, Gooseberry Specialist.*

So far I have cut at the surface, and, if too many shoots sprang up, have cut away what I did not need for renewal.

**835.** STR.—I have trimmed all my plantation to about six stems each, and shall allow no new wood to grow till I have had three good crops; then I shall cut one stem away and permit a new one to grow in its place. Is this about right, and shall I not have a larger crop of larger fruit, by allowing the bush to use all its sap for the growth of fruit, instead of part of it going to the growth of new wood?

*Reply by Stanley Spillett, Nantyr.*

In theory this seems about right, but in practice I find that just as large berries, and as many of them, will be produced, if a couple of good strong shoots are allowed to grow at the same time.

The error seems to be in assuming that a tree has so much energy, and we can do no more than direct this to either growing wood or fruit.

Meehan, I think it is, contends that every plant regulates its root growth to its foliage. The more leaves, the more roots. He maintains that the suckers from the roots of apple or plum trees, though unsightly, and therefore ought to be cut away, do not rob the tree of nourishment, as the root growth is proportionally increased.

---

### Coal Ashes.

**836.** STR.—Would you kindly inform me if you consider coal ashes good for young trees. Some whom I have been casually talking to state that it is, others claim that it has a tendency to harden the land after the first year. If you would give me your opinion in the matter it would oblige me very much.

W. COWIE, *Port Colborne.*

Coal ashes have little or no value as a fertilizer. They form a good mulch on the surface about a tree to retain moisture, and mixed with the soil it has a useful mechanical effect, in rendering it more porous.

---

### Powdery Mildew in Greenhouse.

**837.** STR.—I have a small 8x10 greenhouse, 6 ft. high from front wall, for starting flowers and early tomatoes. I have Black Hamburg grape vine in it, just coming into bearing, but the leaves are turning brown through either some disease or some insect. Could you suggest a remedy?

WM. DICKSON, *Parkhill, Ont.*

*Reply by Mr. J. Craig, of the Central Experimental Farm, Ottawa.*

I cannot gather from the above description what the disease or insect is or might be which would cause the injury described. An effect of this kind is produced by a severe attack of the powdery mildew, one of the *Uncinula* tribe. For this I would spray the vines with Bordeaux mixture early in the season, and follow with sulphur applied in the ordinary way. Such an effect in a general way is also produced when the leaves are badly attacked by the grape vine leaf thrip. The remedy for this insect is kerosene emulsion.

### How to Apply Commercial Fertilizers.

**838.** SIR,—How can I apply commercial fertilizers to the soil in the cultivation of garden stuff, potatoes, corn, strawberries, and fruit trees to get the best result?

*Reply by Professor Hutt, Ontario Agricultural College, Guelph.*

There are so many kinds of commercial fertilizers, and such a variety of soils that I am inclined to believe that each grower must find out by his own experiments which fertilizers will give the best results on his soil. Barnyard manure is the best general fertilizer, and should not be discarded for any other until experiments have shown that something else will surpass it. The various kinds of special fertilizers may well be tried along with it, and the results noted. Nitrate of soda, in small quantities, should give good results on early vegetables. Superphosphate gives good results on soils lacking in phosphate. Unleached wood ashes is one of the cheapest and best potash fertilizers, and on light sandy soils give good results with nearly all crops. It is a specific fertilizer for fruit trees, vines and bushes. All of these fertilizers should be sown broadcast and worked into the soil with the cultivator.

---

### Fruits for the Home Garden.

**839.** SIR,—Kindly name the best varieties of fruits for the home garden,

H. H. A., *Toronto.*

The following are good for the home garden, and would probably succeed at Toronto:—*Raspberries*: Brinckle's Orange, Turner, Cuthbert, Hillborn. *Blackberries*: Agawane, Snyder. *Currants*: Cherry, White Grape, Black Naples. *Cherries*: Early Richmond, Montmorency, Windsor. *Gooseberries*: Pearl, Downing, Whitesmith. *Grapes*: Geneva, Concord, Laidley, Vergennes. *Plums*: Renie, Claude, Bradshaw, Imperial Gage.

---

### ✱ Open Letters. ✱

#### The Gentle Bees.

SIR,—I see you have McArthur's advt. What he states is not true; the North American Convention never admitted his bees were the gentlest; his name or his bees were never even mentioned in the convention.

R. F. HOLTERMAN.

---

#### Lovett's Best Blackberry.

SIR,—Some one was inquiring about the success of Lovett's Best Blackberry in Ontario. We have grown it three years, and no fruit. It has been killed to the snow line every winter. The \$1,000 Black Cap is too small a berry for us, where we can grow Hillborn and Older to perfection. Success to the CANADIAN HORTICULTURIST,

ALF. BROWN, *Pictou, Ont.*



### Fertilizing with Corn Cobs.

SIR,—In the Annual Report of the Ontario Fruit Growers' Association for 1891, which I have had the pleasure of receiving, I have read some discussions on the proper fertilizer for apple and other fruit trees. Will you allow me to give, what I was many times told down in *Old Kentucky*, where I lived for several years, was the best means to fertilize such trees? "Dig the whole surface a spade deep around the tree, and some four or five feet out from the trunk, throwing the soil outside; then fill in to the depth of three or four inches with corn cobs, cover up with the soil again, evenly, and leave it. Of course the cobs will not decay immediately, but their general decomposition will feed the tree by the roots and prove of great benefit."

Since writing the above, the thought has struck me that if the soil was roughly broken up, under the trees, and ground or crushed corn cobs scattered thickly on the surface, in the autumn, the moisture of winter rains and snow would help decompose the intended fertilizer and carry the strength or virtues of it down to the roots. This I think would be to obtain the advantage quicker than the other, cruder plan, and a greater number of trees could be so treated from the same quantity of original cobs, annually; and if the application showed a benefit, the number so treated could be increased indefinitely, according to the quantity of cobs saved and collected.

J. P. D., *Amherstburg, Ont.*

---

REPORT OF OBSERVATIONS OF INJURIOUS INSECTS AND COMMON FARM PESTS, during the year 1895, with methods of Prevention and Remedy. By Miss Eleanor A. Omerod, F. R. Met. Soc., etc. 1896. Published at London, by Simpkin, Marshall Hamilton, Kent & Co. One of the most interesting works on insects available.

---



## Getting Ready.



**I** CAN almost hear the stirring,  
The whispering down below,  
Where earth's sweet tender darlings  
Are beginning now to grow.

Dear Violet is waking,  
And Buttercup mayhap,  
And Mother Earth is weaving  
Soft siik for each new cap.

She is weaving Daisy's fringes,  
And carving Cowslip's cup;  
She is calling Honeysuckle,  
And bidding her come up.

And the blossoms will not tarry,  
For they say to one another,  
"Dear sisters, haste, make ready  
To obey our faithful mother."

Each of the host of grasses  
Will bring his emerald feather,  
Alone they are too small to help,  
But mighty all together.

—*Mary M. Betts.*

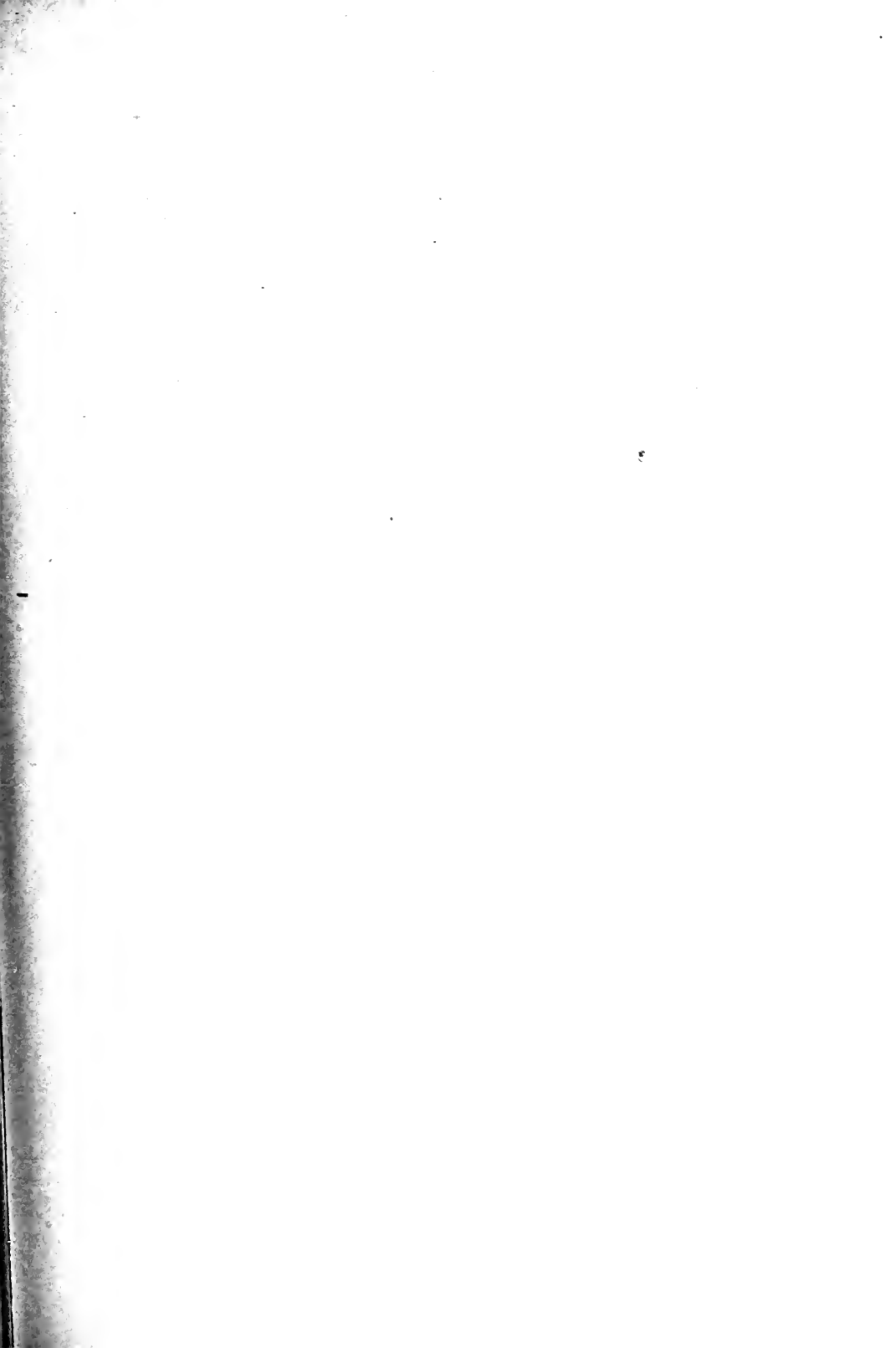



STECHERT & SONS, N.Y.

GABRIEL LUIZET.

THE  
Canadian Horticulturist

VOL. XIX.

1896.

No. 6.

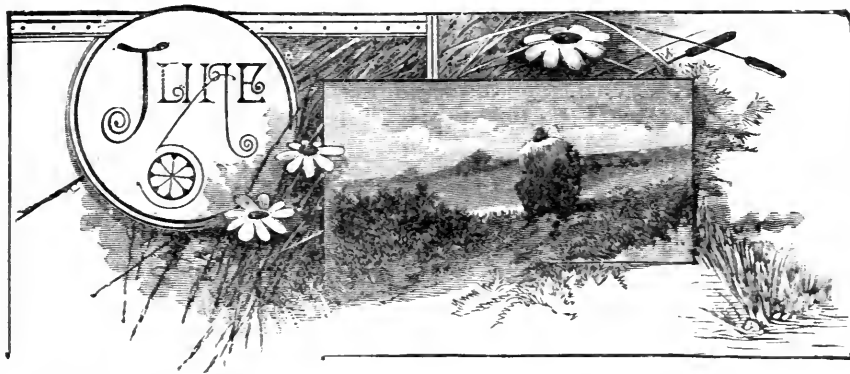

GABRIEL LUIZET ROSE.



HIS excellent rose made its bow to the Ontario Fruit Growers Association last spring (1895) when a large number were distributed among our members. Some of them should bloom this month, and our readers will be able to compare their specimens with our frontispiece.

It is still a new rose to many, but is bound to take its place among the most beautiful, and, what is still more in its favor, as one of the sweetest of the hardy kinds. It is admired for its lovely coral red, suffused with lavender pearl; also for being so double and so free in blooming.

Many amateurs fail to grow good roses because their soil is too light and sandy. Such soil should be in part renewed and a compost of clay and manure dug in about the plants, if good blooms are desired.

Then in their display in vases, many mix them in a tight bouquet of other flowers, a most unfavorable style for the best effect. Roses should rather be in a vase by themselves, with long stems, not too closely confined.

Other amateurs are discouraged because of the aphid, and seem never to realize how easily it may be destroyed by using kerosene emulsion.

The Hatch Experiment Station reports in its experiments on insects that twelve rose bushes of different varieties were placed in the insectary greenhouse last April, and as they were infected with plant lice and red spiders those insects were allowed to multiply until the lice literally covered every green twig and more or less of the surface of the leaves. The red spiders also had become

exceedingly numerous on the leaves. A pailful of kerosene emulsion was prepared, and each rose bush was inverted and dipped into it and held there about a quarter of a minute, or long enough to allow the emulsion to reach every insect on the bush. In immersing it in this way the pot was held in the left hand with the right hand over the top, to prevent the earth from falling out. An examination of the bushes two days later failed to reveal a single plant louse or red spider, and none appeared on them during the remainder of the season, thus proving that the work was thorough and effectual. When rose bushes are too large to be treated in this way they may be showered.

The Hatch Station prepares kerosene emulsion in the following manner :— One quarter of a pound of common bar soap is dissolved in two quarts of boiling water, and while still hot four quarts of kerosene oil are added, the whole mixture being then churned through a small hand force pump, with a small nozzle turned into the pail. This churning must be continued about five minutes, until the whole forms a creamy white mass, which becomes jellylike when cool. Care must be taken to have the solution of soap hot when the kerosene is added to it and the churning done, but it must not be near a fire.

Before applying the kerosene emulsion to plants it must be diluted with water in the proportion of one quart of the emulsion to nine quarts of water which must be thoroughly mixed. The above will make sixty quarts of the insecticide ready for use. The emulsion will keep for a long time without injury and may be diluted when needed for use. This insecticide is one of the best substances for the destruction of vermin on domestic animals and in henhouses.

---

### COMPOST FOR ROSES.

The best soil for roses is what is known by gardeners as a rich hazel loam of a moderately firm texture. Cut it with a spade from three to nine inches thick, according to quality. Where it can be had in the form of old sod, clear of trees (as decaying leaf mould is absolutely injurious to roses), it is so much more valuable. In soil as described above, the roots of the grasses will form a dense fiber all through it, sometimes ten to twelve inches deep; then I prefer to take the whole depth, and if a yellow clay below should add some to the compost. The next thing required is well-decomposed cow manure; this, if possible, should be at least one year old. This on hand, commence your compost heap, to every eight or nine loads of good loam, adding one load of equal size of manure, and so continue until enough is collected for the season's use. Where the soil is inclined to be heavy, add one part to ten of good sharp sand as you go along; let it lie a few days to get settled. If it heats, so much the better. Turn the whole over and beat it up fine with digging forks; if it is not considered rich enough, add a little pure ground bone, as it is mixed to go into the houses, and you have a compost that will grow good roses if judicious care is taken of the plants.—American Florist.

## THE INFLUENCE OF A WHITE ROSE.



HE far-reaching influence of a little act of kindness, accompanied by "just a white rose," is beautifully shown in the following story told in *The Silver Cross*. Kindness and sympathy are rarely wasted on the unfortunate :

A wealthy lady, young and beautiful, who had lately experienced genuine conversion, was so overflowing with love for the Saviour that she was drawn to visit those who were in prison. One day, before starting on this errand of mercy, she went to her conservatory and her gardener gathered her up a large box of flowers and was about to tie it up for her when she noticed a perfect white rose untouched, and asked that it be added.

"Oh, no!" he said, "please keep that for yourself to wear to-night."

"I need it more just now," she said, and took it with her on her journey.

Reaching the prison she commenced her rounds among the women's wards, giving a few blossoms to each inmate, with a leaflet, a text, or a message of sympathy and Christian hope.

"Have I seen all the prisoners here?" she asked the jailer.

"No; there is one whom you cannot visit, her language is so wicked it would scorch your ears to hear it."

"She is the one who most needs me," she answered. "I have one flower, the choicest of all I brought; can you not take me to her?"

Then when they confronted each other on either side of the grated door, the visitor was greeted with curses, and the only reply she gave was the beautiful white rose, which was left in the woman's cell. As she turned away she heard one heart-breaking cry, and the voice that had breathed imprecation moaned over and over again the one word, "Mother! mother! mother!"

The next week she came again. The jailer met her, saying: "That woman whom you saw last is asking for you constantly; I never saw a woman so changed."

Soon the two were alone in the cell, and the penitent, her head resting on the shoulder of her new found friend, told, with sobs, her sad story—

"That white rose was just like one which grew by our door at home in Scotland, my mother's favorite flower. She was a good woman; my father's character was stainless, but I broke their hearts by my wicked ways, then drifted to America, where I have lived a wicked life; is there any hope for me?"

And so the dawning of a better day came, as the two "reasoned together."

Many visits the lady made in that narrow room, until she seemed an angel of light to its inmate. When the time came for the woman's release, the love of Christ constraining her, she went out into the world to devote her life to the saving of such as she had been.

## EXPOSURE FOR A ROSE BED.

A friend inquires what is the best exposure for a rose bed. We would say that any exposure is good enough, the main point being to have the soil in proper condition, which is that it shall have good drainage and be well enriched. On a level surface, especially, must the drainage be well attended to, but this is scarcely less necessary on hillsides even of considerable declivity, if the soil is heavy. A slope to the east, or the north, we think most desirable for roses, for the reason that the blooms will last longer, and there is less danger from severe freezing in winter. A southern exposure might give a little earlier bloom but it would be of shorter duration and the danger of injury in winter is greater, and the same is true of a western exposure. But if circumstances should decide any one of these exposures it should not exclude the pleasure of a rose bed. Experiences might vary with the different exposures, and varieties which might succeed with one might not be so well adapted to another, but this is true in regard to all locations. The rose is so beautiful and desirable, and with moderate attention will bloom so generously, that it should be universally planted, and that not sparingly.—Vick's Monthly.

### Fragrance of La France Rose.

Not one of the least of the qualities we desire in a rose is fragrance ; in this regard all classes must do homage to La France, which H. W. Ellwanger characterizes as the sweetest of all roses. If he were compelled to choose one variety it would be La France. It is rather tender, but it can easily be protected, and so winter safely. It does not always open well, but it is a simple matter to assist it ; an operation not practicable with most varieties that do not open perfectly. If La France does not develop well, by pressing gently with the finger the point of the bloom, and then blowing into the center, the flower will almost invariably expand, the pent up fragrance escape and almost intoxicate with delight our sense of smell.—R. Y. N.

---

**Herbaceous Plants in Summer.**—The great majority of hardy perennial flowers are natives of woods or grassy places where the earth is shaded from the summer suns. When they are removed to open borders they suffer seriously from summer heat. It is, therefore, good practice in these open sunny situations to have the ground mulched,—that is to say, covered with something like decayed leaves or half-rotted straw, or anything that will prevent the scorching rays of the sun on the earth. Herbaceous plants do not care so much for bright sun as they do for a cool soil at the roots. For the same reason a loose, open soil is better for growing herbaceous plants than soil of a heavier character, because having more air spaces, it is cooler. In short, it is a cool soil more than shade that herbaceous plants require.—Mechan's Monthly.



## A FERN LUNCH PARTY.



COOL and pretty entertainment for the late summer is a fern party, and especially is it within the reach of all out-of-town residents. Gather from the woods as many ferns as you can, the largest to the smallest—each has its particular mission in the scheme of decoration. In sending out your invitations, paste neatly at the top of the card a tiny fern of delicate pattern. On the day of your entertainment, if the exterior of your house will lend itself to the plan, mass ferns generously around either post at the foot of the steps. Have them follow the railing, be arranged in shady corners on the porch, and, of course, meet the eye in the hall. In the dressing-rooms, over the white linen covers on the dressing table; lay the ferns so they will completely cover them, and decorate the mirrors, fire-places and mantels. Exquisite effects can be made at the windows with the soft lace curtains. In the drawing-room bank the mantle-pieces, and at one end tie a large, green satin bow, made of feather-edge ribbon. Tie bunches of ferns on the lamp-shades. You will find the green or ferns will blend with almost any shade of silk, but, of course, all striking inharmonious colors must be removed from the green.

When the guests enter the dining-room the effect should be that of going into a fernery. Bank the mantle as in the drawing-room. In the corners have large boxes filled with ferns, and arrange them to run up as high as possible, which can be done by the aid of tacks and fine green cord. Have the table laid with a fine white damask cloth, fern pattern, and at the two diagonal corners arrange gracefully loose bunches of the larger ferns tied with large bows of ribbon. The linen centerpiece should be embroidered in a fern design, and on it place a big glass bowl filled with the choicest specimens of the delicate plant. Set each plate on a mat of ferns, which can be easily made by covering a stiff foundation with them. The white candles should have green paper shades, and the entrees should, whenever permissible, be garnished with bits of green.—Landscape Architect.

**The Marguerite Carnation.**—One of the most charming summer flowering plants we have is the carnation, but, on account of its inability to withstand outdoor exposure, most varieties are propagated and grown in greenhouses. When set out in the garden they are very unsatisfactory, and on this account this lovely flower has been compelled to take a back seat, and give place to the more hardy varieties. However, with the advent of the Marguerite, a fresh impulse has been given to the growing of outdoor carnations. At the present time the writer has a bed of Marguerites which were grown from seed planted last April. The plants are very stocky and compact, and full of buds, while some are just opening, and in spite of six weeks without a drop of rain, they are as varied in color and as double, and almost as large as the best greenhouse-grown specimens, and I think in fragrance even surpass them. The second season is when they will appear at their best. They are quite hardy. I find no difficulty in keeping them over winter if the plants are carefully covered with some coarse litter, straw, forest leaves, or evergreen boughs. As a large packet of seed can be procured from any florist at a very small cost, every lover of fine carnations should give the beautiful Marguerite a trial.—American Agriculturist.

## THE CULTIVATION OF THE CANNA, SWEET PEA, ETC.

*A paper read before the April Meeting of the Woodstock Horticultural Society,  
by Mr. John Pike, Gardener and Seedsman.*

### The Canna.



AS we are to be supplied with roots of this plant through our local Society, perhaps the following remarks, and the criticisms on this paper will give us the necessary information how best to cultivate and care for them. Canna is the Celtic name for cane or reed as its habit of growth also implies. The Canna is an extensive and very ornamental order of tender herbaceous perennials; most of them have showy flowers; they are also grown for the remarkable beauty of their foliage, and are equally effective either planted singly or grouped in beds.

The cause for the recent popularity of this plant may be attributed to it being used so extensively for ornamentation at the World's Fair, a few years previous to which vast improvements had been made in them by the introduction of the new dwarf large flowering French strains, which are of the ever-blooming class. This flower is now out-doing all other summer bedders. Every season their splendid flower and foliage effects are increasing in public parks and private grounds; they also make handsome pot plants, grown in large pots or tubs. I believe the American nation has never decided upon a national flower, although there was considerable discussion upon the matter a few years ago, but I presume they are content to keep to the old adage, expressed in the following lines:—

France has the Lily, England the Rose,  
Scotland the Thistle which everyone knows,  
While Ireland has the Shamrock which grows on the hill,  
But the American emblem is the \$1.00 bill.

Why could they not claim the Canna, as it is known that with the Four hundredth Anniversary of the discovery of America, the average American flower grower first adopted this plant.

Cannas may be grown from seed planted early in greenhouse, hot-bed, or pots in the house. The great difficulty in getting seeds to start (on account of the extreme hardness of the shell) may be overcome by soaking the seed in hot water, or else break away a portion of the outside shell, so that the moisture will penetrate and facilitate their germination. Plants started from seed will usually flower by the end of July, and continue to bloom until frost; these plants may then be lifted into pots and will flower far into the winter; but where results are desired the first summer, it is better to propagate from divisions of the roots. Start the bulbs in pots in March or April, not using much water until they start into growth; then water freely and place in a good light. June 1st is early

enough to trust the plants out doors in this latitude. Cannas will thrive on not too rich soil, if well watered.

Taking care of the roots in winter is often a failure, owing to not understanding what conditions they require ; some rot them with water. They require about the same treatment as a Dahlia root, viz. : take up the roots in October, and, after letting them dry a few days, store away in a cellar, free from frost and where the air contains some moisture, so that the roots can take up moisture out of the air, and not the dry air take the moisture out of them ; kept near a heap of potatoes or other roots would be about the right place for them. The flowers of the dwarf French class are similar to the Gladiolus, but excelling them in brilliancy of color and markings. The newest addition in Cannas, "Queen Charlotte," comes from Germany, a description of which I will read, as anything better or more attractive than we already have in the French class, is worth consideration :

"This grand Canna was raised in Germany and sent out under the name of 'Königen Charlotte' ; this we have changed to 'Queen Charlotte,' by which name it would eventually be known in any case, *Königen* being the German for *Queen*.

"From the first successful attempt to improve the Cannas, their future and possibilities led all to anticipate what might be accomplished by continued and intelligent effort toward improving them.

"Hitherto we have been especially indebted to Mons. Crozy for enabling us more vividly to realize these glorious possibilities, and after the introduction of Mad. Crozy Canna, connoisseurs thought the culminating point of perfection had been reached. But it is apparent from this that nature knows no limit, and 'Queen Charlotte,' the acknowledged Queen of Gilt-edged Cannas, affords another example of those unexpected results which revolutionize theories and mark an epoch in the history of successful hybridization.

"When seen in groups, the brilliancy of 'Queen Charlotte' dazzles the eye with its brilliant scarlet-crimson, massy gold and rich orange-scarlet, separate and distinct, yet blended as only Nature can blend and harmonize in her own workshop and in her own way. The grand color effects produced can only be conceived by actual observation, and but faintly expressed by the most minute and accurate description ; the intense velvety crimson of the ground color, melting through the massy gold bands which belt it round, reflects upon the eye in different tints and tones, until its defining power is lost in admiration of the feast of crimson and gold presented to it.

"As a pot plant for winter flowering, 'Queen Charlotte' has a brilliant future, while for massing it needs no prophet to foretell that it will, before long, be given first place in the flower garden of every park, cemetery and private garden throughout the world."

Some of the species are edible, being grown extensively in Peru and the Sandwich Islands as a vegetable, from which we also obtain arrowroot—which

makes an excellent invalid's diet, but now largely supplanted by less nutritious Scotch oatmeal, American corn starch and other cheaper preparations.

### Annuals.

It is now in season to consider the starting of Annuals, as the bulk of our summer flowers are derived from them. Hardy Annuals, such as Nasturtium, Mignonette, Candytuft, Sweet Peas, etc., may be sown in the open ground in April or May; tender Annuals, requiring protection, should be sown in the greenhouse or hot-bed. We also hear a good deal of a few seeds started in a box in the house; this appears to me to be a backwoods custom, and handed down since before the time of commercial plant growers. The plants so raised are usually about fit for the same fate as the doctor recommended for the cucumbers, who said: "First pare the cucumbers, then slice them very thin, add salt, vinegar and plenty of pepper, then raise the window and chuck them out." The plants are unhealthy without the proper surroundings to give them a start in life; it is better to buy plants properly raised. The sowings may, however, be delayed until the ground is warm out-doors, say, the middle of May, in which case they will bloom later.

### Sweet Peas.

Although an old-fashioned flower, they are again gaining in popular favor. It delights in a cool, moist soil. Sow the seed as early in spring as possible; the seed will germinate in a low temperature, and make considerable growth in the cool, moist, spring-time. To cater to its proclivity for moisture (in situations where it will allow of it), it is better to plant in a trench a foot deep, covering the seed about an inch and gradually drawing the soil to them as they grow, taking care not to cover the crowns at any time. Potash, in the form of wood ashes, is an excellent fertilizer; they love plenty of water, and soap suds is a good way to apply it, poured into the trench. It is very necessary to pick off all blossoms, as, if they are allowed to go to seed-pods, the vines will die off early. Some of the best varieties are: Emily Henderson, pure white; Blanche Ferny, pink and white; Orange Prince, Painted Lady, Countess of Radnor, mauve; Monarch, a rich purplish maroon, and a number of others of the large flowering class. Several colors in double Sweet Peas are now sold, but they do not come true from seed, and are rather disappointing.

### Cupid Sweet Peas.

The unique floral novelty for 1896, the first of a race of dwarf Sweet Peas. We have heard much and seen little of this novelty, as this is the first year it has been offered; preliminary notices were sent in July last, that this wonder would be simultaneously offered for sale in all parts of the world. It originated as a sport in 1893, with Mr. C. C. Morse, of Santa Clara, Cal., who sold the stock to Messrs. W. Atlee Burpee & Co., who have since grown it true from

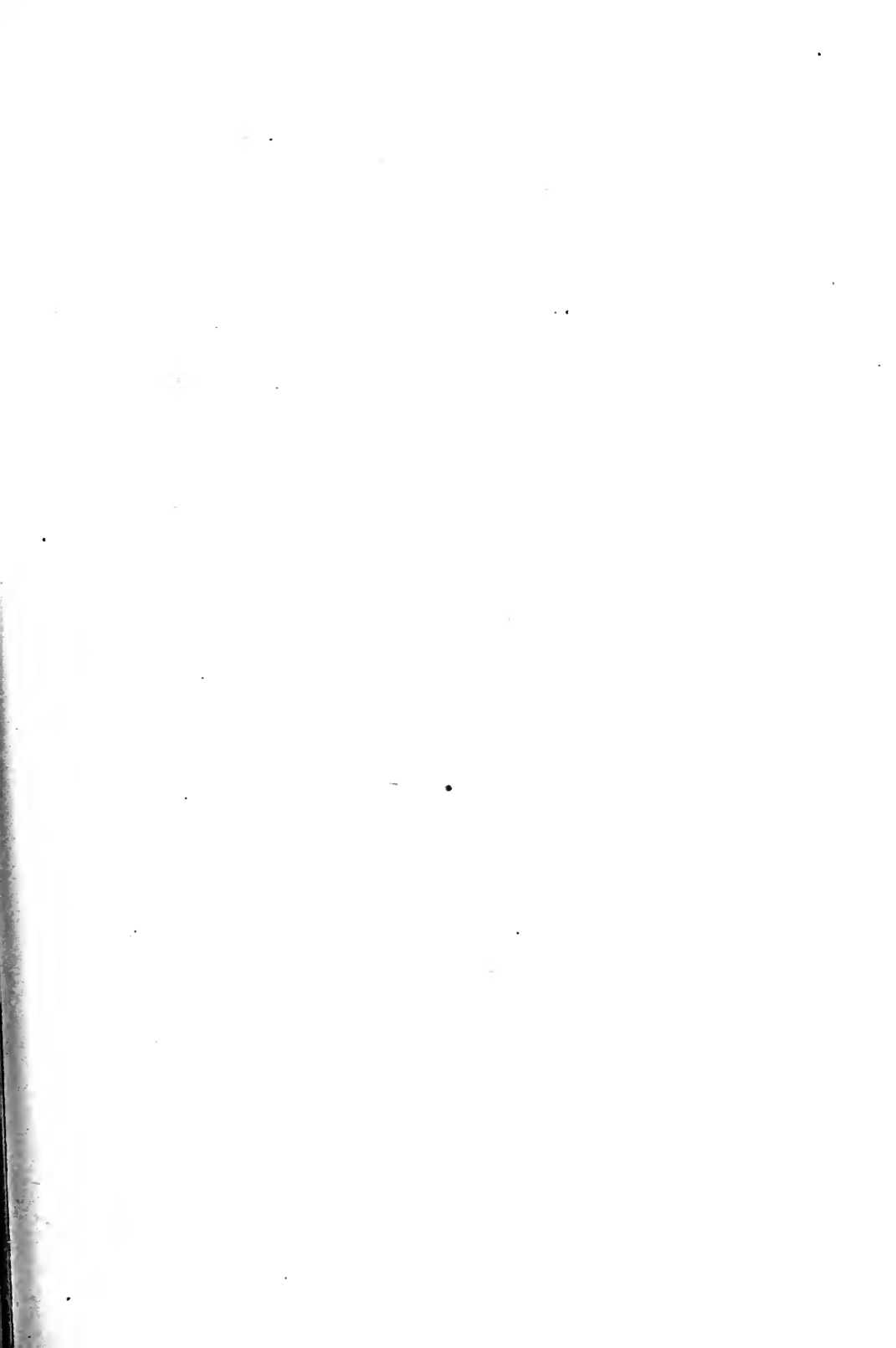

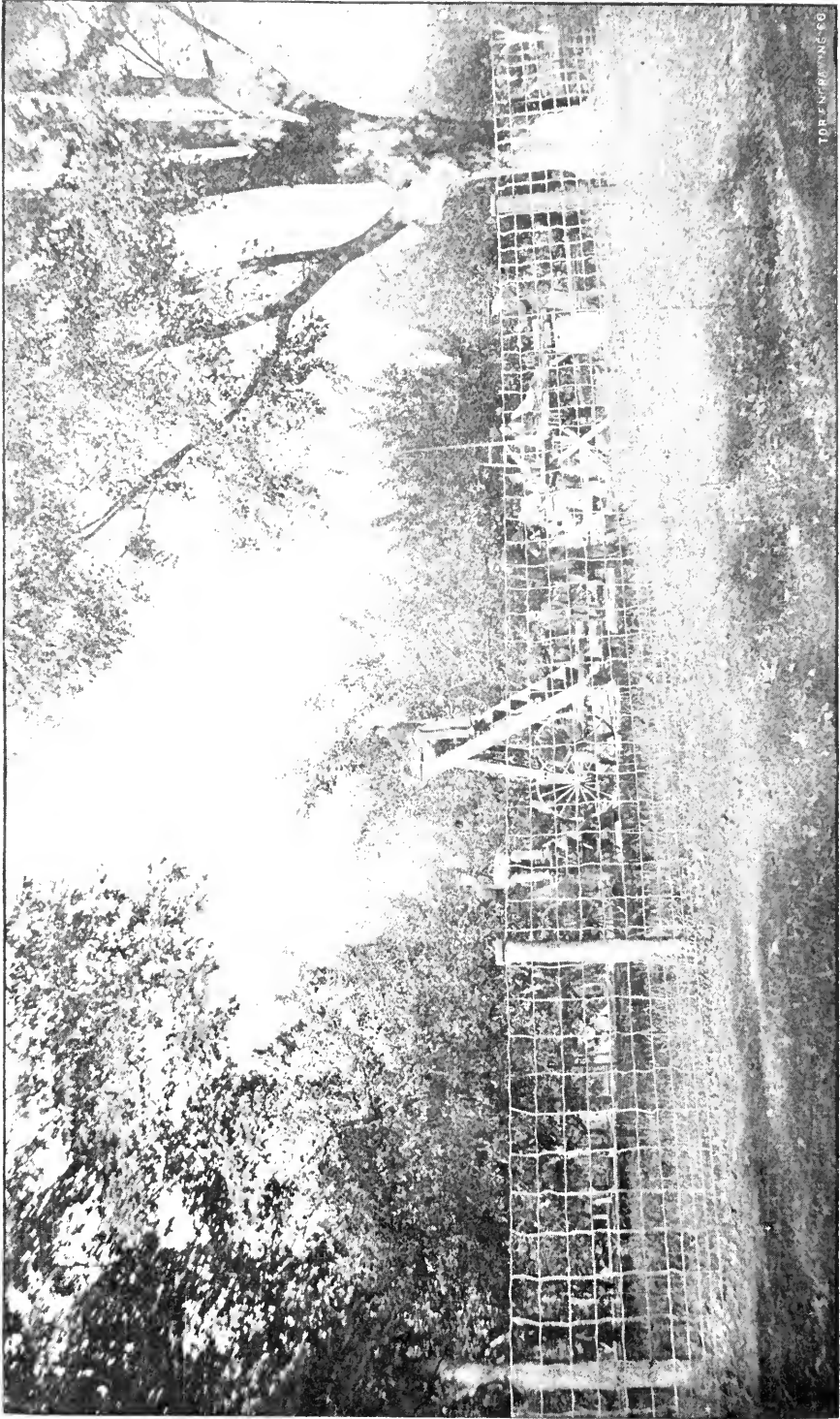

T. B. L. & S. B. L. & C. O.

FIG. 958.—A VIEW OF COL. ROGER'S ORCHARD, GRAFTON, ONT.

seed. This year they appointed wholesale agents for the sale of it in Great Britain, Australian Colonies, India, France, Germany, Spain, Italy, Russia and other continental countries. As a pot plant it received an award of merit (the highest honor that can be conferred on a new variety) at the Royal Horticultural Society, held in London, England, last year. From what we read of it, it comes true from seed, grows 5 or 6 inches high, the flowers are borne on long stems, the color white. I have started some in pots, two seeds in each pot, and intend to plant it in the open; I hope others of this Society will give it a trial.

### New Branching Aster

As a rival of the Chrysanthemum. Chrysanthemums are rarely brought to perfection by amateurs, and are best left to the professional florist. Asters are easy of culture, and in the new Branching, introduced in 1893, we have a flower closely resembling it in form and color. Many will remember seeing them offered for sale in the flower stores last fall, and a great many might have mistaken them for Chrysanthemums. The flowers have broad wavy petals, gracefully curled and twisted; the season for blooming is earlier than the Chrysanthemum, but later than any other variety of the Aster tribe. This gives it a special value for a late fall flower; the flowers are borne on long stems and are particularly suitable for cutting, as they will keep a long time and the flowers expand in water. If arrangements can be made for covering the plants on frosty nights, the blooming can be extended considerably past the time of other outside flowers. They are also admirably adapted for pot plants to flower in the house in the Chrysanthemum season. One grower writes of them in their last fall trial: "I have a dozen pots of the Branching Asters, loaded with flowers, that are the admiration of every one, and many say they must be Chrysanthemums. I think them a fine pot plant every way." The colors are white, pink, crimson, purple; the time for starting and transplanting is the same as for all other varieties of Asters.

**The Orchard Fence.**—It is time that the farmers of Ontario began to pay greater attention to the tidy appearances of their farms, and especially of their orchards. The old rail fence with its snake like curves is fortunately disappearing from our road sides; now let us have a fence which is as nearly invisible as good service will permit, that will neither favor the growth of weeds nor even serve as a shelter for mice. One of the members of our association, Col. Roger, of Grafton, Ont., has put up such a fence around his orchard and we have pleasure in showing our readers a view of his place in apple harvest, as an example worthy of imitation.

**Fallow** crops are the best for orchards, potatoes, vines, buckwheat, roots, Indian corn, and the like. . . . If we desire our trees to continue in a healthy bearing state, we should, therefore, manure them as regularly as any other crop, and they will amply repay the expense.—A. J. DOWNING, *The Fruits and Fruit Trees of America*, 1st Edition, 1845.

## CULTURE OF GLADIOLUS.



FOR some years I have been cultivating and experimenting with the Gladiolus, and the longer I raise it the more fascinated I become with its culture. The first year I raised it I met with rather indifferent success in getting the plants to bloom; although I thought I planted blooming sized bulbs, still, upon many of them no flowers appeared. Now I am rarely troubled in that way. I have of late years selected a sunny situation for the planting of the bulbs, and I always have the ground manured and well plowed under the fall previous. Then in the spring have it well spaded to a good depth, and the ground thoroughly pulverized. I believe firmly in deep planting; the bulbs attain a greater size, and are better enabled to endure some of the great drouths which visit so many portions of our country. If you have a number of bulbs, plant in rows from fourteen to eighteen inches apart and four inches apart in the row, and make it a rule to thoroughly cultivate between the rows until the leaves are too high to admit of it. I never allow a weed to be seen, neither do I plant any low-growing plants between, such as Alyssum, etc., as a mulch.

Then they are so easily cared for during winter. A dry, frost-proof cellar is all they require, and that is no more than is required for the commonest vegetable. I put mine in cloth bags and hang to the cellar ceiling to keep from mice. He who is induced to grow these lovely lily-like flowers one year will want to get out of the city if he lives there, into the country where he may grow them as he chooses by the acre, so great will his love for them be, and there are so many varieties of them, he will want them all.—Vick's Magazine.



FIG. 959.—SCARLET GLADIOLI AND WHITE ASTER.

I THINK it is wise for the florist and the gardener to bear in mind that the art of making a garden appear beautiful rests mostly with his ability to make an effective use of material at his disposal. One may have all the best things in great plenty, and yet fail to place them together so they will not lose their true value. Sunflowers may be grown so their untidy feet shall be hidden by nasturtium and alyssum; blue delphiniums may be relieved by a bed of dwarf whitephlox, and a dozen cannas can make an equal show with fifty if they are each one given a fair chance; but if sunflower, delphinium, and canna are crowded together without regard to color and form, if the ground beneath them is left bare and encircled by a prim ribbon border of dull and bright leaved colcus then one may bid farewell to artistic endeavor and cultivate the acquaintance of mechanical ingenuity.—American Florist.



## A PLEA FOR THE CYCLAMEN.



YCLAMEN *Persicum* and *C. giganteum* are very desirable plants for pot culture, especially for winter blooming. They are universal favorites, still they are not cultivated to the extent that they should be. No window garden is complete without one or more of these bulbs. They are very easy to raise, both from bulb and seed, and repay you tenfold for the care you give them, in the long continuous bloom throughout the winter months when flowers are scarce.

I have a cyclamen, deepest rose in color, that I have grown in a pot the last year, for house decoration, that is very beautiful; some of the leaves are immense, drooping gracefully over the jar and nearly hiding it from view; the flowers, and buds over fifty in number run up strong stems far above the leaves. These added to the exquisite markings of its foliage make a most beautiful bouquet for parlor or dining room.

In raising cyclamens in the house give them a cool place, a north window is best, where they can have plenty of light and air. Keep them from the hot rays of the sun and where there is stove or furnace heat, keep a wet sponge under the leaves. When in bloom it is a great help in making a beautiful plant. After the blooming season is past, gradually withhold water till the bulb is dry, when it should be left to rest till October, when you re-pot it in rich, sandy loam, encasing the bulb over two-thirds in the soil, leaving the top entirely exposed. Have good drainage at the bottom, water well, place in a cool, shady place till it show signs of growth; then water freely till flower buds appear, when plant food should be given once a week. On approach of cold weather remove to parlor or window garden. The secret in growing cyclamens is low temperature, light and air.



FIG. 960.—CYCLAMEN.

A friend traveling through Northern Italy was greatly pleased with the beautiful flowers of the cyclamen which grow there in great abundance. She had often admired the cyclamen bloom in my window garden in my Northern home, so while basking under the warm sunny skies of Italy, with its beautiful wild flowers at her feet, her thoughts flew back to her friends on this side of the Atlantic, wishing they too could enjoy with her these lovely flowers grown in the home nature had prepared for them.—Out of Doors for Women.

## PLANTS FOR TABLE DECORATION.



THE first essential to plants for this use is perfect cleanliness and freedom from yellow leaves; given this condition and any plant in bloom or out is better than none at all. If the pot is not ornamental, hide it in some way. I attended a banquet recently and on a table was a pot of beautiful white hyacinths, but a quiet investigation proved the pot to be an old tin can wrapped in a sheet of snow white cotton batting, banded down with white ribbon to imitate hoops. Tissue paper can be crimped by drawing through the hands and then arranged in various ways to cover an unsightly pot or can. There are many easy and inexpensive ways of making substitutes for the beautiful jardinières which are always ready, but which all do not happen to have.

One nice way of growing plants for the table is in the low round flaring hanging baskets. When these are placed on the table and the drooping plants arranged over the cloth, it makes a very effective arrangement. Remembering that yellow is one of the best colors to light up, have among the plants some of the beautiful Eclipse abutilon with its pointed leaves of brilliant yellow and green. It is always as beautiful as blossoms, and when in bloom it is exquisite. The small growing varieties of ferns if grown in low pots or on plates are among our best decorative plants, the maidenhair being a general favorite. I have spoken of plants in this connection because it is possible for anyone with even a few plants to have them on the table every day, while comparatively few can use cut flowers every day unless it may be during the summer season.

The arrangement is simply a matter of taste, but care must be taken as to colors, odors, etc., or the effect will be spoiled. Flowers with strong odors are never desirable on a table. One pretty arrangement is to lay a square or oblong piece of looking-glass on the cloth. Trail smilax, ferns or other suitable foliage around the edge and carelessly drop a spray or cluster of flowers on the glass. This is, of course, for the centerpiece; at each end, if the table is long, place a small doily and arrange the same kind of foliage to trail off over the cloth in a gracefully irregular way. Place the salt and pepper set, bonbon dish or other small affairs on the doilies to give them the appearance of being there for use.

*Asparagus tenuissimus* is a plant which should be universally cultivated for all kinds of decoration; the foliage is like a fern in some ways, although it is a climber like the smilax, and so fine and airy that it seems like a film, but its best point is its durability, as it will keep fresh longer after being cut than almost any other plant.—Farm and Home.

## LAWN MAKING.



HAVING secured our seed, such as it is, the next question is, In what quantities and how shall we sow it? Again comes in the question of the quality of soil, its comparative moisture and its cleanness. Under the most favorable circumstances a large proportion of the seed sown will fail to germinate. It is, therefore, wise to sow grass seed liberally.

The price of grass seed is comparatively low. I have consequently not hesitated to use, in some cases, six bushels of Kentucky blue grass or red top to the acre, although seedmen only advise two or three. The art of sowing grass seed properly requires some experience to acquire. The great difficulty is to sow it evenly. Like mowing and other farming operations, it takes trouble to learn how to sow grass seed properly. You must get up early in the morning before the wind has risen. You must consider the direction from which the wind blows, and do a good many things that can hardly be set down intelligently on paper.

When the seed is sown the next thing is to rake with a fine-toothed iron rake the entire lawn over thoroughly. Some people content themselves with a harrow for such work, but it does imperfect work at best. After the raking a heavy iron roller should be used at once over every part where the seed is sown. This sets the seed in the ground firmly and helps wonderfully to secure an even mat of grass, especially if a drought sets in soon after the sowing. It is a good plan also to continue this rolling once or twice after the grass has started and before it is fit to mow.

The first cutting with the mowing machine should come as soon as the grass is high enough for the knives of the machine to fairly take hold. Frequent mowing during the early development of the lawn tends to thicken and strengthen the growth of lawn grass and thus keep down objectionable wild grasses and weeds.

Viewing the matter in this light, we should not hesitate to weed the lawn all summer if necessary, to water it daily in dry weather, and yearly renew bare spots with better soil, to cover it with seed again, and fertilize the entire surface with frequent applications of manure, and in addition to roll it from time to time when the ground is soft. In the course of years, however, the good results of such work must tell, and the necessity for it become much diminished; but vigilance and intelligent culture will be always and continually required under the most favorable circumstances. — SAMUEL PARSONS, JR., in *Landscape Gardening*.

If the ground, which has been appropriated to the orchard, be also occupied as farming land, as is usually done for a few years after planting, while the trees are small, it should be exclusively devoted to hoed crops; by which is meant those that require constant cultivation and stirring of the soil. — JOHN A. WARDER, Apples, 1867.

## ↻ The Orchard and Fruit Garden. ↻

### CAUSES OF FAILURE IN APPLE CULTURE—IV.

FROM AN ADDRESS BY THE SECRETARY.

#### 6. Bad Harvesting.



VEN presuming that the orchard has been properly cultivated, pruned and enriched, there are many who yet fail to handle the fruit to the best advantage. In the first place, it is a common mistake to leave the fruit hanging too long on the trees before picking, and in consequence they become too ripe to keep well, and a large proportion is spoiled by falling to the ground. My experience has led me to begin gathering much earlier than formerly, and indeed before my neighbors seem to think of it. At one time it was my rule to begin gathering them about the 9th of October, but the high winds of that month made such havoc with them that I soon changed the rule. The 20th of September is none too soon to begin with such kinds as have attained full size and color, and if by that time all the apples upon a tree have not reached maturity, it will pay to make two pickings, leaving the greener and smaller ones to grow and color up. Attention to the details of preparing fruit for market always returns a good profit and must not be grudged. Careful handling and careful sorting are of paramount importance. Many throw apples into the basket as if they were potatoes, or squeeze them with thumb and finger as if they were made of stone, and so leave marks which spoil their beauty. Round swing-handle baskets, attached with a wire hook to the rounds of the ladders, are the best for apple picking.

Most orchardists empty their apples in piles upon the ground, but sorting in that case is back-breaking work, and every rain delays it. Some empty them in heaps upon the barn floor, but in a large orchard this means much labor in carting. My custom has been to empty into barrels in the orchard, head up without pressure, write the name of apple on the end, and store under cover; and then in packing empty them out on a packing table for sorting. For young orchards and scattered varieties this is the best plan I know of, for the important work of packing can then be done in a clean, dry place without moving about with nails and mallets and press from one part of the orchard to another.

Many inquiries are received concerning the best plan for the farmer to dispose of his marketable apples, whether he should sell them at home or ship to a foreign market. Well, if he has a very large orchard so that he can ship by the carload; or if he has small lots of one special kind, such as the Gravenstein or King, I would say ship to some reliable English wholesale house. As I can show from my account sales, my Gravensteins and Kings, in some ordinary seasons have sold in Covent Garden Market, London, Eng., as high as \$6 per barrel, which I consider paid me very well. Of course these apples were extra selected, all No. 1 grade, and highly colored.

But with mixed lots, less than carloads, it is better to take \$1. or even 75cts. per barrel for the fruit at home, than risk a possible loss by shipping so far.

But at even \$1 a barrel, I ask what farm crop pays better. Take for example an acre planted entirely with Baldwins and Greenings, and what will it pay you at those prices? Suppose you only get 100 barrels a year on an average from it, what other crop would give you \$75 or \$100 per acre with less labor.

Of course it is expensive work planting and raising an apple orchard, a heavy investment; but I am not urging the planting of new orchards so much as the better care of those we have.

### 7. Poor Varieties.

Perhaps you have not the most profitable kinds; then top graft and you will soon have those varieties which are proved most desirable. The work of grafting is not difficult or mysterious but quite practicable by any one who can handle his knife skillfully; for old trees a method known as crown grafting is very well adapted, as figured in a recent number of the *Rural New Yorker* and by favor of the editor we are enabled to give our readers the following description of it with an excellent illustration.

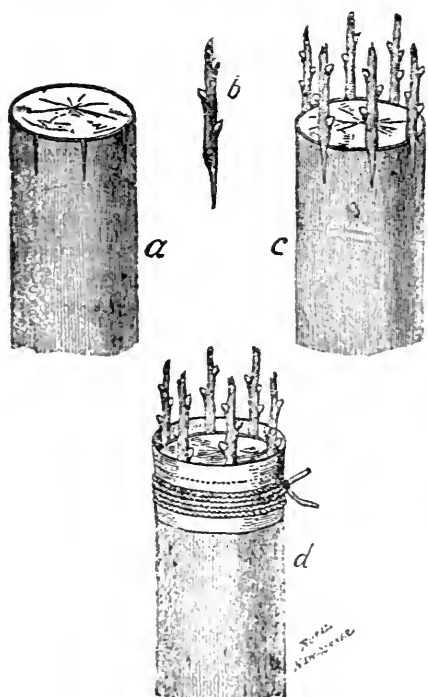

FIG. 961.—CROWN GRAFTING

“The following is an easy and effective method of grafting old trees. By it the percentage of failure is reduced to a minimum, and branches at least six inches in diameter, and, in the case of pear trees 75 years old, may be worked with assured success. Last year we mentioned the case of such a pear tree having been grafted two years before with the Kieffer, that gave a full crop last fall. Saw off the branch at right angles to the stem to be grafted, as at Fig. a. Then cut a clean slit in the bark through to the wood, the same as in budding. Separate the bark from the wood and insert the cion b, one for each slit. The number of slits for each stock will be determined by its size. We will suppose the stock illustrated to be six inches in diameter, and that six cions are to be inserted. The stock after receiving the six cions is shown at c. Grafting wax is not needed. A thick paper may be wound about the top of the stock extending about one inch above it and securely tied with a strong twine as

shown at d. The space above the stock encircled by the inch of paper may then be filled to the top of the paper with a puddle of soil and water, make so thin that it can be readily poured from any suitable vessel. This mud protects the surface of the wood of the stock, and excludes the air from the insertions. It gives every advantage of wax without its objections. Of course stocks of any size may be worked in this way. One, two, or any number of cions may be inserted according to the size of the stock."

I have now given an outline of the chief causes of failure in apple growing in Ontario, and at the same time indicated how they may be overcome. I believe in the future of apple growing in Ontario, for we can grow the finest apples in the world, and our fruit is wanted. Let us grow it in that perfection to which our soil and climate is so well adapted and establish a reputation for first-class honest packing of selected high grade fruit and then our fruit growers will be the most successful class of people in Canada.

---

### A NOVEL MODE OF PRUNING BLACK CURRANTS.

In judging cottage gardens in Essex the other day I came upon a lad sitting on the ground picking the currants off a bough that had been broken off by accident. Remarking on this comfortable method of picking Black Currants on a hot day, my fellow-judge said that he had improved on that simple plan for years. He prunes his black currants so soon as the fruit is ripe, and carefully removes the fruiting branches to a clean packing shed or potting bench, where the fruit is picked under cover in cleanliness and comfort. The major portion or whole of the fruiting branches are then removed annually, the black current bushes being pruned back to the young wood. The wood being thus fully exposed in July, ripens thoroughly before the end of the season and produces full crops of the finest fruits. Of course, for this mode of culture the single-stem style of training is abolished in favour of the production of few or many suckers—from six to a dozen. The bearing wood and bushes to a great extent thus become annuals, and renew their youth as well as their vigour every year.

I have not hitherto adopted the early annual cutting back of my fellow juror. My experience, however, in regard to the wisdom of renewing black currants from suckers entirely agrees with his. His earlier and more severe pruning is also altogether in favour of the improved strength and fertility of the young wood from base to summit, and his samples are most all alike good—a great point in dry seasons like the present. It is no exaggeration to affirm that nine-tenths of the black currants met with this year on bushes grown on the old crowded system are of no commercial value, the major bulk consisting of dry hard flesh, the skins being nearly as tough as an old shoe. But notwithstanding the persistent drought, the fruit on last year's shoots, where these have been fairly fed without overcrowding, is of average size and full of juice. And yet how many go on crowding black currants with old wood, cutting back the best of the young shoots into close spurs—a mere wanton waste of vital force and useful fruit.—The Garden

## NOTES ON A LECTURE TOUR.—II.



THE more one sees of this Province of Ontario the more he is impressed with the splendid heritage he possesses in its natural beauties, its almost limitless resources, its wealth of fruit and foliage and flower, its possibilities of development, and his own responsibilities in relation thereto. All this wealth has not been bestowed upon man without a corresponding responsibility in the use that he makes of it. Man bears a responsible relation to every gift that has been given to him for his use. All gifts were given to him for his pleasure and his profit, and the nearer he approximates to the designs of nature in the bestowal of those gifts the more real pleasure and profit does he enjoy. If he fails in his obligation and neglects his opportunities in this regard, he fails in the development of his better nature. Too many men seem contented to live only the hard practical side of life, neglecting altogether the finer or picturesque side. One is man's own side the other is Nature's side. The one man brought upon himself the other was given to him by his Creator, and he too often refuses to accept it even as a gift.

In no country in the world are the opportunities for development and improvement in the material conditions of life greater than they are in this Province of Ontario. And until comparatively recent years, in no country perhaps, have those opportunities been so sadly neglected. American visitors have told us that to them this is very noticeable, especially in our rural districts. They wonder at it too when we possess a land of such richness and a country of such possibilities in material and artistic development. Too often they notice our splendid farm houses without a bit of ornamentation about them in shade tree, shrubbery or flower bed. They naturally ask why was such a land of fruitfulness, or such a wealth of forest tree, evergreen, shrubbery and flowers given to us if not to be used for our profit and enjoyment.

Now, what we want to impress upon the readers of the HORTICULTURIST is that removal of this defect is one of the aims and objects of the Ontario Fruit Growers' Association. It aims at the development of floriculture, arborculture, landscape ornamentation and the general beautifying of the home in town, city and rural district as well as the development of fruit-growing.

To this end it has made special efforts during the last few years to organize affiliated associations in our towns and cities whose membership are more particularly interested in flori and arborculture, and whose example and influence will, it is hoped, widen out in time to the suburbs and surrounding rural districts. No city dweller is so selfish or so unpatriotic as not to desire the general improvement of the country immediately surrounding him as well as the improvement of the city in which he resides. His aid and influence is sought

that the consummation of that desire may be hastened. The Ontario Fruit Growers' Association recognize that this Province of Ontario may be made not only the greatest fruit producing country on the Continent, but one of the most picturesque and attractive countries in the world to live in. This being their faith they are following it up with work, hence the organization of the affiliated societies and the sending out of lecturers to address them at their annual meetings.

The first of those societies that I had the privilege of visiting in the month of March, was at the Town of Port Hope. Port Hope is so naturally picturesque that little need be done by man to set off its romantic beauties. Much, however, has been done in this charming town in the way of floriculture, and there I found a very enthusiastic Horticultural Society, numbering well up to a hundred members. The floral display in the hall at their annual meeting was very fine, and the meeting though not a large one was made up of the best citizens of the place. It is almost needless to assert this, for had they not been the best people they would not have been there where flowers and nature were the topics of thought and expression. The society at Port Hope is particularly fortunate in having among its membership Dr. Purslow, of the Collegiate Institute and Dr. Bethune of Trinity College School. These eminent scholars and naturalists made the writer's duties very light, and after their exhaustive and valuable papers I spoke briefly, in a general way, confining myself to no particular topic. There is much missionary work for the Port Hope Horticultural Society to do in the immediate districts to the north and westward where many farm houses are in a state of neglect when a very little effort and expense would add much to their comfort and attractiveness, and hence to their value.

*Mitchell.*

T. H. RACE.

---

### SMALL FRUITS.

Nitrate of soda is a valuable fertilizer for these crops, especially strawberries and raspberries. It should be applied with powdered phosphate of lime to produce its best effects. This application to strawberries will not only double but sometimes treble the yield. The berries are larger in size, handsomer in color and of fine flavor.

Ordinary manure will not produce such results, for the reason that it is not converted into plant food until after the demand of the fruit.

The plants grow early in the season, and nitrate of soda being a leaf and stem former, while the phosphate of lime is a seed former, they are assimilated by the plant, and at once taken up and appropriated, furnishing the food necessary for the growth of the plant, and the food development of the fruit. As an available source of nitrogen, containing 16 per cent., and also 35 per cent. of soda, which is a substitute for potash for agricultural as well as for industrial purposes, the market does not furnish a better article or one that is more immediately active, and with the phosphate of lime it makes a complete manure.—New York Tribune.



## COMMERCIAL MELON GROWING UNDER IRRIGATION.



THE watermelon delights in a light sandy soil, while its companion, the cantaloupe, succeeds best on a clay loam, or at least a heavier soil than the former. Both do best on the new land, and as this is about all exhausted that is under irrigation in this section some plan of renewal must be adopted. We are having very good success by allowing the land to produce a crop of corn every other year, but it seems the best results will be obtained by plowing under alfalfa sod and growing about two crops of melons in succession on the same land.

The ground for melons should be irrigated during the winter or early spring, so that when plowed and harrowed in April it will hold moisture long enough to bring up the plants, seeds of which should be planted about the first of May, or after the soil has become warm enough to hasten germination. The furrows for irrigation are made before planting and should be run in the direction the water will run most readily, the tools generally used being either a single shovel or six inch diamond plow. For watermelons these furrows should be about nine or ten feet apart, and the hills about eight feet in the row. Cantaloupes need less room, and six by four feet will do very well.

The planting is usually done with a hoe; a hole about two inches deep is drawn out, into which five or six seeds are scattered, when the soil is replaced and firmed a little with the back of the hoe. When this is accomplished the top of the hill should be on a level with the land, and the seeds about on a level with the edge of the water when it comes slowly down the furrow in irrigating during the summer. Then the plants when they come up should be near enough the brink of the furrow to get their roots thoroughly saturated, but never be flooded. The ground between the rows should be kept free of weeds and well cultivated, while the hoe should be brought into frequent use around the hill, and when the plants get large enough to judge of their vitality they should be thinned to about two or three of the strongest, standing two or three inches apart in the hill.—FRANK CROWLEY, Col., in *American Agriculturist*.

---

**Growing Cucumbers for Pickling.**—Growing cucumbers so as to have a large quantity of small ones for pickling, is quite a distinct art of culture from growing them for ordinary uses. In order to have them bear abundantly, and not get large, they are usually sown in long ridges, and suffered to grow up rather thickly together. The vines are continually being pinched back, in order that they may produce a large number of comparatively small shoots, which naturally produce weaker cucumbers than larger and stronger shoots would. They usually bring, at wholesale, from fifteen to twenty dollars a bushel.—*Meehans' Monthly*.

## ESSENTIALS IN STRAWBERRY GROWING.



PROF. LAZENBY, before the Columbus Horticultural Society, gave the following summary of essential points to be kept in mind: (1) The most profitable varieties for the commercial grower are those not easily influenced by differences of soil and climate. Those which succeed well on wide areas are usually better than those which have a more local reputation. (2) Pistillate varieties, when properly fertilized, are more productive than the sorts with perfect flowers. (3) The value of a variety for fertilizing pistillate flowers does not depend so much upon the amount as upon the potency of its pollen. (4) The flowers of pistillate varieties are less liable to be injured by frost than the flowers of perfect varieties. (5) Varieties that are neither very early nor very late in points of maturity, are the most productive and have the longest fruiting season. (6) As a rule, varieties that have the most vigorous and healthy foliage are the least productive, while those with a weaker growth of foliage and a greater susceptibility of leaf-blight are usually more prolific. (7) Winter protection may be dispensed with upon well drained, sandy soils, but appears to be a necessity upon heavier ones. (8) The leaf-blight may be checked by using the Bordeaux mixture, beginning just as soon as the leaves appear and continuing the application every few weeks throughout the season.

---

## WATERING LARGE AND SMALL FRUITS.



APPLES, peaches, pears and similar fruits should be thoroughly irrigated in the fall, as soon as the leaves are brown or fall off, then again in the spring as soon as the frost is out of the ground. The orchard should always be cultivated and kept free from weeds. Until the trees shade all of the ground, more or less crops that require cultivation may be raised among the trees. The cultivation of fruit trees should be merely surface deep, so as not to disturb the rootlets which seek the very top of the soil for sunshine and air to support and mature the fruit. Too much water is as injurious as too little for fruit trees, same as for other crops. Orchards should never be irrigated later than the last of July, until the leaves fall off in the fall.

Small fruits and strawberries should be watered two or three times a week during the remainder of the season to prevent the soil from becoming dry. Blackberries and raspberries do not require watering as often as strawberries, but the ground should be kept moist. Strawberries, blackberries and raspberries yield the best returns, if, in addition to irrigating by flooding, the vines and bushes are sprayed with water from a hose.

## CELERY UNDER IRRIGATION.

The soil for celery should be plowed deep and harrowed fine. Soil containing a small amount of alkali is to be preferred, as is also loam rather than sand. Early varieties such as white plume and golden self-blanching are set out from June 15 to July 1; later varieties from July 1 to 15. Rows for early varieties may be from 3 to 4½ ft, depending on the amount of banking to be done. Rows for late varieties must be five feet apart to give soil and room for banking. Plants in either case may be 6 inches apart in the rows.

Unless assured of two or three days wet weather just after planting, it is best to irrigate as soon as the plants are set, and repeat in a few days. Replanting unless done very soon is not advisable. In order that irrigation may not wash out or otherwise injure the plants, it is necessary that the latter be set out on the sides of the ridges, leaving the bottom of the trenches free for the passage of the water. The cultivation of celery should be thorough. The soil about the plants needs to be hoed or otherwise kept mellow. Soil needs to be filled in about the plants occasionally to force them to grow upright instead of sprawling over the ground. When the celery is a foot high it must be "handled." This consists in gathering the stems all together and drawing soil about them for the purpose of keeping them upright and thus preventing them from being covered by the furrow slices that are afterward turned against them.—Farm and Home.

## MANURE FOR PEACH TREES.



THE peach tree grows so easily and so luxuriantly, and over such a vast extent of country, that few think of supplying it with other nutriment than is found naturally in the soil. Without doubt this is sufficient in many cases, particularly in the newer portions of the country. But every year of cropping in the usual way lessens the fertilizing ingredients laid away in the earth in bygone centuries, and fruit trees, as well as corn, wheat, etc., suffer by its diminution. Indeed, fruitbearing, particularly bearing heavy crops of large fine fruit, makes one of the heaviest drafts, if not the heaviest of all, on the land.

Among fertilizers one of the most important for most crops—and particularly for fruit trees—is potash in some form. This is easily applied in wood ashes, none of which, even if leached for soap-making, should ever be wasted. It is very trying to see ashes emptied out in the road or by the side of a run as has been observed more than once. The ashes may be applied whenever convenient; not around the trunks where they can do little good, but scattered over the entire surface as wide as the branches extend. Anyone who has tried this must have noticed the fine growth of the trees and the thrifty dark green of the leaves afterward.

It is not probable that ashes will cure the yellows now becoming so common in some sections, though at one time there was considerable hope in this direction. But prevention is better than cure; and there is good reason to believe that a peach tree kept in vigorous health will be able to resist the yellows; just as perfect health in the human system prevents, or throws off many forms of disease. Barnyard manure is also a good fertilizer for peach trees as well as for most other things dependent on the soil. But it should be remembered that ashes, or anything containing potash, must not be applied at the same time with barnyard manure; for the ammonia, one of the best elements in the latter, would be liberated by potash and lost. Six months at least should intervene between the application of these two valuable fertilizers—the best probably, of all fertilizing materials, considering everything.—National Stock man.

---

### CUCUMBER UNDER GLASS.

Although the cultivation of cucumbers during the winter months is somewhat troublesome, they are comparatively easy of management during the longer and brighter spring days. Plants from seed sown at the end of February will give a supply of fruit from about the middle of April until plants outside begin to bear. The starting of seeds is sometimes troublesome on account of dampening off just after germination has begun; this can be prevented by careful planting. A little study of the habit of the seed will show that the embryo breaks through the shell at the point or thin end, the root being first produced. The seeds should be set so that the roots can go directly down into the soil and the top shoot upward. If the seeds are sown at random the little plant, after germination, is sometimes in a position from which it cannot extricate itself. They should be sown in small pots in a light sandy soil and placed in a good bottom-heat; as soon as the plants are up they should be removed to a light situation near the glass, but shaded from strong sunlight. They must be shifted into larger pots as soon as they are strong enough, using a heavier soil than before, and which the roots will now be able to take hold of. When planted into their permanent quarters a few tobacco-stems spread about will help to keep off the black fly, which is always a ready enemy. It is necessary to keep the atmosphere moist and to syringe twice daily on bright days, but the syringing must be done lightly, as the leaves are tender and easily damaged. On this account smoking should never be resorted to as a means of destroying the fly, but if this pest becomes troublesome fresh tobacco should be spread over the pipes and sprinkled with water. This should be done when the pipes are warm and the house is closed. A night temperature of sixty degrees is sufficiently high, with a rise of fifteen degrees through the day. The plants may be slightly shaded to advantage when the sun is bright. We have tried several varieties, but find none equal to Telegraph for quality, productiveness and free growth.

## PREPARATION FOR WINTER GARDENING.



Esay that winter-gardening begins with autumn, but summer, or even the month of May, is none too soon to begin planning for our winter gardens, if we wish to make sure of all the beauty and all the pleasure that may be derived from them. One of the very first points requiring attention is to provide suitable plant-stock between this month and the time of frosts. Here let the inexperienced be on their guard; not all pot-plants are alike suitable for cultivation in dwellings. Let the list be confined to such plants as are known beyond doubt to be well adapted to this purpose, and do not invite failure and disappointment by attempting to grow others. The list of good winter-flowering plants is so long and so varied that any taste may be satisfied with a choice of thoroughly tested sorts.

A list of fifty distinct kinds of plants specially adapted to window-culture is given below :

- |   |                                     |
|---|-------------------------------------|
| 4 <i>Abelia rupestris</i> .             | 4 Lantana.                          |
| 5 Abutilon, bush and trailing.          | 1 Madeira-vine.                     |
| 3 Achania.                              | 2 Maurandia.                        |
| 4 Agapanthus.                           | 5 Moneywort.                        |
| Agave.                                  | 4 Myrtle (myrtus).                  |
| 3 Aspidistras.                          | 3 Neprolepsis (fern).               |
| 4 Amaryllis.                            | 3 Orange.                           |
| 3 <i>Aralia Sieboldii</i> .             | 5 <i>Othonna sedifolia</i> .        |
| 3 Begonias.                             | <i>Oxalis rosea</i> .               |
| 4 Cactuses.                             | 2 Petunia.                          |
| 5 Calla.                                | 5 <i>Plumbago Capensis</i> ,        |
| 4 Chrysanthemums.                       | 2 Primulas.                         |
| 3 <i>Corypha australis</i> (palm).      | 3 <i>Pteris tremuloides</i> (fern). |
| 1 Crocuses.                             | 3 <i>P. argyrea lanceolata</i> .    |
| 3 <i>Cyclamen persicum</i> .            | 5 Passiflora.                       |
| 3 <i>Cyperus alternifolius</i> .        | 4 Roses, Monthly Bengal.            |
| 3 Date-palm.                            | 3 Sago-palm.                        |
| 4 <i>Euonymus Japonica</i> .            | 4 <i>Saxifraga sarmentosa</i> .     |
| 4 <i>Farfugium grande</i>               | 4 <i>Senecio scandens</i> .         |
| 3 <i>Ficus elastica</i> (India-rubber). | 1 Snowdrops.                        |
| 3 <i>Ficus elastica variegata</i> .     | 4 Tradescantia, trailing.           |
| 5 Geraniums.                            | 1 Tulips.                           |
| 5 Heliotrope.                           | 4 Vallota.                          |
| 1 Hyacinth.                             | 5 Vinca (periwinkle).               |
| 4 <i>Hydrangea hortensis</i> .          | 2 Wax-plant.                        |
| 5 Ivies.                                |                                     |

To have a good stock of these plants by fall, the following course should be pursued: Order from the greenhouse ordinary sizes of all the plants wanted except those preceded by (1), which are bulbous, and (2) which are to be seed-grown. Seeds of the latter should be sown early in summer. The bulbous sorts are to be procured in September, and started then in pots.

The kinds preceded by (3) should be grown in pots sunken to the rim in earth, in a spot shaded for about three hours at mid-day. If no other shade is convenient, let the plants stand together in some spot and place a canopy, made of lath nailed an inch apart on a frame and raised about four feet from the ground directly over them. A small empty pot should be set under the middle of each pot containing a plant, to prevent the roots from sticking through the drainage-hole into the soil beneath.

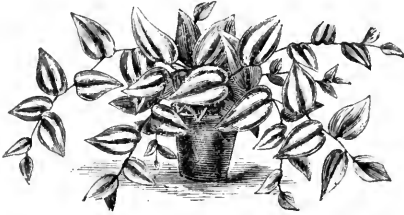

FIG. 962.—TEDESCANTIA.  
from fierce winds.

The plants preceded by 5 are comparatively rapid growers, and will summer well if knocked out of their pots and planted in the open soil, where they will grow until September. Such plants as are kept through the summer in pots should be carefully tended. They must never suffer for want of liberal watering. When water is given, saturate the soil thoroughly to the very center of the plants' ball of roots. In cases where root-growth is active, the plants should be repotted into pots a size larger, whenever an examination of the ball of earth shows a lacework of white roots surrounding it. To remove a ball of roots from its pot, invert the plant with the surface of the soil resting on the palm and outspread fingers of the left hand, and with the bottom of the pot grasped firmly in the right hand. Strike the rim of the pot sharply upon the edge of a table or bench, and the ball of earth and roots will be dislodged. Rapid-growing plants like chrysanthemums should be pinched back at intervals until August to make them branch freely. Such plants in particular must not be allowed to suffer even once for lack of water, as this will cause the lower leaves to turn yellow and drop.

To provide good soil for the window plants is an essential point in their successful cultivation. None is better for the average of plants in the list given than what florists call "fibrous loam." This is made by cutting sod about three inches thick from an upland pasture lot, or from a country roadside, and stacking it up for some months before it is used. Broken up in rough pieces the size of marbles, such soil contains, with the addition of a sprinkling of fine old manure or bone-dust, all the elements really necessary for a plant's existence. It is a mistake common among window-gardeners to suppose that finely-sifted soil is most congenial to plant-growth; one that is somewhat rough and fibrous is much better.

The beauty of the winter garden is well insured by such a selection of plants, cared for in the manner indicated until autumn, when further directions will be in order.—American Gardening.

The figure 4 preceding names in the list indicates that such plants, while being grown in the open air in pots that are plunged, may be fully exposed to the sun. To set them in an angle where the sun-heat is excessive would not be good treatment; they should be in the line of morning breezes, but sheltered somewhat

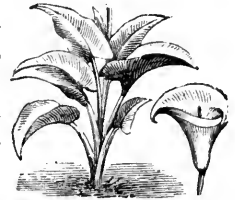

FIG. 963.—CALLA LILY.

## ASPARAGUS CULTURE FOR CITY AND VILLAGE LOTS.



ASPARAGUS, considered as a vegetable, has some peculiarities which distinguish it from other plants of the kitchen garden. The growing plant is very beautiful. Its feathery masses of graceful foliage, its peculiar shade of green in summer, the bright red berries contrasted with the rich yellow of the maturing plant in the autumn, make it well worthy of a place among ornamental plants, particularly in the shrubbery border. In cultivation the plant is injured rather than benefited by frequent stirring of the soil; all it asks is abundant room, not less than five feet square to each plant, and liberal feeding. It takes time to establish itself, but when this is well done a little care and free manuring each year will keep it permanently and enormously productive, a single plant under the Argenteuil system of cultivation having furnished thirty-seven pounds of the choicest asparagus in a season.

The beauty, the ease of culture, the permanency and productiveness of the plants, and the fact that asparagus, even more than most vegetables, should be used when perfectly fresh—should be cut and cooked the same hour—warrant the cultivation of this plant in places where the attempt to grow other vegetables might not be wise. A few plants can be introduced with good effect in highly kept pleasure-grounds. A few can be set in the corner of the fence or beside the shed in places too contracted to warrant the attempt to have a garden of any kind. In fact, there are very few town and village places that could not easily furnish the family with an abundant supply of this vegetable at a trifling expenditure of labor, and without detracting from the beauty or usefulness of the grounds. As a guide to those who may wish to undertake asparagus culture in the way suggested, I give the cultural methods followed in the Argenteuil district of France, which has the reputation of producing the finest asparagus in the world. A considerable proportion of that grown there is the product, not of asparagus farms, or even of fields and beds, but of single plants or clumps standing by themselves, or in groups of from five to twenty scattered here and there in any open space that may chance to be left in corners or between trees and buildings. Wherever there is an unused bit of ground five feet in diameter, which is not in dense shade or liable to be covered with water, there the Argenteuil gardener sticks in a plant, gives it good care, and is well repaid for his labor.

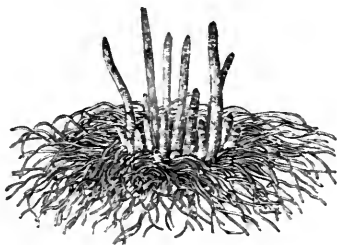

FIG. 964.

The method of cultivation is simple. The spot is put in good tilth and

made moderately rich ; a vigorous plant is carefully set out so that its crown will be about four inches below the surface-level ; weeds are kept down by shallow surface cultivation, and in the fall, after the tops are fully matured and dead, the surface for a circle of five feet in diameter is covered with rich and well-rotted manure. As early in the spring as possible this manure is well-forked into the surface, and the starting weeds kept down by shallow hoeing until the plant has made sufficient growth to take care of itself. The third season the treatment is the same as in the second, especial care being taken to take out any seedling asparagus plants which may spring up, they being treated as the worst of weeds. The fourth season the harvest commences, though if the plants have made a good growth a few cuttings are made the third year, but it is considered a better practice to wait until the fourth, in order that the plants may become well established. The manure is spaded in as early in the season as possible, and as soon as the first shoots appear at the surface the soil is heaped over the crown of the plant in a mound about a foot high, which serves to blanch the growing shoots. In gathering, the shoots are broken as far as possible below the surface. The covering soil being friable from its abundant manuring enables one to secure much longer shoots than if it were level. Care is taken to remove all the shoots at each picking and not to prolong the season far into the hot weather, so that the plants may have a chance to make a good growth in preparation for the next season's crop. At the close of the season the mound of earth is levelled with the surface, and about two quarts of fresh wood-ashes and a handful of salt are scattered about each plant and hoed into the surface. The treatment given the fourth year is repeated, and the shoots gain in number and size as the plant increases in age.—Garden and Forest.

---

## THE FRUIT HOUSE.



FRUIT house entirely above ground can be put up at not a very large cost, in which an even temperature can be maintained, and which will keep out the frost, as follows : Prepare a good tight foundation of stone for the building. Use 2 x 4 inch studding for the sides. The sides should be about eight feet high. Sheath on the outside of the studding with inch lumber, and cover this with building paper, and then on the outside of this with another course of studding, sheathing and building paper. Do this until the wall has three air spaces. The roof is constructed the same way to protect from heat as well as frost. The writer has recently constructed a cellar and fruit house over it, as follows : The floor between the cellar and the fruit room above is laid with 2 x 8 joists, sealed above and below with inch boards. The space between is filled with sawdust. The studding for the sides are 2 x 6, eight feet high. Outside it is sheathed lengthwise with inch lumber, and on this a layer of building paper. Then comes



a course of inch pine siding and battens. On the inside a layer of building paper is tacked to the studding and then a course of inch lumber. The 6-inch space between the two courses of sheathing is filled in with sawdust well packed. Building paper is tacked to the under side of the rafters an inch pine ceiling is put on and the 4-inch space between the roof boards and ceiling is filled in with sawdust. It is ventilated with windows at each end.

The main points to be kept in view when planning a storage place for our apples are good drainage, good ventilation and security from heat and cold. Here in this climate we are very apt to have in the late fall and also during the winter months warm spells of weather; and during these warm spells the ventilators should be opened at night after the atmosphere has become cool, and kept closed during the daytime. In this way a nearly even temperature can be maintained, not so low, perhaps, as in a costly cold storage plant, but sufficiently low as to meet the requirements of the average fruit grower.—From Transactions of Missouri Horticultural Society.

## YIELDS AND PROFITS OF THE BLACKBERRY.



THE year following the planting, there should be a sufficient yield to pay for the cost of the plantation to that time. The third year, the crop should be large, and from that time on, the yield should be nearly uniform, when the seasons are good. I do not know the limit to the profitable age of a blackberry plantation. It is certain that it should continue to bear heavily for twenty years if

it has good care, and I am told by careful growers that a patch will last even longer than this. As the plants are generally grown, however, they cannot be expected to hold out this long, for the land becomes hard and foul, and the plants full of dead and diseased wood.

Blackberries are capable of yielding 200 bushels per acre, year by year, unless very unfavorable seasons intervene. This Station once made an inquiry amongst fifty growers in various parts of the country as to the average yield of blackberries. The lowest return was 40 bushels, the highest over 300 bushels, and the average of the whole fifty was 98 bushels per acre. The prices in this State range from seven to fifteen cents a quart. J. M. Mersereau, of Cayuga, one of our best blackberry growers, recently said to me: "Let me choose the soil, and I will guarantee to clear \$200 per acre on blackberries." In our own experience at Ithaca, blackberries have sold the most readily of any of the bush fruits, at prices ranging from eight to fifteen cents per quart. Granville Cowing, Muncie, Indiana, a most successful grower of this fruit, makes me the following statements respecting the profits of it: "The blackberry is probably the most profitable of the small fruits. Owing to its firmness it can be kept much longer in good condition than the strawberry or raspberry, and often brings better prices. The best varieties are enormously productive, their cultivation comparatively easy, and a well kept plantation of them should last a life time." Whilst all these figures and statements are tempting, it must, nevertheless, be said that the blackberry, like all other fruits, yields the golden harvest only to those who work for it, and who think whilst they work.—Cornell B. 99.



## The Canadian Horticulturist

SUBSCRIPTION PRICE, \$1.00 per year, entitling the subscriber to membership of the Fruit Growers' Association of Ontario and all its privileges, including a copy of its valuable Annual Report, and a share in its annual distribution of plants and trees.

REMITTANCES by Registered Letter are at our risk. Receipts will be acknowledged upon the address label.

### ❖ Notes and Comments. ❖

THE RED CROSS CURRANT is held by the introducers at \$1. per plant !

THE CLARKSBURG NOZZLE is a good one. We have tried it at "Maplehurst" this spring and the foreman thinks it is superior to the MaGowan.

ERRATA.—The average yield of Mr. Orr's vineyard is given on p. 112 as three tons, this should read three tons per acre.

FAMEUSE apples were quoted on the same date in Montreal, at from \$2.50 to \$4.00 per barrel.

NO GRAPE BUDS.—The Grape Belt, of Chautauqua Co., N.Y., reports that there are no fruit buds on the grape vines in that part of the State, owing, probably to the frost in May, 1895.

THE POTATO ROT is a fungus parasite, and may be prevented from injuring the potato vines by spraying them with the Bordeaux mixture early in July, and two or three times later on.

MR. A. S. FULLER, author of many excellent works on Horticulture, died suddenly at his home at Ridgewood, N.Y., on May 4th, at the age of sixty-eight years. He was a practical florist and fruit gardener, and for twenty-five years agricultural editor of the Weekly Sun. He was editor and part owner of the Rural New Yorker.

MR. A. A. PETTIT, Director of Spraying Experiments for Ontario, has resigned his position to enter political life as Conservative Candidate for South Wentworth. Our Director, M. W.M. Orr, of Fruitland, as been appointed to his position.

ASPARAGUS was quoted at a high price on May 1st, in Montreal. This vegetable is one which fruit growers might well plant in a young orchard, or fruit garden, because it grows easily and is harvested before the orchard tree makes much growth. It also brings in a little money at an early part of the season, when expenses are heavy and no fruit crop is ready to harvest.

---

THE WILDER GRAPE.—To-day, the 25th of May, 1896, we have opened a box of Wilder grapes in perfect condition, sent us by Mr. E. B. Edwards, of Peterboro'. They are rather under size for this variety; perhaps they do not grow as large in that section as south of Lake Ontario.

Mr. Edwards writes that apples promise a heavy crop so far this season, especially the Blenheim Orange, which look finer than ever. This apple is a favorite with Mr. Edwards, and has proved one of his most profitable varieties.

---

JAPAN PLUMS.—Mr. John Craig speaks of the hardiness of these plums as follows: "The Russian plums are fully 25 per cent. hardier than the Japanese plums and some of them are equal in quality. The majority of those which I have tested are not nearly as handsome in appearance, but in this locality the Japanese plums are absolutely valueless, as the trees will not stand our climate. In portions of Ontario, British Columbia and Nova Scotia they are destined to be of great value. The Russian sorts as a rule have not proved productive thus far, although, as before stated, the trees are hardy and vigorous.

---

AN amusing anecdote is given respecting the late Duke of Leinster, who, upon one occasion having run across one of his farm laborers, is reported to have said to him: "I regret, owing to a report made by my steward, at having to dispense with your services, as there is not, I believe, sufficient work for all." Upon hearing this the man innocently remarked "Faith, your Grace, there is no necessity to dismiss me on account of scarcity of work, as very little would keep me busy." The duke was so much amused by his ready wit that he vetoed the advice of his steward and kept the laborer in his service.

---

THE BLOOM of fruit trees of all kinds has been exceptional for two seasons, first, its earliness, and second, its abundance. We in Southern Ontario had cherry bloom before April was over, and our apple bloom was at its height about the 9th of May, earlier than ever within the "memory of the oldest inhabitant." Usually the even years give the great apple crops in Ontario, and from present appearances 1896 will break all records, and every tree is doing its best, especially of such standbys, as Baldwin and Greening. Cranberry Pippins are light; they have taken to bearing at Maplehurst in the odd years, when most needed. Astracans are heavy. Of pears the Bartlett is well loaded, and clean, indeed most varieties show well; cherries are also setting a most abundant crop. Even the peach shows up well about Grimsby, while about St. Catharines, and in Niagara district there are very few if any buds which escaped the winter's frost, and the same is reported from the State of New York. Altogether the indications are, that fruit growers will have a successful season, which will help make for recent failures.

## ❖ Question Drawer. ❖

### Propagating the Plum.

**840.** SIR,—Would you describe the propagation of the plum, budding, etc., and say whether it will do to bud upon suckers which grow from the roots?

D. N. ANDERSON, *Wyoming.*

Plums are usually budded upon seedlings of some free growing variety. The pits should be sown in the fall soon after the plums are harvested and before the pits have had time to become very dry. They are sown in drills about an inch and a half deep, much the same way that peas are sown. The frost of the winter will crack the pits and in the spring they will begin to grow. When the seedlings are one year old they may be transplanted into nursery rows and set from four to six inches apart. Early in July following they will be fit

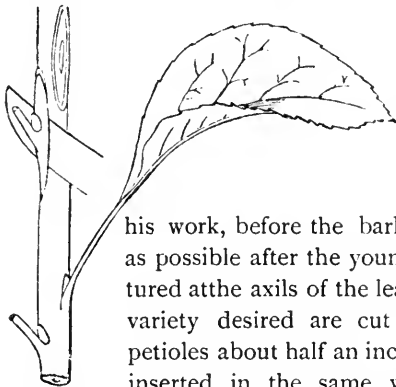

FIG. 965.

for budding. As the bark of the plum is somewhat more difficult to work than the peach, it is necessary for the budder to watch the growth in order to seize the most favorable time for

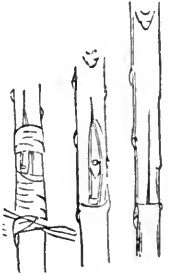

FIG. 966.

his work, before the bark becomes dry and as soon as possible after the young buds are sufficiently matured at the axils of the leaves. Sticks of buds of the variety desired are cut and the leaves trimmed off, leaving the petioles about half an inch long for handles. Buds are then cut and inserted in the same way as has been previously described for budding peaches. Fig. 965 shows the manner of cutting the bud to be inserted, and 966 shows the manner of slitting the bark, inserting the bud, and tying it with raffia, or basswood bark. Success might possibly be had in budding on sprouts from old trees, although in transplanting they might not be so sure to survive as the seedlings, the roots being poorly formed.

### How to Apply Nitrate of Soda and Bone Meal.

**841.** SIR,—I have been using bone meal and nitrate of soda as advised by writers on lettuce culture. I used soil that had been frozen solid. On a bed 100 ft. square I put two pounds of bone meal. I have cut this day, April 20th, first class Golden Queen Cabbage lettuce and Spindlow's Double Curled lettuce. I put two pounds of nitrate of soda on 100 square feet of land planted with the same varieties, and the result is that they are not nearly ready, and there is no appearance of their ever maturing. Again, on 200 feet of ground I put two pounds of soda and two pounds of bone meal, well mixed, and the result was almost a total failure. Now what caused the failure? Did the nitrate of soda retard the growth or did the bone meal cause extra rapid growth. In the case of the bone meal there was no failure whatever. In the case of the soda fully fifty per cent. of the plants died out and had to be replaced. If the soda killed fifty per cent., why not all?

Are two pounds of soda too much to apply to 100 square feet of ground for lettuce.

WM. SPENDLOW, *Billing's Bridge, Ont.*

*Reply by Prof. H. L. Hutt, Ontario Agricultural College, Guelph.*

In such experiments one plot should always be left with no fertilizer, to serve as a standard by which might be compared the relative values of the different fertilizers or mixtures used. From the fact that the plants were killed when the nitrate of soda was used, shows that it was applied in too large a quantity. From  $\frac{1}{4}$  to  $\frac{1}{2}$  lb. would be nearer the proper quantity to use on 100 sq. ft. of ground. It might be applied to the best advantage by dissolving it in a pail of water and then applying it with a sprinkler. Care should be taken, however, that the other plots in the experiment receive an equal quantity of water. Nitrate of soda can be most economically used by applying it in small quantities at intervals of ten days or two weeks.

---

### Hardiness of Japan Plums.

**842** SIR,—Are the Japan plums, Abundance, Burbank, Satsuma and Willard, as hardy as the Lombard or the Bradshaw.

J. D. STEWART, *Aitken's Ferry, P. E. I.*

The Japan plums are not as hardy as the Lombard, although they appear to be doing well in southern Ontario. Will our subscribers who have had experience with them farther north, please say whether they are hardy with them.

---

### Quinces.

**843.** SIR,—Are the Champion and Rea's Mammoth quinces as hardy as the Lombard plum? Compare season of ripening with Lombard plum.

J. D. STEWART.

So far as our experience goes in southern Ontario the quinces are as hardy as the Lombard plum, but we have not yet received results of any experiments with them in our stations farther north. The season of ripening of the quinces is at least two or three weeks later than that of the Lombard plum.

---

### Plum Baskets.

**844.** SIR, —What quantity of plums does the plum basket of Ontario contain?

J. D. STEWART.

The plum and peach basket of Ontario are the same size and hold about a peck and a half.

### The Willard Plum.

**845.** SIR,—What is the general opinion of plum growers of the value of the Willard? J. D. STEWART.

*Reply by Mr. J. K. Gordon, Whitby.*

The Willard is a yellow freestone plum of medium size and quality; the earliest in ripening of all the Japan varieties which I think constitutes its chief value for market; but as it is also a very early bloomer, I am afraid that our May frosts will render it unproductive here, and I would not, therefore, advise that it should be largely planted in Ontario County.

---

### Principal Varieties of Hardy Plums.

**846.** SIR,—Can you give a list of the principal varieties of plums of the same hardness as Lombard? as Bradshaw? J. D. STEWART.

*Reply by Mr. Gordon.*

The Lombard is not so hardy as the Bradshaw, and I class with the Lombard the following varieties as possessing the same degree of tenderness, viz.: The Willard and Abundance, Grand Duke, Orange, Diamond, Goderich, Oullin's Golden Gage and Reine Claude de Bavay. While I would rank the Bradshaw with the following hardier varieties, that is to say: Yellow Egg Imperial Gage, Smith's Orleans, French and Italian Prunes, Washington, Duanes Purple, etc.

---

### The Saunders Plum.

**847.** SIR,—What is thought of the Saunders plum in Ontario? With me it is a poor affair, at least on young trees, being small and of only medium quality. J. D. STEWART.

The Saunders is not generally known, or grown in this county (Ontario). From my experience I describe it as a healthy, hardy, underized tree, with slender, pendant branches, and a prolific bearer of handsome yellow fruit, medium to small in size, and medium to poor in quality; season quite early, which, with its fine color, may cause it to sell well, in case its small size and poor quality prove to be no objection.

---

### Propagating the Gladiolus.

**848.** SIR,—In propagating the Gladiolus—I. Would you rely upon the small root offsets for satisfaction, or would you prefer the seeds?

II. What type would you be most likely to obtain from the offsets, and from the seeds?

III. Which would be nearest to the parent? and if differentiated, in what direction, for better or for worse?

IV. How long will the best imported bulbs remain up to the standard of the variety in our conditions? and from whence do we obtain our finest strain of bulbs?

I am very glad you are giving some attention to this truly beautiful and justly popular flower. I firmly believe that it will amply repay any amount of attention given to it, and be likely to improve both itself and its devoted cultivator. It is easily managed and well suited to popular use. Success to the kindly efforts of the CANADIAN HORTICULTURIST.

B. GOTT, *Strathroy, Ont.*

*Reply by H. H. Groff, Simcoe, Ont.*

In replying to yours of the 4th inst., let me ask your readers not to lose sight of the fact, that we are speaking of hybrid Gladioli, and that the results of later work, containing as it does, such a complex mixture of blood from several species, produces a most variable flower; and when raised from choice seed, it is likely to break into endless combinations of form and beauty.

The amateur of to-day fails to realize the value of his heritage, in the results of many past years of experiment and labor, now offered at his very door; and those of long experience have yet to learn how far beyond their expectations this work has been carried, to its present successful issue.

Below find my replies to the questions from you:—

Ans. 1.—Varieties are increased by the small root offsets, or bulblets, which invariably reproduce the parent, excepting in special cases of reversion to one of the species from which the variety originally descended. Botanically speaking, no two seedlings are alike, and they are as likely to resemble any other variety of their section as either the seed or pollen parent, excepting in cases of special selection, and even then no definite results can be foretold, the chief advance being in the line of quality.

Ans. 2.—Reply to No 1 covers this query.

Ans. 3.—This depends entirely upon the stock used and methods practised in seed raising. In my own work, varieties originate that are superior to those they resemble in the choicest importations; seventy-five per cent. are often worth retaining, while, from ordinary commercial seed, over five per cent. is the exception.

Ans. 4.—Imported bulbs often fail entirely, before becoming acclimatized, and in the Gandavensis section I have long claimed that high-priced varieties should be furnished in strong, unbloomed bulblet grown bulbs, which are invariably refused, the grower knowing their greater value, and the average buyer preferring something big. Many of these big bulbs fail to produce a characteristic flower for two successive seasons, and often not until grown again from bulblets. These are all questions of the vitality of each individual variety. Europe has always produced the most advanced work on general lines; but we, thanks to the laborers of the past, can easily place ourselves on an equal footing, without the loss of time necessary in building up from the species.

## \* Open Letters. \*

### Seely Basket.

SIR,—I notice your favorable commendation of the Seely fruit basket and have had some inquiries from Ontario for material for the construction of that basket, namely veneer splints and discs for top and bottom. I would like to know if there are any people in your fruit district who are making an effort for fancy packages of fruit. I have been perfecting forms, presses and such other requisites for a uniform and convenient size which would be easily manufactured and easily handled in packing, which is no easy matter, as I am already engaged in an extensive and long established business.

I. B SEELY, *Philadelphia, Pa.*

---

### Gladiolus Degeneration.

SIR,—On page 171 you make me say, "raise your own seed as well." This should read "raise from seed." Of course any one can raise his seed, but my claim is that new crosses from seeds (wild varieties) are necessary to restore the fading vitality of the commercial gladioli *Gandivensis*. Few choice collections have the necessary stock for such work and practically none of the amateur collections.

H. H. GROFF, *Simcoe, Ont.*

## ↪ Our Book Table. ↩

THE BAMBOO GARDEN, by A. B. Freeman, Milford, C. B., author of "Tales of Old Japan," illustrated by Alfred Parsons. Published by McMillan & Co., of London and New York. Price, \$3.

This is a beautifully got up volume in every respect, and so attractive that even one who has no interest whatever in the cultivation of the bamboo can read it with pleasure and profit. It deals especially with such varieties of hardy bamboos as can be grown in England, describing their propagation, culture, uses, superstition, classification, description of species, etc, etc.

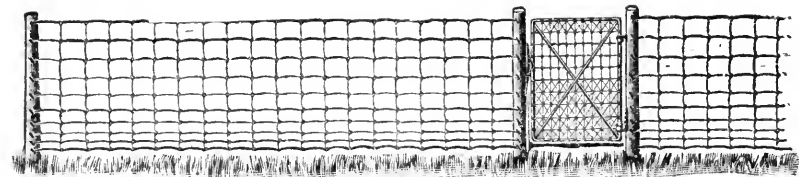

## The Fence That Pays.

Farmers that buy THE PAGE are always satisfied THE PAGE turns all their stock, does not sag, and requires no attention until the posts wear out.

Send for free illustrated paper and catalogue giving full particulars.

THE PAGE WIRE FENCE COMPANY OF ONTARIO, Limited.  
Walkerville, Ont.







PURPLE BERBERRY.  
(*Berberis Purpurea.*)

THE  
Canadian Horticulturist

VOL. XIX.

1896.

No. 7.



THE BARBERRY.

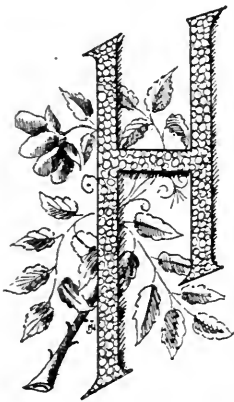

EDGES, such as form the pretty boundary of country lanes in England, are few enough in Canada. Our Canadian farmers have as yet been so busy with the necessaries that the ornamental has been neglected. But the time is at hand for an improvement in this regard; when our country roads will no longer be margined by the ugly snake fence, or even by stiff boards or pickets, but by a graceful border of living green.

Though perhaps not forming so effective a hedge as the thorn for turning cattle, the barberry succeeds better in Canada, and will grow on stony or sandy land where many shrubs would fail. It is quite ornamental too with its racemes of flowers in spring, and scarlet berries in autumn which hang the winter through, reminding us of Longfellow's couplet in *Hiawatha*,

“Where the tangled barberry bushes  
Hang their tufts of crimson berries.”

There are a good many varieties of this shrub, about thirty being described by Nicolson in his *Dictionary of Gardening*. The *Common Barberry*, (*Berberis vulgaris*) which is a native of Britain, is a free grower and forms an excellent hedge. There are a good many variations in coloring of fruit and foliage which when constant are indicated by distinct names. The one which forms the frontispiece of this number is called *B. vulgaris purpurea* because of the purple color of the foliage, which makes it a highly ornamental shrub. On poor sandy

soil, well exposed to the sun, this coloring is heightened still more. *Berberis Thunbergii* is a variety introduced from Japan by the botanist Thunberg. It forms a dense graceful bush about three feet high and of rounded form. It is a most pleasing ornamental shrub with its bright red bark, its fruit which hangs throughout the winter, and its beautiful foliage in summer.

### SOME DESTRUCTIVE INSECTS.



THE above is the title of Bulletin 68 of The Ohio Experiment Station, in which some destructive insects are well treated of.

*The Canker Worm*, one of them, is a very old one in Canadian orchards, which for some years past has been stripping some apple orchards east of Hamilton, to such an extent as to leave not a vestige of foliage. Mr. Orr, who is superintendent of spraying operations in Ontario, says this insect is wide spread and very destructive.

For the benefit of any readers who have never become acquainted with this insect we give the accompanying illustration, showing (a) a cluster of eggs, (b) some of same magnified; these hatch out as the leaves expand in the spring, into the well known measuring worm (c) which when disturbed drops quickly and hangs by a thread. If a tree is badly infested a smart knock will bring down hundreds, hanging by as many threads, ready to crawl back and continue their work of destruction. When full-grown the worm drops by the thread to

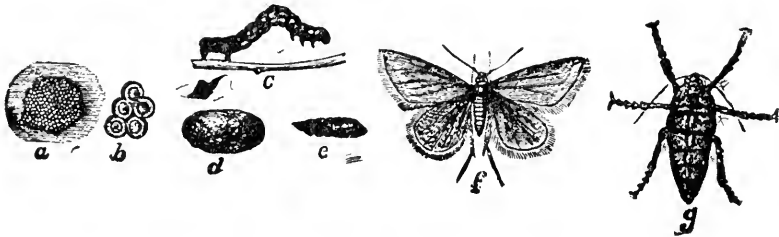

FIG. 966.—THE CANKER WORM.

the ground, and burying itself three or four inches below the surface forms a tough, buff colored cocoon (d) within which the chrysalis lies hidden till spring. Emerging with the first warm weather, the female moth (g) which is wingless, climbs the trunk of the nearest apple tree, awaits the company of the male (f) which is winged, and then proceeds to lay the eggs as first described.

Formerly the wingless female suggested the simple method of protecting the tree by bands of some sticky substance as practiced most faithfully by the writer about twenty years ago, when his orchard was attacked by this worm in great numbers. But since adopting the spraying with Paris green, no other means of

defence is needed. We simply poison the leaves, and then permit the canker worm to eat a daily dose.

*The Strawberry Sawfly* is another of the insects described and may easily be identified from the accompanying illustration, though more commonly known in the larval state, coiled up as shown at 6. This insect is also known as the strawberry slug, though it really is closely allied to the currant worm. The parent fly (3) deposits its eggs within the tissues of the leaves or stems, and the larvæ hatch out and begin feeding, and soon grow to be about  $\frac{3}{4}$  of an inch long (4 and 6). After five or six weeks in this state they go beneath the surface of the ground and form cocoons (7) and change into pupæ (1 and 2) which at length become flies.

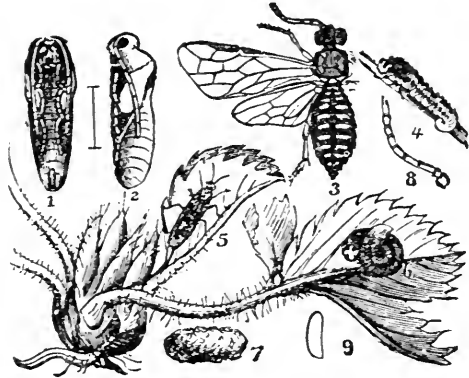

FIG. 967.—THE STRAWBERRY SAWFLY.

Spraying with Paris green may be used as a remedy where there is no fruit to be harvested ; otherwise insect powder may be used.

## CURRANTS.



URRANTS are a delicious acid fruit, extensively used in cooking and the making of jellies and jams. To fruit growers of long ago, only two varieties were known, the black and the white ; but a large number of species are now cultivated and brought to our markets.

For breakfast, a bowl of white and red currants on the stems, served with powdered sugar, form an appetizing and wholesome dish ; stewed and sweetened, they are a delicious sauce to be eaten with meats ; while made into tarts and pies, they are dainty and acceptable for the summer luncheon and dinner table.

Where a variety is desired for the table, currant compote, cream, sponge, water-ice and float may be made.

Of all fruits, currants are preferable for jelly, in making which less sugar is required than for any other fruit, always with the certainty of success. Currant jelly likewise has the merit of being suitable alike for serving with meats, flavoring sauces and using for making cakes and preparing various desserts.

Currants make a delicious jam, and may be canned green or ripe for winter use. Syrup made from them is not only a delicate flavoring for creams, ices,

saucers, custards and blanc manges, but also a beautiful coloring for fancy deserts. Wine made from currants is much esteemed in England, and is found in every household. It is said to possess great virtue in restoring the tone to a delicate stomach. Currant shrub is a refreshing summer drink, and currant cordial is so beautiful to look at, that the labor of making it would be more than repaid if it laid claim to no other quality; but it is quite as good in taste as it is in appearance.

The black currant, preserved or made into jelly or wine, is of value in the treatment of many ailments, such as sore throat, severe colds and general debility.

Altogether, the currant is a very desirable fruit for use in the household.—  
E. P. R.

### RIPE ROT OF PLUMS.



HIS disease has been very prevalent in the Niagara district, especially in wet seasons, often resulting in the loss of a large portion of the crop. The same fungus also attacks the peach, and is very destructive of the ripening fruit of such varieties as Hales and Alexander. Mr. Beach, of Geneva, in Bulletin 98, shows that this rot may largely be reduced by Bordeaux mixture.

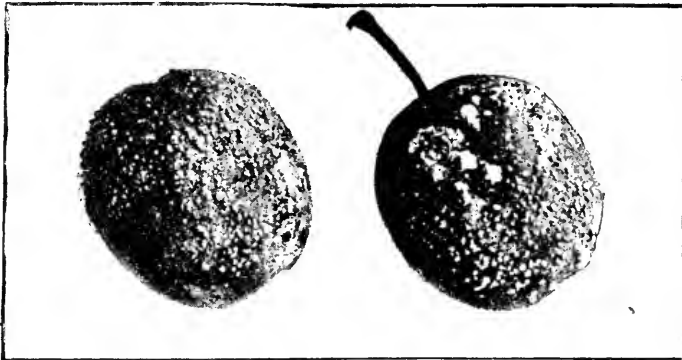

FIG. 968.—RIPE-ROT OF PLUMS (BEACH BULLETIN 98.)

The following course of treatment is recommended in this bulletin :

1. In case there is reason to fear an attack of the fruit rot fungus on the blossoms, spray thoroughly with Bordeaux mixture before the blossoms open.
2. When no attack of the fruit rot fungus in the blossoms is feared, let the first spraying be made soon after the blossoms fall. If Paris green is to be used against the curculio it may be mixed with the Bordeaux mixture at this time, using one pound to two hundred and fifty to three hundred gallons of the

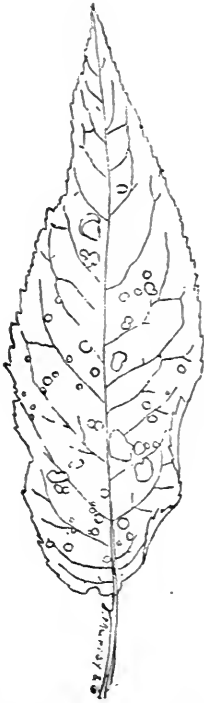

FIG. 969.—SHOT-HOLE  
FUNGUS.

mixture. The second treatment should be made about June 1st, and the third about June 15th. Should this treatment be insufficient to hold the disease in check, a fourth spraying may be made about July 15th.

In conclusion, it should be said that thoroughness in spraying is essential to success. It is not necessary to drench the trees but the aim should be to completely cover every leaf with fine mist-like particles of the spray. To do this it is necessary to have a powerful pump and good nozzle.

*The Plum Leaf Spot*, or shot-hole fungus has been successfully dealt with at the New York Experiment Station by use of Bordeaux mixture applied three times, viz.: May 17th, June 1st and June 15th. Only ten per cent. of injury was apparent in the case of the treated trees, while 78 per cent. was observable on those untreated.

This fungus makes its appearance soon after the first leaves are full grown, first by little discolored spots, about  $\frac{1}{8}$  of an inch in diameter, with margins tinged with purple or red. These spots gradually become  $\frac{1}{2}$  of an inch in diameter, and sometimes coalesce. The tissues wither, and frequently break away from the healthy portions surrounding them, leaving the circular holes represented in Fig. 969.

## SCORE CARDS FOR JUDGES.

OUR readers will remember that Score Cards were prepared by the Ontario Fruit Growers Association for the use of Judges at exhibitions, and described in the report for 1894. At the Industrial last year these Cards were tried and found to serve an excellent purpose, because it necessitated judging by points instead of the hasty jumping at decisions so commonly practised. Of course Judges who attempt such careful work are entitled to higher compensation than when using the old method, and where one Judge is made responsible in place of three, that one should receive the fees formerly allowed the three Judges.

In order to make the cards a little simpler, we have reduced the several score cards for dessert, cooking and general purpose apples, to one; simply by giving at the head the points belonging to each division, thus:—

### Score Card for Collections of Apples and Pears

Ten Points as follows:

For Cooking:—Form 1; Size 3; Color 1; Uniformity 2; Clearness 3.

For Dessert:—Form 2; Size 1; Color 2; Clearness 3; Uniformity 2.

General Collection:—Form 1; Size 2; Color 2; Clearness 3; Uniformity 2.

Variety.	Value of Sample.	Catalogue Value of Variety.	Total Points.

*N.B.—To sum up total of points add maximum of five times the number of varieties for covering the season.*

From the scale of points given, it is easy to score up the value of the sample plate of each variety shown in a collection. The Catalogue value of a variety may be had from the table in the report of the Fruit Growers' Association; adding together the value of the sample and the catalogue value of the variety we have the total number of points for each variety. These added will give the total value of the collection.

Since it is important that a collection should cover the season in period of maturity and use, a certain maximum number of points is added to the total for this, say equal to five times the number of varieties.

For single plates the cards are of little or no service.

For collections of grapes a similar score card is used, as follows :—

### Score Card for Collection of Grapes.

Ten Points, as follows :—Flavor, 3 ; Form of Bunch, 1 ; Size of Bunch,  $1\frac{1}{2}$  ; Size of Berry,  $1\frac{1}{2}$  ; Color, 1 ; Firmness,  $\frac{1}{2}$  ; Bloom,  $\frac{1}{2}$  ; Freedom of Blemish, 1.

Variety.	Value of Sample.	Catalogue Value of Variety.	Total Points.

*N.B.—To sum up total of points add maximum of five times the number of varieties for covering the season.*

Officers of fairs so desiring may print and use copies of these cards, or correspond with the Secretary of the Fruit Growers' Association for cards already printed.



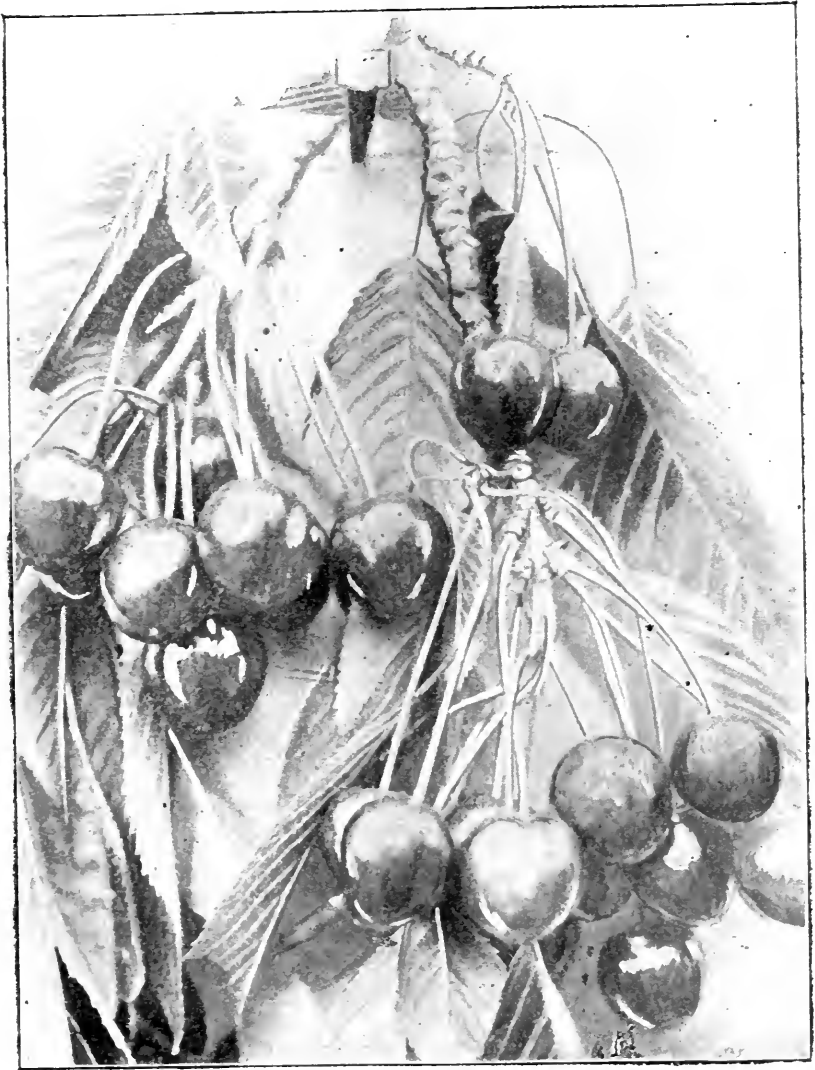

FIG. 970.—BRANCH OF EARLY PURPLE CHERRIES.

## THE EARLY PURPLE.



THE earliest dessert cherry is the Early Purple, a foreign variety known in France as the Early Purple Guigne. The tree is a vigorous upright grower, not subject to black knot, and it becomes quite productive as the tree acquires age. A tree about thirty years planted at Grimsby yielded, in 1886, 144 quarts; they were harvested on the 11th of June, and sold in the wholesale market at an average of 12 cents per qt. This is the tree's best record, for usually the birds destroy the fruit before it matures, and if gathered as soon as colored red it is little more than "skin and bones." The last few days of growth it fills out wonderfully, and becomes almost a so called "black cherry." The variety is quite hardy south of Lake Ontario, and is worthy of trial farther north.

The branch which we have photographed for the illustration was taken from the tree above referred to, and shows the habit of fruiting, as well as the cherries in natural size.

*Tree.*—Upright, vigorous, healthy, productive when full grown.

*Fruit.*—Medium size, roundish heartshaped; skin dark red to purple; stem two inches long in a shallow cavity; suture obscure.

*Flesh.*—Color, red to purple; texture tender, juicy; flavor sweet and pleasant.

*Season.*—June 10th to 15th.

*Adaptation.*—Grown at Grimsby for thirty years and quite hardy; fairly hardy in Maine and Michigan.

**Pleasure Grounds.**—Grass lawns that have become browned by the recent dry weather should not be mown very closely. Raise the knives in the machine well up, and remove the grass-box, so that the cut grass may remain as it is scattered about by the machine; it will then assist in keeping the lawn green. If the lawn has not been mown for some time owing to the drought, it will be well to mow it lightly over with a sharp scythe before the lawn mower is used on it again. Grass-edgings should be kept tidy by clipping with the edging shears, and narrow verges of grass in dry situations require to be well watered during dry weather.—Gardeners' Chronicle.

A little girl in Aberdeen brought a basket of strawberries to the minister very early on Monday morning. "Thank you, my little girl," he said; "they are beautiful. But I hope you didn't gather them yesterday, which was the Sabbath day?"

"No, sir," replied the child, "I pulled them this morning. But they was growin' all day yesterday."

## TENDER FRUITS IN ENGLAND.



P EACHES and nectarines grown in England, if of good quality, find a ready sale, and suffer nothing from the competition of foreign supplies, which are either of inferior sorts, unripe, or too much damaged to find much favor. Expert growers of these fruits contrive to maintain a supply from April to November by cultivating a variety of sorts under different temperatures. Mr. Munro says there were often a thousand boxes of English-grown peaches and nectarines disposed of daily last year in Covent Garden. I have tasted here peaches from California which compared favorably with the English grown fruit.

Grapes are in greater demand than ever. Enormous quantities are imported from the Cape, Spain, etc., yet cultivators in this country find this fruit a profitable investment, the acreage of glass devoted to it being largely increased every year. I am told that good grapes grown under glass in England pay at one shilling per pound. The varieties cultivated are chiefly Alicante, Black Hamburg and Gros Colman. About one thousand tons of English-grown grapes are now annually marketed in this country, and nearly twice that quantity are received from the Channel Islands, where grape culture has become a staple industry. Even Belgium sends forced grapes to the English market, about two hundred tons being received from that country last year, a prohibitive duty practically closing the Paris market to them.

Cucumbers at one time were largely imported from the Continent, but now English growers supply the Continental markets as well as their own. Mr. Munro estimates the supply of this fruit from March to the end of July at about fifty thousand per day.

The increase in the consumption of tomatoes in England within the last ten years has been phenomenal. They are a certain source of profit to the beginner with limited capital, being easily grown and marketed and readily sold. The quantity of house-grown fruit that passed through Covent Garden market alone from March to November is estimated at two thousand tons, and this is probably only a tithe of what is marketed throughout the country. I know a market grower in the provinces who cannot sell apples and pears at any price, while his tomatoes offered direct to the same consumers sold readily at sixpence per pound, the price asked for six pounds of apples. My friend proposes to leave the supply of apples and pears to the foreigners, and to devote himself entirely to tomatoes and cucumbers.—W. WATSON, *Garden and Forest*.

## ABOUT CURRANTS.



THE marked development in recent years of the interest in currants as a market fruit has naturally been accompanied by the introduction of many new varieties and some old varieties under new names. The newer candidates for favor include the Eclipse, North Star, Red Cross and Wilder of the red kinds, and Marvin's Seedling, Caywood's Seedling and White Versailles of the white kinds, and several other sorts. None of these have been fruited here long enough to determine their productiveness.

North Star, introduced from Minnesota, makes a vigorous upright or somewhat spreading growth. The color of the fruit is much like that of the Red Dutch; bunches medium length; fruit probably large under good cultivation, but varying from small to large. Red Cross, from seed of Cherry fertilized by White Grape, was originated by the originator of Brighton Grape. The fruit is medium to very large, milder-flavored and lighter in color and somewhat later in season than Cherry. Habit of bush, upright, vigorous. Eclipse is a good grower and bears bunches from two and a-half to three inches long. The fruit varies from small to large; color good, somewhat lighter than that of Fay; flavor comparatively mild. Wilder, from seed of Versailles, originated about eighteen years ago with Mr. E. Y. Teas, Irvington, Indiana. It is a good grower, bearing fruit medium to very large, less uniform in size than Fay, and somewhat lighter in color. It appears to be worthy of extended trial as a late kind.

Among the red currants that have been in full bearing at this station during the last three years, Cherry has been one of the most desirable of the large-fruited kinds. Fay yields longer bunches and more uniformly large fruit than Cherry, but it does not make as satisfactory a bush, nor has it been as productive in this locality as the Cherry. Neither of these kinds will remain on the bushes in good condition for shipping as late as will Victoria, Prince Albert or Wilder. On account of its thin skin and abundance of fine-flavored juice, Cherry is liked at fruit-preserving establishments for making into jam, but it is necessary to evaporate away more of its juice in making jelly than it is with some other varieties. Fay and Prince Albert are especially liked for making into jelly, because of their large size, thin skin and rich pulp.

Prince Albert is a vigorous grower, more upright even than Red Dutch. When well grown the fruit will pass for large. Of all the varieties in full bearing here during the last three years it has given the highest average yield, and London Red, also known as Short-bunched Red, has taken second place. The London Red, like Cherry, has short clusters, with stem so short as to make it difficult to pick. The fruit varies from medium to large and is similar to Red Dutch in color and quality. One of the most valuable of the kinds that produce

medium-sized fruit is Victoria, also known in Canada as Ruby Castle or Raby Castle. The bush is a very strong grower, upright and very productive. The cluster of well-formed buds at the end of the shoot, the bluish gray color of the buds and the rather pale green foliage are quite characteristic of this variety. The clusters are of good medium length. The fruit is late in coloring, has a bright red color, and will keep on the bushes in good condition later than either Cherry or Red Dutch.

The market demand for white currants is quite limited, and the number of new white varieties is not so great as the number of newly-introduced red sorts. White Grape and White Dutch still remain the standard sorts. White Imperial has not yet fruited here. Caywood Seedling is a very productive white kind, with spreading or drooping branches. The fruit is large, attractive and of good quality. Marvin's Seedling is similar in color to White Grape, larger in size and rather more acid. White Versaillaise has long, well-formed clusters slightly darker in color than White Grape; berries larger, less juicy and about the same in acidity as White Grape.—W. P., in Garden and Forest.

### COMPOSITION AND ACTION OF WOOD ASHES.

“Leached and unleached Canada ashes have approximately the following percentage composition :

	Unleached Ashes.	Leached Ashes.
Sand, earth and charcoal . . . . .	13.0	13.0
Moisture . . . . .	12.0	30.0
Carbonate, with some hydrate of lime . . . . .	61.0	51.0
Potash [chiefly as carbonate] . . . . .	5.5	1.1
Phosphoric acid . . . . .	1.9	1.4
Other matters by difference . . . . .	6.6	3.5
	<hr/> 100.0	<hr/> 100.0

“It appears from this statement that more than half the weight of both leached and unleached ashes consists of lime, partly as hydrate, but chiefly as carbonate; the same material chemically as chalk or limestone, but finer, and so likely to be quicker in its action.

“It has long been known that chalk or limestone may benefit both very heavy and very light lands, making the one looser in texture and less apt to puddle, and the other closer and more compact. It does this in the one case by separating the particles of sticky clay, and in the other by filling up the interspaces of a coarse soil. A writer on agriculture in the early part of the last century says of chalk: ‘it causes great fertility, especially on such lands as are apt to lose the riches of dungs laid on them, and to forget in a little time

that they have had any kind and indulgent benefactor. Here chalk is of excellent use to drive away such ingratitude, having a retentive quality to enclose and stay the salts.'

"It needs to be borne in mind that potash or soda lye binds a clay soil, making it heavier, more tenacious and cloddy than before, and it may be that on this account a heavy application of *unleached* ashes to a clay soil would either not help it at all or even damage it, while on light soils unleached ashes would be more beneficial than leached ashes. This favorable action on light soils has made ashes popular in this State, where our soil is for the most part light and sandy. They 'keep the soil moist' as the saying is, that is by filling up the pores and compacting it, the soil water is made to rise more readily in it from the subsoil, bringing plant food with it and preventing drought.

"Besides this action of ashes which is in large part at least mechanical, they also tend to correct 'sourness' of the soil. In most cases this is not due to free acid, but to the presence of soluble iron salts, which in undue quantity are poisonous to plants, and in smaller quantity show that the soil is stagnant, and needs aeration. Ashes precipitate these salts and opens the soil that contains them to the air, by making it looser in texture.

"When potash salts have been used in large quantities and the potash has been largely taken up by a rapidly growing crop, as tobacco, leaving most of the acid with which the potash was combined in the soil, ashes or lime may profitably be used to neutralize it. Our best tobacco growers use stone lime or cotton hull ashes largely on their tobacco land, with excellent results.

"A third way in which ashes benefit land is in promoting nitrification; that process by which the more or less inert nitrogenous matters in the soil are made to yield nitrates, from which our field crops obtain most, if not all, their nitrogen supply. This process is in some way connected with the life of low organisms, which are invariably present in fertile soils. Nitric acid can only be produced, however, when carbonate of lime is present to supply a base with which the acid may combine, and a soil mildly alkaline is the one most favorable to the growth of these organisms and the formation of nitrates.

"Such is, in brief, our present knowledge regarding the action of ashes. It is clear that the quantities of potash and phosphoric acid present do not wholly measure the value of ashes, nor does it pay to buy them simply to supply a deficiency of these two things in the manure. The quantities of potash and phosphoric acid in a ton of ashes costing \$12 to \$15, can be bought in the form of muriate of potash and superphosphate of lime for \$8 or \$9. But ashes temper certain soils, making them easier to work, moister, and more retentive of manure, correcting 'sourness,' promoting the solution of plant food in them, and so preparing the way for the use of fertilizers, which, directly applied, might be wasted. To accomplish these ends, ashes have to be used in considerable quantity, and probably a single heavy dose would help more than the same quantity applied in fractions, through three or four successive years, if the object is to change the mechanical condition of the soil strikingly."

Ten Thousand Pounds of Wood contained Pounds of the Ingredients named :

Potash .....	19.02	18.06	16.85	14.94	13.95	13.80	10.60	7.13	5.01	4.54	3.02	2.90	.79
Phosphoric acid.....	5.72	9.55	6.96	1.15	5.98	5.83	2.49	3.19	1.24	.96	.62	1.09	.73
Lime .....	26.41	24.73	35.61	7.60	27.40	18.40	7.85	14.21	18.04	15.16	12.46	7.93	12.12
Magnesia.....	4.67	.49	5.28	.10	3.05	4.86	.90	2.94	2.03	.74	.10	.34	1.17
<b>The Pure* Ashes of the Woods contained the following per cents. of the Ingredients named :</b>													
Potash .....	28.04	23.17	21.92	46.04	24.66	28.60	42.16	19.54	15.35	19.70	14.30	18.10	3.85
Phosphoric acid....	8.51	12.23	9.00	3.58	10.55	11.97	9.48	8.75	3.82	4.18	4.33	6.76	4.11
Lime .....	38.93	31.62	46.39	23.57	48.26	37.94	29.85	38.94	55.24	65.53	58.98	49.18	67.73
Magnesia.....	6.80	.62	6.88	.60	5.38	10.04	3.43	8.05	6.25	3.20	.50	2.11	6.54

\*Free from carbon and carbonic acid.

## PLUM GROWING IN THE COLD NORTH.



At the meeting of the Iowa State Horticultural Society, H. A. Terry, of Crescent, who has done more than anyone in the State on the introduction of our native American plum, said that for the purpose of propagation, select a good, clean piece of ground, rich enough to grow good corn, and prepare it in the best possible manner. About October 1st the land is prepared, giving it the best cultivation. Make furrows about 2 inches deep and  $2\frac{1}{2}$  feet apart. The pits are planted immediately. Cover so as to level the ground. The sooner the pits are planted after they are gathered the better they will germinate. If not planted too thickly, they will be large enough to bud the first season. The varieties best adapted for Southern Iowa are Milton, Charles Downing, De Soto, Hammer, Jones, Hawkeye, Forest Rose, Cheney, Macquoketa, Wolf, Crescent City, Col. Wilder and Champion. Milton is the earliest and Champion the latest. This list fills the season from the first of July till hard frosts.

Hon. Silas Wilson, of Atlantic, paid a high tribute to the culture of native plums in Iowa. He thought much would come from the work of hybridization and cross-fertilization, as witnessed by the excellent results obtained by Luther Burbank, of California, in the Wickson plum and Giant prune. Iowa plums of recent introduction, that have an established merit, are Hawkeye, Wyant, Milton, Tatge, Charles Downing, Hammer, Communia and Rockford. Of the Chickasaws, Milton should be placed first and Charles Downing second. The Milton ripens three weeks earlier than the Wild Goose. The Charles Downing is a good keeper, a beautiful plum, and superb in quality. The Tatge is of European strain, and originated in Benton County some 25 years ago. It is a heavy bearer, and belongs to the Lombard family.

Hon. J. G. Berryhill, of Des Moines, who is cultivating our various native plums for commercial purposes, considers Forest Garden, De Soto, Wolf, Hawkeye, Miner, Maquoketa and Milton as best suited for Iowa conditions. Hawkeye is the largest and most attractive of the American varieties. De Soto is a wonderful bearer, but is not adapted to all soil conditions. Forest Garden is one of the best plums for home growing, but it is not so valuable for distant shipment. Wolf is the most profitable plum to grow. It bears well and early. The Miner has been a profitable plum. It is productive, but only when surrounded by other plums like Wolf, De Soto or Forest Garden. The Russian plums have not been successful on his place.

C. L. Watrous gave it as his opinion that our native plums are most satisfactory. Col. G. C. Brackett stated that at the various trial stations in Iowa, De Soto, Forest Garden, Wolf and Stoddard have done best. During the dis



cussion it was stated that of the Domestic type the *Communia* and *Richland* have borne good fruit. In fact, all of the Domestic have done well in the southern half of Iowa the past year. The Japan plums show vigor of growth, but in some cases do not mature their wood. Mr. Berryhill has had most success with Willard. It flowers at Des Moines from the middle to the latter part of April. The Japan plums come into bloom suddenly, ripen earlier than any of our plums, and with them we may have fruit from June until the end of the season.

## HOW TO LAYER GRAPE VINES.



GRAPE layer is a branch of the previous year's growth laid in early spring in a trench and covered with earth. Shoots start up from this and beneath each shoot will be some roots, thus making a new plant at each joint. But in a very dry season many of the joints will not root, or if they do will make poor growth.

Better success may be attained by waiting later in the season.

A bare branch laid in a trench, even if very lightly covered with earth, gets such a set back that many of the eyes will push feebly or not at all. Leave the branch on the trellis till June or later, and let the buds push to six inches or more in length. Then dig a bed of mellow soil and lay the branch on it to see how many of the shoots will turn upwards. Cut out all that grow downwards, and cut a slight notch under each of the other shoots on the main stem. This is to arrest the flow of sap and cause the roots to form. When you have got the branches you want, cut off the lower leaves at the basis of each shoot. They do no good, and if left would be covered with earth when they would rapidly decay and injure the plants. Dig a slight hollow deep enough to come to moist earth, and with one or more forked sticks pin down the branch to the ground, pressing it firmly against the soil. This is very important, as when roots are formed it is necessary that they come in contact with the earth as soon as possible. Finally, after the branch is trimmed and laid down, with a sharp knife cut a ring around it an inch wide, completely scraping off every particle of the bark down to the wood. The effect of this is to entirely arrest the backward flow of the sap to the roots. The sap makes its way to every cut place, and forms the basis from which the roots push. Make this excision near the ground, and finally lay it down and cover it with earth. The part of the branch outside the cut will soon swell to double the size of that next the stem. This engorgement of sap goes into the new roots as they push from the shoots and makes them very vigorous.

Shoots of this season's growth will become firm enough to layer by mid-summer. The extreme shoot should be cut back severely, so as to throw the sap back into the laterals. Cut away the leaf under each shoot before setting.

*Tiverton, Ont.*

A. H. CAMERON.

## CANADIAN APPLES IN ENGLAND.



N the Edinburgh market, as in other markets of Great Britain, the best grades of well-colored apples are in the highest demand, such as Baldwins, Northern Spys, the genuine Spitzenbergs, York Imperials and Romanites from Virginia, which last are quite different from the fruit of the same name from other parts of the United States, the latter being a pale, undecided color, instead of dark rich-looking like the Virginia fruit. Baldwins are inclined to ripen quickly, but their quality is liked and they always command a ready sale, bringing from \$4.50 to \$5.50 a barrel. The Northern Spys are favorites, especially those from Canada, which seem to be superior in keeping quality to those grown farther south. Many apples are exported as Spitzenbergs which do not have the shape of the genuine fruit and which are quite inferior in flavor and have none of that dissolving quality which distinguishes the true fruit. The King apples, especially those from Canada, take the first rank on account of their color, their flavor, their fine fibre and the rich look of their flesh, and they always bring good prices. Of course, the Newtown Pippin is the favorite among green apples, and those grown in Virginia of the finest flavor and most melting quality, in ordinary seasons range from \$5.00 to \$7.50 a barrel, but owing to their abundance this year prices ruled lower. It should be noted that there are two kinds of Newtown Pippin which reach Great Britian, one of which is gritty, hard and inclined to be dry, resembling somewhat the Swaar. They are more beautiful, however, than the Virginia Newtowns, which do not look as bright, being of a greenish yellow with a small red spot. The Rhode Island Greenings is always in demand for cooking purposes, and Greenings grown in Canada have superior keeping qualities. The prices rule from \$3.50 to \$3.75 with a fair ordinary supply, but when the importations are excessive they have fallen as low as \$2.75 a barrel. There is little demand for Russets, except when other apples are scarce. During the season of abundance they are neglected and sell at low figures. The York Imperial is a comparatively new apple, but as it has arrived this season it commands good prices on account of its size and bold appearance. It has brought from \$4.00 to \$4.50 generally, but when other kinds are scarce it has sold for as much as \$5.50. Rome Beauties have not been known much until recently, but being of a good keeping quality and bright color they command ready sales, although they are rather dry in quality. Ben Davis has little to commend it except fair quality, and there is no active demand for it when there is anything like a fair supply of other kinds. Winesaps from Virginia are much sought for here. They have a rich deep color and superior flavor, excellent keeping quality, and they carry well, so that they have everything to recommend them. They generally sell at from \$4.50 to \$6.00 per barrel. The so-called Winesaps from other parts of the United States are often poor and

soft. This may be due to lack of care in thinning and sorting, but, as it appears in the English markets, the even-sized, beautiful fruit from Virginia is quite as distinct as if it was a different variety, as perhaps it is. In richness of flesh the true Winesap can hardly be surpassed. The Fameuse is also a great favorite on account of its flavor and the absence of any grit in the flesh, while the smooth texture of its skin is near perfection.—Garden and Forest.

## CRIMSON CLOVER.



RIMSON clover succeeds well in Ontario. Mr. D. J. McKinnon, of Grimsby, has experimented quite extensively with it, and has proved its adaptability to the Niagara District. He seeded his young fruit plantation with it last midsummer, and left the clover standing as a protection until the middle of May last, when he plowed it under. It covered the ground most completely, and was so beautiful

in appearance that it was worth a journey to see it; and when plowed under it serves an excellent purpose as a fertilizer.

Prof. Bailey, in a recent bulletin, advises that the cultivation of fruit orchards and gardens be discontinued early in the fall, that the trees and plants may ripen their growth. Some catch crop is then desirable, and one of the best is crimson clover. He says:—"This crop will, if properly plowed under, greatly improve the mechanical condition of the soil; its roots will catch some of the leaching nitrates, of which the roots of the trees are now in little need; it will catch the rains and snows of fall and winter and hold them until they gradually percolate into the earth; it will prevent the puddling and cementing of the soil during winter.

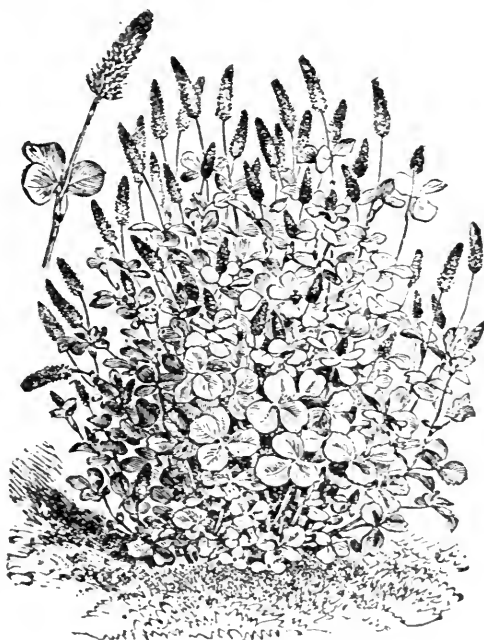

FIG. 971.—CRIMSON CLOVER.

## NOTES ON A LECTURE TOUR.—III.



Y far the most active and enthusiastic society that it was my privilege to visit during my tour of March last was the society at Napanee; and to the energy and enthusiasm of its president, Mrs. Judge Wilkinson, is due, in a very large measure, its activity and success. The floral display in the hall at the annual meeting was a lovely one, and the taste displayed in the order and decorations of the hall, together with the very excellent vocal and instrumental music given in the programme, all gave evidence that the citizens of Napanee were cultured in art as well as in nature. And the suburban houses and adjacent farms, as far as any observation could reach, gave evidence that home ornamentation was not neglected by the farmers and suburban dwellers.

At Trenton the meeting was a small one compared with the crowded hall at Napanee. But this was due largely to the fact that several other entertainments were being held in the town on the same evening. In its surroundings nature has done much for Trenton for it is certainly located in a very picturesque spot. While there I met Mr. Dempsey our experimenter for that district who was then, in March, shipping two carloads of apples from his own storage buildings to Montreal and realizing a good price for them. Mr. Dempsey is strongly convinced that there is money in apples for any man who will provide himself with proper storage and keep them till the winter is well advanced. But he is not convinced that there is any money in it for the fruit experimenter at the allowances now made to the several experiment stations, nor can he see any utility in planting for testing purposes a great lot of old varieties of fruit, many of them now commonly grown and some discarded long ago as worthless.

Making my way through the terrible snow blockade to Lindsay I was unable to see much of the country to judge of the progress made in orchard planting, as I travelled much of the time in the darkness, and when daylight favored me the country had largely disappeared beneath the mountains of snow. In a horticultural sense the town of Lindsay has made wonderful progress in the last twenty-five years. Tree planting on the streets and avenues has been pushed with commendable enterprise and the town must look very pretty with its wealth of foliage in the summer season. I was delightfully entertained in Lindsay by a member of our association, Mr. W. M. Robson, and here also I met our esteemed and energetic director Mr. Beall. Mr. Robson and Mr. Beall are close neighbors, and to me it was a pleasing privilege to go over their extensive grounds and to observe the thrift and well-cared-for trees, vines and bushes that made up their orchards, vineyards and small fruit grounds. For town residents they are both large growers of fruit, and verily our director Mr. Beall is a practicer as well as a preacher in horticulture. From indications visible on every hand the handsome and progressive town of Lindsay has evidently profited both from his preaching and his example.

The society at Lindsay has a large membership, the annual meeting was well attended and the floral display in the hall was a magnificent one. What surprised me much was to find in that Northern town that the pear and plum trees, grapevines, and shubbery of all kinds looked just as vigorous and thrifty as at any of the frontier towns on Lake Ontario, and that roses were grown more extensively and with less difficulty out there than at the front.

*Mitchell.*

T. H. RACE.

## CANADIAN APPLES FOR NEW YORK CITY.

*To the Editor of THE CANADIAN HORTICULTURIST.*

SIR,—A few days since my grocer opened a barrel of Baldwin apples taken the day he purchased them from a cold storage warehouse. They were of good size, fine red color, and fairly free from defects. He gave \$5.50 for them, and retailed them at 75 cents per peck. They were Northern Spy apples.

To-day I gave five cents for two medium-sized Northern Spys, of fine color; on the same stand prime navel oranges from California, were selling at the same price. During the months of October, November and December last we paid our grocer 40 cents per peck for Southern Greenings. They were thick-skinned, coarse-grained, and of a flat sub-acid flavor, only good for cooking, and yet they were the best for the money in the market.

It is now ten years since I left Oshawa, Ontario, and came here to reside. The fruit most difficult to obtain of *fine* quality, each spring, has been apples. Apples from south of Lake Erie and New York State are poor keepers, and lack in flavor. The very best apple country upon this continent is in Ontario, east of Kingston, and south of Georgian Bay. The skin of the apple in that section is thin and high-colored, the flesh fine-grained and brittle, the flavor a brisk, rich sub-acid; fine to eat out of the hand, or to cook. They are better keepers than any apples that I know of. By the time young trees planted now come into full bearing, we shall have in this Republic 100,000,000 of consumers; and if all the land in the section of Ontario I have named was planted with apples, this market would consume them at remunerative prices. There is not the *slightest danger of over-stocking* this market with apples of *prime quality* exposed for sale in March, April, and May.

I have never tasted a prime red Astrachan since I came here, such as I grew in my garden in Oshawa, although I have hunted the markets for them. I suggest that some fruit dealer send to this market some FINE red Astrachans this summer in kegs or half barrels; pack them carefully; ship to some good commission merchant in New York; brand them *plainly* as from *Canada*, and adopt some trade mark so as to establish a reputation for the brand, and I am confident that even after paying the duty and charges upon them they will yield

a fair price. When I resided in Rochester I sent some Louise bonne de Jersey Pears to this market in kegs ( $\frac{1}{4}$  barrels), and I received for them after deducting all charges, \$5.50 per keg; this was in 1860. Had I sent them in full barrels they would not have netted me more than \$16 per barrel. Many persons are ready to pay \$2 for a keg of *fine* red Astrachans, who would not give \$6 for a barrel; *superiority* is always in demand, the market is never overstocked, while the market is glutted with *inferiority* at all seasons. Benoni, St. Lawrence, Gravenstein and Maiden's Blush, might be sent here in the same way, as well as Duchess of Oldenburg. The market for *prime* Fameuse or Snow apples, is unlimited.

The success of such an experiment will depend on the quality of the fruit and the care in packing. When the brand is established the demand will far exceed the supply.

In 1894 thirteen hundred carloads of green fruit from California, came to this city, and was sold at auction. The railway freight and ice for refrigerator cars makes the charges about \$50 per ton of fruit, and yet the trade is increasing; in fact, is only in its infancy. Carloads of California plums were retailed in this city at the rate of two for 5 cents, and yet the quality is inferior to *Ontario plums*. Western Ontario should be one vast apple orchard. Cheese at 10 cents per pound only returns 2 cents per quart for the milk, and yet the cheese industry is receiving much attention from the government of Ontario. Fruit can be made more profitable now that we have canning factories, evaporating factories, and cold storage, with a constantly expanding market.

The increase in the population of Canada and the United States from 1900 to 1910, will not be much less than 20,000,000, and in addition to this expansion of population the consumption of fruit per capita is rapidly increasing.

With a population of 25,000,000 we consume less than 40 lbs. of sugar per capita, or, 1,400,000,000 lbs. Now, with a population of 70,000,000, we consume 65 lbs. per capita, or, 4,500,000,000. As with sugar so it will be with fruit.

FRANCIS WAYLAND GLEN.

543 Madison St., Brooklyn, N. Y.

**Increasing a Wheelbarrow's Capacity.**—When wheeling corn fodder and other light stuff, a wheelbarrow's capacity is too limited for convenience.

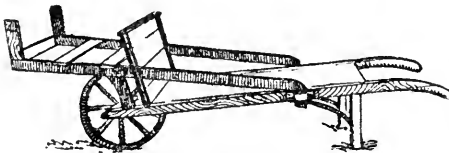

FIG. 972.

The illustration shows a simple attachment that can be slipped into the barrow on such occasions, to the great increase of its capacity. The side pieces should be hardwood strips. The attachment may be supported by

hooks from the strips to the top of the wheelbarrow's back if preferred.—American Agriculturist.



## THE FRUIT CROP.



WE have purposely delayed making any reports on the fruit prospects of the present season until this month, in order that we might first pass by the season of most uncertainty. Now that the fruit has not only set, but also begun rapid growth, one may calculate with some degree of certainty upon the crop. The branches shown above were cut at Maplehurst about the 10th of June, to show the fruitfulness of the trees. Beginning on the left the varieties are Baldwin apples, Rivers peaches, Bartlett pears, Governor Wood cherries, and King apples. All these are as full as the trees can carry. The King apple trees never have carried such a quantity of fruit as they are doing this season, while even the Baldwin, which has for ten or twelve years been almost barren seems to have recovered its old-time fruitfulness. Many growers had become discouraged with this variety, and had rooted up their orchards, and now they will surely mourn their rashness. Bartlett pears and cherries are not grown very far north, but in Grimsby district, this year promises to furnish the finest quality ever known, while the cherries, which we are beginning to harvest, will out-yield any previous year. Peaches also are a magnificent crop in certain favored sections, especially are they abundant about Grimsby, while on the other hand they are failures both east and west, owing to the severe frosts of last January which has also cut them off in both the States of New York and Michigan.

Mr. J. M. Fisk, President of the Quebec Pomological Society, writes as follows concerning the fruit in that section: May opened very warm, and we have had no frosts to check vegetation, but generally cool weather since June came in. In fact such weather as we might have looked for in May. The outlook for the apple crop is first-class. There was an abundance of bloom, and good prospect of a crop of most varieties except Bl<sub>e</sub>

Pearmain. This variety, although full of blossom, is carrying little fruit. There is no show of scab as yet. I have sprayed twice, and am inclined to let things go at that. Spraying is practised by a number of fruit growers in this locality. No signs of pear blight up to date, but plenty of other enemies to fight, as bud moth, tent caterpillar and curculio. All small fruit promise an average crop.

Mr. George Nicol of Cataragui, Director for the Counties of Frontenac, Leeds, Grenville and Brockville, and the City of Kingston, writes: The prospects for the various fruits is most favorable. Strawberries, although badly winter-killed, are coming on plentifully, and are fine in quality. Gooseberries, raspberries and currants are yielding abundantly. Apples have set well, and the foliage looks fine, except where attacked by the cigar-case bearer. Last season this pest was noticed in this locality in a limited number, but this year its ravages have increased, and will seriously affect the apple crop.

OTTAWA VALLEY.—Mr. J. G. Whyte reports as follows: Apples, early, good; over the average in most places. Twig blight showing, but not serious yet. Apples, late, under the average. Plums, native red, a very heavy crop, no sign yet of the blight. Plums, blue and green, a complete failure, 32 below zero last winter was fatal to all varieties of *Prunus domestica*. Cherries, much under the average; many trees were root killed by the severe cold of last winter. Grapes, an average crop. Currants, black, red and white, all loaded with fruit, above the average. Gooseberries, native, an extra crop. Foreign varieties, that came through the winter all right are a full crop, but many varieties were badly winter killed. Raspberries, red, under the average, most kinds were injured by the severe cold of last winter. Raspberries, black, a full crop. Blackberries, very few grown here, but those that passed through the winter safely are bearing well. Strawberries, not over half a crop; old plantations were badly winter-killed, a fair crop on plants put out last season.

SIMCOE COUNTY.—Mr. G. C. Caston writes as follows: So far as I can ascertain the fruit in this district will be as follows: Apples, above average; prospects of the largest crop for several years. Plums not much grown here, wild or common red plentiful, but nearly all spoiled by curculio. Improved varieties fair. Cherries very light. Pears light to medium. Small fruits suffered from drouth. We had no rain all the spring and up to the 5th of June. Since then we have had some showers, and strawberries may yet do fairly well. Raspberries will likely be an average crop. Gooseberries and currants are fruiting well. As to grapes, so few are grown here that they are not of any consequence.

PERTH AND MIDDLESEX.—Mr. T. H. Race, of Mitchell, writes: The fruit prospects throughout this district are on the whole very promising. Apples promise a full crop. Cherries a full crop. Pears and plums a fair crop, as the trees did not blossom as heavy as last year. In small fruits, black currants are dropping badly and only quarter of a crop can be looked for at best; red and white currants are promising well. Gooseberries are a heavy crop, but the mildew is playing havoc with them in many localities. In some gardens no varieties are exempt from this disease this year, where mildew never appeared before. Raspberries promise a very heavy crop, though the plantations both in wild and cultivated are much more limited than formerly on account of the frosts of last year. As yet there are no indications of dropping except with black currants.

NIAGARA DISTRICT.—Mr. A. M. Smith, of St. Catharines, writes: I think the following will be about the result of the fruit crop for the district I represent.—Strawberries, 75 per cent., early varieties injured by drouth; red raspberries, 50 per cent. badly wintered killed in some places; blackcaps, 80 per cent.; blackberries, 90 per cent.; sweet cherries 80 per cent.; sour cherries, 50 per cent.; plums 75 per cent.; fruit buds of Japan and tender sorts hurt by winter frosts; pears, Bartlett and Kieffer 100 per cent., a good many other varieties light, not more than 60 per cent. on the whole; peaches, excepting in the Grimby section, very light, not more than 25 per cent.; grapes promise well where vines were not injured by last year's frost, probably 80 per cent.; apples better than they have been for years, 100 per cent., except perhaps on Spys which are light in places.

HURON, BRUCE AND GREY.—Mr. John Stewart, of Benmiller, writes: Apples, the best for a number of years, the fruit is clean and free from spot. If nothing happens, it will be the best crop on record. It would pay to thin out the fruit. Pears will be an average crop. The fruit is clean and free from spot. The Bartlett is bearing the heaviest crop. The plum crop is very large and not much affected with curculio. Cherries are an average crop. Gooseberries and currants will be a large crop. Peaches and grapes very little grown in this district for market.



MR. JOHN CRAIG, of the Central Experimental Farm, writes: The prospects for a good crop of apples in this district are very encouraging. Native Canadian and American plums have set very well and are at this time carrying a full crop of young fruit. Blue plums, (European type) however, were badly injured, last winter both wood and fruit buds, and consequently will yield but lightly. Cherries will also not exceed a medium crop. Raspberries were badly injured in some districts and with the exception of young plantations will probably be a medium to light crop. Plantations three or four years old were much less injured than those which were five, six and seven years of age. Roses, bulbous plants, perennials and the tender shrubs all show the effect of an unusually severe winter. The low temperatures of late December and early January without snow on the ground carried the frost to an unusual depth and wrought considerable injury to fruit trees and tender plants. I have noticed many instances of root killing among apples, pears, cherries and plums. Trees of Duchess and Wealthy have been injured, and in some cases killed, in this district owing to the loss of the seedling roots on which they were budded, while the tops were quite uninjured.

Strawberries on the Experimental Farm will give us a fair crop unless extremely dry weather intervenes. Most varieties have come through in fair condition. Reports have come to us of Woolverton having winter killed badly in this section. In our three year old plantations of 100 varieties there is no variety more vigorous than the Crescent at the present time.

YORK, ONTARIO AND PEEL.—Mr. W. E. Wellington reports: Apples, about 75 per cent., except Northern Spy a failure; Pears, 20; Plums a failure except common red 100; Cherries, 25; Gooseberries, 75; Red Currants, 30; Grapes, 25; Blackberries, 100; Raspberries, 100.

DURHAM, NORTHUMBERLAND, PETERBORO AND VICTORIA.—Mr. Thos. Beall of Lindsay, writes: The apple crop this season promises to be about average taking it altogether. That is the summer and fall varieties will be rather above average, and the winter varieties rather under. Pears will not average more than from five to ten per cent. of average crop. Plums, practically none, Cherries, about ditto. Grapes promise an average crop. Gooseberries, Currants and Strawberries will each give a full average. There is no "Scab" in this neighbourhood and there is but little injury being done by the usual insect pests.

ESSEX, KENT AND LAMBTON.—Mr. Alex. McNeill, of Windsor, writes: The prospects for fruit in Essex could hardly be better. As will be seen from the following estimate, there are no failures and only a few kinds below a full crop. Apples, 100 (full crop); Pears, 95; Plums, 100; Peaches, 100; Cherries, 75; Gooseberries, 70; Strawberries, 100; Raspberries, 100; Currants, 100. There is no indication of any unusual attacks of insects or fungus.

**Shrubby Borders and Beds** should be frequently hoed and raked, to give them a tidy appearance. Gravel walks and drives which are made with materials that become very loose during dry weather should be watered and rolled. Keep them clean from weeds by hand weeding, or by application of a weed-killer, which is a much cheaper process in the end than using hoe and rake to them, especially where large gravel is used. The watering of trees and shrubs that were planted late in the season should be continued during dry weather.—Gardeners' Chronicle.

We next proceed to cultivate the soil beneath, and between the trees, until they arrive at their complete size, as the quality, excellence, and maturity of the fruit will, in a great measure, depend upon its proper culture. . . . In fact, it has been ascertained by experience and observation, that apples, pears, peaches, etc., attain to their highest perfection only when the soil about the roots is kept open, and frequently manured.—JAMES THATCHER, *The American Orchardist*, 1st Edition, 1822.

## THE STRAWBERRY LEAF-ROLLER.



SHORT time ago a sensational paragraph appeared in the Ottawa papers, stating that the strawberry crop in Prince Edward Co. had been destroyed by "a new blight." Enquiry from growers has shown the reports to be unfounded. A destructive insect is at work, however, as is shown by the following very interesting letter from Mr. Alfred Brown, of Picton, Ont. I quote it in order to draw

attention, in the absence of Dr. Fletcher, to a sometimes very injurious insect to strawberry plantations :

"DEAR SIR,—Your favor *re* strawberry blight came to hand Saturday night. After shipping our berries this a.m., I spent balance of day with growers, and could find no trace of damage by *blight*. There are, however, a great many failures owing to the severe winter, some losing all their strawberries and most of their raspberries. Fruit trees generally are damaged more or less. Our three acres of strawberries are not more than 20% of a crop: Wilson, Williams and Beder Wood nearly all gone, and Crescent damaged, but the best of the lot.

I found a grower near Picton having what seems to be a serious pest—a Leaf-roller. He has four acres of 1894 planting, which look as if fire had been over them. His plants set out in 1895, are not quite so bad, but the insect is quite plentiful and gives the rows the appearance of having been affected by a severe drought. I send by this mail a sample of leaves from this yard, also a sample of leaves affected with spot. A neighbor with only one farm between has no insects worth mentioning; another a short distance away has his Wilson's badly affected with the "Leaf-roller."

Our three acres of raspberries are the best show for a full crop we have had thus far. One acre, set this spring, has been damaged to a considerable extent by cut-worms, specimens of which were sent to Prof. Fletcher, yesterday. Very little hay in the county. Spring crops generally good."

As it is important that this pest should be destroyed at once and that growers should be on the look out for it, I cannot do better than give Dr. Clarence Weed's description of this insect, as found in his excellent work "Insects and Insecticides" at page 88. The description, life history and remedy is given as follows :

"*The Strawberry Leaf-Roller—Phoxopteris Comptana.*—This is a small, brownish caterpillar that folds the leaflets of the strawberry by bringing the upper surfaces together and fastening them by silken cords, and feeds upon their substance till they look brown and scorched. It is sometimes exceedingly destructive, and has been considered by some entomologists as the most injurious of the insect enemies of the strawberry. It probably occurs in nearly all the Northern States and, is also found in Europe, where, however, it does not prove troublesome. It hatches from eggs laid in spring upon the strawberry

plants by a small, redish-brown moth. The larva attains its full growth in June, when it is nearly half an inch long, of a brownish or greenish color, with a shining yellowish-brown head. The larva pupates within the rolled leaf, and about mid-summer emerges as a moth. These moths deposit eggs for a second brood of caterpillars that feed upon the leaves late in summer, changing to pupæ early in autumn, and, passing the winter in that condition, emerge again as moths the following spring, thus completing the cycle of the year. In the Southern States there are three, and possibly four broods a year.

*Remedies.*—The best way to destroy this pest is to mow the field soon after the strawberry crop is gathered, and after leaving it a day or two to become dry, burn it over. This will destroy the leaf-rollers as well as several other kinds of insects, and the spores of fungus diseases. It is sometimes necessary to scatter a little straw over the field where the leaves are not thick enough to burn well. The plants will not be damaged, but will soon send up a new lot of leaves that will grow rapidly, and be free from insect and fungus attack. If for any reason this method is not desirable, the insects of the second brood may be destroyed by spraying or dusting the plants in August with some poisonous insecticide."

This insect is also described and figured in that excellent work, "Insects Injurious to Fruits," by Dr. Saunders. Practically the same remedies are recommended.

In this connection I wish to emphasize the benefits derived from treating a strawberry bed affected with rust in this way. Two years ago I burned every alternate row of plants in our experimental plots, and found the succeeding growth to be exceedingly healthy. The plants came through the winter uniformly in a very successful and satisfactory condition. I believe it to be an excellent practice in large commercial plantations.

Yours very truly,

Ottawa, June 25th.

JOHN CRAIG, *Horticulturist.*

### PLOWING WITH THREE HORSES ABREAST.

One on the furrow and two on the land, I use the whiffletree pictured. The long whiffletree *d* is  $4\frac{1}{2}$  ft. long, the main clevis *a* being 18 in. from one end. The doubletree, *e*, is 3 ft. long, and the singletrees, *f*, are each 20 in. in length. To hitch up, fasten the clevis, *a*, to the plow clevis; the short end of the long whiffletree goes next to the plowed ground. Then fasten the doubletree to clevis *b*, and one singletree to clevis *c*. Three clevises will be required on the long whiffletree and three on the doubletree. Both larger trees will require five open rings, and if the plow is fastened at *a* with an open ring, another is necessary. Such a rig will answer for a team weighing up to 1200 lbs. to each horse. For heavier horses, the proportion of the trees must be enlarged. This rig can be used for harrowing, rolling or dragging land.—Farm and Home.



FIG. 973.

## ❖ Flower Garden and Lawn. ❖

### THE ROSE.



DIRECTOR SAUNDERS in his Report for 1895, has an interesting report on roses, and we select several paragraphs :

*Hardiness.*—Among the summer roses, all the varieties of Moss roses have been found quite hardy, also the Prairie roses and the Persian yellow. Among the miscellaneous varieties in this class Madame Plantier deserves a place in the front rank for hardiness, vigor of growth and abundance of bloom. The flowers are white, double and very fragrant. As already stated none of these roses bloom in the autumn, but they flower profusely during their period of blooming which usually lasts from two to

three weeks.

The Teas or ever-blooming sorts are all too tender for outdoor culture in Ottawa unless they are taken up in the autumn, packed in sand and stored in a cool cellar during the winter. Several of the Hybrid Teas have proven fairly hardy, notably La France and Captain Christy, but of all roses for outdoor culture the Hybrid Perpetuals are by far the most useful and satisfactory, many of them with a little protection are quite hardy, and reward the cultivator with a wealth of bloom which is highly gratifying. The principal part of the crop of flowers is borne from the middle of June to the middle of July, but many of the most esteemed varieties continue to bloom at intervals until late in the autumn.

*Planting and Treatment.*—The rose needs a rich soil; a good garden loam enriched with well rotted manure dug to a depth of twelve inches or more will suit it well. A more or less sheltered but sunny location is also advantageous, but roses will not thrive in the immediate vicinity of large trees whose foliage interferes with the free access of sunlight and whose spreading roots monopolise the available plant food in the soil. In selecting roses for planting it is a great advantage to have them on *their own roots*, notwithstanding that some of the varieties thus propagated are poor growers, otherwise one is continually troubled with strong growing suckers from the wild stocks, which if not early noticed and promptly removed will often weaken and eventually smother out the graft. In planting spread the roots carefully so as to give them their natural positions, set the plant a little deeper than as grown in the nursery, and press the soil firmly about the roots.

*Injurious Insects.*—To prevent injury from insects spray or syringe the bushes just as they are coming into leaf with Paris green and water in the

proportion of a teaspoonful of the poison to three gallons of water, stirring frequently while using, and repeat this application whenever leaf-eating insects appear. If thrip is troublesome, spray the foliage while the insects are still young with kerosene emulsion or a strong decoction of tobacco stems, four to eight ounces, boiled for ten minutes in a gallon of water to which  $\frac{1}{4}$  lb. of soap may be added. The latter is also a useful application for the green aphid.

*Winter Protection.*—For winter protection the plan which has been most successful at the Experimental Farm—where the bushes are planted three feet apart each way with six feet of space between every third row—is to dig between the rows and throw the earth about the rose bushes, covering them up to a depth of eight or ten inches. Fill the trenches made by the removal of the earth with fresh manure and loosely cover the earth around the plants with two or three inches of the same material. The stems are usually cut back to about one foot in height before covering. In the spring remove the earth from about the roses, and bury up in the soil as much of the manure as is practicable, and as soon as the buds start remove any dead wood with a sharp knife or pruning shears. Under such treatment the rose beds at Ottawa have been very successful and have given much pleasure to the visiting public throughout the season.

Mr. Saunders closes by giving a list of between thirty and forty varieties which have been found so far, hardy, at Ottawa, and among them the rose illustrated by us last month. We give both the illustration and the description:

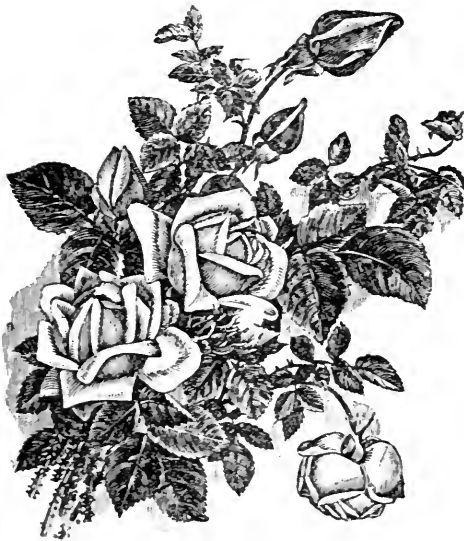

FIG. 974.—MADAME GABRIEL LUIZET.

*Madame Gabriel Luizet.*—Fig. 974 represents this rose on a reduced scale. A very strong grower and an abundant bloomer. The flowers are very large, cup-shaped, compact, very handsome, of a creamy rose-color, and slightly fragrant. One of the finest roses in the collection and a fair bloomer during the autumn.

**The Bushel Box** is a handy thing. Make them 17 in. long, and 12 in. by 14 in. inside measurement. The ends should be of dressed inch lumber, and the sides and bottom of half inch lathing, 2 in. in width.

## WILD-FLOWERS AND THEIR CULTURE.

People usually make too hard work of cultivating wild plants. They are apt to attempt to imitate the natural conditions under which they find the plants. This, to a certain extent, is wise, but in most cases it is easily carried too far. The problem is simplified when we once come to understand that wild plants grow where they are obliged to grow, rather than where they desire to grow. Because a plant grows in the woods is little reason to expect that it may not grow equally well in the sun. And then, it is not necessary to wait until fall or spring to take up the wild plants. At every outing, whatever the time of year—if the ground is not frozen—I mean to go prepared to bring home roots. In these sultry July days I am bringing home wild herbs, and next year I expect to see most of them bloom. I dig them up with a comfortable ball of earth, cut the tops off nearly to the ground, and keep them moist until I get them home; then they are set in the border, and if dry weather follows, a little water given occasionally at sundown helps them to grow. I do not pretend to say that July is as good a time as April or October to remove plants, but one must capture the good things as he finds them. \* \* \* The native orchids, however, usually require careful management, being among the most difficult of native plants to colonize. Most of them require complete or partial shade and a moist subsoil. If a water supply is at hand, a moist plat under trees or about buildings, where there is some protection from wind, can be made, and clumps of many species can be removed with safety. It is best to remove them in summer, as soon as the flowering season is past. In most cases, however, the plantation will prove to be short-lived, and fresh recruits will be needed from time to time.—L. H. Bailey, in American Gardening.

## FLORAL DECORATIONS.



THE floral decorations for a wedding, reception, lunch or tea, form fully as important an item as the menu. A most effective center-piece for a dinner-table is a little lake with exquisite water lilies afloat.

A unique piece seen at a recent social gathering was a basket in the shape of a straw hat, silvered and mounted on a tripod. This was filled to overflowing with *Mermet* roses and their foliage; the effect was most charming.

At a recent reception one of the dressing-rooms was a symphony in red. The room was flooded with a rosy-hued light, the pleasing atmospheric effect resulting from the handsome red shade of the lamp. A large mirror reflected the pervading hues of the apartment, the frame being gracefully draped with a

large red crepe shawl, heavily fringed. Red carnations in abundance were used for decorations.

Among the new center-pieces for dinners is a tiny lake with a small fountain playing in the center. Two silver swans are on the lake, and around it is green moss and vines.

Flowers are no longer massed together as they once were. While calling at a beautiful home in California I was pleased, and at the same time surprised, to see a dozen varieties of flowers in as many different vases. The glorious California poppies, whose sheen no artist can put on canvas, were in a large glass bowl where the sun's rays fell on them. They brought to mind Rose Harwick Thorpe's poem dedicated to them :

Flower of the westland, with calyx of gold,  
Swung in the breeze and lace woven sod,  
Filled to the brim with the glory of God,—  
All that the wax-petaled chalice can hold ;  
This was the birth of it on the brown plain,  
The sun dropped a kiss in the footprint of rain.

The modest little violets, which are such a favorite everywhere, were carelessly arranged in low, quaint shaped little glasses with an abundance of their own foliage. Beautiful roses with long stems were gracefully arranged in tall slender glasses. Pansies in all their glory, varying from a golden yellow to a royal purple and velvety black, were laid in flat dishes on a bed of green vines and leaves. Then there were carnations, camelia japonica, cosmos, etc., each flower showing off to the best advantage. It was truly a study for an artist.

Baskets and shells make admirable receptacles for flowers. A large silver dish is most effective when filled with pink flowers and green leaves or vines.

Sweet peas and mignonette should always be grouped together. While sweet peas are pretty arranged alone, the two together are an improvement. There is no more picturesque and effective decoration for a summer luncheon or dinner than maiden-hair ferns. Having the dining room profusely decorated with this graceful fern, and let the menu so far as possible be in green and white.

Fern dishes are much more reasonable than ever before, so nearly every one can afford at least one. When filled with the lovely growing maiden-hair nothing can be more effective or refreshing.

Tall Chinese vases which can be placed on the floor in corners or near the mantel are much liked for large, long-stemmed flowers. A pretty rose vase is of pale green glass.

Natural effects and an absence of conventionality should characterize the arrangement of flowers at all seasons and in all places.

Simplicity is the cry of the hour in floral decorations as in house furnishing, and the most delightful entertainments are those where carelessness, grace and simplicity are combined.

The Farleyense fern is very popular for the table decorations. Around the candelabra, in the center of the table, a wreath is frequently made of this fern, which is coarser than the maiden-hair and liked better by some. Through this heavy wreath are allowed to peep exquisite roses fastened in wet moss—Gen. Jacqueminot, American Beauty, Caroline Testout, Catherine Mermet, La France and Perle des Jardins all answer admirably for this purpose. Wild flowers prettily arranged make quite as satisfactory decorations as the cultivated ones; in fact wild flower luncheons were quite the rage last year, and bid fair to be this.

In the way of souvenirs nothing can be more dainty and attractive than tiny baskets of flowers with bows of ribbon tied on the handle.

CARRIE MAY ASHTON, in *Vick's Magazine*.

---

**Mulching Sweet Peas**—Sweet Peas are invaluable where many cut flowers are needed in June, July, and August, and by successional sowings a constant supply of their richly coloured blooms may be had over the whole of that period. It is not necessary, except for market purposes, to sow a long row at one time. A third at three different intervals is quite sufficient unless several sorts are wanted, and even the seed can be mixed. A row 5 yards or 6 yards long if well mulched and watered several times when flowering with liquid manure will produce an astonishing supply, but if mulching and picking off the seed-pods is neglected, a short-lived, meagre crop of bad colour will be the result. A quick lad will in a few hours clear off all the seed-pods from a long row, and thus give the haulm another lease of life. I am growing the lovely pink Princess Beatrice this season, also the White Emily Henderson and the ordinary mixed varieties.

---

**Herbaceous Plants in Summer.**—The great majority of hardy perennial flowers are natives of woods or grassy places where the earth is shaded from the hot summer suns. When they are removed to open borders they suffer seriously from summer heat. It is, therefore good practice in these open sunny situations to have the ground mulched or covered with something like decayed leaves or half-rotted straw or anything that will prevent the scorching rays of the sun on the earth. Herbaceous plants do not care so much for bright sun as they do for a cool soil at the roots. For the same reason a loose, open soil is better for growing herbaceous plants than soil of a heavier character, because having more air spaces, it is cooler. In short, it is a cool soil more than shade that herbaceous plants require.

---

**Among** the hoed crops which are best suited to young trees, are potatoes, ruta bagas, beets, carrots, beans, and all low hoed crops. . . . All sown crops are to be avoided, and grass is still worse. Meadows are ruinous—JNO. J. THOMAS, *The Fruit Culturist*, 4th Edition, 1847.



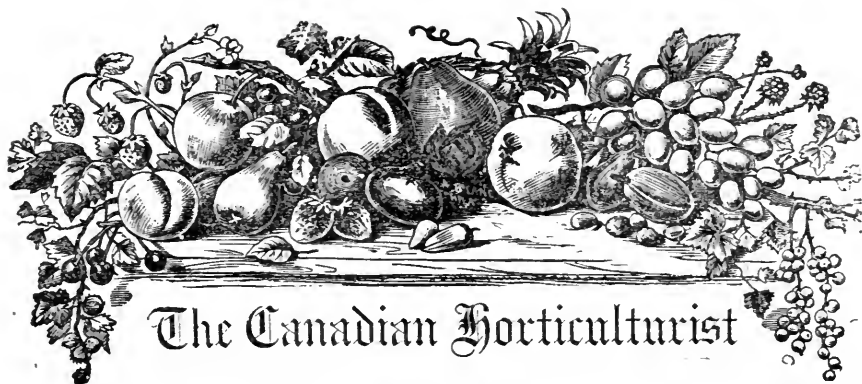

## The Canadian Horticulturist

SUBSCRIPTION PRICE, \$1.00 per year, entitling the subscriber to membership of the Fruit Growers' Association of Ontario and all its privileges, including a copy of its valuable Annual Report, and a share in its annual distribution of plants and trees.

REMITTANCES by Registered Letter are at our risk. Receipts will be acknowledged upon the address label.

### ✦ Notes and Comments. ✦

THE DROUTH IN ENGLAND has been so serious as to impare the otherwise excellent prospects of the English fruit grower for a heavy crop of apples and pears.

MR. T. C. ROBINSON, of Owen Sound, has again entered upon the nursery business at that place, and will be pleased to correspond with old patrons.

NO PREMIUM PLANTS.—Many subscribers complain they have received no plant this spring. This is because they did not ask for it. Thinking that those not choosing did not desire one, none were sent in such cases.

SELBY'S SEEDLING STRAWBERRY comes to hand from Newcastle, Ont., badly packed, and therefore not in condition to judge of its quality. Mr. N. T. Selby writes that the plant is strong and healthy, and the berry ripens extra early.

THE FIRST CARLOAD of melons from Florida arrived in New York early in June. The crop is short owing to drouth, while in Georgia the average has been reduced more than one half. New York City consumes about 20,000,000 melons per annum.

LIME LACKING.—Compared with the soils of other countries, Mr. Shutt, of Ottawa says, many in Canada appear deficient in lime. This fact suggests that the judicious application of lime, marl or gypsum (at the same time supplying other forms of plant food) would lead to good results.

THE GENTLE BEES.—Mr. John McArthur writes to deny Mr. Holterman's statement, and sends a copy of the American Bee Journal and report of the Convention in which Mr. McArthur's name is mentioned and also a copy, of an article by the editor describing his visit to Toronto Island, and how wonderfully patient of abuse Mr. McArthur's breed of bees was. We have no room for discussing disputed points.

---

A BIG STRAWBERRY.—Mr. S. T. Pettit, of Belmont, sent us a four quart pail containing some immense samples of the Sharpless strawberry grown on his farm. The soil is clay loam and evidently well adapted to growing strawberries. One of these berries measured  $6\frac{1}{4}$  inches in circumference and weighed  $1\frac{1}{4}$  oz. Mr. Pettit claims that every farmer should grow a good patch of strawberries for home use whether he grows them for market or not.

---

THE SAN JOSE SCALE.—The dreadful San Jose scale has been spread all over the Union by trees from California nurseries. The kerosene and soap emulsion recommended by the Washington authorities has proved very unsatisfactory; but the following has been found to be a perfect remedy: Boil 10 pounds unslaked lime and 20 pounds sulphur in 20 gallons of water four hours. Then slake 30 pounds more lime, adding 15 pounds stock salt while slaking. Mix all together and cook an hour longer. Strain and spray as soon as leaves fall in autumn and when buds swell in spring.—Ex.

---

PROTECTING CHERRIES FROM BIRDS.—Horticulturist Troop of the Indiana Station has been experimenting with bird netting to protect several trees of Russian cherries from birds. Two six year old trees of Bessarabian cherries bore half a bushel of fine fruit each, where protected, those not covered were entirely stripped. About 75 square yards of netting were used for trees 10 feet high; the cost was four cents per square yard. Mr. Henry R. Boardley, of 186 Denmark Road, Lowestoft, England, writes he has a large stock of garden netting at low rates.

---

A LIVE WESTERN HORTICULTURAL SOCIETY.—The Iowa Society is making rapid progress, judging by the Report for 1895, just to hand. The State grants them \$2500, and the Society has four Sub-societies, to each of which it grants \$150 per annum. There are also sixteen fruit experiment stations in the State, under the control of the Society. The work of these is, however, rather desultory and the fruits planted in convenient vacancies in various parts of the fruit farms, so that little satisfaction can be got from the station reports; of course little can be expected when only \$10 per annum is allowed each experimenter, but it is proposed to increase this to \$50 each per annum. It is also proposed to ask the State for \$10,000, to establish a central station of forty acres in charge of the Secretary, who is also visitor to sub-stations.

In reporting on the work of the stations the Secretary, Mr. G. C. Brackett speaks of the Stoddart plum as one of the best natives of Iowa, of recent introduction. For that State the following list is also commended : DeSoto, Wolfe, Hawkeye, Rockford, and Forest Garden.

He speaks well of Columbus and Chautauqua gooseberries, the fruit of both being large and fine ; and he condemns the North Star currant.

The Russian pears have not proved a success in Iowa, an experience similar to our own in Canada. The Wragg cherry he declares to be identical with the English Morello.

A paper on "Co-operative Fruit Handling and Selling," is suggestive. Such an association must of course secure uniform packages, and honest packing ; a competent man must examine and brand the packages Grade 1 or 2 as the case may be, and when once the reputation of the association is established there is no difficulty in finding sale for the goods at remunerative prices.

---

PACKING CHOICE EARLY PEACHES in one layer boxes holding 18 to 24 specimens of fruit is practised in England, and suggests to us some better way of putting up our extra selected stock than in baskets. *The English Fruit Grower* says : The first point is to ensure that each fruit is packed so firmly that it will not shift and bruise in transit. Some senders wrap each fruit first of all in tissue paper large enough to cover it. The ends are twisted at the top, and this twist, if kept upright will be useful as a handle to pack and unpack the fruit without handling the fruit itself after it is once wrapped up. The box will hold about 18 or 24 fruits. The fruit, when papered, can be packed in bran or preferably wadding. We say preferably wadding, because its use is very effective. One layer should be spread over the inside bottom of the box. A strip should be put round the sides, then a piece folded about 2 in. or 3 in. deep, according to the size of the fruit, and about 6 in. or 8 in. long, can be wrapped around the sides of the peach. It can then be put in its place in the box, and thus packed closely together and in rows, the box when filled is fit to travel any distance in the United Kingdom without risk. A sheet of wadding placed over all the fruit before the lid goes on is all that is needed to complete the process. Any special wooden box maker will supply peach boxes.

---

THE GLADIOLUS is the gem of all summer flowers because of its richness, brilliancy and variety of color. No other plant is so easy to grow, so certain to bloom or so brilliant in effect. It is admirable for borders or for groups. The bulbs may be planted from the earliest spring until August. The flowers are extremely durable and thus valuable for decorative purposes. When frosts come, the unblossomed spike may be cut and placed in vases, where many will open. To get the best quality of bulbs, do not let the spikes go to seed.

F. & N.

## ❖ Question Drawer. ❖

### Blight on the Narcissus.

**849.** SIR.—Can you tell me the cause of the blight on the narcissus buds, samples of which I enclose. I have a large plantation of them and hundreds of the buds are thus blighted.

H. ROBINSON, *Collingwood, Ont.*

*Reply by Horticulturist Craig, of the Central Experimental Farm, Ottawa.*

I do not find that the Narcissus buds are attacked by any disease, but I am of the opinion that the flower buds have failed to develop properly on account of a weakness of the bulbs, induced by the severe cold of last winter, rather than that have been affected by any fungus disease. A number of cases of hyacinths, narcissi and other bulbs have come under my notice where they have been severely injured by the extreme cold of last winter.

---

### Currant Leaf Fungus.

**850.** SIR.—I enclose a leaf of my red currant bush affected with a fungus which has been quite serious. Some of the bushes affected last year have since died.

J. PARKINSON, *Portage la Prairie Man.*

*Reply by Horticulturist Craig, Central Experimental Farm, Ottawa.*

The leaf enclosed is affected with the disease known as *Gleosporium ribis*. This frequently attacks English gooseberries causing considerable damage. It may be prevented by a judicious and presistent use of Bordeaux mixture.

---

### Gall on Rose Leaves.

**851.** SIR.—I enclose a twig of *Rosa rubifolia* which you sent me a year ago. The bush is growing well, but is being covered with fuzzy stuff which the florists do not understand. Please favor me by telling me what it is and how to get rid of it.

MR. R. CHISNELL, *Hamilton, Ont.*

The fuzzy stuff mentioned by our correspondent is a gall caused by the gall fly. The eggs are deposited on the leaves, and cause the peculiar growth. The galls should be cut off and burned as soon as they appear, as, otherwise, they will soon destroy the bush, as they already have done with the sweet briar in southern Ontario.

---

### British Columbia Apples.

**852.** SIR.—In the 1st report of the Fruit Growers' Association I notice a reference to British Columbia apples. These are not as well flavored as those grown in Ontario, nor will they keep as well. Spy, Baldwin and Greening will not keep much after Christmas. They are great sized apples and fine in appearance, but rather coarse grained. Seeing Spy

apples in a store in Vancouver early in May, I said, "Northern Spys—How's this." "Oh, they are from Ontario," the man replied, and he added with emphasis, "and they will keep." But Russets are as good as in Ontario and well flavored, and the Newtown Pippin succeeds well also.

W. E. BROOKS, *Mount Forest, Ont.*

### English Gooseberries.

**853.** SIR.—Nurserymen are out concerning English gooseberries which they recommend as being free from mildew. The Keepsake is a determined mildewer, some of my Industry mildew and so do Ashton's Red and Whitesmith a little. White Eagle is free from mildew and of a vigorous growth. It is even superior to the Yellow Scotch, but the latter is far ahead of Industry or any of that class for vigorous growth, and is mildew free. I have not seen the mildew as yet upon the Lancashire Lad, Rifleman, Red Champagne, Crown Bob or Ashton's Red, except a little on the berry of the latter. On Ashton's Red, that is Red Warrington, there is mildew on some of the berries, both here and on our own place. It is curious that Green describes the Lancashire Lad as smooth, when I have it from him hairy, and also some from England. Mr. Spillett describes the Chatauqua as small, but it is not small. It is a difficult to get a perfect gooseberry for this county. Pearl and Downing are too small. Mr. Spillett thinks too much of rapid wood growth. Many of the best English kinds at their home are of slow growth, but in the end become large bushes that will yield sixteen quarts, and will outlast the rapid growers for number of years in first class bearing condition.

W. E. BROOKS, *Mount Forest, Ont.*

### Unfruitful Pear Trees.

**854.** SIR.—My Clapp's Favorite pear orchard, seven years plants, grows rapidly, and blossoms freely every spring, but fruit drops off. I spray it in spring with sulphate of copper. Had I better sow seeds of some crop in the orchard?

JOHN BEAMER, *St. George.*

A seven year old pear tree, growing rapidly should not be expected to bear much fruit; it cannot well make a heavy wood growth, and bear fruit as well. The subscriber must either wait a few seasons longer, or else seed down the orchard to clover, and check the rapid wood growth.

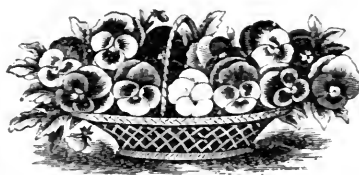

## \* Open Letters. \*

### Fruit in Manitoba.

SIR,—I am confident that apples can be grown here yet, though many people think otherwise; but when young trees grow in the summer and live through the winter, they will surely get large enough, and if they grow large enough, why will they not bear apples? I believe there are twenty-five varieties of apples of the catalogue of Messrs. Stone & Wellington, that will grow here; and, if money were a little more plentiful, I would not hesitate to plant ten acres with two year old trees. Black, white, and red currants look well, and so do gooseberries, raspberries and strawberries.

J. PARKINSON, *Portage la Prairie, Man.*

---

### Unproductive Gooseberry Bushes.

SIR,—Being confined to the house with an attack of catarrh, my mind has been running over my changed luck in growing gooseberries. Formerly for years I never had even a middling crop, but the bushes bore every year seemingly every berry the limbs had room for. What is the matter then that bushes run for fruit (not for plants), last year bore only a scattering crop though they bloomed profusely in spring, and the fruit set nicely, but afterwards disappeared as if by magic. Again, this year the bushes set a fine crop, but again this dropping has gone on till only very few are left.

Let me give a sketch of my experience, so that haply the cause for this may be discovered.

Formerly I had not the time or implements necessary to cultivate, but mulched instead—in some cases imperfectly, but kept the weeds cut under and between the bushes, with ordinary chop-hoe and shove-hoe, so that the soil was not disturbed more than half an inch deep; and year after year had loads of fruit. One hard knoll, the top soil of which had been scraped off often became so hard that *it was impossible to cut the weeds*. (*I always dug in the fall after picking*), and still the bushes on this knoll never gave less than five quarts to the bush, 75 bushes set 4 x 4.

Well, I got improved machinery, a Planet Jr. Horse Hoe, with all its combinations, and started to cultivate deep last year, with the result that I had a poor scattering crop. This year the ground being hard, we decided to dig before setting the scuffler to work. The soil was so solid that it broke out in chunks from 6 inches to 8 inches deep; and though the scuffler was immediately set to work the young fruit again disappeared completely.

I first noticed this with bushes that had been mounded up to grow plants; though only a few lower limbs and suckers were cut away the main stems never bore any fruit. This fact I mentioned to you last summer when visiting my place. The removal of the same wood without any disturbance of the soil, would only have the effect of increasing the size of the remainder of the fruit.

This year I have four rows with 30 to a row, which were mounded up last summer; these mounds were not removed this spring, and the stems above the mounds are bearing a good crop of fruit while the fruit has nearly all fallen from the adjacent rows which are being cultivate.

I notice by reading up everything at my command, that this is not a new idea, but it has been noted by a number of fruit growers in the United States; among the rest, the Rural New Yorker.

Mulching is certainly easier and saves a great deal of hard work, but one cannot have his garden looking so nice and trim. I have no doubt that deep cultivation of the soil early in spring, especially if the weather is dry, will invariably be followed by this result. Years ago I took great interest in the Fay's Red Currant and the Champion Black, and had about 400 bushels of each. These were dug among first thing in the spring and afterwards continually cultivated with a Planet Jr. Hand Wheel hoe. Every year the currants dropped till only the naked peduncles were left. During all this time I had a plot of Downing gooseberries mulched, for the want of time to cultivate, and they bore enormous crops every year. Now, upon the same soil, very rich, almost every berry falls, the only difference being thorough cultivation.

Nantyr, June 11th, 1896.

S. SPILLETT.

### Saunders Plum.

DEAR SIR,—I notice an article in the *Horticulturist*, June number page 214, regarding Saunders Plum, which differs very much with my experience with it, also with my neighbors, where quite extensively grown. As grown in this district it is of first quality, very attractive, large yellow plum: good grower, healthy foliage: ripens last of July or first of August. Was exhibited first time at Fruit Growers' Association meeting held in St. Catherines, in 1883, and pronounced excellent quality, worthy of extensive trial. That fruit was grown on the original tree, grown by John Arris, Belleville.

W. H. DEMPSEY.

### Saunders Plum.

SIR,—I notice in the June number of the *Horticulturist* on question No. 846 at the request of Mr. J. T. Stewart as to the hardiness of the principal varieties of plums and am surprised at the answer given by Mr. Gordon which may mislead many who intend setting out plum orchards.

I will give a list divided into three classes: hardy, medium and tender according to my judgment and from personal observations, principally while trees are young. Some of these varieties, although tender in the nursery row, may overcome this with age:

*Hardy*.—Brant of Naples, Gueii, Duanes Purple, Lombard, Shippers Pride, Spaulding, Saunders, Red Egg, Peach, McLaughlin, Monarch, Field, Yellow Egg, and Bradshaw. The latter, although not as hardy as Lombard should class with the hardy sorts.

*Medium*.—French, Italian, and German Prunes, Gen'l Hand, Smith's Orleans, Grand Duke, Jefferson, Imperial Gage, Moore's Arctic, Pond's Seedling, Shropshire Damson, Abundance, Willard, Satsuma, Ogon, Chabot, Red June, Wickson.

*Tender*.—Coe's Golden Drop, Victoria, Reine, Claude, Kelsey,

E. MORRIS, *Fonthill*.

### Notes from Simcoe Experiment Station.

THE Smith's Giant Black Cap raspberry has proved entirely hardy here. It was exposed to a temperature of 26 degrees below zero without any protection whatever, and the canes are alive to the very tips. If the fruit turns out to be of good quality, it will be an acquisition for this section. It is fruiting heavily this season and we will soon know something of its quality.

THE Baba and Bessemianka Pears are seemingly quite at home and find here a congenial climate. I believe they will be like the Duchess apple in that respect. They are very thrifty so far, seem not to be affected in the least by extreme cold, and the foliage is of that dark green color and luxuriant growth so characteristic to hardy varieties.

WITH respect to your query last year, Mr. Editor, "Does a profusion of bloom draw heavily on the vigor of the tree even though it produces no fruit?" I would say I believe it does. My Flemish Beauty pear trees were last year a perfect mass of bloom. The frost came just as the fruit was setting and almost totally destroyed it. Only a few specimens on each tree survived. This year only a few blossoms appeared on those trees, although they were in a very healthy condition. Did the failure of the fruit cause a larger growth of wood, and consequent failure to form fruit buds? Or, was this year's failure owing to the great quantity of bloom last year drawing heavily upon the fruiting capabilities of the trees? I am inclined to believe the latter.

G. C. CASTON.

### Soda Not a Substitute for Potash.

SIR,—In the clipping marked "Small Fruits," page 200 of the June issue of the *HORTICULTURIST*; speaking of the value of Nitrate of Soda as a fertilizer, it is there stated, "As an available source of nitrogen, containing 16 per cent., and also 35 per cent. of soda, which is a substitute for potash for agricultural as well as for industrial purposes, the market does not furnish a better article or one that is more immediately active, and with the phosphate of lime it makes a complete manure."

I wish to point out that soda cannot be substituted for potash in agriculture. Plants have not any, or at the best a very slight, elective ability in respect to the nature of their food, and very many careful experiments have proved that potash as an essential element of their constituents, cannot be replaced by soda. This fact disproves the assertion that with phosphate of lime nitrate of soda makes a "complete manure." To such an end, potash must be applied in one or other of the forms procurable for agricultural purposes. These are: Wood ashes, containing about 5.5 per cent. of potash; the Muriate, containing about 5.4 per cent. of potash; the Sulphate (high grade), containing about 5.4 per cent. of potash; the Sulphate (low grade), containing from 25 to 30 per cent. of potash; Kainit, containing about 15 per cent. of potash.

Yours faithfully,

FRANK T. SHUTT, *Chemist, Expl. Farms, Ottawa.*

---

### Errata.

SIR,—Correction on page 216 adds to the complication. New crosses from *seeds* (wild varieties), should read "*species*," not "*seeds*."

H. H. GROFF, *Simcoe, Ont.*

---

## ↻ Our Book Table. ↻

REPORT OF THE DIRECTOR OF THE DOMINION EXPERIMENTAL FARMS, by Wm. Saunders, F.R.S.C., F.L.S., F.C.S., 1895, containing the results of numerous careful experiments.

FLAX.—A bulletin by Mr. Wm. Saunders, Director Dominion Experiment Farms. This crop is of late receiving increased attention in Canada, and in Ontario there are from twelve to fifteen thousand acres devoted to it. At Baden, Ontario, there is a firm which operates large oil mills for the manufacture of linseed oil, and twelve scutching mills for the manufacture of flax fibre. For oil, this firm alone uses from 450,000 to 500,000 bushels of flax seed annually, and the quantity of oil is from 15,000 to 20,000 barrels annually, all of which finds market in the Dominion.

POTATO CULTURE on the Island of Jersey, by Chas. D. Merrill, Beloit, Wis., published by A. J. Root, Medina, Ohio, 1896, as a supplement to the Potato Culture, by Terry. This is a very interesting and suggestive pamphlet, and every potato grower should read it.

CHEMICAL WORK IN CANADIAN AGRICULTURE, a pamphlet containing a valuable paper on this subject by F. T. Shutt, Chemist, Dominion Experimental Farms, Ottawa.

---

### The Foreign Apple Crop.

Charles Forster, of 76 and 78 Park Place, N.Y., who represents Simons, Jacobs & Co., Glasgow, Scotland; Garcia, Jacobs & Co., London, Eng.; and Simons, Shuttleworth & Co., Liverpool, Eng., is in receipt of the following from Michael Simons of Glasgow, under date of June 3rd from London: "As regards apples I think it may be put down as almost certain that the crop in Great Britain will be about one of the poorest that has been known for a long time. At one time the prospect was favorable indeed, but the long continued drought has produced an abundance of caterpillar and other insects, with the result that the outlook has been completely changed. In France they do not speak very cheerfully of their crop. On the other hand, prospects in Holland, Belgium and Germany are said to be fairly good. I believe, however, that it will not be long before we hear that in these countries too the crop has been destroyed by the same influence that has been at work in Great Britain. I should say that on the whole the outlook for the American season is decidedly good. The general outlook for all other fruits is favorable, especially pears, but as regards these latter, it is said that on account of their abundance, particularly in France, whence the main supply is derived, the fruit will tend to be of small size."



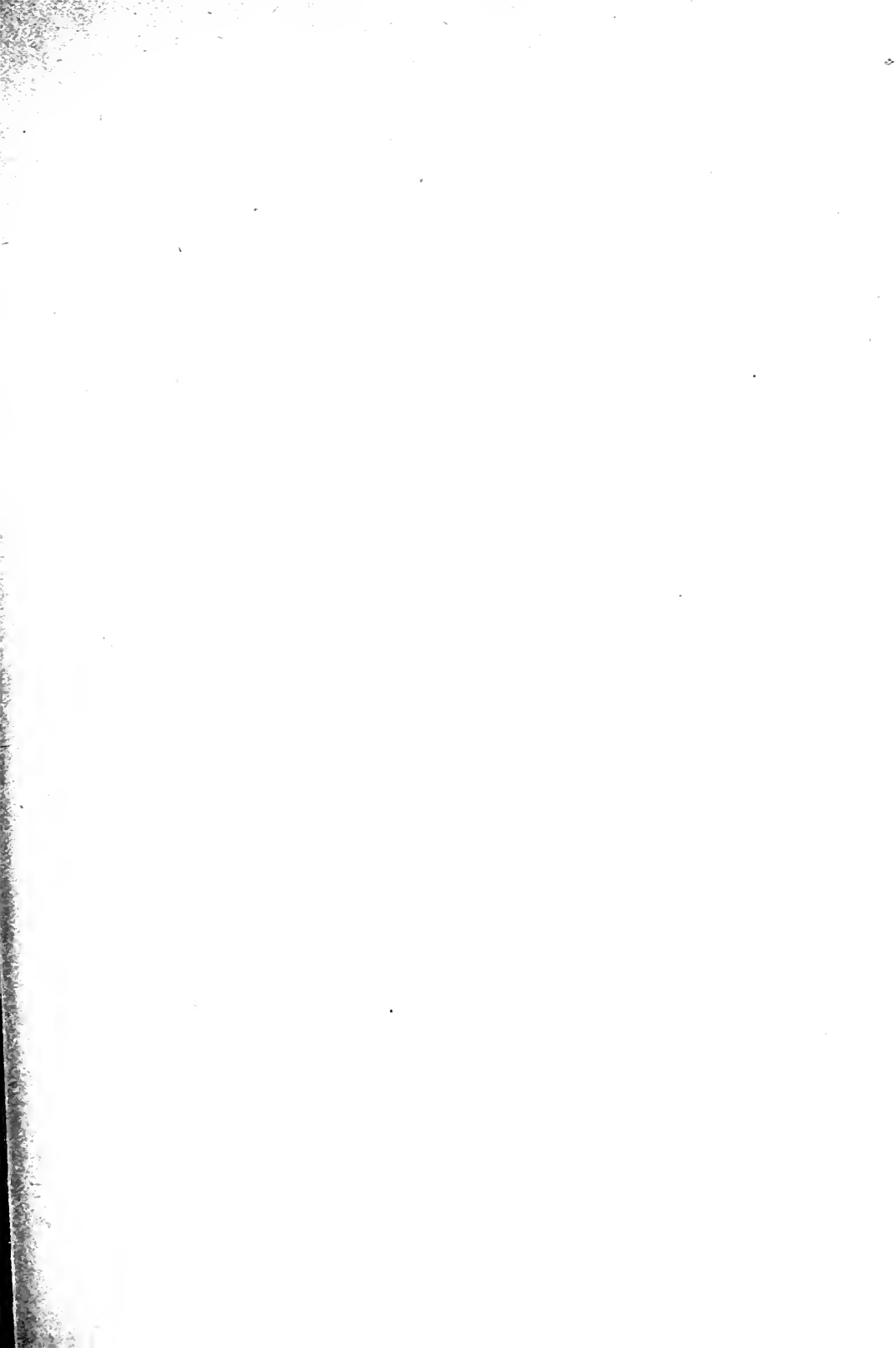

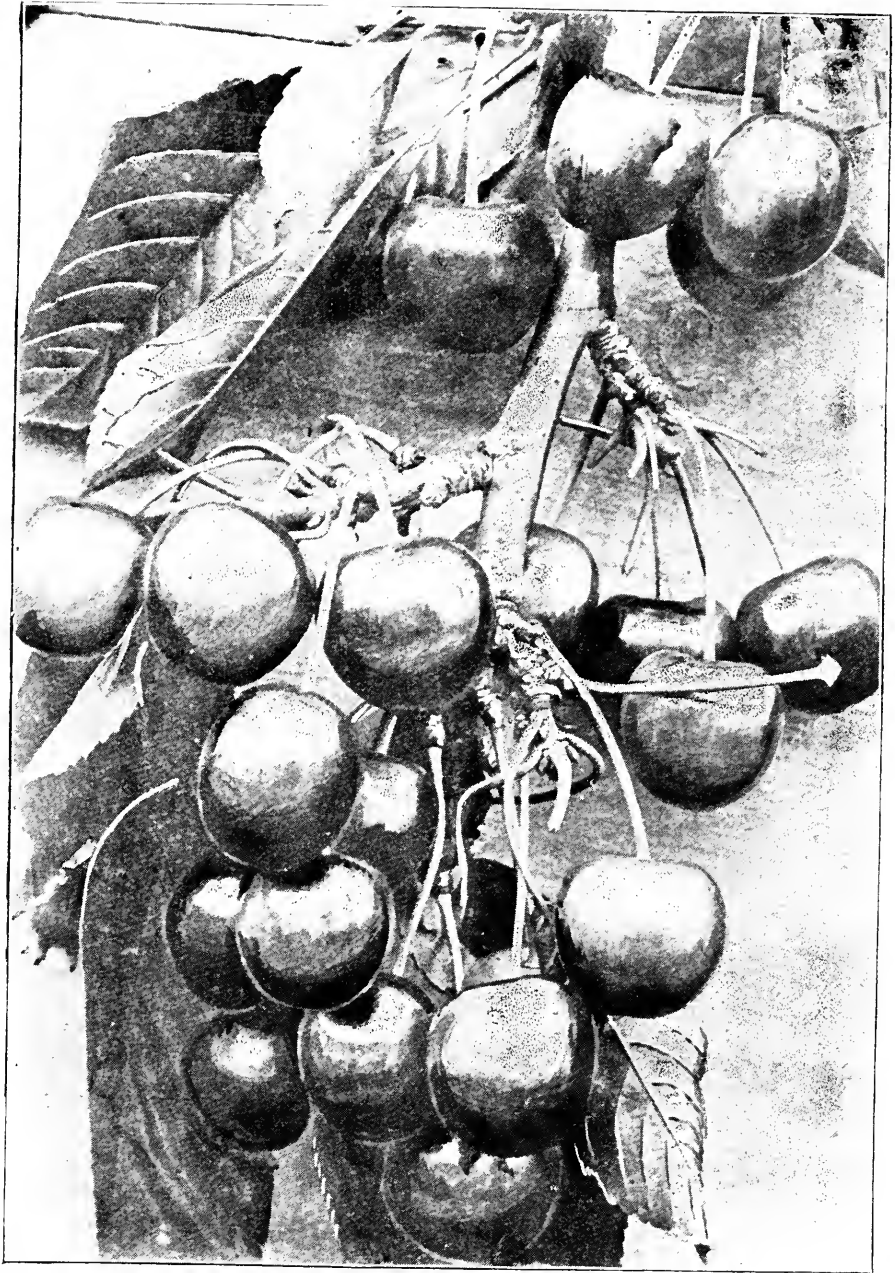

YELLOW SPANISH FRUITING BRANCH EXACT SIZE, FROM PHOTOGRAPH.

THE  
Canadian Horticulturist

Vol. XIX.

1896.

No. 8.

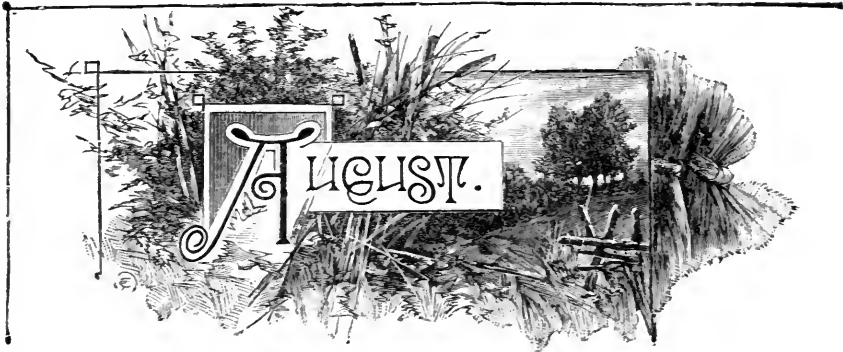

THREE BIGARREAU CHERRIES.



THE cherry season in the Niagara District, which began about the 10th of June with the Early Purple (Fig. 970) and closed about the 10th of July with Windsor and Montmorency, has been one of the best seasons on record. Frequently the cherry rot sets in, and favored by occasional showers almost ruins the whole crop, giving much work on the assorting tables, and little satisfaction to the grower. The very finest looking varieties, such as Napoleon and Yellow Spanish are most subject to this fungus; they grow in close bunches and this habit of fruiting favors the rapid spread of the rot from cherry to cherry. Then again the aphid appears at times in numbers innumerable, and renders the leaves and fruit sticky and disgusting in appearance. This year, however, the dry weather has been a disguised blessing in preventing fungus growth of every kind, while other conditions have destroyed the aphid. Nothing, therefore, interfered with the perfect maturity of a magnificent crop, which has probably surpassed any previous record.

The three largest cherries of the season, grown at Maplehurst, are Yellow Spanish, Napoleon, and Monstreuse de Mezel.

One immense tree of the first named, thirty years planted, yielded this season three hundred and sixty quarts, while an instance is reported of a Napoleon yielding four-hundred and fifty quarts! The Monstreuse de Mezel is

also a productive variety ; a fine tree, thirty years planted, gave us one hundred and eighty quarts, not quite so many as the others but so enormous in size, and so rich in flavor, that they brought the highest price in the markets.

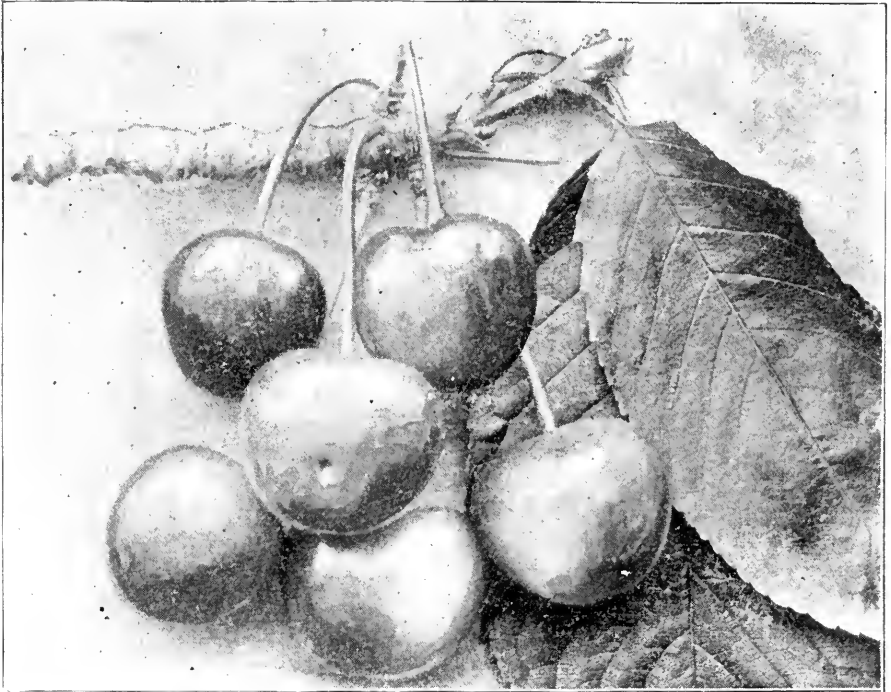

FIG. 975.—YELLOW SPANISH.

All three cherries above mentioned are of the Bigarreau, or firm fleshed class of *Prunus avium*. The Yellow Spanish (Fig. 975) is a type of the Bigarreau division, and, while firm it is juicy and possesses an excellent flavor. This cherry was introduced into America in the year 1800, and is a most valuable variety, fully maturing with us about the first of July or later, according to the season.

The Napoleon is a fully larger cherry than the Spanish, which becomes richly shaded with deep red in the sun. It ripens a little later than the last mentioned variety and the tree is usually much more productive; the fruit is, however, not so highly flavored, and therefore not so much esteemed as a dessert cherry.

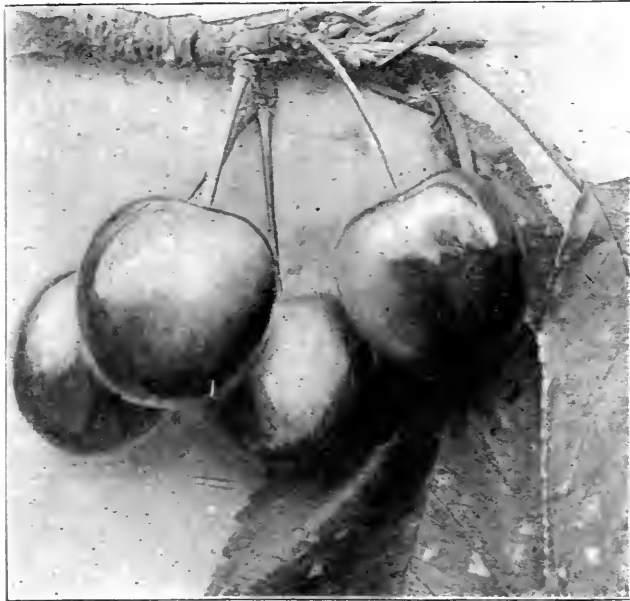

FIG. 976.—NAPOLEON.

The great drawback to both these varieties of cherries is their great tendency to rot on the trees before or at maturity, and for that reason we Canadian growers too often harvest them while still immature, and lacking both color and flavor.

The Monstreuse de Mezel, (Fig. 977) or Mezel for short, as we prefer to call it, surpasses any cherry we know for beauty, size and flavor combined. It very much resembles the Tartarian in appearance, but is larger, later, and firmer in flesh, while the tree is a more vigorous grower, according to our experience at Maplehurst. It is fully mature the first week in July.

In this connection it may be interesting to our readers to have a view of a corner of the packing house showing a shipment of Mezel cherries just ready for covering. We use a special basket for fancy cherries like these, with name of shipper on each end. The fruit is first turned out on a packing table

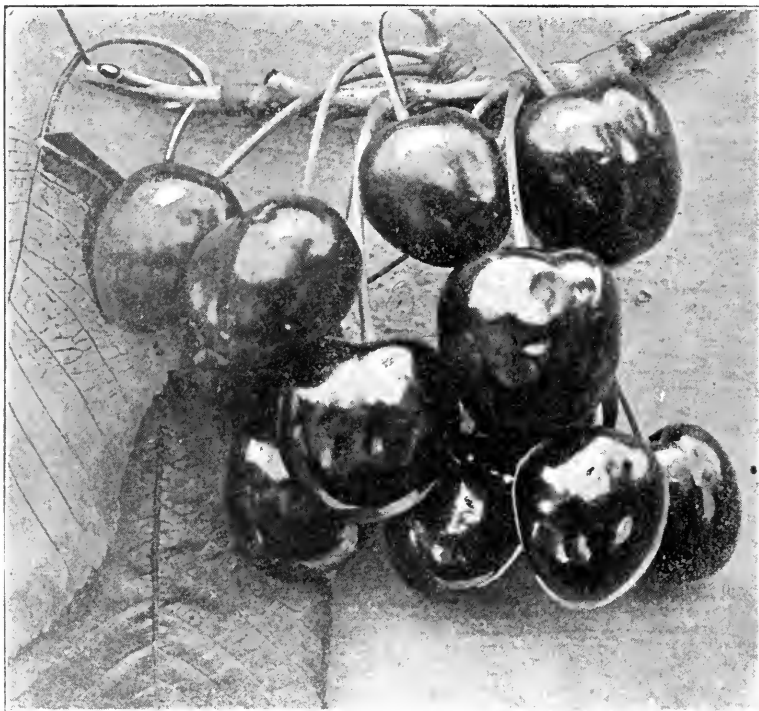

FIG. 977.—MEZEL.

the inferior cherries thrown out, and the fancy grade carefully placed in the basket which holds about six quarts. The stems of the top layer are all turned down which much improves the appearance of the package.

We have much yet to learn about fancy packing, but the grower who can successfully accomplish it will be amply repaid.

We may caution Canadian growers not to plant largely of these finer varieties of foreign cherries outside the peach belt, for their fruit buds are little hardier than those of that fruit; but there are varieties which they may plant with profit, to which we will refer at some future time.



FIG. 978.—MEZEL CHERRIES PACKED FOR SHIPMENT.

**Mahaleb Cherry Seedlings** are the favorite for cherry propagation with American nurserymen. They are a small, wild tree found on sand knolls and dry rocks, over Western Europe, with white bark, hard, close-grained, dark-colored wood, small black bitter fruit and flowering in short racemes. The wood, leaves, flowers and fruit are so powerfully perfumed that it is known as "the perfumed cherry." The mazard seedling is from the pits of the wild red cherry of Europe; it is nearly allied to and supposed to be the original form of many of our cultivated varieties. The choke cherry is neither the one or the other, being an American seedling known as the *Prunus Virginiana*. The myrobolan plum from seedling is an imported plum from Europe used extensively by American nurserymen as stocks upon which to graft and bud plums, prunes and apricots. —Director S. M. Emery, Mont. Exp. Sta.

## A HUGE TOMATO.



EARLY last month the writer received from Mr. John Kerman, Grimsby, samples of his fine Ignotum tomatoes grown under glass here at Grimsby. The samples were accompanied by the following note:—

SIR:—I would like to call your attention to the large tomato which weighed when picked 1 lb. 11½ oz. This is the largest tomato I have ever grown. I picked one a few days ago which weighed 1 lb. 8½ oz. I sent it to Prof. Bailey, of Cornell; when acknowledging it he said it was by far the largest hot house tomato he had ever seen, and he had only grown one larger outside, which was of the variety Ponderosa, and weighed 1 lb 10½ oz.



FIG. 979.—IGNOTUM, REDUCED NEARLY ONE-HALF.

We measured the large sample referred to, and found it was 16¼ inches in circumference; and then we photographed it that our readers might see it also. Mr. Kerman has about four hundred feet of glass devoted to growing the tomato, and seems to thoroughly understand his business. He has wide connections with the best American markets where his fine stock commands the best prices.

**Wash for Peach Trees.**—We usually wash our peach trees in May with a solution composed of 15 pounds of potash to a 48 gallon cask of water and 1 quart of crude carbolic acid, and lime enough to make a good paste. We have used cotton hull ashes for a wash, but it burned the trees some. A bushel of ashes was put in a barrel of water and applied in May. The acid, potash and lime wash is so offensive to borers that we have but a small percentage of them.—J. H. Hale, Connecticut.



## SELECTION OF APPLES; PACKING.



IN sending apples to England, the only way in which they can be secured from bruising is to pack them in proper boxes. Most of our Quebec apples are too tender in flesh and skin to stand packing in barrels without bruising. The Fameuse, Wealthy, Winter St. Lawrence, McIntosh Red, etc., may be classed as late autumn and early winter fruit, and are in perfect order for the table between the 1st November and the middle of December. It is a vital error to pack such apples in barrels, for it is certain that when they arrive in England they will be found to be bruised or crushed.

In barrels, apples will hardly stand even a short journey, unless they be packed very tightly and the tops and bottoms of the barrels be pressed so firmly into the fruit that there be no rattling about; on the other hand, our tender apples cannot be packed in this way without getting crushed, and even the slightest bruise will soon cause rotting. For the last ten years I have adopted a patented box that has given me perfect satisfaction: see engraving. (Fig. 980).

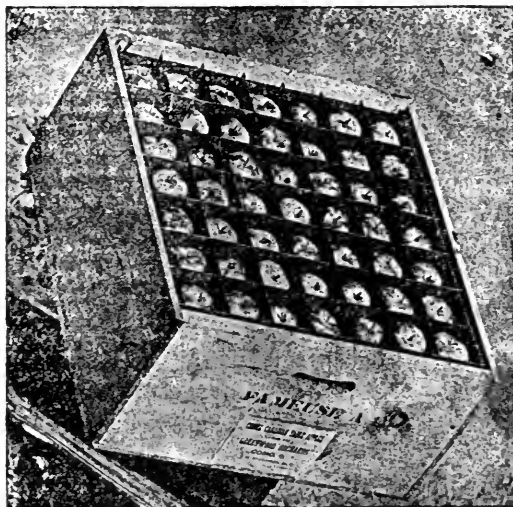

FIG. 980.—PATENTED BOX FOR FRUIT.

In these boxes we even succeeded in sending Duchess apples in perfect order, last season, to Liverpool and Edinburgh. Autumn St. Lawrence, too, arrived in England in capital condition; but as this variety was not known there, and the color did not please the English, my agent did not return me

much encouragement. The Wealthy, Red McIntosh, and Winter St. Lawrence were highly appreciated. Their deep, rich color pleased the buyers. The best way of finding out the state in which the fruit arrives in England is to have agents there to watch the arrival of our apples.

The Wealthy and the Winter St. Lawrence, which I sent to my brother, in England, via London, about the 1st October, not only reached him in perfect order, but on the 7th December, when he wrote to me, were as firm and crisp as need be. This shows clearly the excellence of the compartment-box for packing this kind of fruit.

If the boxes are filled in the orchard, and the fruit carefully handled, it cannot be bruised or injured unless the boxes are flung about or smashed. I must say that, during the last ten years, great improvement is visible in the way boxes are dealt with aboard ship. For more than three years I have had no complaint to make. The boxes weigh about 65 to 70 lbs. when full. They can easily be carried by putting the fingers into the slits at each end of the box.

Last year, I sent a good many empty boxes of this kind to orchardists in Nova Scotia, who wished to try them for exporting their famous Gravensteins. I hear they answered perfectly. Of course, the apples whose flesh is firm and hard enough to stand the voyage when packed in barrels, cost less to send, and most of these apples will for many years continue to be sent in this way.

The Tasmanian apples, which are sold in great quantities in spring and summer, are sent in long boxes, each apple wrapped in paper; and yet this fruit, that has several thousand more miles to travel than our Canada apples, reaches England in perfect condition.

If we Canadian fruit-growers study the demands of the English market as earnestly as our exporters of butter and cheese have done, we shall soon see that it is absolutely necessary that our fruit should reach England without bruises or any other injuries.

R. W. SHEPPARD, JR., Montreal.

---

**Professor Troup**, of the Indiana Experiment Station, writes in the North American Horticulturist that sixty-seven trees of Missouri Mammoth quinces near Indianapolis, and ten years old from the graft, yielded last year 140 bushels of the finest selected fruit. Quinces of this variety are said to ripen ten days earlier than Orange quinces; they are much larger, of firmer texture and quite as highly flavored. Professor Troup adds that the failure of a quince-tree to produce a good yield is more often due to neglect than to any deficiency of soil or severity of climate.

## NOTES ON GOOSEBERRIES.



RECEIVED on July 8th by express a number of gooseberries from John Carnie, Esq., of Paris. These consisted of two varieties: Carnie's Yellow and Phoenix. The former were in very bad condition, the Phoenix being greener were in better shape. Carnie's Yellow, as the name indicates, is yellow, and a very fine berry apparently. In size about equal or a little larger than Chautauqua, 12 berries weighing  $2\frac{1}{2}$  ozs. Phoenix is a magnificent berry, as large or larger than Triumph, 12 berries weighing  $3\frac{1}{2}$  ozs. I find the bush of Carnie's Yellow to be quite vigorous, and, as Mrs. C. says, it is a great cropper: it will no doubt be a popular variety. The foliage and tips of the young wood of every variety under test mildewed with me this year, drought with heavy dews at night seems to be favorable for the growth of this fungus.

I cannot imagine where friend Brooks got the idea that Chautauqua is reported by me as a small berry. I may have in private correspondence carelessly spoken of it as small as compared with English varieties in general. The Lancashire Lad is certainly a hairy berry, and Mr. B. is correct in using the term *hairy*, as prickles don't correctly express the fact. No doubt the berry in its wild state was covered with what may be properly called prickles, but cultivation has changed the character of these till hairy or pubescent is the more correct expression.

Yes; my private opinion is that vigor is absolutely essential in any variety that it shall be a success in Canada, and every year strengthens this opinion. I find that as a general rule the vigorous growers are less effected by mildew. The longer, cooler summers in England, with absence of mildew, make the conditions quite different. However, as my duty is to report what I find to be the truth, and not what I think, I may have reason in the future to change my mind.

*South Simcoe Exper. Station.*

STANLEY SPILLET,

---

**Small Cost of Spraying.**—During last year the Delaware Experiment Station made some exhausting tests as to the cost of spraying trees. In using the Bordeaux mixture they sprayed the trees six times, and reckoned in the cost of materials and cost of labor, and found it to be 2 cents per tree per spraying or 12 cents per tree for the season. The result was that the rot was reduced to one-third what it was on the unsprayed trees. They found also that four sprayings gave about the same results as six sprayings, and that there was about twice as much rot with two sprayings as with four or six. So we see that four sprayings, or 8 cents per tree, is all that it really costs.—New York Farmer.

## THE FRUIT GARDEN.



**P**UMS and peaches may taste better when they are allowed to ripen perfectly on the trees before being plucked, but apples or pears don't: they should be gathered before they are ripe and brought indoors into a cool, dark room or cellar and there allowed to mellow at leisure. Among pears we now have Doyenne d' Ete, Osband's Summer and Giffard, in using condition, and some Margaret and Clapp's Favorite plucked and in store. When gathered eight to twelve days before they are ripe they don't assume that dry, insipid condition that pears that ripen on the tree are apt to have, they are juicy, refreshing and well flavored, and they keep longer. Early fruit when stored in the house or cellar is apt to be kept too warm and dry, avoid this as much as practicable, heat hastens maturity and decay, and dryness causes it to shrivel. While we can stow winter apples in bins or barrels with perfect safety, keeping fruit in any such bulk at this time of year is to invite decay.

It is now time to set out strawberry plants. The ground should be deep, rich, and moist if possible. The best sorts to plant are the ones that thrive best in your locality, for no strawberry is good in all places. We recommend for trial Sharpless, Bubach, Parker Earle, Marshall, Timbrell and Brandywine. Some one of these is almost certain to suit your ground. What are called potted plants, are runners that have been rooted into little pots plunged under the brim in the ground; when the pots are filled with roots the runners are severed from the parent plant, and are fit for planting out. Before setting them shake the ball of earth and roots a little to unravel the roots somewhat, and plant firmly. Strawberry plants set now or for six weeks to come should yield a fine crop of big berries next June. While as potted plants is an excellent way to get young stock from the nurseryman, it isn't at all necessary in the case of saving runners from our own beds, when they are well rooted lift them with a trowel and plant them out at once. Our rows are two feet apart, and hills about 20 inches asunder in the row, three plants in each hill. We also have a good many rows where the plants are set six to eight inches apart in the row and not in hills at all. But this system is only for the garden, in the field the rows should be three feet apart.

As soon as red raspberry bushes have finished bearing cut out the old canes and the most slender and supernumerary of the young ones, but don't shorten back any of the young canes retained for next year's crop, it would cause them to sprout again, hence become more tender than if left uncut, hence more apt to winter kill.

Thin out old, scraggy, and worthless wood from the currant bushes to allow of the young stems remaining ripening up their wood better.—Gardening.

## YIELDS AND PROFITS OF THE BLACKBERRY.



THE year following the planting, there should be a sufficient yield to pay for the cost of the plantation to that time. The third year, the crop should be large, and from that time on, the yield should be nearly uniform, when the seasons are good. I do not know the limit to the profitable age of blackberry plantations. It is certain that it should continue to bear heavily for twenty years if it has good care, and I am told by careful growers that a patch will last even longer than this. As the plants are generally grown, however, they cannot be expected to hold out this long, for the land becomes hard and foul, and the plants full of dead and diseased wood.

Blackberries are capable of yielding 200 bushels per acre, year by year, unless very unfavorable seasons intervene. This station once made an inquiry amongst fifty growers in various parts of the country as to the average yield of blackberries. The lowest return was 40 bushels, the highest over 300 bushels, and the average of the whole fifty was 98 bushels per acre. The prices in this State range from seven to fifteen cents a quart. J. M. Mersereau, of Cayuga, one of our best blackberry growers, recently said to me: "Let me choose the soil, and I will guarantee to clear \$200 per acre on blackberries." In our own experience at Ithaca, blackberries have sold the most readily of any of the bush fruits, at prices ranging from eight to fifteen cents per quart. Granville, Coving, Muncie, Indiana, a most successful grower of this fruit, makes me the following statements respecting the profits of it: "The blackberry is probably the most profitable of the small fruits. Owing to its firmness it can be kept much longer in good condition than the strawberry or raspberry, and often brings better prices. The best varieties are enormously productive, their cultivation comparatively easy, and a well kept plantation of them should last a life time." Whilst all these figures and statements are tempting, it must, nevertheless, be said that the blackberry, like all other fruits, yields the golden harvest only to those who work for it, and who think whilst they work.—Cornell B. 99.

---

**Chestnuts.**—The American chestnut has the sweetest kernels, but are smaller, and the trees must be some fifteen or more years from the seed before they bear. The European, or Spanish chestnut, has nuts nearly double the size of the American, but are tamer in flavor. But the seed will bear at about ten years from the seed. The dwarf Chinquepin Chestnut will often bear the second or third year from seed, but the nuts are so small, that they are not in general use. The Japan chestnut, is a comparative dwarf, though a stronger grower than the American Chinquepin,—but the nuts are as large as the European chestnut, with about the same taste. Like the Chinquepin, they bear early. But all the kinds bear early when grafted from bearing trees.—Meehans' Monthly.

## CLOSE PRUNING AND TYING OF RASPBERRIES.



FOR several years back a wealthy neighbor in sight of my home, has had a raspberry patch which he has pruned very closely in August and kept tied to small stakes scarcely larger than bean poles and four and one-half feet high. The varieties are Gregg and some early variety, probably Souhegan. Thorough cultivation has been given by plowing in the spring and cultivating after fruiting. The canes are allowed to grow at will until after picking when the old wood is removed and the new tied to the stakes and the ends cut off about five feet high. Short laterals grow after this pruning and contrary to what one would suppose, do not winter kill any worse than when pinched early in the season. I think this plantation must be about ten years old, and up to last year was wonderfully productive. Last year anthracnose injured a part of it, but there is a little this year. However I think it has seen its best days and should be cleared up and the ground treated to rotation crops.

Nearer home a young gardener is practicing the same method and his plantation seems wonderfully productive, but what the yield is I am unable to say as I dislike to ask him. He might think it none of my business and give me an answer that might not tally with the facts. He does not have a stake for every hill but uses No. 12 wire with stakes 20 or more feet apart. The merit of the plan lies in the effect that the canes are up out of the way and secure from breaking by wind, ice, or snow, and the fruit gets abundant light and air and is easy to pick. The young gardener grows early cabbage, beets, onions, radishes and lettuce in rows between the raspberries which are seven feet apart, one way, and three the other. The plantation is close to the barnyard and manure is applied with a wheelbarrow. The manure helps the berry crop, and it is possible the berries use some portion not needed by the vegetables. I am thinking of wiring up an acre which I planted four feet apart, believing that I can get enough more from it to pay for the work and expense with a handsome profit to boot.—L. B. Pierce, E. F. G.

---

**A Medina, N.Y.**, letter dated June 13, says: "Orleans County fruit growers have a new apple destroyer to contend with in the form of a small green worm which eats into the apple itself when it has begun to form. The worm is smaller than the dark worm which sometimes attacks the matured fruit and eats its way into the heart of the apple, causing it to wither and die. Some orchards in this vicinity are most devastated by this new pest. In the early spring the most promising fruit was the Baldwin, which is grown in large quantities throughout the country. This apple has come along so rapidly, however, that many orchards are far in advance of the season. In several large orchards the fruit will be premature. Already in some cases the Baldwin has begun to color, though the apple is but one-third the usual size."—Fruit Trade Bulletin.

## GREEN VEGETABLES AND FRUITS.



THE cabbage has been laid down as the healthiest of green vegetables. The early spinach also has its virtues, and it is said that the American dandelion root and leaf, whether used as greens or as a salad, has a direct agency in assisting the liver to do its work. The tomato is acknowledged as one of the most valuable of blood purifiers, and is largely eaten. The silica in corn and peas has the reputation of being of use to growing children, lettuce and celery of resting the nerves, onions and onion tops of aiding digestion, encouraging sleep, and stimulating the circulatory system, and carrots of preventing dyspepsia; while the turnip is very nutritious.

Cucumbers come in season to cool the heated frame. Strawberries and cherries are cooling and purifying; the juice of the apple and orange, taken in the early morning, is a fine tonic, and the peach, when in perfect condition, is well known as a corrective. A change to a vegetarian and fruit diet for a day or so will sometimes work wonders in quickly restoring health.—New York Farmer.

## RUSSIAN PLUMS.

SIR :—I note by the excellent "HORTICULTURIST," and also by letter from Mr. Craig, that the Russian plums are not generally proving satisfactory as regards production, and perhaps in quality. I have quite an assortment of them, received from Prof. Budd of Iowa, four and five years planted, and am getting as much fruit from them as from other varieties, except perhaps some of our own and western wild kinds. They are perfectly hardy, and vigorous growers. It occurs to me that perhaps my method of planting with all these varieties and species together, closely planted, may account for my better success. The soil of my plum orchard is sandy on the surface, but deeply underlaid with clay at a depth of one or two feet. Surface water does not stand upon such a soil; but there is always moisture at a moderate depth. I am aware that perhaps few would have just such a piece of ground; yet my experience might afford a hint as to the needs of the Russian, and indeed all plums, for I see very little of a distinguishing character in the Russians, except perhaps a somewhat dwarf growth and early fruitage. For profit alone I should prefer our own wild plums (Western and Eastern alike), so far as I have gone in plum culture. They are immense crops, and the fruit sells at wholesale for quite as much money as the foreign sorts.

*Newport, Vt.*

T. S. HOSKINS.

## SOME NEW GOOSEBERRIES.



AN article in an English paper recently giving almost fabulous reports concerning the productiveness of gooseberries in that far-away island, led me to investigate the merits and success of certain new and large varieties now being tried in this country. That Gooseberry culture has been greatly stimulated and increased either by improved methods of culture, or by better and larger sorts recently brought out, is evinced by a recent order given by one man for 90,000 plants. The English article above referred to stated that 27 tons of fruit had been harvested from 10 acres and the following year 30 tons. But the variety there cultivated is the Industry and it does not generally succeed in this country. It is too productive and lacks vigor.

An amateur has been testing nearly all of the new sorts as they have appeared and finds a ready market for all the fruit he can grow. Downing with him ranks high, but is small to medium in size; 29 points. Smith's Improved, small, quality best, has 30 points in its favor. Keepsake, medium to large, 27 points. Industry, large, is graded at 27 points. Red Jacket very productive, 32 points. Triumph, or Columbus, which is the same, is very large and scores 27 points. In freedom from mildew Downing ranks as best and Red Jacket as second. With me the report would be reversed, for I have not found a trace of mildew since I have had that variety and the Triumph has been equally free though not so vigorous a grower. If these large varieties should prove as productive and healthy as the Houghton a great and valuable addition will have been made to the fruits of the temperate zone and especially to us in America.—Farm and Home.

---

**Elberta in Michigan.**—The Elberta was doing finely. It marks an era on peach culture as great as the Concord grape did in grape culture. It is large, handsome and of uniform size and very excellent quality. Planters of peach trees are now growing varieties that will give a succession through the season, whereas they formerly planted all the late varieties. Continued cultivation from early to late has been found the best for peach orchards, beginning with the blooming of the trees. Orchards that were not cultivated until June produce fruit, but its size was not nearly as large as those cultivated early. The fruit is mostly handled by shipping associations and the cost of grading, packing, packages and marketing is 18 1-2 to 20 cents per bushel. One of the most profitable methods in peach culture is proved to be that of thinning the fruit in its early stages. There is much less strain upon the tree, the fruit is more uniform in size, and much larger and finer than where not thinned. Mr. Miller closed with the remark made by an intelligent observer of mankind, that the commercial fruit growers were the most intelligent class of agriculturists.—Country Gentlemen.



## SMITH'S GIANT BLACK CAP.

On the 8th of July we called on Mr. A. M. Smith to see his seedling black-cap. He has about half an acre in full bearing, and carrying an immense load of fruit.

Mr. Smith thinks it is showing sufficient merit to deserve dissemination among our fruit growers, as a first class hardy and productive raspberry. Our acquaintance with it is too limited to say much in this regard as yet, except

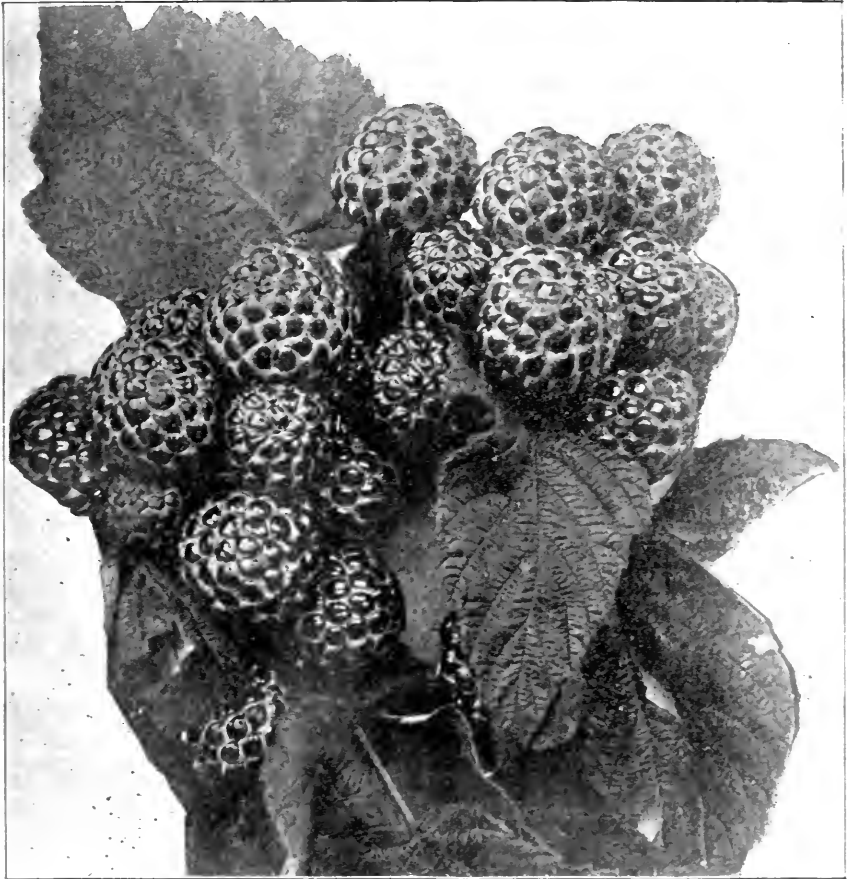

FIG. 951. — SMITH'S GIANT BLACK CAP.

to note that Mr. Caston calls it hardy at our Simcoe station, north of Barrie; and the crop at Mr. Smith's speaks for its productiveness; but all this needs farther test at our other stations. In size it is much the same as Gregg. The engraving is from one of our photographs of this berry, showing two clusters of Smith's Giant, natural size.

## WESTERN JOURNALISM.



copy of the "Montana Fruit Grower" has just been examined by the writer with considerable interest. The free and easy manner with which the typical Western Journalist and correspondent uses the English language is well known and easily recognized. That this peculiar style of diction is not in vogue only with daily and weekly news and business sheets, may be inferred from the following sentences taken from a more than usually racy article in the Journal mentioned above, in which the practice of buying foreign grown nursery stock is denounced and the danger of importing injurious diseases and insects is emphasized.

"Here we see a quarrel in progress between New York and Washington as to which has given us the great wild, woolly, white-eyed, bald-faced, and peaked-toed tree aphid. This terrible monster was purchased by some 'd——' like myself, from one or the other of them, when he could have bought better stock at half the price right across the next section from his home ranch. Yes, Mr. Editor, that is just what I did, although I did not import the wild and woolly monster then or since. I can, however, produce a man who knows the "wall-eyed critter" by his roar, who found one, a whole one, alive and foaming at the mouth, on a tree that came from New York the same as mine did. Mine, however, was small fruit, and had sat in a flat car at Missouri 7 days, and were dead or died shortly after planting. I paid \$1 apiece for some varieties. Three of us—neighbors—saved one tree, a plum, out of orders aggregating \$50, with the best of care, out of that flat car. At the same time I planted the same kind of fruit from the nursery across the section, which are in blossom this year, and may perhaps bear some fruit. These last did not cost me a cent, the owner of the nursery having given them to me to place along side my boasted \$1 apiece New York stock to see if they would grow, he said. He is an old country German, was a 'Koenig's Gärtner' there, sort of purveyor to the 'Pooh Bah,' of Germany, I suppose."

The following advice is given with regard to purchasing Eastern nursery stock :

"I say, let us ranchers buy from neither a 'New York insect and tree raiser,' or a 'Washington bug and blackberry grower,' or an 'Idaho snail and strawberry planter,' but, let us buy our fruit trees right at home in Montana. Let us band together to get State laws passed so that no one can sell these pestiferous, infectious things to suckers like myself who give them a dollar apiece for their dead and dying—travel-killed—bug coffins. We shall not anyhow have to be paying freight on such monsters as the woolly aphid."

Comment on the above is hardly necessary. We trust that the need of this vivid "Arizona Kicker," style is not felt at present nor likely to be demanded by CANADIAN HORTICULTURIST readers in the future. J. C.

## PACKING APPLES FOR THE LONDON MARKET.



THE Tasmanian Journal of Agriculture contains the following advice from a London writer, on packing fancy apples for that market.

Grade the apples so that each box contains fruit of equal size, that is, do not put two sizes into one box. It always damages the sale. If the packer has three sizes let him put them into three different sets of boxes and sell them in three grades.

Another important thing is to pack the apples in rows, all with their noses up and stocks down. They look so uniform when opened, and show to the buyer that the packer may be trusted as knowing his business. It is a most foolish thing if there is a little hole at one corner or elsewhere to place a small apple in it. Instead of a small apple stuff a piece of paper there. If the buyer sees only one small apple on the top he will surmise there are others underneath, and bid a shilling less for the box; and if there are 10 boxes in the lot the packer loses 10s for one small apple's sake. Again, the packer should remember the one golden rule for success on the London market—send nothing but the very choicest fruit—and then he will soon get a reputation and find his goods sell on his brand. It is so with several large French exporters, and it should be the honor of the Australian exporters to achieve a similar reputation. Inferior goods of all kinds London is full of, and they never pay the grower. It is the main road to a successful trade to earn a reputation for choice quality goods. It will pay the exporter in the long run better to send 50 boxes of choice apples than 100 of medium quality. It must never be forgotten that there is a very wealthy community of consumers in London who do pay, and are prepared to pay, high prices for choice goods, only it is an absolute necessity that they should be choice. The market for this choice stuff is of course limited, but it is extensive enough to take all the very choicest fruit that the colony can produce.

## UNITED STATES A MARKET FOR CANADIAN APPLES.

SIR,—Some of your readers may consider my statement for prime apples an over estimate, but it is not. The apple crop of the United States for 1895 was 65,000,000 barrels or about one barrel per capita. By 1910 the population of the country will exceed 90,000,000 and the per capita consumption will increase as it has done for the past twenty years and at that date if it is only  $1\frac{1}{4}$  barrels per capita the total consumption will be 112,500,000 barrels. If *prime* apples can be sold in our large cities at the east at retail for \$4 per barrel and at that price they should yield a fair return to the producer, the consumption will be very great. I was a nurseryman at Rochester from 1853 to 1861 and frequently heard fruit growers at our conventions, warn their fellow members against the

over production of apples, and yet in 1895, with a crop of 65,000,000 barrels, there was no over supply of *prime* fruit, at far larger prices than they commanded in 1855; and if Ontario has 10,000,000 barrels of *prime* apples to send us in 1910 or 1920 they will find a market at prices which will yield a much better return than wheat, barley, cattle, horses, sheep, cheese or butter.

I shall make inquiry and learn the name and address of some *reliable fruit dealer* in this city, and give it to your readers in my next letter. Let me warn them again to *pack with care*, in neat and clean packages, only prime fruit and brand distinctly, and thus establish a valuable reputation.

There were two mistakes in the figures of my last letter, as published, 25,000,000 should have been 35,000,000, and 4,500,000,000 should have been 4,550,000,000.

The Ontario apple is superior in quality to all other American apples. The superiority is due to the climate and for this reason the demand for prime Ontario apples will always exceed the supply when they have an established reputation.

I have received a number of communications from Canadian fruit growers since my letter respecting the shipment of prime Summer apples in small packages from Canada to our Eastern markets, appeared in the July issue of the CANADIAN HORTICULTURIST, asking for the name and address of fruit merchants to whom fruit can be safely consigned for sale. I have made some inquiries and given the subject considerable consideration, and have concluded to suggest that your Association should send an agent to Boston to open up a market in New England with that city as a centre, another to New York City; and still a third to Philadelphia. From these three centres a very wealthy consuming population of 8,000,000 can be reached, south of Portland, Maine, and north of the Potomac River, for the trial of the experiment.

Let all the apples sent to these agents be most carefully selected and packed in neat, clean, fresh cases, or kegs, containing not more than one bushel each. Success depends upon selection, packing, quality, condition and appearance when exposed for sale.

If the crop of Summer apples is abundant, growers can well afford to send only the very best to this market as an experiment. Make them so fine that they will command attention. Brand carefully and distinctly the name "Canada" upon each package and instruct the agents to advertise them as "Canadian Apples." They should arrive here in the night and be sold the next morning at auction for *spot cash* on the wharf where they are delivered from the cars.

Nearly all of the California fruit comes to this market by the Erie Railway, and is opened and arranged at once for sale at auction upon the Erie Railway wharf early the next morning.

In 1894 two car-loads of California pears, plumps, peaches and grapes came to New York on the same train, and were sold at auction on the same wharf at

the same time. One of them sold for \$2800, and the other did not realize more than the freight, ice, and other charges. The first was superior fruit, carefully selected and well packed, the other was a mixed lot in quality, badly packed. Both were in sound condition and healthy, but there was a great contrast in the appearance. One yielded a liberal return, and the other was a total loss to the grower and shipper. Superiority commands a market at good prices, when inferiority must be sold at a loss to all concerned.

Ship Red Astrachan, Benoni, Gravestein, Duchess of Oldenburg, Primate, Sweet Bough, Sour Bough, St. Lawrence, Maiden's Blush, Porter and Fameuse, or Snow Apples. I never have been able to purchase here, during the last ten years, fine snow apples for less than 75 cents per peck. There may be other varieties which are of good quality and fine appearance. Crabs might be shipped to some extent as a trial. The name of the variety should be branded upon the package so as to establish a reputation for it and educate the consumers to ask for it. Fair peaches to-day are sold by the street vendors for one cent each; better ones are three for five cents, still better ones at two for five; and superior Crawfords at five cents each, and the price of the best was firmer than that for those of fair quality.

I purchased three fair sized, southern Red Astrachan apples to-day for five cents. They were soft, coarse grained, very mild in flavor, and thick skinned. Not like those grown in Canada, crisp, brittle, brisk acid flavor, appetizing, refreshing, fine-grained and thin-skinned.

Our crop of apples for 1895 was estimated at 65,000,000 barrels, or nearly one barrel per capita, and yet cooking apples sold here at retail for from \$2 to \$3 per bushel through December, January, February, and March, and prime eating apples at a higher price. The per capita consumption of fruit is increasing as well as our population. In 1910 our population will exceed 90,000,000, and if we consume only one and one-quarter barrels per capita the grand total consumption at that time will be 112,500,000 barrels per annum.

Intelligent, patient, persistent labor, combined with integrity, has opened and held a market in Great Britain for 155,000,000 pounds annually of prime, full, cream, Canadian cheese.

Having had twenty-five years experience as a manufacturer of reapers, mowers, binders, grain drills, broad-cast seeders, horse hay racks, plows, threshers, horse-powers and agricultural engines with the farmers of Canada, I appreciate their high character, industry, patience, persistence, and integrity.

The climate of Canada produces a better apple than any other section of this continent. Prove it by sending prime fruit here, well packed, and establish the high character of Canada apples, and the demand will exceed the supply. Canadian apples retain their firmness, brisk acid flavor, crispness and appetizing quality longer than those from south of the Great Lakes, and are better keepers. Cold storage can be provided in Canada very cheaply, and prime winter apples

can be sent here by the car-load in February, March and April, and sold at good prices. There are far less difficulties to overcome in opening and retaining a market here for 10,000,000 barrels of prime Canadian apples, at remunerative prices, than in making and retaining a market in Great Britain for 155,000,000 pounds of prime cheese or 100,000 head of prime stall fed cattle. The cheese and cattle nets the producers not more than \$15,000,000, while the apples will net not less than \$20,000,000, and cost less labor, and represent the product of less land.

I am sure my friend, the Honorable John Dryden, Minister of Agriculture, who still represents dear old South Ontario in the Commons of the Province, will assist in all legitimate ways to advance the fruit industry of Ontario as he has that of the dairy. Nature has done far more for Ontario as a successful apple producing country, than it has as a cheese or fat cattle producer. Farmers have learned that they cannot cheat a cow or stalled ox of their food or good care with impunity. Neither can they their apple orchards. Our Canadian cousins need not have any anxiety as to the outcome of our Presidential election. We shall route the crazy conglomerates who met, formulated and published a platform of principles at Chicago early this month, horse, foot and artillery, and bury them in the grave with the destructive policy of revenue reform, rag money, free silver, bimetallism, communism, anarchy, Clevelandism, and repudiation, and restore the constructive policy of protection to American interests of every kind, name and nature, and thus enter upon a long period of prosperity with a very largely increased power of consumption under the administration of the incarnation of prosperity and financial integrity—President William McKinley.

We shall not commit financial, commercial, and industrial suicide on the invitation of revenue reformers again so long as the enforced idleness, self-denial, severe and painful economy, and humiliation of the past three years is remembered, and, therefore, Ontario's fruit growers may confidently look forward to a marked increase in the demand for prime apples such as they alone can supply.

Cleveland revenue reform, like the small pox, once in a generation is quite enough for the electorate of this Republic.

I may add that it will give me very great pleasure to assist in every legitimate and possible way to successfully introduce Canadian fruit in Greater New York and vicinity.

With best wishes, I am, my dear Mr. Secretary,

Yours faithfully,

*543 Madison St., Brooklyn.*

FRANCIS WAYLAND GLEN.

**THOSE SCORE CARDS.**

At the last meeting of our Association a Committee was appointed to revise and report upon the score cards for judging fruit which had been introduced by the Secretary. This Committee consisted of Messrs. A. H. Pellet, Alex. McNeill, and T. H. Race. The two first named met with the Secretary at his office on Friday, July 24th, and after considerable discussion decided upon commending the following score card for use in judging apples and pears :

**Score Card for Apples and Pears.**

POINTS.	VALUE.
Color .....	
Size .....	
Quality .....	
Commercial value .....	
Total .....	

*N. B.—Maximum of points for each plate 10*

For judging Grapes the following card was commended :

**Score Card for Grapes.**

POINTS.	VALUE.
Color .....	
Size of bunch and berry.....	
Form of bunch .....	
Flavor.. .....	
Total .....	

*N. B.—Maximum of points for each plate 10.*

In judging single plates, a half dozen of the best plates could be selected by the eye, and then the score cards filled for those securing the prize, to show the ground upon which the prize had been awarded.

In collections, the best collections could be first detected, and then the score cards placed on each plate of these collections: The sum of points gained by all the plates in a collection would determine the relative merit of these collections, and consequently the ones deserving of the prize.

For commercial value, and for quality, the judge would of course consult the Report of the Fruit Growers' Association, at least in case of any fruit concerning the value of which he was in doubt. We hope that the public will demand of the Fair Manager that these cards be given a good trial during the coming season.

A HOME-MADE HAND CART.



EARLY every farmer is possessed of an old, worn-out buggy or vehicle of some sort from which he can obtain a pair of wheels and an axle. Take the axle (*a*) to a blacksmith and have it cut and welded to measure about 2 ft. between the wheels. Then get two strong oak pieces for handles about 2x3 in. and 5½ to 6 ft. long, and shave them down into shape (*b*). Next get four small iron straps (*c*) with bolt holds at the ends (*e*) to lay across handles at *f*, and likewise four more to fit directly under axle. Connect these with light, strong bolts, letting ends of handles reach about twelve inches over axle (*g*), and just wide enough apart to admit a milk can between. About three inches from the end, at *h*, bore two small holes and drive in two iron or hardwood pegs, leaving about an inch out to catch in handles of can. Bolt on a crosspiece (*i*) underneath handles put on wheels, and your cart is done. With this cart a man can pick up and wheel on the level an ordinary milk can of milk, water, swill or other substance; it can be used for wheeling bags of grain, baskets, boxes, etc., by setting on axle and crosspiece. In fact, no farmer knows the number of uses to which such a cart can be put till he has tried one for awhile on his farm.—Farmers' Advocate.

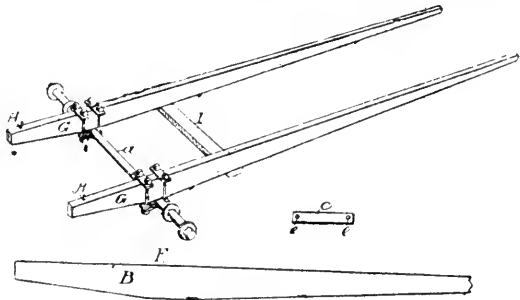

FIG. 982.—HOME MADE HAND-CART.

**Wire Fence Without Barbs.**—Many thoughtful farmers object to barbed wire, as each year serious accidents to stock result from its use. Where sheep and hogs, however, are pastured, the plain wire needs to be put close together below or the animals will press them apart and crawl through, especially when

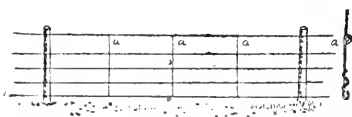

FIG. 983.—IMPROVED WIRE FENCE.

the posts are located from 12 to 16 feet apart. This can be overcome by the plan shown in the sketch. Set the posts 14 feet apart, and put on the usual number of wires. With No. 12 wire cut into the proper length, wrap one end around the top wire, then wrap once closely around the next one, and so on until the bottom is reached, placing three of these cross wires (*a*) between each post. The manner of doing this is shown more clearly in the sketch above. To keep the wires equally distant, saw notches one inch deep in a hardwood board the distance apart that the wires are attached to the posts; place these over the wires as near as possible to the point where the connecting wires are to be wound, moving along when the wire is firmly wound in place.—Am. Agri.



## SIZE OF FRUIT PACKAGES.

The following weights and sizes of fruit packages have been widely adopted in the United States :—

Box.	Weights—lbs.	Outside Measurement.			Lineal Measurement.		
		Height.	Width.	Length.	Height.	Width.	Length.
Apples.....	55	12	12½	19¾	11	12	19¾
Pears.....	45	9½	12½	19¾	8½	11½	19¾
Berry—24 boxes.....	25	8¼	14	19¾	7¼	13¾	19¾
Berry—4 baskets.....	25	5½	16½	17	4½	16	17¾
Plum or Peach.....	20	5½	12	19¾	4¼	11½	19
Cherry.....	10	2¾	10¾	19¾	2	9¼	19¾

The 5 and 6 inch plum or peach boxes are not included in these weights but go on actual weight, to be determined hereafter. The railroads measure all boxes by extreme outside measurements. This action will result in considerable saving of time and expense in rating cars, as the weight will be determined by counting boxes instead of continuous weighing.

**Irrigation in the East** has been made a special study by Prof. F. M. Rane, at the West Virginia and New Hampshire experiment stations. In bulletin 33, W. Va, he described sub-irrigation in greenhouses, which has since come into quite general use, and bulletin 34, N.H., shows that the same system works well out doors. By this system, the water is applied below the plants by means of lines of tile placed from six inches to two feet below the surface and from 6½ to 40 ft. apart, having a drop of about one inch per 100 ft. By this plan the surface soil never bakes or surface-hardens, plants run very evenly, soil can be worked at any time and can be kept in better condition, less water is required, the tile serves to both water the beds and retain the moisture, surface evaporation is slight, fungus diseases are not so prevalent, and the openings underneath the soil allow the free access of air so that the soil never becomes sour or stagnant. Where it is desirable to get the water to the roots of plants with as little waste as possible, it may be run through common porous 2½ inch drain tiles laid end to end on the surface of the soil between the rows of vegetables. By stopping up the further end, the water leaks through the joints sufficiently to moisten the plants at either side. In the case of celery, the tile are run beside the rows and covered up as the plants are banked up, this proving sub-irrigation in the latter part of the season. This plan is a great economizer of time in watering, saves water, applies it where the plant cannot help but receive benefit from the water, and is simple, practical and inexpensive. Prof. Rane concludes that sub-irrigation, surface irrigation, cultivation, mulching and subsoiling are all methods of counteracting drouth that can be applied at a practical profit on many farms in the middle and eastern states.

## ❖ Flower Garden and Lawn. ❖

### A PRETTY LAWN TABLE.



TUMPS of old trees that have outlived their usefulness and been relegated to the wood pile are not uncommonly seen upon lawns, and many attempts are made to turn them to artistic and useful account. The stump is first sawed to a flat surface and then fitted with a top of thick boards of the desired dimensions. Four rustic supports or brackets are placed underneath at the four corners. These should be as much as possible in their natural state, with any little crookedness or knots allowed to show, as they add much to the pretty effect on the whole. The edges, too, of the top board may be given a rustic tone by tacking to them strips of wood with the bark on them. When the little table is finished and "set" with its dishes and pots of plants, the owner of it is quite sure to stand a little way off and admire it audibly. All summer long it will be a charming abiding place for the choicest house plants, out of the reach of tiny marauders and within sure reach of admiring eyes.—Farm and Home.

---

### CRIMSON CLOVER.



CRIMSON clover was introduced in this country a number of years ago by the late Dr. Haradine. Being a great lover of flowers, he was attracted to this plant by its beauty, which is hardly exceeded by the finest flower that adorns yard or garden. The beautiful deep green which may be seen all through winter when not entirely covered with snow grows deeper and brighter as spring advances until early in May when the flowers appear and the field changes from a green to a brilliant crimson, making a sight to behold and remember.

At first its value as a forage plant was not understood, and as a soil restorer it was unknown and the progress of the plant at first was rather slow.

Every one admired its beauty, and numerous plots were grown for ornamental purposes, but years elapsed before farmers awoke to its value as a regular rotation crop.

To-day crimson clover is grown to a greater or less extent in every state in the Union. It is good for hay, good for fall and early spring pasture, valuable for seed, which it produces in large quantity.

Its greatest value lies in its ability to store up plant food and at the same time send deep feeding roots far down into the subsoil and bring to the surface elements of fertility that would otherwise be lost.

Crimson clover is an annual and must be sown in its proper season; this extends from August to October 15th. About eight or ten quarts are usually sown on an acre.—C. Staples, in Farm, Field and Fireside.

## A FLORAL LOVE STORY.



**F**AIR (Marigold) a maiden was, (Sweet William) was her lover ;  
 Their path was twined with (Bitter-sweet), it did not run  
 through (Clover).  
 The (Ladies' Tresses) raven were, her cheeks a lovely (Rose),  
 She wore fine (Lady's Slippers) to warm her small (Pink) toes.  
 Her (Poppy) was an (Elder) who had a (Mint) of gold,  
 An awful old (Snapdragon), to make one's blood run cold !  
 His temper was like (Sour Grass), his daughter's heart he wrung  
 With words both fierce and bitter—he had an (Adder's Tongue) !  
 The lover's hair was like the (Flax), of pure Germanic type ;  
 He wore a (Dutchman's Breeches), he smoked a (Dutchman's Pipe).  
 He sent (Marshmallows) by the pound, and choicest (Wintergreen) ;  
 She painted him (Forget-me-nots), the bluest ever seen !  
 He couldn't serenade her within the (Nightshade) dark,  
 For every (Thyme) he tried it her father's (Dogwood) bark,  
 And so he set a certain day to meet at (Four-o'clock),—  
 Her face was pale as (Snowdrops), e'en whiter than her frock.  
 The lover vowed he'd (Pine) and die if she should say him no.  
 And then he up and kissed her beneath the (Mistletoe).  
 " My love will (Live-for-ever), my sweet, will you be true ?  
 Give me a little (Heartsease), say only ' I love (Yew) ! ' "  
 She faltered that for him alone she'd (Orange Blossoms) wear—  
 Then swayed like supple (Willow), and tore her (Maidenhair)  
 For (Madder) than a hornet, before them stood her Pop,  
 Who swore he'd (Cane) the fellow until he made him (Hop) !  
 Oh, quickly up (Rosemary) ! she cried, " You'll (Rue) the day,  
 Most cruel father ! Haste, my dear and (Lettuce) flee away ! "  
 But the inhuman parent so plied his (Birch) rod there  
 He settled all flirtation between that hapless (Pear).  
 The youth a monastery sought, and donned a black (Monkshood) !  
 The maid ate (Poison Ivy), and died within a wood.  
 —Catherine Young Glen, in March Ladies' Home Journal.



## The Canadian Horticulturist

SUBSCRIPTION PRICE, \$1.00 per year, entitling the subscriber to membership of the Fruit Growers' Association of Ontario and all its privileges, including a copy of its valuable Annual Report, and a share in its annual distribution of plants and trees.

REMITTANCES by Registered Letter are at our risk. Receipts will be acknowledged upon the address label.

### ✦ Notes and Comments. ✦

SAMPLE OF A SEEDLING GOOSEBERRY comes to hand from Mr. J. P. Crouch, Davisville, which grew on a bush three years old. The berry is dark green, oblong and slightly obovate; size nearly equal to Whitesmith.

THE P. BARRY PEAR must be a good keeper. Garden and Forest states that this variety from cold storage was being offered for sale on the 1st of July in New York City, along with the first harvest apples of this season from California.

CIDER.—In reply to an inquiry published in this Journal last February, on page 72, a subscriber writes: I beg to say that Messrs. A. H. Rurdan, Co., of Annapolis, N.S., are engaged in the manufacture of that article, under the style of "The Valley Cider Works."

HOW TO SELL OUR APPLE CROP to advantage will be a problem facing Canadian fruit growers this fall. Never was there known such a yield, and so few calls. Fortunately Europe is open for a large quantity, but even those markets will be too small this season. We have proved that Australia is an excellent market for Canadian apples, our Cranberry Pippins bringing nearly four dollars a bushel at Sidney. The only blockade is the want of a cool storage for crossing the tropics. What greater public benefit could our new Dominion Government bestow upon Canada, than to subsidize the C. P. R. steamers on condition of providing cold storage accommodation for Canadian apples to New Zealand and Australia. What a source of wealth would thus be gained to the Canadian apple growers!

THE WORLD'S FAIR MEDAL AND DIPLOMA, so long promised has at last appeared, after about three years delay. The tardiness is said to be due to the difficulty in procuring parchment in sufficient quantity and of proper quality. The writer took care to exhibit a complete set of bound copies of our journals and reports, under the head of Horticultural literature; and for this exhibit a medal and diploma was awarded our Association. On the diploma we read "This exhibit is of a very high order of merit. It exhibits the extensive and progressive work of a wonderfully successful organization."

---

THE ARMY WORM is marching through portions of Welland County destroying everything in its way. Prof. Panton of the O. A. C., Guelph, has been visiting the infested sections, and reports finding a parasite beginning to prey upon the worms, and many of the latter are now turning in to pupæ, so their work is nearly over for this season.

Prof. Panton advises ploughing furrows to intercept their march, into which they will fall and can be easily destroyed; spraying with Paris Green the plants in advance of them; scattering dry straw upon them and burning them, etc.

---

AN IMMENSE APPLE YIELD is reported in Perth County by the Globe. This is but a sample of the state of this crop all over Ontario. Not only will the yield be abundant, but the size and appearance surpasses all previous records. Nearly the whole crop will be grade 1. This is the season for Canadian fruit growers to extend their apple markets throughout the whole world. If no outlet is furnished, our apples may rot on the trees, even at the best, with only the European markets, our apples will not be worth more than 50 cents a barrel in the orchards, and at that it may be difficult to get them out of the country, unless exceptional facilities are provided.

---

PLANTING RASPBERRIES IN THE PEACH ORCHARD.—This practice, very common in the Niagara District, is not commended by Mr. Van Deman. He says, among peach, plum and cherry trees I would never set raspberries, blackberries or currants, because they should be set in no soil and climate over 20 feet apart and their roots will soon need all of the space even if their tops do not cover it. The berries need feeding and pushing to their highest bearing limit, and so do the peaches and cherries. Each needs all the opportunities the soil will afford.

Now, no doubt the objection is well taken and applies well in those districts where the peaches may be expected to produce a crop about every year; but when, as in Canada, we only harvest a peach crop at an average of once in four years, it seems to be a wise step to set at least one row of Cuthberts between each row of peach trees, in order that we may at least receive enough from the ground to cover the cost of cultivation.

THE APPLE CROP.—Messrs. M. H. Peterson & Co. of Toronto, write;—  
 “From reports concerning the apple crop so far received (July 7th), the indications are as follows,—Great Britain and the Continent, excepting Belgium and the Rhine Valley, a short crop; Maine, the New England states and New York a large crop; Missouri and Illinois, a short crop; Ontario and Nova Scotia, a large crop, good quality.

---

CANADA'S GREAT EXPOSITION.—The Toronto Industrial Exhibition, now known as “Canada's Great Fair,” is an occurrence to which almost every Canadian looks forward with pleasurable anticipation, as it is made the occasion for their annual holiday outing. It is to be held this year from the 31st of August to the 12th of September, and as the live stock exhibitors and various associations have agreed to have their stock on the grounds from Thursday, the 3rd September, till the close of the Fair, the first week will now be as good as the second. We have received a copy of the Prize List, which is unusually well gotten up. Any one desiring a copy can obtain one by dropping a post card to Mr. H. J. Hill, the Manager, Toronto. A great programme of interesting attractions is promised. Applications for space should be made early.

---

THE RED CROSS CURRANT.—A sample of this currant has just come to hand (1st July) from Chas. Green, Rochester, the introducer. In size and appearance there is little to distinguish from the Cherry currant, except that the flavor is not so tart. Mr. Green writes:

We have instructed Jacob Moore to send you by this mail a sample of his new seedling currant, named “Red Cross,” which we purchased of him last Fall for \$1,250.00. Mr. Moore says that his currants were injured by late Spring frosts, hence we are not sure that you will get a good sample. Should you think this worthy of notice in your journal, I will be pleased to have you give it such attention.

*Description.*—On our grounds at Rochester, N. Y., the Red Cross currant is as large as Cherry or Fay. Its peculiar advantage over either of the above varieties is that it makes twice the growth, having made from 18 to 24 inches last Fall, set plants up to July 1st. The fruit is often so dense upon the stalks as to hide the canes entirely from view; color bright red; berries set in compact cluster, with long stems of which to pick. This is the first variety introduced of a large number of seedlings the result of scientific crosses by the veteran hybridist, Jacob Moore, originator of the Brighton grape, Diamond grape, Bartlett Seckle pear, and other new fruits.

Yours truly,

CHAS. A. GREEN.

**NEW FRUITS**—We are reminded by a letter from Mr. D. W. Beadle, the well known Canadian pomologist, that the Fruit Growers' Association has a duly authorized Committee on New Fruits, consisting of Horticulturists, John Craig Ottawa and H. L. Hutt Guelph, and the Secretary of our Association. It will be a public benefit, as well as an individual advantage, if those having new fruits of merit will forward the same to any of the members of this Committee.

**MESSRS. WOODALL & Co's.** Apple Diagram for 1896 has come to hand. It shows that Canadian Baldwins still hold their place at the top for value in the Liverpool market. The second place is held by Main Baldwins, while the third and fourth place is in dispute between New York and Boston Baldwins. Canadian Baldwins started out last October at 17/ touched 15/6 in November, and reached 23/ in April.

The quantity of apples imported into Liverpool market in 1894-5 was 857,215 barrels, and in 1895-6, 438,354 barrels. This year will no doubt break all records.

**DWARF APPLES.**—Mr. Lodeman, Assistant Horticulturist at Cornell, has issued a bulletin (No. 116) on "Dwarf Apples," in which after discussing their merits and productiveness, as compared with standards, he does not recommend them for profit. For fancy or dessert purposes dwarf trees answer an excellent purpose, often yielding finer fruit than standards while the trees of course occupy much less room. Apple trees are usually set 30 to 40 feet apart, but dwarfs may be set 8 or 10 feet apart. Two kinds of stocks have been used for dwarfing the apple, viz., the *Paradise*, comprising several European varieties of small growth; and the *Doucin* an Italian variety of stronger growth than the French *Paradise*, but not so valuable, and therefore almost wholly discarded by nurserymen of late. The yield from dwarf apple trees usually averages two or three pecks per tree, and possibly 300 trees might be set to an acre.

**FLOWER SHOWS** are all important to the successful Horticultural Society—especially those affiliated with our Association. We do not mean those cumbersome affairs at which the chief object of the officials is to enrich their treasury, so that every kind of objectionable feature is introduced to draw the crowd; and at which the exhibitors themselves, aim only at carrying off the prize money. We refer to an exhibition of another character entirely; a much simpler undertaking for the officials and a much more enjoyable and successful affair for the members of the Society generally, because all share equally in the results.

First, let our Societies lay down the ruling principle that the first aim is the general good of the members and the encouragement of a taste for floriculture and fruit culture. Then in the summer let the directors plan upon at least one special meeting of the Society, at which flowers and fruits are shown by the members, for comparison, but no money prizes allowed. Art work may also be shown if thought advisable. Let some flower be prominent, something which has been distributed by the Society, as sweet peas or gladioli. The room or hall should be in charge of a Committee of Arrangements, who should place the flowers on tables up and down the centre of the hall in the afternoon, and then in the evening, say at 7.30, let it be thrown open to the members and the public generally, either with or without admittance fees. The first hour should be a *conversazione*, the visitors walking about among the floral exhibits and comparing notes. Then the last hour the President should call the meeting to order for a formal programme of music, readings and addresses. A meeting like this is held every year about the 1st of September by some of our societies, and is looked upon as the social event of the season.

## ❖ Question Drawer. ❖

### Knotty Growth.

**855.** SIR.—I enclose a growth that grew in the bark of young winter St. Lawrence trees. Will you please tell me the cause, remedy, and if it is injurious to the trees?

A. S. CROSBY, *Compton, Que.*

*Reply by Horticulturist Craig, of the Central Experimental Farm, Ottawa.*

I find that they are not of fungus or parasitic origin, but appear to be an extraneous knotty growth made up of woody fibre. The little tubercles seem to contain an extra amount of starchy matter, and in this way may possibly serve the purpose of storehouses for this food material. I do not think that these little outgrowths are characteristic of Winter St. Lawrence, as I have frequently seen them on other varieties of apples, but usually at or near a terminal bud, or what was a terminal point of growth.

---

### Spraying.

**856.** SIR.—Please give me some information on this subject. I have been using Anderson's Double Action Spray Pump, spraying for others at five cents per tree for three applications. I used Bordeaux as recommended in your annual report, and a barrel covered from eighty to one hundred trees? One person has a blighted tree, and he claims it was due to the spraying and wants damages.

WM. LEONARD, *Woodstock, Ont.*

Our correspondent has evidently done his work properly, following the directions given in our report. Nothing but good could possibly result, so that he is justly entitled to be paid for his work, instead of paying for damages by the blight, which has no connection whatever with the spraying.

The apple twig blight is very serious in many parts of Ontario, especially about Hamilton and west. It is as mysterious in its origin and cause as the pear blight, and thus far no certain remedy has been discovered. The affected parts should be cut off and burned.

---

### Rose Beetle.

**857.** SIR.—There is (to me) a new insect doing a good deal of damage in pear and apple orchards here, it is a small beetle about one-third of an inch long, fawn or drab color, with a bronze cast about the head. It is exceedingly active dropping and flying off when disturbed. It is eating the small apples, seems to prefer "Kings." I saw as many as a dozen on one apple at Mr. Freely's one day recently, he says spraying does not check them. What remedy would you advise?

WM. H. WYLIE, *Niagara, Ont.*

Mr. James Fletcher says it must be the rose beetle (*Macrodactylus sub-spinosus*) an insect which so far seems to baffle the entomologists as far as an effective remedy is concerned.



### White Horned Maple Borer.

**858.** SIR.—The fly I enclose I found on a maple tree, and, as the few we have are nearly killed by some insect, I thought this might be the one. It seems to be a kind of borer. I used to find little empty cases same as the one sent, sticking out of the bark, and my father cut out many of the maggots from under the bark last year. Is there any remedy to preserve the trees from dying?

MRS. TOBIN, *Fergus, Ont.*

*Reply by Mr. James Fletcher.*

The fly-like insect which Mrs. Tobin has found destroying her maple leaves belongs to the Horn Tail family and is known as the White-horned Maple borer. The only remedy which can be suggested for this insect is washing the trees with an alkaline wash, the same as is done for borers in apple and other fruit trees. In this way the female will be prevented from depositing eggs upon the bark.

### The Four-lined Leaf-bug.

**859.** SIR.—I send you samples of black and green insect, found on my *Datura*; it also did much harm to my pansy blossoms.

MRS. F. TOBIN, *Fergus, Ont.*

*Reply by Jas. Fletcher, Entomologist, Central Experimental Farm, Ottawa.*

The insects complained of by Mrs. Tobin, of Fergus, are, No. 1, "a green and black bug," found on her *datura*, which it punctured and destroyed the appearance of by making a large number of dark spots on the leaves and flowers, and which Mrs. Tobin says also injured her pansy blossoms last year. It is the Four-lined Leaf-bug, which is figured and described in the Experimental Farms' Report for 1893, page 181. The only way to treat these insects is to dust the plants with Pyrethrum powder at the time the young bugs make their appearance. Mr. Slingerland made the important discovery that this insect passes the winter in the egg state. The eggs being embedded in the tips of the branches of currants and other shrubs. He says, on bushes which have been infested this year the egg scars can soon be found during the winter, as the whitish tips of the eggs are quite conspicuous. The eggs remain in the tips of the twigs for nine months, making it practical to prune during winter months when other work is not pressing.

### Irrigated Fruit Farms.

**860.** SIR.—Are there any fruit farms successfully irrigated in this Province? I want to try it by use of a hydraulic ram.

H. PICKET, *Clarkson, Ont.*

We know of no such instance. Some fruit gardens have been fairly well irrigated with windmill power about Grimsby. We shall be pleased to hear from any one who has tried irrigation on a larger scale.

## Hardy Plums.

**861.** SIR,—Isn't there something wrong about the reply to question 846 in June number? I think Mr. Gordon is mistaken about the tenderness of Lombard. Lombard has been, according to Horticultural Reports, for many years recognized as one of the very few really hardy varieties. We find it classed with Weaver and Damson in North-Western State reports, and our experience here in New York State this year is, that whereas nearly every other variety (unless it was sheltered or in very favorable location) have failed to produce, the Lombard is showing a fair crop. Again Lombard is used largely as a stock tree on which to bud or graft poor growing varieties. If not hardy it could not well be used profitably. I think I speak the mind of many orchardists in the State when I say that Lombard is much hardier than at least four or five of the varieties named by Mr. Gordon as hardier than the Lombard.

E. H. BURSON, *Clifton, N. Y.*

---

## Ice House and Cold Storage.

A subscriber in Agassiz, B. C., asks the following question, to which we invite answers by our readers.

**262.** SIR,—I want to build an Ice House and Cold Storage, suitable to hold say 1000 bushels of fruit? Can any of your subscribers advise me how best to arrange the two buildings together and the size required? Lumber can be laid down for about \$14 per 1000. Stone can be had by blasting out the solid rock, adjoining the spot I intend building on? About what would be the cost of such a building suited to my purpose? As I can get the lumber cheaper now than later, if I use that material, I would like to get as early reply as convenient. As saw dust will be rather expensive could I use hay or straw for packing between walls? I want the building so that I can use ice during the summer season for other purposes aside from cold storage.

---

## \* Open Letters. \*

### Large Gooseberries.

SIR,—Mr. Porter, one of your subscribers here, is working away in true Lancashire style to grow monster gooseberries. He showed me the Triumph which is a very pretty sight, ropes (as Mr. Spillett would say) of them under every branch equal to the best Downing, but much larger. My Triumph has mildewed but only a little. In White Eagle I have a berry much larger than any of Mr. Porter's. I have only one bush, no mildew and the growth would please even Mr. Spillett. The berry is smooth like Whitesmith. The Yellow Scotch appears to me fit for this country. It grows well, has nice fruit and does not mildew. I think I told you that both Columbus and Industry mildews with me, as do Crown Bob and Red Warrington. Sulphur is clear so far. Mr. Porter has several seedlings, mostly of Whitesmith, some of which are A 1.

W. E. BROOKS, *Mount Forest.*

---

### Crimson Clover.

DEAR SIR.—On page 233 of the July No., you say, "Crimson Clover does well in Ontario." Allow me to criticize. If by "Ontario," you mean the "farm of Mr. D. J. McKinnon," the vicinity of "Grimsby," or the Niagara District," I would not take issue; but for fear that some of your readers take your "Ontario" in its broad meaning, I will give you my experience here at Port Elgin.

My soil is sandy and naturally drained, but between drouths and frosts, failures with the older varieties of clover have followed me persistently for the past three or four years,

until I was easily induced by the high sounding praises of American Seedsmen and the most respected Agricultural Journals of the U.S., to give the crimson variety a trial.

About the first of August of last year I sowed about  $1\frac{1}{2}$  acres, all in well prepared land, except that it was poor. Part of this was lightly scuffled in, between rows of corn, and the balance in open ground, alone.

The afternoon it was sown was showery but very warm, and continued so all night, and the seed, which is round, fat and seems full of vitality, was on examination next day at 10 o'clock found to be sprouted a  $\frac{3}{4}$  inch. This beginning pleased me and all my neighbors. My interest was aroused, and I watched it almost daily as it kept fastening itself to the soil, and making its wonderful growth upwards in the lean land, until the first snow fell, and I was satisfied that the crop went into winter quarters in first class order, and my hopes were mighty that we had at last a clover that would supercede all others.

Under the snow this clover lay all winter, under what I thought the most favorable conditions, the covering being uniformly and throughout about 6 to 8 inches.

March and April were not unfavorable months, but right here is where my experience with Crimson Clover ends. I never saw any more of it, and if the roots have continued to grow as they did last summer, they have gone the other way.

However, I am going to try it again as a summer crop.

The circulation of the Horticulturist is so large; its reliability and influence so great that a misunderstanding may be the means of loss to its readers; hence these remarks.

J. H. Wismer, *Port Elgin.*

### The First and Best Raspberry.

DEAR SIR,—This is the earliest red raspberry cultivated at the present day; it is a seedling discovered growing wild in the woods and it is quite distinct from any other variety of red raspberry known at the present day. It produces its fruit buds on wood of last season's growth, and it is therefore ready at the very least approach of warm weather, to commence blooming; with us, it blooms in the winter, long before strawberries are beginning to start, and in climates where this early bloom does not get killed, it will ripen its fruit long before any strawberry. Where we live here, there is very cold weather at intervals, during March and April, and the first blooms of this raspberry, are always killed; still later, they throw out new fruit buds, and there is always a crop in spite of the severe frosts, and this crop, too, ripening earlier than any other raspberry. We have quite a good chance to observe the merits of all new raspberries, as we grow all the varieties of raspberries that there is known at the present day, of any importance, having at present, about 86 kinds. The First and Best raspberry, is of large size, and of a beautiful light rosy crimson color, and very deliciously flavored; the bushes yield enormous crops, and the fruit is of uniform size, from the beginning to the end of the season.

S. L. WATKINS, *Griszly Flats, Calif.*

### Canadian Fruit and Fruit Trees in England.

SIR,—Last winter I received an order from H. R. H., the Prince of Wales, to ship him some of our Province of Quebec apple trees. I sent to Sandringham, Norfolk, about the first of May, twelve each of Fameuse, Wealthy, Winter St. Lawrence and McIntosh Red. They were carefully packed in a box with damp moss around the roots.

I received a letter from Major Gen. Sir F. de Winton, the Controller of the Household, as follows:

“YORK HOUSE, ST. JAMES'S PALACE, S. W. LONDON.

June 24th, 1896.

“DEAR SIR,—With reference to your letter of the 1st May, I have much pleasure in informing you that the parcel of trees arrived safe and in good condition and have given complete satisfaction. They have all been planted and so far seem to be doing very well.”

I have sent this extract of Sir F. de Winton's letter because I think you will be interested in knowing that our Canadian trees are appreciated in England, and can be delivered

there in good order. The Prince of Wales desired to have these trees because he had tasted some of the apples which I had sent to Sir F. de Winton last fall, in the compartment cases, and H. R. H. thought that at Sandringham he could grow as good apples. We shall see in good time if the apples will have the colour of our Canadian fruit. There is a very large and excellent crop of apples in this Province, this season. Prices will probably range low.

R. W. SHEPHERD, *Montreal Que.*

---

## FRUIT PROSPECTS.

WENTWORTH, WATERLOO, DUFFERIN AND HALTON COUNTIES.—Mr. W. M. Orr, of "Fruitland," Ont., Provincial Director of Spraying Experiments, writes :

I have reports from eight points in Counties of Wentworth, Waterloo, Dufferin and Halton as follows ; Apples, 80 to 90 per cent. ; peaches, 00 ; plums, 7 per cent. ; grapes, 75 per cent. ; pears, 30 to 40 per cent ; strawberries, 75 per cent. ; cherries, 5 per cent. ; raspberries, 75 per cent.

Around "Fruitland" and Winona : Plums, 90 per cent., peaches, 25 per cent.

Reports from twenty-nine points throughout Ontario where experimental spraying is being done, indicate a large apple crop, and as the codling moth has not attacked the fruit up to date, our apples will probably be free from worms this year. The canker worm is spreading in many sections. Many trees, and in some cases, whole orchards have been defoliated. Other insect enemies are reported numerous.

---

## ↗ The Markets. ↖

### Our Apple Markets.

LIVERPOOL, Messrs. L. H. William, writes : SIR,—The crop this season in the Home Country, and also for the most part on the Continent, is exceedingly light, owing to both drought and blight ; and as our markets now rely, under any circumstances, on receiving large quantities of your best growths, the prospects are extremely favourable. Early shipments will do well, provided the fruit is fine and arrives here in sound condition.

May add we have every facility for handling large quantities of Apples promptly and to advantage ; and intending shippers may rest assured their consignments will always have our careful personal attention.

Would draw your attention to the grading of the fruit for export.

---

### The Foreign Apple Markets.

Messrs. Isaacs & Sons, of London England write, under date of June 17th :

SIR,—We take this early opportunity of giving you a few particulars of the prospects of our Home and Continental apple crops :

ENGLAND.—As usual at this time of year, reports from the various English apple-growing districts are somewhat conflicting, but after carefully weighing the information from the various sources, we are of opinion that the apple crop in England will be considerably below that of last season.

GERMANY.—Our information from Germany, whence large quantities of apples are generally shipped to our market, is that the crop will be much below that of last season, and it is not expected that there will be more than a quarter crop in that country.

FRANCE, BELGIUM AND HOLLAND.—Some of the districts in those countries report prospects of good crops. The bulk of these apples find their chief outlets in the North Eastern counties of England, and are not shipped to any extent to the London Markets.

Should the present drought continue, the crops on the Continent, as well as in England, are likely to be prejudicially affected.

So far, things certainly look as if there will be a good field for apples shipped from your side to our markets.

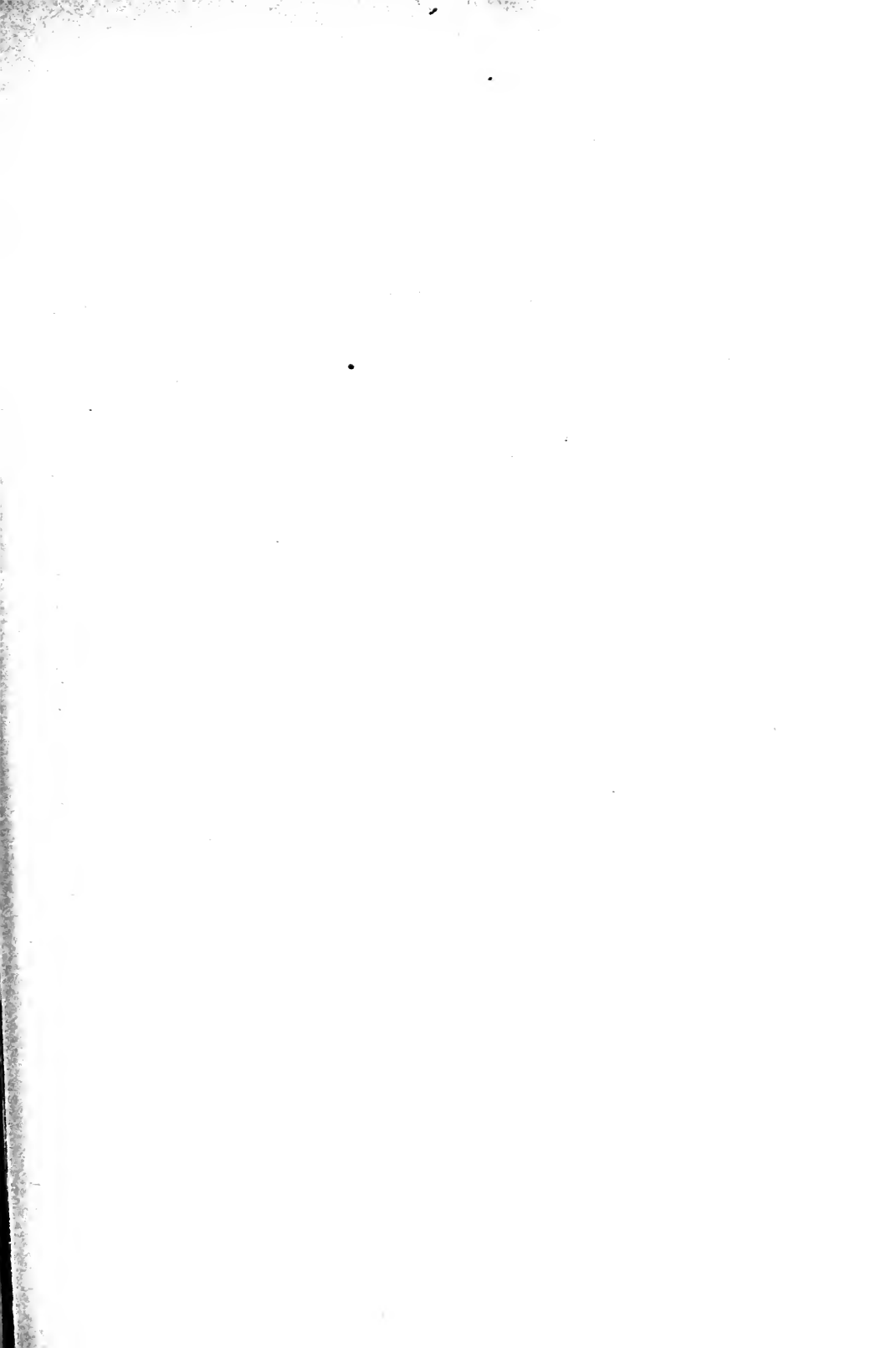



J. J. J. J. J.

THE "STEVENSON HOMESTEAD" AT GUELPH, ONT.

THE  
Canadian Horticulturist

VOL. XIX.

1896.

No. 9.



PROMINENT CANADIAN HORTICULTURISTS.—XXVI.

REV. E. B. STEVENSON, GUELPH, ONT.



HERE are men who are said to ride hobbies because, whatever their regular avocation may be, they have some favorite line of study or pursuit in which they are deeply interested and which seems to carry them away at times entirely from the business of life. This is commendable too, in many instances, especially where, as in the case of Mr. Stevenson, the hobby is such as to be a means of physical recreation and mental refreshment. So much has he become engrossed in the study of the strawberry, that it has become to him a delight, and every new variety produced by his experimental hybridization becomes another addition to his pets.

Last year Mr. Stevenson was appointed experimenter in strawberries for the Provincial Department of Agriculture, and a valuable report from him has just been published in the Fruit Growers' Report for 1895. It was in order to see some of his favorite varieties that the writer visited Guelph on the 10th of June last. Maplebank, at Guelph, is the early home of our strawberry specialist, and is still occupied by his father, Mr. William Stevenson, and here the pet varieties of strawberries have also a permanent home.

Maplebank is situated on a beautiful elevation commanding a fine view of the City of Guelph. The house is antique both in structure and in furnishing, and is surrounded by a spacious and interesting yard planted with

some horticultural varieties. From the point of view in our photograph a handsome weeping elm partially hides the front porch from view.

Mr. Wm. Stevenson, the occupant of this home, has always been passionately fond of the cultivation of fruits and flowers. For twenty-five years he conducted the Maple Bank Nursery, and then, retiring from that, gave his whole attention to growing fruits and especially strawberries.

He has twice been elected Mayor of Guelph, viz., in 1885 and again in 1886, besides holding many other prominent offices.



FIG. 984.—REV. E. B. STEVENSON, GUELPH, ONT

Under these favorable surroundings and conditions our strawberry experimenter grew up, and became an enthusiast in the study of it. To quote his own words :

“As for myself I do not remember the time when I did not take a great interest in the strawberry. I always thought it the queen of fruits from the time when as a boy, I used to go down cellar with a bowl and spoon and skim off



some cream from mother's milk pans (for we kept a cow), and then went to the cupboard and got a slice of bread and butter and some sugar, then went to the

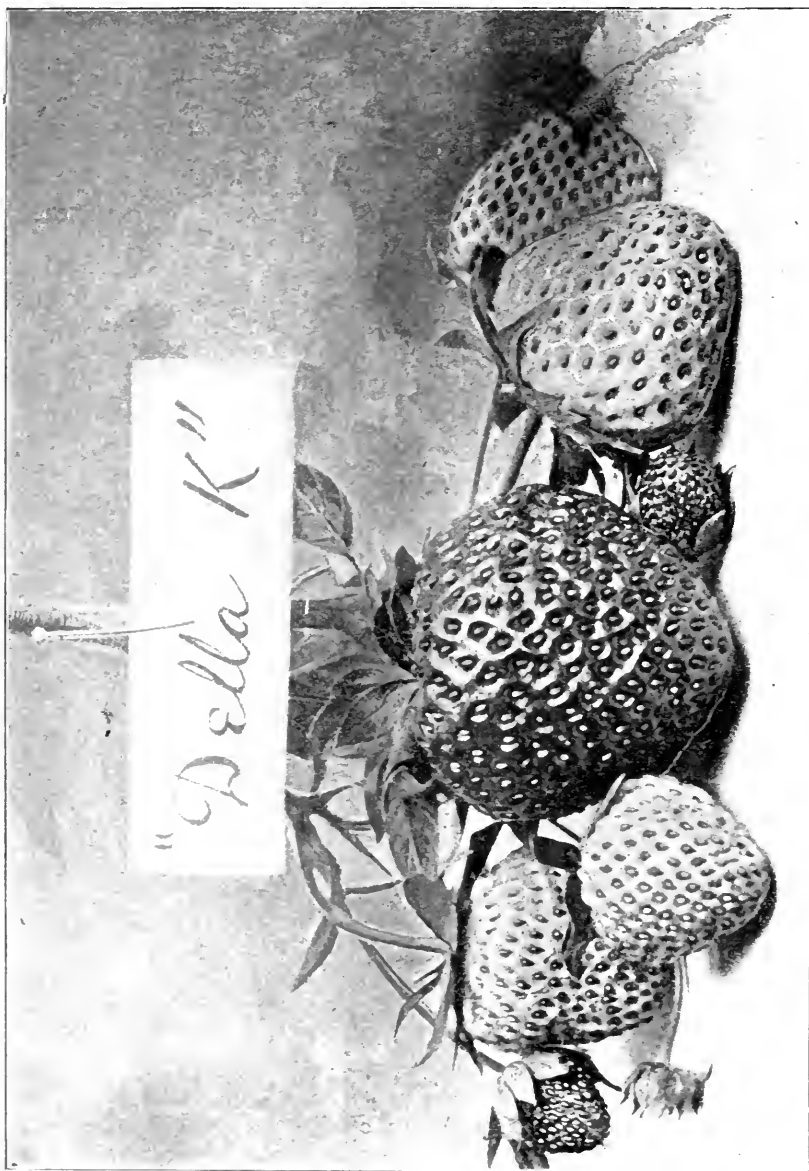

FIG. 985.—"DELLA K."

strawberry bed and feasted: from that time till now I have loved the strawberry

above other fruits ; for some years past, seeing the way in which other fruits were being improved, I asked myself the question why not the strawberry? and on making enquiry as to the parentage of some of the new ones, I was nearly always met with the answer : ' A chance seedling just found growing,' or ' I found it in a fence corner,' or on a ' stone heap.' Not very often could

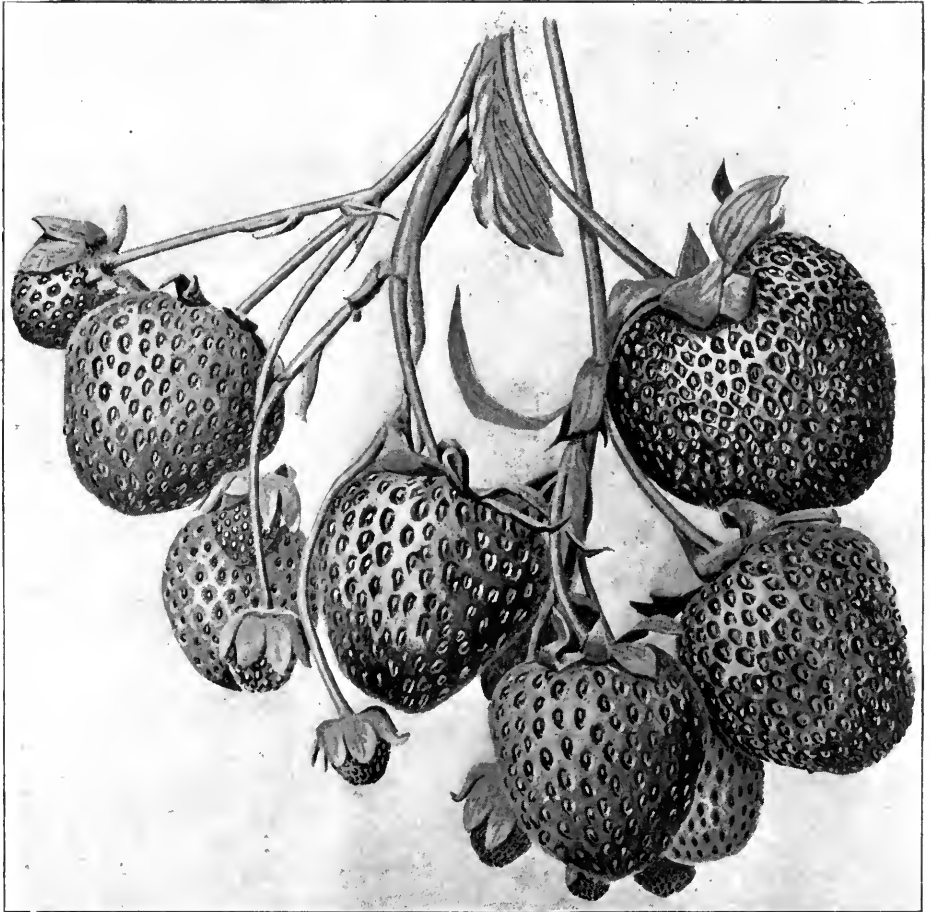

FIG. 986.—CLYDE.

the introducer tell its parentage, and so I thought it strange that some one had not tried to improve it on some systematic principle, and so I have been trying for a few years to do so. I have a few very fine seedlings, I enclose one I have named ' Della K ;' it is a seedling of Sharpless. The picture is the exact size of the berry and bunch."

Mr. Stevenson graduated in Arts at Victoria College, in 1879, at the age of thirty, taking first class honors in Natural Science, and afterwards spent one year in post graduate work.

Speaking of his pets, Mr. Stevenson says: "Among the seedlings I have now growing are Crescent crossed with Marshall; Bubach crossed with Clyde and Woolverton and Brandywine; Haverland crossed with the same, viz., Clyde, Woolverton, Brandywine and Belmont; and seedlings of Timbrell



FIG. 987.—HAVERLAND.

crossed with Marshall and Brandywine, some of these are grand. Edith (the largest) crossed with Clyde and Woolverton; Mary crossed with Clyde and Woolverton; Princess crossed with Marshall. Seedlings of Haverland crossed with Belmont, crossed with each other; some of these that fruited this year are grand. Some of the berries were  $2\frac{1}{2}$  inches in diameter, good color and firm:

some of them very promising. I have some 215 varieties set out in test plot to fruit in 1897, in addition to many seedlings of the above crosses."

Among the many varieties of strawberry in fruiting at Maplebank, which are before the public already, Mr. Stevenson prefers two for the Commercial plantation, viz., Clyde and Haverland. The Clyde is a seedling of Crescent Cumberland, which was originated by Dr. Stayman, of Kansas. A bunch grown by Mr. Stevenson is here shown exact size of specimens, and the fruitfulness on his grounds this season was the very highest degree. He classes it second early in season; berry large, firm, color bright scarlet, and quality good. One of the best general purpose berries

Another valuable market variety and one already largely grown by fruit men in some parts of Ontario is the Haverland, a bunch of which from Mr. Stevenson's plantation is shown full size in our engraving. This is a mid-season variety, which originated in Ohio. Mr. Stevenson says of it: The Haverland is magnificent in its foliage, most numerous in runners, and enormous in quality of fruit. Berry large, to very large, somewhat soft; color rather light; quality fair. A fine berry for the home garden and near market.

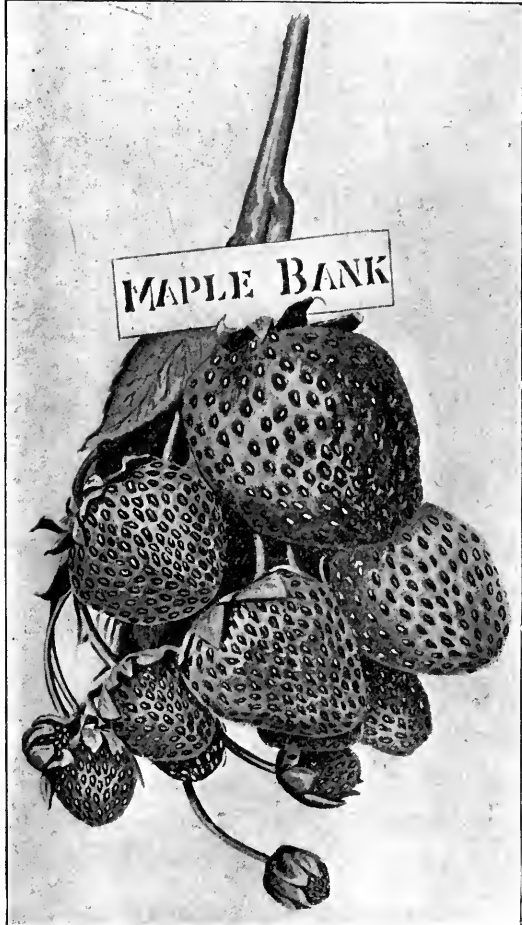

FIG. 988.—MAPLE BANK (FROM PHOTOGRAPH.)

No doubt as the result of Mr. Stevenson's careful work in hybridizing, many excellent varieties will be originated, better adapted to Ontario than any foreign kinds. One promising seedling, originated by Mr. Wm. Stevenson, was named Maplebank, a branch of which we photographed, natural size.

This was thought to be a cross between Crescent and Wilson. The plant is a strong vigorous grower, making a wide matted row, and productive. Berry large, firm, quality best; season medium to late.

## GOOSEBERRIES FROM F. W. PORTER.



URING the first week in August, one of our subscribers, Mr. F. W. Porter, of Mount Forest, sent us a box containing exceedingly fine samples of gooseberries. The season with him must be much earlier than at Grimsby, as all varieties were then over in this section for more than a week. Mr. Porter's samples of *Whitesmith* were superb, larger than we can grow on our sandy soil in the Niagara District. It is somewhat inclined to mildew with us, but Mr. Porter reports that he had not a single mildewed berry, and such a crop as never before, some bushes yielding eleven quarts, and all his bushes averaging eight or nine quarts each. The samples of *Whitesmith* were so fine, that we photographed one branch for the public benefit, exactly the same size as the original. The day is now about over when we can sell small gooseberries in our markets. This season we can scarcely give away small gooseberries, and even Downing and Smith, two fair-sized berries were a drag on the market at four and five cents a quart, while large berries like *Whitesmith* sold at six cents or over.

Mr. Porter writes as follows: "The *Triumph*—not so well-known—deserves special notice. To say it was heavily loaded would not be full justice; every branch was a marvel of itself, but its greatest beauty lay in its uniformity of size. The stems are a little on the slim side, more so than *Whitesmith* and others. The quality is not the highest, still it is good; but for profit and appearance it ought to take well with the public, and *Stone & Wellington* deserve credit for disseminating so good a variety. I ought to state that as yet it shows no sign of mildew; I wish I could say as much in favor of the *Autocrat*, it has only two good qualities, namely, a good grower with stiff shoots and nearly mildew proof. I cannot agree with Mr. Spillet about having the taste of the *Green Gage* plum. I don't consider it equal to either *Industry*, *Whitesmith* or others in my possession, it has no pronounced flavor, but worse than that it is a poor bearer and of only medium sized berries; I did not think it worth while to send you specimens. The fruit drops as soon as ripe.

"The *Industry* being also long in the field does not require any remarks more than to say that it is not the early berry that the English accounts give of it.

"Coming to the much talked of *Lancashire lad*--as this is the first season of its bearing with me—I cannot say much of its merits. I was somewhat disappointed in its flavor. I expected something better. Its berries are large and although hairy at first, they become almost smooth when ripe. I agree with Mr. Spillett with its being a slow crooked grower, its leaves are a light green, and it is much inclined to mildew.

The yellow variety sent to you is a cross between a smallish English yellow variety of good quality with Whitesmith. Its merits are its being non-mildewing, a fine strong grower, upright in growth with best foliage I know of. The berries are well protected from frost and is pretty in the garden. But it is not of high quality.

The variety sent in the last batch designated "The noblest Roman of all" is my favorite. It is a seedling from Whitesmith, but it is rounder in form, whiter in color and the veining different; very juicy with enough tartness to give it a pronounced flavor, making it an excellent preserver. I had no large specimens to send you, they being all pulled; it is a strong grower with large healthy foliage; no mildew thus far, also productive. Another specimen sent, of very good quality, and a heavy bearer; size medium, and non-mildewing, well-worth growing. I have some other good varieties I would liked to have sent you but it was too late. I will make a few remarks on the currants: I

was too late in sending them as the currants get bitter when left long on the bush. The samples sent attached to the branch, also those sent without the

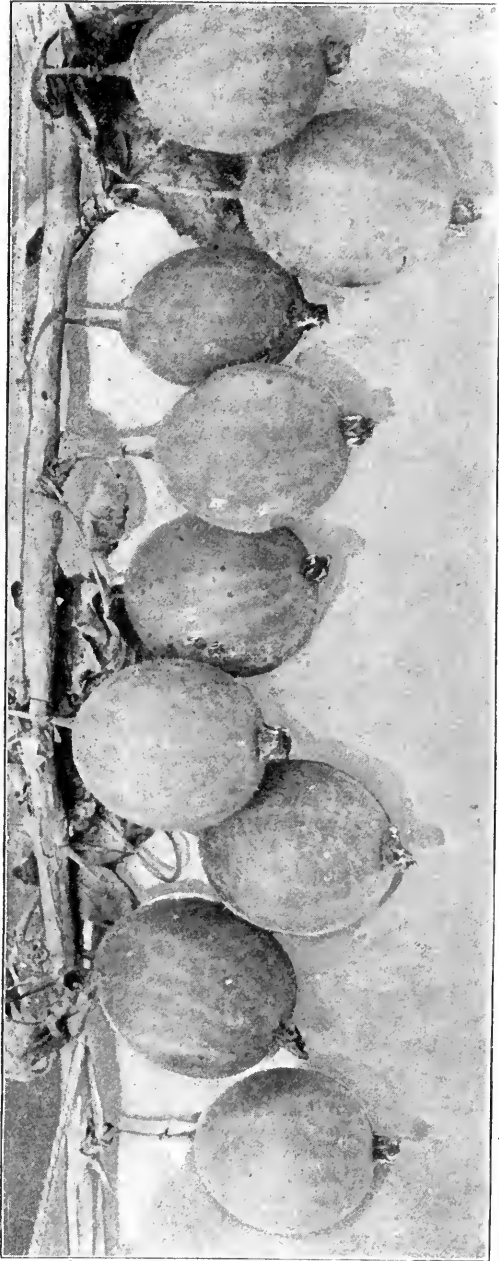

FIG. 989.—WHITESMITH GOOSEBERRIES, GROWN BY F. W. PORTER, MT. FOREST.

branch, are seedlings from the Cherry, you could judge of the enormous quantity of the one as well as the size of the other. Though not so productive, it is very large, and the quality of both are about the same as the Cherry. The other sent, attached to the branch, is about the size of the Victoria, very productive and of the best flavor of any red that I ever tasted. All of the three sent are straight, strong growers. The last variety I call the Foundling, not knowing its origin.

“Coming to describe the *White*, I would say it is a seedling, its origin I cannot tell, but it is a beauty in every way, a fine erect, stout grower like the Grape or like Fay’s Prolific, the fruit stalk is a good length the bunch is longer and the size of the berry more equal than the Grape.

“‘Last but not least,’ comes the *African Queen*—the black currant—I think it is a seedling from Lee’s Prolific (a misnomer, it ought to have the prefix un added to it. I have been trying for the last twenty years to get bushes that would pay for the land they occupied.) I have had several varieties of black currants, but they were failures. I thought when I got the Saunders I was in for something good but thus far I have been disappointed. It may do better on a different soil. I am greatly pleased with my seedling, in fact I have never seen anything like it; of course from what I sent you you can judge of its merits. It was too long on the bush to have its good flavor.”

---

## METHODS OF PICKING AND PACKING GRAPES.

**P**ICK in crates, crates setting on stools. Handle crates carefully, and set crates in shade if they are not immediately drawn to the storage room. Drive if possible without jolting the load even if on springs. The slightest jar cracks fresh picked grapes, and thousands of dollars are lost in this entire grape belt every year by the carelessness of workmen in handling grapes. Crates 12 inch by 24 inch outside, and 6 inch sides, sides solid and even with top of ends, bottom tight, will handle best, pack up best, and keep the fruit in best shape if stored for any length of time. Up to the middle of October pack as fast as you pick, and get to market as quick as you can. Girls will pack 200 nine pound baskets of fresh picked grapes as easily as 100 baskets of wilted grapes that have stood several days. Three-fourths of a cent per basket for packing fresh picked grapes is better wages than one cent per basket we used to pay when grapes were allowed to stand from 24 to 48 hours to wilt.

Provide a cool storage room and hustle your grapes in after the middle of October, and save exposure to frost and severe storms.—Fruit Growers’ Journal.

## MOUNT TACOMA.



ROBABLY the most magnificent scenery in the world is afforded in the region of the Rocky Mountains, near the Western Coast of our Continent. What grander view could there be than the one shown in our engraving of Mount Tacoma, one of the highest mountains of the cascade range of the Sierra Nevadas? Not far from it the Northern Pacific R. R. crosses the Stampede Pass, at an elevation of 3,600 feet, and winds down toward Puget Sound, which is considered the most beautiful sheet of salt water in the world. It is along this line that this view was taken, and the only one of many that might be models for the most expert artists in the world.

We quote a paragraph from a contemporary concerning the lofty mountain above mentioned :—

“Mount Tacoma, prince of that royal family, the Cascades, highest of them all, clad in his robes of perpetual white, is seen from Tacoma and Olympia as from no other points. Towering above the clouds, to-day seeming but twenty or thirty miles distant, to-morrow seeming an hundred ; a pure white in the noon-day light, turning to a beautiful pink with purple foot-hills in the light of the setting sun, and then fading to a silver gray, unsympathetic but regal in grandeur, this fine mountain is in itself the building of a great empire, whose private and public life cannot but take color and character from its sturdy and stately presence.”

Regarding the name of this mountain, Meehans' Monthly says :—  
 “Residents of the North-West Coast are exercised about the name of the great mountain known in geography as Mount Ranier, but which they insist shall be called Tacoma. Vancouver was the first geographer who saw it, and under geographical rules had the right to give it a name. He named it after a friend in the O'ld World named Ranier. The Indians had long ago known it as Tacoma, and the effort is to set aside the geographical name in favor of its ancient Indian one.”

Mount Tacoma is possibly one of the most remarkable of mountains. The glaciers which flow from it are among the most wonderful in the world. It furnishes the water for a large number of western rivers.

Those who are well versed in Indian history conclude that the Indian inhabitants of this part of America came from Alaska, and that from this point the immigration was southwardly until they eventually settled ancient Mexico and Peru. That the Indians of Alaska came from Asia is pretty clearly settled now. The line of their journeyings seems to have been all along the Pacific coast. Tradition among the Alaska Indians, describing the country from which their forefathers came, seems to fit Kamatschatka so clearly that there is little room now for doubt of the Asiatic origin of the Indian race.





FIG. 990.—MOUNT TACOMA.

## THE BANE AND ANTIDOTE.

## The Army Worm and Moth and Its Deadly Enemy.

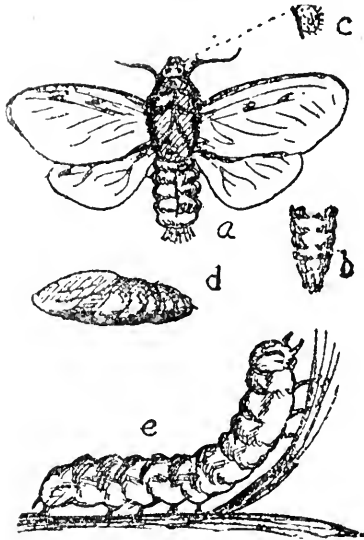

FIG. 991.—Army worm (*Leucania unipacta*), about natural size. a, male moth; b, abdomen of female; c, eye; d, pupa; e, caterpillar.

skin of the caterpillar, to which they adhere firmly. When the young maggot hatches, it eats its way through the skin into the body of its host and thrives at its expense.

In July last Prof. Panton, of the O.A.C. Guelph, found the army worm in great abundance in the vicinity of Port Colborne; and also Guelph. Every green thing was being devoured along the path of the army of worms which, however, had then nearly closed their campaign for the present season.

In 1888 Mr. Fletcher, in his address to the Entomological Society of Ontario, referred to the army worm (*Leucania unipacta*) as being common in Canada, but rarely causing serious damage. He said :

A fact which has frequently been observed with regard to these caterpillars, and one which gives great comfort, is that whenever they increase largely in numbers, they are invariably checked by the appearance of friendly parasitic insects. It must be remembered that all insects are not injurious, but on the other hand that many are very beneficial, preying upon and destroying injurious kinds. These belong to different natural orders \* \* \* Of the Diptera or two-winged flies, there are several species of *Tachina* flies, which closely resemble our common house flies. These lay their eggs on the surface of the



FIG. 992.—Yellow-tailed *Tachina*-fly (*Exorista flavicauda*), which is parasitic on the army worm. (Double natural size.)

**Kieffer a Good Market Pear.**—It is remarkable that the only pear that is exhibited freely on the fruit stands of Philadelphia, during midwinter, is the Kieffer. This is in abundance everywhere. Whatever critics may say of their quality, somebody likes them, as they sell freely. A good point with them is that they do not rot easily by handling, as other pears do. They rank with the apple in this respect.—*Mechans' Monthly*.

## HENS IN THE ORCHARD.

Many farmers or orchardists would like to have hens in the orchard for the good their presence would do the trees, were it not that the fowls must be kept confined because of the damage they would do the adjacent garden and flower

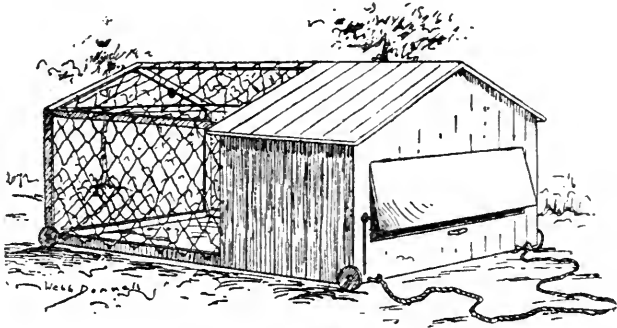

FIG.—993. MOVABLE SUMMER POULTRY HOUSE.

beds. The sketch shows a way to keep one or more flocks of hens in an orchard. A light, low house, made of half-inch matched stuff, has a wire run attached to the end, as shown in the illustration. The house has no floor. The eggs are gathered by opening a hinged board in the end. Low trucks are attached to the corners so that the whole can be moved occasionally to a new location. It can thus be moved up and down beside the row of trees, stopping for a day or two under each tree, scratching, fertilizing the ground and destroying insects. The fowls all do well under such conditions, and their presence will be of great value to the orchard. The lower sill of the sides of the house should continue out and form the base of the sides of the run.—Amer. Agriculturist.

**The Phylloxera in Canada**—This morning (3rd August) Mr. Chester Hunter, of Grimsby, brought us a branch of a grape vine badly affected with this insect, which we photographed in order to show our readers how it affects the foliage and to warn them against it. The leaves are covered with galls; each of which contains two or three full-grown insects and a hundred or more eggs. Cutting down through one of the galls these eggs could be plainly seen with weak power of the microscope. As the eggs begin to hatch the gall becomes overcrowded, and the full-grown lice emerge through the opening in the upper surface of the leaf and soon cause new galls in which they take up their abode. Mr. Fletcher, of Ottawa, has kindly written for us a note on the Phylloxera, which appears on page 308, where also see engraving above referred to.

## BLIGHT ON THE APPLE AND PEAR.

By JOHN CRAIG, HORTICULTURIST, EXPERIMENTAL FARM, OTTAWA.



URING the past five weeks a large number of specimens of apple and pear twigs killed by "blight," variously known under the names of "Apple Blight," "Pear Blight," "Twig Blight," and "Fire Blight," have been received at this office. The leaves have a brown, scorched, but not shrivelled, appearance; the bark, on the other hand, is shrivelled and withered, in addition to being discolored. The presence of this disease has been noticed in America for more than 100 years. It is easily recognized by the manner of its growth and development upon apple trees, which is usually as follows:—When the tree has made a growth of a few inches, the leaves on some of the young shoots may be observed to suddenly turn brown, in a single night, as it were. If the tree is watched closely, this browning will be found to extend downwards upon nearly all of the twigs which have been attacked. In some cases the discoloration of the bark ceases when a larger branch is reached; in other instances the large branch becomes affected, communicating in turn the disease to the stem, in which case the death of the tree may be looked upon as a certainty. Often, however, the scorching and browning affects only the young terminal twigs. Crab trees are frequently affected in this way. It is the least injurious form of the disease. Pears are often attacked in the main branches and on the stems, the disease finding entrance through spurs and tufts of leaves. A tree attacked in this way usually succumbs. Until 1880 nothing was definitely known regarding the nature of the malady. In that year Prof. Burrill, of Illinois, published the first authoritative account of the bacterial or "germ" origin of this disease. Prof. Burrill's investigations were afterwards abundantly corroborated by the careful work of Prof. Arthur at the New York Experiment Station. The disease is known to be caused by a bacteria now recognized in science by the name of *Micrococcus amylovorus*. Prof. Arthur proved the contagious character of the disease, and also its bacterial nature, by demonstrating that it could only be transmitted artificially by using the juices of branches which contained the characteristic bacteria. This disease finds most congenial conditions for rapid development in fast growing varieties, having an abundance of succulent tissue. It usually obtains an entrance by way of the youngest leaves, or through the blossoms. At this time, too, wood is in an immature condition. The bacteria causing the disease may remain alive in dead branches on the tree, and also in those which have been removed, and in this way communicate the disease to healthy trees. In addition to apple and pear trees, this disease attacks other members of the rose family, notably Hawthorn and Mountain ash.

Blight was prevalent throughout Eastern Ontario and the Province of Quebec in 1892 and 1893. This year it has caused much damage to apple and pear orchards in Southern Ontario, and has been more or less injurious throughout the whole of Ontario and Quebec.

#### Remedies.

No directly effective remedy is known at the present time. The following, of a preventive character, should be applied:—

1. Prune off and burn all blighted branches as soon as noticed, cutting 12 or 15 inches below the diseased wood, as shown by the blackened and shrivelled bark, painting the cut surface with linseed oil.
2. Follow such a system of culture as will tend to produce a moderate growth of well ripened wood.
3. If an orchard which has been cultivated previous to the attack is seriously affected, try seeding to clover for a year; this, coupled with a liberal top dressing of wood ashes, may tend to lessen liability to the disease. In a case of this kind avoid using barnyard manure.
4. Grow, as far as possible, the varieties which in that particular locality have shown greatest immunity from the disease.
5. In Southern Ontario—where they are not specially needed—Transcendent and Siberian crabs often act as breeding places for the disease, and for this reason should be destroyed.

Further information regarding the disease may be found in the Report of the Horticulturist of the Central Experimental Farm, for 1893. A few copies of this may be had on application to the Director, or to the Horticulturist, Central Experimental Farm, Ottawa.

#### NOTES—SIMCOE EXPERIMENT STATION.



**HERRIES.**—Some of these two years planted, have borne a few cherries this year. The Dye House and Vladimir were the ones that matured enough specimens to enable one to judge of their merits. These two seemed to be very much alike. They are sour cherries, and will be suitable for canning. When thoroughly ripe are very handsome in appearance. Some specimens of the Dye House were left till dead ripe, and were a very dark red, nearly black, of a good size, and might easily be mistaken for oxhearts; but they are pretty sour. However, I hope to have enough next year to test their canning qualities. They are quite thrifty here, and will likely be a valuable acquisition in this section. I tested several of the old varieties some years ago, red, yellow and black, such as Black Tartarian, Governor Wood, and others, but never succeeded in growing anything better than the Early Richmond.

If these Russian varieties, of which I have ten under test, prove to be of fairly good quality, they will pay well to grow in this section ; as the growing of cherries has been almost entirely abandoned of late years. They seem inclined to bear early, and so far have proved hardy. They have been exposed to a temperature of 26° below zero without injury. The testing of these cherries will be a very interesting and important part of the work of this station.

*Raspberries.*—The Columbian raspberry is a prodigy. It surpasses in productiveness anything that has come under my notice in the raspberry line. In appearance it is another edition of the Shaffer, but does not come up to it in quality, neither for canning or eating fresh. I would not advise the planting of either of these varieties for market, as there seems to be a prejudice against them on account of their color, and they would not carry as well as the red varieties ; especially is this true of the Shaffer. The Columbian is firmer, but would not be satisfactory as a shipper.

But for the home garden both of these varieties should have a place. They will give splendid returns under fair cultivation. The following would be a nice selection for the home garden : Cuthbert, Golden Queen, Columbian, Shaffers, and the "Older" Black Cap, with a few plants of the Marlboro' for early use.

G. C. CASTON.

---

## FRUIT STORAGE.



It is not necessary to go to any extravagant expense, and, besides, it is not needed. Select a gravelly hillside. Excavate to the required size and depth, and then wall it up with stone picked off your fields. Then roof it over. A double roof is best, built in the following manner : Lay a plate on the wall and put on rafters and sheathing as for a roof. Cover sheathing with building paper. Over this lay a second course of rafters with sheathing as before. Fill in between the two courses of sheathing with sawdust. Then put on the shingles. Before shingling a good ventilator should be put in, running up through the roof. Then with double doors to your cellar you are prepared to hold your apples. Care should be taken to see the cellar is well drained and well ventilated. The main thing is to keep as near an even temperature as possible. In warm weather in the fall, after the apples are put in store, the ventilators should be opened at night and closed in the day time. All the work on a cellar like this can be done with the ordinary help on the farm. It does not require a skilled mechanic to excavate the cellar, to make the mortar or lay the wall. The roof and doors you can build as well. The work can be done at odd times during the summer, when you would not usually be otherwise engaged.

A good and satisfactory storage for your fruit or vegetables can be put up

even cheaper than the one I have described, and it would pay for itself almost the first season. After excavating the cellar and building the wall as before, set up a row of posts along the centre the long way of the cellar, high enough when a ridge pole is put on to support the upper ends of the rafters. Cover the rafters with rough boards as for roofing, and then cover with dirt, well packed down and thick enough to turn the water and keep out the frost. The timbers should be of good size, sufficient to sustain the weight of the roof.

A fruit house entirely above the ground can be put up at not a very large cost, in which an even temperature can be maintained and which will keep out the frost, as follows: Prepare a good tight foundation of stone for the building. Use 2x4 inch studding for the sides. The sides should be about eight feet high. Sheath on the outside of the studding with inch lumber, and cover this with another course of studding, sheathing and building paper. Do this until the wall has three air spaces. The roof is constructed in the same way to protect from heat as well as frost.

The writer has recently constructed a cellar and fruit house over it, as follows: The floor between the cellar and fruit room above is laid with 2x8 joists, ceiled above and below with inch boards, and the space between it is filled with sawdust. The studding for the sides are 2x6, eight feet high. Outside it is sheathed lengthwise with inch lumber, and on this is a layer of building paper. Then comes a course of inch pine siding and battened. On the inside a layer of building paper is tacked to the studding and then a course of inch lumber. The six-inch space between the two courses of sheathing is filled with sawdust well packed. Building paper is tacked to the under side of the rafters, and an inch pine ceiling is put on, and the four-inch space between the roof boards and ceiling is filled in with sawdust. It is ventilated with windows at each end.

The main points to be kept in view, when planning a storage place for our apples, are good drainage, good ventilation and security from heat and cold. Here in this climate we are very apt to have, in the late fall, and also during the winter months, warm spells of weather, and during these warm spells the ventilators should be opened at night after the atmosphere has become cool, and kept closed during the daytime. In this way nearly an even temperature can be maintained, not so low, perhaps, as in a costly cold storage plant, but sufficiently low to meet the requirements of the average grower.—From a paper by J. M. Purdy, read before the Minnesota Horticultural Society.

**Pears.**—The crop is ready to pick as soon as the color begins to change and the stem will part readily from the branch. The ripening process should then be continued indoors in a still, dark room, which must be cool for slow ripening and warm for quick ripening. For marketing especially fine fruit, use small packages. Bartletts may be picked while hardly more than half grown. They will ripen up for market, and sometimes bring a much better price than the later, fully-developed and matured pears, while those left on the tree will come out all the finer, and perhaps continue later in good condition.

## COLD STORAGE FOR FRUITS.

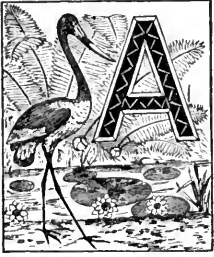

At a meeting of Massachusetts horticulturists, Dr. Jabez Fisher, in speaking on "The Preservation of Fruits by Cold Storage," said he had first begun to experiment in this direction more than 20 years ago, when he placed a crop of pears in an ice-house, and held them back from the market for several weeks, and in that way realized a profit twice as great as usual. For the grower of small fruits, like strawberries and raspberries, he said, cold storage is not at all practicable. But for the preservation of the winter apple, it is a method shown to be very valuable and certain to add much to one's income from the fruits he raises. He said :

When you are ready to harvest your apple crop, the thing to do is to discover how to get the most money for it. If you have a good cellar, you can keep apples there with good results. A building can be constructed which will accomplish the same purpose. It should be built with double walls, with a space of one foot between. This space should be filled with planing mill shavings. An earth floor will answer, although a cement floor is better. There should be no windows in this structure, and there should be a double door on the north side. There should be a good-sized ventilator in the centre of the building.

When you are getting ready to store your apples, you want to take advantage of every cold night to reduce the temperature by leaving the doors open. Of course there will be some nights when the temperature in the building will be cooler than in the open air. On such nights keep the door shut. After the apples are picked, I prefer to put them into bushel boxes rather than into barrels. After the apples are picked, the sooner you get them into the cellar or storage house, where there is an equable temperature, the better. In packing apples for the market, never put a large apple and a small apple side by side. Apples that are nearly of a size will sell much more readily and for a better price than when they are ill assorted.

---

**Chrysanthemums.**—The thinning of buds should go on from day to day. The value of the crop depends on thinning. One good flower is worth ten poor ones. The plants have now branched out into leaders and laterals. The leaders, of which there may be from three to five, will form what is termed the crown bud, one bud on each stem. The plant will branch again, forming leaders known as terminals, with buds known as terminal buds, or the termination of the plant's growth. As a rule the crown buds form the best flowers, but if they form too early, let the terminals grow and take out the crown bud. Nip out all buds except those in the centre of the cluster. Keep show plants staked and tied up to induce shapeliness. Give all plants plenty of water and liquid manure twice a week.



## THE GREEN GRAPE-VINE SPHINX.

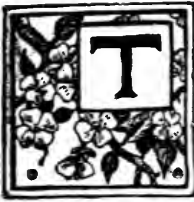

HERE may frequently be found on grape-vines of all varieties during the summer, caterpillars shaped as in the cut given herewith. When full-grown this caterpillar is about two inches in length with a small head. The body is green and is covered with small yellow dots. Along the sides are seven pale stripes sloping backwards and shaded behind with dark green. A white stripe also margined with dark green runs along each side from the horn at the end of the body. The series of spots shown on the back consists of blotches of pale lilac, bordered with yellow. The anal horn, which is nearly a quarter of an inch long, is blueish spotted with black in front, and yellow behind. When at rest the head and the next two segments are drawn back into the fourth and fifth, which are much distended. This habit is also characteristic of the Achsmon Sphinx, a much larger caterpillar, which is occasionally found on grape-vines with the Green Grape-vine Sphinx. It, however, may be at once recognized by its ruddy color, and from the fact that when full-grown, instead of the anal horn, it has merely a polished tubercle.

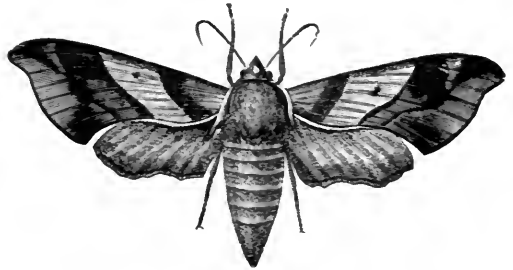

FIG. 994.—THE GRAPE-VINE SPHINX.

When the Green Grape vine Sphinx is full-grown, it leaves the foliage and forms a loose cocoon on the ground or near the base of the vine on which it has fed. The chrysalis is of a pale-drab color finely dotted all over with black points. The breathing pores along each side are black and conspicuous. There are two broods of this insect in the year. The moths from the first brood appear in July, and these lay eggs the caterpillars of which attain full growth in September, pass the winter in the chrysalis state and appear as moths in the following May. The perfect insect is a very beautiful moth, which expands about two inches and a half from tip to tip of the opened wings. The front wings are of a dark olive-green color, crossed by bands of greenish-gray. The hind wings are of a dull brick red.

These caterpillars are sometimes very destructive to the foliage of grapevines, but are easily destroyed and can be controlled without difficulty by hand-picking.

*Central Exper'l Farm, Ottawa.*

JAS. FLETCHER.

## THE GRAPE PHYLLOXERA (*PHYLLOXERA VASTATRIX*) PLANCHON.



HERE are few injurious insects so well-known by name as the notorious Phylloxera which has been the cause of such enormous losses to the grape growers of France, Italy, Spain and other countries in Europe. This pernicious insect is a native of America and has been introduced into the vineyards of Europe with American grape-vines. It has become thoroughly established there and now every year commits most serious depredations, such indeed as are unheard of on this side of the Atlantic. The life-history of this insect is very remarkable and was worked out with great skill by the late Prof. C. V. Riley who published a full account of it in his celebrated Missouri Reports. In Saunders' "Insects Injurious to Fruits," the main points of the life-history are given as well as in Weed's "Insects and Insecticides." There would be no useful end attained in giving the readers of the CANADIAN HORTICULTURIST all the details of this long and complicated history. Those wishing to study it can find it in the above named works. Suffice it to say that there are two forms of this insect

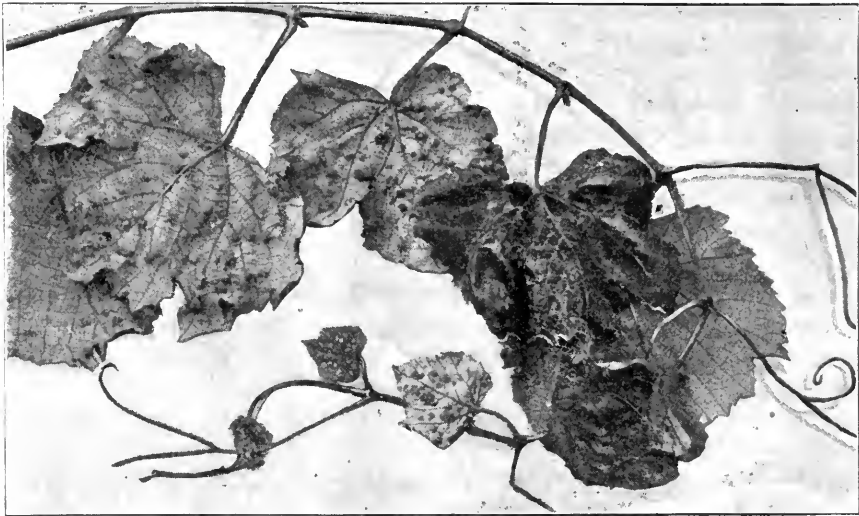

FIG.—995. BRIGHTON VINE COVERED WITH PHYLLOXERA LEAF GALLS.

with very different habits; the first produces greenish-red or yellow galls on the foliage as shown in the illustration; the other, which is the most injurious, attacks the roots, causing swelling on the young rootlets, which finally decay, and thus the root system of the vine is destroyed. The winter is passed in a dormant condition on the roots. When growth begins in the spring, the lice

revive, and increase rapidly in numbers. There are five or six generations of wingless females, all of which bear young without the intervention of males. About the middle of July some winged females are produced which leave the roots and fly to other vines, when each one lays a few eggs of two different sizes and then dies. In about a fortnight perfect males and females are produced from these eggs, the females from the larger eggs; they are born for no other purpose than the reproduction of their kind, and are without means of flight, of taking food or excreting. Each female lays one egg from which comes an egg-bearing wingless mother, thus beginning again a new cycle of existence. It has

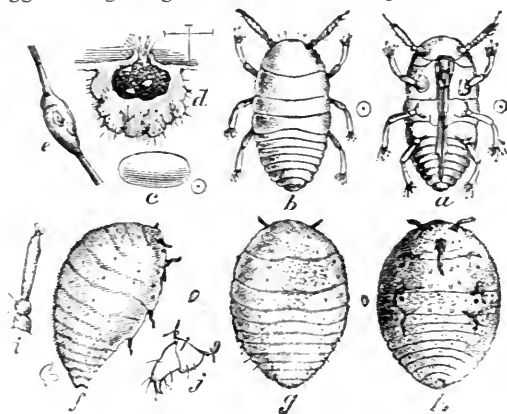

FIG. 996.—PHYLLOXERA.

been also discovered that the winged females are not actually necessary for the perpetuation of the species; for some of the wingless underground form lay a few eggs of two sizes from which males and females are produced. The use then of the winged females seems only to be to secure the distribution of the species; for these winged females which begin to appear in July continue to appear through the rest of the season and are most abundant

in August.

If to the above we now add that occasionally the underground form leaves the roots and produces galls on the leaves, we have a general outline of the whole life-history of this species. In Canada the injury from the Phylloxera is seldom serious. The form on the leaves is occasionally rather abundant in the Western part of Ontario; but the root-inhabiting form has been seldom complained of or even observed.

Some years ago Dr. Saunders saw a vineyard of Clinton vines severely attacked in the neighborhood of London, Ontario. The result was that most of these vines died, but such an attack as this in Canada is quite exceptional.

*Remedies.*—Numerous experiments have been tried in this country and all others which the Phylloxera has invaded, to find some means of fighting it successfully, but up to the present nothing quite satisfactory has been discovered. Flooding the vineyard has been adopted where practicable in Europe, and the use of bi-sulphide of carbon which is forced into the ground about the roots by means of a special instrument. In this country the only remedy which has been found necessary is the destruction of badly infested vines or the removal of gall-bearing leaves from those which are less seriously attacked.

JAS. FLETCHER.

## A RUSSIAN SALVIA.



FIG. 997.—RUSSIAN SALVIA.

The illustration is from a photograph of a Russian Salvia, seeds of which were sent us in the spring of 1895 by Mr. Niemetz: The first year it did not flower, but this year, has grown most vigorously to a height of two or three feet with immense leaves, and spikes of white flowers. These latter were very showy against a background of Norway Spruce trees. Being easily grown from the seed, it is a flower within everybody's reach, and well adapted to the old-fashioned garden.

The Salvias are very numerous, about four hundred and fifty varieties having been described, two of them natives of Great Britain. Another, *S. officinalis*, is the well known sage, more in demand for its leaves, than for its fruit.

## APPLE NEWS.

## The Fruit Crop.

SIR,—The good report which I sent you for publication in the HORTICULTURIST some time ago will have to be modified a little. The apple tree twig blight which appeared to be noticed here for the first time last summer, has again visited us, and is doing great injury to the orchards in this district. It is first noticed at the extremity of the small twigs, though oftentimes it attacks limbs an inch or more in diameter, and that in the middle of the limb. The fruit immediately ceases growing, and the disease spreads both ways and will eventually kill the tree. The Ben Davis seems particularly subject to it, the writer having lost two fine trees, also one Wallbridge and one Duchess Oldenburg, and a Golden Russet. A neighbor of mine has also lost several Ben Davis.

It is well to sound a note of alarm about this disease. One of our members, Mr. D. Monroe, of Cedar Brae, Cornwall, has already sent samples of infected trees to Professor Craig, Ottawa, and that gentleman's answer has been published in our local papers. His instructions are, to immediately prune the affected limbs and burn them, taking care to disinfect the shears, saws, etc., used in the work.

I would also supplement this by scraping the loose bark off the lower part of the large limbs and trunks of *all* the trees, and wash with strong soap-suds, thus inducing a vigorous, healthy growth, which will help to ward off this, or any other disease fruit trees are subject to. The tent caterpillar is also making his annual visit. Cut off the infested limb, sprinkle a little coal oil on and burn it.

*Cornwall, Ont., Aug. 6, 1896.*

W. S. TURNER.

---

 THE EUROPEAN APPLE CROP.

Messrs. Simon Shuttleworth & Co., of Liverpool, write :—

SIR,—Since our last advice of June 15th, we have had more specific crop information from our people in Europe, and have ourselves travelled over several thousand miles of the United States and Canada. Regarding Europe, we beg to summarise as follows :

*England and Scotland* will be short of apples, especially for winter use.

*Ireland* has a good crop, but cuts no figure. It is expected that all of these will be used up before the American and Canadian crop begin moving in any quantity.

*Holland* will not likely have over one-third of a crop.

*Belgium and France.*—We take these together, as the apple crop this year

is largely on what is called the Franco-Belgian frontier ; otherwise than here, France is light and Belgium under the normal.

*Germany.*—In the Hamburg district there is a very small yield, in central Germany a half crop, and in the south a little better.

*Servia* and other European States will have some apples, but they are too far away to cut any figure in the direction of competition against American and Canadian supplies.

The crop in Nova Scotia is enormous and of fine quality. The crop in Canada is also fine in quality and of more than ordinary proportions. The crop in New England is also good and of good quality. Michigan has a good crop of apples, and so have certain sections of Ohio, Illinois, Missouri and Kansas. We know nothing definitely of other western sections. Virginia and Kentucky are light, and New Jersey is not heavy in her regular bearing districts, but the state at large will have a lot of apples. The same may be said of Pennsylvania and Maryland. New York state promises one of the largest and best crops on record. This may be put down as authentic. The meaning of it all is this : The crop being generally good all along the Atlantic seaboard and in territory that has always exported and is familiar with the requirements of the English markets, we may look for a very large movement abroad. It will make speculation hazardous on account of the enormous supply ; but if the surplus is started early enough and in large enough quantity to establish an early moderate selling basis, it will mean to the United States and Canada a tremendous and steady demand that will absorb their excess at paying value to both grower and dealer.

We shall be in shape to move any additional share of business that may come to us this year, having opened houses at both Leith and Edinburgh, Scotland, and established an agency at Hamburg, Germany. For several seasons now our combined outfit has handled over one-third of the annual exports of apples to the United Kingdom, and we propose to lose no portion of it this year through lack of enterprise in developing new markets. We shall offer the usual facilities of cable return upon shipments, and can promise more and fuller advice than any of our good competitors, for the simple reason that our lines are more extended, our ability for sale and distribution of stock is larger, and our agents cover more territory and are generally better posted than other apple people in the business. Their services and ours are at your disposal, and we shall do our very best in your interest.

---

## THE APPLE CROP OF WESTERN EUROPE.

I beg to submit, for your information, some particulars as to apple crops in western Europe, which may assist you in estimating our probable requirements from your side.

*Portugal.*—Every promise of a large and good crop. The first shipments have arrived, and are realizing prices equal to 15/ to 17/ per American barrel.

*Holland and Germany.*—Early kinds short in quantity; later sorts more abundant, but total yield probably not more than one-third of the average.

*France and Belgium.*—The reports to hand show that there will be a fair supply of early sorts; but of late kinds the crop will be deficient.

*England.*—The main substance of the majority of reports from our home districts consists principally of records of the weather, which has certainly been exceptional, and 1896 must inevitably be remembered as the "frostless" year. In the early spring, indications of abundant crops predominated generally throughout the country. But the hopes thus raised were shattered later on by long-continued drought, the injurious effect of which was intensified by a series of excessively cold nights during the early part of May. After this we had rains, but they proved extremely local, and did not favorably affect the crop generally.

The net result is to indicate that of early kinds our crop will be scarce and soon over. Of later sorts the yield will be much below the average, and altogether insufficient to affect our requirements from your side, and our London markets should be prepared to receive fruit from America and Canada at a much earlier date than for many years past. And I consider there will be a special opening for supplies from the Hudson River.

*Covent Garden, London, Eng.*

J. B. THOMAS.

## APPLES.

Messrs. Woodall & Co., Liverpool, write: The past season, as shewn below, was comparatively unimportant, the total imports into Great Britain being 788,000 barrels, against 1,438,200 barrels in the previous season. The quality and condition (especially of Canadian) were generally good, and a much larger quantity could have been disposed of without affecting prices. A feature of the past season was the Albemarle Pippin, which made its appearance in large quantities, and, being of good size, clear skinned, and of excellent flavor, it at once usurped the position of the Newtown Pippin, which for some time past has been small and scabby. The quantity, however, was so large, that with the exception of one period, only moderate prices were obtainable; but they will undoubtedly take the first position on the market, and growers of Newtowns must endeavor to improve the fruit or be left in the background. The English crop last Autumn was the largest on record, and it was thought that American and Canadian fruit would not be wanted; but as soon as good sound varieties especially Baldwins—began to arrive, their superiority at once asserted itself: and throughout the whole season there was an active demand at a comparatively high range of prices—this being particularly the case when Canadian shipments came to hand, which again confirms our opinion that the English

apple crop interferes very little with the consumption of American and Canadian fruit.

The prospects for the coming season are very good, for not only is our own crop short, but the unprecedentedly hot weather has hurried all fruit forward, and by the time American and Canadian apples arrive, there will be little, if anything, to compete with them. The latest reports from the Continent point to a similar state of things prevailing there.

The total imports into Great Britain during the past season, from United States, Canada, and Nova Scotia, were as under :

Liverpool, .. .. .	438,354	Barrels.
Other Ports, .. .. .	349,646	"
	<hr/>	
Totals .. .. .	788,000	"
Against same period 1894-95 ..	1,438,200	Barrels.
" " " 1893-94 ..	175,000	"
" " " 1892-93 ..	1,204,000	"

#### Reports of the British Apple Crop :

	Over average.	Average.	Under average.	Reports.
This year.....	75	152	165	
Against last year.....	160	161	50	"
" 1894.....	2	44	278	"

### BEST SIX VARIETIES OF PEACHES.

Mr. W. W. Hillborn, our experimenter in peaches and strawberries at Leamington, Ont., has been interviewed by the representative of the R. N. Y.

In reply to questions about varieties, he said :—

“Of course, we are experimenting with all the varieties we can get hold of, to find out which is the most suitable for our climate and location. Our idea is to get varieties that will give us a continuous crop during the whole season, and there are a great many varieties that come in together. To get the best of each, we must plant all of them and then select. In that way we can get a continuous crop from the earliest to the latest. I like the Alexander for the first ripening ; then Hale’s Early, Early Michigan and Lemon. The yellow peaches come in about that time, and, of course, when the yellow ones come, we have no market for the white or clingstones. Early St. John is the first ; then Early Comfort and Barnard’s Early. An excellent one that we have had a few years in Canada, is the Fitzgerald, an improvement on the Early Parker. Then Elberta comes in soon after that, followed by Hill’s Chili, Longhurst and late Crawford. The Lemon, I believe to be the best late peach we have. We also have the Smock and the Salway.”

“What about the Crosby ?”



"We have used the Crosby, but so far, I am not very favorably impressed with it."

"What objection do you find to it?"

"With young trees, it does not get large enough, and does not color up quite so nicely as some. We have planted it largely, however, and it may do better when the trees get larger."

"What three varieties would you recommend a beginner to plant?"

"We cannot cut it down to three varieties and cover the season."

"What would be the best one-half dozen varieties then?"

"Of course, much will depend on the location; but on general principles, in a peach-growing district, I think that the following list would be about as good as I could give off hand. I would cut out the white, or clingstones, entirely, in so small a list: Early St. John, Early Crawford, Elberta, Late Crawford, Lemon and Smock."

---

### RUSSIAN PEARS.

The most highly recommended of the Russian pears of the Budd-Gibb importation is Bessemianka (seedless). At the meeting of the American Pomological Society, last fall, in Boston, all who had tested these pears agreed as to its entire hardiness, and placed Sapieganka next. Fortunately, this also is reported to be very good in quality. Both are of medium size, the trees good growers, and most are said to come early to bearing. I have some forty trees of these and other sorts from Russia and Poland. Not all are strictly iron-clad in our "test winters," in fact, Bessemianka seems to be the only one utterly untouched by 40° below zero. But Sapieganka is only slightly hurt, while several others are likely to succeed fairly well. Bessemianka is a free, upright grower; yearling trees set in the spring of 1885 being now from six to nine feet high. As Mr. Gibb had fruit on Bessemianka last year, and mine bloomed this season, it would seem that they are, as reported, early to come to bearing. Sapieganka is the reverse of Bessemianka in being a low, straggling grower, though vigorous. It is distinguished, also, by its red leaf-stalks. The leaves of most of these pears are thick and glossy, though less so than the Chinese pears. —Vick's Magazine for August.

## ⇒ Flower Garden and Lawn. †

### DIGGING AND CARING FOR GLADIOLUS BULBS.



YOU can begin to dig gladioli from September 20 to October 20, as soon as the foliage shows signs of ripening or browning, which is usually one month or two after flowering. Take a garden or potato fork, and run it down below the bulb, press down on the handle until the soil and bulbs are well loosened, taking care not to disturb the bulbs too much to loosen the bulblets. Then pull the bulbs out of the soft dirt by the stalks and lay them down one way on the ground in little heaps ; if any very ripe and loose bulblets drop in this process you can see them and pick them up. When you have dug all the bulbs you wish to care for this day, take a common pair of pruning shears, or even a pair of large scissors, hold from three to six stalks in the left hand and the bulbs over a shallow box, and cut the stalks off about one inch from the bulb ; spread the bulbs then on a floor, or in shallow boxes, or over close slats or sieve-like perforations, which is a little the best, in a dry airy place as long as you can with safety from freezing ; if you can keep them in this way until Christmas, so much the better. By January you should pull off the bare plate or loose shell and old roots, which is easily done by pressing the thumb against them. When a man can clean from 10,000 to 20,000 bulbs in this way in a day you can see it is no great labor. After the roots are off collect all the little black bulblets in a box by themselves. If you have any considerable amount of them put dirt and everything into a sieve, then you can shake the dirt out and throw the roots out very quickly. Put the bulblets down cellar or in any other cool moderately dry place, and plant them as early as you can get in the ground in the spring. Now the large bulbs are separated from the bulblets you can put them in slat bottomed boxes, about 3 or 4 inches deep, down cellar in a dry cool place free from frost. In this way you can keep your bulbs as well all winter as the florist, and always have fine large flowers at little actual cost and labor.—Gardening.

---

### VARIETIES OF CANNA INDICA.



THE new varieties of Canna are beautiful things in the flower-garden, but cultivators will not get the utmost out of them that they are capable of unless special preparations are made for them. Merely to dig the ground after manuring it is not enough. It should be remembered that the Canna is a native of the tropics, and can only be relied upon to flower well in the warmest of summers when some endeavors are made to imitate tropical conditions. The first of these is warmth of soil, and this can be obtained in a modified degree by putting, say, a bed of

1 1/2 foot thick of fermenting materials, consisting of two-thirds last year's Oak or Beech leaves, and one-third short stable-litter, treading the mass fairly firmly together. This affords warmth and drainage, but failing the leaves and dung, their place may be taken with furnace-clinkers, brickbats, etc., to the depth of a foot, putting a layer of rotten dung, 6 inches thick, on the top of these. The spot chosen for the Cannas should be the hottest in the garden (at the foot of a south wall if cut blooms are looked for), and the plants should stand at least 2 to 3 feet asunder, according to strength, so that the sun may reach them all round, and the soil; mulching in our climate does harm, in preventing the sun-heat penetrating the soil, and its place should be taken by a bi-weekly stirring of the soil to aerate it, and prevent the loss of moisture, a crumbly surface doing this almost as effectually as a mulch. The rest is a matter of water and liquid-manure. The foliage should not be wetted at night, but about seven in the morning if the previous day was hot and it is likely to be so the next. If the bare appearance of the soil in the early stages of growth be not liked, put around the bed a row of *Aralia papyrifera* (Chinese Rice-paper plant), *A. Sieboldi*, *Farfugium grande*, a dwarf *Solanum*, or some of the taller varieties of tuberous *Begonias*—now, we fear, almost lost to gardens, but which are as graceful as a *Fuchsia*.—Garden Chronicle.

## PREPARING PLANTS FOR WINDOWS.



THE preparing of plants for windows for winter is very apt to be overlooked at this season of abundance of flowers. It is because of this neglect that very much of the disappointment so many have arises. Those who do not care to prepare the plants or neglect to do so, usually depend on plants dug up from the garden when summer is over, or on what stray plants in pots happen to be available. It is much better to start at once to get established in pots a lot of nice plants in good assortment, such as are known to be good winter bloomers. Taking the geranium as an illustration, the best results follow the taking of small plants which have been in pots all summer. Without exception, such plants are the best, whether they be geraniums or anything else suitable for winter. If such plants are not already in pots, dig up from your garden some medium sized ones, prune the tops back somewhat, to make them bushy and to lessen the risk of harm from transplanting, and then place them in pots a little larger than what will hold the roots comfortably. Do this soon. They should then be placed in a damp, shady place for a while, such as a shaded frame, free from much

wind, and be kept well watered. A shed or even a cellar will answer the purpose, as the shade and moisture are badly needed only for a day or two, that the plants may not suffer from too great evaporation. If taken up now and treated in this way, roots are soon made, the plants established, and new growth commenced before cool weather comes. Plants already in pots should be shifted into a size larger about the close of August, shaking from the roots as much of the old soil as possible. When this old soil is difficult to shake off, as sometimes happens, place the plants in a bucket of water for a little while, then it can all be washed away. A pot but a size larger or even the same pot is better than a larger one, as plants do not grow too large and flower better thereby. A good selection of winter plants may be made from the following list: Geraniums, abutilons, coleus, ageratum, fuchsias, linums, *Impatiens sultani*, *Cypripedium insigne*, calla, begonias, both the flowering and the foliage kinds, ferns, *Oxalis cernua*, Catalonian jasmine, *Cystis racemosus*, carnations, primroses, streptosolon, heliotrope, *Ruellia macrantha*, pansies and lobelias. Common candytuft sown now gives plants which bloom all winter long.

I hardly know whether to recommend roses, or not, because all do not succeed with them. But I have seen the well-known *Hermosa*, *Malmaison*, *Perle*, *Archduke*, *Charles* and other everbloomers flowering in good shape in windows. There must be a temperature not lower than 55° at night, to have roses thrive. Cactuses are sometimes desired both for their odd appearance and their beautiful flowers. Among the best blooming are the *epiphyllums*, and perhaps *truncatum* is the most satisfactory species, its crimson flowers being produced freely. Being a not over strong grower, it is often grafted on stronger growing sorts.

Special mention must be made of the cyclamen. But few plants are as good for winter blooming. Perhaps *persicum* is the best species for the purpose. It is not a hard plant to grow, and then, besides its healthy foliage and pretty flowers, the blossoms are so lasting, an individual flower often remaining in good condition for six weeks.

Palms are now largely used for winter decoration, and one of the best for dwelling houses is the *Areca lutescens*. It is of graceful growth and does not object to dwelling rooms as some palms do.

Bulbs are indispensable for winter. September is soon enough to start them. Afterwards a few more should be started about every two weeks, that a succession may be provided for. Hyacinths, tulips and crocuses still find much favor for the purpose.

A few vines among the other plants and to train about the sides of the windows may be used to good advantage. The common English ivy, the *senecio scandens* and the moon flower are excellent for the purpose. They can be supported up the sides of the windows and festooned across the top, to form a green covered bower, and when in this shape their value is apparent. It is as

well to start with strong ivy plants, as they are somewhat slow of growth at times. Two plants of partly creeping habit are *Panicum variegatum* a plant of angular growth but of exceedingly pretty variegated foliage and the wandering jew, *Saxifraga sarmentosa*; the latter sends out runners as strawberries do, which hang over the pot, rooting when they touch soil.

Good soil is an important matter in the growing of plants. Florists prepare a heap of it a year beforehand, by taking the top spit of a meadow, cutting it in squares as is done for sodding purposes, and making a heap by placing a layer of sod and a layer of stable manure alternately. When rotted up this is excellent. In an emergency such sods may be cut from a meadow and be chopped up into quite small pieces, be mixed with one-fourth decayed manure and used at once.

To have success with flowers, it is most important that the plants enter the house entirely free from insects. Green fly, thrip, red spider, and mealy bug are their chief enemies. Examine them well from now on, syringing them well at times with force enough to dislodge any insects that may be on them, which can be done except in the case of the mealy bug. These get in the axils of the leaves and are destroyed by gardeners by using a tooth brush to dislodge them.

Provision should be made now for suitable stands for the plants. The window-sill is not the place for them. With saucers under the pots tables can be used. Zinc lined boxes are now much used. They are made long and narrow, to suit the ledge of the window, whatever the length may be. They can be made of a size to be set on a table and of any size desired. These boxes are not intended for plants to be planted in them, but only to hold the pots, so as to catch what water runs from the plants.

It seems out of season to refer to plants for winter now, but it is not. This is the time to begin to get the collection together, if we would have the pleasure beautiful plants bring us in the winter season.—JOSEPH MEEHAN in *Country Gentlemen*.

## DRIED FLOWERS AS ORNAMENTS.



FOR winter use as bouquets, immortelles, grasses, sedges, berries, etc., preserve a fresh appearance and enhance the beauty of the farmer's home. Now is the time for the farmer's wife to make the selections for drying and preservation. There is a class of plants called everlasting, immortelles, and the like, which from their strawy nature are particularly adapted to winter use, retaining their colors fully as well after drying as when growing. An old favorite of this class in times gone by was the Globe amaranth, with several colors. It was useful as a garden flower and excellent in the winter bouquet. Now it is almost a rarity.

Then there are several colors of acroclinums, very graceful in outline. The amobiums, aelichrysum or eternal flowers, the rhodanthes, xeranthemums or straw flowers, all were common garden plants a few years ago.

Drying these flowers consists simply in cutting at the proper time, which is when in full bloom, and before seeds have formed. Where practicable the whole plant may be cut or pulled and hung bottom up in a partially darkened room or shed. Usually, however, the flowers come out at different times and must be cut as ready, leaving on as much stem as possible. Tie in bunches and hang up. The immortelles imported in such quantities from France and Germany, originally yellow but now to be had in various colors, are charming herbaceous plants. Unfortunately they are not hardy with us. There are, however, several natives of the same genus, gnaphalium, in English cudweed or common everlasting, which may be preserved in a similar manner. There are also the purple cudweeds and the pearly everlastings, often found in dry, gravelly or sandy soils, which may be had for the gathering. All the work necessary is to hang up in the spare room until the whole collection is harvested or the material is wanted for making the winter bouquet.

As flowers in themselves will have a somewhat stiff appearance alone, dried grasses of various kinds will be found very useful. Hang bottom up to dry, as directed for flowers, for the reason that all plants when first cut wilt and are unable to hold their parts erect. They soon become rigid and when fully dried have had a quite natural appearance.

If flowers are allowed to even partially ripen seed, they will fall to pieces when taken into a warm room. Among the best grasses are foxtail, cat-tails, bents, feather grass and numerous march grasses and sedges. The many brizas or quaking grasses are all well known. Even wheat, rye and oats, if collected early enough, are quite desirable, as are also a number of summer grasses — Farm and Home.



FIG. 998—FLOWERS PRESERVED FOR WINTER USE.



## The Canadian Horticulturist

SUBSCRIPTION PRICE, \$1.00 per year, entitling the subscriber to membership of the Fruit Growers' Association of Ontario and all its privileges, including a copy of its valuable Annual Report, and a share in its annual distribution of plants and trees.

REMITTANCES by Registered Letter are at our risk. Receipts will be acknowledged upon the address label.

### ✦ Notes and Comments. ✦

A BLUE PLUM, about the size of Lombard, but of much better quality, comes from Mr. A. M. Smith. This would appear to have value on account of its earliness, ripening about July 15th this season.

SAMPLES OF THE FINEST EARLY WISON BLACKBERRIES we have seen were brought into this office on the 10th Aug., 1896, by Mr. Charles Gethim, fruit grower, Grimsby. Many of the berries measured  $1\frac{1}{4}$  inches in length, and an inch in width, and on the one branch we counted thirty berries. The variety is, however, a little tender for our climate.

BRANDYGAGE AND OULLIN'S GOLDEN GAGE PLUMS came to hand August 1st, from Mr. David Blackadder, Windsor, who has the stock of the late James Dougall. The first is a rather small, but very productive yellow variety, with Mr. Blackadder, and suitable for canning; while the latter is a fine yellow dessert plum of large size, and excellent quality.

PRUNING BACK RASPBERRY CANES.—In all our large market plantations of Cuthbert raspberries, it has become a custom to severely cut back the young wood in the growing season. This is certainly a great convenience in cultivating, as well as in gathering the fruit; but the question is an open one whether more fruit would not be gathered by leaving the canes to grow uncut during the summer, and in spring cutting off merely the weak ends. There is no doubt that the strong buds all the way up the cane will produce fruit, and a large part of this is cut away by the usual custom of shortening in.

**PRESERVATIVE FLUIDS.**—Mr. E. M. Burch, Spokane Falls, Wash., writes, he has been experimenting with fruit preservatives, and has found that first class olive oil will keep all kinds of delicate fruits in perfect condition indefinitely. Also that purified glycerine will keep light colored berries and cherries in perfect condition.

---

**SAUNDERS' PLUM.**—A package of samples of this variety came to hand on the 5th August, just in prime condition for eating. They were grown by Mr. E. Morris, of the Fonthill Nurseries. It is a fine-looking yellow plum, of fair size, and good quality, ripening before the market is filled with other varieties, and it should therefore command a good price.

---

**UNITED STATES APPLE MARKETS** may be the best for Canadian apples some seasons, but this year we think Mr. Glen's hopeful views would be doomed to disappointment owing to the immense crop in New York State. We are pleased to hear from a Canadian residing in New York, and to know his views on this important subject—of the best market for Canadian apples. Another season we hope to test his encouraging statements, by placing some of the choicest of Ontario's apples in the hand of some reliable New York commission house; but this year we expect to see every market in North America full of apples, and export our only hope for making sales of our crop.

---

**AMMONIA AS A TREE WASH.**—Anyone who takes a careless "sniff" at the hartshorn bottle can readily understand how even a moderate dose of ammonia will produce fatal results when designedly administered. But in these very qualities (says Colman's Rural World) is to be found the great value of ammonia in keeping orchard trees clean and vigorous. What insect can possibly live to do damage to trees after having received even a homœopathic dose of ammonia? Trees given a good ammonia wash once or twice a year will show in their clean, shining bark and glossy leaves a high appreciation of such attention, and many orchardists who have used these preparations bear testimony to their substantial value in increasing the vigor of the trees and the size and quality of the crop. It is comparatively cheap, and its timely application to almost any orchard will be found to pay handsome dividends.





## ❖ Question Drawer. ❖

### Marketing Grapes.

**863.** SIR,—Please let me know in this journal the best way to gather and sell grapes?  
J. G., Cayuga, Ont.

Grapes, like other fruits, need to be carefully handled to bring the best prices. The vines need to be gone over frequently during the ripening season, gathering only those with full color, because grapes do not, like other fruits, color after being gathered. The bunches should be cut off with a pair of scissors, and so handled as not to disturb the bloom. Ordinary varieties may be at once packed from the vines into the basket that is intended for sale. Choice varieties should be gathered in shallow trays or baskets, in which they should stand a day or two on shelves in the fruit house, and then re-packed. By this treatment the stems will wilt and the bunches will then keep without moulding, and pack more closely than when green.

A desirable grape package for fancy fruit is one which can be packed from the bottom against the cover; but in the absence of such a package the ordinary basket, such as is sold by all our basket factories, answers an excellent purpose. For ordinary stock or for wine grapes the 15 or 20 lb. basket answers well, but for choice grapes, especially the Rogers, which are intended for dessert purposes, the eight or ten pound basket is best. A fine cover, with an opening over which purple leno is stitched, is now made for these baskets, and for cheapness and simplicity cannot be excelled.

The price of grapes, as well as that of other fruits, is much lower than formerly. If the grower can realise one cent and a half a pound net he is doing very well now-a-days, and indeed with such productive varieties as the Concord this price will pay him very well.

Unless the grower has some regular customer, he must of course be content to consign his fruit to some reliable commission house, such as those advertising in this journal, and be content to accept returns made by the salesman, which must not be expected to be always satisfactory.

---

### Tulips from Seed.

**864.** SIR,—How do you raise tulips from seed, and when should it be sown? Can new varieties be produced in this way?

A SUBSCRIBER, Hamilton.

*Reply by H. L. Hutt, Horticulturist, Ontario Agricultural College, Guelph.*

It is the same with tulips as with all other plants; new varieties are produced only from seed. The production of new varieties is very interesting, but it requires patience. Seedling tulips have to be grown from five to seven years

before they become large enough to bloom, and then the grower is fortunate if one in a hundred is worthy of propagation. The seed should be gathered from the best flowers and sown as soon as ripe, in a light loamy soil, where it can be protected from too hard freezing. The first year bulbs about the size of peas will be produced; these must be grown on the same as the flowering bulbs; taking them up when ripe and replanting in autumn.

---

### Raspberry Canes Affected.

**865.** SIR,—What is the cause of Cuthbert leaves curling, and fruit drying before maturity on some of my Cuthbert bushes?

J. M. O., *Komoka.*

Possibly they are affected with the raspberry anthracnose, a fungus disease of the stalk, which appears first in the form of small reddish-purple spots scattered over the surface near the ground; or the injury may be due to a borer in the root or in the cane.

---

### Columbian Raspberry.

**866.** SIR,—Have you fruited the Columbian raspberry, and what are its merits?

J. M. O., *Komoka.*

We have fruited this raspberry at our Burlington Fruit Experiment Station, during the present season. The writer visited the plantation there on the 15th of July, and found Shaffer and Columbian fruiting side by side. The chief note made was that Columbian was the most heavily laden with fruit; otherwise they were very similar.

---

### Pruning the Climbing Rose.

**867.** SIR,—Give the proper method of pruning climbing roses. Should the wood be cut back every year as recommended for bush roses? How old should the wood be to bloom well?

J. M. O., *Komoka, Ont.*

Climbing roses are not cut back in the same way as bush roses. When first planted, they should be cut back to two or three buds; thereafter little pruning is needed except bent out weak branches, or canes, sickly and dead wood, and to direct the growth in a symmetrical fashion. Usually the climbing rose improves each year in blooming qualities. A Baltimore Belle at Maplehurst, thirty years planted, is covered with bloom every season, just after the bush roses are over.

---

### Best Red Winter Apples.

**868.** SIR,—Please tell me which you think the best red skinned, hardy winter apples, varieties which are hardy and bear early and abundantly. I have plenty of Ben Davis, Baldwin and Pewaukee now. I want the very best for sale and export; soil clay, near Lake Simcoe.

T. F. CHAPIN, *Lisle, Ont.*

The perfect apple is not yet introduced, that will meet all requirements. The Blenheim Orange is a magnificent early winter apple for the middle of our Province; at Peterboro' Mr. Edwards counts it one of his finest varieties for export. The Ontario is winning favor everywhere as a winter export apple, being of excellent quality and fine appearance. The Wealthy is a beautifully striped, early winter apple, the quality of which somewhat resembles the Snow apple, but of larger size. It is highly valued because of its hardness. The York Imperial is a claimant for the first place as a winter export apple.

---

### Plants for Name.

**869.** SIR,—I send you two cuttings which I found growing on sheltered places here. The one with the stone fruits grows on a shrub-like tree, ten or twelve feet high. The other is a slender growing vine with bright scarlet berries when ripe?

WM. HARRIS, *Rockwood, Ont.*

*Reply by Prof. J. H. Panton, O. A. C., Guelph.*

Of the plants sent for identification, the one with red berries is bitter-sweet (*Solanum dulcamara*. Order Solanaceæ). The other is Alternate-leaved Cornel (*Cornus alternifolia*. Order, Cornaceæ.)

---

### An Insect Affecting the Wisteria.

**870.** SIR,—I mail you two specimens of a long yellow worm in its nest in the leaves of a Wisteria vine. Quite a number of them appear each year. Can you tell me the name, history and remedy.

A. S. SMITH, *Ravenswood, Ont.*

*Reply by Prof. Jas. Fletcher, Exper. Farm, Ottawa.*

The two yellow caterpillars found by Mr. Smith on his Wisteria vines are those of the handsome silver-spotted skipper butterfly, *Eudamus Tityrus*. This is a very large species for the family to which it belongs, spreading about two inches from tip to tip of the wings. It is a dark chocolate brown with a row of large satiny, old-gold spots on the upper surface and a large silvery white spot on the lower side of the hind wings. It is found in nearly the whole of the United States and Eastern Canada as far west as Manitoba. The curious, formidable-looking caterpillar which you send makes a nest within which it remains concealed, by fastening together with silk the leaves of various plants belonging to the pea family, such as the Wisteria, upon which Mr. Smith found it. It is also common on the locust—*Robinia*—and I have sometimes found it on various kinds of beans. The perfect insect is a beautiful butterfly and a very vigorous flyer. This caterpillar, although occasionally abundant, can be easily destroyed by hand picking when with a very little practice the tent-like nests can be detected and plucked off.

## Strawberries from Seed.

871. SIR,—Is there any special way of growing strawberry plants from seed? I have got seed of the "Alpine" varieties, from Sutton, of Reading, Eng., two years in succession, and have not been able yet to get one plant to grow. I have succeeded in growing everything I tried, from teaberries up. I thought perhaps the seed I got last year was old, but was assured this spring the seed was fresh, and ought to grow; but up to date have nothing to look at but the ground I put it in. Also, what is the name of the *very latest profitable* strawberry to grow, and the largest raspberry?

J. A. G. CAMPBELL.

*Reply by Mr. E. B. Stevenson, of Freeman.*

(1) There is no special way to grow plants from strawberry seed. I have never had any trouble with fresh seed. I have grown it in pots in the house in winter, also in shallow boxes, and also in the open ground. It is slow to germinate, taking from four to six weeks before it begins to appear, I should say your seed had lost its vitality. I have now a fine lot of plants from seed sowed from last year's fruit. (2) I would name as the *very latest profitable* strawberry, the "Clyde."

---

## NEW OR LITTLE KNOWN FRUITS.

### Whaley's Favorite Peach.

SIR,—I send enclosed in this box a sample of my seedling peaches; they should have been picked forepart of this week; so, being so ripe, they may not show up nicely when you receive them. They are fully two weeks ahead of the Crawfords. I think that they are just what the peach growers have been looking for, however, will leave that to your judgment. If you think that they are worthy of recommendation, would be pleased if you would publish their good qualities, they are named Whaley's Favorite.

MARK WHALEY, *Olinda, Essex Co.*

The above letter was dated August 7th, and the peaches were opened August 9th, when all but one was decayed. We certainly are looking for an early yellow-fleshed free-stone peach, that can compete in our markets with the Elberta and Crawford from the South, which flood our markets in competition with our River's, Waterloo's and Hales'. The latter are clings of the worst order and are not wanted for preserving. The samples sent us by Mr. Royce are yellow in flesh, a good color, and fair size, not quite free-stone, but can scarcely be called cling, so that they are well worthy of careful testing.

---

THE WATERLOO HORTICULTURAL SOCIETY has a membership of 125, all members of our Association. Mr. Beall will report concerning it in our next number.

---

THE FLOWER SHOW of the Grimsby Horticultural Society was appointed for Tuesday evening, September 1st. The first part of the evening will be a *conversazione*, and a very popular occasion, with the flowers as a centre of attraction. The last hour will be improved by a programme of instrumental and vocal music, recitations and addresses.

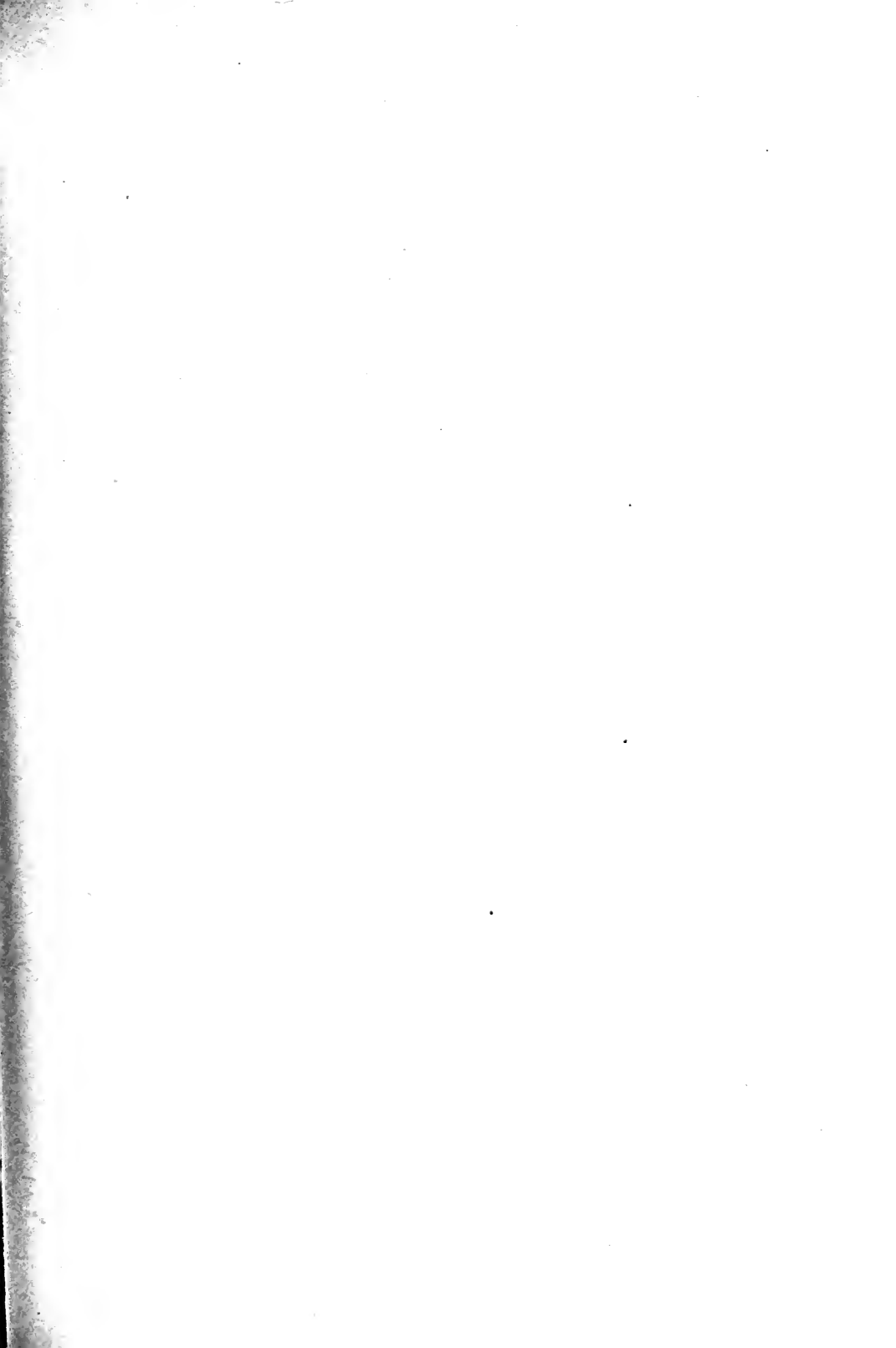



© E. H. P. H. M. R. O. A. U. S. T. E. N. A.

YORK IMPERIAL.

THE  
Canadian Horticulturist

VOL. XIX.

1896.

No. 10.



THE YORK IMPERIAL.



HIS is an apple that has been grown with great success in Pennsylvania, where it originated. For a winter export apple it stands at the head of the list in that State, but of course it may not be adapted to the Province of Ontario. Mr. Van Deman commended it at the last meeting of the New York Fruit Growers, and said he believed it would succeed in New York State. The apple is being tested by the Ontario Fruit Experiment Stations, and in due time a report of it will be given.

The following paragraph concerning this apple, appeared in Mr. Van Deman's report as U. S. Pomologist for 1891:—

“This notable winter apple, though not new in some sections, is deemed of so much value for both market and family use, and adapted to so large a territory as to deserve special attention. The variety originated at York, Pennsylvania, and was brought to public notice in 1855, but only before small Local Associations. In 1871 it received from the American Pomological Society very high commendations for cultivation in Pennsylvania, Virginia and Maryland. Since then it has been grown in nearly all the apple sections of the country, with remarkable success. It is one of the most popular kinds grown for market in the States above mentioned, and is often called in Virginia by the synonym of Johnson's Fine Winter. For several years I have noticed its good behaviour in the orchards of Kansas and Missouri. In Illinois and Indiana it does well, and also in California, where a few trees have been planted. There is not a market apple now known which is more worthy of being planted.

The tree is vigorous and well-shaped, forming a round head and being an abundant bearer, although not too productive. One objection to it is the peculiar oblique form of the fruit, which makes it difficult to pare on a machine. It may be described as follows:—Fruit in size medium to large; form, round or oblong, diameters nearly equal, angular, oblique; surface smooth, sometimes having russet patches; color, yellow, with indistinct red stripes over a lighter shaded red; basin, deep, wide, abrupt, regular or slightly plaited; eye, nearly closed; cavity, deep, narrow, russeted; stem, short; core, small, closed; seeds, numerous, small, plump; flesh, yellow, firm, juicy, a little coarse, flavor pleasant, sub-acid; quality, good to very good; season, December to spring in the central States.”

### THE FRUIT EXHIBIT AT THE INDUSTRIAL.



FIG. 998.—LORD ABERDEEN.

**P**ERHAPS never before in the history of the Industrial Fair, was a finer collection of apples and pears shown than was placed upon the tables this year by Ontario Fruit Growers.

The Fruit Experiment Stations of Ontario also contributed largely to the interest of the fruit exhibit, by showing about six hundred and sixty varieties of fruit, some of them chemically preserved, and others fresh from the orchard.

In accordance with the instructions of the Board the Secretary, with the co-operation of the experimenters had put up 150 bottles of such fruits as could



not otherwise be kept, as cherries, berries, early peaches, and plums, gooseberries and currants. This exhibit was shown on shelves at the ends of the fruit tables and attracted a great deal of attention. The Secretary and Prof. Hutt, were on hand most of the time to answer enquiries and give information concerning experimental fruit growing. These two gentlemen are making a study of varieties, and are constituted by the Board a Committee of Nomenclature on fruits. The importance of such a committee is evident from the fact that even this year some varieties which were not true to name, had prizes awarded them by the judges.



FIG. 999.—BOTTLED FRUIT AT THE INDUSTRIAL.

If the awards are any indication of the advantages of the various sections for fruit growing it would appear that the region of Hamilton and of the Bay of Quinte are foremost in merit. In the collection of forty varieties for example the 1st prize went to Hamilton, the 2nd to Burlington and the 3rd to Trenton; for the twenty varieties, the 1st prize went to Hamilton, the 2nd to Burlington and the 3rd to Trenton. Of the five varieties for export, the prizes were, 1st Burlington, 2nd Belleville, 3rd Hamilton, 4th Hamilton. Of the five for cooking the 1st prize went to Belleville, and of the five for dessert the 1st went to Burlington. Are these then the two rival sections, and are no others equal to them? No doubt many of our readers will dispute such an inference.

The five 1st prize varieties for cooking were King, Duchess, Spy, Ontario, and Greening; for Dessert, Spy, Spitzenberg, Ribston, Swazie Pomme Grise, and Fameuse; for export, Blenheim, Baldwin, Spy, King, Golden Russet.

Chief among the distinguished visitors to our fruit exhibit was His Excellency, Lord Aberdeen, who is himself a fruit grower, and evidently takes the deepest interest in this branch of industry.

The Minister of Agriculture for the Dominion, the Hon. Sidney Fisher, together with the Hon. John Dryden, Minister of Agriculture for Ontario, also visited and examined our fruit exhibit.

## CO-OPERATION IN CANNING AND EVAPORATING.



WHETHER or not the canning industry in a community can be made to pay depends in large part upon the manner in which it is instituted and conducted. There is certainly room here for co-operation on the part of those who make a specialty of growing fruit and vegetables, but the wisest kind of judgment must be followed, and the best business management employed. Never has there been a time when the use of canned goods was more general than to-day. This mode of successfully preserving surplus fruits and vegetables at a time when there would otherwise be no adequate market for them, carries profit to an army of agriculturists. At the same time it benefits the consuming masses, providing desirable food products throughout the entire year at moderate cost.

That farmers may here successfully co-operate has been proved many times. For example, in one Connecticut town last season, two score farmers in this manner found a ready market for their product, which in turn was preserved in such unusually fine shape that the management readily sold all at figures decidedly above the market for ordinary canned goods. This factory, employs 80 to 100 people several months in the year, mostly members of farmers' families, and in September its weekly payroll was \$600. It puts up tomatoes, pickles, squash, onions, peppers, cauliflowers, apples and small fruits, the product last year including 20,000 cases of tomatoes (of 24 cans, each weighing three pounds), 1,200 bbls. catsup, 28,000 gals. of bottled preparations, and other stuff in proportion. The object is to make the best product possible, and farmers are encouraged to bring only choice vegetables and fruits to the factory. One man raised 1,213 bushels of first quality tomatoes on one acre, which, at 30c. per bushel, brought \$363.90, also 12 tons of squash from half an acre, at \$10 per ton.

We have consistently maintained, however, in former seasons, and again repeat it, that any community may well go slow about believing literally all the claims made by promoters, whose only purpose is to sell machinery and apparatus at high prices, perhaps loading down the local association with a burdensome debt sufficient to more than offset all profits for five years. There are plenty of reliable concerns with requisite machinery for a model canning plant, who will quote same, or erect and equip factories ready for use. Only use your judgment and avoid the impositions of those whose claims are not worthy of confidence. Evaporating of fruits and vegetables may also be done co-operatively, but usually it is better not to try to combine a cannary with an evaporating plant.

While considering the advisability of establishing a canning factory, do not lose sight of the market conditions in a broad sense. The fact must be recog-

nized that this industry, like many others, has during the past few years gone through a period of depression. Up to a couple of years ago production in some directions was greatly in excess of requirements, prices during the past season have been forced to phenomenally low levels, and the output of many factories finally marketed at less than cost. Last year, however, the total pack—especially of tomatoes—was much smaller, and now there is a prospect of consumption, speedily overtaking production. In this case, with prices to consumers low, and with a prospect of a speedy return of industrial activities, there ought to be an outlet for canned goods of every description, at prices remunerative to both growers and packers.—American Agriculturist.

## NEWS FROM OUR AFFILIATED HORTICULTURAL SOCIETIES.

### Napanee.



THE first annual show of the Horticultural Society was held Friday evening in the Town Hall. The Exhibition was in every way a marked success. The one drawback being the too brief period in which the show was open to the public. The display of plants and flowers was large and varied reflecting the highest credit on the exhibitors as to variety and beauty. The grouping was very effective showing great taste by the management. The floral decoration on some of the tables called for special praise. Besides the three main pyramids, were table-mantle, fire-place and piano decorations, all works of art. The table decoration and the sweet pea table were the work of Mrs. Herrington, Miss Leneau and Miss Christie Mill, the mantle decoration being the result of the taste of Mrs. Wright. During the evening the visitors to the show were treated to a choice programme of vocal and instrumental music. Miss L. Daly, the well known soprano, sang in her accustomed beautiful style. Mr. Willie Rockwell gave a solo with fine effect. Mr. J. F. Tilley our popular basso, contributed two numbers. The three Messrs. Rockwell were heartily encored after the rendering of "The Sea." Miss Laura Ward acted as accompanist and also played an instrumental piece. The minute dance by four young ladies beautifully dressed to represent the seasons was simply bewitching; Miss Murdock, represented spring; Miss Pollard, summer; Miss Bristol, autumn and Miss Ward, winter. The show was a pleasant surprise to all and its great success has induced the Society to consider the proposal for the holding next year of a two days' exhibition in a larger building if obtainable. Almost double the exhibit could have been made if space had been obtainable, and it is to be noted that it was members of the Society only who had contributed. The whole undertaking was the result of the work of the directors, assisted by

various members of the Horticultural Society. The present directors are Mrs. Wilkinson, President ; Mr. T. M. Henry, Vice-President ; Mr. J. E. Herring, Sec.-Treas., and Mesdames Wright, Mill, Richardson, McNeill and Messrs. Bowerman, Herrington, Lloyd, Harmer and Ward.—Star.

### Waterloo.

The Annual Exhibition of the Waterloo Horticultural Society, which was held on the 20th and 21st ult., was successful beyond the expectation of those most interested in its success. All the available room in the Town Hall was covered with flowers, fruit and vegetables. About four-fifths of the bench room was occupied by flowers—some 300 exhibits—consisting of cut flowers shown singly and in bunches of from two or three to a dozen or twenty specimens in each receptacle, and also of plants in pots. These great masses of bloom were so arranged in connection with the large number of plants in pots, so mingled with the gorgeous foliage plants, as to produce the most pleasing effects, the beauty of which was thoroughly appreciated by the large concourse of visitors who thronged the Hall on both evenings.

This exhibition differs from most horticultural shows, in having a more abundant floral display and in the absence of that formality of arrangement of the different classes and varieties essential to a well-ordered competitive exhibition. Here, no prizes are offered for competition, and no fee is charged for admission. The public at large are invited to be present and every one is admitted free.

In the Hall there are no constables to cry "Hands off," when a visitor gets a little too near the benches, and whose only other duty, generally, is to *prevent visitors from examining the exhibits*. Here, instead of these gentry, may be found James Lockie, Esq., the energetic and indefatigable President of the Society ; Mrs. Hohmeier, the Vice-President ; Mr. Raymo, the Secretary ; Mrs. Dr. Webb, Mr. Bolduc, Mrs. Bruce, and others of the Directors, together with Miss Maggie Bruce, to whom had been wisely given the entire superintendence of the floral decoration ; all in their places, giving every information required respecting the exhibits. And, I scarcely need add, the visitors gladly availed themselves of this opportunity to acquire a great deal of valuable knowledge respecting the cultivation and peculiarities of growth of many, to them, new flowers.

All the exhibits are contributed by the members of the Society and other residents of the town. The expense incurred in placing the exhibits on the benches, and returning them (when necessary) to the owners, is borne by the Society, and the free admission of the public is regarded by the Board of Directors as in some sense an equivalent for the large grant from the public funds given by the Provincial Government.

The Waterloo Society this year consists of 125 members, who each pay one dollar only. For this small fee every member has received the CANADIAN HORTICULTURIST and all other the privileges of membership in the Fruit Growers' Association of Ontario, as well as the additional privilege of a free lecture on practical Horticulture by Dr. Beadle, of Toronto. Also their choice of either of the following premiums:—1st. One tree each Wilder Early pear, McLaughlin plum and Montgomery cherry. 2nd. One each spirea van Houtti, Gen. Jacqueminot rose, and clematis paniculata. 3rd. Six cannas, twenty gladioli, and two dahlias. 4th. Twelve house plants, assorted. And each member is yet to receive twelve of the best hyacinth bulbs that can be obtained.

The improvements that have taken place in the cottage homes of Waterloo during the past summer, through the influence of this Society, is very marked, and gives ample proof that the plan of conducting the affairs of Horticultural Societies, where every member receives an equal share of the advantages of such associations, commends itself as being infinitely superior to the old system of using all its money in holding a competitive exhibition, whereby about one-tenth of its members generally share between them ninety-nine per cent. of its funds, while the remaining nine-tenths receive no advantages whatever.

*Lindsay, August, 1896.*

THOS. BEALL.

### A HAND APPLE PICKER.

As the season for picking winter apples is now on, orchardists will find the illustrated picker of great service in reaching the fruit on extended limbs. One man can stand under a tree and pick nearly all the fruit from the tree, including the hardest to get at—that on the ends of the branches. The frame is made of heavy wire, or light round iron, and a sack of heavy cloth sewn to the frame, leaving the slots at each end so that an apple will be free to enter the sack. Then all you have to do is to push or pull, and the apple drops into the sack. I have one with a fourteen-foot and another with a six-foot handle. The wire from A to B is eight inches wide, from C to D ten inches. The slots at C and D are three inches long and an inch wide. The handle or pole may be of any desired length.—American Agriculturist.

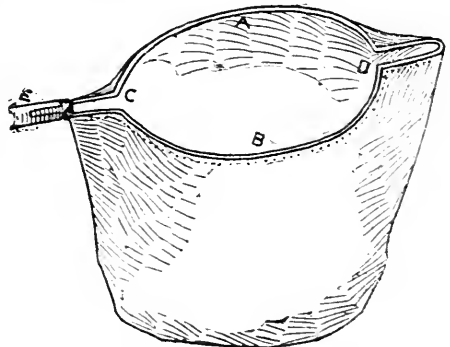

FIG. 1000.—FOR PICKING FRUIT WITHOUT BRUISING.

## DUTCH BULBS.



THE frost having put the finishing touch to the work of the summer season, now is the time to commence for next spring. Get your beds in readiness for everything you intend to plant; then put in your bulbs without delay. If your plants are not already laid, lay them; then carry out your designs.

*Tulips*, which are the most showy of spring flowers, may be planted now; it is better they should; however they can be safely put out next month. Make the soil good and rich, work it deep, then put in your bulbs, six inches apart each way, and cover them with four inches of good soil. Be sure to have a bed of Parrot Tulips, which are, botanically, monstrosities; from the florist's standpoint, sports; but from the amateur's standpoint, simply gorgeous. While Tulips are the most hardy of all bulbs, in this climate, where freezing and thawing alternate so rapidly, and in such a marked degree, it will pay well to mulch the bed sufficiently to prevent this.

*Hyacinths* can and should be planted now. Every day's delay detracts from their usefulness and from the pleasure you receive from growing them. Plant in good soil, and cover with four inches of the same. Then mulch so thoroughly that frost cannot reach them. This you *must do* if you hope to be successful. In selecting, exercise your own taste so far as color is concerned, and also as regards the double and single forms. Buy good bulbs, cheaply if you can, but under no circumstances buy *cheap* bulbs. For bedding purposes, the second or third size is the best, as they will last longer without breaking up; but for pots or glasses get the best only.

*Crocuses* *must* be planted at once, if at all. It is no use to plant them after they commence growing; they will be sure to disappoint you if you do. Lift up the sod in places on the lawn and put them in promiscuously; they will make it cheerful in spring. Plant them in every sunny nook; they will bring plenty of sunshine with them. If their room is wanted for other things, throw them away after flowering; their one season of beauty will more than repay their cost.

*Crown Imperials* should have a place in every garden, and it should be a sunny place, as they are about the first to appear in spring. They are heroic resolutions in leaf and stem as they push themselves out of the ground after the first few days of encouraging growth; and no amount of frost will check their energies after once starting. But mulch them; they do not like to sleep through winter in a frozen bed.—American Gardening.



FIG. 1001.—PARROT TULIP.

## THE APPLE TREE BORER (*SAPERDA CANDIDA*) IN MUSKOKA.



INTNER, in his first New York report, gives a list of one hundred and seventy-six insects more or less injurious to the apple tree. Many of these are only accidental feeders, and several are not Canadian. However, two of the most destructive species, *Ædemia concinna* (the red-humped apple tree caterpillar), and *Saperda candida* (the striped apple tree borer), are very common throughout northern Ontario, and one of these, the borer (beetle) is the principal cause of the failure of apple culture in Muskoka. Although often catalogued as a Canadian apple tree pest, it was not reported as being very injurious in the front counties of Ontario; in fact, it was rare, and entomologists found some difficulty in procuring a good series of cabinet specimens. But so abundant is this insect in Muskoka, that in the ovipositing season (June) fifty specimens may be taken from the trunk of one small apple tree. The natural habitat of this borer is our native cherry trees, *Prunus serotina* and *Prunus pennsylvanica*, and as these abound along roadsides and over burnt-over lands throughout Muskoka, of course this accounts for the beetle being so numerous.

The settlers have made laudable and persistent efforts in the way of purchasing trees and planting orchards, with very little result, and the consequent loss to the country is probably one million of dollars.

These native cherry trees are of no value, not even as shade trees, and as they are infested with the borer larvæ, the first suggestion is to cut them down and burn them, either in the fall or before the beetles emerge in the spring. One or two days' work from every settler would perhaps be quite sufficient. Fifty pairs of beetles to each wild cherry tree is no doubt a moderate estimate, and as they take very readily to apple trees, in fact, seem to prefer them, the great danger to orchards is readily seen.

The whole question of fruit raising in Muskoka is one of very great importance, and deserving of a special, full and careful investigation by the agricultural authorities.

Toronto, August, 1896.

W. BRODIE.

---

**Unfermented Wine.**—Weigh the grapes picked from the stems. Mash to break skins. Put in a porcelain kettle, add a very little water, cook till stones and pulp separates; press and strain through a thick cloth, return juice to kettle, and add 3 lbs. sugar to every 10 lbs. grapes; heat to simmering, bottle hot, and seal. This makes one gallon and is good.—Practical Housekeeping.

## THE STARLING.

SIR,—Referring to the correspondence published on page 134 of your journal for May, 1891, on the subject of the Starling as a desirable bird to have introduced into this country, I have again satisfaction in sending you herewith a cutting from a recent issue of a London, Eng., paper, which contains an extract from the Report of the Highland Agricultural Society of Scotland on the same subject.

Mr. Gilmour observes :—“The result of the investigation confirms me in the opinion I have long held—that rooks in the enormous quantities in which we have them in counties such as Fife do an immense amount of damage, and I would urge those who have the control of rookeries to see that the numbers of their inmates are kept within reasonable limits.” The starling comes out of the ordeal with a creditable record. The inquiry shows that about three-fourths of this bird’s food is insect—largely of the injurious class—and one-fifth grain, while there was no trace of any other crop being touched. Summarising the results of the whole inquiry, Professor McAlpine says :—“If this estimate is correct, as it certainly appears to be, there can be little hesitation regarding the starling. He is a bird rather to be fostered than destroyed ; he is a benefactor rather than a foe to the farmer. Of the pigeon it may be said that he is an unmitigated scoundrel ; of the rook that he is a cunning rogue ; but of the starling we can say with truth that he is our natural friend, by habit and by instinct.”

I have not observed that the matter has been discussed at all at any of your meetings. In view of what Mr. Gilmour says in his report concerning this bird, I would suppose it to be well worthy of the attention of our Association.

*Annapolis, N. S.*

E. D. ARNAUD.

---

## IRRIGATION.

SIR,—I might say, in answer to Mr. H. Picket’s inquiry, *re* irrigation, that I have irrigated an eight-acre apple orchard for years, and have found it of great advantage almost every year, and especially a summer like the one a year ago. The fruit is much larger, and the trees will make a good growth of wood, even when they are heavily loaded with fruit. A glance at the foliage would convince any person, during a dry summer, of its benefits. My mode of applying is quite simple. The orchard is on a mountain side ; three springs rise at the top, and by ditches I convey the water to wherever wanted. I watered twice during the dry spell in the early part of this season, and my young trees have kept growing right along. Trees planted one year ago have made over two feet of wood this season.

One other subject I would like to mention, which I have been watching carefully since I noticed Mr. Caston mentioned it, and that is crutch rot of the



Spy apple tree. I feel satisfied it is caused by the old bark lodging in the crutch of the trees. The Spy is a very upright grower, and only in that kind of a crutch have I found the least sign of the bark showing signs of rot wherever the branches are at an angle of forty-five degrees, or nearer a right angle. Spys are all right ; the old bark should be carefully scraped out, if not at the age he mentioned (about sixteen years), it will be found that the green bark has rotted away and the wood begins to decay.

*Vandeleur.*

J. I. GRAHAM.

## APPLE PICKING AND PACKING.



OW that the vexed question of the size of apple barrels is finally settled (the larger being universally adopted), the manner of harvesting these immense crops the most expeditiously, and with least expense during the shorter days of uncertain autumn weather, should be considered. As now generally practised — picking each apple separately — it is necessarily slow, laborious and expensive. But thanks to the Yankee ingenuity the needs of this emergency, like many others seems to be successfully met. A prominent and extensive fruit grower of Genesee county has invented and quite satisfactorily used for two seasons an apparatus constructed of canvas, resembling somewhat that of an inverted umbrella, into which the fruit is shaken from the tree. And from an aperture in the smaller and lower part, it is deposited in a basket, to be carried away and assorted. While many are prejudiced against shaking winter fruit from trees under any consideration, the sales of fruits at different periods during the season gathered in this manner, the condition, relative to its keeping qualities, and the prices obtained, prove that in the harvesting the fruit of the extensive apple orchards of western New York, and other parts of our country, hand picking as generally practised, is now hopefully being superseded.

The ease and convenience in assorting apples can be greatly enhanced by using a table constructed for the purpose as follows : Length 7 feet, width  $3\frac{1}{2}$  feet, height 3 feet. The top should consist of canvas or oilcloth securely nailed to the frame, strips three inches wide of inch stuff, and, for convenience, openings should be left in each corner large enough to admit a half bushel basket. These rest on supports fastened to the legs of the table, the latter being made three inches wide and two inches thick, all well braced. The writer can vouch for the ease, comfort and facility of the work performed by its aid, and could not be induced to return to the tiresome, back-aching method of sorting on the ground. Not being patented they are free to all, and are truly a great acquisition, not only in the apple orchard, but are desirable for handling pears and quinces as well.—Farm and Vineyard.

## ABOUT CIDER AND VINEGAR.

The best cider vinegar is made without the addition of water. It takes this more than a year to make, and then it is too strong for ordinary use, and should be mixed with one third, more or less, of water. Nothing else should be added. If the cider is left in barrels, covered with a cloth, until vinous fermentation ceases it will shorten the time somewhat. But a good vinegar cannot be made in a day.

A good way is to fill a barrel up to the bung with cider and rainwater in the proportion of one gallon of rainwater to two of cider, and store in a warm place. Acetic fermentation will be hastened by scalding the barrel with boiling vinegar before filling. So also will a few strips of folded brown paper saturated with molasses. The vinegar, after being fully fermented should be drawn off from the mother and put into another cask.

Another good way to make cider vinegar is to take ten gallons of apple juice fresh from the press and let it ferment fully, which will be in about two weeks, or sooner if kept warm; then add eight gallons new cider, for producing a second fermentation, and in two weeks add a like quantity for a third fermentation. This last is sufficient. Then stop the bung-hole, which should have been covered with gauze to keep out insects, with an empty bottle with the neck downward, and expose it to the sun for some time. When the vinegar is come, draw off one half into a vinegar cask and set it in a cool place above ground for use when clear. With the other half in the first cask proceed to make more vinegar in the same way. Thus one cask is to make in, the other to use from. When making the vinegar, let there be a moderate degree of heat and free access of external air. The process may be hastened by adding to the cider, when you have it, a quantity of the "mother" of vinegar, as it is called—a whitish, ropy coagulum, of a mucilaginous appearance, which is formed in the vinegar and acts as a ferment. The strength of vinegar depends on the amount of sugar or starchy matter to be ultimately converted into acetic acid.—Fruit Growers' Journal.

---

**Pruning** should not be commenced until the vine has become thoroughly dormant, say about the middle of November. Our object during the summer has been not to grow any superfluous wood, so in pruning we should leave only such canes as are needed to renew the parent vine. Trim all laterals not required back to two buds, and see that the vine is securely fastened to its support when not layered for the winter. It is a good practice to rake up all grape foliage and trimmings, and burn them. Whatever disease there may be present will be most likely to be found on the foliage and tender shoots. Throw a light covering of evergreen boughs, corn stalks or coarse, strawy manure around the roots for winter and let them rest.—The American Cultivator.

## OUR APPLE MARKETS.

Messrs. Jas. Adam, Son & Co., of Liverpool, write :—

SIR,—As customary, we once more take pleasure in reporting on the prospects for American and Canadian apples, as viewed from present aspects.

From what we can gather, it would appear as if home supplies were going to be on a moderate scale, as although reports from some of the growing districts indicate an average yield, those from others, and these the principal from which marketable supplies are available, speak of a light crop.

On the Continent, also, some sections are very short of apples, but in others there are plenty of good quality, whence quantities will inevitably find their way to this country. These, of course, may to some extent affect the sale of transatlantic growths, but, as a rule, home and Continental supplies do not count for so much as is generally supposed, when the fruit from your side is of *good quality*, and, if reports prove true, that such is the case this year, we look for a good and active demand throughout the season.

In view, however, of the large crops reported from the States and Canada, it cannot be expected that prices will rule high, and we hope at the outset that shippers will not be induced to pay too much in the orchard. Great care, moreover, should be given to the grading and packing of the fruit, as the cost of shipping and handling is identically the same on a poor as on a good barrel, while the larger operators will do well to see that the best keeping varieties only are held over for shipment in the spring.

Messrs. M. H. Peterson, Liverpool, write :—

SIR,—We beg to submit for your perusal and guidance our ideas regarding the indications of this year's apple crop and prospects, formed both from observation and from reports by us received from reliable correspondents from various apple producing sections wherever apples are grown.

*Great Britain.*—Appreciably less than last year, as from 392 reports received, only 75 are above average, while 152 are average, and 165 under average; while last year, from 371 reports received, 160 were over average, 161 average, and 50 under average.

It is true Ireland has quite a crop of apples, but these do not seriously compete with apples from this side.

*Continent.—Germany and Holland.*—About one-third of an average crop, with late varieties preponderating.

*France and Belgium.*—Late kinds short, and early sorts in fair supply, except along the Franco Belgian frontier, where there is quite a crop.

*Portugal.*—A promising crop, of good quality.

*Italy.*—A fair crop, which, however, is usually not sent to Great Britain until January or February.

*United States.*—New England States, New York and Michigan the largest

crop in years, mostly of good quality. Ohio, Pennsylvania, Indiana, Illinois, Iowa and Wisconsin a fair crop. Missouri and Kansas considerably less than last year.

*Canada.*—*Nova Scotia* a large crop of good quality—many young orchards just commencing to bear are well loaded. *Ontario* will also have a large crop, of generally good quality. In one county alone, all estimates received state the yield will not be less than 500,000 barrels.

One can readily understand that this season, so far as this side is concerned, the large yield is in the portions which naturally and usually export to Great Britain. The United States are supplied much beyond their requirements, and from many quarters comes the enquiry, what is to become of this year's enormous apple crop?

The only accessible market which has not a sufficient home supply is again, this season, Great Britain; but different sections from this side could, if shipments were freely sent, swamp this market, and the great question therefore is, how are we to market this enormous crop with the least sacrifice to growers and buyers?

Great Britain can take a large quantity of choice apples, properly graded and carefully packed, at a low first price; and should anyone not rigorously observe this rule this season, it seems almost inevitable that results must be unfortunate. In estimating this season's prospects, bear in mind that there is a large amount of freight to be moved out of the country, and as the cost of transportation is a most important element, in reckoning on the cost of the package before the fruit is marketed, advise yourself before concluding the price the market will stand, what the through freight probably will be.

As a matter of fact, the through rate at present quoted is considerably higher than for a few years back, and as these rates are variable and quite liable to advance, the purchasing question is not an easy one. We would remind buyers that it is dangerous this season to be misled by glowing accounts of the probable market price to be realized for apples, so apt to be sent out by would-be receivers, who cannot possibly appreciate the immense crop on this side.

Remember large losses quickly swallow many small profits with sad experience the only residue.

We, of course, base our remarks upon the indications as they are to-day barring wind and hailstorms, and dropping through heat or other unforeseen causes which might, and sometimes do occur. At present this season has all the *earmarks* of a *cautious year*.

We would, therefore, again this season, urge *buyers* and *shippers* to be *most conservative* in their operations, only *handling hand-picked fruit, carefully graded and properly packed, by experienced packers, at reasonably low first cost*. There is an abundance of choice fruit for all, and anyone basing his operations on excitement, rivalry or unfounded rumours, cannot hope for a satisfactory season. Remember the freight and carrying charges are as much on a poor as a good barrel of apples.

Guard against handling a quantity of apples greater than you yourself or some one of experience, in whom you have confidence, can personally oversee. There cannot be an outlet without consumption, and consumption to be at all commensurate with our enormous yield, must be at a low price. We have the supply, and the demand depends entirely upon the quantity, quality and cost.

---

Messrs. Simons, Jacobs & Co., of Glasgow, write :

SIR,—We cannot too strongly urge upon shippers the necessity of only shipping the very best fruit and having it properly graded and packed for export. Packing that ordinarily does for home trade will not do for export.

Selling as we have done for a number of years past one-third of the total exports of apples from America, we thoroughly appreciate the importance of proper handling and packing for export. While there are many shippers who understand how to pack, yet there are many who do not, and, with a probability of a large number of new shippers engaging in the export trade this season, we beg to offer a few suggestions that may be profitably followed :

Only use the full-sized standard apple barrel. Do not pack apples that have been picked with a club, because prices are low. If possible, do not pack apples that have been piled on the ground for the sun, dews, rains, and extreme changes in temperature to unduly ripen. Any person who will take the trouble to compare apples that have been exposed to these influences with those of the same kind that have not been will readily understand why we strongly condemn the very common practice of leaving apples on the ground a day or two before packing. Select and carefully grade the fruit, putting in nothing bruised or defective. When packing, face the barrel (stems down) with a fair sample of the fruit which it is to contain. Upon this facing or layer place by hand, about a half bushel of apples in the shape of a cone or pyramid, then commence filling. After each basketful, jar the barrel to make the fruit settle well together. When the barrel is about half full put in the racking head (a padded piece of wood a little less in diameter than the barrel head) and thoroughly rack the barrel. Continue filling as before till the barrel is full, then tail up, that is, turn each apple stem end up, again putting on the racking head, holding it in position with the hands, and thoroughly rack the barrel again. After the racking has been done the fruit should be just about level with the top of the chime, and with a little straightening up the pressed ends should look almost the same as the faced. Thorough racking obviates the need of heavy pressing and prevents the barrels from becoming slack through the decay of the crushed fruit.

---

**Teddy** brought a green caterpillar in from the garden the other day, and showing it to his mother, he exclaimed, "I've got a big worm, mamma, but he ain't ripe yet."—Harper's Round table.

## THE ELBERTA PEACH.



AMONG the whole list of peaches, both old and new, there is no variety that has attained a higher place in public estimation than the Elberta. It is liked equally well by the grower and consumer. About 25 years ago Dr. Samuel H. Rumph, of Georgia, raised about 12,000 seedling peach trees from seeds saved from the very choicest named varieties, and in the whole lot there was but one that he deemed worthy enough to be preserved. This was the product of a cross between the Chinese Cling and Crawford Early. He bestowed upon it the name Elberta, in honor of his wife, and it has in turn been an honor to its namesake. Knowing something and hoping more of its good qualities, he planted extensive orchards of it, from which he shipped large quantities of choice fruit, and realized profitable returns. It was not long before other peach growers learned of the good qualities of the Elberta, and began to plant it; first in the Southern States, where it had already proved its value beyond question, and then in the northern peach-growing sections. It has proved to be one of the standards in all regions from Georgia to Michigan, and from Connecticut to California. The tree is vigorous enough to make a good orchard tree, spreading in habit, and has large leaves, somewhat like its parent, and is as hardy in tree and bud as the average of varieties. It ripens its fruit a little before mid-season, or about with Old Mixon Free. The fruit is above the average in size and oval in shape, with a suture on one side. The color is lemon yellow, a blush on the sunny side. The flesh is rather pale yellow, tender and juicy, yet firm enough to ship well. In flavor there is nothing lacking. Altogether, there is, perhaps, at the present time no peach, for all sections and all purposes, quite so valuable as the Elberta.—H. E. Van Deman in Horticulture.

---

## THE TETOSKY APPLE.

Judging from an article in the Home Farm, this apple is singularly little known in Maine, though it has been in New England all of forty years. The Home Farm says it is one of the best Russians in quality, and a correspondent thinks it quite an acquisition as an early apple. In comparison with the Yellow Transparent, the Tetofsky is "nowhere" among the Russian sorts, either in quality, size, beauty or earliness. It is not a bad apple to eat raw or cooked, and is productive, but it has the very serious fault of dropping nearly its whole crop prematurely, owing to the fact that it grows in clusters on short spurs, something like those of the pear. It is, however, a most excellent variety to use as a stock for better sorts, especially those late in coming to bearing, or a little tender against severe cold. The Wealthy, like the Baldwin, is proving not to have a sound trunk when grafted or budded low, and the Tetofsky is an excellent stock to graft that, the Fameuse, or any other better apple on. In this respect it is far superior to the crabs.

H.

## USES OF PLASTER.

There seems to be an opinion prevalent with many that as plaster or sulphate of lime does not enter largely into the composition of plants, it can be of but little use as a fertilizer. They do not consider that there are substances which, while they do not contribute directly to the growth of plants, have chemical or mechanical properties that play a very important part in vegetation. Plaster has both of these properties. As a disinfectant and deodorizer it is one of the best, as well as cheapest, substances at our command. Any one who has kept stock of any kind stabled during the warm summer months, knows what a hard task it is to keep their apartments clean and odorless. Now, if they will keep a barrel of fresh-ground plaster in a convenient corner, and every day, on sweeping the floor clean, sprinkle it freely with the plaster, it will absorb all disagreeable, noxious odors, rendering the air sweet and pure, while the value of the manure will be greatly enhanced by the retention of the ammonia. Poultry-houses should also be swept clean at least twice a week in summer, and once a week in winter, and the floors sprinkled with plaster; it will add greatly to the value of the manure, and the satisfaction of having clean, sweet, odorless coops and healthy flocks, will abundantly pay expenses. Try it and be convinced.—American Agriculturist.

---

## GRAPE JUICE.

When the grapes are at the best for eating, they are just right for juice. They should be fully ripe. Wash in a colander, and then strip from the stems, throwing out all faulty ones. Put them into a fruit kettle with nearly enough water to cover; a good rule, is two quarts of water to six quarts of stripped grapes; if barely ripe take a little less water; no sugar is needed. Skim when they begin to boil, heating slowly, and when the whole mass is boiling hot, strain through a flannel or cheese cloth; a thin muslin like that used for flour sacks will do. This gives the clear juice, with very little pulp. When no more juice will run through, put the seeds and skins into a coarse linen bag, or one of ordinary cheese-cloth, and express the remainder; a jelly squeezer would answer, but it is sure to discolor, more or less. Add no sugar. The less the fruit (or juice) is cooked, the brighter the color and the better the flavor; like all the small or tender fruits, it is injured by long or rapid boiling; the color becomes dark, and the fine, fresh flavor is gone. After straining and squeezing, put all the liquid back into the kettle, let it come slowly to a boil, and then remove from the fire or seal in cans. This juice put into glass cans or bottles.

## ❖ Flower Garden and Lawn. ❖

### CLEMATIS VIRGINIANA (VIRGIN'S BOWER.)

**F**EW of our readers, even among those who belong to our affiliated Horticultural Societies, are aware that we have in Ontario a native variety of Clematis which is sufficiently hardy to be grown even in our Northern sections. Some years ago we received some plants of it from Mr. J. P. Cockburn, of Gravenhurst, and these have thrived wonderfully well, covering a portion of the front porch as seen in our engraving. (Fig. 1002.)

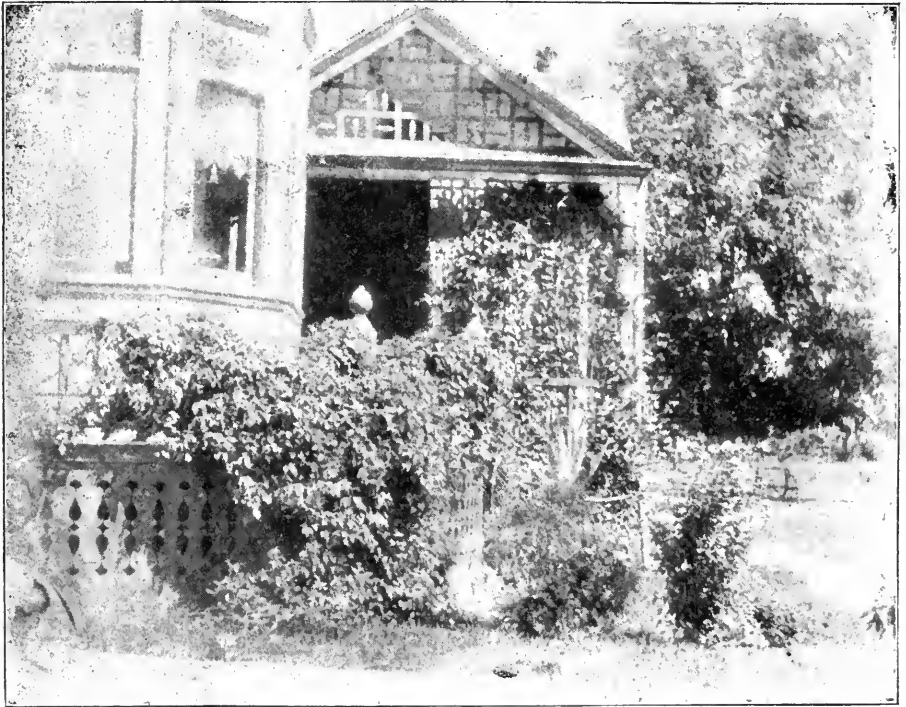

FIG. 1002.—PORCH COVERED WITH VIRGIN'S BOWER.

The flowers are white and small, compared with many foreign varieties, but are so numerous as almost to cover the vine, and grows in panicles as shown in Fig. 1003. These come on the new wood in June and July, and in August the



flowers are succeeded by numerous carpels, with long tails, as shown in Fig. 1004, and which are also ornamented. The leaves of the Virgin's Bower are alternate, and each leaflet is acute heart-shaped, and coarsely toothed, and often cut in deep lobes. The vine grows stronger each year, and will reach up fifteen or twenty feet.

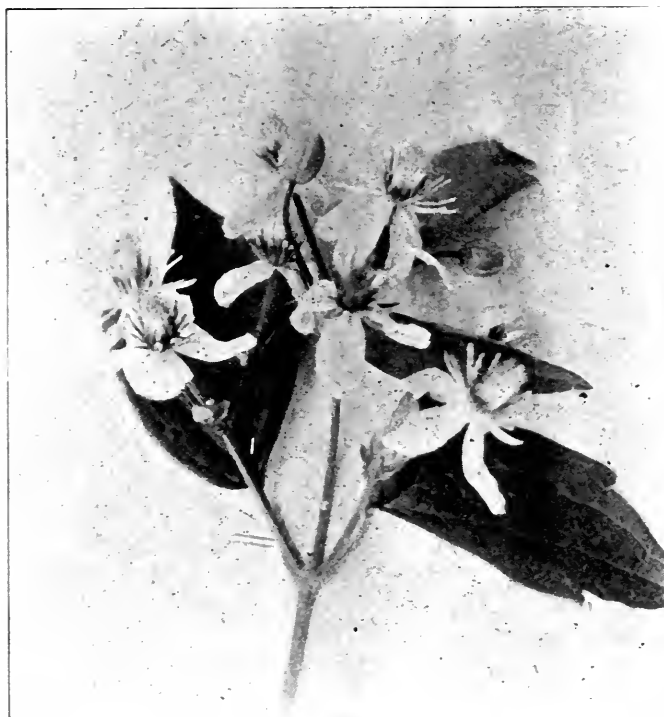

FIG. 1003.—BUNCH OF FLOWERS.

The pronunciation of the word clematis is not uniform. People in the United States incorrectly say clemat'is, while many in Canada as incorrectly say clemat'is. Mr. Nicholson, of Kew Gardens, one of the best authorities on gardening, gives cle'matis as being most correct, following the derivation from



FIG. 1001.—A BUNCH OF CARPELS.

the Greek *κλημα*, a vine branch. The best usage, however, and the authority of Webster, and of the Standard, is *clem'atis*, which therefore we will follow.

### A BELT OF YUCCAS.

This yucca is a capital plant for amateurs to grow because it "lasts for ever," and it is always neat in appearance, except for a few dead leaves that can be pulled off, and does not spread out of bounds; and its flowers are bold, conspicuous and showy, and it blooms at mid-summer, a time of year when we want something striking in our gardens.

There are several varieties of it differing from one another in the stiffness or threadiness of their leaves, the size, fullness and whiteness of their flowers and their taller spikes. One can see the difference between them in that, while the majority of the flower spikes run from four to six feet high, there are some clumps whose flower spikes are eight to ten feet high, and this character is permanent. And one of our prettiest hardy plants is the variegated-leaved form of this yucca. Its leaves are green, belted or streaked lengthwise with white.

*Yucca angustifolia* is hardy from New York south and makes handsome clumps three to four feet high. But the grand yucca *gloriosa*, which is the tree-like yucca so common in southern gardens is not hardy in the north.—Gardening.

## VIOLETS.



VIOLETS are known in Europe as the imperial flower. They belong to the pansy family (*Viola*). They express faithfulness, and this is perhaps why Bonaparte first adopted the violet as the imperial flower. The Paris Temps relates that before departing for the Island of Elba, Bonaparte was walking in the gardens of the Fontainebleau, accompanied by the Duc de Bessano and General Bertrand. The emperor was still uncertain whether he should offer resistance or betake himself into exile in peace. The Duc de Bessano was endeavoring to show him that it was now no time for drawing back. Greatly impressed by the objections of his secretary, Napoleon continued to walk up and down in silence. He had no reply to make, and he was seeking something to distract his attention from the embarrassment of his position. Suddenly he saw near him a pretty child of three or four years of age, who was picking violets, of which he had already made a little bunch. "My dear," said the emperor, "will you give me your nosegay?" "Certainly, sir," replied the lad, handing it to him with infinite grace. Bonaparte took the flowers, and kissed the child (whom he recognized as the son of a man employed about the chateau), and continued his walk. "Well, gentlemen," he said to his courtiers after a few minutes' silence, "what do you think of that child? This chance meeting seems to me like a piece of advice warning me for the future to imitate this modest flower. Yes, gentlemen, henceforward violets shall be the emblem of my desires." The emperor's adherents afterwards carried a bunch of violets in their hand, or wore them in their buttonhole when in season: this is how they recognized one another.

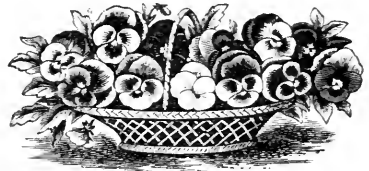

FIG. 1005.—BASKET OF FLOWERS.

There is no flower unless it is the rose, more prized by our ladies than English violets. The species known by this name is found all over Europe, in some parts of China and Japan. Marie Louise, dark blue, and Neapolitan, light blue, are the most in cultivation, Swanley White, has lately come to us from Europe, and is so much in demand in the cities that it is not very plenty yet. The single dark blue, Cæsar, is prized by many, but I cannot see that it has any special quality, unless it be profusion of bloom.

Violets have been recommended for house-blooming, but my experience is that they do not do well in the house on account of the dry atmosphere. If placed in a conservatory in the cool part, near the glass, they will give an abundance of bloom. The essential points for violets are a soil that is porous and at the same time has enough clay to retain nourishment, and low temperature, not over 40° by night, and 60° by day, with plenty of air in bright weather.—Farm and Home.

## WALKS AND DRIVES IN PRIVATE GROUNDS.



IN all places of sufficient extent or pretension to invite artistic design in the laying out of the grounds, the plan of the necessary walks and drives calls for careful study, in order to combine the greatest convenience in use with harmonious relation to the grounds as a whole. Even on places of only a few acres it is well to consider and sketch in advance of construction the elements of a satisfactory working plan of the roads and walks. Position and alignment depend chiefly on local conditions, but some general rules are more or less applicable to all cases, such as utility, convenience, proportion and construction.

For walks in nearly constant use, flagstones are preferable to gravel, especially in the immediate vicinity of buildings. Where flagging or concrete is too expensive, gravel is the material most usually available. Such a walk should have a foundation of 6 to 9 inches in depth, of stone chips or coarse gravel, to give it proper drainage in wet weather. The surface material should compact readily by rolling or by travel. The gravel must be fine enough not to be harsh or gritty under foot, yet not so fine as to be slimy after a shower. A slight crown on the middle is an advantage, and paved gutters should be provided if there be any stretch with a steep gradient. The width should be determined by convenience in use, 4 feet being required for two persons going abreast or passing each other but greater width may be demanded by other conditions.

Winding walks for pleasure only across open lawns, or along their borders, are unnecessary if the travel on such lines can be sustained by the greensward without damage. Walks made for show only are in bad taste because worse than useless. Such walks are sometimes surfaced with small pebbles of nearly uniform size, round, smooth and clean, but so loose that nobody can walk on them, until by neglect they become encased and cushioned with weedy grasses. All gravel walks in places where frequent hoeing and stirring are necessary to check such weeds are evidently of little use, and are of no value for ornament.

In private grounds walk and drive are often happily combined in one. The smooth wheel track makes an excellent path, and there is always room to give a vehicle the right of way without any risk of collision. Where no special advantage can be gained by using a separate path there is no incongruity in walking on the drive.

The proper width of the drive is determined by the conditions of its use. On short stretches where vehicles have no occasion to pass each other, eight feet may suffice, but otherwise fourteen to eighteen feet may be necessary, according to the general proportions of the adjacent grounds. Where a drive is so narrow as to confine the travel to one line, a gutter like groove will be worn along its center, if "one hoss shays" are in general use on it.

Such drives are usually constructed with a foundation of stone spalls on coarse gravel and surfaced with finer gravel or finely crushed stone. The cases are rare where a substantial macadam structure is built, but the principles governing the macadam process should be followed as closely as circumstances will permit. These may be briefly stated as a guide to the inexperienced.

The depth of structure should be sufficient when firmly compacted to support without yielding the heaviest loads likely to pass over it and to withstand displacements by frost. This will depend largely upon the nature of the subsoil and the drainage conditions in wet weather. The common depth for local drives varies from six to twelve inches, but there may be conditions where a depth of 18 inches is necessary. It may be naturally supposed that a depth of 18 inches is only three times as strong as a depth of 6 inches, but in reality it is nine times as strong. The pressure of a load spreads through the roadway in the form of a cone with its apex at the wheel. The area of the base of this cone increases as "the square of the depth." Thus if the depth of "macadam" be 6 inches, the weight at the bottom will be spread over 36 square inches. A depth of 12 inches will be four times as strong, and the bearing surface as the bottom will then be 144 square inches and so on.

When the structure is given a depth of 12 to 18 inches, the bottom half is usually built up with rough stones and spalls compactly placed, and the interstices filled with small stones. Over this to the surface grade is placed one or more layers of stone broken into angular cubes of one to two inches across. This is thoroughly rammed or rolled into place, and then covered with a thin layer of fine gravel, or fine screenings from a steam stone crusher. Where work of this kind is now done on a large scale, the macadam stone is all broken by machinery, and the material is thoroughly compressed by a steam road roller of 18 to 20 tons weight. Sprinkling carts are also used in further compacting the surface layer, and thus a smooth and hard driveway is at once secured.—Wm. McMillan, in *Gardening*.

---

**The Myrtle.**—Another "classic" is the Myrtle, *Myrtus communis*. It grows to be a large, compact, shrubby plant, thickly set with shapely branches, and, when well grown, these branches are covered with small, white flowers, having a rich fragrance. The leaves are evergreen and shining, and, when brushed or bruised, they also are fragrant. It must have plenty of pot room, delights in being bedded out in summer, and a rich soil, such as you would give Roses and Carnations. Three things must be closely guarded against in growing the Myrtle, hot sunshine, sour soil from imperfect drainage, and the red spider. Sprinkle the leaves daily, shift into larger pots occasionally, and do not give too high a temperature. For bouquet work it is very valuable, and grown into a large, handsome shrub it is ornamental in a high degree. Cuttings of the young wood root easily. There is a double variety, also, which is said to be very beautiful, but I have never seen it.—Vick's Magazine.



## The Canadian Horticulturist

SUBSCRIPTION PRICE, \$1.00 per year, entitling the subscriber to membership of the Fruit Growers' Association of Ontario and all its privileges, including a copy of its valuable Annual Report, and a share in its annual distribution of plants and trees.

REMITTANCES by Registered Letter are at our risk. Receipts will be acknowledged upon the address label.

### ➤ Notes and Comments. ❖

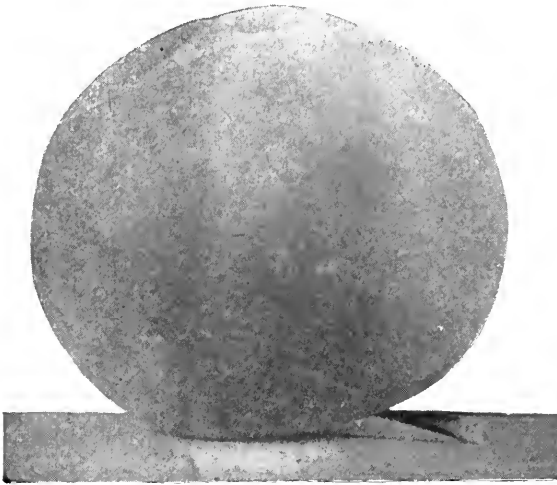

FIG. 1006.—YELLOW ST. JOHN.

THE YELLOW ST. JOHN promises to be the most popular peach of its season. To-day (Aug. 25) we visited the peach orchard belonging to Mr. Jonathan Carpenter, of Winona. He has several thousand trees, and a good many varieties for a commercial orchard, and counts the Yellow St. John as one of his best. His trees are five years planted, and receive the very best of cultivation and manure. He prunes them low and shortens them in, so that

the trees are very compact and easily picked. Under such treatment it is not surprising that his trees yield an average of five baskets per tree.

Mr. Carpenter does hand work in his peach orchard, but has a disc harrow, with an extension which will reach well under the projecting limbs and cultivate close to the very trunk. His orchard is situated on the lake shore near Winona, and the house is a substantial stone building, the approach to which is by a long avenue lined with Norway Spruce trees.

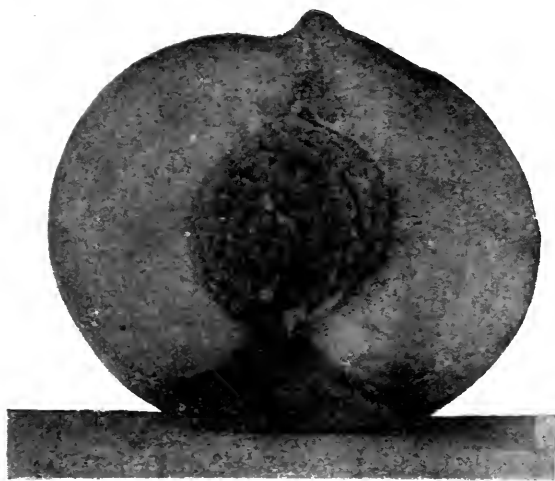

FIG. 1007.—YELLOW ST. JOHN (SECTION).

We brought home a sample of this peach for photographing, as is evidenced by the accompanying Fig. 1006. The peach is medium to large in size, yellow with dark rich red on sunny side; apex, small pointed; flesh, yellow, red at stone, juicy, melting, rich delicious flavor; stone large, free; season, 20th to 25th August.

PEACH YELLOWS AND BLACK KNOT have been made the subject of a special bulletin (No. 72), by the Experiment Station, Wooster, O., at the request of the state. This bulletin gives fruit growers full information concerning these diseases, and is sent free to applicants interested in the subject.

THE MEETING OF THE GRIMSBY HORTICULTURAL SOCIETY on Tuesday evening, September 1st, was, as usual, a great success. There was an elegant display of flowers shown by the members of the Society, and more especially by our amateur florists, A. Terryberry, A. E. Cole and Wm. Gibson. The first part of the evening might be called a *conversazione* during which the people met together and talked of the beauties before them. About nine o'clock the Chairman, Mr. J. G. Grout, called the meeting to order for the following programme: Piano duet, Misses A. McGibbon and F. Woolverton; vocal duet, Mr. and Mrs. Unwin; piano solo, Miss F. Woolverton; Chairman's address, Mr. J. H. Grout; recitation, Miss Metcalfe; address on "Lawn Ornamentation," Prof. John Craig of Ottawa; recitation, Miss Metcalfe; vocal solo, Miss Vahey.

HORTICULTURAL SOCIETIES may be organized now for 1897. The first meeting for organization proposed is fixed by law for the second Wednesday in January of any year; but previous to that time the real work must be done, viz.: Fifty names must be secured, who are willing to become members, and sign the declaration to that effect, paying in \$1 each to the funds of the Society. This declaration, thus duly signed, must be sent to the Minister of Agriculture for the Province, who will authorize a person to call the first meeting as above

and of this meeting at least two weeks public notice must be given. It is therefore time to be collecting names thus accomplishing the preparatory work, and anyone intending to take up the matter should write to the Department of Agriculture, Toronto, for a copy of the Acts relating to horticulture, in which all information can be found. Most of the recently formed Horticultural Societies have affiliated with the Ontario Fruit Growers Association, thus securing for all their members our monthly journal and report. One of our Directors, Mr. Thos. Beall, of Lindsay, has interested himself in such Societies, and will attend any meeting for organization to give information upon the privileges of affiliation with us, upon request from any persons interested in having such information. We have just received a letter from one of our members at Smith's Falls, who thinks a strong Society can be formed at that place, in affiliation with us.

---

COLD STORAGE.—During the Toronto Fair the writer paid a visit to the Dominion Cold Storage Company's premises at Toronto, and was surprised to find such excellent storage so near at home. There is no doubt that for certain perishable products, it would always pay the cost of storage to hold them until the glut is over. What fruits would pay for storage must be studied out each season for itself by each grower, for no rule seems general. Mr. Jones, the Toronto manager, gave us the following items of information :—We have altogether 15 store-rooms—the ground floor room is the largest, and will contain about eight carloads of butter. We keep it for goods having no odors, such as butter, lard, maple syrup and canned goods. The temperature here ranges from 40° to 42°. Another butter room on first floor is kept below freezing for choice highly salted butter, which is to remain in storage for a long time. Our cheese room will hold about three carloads, and is kept at 35°. This room we use for fruit also. Our fruit rooms are kept at 35° and 40°, according to the ripeness of the fruit when we receive it ; we have three fruit rooms, two of which are now filled ; the other has just been vacated by oranges and lemons, and is ready for pears, peaches and grapes ; it will hold about three carloads. We have stored since June 1st, about eight carloads of oranges and lemons, and about a car of California pears and peaches, as the oranges and lemons go out fresh fruit takes their place ; we have some very fine Canadian pears now in, and keeping perfectly. With the exception of two large rooms filled with evaporated fruits, such as peaches, apricots, plums, prunes, apples, raisins, figs, etc., and nuts of various kinds, which retain all their weight and freshness in cold storage ; the rest of our space is devoted to eggs. Eggs keep better in cold storage than if pickled, and seal for better prices.

It is no trouble to keep early pears and late peaches fresh till Christmas, and late pears, grapes and apples till the spring, if they reach us in the proper condition. They must not be quite ripe, and must be all of one degree of ripeness ; carefully selected, and packed in shallow boxes or trays. Our space is so limited now, that we have room for only a few growers who wish to experiment, and we think all who have choice fruit should, if possible, cold store a little of it.



**HYACINTH CULTURE IN POTS.**—The Waterloo Horticultural Society has just issued the following circular to its members, in view of the distribution of bulbs now about to be made by the Society — Three or four bulbs can be planted in an 8 or 10 inch pot, but single bulbs in 5 inch pots are preferable. Many good plants are grown in tin cans with holes punched in the bottom for drainage. Any good potting soil will do ; if stiff, mix with sand to make it porous ; merely cover the bulb with soil, leaving it slightly lower than the rim to permit of watering. Press the soil lightly around the bulb, but NOT BELOW ; if pressed too firmly in the soil when the roots begin to grow they will lift the bulb out of its proper position. After potting, water moderately and set in the coolest part in the cellar, cover so they are perfectly dark, but leave room for tops to grow. They can be placed out of doors, covered with four or six inches of coal ashes, until hard frost, and then removed to a dark cellar. The object in this is to have the pots filled with roots before the top grows. Plant in September or October, for the longer time they have to make roots the better the bloom, but do not bring them out of the cellar until January. If the tops have started, bring gradually to the light to give natural color. Do not hurry them, as the very best bulbs will bloom poorly in December or in January ; poorer bulbs will bloom well in February or March.

*In Glasses.*—Fill the glass with pure rain water until it barely touches the bulb, place in the dark as described above, and delay bringing up until the glasses are filled with roots, and not then if too early in the season ; change the water occasionally, but be careful not to break the tender roots. The single varieties are best for house culture.

*In the open ground.*—Plant in good, well enriched soil, four to six inches deep and six inches apart, but do not allow them to touch fresh manure ; after the ground has frozen cover with strawy manure, to keep from freezing and thawing, but remove in spring, before the tops begin to grow. Hyacinths, after blooming in water, are worthless ; those in pots, if kept growing until the tops die off naturally, will do fairly well planted out next fall, but are not worth forcing again. In the open ground they can be left three or four years without removal

Do not fail to join the Waterloo Horticultural Society for 1897. One dollar, if paid by January 1st next, will entitle you to the Canadian Horticulturist Monthly, the bound volume of Reports of the Canadian Fruit Growers' Association and Entomological Society, and a share in the plant distribution of that Association, and your choice of fruit trees, shrubs, plants and bulbs as premiums. These will be larger and better than any previous year. Subscriptions received by the President, Secretary, or any of the Directors.

## ❖ Question Drawer. ❖

### Low Prices for Apples.

**872.** SIR,—It is reported in this neighborhood that the dealers are combining to offer the apple growers an absurdly small price for apples this season. Why do not the officers of our Fruit Growers' Association take steps to counteract such a combine by making arrangements and giving information with a view to enable the growers to ship their apples for exportation direct without the intervention of the dealers, as many of them would do were this done? This seems an occasion on which the Association might well show its usefulness and justify its existence.

ARTHUR G. HEAVEN, *Glenside, Oakville.*

We would be glad, for our own sake as well as that of our subscribers, to keep the price of apples up to a satisfactory amount this season, for we have ourselves 2,000 or 3,000 bbls. to harvest. But the outlook is discouraging, and we cannot hold out hopes of high prices. If a grower can get from 60c. to \$1 for his fruit this season, as it lies in his orchard, he is safer than the man who exports, not knowing whether he will receive any returns, or there will be a draft upon him for transportation charges. However, we hope that the export trade will take all our apples at paying prices, and we will do our best to give our readers the fullest information concerning the apple market from time to time.

---

### Wintering Climbing Roses.

**873.** SIR,—Kindly inform me how I may best winter my climbing roses. I have three varieties, viz., Baltimore Belle, Prairie Queen, and Seven Sisters, the latter being about eight feet high.

MRS. VANDERWOORT, *Sidney Crossing, Ont.*

The Seven Sisters, properly called Grevillia, is too tender to succeed well in Ontario; it is of Japan origin, and tree peddlers often push its sale in places where it is ill adapted; the other two are hardy and need no protection, indeed Prairie Queen is a native, and found growing in many of the Western States. If protection is needed, a mulch of coarse manure is useful, and in the case of Grevillia, the stems might be laid down and covered with earth.

---

### Blackberries Failing.

**874.** SIR,—The Snyder grows vigorously to new wood with me, and sets plenty of fruit; then it dries right out and dies to the ground, the berry shriveling just as it begins ripening.

T. M. G., *Norwood.*

Probably the soil is not adapted for the growth of berry. Correspondence is invited upon the question.

### Where to Ship Apples.

**875.** SIR,—I have a large quantity of winter apples. Would you advise me to ship them on my own account ; and which is the best market ?

J. H. B.

We dare not undertake to answer such questions. For ourselves we intend exporting our whole crop, hoping to do better than the price offered by buyers, viz., 50 cents a barrel for the fruit ; but which is best is still problematic. The European crop is fortunately short, otherwise our apples would very likely not be worth picking this season of abundance ; but whether the immense quantities to be forwarded will not overstock the foreign market, is the question.

The Niagara District Fruit Growers' Stock Co. forwarded a car load of fall apples to England, which netted the shippers 42 cents per barrel, but of course they did not arrive in good condition.

---

### Hardiness of Weigelia.

**876.** SIR,—I would like to ask a question or two through your valuable paper. Is the Wistaria vine and the Weigelia shrub hardy in this locality, centre Frontenac, and if not, what is the proper way to protect them in the winter ?

A. F. BOND, *Inverary.*

*Reply by Mr. John Craig, Ottawa.*

Weigelia Rosea is a beautiful, half-hardy shrub at Ottawa, and I presume it would succeed better at Frontenac. It always blooms on the lower, snow-protected branches, and sometimes comes through the winter entirely uninjured. It is probably the hardiest of a great many varieties.

None of the Wisterias have proved hardy, or even half-hardy here but have not been protected. They might be laid down in the autumn and covered in the same manner in which grape vines are treated towards the north.

---

### When to Plant Apple Trees.

**877.** SIR,—Would you advise planting an orchard in fall or in spring ?

A. M., *St. Catharines.*

We would advise the spring in Canada, because the tree seems less affected by frost if left undisturbed through the winter in the ground where it has grown, and where its rootlets have a tight hold. We have sometimes noticed even a hardy tree like the apple, much set back by fall planting, and starting its spring growth much later in the spring, than trees not moved. As a rule it may be safe to move apple and pear trees in the autumn, as the check may not be very observable, but peaches, plums and cherries succeed best if planted in spring.

### Ammonia.

**878.** SIR,—What strength should ammonia be used for spraying?

J. E. K. HERRICK, *Abbotsford.*

Two quarts for twenty-five gallons of water. Ammonia, however, so soon evaporates, that we would commend some other specific washes as more serviceable and less expensive.

### Early Potato.

**879.** SIR,—What is the earliest potato for market?

H., *St. Catharines.*

During the past season we have grown Burbee's Early, with much satisfaction. It is very early, of fine size and quality.

Possibly some reader knows an earlier variety still.

### Distance to Plant.

**880.** SIR,—What is the best distance for planting plums, pears and cherries in this neighborhood?

H., *St. Catharines.*

Twenty feet is not too great a distance for all standard pears, plums, and either Heart or Bigarreau cherries. Dwarf pears, quinces and Morello cherries may be planted half this distance.

### THE MINER PLUM.

Some claim that the Miner plum is a profitable variety, while others contend that it did not bear, and they were on the point of digging up the trees. The fruit is large; skin, bright scarlet; flesh, yellow and adheres to the stone. The quality is good, and although the Miner is not invulnerable to the curculio, it does not cause the fruit to drop.

The tree is a strong grower, and will attain a height of six feet the second year from root cuttings. Owing to its rapid growth it will not bear while young. We are assured by those who have old trees that they have an abundance of fruit every year. We expect to see this variety become quite popular in a few years, as the demand is already on the increase.

*Tiverton, Ont.*

A. H. CAMERON.

## \* Open Letters. \*

### Humboldt Blackberries.

SIR,—These are a new and distinct sort of blackberries ; they grow in a trailing, prostrate form, and should be trained on trellises ; the fruit is very large, good specimens being  $1\frac{1}{2}$  inches long, and nearly an inch thick, and of a beautiful, jet black color ; their flavor, however, is what charms everybody, being entirely different from that of any other variety of blackberry known, or in fact any other berry ; their fascinating, spicy flavor, makes them of unrivalled value, for pies, jams, jellies, etc. They are the earliest blackberries known, ripening about a month before the Early Harvest blackberry. They are very hardy, and will endure almost any climate. They are marvellous yielders, and give heavy crops the next season after being set out. As a money maker, it stands high, as all its crop of fruit is ripened before the Early Harvest and other common blackberries commence to ripen ; and it is these early berries that command the highest prices in market.

S. L. WATKINS, *Grizzly Flats, Cal.*

---

### Trees Worth Planting.

SIR,—In choosing trees for planting for either timber or shade, the aim should be to have what will make the largest growth of wood in the shortest possible time. In planting for timber, the quality of the wood is the chief consideration. In planting for shade, beauty, symmetrical figure and cleanliness are to be regarded ; but when one tree possesses all these qualities, it may be good either for timber or shade.

It is always best to plant for shade reliable free-growing varieties, which are sure to make a growth, and remain healthy, even though they are not as handsome as some of the other kinds, which may do well in other localities.

For timber or for shade, the wild cherry might be put to a good use. It may be trained into almost any desired shape, and its dark green pear-like foliage gives it a very ornamental appearance.

The American mulberry is a very handsome tree, and one or more specimens should be in every collection. Its rapid growth and the beauty of its foliage ought to make it a favorite, aside from the value of its fruit, which is excellent for dessert and canning purposes. Magnolias are very popular, and some will have them if they have to search the swamps, or pay a high price to get them. Unlike the ill-shaped specimens in the swamps, the magnolia properly cultivated may be made to grow symmetrical, and become a ‘thing of beauty,’ for its large bright leaves are always fresh, and the seed-pods colored red and brown, are an ornament to the tree.

A. H. CAMERON, *Tiverton, Ont.*

---

### Superiority of Canadian Apples.

SIR,—To-day I purchased some *fair, handsome* Early Jose apples at one cent each, from the South. They measured one and three-quarter inches in diameter the longest way. They were *free* from defects. color dull crimson, skin *very* thick, flat sub-acid flavor, flesh soft, but they *were not over-ripe*. In my garden at Oshawa, the Early Jose was thin-skinned ; cheek in the sun bright deep crimson, flesh *butter*, brisk sub-acid flavor, which was appetizing and refreshing. Now this is a fair statement as to all summer apples from the South, as compared with Canadian apples. The clear dry air of Ontario gives the fine brilliant color, which makes apples *attractive*, and when in addition they are refreshing and appetizing, they create their own market when they are known. To make them known, send them to market and advertise them, and from that time they will advertise themselves. God made the conditions which makes Canadian apples (Ontario and Quebec) superior to others. Man cannot make them or change them, therefore you cannot over-stock this market with prime fruit, well and carefully packed in small packages. Long before trees now planted come into bearing, your farmers will have free access to this market.

September 1st, 1896.

FRANCIS WAYLAND GLEN, *New York.*

## Mildew-Proof Gooseberries.

SIR,—I find I must alter my list of supposed mildew-proof gooseberries, as this hot, dry summer produced mildew on every variety except Houghton, Downing and Smith. Triumph showed slight mildew on the top of the shoots. This variety is less subject to mildew than the Industry. To me the new American berries, Columbus, Triumph and Chautauqua appear to be simply Whitesmith seedlings. The Chautauqua and Columbus have the best flavor, but it is a very faint flavor indeed, while the Triumph is so poor to eat that I infinitely prefer the Whitesmith. These large American berries show no trace of any native strain. Still they are fine, satisfactory berries, equal to the Whitesmith in size and of much freer growth.

W. E. BROOKS, *Mount Forest, Ont.*

## Good Prices for Fancy Fruit.

SIR,—Just as I anticipated, fine summer apples are the rarest fruit in this market. Friday last at 6 a.m., I went fruit hunting, so as to catch the grocers just as they came from the wholesale market. I saw and purchased a small measure (two quarts) of handsome Red Astrachans, price 20 cents; skin thick enough for upper leather. Very mild; sub-acid flavor; there were fifteen apples in the two quarts; price per bushel at that rate, \$3.20. Saturday I purchased from the push carts on Frinting-house Square, twenty *superb Crawford peaches* for 25 cents, and fine yellow egg plums for 10 cents per dozen. From my grocer, same day, *prime* five-pound baskets of Delaware and Niagara grapes for 25 cents; twenty *prime* Bartlett pears for 25 cents. The apples are scarce, but the plums, pears and peaches are abundant. The plums are from California, South Carolina and Georgia. Your September plums will find a good market here, and you cannot even stock this market with fine blue Damson for preserving and pickling this fall. Last year ten-pound baskets of such plums were scarce at 75 cents in Fulton market, and none to be had of grocers at any price. The rarest of all the small fruits this year were Black-caps. They are my favorite fruit, and I only secured them three times of my grocer, and paid 15 cents per quart for them. Give us some good Canadian apples, apples that are appetizing, and when they are known, you cannot supply the demand if you produce a million barrels.

FRANCIS WAYLAND GLEN, *New York.*

August, 1896.

## Astrachan Apples.

SIR,—To-day I purchased three handsome smooth *dull red* Astrachan apples, free from spot of blemish, for five cents. I ate one of them and gave the other two away. Why? Because they were so near sweet that they were insipid, and produced a feeling of fullness in the region of the stomach. If they had been grown in Ontario, I should have eaten all three of them, and purchased three more. Ontario apples are appetizing, while those I purchased to-day produced a clogging sensation, and one was enough. Ontario apples create their own market when once known. Only Ontario air and sunshine can produce them. Man cannot make the same combination of air and sunshine, and, therefore, cannot grow Ontario apples south of Lake Ontario.

FRANCIS WAYLAND GLEN.

↪ Our Book Table. ↩

THE NURSERY BOOK, a complete guide to the multiplication of plants, by L. H. Bailey, 3rd edition. New York: The MacMillan Co., 66 Fifth Avenue. 1896. Price \$1.

This is a most useful book for all those interested in the propagation of trees and plants. Like all Prof. Bailey's writings, it is lucid and yet very comprehensive. Chap. I. is devoted to Seedage; Chap. III. to Layerage; Chap. IV. to Cuttage; Chap. V. to Graftage. This is the 3rd edition and is well illustrated.



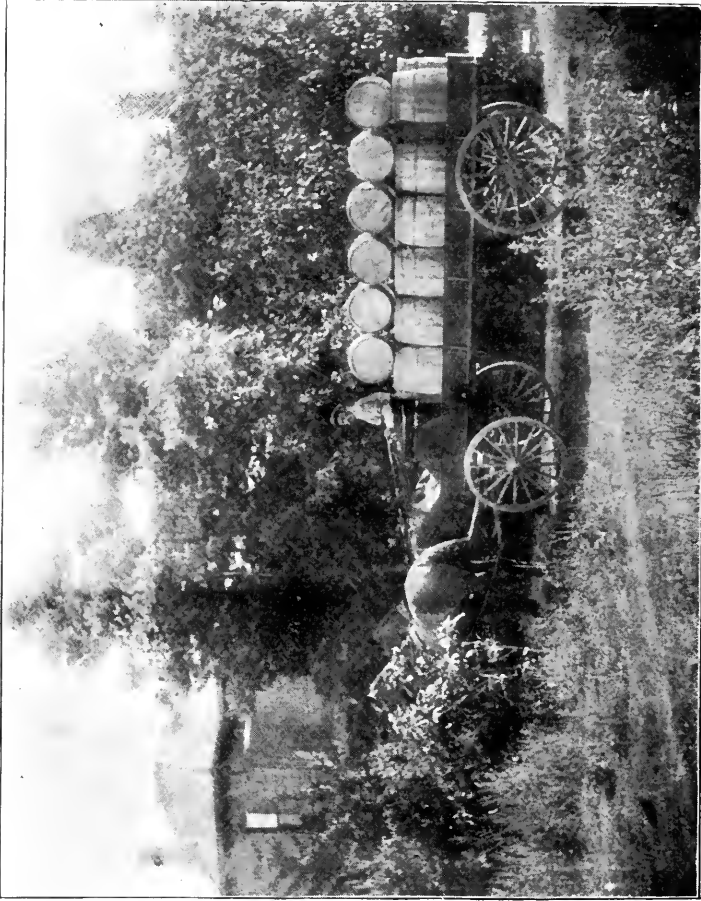

**Shipping Bartlett Pears.**



THE  
Canadian Horticulturist

VOL. XIX.

1896.

No. II.

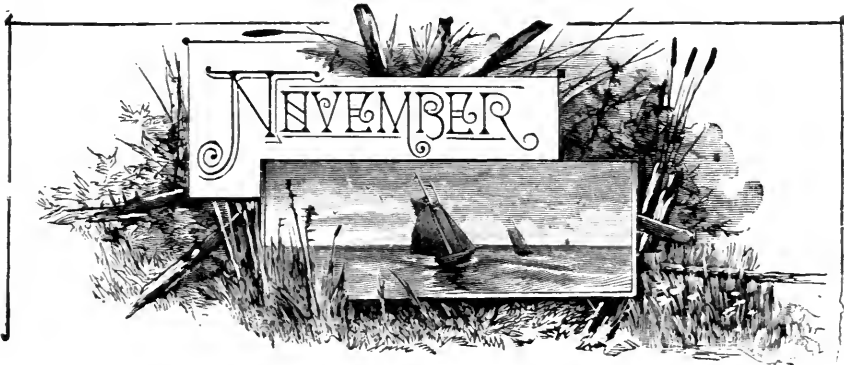

MR. GEORGE CLINE'S PLUM ORCHARD.



ONE of the largest plum orchards in the Niagara District belongs to Mr. George Cline, and is situated about midway between Grimsby and Winona. The conditions here at the foot of "The Mountain" are much the same as those at Clarksburg, where our Plum Experiment Station is situated, so that varieties that succeed at the one place may be almost counted upon as sure to succeed at the other.

It is the same mountain that winds up from Hamilton to the Manitoulin Islands, passing near to Collingwood, and dividing up near Clarksburg to form the Beaver Valley. When driving through this section with Prof. Hutt, we were struck with the general appearance of the orchards which so resembled our own at Grimsby.

We visited Mr. Cline on the 14th of August, and found his force of pickers busily engaged harvesting the Bradshaw; we took a snap shot of them at work as shown in the engraving on the next page. Mr. Cline's trees are breaking down under their immense loads of fine fruit. He had nearly all varieties in his orchard, but of course, confines his attention to only a few for market purposes. Already he had harvested about 4,000 baskets—chiefly Bradshaw and Washington, and expected that his crop of all varieties would amount to about 12,000 baskets. This is not an extraordinary crop when we consider that Mr. Cline has about 5,000 plum trees, mostly in bearing.

The plums are picked by gangs of men in the orchard as shown in Fig. 1008, and brought to the fruit-house for packing. Mr. Cline's sons take charge of the work to a large extent, and superintend the packing and shipping.



FIG. 1008.—PICKING PLUMS IN MR. CLINE'S ORCHARD.

Mr. Cline's fruit-house (Fig. 1009) is simple in construction, and quite inexpensive, costing only about \$300 complete. The main part is 24 x 36, built

of concrete, with cellar under the whole, the walls of which are about nine feet high. The shed addition for driving under is 14 x 36. The whole can be easily understood from the accompanying engraving.

The Bartlett pears were also being harvested at the time of our visit and shipped away in barrels to Canadian markets. A load of about fifteen barrels of them was just going off to the train, and we took a snap of them also (frontis-



FIG. 1009.—FRUIT HOUSE.

piece) in order to show our readers Mr. Cline's new fruit wagon, which is well adapted to carrying large loads of fruit. Many fruit growers about Grimsby are providing themselves with large platform wagons, which will carry about twenty barrels standing upright, but Mr. Cline prefers this long commodious box.

Mr. Cline's fruit farm is near the Mountain extending down to the line of H. G. & B. electric line by the side of which he has built his house, a two story brick, well sheltered by groups of evergreens, and other trees. (Fig. 1010.)



FIG. 1010.—RESIDENCE OF MR. GEORGE CLINE, NEAR GRIMSBY.

**C. R. H. Starr**, of Wolfville, Nova Scotia, says that the output of Nova Scotia apple orchards to the English markets this year will be between 300,000 and 400,000 barrels. The crop will be the greatest in the history of Nova Scotia. The year before last the export from Nova Scotia to England was 225,000 barrels, and last year it was less. The crop is light in England, but it is heavy in the United States and Ontario, as well as in Nova Scotia. Tonnage is comparatively scarce and shippers are compelled to pay about five cents per barrel more than last year.

**English Rules for Judging Fruit.**—The following rules, says Garden and Forest, are in use by the Royal Horticultural Society, London: The fruit is judged by points, 12 being the maximum, and these points are distributed in the following proportions: For flavor, 6; for quality, 3; for appearance, 2; and for size, 1. It is explained that "quality" is intended to mean the degree of smoothness or meltingness of the flesh (the absence of grit), or, in case of early apples, crispness and juiciness of the flesh may be considered. Quality, therefore, refers mainly to the texture of the flesh. Appearance, of course, includes color and beauty of form; but size, which counts only one-twelfth in the estimate, does not mean that the largest fruit receives the highest marking. There is a type size, which invests the fruit with its greatest value for table use, and this is counted perfection. Enormous specimens are not preferred, since beyond a certain point size is a defect in dessert fruits.

## PACKING APPLES.



ALL apple growers who have a few hundred barrels or more of apples to handle should be able to pack their own apples in a proper manner for export. This is all the more important in a season like the present, when apples are so abundant, that buyers can get fine fruit at their own prices. How is it that when winter apples are selling (Oct. 6th) in England at from \$2.50 to \$3.50 per bl., buyers here are only paying about 80 cents per barrel? All the expenses of export are only about \$1.25, and it is plain that the buyer is making more than the grower.

A few hints on the best methods of apple packing will therefore be in place, and may help our growers to get proper remuneration for their goods. Indeed in no other business except apple growing, do people ever think of waiting for somebody to come along and pack their goods. Why then should the fruit grower let his apples rot in his orchard waiting for some travelling buyer to offer him a mere song. He should on the other hand wake up to his opportunities, learn to pack his own fruit, and put himself in communication with the best markets.

*Harvesting.*—A common mistake is to leave apples hanging on the trees till the middle of October, by which time a large quantity of the sound fruit will be blown off by the winds, and that remaining will be over ripe. It is better to begin as soon as the apples have their full color, and this begins with some varieties about the 20th of September. Our practice is to gather apples in about the following order, according to their time of maturity; viz., Blenheim, King, Ribstons, Snow, Greening, Cranberry, Golden Russet, Spitzenberg, Baldwin, Roxbury Russet, Spy.

In the case of a large crop of a thousand or more barrels it is best to pack for the most part in the orchard. We do not favor the common practice of making piles on the ground, to be left exposed to rain and sun, and to be picked up again by hand. A packing table can be quickly made, such as is shown in the illustration, Fig. 1011; this is carried from place to place in the orchard, convenient to the trees, and the pickers dump the apples upon it, while the packer proceeds to pack them into the barrels. One good packer with an assistant a part of the time, will put up, and head thirty or forty barrels a day in this way; and keep four or five pickers at work.

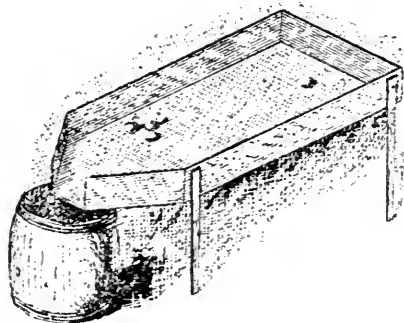

Fig. 1011.—PACKING TABLE FOR APPLES.

In grading it is very important to make No. 1 strictly first class, free from worm-holes, knots or scab, and fairly even in size. If No 1 grade shows too great a difference in size, it is well to separate large ones, and make *No. 1. first size*, and *No. 1 second size*. In a year like the present, it will not pay to put up grade No. 2 at all. Better let them waste in the orchard than glut the market with them, and perhaps the shippers be drawn on for the freight.

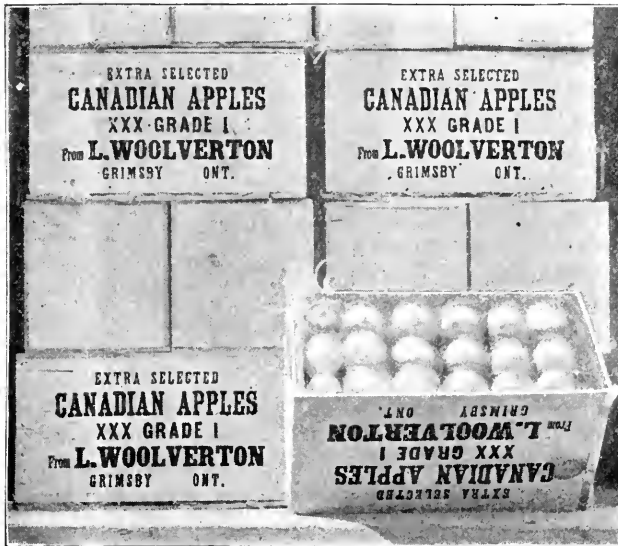

FIG. 1012.--

For extra fancy apples, such as selected Fameuse, selected Kings and Cranberry Pippins, it sometimes pays to use a half barrel or bushel case, such as was shown at the recent meeting of our Association at Woodstock by the writer. Especially for our export trade in apples to Australia, there is no doubt that the bushel case is well adapted, but for ordinary stock the barrel is the best package. We experimented considerably with the bushel case last year, and the report from Liverpool advised they be not used for ordinary stock ; that the barrel was the best possible package for the wholesale markets.

## THE SCARLET PIPPIN.



HEN paying an official visit to Mr. Harold Jones, fruit experimenter for the St. Lawrence district, last year, we were shown an apple of great beauty which originated at this station, and which seemed to possess promise of great value. Mr. Jones himself has proved it most valuable for export as a high class dessert apple, free from scab to which the Fameuse is subject, and almost equal to this famous apple in quality. Mr. Jones showed some beautiful samples of this apple at the winter meeting of our Association at Woodstock, and now Mr. Craig, of the Central Experimental Farm, at Ottawa, has had his atten-

tion also drawn to this apple. Mr. Craig has forwarded two samples to the writer, and writes :

SIR,—I sent you on Saturday a package containing some specimens of an apple called the "Crimson Pippin" sent to me by Mr. Harold Jones, apple experimenter at Maitland, Ont. I send this to you in order to draw the attention of the readers of the HORTICULTURIST to a family of exceedingly interesting, and what I think will prove valuable apples, which seem to have originated in or about Brockville. I say family of apples because from the character of the flesh and judging by its quality and general appearance I believe this Scarlet Pippin to be a relative of or to have originated from the same strain of seed as that which produced the McIntosh Red. A number of seedlings of the same character have been sent to me from the St. Lawrence district about Brockville. Only two days ago some specimens were sent in here which were grown from seed obtained

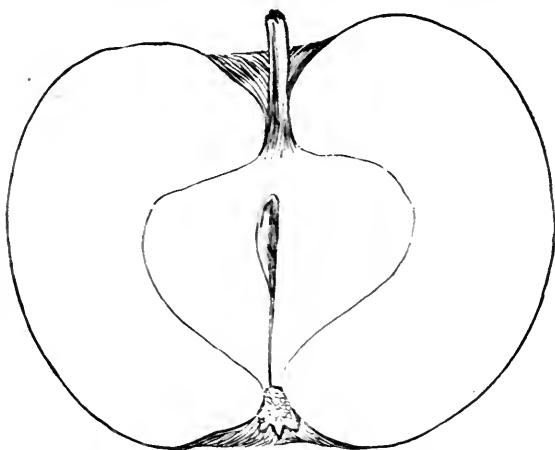

FIG. 1013.—SECTION OF CRIMSON SCARLET PIPPIN.

from that region about 18 years ago. This latter sample would easily pass for a McIntosh Red, but was firmer in flesh and slightly more acid. I merely mention this fact in order to show what is being done in a hap-hazard way in plant breeding and to emphasize what might be done if a carefully thought out line of action were decided upon and carried to completion.

## THE BAY OF QUINTE APPLE STATION EXHIBIT.

OUR Fruit Experiment Station near Belleville promises to be of great practical value to apple growers. One hundred and thirty varieties of apples were shown at the Industrial from this Station, and our experimenter, Mr. W. H. Dempsey, was himself present with us most of the time to give information concerning varieties. A view of some of these stations is here given by the kindness of our excellent contemporary "Farming." The fruit trees at the Station were largely planted by Mr. P. C. Dempsey, our late Director for Division No. 4, and his son, Mr. W. H. Dempsey, is



FIG. 1014.—A VIEW OF BAY OF QUINTE STATION.

proving himself a worthy successor. He not only interests himself in the many varieties top-grafted in his orchard, but takes great delight in adding all the new varieties which we are forwarding him by order of the Board of Control. It is the intention that this Station should have every variety grown in Canada under test, so that we may report upon its value.



## OUR EXPORT TRADE IN FRUITS.



ORTUNATELY for the future prospects of Ontario Fruit Growers, the Department of Agriculture for the Dominion is making arrangements for the encouragement of our export trade in fruit. The exceedingly large crop of fine apples harvested the present season, demonstrates not only the great possibilities of Ontario as a fruit producing country, but it also proves the importance of an extended export trade in all our finer fruits. The other British Colonies are taking full advantage of the excellent market of the mother country, and are reaping a great increase of revenue thereby. The Journal of the Society of Arts published in Covent Garden, London, says :—

The increased facilities for exporting fruit by the adoption of cool chambers have enabled Australian fruit growers to compete with foreign States in the fruit supply for the English market. The Tasmanian trade with England has passed the experimental stage, and every season large steamers visit Hobart to receive fruit for the home market. With the exception of Tasmania, at least up to 1892, all the colonies imported more fruit and fruit products than they exported. The garden and orchard crops of Queensland, Victoria, and West Australia give the most return per acre—from £20 to £24. In the other colonies, in 1892, it averaged from £11 for New South Wales to £19 for New Zealand. The smallness of the average for New South Wales was explained by the fact that the producers could not get their produce sold and had no facilities for disposing of it.

*New Zealand* has left no step untaken to develop an export industry. The Government appoints pomologists and instructors, gathers information about the demand in the home market, and all advice likely to be useful to would-be exporters. Generally speaking, all English fruits grow luxuriously, and in the Auckland district, oranges, lemons, and limes flourish as well as olives, the manufacture of oil from which promises to be an important industry. Home grapes are largely sold in the Auckland market. The apple orchards near there have existed half a century, and yield returns of £40 to £50 per acre. Orchard planting is progressing, and must soon become an important industry. *New Zealand* has to some extent mastered the problem of landing fruit in a good condition in the London market, and the trade has passed the initial steps. It is important to notice that fruits of the proper varieties, and properly packed, have invariably realized remunerative prices. It is largely a question of packing and freights as to how great an extent the trade grows.

It will be necessary to say little about fruit in *Tasmania*. Apples from

that colony have become in England one of the most acceptable fruits for the early spring, though they were unknown to us here as an article of commerce prior to 1889. Expert advice on the varieties, the modes of packing, transit, and all details was sought. Then the market was sounded, fruit brokers approached, and the information sent throughout the colony. The mail companies assisted, and the fruit, on arrival, was inspected and reported upon. All this is unnecessary now; a sound footing for the trade has been secured, and Tasmania sent us last season 160,000 bushels of apples. Some improvement however, is needed in distribution here, for the growers declare that the London middleman swallows too large a proportion of the profits.

Canada has done her part in one fruit only, and that is the apple, a trade which is rapidly assuming colossal proportions. In 1881 Canada sent to Great Britain over 45,000,000 lbs. of fruit, and in 1891 over 68,000,000. The average export of apples each year from 1891 to 1893 was over 2,000,000 bushels, against only 176,000 bushels from other British possessions. In 1895 Canada's exported apples amounted to nearly two million dollars. But this is only a small part of what Canada can do in apples, as the records of 1896 will testify. Then consider her grapes, plums, peaches, pears, tomatoes, early apples, and small fruits, all of which might find a good market in the great cities of Europe, if cold storage chambers of sufficient size can be secured. This, we are glad to note, is one of the plans which the Hon. Sidney Fisher, the Minister of Agriculture, has in view.

According to the Journal above quoted, there are in Great Britain some 218,428 acres of orchards; they are increasing very slowly and, considering a trade in fruit, if we except pears in a good season, English competition need not be considered. Much development of English fruit-raising will not take place;—the difficulties are (1) the climate, (2) land tenure, (3) unprofitableness in most years. We may, therefore, look with confidence upon the permanence of this export trade.

There is also hope that Australia may become a good market for Ontario apples. Cranberry Pippins sent by the writer to Sidney in 1895, sold as high as \$3.75 per bushel case, and the freight through was only about \$1 per case. The only bar is want of cool chambers for crossing the tropics, but we are informed there are already cool chambers on board the steamers from London to Sidney, so when we have them from Montreal to London, the chain will be complete.

---

### THE IRON-CLAD APPLES.

The dwellers in those cold parts of our continent where the thermometer ranges downward into the thirties and forties below zero all through the winter, and the mercury is almost sure to freeze two or three times, have been greatly

cheered by the discovery of apple trees which will endure such cold without harm, and yield good fruit abundantly. With such sorts as the Russian Yellow Transparent, Tetofsky, Duchess of Oldenburg, Switzer, Longfield, Antonovka, Titovka, Bogdanoff, Arabskoe, and the Anises, and the American seedlings, Bethel, Foundling, Wealthy and Scott's Winter, with various others now being brought into notice, there is no part of North America yet inhabited by white men that cannot grow good apples in profusion. The demonstration of this fact has been accomplished in the last fifteen years. It is the work of men unknown to fame, whose names will never be celebrated in the historical annals of any country, yet who have conferred a great and enduring boon upon many millions.—Vick's Monthly.

### LORD ABERDEEN'S REFERENCE TO OUR ASSOCIATION.



It is with some satisfaction we notice that the first gentleman in Canada, our Governor General, is a regular reader of this Journal and of our reports. In his recent address at Markham, he made reference to our work in the following terms:—"What did we read in one of the Toronto daily newspapers last Monday? We read, or might have read, the following: 'Canadian apples, London, Sept. 27. Messrs. Woodall & Co., of Liverpool, report that Canadian fruit arrived freely during the past week, and has shown more quality. The quotations per barrel are as follows: Fancy reds, 14s. to 17s. 9d.; good reds, 12s. to 15s.; 20 oz., 9s. to 11s.; White & Co., of London, report the arrival of 700 barrels from Canada, chiefly fall fruit, fetching 10s. to 14s. per barrel; also 800 Nova Scotians, chiefly Gravensteins, fetching 8s. to 12s. A large quantity came here via Liverpool, of which Baldwins fetched 11s to 13s. per barrel; Kings, 14s. to 17s.; Greenings, 10s. to 11s. A lot of these were slack-packed fall fruit, and ought never to have been shipped here, as it spoils the business. There is every prospect of good business for good apples, properly packed, arriving here in good condition.'

"It is not the first time that we have heard something of this sort. If any one were to stand up in this crowd and say something hostile to Canada or her trade, I don't think he would get a favorable reception. I would not envy him. But what about sending inferior and badly packed articles to a distant market? However unintentional there is the liability to a harmful result. (Hear, hear.) I believe Sir Charles Tupper, when High Commissioner, did good service when he objected to all the apples from this continent being described as American. He encouraged a system by which Canadian apples should be classified as a distinctive article in the British market. This is, of course, desirable, but it involves responsibilities, as well as advantages. If Canadian apples are to be

classified as such, this, of itself, emphasizes the need of care and watchfulness. And I venture to say that the Ontario Fruit Growers' Association has done good service in this direction. I believe there is still some difference of opinion as to whether the inspection and grading of fruit should be compulsory. There is, in fact, already a statute providing for this, but I understand that it is to a considerable extent inoperative. If, however, the Fruit Growers' Association believe that it ought to be put in full force, I have little doubt that they will succeed, and it is to be hoped, therefore, that they will move forward in that direction, if such action seems clearly desirable. I have alluded to fruit, but similar observations might be applied to other products, and more especially to those of the dairy. And not only is watchfulness needed, but we must also agree that a system of cold storage would do much towards enabling the Canadian farmer to enter the British market. As to the association to which I have referred, and others of a similar sort, I think their existence certainly illustrates that recognition on the part of the farmers of the need of scientific, as well as energetic, methods of farming, and their existence is therefore doubly to be welcomed. Farming is a pursuit needing skill, brains and all the resources of our community, and, as I have said already, those who promote the agricultural interests, are doing a patriotic work, of benefit not only to themselves, but to future generations."

## QUINCE CULTURE.



ANY soil that will grow 50 bushels of corn or 100 bushels of potatoes per acre will grow quinces. The ground should be rolling enough to drain well but not hilly enough to permit the soil to be badly washed away by rains. If it washes the top soil will soon disappear, leaving the roots near the surface, or entirely exposed, which means death to the trees. Plant in rows 14 by 14 ft. Some growers advocate planting by setting one tree in the center of each four trees, but my experience is directly against it. In squares, rows both ways, the cultivation can be done both ways, which is the easiest, cheapest and best.

Quinces, like forest trees, need but little training. During the first two years remove branches that are likely to interfere or cross, for all branches then will be main branches in time, and will seriously interfere if allowed to cross or touch each other. After that the trees will nearly take care of themselves, as far as training is concerned. Let them head low and remain so; for quinces are of a dwarf habit. If the head is formed within a foot of the ground, it will not be too low. The best tool for cultivating is a disk or cutaway harrow, followed at intervals by an Acme harrow. These tools reach beyond the team and under the branches of the trees, thus stirring the soil and keeping down

the weeds under the trees. A plow is not very satisfactory. It cannot be used under the trees without danger of barking them; it does not leave the ground level and must be followed by some other tool to smooth down the ridges. The other tools mentioned do not throw dirt enough to form a ridge either at the trees or in the space between; either of which would not be desirable.

In the selection of modes of cultivation, above all things use horse power, as it will not pay to do much hand work. Quinces are very subject to the ravages of the borer, the eggs of which are laid by a moth in the spring at the base of the tree. When hatched, the young grubs bore into the tree and there remain, feeding on the sap, wood and bark until full grown. If not protected from its ravages the tree will be killed. No perfectly sure preventive has yet been devised, although several methods have been used that are helps. One is to mound up the earth around the base of the tree in the spring. Leave it until the moth has deposited her eggs, then remove it; which will generally remove the eggs and small grubs and cause them to be killed by the hot sun. Another method is to smear the base of the tree with coal tar or other preparation, that will repel the moth and kill the eggs and larvæ. Sometimes a mound of ashes around and close against the tree answers admirably. But when once in the tree it is best to kill them by knife and wire if possible, even at the risk of some damage to the trees, as their presence there in any considerable numbers means great injury to and final death of the trees.

Rotten chips from the wood, the ashes from the house, manure from the pig-pen, cow-stable or barnyard are all valuable fertilizers. If the orchard is large, or the soil not as good as desired, these can be pieced out with commercial fertilizer; all put on broadcast and harrowed in. Salt is sometimes recommended, but in the experiment I have made with it I could discover no appreciable benefit. Of varieties, I have had best success with the Orange and Old Pear, although Champion and Meechs' Prolific are both good.—T. E. Goodrich, Union Co., Ill.

---

### THE LAWRENCE PEAR.

Many Eastern pomologists are fond of building up their faith with Beurre d' Anjou for their corner stone. While nothing can be said against this excellent variety, as time goes by, the impression of many growers in this part of the country is that the Lawrence is second to none for the purpose. It would be a loss to be bound down to but two or three kinds of pears, and no one here would like to be without the Bartlett and the Seckel in the garden, but where marketing or preserving is in question, it is safe to say the Lawrence is unsurpassed for profit. The tree is, perhaps, not so rampant a grower as some others, but then it is hardy and healthy, and a most prolific bearer. By a little care one can have the fruit to eat all winter. Left to itself it ripens about the

time of the first frosts here, say the early part of November. But some can be gathered earlier than this and ripened indoors. When all are picked and stored indoors, they ripen one after another for a period of a couple of months. There are really but few good winter pears, which is what makes this of so much value. There is one way in which this fine pear can be had, not only all winter, but all the next summer too, and this is by canning it. It is one of the very best of them all for this purpose, possessing a flavor which suits the taste of almost every one. If a half dozen pears are to be planted, let one of them without fail be a Lawrence.—Practical Farmer.

### FERTILIZING THE ORCHARD.



HERE is much yet to be learned respecting the fertilizing of orchard lands. In general, nitrogen can be supplied in sufficient quantity by thorough tillage and the use of occa-

sional cover crops of crimson clover, peas or vetch. In fact, it seems to be easy to apply too much nitrogen on some lands, causing the trees to make a too heavy growth. Young trees make light drafts of potash and phosphoric acid, and it is probable that apples and pears do not need much fertilizing on good soils for the first three or four years, if they are given good cultivation, unless other crops are grown with them. But just as soon as the trees show an inclination to bear, judicious applications of the mineral fertilizers may be made. If this fertilizing is begun thus early in the life of the orchard, and if the tillage is good,

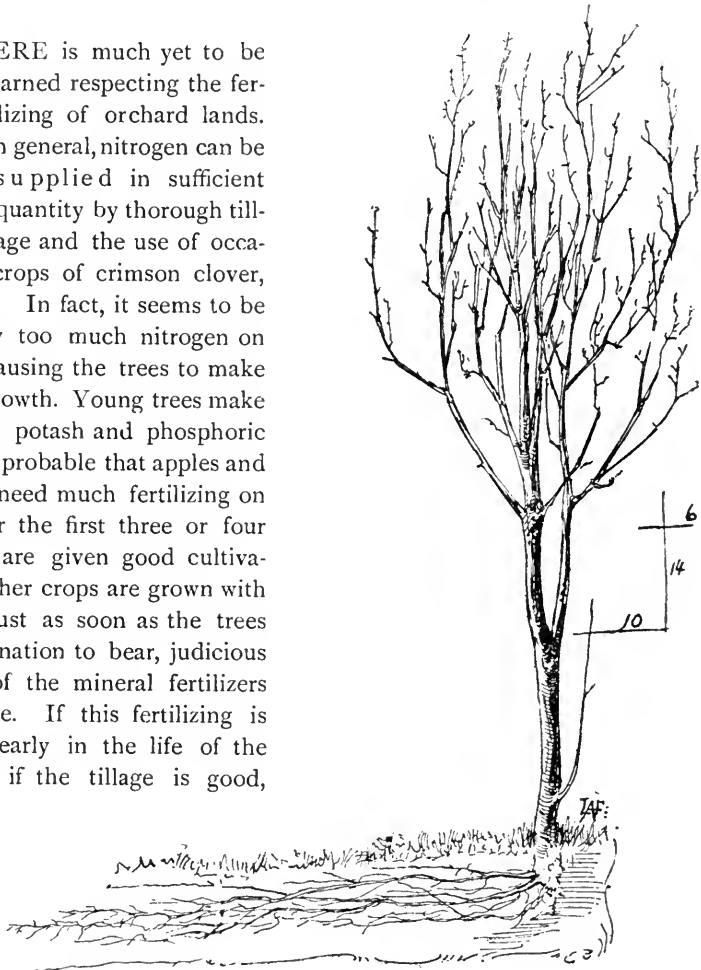

FIG. 1015.—ROOTS OF AN APPLE TREE IN SOD.

the applications need not be very heavy, but they should be applied every year. Two or three hundred pounds of high-grade muriate of potash, and an equal weight of some high-grade phosphate (as Florida or South Carolina rock or fossil bone) may be considered to be good dressings. Stable manures are excellent, but they are so seldom to be had in sufficient quantity that they are practically beyond reach.--Cornell Bulletin.

### IMPROVED PROCESS IN CIDER MAKING.\*



CIDER apples should be placed in piles 12 or 18 inches deep under cover in well-aired sheds, to avoid heating and to protect them from frost and rain, all of which rob apples of flavor and sugar. Even a few decayed apples will cause the cider to be flat and of bad flavor. The French are careful not to mix properly matured fruit with either green or overripe fruit. To make fancy cider the fruit must contain sugar, albuminoids, tannin, mineral matter and a certain degree of acidity. Sugar is necessary to cause fermentation, and its transformation into alcohol gives to the cider its strength and body, and its preservative property. One may overcome its absence by adding, say  $3\frac{1}{2}$  pounds of sugar to the barrel of crude juice. Tannin is pre-eminently the clarifying and antiseptic property of cider, and serves to modify the alcohol in cider, and without it the cider would soon become thick and ropy. In apples of good quality there should be from three to four grains of tannin per thousand, but certain sweet apples do not contain more than two grains. Albuminous bodies give body and softness to the cider, and help to preserve it by preventing fermentation of cider into acetic acid or vinegar. A moderate quantity of malic or tartaric acid is indispensable to proper fermentation, during which these acids act upon the alcohol as it is produced and form an ether, which gives to the cider a characteristic taste and smell known as "bouquet." Very sour apples contain too much acid and are mixed with sweet fruits to improve the taste of the cider and render it more digestible; hence, the mixing of several varieties of apples.

We judge French cider mills are not usually as good as our American machines, which make a complete mash of the fruit by grinding it up to fine pulp. After mashing the apples, the usual practice in France is to place the pulp in uncovered vats or tubs and leave 12 or 14 hours before pressing, stirring meanwhile from time to time with a wooden shovel, in order to bring the mass

\*Compiled from a report of the recent French Pomological Congress, made to the Department of State by Consul Chancellor. Cider is superseding wine in France, and the utmost care is used in making it. Last year 678,000,000 gallons of cider were made in France, an increase of one-third over 1895 and nearly double the average of the past ten years.

into contact with the air. This is done to improve the color of the cider and make it richer in tannic acid, but recently it has been found that these advantages can be obtained as readily by aerating the crude juice, which is the practice in the best American cider mills. Before running the crude juice into barrels, the utmost pains is taken to have them perfectly cleaned. The barrel is washed with a bucketful of warm water containing a quart of ordinary sulphuric acid, and it is then fumigated with burning sulphur to destroy all vinegar or other germs of decay. The most scrupulous cleanliness is observed in the cider cellar to avoid microbes injurious to the fine quality of cider.

After the juice or "must" is in the barrels, comes the most delicate part of the cider making, for a prompt but brief fermentation is necessary to clarify it before the sugar is entirely changed into alcohol; the remaining sugar keeps up a slow fermentation and prevents vinegar. This "working" is caused by a great variety of microbes,—one will produce a sweet cider, another a dry or sharp cider; one produces a fragrant limpid drink, another gives a flat and turbid cider. In France a leaven or culture of microbes, made from apples of the finest cider qualities, is added to common juice to improve the cider.

Fermentation is slowest at 32° F or less. At 130 to 140°, many of the germs die; between 68 and 78° they are most active. If the temperature is below 68, a small quantity of must, heated to about 120 or 125°, is poured into the barrel. Heating the cellar is condemned, because heat remains after fermentation has been established, and tends to increase the action of the ferments too much. Oxygen is essential to fermentation, hence the liquid should be stirred frequently; draw off a quantity now and then and return it to the barrel; leave the bung-hole open, or preferably, stop it with a bit of cotton wool, which admits the air, but excludes injurious microbes. Fill the barrel only two thirds full of the juice at first, so that a much larger surface of the liquid will be exposed to the air. If the fermentation is retarded because the must is sour or too acid, add a little juice from a barrel that is working satisfactorily. A good cider may be destroyed by the addition of a bad ferment, due to not thoroughly cleaning the vessels used. Sometimes acid juice is neutralized by the addition of a handful of wood ashes to the barrel and then stirred, but this produces a flat cider without color. When fermentation is active, a characteristic brownish foam rises to the surface; otherwise, there will be a white scum, which is a bad sign.

After 10 or 15 days, fermentation ceases. The liquor has become clear, the dregs settling to the bottom or rising to the surface, and the cider shows a specific gravity of 1015 to 1020. This is the time to draw it off by a siphon or by a spigot sufficiently above the bottom not to disturb the dregs. The cider is now run into a clean barrel, where it undergoes a second fermentation. When this ceases, indicated by the absence of further bubbles of carbonic acid gas, the barrel should be completely closed until the time arrives for using the cider. Cider is preserved well enough in barrels when they are completely full,



but when the barrel has been partly emptied, there is danger of its degenerating in quality. Bottling cider has become a large industry in France. It is important to choose the proper moment for bottling, when fermentation is neither too active nor too feeble, so that the cider will be clear and sparkling, make a pleasant, refreshing and hygienic drink. It ought not to be bottled when its specific gravity is greater than 1015, and some experts wait until it indicates not more than 1010, then adding two lbs of sugar to one hundred gals of cider. In that way, a clear fragrant drink, sparkling as champagne, will be obtained.—American Agriculturist.

### THE PEACH WITH THE APPLE.



HERE is perhaps more desire to plant the peach and apple together than any others. It would seem, upon first thought at least, that they are well suited to grow together, because they make trees of about the same general style and size, and the peach trees being the shorter lived will be soon out of the way of the apple trees. This has been tried very often and in some cases with good and satisfactory results, but my own experience and that of most others, whose orchards I have carefully observed, have not been so. The main trouble is, that the peach trees grow the most rapidly for the first few years, and rob the apple trees of a part of their nourishment. This prevents the apple trees from gaining the size and vigor which they should attain before or by the time bearing begins. In many cases the apple part of the orchard is the more valuable, although rarely the peaches pay the best, and in such cases it would have been better that the orchard had been all peaches. In a soil and climate where both succeed the better way is to plant the peaches by themselves and the apples also. Then the cultivation, manuring, spraying and general treatment of each can be done more conveniently and more cheaply. When the two are mixed in the same orchard, they may need different treatment, or, the same kind of treatment at different times.

The better way to fill up an apple orchard with temporary or short-lived trees, which will be out of the way by the time the main orchard needs the whole space is, to plant in between the permanent trees other varieties of apples which come into bearing very early. These will profitably occupy the space, and be ready to be cut back, and finally dug out, by the time their room is needed. Among such varieties are Missouri (Pippin), Wagener, Yellow Transparent, Wealthy and Whitney, which may be used, each in its region of success, or where the market suits it.—Green's Fruit Grower.

## Flower Garden and Lawn. ❀

### THE BEECHES.



AMONG ornamental trees peculiarly fitted for lawn planting the European beech and its numerous varieties are unexcelled. The species itself (*Fagus sylvatica*) is not, as many suppose, of slow growth, but when once established increases rapidly. With ample room, it is a widely spreading umbrageous species of clean growth, strong constitution and apparently not very partial to any one kind of soil. On the outer edge of a group of mixed trees it is especially noticeable for its long drooping branches, densely clothed with bright green foliage. The weeping beech, so called from the curious pendulous branches and numerous slender branchlets, is a tree which we can not too highly praise. It is not adapted for massing, for its peculiar structure fits it for a solitary position where it may have the benefit of the air on every side. To form a first class specimen the branches must receive due attention in its earlier years, both by severe pruning and tying into shape. The owner of a small lot would make a great mistake by introducing the weeping beech into his little collection, as it is assuredly a tree "to which distance lends enchantment to the view."

With the purple or blood-leaved beech the case is different, provided there is sufficient space for its development. The regularity of its growth and striking rich plum color of the foliage render it acceptable in almost any well regulated place. With a background of evergreens it is particularly charming and forms a living picture of which one never tires. An avenue of this form, alternated with some silvery-hued conifer, will create a rich effect where such a system of planting is admissable.

The next variety in point of usefulness is the fern-leaved beech, which is of slower growth than either of the above. To enhance its beauty the branches should be encouraged to start out from the ground. It will also bear clipping equal to a box and thicken up under the process into a dense ball. Without this artificial assistance it is still an exceedingly graceful tree, with long, horizontal branches, clothed with attractive fern-like leaves. It seems equally adapted for massing or as an occasional single specimen on the lawn.

The form known as the cut-leaf beech is similar in growth to the above but has its foliage in curious green strips of different sizes and outlines.

The curled-leaf beech is extremely odd in appearance, but is only grown as an object of curiosity. There is no beauty whatever in such a monstrosity. It may be said, however, in its favor that the tree grows well and is usually well

supplied with deep green foliage. It is the *Fagus sylvatica cristata* of the catalogues. There are two forms of this kind occasionally to be found in foreign collections, with variegated leaves, but as our hot summers invariably scorch them badly it is wise to reject both.

It would be unjust to one of our most valued native trees if in this paper we were to ignore the importance of the American beech (*F. ferruginea*). It is not so dense a grower as its European relative, nor has it as fine large foliage as its foreign relative, but it possesses a beauty peculiar to itself and a character that belongs to no other tree. In a word, it is invaluable as a lawn tree in grounds of ample extent, but would be entirely out of place in the limited door-yard.—Josiah Hoopes.

### GRADING A LAWN.

HE grading, when properly done, is a most costly and difficult task, and that wherein the artistic tastes and judgment of the workman most plainly come to light. Around dwellings there should, of course, be as perfect a grade as possible. Away from dwellings, especially on large lawns, many prefer an undulating surface as being more natural and, therefore, more artistic, with which idea I am in full sympathy. The undulations, when they naturally exist, should be carefully smoothed and made gradual, so that when mown with a horse lawnmower the grass shall not be cut too long and too short in places, making the lawn look spotted, especially in a dry time, when grass cut extremely short is likely to burn out, or at least get badly injured.

I find it takes more care properly to grade a lawn with an undulating surface than on a comparatively perfect grade. The top soil for at least 12 inches should be carefully cleaned of all stones the size of a hen's egg and up, and of all roots and trash of every kind. It cannot be made too clean. For sake of both economy and good work, I use horses and horse implements as much as possible in grading. In so far as they can be used, they are much cheaper than the average Irishman with his wheelbarrow, pick and shovel, and the inevitable short stemmed pipe, smoked upside down. Where soil is not likely to wash, I think it best to let it lie (when graded in the latter part of summer or in the fall) till the following spring. Unless carefully firmed by hand, an expensive task, it is bound to settle more or less unevenly. After settling, the unevenness of the surface can be easily corrected just before seeding. Where any grading is so deep as to go into the subsoil to a considerable extent, care should be used in saving the top soil, so as to have it on top when the grading is completed. The more even the depth of this top soil, the better for the appearance of the lawn.—Country Gentleman.

## CARE OF PLANTS AFTER LIFTING.

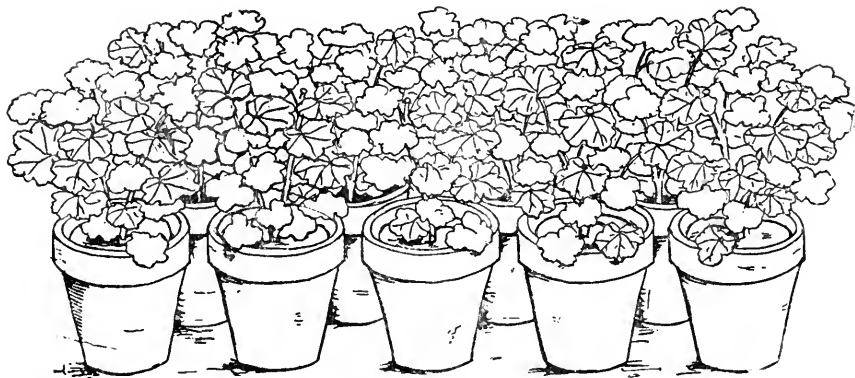

FIG. 1017.—PLANTS AFTER BEING LIFTED FOR WINTERING.



COME now to what I consider one of the most important parts of the planting operation, namely, that which has to do with caring for the stock immediately after it has been potted. It is a point on which success and failure more largely hinge than the average amateur is aware. If I were asked: Why is it that the professional plant grower so uniformly successful in bringing on the plants he lifts, while the amateur so often meets with but half success, my answer would be: Differences in care right after lifting.

Have you ever noticed that when the leaves of any soft-wooded plant wilt completely, be the cause dryness or whatever else, that they never again possess their full beauty? I have. The point I would impress is: So care for the lifted plants that they never will wilt or appreciably flag. It can be done, and this is what the regular florist does, but which the amateur usually in some measure neglects.

How shall it be done? Like many important operations in gardening it is most simple. It consists, first, in setting the newly-potted plants in a body so closely together that the pots almost touch, just as is shown by the mass of geraniums in Fig. 1017. The spot chosen for this should be one that is well shaded, and where the wind does not have sweep. Next comes intelligent watering and sprinkling. Water once thoroughly on the completion of the potting and not again for a week. But in place of watering, sprinkle the foliage lightly, half a dozen times each day. In this way the leaves can be wholly kept from flagging. So far as the roots are concerned these need, in the case of plants thus treated, almost no water, for a week; an excess would be injurious.

After a week the plants should be moved to a place having a little more light; at any rate, they should be spread out to let more air and light down.

among the foliage and between the pots. But keep up frequent sprinkling, the same as before. In about two weeks they will have made enough new roots to sustain them finely in almost any situation, and that without the leaves showing any signs of wilting.

What is worth doing at all is worth doing well; surely in plant culture it is worth while to take some pains to thus get the stock into proper shape for winter.—American Gardening.

## BULBS FOR HOUSE AND WINDOW CULTURE.



WHEN the qualities of the Holland bulbs are considered, the beauty of their flowers, the fragrance of many of them, their hardiness, the ease with which they can be raised, adapted to the circumstances of everyone by their cheapness and the few requirements of culture, so that one having a single window can have the pleasure of them as well as one who has a greenhouse to devote to them, it is not so surprising that so many thousands and millions of these bulbs are raised, but that everyone, who admires plants, does not provide them for house culture as surely as the season of them arrives. It is gratifying to have the evidence which yearly presents itself that the love of these plants is steadily growing and spreading in every direction in town and country life.

If the bulbs are wanted merely for the bloom of one season the character of the soil, provided it be light enough, would be a matter of comparative indifference, for their blooming would depend more on the strength of the bulbs than on the quality of the soil in which they are potted. Most persons, however, after blooming hyacinths and tulips in the house, plant them in the garden in the spring to remain indefinitely, and consequently like to keep them as good as possible. A good potting soil for nearly all bulbs and house plants may be prepared by a little timely attention. A mixture of fibrous loam, leaf mold and sand with a little old stable manure constitutes the proper material; do not use fresh manure. The fibrous loam is prepared by cutting some sods and placing them in a heap, grass side downwards where they will decay. When the grass roots have rotted, and so that they will crumble down, the soil is ready for use, and it can then be mixed with a quarter of its bulk of sand and as much more of old manure. If leaf mould from the woods can be produced about as much of it can be added as a fourth of the loam. These substances well mixed together will make a valuable potting soil.

A 5-in. pot is the best size, but if one has but a 4-in pot it can be used; or if larger ones, they can contain more bulbs. If one is where pots are not easily to be had, a wooden box may be made to do good duty, and many a good wife

knows how handy are tin cans for the same purpose. Bulbs can also be grown and bloomed in wire baskets lined with moss if care is taken to give sufficient moisture. Window boxes are also desirable receptacles for them. Bulbs which have bloomed in water are so far exhausted that they are not worth further attention, but potted bulbs, after blooming, can be cared for until they finish their growth, which may be known by the leaves turning yellow. When this appearance first manifests itself less water should be supplied, until at last the plants are allowed to become dry and dormant. Then they can be planted in the garden, to be left permanently.

After rooting bulbs in a cool and dark place, which is a necessity in order to secure vigorous blooming, the next consideration is to provide them with a place where they will have a good exposure to the sun, and at the same time a temperature comparatively low. A heat as near 50° to 55° as can be maintained is best. It may be somewhat higher in strong sunshine and somewhat lower on cold nights. On mild days they should have the fresh air by opening a window. A high temperature and close air will cause them to grow spindling and feeble. Most bulbous plants require plenty of water during active growth and blooming, and a failure of the supply will shorten their season of beauty.

Great quantities of tulips, hyacinths and crocuses are planted in beds and borders, and even while the weather is still cold, and before the leaves appear on the trees and shrubs, these brilliant hued flowers make the gardens bright and pleasant. They are planted in solid masses of contrasting colors, in lines of different shades, in simple geometrical figures, or in more complicated designs. A piece of well-drained, light and rich soil is the best; if heavy this condition may be much bettered by placing a handful of sand in each hole where a bulb is placed, and after setting the bulb thereon, covering it entirely with sand. Except in heavy tenacious grounds this is not necessary, but even on moderately stiff soils it is a good procedure, and is to be advised if sand can conveniently be had.—James Vick's Sons.

---

### MAKING FRUIT ATTRACTIVE.

Fruit is always sold very largely by its looks. The highly colored apples will always bring higher prices than those of a duller or green color. With pears there is a partial exception, as there are so many superior varieties of a rusty color that this rather than bright red has the preference. But with the pears that do color, the more highly colored any specimen may be, the better it is likely to prove. But so much depends on an attractive appearance that many growers have learned that there is money in putting a spray of green leaves to offset the color of the fruit. This is almost always done in selling the finest peaches, and fruit growers are learning to treat other fruit in the same way.



## The Canadian Horticulturist

SUBSCRIPTION PRICE, \$1.00 per year, entitling the subscriber to membership of the Fruit Growers' Association of Ontario and all its privileges, including a copy of its valuable Annual Report, and a share in its annual distribution of plants and trees.

REMITTANCES by Registered Letter are at our risk. Receipts will be acknowledged upon the address label.

### ↗ Notes and Comments. ↖

THE ANNUAL MEETING OF THE ONTARIO FRUIT GROWERS' ASSOCIATION of Ontario will be held in the lecture hall of the Dairy School Kingston. The meetings will begin on Wednesday Dec. 2nd at 2 o'clock p.m., and continue until Friday noon. The first evening there will be a joint meeting of the Kingston Horticultural Society and the Ontario Association when address are expected from Prof. H. L. Hull, of O.A.C. Guelph, on Chrysanthemum Culture, and from Mr. O. S. Johnston, Kingston, on the Rose Garden, to be followed by discussion.

Besides these there will be addresses from the Mayor of the city, the President of the Kingston Horticulturist Society, and representatives of other affiliated societies.

On Wednesday evening there will be an address by Prof. Knight, of Queen's University, on "Organic Evolution," illustrated by lantern slides. This lecture will occupy about forty minutes, after which addresses are expected from the Hon. Sidney Fisher, Minister of Agriculture for the Dominion, and from either the Minister of Agriculture for Ontario, or his Deputy.

During the Day Sessions subjects of great interest to fruit growers will be considered, as for instance :

How best to develop the Fruit Industry.

Cold Storage.

Transportation.

A Depot for Canadian fruits—London England.

Fruit Culture, and Potato Culture Combined.

Fruit and Dairy Combined.

Hardy Fruits.

Over Planting, etc.

We expect also Director Mr. Saunders, Horticulturist Craig of the Dominion Central Experimental Farm to be present and address the meeting.

There will be a fruit table for samples of fruits and flowers from various parts of Ontario, and notes of anything shown which is of interest will be taken by the Fruit Committee for publication.

---

THE HAMBURGH EXPOSITION of 1896 is to take place next summer, and a letter has just come to hand from the Committee for publication. It appears that no trouble will be spared to make it a grand success, and that horticulture is to receive very special attention.

---

A VERY LATE PLUM.—On the 10th of October Mr. A. M. Smith of St. Catharines sent us a blue plum which he esteems valuable on account of its late season. It is medium size, round, very dark, with greyish bloom; flesh tender, sugary, delicious. He also sends a red plum, of about same size, and season, but much inferior in quality.

---

FRUIT FOR HER GRACIOUS MAJESTY.—On Tuesday the 20th ult., we had a call from two prominent citizens of Hamilton, Mr. Anthony Copp, and Mr. Heard. The object was to secure a shipment of some choice Canadian fruit to be forwarded to the Queen. The idea was that this would advertise Canada's fruit in the most effectual manner, and lead to a great demand in Britain for it. It was agreed that several cases containing each a different variety of fruit, should be sent forward, including such varieties of apples as King, Spy, Cranberry, and Snow; the best Roger grapes, and several varieties of pears.

---

THE GOVERNORS OF THE DAIRY SCHOOL at Kingston have kindly offered to the Fruit Growers' Association of Ontario, the free use of the lecture-room of the Dairy School, for our annual meeting in December. The date chosen, December 1st, at 7.30 p.m., seems to be generally accepted as the most satisfactory. We hope to have some consideration given to the relationship between the two interests. Can dairymen profitably add the orchard to their cares, and can the fruit grower also add the dairy without neglecting his fruit? We expect a paper on this subject from some prominent dairyman.

---

DR. SAUNDERS, Director of the Experimental Farm Systems of the Dominion, has just returned from an extended tour of inspection, as far west as British Columbia. He reports that the fruit crop was much injured by cold, wet weather in blossoming period, but that on the whole the fruit crop of that country is becoming more important each year. The outlet is largely east throughout the North-West territories and to Manitoba, and better freight rates having been secured, the returns to growers are become more satisfactory. He has now under test at Agassiz about 2,000 different varieties of fruits, for the benefit of the fruit growers of the province.



APPLE REPORTS from Great Britain state that the great storms which have recently swept the British coast, have not only stripped the trees of their fruit, but ruined many of the orchards.

---

A FROST on Sunday night the 11th October, badly injured the grape crop not yet gathered in the Niagara District. Some growers have lost tons of their finest varieties. Evidently it pays to be forehanded with fruit gathering.

---

APPLES SHOULD BE GATHERED EARLIER than is customary. Not only does a large part waste by dropping through delay, but those hanging become over ripe for keeping. We found it none too early to begin harvesting our winter apples this season about the middle of September.

---

CURIOUS FREAK.—Mr. J. H. Wismer, Port Elgin, sends us a cross section of an apple which, on its exterior appears to be half a green apple and half a red apple. The line of division is clearly marked, and not only is the coloring of each half quite distinct, but even the dots and other characteristics. Does cross fertilization sometimes take effect upon the fruit as well as upon the seed?

---

APPLES HAVE DONE WELL enough in Great Britain this season, where quality has been first-class. We shipped 59 bls. of Gravenstein, Fall Pippin, Twenty Ounce, Wealthy, etc. Some of the Gravensteins' and Wealthy so'd at 17/6, and the whole lot netted us \$1.50 per barrel. One hundred and fifty barrels of Greenings shipped on the 19th September, sold, averaged 10/ and netted about \$1. We expect to hear better reports of the colored varieties.

---

"EUROPE DEVOURING AMERICA'S APPLES," is the heading of a column of the New York Telegram. The article draws attention to the immense crop of apples in the U. S. and Canada and the unprecedented quantities being sent forward. The shipment from all American ports up to date of about September 30, is 429,530 lbs., whereas to the same date last year the total was only 39,309, an increase of about a thousand per cent.

---

NEW SOCIETIES.—Now is the time for preliminary work. A public meeting should be called—provisional officers appointed—and some one engaged to canvas for new members. Fifty members are needed, and the final organization must be complete soon after January 1st.

Mr. Thomas Bealle, one of our Directors, will visit any place where his services are needed, free of charge, during the month of November, if application is made to the Secretary of the Ontario Fruit Growers' Association, Grimsby. He will thoroughly explain the working of such societies, and the proper method of forming the same.

ONTARIO SNOW APPLES are without doubt about the best dessert apples in the world. We have no doubt that they will command a high price in any market, and Mr. Glen is no doubt correct in all he writes concerning the demand for them in New York City. Indeed anywhere in the Southern cities this magnificent Canadian dessert apple should bring a fancy price during the winter season.

---

A CHRYSANTHEMUM SHOW would be a good thing for our Horticultural Societies to undertake in each place. Why not secure from some good florist enough fine plants to give each member a half dozen or more next May, good stocky plants, already potted, five varieties. What an inspiration such a show would be for the Society, and how it would encourage the cultivation of the chrysanthemum.

If such a plan were thought advisable, preliminary steps should be taken at once, because the plants should be started by a professional, and good stocky plants grown and potted in good time before the spring meeting of the Society. This meeting could be held in April, for the distribution of the plants to the members, and papers read on the cultivation of the chrysanthemum, so that each would know how to proceed.

---

ONTARIO FRUIT GROWERS are just now too much discouraged with their apple crops, and too many are allowing them to waste in their orchards. This should not be, for the finest grade will bring almost as good prices as usual. Seconds should not be gathered at all this season. Mr. E. J. Woolverton has perhaps 2,000 barrels of apples to handle, mostly beautiful Baldwins. He has just sent two car loads, three hundred barrels, to Hamburgh, Germany. We shall be glad to have a report of the results for publication.

---

FRUIT GROWERS should not be too much shaken in their confidence in the apple market by the discouraging reports so freely circulated by Montreal apple speculators. These men report "a collapse in the English market"; that "some recent shipments barely return expenses"; that there is "danger of being drawn upon for charges"; that "growers will do better to ship their fruit to Montreal, etc." Now, this advice is certainly "too thin," for good Canadian winter stock has scarcely begun moving yet, and what has reached England has sold at prices which are about as good as in other years. Evidently these men have an eye to business. They want to discourage our orchardists, until they are willing to almost give away their apples. Then they will step in and buy our magnificent Canadian apples for 40 or 50 cents a barrel, and ship them to Great Britain at a large advance.

## ❖ Question Drawer. ❖

### Best Early Potato.

**881.** SIR,—Can you name a first class early potato that is profitable to grow on rather heavy soil; mine is rich clay loam, I have grown Carman No. 2 and Carman No. 3, this season and they both did better with me than any potatoes I ever grew and very few rotted. It is a pleasure to dig such fine large potatoes.

A. F., *Ridgetown, Ont.*

Would our readers who have experience with potatoes please answer. We have had excellent satisfaction this year at Maplehurst, with Burpee's Early.

---

### The Prairie Rose. (*Question 873.*)

**882.** SIR,—Is there not a slip of the pen in your reply to Mrs. Wanderwoort in your Oct. issue regarding "Wintering roses?" You give Prairie Queen as a native of many Western States. This rose commonly called Prairie Queen, is properly speaking the Queen of the Prairies produced by Messrs. Samuel and John Feast of Baltimore Ms. in 1843. In 1836, they sowed seed of *Rosa setigera* which grows wild in the Western States, and is known as the Prairie Rose. Seedlings from this sowing were fertilized by surrounding flowers from some of the best garden roses, and from their product came Baltimore Belle, Queen of the Prairies. The latter is the hardier of the two, while considered hardly I find they do better with some protection.

W. C. EGAN. *Egandale, Highland Park, Ill.*

We thank Mr. Egan for his note on the Prairie Rose. The fact of the Queen of the Prairie being a seedling of the former, no doubt explains its hardiness. At Grimsby both it and Baltimore Belle are perfectly hardy.

---

### Protecting Trees From Mice.

**883.** SIR,—I have about fifteen hundred young fruit trees planted here in new land that is yet stumpy, and, from last winter's experience, we expect that mice may do them considerable damage. I have thought of wrapping them with tarred paper or lath, or washing them with an emulsion of soap and carbolic acid. Will you kindly advise me the best way to protect the trees and, if you recommend a wash, please give formula.

C. E. SMITH, *Wyebriidge.*

The wash proposed by our subscriber would no doubt be effectual, but the application of tarred paper would be simpler and quite as effective. Our own practice at Maplehurst has always been to clear away all rubbish from the trunk of each tree and place a mound of fine earth, free from sods, around the trunk about ten or twelve inches high. This will save the trees from damage by mice and can be rapidly done with a sharp spade.

### Peaches at Port Hope.

**884.** SIR,—Can you give me any information regarding peach trees. I have a few planted on clay soil, but they die down every winter, being winter killed. They, however, shoot up each spring and grow so as to have a good sized stock. They are planted facing the south. Can anything be done to make them bear?

H. O., *Port Hope.*

The peach will not thrive north of Lake Ontario, and our correspondent will find it impossible to succeed with it at Port Hope, as both tree and buds are too tender to endure the cold of winter. The wood, as he states, is killed back, and, even if the wood endured the cold, the fruit buds would be destroyed. The only possible way by which the amateur might succeed with a special tree would be growing the stock horizontally along the ground in such a way that it might be bent over and entirely covered each winter with earth and lifted up in spring. This plan has been tried successfully with plum trees where the climate was too rigorous for them to thrive otherwise.

---

### Plum Knot.

**885.** SIR,—Kindly let me know a remedy for black knot on plum trees?

H. O., *Port Hope.*

The simplest remedy for the black knot is to use the knife freely, cutting away the affected parts as fast as they appear and burning them. Success has always been had by painting the affected parts with kerosene oil. Care should be taken, however, that none of the oil is allowed to touch the healthy portions, as it would be destructive.

---

### Carnations.

**886.** SIR,—Will Carnations live out doors all winter? If so, how should they be protected? I have potted a couple of plants, do they require much water?

SUBSCRIBER, *Hagerstown.*

*Reply by Prof. Hutt, O. A. C., Guelph.*

There are garden varieties of Carnations which are quite hardy and require little or no protection. A mulch of leaves or straw would be sufficient for them. The tender or greenhouse sorts, however, when grown outside for the summer, should be taken up early in the fall and grown in the house. They require frequent watering to keep them free from the red spider, and should be kept as cool as possible.

## Wintering Dahlias.

**887.** SIR,—How should Dahlia bulbs be kept through the winter?

SUBSCRIBER, *Hagersville.*

*Reply by Prof. Hutt.*

After the tops have been blackened with frost, cut them off; lift the roots and allow them to dry in the sun for a day or two, then store away in the cellar where they will keep cool and dry.

---

## Cauliflower not Heading.

*A question answered by Prof. Hutt.*

In answer to the question of Mr. F. M. Gunn, of Norwood, as to why his cauliflowers do not head, I may say I am in much the same quandary. I find since my return to the College that our cauliflowers have also failed to head. They had the best of attention. The only cause I can attribute it to, is that the seed must have been from poor stock. I understand that the greater portion of our seed comes from Denmark. I have seen it stated by good Danish authorities, that hardly any vegetable or cultivated plant is more liable to deviate and deteriorate than the Cauliflower, and that it requires great skill and experience in selecting the plants for seed, to keep up the quality of habit of sure heading. I think it remains with our seedsmen to ascertain for certain that all of the seed comes from skillful and honorable growers.

---

## Is there a Combine of Apple Buyers?

**888.** SIR,—While casting about me for some light on the present condition of the apple trade, I have decided to trouble you in the matter. The market reports of Woodall & Co. (as reported in the CANADIAN HORTICULTURIST and other papers) are all good as to markets and prospects; but these are flatly contradicted by the dodger-like reports circulated by our local buyers. I have made enquiries by mail in several localities, some quite distant, and, so far as I can learn, each district is left in the hands of its local buyers and all competition avoided. From the above and other circumstances, I am under the impression the apple trade is in the hands of a big combine, and that the grower is not getting the value of his fruit. Would you kindly take the trouble to please say what you can to throw light on the matter, and an early answer would confer a very great favor on

JOHNSON LEADER, *Box 191, Meaford.*

We would not like to accuse Canadian apple buyers of combining against the growers, as hinted by our correspondent, but owing to the reports of an immense apple crop, buyers are afraid to purchase, and naturally report on the dark side. We do think they have colored the reports somewhat dark, by publishing the poor sales of summer and autumn fruits, and not allowing sufficient weight to the good prospects in the English market for good sound winter stock.

As will be seen in our apple reports, the prospect for first class winter stock is brightening ; indeed, has been good all along. It would appear that Europe could use our whole apple crop, if it were sent forward gradually, and not too rapidly. But our whole crop is not going forward. Much of it has already blown off and can only be sold as windfalls to evaporating factories at home ; much is wasting in the orchards for want of hands to gather, or because the owner thinks the value so little, he will not bother with them.

Owing to these circumstances we are continuing to forward our apples direct to a British salesman, believing that there is more money in so doing than in selling at home at 50 cents a barrel. So far (October 22) we have received returns for about 200 barrels partly fall apples, and the average net price has been from \$1.00 to \$1.50 per barrel.

On October 20, a letter was received from the agent of the Canadian Government, who says :—

“ Apples from Montreal have been selling at from ten shillings to twelve shillings a barrel at public auction. The English crop has been a total failure, and, in addition, recent storms have simply ruined the orchards. During the early part of this month the English crop must all be put on the market, as it will not keep, and later on prices will be better. There is just one thing to be remembered, that the demand is limited, and any extravagant shipments to load up the market will certainly be attended with loss. On no account must rubbish be sent, but the very best picked fruit.”

About the same time we received from Montreal apple buyers, circulars such as the following :—

MONTREAL, October 17th, 1896.

APPLES.—The receipts have been very large, our own receipts being close to 1000 barrels per day. Yet, by push we have been enabled to sell most of these as they arrived. Prices have been good compared to other markets. The utter collapse of the English market and the great losses sustained by shippers there, has shut off all orders from the other side. Prices here run steady. Best fancy winter apples, \$1.40 to \$1.75. Fair to good, \$1.10 to \$1.30. Culls, 80c. to \$1.00 per barrel. Good Spies, Greenings, Baldwins and Kings sell best.

We can use all the apples sent us, and you will get a great deal more money in return for your fruit from here than anywhere else.

MONTREAL, October 14th, 1896.

DEAR SIR.—We have several letters about the prospect of apples. It seems worse than when we issued our circular on September 5th. Demand here is very slow at \$1.00 to \$1.25 for medium to fine winter fruits ; good red Snow apples, \$1.25. The British markets have been in a terrible state for the past two weeks, scarcely making freight on several lots, while good stock would scarcely pay for barrels. They claim this is owing to so much soft, poor stock being sent forward, which no doubt has had a lot to do with it ; still we thought that, at moderate prices, they could have used even larger quantities than have gone forward. In this we have been disappointed ; perhaps the lower prices will cause larger consumption now and results may be better, and there should be better demand here from this forward.

We advise shippers to ship only best fruit ; buyers are very much more particular in a full market than when stock is scarce, even though they are paying next to nothing for it. We are situated to handle apples to the very best advantage ; our representative is in Britain now, and if our friends leave their goods to our judgment, we shall do the best we can. We have sold all we could here lately, for we feared shipment across would make less money. Any shipper that may prefer to sell here, or to be shipped to Britain, give your orders and they will be carried out to the letter ; but we think you had better leave it to us, for we have prices, quantities going forward, and all particulars every day.

We do not quite understand why Montreal men should report so gloomy an outlook, unless because they want to buy at the lowest prices, and ship on their own account. True, there is every possibility of our apples overcrowding the British market, but as things are going just now, there is no danger, for very many of our growers are afraid to ship at all, and are allowing the fruit to waste upon the trees.

---

\* Open Letters. \*

### Sierra Crimson Plum.

SIR,—There has been discovered in the Sierra Nevada mountains, a very valuable plum. It is on account of its wonderful flavor, that brings it into great prominence; it is collected in large quantities, and made into jelly and jams, and for this purpose it cannot be excelled. The jams and jellies manufactured from it have a most peculiar and delicate aroma, which charms all who taste it. Our best cultivated plums must take a back seat when this variety is offered for sale, as it outsells them every time. It is about the same size as the Green Gage plum, a brilliant red in color, and most deliciously flavored; there is no acid in the skin, as in most varieties of plums. It is quite a good yielder. The trees never attain a large size, but are quite dwarf. Their native home is high up in the Sierras, where the snow falls twenty feet deep in the winter. They are readily propagated by seeds, as they come true, and there are no varieties.

S. L. WATKINS, *Grizzly Flats, Cal.*

---

### New York City as a Fruit Market for Ontario.

SIR,—I purchased to-day, at the corner of Wall and Williams streets, some Fameuse or Snow apples, which came from Montreal. The price was two for five cents. Twenty apples weighed five pounds, so that the retail price is equal to ten cents per pound. The man from whom I purchased them has sold fruit from that corner year out and year in, for the past seventeen years, and is an experienced gardener or horticulturist. Very few nurserymen are as well informed as he is in horticulture. He told me this morning that he paid \$1.50 for the barrel of apples, and that it contained five hundred. Of the smaller ones he sold three for five cents, and two for five cents of the larger ones. Within five rods of him I could buy just as handsome Snow apples from Maryland, New Jersey, Pennsylvania and Ohio for one cent each. These facts prove what I wrote you in June, that the quality of the Canadian apple, when its character is known, will create a demand which will exceed the supply.

To-day I can purchase seven-pound baskets of Tokay grapes, of *extra quality*, grown in California, for 40 cents, or less than six cents per pound. A few days since I purchased three of the handsomest and most perfect Beurre Hardy pears, grown in California, for ten cents, I ever saw, and took them to the Hon. Charles A. Dana, Editor of the New York Sun. At the same time, I purchased two of the finest Beurre D'Anjou for five cents, also grown in California. A few days since I purchased a 7½ pound basket of Damson plums, at Washington Market, for 75 cents, or at the rate of \$6 per bushel, and at that price they are scarce. Nearly one-half million barrels of apples have already been shipped to Europe from American ports, or more than ten times the amount shipped last year at this date. This market will gladly sell Southern and Western Snow apples to exporters at \$1.50 and \$2.00 per barrel, and buy Canadian Snow apples for home consumption for \$3.50 per barrel.

Just as I wrote you in June, the scarcest fruit in this market is apples of high quality and Damson plums for preserving. I can buy crates of fine Concord grapes at 1½ cents per pound. Five-pound baskets of Delawares and Niagaras at 15 cents each, and five-pound baskets of Concorde at 8 cents. If your prime fall apples are sent here and put in

cold storage on arrival and kept until the surplus from the South and West is disposed of, they will return a far higher price than if shipped to Great Britain. Canada has a monopoly in first-class apples and can sell them after their character is established in this market, duty or no duty, at prices which will secure to the producer a liberal reward. The territory in which prime varieties can be profitably grown in Canada is so small, that there is no danger of over-production, and the sooner you organize in Ontario a Canadian Fruit Growers' Association, and send agents to our chief distributing centres, the better.

FRANCIS WAYLAND GLEN.

132 Nassau St., Room 4, New York City.

### Canadian Snow Apples in New York City.

SIR,—Yesterday I purchased from a fruit stand at the corner of William and Wall Streets two Snow apples, for which I paid 5 cents each. At the same time I saw a gentleman pay sixty cents for twelve of them. They were from Northern Vermont, and the owner of the fruit stand paid \$6.50 for them per barrel in Washington Market. He told me there was 450 apples in a barrel. A few of the smaller ones he will sell at the rate of two for five cents. The barrel will net him at retail \$20. The two I purchased I took to the Hon. C. A. Dana, Editor-in-Chief of the New York Sun. We measured one of them, and it was  $3\frac{1}{2}$  inches in diameter; the other just a shade less.

To-day I went there and purchased three apples and put them in a small box and mailed them to yourself at Grimsby; they are fair average samples of the barrel. The man who keeps the stand told me that he had sold out nearly all of them in about one day. I have no hesitation in saying that 40,000 kegs holding a quarter of a barrel each of the same quality of Fameuse apples could be disposed of in one week in this market at \$1.50 per keg. I suggest that you have the three I sent you painted on a single plate for the HORTICULTURIST. The large one which I gave Mr. Dana was even more highly colored than any of the three I sent you. The quality, as you will see, is best.

Mr. Dana is not only a great scholar, writer, editor, philosophic thinker, clear and far sighted political leader, but also a good horticulturist. He has, perhaps, one of the largest collections of hardy trees and plants in this country at his home at Oyster Bay, and some time when he takes a day off I am going to go out there and write a description of his country seat for the HORTICULTURIST. Although he has nearly reached his four score mile post, he is only a boy in the freshness of his love for nature and his sympathies for humanity. He leaves his home at ten minutes before 8 in the morning, and when he reaches the steamer all of the New York papers are handed him, and by the time the boat reaches the dock in New York, he has read all of them and marked the articles which he wishes his secretary to cut out and lay upon his editorial desk. After he arrives at his office he works incessantly until four in the afternoon, and then takes the boat for home, and spends an hour or so before sun down with his plants, fruits and trees. Beyond all question he is the greatest living American, and I am sure the readers of the HORTICULTURIST will enjoy reading a description of his home on Long Island.

In the summer of 1846 I began my first day's work in a nursery owned by John J. Thomas, for many years the editor of the Cultivator and Country Gentleman. tying pear buds into Hawthorne stocks. I continued to work in the nursery summers until I was fifteen years of age, and attended school winters, and then became the foreman of the Commercial Nurseries of Rochester, owned by Bissell & Hooker. At the end of three years before I was nineteen years of age, I purchased the interest of Mr. Bissell, and the firm of H. E. Hooker & Co. was organized. I continued in partnership with Mr. Hooker until 1861, when I went to Canada to assume the management of the Joseph Hall Machine Works at Oshawa, Ontario, and remained there twenty-five years.

Since 1846 I have taken an active interest in the progress of horticulture, floriculture and agriculture. I shall write some letters to you making suggestions as to fruit culture in Canada, which I hope will stimulate the planting of apple and plum trees in Ontario.

The enormous surplus of apples of indifferent quality, although of handsome appearance, will be sent to Europe, and will probably overstock that market, but relieve this market of the surplus, then any prime Canadian apples which have been kept in cold dry storage will command good prices. If there is any surplus of Damson plums in Ontario, they should be sent here at once.

FRANCIS WAYLAND GLEN, 132 Nassau St., New York,



The samples sent by Mr. Glen are truly excellent, but differ from the common Canadian Snow apples. They evidently belong to the Snow apple family, and are probably McIntosh Red. A colored photo of which was in our Journal for November, 1893, and was highly commended except for its fault of scabbing almost as badly as the Fameuse. No doubt there would be money in growing it, for its quality is about equal to the Fameuse, and it is larger and more showy. The Scarlet Pippin, figured on page 382, is another apple of this class, which may possibly be entirely scabproof; and, if so, will also be a most profitable apple for any market.

---

### Beurre Bosc Pears in New York Market.

SIR,—I stopped at the fruit stand of James N. Bagnall, at the corner of Wall and William Streets, just as he was opening a keg ( $\frac{1}{4}$  barrel) of the finest and largest Beurre Bosc I ever saw. He only paid \$1.25 for the keg. Why? Because they were badly packed, and when they reached this market were bruised, and the bruised spots were discolored. The best of them he was selling for 5 cents each, or three for 12 $\frac{1}{2}$  cents. Just beside them he had some very handsome Beurre D'Comice which came from California. They had been carefully packed in soft papers, and the skin was not in the slightest degree bruised or disfigured. He was selling them for 10 cents each or three for 25 cents. He has been thirty-five years in the fruit business at that corner. I made a mistake in a previous letter in saying he had been there for twenty-three years only. He sells the choicest of fruits of all kinds to the wealthy bankers and brokers of the Street. He seldom displays his fruit before 10 a. m. in the morning, and closes his business soon after 4 p. m. in the afternoon.

The object of this letter is to emphasize the value of careful packing. Had the Beurre Bosc have been carefully packed, they would have readily sold for \$3.50 or \$4 for the  $\frac{1}{4}$  barrel.

FRANCIS WAYLAND GLEN.

Dated October 21st, 1896.

---

### Those Snow Apples.

SIR,—Yours of the 10th inst., came duly to hand, contents are noted, and in reply beg to say: In my opinion you are mistaken about the apples I sent you being McIntosh Red. I compared them with Fameuse from Montreal, Western New York and Pennsylvania, and I am confident that they were genuine Fameuse. Since I sent them to you, I found some Fameuse at the opposite side of Wall Street just as handsome and as large selling for one cent each; they were from the Southwest. Skin very thick, flesh far from firm, flavor too mild to be refreshing or appetizing. The person I bought those of which I sent to you, is an old gardener and has sold fruit from the same stand for twenty-three years, and is as good a pomologist as I have met since I sold out my interest in the Rochester Commercial Nurseries.

I have no interest, direct or indirect, in any nursery, or in any firm or corporation selling trees. My only desire is to promote the growth of such fruits in Ontario as will command a profitable sale in the continental market.

The South and California can beat Ontario in pears, peaches, early plums and grapes, but Ontario and Quebec can beat any part of the United States in apples and late plums. My opinion is that the foreign demand will relieve this market of the surplus of handsome fruit (apples) and then the market will be opened at good prices for fruit of prime quality, such as Ontario and Quebec can give us. If you send your fruit to Europe now, you will compete there with a surplus from this country and be forced to sell at comparatively low prices. On the contrary if you place your prime apples in dry cold storage and then offer them for sale in Boston, New York and Philadelphia, Cleveland, Detroit and Cincinnati, later in the season you will command better prices than you will if you ship them to Europe.

I refer to prime fruit only, put up in comparatively small packages or quarter barrels.

In our houses, with a furnace in our basement or cellars we cannot keep fruit for any length of time and therefore many consumers will gladly pay \$2.00 for a quarter of a barrel of prime apples who would not pay \$6 or even \$5 for a whole barrel.

A few days since I took Mr Dana some very large seckle pears, grown in California. The next day when I called upon him he told me that they were the best seckles he had ever eaten. They were three times the size of the ordinary seckle grown in this section, and I paid five cents for three of them; such facts as these which I can multiply indefinitely convince me that Canadians should grow apples and let California and our Southern States grow pears. Nature or God in Nature has so ordained it, and why should Canadian pomologists undertake to antagonize the inevitable, or in other words the Omnipotent.

I am made to say in one of my previous letters published in the HORTICULTURIST, that Early Joe apples grown in my garden at Oshawa, were bitter, whereas I said they were "brittle."

FRANCIS WAYLAND GLEN.

Dated October 14th, 1896.

### Ammonia.

SIR,—I think that J. E. K. Herrick's query in the October HORTICULTURIST (page 372), probably refers to the strength of the ammonia used in dissolving Copper Carbonate in making the ammonia solution, which is used late in the season as a substitute for Bordeaux mixture, and not to ammonia as a fungicide by itself. I have never known ammonia to be used as a fungicide by itself, and I do not think that it would be of much service. To dissolve 5 ounces of Copper Carbonate, 2 quarts (1 'Winchester') of ammonia of the strength known to the drug trade as '880 fort is necessary. This quantity may then be diluted with 45 gallons of water—the usual capacity of a coal oil barrel. It is then ready for use.

JOHN CRAIG, *Ottawa.*

### The Black Currant, Success.

SIR,—The above mentioned currant, sent out by you a few years ago, fruited with me for the first time this season, and I was greatly pleased with it. It is fully two weeks earlier than the others I have, which, I presume, are Black Naples, and ripens its fruit more evenly, nearly all at once, which is a very desirable feature. The quality is excellent. When at Ottawa Experimental Farm the other day, I saw Prof. Craig putting up a quantity of fruit, and comparing the different kinds. I found no black currants any better than Success, and that was Prof. Craig's opinion. This has been a splendid year in this section for all kinds of small fruits, and I am glad to say more attention is being paid to them. Apples are also a tremendous crop. In many orchards the trees are breaking down.

C. W. YOUNG, *Corwall.*

## ↻ Our Book Table. ↻

PRINCIPLES OF PROFITABLE FARMING, OR HOW TO RAISE LARGE CROPS FOR THE LEAST MONEY, is the title of a pamphlet published and sent free of charge to any farmer applying for it, by the German Kali Works, 93 Nassau St., New York.

# ✦ The Markets. ✦

## The British Apple Market.

Messrs. Jas. Adam, Son & Co., write :—

SIR —Arrivals from all ports show the enormous total of 70,000 barrels, a quantity never previously reported in any one week, so early in the season, and the result has been a complete collapse of the market. This is deeply to be regretted, as the losses to shippers must inevitably be considerable, but, with so much of the fruit being in faulty condition, and, even where sound, so tender as to call for immediate disposal, there has been no alternative but to force sales at best possible. Even as it is, dealers here complain bitterly of the unreliable character of the stock, and are so completely tired of the soft varieties that there is little chance of any improvement in the position of affairs until quality inspires more confidence, and shipments are considerably reduced.

Of course, winters must undoubtedly find a more ready outlet, but it will be necessary for shippers to pay particular attention to the selection and packing of fruit for export, as in such an abundant year, as this is proving itself to be, quality and condition must of necessity be good to command proper attention. As it is, quantity seems to have been the aim of many exporters, so much of the fruit being of a class totally unfit for shipment, and we would again remind all interested that the cost of transit and handling is identically the same on a good barrel as on a poor one.

We give at foot quotations for sound only, which in themselves offer strong evidence of the varied quality, and, from the outside prices paid for some varieties, it will be seen that even now the trade appreciates, and is open to take, good stock, at reasonable rates. Unfortunately, catalogues show still greater ranges than our quotations indicate, and, lamenting as we do the deplorable results, we hope, with due discretion and reasonable judgment, the season may not prove an altogether disappointing one. Abundance is always the forerunner of cheapness, and operators will do well to bear this in mind in their further negotiations.

Quotations : Canadian —Greenings, 6/3 to 10/9 ; Snows, 9/ to 13/ ; Colverts, 5/3 to 8/ ; Ribston Pippins, 6/6 to 10/9 ; Kings, 8/6 to 14/6.

Mr. M. H. Peterson, of Toronto, writes under date 16th October :

Jas. Adam Son & Co., Liverpool, this day cable : “ Market active, prices very firm.”

B. & S. H. Simons, Glasgow, this day cable : “ For winter stock market has advanced.”

Messrs. Woodall & Co., Liverpool, write under date Oct. 10th :—

SIR,—As shewn above, the week's receipts are 84,188 barrels, which for this early period is immense, and approaches the highest figures touched in the height of the previous heaviest season. It was expected that this week's arrivals would probably consist of good sound full sized winter stock, but this has been only very partially realized. The bulk was winter fruit, but generally small and unattractive, most of the Baldwins being wanting in color. Added to this, the condition, especially of New York shipments, has been unsatisfactory, which is very unusual at this early period, and can only be accounted for by being hurriedly packed and shipped in damp, warm weather, which corresponds with what has been experienced here during the past month.

Large quantities have been received from Boston, some of which were absolute rubbish, and should never have been sent, as however scarce apples may be, these never would fill requirements, or be worth the heavy freight and shipping expenses. There have, undoubtedly, been some few good parcels, notably from Canada, but taken as a whole, the fruit was disappointing, and, consequently, buyers of first-class fruit are not operating. The results of the week are disastrously low prices, but it cannot be said that the capacity of the market has yet been tested as to whether it can pay satisfactory prices for good sound fruit with receipts similar to the present.

Under date October of 21st :—

Jas. Adam, Son & Co., Liverpool, this day cable :—“ If the quality is fine, market better, with more enquiry and an upward tendency. Baldwins, 6/ to 10/ ; Greenings, 6/ to 10/ ; Spies, 8/ to 9/ ; Kings, 10/ to 12/.”

B. & S. H. Simons, Glasgow, this day cable : “ Spies, Baldwins, 9/ to 11/ ; Kings, 10/ to 12/ ; Cran Pippin, 20 oz., Gravenstein Snow, 8/ to 9/ ; Greening, Spitz, Seck, Can. Red, Ribston Pippins, 7/ to 9/ ; Russet Cohort, Talman Sweet, 6/ to 8/.”

Duthort & Co., London, also cable : “ Baldwin, Greening, 9/ to 10/ ; Spies, 10/ to 12/ ; Kings, 12/ to 14/.”

## Our Apple Markets.

LIVERPOOL.—Messrs. Simons, Shuttleworth and Co., cable to-day (Oct. 23rd) as follows: Prices to-day remain about the same, the market is stronger, but prices do not show any advance. Quality and conditions are being well paid for, but lower grades and conditions are very weak. The lower prices are inducing a larger consumption, and with smaller shipments we anticipate an advance. Only the finest fruit wanted.

GLASGOW.—Messrs. Simons Jacobs & Co., cable to-day (Oct. 23rd) C Reds, Baldwins, Greenings, Spitz., Seeks, Ribston Pippins, Gravensteins, 9s. to 11s.; G. Russets, R. Russets, Colverts, Jennettings, T. Sweets, 8s. to 10s.; Spies, Cranberry Pippins, 20 Oz.; Pippins, Snows, 10s. to 12s.; Kings, 11s. to 13s. The Market is booming.

LONDON.—Messrs. Garcia, Jacobs & Co., Cable: Prices to-day (Oct. 23rd) rule nearer our highest quotations. The market is showing decided improvement. Baldwins, 9s. to 11s. Greenings, 8s. to 10s.; Spies, 10s. to 12.; Kings, 12s. to 14s.; Cranberry Pippins, 11s. to 13s.; Ribston Pippins, 13s. to 15s.

---

## The Export Apple Trade.

The Montreal Herald of October 22nd, says: "A good deal is heard these days of the wonderful success United States apples are meeting with in the British market. The New York and Boston papers are continually finding satisfaction in the fact that shipments so far are three times heavier than they were last year. And in all their talk Canadian apples are ignored. It may be remarked that the apples which we are weekly placing in the leading English markets are of good quality, and are quietly working their way into favor. Returns at present indicate that Montreal is sending out more apples than any one United States port, while in fact last week more were shipped from this port than Boston and New York combined. Here are the figures for the week ending October 17th:

New York.....	17,842 Barrels.
Boston.....	33,105 "
Montreal.....	66,283 "

Up to date the shipments from Montreal to European ports approximate 350,000 barrels. New York has sent out about 200 000 barrels, Boston 278,000 barrels and Halifax in the vicinity of 95,000. The total Canadian shipments are therefore about 440,000 barrels, and the outward movement gives no indication of abatement.

---

## THE WHOLESOMENESS OF APPLES.

The season of apples is upon us, and their wholesomeness should be again emphasized. The Bulletin of Pharmacy is authority for the statement that apples are the very best thing to eat just before retiring for the night. The statement may be received with incredulity by some persons, but the authority goes on to state that "no harm can come even to a delicate system by the eating of ripe and juicy apples just before going to bed."

That the apple is rich in phosphoric acid is well known. What is not so well known, the Bulletin points out, is that it thoroughly disinfects the mouth excites action of the liver, promotes a sound healthful sleep, helps the kidney secretions, and prevents calculus growths, obviates indigestion, and is one of the known preventives of diseases of the throat. These are benefits enough to make us all apple eaters, surely.—N. Y. Times.

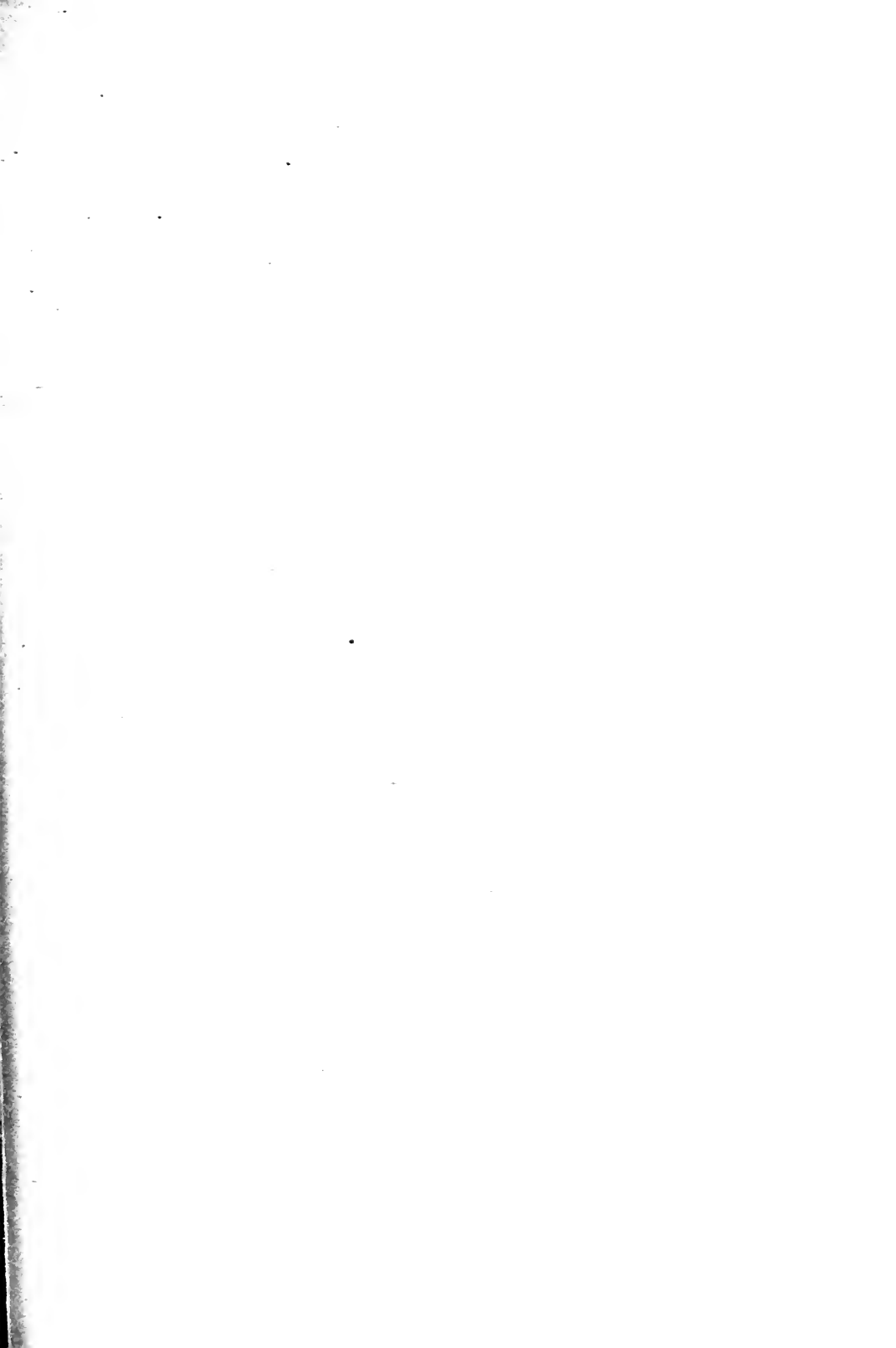



STECHER LITHO CO. ROCHESTER N.Y.

HOWELL.

THE  
Canadian Horticulturist

VOL. XIX.

1896.

NO. 12.



THE HOWELL PEAR.



FOR cultivation in the southern part of our Province we know of no variety of pear of its season superior to the Howell. We have grown it for the past thirty years at "Maplehurst," and the tree has proved itself healthy, vigorous, and productive. Nor is it of less importance to the planter to know that it is an early and regular bearer. The variety originated with Thos. Howell, New Haven, Conn., and bears the name of the originator. The large size, smooth, and clear skin, make a favorite for selling in the markets, at a time when it has few competitors.

The following is the description of this pear, as we have given it in the Report of the Ontario Fruit Experiment Stations.

*Fruit*—Large, obovate, pyriform; skin yellowish, waxen, reddish dots on sunny side, russet dots in the shade; stem  $1\frac{3}{4}$  inches long; no cavity, point of insertion sometimes lipped; calyx partly open, in a deep russeted basin; core small; seeds few, small.

*Flesh*—Creamy-white, juicy, melting, granular near the core; flavor vinous, agreeable; a little tart.

*Season*—Middle of September till middle of October.

## OUR COUNTRY ROADS.



OW that wheeling is such a popular and convenient mode of locomotion, the rough condition of our country roads becomes the more conspicuous, and if the agitation of the wheelmen for an improvement results in improved roads, they will have the lasting thanks of the farmers and fruit-growers of Ontario.

We are pleased to notice the interest now taken in road improvement by the Ontario Department of Agriculture which has appointed Mr. A. W. Alexander, Civil Engineer, Provincial instructor in road making. Road Bulletin No. 2 is just to hand and we have pleasure in giving our readers the following paragraphs and illustrations from it.

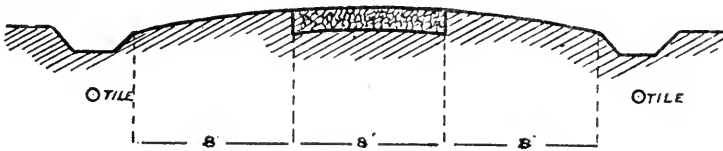

FIG. 1018.—CROSS SECTION OF COUNTRY ROAD.

Common field tile underneath open ditches. Gravel or broken-stone roadbed, eight ft. wide.

## FORMING A ROADBED.

In making a road the grading and draining should be carried on during the same season, first the draining, then the grading. A road which is graded only, and then subjected to the traffic of fall and spring before draining is undertaken, is generally a shapeless mass by the ensuing summer, and a large amount of grading must necessarily be repeated. A road should also be drained and brought to the grade which it is to retain permanently before the road metal (gravel or crushed stone) is placed on it. Metal placed on an undrained roadway is so mixed with mud in the spring and fall as to be almost wasted. The natural soil under the gravel must be sufficiently firm to sustain not only the gravel, but the weight of traffic upon the gravel. No soil will do this unless it is sufficiently drained.

The roadway must be crowned, or rounded up towards the centre, to shed the water from the surface; the surface must be kept smooth and free from tracks, and it is as much the duty of gravel or crushed stone placed on a road to form a smooth, hard surface that will permit the water to flow readily off from it, as it is to form a durable covering to resist the wear of wheels.



The Centre of the road should be excavated to receive the gravel or crushed stone. Where this care cannot be taken the metal may be placed on the centre and the sides graded up. The crown of the road should be obtained chiefly by rounding up the natural soil, but the metal should be several inches deeper in the centre than at the sides. On country roads, a crown of one inch rise to one foot of width from the side to the centre is generally sufficient; on hills it may be greater so as to prevent the water following the wheel tracks and deepening them to ruts.

As an illustration of the advantages of permanent work along this line, the bulletin gives several engravings, some of which by kindness of the Minister of Agriculture, we give in connection with this extract.



FIG. 1019.—METCALFE STREET, ST. THOMAS.

The roadway twenty-two feet wide and curbed with 3 x 10 cedar, is made with a five inch rough flake-stone foundation and covered with clean coursed gravel, seven inches in depth after being consolidated with a heavy roller. It was built in 1892, and the photograph taken May, 1896.

The width of a roadway to be metalled depends upon the amount of traffic it will be required to accommodate. Eight feet will be ample for the majority of roads in rural districts. Roads forming the approach to towns may sometimes be metalled to a width of sixteen feet. The depth of metalling need never exceed after consolidation twelve inches, if of a good quality and clean, and eight inches is the least which should ever be employed, the thickness varying with the amount of traffic. It should be placed on in layers, and each layer thoroughly rolled, the subsoil having first been well consolidated.

After the work of forming the roadbed has been completed, a great deal may be done toward levelling the sides, seeding, planting trees, etc., and not until the road allowance between the fences is brought to a right condition, should the road be considered finished. No investment offers better returns than the building of good roads.



FIG. 1020.—EAST STREET, ST. THOMAS.

The roadway is twenty-two feet wide, curbed with 3 x 10 cedar and made of crushed stone ten inches in depth at the centre and seven at the curb after consolidation with a heavy road roller. The sidewalks are four feet wide, of pine. The street was improved in 1895, and the above photograph taken May, 1896.

#### RESIDENTIAL STREETS OF TOWNS.

The principles of roadmaking which have been discussed, draining, rolling, metalling, etc., are all applicable to town and city streets, but in carrying them into effect they must be modified so as to add to the appearance of the finished roadway in a greater degree. The value of well-built roads in adding to the desirability of a town as a place of residence and thereby increasing the value of property, is greatly underestimated. So much is this the case that, while most country roads are not what they should be the streets of towns and cities are very much worse in proportion to the shorter road mileage and the ability of the citizens to pay for suitable pavements. In every town are to be found streets bordered on each side by handsome private residences and beautiful

lawns, while the streets between them is overgrown with weeds and at times almost impassable. To properly boulevard the streets, curb and macadamize the driveway, is not a costly undertaking, while the benefits in giving a park-like appearance to a street are of a nature not to be overlooked. Wherever street improvement is commenced it becomes very popular.

One of the first considerations is the width of the carriage way. The narrower this can be made, the better is the opportunity to have wide boulevards and handsome shade trees. An unnecessarily wide carriageway entails extra cost of construction and maintenance. A width of from twenty to twenty-six feet is found ample to accommodate the traffic of nearly all residential streets, even of the larger cities.



FIG. 1021.—FOREST AVENUE, ST. THOMAS.

The above photo shows the street in process of construction, May, 1896.

In forming the roadbed it should be excavated to the required width to receive the metalling, and the excavated earth used in making boulevards or for filling in low lots to bring them to the grade of the street. The centre of the street should not be higher than the lawns on either side.

To confine the macadam in place and protect the boulevard and gutters it is advisable to place on each side of the roadbed a line of curbing. Where flagstone is easily obtainable it is the most durable curb, but a good substitute is three by ten inch cedar plank, spiked to six inch in diameter cedar posts. The

posts should be two and a half feet in length placed in the ground at intervals of eight feet, and bevelled at the top so as to slope the curve slightly toward the boulevard.

The following illustration is from a photo of a street of one of the most progressive towns in Ontario. This street was laid in 1895, and its condition in 1896 needs no comment, the picture tells the whole story. It will be seen that there are fine residences on this street, open to full view, the sidewalks are excellent, there are good boulevards, the kerbing is good—but the roadway! The material, evidently, has not been compacted by a roller and one is in doubt whether a gang-plow has not been used by mistake. With a good heavy roller this could be made an ideal town or city street.



FIG. 1022.—AHREN'S ST. BERLIN, APRIL 20TH, 1896.

In obtaining drainage, a line of common tile should be laid under each gutter, below frost, and should be covered if possible with a porous material. The surface water may usually be led to the tile drains by catch basins placed where the grade of the road renders them most serviceable. If a system of sewers exists, it materially simplifies the question of obtaining outlets for surface and tile drains.

Grades should be reduced as far as practicable, having due regard to the draining of surface water and having regard to the elevation of the adjoining property. In fixing the grade it is rarely necessary to injure adjoining property by excess of cuts or fills in front of it.

True economy in expenditure for street improvement is seldom understood in towns, and still more rarely is it put in practice. Streets are constructed and maintained by large amounts annually appropriated from the general funds, but the appropriations are sub-divided and scattered over the street area in such small sums that the work performed, lacking the uniformity and unity so necessary to strong and durable results, is quickly absorbed by the mud. Fifty dollars is spent in an endeavor to cover water with gravel, with the result that the money is lost sight of within a year; whereas a proper amount spent in underdraining and carrying the water away would accomplish results that would be of benefit for a quarter of century.

---

### GOOD ROADS IDEAS.



MAKE the tire wider and the road better. Many farmers' clubs are expressing themselves in favor of broad tires and convict labor on highways. Produce don't produce until it is marketed. The report of Prof. H. L. Waters, dean of the State Agricultural College, on the result of tests made by the difference in draft of wide and narrow-tired wheels, states that "by using the wide tires an average of 53 pounds of draft is saved. A horse is computed to exert a pull of 150 pounds for ten hours per day, travelling at the rate of  $2\frac{1}{4}$  miles per hour. On this basis the wide tires save slightly more than one-third of the exertion of the horse."

An Illinois farmer who has paid \$1,200 road tax on the highways adjoining his farm, says they are no better now than they were years ago. It's the same way most everywhere. Real progress and not temporary tinkering is what we should demand. Roads are the veins and arteries of commerce. The better they are the better the trade circulation.

In Holland, where they have the best roads in the world, it is said that a farmer will haul, with a team of large dogs, as heavy a load as can be drawn over a bad road with a team of horses. This reminds us how dog-gone bad our roads are.

This country has 1,300,000 miles of common roads. This would encircle the globe fifty times, or go to the moon more than five times. But if most of them would go there just once and not come back, earth would be just about as happy.—New York Farmer.

---

**A French** gardener accomplished the unprecedented feat of raising asparagus in October. The Czar had a bunch of it for his dinner on October 6, and the price of it was 90 francs, or 60 cents for each stalk.

## THE EARLY VICTOR.

The Early Victor has fruited at "Maplehurst" for two years past and commends itself as an excellent early black grape. It ripens nearly as early as Champion, and has a very pleasant, sweet flavor, without foxiness. To reach its best condition for use it should be left hanging a week or so after it begins

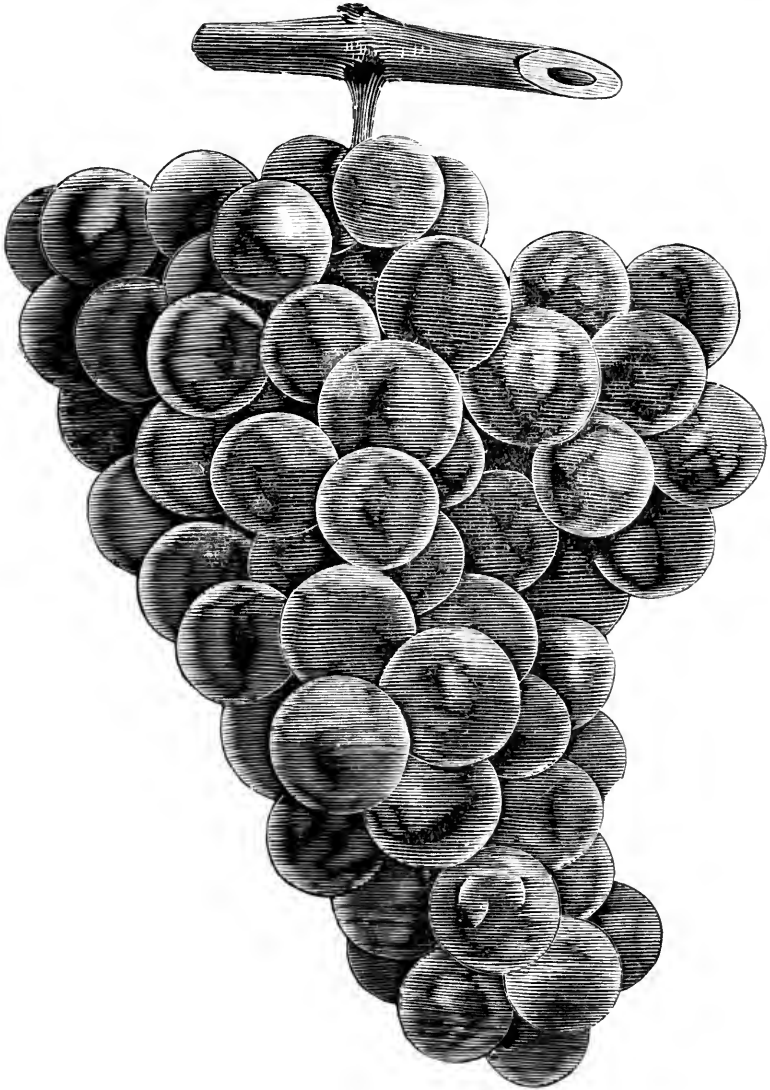

FIG. 1023.--EARLY VICTOR.

coloring. This grape originated with John Burr, of Leavenworth, Kansas, about 1870, from seed of Delaware, fertilized with some variety Lobrusca class. The vine is vigorous, and productive; and the berry medium size, with heavy blue bloom.

## THAWING FROZEN FRUIT.



EXPERIMENTS have been conducted by Professor Muller-Thurgau, with the view of learning the least destructive or injurious method of thawing vegetables and fruits when in a frozen state. Taking fruits of the same kind and quality, and as nearly as possible of the same size, he froze them and then placed a portion of them in lukewarm water and another portion in water at zero, or 32 degrees Fahrenheit.

A third portion he hung up in a room at about 68 degrees Fahr., and a fourth in a place at zero, Fahr. The result, in each case, was as follows :—At a temperature of from 23 to 19 degrees Fahr., the hardest kind of fruits remained uninjured, whether the thawing was slow or quick. Of those which were somewhat over ripe, only the ones which were thawed in warm or cold water were injured, and those thawed in warm or cold air showed little or no evil effects. Of those still more over-ripe, the fruits thawed in water were completely killed, while those thawed in the air were only partially injured. From the above it is deduced that the freezing of fruit is not always fatal ; as if the cold be not too intense, it can be again thawed, and still remain sound. Should the cold be very severe, however, frozen fruit is quite spoiled, and cannot be saved by any means whatever. As soon as it is perceived that the fruit is frozen, it should be warmed, just sufficient to prevent any further freezing ; for the more the ice forms in the fruits, the greater the damage. The warming should be as slow as possible. To immerse them in cold water, or to handle them with warm hands, would effect nothing but injury. Frozen fruit is very susceptible to pressure, which is another reason for not handling it. If it is possible to warm the room where it is lying, it had better be done, and leave the fruit alone. If experiment shows the fruit cannot be kept after slow thawing, it should be kept in the frozen state until eaten. Frozen apples thrown into water and boiled at once, cook as if they were sound, and are not impaired in flavor. If allowed to stand after thawing, chemical decomposition takes place, giving them a flavor characteristic thereof. Frozen apples can best be utilized, however, for cider making, as the flavor of the cider is not impaired, if care is taken to see that the actual work of fermentation begins at once. The same process is pursued in thawing vegetables.—Cal. Fruit Grower.

**Bildad Jones :** “ Father, kin I go down cellar an’ git some apples ter eat ? ” Farmer Jones : “ Yes, Bildad ; but see ye sort ’em all over fust, an’ don’t pick out none but th’ bad ones. ” Bildad : “ But s’pose thar ain’t no bad ones, dad ? ” Farmer Jones : “ Then ye’ll hev ter wait till they gits bad, Bildad. We can’t afford ter be eatin’ good, sound apples thet’s wurrh a dollar a bushel. ”—*Judge.*

## OUR APPLE MARKETS.



HERE is no doubt that apple growing has received a severe set back in Ontario on account of the low prices which have prevailed during 1896. Many growers who have land in orchard that is adapted to peaches or other desirable fruits, or even to vegetable gardening, are digging out the apple trees to make room for more paying crops. Certainly the time has passed when apple orchards of ordinary varieties, without cultivation, manure or pruning, will pay the owner, as they have done in the past; and the time has come when such orchards should either be dug out, or top-grafted to the very finest varieties.

Any one who studies the foreign apple reports, as well as those from Chicago and the South, will find that the finest varieties are worth growing, if the owner is prepared to give them the proper care. Canadian apples take the lead in foreign markets because of their keeping qualities, their beauty of color, and high flavor. As an example in proof we quote from a report by James Adam, Son & Co., Liverpool, dated the 24th October, 1896:

"Arrivals this week show the enormous total of 107,782 barrels, a quantity never previously recorded, even at the height of the heaviest season. Of these, about half were catalogued on Wednesday, and, the quality of Boston and New York stock being mostly of a rather low standard, price, unfortunately, experienced a further decline.

"Canadian stock, however, has maintained a steady tone throughout, anything really choice being eagerly competed for, thus proving that a good outlet exists for fruit of this class. Unfortunately, there is yet plenty of room for improvement in values, if senders are to find the business a profitable one, as, after deducting the heavy freight charges, results, in many instances, barely cover packing expenses, much less cost of fruit, etc. All the same, we can hardly think that proper care is being given to the selecting of fruit for export, so many samples shown this week being anything but good. This, perhaps, applies more particularly to Greenings than to other varieties, many of them being badly spotted, though Baldwins, as a whole, are somewhat of a disappointment thus far, the stock running small in size, and, as before pointed out, being unattractive in appearance. Kings maintain a high standard of quality, and the trade is not failing to appreciate them. Snows, too, considering the quantity, command a fair share of attention, and, although prices were hardly so firm on Wednesday, they picked up again yesterday, when some very satisfactory sales were made of this variety."

In Messrs. Woodall & Co.'s report of Nov. 7th, over 85,000 barrels were reported as receipts of the week, and prices promising to advance. Newtown Pippins were arriving and selling from 14/ to 22/ for medium to good; while Baldwins and Greenings were bringing 9/ to 10; Blenheim's 10/ to 12/3, and King 11/ to 13/.

On the 18th of November the following encouraging reports came to hand:

*Liverpool.*—Messrs. Simons, Shuttleworth & Co., cable:—"Baldwins, Greenings, 10/ to 12/; G. Russets, 11/ to 13/; R. Russets, Spies, Spitz, Seeks, C. Reds, T. Sweets, 9/ to



11/; Kings, Cranberry Pippins, Snows, 13/ to 15/. Only choicest fruit brought the highest quotations. The market opened strong, but declined during the day and closed weaker. We have had to force sales to get stocks out of the way of the large incoming receipts."

*Glasgow.*—Messrs. Simons, Jacobs & Co., cabled 17th :—"Baldwins, Greenings, Spies, Cranberry Pippins, Ribston Pippins, 10/ to 12/; G. Russets, R. Russets, Spitz, Seeks, C. Reds, 9/ to 11/; Kings, 13/ to 15/; Snows, 11/ to 13/. Some fancy fruit brought even higher than our highest quotations. The market opened firm and closed the same, demand good."

*London.*—Messrs. Garcia, Jacobs & Co., cable to-day :—"Baldwins, Kings, 10/ to 12/; Greenings, Spies, 9/ to 11/; G. Russets, 12/ to 14/; Spitz, Seeks, C. Reds, 8/ to 10/. Prices to-day rule about midway between our highest and lowest quotations. The market opened firm and gradually improved, closing with 6p. to 1/ advance. The demand is genuine and good stock advancing."

*Leith.*—Messrs. Michael, Simons & Co., cabled 17th :—"Baldwins, 11/ to 13/; Greenings, 10/ to 12/; Kings, 13/ to 15/."

On the whole it would appear that the best varieties of apples properly selected and packed, have not been unprofitable even this year, and that those who are prepared to make the business a study and follow the best methods of cultivation and packing, as laid down by our Association, may still hope for good success.

## FEEDING APPLES TO STOCK.



SOME twenty years ago I remember having had a very large crop of apples one year, and in order to dispose of the culls, having fed them freely to horses and cows. The experience was so satisfactory that it has induced me to dispose of surplus apples in the same way whenever I had such to feed. Many farmers are prejudiced against apples for feeding milch-cows. I do not see any reason why they should be. Experience is rather in favor of apples if fed judiciously. Any good thing can be overdone. Grain is good for horses, and yet you can injure them by overfeeding. So with apples. I fully agree with my friend Mr. J. S. Woodward, when he says, in the last issue of "Rural New Yorker:"

"The proper way to feed apples to cows is to have them ripe and sound. Green or rotten apples are not good food for anything. The cows should never be given a full feed of them at first, or given them on an empty stomach. At the first the cow should have no more than two or three quarts once a day, but this may be increased so that in ten days she may be safely fed one peck twice a day, and if a very large cow, twice this quantity. In all cases the cow should have some dry food when eating apples, and as apples are quite rich in nutritive ratio—1 to 8—she should have something like clover hay or wheat bran to balance the ration. Cotton-seed meal is a capital food to add to apples for cows, as its effects is constipating, while the apples are rather laxative. Still I would prefer to feed a mixture of cotton-seed meal and wheat-bran. If, when

feeding liberally on apples, the hay should happen to be largely clover, then it would be well to add a little corn-meal to the provender; say, make it one-third each, corn-meal, cotton-seed meal and wheat-bran."

#### HOW TO FEED APPLES TO COWS.

The cow that has her own way in eating apples, or potatoes, namely, picking them up at leisure from the ground or low manger, unmolested, will seldom choke. I often feed apples, especially large ones, whole, and am not in great fear of accidents resulting from the practice. Yet, ordinarily I have the apples ground through the root-cutter, which undoubtedly is the better way. Thus the ground apples, the cut hay or straw and the grain ration can all be mixed, and eaten together. If I had no root-cutter I think I would chop the apples coarsely in a large plank box, using a sharp spade to chop them with, or arrange the manger somewhat on Mr. Woodward's plan here illustrated. He says: "If a pair of

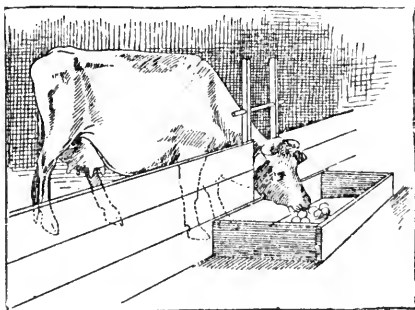

FIG. 1024.

posts or stakes be firmly set in the ground, or made fast to the floor like a pair of stanchions, just far enough apart to admit a cow's neck, and a hole be bored just high enough so that a pin put through will prevent the animal raising her head quite level, it will be impossible for the apples to roll down into the throat and choke her. (Fig. 1024.) The same apparatus will prevent animals choking when eating potatoes or any other food. What makes the animal

choke is raising the head so high that the pieces slip, by their own weight, into the gullet." I think that the instructions and information, as here given, should induce those among our apple-producing friends who have yet been in doubt as to the advisability of feeding apples, to relieve the country of the otherwise undesirable surplus by turning it into milk, butter and meat. Now, in its great wealth, it is really a source of annoyance and loss. It can be made a source of income.—Farm and Forest.

**Apples for Cows.**—We consider apples as a cow food, well worth the cost of picking up. We feed about a peck per cow twice a day just before or after their grain ration. An increase of milk immediately follows such feeding, ceases when the apples give out. For grain with apples, we like wheat-bran, corn-meal and cotton-seed meal, 200 pounds bran, 100 pounds each corn-meal and cotton-seed meal. Apples are a nuisance in a pasture where cows are,

as the cows chase from one tree to another, and use up too much of what ought to be turning into milk; besides, they will get thin in flesh. If a cow get a chance, she will eat enough to make her drunk in short order, unless immediate attention is given her. If we can get them soon after their excessive eating, or when they will not refuse grain, we give them from two to four quarts of corn-meal, and thus prevent any injurious effect. The oil of the meal counteracts the acid of the apple, and fermentation is not caused in the stomach. The corn-meal remedy has been worth much to us. There are now in our barn three cows that got away yesterday, and had about seven hours of all the apples they wanted. They were too full to eat the grain, and are now lordly drunk. They look sorry, but they have ceased to give milk, neither will they, this season, give their full former flow.

R. N. Y.

### THE ELBERTA PEACH.



AMONG the whole list of peaches, both old and new, there is no variety that has attained a higher place in public estimation than the Elberta. It is liked equally well by the grower and consumer. About twenty-five years ago Dr. Samuel H. Rumph, of Georgia, raised about 12,000 seedling peach trees saved from the very choicest named varieties, and in the whole lot there was but one that he deemed worthy enough to be preserved. This was the product of a cross between the Chinese Cling and Crawford Early. He bestowed upon it the name Elberta, in honor of his wife, and it has in turn been an honor to its namesake. Knowing something, and hoping more of its good qualities, he planted extensive orchards of it, from which he shipped large quantities of choice fruit, and realized profitable returns. It was not long before other peach growers learned of the good qualities of the Elberta, and began to plant it; first in the Southern States, where it had already proved its value beyond question, and then in the northern peach-growing sections. It has proved to be one of the standards in all regions, from Georgia to Michigan, and from Connecticut to California. The tree is vigorous enough to make a good orchard tree, spreading in habit, and has large leaves, somewhat like its parent, and is as hardy in tree and bud as the average of varieties. It ripens its fruit a little before mid-season, or about with Old Mixon Free. The fruit is above the average in size and oval in shape, with a suture on one side. The color is lemon yellow, a blush on the sunny side. The flesh is rather pale yellow, tender and juicy, yet, firm enough to ship well. In flavor there is nothing lacking. Altogether, there is, perhaps, at the present time no peach, for all sections and all purposes, quite so valuable as the Elberta.—H. E. Van Deman, in *Horticulture*.

## KEIFFER PEARS FOR THE ENGLISH MARKET.

We note a question and answer in the Rural New York, regarding the Keiffer pear, and as this pear is being widely planted in Ontario, the reply will be of general interest, the question is :—

Would it be advisable to ship Keiffer pears to England? Would they carry across the ocean all right if packed and shipped as soon as picked? Could they be packed better than to wrap each in paper and put them in bushel boxes? I can get boxes for about 12 or 13 cents bound with hoop iron. Or would barrels be best? What would it cost to send them? For how much would they, probably sell? Can you recommend any reliable merchants in England? Is there any other market that would be better?

*Reply by Otto G. Mayer & Co., New York.*

Some of the questions which G. W. F. asks are impossible to answer. If he can ship Keiffer pears in boxes he describes, they will undoubtedly sell in Liverpool, London and Glasgow; but in view of the immense quantity of apples now being sold in these markets, it would be only guess-work to name a probable price. The freight would not be heavy for one of those boxes. The freight across the water would not be over 30 or 40 cents at present rates; maybe less. Of course, everything depends upon the condition in which the fruit arrives. If it should arrive sound, it would meet with a ready sale; but if ripe when shipped it would arrive in bad order without doubt, and there would be losses. Barrels would be undesirable packages, as they are too large for the small dealers abroad to handle. Later in the season there is a large business done in exporting California pears in such boxes.

*Reply by Keugon, Parsons & Co., New York.*

Last season, as there was a heavy crop of pears and a poor market for them here, I sent over some thirty odd lots from different shippers in various parts of New York State, with the object of learning what could be done to relieve the market here. These were chiefly Bartletts. My advice then was to pack the pears green in kegs, and those shippers who followed that advice, and packed green, did pretty well. The merchant to whom I sent them wrote me, suggesting that, in the future, they should be packed in boxes similar to the California boxes, which can be seen anywhere. I do not quite agree with this, as some years previous I sent over some Clairgeau pears, and took a lot of trouble as regards boxes, without any better result. The best package, to my mind, is a bushel keg, and the pears should be packed green. As regards packing in paper, I don't think that it makes any difference. I sent over, last October, about fifty kegs of the Keiffer pears, and I received after deducting all expenses, \$1.20 per keg. The reason that I suggest kegs is that they are easier to get, the fruit can be more easily packed in them, and they stand the handling better. This year it is difficult to say what could be done with pears; there have been shipped 603,000 barrels of apples this season, as against 35,000 last season, with the result that apples are selling very cheaply, which will of course reduce the price of pears.

## A DOMINION JOURNAL.

SIR,—Your kind offer to allow me an opportunity of occasionally ventilating myself on some kindred horticultural subject, is highly appreciated by me, as I dabble a little in nearly every department of its many divisions, and by our exchange of ideas we may profit. If you will bear with me now I will try and lay before you in a roughly hewn out manner an idea which has been cropping up in my mind at intervals, and which if practicable, would benefit the CANADIAN HORTICULTURIST and all the Canadian horticulturists as well.

The scheme is to make the CANADIAN HORTICULTURIST Canadian in its broadest sense, and to extend its circulation all over the length and breadth of our fair land. This, I think, might be accomplished by something like the following arrangement: We have in Quebec, as you have in Ontario, a Fruit Growers' Association; but we have no organ such as the CANADIAN HORTICULTURIST. There is, as you are aware, a Fruit Growers' Association in Nova Scotia. Now wherein would lie the objections to all the Provinces joining interests with the CANADIAN HORTICULTURIST in making it in reality, as in name, the CANADIAN HORTICULTURIST. In a word, let us have the provincial departments under the charge of the different "Fruit Growers' Associations," or of some one well qualified in the several Provinces to supply interesting matter to the amount of two or three pages each week, with power to increase the space as occasion required or the importance of the subject demanded. With the above co-operative arrangement, and a weekly circulation, in my opinion, a great advance would be achieved all along the line. I am sure I am justified in stating that a weekly edition of the CANADIAN HORTICULTURIST would be considered a great boon, and would be very highly appreciated in this part of our province as well as all over our country. The time too seems opportune to advance the CANADIAN HORTICULTURIST plea as an educating medium, and by its appearance *weekly* instead of monthly, its usefulness in that particular line would be certainly more than quadrupled. I think it would most probably follow the established principle in many scientific instances, and become sixteen times more beneficial, and surely that would be something worth striving for. In submitting the above to you, I hope you will give it your consideration, and bring the object foreshadowed into workable shape, because union and co-operation in horticulture, as in all other affairs, is conducive to strength.

Another point of importance in a *weekly* edition would be its value as an advertising medium.

With some such federation of our horticultural forces, our possibilities in the future can only be guessed.

Hoping you can see your way to mature some such advantageous scheme is the desire of

FRANK ROY,

*Corresponding Secretary of the Montreal Horticultural Society  
and Fruit Growers' Association of the Province of Quebec.*

## MANITOBA FRUITS.

A correspondent residing at Morden, Man., has furnished the Horticulturist of the Central Experimental Farm with the following list of fruits exhibited at the Rockwood Fair a short time ago. This exhibition of fruits was brought about by the efforts of Mr. T. Frankland, of Stonewall, Man., one of the pioneer fruit growers of the province.

*Apples.*—Wealthy, Anisim (Russian), Whitney, October, Duchess, Sweet Russet (Russian), Tonka, Excelsior, Recumbent (Russian).

The list of Crabs is quite extended:—Hyslop, Transcendent, Virginia, General Grant, Montreal Beauty, Yellow Siberian, Red Siberian.

Plums include native and American varieties, among the latter DeSoto and Luedloff.

Of grapes, fruit of native seedlings and Moore's Early were shown.

The principal exhibitors were A. P. Stevenson, Nelson, Man. ; W. B. Hall, Headingly, Man. ; Nelson Bedford, Glencross, Man. ; J. O. Graham, Portage la Prairie, Man. ; J. J. Routledge, Miami ; Jos. Tottle, Stonewall, Man. ; W. Saunderson, Souris, Man.

JOHN CRAIG, *Ottawa.*

## NEW FRUITS.

**The Rochelle.**—On the 18th of November we received from Mr. R. W. Shepherd, of Montreal, a sample of a beautiful winter apple which may prove of much value, especially for cold sections, having originated so far north. Mr. Shepherd writes :

The original tree is growing on my farm at Como, Que., on the Ottawa River, 40 miles west of Montreal. The tree is about 18 years old. It grew up in the nursery from the seedling root instead of from the graft. We noticed that the tree was growing from the stock, and because it was a fine looking tree we allowed it to grow, and it has never been transplanted since. When the tree first began to bear, we saw at once that the fruit was very good, and we have since cut off scions for grafting heavily every year. In 1880 the nursery was removed to another part of the farm, and now the Rochelle tree stands between the rows on my wealthy orchard. The tree is quite hardy, in fact appears very hardy and productive. The fruit is very handsome and keeps till midwinter, quality very fine.

**The Fitzgerald Peach** is a chance seedling of Canadian origin, found at Oakville, Ontario, and valued for its hardiness, as well as for its excellent quality. It is being tested at our South Western Station, whence samples were shown at the Industrial, last year.

# Flower Garden and Lawn. ❧

## BUDDING ROSES.



ONE of the easiest and best ways to propagate roses is by budding. I have the *Hermosa*, and desiring to make more plants of the same kind, thought I would try budding it on the wild rose: having one near by, I inserted two buds of the *Hermosa* about the middle of July, and in about three weeks they measured ten inches in height, and had buds almost ready to expand; since then I have given them but little care and attention, but they still continue to bloom, and are in good condition for winter. Although I had then never heard of any one budding the rose, my experiment proved a grand success.

The process of budding is the same as that of the peach, pear, apple, etc., which was explained through the columns of this paper March 1, 1896, but for the benefit of new subscribers, or those who perhaps did not observe closely the process, I will give an explanation with illustrations.

Select a bud from the rose you wish to propagate, and cut about one-fourth of an inch above and below the bud, taking out an elliptical piece with a little wood beneath it, as shown in Fig. *a*.

For the stock, take any hardy or wild rose, cut a T-shaped incision through the bark near the roots (Fig. *b*), carefully raise the ends or bark of the incision and insert the bud (Fig. *c*); then wrap firmly above and below the bud with a strip of cloth about one-fourth of an inch in width, commencing at the bottom and passing above the bud, returning again and tying just below, covering all out the bud, as shown in Fig. *d*.

In about ten days after budding, if done in spring or early summer, unwrap it, and if the operation has been successful, which it is most sure to be if properly done, cut the old stock off about two inches above the bud; and when it has made a new shoot, tie it to this stump to make it grow straight.

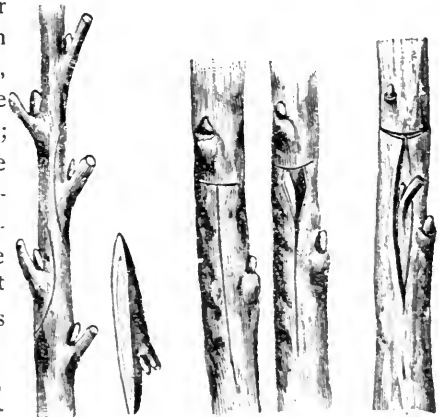

Fig. *a*.

Fig. *b*.

Fig. *c*.

FIG. 1025.—

If budding is done in August or later, rewrap in about ten days, and let the bud and stock alone until spring, then cut off the stock above the bud, and encourage growth. The bud will not start till the following spring, though its union with the stock can readily be distinguished by its plump and fresh appearance.

Buds of different roses, red, white, crimson, etc., may be inserted in a single stock, thereby producing a rose-tree of many colors.

It is not necessary to bud on the wild rose only, but if you have some

other single rose you wish to improve, insert a bud or buds of some nice variety, and I think you will be pleased with the result.

Every lady reader should try this mode of propagating, for it is very simple, and easily done, and you can have a rose ready for bloom in the same length of time it would require a cutting to form roots.—Farm and Fireside.

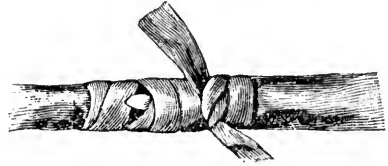

FIG. (d) 1026.—

---

## THE ASH HEAP AND HEN MANURE.

The horticulturist should make an economical disposition of two things that are generally regarded as household nuisances—the ash heap and the droppings of the poultry house. There is nothing that will lighten and loosen a stiff soil so quickly as coal ash siftings. Mr. Allen, the celebrated bulb culturist, of Long Island, thinks there is nothing so good in its mechanical effects and he uses large quantities on his lily beds. Take your ashes every morning as they come from the stoves and before they get wet, sift them through a coal sifter, the coarse part you use on your walks about the premises; the fine, dust-like portion you carry to the henhouse and scatter it over the droppings. It will absorb the gases that arise, keep the floor dry and the air pure—a sort of dry earth system. Every few weeks when the weather permits, the contents of the hen house are wheeled out and spread as a top dressing over the beds of perennials. Will it do any good? Yes, four-fold.

Firstly, it has charitably aided that ash heap to lose its existence; secondly, your hens shall feel better and your labors shall be rewarded with more eggs; thirdly, it does the soil of that flower bed good by loosening it, and fourthly, it does the plants good by feeding them. Why, next June the pæonias will fairly clap their hands for joy. Did you ever dream that a four-fold blessing lay concealed in your ash heap?—Pa. Hort'l Soc. Report.



## THE ABUTILON.



THIS is an interesting genus of annual or shrubby plants, mostly of an ornamental character and widely disseminated, being found in nearly every country, from the West Indies to Siberia, while the difference in geographical range is no less than that of their individual characters. The flowers of one species, *A. esculentum*, are used as a vegetable in Brazil, some of the East Indian species furnish fiber for the manufacture of rope, while the ornamental species furnish some of the grandest objects for the window garden, as well as for the open border. For either place they have no equals when we take into consideration the rare beauty and great productiveness of their flowers. Their mission seems to be to flower, and flower they will under all circumstances—at least as long as they live—and the beauty and number of the flowers are in proportion to the care they receive.

The only objection there can possibly be to them—if that be an objection—is that they grow too freely, usurping the whole window. To obviate this difficulty, the plants to start with should be small, and kept in small pots without shifting. A 4-in pot is sufficiently large for a plant for the window, and this should be constantly in bloom from the time it is 6 inches high until it dies, which it never will do if frost or famine does not consume it. The ornamental varieties are propagated by cuttings, and, as the branches are all terminal flowering, they not infrequently flower on the propagating bench; consequently, plants in full flower in 2-in pots are commonly met in the greenhouse. It is well to start with these for window plants in the fall, gradually shifting them into larger pots when the foliage begins to show a starved appearance. But the change must be gradual, at each shift using a pot but one size larger than the plant previously occupied, and they will bloom the entire winter.

When the weather becomes warm, turn the plants out of the pots into the open border, and their growth will be rampant. With plenty of water and sunshine, and in a deep rich soil, there will be no limit to their flowers. Upon the approach of frost the plant that a year ago was in a thumb pot will now be a strong shrub, fully 4 ft high, altogether too large for any practical purpose. The skillful hand of the hybridizer has worked wonders with the abutilon. The size of the flowers has been wonderfully increased and we now have a large number of varieties, embracing those with self-colored, variegated, or veined, dark rose or crimson, pure yellow of various forms and shades and pure white flowers. A double type has much of merit as a curiosity.

---

## HOW TO IMPROVE A LAWN.

Lawns can be kept green and thickset without the use of stable manure. City and village people who have a few square rods of grass, usually imagine it necessary to keep the plot covered for weeks with highly scented and ill-looking

manure, when the fact is that one half the money's worth of nitrate of soda and powdered phosphate of lime will answer better and create no nuisance. They furnish to the soil, what is most needed, an alkali, phosphoric acid and nitrogen, both of them are inoderous and show their effects immediately on their application.

*Boston, Ont.*

ANDREW H. WARD.

## MANURE FOR FLOWER BEDS.



FRESH compost can only be used with benefit as a mulch in late autumn to prevent the heaving of newly set plants. If compost is to be applied to bulbs or the roots of perennials, it should be at least a year old and thoroughly rotted. A cow and a flower bed travel well together, provided they are kept in separate compartments. The barn yard muck where cows are kept is an excellent plant food; in our estimation it is the best, and whenever we can obtain plenty of it we wish for no other. That part of the enclosure which is free from coarse straw and stable litter, in which the animals thoroughly pulverize their droppings with their feet and incorporate them with the soil underneath contains the correct thing. Scrape this into heaps with hoe or rake, take it to your flower beds and spread it over them in the fall, be liberal with it, don't be afraid, and you will marvel the following summer at the wonders of floral creation. The effect is astonishing. You need no longer lament that your flowers are not as fine as grandmother's were a half century ago. Your plants will receive new life, and their vigorous growth will defy the ravages of the insect world. It will make them more floriferous, and the brilliancy of the colors will surprise you.

The leachings of manure water that accumulate in a depression of the barnyard are a treasure and should be utilized. Carry them to your rose and hydrangea beds after a heavy rain, apply the liquid with a sprinkling can with the rose removed; there let the solution percolate through the soil down to the thread-like, fibrous roots, where nature's alchemist will assimilate them, and mark the result.

If all the barnyard leachings that are now running to waste throughout the country could be utilized in this way, two roses would bloom instead of one, our hydrangeas would have heads twice as large, and other plants would be equally floriferous. Barnyard leachings can be applied with equal benefit to all perennial plants and small fruits. Celery fairly revels in it, and we are safe in saying that a corn stalk would produce twice as much corn.

If we persist in setting out flowering plants and watch them slowly starving to death without making even the feeblest effort to succor them, we will never be successful floriculturists.—Rept. Pa. Hort. Soc., '95.

## STORING VEGETABLES FOR WINTER.



ONE of the first requisites for the successful wintering of many vegetables is protection from hard frosts during the latter days of October. This is especially true of carrots and beets. These should be pulled during the month of October, taking only dry days for the work. Pits for their keeping should be narrow and deep, not over two feet wide and three feet deep, if pits are very wide the vegetables may be spoiled by heating. In pitting, cut off all surplus roots and tops and form the heap above the surface of the ground, so that when covered the water will readily escape.

All vegetables stored in pits should be thickly covered by straw for a first coat, then apply two or three inches of dirt, to be followed by six inches more when winter promises to set in. The usual method of burying cabbage is to place it in a shallow trench heads down; running the rows east and west is preferable, as during the winter it can be taken out easier, the south side of the row not being apt to be frozen hard, incline the roots to the south side of the row to facilitate getting the heads out. In storing celery for winter, dig a trench a few inches deeper than the length of the celery and as narrow as can be dug with a spade, pack the celery close in the trench in an upright position, and cover each root with earth to keep it from wilting, cover the tops with straw or leaves, over which place two boards nailed together in the form of an inverted trough, then cover with earth. Potatoes to be kept in first-class eating condition should be excluded from all light. The bins in which they are placed may be kept covered with blankets, and the windows of the room darkened. Turnips and rutabagas may be kept in the same manner as beets and carrots; salsify and parsnips may also be kept or packed in barrels of moist sand in the cellar. For spring use salsify and parsnip should be left in the ground where grown as kept in this way it is of superior flavor. Winter radishes should be kept in boxes of moist sand in the cellar.—Gardening.

---

**Old, Well Rotted Cow Manure.**—"What soil do you use for those chrysanthemums?" asked a visitor here the other day. "Sod loam and some old cow manure," we remarked. "Good," he replied, "that's just what I want to see. I've been trying to get old, well-rotted cow manure since a couple of years, and have the greatest difficulty in finding it, so I would like to see what yours is like." We lifted a handful of the soil with some lumps of manure in it and showed it to him, when a painful look of disappointment spread over his face. "Why," he exclaimed, "I can get lots of stuff like that. I thought it had to be dry, earthy fine, many years' old stuff!" No, no, that idea is wrong. Cow manure is old enough for potting or other compost purposes, as soon as it is free enough to handle, to chop up and mix up with soil, without being pasty; just as soon as it loses that wet, sticky nature of fresh manure, it is old enough for garden pot purposes.

## THE CALLA LILY.



THE Calla Lily, when properly treated, is a beautiful plant for house-growing. The best method is to procure an earthen jar, suitably decorated on the outside, if desired, by painting or pasting on of flower pictures, or by a paper open-work covering. In this place rich mould, some five or six inches deep, and in this set the calla plant. Now put on the top of this mould a layer of clean, coarse sand, about two inches deep, and on the top of this some small pebbles. Then fill the jar with water, and replace as evaporated, so as always to have the water several inches deep above the pebbles. Place in a warm and sunny window, and the plant will throw up large, luxuriant leaves, to be followed by the magnificent bloom. What is still better, the flower stalks will be sent up in a succession, so as to afford a nearly continuous series of flowers. A few minnows introduced into the water will usually thrive without further care, and will afford a pleasing study.

*Tiverton, Ont.*

A. H. CAMERON.

## FORCING HYACINTHS IN POTS.

For pot culture, the bulbs should be planted as soon as received, a single bulb in a five-inch pot, the top of the bulb to be just below the level of the rim of the pot. The soil should be rich, and it matters little whether it is loamy or sandy, for they will thrive in either. Let the soil be as light or as loose as possible under the bulb, in order that the roots shall have no obstructions to their growth. If the soil is hard packed under the bulbs, the roots will lift the bulbs out, and they cannot be replaced without great injury. After potting the bulbs, plunge the pots in any convenient out-of-the-way place, and cover with soil, coal ashes or almost anything that will keep them dark and cool on top. They will get sufficient heat from beneath to perfect root growth, which is essential to their perfect flowering. Over this covering, coarse manure, leaves or boughs should be placed, sufficient to exclude frost, in order that the pots can be taken out without injury as wanted. In this position they should be left until the middle of December, by which time they will have made considerable top-growth. Then bring into the conservatory or living room any desired number of pots, water thoroughly and give them as light a situation as possible, with as low a temperature as the living room will afford, secure however against frost at night. As the plants advance in growth, give them a warmer and sunny situation, and in six weeks from the time they are brought in, their flowers will be fully developed. At this period it is much better to keep them from the sun and as cool as possible, in order to keep them longer in flower. The hyacinth is one of the few flowers that can be grown in a room without sun; they do better with it, but will bloom very well without, and can be selected for windows where other plants will not perfect their flowers.--C. L. ALLEN, in *Amer. Agr't.*



## The Canadian Horticulturist

SUBSCRIPTION PRICE, \$1.00 per year, entitling the subscriber to membership of the Fruit Growers' Association of Ontario and all its privileges, including a copy of its valuable Annual Report, and a share in its annual distribution of plants and trees.

REMITTANCES by Registered Letter are at our risk. Receipts will be acknowledged upon the address label.

### ↗ Notes and Comments. ↖

REFRIGERATOR SERVICE.—The Dominion Minister of Agriculture has a scheme for a most extended system of Cold Storage service for conveying our perishable products to the British markets. It is said to include refrigerator car service on railways to central places for export to Great Britain. Plans are under consideration for special cars for this work. The scheme includes special cold storage accommodation on shipboard also, so that we have great hope of a new era of prosperity through the enlargement of our markets.

---

WHY DON'T more of our readers take enough interest in this Journal to write for it? So many of them have items of experience to give, that would be of general interest. Why don't the members of our affiliated Horticultural Societies write about their successes or failures with flowers?

---

THE DIRECTORS of the Grimsby Horticultural Society met about November 1st and decided to have a Chrysanthemum show next year. A contract is being made with a florist to grow them during the winter, pinching them back, and transplanting them into 5 inch pots, so that members cannot fail in securing bloom from them. Each member is to receive five different varieties.

---

COAL ASHES are useful as a bed in which to set potted plants, and rooting cuttings; as artificial soil, with plant food added; and for experimental work in nitrogenous fertilizers.

ERRATA.—We regret the mistakes in the announcement of the annual meeting in November number ; the notice was sent the printer too late to have the proof read. Complete programmes have been sent those likely to be interested, and we expect one of the best meetings in the history of the Association.

---

A PROGRAMME and Prize list is just received of a General Horticultural Exhibition in Hamburg in 1897, open from May until September, inclusive. All communications are to be addressed to the Committee of the General Horticultural Exhibition in Hamburg, of 1897.

---

INSPECTION OF FRUIT.—The question of inspecting all fruit being imported into Tasmania is being considered by the Government. The proposal is to inspect fruit on the wharf, so as to prevent the importation of scab, codling moth, and scale insects.

---

THE Dominion apple crop for 1896 has been reckoned at 3,750,000 barrels : the largest importation of apples into England in any one previous year was 1,450,000 ; and probably twice that quantity will go into the English market this year.

---

PEARS IN ENGLAND are bringing very good prices. Beurre Clairgeau and Glout Morceau have sold as high as from \$2.50 to \$5.00 per bushel ; and that, too, carelessly packed in bushel baskets. The highest prices were for the Glout Morceau. The Fruit Grower (London, England) thinks these pears would have sold much better if properly selected and packed in two layer boxes.

---

THE QUANTITY of apples shipped at Grimsby station to November 1st of this year was 10,340 barrels, while the total for all last season was only 13,000. It is evident therefore that we shall far outnumber last season's record at this point before the season closes. And this is, no doubt, but an example of all parts of the Province.

---

GERMAN GOVERNMENT FRUIT DEPOT.—A correspondent of the Dundee Advertiser thus speaks of the institution described in our columns, by our Berlin correspondent, some time since :—“ It was established about three years ago, and exists for the purpose of assisting the fruit-growers of Germany. They send samples of their fruit ; these are shown to fruit-dealers. A bargain is struck if the parties, through the medium of the Department, can fix a price, and the fruit delivered. This is done free of charge, and entirely with the object of developing the trade. So far it has been appreciated by seller and buyer alike, and has met with entire success. Other depots are to be started, if, in fact, they have not already been established, in different centres throughout the Fatherland.”

ADVICES FROM HAMBURG report A 1 Baldwins bringing \$3.00 per barrel in that market. Vienna and Paris also are promising markets for Canadian apples. Mr. Edgar Skelly, of the well known firm of Griffin & Skelly, California, has just returned from a European tour, and states he has great confidence that Austria will yet be one of the best markets for Canadian apples. Perhaps we shall yet command the best apple markets of the world, if we work on right lines, and cease exporting second class apples.

---

FARMERS' INSTITUTE SPEAKERS.—Arrangements have been made by Superintendent Hodson, for over 450 meetings of Farmers' Institutes, with over 50 speakers. Among the latter we notice the following names:—H. L. Hutt, J. H. Panton, of Guelph, D. W. Beadle, Toronto; Alex. McNeil, Windsor; Alf. Brown, Picton; A. W. Peart, Burlington; James Sheppard, Queenston; E. Morden, Niagara Falls, South; M. Burrell, St. Catharines; W. W. Hillborn, Leamington; G. C. Caston, Craighurst, etc.

---

MR. JAMES GOLDIE speaking, in a letter, of certain incidents in the life of his father, the late John Goldie, says in Meehan's Monthly, "My father visited this country (Guelph, Ontario, Canada), in 1817, returning to Scotland, I think, in 1818. He came back again in 1819 and remained, I believe, till 1821. In 1824 he made a collection of plants, trees and shrubs for the Botanical Gardens that were then being constructed in St. Petersburg, Russia, and went there with them. He was connected with the gardens for some time. He travelled in that country collecting novelties, and introduced many fine things. He afterwards re-visited Russia and Siberia to investigate the rich botanical wealth there. He came to Canada in 1844 with his family, and resided at Ayr till his death. Nearly all of his journals and notes of travel in the various countries he visited were lost by the burning of his house."

---

CANADIAN FRUIT FOR HER GRACIOUS MAJESTY. — As intimated in our October number, a collection of some of our finest varieties of apples, pears and grapes have been collected by Messrs. Copp & Heard of Hamilton, and forwarded to the Queen, in order to show what beautiful fruit is grown in this important section of her dominions.

The fruit growers in the Hamilton fruit district responded heartily, and made up a collection of twenty-nine cases, artistically packed in fifty pound cases. These were on exhibition for a few days at Hamilton, before being forwarded.

Mr. Anthony Copp, of Hamilton, writes:—I have written Sir Donald Smith, that we expect him to present the fruit to Her Majesty, and that he is to have it inspected before presentation. I have also sent him a list of growers and varieties of fruit, with description. The fruit sailed on the 7th November

by the Labrador, to the address of Sir Donald Smith, London. It is a nice little present and I hope will go through safely, and be accepted with pleasure by Her Majesty, and it may lead to greater help from the Government in extending our fruit market abroad.

The following is a list of the varieties of fruit sent, with donor's names :—

J. S. Freeman,	Freeman P.O.	—One 50-lb. box apples—	Canada Red.
" "	" "	" "	Baldwin.
C. G. Davis,	" "	" "	Mann.
" "	" "	" "	Wagener.
G. N. Peer,	" "	" "	Snow.
G. E. Fisher,	" "	Eight varieties	dessert apples.
" "	" "	One 50-lb. box	apples—Northern Spy.
" "	" "	" "	Pomme Grise.
A. W. Peart,	" "	" "	Northern Spy.
T. Ghent,	Burlington	" "	Cranberry Pippin.
W. F. Hopkins,	" "	" "	Talman Sweet.
F. W. Fisher,	" "	" "	Bailey Sweet.
John Ireland,	Nelson	" "	A. G. Russet.
" "	" "	" "	Spitzenburg.
" "	" "	" "	R. I. Greening,
E. Peart,	" "	" "	Northern Spy.
W. B. Robbins,	" "	" "	King of Tompkins.
Lieut. McRoberts,	Fruitland P.O.	" "	Snow.
" "	" "	" "	Northern Spy.
Wm. Orr,	" "	One case of	grapes.
M. Pettit,	Winona	" Two cases of	grapes.
" "	" "	" Small quantity of	Duchess pears.
Keep Bros.,	" "	" "	quinces.
Mr. Truesdale,	Hamilton	" A few Ribston	Pippins.
L. Woolverton,	Grimsbay	" One 50-lb. box	apples—Spitzenburg.
" "	" "	" "	King.
" "	" "	Two "	Northern Spy.
" "	" "	One "	Cranberry Pippin.
" "	" "	" "	Baldwin.
" "	" "	" "	Wagener.

A cable on the 20th ult., stated that this fruit had been received by Sir Donald Smith, for presentation, and that the London Daily Telegraph has devoted an article to its description.

UTILIZING THE WHOLE APPLE CROP.—Between cider making, evaporating, canning, and storing in cold storage chambers, all our apples can be utilized to good advantage, even in a year of abundance like the present. An evaporator



capable of evaporating 50 bushels per day can be bought for \$75 to \$125, and the cost of evaporating will average one and a-half cents a pound, and five or six pounds can be made from a bushel of apples.

When there are other means at hand of using the ordinary stock, it is easy to make up one's mind to store only the very best grade. According to the *American Agriculturist*, immense quantities of the very finest grade of apples are now going into cold storage in New York State, in the belief that the market will be better in March and April. Co-operative cold storage houses should be constructed and operated on the same business lines as co-operative cheese factories, and if fruit growers would thus combine in the marketing of their fruit, English buyers could as easily be attracted to American cold storage houses as to our American cheese markets.

---

NEW AFFILIATED HORTICULTURAL SOCIETIES are being formed in several places with the assistance of Mr. Thos. Beall, who thoroughly understands the organization. In response to a letter from one of our members, Dr. J. S. MacCallum, of Smith's Falls, Mr. Beall visited that place, and reports the formation of a strong society. Over one hundred names have been sent in to us from that place. Societies are likely to be formed at Orangeville, Thornbury, Meaford and Durham.

---

THE CHRYSANTHEMUM SHOW at the O. A. C., Guelph, is elegant. On the 18th inst. the writer was shown through the College Greenhouses by the Prof. of Horticulture, Mr. H. L. Hutt, B. S. A., and was surprised at the great extent and variety of the chrysanthemum exhibit. Mr. Hutt has a genius for collecting, and is making his greenhouse collection so varied, that it not only attracts numerous visitors, but is becoming one of the best means of instruction to his students, both concerning the various kinds of flowers, and their respective treatment. He has one exhibition about 120 varieties of chrysanthemums alone; and among them we notice first-class specimens of very showy varieties.

---

ABOUT the 21st inst. the Canadian High Commissioner, Sir Donald Smith received the following note from the Queen's Private Secretary, Lieut.-Col. Sir Arthur J. Bigge, dated Windsor Castle:—"I am commanded by the Queen to beg you to be good enough to arrange that her Majesty's best thanks be conveyed to those fruit growers of the neighborhood of Hamilton, Ont., who kindly offered, through you, for her Majesty's acceptance, a beautiful consignment of their year's crop, which the Queen is glad to hear has been unusually large and excellent in quality. The cases were received yesterday by the Master of the Household. Their contents were in perfect condition and some of the fruit served at her Majesty's dinner proved excellent. Thanking you for the trouble you have taken to ensure the speedy delivery of the fruit, I am, etc."

**THE TARIFF ON FRUIT.**—We understand that the Dominion Government has appointed a Commission to visit the principal towns in Ontario, to learn the wishes of the people on the adjustment of the tariff.

Now we wish in this Journal to exclude everything that is partizan ; our aim is wholly to consider the advancement of the fruit industry, and not the advantage of any party ; but on one thing fruit growers are agreed, whether Grit or Tory, and that is, that our products this year have brought little enough, and that any step that would tend to flood our markets with cheap American grapes and peaches, would be to our hurt.

No doubt some slight adjustments may be made. Our Spy apples sell better in Chicago as a rule, than anywhere, and our Fameuse, in the Southern States ; but the duty of 25 cents a bushel is almost prohibitive. Possibly some way may be seen of inducing our Yankee cousins to remove this burden, in view of some concession that will benefit them some way.

We shall be glad to hear from some of our readers on this subject.

---

**BARS TO CANADIAN NURSERY STOCK.**—We have received from Sidney, N. S. W., a copy of an Act ordering the most careful inspection of all fruit and nursery, which is imported to that country. The object is to prevent the importation of codlin moth, curculio, San Jose scab, apple scab, etc., into the country. This is right enough, only we doubt if that country is much freer than Canada from these evils, for codlin moth and apple scab have long been common in the apple-growing sections of Australia. But this is not to be compared with the action of the Cape Colony Legislature, according to a clipping from the Victoria (B. C.) Colonist, which reads as follows :—“The importation or introduction of any stone-fruit tree, or any fruit, scion, cutting, graft, root or seed, the growth or product thereof, from the United States of America, or the Dominion of Canada, is absolutely prohibited ; and anyone importing or introducing such fruit tree or other article, the growth or product thereof, as aforesaid, shall, upon conviction, be subject to the penalty provided in the body of this proclamation, and in addition thereto the fruit, tree, or other article imported shall forthwith be destroyed.”

Mr. John Craig commenting on the above, writes :—The penalty referred to, and provided elsewhere in this sweeping proclamation, is a fine not exceeding £100, or in default imprisonment not longer than six months. This action seems very arbitrary, but I do not think will affect us very much as our trade with Cape Colony is not likely to be very extensive.

---

**THE ANNUAL MEETING** of the Board of Control of the Ontario Fruit Experiment Stations was held at the O. A. C., Guelph, on the 16th, and 17th of November. There were present, Dr. Mills, Professor Hutt, and Messrs. W. E. Wellington, A. H. Pettit, A. M. Smith, and the Secretary. Mr. W. M.

Orr, of Fruitland, was present to give a general report of his work as Director of Experimental Spraying during the year 1896. In many orchards where the result was not very plain to the eye, the careful weighing and measuring of the resultant crop, showed a large percentage of increase in first-class fruit from trees treated, over those not treated. After some discussion, the Board resolved to suggest, that if this work is to be continued in 1897, some experimental work ought to be done with the kerosene emulsion for bark lice, black aphid and thrip, in order to give public instruction concerning the details of its mixture and application.

The Secretary gave his report of the Experimental Exhibit at the Industrial, and also read descriptions of a large number of fruits, accompanied with life-size photographs, which are to be published in the next report. These will enable anyone, even a novice to identify his varieties, and correct misnomers. The work will also be a guide to planters, concerning the value of each variety for his commercial orchard.

The reports from the Stations were also read, and for the most part were passed as satisfactory. In future, however, more detail of the treatment and yield of different varieties will be expected, while descriptions will only be expected of each one's special fruits.

---

**Small Apples Useless.**—These are the words of a cable lately received concerning a car-load of apples sent to Edinburgh, in which we shipped a lot of second size Baldwins, in barrels by themselves, not mixed with large ones. Later, we had a letter to say that small sized apples, however sound and otherwise perfect, were useless, and would scarcely pay freight. It would be much better to select out the poorest ones, that will keep, and store them for horse feed during the winter. Mr. H. P. Miller writes in the Rural New Yorker: I believe that it will pay to store the small, unmarketable apples for the stock. We once wintered two colts on apples and hay; for some reason, they would not learn to eat grain. I remember that we then believed that we could not have got them through the winter without the apples. They were allowed all they would eat, and they consumed about 40 bushels during the winter. They may be fed whole to horses without danger, but cows are much less liable to choke if the apples are cut in halves for them. I believe that a safe rule in regulating the amount, is to allow a pound a day for each 100 pounds of animal; this for all kinds of stock except hogs. For them, the quantity may be doubled or trebled, as they are the largest feeders among domestic animals. I have had no experience with cotton-seed meal.

## ❖ Question Drawer. ❖

### The Myrtle.

**889.** SIR,—I enclose a piece of myrtle, please tell me whether it is the flowering kind. I have had it six years and it has never bloomed.

A. J. P., *Danville, Que.*

*Reply by James Fletcher, Central Experimental Farm, Ottawa*

The twig you send is from a true myrtle, and this variety is known by gardeners as *Myrtus communis*, variety *angustifolia*. The common myrtle has been a favorite from the remotest ages. Grindon says: "Though now found wild on the shores of the Mediterranean, it came originally from Persia,—how anciently brought thence we may gather from the tradition preserved by Pliny, that the first myrtle that grew in Europe was planted by the tomb of one of the companions of Ulysses. England first possessed the myrtle in 1585, when it was brought from Spain by Sir Francis Carew and Sir Walter Raleigh."

---

### Hall' Honeysuckle.

**890.** SIR,—Will honeysuckles, Hall's for example, succeed if planted in the fall? Should they have a sunny exposure and rich soil?

R. H. LIGHT, *Kingston.*

We may answer yes, to each of these questions; very tender varieties would do better planted in spring; but Hall's Honeysuckle is hardy, and may be planted in the fall.

---

### Wolf River Apple.

**891.** SIR,—What is the origin of the Wolf River apple? Is it a winter variety?  
HENRY C. SABEAU.

The Wolf River originated in Wisconsin, and is a seedling of the Alexander. It is a fall apple of great size and beauty; not considered quite as hardy as the Alexander.

---

### Cauliflowers not Heading—(See page 403.)

**892.** SIR,—I could not succeed with my cauliflowers until I put on a quantity of woodashes at the roots. Out of 45 plants cut, 39 gave solid heads, though not large. I applied the ashes the last of August, and cut the last cauliflower the 11th of November.

CATHARINE A. LEE, *Sutton West.*

## What To Plant.

**893.** SIR,—What are the best varieties of winter apples for a commercial orchard? My situation is on the eastern side of the Mountain.

T. B. MURRAY, *Avening.*

In the District Fruit List published by the Ontario Fruit Growers' Association, the following list of winter apples is recommended for your county, viz. :—Pewaukee, Golden Russet, Scott's Winter, La Rue and Wealthy. In your sheltered location you could, no doubt, grow Ontario and Blenheim, and these two with Wealthy would make a good collection. Our next Fruit Experiment Report will be full of valuable information for you.

---

## Best Early Potato.

(See Question 879 )

SIR,—In reply to the inquiry of A. F. concerning the best early potato, I have grown over thirty early varieties, and I find that the new Jersey Queen, and the Early Maine head the list for productiveness on clay soil.

P. F. CLOSSOM, *Highland Creek, Ont.*

---

## ✱ Open Letters. ✱

### The 1896 Apple Crop.

SIR,—Please find herewith enclosed a short editorial from the Journal of Commerce, entitled The 1896 Apple Crop. "Throughout the States of chief commercial production, including New England, New York, etc., the crop of winter apples is very large, according to the special report in this week's American Agriculturist (New York), which places the aggregate yield at a shade under 59,000,000 barrels for all of the United States, against 60,500,000 barrels in 1895 and 57,629,000 barrels two years ago. This authority says that the crop in New England, New York, Michigan and parts of a few other States is simply phenomenal. New England and New York alone have over 16,000,000 barrels against little more than 7,000,000 barrels a year ago, while Michigan is harvesting the greatest crop of fine fruit ever secured in that State. In sharp contrast, the report covering the Central West shows that in very many instances the crop is insufficient to supply home requirements. This is a decided change in the relative position of the crop compared with the distribution of that of a year ago, and because of the shifting there is a marked difference in the supply available for commercial distribution. Five New England States are credited with 8,500,000 barrels, against scant 4,000,000 barrels in '95 and 7,000,000 barrels in '94. The commercial crop of New York is placed at 7,800,000 barrels, or much more than double that of last year and probably the largest on record, while Michigan is given 6,400,000 against 3,750,000 barrels in '95. The crop has fallen badly in southern Ohio, parts of Indiana, Missouri and elsewhere, and the yield is much smaller in these and a number of other Western and Southwestern States. Crop conditions in Canada were almost perfect from the beginning, with the '95 crop among the largest on record. Quality unusually good."

The Journal of Commerce is the most conservative purely commercial newspaper published in this city. You will observe that the total apple crop of 1896 is less than that of

1895. The various facts which I have given you since June vindicate the advice I gave at that time, to establish agencies in Boston, New York and Philadelphia, for the sale of prime Canadian fruit. The western and southwestern fruit is soft, and must be consumed early, or it will decay and be lost. Prime keepers such as you can supply from Canada, of best quality, will command a higher price in January, February, March and April next, than they did for the same months of this year. The exports to Europe far exceed those of last year, and many beautiful but soft apples have been sent abroad, and I believe they will sell for less than cost in Great Britain, while the effect of their exportation will leave this market comparatively bare of first-class sound apples for home consumption from the 1st of January to the 1st of May.

New York, 29th Oct., '96.

FRANCIS WAYLAND GLEN.

### Apple Bulletin.

The following quotations which are offered by a shipper of Medina, N. Y., serve the purpose of depressing prices and prevent, in a certain degree, the grower from realizing the value of his fruit. They are as follows:—Baldwins, car lots selected fruit, f.o.b., Chicago, 98 cents; St. Louis, \$1.05; Kansas City and Omaha, \$1.35; Denver, \$2.15, and states that he can fill all orders. These prices would net the grower 65 cents, not allowing for the buyer's profit. Now if he makes ten cents per barrel, we have the grower getting 55 cents, which is an absurd price.

The first car from New York sold by the American Fruit Growers' Union, netted the grower, after deducting all charges, such as freight, cartage and commission, 90½ cents for Greenings, 80 cents for Baldwins, 85 cents for Russets, \$1.05 for Spies, and this under the unfavorable conditions of trade caused by warm and stormy weather, and the excitement of a Presidential election.

We look for an improvement over these prices from now on, and advise all growers to co-operate with their local associations and market their fruit through the American Fruit Growers' Union, thus guaranteeing themselves every cent that their fruit will sell for, under the most advanced and proper handling, through the medium of co-operation.

Chicago, Ill., Nov. 5th, 1896.

AMERICAN FRUIT GROWERS' UNION.

### The London Fruit Market.

The Fruit Grower, of London, England, says under date Oct. 28th.:

*Tomatoes.*—Tomatoes show a decided tendency to rise in value. Best fruit is worth 4d. a pound, and this is not to be wondered at; for not only is the weather more favorable for their sale, but the imported samples are scarcer for the week. The smooth skinned varieties of medium size are most sought after by buyers. They are in demand at 4d., and before another week we should not be surprised to find the average coming up to 5d. Good, well-colored fruits are wanted, and speedy advances may be expected.

*American Apples.*—The arrivals of American apples are by no means large, so far as London is concerned; 1982 bushels came into London ports in one day, and 5,723 bushels another day, the latter being the heaviest for any single day during the past week. As a rule the direct supplies for London have not been heavy of late years; and then again the Americans are not so good by any means as those from Canada. Considering the heavy crop it is rather surprising that these direct shipments have not been heavier.

*Canadian Apples.*—In one day 8,205 bushels of apples came to London direct from Canada, then 17,750 bushels on the day following, and 15,705 bushels on the third day, making a magnificent total for three days' receipts. The Canadian apple crop this season is immense, and the quality of the fruit all that one could desire. We are pleased to see Canadian apple growers securing the premier position as regards quantity and quality combined. The sales for best fruit have been good, for, in spite of the heavy supplies, 14s., 15s., and 16s. have readily been realized for best samples. Though prices as 4s. 6d., 5s. and 6s. per barrel are quoted, yet in every instance the samples are only medium or poor. The large well-colored fruits have met a quick sale, and such fruit retailed at 2d. and 3d. per pound comes out as equal to 20s. and 30s. per barrel; and that the public should pay these prices considering the immense supplies, proves the popularity of the fruit in London especially.

## Fameuse Apples for the States.

Notwithstanding the glut of apples in the United States and the exceptionally low prices ruling there, the noted Fameuse apples of this Province are so prized on the other side of the line that ten or eleven car loads have been shipped from the Huntingdon section to Chicago and Cincinnati at good prices. There is an abundance of Montreal Fameuse, and it is to be hoped the demand will come this way, as we could spare a few thousand bbls. at about \$1.50 per bbl. against \$3 to \$4 per bbl. last year. —Montreal Trade Bulletin.

## Our Book Table.

IF YOU WANT A BOOK, telling all about how to raise poultry and the money that can be made upon a small or large scale, and all about the Von Culin Incubators, which they send on trial and do not ask you to pay a cent until after you try it, send five cents to the Von Culin Incubator Co., Delaware City, Del., for their latest catalogue. The book is full of engravings and beautifully printed on fine paper. The cover, printed in colors, represents a farm yard with a pretty girl surrounded by all kinds of poultry.

THIRTY-EIGHTH ANNUAL REPORT of the State Horticultural Society of Missouri. An interesting report of 428 pages. L. A. Goodman, Secretary, Westport, Mo.

THE SURVIVAL OF THE UNSLIKE, a collection of evolution essays suggested by the study of domestic plants, by L. H. Bailey, Professor of Horticulture at Cornell University; published by The MacMillan Company, 66 Fifth Avenue, New York City. Price \$2.

This book of over 500 pages, is full of interest to the grower of fruits or flowers, who wishes to look deeper than the surface. For example, in the chapter on Acclimatization, the author discusses the question under two heads: (1) Change in the individual plant; (2) Variations in offspring, with numerous examples in proof. In the chapter on Sex in Fruits, he discusses the reasons why certain varieties of pears and apples are self-sterile. Other subjects discussed are such as Why are orchards barren? Do varieties run out? Evolution of the glass-house; Are novelties worth their cost? Evolution of the Petunia, etc. We commend this work to all thoughtful horticulturists.

## The Apple Market.

MESSRS. WOODALL & Co., of Liverpool, write under date Nov. 14th:

Although receipts are on a large scale, there is a decrease on last week. The quantity is not more than might be expected in a season of large crops like the present, and now that the arrivals consist of winter stock in sound condition they are not in excess of the demand. The quality of most of the fruit is good, especially Canadian, which proved attractive, and satisfactory results have consequently been realized. The same cannot be said of Boston shipments, which have been variable, and prices show a wide range, as, while some were poor, others were exceptionally fine, Maine especially are beginning to have more color and size. Throughout the week there has been a strong healthy tone at hardening prices, partly assisted by some Continental orders, which may probably continue and be considerably increased, as in some considerable apple growing sections their crops are reported exhausted, and in all others the supply is deficient. This gives assurance of excellent prospects, and with similar or even larger receipts must effectually prevent a recurrence of the disastrous results formerly experienced. At yesterday's sales there was an active demand the market closing at its best, and the advance on good sound ranges from 1/ to 2/ per barrel.

*Newtown Pippins*.—Arrivals continue to increase, and at yesterday's sales there was a slight decline on ordinary to medium fruit, the demand is good, and up to 2/6 was paid for a small lot of fairly fine. The period is arriving when there should be an increased demand, especially for fine, which will undoubtedly be wanted.

### Canadians—

Baldwins.....	9 3 to 12/3	.....	2nds	.....	8/ to 9/
Spy.....	10/ " 11/	.....	"	.....	8 " 9 6
Snow.....	11 6 " 14/3	.....	"	.....	10 6 " 11 3
Kings.....	12 6 " 15/3	.....	"	.....	11/ " 12/
Russets.....	10/6 " 14/	.....	"	.....	8/ " 10/
Greenings.....	9 6 " 12/3	.....	"	.....	8/ " 9

## SPECKED APPLES.



OLD Father Grump, with thrifty care,  
 Had safely stored away  
 For winter use his apple crop—  
 Enough to last till May.

“ We’ll not begin,” said Father Grump,  
 “ To eat ’em yet awhile ;  
 They’ve got to last the winter through—  
 “ There’s none too big a pile ! ”

And so they lay, ’neath lock and key,  
 Till the ripest showed decay,  
 “ Begin on ’em,” then the farmer said,  
 “ Begin on ’em right away !

“ We’ll kinder sort ’em out,” said he,  
 “ And use for sass the wust,  
 And every one who goes for ’em  
 Must take the specked ones fust.”

And so they used the specked ones first,  
 As Farmer Grumps had said,  
 But though they ate some every day  
 The specked ones kept ahead.

And they not only ate them first,  
 But all the winter through  
 If that’s their way, I’ve naught to say,  
 And naught, I’m sure have you.

Now Farmer Hearty always had  
 A well-filled apple bin,  
 But, as he stored them in he said,  
 “ Now listen, we’ll begin

“ To eat the best of ’em right off,  
 And keep on so each day,  
 For some of ’em will not keep long,  
 Though some will last till May.

And so his household one and all,  
 Enjoyed the fruit while sound ;  
 And eating still the ripest first,  
 Had some when May came round.



