

PHYSICAL  
SCI. LIB.

TC  
824  
C2  
A2  
no. 213



UNIVERSITY OF CALIFORNIA  
DAVIS

EDUCATION 59.12

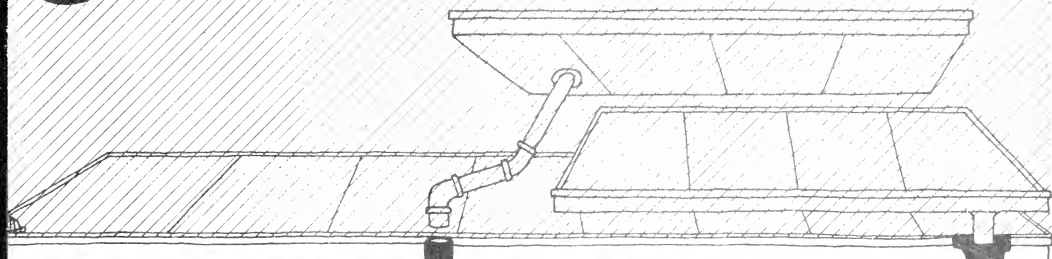

# captured rainfall

UNIVERSITY OF CALIFORNIA  
DAVIS

JUN 17 1981

LIBRARY



Small-Scale Water Supply Systems

Bulletin 213  
May 1981



TC-24  
C2  
A  
nc-213

UNIVERSITY OF CALIFORNIA  
DAVIS

DESIGNAL 54.12



S S

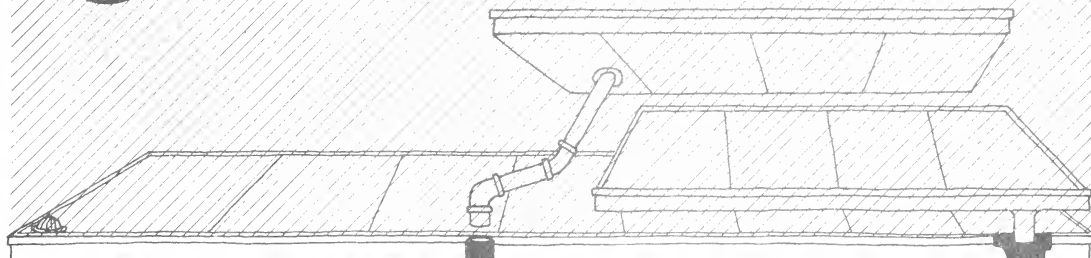

# captured rainfall

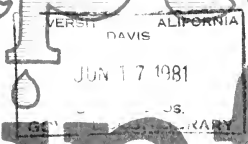

Small-Scale Water Supply Systems

Bulletin 213  
May 1981

Copies of this report at \$1.00 may be ordered from:

State of California  
Department of Water Resources  
P.O. Box 388  
Sacramento, CA 95802

Make checks payable to DEPARTMENT OF WATER RESOURCES  
California residents add 6% sales tax

**STATE OF CALIFORNIA  
The Resources Agency  
Department of Water Resources**

Bulletin 213

**captured  
rainfall** 

**Small-Scale Water Supply Systems**

May 1981

**Huey D. Johnson  
Secretary of Resources  
The Resources Agency**

**Edmund G. Brown Jr.  
Governor  
State of California**

**Ronald B. Robie  
Director  
Dept. of Water Resources**



## FOREWORD

This Bulletin was written to serve three functions. First, it will introduce California water consumers to some water conservation concepts with which they may be unfamiliar, most particularly the idea of capturing and storing rainwater for domestic use. Second, it is an informal report of the proceedings at the Rainwater Cistern Symposium sponsored by the California Department of Water Resources (DWR) and the Monterey Peninsula Water Management District. The Symposium was held at Monterey Peninsula College on January 26, 1979. All references within this Bulletin to "the symposium" or "the conference" are to that January gathering. Third, we hope this will be a useful tool for those of you who are interested in designing cistern systems for your home or community.

The use of small-scale water supply and conservation systems provides a water supply technology for immediate use by the individual, household, or community. We hope that this scale of technology will encourage more people to become more aware of water supply issues in their area and increase their direct participation in acting on local water supply and environmental needs. To promote this kind of individual involvement, on July 26, 1980, Governor Brown signed Assembly Bill 1150 (AB 1150), which provides state personal income tax credit for the costs of water conservation systems constructed for residences in California. The water conservation systems can include rainwater cisterns and greywater systems. The Department of Water Resources' guidelines for system eligibility for this tax credit are now available from the Department. The appropriate tax form is available from the State Franchise Tax Board, Sacramento, CA 95867. Homeowners need only submit a plan of their system to DWR, fill out the proper form from the Franchise Tax Board, and acquire approval from the local health department to obtain the tax credit for their alternative household systems.



Ronald B. Robie  
Director, California Department of Water Resources

## CONTENTS

	<u>Page</u>
Foreword. . . . .	iii
California Water Commission . . . . .	vii
Organization. . . . .	viii
Water Recycling . . . . .	1
Current Water Use and Cost. . . . .	2
Captured Rainfall . . . . .	4
Cisterns, History and Heritage. . . . .	5
A Rainwater Collection System . . . . .	7
Public Health Questions . . . . .	9
A Fog Catchment System. . . . .	12
How Big Should Cisterns Be? . . . . .	13
If you Want to Build a Cistern. . . . .	25
The Costs of Cisterns . . . . .	30
Designing for Conservation: . . . . .	33
Keeping Water on the Site. . . . .	33
Landscape Maintenance. . . . .	34
Site Design and Designing Cities . . . . .	35
Double Water Systems . . . . .	36
Summary . . . . .	40
Further Reading . . . . .	43
Appendix A Calculating the Recurrence Interval of Failure for a Volume of Storage to Supply 100 Gallons a Day for a Family of Two . . . . .	45
Appendix B Program for the Rainwater Cistern Symposium Held at Monterey Peninsula College on January 26, 1979. . . . .	50
Appendix C Estimating How Much Irrigation Plants Require . . . . .	54



CONTENTS

(Continued)

	<u>Page</u>
1 The Hydrologic Cycle . . . . .	1
2 Home Cistern 1918 . . . . .	6
3 Collection System Filters . . . . .	10
4 Fog-Drip System . . . . .	12
5 Water Supply Based on Catchment Area and Rainfall . . . . .	14
6 Nomograph for Design of a Rainwater Collection System . . . . .	16
7 Average Annual Rainfall in California . . . . .	18
8 Nomograph: Cistern Size Based on Area Requiring Irrigation. . . . .	22
9 Different Size Cisterns . . . . .	24
10 Roof Washers. . . . .	26
11 Ideas for Cistern Design. . . . .	27
12 Design the Cistern to Fit Your House. . . . .	29
13 Developments and Cities Can Be Designed to Conserve Water . . . . .	38
14 Combination Rainwater and Greywater System . . . . .	41

Tables

1 Capacities of Various Sizes of Cisterns . . . . .	20
2 Cistern Capacity Reliability. . . . .	21

CONTENTS

(Continued)

	<u>Page</u>
<u>Appendix Tables</u>	
A-1 Precipitation by Months and Accumulated Rainfall (Monterey) (inches)-Monterey, California . . . . .	47
A-2 Recurrence Intervals for Volumes to Meet 100 Gallon/ Day Water Supply from 2,000 sq. ft. - Monterey, California. . . . .	47
C-1 Daily and Seasonal ET Rates in California . . . . .	55
C-2 Water Storage Capacity of Soils . . . . .	56
 <u>Appendix Graphs</u>	
A-1 Precipitation at Monterey and Storage Requirement . . . . .	48
A-2 Storage to Provide 100 Gallons per Day Water Supply, Monterey, CA. . . . .	49

Copies of this bulletin at \$1.00 each may be ordered from:

State of California  
DEPARTMENT OF WATER RESOURCES  
P. O. Box 388  
Sacramento, California 95802

Make checks payable to: DEPARTMENT OF WATER RESOURCES  
California residents add 6% sales tax.

State of California  
Department of Water Resources  
CALIFORNIA WATER COMMISSION

SCOTT E. FRANKLIN, Chairperson, Newhall  
THOMAS K. BEARD, Vice Chairperson, Stockton

Roy E. Dodson ..... San Diego  
Alexandra C. Fairless ..... Arcata  
Daniel S. Frost ..... Redding  
Merrill R. Goodall ..... Claremont  
Donald L. Hayashi ..... San Francisco  
Charlene H. Orszag ..... Sherman Oaks  
James E. Shekoyan ..... Fresno

Orville L. Abbott  
Executive Officer and Chief Engineer

Tom Y. Fujimoto  
Assistant Executive Officer

The California Water Commission serves as a policy advisory body to the Director of Water Resources on all California water resources matters. The nine-member citizen Commission provides a water resources forum for the people of the State, acts as a liaison between the legislative and executive branches of State Government and coordinates Federal, State, and local water resources efforts.

State of California  
EDMUND G. BROWN JR., Governor

The Resources Agency  
HUEY D. JOHNSON, Secretary for Resources

Department of Water Resources  
RONALD B. ROBIE, Director

MARY ANNE MARK  
Deputy Director

GERALD H. MERAL  
Deputy Director

ROBERT W. JAMES  
Deputy Director

CHARLES R. SHOEMAKER  
Deputy Director

OFFICE OF WATER CONSERVATION

Suzanne Butterfield ..... Chief  
M. Kate Williams ..... Assistant Planner, Landscape Water  
Conservation Program

This report was prepared by

A. L. Riley..... Staff Environmental Planner, General Staff Branch,  
Division of Planning

with the assistance of

Richard Beban ..... Freelance Writer  
and

Dr. Frank Pearson.....Sanitary Engineering, Research Laboratory,  
University of California, Berkeley  
William Woodworth.....Monterey Peninsula Water Management District  
Shirley Koploy.....Freelance Writer  
Paul Rodriguez.....Illustrator  
Patricia Ballard.....School of Architecture and Planning,  
University of California, Los Angeles  
Dr. Y. S. Fok.....Water Resources Center, Hawaii  
Dr. Paul Ekern.....Water Resources Center, Hawaii  
Dr. Luna B. Leopold.....Department of Landscape Architecture,  
University of California, Berkeley

All the participants of the Rainwater Cistern Symposium held in Monterey,  
January 1979 (listed in the Appendix B).

## ● WATER RECYCLING

While we late-arriving humans have been proudly patting ourselves on the back for flattening aluminum cans, sorting glass containers and bundling newspapers, Nature has been quietly recycling for eons. One of the simplest and neatest of these natural recycling projects--so simple and neat we tend to lose sight of how grand and eloquent it really is--is the hydrologic cycle. The hydrologic cycle is the key to all biological life on earth. Without water, life cannot exist.

The hydrologic cycle is the scientific name for the constant recirculation of water, powered by the forces of gravity and the sun's heat, from ocean to atmosphere to earth to ocean ad infinitum. In the Winter 1976/77 issue of the magazine Co-evolution Quarterly, Watershed Editor Peter Warshall provides this quick summation of the hydrologic cycle:

"Water endlessly recirculates from ocean to atmosphere....During circulation it is temporarily stored in streams, lakes, the soil, groundwater, plants and animals. Starting in the sky, rain or snow or hail (precipitation) descends to earth. Some is stored on leaves (interception) and is short-circuited back to the sky (evaporation). Some flows off the leaves (throughfall) or down the trunk (stem flow). On earth, rain is absorbed (infiltration) and is stored as soil moisture. If soils are saturated,

the rain fills depressions and begins to run downslope (overland flow). Soil water may percolate deeper to become groundwater or move through the topsoil to streams (throughflow). But, the sun's heat returns some rainfall back to the sky through evaporation from topsoil and lakes and by transpiration from plants. Water in the sky is stored in clouds."

While you need not know the entire hydrologic cycle in order to slake your thirst on a given day, an awareness of its workings can provide a base from which to explore the theories of rainfall capture, reclamation, and reuse we'll be exploring in this bulletin.

### THE HYDROLOGIC CYCLE

FIGURE 1

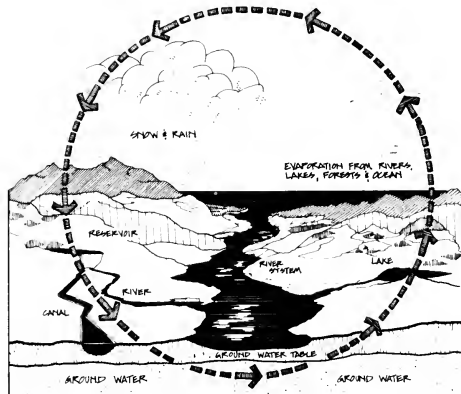

## ● CURRENT WATER USE AND COST

In most communities in California, humans divert water from the hydrologic cycle at one of three points (or in a combination of the three). Water can be:

1. Taken from reservoirs, which are either natural lakes and ponds or holding areas constructed for storage purposes.
2. Diverted from streams or rivers into irrigation or supply systems.
3. Pumped from ground water storage (wells).

In general the transportation, storage and treatment of domestic water are functions performed by government agencies at the municipal or county level. While the State and Federal Governments have involved themselves in massive water supply systems like the California Water Project and the federal Central Valley Project (and do have agencies which monitor water quality) local supplies of drinking and irrigation water have traditionally been developed by local jurisdictions. In California at present there are over 908 special districts dealing with water supplies. These districts break down into 17 subclasses including public utility districts, water districts, irrigation districts and reclamation districts.

For illustrative purposes let's simplify this tangle of agencies. Let's say that

the residents of the town of Aqua, California, vote to form a water district under one of the existing district laws. That district is then empowered to provide water (either community-owned or purchased from private vendors) to the town of Aqua through pipes, pumps and other paraphernalia generally financed through a bond issue. After each resident uses the water, it flows away through the Aqua sewer pipes to a treatment plant where impurities are removed (we hope) before it's dumped back into the watercourse whence it came. From there it'll either flow to the ocean or become the water supply for South Aqua, California.

For the above services, the Aqua Water District charges a fixed rate per litre (or gallon) of water. The present average in California, according to conference participant Dr. Luna Leopold, is between 75 and 85 cents per 3 800 litres (1000 gallons). But, Leopold warns, that's not the real price, and other water experts agree. Leopold says water is generally provided very cheaply relative to its actual cost, so cheaply that "it's always been assumed that wherever you live, somehow or another, the government agencies owe it to you to provide water."

Part of the goal of the Monterey conference was to challenge that public assumption, to make consumers aware that there are other costs involved in the provision of water supplies--not just the cost of the pumps, pipes, and paraphernalia, but the social, environmental

and ecological costs of development and urbanization that are not generally part of a water bill. As conference participant Patricia Ballard of UCLA pointed out, "Fuel and transportation costs are going to have a lot to do with the cost of water itself. As energy becomes limited and higher in cost, you might have more water available, but no way to get it."

According to Gerald H. Meral, Deputy Director of the Department of Water Resources, the transportation charge for State Water Project (SWP) contractors varies for each water contractor on the basis of distance from the source. By 1983 this variable cost will increase significantly due to an expected increase in power costs. For example, communities distant from water supply developments, such as Los Angeles would have to pay a cost of about \$162 per cubic dekametre (\$200 an acre-foot) for delivery of SWP water. [The Los Angeles area is currently charged \$73 per cubic dekametre (\$90 per acre-foot).] For water projects not yet built, users might expect to pay as much as \$240-320 per cubic dekametre (\$300-400 per acre-foot) instead of \$81 per cubic dekametre (\$100 per acre-foot) for existing project water supplies.

Generally speaking, statewide water supplies are adequate for all present needs except during significant drought periods. A part of this need, however, is being met by overdrafting ground water reservoirs. Statewide water demands in the year 2000 could exceed dependable supplies by as much as 8.1 million cubic dekametres (6.6 million acre-feet) per year if agricultural and urban water use continues to increase, ground water supplies are not better managed, and no new supplies are developed. The Department of Water Resources plans to meet these demands through a program that uses a balance of new water facilities, maximum use of existing facilities, water conservation, water reclamation, and ground water storage of water supplies.

For example, the highly urbanized South Coastal area currently has a balance between water supplies and demands. However, as soon as 1990 the projected demand will exceed the supply, and conservation, as well as reclamation and new facilities, will be required. With this in mind the conference explored additional means of conserving and providing water to consumers. In the words of participant William C. Woodworth, the conference tried to "inform the public and key government planners of a supplemental water resource and new technology... the capture of rainfall."

## ● CAPTURED RAINFALL

All water supplies, as we saw in our brief look at the hydrologic cycle, are essentially captured rainfall. Whether the water we drink is from lake, stream or artesian well (or out of a Perrier bottle) it was all rainwater or snow once. The difference between your tap water and what fell from the sky last rainy season is simply the catchment and delivery system and the process by which the rainwater was purified after touching those environmental surfaces.

Patricia Ballard, in her conference presentation, said that the quality of rainwater depends on an area's atmospheric conditions, the quality of collection and delivery surfaces, and the cleanliness of the storage receptacle. Ballard continued: "Rainwater has virtually no bacterial content before it touches the earth's surface. In urban areas, however, rainwater can act with air pollutants to form 'acid rain'. Acid rain is the product of sulfur dioxide ( $SO_2$ ) reacting with atmospheric constituents...which can affect the color, odor and taste of the water, as well as react unfavorably with certain crops. Rainwater should be tested for quality to determine the extent of purification necessary due to these

pollutants if human consumption or irrigation is the end use."

Most experts agree that rainwater is generally clean, but that its interaction with environmental catchment surfaces limits its use as drinking or food crop irrigation water. In effect, the conventional wisdom states, don't drink it if it hits any potentially unclean surface first. The public health implications of captured rainwater will be explored here shortly.

Just because rainwater isn't for drinking doesn't mean it can't be used for other household needs. Generally only 12 percent of your household water supply is used, on the average, in the kitchen for drinking or cooking. For those uses it's best to stick with the tap water supplied by your local water company. For the major household uses, however, like toilet flushing (42%), showering or bathing (32%) or even laundry (14%), "do-it-yourself" captured rainwater is, in most instances, perfectly adequate.

"How do I do it myself?" you ask.

The answer? A "rediscovered" technology with roots in every "primitive" society from the Middle East to Polynesia to the American frontier: the cistern.



## ● CISTERNS, HISTORY AND HERITAGE

If you grew up in the Midwest or West before World War II, you probably recall Grandma or Mom capturing rainwater in a barrel to use for clothes washing because rainwater was "soft". That barrel was a cistern.

If you've been to Hawaii's Volcano House or stayed on a Greek island, your water supply came from a cistern.

Cisterns were a standard feature of just about every California mining town (including San Francisco) and are a major part of the water system in the Caribbean, Korea, Japan, and the State of Israel.

To quote William Woodworth, a cistern is "a man-made tank or catch basin constructed to store water of various quality for later use". Therefore a cistern can be a simple old barrel, a newly constructed 19 000-litre (5000-gallon) redwood tank or a 2500 year old basin carved into soft rock such as Dr. Luna Leopold saw in the Negev Desert and described to a conference panel. Before municipal supply systems became the rule, Ballard said, rainbarrels, cisterns, and wells were common outside American homes (as were waterless privies). The time has come, conference participants agreed, to resurrect the old technology of cisterns.

FIGURE 2

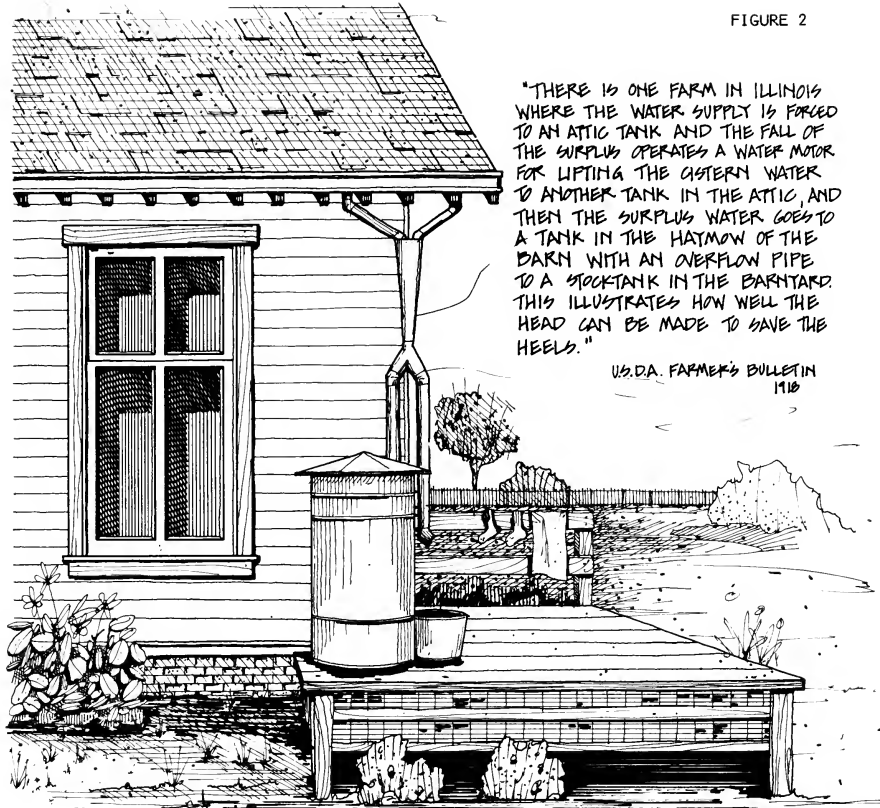

"THERE IS ONE FARM IN ILLINOIS WHERE THE WATER SUPPLY IS FORCED TO AN ATTIC TANK AND THE FALL OF THE SURPLUS OPERATES A WATER MOTOR FOR LIFTING THE CISTERN WATER TO ANOTHER TANK IN THE ATTIC, AND THEN THE SURPLUS WATER GOES TO A TANK IN THE HAYMOW OF THE BARN WITH AN OVERFLOW PIPE TO A STOCKTANK IN THE BARNYARD. THIS ILLUSTRATES HOW WELL THE HEAD CAN BE MADE TO SAVE THE HEELS."

U.S.D.A. FARMER'S BULLETIN  
1918

## HOME CISTERN 1918

## ● A RAINWATER COLLECTION SYSTEM

Cisterns come in all sizes, materials and designs. Before we get into specifics we should digress to describe how a rainwater collection system works. Much of the material that follows in this section is excerpted from Patricia Ballard's conference presentation, which is available in Residential Water Re-Use, a report by Murray Milne of UCLA's School of Architecture and Urban Planning. The report was published in September 1979 by the California Water Resources Center, U. C. Davis.

Ballard said: "A basic rainwater collection system built by the homeowner requires a surface which collects rainfall (catchment), channels it (gutters and downspouts), and stores it (tanks and cisterns). In addition, some form of pumping system will be necessary if water is not stored above the point of use and fed by gravity, or if it must be distributed to remote sites. If rainwater is used for human consumption, a filtration or purification system may be needed, which could range in complexity from a simple screen or sand filter to one of the modern chemical treatment systems."

The high cost of pumping water uphill is a key point touched upon by many conference participants. Dr. Yu Si Fok of the University of Hawaii described one island area 520 metres (1700 feet) above sea level, which obtains all of its water by catchment because the city cannot afford to pump water to the area. The

area in question has 2 000-2 500 millimetres (80-100 inches) of rainfall per year, more than most areas in California (save for a few spots near the Oregon border), but the catchment concept is equally applicable in California mountain areas, augmented, if necessary, by trucked-in water during dry spells.

Ballard continued: "While much of the earth's surface absorbs water into the aquifer [Note: A layer of porous rock, sand, or gravel through which water can pass], impermeable formations such as rock or clay function as huge catchment areas."

Often, catchment areas can be created by adapting a system to the natural contours of the land. Architect Augustine Acuna told the conference of an irrigation system created by the Incas of South America. "The Inca Empire created a sophisticated catchment system underground to collect rainwater coming off the mountains, a system only just being re-discovered now. They terraced the hills to slow down the water flow, giving the water a chance to percolate into the underground drainage area, where it was gravity-fed to the fields." (More on architectural and landscaping possibilities for water conservation can be found in a later section of this bulletin.)

Many environmental surfaces that have been constructed--roofs, streets, parking lots--are created of impermeable materials, which if properly guttered, could catch rainwater. As Ballard said,

". . . the homeowner can use the roof to do more than just keep the rain out, or the driveway to transport more than the family auto. The slope, permeability and degree of containment of the catchment are the significant design variables of a collection system."

Roofs are the ideal catchment surfaces for small scale rainwater collection systems. Flat roofs can catch and even store rainwater, but the weight of water (8.35 lbs. per gallon) and such problems as overflow and leakage militate against roof storage for most homes, save for those built to withstand a heavy winter snowpack. In general, pitched roofs (like most of those in Hawaii) are best for catchment, with gutters draining into closed cisterns. Driveways and

patios can also be used as catchment surfaces, if properly guttered and drained to a collection point. This concept could easily be used in some hilly California counties, Marin for example, where driveways and carports are often on hillsides above dwellings. Runoff from driveways could be stored in cisterns and gravity-fed into homes.

According to Ballard, cisterns should be located, ideally, "as close as possible to both the supply and demand points, either inside or outside the building, above or below ground". Below ground cisterns are insulated from gross temperature changes and easily disguised with landscaping. Ballard also suggests the unused space under many homes as an ideal cistern site.

## ● PUBLIC HEALTH QUESTIONS

With the elements of a simple collection system (catchment, channel, storage) firmly in mind, let's consider some public health questions. As we've seen, rainwater is essentially clean--clean enough for toilet flushing and laundering, at least--but catchment surfaces can present significant contamination problems.

One of the panels at the Monterey conference dealt specifically with public health questions. In addition to the problems involved with rooftop catchment systems, they also considered the collection of runoff from parking lots and storm drains.

The panelists agreed that runoff from the average roof was probably acceptable for non-drinking uses, both inside and outside the home, but that the bacteria and pollution counts were too high for drinking and cooking. Roofs can be polluted by bird droppings, decaying vegetable matter, air pollution and, in some cases, substances used in the construction of the roof itself, leachates like lead and tar. In the words of participant Walter Wong, "My legal opinion is that if you're considering cisterns as an alternative it cannot be accepted as a domestic water supply. It can be accepted as an irrigation system".

The amount of treatment roof runoff requires before it can be considered drinkable (potable) is a matter for

case-by-case analysis. There is no single yardstick. However, the degrees and methods of treatment which could be required are easily summarized from Ballard's presentation. While "rainwater used to flush the toilet or landscape irrigation requires only a simple screen filter...the purification process for rainwater used for human consumption must remove biological or disease-carrying contaminants, air-polluting chemicals, and suspended solids."

Ballard divides the purification process into four, usually sequential, stages: screening, settling, filtering, and sterilizing.

The first stage simply uses screens of increasingly finer gauge to collect large particles and debris, i.e. leaves, bird nests, branches. These filters must be cleaned periodically. Frequently, this is as far as many rainwater cisterns are equipped for water treatment for a landscape irrigation supply.

The second stage, settling, removes the gross turbidity (cloudiness) of the water and aids in the reduction of bacteria. Before cistern water is used, it should be allowed to sit still in the cistern for a period of time so that suspended particles can sink to the bottom of the cistern for later removal. This second stage is generally all that's necessary to purify water for landscape irrigation.

SLOW SAND FILTER

MIXED MEDIA FILTER

FIGURE 3

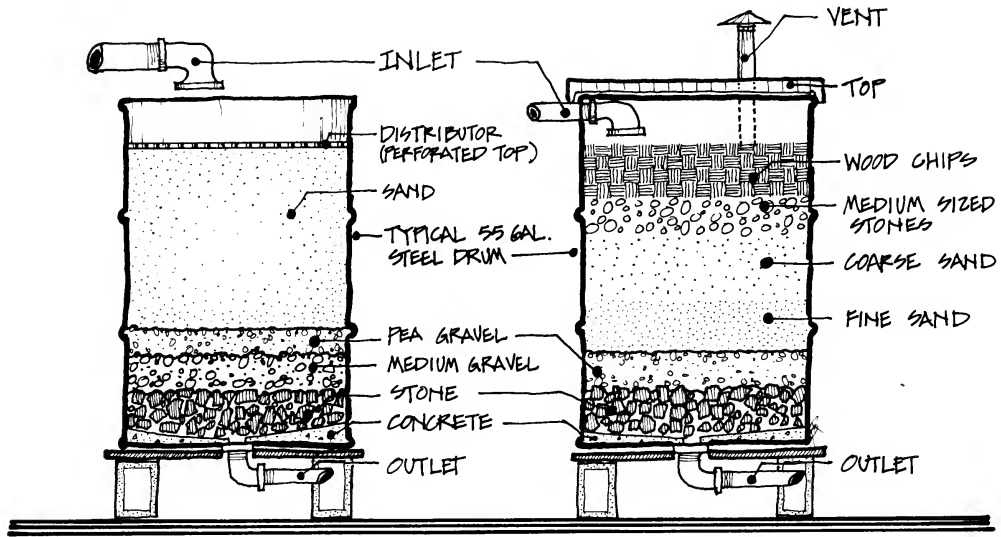

# COLLECTION SYSTEM FILTERS

ADAPTED FROM AN ILLUSTRATION IN M. MILNE'S "RESIDENTIAL WATER USE."

Stage three, filtration, calls for percolating the water through a filtering medium with the help of either gravity or pressure. Collection systems can use a slow sand filter, mixed media sand filter, pressure vessel filter, ceramic filter, or a solar still. Technical details on the latter three can be found in Milne's book. His designs for the first two filters are in Figure 3.

The fourth stage is disinfection or sterilization. Water can be sterilized by boiling or disinfected by the addition of bactericidal chemicals such as chlorine or iodine.

The conference's public health and architecture and engineering panels both discussed the possibility of collecting runoff from shopping center parking lots, city storm drains and other large public catchment areas. All agreed that such capture was feasible, but that there were more problems involved in this alternative. The problems include:

1. Size. Small-scale, on-site collection systems were deemed ideal because there's a short distance between supply and demand. The collector and user of the water are the same person, the householder. Larger collection schemes may involve more hardware for water distribution.
2. Cost. This relates to scale. Water can be collected at a storm drain outlet, but it must be trucked or pumped back to a purification plant

if it is to be reused for household uses, adding transportation costs to the cost of treatment. It appears that water reuse is one area where the "small is beautiful" concept of appropriate technology is applicable.

3. Pollution. The more catchment and collection surfaces rainwater touches, the dirtier and more polluted it becomes. Runoff from a large parking lot or a storm drain system will be heavily polluted with hydrocarbons and other chemicals from automobile drippings, heavy metals like lead, zinc and copper, and higher concentrations of the normal bacteria and contaminants associated with single dwelling catchment systems.

While larger systems involve larger problems, the panelists nonetheless agreed that such operations are feasible for water collection for the irrigation of public landscaping, at least. Golf courses in Orange and Monterey Counties are currently being irrigated with treated sewage instead of potable water. And the lakes in San Francisco's Golden Gate Park are themselves treated sewage. Irrigation of food crops with such water is not recommended, however, because the water contains high concentrations of heavy metals, nitrates, and other contaminants. These substances must be removed since they collect and concentrate in living tissue. In the hope of solving some of these problems, the Monterey Water Pollution Control Agency is investigating use of treated waste water for irrigating vegetables.

## ● A FOG CATCHMENT SYSTEM

Another more esoteric but still feasible technology discussed at the Monterey conference was fog catchment. A fog catcher, according to Dr. Paul Ekern, "is simply a man-made screen, mesh, or other device designed to catch water droplets (in the same manner as trees do) from wind blown fog". Ekern has had success capturing measurable amounts of water from fog, using a louvered device with slats set vertically for rapid draining. Ekern and others in Hawaii, Chile, Mexico, Japan, and South Africa have experimented with a variety of devices and feel certain that the technique is applicable to areas such as California's coast, where fog may be more frequent than actual rainfall.

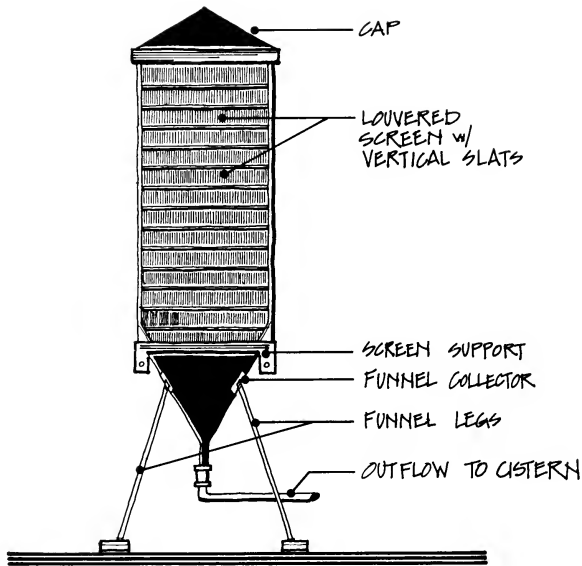

## FOG-DRIP COLLECTOR

SKETCH FROM A PHOTOGRAPH PROVIDED BY DR. P. EKERN



## ● HOW BIG SHOULD CISTERNS BE?

Now that we have seen why cisterns can be helpful, and some of the problems to be wary of, suppose we decide to go ahead with our own system? How big should it be? How much water do we need? How do we make it and how much might it cost?

The California Department of Water Resources estimates that the average home water use is 570-760 litres (150-200 gallons) per person a day.

This means that on the average one person uses about 240 000 litres (64,000 gallons) a year. On the average, 56 percent of this is for in-house uses and 44 percent for outside uses. These percentages and the actual amount used change from region to region. Affluent communities tend to use more exterior water for swimming pools and landscape irrigation and somewhat more for interior appliances. For example, Ellen Stern Harris of the Metropolitan Water District in the Los Angeles area reported at the symposium that about 70 percent of the residential water use in Beverly Hills is for landscaping. Also, in hotter, dryer regions there is a higher demand for landscape water than in the more humid regions.

Thanks to conservation measures, general per capita water use has fallen since the 76-78 drought. Government agencies and private landscape maintenance firms learned during the drought to reduce long-term water use 20-50 percent by

simply using more efficient irrigation techniques and horticultural practices such as mulching. In some cases, 90 percent cutbacks in landscape water use during the drought were attained by using more efficient irrigation methods and changing some horticultural practices. Based on this kind of information, the Department of Water Resources feels that Californians should be able to reasonably reduce landscape water needs 50 percent by 2000. This could be accomplished by changing the design of new housing developments and by using drought-tolerant plants and water-conserving irrigation methods in old, as well as new, housing.

Water can also be conserved in the home by use of such devices as shower and faucet flow restrictors, toilet dams, and water-conserving models of dish and clothes washers. The use of flow restrictors in faucets and showers and use of low-water-using toilets can easily reduce total water use by 25 percent. Symposium participants agreed that many households could almost effortlessly reduce water use by 50 percent through simple indoor and outdoor water-conserving measures. Therefore, the average person's water use could be as low as 280 litres (75 gallons) a day. (The average daily per capita use for the country as a whole is only 250 litres - 75 gallons - per day. How then do we decide how much water to catch off our roofs? Should we try to catch all our water needs -- toilet flushing and laundry water as well as landscaping -- or should we just provide for landscape and irrigation?

RAINWATER COLLECTED, IN LITRES

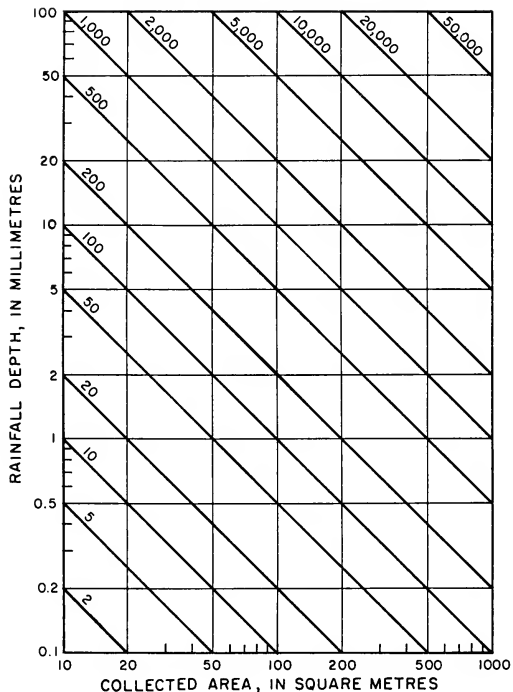

ENGLISH UNITS

FIGURE 5

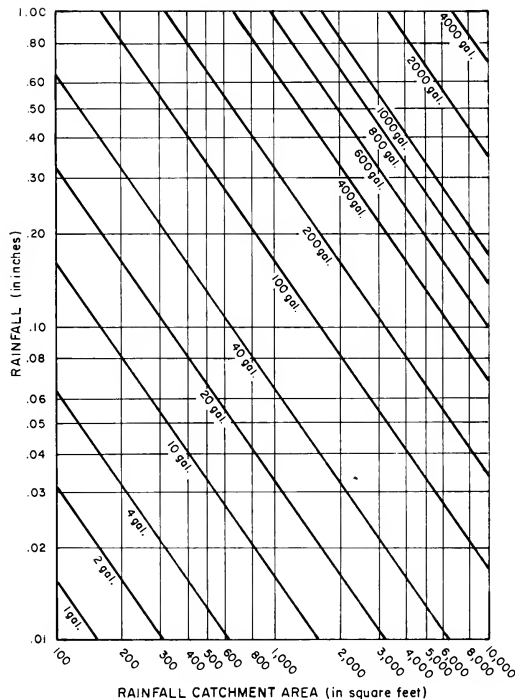

# WATER SUPPLY

BASED ON CATCHMENT AREA AND RAINFALL

SOURCE: WENTWORTH (1959)  
 (1 in of RAIN PER SQUARE FOOT = 0.6 GAL.)  
 1mm of RAIN PER SQUARE METRE = 1 LITRE

There are so many variables behind these questions that we can't provide hard answers. However, we do have a wealth of information from the conference which can help us decide on the size of a cistern.

Once you have an idea of how much water you want your cistern system to supply, you need to calculate how much water the rainfall in your area will provide, and then determine how big the storage tanks should be.

Your first problem is to determine the average rainfall in your area, based on several years of rainfall records. First, multiply your daily needs by 365 to get your yearly water supply needs. Then go to your local library and look up the figures for minimum annual rainfall for your area for the last 10 or 20 years.<sup>1/</sup> Note the minimum annual rainfall for that period of time, note which months comprise your drought period, and note the lowest rainfall that occurred during that time. You can then use these figures to help design your system to provide water during the lowest rainfall periods. Figure 5 shows

<sup>1/</sup> Ask for Climatology of the U.S. No. 86-4, "Decennial Census of the U.S. Climate, Climatic Summary of the U.S. Supplement for 1951-1960; 1960-1970, California", published by the U.S. Department of Commerce, National Oceanic and Atmospheric Administration.

that 1 inch of rain falling on 1 square foot of roof or catchment space supplies 2.3 litres (0.6 gallon) of water. (This does not take into account leakage in your system, roof washing, or evaporation -- occurrences you may want to account for in your calculations.) Figure 5, provided to the conference by Dr. Fok, makes it quite easy to relate catchment area and water supply.

Using the graph, you can compare your annual water needs with the amount of water that is likely to be available from rainfall. You may want to increase your catchment surface by adding the garage roof or paved surfaces to your catchment scheme. You may also want to see how you can conserve more and decrease your water demand. If there is enough water for your needs, then multiply the number of days of the maximum length drought period by your daily water needs to calculate the gallons of storage needed to have as reliable a system as possible.

Many of you will be building cisterns just to provide a water supply for landscape needs during the dry summer season. Remember that about half of the water a household uses in a year is used on the landscape but that most of this water use in California occurs between May and November. If we assume the average household comprises about 2.5 people, then total annual home water use could be calculated as 104 000 litres (27,000 gallons) per capita year X 2.5, which equals 259 000 litres

FIGURE 6

METRIC UNITS

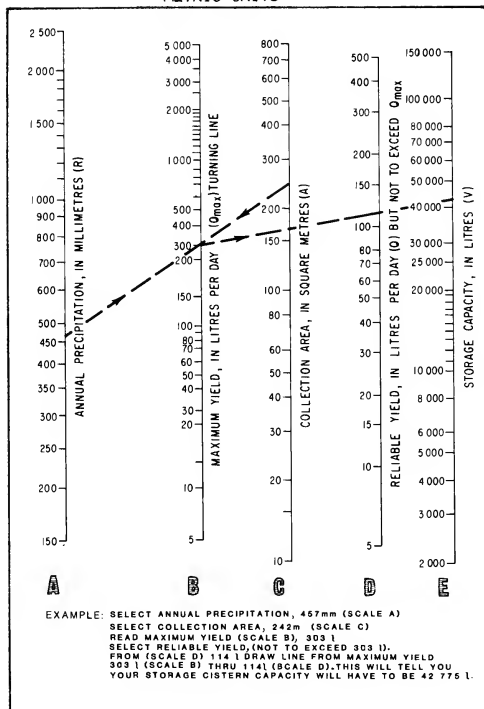

ENGLISH UNITS

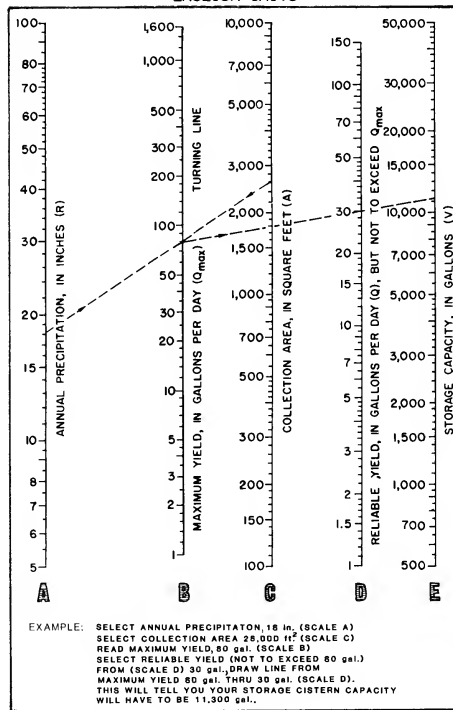

## NOMOGRAPH FOR DESIGN OF A RAINWATER COLLECTION SYSTEM

(68 000 gallons a year).<sup>1/</sup> We can then assume that the average household will need about half of this, or 130 000 litres (34,000 gallons) for landscape watering between May and November. This figure can be reduced significantly if you restrict irrigation to infrequent watering of drought-tolerant or water-conserving plants, vegetable gardens, or reduced areas of lawn you have felt necessary to keep for active uses.

Table 1 shows how large your cistern should be to hold the amount of water you want. Instead of building one huge tank we suggest that several smaller tanks be placed around your homestead. Smaller cisterns are easier to handle and design into your building and site. They also can help keep the water supply closer to the point of use.

The University of California's Sanitary Engineering Research Laboratory (SERL), under the supervision of Dr. Frank Pearson, has some advice to make the job of sizing cisterns easier. SERL points out that we usually don't need to design a cistern system on the basis of the lowest rainfall we can expect in 20 or more years. Designing for this degree of reliability may be more expensive than it's worth.

SERL collected daily rainfall data for a 10-year period and monthly rainfall data for a 40-year period for 13 locations in

---

<sup>1/</sup> Remember that as more people are added to a house the per capita use of water for landscaping drops.

the State. From this information a nomograph (Figure 6) was developed, which can be used to determine the yield in litres (gallons) per day (line B) your cistern can provide, once you have the information on annual precipitation (line A), and the amount of collection area you have (line C). Figure 7 is a map of California with lines drawn on it to indicate the mean annual rainfall for different geographic areas. Find your location on the map and find out what the mean annual rainfall is for your area. Assume the annual precipitation in your area is 460 millimetres (18 inches). Further assume that your catchment area totals 240 square metres (2,600 square feet). If you draw a line from 460 millimetres (18 inches) on line A to 240 square metres (2,600 square feet) on line C, you'll find that your maximum yield is approximately 300 litres (80 gallons) per day.

Line D was arranged so that you can select the amount of yield in gallons per day that you want to have as a reliable water supply. A "reliable water supply" is defined by this nomograph as the number of gallons per day that the cistern could have provided without failure during the 40-year period of rainfall records analyzed. Let's say you want to have no less than 110 litres (30 gallons) available each day. Draw a line from your maximum yield on line B [300 litres (80 gallons)] to 110 litres (30 gallons) a day on line D. Extend this line to storage capacity, line E, and read how much water your tank should hold [42 800 litres (11,300 gallons)].



FIGURE 7  
MEAN ANNUAL PRECIPITATION

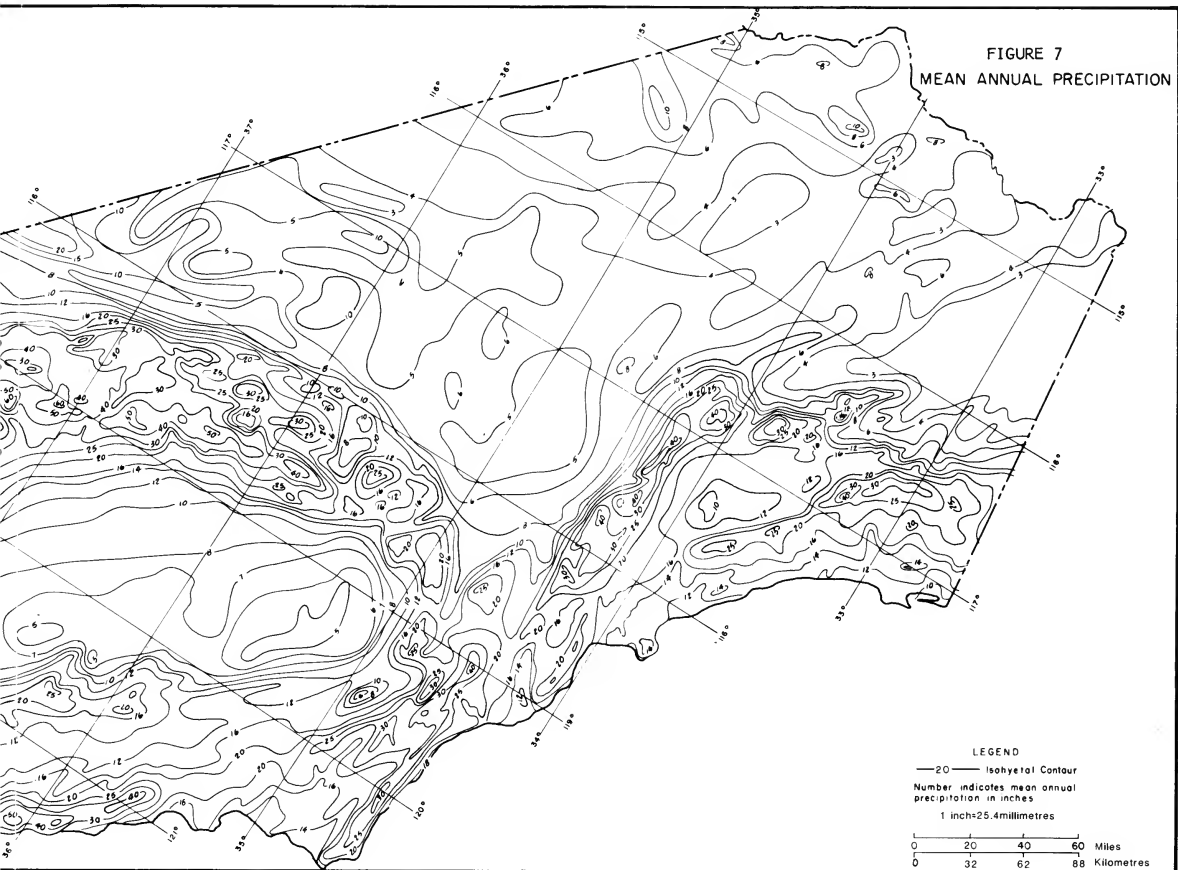

TABLE 1

1 FOOT=0.3048 METRE      1 GALLON=3.7854 LITRES

Depth in Feet	Diameter of Round Type — Length of Sides of Square Type (Feet)																	
	5	6	7	8	9	10	11	12	13	14	15	16	17	18				
	ROUND TYPE (gallons)																	
5	735	1055	1440	1880	2380	2935	3555	4230	4965	5755	6610	7515	8485	9510				
6	882	1266	1728	2256	2856	3522	4266	5076	5958	6906	7932	9018	10182	11412				
7	1029	1477	2016	2632	3332	4109	4977	5922	6951	8057	9254	10521	11879	13314				
8	1176	1688	2304	3008	3808	4696	5688	6768	7944	9208	10576	12024	13576	15216				
9	1323	1899	2592	3384	4284	5283	6399	7614	8937	10359	11898	13527	15273	17118				
10	1470	2110	2880	3760	4760	5870	7110	8460	9930	11510	13220	15030	16970	19020				
12	1764	2532	3456	4512	5712	7044	8532	10152	11916	13812	15864	18036	20364	22824				
14	2058	2954	4032	5264	6664	8218	9954	11844	13902	16114	18508	21042	23758	26628				
16	2342	3376	4608	6016	7616	9392	11376	13536	15888	18416	21152	24048	27152	30432				
18	2646	3798	5184	6768	8568	10566	12798	15228	17874	20718	23796	27054	30546	34236				
20	2940	4220	5760	7530	9520	11740	14220	16920	19860	23020	26440	30060	33940	38040				
	SQUARE TYPE (gallons)																	
5	935	1345	1835	2395	3030	3740	4525	5385	6320	7330	8415	9575	10810	12112				
6	1122	1614	2202	2874	3636	4488	5430	6462	7584	8796	10098	11490	12974	14534				
7	1309	1883	2569	3353	4242	5236	6335	7539	8848	10262	11781	13405	15134	16956				
8	1496	2152	2936	3832	4848	5984	7240	8616	10112	11728	13464	15320	17296	19378				
9	1683	2421	3303	4311	5454	6732	8145	9693	11376	13194	15147	17235	19458	21800				
10	1870	2690	3670	4790	6060	7480	9050	10770	12640	14660	16830	19150	21620	24222				
12	2244	3228	4404	5748	7272	8976	10860	12924	15168	17592	20196	22980	25944	29068				
14	2618	3766	5138	6706	8484	10472	12670	15078	17696	20524	23562	26810	30268	33912				
16	2992	4204	5872	7664	9696	11968	14480	17232	20224	23456	26928	30640	34592	38756				
18	3366	4842	6606	8622	10908	13464	16290	19386	22752	26388	30294	34470	38916	42600				
20	3740	5380	7340	9580	12120	14960	18100	21540	25280	29320	33660	38300	43240	48444				

TAKEN FROM "PLANNING FOR AN INDIVIDUAL WATER SYSTEM"  
 AMERICAN ASSOCIATION FOR VOCATIONAL INSTRUCTIONAL MATERIALS, ATHENS, GA. MAY 1973

# CAPACITIES OF VARIOUS SIZED CISTERNS



The maximum yield attainable in this example (from B) is 300 litres (80 gallons) per day. If you want to store that much water you would find the storage capacity you needed by locating 300 litres (80 gallons) per day on B and D and extending a line to E to find that you need a cistern big enough to hold about 140 000 litres (37,000 gallons)! Obviously, most of us are not interested in building that big a cistern, but fear not, you probably don't need that capacity.

Generally, systems that are designed to be reliable over a relatively short period require less storage than those made for long-term reliability. Table 2 was developed to use with the nomograph so you could determine how much water to store for water supplies of varying reliability.

So, if you can tolerate a water shortage once every 10 years instead of 40 years, take 45 percent of the value shown in the nomograph (a more manageable 63 027 litres [16,650 gallons]) for a supply of 300 litres (80 gallons) per day, or 19 250 litres (5,085 gallons) for a supply of 114 litres (30 gallons) per day) and use that as your storage amount.

This method applies where the same quantity of water is to be used each day throughout the year. If the use of cistern water only during the summer months is envisioned, Figure 8 may be useful. Suppose, for example, that we

STORAGE CAPACITY  
REQUIRED  
(AS A PERCENTAGE  
OF THE VALUE SHOWN  
BY THE NOMOGRAPH)

TABLE 2

40 YEARS	100%
20 YEARS	70%
10 YEARS	45%
5 YEARS	30%

RELIABILITY OF WATER SUPPLY  
(AVERAGE TIME BETWEEN SHORTAGES)

**CISTERN CAPACITY  
RELIABILITY**

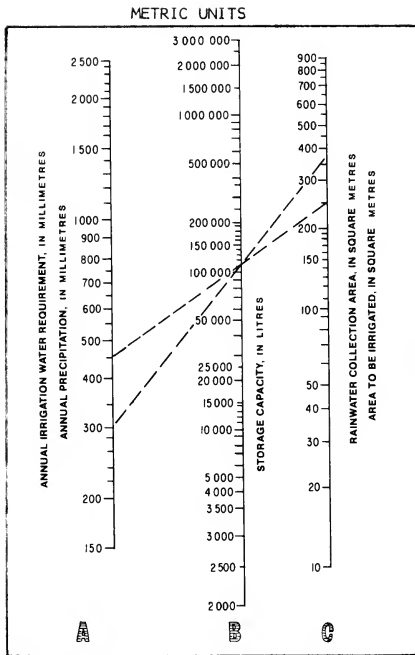

EXAMPLE - SELECT ANNUAL PRECIPITATION = 457 mm (SCALE A)  
 SELECT RAINWATER COLLECTION AREA = 251 m<sup>2</sup> (SCALE C)  
 READ STORAGE CAPACITY = 113 562 l (SCALE B)  
 SELECT ANNUAL IRRIGATION WATER REQUIREMENT = 305 mm (SCALE A)  
 READ AREA TO BE IRRIGATED WITH RAIN WATER = 372 m (SCALE C)

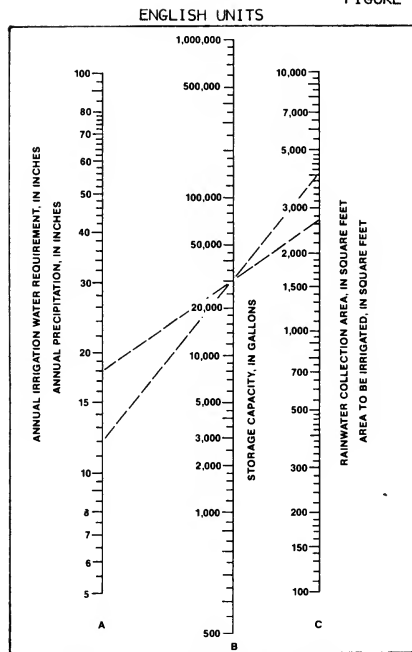

EXAMPLE - SELECT ANNUAL PRECIPITATION = 18 IN. (SCALE A)  
 SELECT RAINWATER COLLECTION AREA = 2700 SQ FT (SCALE C)  
 READ STORAGE CAPACITY = 30,000 GAL (SCALE B)  
 SELECT ANNUAL IRRIGATION WATER REQUIREMENT = 12 IN. (SCALE A)  
 READ AREA TO BE IRRIGATED WITH RAIN WATER = 4000 SQ FT (SCALE C)

# NOMOGRAPH FOR CISTERN SIZE BASED ON AREA REQUIRING IRRIGATION

have a property in a location where the rainfall is 460 millimetres (18 inches) a year, and that the area available from which rain could be collected is 250 square metres (2,700 square feet). Our garden needs about 300 millimetres (12 inches) total depth of water for irrigation during the dry season for nondrought-tolerant species. The remainder of the garden is drought tolerant and does not need any dry season water. (Appendix C discusses how you can figure out how many inches of water you need for watering in the summer.) The questions are, how big a tank do we need and how much garden can we water from it?

Figure 8 shows (by reading line B where the intercept is created by joining 460 millimetres [18 inches] on line A with 250 square metres [2,700 square feet] on line C) that we would need a 114 000-litre (30,000-gallon) tank to capture all the rainfall for that year.

By reading on line C the intercept of the line joining the 12 inches (which is all we need for irrigation) on line A with the 114 000 litres (30,000 gallons) on line B, we find that this cistern will water 370 square miles (4,000 square feet). If this is too much, the tank size should be reduced. For example, 37 square metres (400 square feet) can be irrigated from a 11 400-litre (3,000-gallon) tank.

Dr. Leopold explained at the symposium how you can calculate for yourself the amount of storage required for a desired supply of water for different reliability levels once you get information on your local rainfall records. The reliability factor we speak of here is what the hydrologists call the "recurrence interval" of failure. Those who would like to go through the mathematical calculations may turn to Appendix A, which explains the process.

FIGURE 9

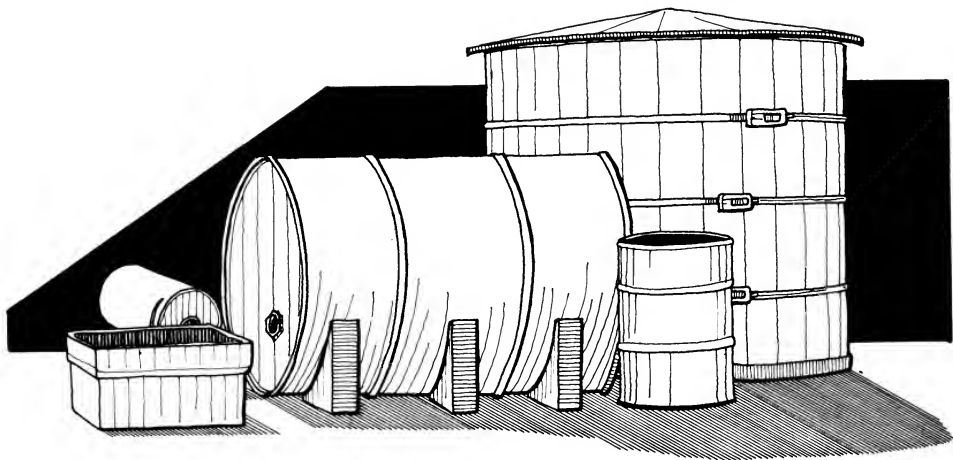

DIFFERENT SIZE CISTERNS

## ● IF YOU WANT TO BUILD A CISTERN

Thus far, we have discussed a variety of ways of catching and storing water, along with the public health actions involved. If you have considered your water needs, the nature of your sites, and the potentials they provide for catching and storing water, and have decided you want to build a cistern, you are now ready for some practical advice. Conference participants Patricia Ballard and William Woodworth (who has constructed several cisterns in the Monterey Peninsula area) have information and experience that will be useful to your design and construction process.

First, Ballard warns, look carefully at the materials used in constructing your roof, as they can affect water quality and yields. Thatch or rough-surfaced roofing materials tend to collect dust and other debris. Asbestos shingles, chemically treated wood shingles, and lead roofs can release toxic substances into the water you are collecting. Smooth roof surfaces will probably average less than 10 percent water loss while rougher, shingled or gravel surfaces will probably not exceed 15 percent. A good rule of thumb is that 80 percent of the rainfall will probably be recovered for storage, allowing for losses due to inefficiency in the collection process and evaporation.

Different ingenious gadgets, called "roof washers", have been devised for cisterns. Since the first part of the

rainfall collects the dirt or pollutants on the roof's surface, we can improve the quality of the cistern supply by washing the roof with the first rainfall and discarding this water. These washers can be operated manually or automatically. Refer to Figure 10 printed here with the permission of the American Association for Vocational Instructional Materials. This organization has a very fine publication, with easy-to-understand instructions for designing small scale water systems. Figure 11, also from this publication, shows a baffle system in which the first 38 litres (10 gallons) or so are caught in the first chamber, with the rest of the water supply "flooding" over the baffle to the second chamber. A good rule is to use 38 litres (10 gallons) of wash water for each 93 square metres (1,000 square feet) of catchment area. Refer to the earlier information on water treatment as well as the diagrams here.

Woodworth advises that although gutters are supposedly designed with a certain degree of slope to aid water movement, they are not always installed this way. First, make sure your gutter has a slope. Second, do not glue your gutter system together. The gutter system should be designed for easy disassembly. You will appreciate this forethought if debris should get caught somewhere in the system or if you should wish to

1/ AAVIM, Planning For An Individual Water System, Engineering Center, Athens, Georgia, 1976.

FIGURE 10

Methods of roof washing for cistern water. (a) Hand-operated diversion valve used to waste first rainfall. After roof is washed, the valve is changed so water will enter the cistern. (b) Automatic roofwash. The first rainfall flows into the drum. After the drum is filled, the remaining water flows into the cistern. During a period without rainfall, water dripping from the opening in the waste line empties the drum.

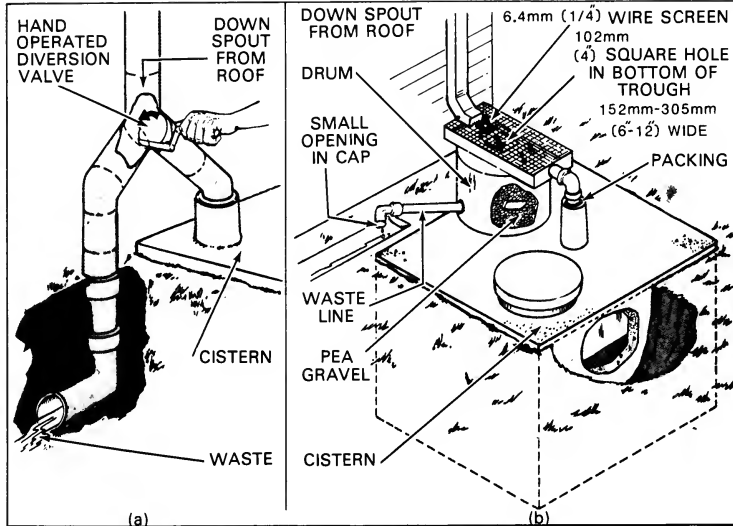

SOURCE: AAUM, "PLANNING FOR AN INDIVIDUAL WATER SYSTEM", 1973

# ROOF WASHERS

FIGURE 11

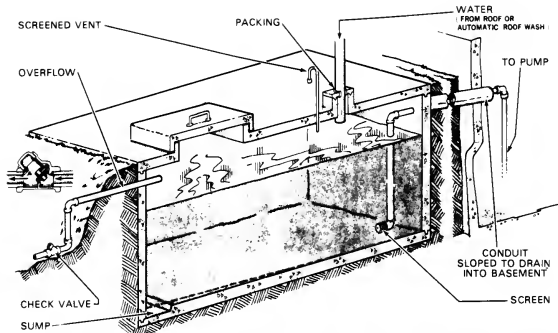

A CISTERN MUST BE WELL CONSTRUCTED TO KEEP SURFACE WATER FROM ENTERING AROUND THE POINTS WHERE PIPING ENTERS THE CISTERN, AND WHERE THE COVER FITS OVER THE ACCESS HOLE. THE CHECK VALVE KEEPS PESTS FROM ENTERING THE OVERFLOW.

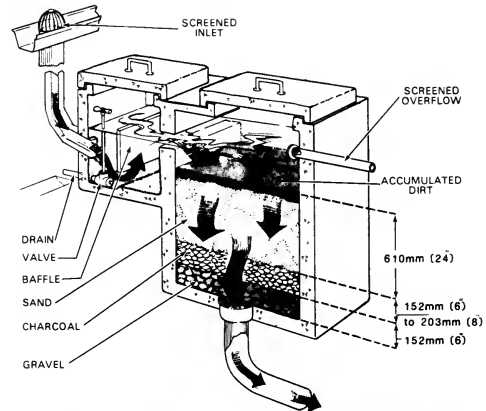

A SAND FILTER OF THIS TYPE CAN BE VERY EFFECTIVE IN REDUCING POLLUTION OF CISTERN WATER IF KEPT CLEAN. IF NOT CLEANED REGULARLY, IT CAN BE A SOURCE OF POLLUTION.

## IDEAS FOR CISTERN DESIGN

SOURCE: AAUIM, "PLANNING FOR AN INDIVIDUAL WATER SYSTEM" 1973

clean it. Round downspouts are more flexible than rectangular ones and are easier to bend in the directions required. Put a screen above the downspout where it connects to the gutter (see Figure 11). Metal gutters could contaminate the runoff water with heavy metal ions or rust, but a nontoxic (not lead-based) waterproof paint can help solve these problems.

The next step is to consider how to deliver your water to the point of use. If possible, rely on gravity to transport your water; if necessary, install a pump. Most landscape irrigation systems can be run on gravity. If your cistern is being used to supply household needs, you probably need a pump and pressure switch to automatically supply the cistern's water supply to the household.

A gravity flow system from an elevated cistern may not provide enough water pressure to run washers, toilets, etc.

A toilet may require at least 34 kilopascals [5 pounds per square inch (psi)] pressure. Water pressure equals about 3 kilopascals (1/2 psi) per foot of head, which is the vertical height from the point of use to the surface of the water. This means that the bottom of the cistern should be at least 3 metres (10 feet) higher than the toilet tank. (It may be possible to find a toilet ball valve that will operate on 2 metres (6 feet) of head.) Lastly, put a lid on your cistern to minimize summer evaporation and to prevent live or inanimate objects from falling in.

Woodworth concludes his tips by advising that cisterns can easily be designed to fit into the architecture of your house or concealed behind plants or structures. Cisterns need not create a blight around your house. Figure 12 shows how cisterns can be built to fit unobtrusively into the structure of your house.



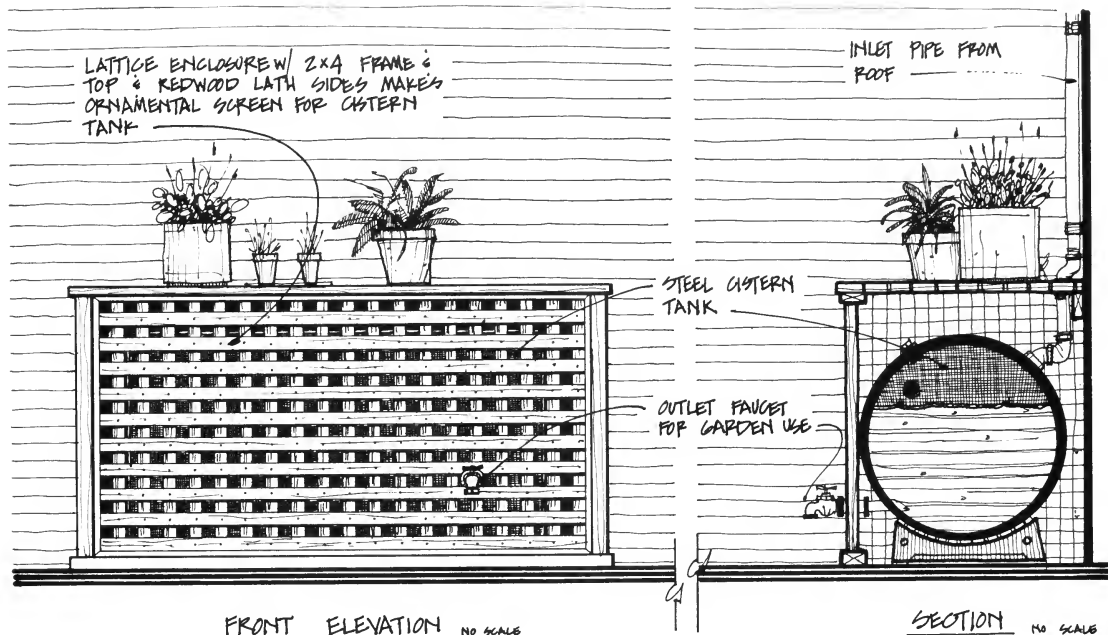

DESIGN THE CISTERN TO FIT YOUR HOUSE

## ● THE COST OF CISTERNS

Conference participant Lloyd Fowler addressed the variables in the cost of cisterns based on a study done by the California Association of Reclamation Entities of Water. Fowler said the cost of a cistern "would probably exceed what you pay from public service. Which is not to say that cisterns are uneconomic, but that a comparative cost of an alternative is less. It may be that if cisterns are put in, prices will change. If you use cisterns to supply some of the water, you still have to supply additional water. If you sell a lesser quantity of water through a community supply system, you have to charge more per unit, as we did during the drought. The costs of supplying the water don't change, so the unit cost has to rise."

Considering all the variables, Fowler continued, "Our rough estimates are that you could put in a cistern to supply half your water needs in an area with 20 inches annual rainfall for something on the order of \$300 to \$600 an acre-foot [an acre-foot = 325,851 gallons]. As you go into larger capacities, this involves a distribution system, and it becomes less feasible, escalating to the order of \$1,000 or more per acre foot of yield.\* This indicates to us that the individual household systems are potentially more economical than medium- or large-sized catchment areas. We have looked at the possibility of using cisterns in many areas where there are now problems with supply and we think there is a place for them there. We also see

\*1 acre-foot = 1.23 cubic dekametres.

a great place for them in strictly urban environments in highly concentrated population areas."

Other conference-goers supported the idea of cisterns for apartment buildings and condominiums in urban areas, with Ellen Stern Harris pointing out that 50 percent of Californians live in multiple-unit dwellings.

William Gianelli, former Director of the Monterey Peninsula Water Management District, on the same panel with Fowler, told of his experience in getting cost estimates for a tank for his home. "I did a study on my own house. My water bill for the months from May 1 to November 1, a dry period, was \$43.50 for 47,500 gallons.\* Assuming that the non-potable portion of this use would be 20,000 gallons,\*it would require a tank of this size to carry one through the dry period. In terms of what I paid to the water company, that 20,000 gallons would cost \$20. I called the tank people in Salinas concerning the cost of tanks. A 20,000 gallon tank, which is what it would require to catch the water, if I could catch it, to carry me over the summer, would cost approximately \$3,500, exclusive of other costs."

William Woodworth, a cistern owner and builder on the Monterey Peninsula, projects another cost estimate based on his experience in building several cisterns. He now has a cistern system on his property, with a capacity of about 1,000 gallons. His cost thus far is

\*47,500 gal.= 180 000 litres; 20,000 gal. = 76 000 litres.

\$600, but he anticipates he can double the capacity for only \$400 more. The cost range of building for 1,000-gallon capacity has been as low as \$200 to \$600.

Cisterns may indeed appear on the surface to be an expensive alternative. However, Woodworth pointed out that direct comparison with the cost of the water company is misleading (particularly remembering Dr. Leopold's comments about the real cost of water as well as the new projections on the rising cost of water in the next 20 years). Perhaps it would be fairer to compare the cost effectiveness of swimming pools and/or hot tubs where the amenities and personal benefits have to be properly weighed to make sense. Woodworth has prepared a graph for the Monterey area which shows the projected increase of water cost per 3 800 litres (1,000 gallons) and another graph which reflects the savings in dollars per 3 800 litres (1,000 gallons) used to replace water district deliveries. Graphs such as these may be a useful tool for deciding how economical a cistern may be to you.

Moreover, Woodworth said, "If cisterns are installed at the time the house is built, the economic tradeoff is most beneficial. Then the costs can be written off, amortized, over the life of the mortgage. However, where the home already has expensive trees, gardens, and lawns, the economic tradeoff can then easily be recognized in favor of the homeowner. The longer a drought lasts, the more economic justification

there is to install a largely automatic cistern collection and distribution system."

At this point you may be interested in what the value of your landscape may be. The drought of 1976-77 required many people to come to terms with the value they assign to their landscapes. While many refused to put a monetary value on a favorite tree or the aesthetics of landscaping, or the environmental functions of a landscape to provide privacy and cool, stabilize, or filter air, real estate agents did provide added monetary values ranging from \$1000-\$5000 for an average household with a newly planted landscape. Some mature landscapes on larger lots were valued at \$25,000.

A Monterey Peninsula resident and owner of cisterns, Dick Lord, said that he viewed the cost of his cisterns as an insurance premium to guard against loss of his garden in the event of future water shortages.

Woodworth, in a paper distributed at the conference, listed what he considers other benefits for homeowners: "A major benefit is certainly greater independence from the water company. Some income tax incentive benefits will undoubtedly occur on this capitalized expense. Resale values of such homes will no doubt rise in direct proportion to the installed cistern water system."

If building from the ground up, a homeowner can also include a greywater

recycling system (greywater is all used household water except that contaminated by human excrement) with necessary purification devices, drought-resistant landscaping, and many other concepts we'll explore in the next section of this bulletin.

To recapitulate, it's hard to tell what a cistern will cost, as each area in California has its own unique rainfall characteristics. Cost estimates range from \$100 to \$3,500, depending on the system, degree of water purification, and distance from place of storage to place of use. One important final point about cisterns--indeed about the cost of water from any source: The best way to lower the cost of a system is to lower

the demand. In other words, if you need a 86 000-litre (20,000-gallon) tank to meet your needs through a dry season, consider putting in a 38 000-litre (10,000-gallon) tank and halving your own demand for water. Installation of a waterless or composting toilet would cut water use by almost half in one simple step.

New ways of designing our cities and landscapes will also significantly affect the amount of water we will need. The next section covers integrating cisterns into a water conservation program for the home and how to select the most efficient size for a cistern, based on your water conserving abilities.

## ● DESIGNING FOR CONSERVATION:

### ● KEEPING WATER ON THE SITE

The focus of this bulletin thus far has been on adding cisterns and rainwater collection systems to existing dwellings, a process engineers call retrofitting. Two of the Monterey conference panels, however, dealt with designing new developments, single-family dwellings, apartment buildings, and public buildings with water reclamation technologies as integral design features. Most housing developments, for example, are built with large sewer systems designed to quickly carry off storm water and dump it, treated or untreated, into the nearest watercourse, bay, or ocean.

Said panelist Doug Catey, "Right now when development occurs, standard practice is to try to get rid of storm water. That's usually accomplished by concentrating the flow off the roof into the gutter, into the street, and then into the storm drain and hopefully off-site because by that time it's pretty poor quality. It has to go somewhere where it won't do too much damage. We've had mixed success with that because it's a very expensive approach, what with the cost of storm draining going up all the time. Also, we haven't always been able to find a place to dump this poor quality water."

Watersheds are fragile ecosystems. Their effectiveness is greatly lessened when roofs, pavements, and other

impervious surfaces are imposed over the land. These surfaces encourage rapid runoff (95 percent of water hitting them runs off), generally into storm drains, thus percolation of water into the soil is prevented. Suppose developments were designed to encourage percolation of water?

Catey again, summing up conclusions of a study done by the Association of Monterey Bay Area Governments, said "Part of our recommendations are that new developments, if at all feasible, keep rainwater on site, either within individual lots or a whole subdivision. It could be some sort of retention basin. Water could actually percolate into the ground and act as a form of ground water recharge which, in some of the basins in or area, is very important from a water supply standpoint. Carmel Valley and Seaside aquifers are both in a situation where the demand on the water body is beginning to reach supply. From a cost standpoint, for a new development, it's fairly promising to be able to capture rainwater on site, depending on the soil. If you can percolate it into the ground, you may actually end up with a cheaper development than if you go into the conventional storm sewer."

Catey listed four ways in which on-site management of storm water can be used to a community's advantage:

1. Control of storm water without major capital-intensive facilities--pipes, ditches, floodgates, etc.

2. Control of erosion and sedimentation.
3. Contribution to ground water recharge.
4. Stretching the water supply by reducing the amount communities have to pump out of the ground.

The concept of "zoning with water", denying water hookups or building permits to new developments because of dwindling local supplies, has been a political football throughout the Seventies in communities all over California. In Marin County, for example, an early Seventies moratorium on water hookups by the Marin Municipal Water District had conservationists and developers squared off in a protracted conflict. Orange County has already imposed limitations on housing permits because of its existing water shortage while, in Hawaii, Maui County has done the same. However, if developments were designed to keep rainwater on site--with retention basins, cisterns, atrium-style houses as in the Middle East, and increased open space--perhaps some of these housing shortages could be circumvented.

Ann Riley, in her presentation at Monterey, focused on three ways urban design techniques could be used to conserve water in cities through:

1. New landscape maintenance practices.

2. Redesigning and planning sites around buildings and the cities around those buildings.
3. Developing small scale water supplies, including double water systems.

## • LANDSCAPE MAINTENANCE

"Mulch", Ann Riley said, "is magic stuff. When you put it on the ground you decrease the evaporation of water from the ground significantly." In addition, the mulch sometimes offers a comfortable environment for the parasites of insects, which may contribute to keeping insect populations manageable, and keeps water-demanding weeds under control. The mulch also cuts down on compaction of the soil. Soil in good condition can hold water better than soil that is too compacted, too sandy, or too clayey.

"When you require a fertilizer, compost can be used to help soil stay in good condition and hold water better. Compost is created by taking leaves or plant clippings from around your property and vegetable leftovers from your kitchen and mixing them up in a compost bin in the back yard, and letting them break down to create natural fertilizer."

Riley also recommended drip irrigation, which uses less water, by directing the water used straight to deep root systems. The water does not pond on the

top of the ground. The Department of Transportation has shown that in certain harsh locations, drip irrigation has made it possible for some plants to grow where they did not survive previously.

## • SITE DESIGN AND DESIGNING CITIES

Riley also recommended the use of drought-tolerant plants which are aesthetically pleasing as well as capable of surviving on little moisture. She also suggested designing our landscapes so we can grow food and put water to use both for ornamental purposes and growing food plants. For example, she suggests almond trees, fruit trees, and herb gardens. Replanting with plants native to the area is a wise way of assuring the plants are well adapted to local water and environmental conditions.

Riley further suggested fire-retardant plants (the South African daisy is a common example). In fire-prone areas in California, fire fighting requires a significant amount of water. The use of fire retardant plants can assist in reducing fire hazards in these areas. The Novato Fire Protection District in Marin County makes a distinction between different areas according to the amount of water that needs to be delivered for

fighting fires. Where shake shingle roofs are used, they require that the water pumps carry 5 680 litres (1,500 gallons) per minute to fight fires. If you use a special composite type of roof shingle, the fire department says you only need to deliver 3 790 litres (1000 gallons) per minute.

Likewise, it is frequently suitable to select water-conserving erosion control plants. These plants will protect the soil, facilitate infiltration of rainwater for recharging ground water supplies, and reduce runoff.

Certain types of building materials and methods of construction allow water to stay on site rather than run off. Decomposed granite, brick, and gravel can all be used for pathways instead of nonpermeable concrete. Rather than hit the surface and run off into the street, the water can soak right down into the ground and create a soil-water reservoir for the plants.

Developers are now finding out that if they keep more of the land around their developments undisturbed, it will be more attractive. They're creating a new market for the kind of natural, undisturbed landscape found in such places as Pacheco Creek development in Marin County or Portola Valley Ranch in Santa Clara County, rather than for the now outdated English-style green grass bowing lawn landscape. Pacheco Creek development, for example, is going to

1/ California Department of Water Resources. Plants for California Landscapes, A Catalog of Drought Tolerant Plants, Bulletin 209, September 1979.

build in the valley and leave the steep valley walls with their native grasses and oaks intact. That way, water is conserved and the problems of erosion and visual impacts of building on the slopes are also avoided. The amount of water needed to irrigate Portola Valley Ranch is reduced greatly because a large part of the landscape is natural, and the water being held on the site in the reservoir and in the drainage systems is available for the plants to use. The replanted areas have been planted with drought-tolerant natives.

What frequently happens in developments is that the more you pave the land, the more water you have running off it; then it goes into streams during a storm, scours the sides, which causes erosion problems. You lose a lot of water at once going downstream. If we can modify the way we design our sites and our developments--so that more water is held on the site--then we're also going to have fewer of these stream rechannelization projects and flood control problems caused by large quantities of water quickly running off the urban surfaces into the streams.

### • DOUBLE WATER SYSTEMS

Double water systems consist of two different plumbing systems within a building, one to carry potable water, and one to carry lower quality recycled water. During the 1976-77 drought, a double water system of sorts was used by some water consumers in Marin County who dis-

connected their kitchen sink drainpipes and collected dishwashing water to water their plants or to flush their toilets. While public health officials frown upon this use of "greywater", the actual practice was officially overlooked because of the severity of the drought condition (water supplies to Marin residences were cut back 57 percent). Apparently, no one took ill from this greywater recycling.

Because of the drought experience, many persons are taking a second look at the use of greywater as a landscaping or gardening resource. California's Farallones Institute currently is testing two greywater recycling projects, while other conservation groups (and some "eco-outlaws" in rural areas like Bolinas) are testing their own designs. The idea of building greywater recycling systems was also a topic discussed at the Monterey conference.

Architect Augustine Acuna told a panel about two different kinds of double water systems. The first provides two different grades of water to residential buildings.

"In Italy, for instance", Acuna said, "if you live in a pension or an apartment house you actually have two plumbing systems. You have a potable water source, then you have a secondary source which is your shower water, water to wash certain things that you're not going to eat directly or you have to cook first. But your fresh water is



available only, say, two days of the week. That has an impact on your lifestyle."

The second kind of double water system is essentially a double plumbing system for taking household greywater and recycling it with the same residence. For systems such as these, Acuna says "The cost could be just about double your plumbing costs right now. A normal plumbing system takes the water from various outlets to a dirty water line and then, in the city, to the sewer or in the country to a septic line. Kitchen water used for rinsing a head of lettuce or washing dishes is not polluted in the same way as water that comes out of the toilet. Even shower water can be treated with a chemical and

reused, at least for maybe a second shot through the toilet. So you have to think about doubling your plumbing lines. Take the water from the sink and shower drains and keep it in a collection tank. The toilet line, as always, goes straight to the sewer."

The concept of greywater recycling is presently more feasible in existing single-family dwellings, as there are generally fewer regulations applying to single-family homes than to either groups of dwellings or municipal or public systems. The panel agreed that architects presently have little or no knowledge of greywater recycling or designing systems to implement it, but that it is an area worthy of further study and action.

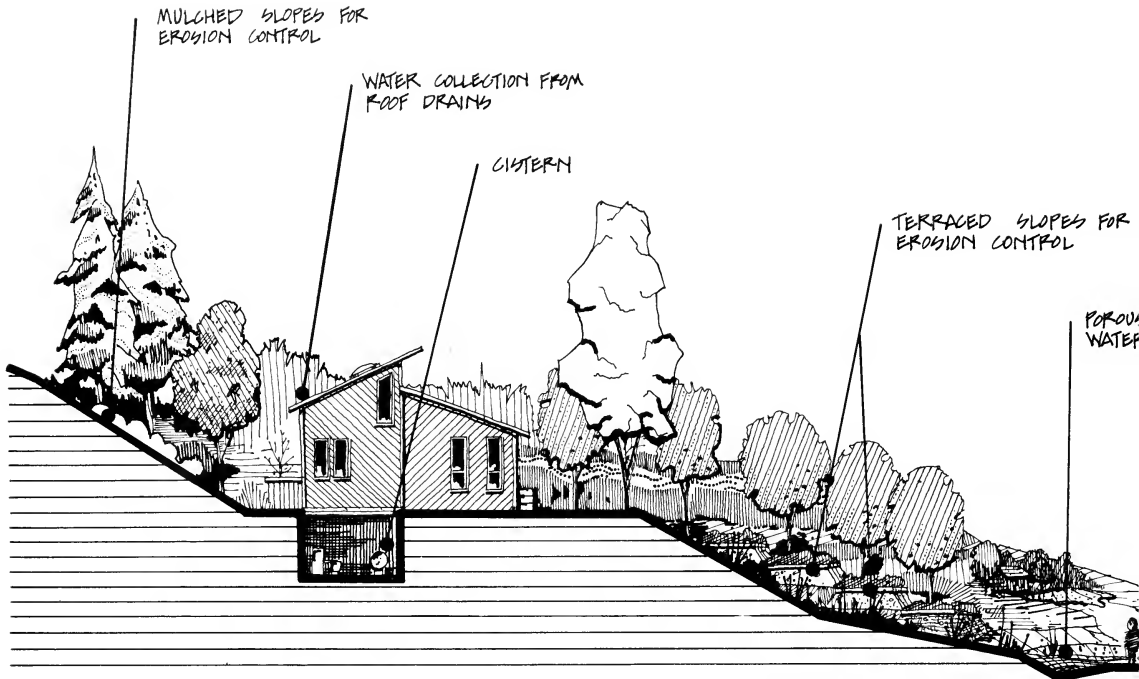

DEVELOPMENTS & CITIES CAN BE DESIGNED TO

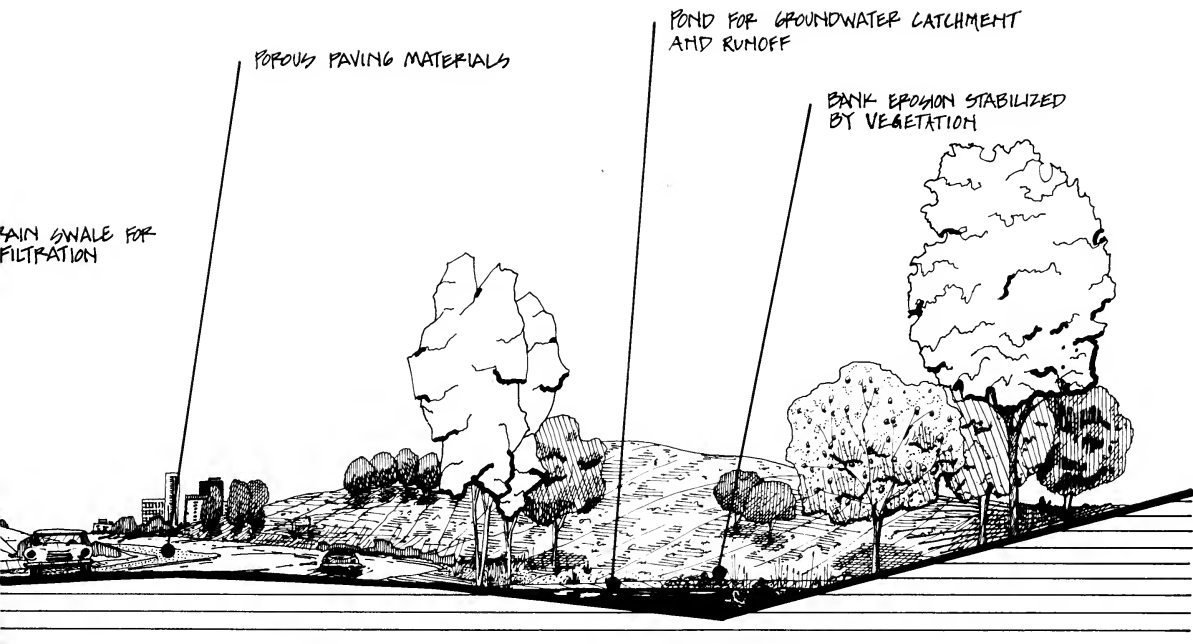

CONSERVE WATER

## ● SUMMARY

There were three goals for this symposium. One was to understand how to capture and use rainwater to irrigate landscapes. A second was to determine the potential savings of limited potable water we can make by developing these alternative supplies. The third was to discuss preparation for the next drought cycle. These goals more specifically were reduced to the following "how-to" objectives:

1. How to capture urban run-off water.
2. How to develop more small reservoirs and second water delivery systems.
3. How to use cisterns and ponding.
4. How to coordinate water supplies to meet a diversity of needs.
5. How to get more public involvement in planning.
6. How to pay for all this.

Water catchment technology, new and old, was covered and ideas were exchanged for fitting theory and present technology into the real world of further expected drought situations. Participants with a wide variety of backgrounds and subject interests enriched the discussions and flavored the conclusions.

For instance, a Sierra Club environmentalist teamed with certified public accountants and retired industrialists

on costs and how to pay for cistern technology. Conservationists exchanged ideas with architects, builders, and golf course managers. School experts and educators wrestled with their readiness to train and motivate people to innovate small water systems. Often the subject of incentives crept into the discussions. Perhaps too much time was devoted to justifying the size and cost of cisterns on private property and not enough time was spent discussing their larger scale use for public lands. The potential of their use for school campuses, parks, golf courses, and green belts was identified, however.

For example, the Monterey Peninsula Water Management District has funded research on the application of cisterns to residential and institutional situations.

The main theme which evolved from the symposium was that water cisterns are well worth looking to for helping to solve localized water problems by augmenting normal potable water service systems. A continuing program of cistern rain catchment technology can develop if:

- More water catchment symposiums and workshops are held
- Funding for pilot studies and demonstration projects can be found
- More information for the public with more feedback can be generated.

FIGURE 14

Those interested in pursuing the use of cisterns for their communities can obtain more information from Bruce Buel, Manager, Monterey Peninsula Water District, P.O. Box 85, Monterey, CA 93940. A 30-minute tape of the workshop summary session (See Appendix B) may be obtained from the water district.

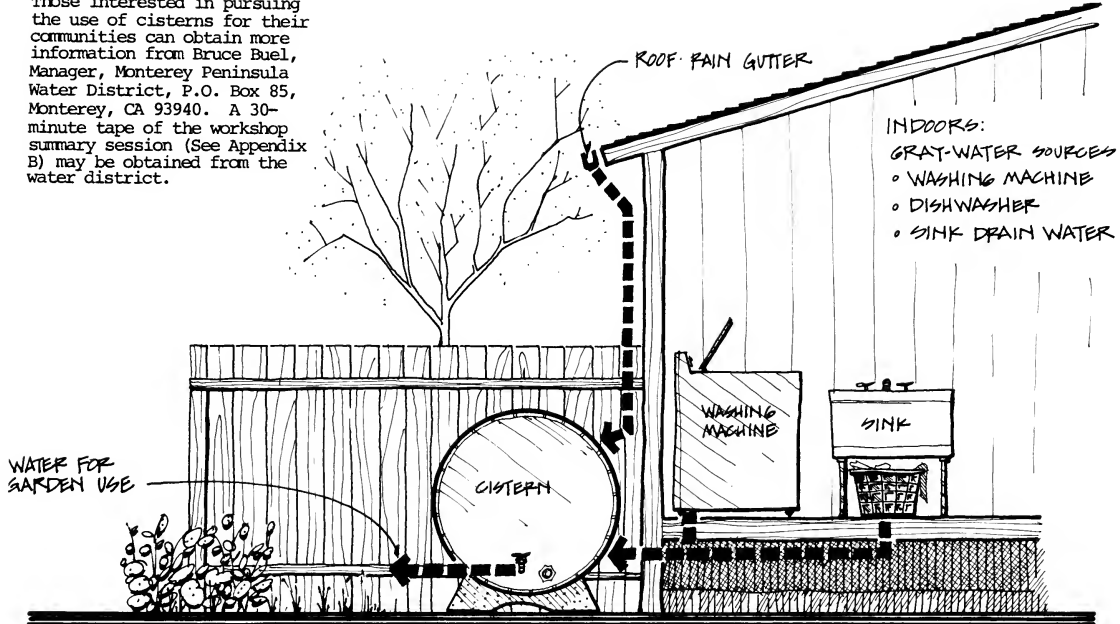

# COMBINATION RAINWATER - GRAYWATER SYSTEM



## ● FURTHER READING

The list which follows is not, in the classic sense, a bibliography. It is a list of some of the works consulted by the writers of this report which are general (and interesting) enough to appeal to a lay reader who wants to delve further into water supply information.

American Association for Vocational Instructional Materials, Planning for an Individual Water System. May 1973. 156 pp.

California Department of Water Resources, The 1976-77 California Drought, A Review. May 1978. 228 pp.

California Department of Water Resources, Outdoor Water Conservation for Environmental Impact Reports, Review. 1979. 3 pp.

California Department of Water Resources, Plants for California Landscapes, a Catalog of Drought Tolerant Plants. Bulletin 209. September 1979. 127 pp.

California Department of Water Resources, Water Conservation in California. Bulletin 198. May 1976. 95 pp.

California Division of Forestry, Ten Thousand Gallon Concrete Water Cistern Construction, Specifications with Diagrams. 1963. 48 p.

California State Water Resources Control Board, Residential Greywater Management in California. January 1980. 34 pp.

Dunne, Thomas, and Leopold, Luna, Water in Environmental Planning. W. H. Freeman, Co., S.F. 1978. 815 pp.

Egern, Paul C., "Direct Interception of Cloud and Fog Water", paper prepared for Rainwater Cistern Symposium, Monterey, CA. Water Resources Research Center, University of Hawaii at Monoa, Honolulu, Hawaii. January 26, 1979.

Farallones Institute, Grey Water Use in the Home Garden. Integral Urban House, Berkeley. 1978. 22 pp.

Fok, Yu-Si, "Past, Present and Future of Rainwater Cistern Systems in Hawaii", paper prepared for presentation to the Rainwater Cistern Symposium, Monterey, CA.

Jenkins, Dave, and Pearson, Frank, Feasibility of Rainwater Collection Systems in California. California's Water Resources Center, University of California, Contribution No. 173. August 1978.

League of Women Voters of California, California's Lifeline: Water. Publication #M781/1. January 1978. 115 pp.

Leopold, Luna, Water, a Primer. W. H. Freeman & Co., San Francisco. 1974. 172 pp.

Marshall, Peter, editor, "Watershed Consciousness" a series of articles in Co-Evolution Quarterly, Issue 12, December 12, 1976. Point Publisher, Sausalito.

Milne, Murray, Residential Water Re-Use, California Water Resources Center, U. C. Davis. September 1979. 553 pp.

Pearson, Kim, Valentine, and Jenkins, Storage Requirements for Domestic Rainwater Collection Systems in California. Sanitary Engineering Research Laboratory, University of California, Berkeley. 1979.

University of California Cooperative Extensive Service, Saving Water in Landscape Irrigation, Leaflet 2976. Prepared and distributed through the cooperative efforts of the California Department of Water Resources and the University of California, Division of Agricultural Sciences.



## ● APPENDICES

### APPENDIX A

CALCULATING THE RECURRENCE INTERVAL OF FAILURE FOR A VOLUME OF STORAGE TO SUPPLY 100 GALLONS A DAY FOR A FAMILY OF TWO

This appendix presents recurrence interval of failure calculations used by Luna Leopold at the Rainwater Cistern Symposium.

Assumptions: A family of two with a 2,000-square-foot roof area in the Monterey area and a water demand of 100 gallons per day (50 gallons per person) or 36,500 gallons a year.

The volume of water falling on the roof is:

$$1/12' \times 2,000 \text{ sq. ft.} \times 7.5^* = 1,250 \text{ gallons/inch} \\ (*1 \text{ cubic foot} = 7.48 \text{ gallons})$$

The amount of precipitation required to supply 36,500 gallons from a 2,000-square-foot roof is:

$$36,500 \text{ gal.} / 1,250 \text{ gal. in.} = 29.2 \text{ inches a year}$$

The average annual rainfall in Monterey is 16.47 inches, which is not enough for this system to work at its present size. If the catchment area were doubled to 4,000 sq. ft., then the volume of rain captured could double:

$$1/12' \times 4,000 \text{ sq. ft.} \times 7.5 = 2,400 \text{ gallons/inch}$$

and the precipitation required would be halved:

$$36,500 \text{ g.} / 2,400 \text{ gal. in.} = 14.6 \text{ inches a year.}$$

Hydrologists use a mathematical formula to calculate the probability of floods or frequency of the occurrence of different rainfall quantities. Leopold uses the formula shown here to figure the frequency a given amount of rainwater storage will fail to meet the demand for 100 gallons a day.

$$(\text{Recurrence Interval}) \text{ RI} = \frac{N + 1}{M}$$

In this formula: N = the number of years of precipitation records, and M is the rank of the array of figures for the storage amount required to meet the difference between supply and demand (Table A-2).

First, data on Monterey's monthly precipitation for the years 1959-1976 was collected. Table A-1 shows a sample of this data which includes the information for 1959-1964. The monthly precipitation sums were then plotted on a graph, and the difference between the demand and supply curves was then determined, as shown in the example Graph A-1. The greatest difference each year indicates the storage requirements.

Table A-1 lists the storage requirement for each year from 1959-1976, as shown by the graphs. The third and fourth columns in the table rank the storage requirements for each year from the largest to the least. The recurrence interval figured by using the formula, as shown in Table A-1, indicates the frequency (in years) you can expect that storage will fail to meet the 100-gallon-a-day demand. By plotting storage requirements against the recurrence intervals on a graph with a logarithmic scale for the ordinate (as shown by Graph A-2), you will find that the graph produces a more or less straight line. By using this straight line relationship you can get a good idea of the recurrence interval of failure for any size storage tank. For example, a storage tank of 28,000 gallons would fail to meet the demand once every 10 years. A failure only once every 20 years would require 32,000 gallons of storage.

Refer to Water, A Primer by Luna Leopold, (published by W. H. Freeman and Co., 1974) for more information on recurrence intervals.

Table A-1. Precipitation by Months and  
Accumulated Rainfall, Monterey, CA  
(inches)

	Precip. (in.)	Total (in.)	Precip. (in.)	Total (in.)	Precip. (in.)	Total (in.)
	<u>1959</u>		<u>1961</u>		<u>1963</u>	
Jan	4.85	4.85	1.89	31.03	3.05	58.41
Feb	5.76	10.61	1.17	32.20	2.70	61.11
Mar	.82	10.93	2.58	34.78	4.14	65.25
Apr	.29	11.22	1.29	36.07	--	65.25
May	.12	11.34	.72	36.79	--	65.25
Jun	.00	11.34	.00	36.79	--	65.25
Jul	.00	11.34	.00	36.79	--	65.25
Aug	.04	11.38	.14	36.93	--	65.25
Sep	3.14	14.52	.09	37.02	--	65.25
Oct	.00	14.52	.04	37.06	1.46	66.71
Nov	.00	14.52	1.74	38.80	3.77	70.48
Dec	.59	15.11	1.19	39.90	.53	71.01
	<u>1960</u>		<u>1962</u>		<u>1964</u>	
Jan	4.30	19.41	2.64	42.63	3.50	74.51
Feb	4.53	23.94	5.17	47.80	.42	74.93
Mar	.84	24.78	2.57	50.37	2.23	77.16
Apr	.88	25.66	.30	50.67	.22	77.38
May	.34	26.00	.15	50.82	.86	78.24
Jun	.00	26.00	.23	51.05	.22	78.46
Jul	.03	26.03	.00	51.05	.09	78.55
Aug	.00	26.03	.25	51.30	.35	78.90
Sep	.13	26.16	.15	51.45	.01	78.91
Oct	.07	26.23	1.33	52.78	.78	79.69
Nov	2.06	25.29	.37	53.15	3.29	82.98
Dec	.85	29.14	2.21	55.36	6.45	89.43

Table A-2. Recurrence Intervals  
for Volumes to Meet 100 gal/day  
Water Supply from 2,000 sq. ft.  
Monterey, California

Year	Req'd Storage	Rank	Storage By Rank	RI = N + 1 M
	(Gal)		(Gal)	
1959	21250	1	31250	19
1960	27500	2	27500	9.5
1961	17500	3	27500	6.33
1962	18750	4	23750	4.75
1963	20000	5	21250	3.8
1964	23750	6	21250	3.17
1965	17500	7	20000	2.71
1966	21250	8	20000	2.37
1967	12500	9	18750	2.11
1968	18750	10	18750	1.9
1969	16250	11	18750	1.73
1970	20000	12	17500	1.58
1971	16250	13	17500	1.46
1972	27500	14	17500	1.36
1973	18750	15	16250	1.27
1974	16250	16	16250	1.19
1975	17500	17	16250	1.12
1976	31250	18	12500	1.06

GRAPH A-1

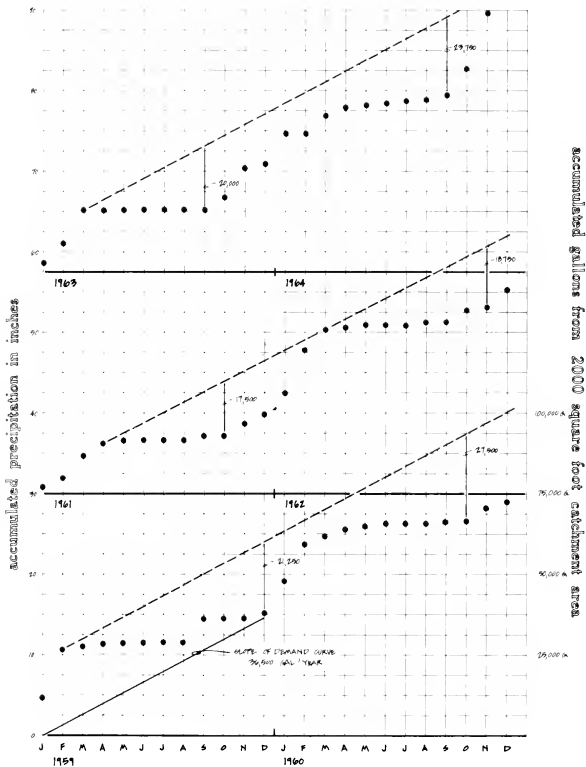

PRECIPITATION AT MONTEREY AND STORAGE REQUIREMENT

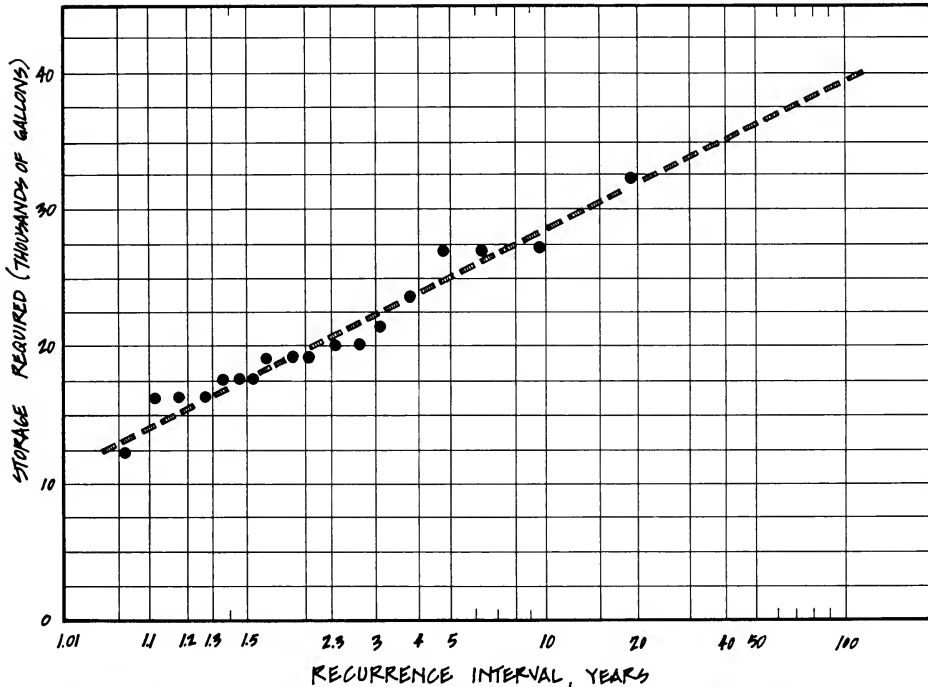

\* GIVEN AVERAGE ANNUAL RAINFALL OF 16" (CALCULATED FOR MONTEREY PENNINSULA)

STORAGE REQUIRED TO PROVIDE 100 GALLONS  
 PER DAY WATER SUPPLY      BASED ON 2000 SQUARE FOOT CATCHMENT AREA

# RAIN WATER CISTERN SYMPOSIUM

Monterey, California, 26 January 1979

**THEME:** *“Capturing the Rainfall – A Small Scale Approach For Urban Use”*

**PURPOSE:** *Explore Opportunities and Plan for Meeting Local Water Supply Needs by Trapping, Storing and Distributing Rain Water.*

**INITIAL GOAL:** *To Irrigate Our Landscapes With Rain Water To Save Our Limited Drinking Water Supply and be Ready For the Next Drought Cycle,*

**HOW CAN WE---**

- a. *Use present urban run-off?*
- b. *Establish and use small ponding structures, cisterns, and take advantage of storm sewer water supplies?*
- c. *Develop non-potable reservoir and delivery systems?*
- d. *Coordinate future water supply activities with all the various agencies involved?*
- e. *Obtain public involvement in implementing alternative water supply systems.*
- f. *Pay for all of this?*

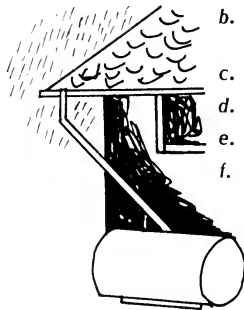

## Capturing the Rain: A Small Scale Approach For Urban Use

Monterey Peninsula College  
Friday, January 26, 1979  
8:15 a.m. – 5:30 p.m.

Cosponsored by the California Department of Water Resources  
and the Monterey Peninsula Water Management District

## PROGRAM

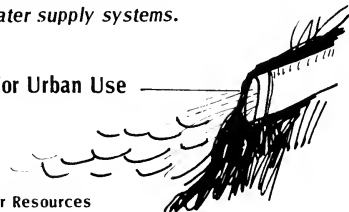

APPENDIX B

8:20 - Opening Remarks - Welcome.

8:30 - Panel Session: Water Supplies for California's Communities: Management Alternatives

Panel Moderator: Dr. Gerald Meral, California Department of Water Resources

Panelists: Luna Leopold, Professor - University of California at Berkeley, Department of Geology and Geophysics, and Landscape Architecture; Lloyd Fowler, Chief Engineer - Santa Clara Valley Water District; William Gianelli, Director - Monterey Peninsula Management Water District; Ellen Stern Harris - Metropolitan Water District, Los Angeles.

9:30 - Coffee Break.

9:45 - Professor Luna Leopold - University of California at Berkeley: "The Implications of On-Site Water Catchment for Urban Environments".

10:30 - Patricia Ballard from the Office of Professor Murray Milne, University of California at Los Angeles: "The Architecture and Engineering of Water Catching Systems".

11:15 - Coffee Break.

11:30 - Assemblyman Henry Mello, Member State of California Assembly Committee on Water, Parks and Wildlife: "Coastal Water Supply and Demand Along Monterey Bay", and Dr. Paul Ekern and Dr. Yu-Si Fok of the Water Resources Research Center, University of Hawaii: "The Significance of Rainwater Cisterns in Hawaii's Water Resources Management".

HALL #1

1:15 - GOLF COURSE & GREEN BELT IRRIGATION - Water needs, new water management methods.

Panel Moderator: W. C. Woodworth, Monterey Peninsula Water Management District.

APPENDIX B

HALL #1 (Continued)

Panelists: John Zoller, Pebble Beach Golf Course Mgr.; Bob Hanna, Exec. Dir. of N. CA Golf Assoc.; Joe Pintar, Pacific Grove Military Golf Course Mgr (Army); Cmdr. James Woods, Navy Golf Course, Monterey; Dr. Douglas McLain, Computer Spec, NOAA, Monterey, CA;

- 2:15 - URBAN DESIGN FOR CONSERVATION - The role of cisterns in a regional water supply. How we can design our cities.

Panel Moderator: Marlene Blaisdell, Water Comm., League of Women Voters.

Panelists: Ann Riley, Landscape Planner, Dept. Water Resources, Sacramento; Ferdinand Ruth, Santa Catalina School, Monterey; Bob Johnson, Mgr. Soquel Water Dist.; Dr. Luna Leopold, Univ. of Calif., Berkeley.

- 3:15 - ARCHITECTURE & ENGINEERING FOR CISTERN SYSTEMS - The existing use of cisterns and the need for innovative designs.

Panel Moderator: Ted Larson, Architect, Pacific Grove.

Panelists: Augustine Acuna, Pres. Monterey Chapter, American Institute of Architects; Pat Ballard, UCLA, School of Architecture; Dr. Yu-Si Fok, Water Resources Research Center, Hawaii.

- 4:30 - SUMMARY SESSION - Reports from each workshop; proposed actions; followup.

Moderator: Ann Riley.

HALL #2

- 1:15 - PUBLIC HEALTH & STORM WATER USAGE - How to design cisterns for health, relate to effluent use systems.

Panel Moderator: Caroline Page, Pres. League of Women Voters.

Panelists: Walter Wong, Monterey Co. Health Dept; Marit Evans, Regional Water Quality Control Bd; Doug Catey, Engr, AMBAG, Monterey.



APPENDIX B

(Continued)

HALL #2 (Continued)

2:15 - HOW TO PAY FOR CATCHING RAIN SYSTEMS - Public? Private? Economic trade-offs.

Panel Moderator: C. William Maxeiner, Retired Exec, Dillingham Corp.

Panelists: Malcom Defore, CPA, Cistern Owner; Morris Cox, Retired Industrial Company Pres., Cistern Owner and Chairman of Volker Foundation; Carl Larson, Business Conslt, Sierra Club Representative; Richard Lord, Retired Business Executive, Board of Pebble Beach Sanitary Dist., Owner of Cistern; Tom Wortham, Mgmt. Specialist, Golden Gate College, Pacific Grove.

3:15 - WORK OPPORTUNITIES IN SMALL SCALE WATER SYSTEMS - Training, education needs, economic scenario, energy related topics.

Panel Moderator: Dick Bragg, Pres., Monterey County School Bd.

Panelists: Tom Adamson, Monterey Co. Adult Education; John Saavedra, Monterey Co. Economic Development Office, Salinas; Vince Bradley, Supv., Monterey Peninsula College Adult Education; Dr. Phil Nash, Vice Pres., Monterey Peninsula College; Rudy Neja, Agricultural Dept., Salinas.

## APPENDIX C

### ESTIMATING HOW MUCH IRRIGATION PLANTS REQUIRE

#### Water use by Plants<sup>1/</sup>

Most irrigation water applied to plants goes out through the leaves as water vapor, while some evaporates from the soil. This is known as evapotranspiration--generally shortened to ET. The rate of ET is influenced by climate: sunlight, temperature, humidity, and wind. Because of differences in climate, ET rates are different in various locations and from season to season. It is important to have a rough idea of the amount of water used through ET by your landscape plantings. Otherwise you may put on too much or too little water to replace the loss.

Average ET rates for California are listed in Table C-1. These figures reflect the amount of water that most plantings will use if there is plenty of moisture in the soil and if the soil surface is at least 80 percent covered or shaded by plant foliage.

The figures in the table indicate the average daily water use by 4-inch-high turfgrass. (This is the standard ET rate used by water scientists.) In estimating the ET rate for your landscape plantings, you will need to consider two other factors:

1. The figures in the table are averages. The actual water loss will range up or down somewhat (possibly 20 percent to 25 percent during unusually hot or windy days or unusually cool, cloudy days).
2. Larger plants may use somewhat more water than grass, depending on their shape and exposure to the sun. Solid or almost solid plantings of shrubs or trees often use 10 percent or 20 percent more water than indicated in the table. A large solitary shrub or tree, because of its greater exposure to the sun and wind, may use two or three times as much water as a comparable area of turf. (Its larger root system compensates for the additional water use.)

---

<sup>1/</sup> The information in this section, Water Use by Plants, is taken from the University of California Cooperative Extension Leaflet 2976, Saving Water in Landscape Irrigation. The leaflet was prepared and distributed through the cooperative efforts of the California Department of Water Resources and the University of California Division of Agricultural Sciences.

Table C-1. Daily and Seasonal ET Rates in California\*

	Northeastern Mountain Valleys	North Coast- Coastal Valleys and Plains	North Coast- Interior Valleys	Sacramento Valley	San Joaquin Valley	Central Coast- Coastal Valleys and Plains	Central Coast- Interior Valleys	Sierra (Tahoe Basin)	South Coast- Coastal Valleys and Plains	South Coast- Interior Valleys	Southern California Desert
	inches per day										
January	0.02	0.02	0.03	0.04	0.03	0.06	0.05	--	0.06	0.06	0.09
February	0.04	0.04	0.04	0.06	0.06	0.08	0.08	--	0.09	0.09	0.13
March	0.07	0.06	0.08	0.1	0.1	0.1	0.11	--	0.1	0.11	0.19
April	0.12	0.08	0.11	0.15	0.15	0.13	0.14	0.10	0.13	0.14	0.25
May	0.16	0.11	0.16	0.19	0.21	0.15	0.18	0.13	0.14	0.16	0.33
June	0.19	0.12	0.20	0.24	0.25	0.16	0.21	0.16	0.17	0.20	0.38
July	0.26	0.11	0.23	0.26	0.25	0.17	0.22	0.20	0.18	0.22	0.37
August	0.23	0.11	0.20	0.22	0.21	0.16	0.19	0.17	0.18	0.22	0.31
September	0.16	0.09	0.15	0.17	0.16	0.13	0.16	0.13	0.15	0.17	0.28
October	0.09	0.06	0.09	0.11	0.11	0.1	0.12	0.09	0.11	0.12	0.2
November	0.03	0.04	0.04	0.05	0.05	0.07	0.08	--	0.09	0.08	0.12
December	0.02	0.02	0.02	0.03	0.02	0.05	0.05	--	0.07	0.06	0.06
Totals: inches											
November- March	5.1	5.3	6.3	8.5	7.9	10.7	10.8	--	12.1	11.5	17.7
April- October (growing season)	37.1	20.8	34.9	40.7	40.7	30.6	37.5	30.0	32.3	37.9	65.1
Annual	42.2	26.1	41.2	49.2	49.0	41.3	48.3	--	44.4	49.4	82.2

\* From Dept. of Water Resources Bulletin 113-3, except for figures for Sierra (Tahoe Basin), which are UC observations for the growing season.

APPENDIX C  
(Continued)

In the spring, make a "water budget" for the coming season. First, estimate the inches of water that will be available to your plants during the growing season by adding the amount already stored in the soil and the amount of irrigation water you expect to add. To estimate the amount of available moisture in the soil at the start of the growing season, determine the storage capacity of your soil reservoir (see Table C-2). Then use a hand-feel test to estimate how full the reservoir is.

Second, determine the expected inches of ET loss during the growing season in your area. Then estimate your minimum requirement. Remember, the ET rates given are close to maximum. Many plants can get by with less. For shallow-rooted water-spenders you are determined to save, figure on replacing almost all of the potential ET loss. For deeper-rooted woody plants on deep soil, you should be able to get by on one-half ET, or even as little as one-fourth.

Table C-2. WATER STORAGE CAPACITY OF SOILS

Soil Texture	Inches of Available Water per foot of soil depth	Gallons per Cubic foot of soil
Sand	1/2 - 1	1/3 - 2/3
Sandy loam	1 - 1-1/2	2/3 - 1
Clay loam	1-1/2 - 2	1 - 1-1/3
Clay	1-1/2 - 2-1/2	1 - 1-2/3

(An inch of water is the amount that would cover the surface 1 inch deep. 1-1/2 inches covering 1 square foot = 1 gallon.)

409 14 '82

NOV 23 '83

DEC 16 '84

JUN 19 1985



3 1175 00652 9294

**THIS BOOK IS DUE ON THE LAST DATE  
STAMPED BELOW**

**BOOKS REQUESTED BY ANOTHER BORROWER  
ARE SUBJECT TO RECALL AFTER ONE WEEK.  
RENEWED BOOKS ARE SUBJECT TO  
IMMEDIATE RECALL**

SEP 24 1981

JAN 6 1982

LIBRARY, UNIVERSITY OF CALIFORNIA, DAVIS

Book Slip--Series 458

State of California--Resources Agency  
Department of Water Resources  
P.O. Box 388  
Sacramento  
95802





3 1175 02041 5397

